

CLINICAL CHEMISTRY

TECHNIQUES, PRINCIPLES, CORRELATIONS

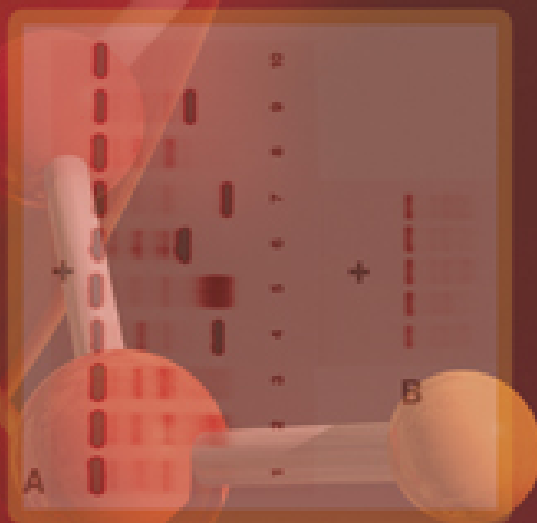

SIXTH EDITION

MICHAEL L. BISHOP
EDWARD P. FODY
LARRY E. SCHOEFF



Wolters Kluwer | Lippincott
Health Williams & Wilkins

thePoint

Clinical Chemistry

TECHNIQUES, PRINCIPLES, CORRELATIONS

SIXTH EDITION

Michael L. Bishop, MS, CLS, MT(ASCP)

Director of Educational Services
Global Med Technologies
El Dorado Hills, California

Edward P. Fody, MD

Medical Director
Department of Pathology
Holland Hospital
Holland, Michigan

Larry E. Schoeff, MS, MT(ASCP)

Professor and Director, Medical Laboratory Science Program
University of Utah School of Medicine
Education Consultant, ARUP Laboratories
Salt Lake City, Utah



Wolters Kluwer | Lippincott Williams & Wilkins
Health

Philadelphia • Baltimore • New York • London
Buenos Aires • Hong Kong • Sydney • Tokyo

Acquisitions Editor: John Goucher
Managing Editor: Meredith Brittain
Marketing Manager: Allison Noplock
Project Manager: Rosanne Hallowell
Designer: Stephen Druding
Compositor: ASI Maryland Composition

Sixth Edition

Copyright © 2010, 2005, 2000, 1996, 1992, 1985 by Lippincott Williams & Wilkins, a Wolters Kluwer business.

351 West Camden Street
Baltimore, MD 21201

530 Walnut Street
Philadelphia, PA 19106

Printed in China

All rights reserved. This book is protected by copyright. No part of this book may be reproduced or transmitted in any form or by any means, including as photocopies or scanned-in or other electronic copies, or utilized by any information storage and retrieval system without written permission from the copyright owner, except for brief quotations embodied in critical articles and reviews. Materials appearing in this book prepared by individuals as part of their official duties as U.S. government employees are not covered by the above-mentioned copyright. To request permission, please contact Lippincott Williams & Wilkins at 530 Walnut Street, Philadelphia, PA 19106, via email at permissions@lww.com, or via website at lww.com (products and services).

9 8 7 6 5 4 3 2 1

Library of Congress Cataloging-in-Publication Data

Clinical chemistry : techniques, principles, correlations / [edited by] Michael L. Bishop, Edward P. Fody, Larry E. Schoeff. -- 6th ed.

p. ; cm.

Includes bibliographical references and index.

ISBN 978-0-7817-9045-1 (alk. paper)

1. Clinical chemistry. I. Bishop, Michael L. II. Fody, Edward P. III. Schoeff, Larry E.
[DNLM: 1. Chemistry, Clinical--methods. 2. Clinical Chemistry Tests. QY 90 C6414 2010]
RB40.C576 2010
616.07'56--dc22

2008052929

DISCLAIMER

Care has been taken to confirm the accuracy of the information present and to describe generally accepted practices. However, the authors, editors, and publisher are not responsible for errors or omissions or for any consequences from application of the information in this book and make no warranty, expressed or implied, with respect to the currency, completeness, or accuracy of the contents of the publication. Application of this information in a particular situation remains the professional responsibility of the practitioner; the clinical treatments described and recommended may not be considered absolute and universal recommendations.

The authors, editors, and publisher have exerted every effort to ensure that drug selection and dosage set forth in this text are in accordance with the current recommendations and practice at the time of publication. However, in view of ongoing research, changes in government regulations, and the constant flow of information relating to drug therapy and drug reactions, the reader is urged to check the package insert for each drug for any change in indications and dosage and for added warnings and precautions. This is particularly important when the recommended agent is a new or infrequently employed drug.

Some drugs and medical devices presented in this publication have Food and Drug Administration (FDA) clearance for limited use in restricted research settings. It is the responsibility of the health care provider to ascertain the FDA status of each drug or device planned for use in their clinical practice.

To purchase additional copies of this book, call our customer service department at (800) 638-3030 or fax orders to (301) 223-2320. International customers should call (301) 223-2300.

Visit Lippincott Williams & Wilkins on the Internet: <http://www.lww.com>. Lippincott Williams & Wilkins customer service representatives are available from 8:30 am to 6:00 pm, EST.

*To Sheila, Chris, and Carson for their support and
patience.*

MLB

*To Nancy, my wife, for her continuing support and
dedication.*

EPF

To my wife, Anita, for her continuing support.

LES

Foreword

Health care delivery and the practice of medicine and clinical laboratory science have undergone exponential change in the last decade. There have been, and continue to be, many factors contributing to that change. Rising costs and concern regarding unequal access to health care and the growing number of uninsured have made health care one of the top issues for this country. Politicians and regulators are faced with the need to provide accessible health care while trying to control costs. Policy makers and payers have increased influence over medical and diagnostic decisions through managed care. Consumers and payers alike expect easy access and the highest quality of care with the most economic prices. Reports on medical errors have raised the visibility for the need for enhanced patient safety and quality initiatives. Emphasis has shifted from simply diagnosing and treating disease to identifying and controlling disease risk factors and maintaining health. There is increased concern about public health issues and bioterrorism as well as environmental effects on health. As a result of these and other factors, laboratory testing is expanding and playing an increasingly valuable and prominent role in health care delivery.

Technological advances have dramatically changed the way we practice clinical laboratory science. Molecular diagnostic testing is allowing earlier detection of disease. Advances in biotechnology including the “omics”—genomics, proteomics, and pharmacogenomics—have given rise to the advent of personalized medicine. We can now determine inherited predisposition to disease, identify protein profiles associated with disease status, and tailor treatment options based on genetic make-up. Testing techniques have shifted from test tubes, beakers, and large, automated analyzers to microanalytic systems (“lab on a chip”) that allow reduced sample size, fewer reagents, and smaller instruments. The walls of the laboratory are disappearing, with increasing numbers of tests that can be performed at the “point of care.”

The demographics of health care are also changing. As a result of the aging population and longer life expectancy, we are seeing an increase in chronic disease, which is impacting the health care system. These demographics not only affect the number and types of indi-

viduals accessing the health care system, but also the workforce that is delivering the care. There is a growing shortage of educated and trained clinical laboratory professionals. This is a result of many factors, including the aging workforce, reduction in educational programs, and competing career opportunities.

As a result of all of these issues, the role of clinical laboratory practitioners is changing. We can no longer afford to be simply analysts that perform, report, and assure the quality of laboratory test results. Clinicians recognize and acknowledge the need for help in test selection and result interpretation. It is essential that laboratory professionals work with physicians in helping them understand testing options and optimize clinical outcomes. In order to do this, clinical laboratory practitioners must be educated and trained not only in test performance and utilization but also in pathophysiology, differential diagnosis, and how diagnostic information contributes to patient care and outcomes.

The sixth edition of *Clinical Chemistry: Techniques, Principles, Correlations* was written with these changing needs in mind. The text provides a comprehensive view of pathophysiology as it relates to clinical chemistry diagnostic testing. It emphasizes the preanalytical, analytical, and post-analytical aspects of diagnostic testing. This text not only provides comprehensive information but also includes case studies and other strategies that will enhance critical thinking and problem-solving skills. Furthermore, Web-based support is provided with the text. Utilization of the text and supportive materials will enhance theoretical, technical, and consultative skill development. This text is not only an excellent resource for clinical laboratory and medical students, but also for clinical laboratory practitioners, clinicians, and other health care providers.

Paula Garrott, Ed.M. CLS(NCA)
Director, Natural Science Division
College of Liberal Arts and Sciences
Chair and Associate Professor Emeritus
Clinical Laboratory Science Department
University of Illinois at Springfield
Springfield, Illinois

Preface

Clinical chemistry continues to be one of the most rapidly advancing areas of laboratory medicine. Since the publication of the first edition of this textbook in 1985, many changes have taken place. New technologies and analytical techniques have been introduced, with a dramatic impact on the practice of clinical chemistry and laboratory medicine. In addition, the health care system is constantly changing. There is increased emphasis on improving quality of patient care, individual patient outcomes, financial responsibility, and total quality management. For this reason, the editors have replaced “Procedures” with “Techniques” in the title in order to reflect the continued evolution of the laboratorian’s role in healthcare. Point-of-care testing (POCT) is also at the forefront of health care practice and has brought both challenges and opportunities to clinical laboratorians. Now, more than ever, clinical laboratorians need to be concerned with disease correlations, interpretations, problem-solving, quality assurance, and cost effectiveness; they need to know not only the *how* of tests but more importantly the *what, why, and when*.

WHAT’S NEW IN THIS EDITION

The editors of *Clinical Chemistry: Techniques, Principles, Correlations* have designed the sixth edition to be an even more valuable resource to both students and practitioners.

Like the previous five editions, the sixth edition of *Clinical Chemistry: Techniques, Principles, Correlations* is comprehensive, up-to-date, and easy to understand for students at all levels. It is also intended to be a practically organized resource for both instructors and practitioners. The editors have tried to maintain the book’s readability and further improve its content. Because clinical laboratorians use their interpretative and analytic skills in the daily practice of clinical chemistry, an effort has been made to maintain an appropriate balance between analytic principles, techniques, and the correlation of results with disease states.

In this sixth edition, the editors have made several significant changes in response to requests from our readers, students, instructors, and practitioners. Ancillary materials have been updated and expanded (see “Additional Resources,” below). Chapters now include current, more frequently encountered case studies and practice questions or exercises. To provide a thorough, up-to-date study of clinical chemistry, all chapters have been updated and reviewed by profes-

sionals who practice clinical chemistry and laboratory medicine on a daily basis. The basic principles of the analytic procedures discussed in the chapters reflect the most recent or commonly performed techniques in the clinical chemistry laboratory. Detailed procedures have been omitted because of the variety of equipment and commercial kits used in today’s clinical laboratories. Instrument manuals and kit package inserts are the most reliable reference for detailed instructions on current analytic procedures. All chapter material has been updated, improved, and rearranged for better continuity and readability. As a new offering, a Web site with additional case studies, review questions, teaching resources, teaching tips, additional references, and teaching aids for instructors and students is available from the publisher to assist in the use of this textbook (see section that follows).

ADDITIONAL RESOURCES

Clinical Chemistry: Techniques, Principles, Correlations, Sixth Edition, includes additional resources for both instructors and students that are available on the book’s companion Web site at thePoint.lww.com/Bishop6e.

Instructors

Approved adopting instructors will be given access to the following additional resources:

- Brownstone Test Generator
- Answers To Case Studies
- Answers To Review Questions
- Image Bank
- PowerPoint slides
- Web links and Teaching Tips

Students

Students who have purchased *Clinical Chemistry: Techniques, Principles, Correlations* have access to the following additional resources:

- Chapter Objectives
- Flash Cards
- Quiz Bank

In addition, purchasers of the text can access the searchable Full Text Online by going to the *Clinical Chemistry: Techniques, Principles, Correlations* Web site at thePoint.lww.com/Bishop6e. See the inside front cover

of this text for more details, including the pass code you will need to gain access to the Web site.

ACKNOWLEDGMENTS

A project as large as this requires the assistance and support of many individuals. The editors wish to express their appreciation to the contributors of this sixth edition of *Clinical Chemistry: Techniques, Principles, Correlations*—the dedicated laboratory professionals and educators whom the editors have had the privilege of knowing and exchanging ideas with over the years. These individuals were selected because of their expertise in particular areas and their commitment to the education of clinical laboratorians. Many have spent their professional careers in the clinical laboratory, at the bench, teaching students, or consulting with clinicians. In these frontline positions, they have developed a perspective of what is important for the next generation of clinical laboratorians.

We extend appreciation to our students, colleagues, teachers, and mentors in the profession who have helped shape our ideas about clinical chemistry practice and education. Also, we want to thank the many companies and professional organizations that provided product information and photographs or granted permission to reproduce diagrams and tables from their publications. Many Clinical and Laboratory Standards Institute (CLSI) documents have been important sources of information also. These documents are directly referenced in the appropriate chapters.

The editors would like to acknowledge the contribution and effort of all individuals to previous editions. Their efforts provided the framework for many of the current chapters. Finally, we gratefully acknowledge the cooperation and assistance of the staff at Lippincott Williams & Wilkins for their advice and support.

The editors are continually striving to improve future editions of this book. We again request and welcome our readers' comments, criticisms, and ideas for improvement.

Contributors

John J. Ancy, MA, RRT

Senior Clinical Consultant
Instrumentation Laboratory
Director, Respiratory Services
St. Elizabeth's Hospital
Belleville, Illinois

Michael J. Bennett, PhD, FRCPath, FACB

Professor
Department of Pathology and Laboratory Medicine
University of Pennsylvania
and
Director, Metabolic Disease Laboratory
Children's Hospital of Philadelphia
Philadelphia, Pennsylvania

Maria G. Boosalis, PhD, MPH, RD, LD

Director, Division of Clinical Nutrition
College of Health Sciences
University of Kentucky
Lexington, Kentucky

Larry Broussard, PhD, DABCC, FACB

Professor
Clinical Laboratory Sciences
Louisiana State University Health Sciences Center
New Orleans, Louisiana

Dean C. Carlow, MD, PhD

Assistant Professor
Department of Pathology and Laboratory Medicine
University of Pennsylvania School of Medicine
and
Medical Director, Clinical Chemistry
Department of Pathology and Clinical Chemistry
The Children's Hospital of Philadelphia
Philadelphia, Pennsylvania

Eileen Carreiro-Lewandowski, MS, CLS

Professor
Medical Laboratory Science
University of Massachusetts-Dartmouth
N. Dartmouth, Massachusetts

Janelle M. Chiasera, PhD, MT (ASCP)

Associate Professor and Director
School of Health Professions
University of Alabama at Birmingham
Birmingham, Alabama

Julia C. Drees, PhD

Clinical Chemistry Fellow
San Francisco General Hospital
University of California
San Francisco, California

Sharon S. Ehrmeyer, MD

Professor, Pathology and Laboratory Medicine
Director, Medical Technology / Clinical Laboratory
Sciences
Department of Pathology and Laboratory Medicine
University of Wisconsin
Madison, Wisconsin

Jordan Erickson, BS

Quality Analyst – Six Sigma Black Belt
Department of Pediatrics
University of North Carolina Healthcare
Chapel Hill, North Carolina

Edward P. Fody, MD

Medical Director
Department of Pathology
Holland Hospital
Holland, Michigan

Elizabeth L. Frank, PhD, DBACC

Assistant Professor – Clinical
Department of Pathology
University of Utah Health Sciences Center
Salt Lake City, Utah

Vicki S. Freeman, PhD

Department Chair and Professor
Clinical Laboratory Sciences
University of Texas Medical Branch
Galveston, Texas

Linda S. Gorman, PhD

CRS Division Director
University of Kentucky
Lexington, Kentucky

Marissa Grotzke, MD

Fellow
Internal Medicine
Division of Endocrinology, Metabolism, and Diabetes
University of Utah Medical Center
Salt Lake City, Utah

Ryan Hungerford, MD

Fellow
Endocrinology
University of Utah
Salt Lake City, Utah

Kamisha Johnson-Davis, PhD

Clinical Chemistry Fellow
Department of Pathology
University of Utah
Salt Lake City, Utah

Robert Jones, MD

Endocrinology Division
Utah Diabetes Center
Salt Lake City, Utah

Thomas P. Knecht, MD, PhD

Medical Director
Abbott Diabetes Care
Alameda, California

Ronald H. Laessig, PhD

Director, Wisconsin State Laboratory of Hygiene
Professor, Population Health Sciences
Professor, Pathology and Laboratory Medicine
School of Medicine and Public Health
University of Wisconsin
Madison, Wisconsin

Louanne W. Lawrence, DrPH, CLS (NCA)

Professor and Department Head
Clinical Laboratory Sciences
Louisiana State University Health Sciences Center
New Orleans, Louisiana

Kara L. Lynch, PhD

Clinical Chemistry Fellow
Department of Laboratory Medicine
University of California – San Francisco
San Francisco General Hospital
San Francisco, California

Ruth McCall, BS, MT (ASCP)

Former Director, Phlebotomy and Clinical Laboratory
Assistant Programs
Central New Mexico Community College
Albuquerque, New Mexico

Christopher R. McCudden, PhD

Assistant Professor
Associate Director Core Laboratory
Director of Blood Gas and Special Chemistry
Department of Pathology & Laboratory Medicine
University of North Carolina-Chapel Hill
School of Medicine
Chapel Hill, North Carolina

Gwendolyn Appell McMillan, PhD

Assistant Professor (Clinical)
Department of Pathology
University of Utah
Salt Lake City, Utah
and
Medical Director
Toxicology, Trace Elements, Pharmacogenetics
ARUP Laboratories
Salt Lake City, Utah

A. Wayne Meikle, MD

Professor
Department of Internal Medicine
University of Utah School of Medicine
and
Staff Physician
University of Utah Hospital
Salt Lake City, Utah

Susan Orton, PhD (ABMLI)

Assistant Professor
Division of Clinical Laboratory Science
The University of North Carolina
Chapel Hill, North Carolina

Joan E. Polancic, MEd, CLS (NCA)

Director of Education and Project Planning
American Society for Clinical Laboratory Science
(ASCLS)
Bethesda, Maryland

Elizabeth Porter, BS, MT (ASCP)

Technical Specialist
Point of Care Testing
Quest Diagnostics
Cincinnati, Ohio

Alan Remaley, MD, PhD

Senior Staff
Laboratory Medicine
National Institutes of Health
Bethesda, Maryland

William L. Roberts, MD, PhD

Professor
Department of Pathology
University of Utah
Salt Lake City, Utah
and
Medical Director
Chemistry Group
ARUP Laboratories
Salt Lake City, Utah

Alan Rockwood, PhD

Associate Professor (Clinical)
Department of Pathology
University of Utah
and
Section Director for Mass Spectrometry
ARUP Laboratories
Salt Lake City, Utah

Michael W. Rogers, MBA, MT(ASCP)

Quality Management Specialist
McLendon Clinical Laboratories
University of North Carolina Hospitals
Chapel Hill, North Carolina

Michelle E. Russell

Biomedical Laboratory Diagnostics Program
Michigan State University
East Lansing, Michigan

Amar Akhtar Sethi, MD, PhD

Physician
Lipoprotein Metabolism Section
National Heart, Lung, and Blood Institute
National Institutes of Health
Bethesda, Maryland

Carol J. Skarzynski, BA, SC (ASCP)

Clinical Instructor
Department of Pathology and Laboratory Medicine
Hartford Hospital School of Allied Health
Hartford, Connecticut

Susan King Strasinger, DA, MT (ASCP)

Faculty Associate
Clinical Laboratory Sciences
The University of West Florida
Pensacola, Florida

Cathee Tankersley, BS, MT(ASCP), CLS (NCA)

Retired Program Director
Faculty, Emeritus
Phoenix College
Phoenix, Arizona

David P. Thorne, PhD, MT (ASCP)

Biomedical Laboratory Diagnostics Program
Michigan State University
East Lansing, Michigan

Lynda L. Tymchak, MEd, MT(ASCP)

Educational Services
Global Med Technologies
El Dorado Hills, California

Tom Wachter

Director of Corporate Safety
ARUP Laboratories, Inc.
and
University of Utah Medical Center
University of Utah
Salt Lake City, Utah

G. Russell Warnick, MS, MBA

Berkeley Heartlab, Inc.
Alameda, California

Betty M. White, MAT, MT (ASCP)

Assistant Professor
Program Director
Clinical Laboratory Science
Western Carolina University
Cullowhee, North Carolina

Monte S. Willis, MD, PhD

Assistant Professor
Pathology and Laboratory Medicine
University of North Carolina
and
Assistant Director
Clinical Chemistry (Core) Laboratories
McLendon Clinical Laboratories
University of North Carolina Hospitals
Chapel Hill, North Carolina

Alan H. B. Wu, PhD

Professor of Laboratory Medicine
University of California – San Francisco
and
Chief, Clinical Chemistry Laboratory
San Francisco General Hospital
San Francisco, California

Contents

PART 1

Basic Principles and Practice of Clinical Chemistry / 1

1 Basic Principles and Practices / 3

Eileen Carreiro-Lewandowski

UNITS OF MEASURE / 3

Electronic Reporting of Results / 5

REAGENTS / 5

Chemicals / 5

Reference Materials / 6

Water Specifications / 6

Solution Properties / 7

CLINICAL LABORATORY SUPPLIES / 9

Thermometers/Temperature / 9

Glassware and Plasticware / 10

Desiccators and Desiccants / 16

Balances / 17

BASIC SEPARATION TECHNIQUES / 18

Centrifugation / 18

Filtration / 19

Dialysis / 19

LABORATORY MATHEMATICS AND

CALCULATIONS / 19

Significant Figures / 19

Logarithms / 20

Concentration / 20

Dilutions / 23

Water of Hydration / 26

Graphing and Beer's Law / 26

SPECIMEN CONSIDERATIONS / 28

Types of Samples / 28

Sample Processing / 30

Sample Variables / 30

Chain of Custody / 31

2 Phlebotomy and Specimen

Considerations / 33

Ruth E. McCall, Cathee M. Tankersley

BLOOD COLLECTION PERSONNEL / 33

PUBLIC RELATIONS AND CLIENT INTERACTION / 34

Professionalism / 34

Patient Consent / 34

Confidentiality and the Health Insurance Portability and Accountability Act / 35

LEGAL ISSUES / 35

INFECTION CONTROL / 35

THE VASCULAR SYSTEM / 39

PHLEBOTOMY-RELATED VASCULAR ANATOMY / 39

H Pattern Veins / 40

M Pattern Veins / 40

Other Veins / 41

SOURCE AND COMPOSITION OF BLOOD

SPECIMENS / 41

TYPES OF BLOOD SPECIMENS / 41

VENIPUNCTURE EQUIPMENT / 41

Tourniquet / 41

Needles / 41

Evacuated Tube System / 42

Syringe System / 44

Butterfly System / 44

Tube Additives / 44

Trace Element-Free Tubes / 46

ORDER OF DRAW AND ADDITIVE

CARRY-OVER / 46

VENIPUNCTURE PROCEDURES / 47

Troubleshooting Failed Venipuncture / 47

Multiple Venipuncture Attempts / 60

PEDIATRIC VENIPUNCTURE / 60

Interacting with a Child / 60

Immobilizing a Child / 61

Pediatric Venipuncture Equipment / 61

GERIATRIC VENIPUNCTURE / 61

QUALITY ASSURANCE IN PHLEBOTOMY / 61

PREANALYTIC CONSIDERATIONS / 62

Problem Sites / 62

Vascular Access Devices / 62

Procedural Error Risks / 62

Patient Conditions and Complications / 63

CAPILLARY SPECIMEN COLLECTION / 64

Alcohol, Gauze, Bandages / 64

Lancets / 64

Warming Devices / 64

Microcollection Tubes / 64

Microhematocrit Tubes / 65

Sealants / 65

Capillary Order of Draw / 65

Indications for Capillary Puncture / 65

CAPILLARY PUNCTURE PROCEDURES / 65

Neonatal Bilirubin Collection / 70

Neonatal Screening / 70

SPECIMEN HANDLING AND PROCESSING / 71

Routine Handling / 71

Special Handling / 71

SPECIMEN PROCESSING / 71

Processing Safety / 72

Specimen Suitability / 72

Centrifugation / 72

Stopper Removal / 72

Aliquot Preparation / 72

3 Laboratory Safety and Regulations / 74

Tolmie E. Wachter

LABORATORY SAFETY AND REGULATIONS / 74

Occupational Safety and Health Act (OSHA) / 74

Other Regulations and Guidelines / 75

SAFETY AWARENESS FOR CLINICAL LABORATORY**PERSONNEL / 76**

Safety Responsibility / 76

Signage and Labeling / 76

SAFETY EQUIPMENT / 76

Chemical Fume Hoods and Biosafety Cabinets / 76

Chemical Storage Equipment / 77

Personal Protective Equipment / 77

BIOLOGIC SAFETY / 78

General Considerations / 78

Spills / 78

Bloodborne Pathogens / 79

Airborne Pathogens / 79

Shipping / 79

CHEMICAL SAFETY / 79

Hazard Communication / 79

Material Safety Data Sheet / 79

OSHA Laboratory Standard / 80

Toxic Effects from Hazardous Substances / 80

Storage and Handling of Chemicals / 80

RADIATION SAFETY / 81

Environmental Protection / 81

Personal Protection / 82

Nonionizing Radiation / 82

FIRE SAFETY / 82

The Chemistry of Fire / 82

Classification of Fires / 82

Types and Applications of Fire Extinguishers / 83

CONTROL OF OTHER HAZARDS / 83

Electrical Hazards / 83

Compressed Gases Hazards / 84

Cryogenic Materials Hazards / 84

Mechanical Hazards / 84

Ergonomic Hazards / 84

DISPOSAL OF HAZARDOUS MATERIALS / 84

Chemical Waste / 85

Radioactive Waste / 85

Biohazardous Waste / 85

ACCIDENT DOCUMENTATION AND**INVESTIGATION / 85****4 Method Evaluation and Quality Management / 88***Christopher R. McCudden, Mike Rogers, Jordan Erickson, Ronald Erickson, Monte S. Willis***BASIC CONCEPTS / 89**

Descriptive Statistics: Measures of Center, Spread, and Shape / 89

Descriptive Statistics of Groups of Paired Observations / 92

Inferential Statistics / 95

REFERENCE INTERVAL STUDIES / 95

Establishing Reference Intervals / 97

Selection of Reference Interval Study Individuals / 97

Preanalytic and Analytic Considerations / 98

Determining Whether to Establish or Verify Reference Intervals / 99

Analysis of Reference Values / 99

Data Analysis to Establish a Reference Interval / 99

Data Analysis to Verify a Reference Interval (Transference) / 99

DIAGNOSTIC EFFICIENCY / 101

Measures of Diagnostic Efficiency / 102

METHOD EVALUATION / 108

Regulatory Aspects of Method Evaluation (Alphabet Soup) / 108

Method Selection / 109

Method Evaluation / 109

First Things First: Determine Imprecision and Inaccuracy / 110

Measurement of Imprecision / 110

Measurement of Inaccuracy / 112

Recovery Studies / 112

Interference Studies / 112

Comparison-of-Methods Studies / 113

Allowable Analytic Error / 115

QUALITY CONTROL / 116

Quality Control (QC) Control Charts / 117

Operation of a Quality Control System / 117

Multi-Rules RULE! / 118

Proficiency Testing / 119

QUALITY MANAGEMENT / 120

Quality Improvement: Lean Six Sigma / 121

Improvement Methodology—DMAIC / 122

Metrics—Lean and Six Sigma / 123

Perspective: Patient Safety, Lean Six Sigma, and the Laboratory / 124

Practical Application of Six Sigma Metrics / 125

PRACTICE PROBLEMS / 126

Problem 4-1. Calculation of Sensitivity and Specificity / 126

Problem 4-2. A Management Decision in Quality Control / 126

Problem 4-3. Interdepartmental Communication / 126

Problem 4-4. Precision (Replication) / 127

Problem 4-5. Recovery / 127

Problem 4-6. Interference / 127

Problem 4-7. Sample Labeling / 127

Problem 4-8. QC Program for POCT Testing / 127

Problem 4-9. QC Rule Interpretation / 127

5 Analytical Techniques / 130*Julia C. Drees, Alan H. B. Wu***SPECTROPHOTOMETRY AND PHOTOMETRY / 130**

Beer's Law / 131

Spectrophotometric Instruments / 133

Components of a Spectrophotometer / 133

Spectrophotometer Quality Assurance / 136

Atomic Absorption Spectrophotometer / 136

Flame Photometry / 138

Fluorometry / 138

Chemiluminescence / 140

Turbidity and Nephelometry / 140

Laser Applications / 141

ELECTROCHEMISTRY / 141

Galvanic and Electrolytic Cells / 141

Half-Cells / 141

Ion-Selective Electrodes / 142

- pH Electrodes / 142
 Gas-Sensing Electrodes / 144
 Enzyme Electrodes / 145
 Coulometric Chloridometers and Anodic Stripping Voltametry / 145
- ELECTROPHORESIS / 145**
 Procedure / 145
 Support Materials / 146
 Treatment and Application of Sample / 146
 Detection and Quantitation / 147
 Electroendosmosis / 147
 Isoelectric Focusing / 147
 Capillary Electrophoresis / 147
- CHROMATOGRAPHY / 147**
 Modes of Separation / 148
 Chromatographic Procedures / 149
 High-Performance Liquid Chromatography / 150
 Gas Chromatography / 152
- MASS SPECTROMETRY / 154**
 Sample Introduction and Ionization / 154
 Mass Analyzer / 156
 Detector / 158
 Applications of Mass Spectrometry in the Clinical Laboratory / 158
- INSTRUMENTATION FOR PROTEOMICS / 159**
 Two-dimensional Electrophoresis / 159
 MALDI-TOF and SELDI-TOF Mass Spectrometry / 159
- OSMOMETRY / 160**
 Freezing-Point Osmometer / 160
- ANALYTIC TECHNIQUES FOR POINT-OF-CARE TESTING / 163**
- 6 Principles of Clinical Chemistry**
Automation / 166
William L. Roberts
- HISTORY OF AUTOMATED ANALYZERS / 166**
DRIVING FORCES TOWARD MORE AUTOMATION / 167
BASIC APPROACHES TO AUTOMATION / 168
STEPS IN AUTOMATED ANALYSIS / 168
 Specimen Preparation and Identification / 170
 Specimen Measurement and Delivery / 170
 Reagent Systems and Delivery / 174
 Chemical Reaction Phase / 174
 Measurement Phase / 176
 Signal Processing and Data Handling / 178
SELECTION OF AUTOMATED ANALYZERS / 179
TOTAL LABORATORY AUTOMATION / 180
 Preanalytic Phase (Sample Processing) / 180
 Analytic Phase (Chemical Analyses) / 181
 Postanalytic Phase (Data Management) / 182
FUTURE TRENDS IN AUTOMATION / 183
- 7 Immunoassays / 185**
Susan Orton
- IMMUNOASSAYS / 185**
 General Considerations / 185
 Unlabeled Immunoassays / 186
 Labeled Immunoassays / 190
- 8 Molecular Theory and Techniques / 202**
Susan Orton
- NUCLEIC ACID-BASED TECHNIQUES / 202**
 Nucleic Acid Chemistry / 202
 Hybridization Techniques / 203
 DNA Sequencing / 205
 DNA Chip Technology / 206
 Target Amplification / 206
 Probe Amplification / 208
 Signal Amplification / 208
 Nucleic Acid Probe Applications / 209
- 9 Point-of-Care Testing / 211**
Elizabeth E. Porter
- ADMINISTRATION AND STRUCTURE / 211**
 CLIA License and Regulation / 211
 Support Staff / 213
 Standardization / 215
 Oversight Structure / 215
- COMMUNICATION / 215**
 Handling a Request for New or Additional Point-of-Care Testing / 215
 Preliminary Selection of Devices/Methods / 216
 Validation / 216
 Contract Negotiation / 216
 Implementation / 216
- PROFICIENCY TESTING / 218**
POINT-OF-CARE APPLICATIONS / 218
 Point-of-Care Glucose / 218
 Point-of-Care Chemistries and Blood Gases / 218
 Point-of-Care Coagulation / 219
 Point-of-Care Hematology / 219
 Point-of-Care Connectivity / 219
- PART 2**
Clinical Correlations and Analytic Procedures / 221
- 10 Amino Acids and Proteins / 223**
Lynda L. Tymchak
- AMINO ACIDS / 223**
 Overview / 223
 Basic Structure / 223
 Metabolism / 224
 Essential Amino Acids / 224
 Nonessential Amino Acids / 226
 Two New Amino Acids? / 227
 Aminoacidopathies / 227
 Amino Acid Analysis / 233
- PROTEINS / 233**
 Importance / 233
 Molecular Size / 233
 Synthesis / 233
 Catabolism and Nitrogen Balance / 235
 Structure / 235
 Nitrogen Content / 236

Charge and Isoelectric Point / 236
 Solubility / 236
 Classification / 237

PLASMA PROTEINS / 238

Prealbumin (Transthyretin) / 238
 Albumin / 238
 Globulins / 240

OTHER PROTEINS OF IMPORTANCE / 247

Myoglobin / 247
 Troponin (cTn) / 248
 Brain Natriuretic Peptide and N-Terminal-Brain
 Natriuretic Peptide / 248
 Fibronectin / 248
 Adiponectin / 249
 β -Trace Protein / 249
 Cross-Linked C-Telopeptides / 249
 Cystatin C / 249
 Amyloid / 249

TOTAL PROTEIN ABNORMALITIES / 250

Hypoproteinemia / 250
 Hyperproteinemia / 250

METHODS OF ANALYSIS / 252

Total Nitrogen / 252
 Total Proteins / 252
 Fractionation, Identification, and Quantitation of
 Specific Proteins / 253
 Serum Protein Electrophoresis / 256
 High-Resolution Protein Electrophoresis / 258
 Capillary Electrophoresis / 258
 Isoelectric Focusing / 259
 Immunochemical Methods / 259

PROTEINS IN OTHER BODY FLUIDS / 259

Urinary Protein / 260
 Cerebrospinal Fluid Proteins / 262

11 Nonprotein Nitrogen Compounds / 266

Elizabeth L. Frank

UREA / 266

Introduction / 266
 Physiology / 267
 Clinical Application / 267
 Methods / 267
 Specimen Requirements and Interfering
 Substances / 268
 Reference Intervals / 268
 Pathophysiology / 268

URIC ACID / 270

Introduction / 270
 Physiology / 270
 Clinical Application / 270
 Methods / 270
 Specimen Requirements and Interfering
 Substances / 271
 Reference Intervals / 271
 Pathophysiology / 272

CREATININE/CREATINE / 273

Introduction / 273
 Physiology / 273

Clinical Application / 273
 Methods / 274
 Specimen Requirements and Interfering
 Substances / 275
 Sources of Error / 275
 Reference Intervals / 275
 Pathophysiology / 276

AMMONIA / 277

Introduction / 277
 Physiology / 277
 Clinical Applications / 277
 Methods / 278
 Specimen Requirements and Interfering
 Substances / 278
 Sources of Error / 279
 Reference Interval / 279
 Pathophysiology / 279

12 Enzymes / 281

Kamisha Johnson-Davis, Gwen A. McMillin

GENERAL PROPERTIES AND DEFINITIONS / 281

ENZYME CLASSIFICATION AND

NOMENCLATURE / 283

ENZYME KINETICS / 283

Catalytic Mechanism of Enzymes / 283
 Factors That Influence Enzymatic Reactions / 284
 Measurement of Enzyme Activity / 286
 Calculation of Enzyme Activity / 287
 Measurement of Enzyme Mass / 288
 Enzymes as Reagents / 288

ENZYMES OF CLINICAL SIGNIFICANCE / 288

Creatine Kinase / 288
 Lactate Dehydrogenase / 293
 Aspartate Aminotransferase / 296
 Alanine Aminotransferase / 296
 Alkaline Phosphatase / 297
 Acid Phosphatase / 299
 γ -Glutamyltransferase / 300
 Amylase / 301
 Lipase / 303
 Glucose-6-Phosphate Dehydrogenase / 304
 Drug-Metabolizing Enzymes / 305

13 Carbohydrates / 309

Vicki S. Freeman

GENERAL DESCRIPTION OF CARBOHYDRATES / 309

Classification of Carbohydrates / 309
 Stereoisomers / 310
 Monosaccharides, Disaccharides, and
 Polysaccharides / 310
 Chemical Properties of Carbohydrates / 311
 Glucose Metabolism / 311
 Fate of Glucose / 311
 Regulation of Carbohydrate Metabolism / 313

HYPERGLYCEMIA / 314

Diabetes Mellitus / 314
 Pathophysiology of Diabetes Mellitus / 316

- Criteria for Testing for Prediabetes and Diabetes / 317
- Criteria for the Diagnosis of Diabetes Mellitus / 318
- Criteria for the Testing and Diagnosis of Gestational Diabetes Mellitus / 319
- HYPOGLYCEMIA** / 320
 - Genetic Defects in Carbohydrate Metabolism / 321
- ROLE OF LABORATORY IN DIFFERENTIAL DIAGNOSIS AND MANAGEMENT OF PATIENTS WITH GLUCOSE METABOLIC ALTERATIONS** / 321
 - Methods of Glucose Measurement / 321
 - Self-Monitoring of Blood Glucose / 323
 - Glucose Tolerance and 2-Hour Postprandial Tests / 323
 - Glycosylated Hemoglobin/Hemoglobin A_{1c} / 324
 - Ketones / 326
 - Microalbuminuria / 326
 - Ilet Autoantibody and Insulin Testing / 327
- 14 Lipids and Lipoproteins** / 328

Amar A. Sethi, G. Russell Warnick, Alan T. Remaley

 - LIPID CHEMISTRY** / 329
 - Fatty Acids / 329
 - Triglycerides / 330
 - Phospholipids / 330
 - Cholesterol / 330
 - GENERAL LIPOPROTEIN STRUCTURE** / 331
 - Chylomicrons / 332
 - Very Low Density Lipoproteins / 333
 - Low-Density Lipoproteins / 333
 - Lipoprotein(a) / 333
 - High-Density Lipoproteins / 333
 - LIPOPROTEIN PHYSIOLOGY AND METABOLISM** / 333
 - Lipid Absorption / 334
 - Exogenous Pathway / 334
 - Endogenous Pathway / 335
 - Reverse Cholesterol Transport Pathway / 335
 - LIPID AND LIPOPROTEIN POPULATION DISTRIBUTIONS** / 336
 - DIAGNOSIS AND TREATMENT OF LIPOD DISORDERS** / 339
 - Arteriosclerosis / 339
 - Hyperlipoproteinemia / 341
 - Hypercholesterolemia / 341
 - Hypertriglyceridemia / 342
 - Combined Hyperlipoproteinemia / 343
 - Lipoprotein(a) Elevation / 343
 - Hypolipoproteinemia / 344
 - Hypoalphalipoproteinemia / 344
 - LIPID AND LIPOPROTEIN ANALYSES** / 344
 - Lipid Measurement / 344
 - Cholesterol Measurement / 344
 - Triglyceride Measurement / 345
 - Lipoprotein Methods / 346
 - High-Density Lipoprotein Methods / 347
 - Low-Density Lipoprotein Methods / 348
- Compact Analyzers / 349
- Apolipoprotein Methods / 349
- Phospholipid Measurement / 349
- Fatty Acid Measurement / 349
- STANDARDIZATION OF LIPOD AND LIPOPROTEIN ASSAYS** / 349
 - Precision / 349
 - Accuracy / 350
 - Matrix Interactions / 350
 - CDC Cholesterol Reference Method Laboratory Network / 351
 - Analytic Performance Goals / 351
 - Quality Control / 351
 - Specimen Collection / 351
- 15 Electrolytes** / 356

Joan E. Polancic

 - WATER** / 356
 - Osmolality / 357
 - THE ELECTROLYTES** / 359
 - Sodium / 359
 - Potassium / 363
 - Chloride / 366
 - Bicarbonate / 368
 - Magnesium / 369
 - Calcium / 373
 - Phosphate / 376
 - Lactate / 378
 - ANION GAP** / 380
 - ELECTROLYTES AND RENAL FUNCTION** / 381
- 16 Blood Gases, pH, and Buffer Systems** / 384

Sharon S. Ehrmeyer, Ronald H. Laessig, John J. Ancy

 - DEFINITIONS: ACID, BASE, BUFFER** / 384
 - ACID-BASE BALANCE** / 385
 - Maintenance of H⁺ / 385
 - Buffer Systems: Regulation of H⁺ / 385
 - Regulation of Acid-Base Balance: Lungs and Kidneys / 385
 - ASSESSMENT OF ACID-BASE HOMEOSTASIS** / 388
 - The Bicarbonate Buffering System and the Henderson-Hasselbalch Equation / 388
 - Acid-Base Disorders: Acidosis and Alkalosis / 389
 - OXYGEN AND GAS EXCHANGE** / 390
 - Oxygen and Carbon Dioxide / 390
 - Oxygen Transport / 392
 - Quantities Associated With Assessing a Patient's Oxygen Status / 392
 - Hemoglobin–Oxygen Dissociation / 393
 - MEASUREMENT** / 394
 - Spectrophotometric (Cooximeter) Determination of Oxygen Saturation / 394
 - Blood Gas Analyzers: pH, pCO₂, and pO₂ / 395
 - Measurement of pO₂ / 395
 - Measurement of pH and pCO₂ / 396
 - Types of Electrochemical Sensors / 397

Optical Sensors / 397
 Calibration / 398
 Calculated Parameters / 398
 Correction for Temperature / 398
QUALITY ASSURANCE / 398
 Preanalytic Considerations / 398
 Analytic Assessments: Quality Control and Proficiency Testing / 401
 Interpretation of Results / 402

17 Trace Elements / 403

Alan L. Rockwood, Elzbieta (Ela) Bakowska

INSTRUMENTATION AND METHODS / 404

Sample Collection and Processing / 404
 Atomic Emission Spectroscopy / 404
 Atomic Absorption Spectroscopy / 405
 Inductively Coupled Plasma Mass Spectrometry / 406
 Interferences / 407
 Elemental Speciation / 408
 Alternative Analytic Techniques / 408

ARSENIC / 409

Health Effects / 409
 Absorption, Transport, and Excretion / 409
 Toxicity / 409
 Laboratory Evaluation of Arsenic Status / 410

CADMIUM / 410

Health Effects / 410
 Absorption, Transport, and Excretion / 410
 Toxicity / 411
 Laboratory Evaluation of Cadmium Status / 411

LEAD / 411

Health Effects / 411
 Absorption, Transport, and Excretion / 411
 Toxicity / 411
 Laboratory Evaluation of Lead Status / 412

MERCURY / 412

Health Effects / 412
 Absorption, Transport, and Excretion / 412
 Toxicity / 413
 Laboratory Evaluation of Mercury Status / 413

CHROMIUM / 413

Health Effects / 413
 Absorption, Transport, and Excretion / 414
 Deficiency / 414
 Toxicity / 414
 Laboratory Evaluation of Chromium Status / 414

COPPER / 414

Health Effects / 415
 Absorption, Transport, and Excretion / 415
 Deficiency / 415
 Toxicity / 415
 Laboratory Evaluation of Copper Status / 415

IRON / 416

Health Effects / 416
 Absorption, Transport, and Excretion / 416
 Deficiency / 416
 Toxicity / 416
 Laboratory Evaluation of Iron / 417
 Total Iron Content (Serum Iron) / 417

Total Iron-Binding Capacity / 417
 Percent Saturation / 417
 Transferrin and Ferritin / 417

MANGANESE / 418

Health Effects / 419
 Absorption, Transport, and Excretion / 419
 Deficiency / 419
 Toxicity / 419
 Laboratory Evaluation of Manganese Status / 419

MOLYBDENUM / 419

Health Effects / 419
 Absorption, Transport, and Excretion / 419
 Deficiency / 419
 Toxicity / 419
 Laboratory Evaluation of Molybdenum Status / 419

SELENIUM / 420

Health Effects / 420
 Absorption, Transport, and Excretion / 420
 Deficiency / 420
 Toxicity / 420
 Laboratory Evaluation of Selenium Status / 421

ZINC / 421

Health Effects / 421
 Absorption, Transport, and Excretion / 421
 Deficiency / 421
 Toxicity / 421
 Laboratory Evaluation of Zinc Status / 421

18 Porphyrins and Hemoglobin / 424

Louann W. Lawrence, Larry A. Broussard

PORPHYRINS / 424

Role in the Body / 424
 Chemistry of Porphyrins / 424
 Porphyrin Synthesis / 425
 Clinical Significance and Disease Correlation / 425
 Methods of Analyzing Porphyrins / 428

HEMOGLOBIN / 430

Role in the Body / 430
 Structure of Hemoglobin / 430
 Synthesis and Degradation of Hemoglobin / 431
 Clinical Significance and Disease Correlation / 432
 Methodology / 437
 DNA Technology / 439

MYOGLOBIN / 440

Structure and Role in the Body / 440
 Clinical Significance / 440
 Methodology / 441

PART 3

Assessment of Organ System

Functions / 443

19 Introduction to Hormones and Pituitary Function / 445

Robert E. Jones

EMBRYOLOGY AND ANATOMY / 445

FUNCTIONAL ASPECTS OF THE HYPOTHALAMIC-HYPOPHYSIAL UNIT / 446

- HYPOPHYSIOTROPIC OR HYPOTHALAMIC HORMONES** / 447
- ANTERIOR PITUITARY HORMONES** / 448
- PITUITARY TUMORS** / 448
- GROWTH HORMONE** / 449
- Actions of Growth Hormone / 449
 - Testing / 450
 - Acromegaly / 450
 - Growth Hormone Deficiency / 451
- PROLACTIN** / 451
- Prolactinoma / 452
 - Other Causes of Hyperprolactinemia / 452
 - Clinical Evaluation of Hyperprolactinemia / 452
 - Management of Prolactinoma / 452
 - Idiopathic Galactorrhea / 453
- HYPOPITUITARISM** / 453
- Etiology of Hypopituitarism / 454
 - Treatment of Panhypopituitarism / 454
- POSTERIOR PITUITARY HORMONES** / 454
- Oxytocin / 455
 - Vasopressin / 455
- 20 Adrenal Function** / 458
- Ryan Hungerford, A. Wayne Meikle*
- THE ADRENAL GLAND: AN OVERVIEW** / 458
- EMBRYOLOGY AND ANATOMY** / 458
- THE ADRENAL CORTEX BY ZONE** / 459
- Cortex Steroidogenesis / 459
 - Congenital Adrenal Hyperplasia / 461
- DIAGNOSIS OF PRIMARY ALDOSTERONISM** / 462
- Diagnosis Algorithm / 463
- ADRENAL CORTICAL PHYSIOLOGY** / 463
- ADRENAL INSUFFICIENCY (ADDISON'S DISEASE)** / 463
- Diagnosis of Adrenal Insufficiency / 464
 - Treatment of Adrenal Insufficiency / 465
- HYPERCORTISOLISM** / 465
- CUSHING'S SYNDROME** / 465
- When Endogenous Cushing's Syndrome Is Confirmed / 465
 - Pituitary versus Ectopic Adrenocorticotropic Hormone Secretion / 466
 - Adrenocorticotropic Hormone Source in Dexamethasone Nonsuppression Adrenocorticotropic Hormone Secretion / 466
 - Inferior Petrosal Sinus Sampling / 466
 - Diagnosis of Cushing's Syndrome / 466
 - When Cushing's Syndrome Is Confirmed, Corticotropin-Releasing Hormone Stimulation Tests Help Determine Adrenocorticotropic Hormone Dependency (Typically Not Necessary) / 467
 - Localization Procedures / 468
 - Algorithm for Cushing's Syndrome Workup / 469
 - Treatment / 469
- ANDROGEN EXCESS** / 469
- Diagnosis of Excess Androgen Production / 470
 - Treatment for Adrenal Androgen Overproduction / 470
- THE ADRENAL MEDULLA** / 470
- Development / 470
 - Biosynthesis and Storage of Catecholamines / 471
 - Catecholamine Degradation / 471
 - Urine and Plasma Catecholamine Measurements / 471
 - Causes of Sympathetic Hyperactivity / 472
 - Diagnosis of Pheochromocytoma / 473
 - Treatment of Pheochromocytoma / 474
 - Outcome and Prognosis / 474
- ADRENAL "INCIDENTALOMA"** / 474
- 21 Gonadal Function** / 477
- Marissa Grotzke*
- THE TESTES** / 477
- Functional Anatomy of the Male Reproductive Tract / 477
 - Physiology of the Testicles / 477
 - Disorders of Sexual Development and Testicular Hypofunction / 479
 - Diagnosis of Hypogonadism / 480
 - Testosterone Replacement Therapy / 480
 - Monitoring Testosterone Replacement Therapy / 481
- THE OVARIES** / 481
- Functional Anatomy of the Ovaries / 482
 - Hormonal Production by the Ovaries / 482
 - The Menstrual Cycle / 482
 - Hormonal Control of Ovulation / 483
 - Pubertal Development in the Female / 483
 - Menstrual Cycle Abnormalities / 483
 - Hirsutism / 487
 - Estrogen Replacement Therapy / 488
- 22 The Thyroid Gland** / 490
- Marissa Grotzke*
- THE THYROID** / 490
- Thyroid Anatomy and Development / 490
 - Thyroid Hormone Synthesis / 490
 - Protein Binding of Thyroid Hormone / 492
 - Control of Thyroid Function / 492
 - Actions of Thyroid Hormone / 492
- TESTS FOR THYROID EVALUATION** / 493
- Blood Tests / 493
- OTHER TOOLS FOR THYROID EVALUATION** / 494
- Nuclear Medicine Evaluation / 494
 - Thyroid Ultrasound / 495
 - Fine-Needle Aspiration / 495
- DISORDERS OF THE THYROID** / 495
- Hypothyroidism / 495
 - Thyrotoxicosis / 496
 - Graves' Disease / 497
 - Toxic Adenoma and Multinodular Goiter / 498
- DRUG-INDUCED THYROID DYSFUNCTION** / 498
- Amiodarone-Induced Thyroid Disease / 498
 - Subacute Thyroiditis / 499
- NONTHYROIDAL ILLNESS** / 499
- THYROID NODULES** / 499

23 Calcium Homeostasis and Hormonal Regulation / 501

Thomas P. Knecht, Ryan Hungerford

CALCIUM HOMEOSTASIS / 501

HORMONAL CONTROL OF CALCIUM

METABOLISM / 501

Vitamin D / 502

Parathyroid Hormone / 503

ORGAN PHYSIOLOGY AND CALCIUM

METABOLISM / 504

Gastrointestinal Physiology / 504

Renal Physiology / 504

Bone Physiology / 504

HYPERCALCEMIA / 505

Signs and Symptoms of Hypercalcemia / 505

Causes of Hypercalcemia / 505

Endocrine Causes of Hypercalcemia / 505

Organ System Causes of Hypercalcemia / 507

Medications That Can Cause

Hypercalcemia / 508

HYPOCALCEMIA / 508

Signs and Symptoms of Hypocalcemia / 508

Causes of Hypocalcemia / 509

Endocrine Causes of Hypocalcemia / 509

Organ System Causes of Hypocalcemia / 510

Medications That Affect Calcium

Metabolism / 510

METABOLIC BONE DISEASES / 512

Rickets and Osteomalacia / 512

Osteoporosis / 512

24 Liver Function / 516

Janelle M. Chiasera, Xin Xu

ANATOMY / 516

Gross Anatomy / 516

Microscopic Anatomy / 517

BIOCHEMICAL FUNCTIONS / 518

Excretory and Secretory / 518

Synthetic / 519

Detoxification and Drug Metabolism / 520

LIVER FUNCTION ALTERATIONS DURING DISEASE / 520

Jaundice / 520

Cirrhosis / 522

Tumors / 523

Reye Syndrome / 524

Drug- and Alcohol-Related Disorders / 524

ASSESSMENT OF LIVER FUNCTION/LIVER FUNCTION TESTS / 525

Bilirubin / 525

Urobilinogen in Urine and Feces / 526

Serum Bile Acids / 527

Enzymes / 528

Tests Measuring Hepatic Synthetic

Ability / 529

Tests Measuring Nitrogen Metabolism / 529

Hepatitis / 529

25 Cardiac Function / 541

Janelle M. Chiasera

ANATOMY AND FUNCTION OF THE HEART / 541

Anatomy / 541

Function / 541

PATHOLOGIC CONDITIONS OF THE HEART / 543

Cardiovascular Disease / 543

Congenital Cardiovascular Defects / 544

Heart Failure / 545

Acute Coronary Syndromes / 546

Hypertensive Heart Disease / 547

Infective Heart Disease / 548

DIAGNOSIS OF HEART DISEASE / 549

Laboratory Diagnosis of Myocardial Infarction / 549

Markers of Inflammation and Coagulation

Disorders / 552

Markers of Congestive Heart Failure / 553

Patient-Focused Cardiac Tests / 554

Role of Laboratory in Monitoring Heart

Disease / 554

26 Renal Function / 557

Kara L. Lynch, Alan H. B. Wu

RENAL ANATOMY / 557

RENAL PHYSIOLOGY / 558

Glomerular Filtration / 558

Tubular Function / 558

Elimination of Nonprotein Nitrogen Compounds / 561

Water, Electrolyte, and Acid-Base Homeostasis / 561

Endocrine Function / 563

1,25-Dihydroxy Vitamin D3 / 564

ANALYTIC PROCEDURES / 564

Clearance Measurements / 564

Urine Electrophoresis / 565

β_2 -Microglobulin / 565

Myoglobin / 565

Microalbumin / 566

Urinalysis / 566

PATHOPHYSIOLOGY / 570

Glomerular Diseases / 570

Tubular Diseases / 571

Urinary Tract Infection/Obstruction / 571

Renal Calculi / 571

Renal Failure / 572

27 Pancreatic Function and Gastrointestinal Function / 578

Edward P. Fody

PHYSIOLOGY OF PANCREATIC FUNCTION / 578

DISEASES OF THE PANCREAS / 579

TESTS OF PANCREATIC FUNCTION / 581

Secretin/Cholecystokinin Test / 581

Fecal Fat Analysis / 582

Sweat Electrolyte Determinations / 583

Serum Enzymes / 583

PHYSIOLOGY AND BIOCHEMISTRY OF GASTRIC SECRETION / 585**CLINICAL ASPECTS OF GASTRIC ANALYSIS / 586****TESTS OF GASTRIC FUNCTION / 586**

Measuring Gastric Acid in Basal and Maximal

Secretory Tests / 586

Measuring Gastric Acid / 586

Plasma Gastrin / 586

INTESTINAL PHYSIOLOGY / 587**CLINICOPATHOLOGIC ASPECTS OF INTESTINAL FUNCTION / 587****TESTS OF INTESTINAL FUNCTION / 587**

Lactose Tolerance Test / 587

D-Xylose Absorption Test / 587

Serum Carotenoids / 588

Other Tests of Intestinal Malabsorption / 588

28 Body Fluid Analysis / 591*Susan Strasinger***AMNIOTIC FLUID / 591**

Neural Tube Defects / 592

Hemolytic Disease of the Newborn / 592

Fetal Lung Maturity / 593

PHOSPHADIDYLGlycerol / 596**FLUORESCENCE POLARIZATION / 596**

Lamellar Body Counts / 596

CEREBROSPINAL FLUID / 597**SWEAT / 599****SYNOVIAL FLUID / 600****SEROUS FLUIDS / 601**

Pleural Fluid / 601

Pericardial Fluid / 602

Peritoneal Fluid / 602

PART 4**Specialty Areas of Clinical Chemistry / 603****29 Therapeutic Drug Monitoring / 605***David P. Thorne, Michelle E. Russell***ROUTES OF ADMINISTRATION / 606****ABSORPTION / 606****FREE VERSUS BOUND DRUGS / 606****DRUG DISTRIBUTION / 607****DRUG ELIMINATION / 607**

Metabolic Clearance / 609

Renal Clearance / 610

PHARMACOKINETICS / 610**SAMPLE COLLECTION / 612****PHARMACOGENOMICS / 612****CARDIOACTIVE DRUGS / 612**

Digoxin / 612

Quinidine / 613

Procainamide / 613

Disopyramide / 614

ANTIBIOTICS / 614

Aminoglycosides / 614

Vancomycin / 614

ANTIEPILEPTIC DRUGS / 615

First-Generation Antiepileptic Drugs / 615

Second-Generation Antiepileptic Drugs / 616

PSYCHOACTIVE DRUGS / 618

Lithium / 618

Tricyclic Antidepressants / 619

Clozapine / 619

Olanzapine / 619

IMMUNOSUPPRESSIVE DRUGS / 619

Cyclosporine / 619

Tacrolimus / 620

Sirolimus / 620

Mycophenolic Acid / 620

ANTINEOPLASTICS / 620

Methotrexate / 621

30 Toxicology / 622*David P. Thorne, Michelle E. Russell***EXPOSURE TO TOXINS / 622****ROUTES OF EXPOSURE / 622****DOSE-RESPONSE RELATIONSHIP / 623**

Acute and Chronic Toxicity / 623

ANALYSIS OF TOXIC AGENTS / 624**TOXICOLOGY OF SPECIFIC AGENTS / 624**

Alcohol / 624

Carbon Monoxide / 627

Caustic Agents / 627

Cyanide / 627

Metals and Metalloids / 628

Pesticides / 631

TOXICOLOGY OF THERAPEUTIC DRUGS / 631

Salicylates / 632

Acetaminophen / 632

TOXICOLOGY OF DRUGS OF ABUSE / 633

Amphetamines / 634

Anabolic Steroids / 635

Cannabinoids / 635

Cocaine / 635

Opiates / 636

Phencyclidine / 636

Sedatives-Hypnotics / 636

31 Circulating Tumor Markers: Basic Concepts and Clinical Applications / 637*Christopher R. McCudden, Monte S. Willis***TYPES OF TUMOR MARKERS / 637****APPLICATIONS OF TUMOR MARKER****DETECTION / 638**

Screening / 640

Prognosis / 640

Monitoring Effectiveness of Therapy and Disease

Recurrence / 642

RECOMMENDATIONS FOR TEST ORDERING / 642**METHODS / 642**

Immunoassays / 643

High-Performance Liquid Chromatography / 644

Immunohistochemistry / 644

Enzyme Assays / 644

FREQUENTLY ORDERED TUMOR MARKERS / 645

α -Fetoprotein / 645

Cancer Antigen 125 / 646

Carcinoembryonic Antigen / 646

Human Chorionic Gonadotropin / 647

Prostate Specific Antigen / 648

32 Nutritional Assessment / 651

Linda S. Gorman, Maria G. Boosalis

NUTRITION CARE PROCESS: OVERVIEW / 651

NUTRITION ASSESSMENT / 651

BIOCHEMICAL MARKERS / 653

Macronutrients / 653

CARBOHYDRATES / 656

Urine Testing / 656

Tests to Monitor Electrolyte

Disturbances / 656

MICRONUTRIENTS / 656

Vitamins / 656

Fat-Soluble Vitamins / 657

Water-Soluble Vitamins / 660

MINERAL METABOLISM—CALCIUM/

PHOSPHORUS / 665

Mineral Tests to Monitor / 665

TRACE MINERALS / 666

Trace Elements to Monitor / 666

33 Clinical Chemistry and the Geriatric Patient / 673

Betty White

THE IMPACT OF GERIATRIC PATIENTS ON THE CLINICAL LABORATORY / 673

THEORIES OF AGING / 674

BIOCHEMICAL AND PHYSIOLOGIC CHANGES OF AGING / 675

Endocrine Function Changes / 676

Diabetes Mellitus and Insulin Resistance / 678

Renal Function Changes / 679

Hepatic Function Changes / 679

Pulmonary Function and Electrolyte

Changes / 680

Cardiovascular and Lipid Changes / 680

Enzyme Changes / 680

CLINICAL CHEMISTRY RESULTS AND

AGING / 680

Establishing Reference Intervals for the

Elderly / 681

Preanalytic Variables, the Elderly, and Chemistry

Results / 681

Therapeutic Drug Monitoring in the Elderly / 682

Effects of Exercise and Nutrition on the Elderly and

Chemistry Results / 682

34 Clinical Chemistry and the Pediatric Patient / 685

Dean C. Carlow, Michael J. Bennett

DEVELOPMENTAL CHANGES FROM NEONATE TO ADULT / 685

Respiration and Circulation / 686

Growth / 686

Organ Development / 686

Problems of Prematurity and Immaturity / 686

PHLEBOTOMY AND CHOICE OF INSTRUMENTATION FOR PEDIATRIC SAMPLES / 686

Phlebotomy / 686

Preanalytic Concerns / 687

Choice of Analyzer / 687

POINT-OF-CARE ANALYSIS IN PEDIATRICS / 688

REGULATION OF BLOOD GASES AND pH IN NEONATES AND INFANTS / 688

Blood Gas and Acid-Base Measurement / 689

REGULATION OF ELECTROLYTES AND WATER:

RENAL FUNCTION / 689

Disorders Affecting Electrolytes and Water

Balance / 690

DEVELOPMENT OF LIVER FUNCTION / 691

Physiologic Jaundice / 691

Energy Metabolism / 691

Diabetes / 692

Nitrogen Metabolism / 692

Nitrogenous End Products as Markers of Renal Function / 693

Liver Function Tests / 693

CALCIUM AND BONE METABOLISM IN PEDIATRICS / 693

Hypocalcemia and Hypercalcemia / 693

ENDOCRINE FUNCTION IN PEDIATRICS / 694

Hormone Secretion / 694

Hypothalamic–Pituitary–Thyroid System / 694

Hypothalamic–Pituitary–Adrenal Cortex System / 695

Growth Factors / 695

Endocrine Control of Sexual Maturation / 696

DEVELOPMENT OF THE IMMUNE SYSTEM / 696

Basic Concepts of Immunity / 696

Components of the Immune System / 697

Neonatal and Infant Antibody Production / 698

Immunity Disorders / 698

GENETIC DISEASES / 698

Cystic Fibrosis / 699

Newborn Screening for Whole Populations / 699

Diagnosis of Metabolic Disease in the Clinical Setting / 700

DRUG METABOLISM AND

PHARMACOKINETICS / 701

Therapeutic Drug Monitoring / 701

Toxicologic Issues in Pediatric Clinical Chemistry / 702

Index / 705

PART

1

Basic Principles and Practice of Clinical Chemistry

Basic Principles and Practices

Eileen Carreiro-Lewandowski

CHAPTER

1

CHAPTER OUTLINE

■ UNITS OF MEASURE

Electronic Reporting of Results

■ REAGENTS

Chemicals

Reference Materials

Water Specifications

Solution Properties

■ CLINICAL LABORATORY SUPPLIES

Thermometers/Temperature

Glassware and Plasticware

Desiccators and Desiccants

Balances

■ BASIC SEPARATION TECHNIQUES

Centrifugation

Filtration

Dialysis

■ LABORATORY MATHEMATICS AND CALCULATIONS

Significant Figures

Logarithms

Concentration

Dilutions

Water of Hydration

Graphing and Beer's Law

■ SPECIMEN CONSIDERATIONS

Types of Samples

Sample Processing

Sample Variables

Chain of Custody

■ REFERENCES

The primary purpose of a clinical chemistry laboratory is to facilitate the correct performance of analytic procedures that yield accurate and precise information, aiding patient diagnosis and treatment. The achievement of reliable results requires that the clinical laboratory scientist be able to correctly use basic supplies and equipment and possess an understanding of fundamental concepts critical to any analytic procedure. The topics in this chapter include units of measure, basic laboratory supplies, and introductory laboratory mathematics, plus a brief discussion of specimen collection and processing.

UNITS OF MEASURE

Any meaningful quantitative laboratory result consists of two components. The first component represents the actual value, and the second is a label identifying the units of the expression. The number describes the numeric value, whereas the unit defines the physical quantity or dimension, such as mass, length, time, or volume.¹

Although several systems of units have traditionally been used by various scientific divisions, the **Systeme**

International d'Unités (SI), adopted internationally in 1960, is preferred in scientific literature and clinical laboratories and is the only system used in many countries. This system was devised to provide the global scientific community a uniform method of describing physical quantities. The SI system units (referred to as *SI units*) are based on the metric system. Several sub-classifications exist within the SI system, one of which is the *basic unit*. There are seven basic units (Table 1-1), with length (meter), mass (kilogram), and quantity of a substance (mole) being the units most frequently encountered. Another set of SI-recognized units is termed *derived units*. A derived unit, as the name implies, is a derivative or a mathematical function of one of the basic units. An example of an SI-derived unit is meters per second (m/s), used to express velocity. However, some non-SI units are so widely used that they have become acceptable for use with SI basic or SI-derived units (Table 1-1). These include certain long-standing units such as hour, minute, day, gram, liter, and plane angles expressed as degrees. These units, although widely used, cannot technically be categorized as either basic or derived SI units.

TABLE 1-1 SI UNITS

| BASE QUANTITY | NAME | SYMBOL |
|---------------------------|--|--------|
| Length | Meter | m |
| Mass | Kilogram | kg |
| Time | Second | s |
| Electric current | Ampere | A |
| Thermodynamic temperature | Kelvin | K |
| Amount of substance | Mole | mol |
| Luminous intensity | Candela | cd |
| SELECTED DERIVED | | |
| Frequency | Hertz | Hz |
| Force | Newton | N |
| Celsius temperature | Degree Celsius | °C |
| Catalytic activity | Katal | kat |
| SELECTED ACCEPTED NON-SI | | |
| Minute (time) | (60s) | min |
| Hour | (3,600s) | h |
| Day | (86,400s) | d |
| Liter (volume) | (1 dm ³ = 10 ⁻³ m ³) | L |
| Angstrom | (0.1 nm = 10 ⁻¹⁰ m) | Å |

The SI uses **standard** prefixes that, when added to a given unit, can indicate decimal fractions of multiples of that unit (Table 1-2). For example, 0.001 liter can be expressed using the prefix *milli*, becoming 1 milliliter, which is then written as 1 mL. Note that the SI term for mass is *kilogram*; it is the only basic unit that contains a prefix as part of its naming convention. Generally, the standard prefixes for mass use the term *gram* rather than *kilogram*.

Reporting of laboratory results is often expressed in terms of substance concentration (e.g., moles) or the mass of a substance (e.g., mg/dL, g/dL, g/L, mEq/L, and IU) rather than in SI units. These familiar and traditional units can cause confusion during interpretation. It has been recommended that **analytes** be reported using moles of solute per volume of solution (substance concentration) and that the liter be used as the reference volume.² Appendix D, *Conversion of Traditional Units to SI Units for Common Clinical Chemistry Analytes*, lists both reference and SI units together with the conversion factor from traditional to SI units for common analytes. As with other areas of industry, the laboratory and the rest of medicine is moving toward adopting universal standards promoted by the International Organization for Standards, often re-

TABLE 1-2 PREFIXES USED WITH SI UNITS

| FACTOR | PREFIX | SYMBOL |
|-------------------|--------|--------|
| 10 ⁻¹⁸ | atto | a |
| 10 ⁻¹⁵ | femto | f |
| 10 ⁻¹² | pico | p |
| 10 ⁻⁹ | nano | n |
| 10 ⁻⁶ | micro | μ |
| 10 ⁻³ | milli | m |
| 10 ⁻² | centi | c |
| 10 ⁻¹ | deci | d |
| 10 ¹ | deka | da |
| 10 ² | hecto | h |
| 10 ³ | kilo | k |
| 10 ⁴ | mega | M |
| 10 ⁹ | giga | G |
| 10 ¹² | tera | T |
| 10 ¹⁵ | peta | P |
| 10 ¹⁸ | exa | E |

Prefixes are used to indicate a subunit or multiple of a basic SI unit.

ferred to as ISO. This group develops standards of practice, definitions, and guidelines that can be adopted by everyone in a given field, providing for more uniform terminology and less confusion. As with any change, this process can take time and clinical laboratory scientists must be familiar with the many terms currently in use.

Electronic Reporting of Results

Electronic transmission of laboratory data and the more routine use of an electronic medical record, coding, billing, and other data management systems have caused much debate regarding appropriate standards needed in terms of both reporting guidelines and safeguards to ensure privacy of the data and records. Complicating matters is that there are many different data management systems in use by health care agencies that all use laboratory information. For example, the Logical Observation Identifiers Names and Codes (LOINC) system, International Federation of Clinical Chemistry/International Union of Pure and Applied Chemistry (IFCC/IUPAC), American Society for Testing and Materials (ASTM), Health Level 7 (HL7), and Systematized Nomenclature of Medicine, Reference Technology (SNOMED RT) are databases that use their own coding systems for laboratory observations. There are also additional proprietary systems in use, adding to the confusion. While no uniform standard exists, there is agreement in most systems that each test name should be clearly identified and should have its unique code and should include the value and the unit or the appropriate abbreviation. Reference ranges, for most clinical chemistry tests, are not universal and in those instances need to be included for proper interpretation.

REAGENTS

In today's highly automated laboratory, there seems to be little need for reagent preparation by the clinical laboratory scientist. Most instrument manufacturers also make the reagents, usually in a readily available "kit" form (i.e., all necessary reagents and respective storage containers are prepackaged as a unit) or requiring only the addition of water or buffer to the prepackaged reagent components. A heightened awareness of the hazards of certain chemicals and numerous regulatory agency requirements have caused clinical chemistry laboratories to readily eliminate massive stocks of chemicals and opt instead for the ease of using prepared reagents. Periodically, especially in hospital laboratories involved in research and development, biotechnology applications, specialized analyses, or method validation, the laboratorian may still face preparing various reagents or solutions. As a result of reagent deterioration, supply and demand, or the institution of cost-containment programs, the decision may be made to prepare reagents in-house. Therefore, a thorough knowl-

edge of chemicals, standards, solutions, buffers, and water requirements is necessary.

Chemicals

Analytic chemicals exist in varying grades of purity: analytic reagent (AR); ultrapure, chemically pure (CP); United States Pharmacopeia (USP); National Formulary (NF); and technical or commercial grade.³ A committee of the American Chemical Society (ACS; www.acs.org) established specifications for AR grade chemicals, and chemical manufacturers will either meet or exceed these requirements. Labels on reagents state the actual impurities for each chemical lot or list the maximum allowable impurities. The labels should be clearly printed with the percentage of impurities present and either the initials AR or ACS or the term *For laboratory use* or *ACS Standard-Grade Reference Materials*. Chemicals of this category are suitable for use in most analytic laboratory procedures. Ultrapure chemicals have been put through additional purification steps for use in specific procedures such as chromatography, atomic absorption, immunoassays, molecular diagnostics, standardization, or other techniques that require extremely pure chemicals. These reagents may carry designations of HPLC (high-performance liquid chromatography) or chromatographic (see later) on their labels.

Because USP and NF grade chemicals are used to manufacture drugs, the limitations established for this group of chemicals are based only on the criterion of not being injurious to individuals. Chemicals in this group may be pure enough for use in most chemical procedures; however, it should be recognized that the purity standards are not based on the needs of the laboratory and, therefore, may or may not meet all assay requirements.

Reagent designations of CP or pure grade indicate that the impurity limitations are not stated and that preparation of these chemicals is not uniform. Melting point analysis is often used to ascertain the acceptable purity range. It is not recommended that clinical laboratories use these chemicals for reagent preparation unless further purification or a reagent blank is included. Technical or commercial grade reagents are used primarily in manufacturing and should never be used in the clinical laboratory.

Organic reagents also have varying grades of purity that differ from those used to classify inorganic reagents. These grades include a practical grade with some impurities; chemically pure, which approaches the purity level of reagent grade chemicals; spectroscopic (spectrally pure) and chromatographic (minimum purity of 99% determined by gas chromatography) grade organic reagents, with purity levels attained by their respective procedures; and reagent grade (ACS), which is certified to contain impurities below certain levels established by

the ACS. As in any analytic method, the desired organic reagent purity is dictated by the particular application.

Other than the purity aspects of the chemicals, laws related to the Occupational Safety and Health Administration (OSHA)⁴ require manufacturers to clearly indicate the lot number, plus any physical or biologic health hazard and precautions needed for the safe use and storage of any chemical. A manufacturer is required to provide technical data sheets for each chemical manufactured on a document called a Material Safety Data Sheet (MSDS). A more detailed discussion of this topic may be found in Chapter 3.

Reference Materials

Unlike other areas of chemistry, clinical chemistry is involved in the analysis of biochemical byproducts found in *biological* fluids, such as serum, plasma, or urine, making purification and a known *exact* composition of the material almost impossible. For this reason, traditionally defined standards used in analytical chemistry standards do not readily apply in clinical chemistry.

Recall that a **primary standard** is a highly purified chemical that can be measured directly to produce a substance of *exact* known concentration and purity. The ACS purity tolerances for primary standards are $100 \pm 0.02\%$. Because most biologic constituents are unavailable within these limitations, the National Institute of Standards and Technology (NIST; <http://ts.nist.gov>)-certified **standard reference materials (SRMs)** are used instead of ACS primary standard materials.⁵⁻⁹

The NIST developed certified reference materials (CRMs/SRMs) for use in clinical chemistry laboratories. They are assigned a value after careful analysis, using state-of-the-art methods and equipment. The chemical composition of these substances is then certified; however, they may not possess the purity equivalent of a primary standard. Because each substance has been characterized for certain chemical or physical properties, it can be used in place of an ACS primary standard in clinical work and is often used to verify calibration or accuracy/bias assessments. Many manufacturers use an NIST SRM when producing calibrator and standard materials and, in this way, these materials are considered “traceable to NIST” and may meet certain accreditation requirements. There are SRMs for a number of routine analytes, hormones, drugs, and blood gases, with others being added.¹⁰

A **secondary standard** is a substance of lower purity with concentration determined by comparison with a primary standard. The secondary standard depends not only on its composition, which cannot be directly determined, but also on the analytic reference method. Once again, because physiologic primary standards are generally unavailable, clinical chemists do not by definition have “true” secondary standards. Manufacturers of sec-

ondary standards will list the SRM or primary standard used for comparison. This information may be needed during laboratory accreditation processes.

Water Specifications¹¹

Water is the most frequently used reagent in the laboratory. Because tap water is unsuitable for laboratory applications, most procedures, including reagent and standard preparation, use water that has been substantially purified. Water solely purified by distillation results in **distilled water**; water purified by ion exchange produces **deionized water**. Reverse osmosis, which pumps water across a semipermeable membrane, produces **RO water**. Water can also be purified by **ultrafiltration**, ultraviolet light, sterilization, or ozone treatment. Laboratory requirements generally call for **reagent grade water** that, according to the Clinical and Laboratory Standards Institute, is classified into one of six categories based on the specifications needed for its use rather than the method of purification or preparation.¹² These categories include clinical laboratory reagent water (CLRW), special reagent water (SRW), instrument feed water, water supplied by method manufacturer, autoclave and wash water, and commercially bottled purified water. Laboratories need to assess whether the water meets the specifications needed for its application. Most water parameters include at least microbiological count, pH, resistivity, silicate, particulate matter, and organics. Each category has a specific acceptable limit. A long-held convention for categorizing water purity was based on three types, I through III, with type I water having the most stringent requirements and generally suitable for routine laboratory use.

Prefiltration can remove particulate matter for municipal water supplies before any additional treatments. Filtration cartridges are composed of glass; cotton; activated charcoal, which removes organic materials and chlorine; and submicron filters (≤ 0.2 mm), which remove any substances larger than the filter's pores, including bacteria. The use of these filters depends on the quality of the municipal water and the other purification methods used. For example, hard water (containing calcium, iron, and other dissolved elements) may require prefiltration with a glass or cotton filter rather than activated charcoal or submicron filters, which quickly become clogged and are expensive to operate. The submicron filter may be better suited after distillation, deionization, or reverse osmosis treatment.

Distilled water has been purified to remove almost all organic materials, using a technique of distillation much like that found in organic chemistry laboratory distillation experiments in which water is boiled and vaporized. The vapor rises and enters into the coil of a condenser, a glass tube that contains a glass coil. Cool water surrounds

this condensing coil, lowering the temperature of the water vapor. The water vapor returns to a liquid state, which is then collected. Many impurities do not rise in the water vapor, remaining in the boiling apparatus. The water collected after condensation has less contamination. Because laboratories use thousands of liters of water each day, stills are used instead of small condensing apparatuses; however, the principles are basically the same. Water may be distilled more than once, with each distillation cycle removing additional impurities.

Deionized water has some or all ions removed, although organic material may still be present, so it is neither pure nor sterile. Generally, deionized water is purified from previously treated water, such as prefiltered or distilled water. Deionized water is produced using either an anion or a cation exchange resin, followed by replacement of the removed particles with hydroxyl or hydrogen ions. The ions that are anticipated to be removed from the water will dictate the type of ion exchange resin to be used. One column cannot service all ions present in water. A combination of several resins will produce different grades of deionized water. A two-bed system uses an anion resin followed by a cation resin. The different resins may be in separate columns or in the same column. This process is excellent in removing dissolved ionized solids and dissolved gases.

Reverse osmosis is a process that uses pressure to force water through a semipermeable membrane, producing water that reflects a filtered product of the original water. It does not remove dissolved gases. Reverse osmosis may be used as a pretreatment of water.

Ultrafiltration and nanofiltration, like distillation, are excellent in removing particulate matter, microorganisms, and any pyrogens or endotoxins. Ultraviolet oxidation (removes some trace organic material) or sterilization processes (uses specific wavelengths), together with ozone treatment, can destroy bacteria but may leave behind residual products. These techniques are often used after other purification processes have been used.

Production of reagent grade water largely depends on the condition of the feed water. Generally, reagent grade water can be obtained by initially filtering it to remove particulate matter, followed by reverse osmosis, deionization, and a 0.2-mm filter or more restrictive filtration process. Type III/autoclave wash water is acceptable for glassware washing but not for analysis or reagent preparation. Traditionally, type II water was acceptable for most analytic requirements, including reagent, quality control, and standard preparation, while type I water was used for test methods requiring minimum interference, such as trace metal, iron, and enzyme analyses. Use with HPLC may require less than a 0.2-mm final filtration step and fall into the SRW category. Some molecular diagnostic or mass spectrophotometric techniques may require special reagent grade water; some reagent grade water should be

used immediately, so storage is discouraged because the resistivity changes. Depending on the application, CLRW water should be stored in a manner that reduces any chemical or bacterial contamination and for short periods.

Testing procedures to determine the quality of reagent grade water include measurements of resistance, pH, colony counts (for assessing bacterial contamination) on selective and nonselective media for the detection of coliforms, chlorine, ammonia, nitrate or nitrite, iron, hardness, phosphate, sodium, silica, carbon dioxide, chemical oxygen demand (COD), and metal detection. Some accreditation agencies¹³ recommend that laboratories document culture growth, pH, and specific resistance on water used in reagent preparation. Resistance is measured because pure water, devoid of ions, is a poor conductor of electricity. The relationship of water purity to resistance is linear. Generally, as purity increases, so does resistance. This one measurement does not suffice for determination of true water purity because a nonionic contaminant may be present that has little effect on resistance. Note that reagent water meeting specifications from other organizations, such as the ASTM, may not be equivalent to those established for each type by **CLSI** and care should be taken to meet the assay procedural requirements for water type requirements.

Solution Properties

In clinical chemistry, substances found in biologic fluids are measured (e.g., serum, plasma, urine, and spinal fluid). A substance that is dissolved in a liquid is called a **solute**; in laboratory science, these biologic solutes are also known as *analytes*. The liquid in which the solute is dissolved—in this instance, a biologic fluid—is the **solvent**. Together they represent a **solution**. Any chemical or biologic solution is described by its basic properties, including concentration, saturation, colligative properties, redox potential, conductivity, density, pH, and ionic strength.

Concentration

Analyte concentration in solution can be expressed in many ways. Routinely, concentration is expressed as percent solution, molarity, molality, or normality and, because these non-SI expressions are so widely used, they will be discussed here. Note that the SI expression for the amount of a substance is the mole.

Percent solutions is expressed as equal parts per hundred or the amount of solute per 100 total units of solution. Three expressions of percent solutions are weight per weight (w/w), volume per volume (v/v), and, most commonly, weight per volume (w/v). For v/v solutions, it is recommended that grams per deciliter (g/dL) be used instead of percent or % (v/v).

Molarity is expressed as the number of moles per 1 L of solution. One mole of a substance equals its gram mo-

lecular weight (gmw). The SI representation for the traditional molar concentration is moles of solute per volume of solution, with the volume of the solution given in liters. The SI expression for concentration should be represented as moles per liter (mol/L), millimoles per liter (mmol/L), micromoles per liter ($\mu\text{mol/L}$), and nanomoles per liter (nmol/L). The familiar concentration term *molarity* has not been adopted by the SI as an expression of concentration.

Molality represents the amount of solute per 1 kg of solvent. Molality is sometimes confused with molarity; however, it can be easily distinguished from molarity because molality is always expressed in terms of weight per weight or moles per kilogram and describes moles per 1,000 g (1 kg) of solvent. The preferred expression for molality is moles per kilogram (mol/kg).

Normality is the least likely of the four concentration expressions to be encountered in clinical laboratories, but it is often used in chemical titrations and chemical reagent classification. It is defined as the number of gram equivalent weights per 1 L of solution. An **equivalent weight** is equal to the gmw of a substance divided by its valence. The **valence** is the number of units that can combine with or replace 1 mole of hydrogen ions for acids, hydroxyl ions for bases, and the number of electrons exchanged in oxidation reduction reactions. It is the number of atoms/elements that can combine for a particular compound; therefore, the equivalent weight is the gram combining weight of a material. Normality is always equal to or greater than the molarity of that compound. Normality was previously used for reporting electrolyte values, such as sodium [Na^+], potassium [K^+], and chloride [Cl^-] expressed as milliequivalents per liter (mEq/L); however, this convention has been replaced with the more familiar units of millimoles per liter (mmol/L).

Solution saturation gives little specific information about the concentration of solutes in a solution. Temperature, as well as the presence of other ions, can influence the solubility constant for a solute in a given solution and thus affect the saturation. Routine terms in the clinical laboratory that describe the extent of saturation are *dilute*, *concentrated*, *saturated*, and *supersaturated*. A *dilute solution* is one in which there is relatively little solute. In contrast, a *concentrated solution* has a large quantity of solute in solution. A solution in which there is an excess of undissolved solute particles is a *saturated solution*. As the name implies, a *supersaturated solution* has an even greater concentration of undissolved solute particles than a saturated solution of the same substance. Because of the greater concentration of solute particles, a supersaturated solution is thermodynamically unstable. The addition of a crystal of solute or mechanical agitation disturbs the supersaturated solution, resulting in crystallization of any excess material out of solution. An example is seen when measuring serum osmolality by freezing point depression.

Colligative Properties

The behavior of particles in solution demonstrates four repeatable properties based only on the relative number of each kind of molecule present. The properties of osmotic pressure, vapor pressure, freezing point, and boiling point are called **colligative properties**. *Vapor pressure* is the pressure at which the liquid solvent is in equilibrium with the water vapor. *Freezing point* is the temperature at which the vapor pressures of the solid and liquid phases are the same. *Boiling point* is the temperature at which the vapor pressure of the solvent reaches one atmosphere.

Osmotic pressure is the pressure that opposes osmosis when a solvent flows through a semipermeable membrane to establish equilibrium between compartments of differing concentration. The osmotic pressure of a dilute solution is proportional to the concentration of the molecules in solution. The expression for concentration is the osmole. One osmole of a substance equals the molarity multiplied by the number of particles at dissociation. When a solute is dissolved in a solvent, these colligative properties change in a predictable manner for each osmole of substance present; the freezing point is lowered by -1.86°C , the boiling point is raised by 0.52°C , the vapor pressure is lowered by 0.3 mm Hg or torr, and the osmotic pressure is increased by a factor of 1.7×10^4 mm Hg or torr. In the clinical setting, freezing point and vapor pressure depression are measured as a function of osmolality.

Redox Potential

Redox potential, or *oxidation-reduction potential*, is a measure of the ability of a solution to accept or donate electrons. Substances that donate electrons are called *reducing agents*; those that accept electrons are considered **oxidizing agents**. The mnemonic—LEO (lose electrons **oxidized**) the lion says GER (gain electrons **reduced**)—may prove useful when trying to recall the relationship between reducing/oxidizing agents and redox potential.

Conductivity

Conductivity is a measure of how well electricity passes through a solution. A solution's conductivity quality depends principally on the number of respective charges of the ions present. *Resistivity*, the reciprocal of conductivity, is a measure of a substance's resistance to the passage of electrical current. The primary application of resistivity in the clinical laboratory is for assessing the purity of water. Resistivity or resistance is expressed as ohms and conductivity is expressed as ohms⁻¹ or mho.

pH and Buffers

Buffers are weak acids or bases and their related salts that, as a result of their dissociation characteristics, minimize changes in the hydrogen ion concentration. Hydrogen ion concentration is often expressed as pH. A lowercase *p* in

front of certain letters or abbreviations operationally means the “negative logarithm of” or “inverse log of” that substance. In keeping with this convention, the term **pH** represents the negative or inverse log of the hydrogen ion concentration. Mathematically, pH is expressed as

$$\begin{aligned} \text{pH} &= \log\left(\frac{1}{[\text{H}^+]}\right) \\ \text{pH} &= -\log[\text{H}^+] \end{aligned} \quad (\text{Eq. 1-1})$$

where $[\text{H}^+]$ equals the concentration of hydrogen ions in moles per liter.

The pH scale ranges from 0 to 14 and is a convenient way to express hydrogen ion concentration.

A buffer's capacity to minimize changes in pH is related to the dissociation characteristics of the weak acid or base in the presence of its respective salt. Unlike a strong acid or base, which dissociates almost completely, the dissociation constant for a weak acid or base solution tends to be very small, meaning little dissociation occurs.

The ionization of acetic acid (CH_3COOH), a weak acid, can be illustrated as follows:

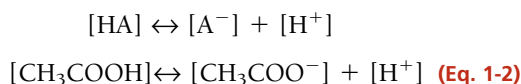

where HA is a weak acid, A^- is a conjugate base, and $[\text{H}^+]$ represents hydrogen ions.

Note that the dissociation constant, K_a , for a weak acid may be calculated using the following equation:

$$K_a = \frac{[\text{A}^-][\text{H}^+]}{[\text{HA}]} \quad (\text{Eq. 1-3})$$

Rearrangement of this equation reveals

$$[\text{H}^+] = K_a \times \frac{[\text{HA}]}{[\text{A}^-]} \quad (\text{Eq. 1-4})$$

Taking the log of each quantity and then multiplying by minus 1 (-1), the equation can be rewritten as

$$-\log[\text{H}^+] = -\log K_a \times -\log \frac{[\text{HA}]}{[\text{A}^-]} \quad (\text{Eq. 1-5})$$

By convention, lower case p means “negative log of”; therefore, $-\log[\text{H}^+]$ may be written as pH, and $-K_a$ may be written as pK_a . The equation now becomes

$$\text{pH} = pK_a - \log \frac{[\text{HA}]}{[\text{A}^-]} \quad (\text{Eq. 1-6})$$

Eliminating the minus sign in front of the log of the quantity $\frac{[\text{HA}]}{[\text{A}^-]}$ results in an equation known as the

Henderson-Hasselbalch equation, which mathematically describes the dissociation characteristics of weak acids and bases and the effect on pH:

$$\text{pH} = pK_a + \log \frac{[\text{A}^-]}{[\text{HA}]} \quad (\text{Eq. 1-7})$$

When the **ratio** of $[\text{A}^-]$ to $[\text{HA}]$ is 1, the pH equals the pK_a and the buffer has its greatest buffering capacity. The dissociation constant K_a , and therefore the pK_a , remains the same for a given substance. Any changes in pH are solely due to the ratio of base/salt $[\text{A}^-]$ concentration to weak acid $[\text{HA}]$ concentration.

Ionic strength is another important aspect of buffers, particularly in separation techniques. **Ionic strength** is the concentration or activity of ions in a solution or buffer. It is defined¹⁴ as follows:

$$\begin{aligned} \mu = I &= \frac{1}{2} \Sigma CiZi^2 \text{ or} \\ &= \frac{\Sigma \{(Ci) \times (Zi)^2\}}{2} \end{aligned} \quad (\text{Eq. 1-8})$$

where Ci is the concentration of the ion, Zi is the charge of the ion, and Σ is the sum of the quantity $(Ci)(Zi)^2$ for each ion present. In mixtures of substances, the degree of dissociation must be considered. Increasing ionic strength increases the ionic cloud surrounding a compound and decreases the rate of particle migration. It can also promote compound dissociation into ions effectively increasing the solubility of some salts, along with changes in current, which can also affect electrophoretic separation.

CLINICAL LABORATORY SUPPLIES

Many different supplies are required in today's medical laboratory; however, several items are common to most facilities, including thermometers, pipets, flasks, beakers, burets, desiccators, and filtering material. The following is a brief discussion of the composition and general use of these supplies.

Thermometers/Temperature

The predominant practice for temperature measurement uses the Celsius ($^{\circ}\text{C}$) scale; however, Fahrenheit ($^{\circ}\text{F}$) and Kelvin ($^{\circ}\text{K}$) scales are also used.^{15,16} The SI designation for temperature is the Kelvin scale. Appendix C (on the companion website) lists the various conversion formulas between each scale.

All analytic reactions occur at an optimal temperature. Some laboratory procedures, such as enzyme determinations, require precise temperature control, whereas others work well over a wide range of temperatures. Reactions that are temperature dependent use some type of heating/cooling cell, heating/cooling block, or water/ice bath to provide the correct temperature environment. Laboratory refrigerator temperatures are often critical and need periodic verification. Thermometers are either an integral part of an instrument or need to be placed in the device for temperature maintenance. The three major types of thermometers discussed include liquid-in-glass, electronic thermometer or **thermistor** probe, and digital

thermometer; however, several other types of temperature-indicating devices are in use. Regardless of which is being used, all temperature reading devices must be calibrated to ascertain accuracy. Liquid-in-glass thermometers use a colored liquid (red or other colored material) or mercury encased in plastic or glass material with a bulb at one end and a graduated stem. They usually measure temperatures between 20°C and 400°C. Partial immersion thermometers are used for measuring temperatures in units such as heating blocks and water baths and should be immersed to the proper height as indicated by the continuous line etched on the thermometer stem. Total immersion thermometers are used for refrigeration applications, and surface thermometers may be needed to check temperatures on flat surfaces, such as in an incubator or heating oven. Visual inspection of the liquid-in-glass thermometer should reveal a continuous line of liquid, free from separation or gas bubbles. The accuracy range for a thermometer used in clinical laboratories is determined by the specific application but, generally, the accuracy range should equal 50% of the desired temperature range required by the procedure.

Liquid-in-glass thermometers should be calibrated against an NIST-certified or NIST-traceable thermometer for critical laboratory applications.¹⁷ NIST has an SRM thermometer with various calibration points (0°, 25°, 30°, and 37°C) for use with liquid-in-glass thermometers. Gallium, another SRM, has a known melting point and can also be used for thermometer verification.

As automation advances and miniaturizes, the need for an accurate, fast-reading electronic thermometer (thermistor) has increased and is now routinely incorporated in many devices. The advantages of a thermistor over the more traditional liquid-in-glass thermometers are size and millisecond response time. One disadvantage can be the initial cost, although the use of a thermistor probe attached to an already owned volt-ohm meter (VOM) can be cost effective. Similar to the liquid-in-glass thermometers, the thermistor can be calibrated against an SRM thermometer or the gallium melting point cell.^{18,19} When the thermistor is calibrated against the gallium cell, it can be used as a reference for any type thermometer.

Glassware and Plasticware

Until recently, laboratory supplies (e.g., pipets, flasks, beakers, and burets) consisted of some type of glass and could be correctly termed *glassware*. As plastic material was refined and made available to manufacturers, plastic has been increasingly used to make laboratory utensils. Before discussing general laboratory supplies, a brief summary of the types and uses of glass and plastic commonly seen today in laboratories is given. (See Appendices G, H, and I on the book's companion website.) Regardless of design, most laboratory supplies must satisfy certain

tolerances of accuracy. Those that satisfy NIST specifications^{20,21} are classified as Class A. Vessels holding or transferring liquid are designed either to contain (TC) or to deliver (TD) a specified volume. As the names imply, the major difference is that TC devices do not deliver that same volume when the liquid is transferred into a container, whereas the TD designation means that the labware will deliver that amount.

Glassware used in the clinical laboratory usually falls into one of the following categories: Kimax/Pyrex (borosilicate), Corex (aluminosilicate), high silica, Vycor (acid and alkali resistant), low actinic (amber colored), or flint (soda lime) glass used for disposable material.²² Whenever possible, routinely used clinical chemistry glassware should consist of high thermal borosilicate or aluminosilicate glass and meet the Class A tolerances recommended by the NIST. Glassware that *does not* meet Type A specifications may have twice the tolerance range despite its appearance being identical to a piece of Type A glassware. The manufacturer is the best source of information about specific uses, limitations, and accuracy specifications for glassware.

Plasticware is beginning to replace glassware in the laboratory setting. The unique high resistance to corrosion and breakage, as well as varying flexibility, has made plasticware most appealing. Relatively inexpensive, it allows most items to be completely disposable after each use. The major types of resins frequently used in the clinical chemistry laboratory are polystyrene, polyethylene, polypropylene, Tygon, Teflon, polycarbonate, and polyvinyl chloride. Again, the individual manufacturer is the best source of information concerning the proper use and limitations of any plastic material.

In most laboratories, glass or plastic that is in direct contact associated with biohazardous material is usually disposable. If not, it must be decontaminated according to appropriate protocols. Should the need arise, however, cleaning of glass or plastic may require special techniques. Immediately rinsing glass or plastic supplies after use, followed by washing with a powder or liquid detergent designed for cleaning laboratory supplies and several distilled water rinses, may be sufficient. Presoaking glassware in soapy water is highly recommended whenever immediate cleaning is impractical. Many laboratories use automatic dishwashers and dryers for cleaning. Detergents and temperature levels should be compatible with the material and the manufacturer's recommendations. To ensure that all detergent has been removed from the labware, multiple rinses with appropriate grade water is recommended. Check the pH of the final rinse water and compare it with the initial pH of the prerinse water. Detergent-contaminated water will have a more alkaline pH as compared with the pH of the appropriate grade water. Visual inspection should reveal spotless vessel walls. Any biologically contaminated labware should

be disposed of according to the precautions followed by that laboratory.

Some determinations, such as those used in assessing heavy metals or assays associated with molecular testing, require scrupulously clean or disposable glassware. Some applications may require plastic rather than glass because glass can absorb metal ions. Successful cleaning solutions are acid dichromate and nitric acid. It is suggested that disposable glass and plastic be used whenever possible.

Dirty pipets should be placed immediately in a container of soapy water with the pipet tips up. The container should be long enough to allow the pipet tips to be covered with solution. A specially designed pipet soaking jar and washing/drying apparatus are recommended. For each final water rinse, fresh reagent grade water should be provided. If possible, designate a pipet container for final rinses only. Cleaning brushes are available to fit almost any size glassware and are recommended for any articles that are washed routinely.

Although plastic material is often easier to clean because of its nonwetable surface, it may not be appropriate for some applications involving organic solvents or autoclaving. Brushes or harsh abrasive cleaners should not be used on plasticware. Acid rinses or washes are not required. The initial cleaning procedure described in Appendix J (on the book's companion Web site) can be adapted for plasticware as well. Ultrasonic cleaners can help remove debris coating the surfaces of glass or plasticware. Properly cleaned glassware should be completely dried before using.

Laboratory Vessels

Flasks, beakers, and graduated cylinders are used to hold solutions. Volumetric and Erlenmeyer flasks are two types of containers in general use in the clinical laboratory.

A Class A *volumetric flask* is calibrated to hold one exact volume of liquid (TC). The flask has a round, lower portion with a flat bottom and a long, thin neck with an etched calibration line. Volumetric flasks are used to bring a given reagent to its final volume with the prescribed diluent and should be Class A quality. When bringing the bottom of the meniscus to the calibration mark, a pipet should be used when adding the final drops of diluent to ensure maximum control is maintained and the calibration line is not missed.

Erlenmeyer flasks and **Griffin beakers** are designed to hold different volumes rather than one exact amount. Because Erlenmeyer flasks and Griffin beakers are often used in reagent preparation, flask size, chemical inertness, and thermal stability should be considered. The Erlenmeyer flask has a wide bottom that gradually evolves into a smaller, short neck. The Griffin beaker has a flat bottom, straight sides, and an opening as wide as the flat base, with a small spout in the lip.

Graduated cylinders are long, cylindrical tubes usually held upright by an octagonal or circular base. The cylinder has calibration marks along its length and is used to measure volumes of liquids. Graduated cylinders do not have the accuracy of volumetric glassware. The sizes routinely used are 10, 25, 50, 100, 500, 1,000, and 2,000 mL.

All laboratory utensils should be Class A whenever possible to maximize accuracy and precision and thus decrease calibration time. (Figure 1-8 illustrates representative laboratory glassware.) Table 1-3 lists the Class A tolerances for some commonly used volumes.

Pipets

Pipets are glass or plastic utensils used to transfer liquids; they may be reusable or disposable. Although pipets may transfer any volume, they are usually used for volumes of 20 mL or less; larger volumes are usually transferred or dispensed using automated pipetting devices or jar-style pipetting apparatus. To minimize confusion, Table 1-4 lists the classification scheme further described here. Examples of pipets are found in Figure 1-1.

TABLE 1-3 CLASS A TOLERANCES

| SIZE (mL) | TOLERANCES (mL) |
|--------------------------|-----------------|
| BURETS | |
| 5 | ±0.01 |
| 10 | ±0.02 |
| 25 | ±0.03 |
| 50 | ±0.05 |
| 100 | ±0.10 |
| PIPETS (TRANSFER) | |
| 0.5–2 | ±0.006 |
| 3–5 | ±0.01 |
| 10 | ±0.02 |
| 15–25 | ±0.03 |
| 50 | ±0.05 |
| VOLUMETRIC FLASKS | |
| 1–10 | ±0.02 |
| 25 | ±0.03 |
| 50 | ±0.05 |
| 100 | ±0.08 |
| 200 | ±0.10 |
| 250 | ±0.12 |
| 500 | ±0.20 |
| 1,000 | ±0.30 |
| 2,000 | ±0.50 |

TABLE 1-4 PIPET CLASSIFICATION

| |
|---|
| I. Design |
| A. To contain (TC) |
| B. To deliver (TD) |
| II. Drainage characteristics |
| A. Blowout |
| B. Self-draining |
| III. Type |
| A. Measuring or graduated |
| 1. Serologic |
| 2. Mohr |
| 3. Bacteriologic |
| 4. Ball, Kolmer, or Kahn |
| 5. Micropipet |
| B. Transfer |
| 1. Volumetric |
| 2. Ostwald-Folin |
| 3. Pasteur pipets |
| 4. Automatic macropipets or micropipets |

Similar to many laboratory utensils, pipets are designed to contain (TC) or to deliver (TD) a particular volume of liquid. The major difference is the amount of liquid needed to wet the interior surface of the ware and the amount of any residual liquid left in the pipet tip. Most manufacturers stamp *TC* or *TD* near the top of the pipet to alert the user as to the type of pipet. Like other TC-designated labware, a TC pipet holds or contains a particular volume but does not dispense that exact volume, whereas a TD pipet will dispense the volume indicated. When using either pipet, the tip must be immersed in the liquid to be transferred to a level that will allow it to remain in solution after the volume of liquid has entered the pipet—without touching the vessel walls. The pipet is held upright, not at an angle (Fig. 1-2). Using a pipet bulb or similar device, a slight suction is applied to the opposite end until the liquid enters the pipet and the meniscus is brought above the desired graduation line (Fig. 1-3A), suction is then stopped. While the meniscus level is held in place, the pipet tip is raised slightly out of the solution and wiped with a laboratory tissue of any adhering liquid. The liquid is allowed to drain until the bottom of the meniscus touches the desired calibration mark

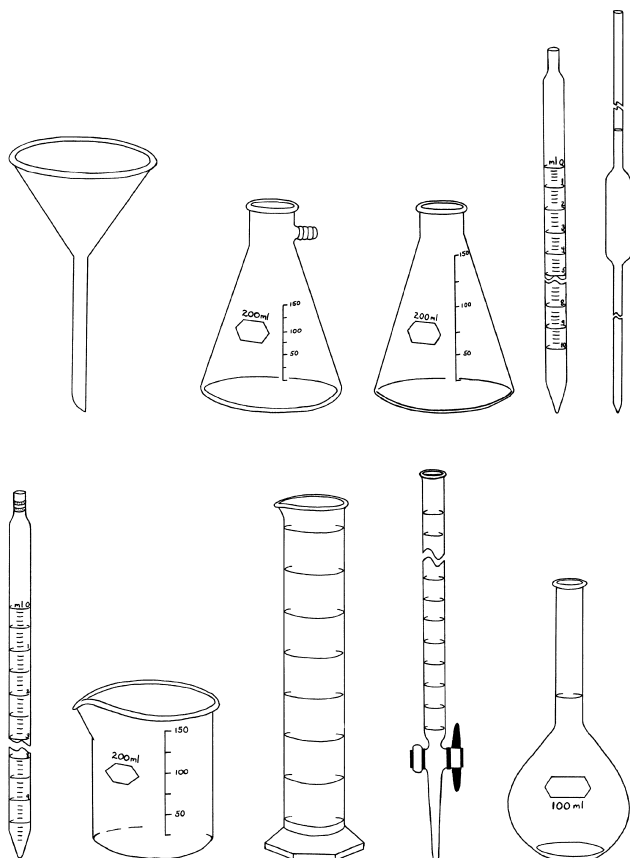
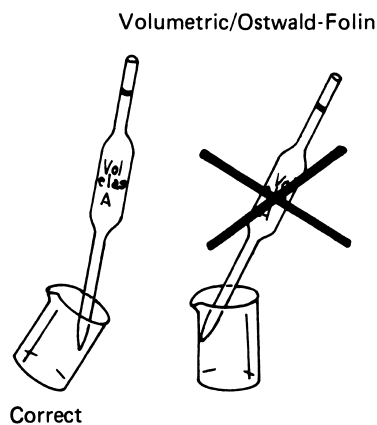
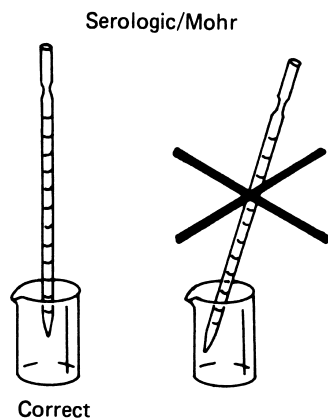
**FIGURE 1-1.** Laboratory glassware.**FIGURE 1-2.** Correct and incorrect pipet positions.

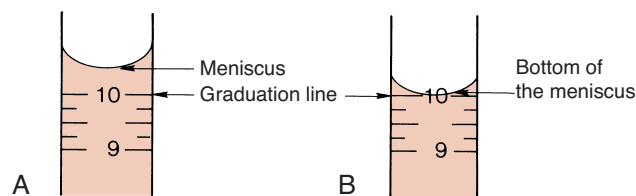

FIGURE 1-3. Pipetting technique. **(A)** Meniscus is brought above the desired graduation line. **(B)** Liquid is allowed to drain until the bottom of the meniscus touches the desired calibration mark.

(Fig. 1-3B). With the pipet held in a vertical position and the tip against the side of the receiving vessel, the pipet contents are allowed to drain into the vessel (e.g., test tube, cuvet, flask). A *blowout pipet* has a continuous etched ring or two small, close, continuous rings located near the top of the pipet. This means that the last drop of liquid should be expelled into the receiving vessel. Without these markings, a pipet is *self-draining*, and the user allows the contents of the pipet to drain by gravity. The tip of the pipet should not be in contact with the accumulating fluid in the receiving vessel during drainage. With the exception of the Mohr pipet, the tip should remain in contact with the side of the vessel for several seconds after the liquid has drained. The pipet is then removed. Various pipet bulbs are illustrated in Figure 1-4.

Measuring or graduated pipets are capable of dispensing several different volumes. Because the graduation lines located on the pipet may vary, they should be indicated on the top of each pipet. For example, a 5-mL pipet can be used to measure 5, 4, 3, 2, or 1 mL of liquid, with further graduations between each milliliter. The pipet is designated as 5 in $\frac{1}{10}$ increments (Fig. 1-5) and could deliver any volume in tenths of a milliliter, up to 5 mL. Another pipet, such as a 1-mL pipet, may be designed to dispense 1 mL and have subdivisions of hundredths of a milliliter. The markings at the top of a measuring or graduated pipet indicate the volume(s) it is designed to dispense.

The subgroups of measuring or graduated pipets are Mohr, serologic, and micropipets. A *Mohr pipet* does not

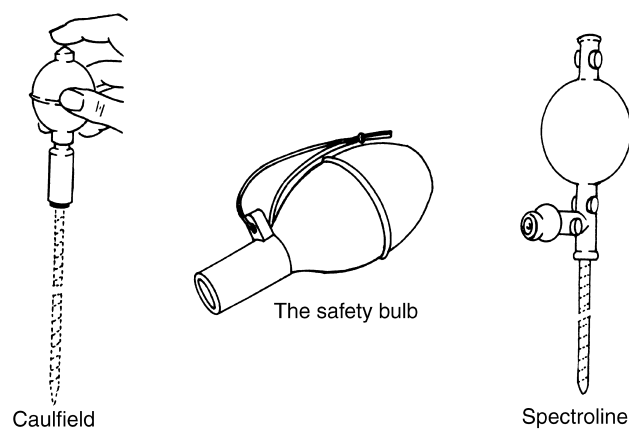

FIGURE 1-4. Types of pipet bulbs.

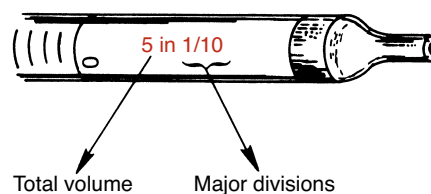

FIGURE 1-5. Volume indication of a pipet.

have graduations to the tip. It is a self-draining pipet, but the tip should not be allowed to touch the vessel while the pipet is draining. A *serologic pipet* has graduation marks to the tip and is generally a blowout pipet. A *micropipet* is a pipet with a total holding volume of less than 1 mL; it may be designed as either a Mohr or serologic pipet. Measuring pipets are used to transfer reagents and to make dilutions and can be used to repeatedly to transfer a particular solution.

The next major category is the *transfer pipets*. These pipets are designed to dispense one volume without further subdivisions. The *bulblike enlargement in the pipet stem easily distinguishes the Ostwald-Folin and volumetric subgroups*. Ostwald-Folin pipets are used with biologic fluids having a viscosity greater than that of water. They are blowout pipets, indicated by two etched continuous rings at the top. The volumetric pipet is designed to dispense or transfer aqueous solutions and is always self-draining. This type of pipet usually has the greatest degree of accuracy and precision and should be used when diluting standards, calibrators, or quality-control material. They should only be used once. *Pasteur pipets* do not have calibration marks and are used to transfer solutions or biologic fluids without consideration of a specific volume. These pipets should not be used in any quantitative analytic techniques.

The *automatic pipet* is the most routinely used pipet in today's clinical chemistry laboratory. Automatic and semiautomatic pipets have many advantages, including safety, stability, ease of use, increased precision, the ability to save time, and less cleaning required as a result of the contaminated portions of the pipet (e.g., the tips) often being disposable. Figure 1-6 illustrates many common automatic pipets. A pipet associated with only one volume is termed a *fixed volume*, and models able to select different volumes are termed *variable*; however, only one volume may be used at a time. The available range of volumes is 1 μ L to 5,000 mL. The widest volume range usually seen in a single pipet is 0 to 1 mL. A pipet with a pipetting capability of less than 1 mL is considered a *micropipet*, and a pipet that dispenses greater than 1 mL is called an *automatic macropipet*.

The term *automatic*, as used here, implies that the mechanism that draws up and dispenses the liquid is an integral part of the pipet. It may be a fully automated/self-operating, semiautomatic, or completely manually

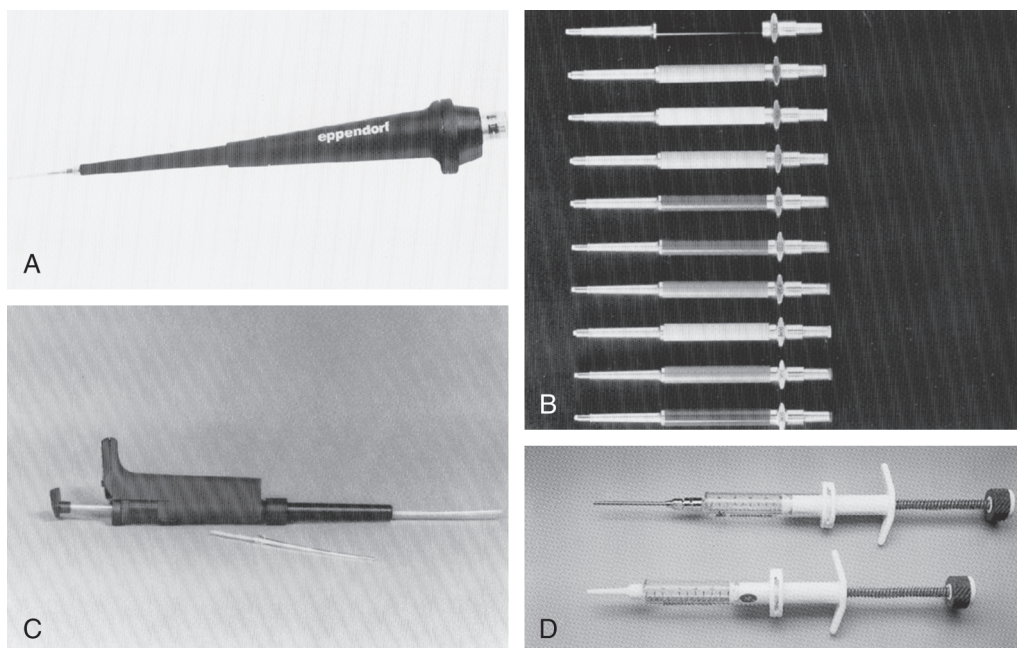

FIGURE 1-6. (A) Fixed-volume, ultramicrodigital, air-displacement pipetter with tip ejector. (B) Fixed-volume air-displacement pipet. (C) Digital electronic positive-displacement pipetter. (D) Syringe pipetter.

operated device. There are three general types of automatic pipets: air-displacement, positive-displacement, and dispenser pipets. An *air-displacement pipet* relies on a piston for suction creation to draw the sample into a disposable tip that must be changed after each use. The piston does not come in contact with the liquid. A *positive-displacement pipet* operates by moving the piston in the pipet tip or barrel, much like a hypodermic syringe. It does

not require a different tip for each use. Because of carry-over concerns, rinsing and blotting between samples may be required. *Dispensers* and *dilutor/dispensers* are automatic pipets that obtain the liquid from a common reservoir and dispense it repeatedly. The dispensing pipets may be bottle-top, motorized, handheld, or attached to a dilutor. The dilutor often combines sampling and dispensing functions. Figure 1-7 provides examples of different types

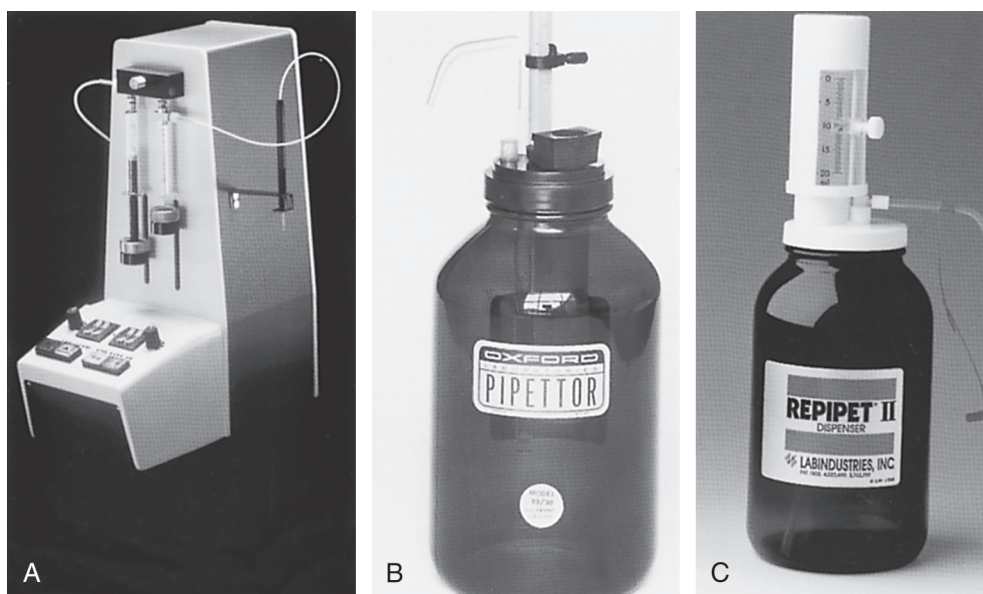

FIGURE 1-7. (A) Digital dilutor/dispenser. (B) Dispenser. (C) Dispenser.

of automatic pipetting devices. These pipets should be used according to the individual manufacturer's directions. Many automated pipets use a wash between samples to eliminate carry-over problems. However, to minimize carry-over contamination with manual or semiautomatic pipets, careful wiping of the tip may remove any liquid that adhered to the outside of the tip before dispensing any liquid. Care should be taken to ensure that the orifice of the pipet tip is not blotted, drawing sample from the tip. Another precaution in using manually operated semiautomatic pipets is to move the plunger in a continuous, slow manner.

Disposable, one-use pipet tips are designed for use with air-displacement pipets. The laboratory scientist should ensure that the pipet tip is seated snugly onto the end of the pipet and free from any deformity. Plastic tips used on air-displacement pipets are likely to vary. Different brands can be used for one particular pipet but they do not necessarily perform in an identical manner. Plastic burrs may be present in the interior of the tip that cannot always be detected by the naked eye. A method using a 0.1% solution of phenol red in distilled water has been used to compare the reproducibility of different brands of pipet tips.²³ When using this method, the pipet and the operator should remain the same so that variation is only a result of changes in the pipet tips.

Tips for positive-displacement pipets are made of straight columns of glass or plastic. These tips must fit snugly to avoid carry-over and can be used repeatedly without being changed after each use. As previously mentioned, these devices may need to be rinsed and dried between samples to minimize carry-over.

Class A pipets, like all other Class A glassware, do not need to be recalibrated by the laboratory. Automatic pipetting devices, as well as non-Class A materials, do need recalibration. A gravimetric method (see page 16) can accomplish this task by delivering and weighing a solution of known specific gravity, such as water. A currently calibrated analytic balance and at least Class 2 weights should be used. A pipet should be used only if it is within $\pm 1.0\%$ of the expected value.

Although gravimetric validation is the most desirable method, pipet calibration may also be accomplished by using photometric methods, particularly for automatic pipetting devices. When a spectrophotometer is used, the molar extinction coefficient of a compound, such as potassium dichromate, is obtained. After an aliquot of diluent is pipetted, the change in concentration will reflect the volume of the pipet. Another photometric technique used to assess pipet accuracy compares the absorbances of dilutions of potassium dichromate, or another colored liquid with appropriate absorbance spectra, using Class A volumetric glassware versus equivalent dilutions made with the pipetting device.

These calibration techniques are time consuming and, therefore, impractical for use in daily checks. It is recommended that pipets be checked initially and subsequently three or four times per year, or as dictated by the laboratory's accrediting agency. Many companies offer calibration services; the one chosen should also satisfy any accreditation requirements. A quick, daily check for many larger-volume automatic pipetting devices involves the use of volumetric flasks. For example, a bottle-top dispenser that routinely delivers 2.5 mL of reagent may be checked by dispensing four aliquots of the reagent into a 10-mL Class A volumetric flask. The bottom of the meniscus should meet with the calibration line on the volumetric flask.

Burets

A **buret** looks like a wide, long, graduated pipet with a stopcock at one end. A buret's usual total volume ranges from 25 mL to 100 mL of solution and is used to dispense a particular volume of liquid during a titration (Fig. 1-8).

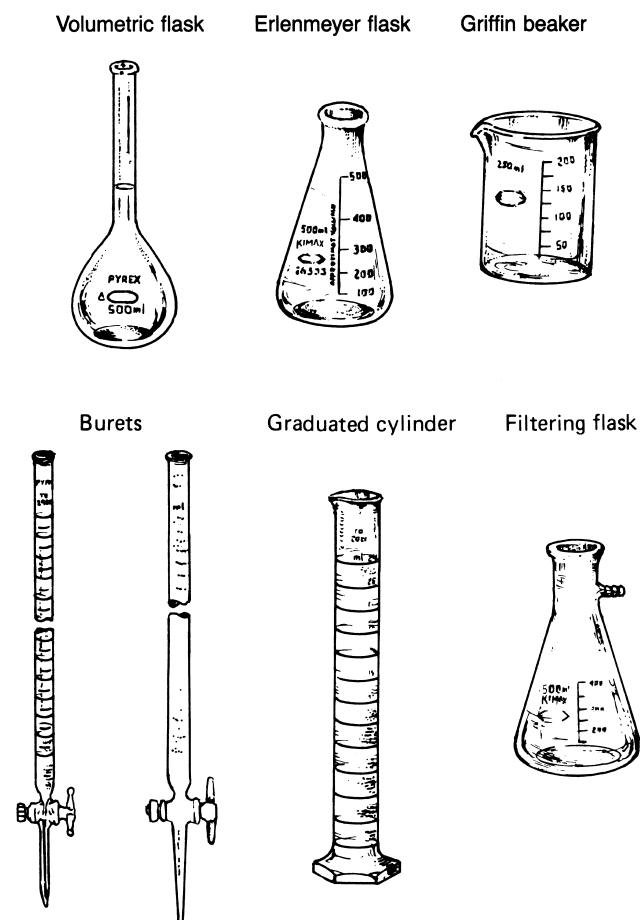

FIGURE 1-8. Examples of laboratory glassware.

Syringes

Syringes are sometimes used for transfer of small volumes (less than 500 μL) in blood gas analysis or in separation techniques such as chromatography or electrophoresis. The syringes are glass and have fine barrels. The plunger is often made of a fine piece of wire. Tips are not used when syringes are used for injection of sample into a gas chromatographic system. In electrophoresis work, however, disposable Teflon tips may be used. Expected inaccuracies of volumes less than 5 μL is 2%, whereas for greater volumes, the inaccuracy is approximately 1%.

Desiccators and Desiccants

Many compounds combine with water molecules to form loose chemical crystals. The compound and the associated water are called a **hydrate**. When the water of

crystallization is removed from the compound, it is said to be **anhydrous**. Substances that take up water on exposure to atmospheric conditions are called **hygroscopic**. Materials that are very hygroscopic can remove moisture from the air as well as from other materials. These materials make excellent drying substances and are sometimes used as **desiccants** (drying agents) to keep other chemicals from becoming hydrated. If these compounds absorb enough water from the atmosphere to cause dissolution, they are called **deliquescent substances**.

Desiccants are most effective when placed in a closed, airtight chamber called a **desiccator** (Fig. 1-9). The desiccant is placed below the perforated platform inside the desiccator. Placing a fine film of lubricant on the rim of the cover seals a glass or plastic desiccator; it is correctly opened or sealed by slowly sliding the lid horizontally. The lubricated seal prevents the desiccator from being

GRAVIMETRIC PIPET CALIBRATION

Materials

Pipet

10 to 20 pipet tips, if needed

Balance capable of accuracy and resolution to $\pm 0.1\%$ of dispensed volumetric weight

Weighing vessel large enough to hold volume of liquid

Type I/CLRW water

Thermometer and barometer

Procedure

1. Record the weight of the vessel. Record the temperature of the water. It is recommended that all materials be at room temperature. Obtain the barometric pressure.
2. Place a small volume (0.5 mL) of the water into the container. To prevent effects from evaporation, it is desirable to loosely cover each container with a substance such as Parafilm. Avoid handling of the containers.
3. Weigh each container plus water to the nearest 0.1 mg or set the balance to zero.
4. Using the pipet to be tested, draw up the specified amount. Carefully wipe the outside of the tip. Care should be taken not to touch the end of the tip; this will cause liquid to be wicked out of the tip, introducing an inaccuracy as a result of technique.
5. Dispense the water into the weighed vessel. Touch the tip to the side.
6. Record the weight of the vessel.
7. Subtract the weight obtained in step 3 from that obtained in step 6. Record the result.

8. If plastic tips are used, change the tip between each dispensing. Repeat steps 1 to 6 for a minimum of nine additional times.
9. Obtain the average or mean of the weight of the water. Multiply the mean weight by the corresponding density of water at the given temperature and pressure. This may be obtained from the *Handbook of Chemistry and Physics*.⁶ At 20°C, the density of water is 0.9982.
10. Determine the accuracy or the ability of the pipet to dispense the expected (selected or stated) volume according to the following formula:

$$\frac{\text{Mean volume}}{\text{Expected volume}} \times 100\% \quad (\text{Eq. 1-9})$$

The manufacturer usually gives acceptable limitations for a particular pipet, but they should not be used if the value differs by more than 1.0% from the expected value.

Precision can be indicated as the percent coefficient of variation (%CV) or standard deviation (SD) for a series of repetitive pipetting steps. A discussion of %CV and SD can be found in Chapter 4. The equations to calculate the SD and %CV are as follows:

$$\text{SD} = \sqrt{\frac{\sum (x - \bar{x})^2}{n - 1}}$$

$$\% \text{ CV} = \frac{\text{SD}}{\bar{x}} \times 100 \quad (\text{Eq. 1-10})$$

Required imprecision is usually ± 1 SD. The %CV will vary with the expected volume of the pipet, but the smaller the %CV value, the greater is the precision. When n is large, the data are more statistically valid.^{21,24}

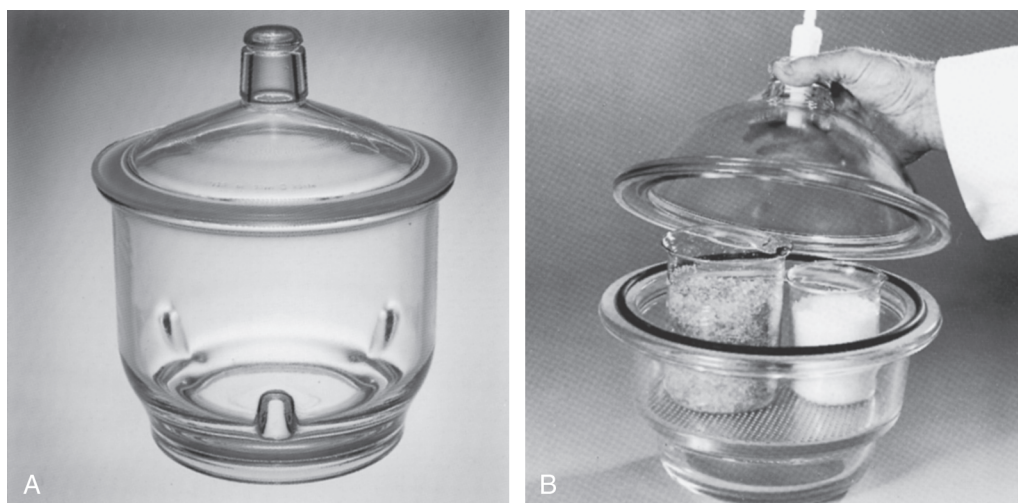

FIGURE 1-9. (A) Glass desiccator. (B) Glass desiccator with dry seal ring (no grease is necessary to seal cover to body).

opened with a direct upward pull. The desiccator should be opened slowly and with caution because the air pressure inside the desiccator could be below atmospheric pressure. Desiccants containing indicators that signify desiccant exhaustion and that can be regenerated using heat or dried in a microwave oven are particularly helpful. Many packaged materials will come with small packets of desiccant material that can be disposed of after the packet is opened. Desiccants that produce dust should also be avoided, and these small packets of desiccants should not be confused with food condiments. In the laboratory, desiccants are primarily used to prevent moisture absorption by chemicals, gases, and instrument components.

Balances

A properly operating balance is essential in producing high-quality reagents and standards. However, because many laboratories discontinued in-house reagent preparation, balances may no longer be as widely used. Balances are classified according to their design, number of pans (single or double), and whether they are mechanical or electronic or classified by operating ranges, as determined by precision balances (readability $\approx 2 \mu\text{g}$), analytic balances (readability $\approx 0.001 \text{ g}$), or microbalances (readability $\approx 0.1 \mu\text{g}$; Fig. 1-10).

Analytic and electronic balances are currently the most popular in the clinical laboratory. Analytic balances are required for the preparation of any primary standards. The mechanical analytic balance is also known as a *substitution balance*. It has a single pan enclosed by sliding transparent doors, which minimize environmental influences on pan movement. The pan is attached to a series of calibrated weights that are counterbalanced by a single weight at the opposite end of a knife-edge fulcrum. The operator adjusts

the balance to the desired mass and places the material, contained within a tared weighing vessel, on the sample pan. An optical scale allows the operator to visualize the mass of the substance. The weight range for certain analytic balances is from 0.01 mg to 160 g.

Electronic balances are single-pan balances that use an electromagnetic force to counterbalance the weighed sample's mass. Their measurements equal the accuracy and precision of any available mechanical balance, with the advantage of a fast response time (less than 10 seconds).

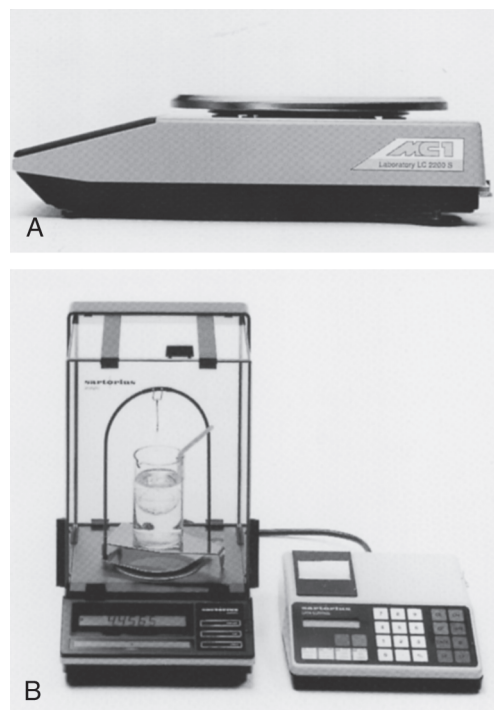

FIGURE 1-10. (A) Electronic top-loading balance. (B) Electronic analytic balance with printer.

Test weights used for calibrating balances should be selected from the appropriate ANSI/ASTM Classes 1 through 4.²⁵ This system has replaced the former NIST Class S standards used prior to 1993. Class 1 weights provide the greatest precision and should be used for calibrating high-precision analytic balances in the weight range of 0.01 mg to 0.1 mg. Former NBS S standard weights are equivalent to ASTM Class 2 (0.001–0.01 g), and S-1 is equivalent to ASTM Class 3 (0.01–0.1 g). The frequency of calibration is dictated by the accreditation/licensing guidelines for a specific laboratory. Balances should be kept scrupulously clean and be located in an area away from heavy traffic, large pieces of electrical equipment, and open windows. A slab of marble separated from its supporting surface by a flexible material is sometimes placed under a balance to minimize any vibration interference that may occur. The level checkpoint should always be corrected before weighing occurs.

BASIC SEPARATION TECHNIQUES

Contemporary modifications of filtration and dialysis use a matrix-based fibrous material that provides a mechanism of separation in many homogeneous immunoassays. These materials may be coated with specific antibody-ligand to foster selection of specific materials or species. Certain labels use magnetic particles in conjunction with strong magnets to effect separation. Further discussion of separation mechanisms used in immunoassays may be found in Chapters 7 and 8. Basic universally used separation mechanisms, outside of those incorporated in immunoassay, are centrifugation, filtration, and dialysis.

Centrifugation

Centrifugation is a process in which centrifugal force is used to separate solid matter from a liquid suspension. The *centrifuge* carries out this action. It consists of a head or rotor, carriers, or shields (Fig. 1-11) that are attached to the vertical shaft of a motor and enclosed in a metal covering. The centrifuge always has a lid and an on/off switch; however, many models include a brake or a built-in tachometer, which indicates speed, and some centrifuges are refrigerated. Centrifugal force depends on three variables: mass, speed, and radius. The speed is expressed in revolutions per minute (rpm), and the centrifugal force generated is expressed in terms of relative centrifugal force (RCF) or gravities (g). The speed of the centrifuge is related to the RCF by the following equation:

$$\text{RCF} = 1.118 \times 10^{-5} \times r \times (\text{rpm})^2 \quad (\text{Eq. 1-11})$$

where 1.118×10^{-5} is a constant, determined from the angular velocity, and r is the radius in centimeters, measured from the center of the centrifuge axis to the bottom of the test-tube shield. The RCF value also may be obtained from a nomogram similar to that found in

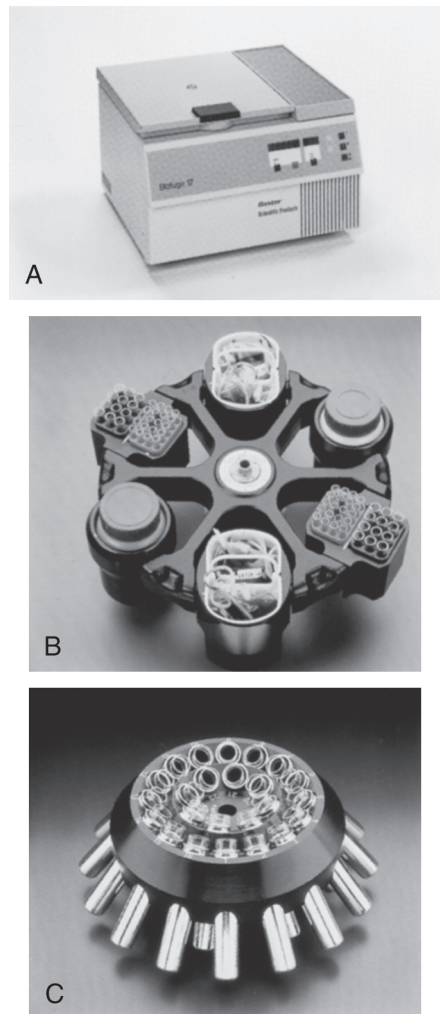

FIGURE 1-11. (A) Benchtop centrifuge. (B) Swinging-bucket rotor. (C) Fixed-head rotor.

Appendix F on the book's companion website. Centrifuge classification is based on several criteria, including benchtop or floor model, refrigeration, rotor head (e.g., fixed, hematocrit, swinging-bucket, or angled; Fig. 1-11), or maximum speed attainable (i.e., ultracentrifuge). Centrifuges are generally used to separate serum or plasma from the blood cells as the blood samples are being processed; to separate a supernatant from a precipitate during an analytic reaction; to separate two immiscible liquids, such as a lipid-laden sample; or to expel air.

Centrifuge care includes daily cleaning of any spills or debris, such as blood or glass, and ensuring that the centrifuge is properly balanced and free from any excessive vibrations. Balancing the centrifuge load is critical (Fig. 1-12). Many newer centrifuges will automatically decrease their speed if the load is not evenly distributed, but more often, the centrifuge will shake and vibrate or make more noise than expected. A centrifuge needs to be balanced based on equalizing both the volume and weight

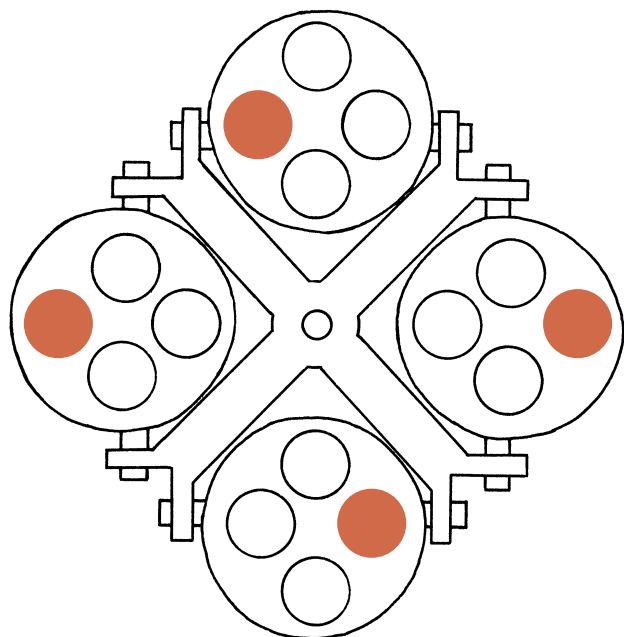

FIGURE 1-12. Properly balanced centrifuge. Colored circles represent counterbalanced positions for sample tubes.

distribution across the centrifuge head. Many laboratories will make up “balance” tubes that approximate routinely used volumes and tube sizes, including the stopper on phlebotomy tubes, which can be used to match those needed from patient samples. A good rule of thumb is one of even placement and one of “opposition.” Exact positioning of tubes depends on the design of the centrifuge holders.

The centrifuge cover should remain closed until the centrifuge has come to a complete stop to avoid any aerosol contamination. It is recommended that the timer, brushes (if present), and speed be periodically checked. The brushes, which are graphite bars attached to a retainer spring, create an electrical contact in the motor. The specific manufacturer’s service manual should be consulted for details on how to change brushes and on lubrication requirements. The speed of a centrifuge is easily checked using a tachometer or strobe light. The hole located in the lid of many centrifuges is designed for speed verification using these devices but may also represent an aerosol biohazard. Accreditation agencies require periodic verification of centrifuge speeds.

Filtration

Filtration can be used instead of centrifugation for the separation of solids from liquids. However, paper filtration is only occasionally used in today’s laboratory and, therefore, only the basics are discussed here. Filter material is made of paper, cellulose and its derivatives, polyester fibers, glass, and a variety of resin column materials.

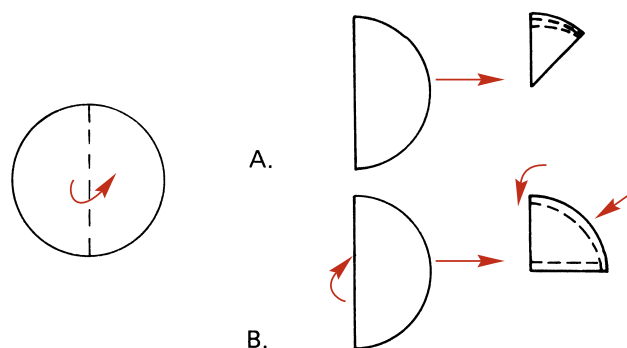

FIGURE 1-13. Methods of folding a filter paper. (A) In a fan. (B) In fourths.

Traditionally, filter paper was folded in a manner that allowed it to fit into a funnel. In method A, round filter paper is folded like a fan (Fig. 1-13A); in method B, the paper is folded into fourths (Fig. 1-13B).

Filter papers differ in pore size and should be selected according to separation needs and associated flow rate for given liquids. Filter paper should not be used when using strong acids or bases. When the filter paper is placed inside the funnel, the solution slowly drains through the filter paper within the funnel and into a receiving vessel. The liquid that passes through the filter paper is called the **filtrate**.

Dialysis

Dialysis is another method for separating macromolecules from a solvent or smaller substances. It became popular when used in conjunction with the Technicon Autoanalyzer system in the 1970s. Basically, a solution is put into a bag or is contained on one side of a semipermeable membrane. Larger molecules are retained within the sack or on one side of the membrane, while smaller molecules and solvents diffuse out. This process is very slow. The use of columns that contain a gel material has replaced manual dialysis separation in most analytic procedures.

LABORATORY MATHEMATICS AND CALCULATIONS

Significant Figures

Significant figures are the minimum number of digits needed to express a particular value in scientific notation without loss of accuracy. The number 814.2 has four significant figures, because in scientific notation it is written as 8.142×10^2 . The number 0.000641 has three significant figures, because the scientific notation expression for this value is 6.41×10^{-4} . The zeros are merely holding decimal places and are not needed to properly express the number in scientific notation.

Logarithms

The base 10 *logarithm* (log) of a positive number N greater than zero is equal to the exponent to which 10 must be raised to produce N . Therefore, it can be stated that N equals 10^x , and the log of N is equal to x . The number N is the antilogarithm (antilog) of x .

The logarithm of a number, which is written in *decimal* format, consists of two parts: the character, or characteristic, and the mantissa. The characteristic is the number to the left of the decimal point in the log and is derived from the exponent, and the **mantissa** is that portion of the logarithm to the right of the decimal point and is derived from the number itself. Although several approaches can be taken to determine the log, one approach is to write the number in scientific notation. The number 1,424 expressed in scientific notation is 1.424×10^3 , making the characteristic value a 3. The characteristic can also be determined by adding the number of significant figures and then subtracting 1 from the sum. The mantissa is derived from a log table or calculator having a log function for the remainder of the number. For 1.424, a calculator would give a mantissa of 0.1535. Certain calculators with a log function do not require conversion to scientific notation. This would give a log value of 3.1535 (3 plus 0.1535).

To determine the original number from a log value, the process is done in reverse. This process is termed the *antilogarithm*. If given a log of 3.1535, most calculators require that you enter this value, use an inverse function, and enter log, and the resulting value should be 1.424×10^3 . Consult the specific manufacturer's directions to become acquainted with the proper use of these functions.

Negative Logarithms

The characteristic of a log may be positive or negative, but the mantissa is always positive. In certain circumstances, the laboratory scientist must deal with inverse or negative logs. Such is the case with pH or pK_a . As previously stated, the pH of a solution is defined as minus the log of the hydrogen ion concentration. The following is a convenient formula to determine the negative logarithm when working with pH or pK_a :

$$\frac{\text{pH}}{pK_a} = x - \log N \quad (\text{Eq. 1-12})$$

where x is negative exponent base 10 expressed without the minus sign and N is the decimal portion of the scientific notations expression.

For example, if the hydrogen ion concentration of a solution is 5.4×10^{-6} , then $x = 6$ and $N = 5.4$. Substitute this information into Equation 1-12, and it becomes:

$$\text{pH} = 6 - \log 5.4 \quad (\text{Eq. 1-13})$$

The logarithm of N (5.4) is equal to 0.7324, or 0.73. The pH becomes

$$\text{pH} = 6 - 0.73 = 5.27 \quad (\text{Eq. 1-14})$$

The same formula can be applied to obtain the hydrogen ion concentration of a solution when only the pH is given. Using a pH of 5.27, the equation becomes

$$5.27 = x - \log N \quad (\text{Eq. 1-15})$$

In this instance, the x term is always the next largest whole number. For this example, the next largest whole number is 6. Substituting for x , the equation becomes

$$5.27 = 6 - \log N \quad (\text{Eq. 1-16})$$

Multiply all the variables by -1 :

$$(-1)(5.27) = (-1)(6) - (-1)(\log N).$$

$$-5.27 = -6 + \log N \quad (\text{Eq. 1-17})$$

Solve the equation for the unknown quantity by adding a positive 6 to both sides of the equal sign and the equation becomes:

$$6 - 5.27 = \log N$$

$$0.73 = \log N \quad (\text{Eq. 1-18})$$

The result is 0.73, which is the antilogarithm value of N , which is 5.37, or 5.4.

$$\text{Antilog } 0.73 = N; N = 5.37 = 5.4 \quad (\text{Eq. 1-19})$$

The hydrogen ion concentration for a solution with a pH of 5.27 is 5.4×10^{-6} . Many scientific calculators have an inverse function or syntax that allows for more direct calculation of inverse or negative logarithms. It is important, however, to fully understand the proper use of the many calculator functions available, keeping in mind that the specific steps vary between manufacturers.

Concentration

A detailed description of each concentration term (e.g., molarity, normality) may be found at the beginning of this chapter. The following discussion focuses on the basic mathematical expressions needed to prepare reagents of a stated concentration.

Percent Solution

A percent solution is determined in the same manner regardless of whether weight/weight, volume/volume, or weight/volume units are used. *Percent* implies "parts per 100," which is represented as percent (%) and is independent of the molecular weight of a substance.

Example 1-1 Weight/Weight (w/w)

To make up 100 g of a 5% aqueous solution of hydrochloric acid (using 12 M HCl), multiply the total

amount by the percent expressed as a decimal. The calculation becomes

$$5\% = \frac{5}{100} = 0.050 \quad (\text{Eq. 1-20})$$

Therefore,

$$0.050 \times 100 \text{ g} = 5 \text{ g of 12 M HCl} \quad (\text{Eq. 1-21})$$

Another way of arriving at the answer is to set up a ratio so that

$$\frac{5}{100} = \frac{x}{100}$$

$$x = 5 \quad (\text{Eq. 1-22})$$

Example 1-2 Weight/Volume (w/v)

The most frequently used term for a percent solution is weight per volume, which is often expressed as grams per 100 mL of diluent. To make up 1,000 mL of a 10% (w/v) solution of NaOH, use the preceding approach. The calculations become

$$0.10 \quad \times \quad 1000 = 100 \text{ g}$$

(% expressed as a decimal) (total amount)

or

$$\frac{10}{100} = \frac{x}{1000}$$

$$x = 100 \quad (\text{Eq. 1-23})$$

Therefore, add 100 g of 10% NaOH to a 1,000-mL volumetric Class A flask and dilute to the calibration mark with reagent grade water.

Example 1-3 Volume/Volume (v/v)

Make up 50 mL of a 2% (v/v) concentrated hydrochloric acid solution.

$$0.02 \times 50 = 1 \text{ mL}$$

or

$$\frac{2}{100} = \frac{x}{50}$$

$$x = 1 \quad (\text{Eq. 1-24})$$

Therefore, add 40 mL of water to a 50-mL Class A volumetric flask, add 1 mL of concentrated HCl, mix, and dilute up to the calibration mark with reagent grade water. Remember, always add acid to water!

Molarity

Molarity (*M*) is routinely expressed in units of moles per liter (mol/L) or sometimes millimoles per milliliter (mmol/mL). Remember that 1 mol of a substance is equal to the gmw of that substance. When trying to determine

the amount of substance needed to yield a particular concentration, initially decide what final concentration *units* are needed. For molarity, the final units will be moles per liter (mol/L) or millimoles per milliliter (mmol/mL). The second step is to consider the existing units and the relationship they have to the final desired units. Essentially, try to put as many units as possible into “like” terms and arrange so that the same units cancel each other out, leaving only those wanted in the final answer. To accomplish this, it is important to remember what units are used to define each concentration term. It is key to understand the relationship among molarity (moles/liter), moles, and gmw.

Example 1-4

How many *grams* are needed to make 1 L of a 2 *M* solution of HCl?

Step 1: Which *units* are needed in the final answer? *Answer:* Grams per liter (g/L).

Step 2: Assess other mass/volume terms used in the problem. In this case, moles are also needed for the calculation: How many grams are equal to 1 mole? The gmw of HCl, which can be determined from the periodic table, will be equal to 1 mole. For HCl, the gmw is 36.5, so the equation may be written as

$$\frac{36.5(\text{g})\text{HCl}}{\text{mol}} \times \frac{2 \text{ mol}}{\text{L}} = \frac{73(\text{g})\text{HCl}}{\text{L}} \quad (\text{Eq. 1-25})$$

Cancel out like units, and the final units should be grams per liter. In this example, 73 grams HCl per liter is needed to make up a 2 *M* solution of HCl.

Example 1-5

A solution of NaOH is contained within a Class A 1-L volumetric flask filled to the calibration mark. The content label reads 24 g of NaOH. Determine the molarity.

Step 1: What *units* are ultimately needed? *Answer:* Moles per liter (mol/L).

Step 2: The units that exist are grams and 1 L. NaOH may be expressed as moles and grams. The gmw of NaOH is calculated to equal 40 g/mol. Rearrange the equation so that grams can be canceled and the remaining units reflect those needed in the answer, which are mole/L.

Step 3: The equation becomes

$$\frac{24 \text{ g NaOH}}{\text{L}} \times \frac{1 \text{ mol}}{40 \text{ g NaOH}} = 0.6 \frac{\text{mol}}{\text{L}} \quad (\text{Eq. 1-26})$$

By canceling out like units and performing the appropriate calculations, the final answer of 0.6 *M* or 0.6 mol/L is derived.

Example 1-6

Make up 250 mL of a 4.8 *M* solution of HCl.

Step 1: *Units* needed? *Answer:* Grams (g).

Step 2: Determine the gmw of HCl (36.5 g), which is needed to calculate the molarity.

Step 3: Set up the equation, cancel out like units, and perform the appropriate calculations:

$$\frac{36.5 \text{ (g) HCl}}{\text{mol}} \times \frac{4.8 \text{ mol HCl}}{\cancel{\text{L}}} \times \frac{250 \text{ mL} \times \cancel{1 \text{ L}}}{1,000 \text{ mL}}$$

$$= 43.8 \text{ (g) HCl} \quad (\text{Eq. 1-27})$$

In a 250-mL volumetric flask, add 200 mL of reagent grade water. Add 43.8 g of HCl and mix. Dilute up to the calibration mark with reagent grade water.

Although there are various methods to calculate laboratory mathematical problems, this technique of canceling like units can be used in most clinical chemistry situations, regardless of whether the problem requests molarity, normality, or exchanging one concentration term for another. However, it is necessary to recall the interrelationship between all the units in the expression.

Normality

Normality (N) is expressed as the number of equivalent weights per liter (Eq/L) or milliequivalents per milliliter (mEq/mL). Equivalent weight is equal to gmw divided by the valence (V). Normality has often been used in acid-base calculations because an equivalent weight of a substance is also equal to its combining weight. Another advantage in using equivalent weight is that an equivalent weight of one substance is equal to the equivalent weight of any other chemical.

Example 1-7

Give the equivalent weight, in grams, for each substance listed below.

- NaCl (gmw = 58 g, valence = 1)
 $58/1 = 58 \text{ g per equivalent weight} \quad (\text{Eq. 1-28})$
- HCl (gmw = 36, valence = 1)
 $36/1 = 36 \text{ g per equivalent weight} \quad (\text{Eq. 1-29})$
- H_2SO_4 (gmw = 98, valence = 2)
 $98/2 = 49 \text{ g per equivalent weight} \quad (\text{Eq. 1-30})$

A. What is the normality of a 500-mL solution that contains 7 g of H_2SO_4 ? The approach used to calculate molarity could be used to solve this problem as well.

Step 1: Units needed? *Answer:* Normality expressed as equivalents per liter (Eq/L).

Step 2: Units you have? *Answer:* Milliliters and grams. Now determine how they are related to equivalents per liter. (Hint: There are 49 g per equivalent—see Equation 1-30 above.)

Step 3: Rearrange the equation so that like terms cancel out, leaving Eq/L. This equation is

$$\frac{7 \text{ g H}_2\text{SO}_4}{500 \text{ mL}} \times \frac{1 \text{ (Eq)}}{49 \text{ g H}_2\text{SO}_4} \times \frac{1,000 \text{ mL}}{1 \text{ L}}$$

$$= 0.285 \text{ Eq/L} = 0.285 \text{ N} \quad (\text{Eq. 1-31})$$

Because 500 mL is equal to 0.5 L, the final equation could be written by substituting 0.5 L for 500 mL, eliminating the need to include the 1,000 mL/L conversion factor in the equation.

B. What is the normality of a 0.5 M solution of H_2SO_4 ? Continuing with the previous approach, the final equation is

$$\frac{0.5 \text{ mol H}_2\text{SO}_4}{\text{L}} \times \frac{98 \text{ g H}_2\text{SO}_4}{\text{mol H}_2\text{SO}_4} \times \frac{1 \text{ (Eq) H}_2\text{SO}_4}{49 \text{ g H}_2\text{SO}_4}$$

$$\frac{0.5 \text{ mol H}_2\text{SO}_4}{\text{L}} \times \frac{98 \text{ g H}_2\text{SO}_4}{\text{mol H}_2\text{SO}_4} \times \frac{1 \text{ (Eq) H}_2\text{SO}_4}{49 \text{ g H}_2\text{SO}_4}$$

$$= 1 \text{ Eq/L} = 1 \text{ N} \quad (\text{Eq. 1-32})$$

When changing molarity into normality or vice versa, the following conversion formula may be applied:

$$M \times V = N \quad (\text{Eq. 1-33})$$

where V is the valence of the compound. Using this formula, Example 1-7.3 becomes

$$0.5 \text{ M} \times 2 = 1 \text{ N} \quad (\text{Eq. 1-34})$$

Example 1-8

What is the molarity of a 2.5 N solution of HCl? This problem may be solved in several ways. One way is to use the stepwise approach in which existing units are exchanged for units needed. The equation is

$$\frac{2.5 \text{ Eq HCl}}{\text{L}} \times \frac{36 \text{ g HCl}}{1 \text{ Eq}} \times \frac{1 \text{ (mol) HCl}}{36 \text{ g HCl}}$$

$$= 2.5 \text{ mol/L HCl} \quad (\text{Eq. 1-35})$$

The second approach is to use the normality-to-molarity conversion formula. The equation now becomes

$$M \times V = 2.5 \text{ N}$$

$$V = 1$$

$$M = \frac{2.5 \text{ N}}{1} = 2.5 \text{ N} \quad (\text{Eq. 1-36})$$

When the valence of a substance is 1, the molarity will equal the normality. As previously mentioned, normality either equals or is greater than the molarity.

Specific Gravity

Density is expressed as mass per unit volume. The specific gravity is the ratio of the density of a material when compared to the density of water at a given temperature. The units for specific gravity are grams per milliliter. Specific gravity is often used with very concentrated materials, such as commercial acids (e.g., sulfuric and hydrochloric acids).

The density of a concentrated acid can also be expressed in terms of an assay or percent purity. The actual concentration is equal to the **specific gravity** multiplied by the *assay* or *percent purity value* (expressed as a decimal) stated on the label of the container.

Example 1-9

A. What is the actual weight of a supply of concentrated HCl whose label reads specific gravity 1.19 with an assay value of 37%?

$$1.19 \text{ g/mL} \times 0.37 = 0.44 \text{ g/mL of HCl} \quad (\text{Eq. 1-37})$$

B. What is the molarity of this stock solution? The final units desired are moles per liter (mol/L). The molarity of the solution is

$$\frac{0.44 \text{ g HCl}}{\text{mL}} \times \frac{1 \text{ (mol) HCl}}{35 \text{ g HCl}} \times \frac{1,000 \text{ mL}}{\text{L}} \\ = 12.05 \text{ mol/L or } 12 \text{ M} \quad (\text{Eq. 1-38})$$

Conversions

To convert one unit into another, the same approach of crossing out like units can be applied. In some instances, a chemistry laboratory may report a given analyte using two different concentration units—for example, calcium. The recommended SI unit for calcium is millimoles per liter. The better known and more traditional units are milligrams per deciliter (mg/dL). Again, it is important to understand the relationship between the units given and those needed in the final answer.

Example 1-10

Convert 8.2 mg/dL calcium to millimoles per liter (mmol/L). The gmw of calcium is 40 g. So, if there are 40 g per mol, then it follows that there are 40 mg per mmol. The units wanted are mmol/L. The equation becomes

$$\frac{8.2 \text{ mg}}{\text{dL}} \times \frac{1 \text{ dL}}{100 \text{ mL}} \times \frac{1,000 \text{ mL}}{\text{L}} \times \frac{1 \text{ (mmol)}}{40 \text{ mg}} \\ = \frac{2.05 \text{ mmol}}{\text{L}} \quad (\text{Eq. 1-39})$$

Once again, the systematic stepwise approach of deleting similar units can be used for this conversion problem.

A frequently encountered conversion problem or, more precisely, a dilution problem occurs when a weaker concentration or different volume is needed than the stock substance available, but the concentration *terms* are the same. The following formula is used:

$$V_1 \times C_1 = V_2 \times C_2 \quad (\text{Eq. 1-40})$$

This formula is useful only if the concentration and volume units between the substances are the *same* and if three of four variables are known.

Example 1-11

What volume is needed to make 500 mL of a 0.1 M solution of Tris buffer from a solution of 2 M Tris buffer?

$$V_1 \times 2M = 0.1M \times 500 \text{ mL} \\ (V_1)(2M) = (0.1M)(500 \text{ mL}); (V_1)(2M) = 50; \\ \text{therefore } V_1 = 50/2 = 25 \text{ mL} \quad (\text{Eq. 1-41})$$

It requires 25 mL of the 2 M solution to make up 500 mL of a 0.1 M solution. This problem differs from the other conversions in that it is actually a dilution of a stock solution. A more involved discussion of dilution problems follows.

Dilutions

A **dilution** represents the ratio of concentrated or stock material to the total final volume of a solution and consists of the volume or weight of the concentrate plus the volume of the diluent, with the concentration units remaining the same. This ratio of concentrated or stock solution to the total solution volume equals the **dilution factor**. Because a dilution is made by adding a more concentrated substance to a diluent, the dilution is always less concentrated than the original substance. The relationship of the dilution factor to concentration is an inverse one; thus, the *dilution factor increases* as the *concentration decreases*. To determine the dilution factor, simply take the amount needed and divide by the stock concentration, leaving it in a reduced-fraction form.

Example 1-12

What is the dilution factor needed to make a 100 mEq/L sodium solution from a 3,000 mEq/L stock solution? The dilution factor becomes

$$\frac{100}{3,000} = \frac{1}{30} \quad (\text{Eq. 1-42})$$

The dilution factor indicates that the ratio of stock material is 1 part stock made to a *total volume* of 30. To actually make this dilution, 1 mL of stock is added to 29 mL of diluent. Note that the dilution factor indicates the parts per total amount; however, in *making* the dilution, the sum of the amount of the stock material plus the amount of the diluent must equal the total volume or dilution fraction denominator. The dilution factor may be correctly written as either a fraction or a ratio. Confusion arises when distinction is not made between a ratio and a dilution, which by its very nature is a ratio of stock to diluent. A ratio is always expressed using a colon; a dilution can be expressed as either a fraction or a ratio.²⁶ Many directions in the laboratory are given orally. For example, making a “1-in-4” dilution means adding one part stock to a total of four parts. That is, one part of stock would be added “to” three parts of diluent. The dilution factor would be 1/4. Analyses performed on the diluted material would need to be multiplied by 4 to get the final concentration. That is very different from saying make a “1-to-4” dilution! In this instance, the dilution factor would be 1/5! It is important during procedures that you fully understand the meaning of these expressions. Sample dilutions should be made using either reagent grade water, saline, or method-specific diluent using Class A glassware. The

sample and diluent should be thoroughly mixed before use. It is not recommended that sample dilutions be made in smaller-volume sample cups or holders. Any total volume can be used as long as the fraction reduces to give the dilution factor.

Example 1-13

If in the preceding example 150 mL of the 100 mEq/L sodium solution was required, the dilution ratio of stock to total volume must be maintained. Set up a ratio between the desired total volume and the dilution factor to determine the amount of stock needed. The equation becomes

$$\frac{1}{30} = \frac{x}{150}$$

$$x = 5 \quad \text{(Eq. 1-43)}$$

Note that $\frac{1}{30}$ reduces to the dilution factor of $\frac{1}{30}$. To make up this solution, 5 mL of stock is added to 145 mL of the appropriate diluent, making the ratio of *stock volume* to *diluent volume* equal to $\frac{1}{145}$. Recall that the dilution factor includes the total volume of *both* stock plus diluent in the denominator and differs from the amount of diluent to stock that is needed.

Example 1-14

Many laboratory scientists like using $(V_1)(C_1) = (V_2)(C_2)$ for simple dilution calculations. This is fine, as long as you recall that you will need to subtract the stock volume from the total volume final for the correct *diluent* volume.

$$(V_1)(C_1) = (V_2)(C_2)$$

$$(x)(3,000) = (150)(100)$$

$$x = 5; 150 - 5 = 145 \text{ mL of diluent}$$

should be added to 5 mL of stock (Eq. 1-44)

Simple Dilutions

When making a *simple dilution*, the laboratory scientist must decide on the total volume desired and the amount of stock to be used.

Example 1-15

A 1:10 ($\frac{1}{10}$) dilution of serum can be achieved by using any of the following approaches. A ratio of 1:9—one part serum and nine parts diluent (saline):

- 100 μL of serum added to 900 μL of saline.
- 20 μL of serum added to 180 μL of saline.
- 1 mL of serum added to 9 mL of saline.
- 2 mL of serum added to 18 mL of saline.

Note that the sum of the ratio of serum to diluent (1:9) needed to make up each dilution satisfies the dilution factor (1:10 or $\frac{1}{10}$) of stock material to total volume. When thinking about the stock to diluent volume, subtract the

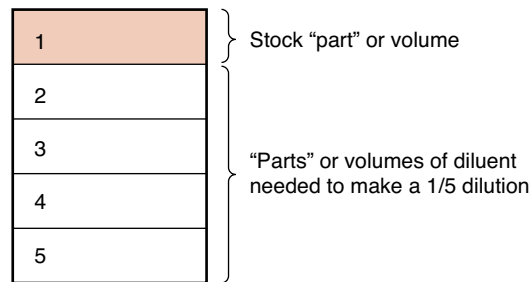

FIGURE 1-14. Simple dilution. Consider this diagram depicting a substance having a 1/5 dilution factor. The dilution factor represents that 1 part of stock is needed of a total of 5 parts. To *make* this dilution, you would determine the volume of 1 “part,” usually the stock or patient sample. The remainder of the “parts” or total would constitute the amount of diluent needed, or four times the volume used for the stock.

parts of stock needed from the total volume or parts to get the number of diluent “parts” needed. Once the volume of each part, usually stock, is available, multiply the diluent parts needed to obtain the correct volume.

Example 1-16

You have a 10 g/dL stock of protein standard. You need a 2 g/dL standard. You only have 0.200 mL of 10 g/dL stock to use. The procedure requires 0.100 mL.

Solution:

$$\frac{2 \text{ g/dL}}{10 \text{ g/dL}} = \frac{1}{5} = \text{Dilution factor} \quad \text{(Eq. 1-45)}$$

You will need 1 part or volume of stock of a total of 5 parts or volumes. Subtracting 1 from 5 yields that 4 parts or volumes of diluent is needed (Fig. 1-14.) In this instance, you need at least 0.100 mL for the procedure. You have 0.200 mL of stock. You can make the dilution in various ways, as seen in Example 1-17. This is a personal decision and often reflects the volumes of available pipets, etc.

Example 1-17

There are several ways to make a 1/5 dilution having only 0.200 mL of stock and needing a total minimum volume of 0.100 mL.

- Add 0.050 mL stock (1 part) to 0.200 mL of diluent (4 parts \times 0.050 mL).
- Add 0.100 mL of stock (1 part) to 0.400 mL of diluent (4 parts \times 0.100 mL).
- Add 0.200 mL of stock (1 part) to 0.800 mL of diluent (4 parts \times 0.200 mL).

The dilution factor is also used to determine the final concentration of a dilution by multiplying the original concentration by the inverse of the dilution factor or the dilution factor denominator when it is expressed as a fraction.

Example 1-18

Determine the concentration of a 200 μmol/mL human chorionic gonadotropin (hCG) standard that was diluted 1/50. This value is obtained by multiplying the original concentration, 200 μmol/mL hCG, by the dilution factor, 1/50. The result is 4 μmol/mL hCG. Quite often, the concentration of the original material is needed.

Example 1-19

A 1:2 dilution of serum with saline had a creatinine result of 8.6 mg/dL. Calculate the actual serum creatinine concentration.

Dilution factor: 1/2

Dilution result = 8.6 mg/dL

Because this result represents 1/2 of the concentration, the actual serum creatinine value is

$$2 \times 8.6 = 17.2 = 17.2 \text{ mg/dL} \quad (\text{Eq. 1-46})$$

Serial Dilutions

A **serial dilution** may be defined as multiple progressive dilutions ranging from more-concentrated solutions to less-concentrated solutions. Serial dilutions are extremely useful when the volume of concentrate or diluent is in short supply and needs to be minimized or a number of dilutions are required, such as in determining a titer. The volume of patient sample available to the laboratory may be small (e.g., pediatric samples), and a serial dilution may be needed to ensure that sufficient sample is available. The serial dilution is initially made in the same manner as a simple dilution. Subsequent dilutions will then be made from each preceding dilution. When a serial dilution is made, certain criteria may need to be satisfied. The criteria vary with each situation but usually include such considerations as the total volume desired, the amount of diluent or concentrate available, the dilution factor, the final concentration needed, and the support materials required.

Example 1-20

A sample is to be diluted 1:2, 1:4, and, finally, 1:8. It is arbitrarily decided that the total volume for each dilution is to be 1 mL. Note that the least common denominator for these dilution factors is 2. Once the first dilution is made (1/2), a 1:2 (least common denominator between 2 and 4) dilution of it will yield

$$\frac{1}{2} \times \frac{1}{2} = \frac{1}{4}$$

$$\begin{aligned} &(\text{initial dilution factor})(\text{next dilution factor}) \\ &= (\text{final dilution factor}) \quad (\text{Eq. 1-47}) \end{aligned}$$

By making a 1:2 dilution of the first dilution, the second dilution factor of 1:4 is satisfied. Making a 1:2 dilu-

tion of the 1:4 dilution will result in the next dilution (1:8). To establish the dilution factor needed for subsequent dilutions, it is helpful to solve the following equation for (x):

$$\begin{aligned} &\text{Stock/preceding concentration} \times (x) \\ &= (\text{final dilution factor}) \quad (\text{Eq. 1-48}) \end{aligned}$$

To make up these dilutions, three test tubes are labeled 1:2, 1:4, and 1:8, respectively. One milliliter of diluent is added to each test tube. To make the primary dilution of 1:2, 1 mL of serum is added to test tube no. 1. The solution is mixed, and 1 mL of the primary dilution is removed and added to test tube no. 2. After mixing, this solution contains a 1:4 dilution. Then 1 mL of the 1:4 dilution from test tube no. 2 is added to test tube no. 3. Mix, and the resultant dilution in this test tube is 1:8, satisfying all of the previously established criteria. Refer to Figure 1-15 for an illustration of this serial dilution.

Example 1-21

Another type of serial dilution combines several dilution factors that are not multiples of one another. In our previous example, 1:2, 1:4, and 1:8 dilutions are all related to one another by a factor of 2. Consider the situation when 1:10, 1:20, 1:100, and 1:200 dilution factors are required. There are several approaches to solving this type of dilution problem. One method is to treat the 1:10 and 1:20 dilutions as one serial dilution problem, the 1:20 and 1:100 dilutions as a second serial dilution, and the 1:100 and 1:200 dilutions as the last serial dilution. Another approach is to consider what dilution factor of the concentrate is needed to yield the final dilution. In this example, the initial dilution is 1:10, with subsequent dilutions of 1:20, 1:100, and 1:200. The first dilution may be accomplished by adding 1 mL of stock to 9 mL of diluent. The total volume of solution is 10 mL. Our initial dilution factor has been satisfied. In making the remaining dilutions, 2 mL of diluent is added to each test tube.

$$\text{Initial/preceding dilution} \times (x) = \text{dilution needed}$$

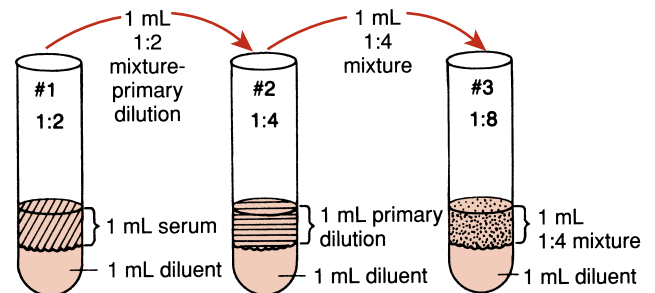

FIGURE 1-15. Serial dilution.

Solve for (x).

Using the dilution factors listed above and solving for (x), the equations become

$$1:10 \times (x) = 1:20,$$

where (x) = 2 (or 1 part stock to 1 part diluent)

$$1:20 \times (x) = 1:100,$$

where (x) = 5 (or 1 part stock to 4 parts diluent)

$$1:100 \times (x) = 1:200,$$

where (x) = 2 (or 1 part stock to 1 part diluent)

(Eq. 1-49)

In practice, the 1:10 dilution must be diluted by a factor of 2 to obtain a subsequent 1:20 dilution. Because the second tube already contains 2 mL of diluent, 2 mL of the 1:10 dilution should be added (1 part stock to 1 part diluent). In preparing the 1:100 dilution from this, a 1:5 dilution factor of the 1:20 mixture is required (1 part stock to 4 parts diluent). Because this tube already contains 2 mL, the volume of diluent in the tube is divided by its parts, which is 4; thus, 500 μ L, or 0.500 mL, of stock should be added. The 1:200 dilution is prepared in the same manner using a 1:2 dilution factor (1 part stock to 1 part diluent) and adding 2 mL of the 1:100 to the 2 mL of diluent already in the tube.

Water of Hydration

Some compounds are available in a hydrated form. To obtain a correct weight for these chemicals, the attached water molecule(s) must be included.

Example 1-22

How much $\text{CuSO}_4 \cdot 5\text{H}_2\text{O}$ must be weighed to prepare 1 L of 0.5 M CuSO_4 ? When calculating the gmw of this substance, the water weight must be considered so that the gmw is 250 g rather than gmw of CuSO_4 alone (160 g). Therefore,

$$\frac{250 \text{ g } \text{CuSO}_4 \cdot 5\text{H}_2\text{O}}{\text{mol}} \times \frac{0.5 \text{ mol}}{1 \text{ L}} = 125 \text{ g/L} \quad (\text{Eq. 1-50})$$

Cancel out like terms to obtain the result of 125 g/L. A reagent protocol often designates the use of an anhydrous form of a chemical; frequently, however, all that is available is a hydrated form.

Example 1-23

A procedure requires 0.9 g of CuSO_4 . All that is available is $\text{CuSO}_4 \cdot 5\text{H}_2\text{O}$. What weight of $\text{CuSO}_4 \cdot 5\text{H}_2\text{O}$ is needed? Calculate the percentage of CuSO_4 present in $\text{CuSO}_4 \cdot 5\text{H}_2\text{O}$. The percentage is

$$\frac{160}{250} = 0.64, \text{ or } 64\% \quad (\text{Eq. 1-51})$$

Therefore, 1 g of $\text{CuSO}_4 \cdot 5\text{H}_2\text{O}$ contains 0.64 g of CuSO_4 , so the equation becomes:

$$\frac{0.9 \text{ g } \text{CuSO}_4 \text{ needed}}{0.64 \text{ CuSO}_4 \text{ in } \text{CuSO}_4 \cdot \text{H}_2\text{O}} = 1.41 \text{ g } \text{CuSO}_4 \cdot 5\text{H}_2\text{O} \text{ required} \quad (\text{Eq. 1-52})$$

Graphing and Beer's Law

The **Beer-Lambert law (Beer's law)** mathematically establishes the relationship between concentration and absorbance in many photometric determinations. Beer's law is expressed as

$$A = abc \quad (\text{Eq. 1-53})$$

where *A* is absorbance; *a* is absorptivity constant for a particular compound at a given wavelength under specified conditions of temperature, pH, and so on; *b* is length of the light path; and *c* is concentration.

If a method follows Beer's law, then absorbance is proportional to concentration as long as the length of the light path and the absorptivity of the absorbing species remains unaltered during the analysis. In practice, however, there are limits to the predictability of a linear response. Even in automated systems, adherence to Beer's law is often determined by checking the linearity of the test method over a wide concentration range. The limits of linearity often represent the reportable range of an assay. This term should not be confused with the reference ranges associated with clinical significance of a test. Assays measuring absorbance generally obtain the concentration results by using a Beer's law graph, known as a standard graph or curve. This graph is made by plotting absorbance versus the concentration of known standards (Fig. 1-16). Because most photometric assays set the initial absorbance to zero (0) using a reagent blank, the initial data points are 0,0. Graphs should be labeled properly and the concentration units must be given. The horizontal axis is referred to as the x-axis, whereas the vertical line is the y-axis. It is not important which

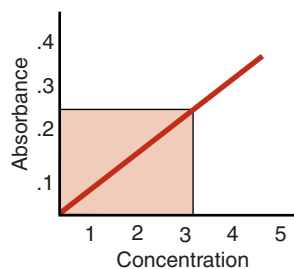

Unknown absorbance = .250
Concentration from graph = 3.2

FIGURE 1-16. Standard curve.

variable (absorbance or concentration) is assigned to an individual axis, but it is important that the values assigned to them are uniformly distributed along the axis. By convention, in the clinical laboratory, concentration is usually plotted on the x -axis. On a standard graph, only the standard and the associated absorbances are plotted.

Once a standard graph has been established, it is permissible to run just one standard, or calibrator, as long as the system remains the same. **One-point calculation or calibration** refers to the calculation of the comparison of the known standard/calibrator concentration and its corresponding absorbance to the absorbance of the unknown value according to the following ratio:

$$\frac{\text{Concentration of standard (Cs)}}{\text{Absorbance of standard (As)}} = \frac{\text{Concentration of unknown (Cu)}}{\text{Absorbance of unknown (Au)}} \quad (\text{Eq. 1-54})$$

Solving for the concentration of the unknown, the equation becomes:

$$C_u = \frac{(A_u)(C_s)}{A_s} \quad (\text{Eq. 1-55})$$

Example 1-24

The biuret protein assay is very stable and follows Beer's law. Rather than make up a completely new standard graph, one standard (6 g/dL) was assayed. The absorbance of the standard was 0.400, and the absorbance of the unknown was 0.350. Determine the value of the unknown in g/dL.

$$C_u = \frac{(0.350)(6 \text{ g/dL})}{(0.400)} = 5.25 \text{ g/DL} \quad (\text{Eq. 1-56})$$

This method of calculation is acceptable as long as everything in the system, including the instrument and lot of reagents, remains the same. If anything in the system changes, a new standard graph should be done. Verification of linearity and/or calibration is required whenever a system changes or becomes unstable. Regulatory agencies often prescribe the condition of verification as well as the how often the linearity needs to be checked.

Enzyme Calculations

Another application of Beer's law is the calculation of enzyme assay results. When calculating enzyme results, the *rate of absorbance change* is often monitored continuously during the reaction to give the difference in absorbance, known as the **delta absorbance**, or ΔA . Instead of using a standard graph or a one-point calculation, the molar absorptivity of the product is used. If the absorptivity constant and absorbance, in this case ΔA , is given, Beer's law can be used to calculate the enzyme concen-

tration directly without initially needing a standard graph, as follows:

$$A = abc$$

$$C = \frac{A}{ab} \quad (\text{Eq. 1-57})$$

When the absorptivity constant (a) is given in units of grams per liter (moles) through a 1-centimeter (cm) light path, the term *molar absorptivity* (ϵ) is used. Substitution of ϵ for a and ΔA for A produces the following Beer's law formula:

$$C = \frac{\Delta A}{\epsilon} \quad (\text{Eq. 1-58})$$

Units used to report enzyme activity traditionally have included weight, time, and volume. In the early days of enzymology, method-specific units (e.g., King-Armstrong, Caraway) were all different and confusing. In 1961, the Enzyme Commission of the International Union of Biochemistry recommended using one unit, the **international unit (IU)**, for reporting enzyme activity. The IU is defined as the amount of enzyme that will catalyze 1 μmol of substrate per minute per liter. These units were often expressed as units per liter (U/L). The designations IU, U, or IU/L were adopted by many clinical laboratories to represent the IU. Although the reporting unit is the same, unless the analysis conditions are identical, use of the IU does not standardize the actual enzyme activity and, therefore, results between different methods of the same enzyme do not result in equivalent activity of the enzyme. For example, an ALP performed at 37°C will catalyze more substrate than if it is run at lower temperature, such as 25°C, even though the unit of expression, U/L, will be the same. The SI recommended unit is the *katal*, which is expressed as moles per liter per second. Whichever unit is used, calculation of the activity using Beer's law requires inclusion of the dilution and, depending on the reporting unit, possible conversion to the appropriate term (e.g., μmol to mol, mL to L, minute to second, and temperature factors). Beer's law for the IU now becomes:

$$C = \frac{(\Delta A) 10^{-6} (TV)}{(\epsilon) (b)(SV)} \quad (\text{Eq. 1-59})$$

where TV is total volume of sample plus reagents in mL and SV is sample volume used in mL. The 10^{-6} converts moles to nmol for the IU. If another unit of activity is used, such as the katal, conversion into liters and seconds would be needed, but the conversions to and from micromoles are excluded.

Example 1-25

The ΔA per minute for an enzyme reaction is 0.250. The product measured has a molar absorptivity of 12.2×10^3 at 425 nm at 30°C. The incubation and reaction

temperature are also kept at 30°C. The assay calls for 1 mL of reagent and 0.050 mL of sample. Give the enzyme activity results in international units.

Applying Beer's law and the necessary conversion information, the equation becomes:

$$C = \frac{(0.250)(10^{-6})(1.050 \text{ mL})}{(12.2 \times 10^3)(1)(0.050 \text{ mL})} = 430 \text{ U} \quad (\text{Eq. 1-60})$$

Note: b is usually given as 1 cm; because it is a constant, it may not be considered in the calculation.

SPECIMEN CONSIDERATIONS

The process of specimen collection, handling, and processing remains one of the primary areas of *preanalytic* error. Careful attention to each phase is necessary to ensure proper subsequent testing and reporting of meaningful results. All accreditation agencies require laboratories to clearly define and delineate the procedures used for proper collection, transport, and processing of patient samples and the steps used to minimize and detect any errors, along with the documentation of the resolution of any errors. The Clinical Laboratory Improvement Amendments Act of 1988 (CLIA 88)²⁷ specifies procedures for specimen submission and proper handling, including the disposition of any specimen that does not meet the laboratories' criteria of acceptability, be documented.

Types of Samples

Phlebotomy, or *venipuncture*, is the act of obtaining a blood sample from a vein using a needle attached to a syringe or a stoppered *evacuated tube*. These tubes come in different volume sizes; from pediatric sizes ($\approx 150 \mu\text{L}$) to larger, 7-mL tubes. The most frequent site for venipuncture is the antecubital of the arm. A tourniquet made of pliable rubber tubing or a strip with Velcro at the end is wrapped around the arm, causing a cessation of blood flow and dilation of the veins, making them easier to detect. The gauge of the needle is inversely related to the size of the needle; the larger the number, the smaller are the needle bore and length. An intravenous (IV) infusion set, sometimes referred to as a butterfly because of the appearance of the setup, is used whenever the veins are fragile, small, or hard to reach or find. The butterfly is attached to a piece of tubing, which is then attached to either a hub or a tube. Sites adjacent to IV therapy should be avoided; however, if both arms are involved in IV therapy and the IV cannot be discontinued for a short time, a site *below* the IV site should be sought. The initial sample drawn (5 mL) should be discarded because it is most likely contaminated with IV fluid and only subsequent sample tubes should be used for analytic purposes.

In addition to venipuncture, blood samples can be collected using a skin puncture technique that customar-

ily involves the outer area of the bottom of the foot (a heel stick), the fleshy part of the middle of the last phalanx of the third or fourth (ring) finger (finger stick), or possibly the fleshy portion of the earlobe. A sharp lancet is used to pierce the skin and a capillary tube (i.e., short, narrow glass tube) is used for sample collection. Additional information regarding phlebotomy and skin puncture is available in Chapter 2.²⁸

Analytic testing of blood involves the use of whole blood, serum, or plasma. **Whole blood**, as the name implies, uses both the liquid portion of the blood called *plasma* and the cellular components (red blood cells, white blood cells, and platelets). This requires blood collection into a vessel containing an anticoagulant. Complete mixing of the blood immediately following venipuncture is necessary to ensure the anticoagulant can adequately inhibit the blood's clotting factors. As whole blood sits, the cells fall toward the bottom, leaving a clear yellow supernate on top called *plasma*. If a tube does *not* contain an anticoagulant, the blood's clotting factors are active to form a clot incorporating the cells. The clot is encapsulated by the large protein fibrinogen. The remaining liquid is called **serum** rather than plasma (Fig. 1-17). Most testing in the clinical chemistry laboratory is performed on either plasma or serum. The major difference between plasma and serum is that serum does not contain fibrinogen (i.e., there is less protein in serum than plasma) and some potassium is released from platelets (serum potassium is slightly higher in serum than in plasma). It is important that serum samples be allowed to completely clot (≈ 20 minutes) before being centrifuged.

Centrifugation of the sample accelerates the process of separating the plasma and cells. Specimens should be centrifuged for approximately 10 minutes at an RCF of 1,000g to 2,000g but should avoid mechanical destruction of red cells that can result in hemoglobin release, called **hemolysis**.

Arterial blood samples measure blood gases (partial pressures of oxygen and carbon dioxide) and pH. Syringes are used instead of evacuated tubes because of the pressure in an arterial blood vessel. The radial, brachial, and femoral arteries are the primary arterial sites. Arterial punctures are more difficult to perform because of inherent arterial pressure, difficulty in stopping bleeding afterward, and the undesirable development of a hematoma, which cuts off the blood supply to the surrounding tissue.²⁹

Continued metabolism may occur if the serum or plasma remains in contact with the cells for any period. Evacuated tubes may incorporate plastic, gel-like material that serves as a barrier between the cells and the plasma or serum and seals these compartments from one another during centrifugation. Some gels can interfere with certain analytes, notably trace metals, and drugs such as the tricyclic antidepressants.

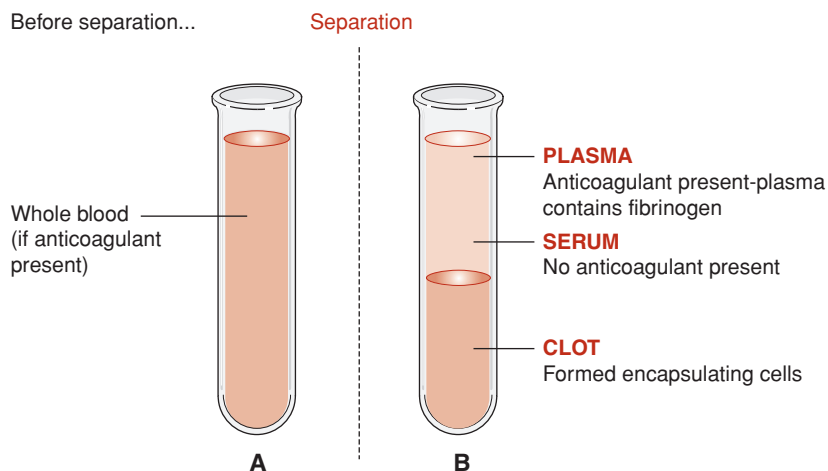

FIGURE 1-17. Blood sample.

Proper patient identification is the first step in sample collection. The importance of using the proper collection tube, avoiding prolonged tourniquet application, drawing tubes in the proper order, and proper labeling of tubes cannot be stressed strongly enough. Prolonged tourniquet application causes a stasis of blood flow and an increase in hemoconcentration and anything bound to proteins or the cells. Having patients open and close their fist during phlebotomy is of no value and may cause an increase in potassium and, therefore, should be avoided. Intravenous contamination should be considered if a large increase occurs in the substances being infused, such as glucose, potassium, sodium, and chloride, with a decrease of other analytes such as urea and creatinine. In addition, the proper antiseptic must be used. Isopropyl alcohol wipes, for example, are used for cleaning and disinfecting the collection site; however, this is not the proper antiseptic for disinfecting the site when drawing blood alcohol levels.

Blood is not the only sample analyzed in the clinical chemistry laboratory. Urine is the next most common fluid for determination. Most quantitative analyses of urine require a timed sample (usually 24 hours); a complete sample (all urine must be collected in the specified time) can be difficult because many timed samples are collected by the patient in an outpatient situation. Creatinine analysis is often used to assess the completeness of a 24-hour urine sample because creatinine output is relatively free from interference and is stable, with little change in output between individuals. The average adult excretes 1 to 2 g of creatinine per 24 hours. Urine volume differs widely among individuals; however, a 4-L container is adequate (average output is ≈ 2 L). It should be noted that this analysis differs from the creatinine clearance test used to assess glomerular filtration rate, which compares urine creatinine output with that in

the serum in a specified time interval and urine volume (often correcting for the surface area). The generic formula is:

$$\text{UV/P} \quad (\text{Eq. 1-61})$$

where U represents the urine creatinine value in mg/dL, V is urine volume per unit of time expressed in mL/min, and P is the plasma or serum creatinine value in mg/dL. This formula expresses the creatinine clearance value in mL/min (see Chapter 24).

Other body fluids analyzed by the clinical chemistry laboratory include **cerebrospinal fluid (CSF)**, *paracentesis* fluids (pleural, pericardial, and peritoneal), and amniotic fluids. The color and characteristics of the fluid *before* centrifugation should be noted for these samples. *Before* centrifugation, a laboratorian should also verify that the sample is designated for clinical chemistry analysis *only* because a single fluid sample may be shared among several departments (i.e., hematology or microbiology) and centrifugation could invalidate certain tests in those areas.

CSF is an ultrafiltrate of the plasma and will, ordinarily, reflect the values seen in the plasma. For glucose and protein analysis (total and specific proteins), it is recommended that a blood sample be analyzed concurrently with the analysis of those analytes in the CSF. This will assist in determining the clinical utility of the values obtained on the CSF sample. This is also true for lactate dehydrogenase and protein assays requested on paracentesis fluids. All fluid samples should be handled immediately without delay between sample procurement, transport, and analysis.

Amniotic fluid is used to assess fetal lung maturity (L/S ratio), congenital diseases, hemolytic diseases, genetic defects, and gestational age. The laboratory scientist should verify the specific handling of this fluid with the manufacturer of the testing procedure(s).

Sample Processing

When samples arrive in the laboratory, the samples are then processed. In the clinical chemistry laboratory, this means correctly matching the blood collection tube(s) with the appropriate analyte request and patient identification labels. This is a particularly sensitive area of preanalytic error. Bar code labels on primary sample tubes are a popular means to detect errors and to minimize clerical errors at this point of the processing. In some facilities, samples are numbered or entered into work lists or a second identification system that is useful during the analytic phase. The laboratory scientist must also ascertain if the sample is acceptable for further processing. The criteria used depend on the test involved but usually include volume considerations (i.e., is there sufficient volume for testing needs?), use of proper anticoagulants or preservatives, whether timing is clearly indicated and appropriate for timed testing, and whether the specimen is intact and has been properly transported (e.g., cooled or on ice, within a reasonable period, protected from light, in a tube that is properly capped). Unless a whole blood analysis is being performed, the sample is then centrifuged as previously described and the serum or plasma should be separated from the cells.

Once processed, the laboratory scientist should note the presence of any serum or plasma characteristics such as *hemolysis* and *icterus* (increased bilirubin pigment) or the presence of turbidity often associated with *lipemia* (increased lipids). Samples should be analyzed within 4 hours; to minimize the effects of evaporation, samples should be properly capped and kept away from areas of rapid airflow, light, and heat. If testing is to occur after that time, samples should be appropriately stored. For most, this means refrigeration at 4°C for 8 hours. Many analytes are stable at this temperature, with the exception of alkaline phosphatase (increases) and lactate dehydrogenase (decreases as a result of temperature labile fractions four and five). Samples may be frozen at -20°C and stored for longer periods without deleterious effects on the results. Repeated cycles of freezing and thawing, like those that occur in so-called frost-free freezers, should be avoided.

Sample Variables

Sample variables include physiologic considerations, proper patient preparation, and problems in collection, transportation, processing, and storage. Although laboratorians must include mechanisms to minimize the effect of these variables on testing and must document each preanalytic incident, it is often frustrating to try to control the variables that largely depend on individuals outside of the laboratory. The best course of action is to critically assess or predict the weak areas or links, identify potential

problems, and put an action plan in place that contains policies, procedures, or checkpoints throughout the sample's journey to the laboratory scientist who is actually performing the test. Good communication with all personnel involved helps ensure that whatever plans are in place meet the needs of the laboratory and, ultimately, the patient and physician. Most accreditation agencies require that laboratories consider all aspects of preanalytic variation as part of their quality assurance plans, including effective problem solving and documentation.

Physiologic variation refers to changes that occur within the body, such as cyclic changes (diurnal or circadian variation) or those resulting from exercise, diet, stress, gender, age, underlying medical conditions (e.g., fever, asthma, obesity), drugs, or posture (Table 1-5). Most samples are drawn on patients who are fasting (usually overnight for at least 8 hours). Because overnight and fasting are relative terms, however, the length of time and what was consumed during that time should be determined before sample procurement for those tests most affected by diet or fasting. Patient preparation for timed samples or those requiring specific diets or other instructions must be well written and verbally explained to patients. Elderly patients often misunderstand or are overwhelmed by the directions given to them by physician office personnel. A laboratory information telephone number listed on these printed directions can often serve as an excellent reference for proper patient preparation.

Drugs can affect various analytes.³⁰ It is important to ascertain what, if any, medications the patient is taking that may interfere with the test. Unfortunately, many laboratorians do not have either the time for or access to this information and the interest in this type of interference only arises when the physician questions a result. Some frequently encountered influences are smoking, which causes an increase in glucose as a result of the action of nicotine; growth hormone; cortisol; cholesterol; triglycerides; and urea. High amounts or chronic consumption of alcohol causes hypoglycemia, increased triglycerides, and an increase in the enzyme gamma-glutamyltransferase and other liver function tests. Intramuscular injections increase the enzyme creatine kinase and the skeletal muscle fraction of lactate dehydrogenase. Opiates, such as morphine or meperidine, cause increases in liver and pancreatic enzymes, and oral contraceptives may affect many analytic results. Many drugs affect liver function tests. Diuretics can cause decreased potassium and hyponatremia. Thiazide-type medications can cause hyperglycemia and prerenal azotemia secondary to the decrease in blood volume. Postcollection variations are related to those factors discussed under specimen processing. Clerical errors are the most frequently encountered, followed by inadequate separation of cells from serum, improper storage, and collection.

TABLE 1-5 VARIABLES AFFECTING SELECT CHEMISTRY ANALYTES

| FACTOR | EXAMPLES OF ANALYTES AFFECTED |
|---------------------------------|--|
| Age | Albumin, alkaline phosphatase (ALP) (↑ older), phosphorus (P), cholesterol |
| Gender | (↑ Males): Albumin, ALP, creatine, Ca ²⁺ , uric acid, creatinine kinase (CK), aspartate aminotransferase (AST), phosphate (PO ₄), BUN, Mg ²⁺ , bilirubin, cholesterol (↑ Females): Fe, cholesterol, γ-globulins, α-lipoproteins |
| Diurnal variation | ↑ in AM: adrenocorticotrophic hormone (ACTH), cortisol, Fe, aldosterone ↑ in PM: acid phosphatase, growth hormone, parathyroid hormone (PTH), thyroid-stimulating hormone (TSH) |
| Day-to-day variation | ≥20% for alanine aminotransferase (ALT), bilirubin, Fe, TSH, triglycerides |
| Recent food ingestion | ↑ Glucose, insulin, triglycerides, gastrin, ionized Ca ²⁺ ↓ chloride, phosphorus, potassium, amylase, ALP |
| Posture | ↑ When standing: albumin, cholesterol, aldosterone, Ca ²⁺ |
| Activity | ↑ In ambulatory patients: CK ↑ With exercise: lactic acid, creatine, protein, CK, AST, lactate dehydrogenase (LD) ↓ With exercise: cholesterol, triglycerides |
| Stress | ↑ ACTH, cortisol, catecholamines |
| Race | Total protein (TP) ↑ (black), albumin ↓ (black); IgG 40% ↑, and IgA 20% ↑ (black male vs. white male); → CK/LD ↑ black males; ↑ cholesterol and triglycerides > white >40 years old (glucose-incidence diabetes in Asian, black, Native American, Hispanic) |
| Require fasting | Fasting blood sugar, glucose tolerance test, triglycerides, lipid panel, gastrin, insulin, aldosterone/renin |
| Require ICE (immediate cooling) | Lactic acid, ammonia, blood gas (if not cooled = ↓ pH, and po ₂) |
| Hemolysis | ↑ K ⁺ , ammonia, PO ₄ , Fe, Mg ²⁺ , ALT, AST, LD, ALP, catecholamines, CK (marked hemolysis) |

Chain of Custody

When laboratory tests are likely linked to a crime or accident, they become forensic in nature. In these cases, documented specimen identification is required at each phase of the process. Each facility has its own forms and protocols; however, the patient, and usually a witness, must identify the sample. It should have a tamper-proof seal. Any individual in contact with the sample must

document receipt of the sample, the condition of the sample at the time of receipt, and the date and time it was received. In some instances, one witness verifies the entire process and co-signs as the sample moves along. Any analytic test could be used as part of legal testimony; therefore, the laboratory scientist should give each sample—even without the documentation—the same attention given to a forensic sample.

REFERENCES

1. National Institute of Standards and Technology (NIST). Reference on constants, units, and uncertainty. Washington, D.C.: U.S. Department of Commerce, 1991/1993. (Accessed December 2007 at <http://physics.nist.gov>.) [Adapted from Special Publications (SP) nos. 811 and 330.]
2. National Committee for Clinical Laboratory Standards (NCCLS)/CLSI. The reference system for the clinical laboratory: Criteria for development and credentialing of methods and materials for harmonization and results; approved guideline. Wayne, Pa.: NCCLS, 2000. (NCCLS Document no. NRSL 13-P.)
3. American Chemical Society (ACS). Reagent chemicals. 9th ed. Washington, D.C.: ACS Press, 2000.
4. Department of Labor and Occupational Safety and Health Administration (OSHA). Occupational exposure to hazardous chemicals in laboratories. Washington, D.C.: OSHA, 1990. (Federal Register, 29 CFR, Part 1910.1450.)
5. National Institute of Standards and Technology (NIST). Standard reference materials. Washington, D.C.: U.S. Department of Commerce, 1991. (Publication no. 260.)
6. International Union of Pure and Allied Chemistry (IUPAC). In: McNaught A, Wilkinson A, eds. Royal Society of Chemistry. Compendium of Chemical Terminology, 2nd ed. Cambridge, UK: Blackwell Scientific, 1997.
7. Clinical and Laboratory Standards Institute (CLSI)/National Committee for Clinical Laboratory Standards (NCCLS). How to

- define and determine reference intervals in the clinical laboratory; approved guideline. 2nd ed. Villanova, Pa.: 2000. (Publication no. C28-A2.)
8. International Organization for Standardization, European Committee for Standardization (ISO). In vitro diagnostic medical devices—measurement of quantities in samples of biological origin—metrological traceability of values assigned to calibrators and control material. Geneva, Switzerland: ISO, 2000. (Publication no. ISO/TC 212/WG2 N65/EN 17511.)
 9. Lide DH, ed. Handbook of chemistry and physics. 88th ed. Boca Raton, Fla.: CRC Press, 2008.
 10. National Institute of Standards and Technology (NIST). Standard reference materials program. Washington, D.C.: U.S. Department of Commerce. (Accessed January 2008 at <http://ts.nist.gov/measurementservices/referencematerials/CATALOG/>.)
 11. Carreiro-Lewandowski E. Basic principles and practice of clinical chemistry. In Bishop M, Duben-Engelkirk J, Fody P, eds. Clinical chemistry, principles, procedures, and correlations. 4th ed. Baltimore, Md.: Lippincott Williams & Wilkins, 2000.
 12. Clinical Laboratory Standards Institute/National Committee for Clinical Laboratory Standards. Preparation and testing of reagent water in the clinical laboratory; approved guideline. 4th ed. Wayne, Pa.: 2006. (Publication no. C3-A4.)
 13. College of American Pathologists (CAP). General laboratory guidelines; water quality. Northfield, Ill.: CAP, July 1999.
 14. Skoog D, West D, Holler J, Crouch S, eds. Analytical chemistry: an introduction. 7th ed. Stamford, Conn.: Thompson/Brooks-Cole, 2000.
 15. National Committee for Clinical Laboratory Standards (NCCLS)/Clinical Laboratory Standards Institute. Temperature calibration of water baths, instruments, and temperature sensors. Villanova, Pa.: NCCLS, 1990. (Publication no. I2-A2.)
 16. National Institute of Standards and Technology (NIST). Calibration uncertainties of liquid-in-glass thermometers over the range from -20°C to 400°C . Gaithersburg, Md.: U.S. Department of Commerce, 2000.
 17. National Institute of Standards and Technology (NIST), Wise J. A procedure for the effective recalibration of liquid-in-glass thermometers. Gaithersburg, Md.: NIST August 1991. (Publication no. SP 819.)
 18. Bowers GN, Inman SR. The gallium melting-point standard. Clin Chem 1977;23:733.
 19. Bowie L, Esters F, Bolin J, et al. Development of an aqueous temperature-indicated technique and its application to clinical laboratory instruments. Clin Chem 1976;22:449.
 20. American Society for Testing and Materials (ASTM). Standards specification for volumetric (transfer) pipets. West Conshohocken, Pa.: ASTM, 1993:14.02:500–501. (Publication no. E969–83.)
 21. American Society for Testing and Materials (ASTM). Calibration of volumetric flasks. West Conshohocken, Pa.: ASTM, 2003:14.04. (Publication no. E288–94.)
 22. Seamonds B. Basic laboratory principles and techniques. In: Kaplan L, Pesce A, Kazmierczak S, eds. Clinical chemistry. Theory, analysis, and correlation. 4th ed. St. Louis, Mo.: CV Mosby, 2003.
 23. Bio-Rad Laboratories. Procedure for comparing precision of pipet tips. Hercules, Colo.: Bio-Rad Laboratories, 1993. (Product Information no. 81-0208.)
 24. National Committee for Clinical Laboratory Standards (NCCLS). Determining performance of volumetric equipment. Villanova, Pa.: NCCLS, 1984. (NCCLS document no. 18-P.)
 25. American Society for Testing and Materials (ASTM). Standard specification for laboratory weights and precision mass standards. West Conshohocken, Pa.: ASTM, 2003:14.04. (Publication no. E617–97.)
 26. Campbell JB, Campbell JM. Laboratory mathematics: Medical and biological applications. 5th ed. St. Louis, Mo.: CV Mosby, 1997.
 27. Centers for Disease Control and Prevention, Division of Laboratory Systems. Clinical laboratory improvement amendments. CFR Part 493, Laboratory requirements. (Accessed May 2007 at <http://www.phppo.cdc.gov/clia/regs2/toc.asp>.)
 28. Clinical Laboratory Standards Institute (CLSI)/National Committee for Clinical Laboratory Standards. Procedures and devices for the collection of diagnostic blood specimens by skin puncture. 5th ed. Wayne, Pa.: CLSI, 2004. (Approved standard no. HO4-A5.)
 29. Clinical Laboratory Standards Institute (CLSI)/National Committee for Clinical Laboratory Standards. Procedures for the handling and processing of blood specimens. 3rd ed. Wayne, Pa.: CLSI, 2004. (Publication no. H18-A3.)
 30. Young DS. Effects of drugs on clinical laboratory tests. 5th ed. Washington, D.C.: AACC Press, 2000.

Phlebotomy and Specimen Considerations

Ruth E. McCall, Cathee M. Tankersley

CHAPTER

2

CHAPTER OUTLINE

- **BLOOD COLLECTION PERSONNEL**
- **PUBLIC RELATIONS AND CLIENT INTERACTION**
 - Professionalism
 - Patient Consent
 - Confidentiality and the Health Insurance
 - Portability and Accountability Act
- **LEGAL ISSUES**
- **INFECTION CONTROL**
- **THE VASCULAR SYSTEM**
- **PHLEBOTOMY-RELATED VASCULAR ANATOMY**
 - H Pattern Veins
 - M Pattern Veins
 - Other Veins
- **SOURCE AND COMPOSITION OF BLOOD SPECIMENS**
- **TYPES OF BLOOD SPECIMENS**
- **VENIPUNCTURE EQUIPMENT**
 - Tourniquet
 - Needles
 - Evacuated Tube System
 - Syringe System
 - Butterfly System
 - Tube Additives
 - Trace Element-Free Tubes
- **ORDER OF DRAW AND ADDITIVE CARRY-OVER**
- **VENIPUNCTURE PROCEDURES**
 - Troubleshooting Failed Venipuncture
 - Multiple Venipuncture Attempts
- **PEDIATRIC VENIPUNCTURE**
 - Interacting with a Child
 - Immobilizing a Child
 - Pediatric Venipuncture Equipment
- **GERIATRIC VENIPUNCTURE**
- **QUALITY ASSURANCE IN PHLEBOTOMY**
- **PREANALYTIC CONSIDERATIONS**
 - Problem Sites
 - Vascular Access Devices
 - Procedural Error Risks
 - Patient Conditions and Complications
- **CAPILLARY SPECIMEN COLLECTION**
 - Alcohol, Gauze, Bandages
 - Lancets
 - Warming Devices
 - Microcollection Tubes
 - Microhematocrit Tubes
 - Sealants
 - Capillary Order of Draw
 - Indications for Capillary Puncture
- **CAPILLARY PUNCTURE PROCEDURES**
 - Neonatal Bilirubin Collection
 - Neonatal Screening
- **SPECIMEN HANDLING AND PROCESSING**
 - Routine Handling
 - Special Handling
- **SPECIMEN PROCESSING**
 - Processing Safety
 - Specimen Suitability
 - Centrifugation
 - Stopper Removal
 - Aliquot Preparation
- **BIBLIOGRAPHY AND SUGGESTED READING**

The collection, handling, and processing of specimens represent a critical step in specimen analysis. Physicians rely on results obtained from quality laboratory specimens to confirm health or diagnose and treat patients. The most sophisticated laboratory equipment cannot deliver valid results if specimen integrity is compromised. Consequently, standards such as those established by the Clinical and Laboratory Standards Institute

(CLSI) must be followed to protect specimen integrity and ensure that quality specimens are submitted for testing.

BLOOD COLLECTION PERSONNEL

Many types of laboratory tests are performed on blood specimens. The process of collecting blood is called *phlebotomy*, which literally translated means “to cut a

vein.” The two main phlebotomy procedures are *venipuncture*, in which the blood is collected through a needle inserted into a vein, and *capillary puncture*, in which the blood is collected from a skin puncture made with a lancet or similar device. Although laboratory technicians and technologists, and other health care professionals, sometimes perform phlebotomy, some individuals called phlebotomists have been specifically trained in blood collection techniques and are employed primarily to collect blood specimens.

PUBLIC RELATIONS AND CLIENT INTERACTION

Blood collection personnel play an important role in public relations for the laboratory (often being the *only* contact a patient has with it) and the health care facility. Patients often equate this encounter with the caliber of the laboratory and the quality of care they receive from the health care facility. An assured professional can put the patient at ease and facilitate a positive interaction.

Professionalism

Blood collection personnel must project a professional image. This image involves appearance, attitude (including certain behavioral characteristics), communication skills, and bedside manner.

Appearance

The impression a phlebotomist makes when first approaching a patient sets the stage for future interaction. Appearance makes a statement and plays a major role in whether the image projected portrays a trustworthy professional. Lab coats should protect clothing underneath. Shoes should be conservative and clean. Close attention should be paid to personal hygiene. Hair, if long, must be pulled back and fingernails should be short for safety’s sake. Centers for Disease Control and Prevention (CDC) hand hygiene guidelines state that health care workers with direct patient contact cannot wear artificial nails or extenders.

Attitude

Attitude is the feeling or emotion an individual has with regard to something—a job or activity, for example. A professional attitude involves the following personal behaviors or characteristics:

- *Integrity or honesty*: doing what is right regardless of the circumstances. For example, always following CLSI standards, which are essential to the quality of test results.
- *Compassion*: a deep awareness of the distress of others and a desire to alleviate it. A compassionate phlebotomist is sensitive to patient needs and willing to offer reassurance.

- *Motivation*: having the drive to meet a need or achieve a goal. Motivated individuals typically find the workplace a challenge no matter what their tasks entail.
- *Dependability and work ethic*: able to be relied upon, and being self-directed because of a belief in the importance of work. These two traits go hand in hand. An individual who possesses them arrives on time, tackles assignments with enthusiasm, and is an asset to the laboratory.
- *Diplomacy*: skill in handling situations without creating hostility. A phlebotomist must use effective communication skills and tact while dealing with patients, even in stressful situations.
- *Ethical behavior*: conforming to a standard of right and wrong conduct. The primary objective in any health care professional’s code of ethics should be the patient’s welfare.

Communication Skills

A patient’s perception of a health care facility and the quality of service delivered is derived from employees such as the phlebotomist with whom he or she is involved personally. If the phlebotomist responds properly to the needs of a patient due to good communication between the two of them, the patient typically develops a favorable impression of the phlebotomist and the facility.

Listening forms the foundation for good interpersonal communication and is especially important in establishing rapport with patients. An active listener uses feedback to ensure that he or she is interpreting what is said exactly as it was intended.

Using easily understood vocabulary encourages good verbal communication. Approximately 80% of language is nonverbal (unspoken), however. Unlike verbal communication formed from one-dimensional words, nonverbal communication is multidimensional, involving many elements. Much can be learned about a patient’s true feelings by observing nonverbal communication, which seldom lies. The patient’s face often tells what he or she will not say.

Bedside Manner

A phlebotomist may encounter family or visitors when collecting specimens. Discretion is important in dealing with them as they can help calm the patient’s fears or they can raise the patient’s anxiety level. If the phlebotomist feels it would be best, they can be asked to leave the room. Family members can be a source of comfort to a child during a phlebotomy procedure and are normally encouraged to stay in the room, and they may even be asked to assist.

Patient Consent

It is critical that patient consent be obtained before initiating any phlebotomy procedure. There are different types of patient consent, and examples are listed in Box 2-1.

BOX 2-1. EXAMPLES OF TYPES OF PATIENT CONSENT

| | |
|--------------------|--|
| Informed consent | Implies voluntary permission for a medical procedure, test, or medication will be given |
| Expressed consent | May be given verbally or in writing |
| Implied consent | Does not require a verbal expression of consent. Actions can imply consent (e.g., the patient holds out an arm after being told a blood specimen is to be collected) |
| HIV consent | Laws specify exactly what type of information must be given to inform the client properly |
| Consent for minors | Parent or guardian consent is required (health care personnel who do not obtain it are liable for assault and battery) |
| Refusal of consent | An individual has a constitutional right to refuse a medical procedure such as venipuncture |

Confidentiality and the Health Insurance Portability and Accountability Act

Maintaining patient confidentiality protects patients and practitioners. Health care workers are required to treat all patient information as private and confidential. Because it can now be easily transmitted electronically, the Health Insurance Portability and Accountability Act (HIPAA) was passed to more closely secure patient information. This federal law requires that patients be given information on their rights concerning the release of protected health information (PHI) and on how it will be used. All health care workers must sign a special form stating they understand HIPAA rules and will keep all patient information confidential. Penalties for HIPAA violations include disciplinary action, fines, and possible jail time.

CASE STUDY 2-1

The co-anchor for a local television station newscast comes to a clinic for a blood test. The phlebotomist recognizes her immediately. They have a pleasant conversation while the phlebotomist draws the specimen. Later that evening the phlebotomist says to her husband, “Guess who I drew today?” She then proceeds to tell him the co-anchor’s name, adding, “She is probably bipolar because I drew a lithium level on her.”

Questions

1. What mistake did the phlebotomist make?
2. What law was violated by her actions?
3. What legal action could result?

LEGAL ISSUES

The bulk of legal proceedings dealt with in medical offices or other health care facilities are between two private parties and fall under the category of **civil actions** in which damages may be awarded in the form of monetary penalties. The most common civil actions in health care are based on **tort**, an intentional or unintentional wrong or act that is committed without just cause. Examples of tort actions that could involve phlebotomists are as follows:

- **Assault**: a threat that causes one to be in fear of immediate harm
- **Battery**: deliberate harmful or offensive touching without consent or legal justification
- **Invasion of privacy**: violation of one’s right to be left alone
- **Breach of confidentiality**: failure to keep private or privileged information confidential
- **Negligence**: doing something that a *reasonable* person would not do or not doing something that a *reasonable* person would do
- **Malpractice**: a type of negligence committed by a professional
- **Standard of care**: a duty to protect someone from harm established by standards of the profession and expectations of society

INFECTION CONTROL

Standard precautions must be taken with every patient to prevent the spread of infection. This includes wearing personal protective equipment (PPE) when drawing blood or handling specimens and using proper hand hygiene procedures. Additional transmission-based precautions (i.e., airborne, droplet, or contact) may be required for patients with certain diseases.

- **PPE**: Lab coats or gowns, and gloves are required for phlebotomy procedures and during specimen handling

text continues on page 39

BOX 2-2. STANDARD AND TRANSMISSION-BASED PRECAUTIONS

STANDARD PRECAUTIONS**FOR INFECTION CONTROL****Handwashing**

Wash after touching **body fluids**, after **removing gloves**, and between **patient contacts**.

**Gloves**

Wear **Gloves** before touching **body fluids**, **mucous membranes**, and **nonintact skin**.

**Mask & Eye Protection or Face Shield**

Protect eyes, nose, mouth during procedures that cause **splashes** or **sprays** of **body fluids**.

**Gown**

Wear **Gown** during procedures that may cause **splashes** or **sprays** of **body fluids**.

**Patient-Care Equipment**

Handle soiled equipment so as to prevent personal contamination and transfer to other patients.

**Environmental Control**

Follow hospital procedures for cleaning beds, equipment, and frequently touched surfaces.

**Linen**

Handle linen soiled with **body fluids** so as to prevent personal contamination and transfer to other patients.

**Occupational Health & Bloodborne Pathogens**

Prevent injuries from needles, scalpels, and other sharp devices.



Never recap needles using both hands.

Place sharps in puncture-proof sharps containers.



Use **Resuscitation Devices** as an alternative to mouth-to-mouth resuscitation.

**Patient Placement**

Use a Private Room for a patient who contaminates the environment.

"Body Fluids" include **blood**, **secretions**, and **excretions**.

(continued)

BOX 2-2. STANDARD AND TRANSMISSION-BASED PRECAUTIONS (continued)**AIRBORNE PRECAUTIONS**

(in addition to Standard Precautions)

VISITORS: Report to nurse before entering.**Patient Placement**Use **private room** that has:

- Monitored negative air pressure,
- 6 to 12 air changes per hour,
- Discharge of air outdoors or HEPA filtration if recirculated.

Keep room door closed and patient in room.**Respiratory Protection**Wear an **N95 respirator** when entering the room of a patient with known or suspected infectious pulmonary **tuberculosis**.**Susceptible** persons should not enter the room of patients known or suspected to have **measles** (rubeola) or **varicella** (chickenpox) if other immune caregivers are available. If susceptible persons must enter, they should wear an **N95 respirator**. (Respirator or surgical mask not required if immune to measles and varicella.)**Patient Transport**Limit transport of patient from room to essential purposes only.
Use **surgical mask** on patient during transport.Form No. **APR**

BREVIS CORP., 3310 S 2700 E, SLC, UT 84109

© 1996 Brevis Corp.

DROPLET PRECAUTIONS

(in addition to Standard Precautions)

VISITORS: Report to nurse before entering.**Patient Placement****Private room**, if possible. Cohort or maintain spatial separation of **3 feet** from other patients or visitors if private room is not available.**Mask**Wear mask when working within **3 feet** of patient (or upon entering room).**Patient Transport**Limit transport of patient from room to essential purposes only.
Use **surgical mask** on patient during transport.Form No. **DPR**

BREVIS CORP., 3310 S 2700 E, SLC, UT 84109

© 1996 Brevis Corp.

(continued)

BOX 2-2. STANDARD AND TRANSMISSION-BASED PRECAUTIONS *(continued)*

CONTACT PRECAUTIONS

(in addition to Standard Precautions)

VISITORS: Report to nurse before entering.



Patient Placement

Private room, if possible. Cohort if private room is not available.



Gloves

Wear gloves when entering the room.

Change gloves after having contact with infective material that may contain high concentrations of microorganisms (**fecal** material and **wound drainage**).

Remove gloves before leaving patient room.



Wash

Wash hands with an **antimicrobial** agent immediately after glove removal.

After glove removal and handwashing, ensure that hands do not touch potentially contaminated environmental surfaces or items in the patient's room to avoid transfer of microorganisms to other patients or environments.



Gown

Wear gown when **entering** patient room if you anticipate that your clothing will have substantial contact with the patient, environmental surfaces, or items in the patient's room, or if the patient is **incontinent**, or has **diarrhea**, an **ileostomy**, a **colostomy**, or **wound drainage** not contained by a dressing. **Remove** gown before leaving the patient's environment and ensure that clothing does not contact potentially contaminated environmental surfaces to avoid transfer of microorganisms to other patients or environments.



Patient Transport

Limit transport of patient to essential purposes only. During transport, ensure that precautions are maintained to minimize the risk of transmission of microorganisms to other patients and contamination of environmental surfaces and equipment.



Patient-Care Equipment

Dedicate the use of noncritical patient-care equipment to a single patient. If common equipment is used, clean and disinfect between patients.

and processing. New gloves must be worn for each patient. Masks or respirators may be required when drawing blood from patients with certain transmissible diseases.

- **Hand hygiene:** Proper hand hygiene is the most important means of preventing the spread of infection. Hands must be decontaminated frequently, including after glove removal, as gloves can contain defects. CDC and Healthcare Infection Control Practices Advisory Committee (HICPAC) guidelines allow use of alcohol-based antiseptic hand cleaners instead of hand washing if hands are not visibly soiled. To achieve antisepsis, cover all hand surfaces with ample cleaner and let it evaporate. If no hand washing facilities are available, clean visibly soiled hands with detergent wipes followed by alcohol-based cleaner.
- **Isolation:** Isolation procedures separate certain patients from others and limit their contact with hospital personnel and visitors. A description of required precautions is normally posted on the patient's door and must be followed by all who enter the room. A cart containing supplies needed to enter the room or care for the patient is typically located outside the door.

THE VASCULAR SYSTEM

Basic knowledge of the vascular system, the network of arteries, veins, and capillaries that circulate blood

throughout the body, is important to anyone who performs phlebotomy.

- **Arteries** (Fig. 2-1) have thick walls to withstand the pressure of ventricular contraction, which creates a pulse that can be felt, distinguishing them from veins. When arterial blood is collected by syringe, the pressure normally causes blood to “pump” or pulse into the syringe under its own power. Normal systemic arterial blood is bright red because it is oxygen rich.
- **Veins** (Fig. 2-1) have thinner walls than the same-size arteries because blood in them is under less pressure. Consequently, they collapse more easily. Blood is kept moving through veins by skeletal muscle movement and the opening and closing of valves that line their inner walls. Normal systemic venous blood is dark bluish red because it is oxygen poor.
- **Capillaries** (Fig. 2-1) are only one cell thick to allow the exchange of gases and other substances between the tissues and the blood. The capillary bed in the skin can easily be punctured with a lancet to provide blood specimens for testing.

PHLEBOTOMY-RELATED VASCULAR ANATOMY

The major veins for venipuncture are in the antecubital fossa, the area of the arm in front of the elbow. Here, several large veins lie near the surface, making them easier to locate and draw blood from. Although exact locations

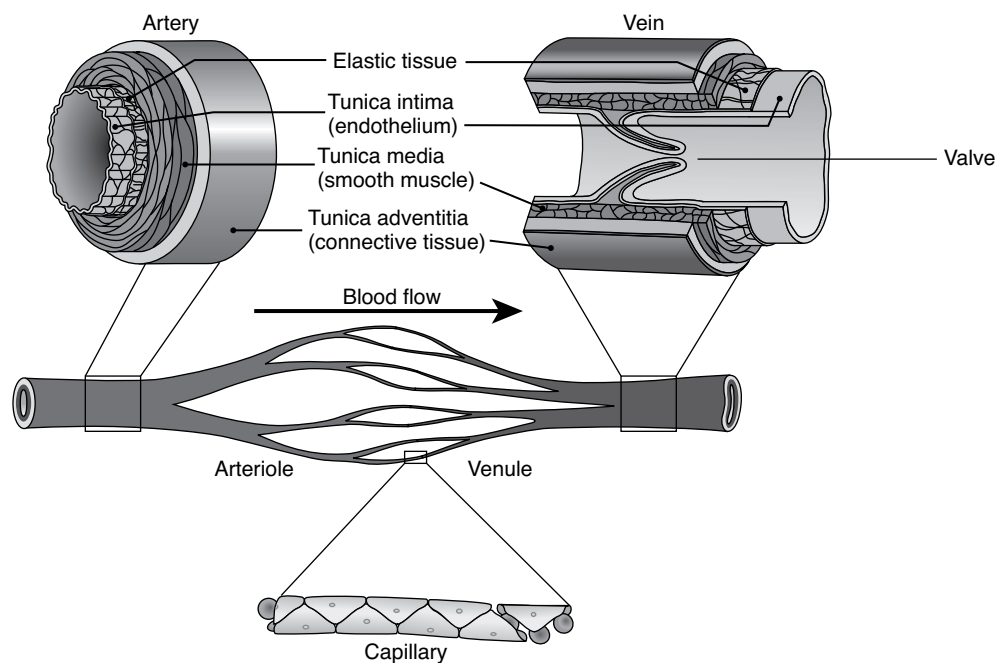

FIGURE 2-1. Artery, vein, and capillary structure. (Reprinted with permission from McCall R, Tankersley C. *Phlebotomy essentials*. 4th ed. Baltimore, Md.: Lippincott Williams & Wilkins, 2008.)

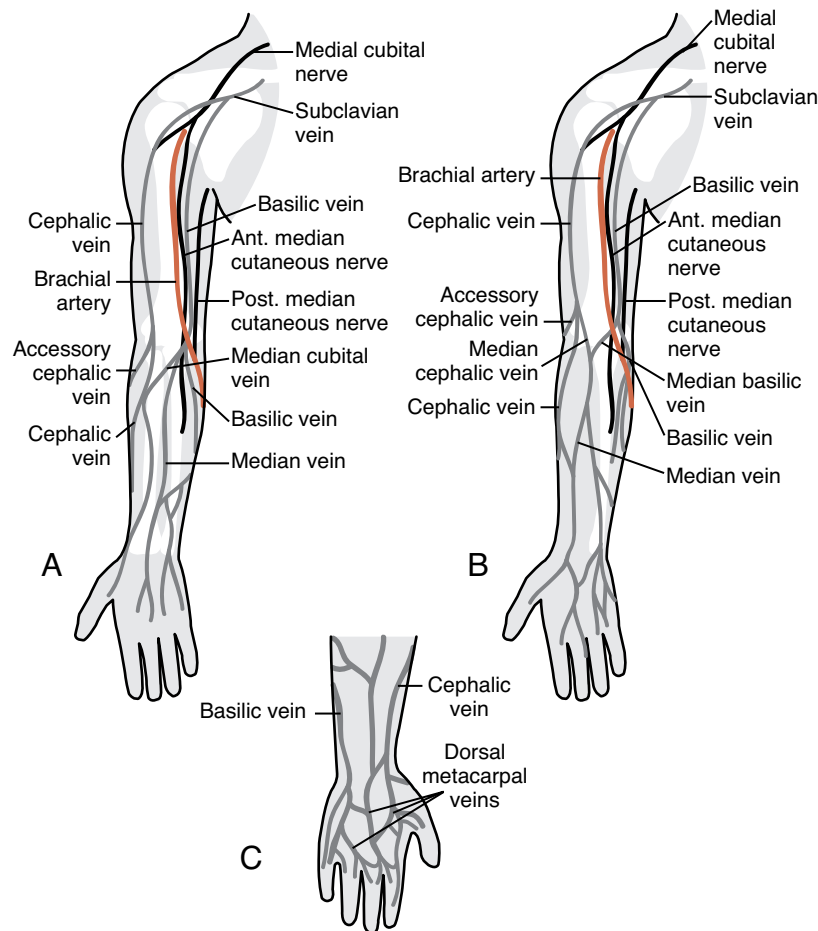

FIGURE 2-2. Principal veins of the arm including major antecubital veins. **(A)** H-shaped pattern of antecubital veins of the right arm in anatomic position. **(B)** M-shaped pattern of antecubital veins of the right arm in anatomic position. **(C)** Right forearm, wrist, and hand veins in prone position. (Reprinted with permission from McCall R, Tankersley C. *Phlebotomy essentials*. 4th ed. Baltimore, Md.: Lippincott Williams & Wilkins, 2008.)

vary slightly from person to person, two basic patterns in which the veins form the shape of either an “H” or an “M” are seen most often (Fig. 2-2).

H Pattern Veins

The H pattern (Fig. 2-2A) is displayed by approximately 70% of the population and includes the following veins:

- **Median cubital vein:** located near the center of the antecubital fossa. It is the preferred vein for venipuncture in the H pattern because it is typically large, closer to the surface, and the most stationary, making it the easiest and least painful to puncture and the least likely to bruise.
- **Cephalic vein:** located in the lateral aspect of the antecubital fossa. It is the second-choice vein in the H pattern. Although often harder to palpate (feel) than the median cubital, it is fairly well anchored and often the only vein that can be felt in obese patients.

- **Basilic vein:** located on the medial side of the antecubital fossa. It is the last choice in either pattern. Although normally large and easy to feel, it is not well anchored and rolls easily, increasing risk of puncturing a median cutaneous nerve branch or the brachial artery that is nearby. CLSI recommends against using it unless no other vein in either arm is more prominent.

M Pattern Veins

Although the cephalic and basilic veins help form the M pattern (Fig. 2-2B), the veins commonly used for venipuncture in this pattern are the following:

- **Median vein:** located in the very center of the pattern. It is the first-choice vein in the M pattern because it is well anchored, tends to be less painful, and is not as close to major nerves or arteries as the others, making it generally safest to puncture.

- Median cephalic vein: branches from the median vein to the lateral aspect of the arm. It is the second-choice M-pattern vein because it is accessible, unlikely to roll, less painful, located far enough away from major nerves or arteries, and generally safe to puncture.
- Median basilic vein: branches from the median vein to the medial aspect of the arm. It is the third choice in the M pattern because, although it may appear more accessible, it is located near the anterior and posterior branches of the median cutaneous nerve.

Other Veins

Although antecubital veins are used most frequently, veins on the back of the hand and wrist (Fig. 2-2C) may also be used for venipuncture. Veins on the underside of the wrist, however, should *never* be used for venipuncture. Leg, ankle, and foot veins are sometimes used but not without permission of the patient's physician, due to a potential for significant medical complications.

SOURCE AND COMPOSITION OF BLOOD SPECIMENS

Blood specimens can be obtained from arteries and veins and by puncturing the capillary bed in the skin. Composition varies by source in the following manner:

- Arterial blood composition is normally uniform throughout the body. However, because arterial puncture is technically difficult and potentially hazardous, it is primarily reserved for blood gas evaluation and certain emergency situations and performed only by those with special training.
- Venous blood composition is affected by metabolic activity of the tissue it drains and varies by collection site. It differs most from arterial blood in its lower oxygen content, but chloride, glucose, pH, CO₂, lactic acid, and ammonia levels may also differ. Impaired blood flow can affect other analytes.
- Capillary blood contains arterial and venous blood plus tissue fluid. Because it enters capillaries under pressure, the arterial portion is highest. Warming the site increases it further. The composition differs most from venous blood. Capillary glucose is normally higher; calcium, potassium, and total protein are normally lower. Squeezing the site can falsely elevate potassium levels, however.

TYPES OF BLOOD SPECIMENS

Regardless of source, blood is approximately 55% fluid and 45% blood cells. Tests can be performed on serum or plasma derived from the fluid portion, or on whole blood. The type of specimen tested depends on the

test, how urgently results are needed, and the equipment used.

- *Serum* is normally a clear, pale yellow fluid (nonfasting serum can be cloudy due to lipids) separated from clotted blood by centrifugation. Many chemistry tests are performed on serum.
- *Plasma* is normally a clear to slightly hazy, pale yellow fluid that separates from the cells when blood in an **anticoagulant** tube is centrifuged. Plasma contains fibrinogen; serum does not because it was used in clot formation. Many chemistry tests can be performed on either serum or plasma. Stat and other tests requiring a fast turnaround time (TAT) are often collected in tubes containing **heparin** anticoagulant because they can be centrifuged immediately to obtain plasma.
- *Whole blood* contains both cells and plasma, like blood in the body. As with plasma, it must be collected in an anticoagulant tube to keep it from clotting. Whole blood is used for most hematology tests and many point-of-care tests (POCTs), especially in acute care and stat situations.

VENIPUNCTURE EQUIPMENT

Venipuncture, the most common way to collect blood specimens, can be performed by three basic methods—evacuated tube system (ETS), needle and syringe, and winged infusion set (butterfly). ETS is the preferred method because blood is collected directly from the vein into a tube, minimizing the risk of specimen contamination and exposure to the blood. Although discouraged by CLSI due to safety and specimen quality issues, a needle and syringe are sometimes used on small, fragile, or damaged veins. A butterfly set can be used with the ETS or a syringe and is often used to draw blood from infants and children, from hand veins, and in other difficult-draw situations.

Tourniquet

A tourniquet (Fig. 2-3) is applied to a patient's arm during venipuncture. It should be fastened tight enough to restrict venous flow but not arterial flow. This distends the veins, making them larger and easier to find, and stretches the walls so they are thinner and easier to pierce. A tourniquet must not be left on longer than 1 minute because specimen quality can be affected.

Needles

Phlebotomy needles are sterile, disposable, and sized by length and gauge. Length selection depends on vein depth and user preference. Gauge is a number that relates to needle diameter or bore. Gauge and bore are inversely related (i.e., the larger the gauge, the smaller is the bore). Gauge is selected for the size and condition of the vein and amount of blood required for the test. An



FIGURE 2-3. Several types of tourniquets (*top to bottom*): buckle closure, latex strap, nonlatex strap, and Velcro closure. (Reprinted with permission from McCall R, Tankersley C. *Phlebotomy essentials*. 4th ed. Baltimore, Md.: Lippincott Williams & Wilkins, 2008.)

appropriate gauge is important. If it is too large, the needle can damage the vein. If it is too small, the needle can hemolyze the blood. Venipuncture needles include gauges 21 to 23, with a 21 gauge considered standard for routine venipuncture. Needles are available with or without safety features. A needle that does not have a safety feature must be used with equipment (i.e., tube holder or syringe) that does. Needles are color-coded for easy identification, although colors may vary by manufacturer.

Evacuated Tube System

An ETS has three basic components—a **multisample needle**, a tube holder, and various types of evacuated tubes.

- A **multisample needle** (Fig. 2-4) allows collection of multiple tubes during venipuncture. It is threaded so



FIGURE 2-4. Multisample needles with color-coded caps. (Reprinted with permission from McCall R, Tankersley C. *Phlebotomy essentials*. 4th ed. Baltimore, Md.: Lippincott Williams & Wilkins, 2008.)

it can screw into a tube holder, and it has a **beveled** point on each end. The tube end of the needle is covered by a sleeve that retracts as it penetrates the stopper, allowing blood flow, and recovers the needle to prevent blood leakage when the tube is removed.

- A **tube holder** (Fig. 2-5) is a plastic cylinder with a small opening for a needle at one end and a large



FIGURE 2-5. Traditional needle and tube holders. (Reprinted with permission from McCall R, Tankersley C. *Phlebotomy essentials*. 4th ed. Baltimore, Md.: Lippincott Williams & Wilkins, 2008.)

opening for tubes at the other. The tube end has flanges to help place and remove tubes. Holders are available with or without safety devices. A holder without a safety device must be used with a needle that has one.

- **Evacuated tubes** (Fig. 2-6) have a premeasured vacuum that automatically draws the volume of blood indicated on the label. A tube that has lost all or part of its vacuum will fail to fill with blood or fill incompletely. Vacuum loss can occur if tubes are stored improperly, opened, dropped, or advanced too far onto the needle before the draw or if the needle bevel backs out of the skin during the draw. Tube stoppers are color-coded to identify a type of **additive**, absence of additive, or special tube property. Although generally universal, color-coding varies slightly by manufacturer. Table 2-1 lists common stopper colors, additives, and departments.



FIGURE 2-6. Evacuated tubes. (Reprinted with permission from McCall R, Tankersley C. *Phlebotomy essentials*. 4th ed. Baltimore, Md.: Lippincott Williams & Wilkins, 2008.)

TABLE 2-1 COMMON STOPPER COLORS, ADDITIVES, AND DEPARTMENTS INVOLVED

| STOPPER COLOR | ADDITIVE | DEPARTMENT(S) |
|--------------------------|--|--|
| Light blue | Sodium citrate | Coagulation |
| Red (glass) | None | Chemistry, blood bank, serology/immunology |
| Red (plastic) | Clot activator | Chemistry |
| Red/light gray (plastic) | Nonadditive | NA (Discard tube only) |
| Red/black (tiger) | Clot activator and gel separator | Chemistry |
| Gold | | |
| Red/gold | | |
| Green/gray | Lithium heparin and gel separator | Chemistry |
| Light green | | |
| Green | Lithium heparin Sodium heparin | Chemistry |
| Lavender | EDTA | Hematology |
| Pink | | Blood bank |
| Gray | Sodium fluoride and potassium oxalate Sodium fluoride and EDTA Sodium fluoride | Chemistry |
| Orange | Thrombin | Chemistry |
| Gray/yellow | | |
| Royal blue | None (red label) EDTA (lavender label) Sodium heparin (green label) | Chemistry |
| Tan (glass tube) | Sodium heparin | Chemistry |
| Tan (plastic) | EDTA | |
| Yellow | Sodium polyanethol sulfonate (SPS) | Microbiology |
| Yellow | Acid citrate dextrose (ACD) | Blood bank/Immunoematology |

Reprinted with permission from McCall R, Tankersley C. *Phlebotomy essentials*. 4th ed. Baltimore, Md.: Lippincott Williams & Wilkins, 2008.

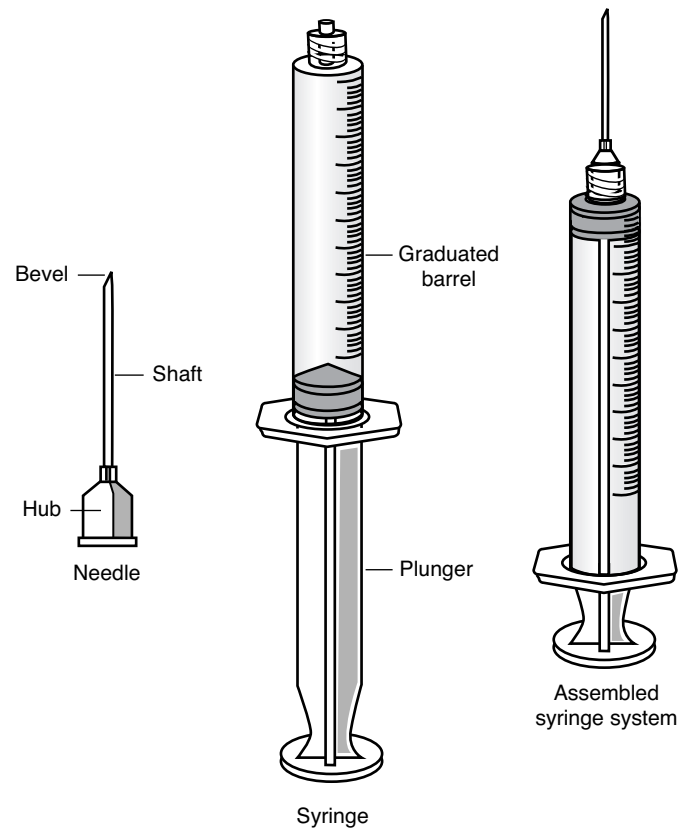

FIGURE 2-7. Traditional syringe system components. (Reprinted with permission from McCall R, Tankersley C. *Phlebotomy essentials*. 4th ed. Baltimore, Md.: Lippincott Williams & Wilkins, 2008.)

Syringe System

Although the preferred venipuncture method is the ETS, a syringe (Fig. 2-7) system, which includes a plastic syringe, a needle, and a transfer device, is used in certain situations.

- Syringe needles are available in a wide range of gauges and lengths for many different uses. Those appropriate for venipuncture are 21- to 23-gauge, sterile, Luer-Lok style, hypodermic needles from 1 to 1 2/3 inches in length. They must have a resheathing feature (Fig. 2-8) so they can be safely removed from the syringe and a transfer device attached.
- Syringes are available in various sizes selected according to the size and condition of the vein and the amount of blood needed. They have a barrel with graduated markings in either milliliters (mL) or cubic centimeters (cc) and a plunger that fits snugly into it (Fig. 2-8). During venipuncture, the plunger is slowly pulled back, creating a vacuum that pulls blood into the barrel.
- Transfer devices reduce needle sticks and aerosol exposures when filling tubes from syringes. A transfer device is like a tube holder with a needle inside. It is attached to a syringe after needle removal. A tube is pushed onto the needle until blood flows from the syringe into the tube.

Butterfly System

A butterfly (winged infusion set) is a short needle with a plastic part resembling butterfly wings and a length of tubing with a Luer fitting for syringe use or a Luer adapter for ETS use (Fig. 2-9). They come in various gauges, with 23 gauge most commonly used for phlebotomy. During use, the plastic wings are typically held together with the thumb and index finger, allowing the user to achieve the shallow needle angle needed to access small veins. Smaller needles increase the risk of specimen **hemolysis**. **Butterfly needles** used for venipuncture must have safety devices.

Tube Additives

Most ETS tubes contain additives. If the additive is an anticoagulant, the blood will not clot and the specimen will be whole blood that can be centrifuged to obtain plasma. All other additives and additive-free tubes (e.g., glass red top) produce serum specimens.

An additive functions optimally when the tube is filled to its stated volume and gently inverted immediately after collection to mix the additive with the blood. Specimen quality can be compromised if a tube is partially filled. Shaking or vigorous mixing can

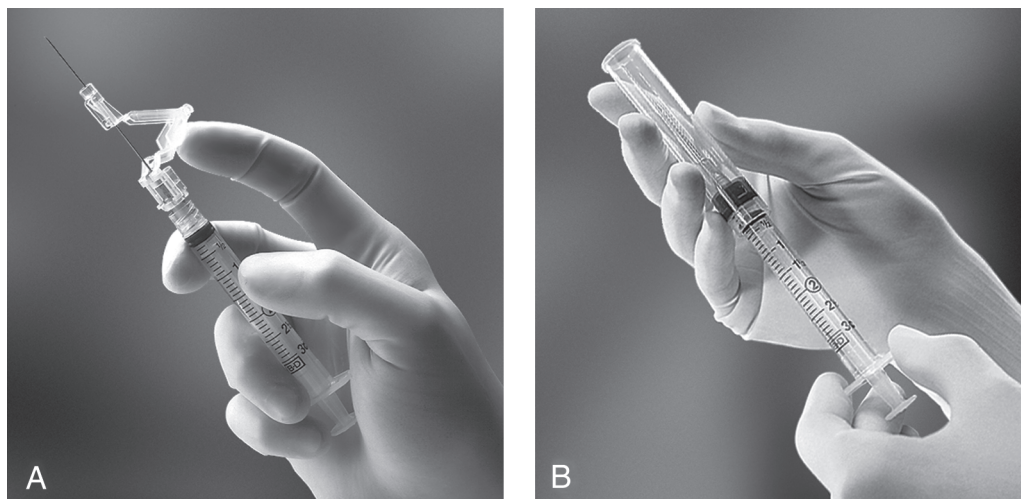

FIGURE 2-8. (A,B) Syringe with BD SAFETYGLIDE hypodermic needle attached. (Courtesy of Becton Dickinson, Franklin Lakes, N.J.)

hemolyze the blood, making it unsuitable for testing. Additive reliability is guaranteed until an expiration date on the label if the tube is handled and stored properly. Expiration dates should be checked and expired tubes discarded. The most common additives are categorized as follows:

- Anticoagulants prevent blood from clotting and include ethylenediaminetetraacetic acid (**EDTA**),

citrates, heparin, and oxalates. Each is designed for use in certain types of testing, and it is important to use the correct one.

- **Antiglycolytic agents** prevent glycolysis, which can decrease glucose concentration by up to 10 mg/dL per hour. The most common antiglycolytic agent, **sodium fluoride**, preserves glucose for up to 3 days and inhibits bacterial growth. It is often combined

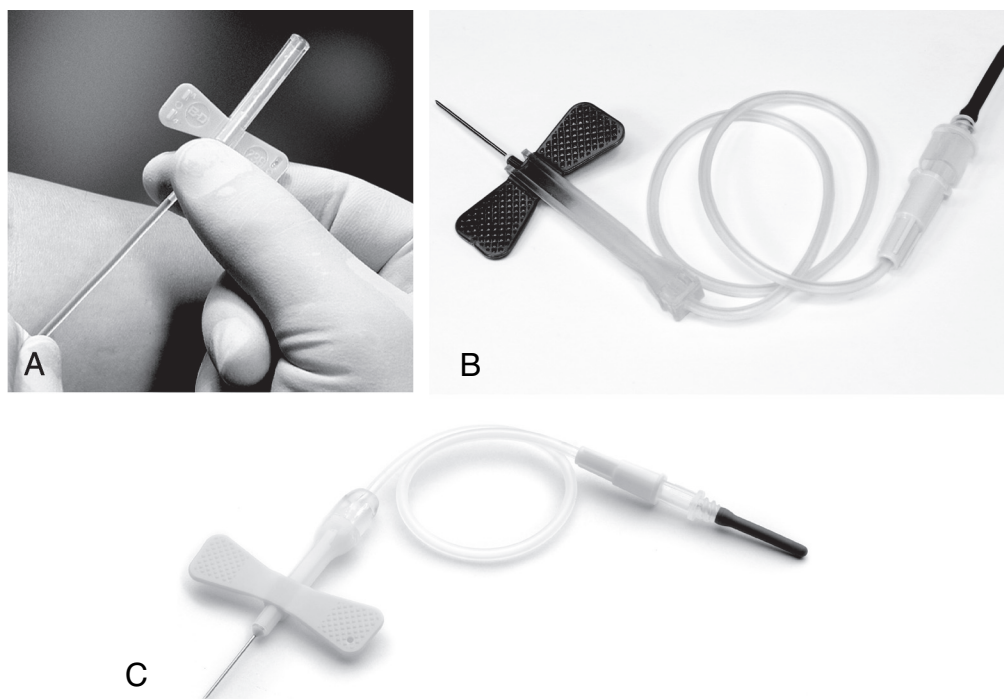

FIGURE 2-9. (A,C) Example of a safety winged infusion set. (Reprinted with permission from McCall R, Tankersley C. *Phlebotomy essentials*. 4th ed. Baltimore, Md.: Lippincott Williams & Wilkins, 2008.)

with **potassium oxalate** anticoagulant to provide plasma specimens. In addition to glucose, sodium fluoride is used to collect ethanol specimens to prevent an increase in alcohol due to fermentation by bacteria.

- **Clot activators** are coagulation factors such as thrombin and substances such as glass (**silica**) particles and inert clays like diatomite (Celite) that enhance clotting by providing more surface for platelet activation. The clot activators in gel separator tubes and plastic red top tubes are typically silica.
- **Thixotropic gel** separators are inert substances contained in or near the bottom of certain tubes. During centrifugation, the gel lodges between the cells and the fluid, forming a physical barrier that prevents the cells from metabolizing substances in the serum or plasma.

Trace Element-Free Tubes

Trace element-free tubes are as contamination free as possible. They are used to collect specimens for trace element, toxicology, nutrient, and other tests that detect analytes found in the blood in such tiny amounts that trace elements leached into the blood from tube or stopper materials could falsely elevate test results. The tubes contain EDTA, heparin, or no additive.

ORDER OF DRAW AND ADDITIVE CARRY-OVER

The **order of draw** is a special sequence of tube collection that reduces the risk of specimen contamination by microorganisms (e.g., blood cultures) and additive carry-over, which affects some chemistry tests. Additive carry-over can occur when blood in an additive tube touches the needle during venipuncture or during transfer from a syringe. Additive in the blood that is on or within the needle can then be transferred to the next tube drawn or filled. EDTA carry-over causes more problems than that of any other additive. Heparin causes the least interference in testing because it also occurs in blood naturally. Carry-over is less likely to occur if tubes fill from the bottom up, which keeps tube contents away from the needle. Common tests affected by additive contamination are listed in Table 2-2. The CLSI order of draw is shown in Box 2-3.

The most common tubes in the order of draw can be remembered by recalling the phrase “stop, light red, stay put, green light, go” (*Phlebotomy Essentials*, 4th ed.). The first letter of each word in the phrase stands for a tube in the order of draw: S (sterile), L (light blue), R (red), S (serum separator tube or **SST**), P (plasma separator tube

TABLE 2-2 COMMON TESTS AFFECTED BY ADDITIVE CONTAMINATION

| CONTAMINATING ADDITIVE | TESTS POTENTIALLY AFFECTED |
|----------------------------|---|
| Citrate | Alkaline phosphatase Calcium Phosphorus |
| EDTA | Alkaline phosphatase Calcium Creatine kinase Partial thromboplastin Potassium Protime Serum iron Sodium |
| Heparin (all formulations) | Activated clotting time Acid phosphatase Calcium (some test methods) Partial thromboplastin Protime Sodium (sodium formulations) Lithium (lithium formulations) |
| Oxalates | Acid phosphatase Alkaline phosphatase Amylase Calcium Lactate dehydrogenase Partial thromboplastin Potassium Protime Red cell morphology |
| Silica (clot activator) | Partial thromboplastin time Protime |
| Sodium fluoride | Sodium Urea nitrogen |

Reprinted with permission from McCall R, Tankersley C. *Phlebotomy essentials*. 4th ed. Baltimore, Md.: Lippincott Williams & Wilkins, 2008.

BOX 2-3. CLSI ORDER OF DRAW

1. Sterile tube (e.g., blood culture)
2. Coagulation tube (e.g., blue top)
3. Serum tube with or without clot activator, with or without gel (e.g., red top)
4. Heparin tube with or without gel separator (e.g., green top)
5. EDTA tube with or without gel separator (e.g., lavender top, pearl top)
6. Glycolytic inhibitor tube (e.g., gray top)

TABLE 2-3 ORDER OF DRAW, STOPPER COLORS, AND RATIONALE FOR COLLECTION ORDER

| ORDER OF DRAW | TUBE STOPPER COLOR | RATIONALE FOR COLLECTION ORDER |
|--------------------------------------|-------------------------------------|---|
| Blood cultures (sterile collections) | Yellow SPS Sterile media bottle | Minimizes chance of microbial contamination |
| Coagulation tubes | Light blue | The first additive tube in the order because all other additives affect coagulation tests |
| Glass nonadditive tubes | Red | Prevents contamination by additives in other tubes |
| Plastic clot activator tubes | Red | Filled after coagulation tests because silica particles activate clotting and affect coagulation tests (carry-over of silica into subsequent tubes can be overridden by anticoagulant in them) |
| Serum separator tubes (SSTs) | Red and gray rubber Gold plastic | |
| Plasma separator tubes (PSTs) | Green and gray rubber | Heparin affects coagulation tests and interferes in collection of serum specimens; causes the least interference in tests other than coagulation tests |
| Heparin tubes | Light-green plastic Green | |
| EDTA tubes | Lavender Pink | Responsible for more carry-over problems than any other additive: elevates Na ⁺ and K ⁺ levels, chelates and decreases calcium and iron levels, elevates PT and PTT results |
| Plasma preparation tubes (PPTs) | Pearl top | Sodium fluoride and potassium oxalate affect sodium and potassium levels, respectively, after hematology tubes because oxalate damages cell membranes and causes abnormal RBC morphology. Oxalate interferes in enzyme reactions. |
| Oxalate/fluoride tubes | Gray | |

Reprinted with permission from McCall R, Tankersley C. *Phlebotomy essentials*. 4th ed. Baltimore, Md.: Lippincott Williams & Wilkins, 2008.

or **PST**), G (green), L (lavender), and G (gray). The phrase places the red top before the SST and the PST before the green top for convenience in memorization. The order of draw, with stopper colors and rationale for collection order, is summarized in Table 2-3.

CASE STUDY 2-2

A phlebotomist is sent to the cardiac care unit (CCU) to collect a complete blood count (CBC) on a patient. The patient has tiny veins, so he selects a small lavender-top tube and proceeds to collect the specimen. While blood is filling the CBC tube, the patient's nurse tells him that the physician has added a *stat* potassium to the request. He finishes collecting the CBC specimen, grabs a small-volume green top, and proceeds to collect the potassium specimen.

Questions

1. What error did the phlebotomist make?
2. Which specimen could be affected by the error, and how?
3. What effect could the error have on test results?
4. How could the error have been avoided?

VENIPUNCTURE PROCEDURES

The following ETS (Procedure 2-1), butterfly (Procedure 2-2), and syringe (Procedure 2-3) venipuncture procedures include the steps necessary to obtain an appropriately identified quality blood specimen from a patient's arm or hand vein.

Troubleshooting Failed Venipuncture

Failure to draw blood can be caused by a misaligned tube in the holder, loss of tube vacuum, or improper position of the needle in the vein. A properly positioned needle is correctly seated in the **lumen** (Fig. 2-10A). If initially blood is not flowing into the tube, check the following:

- **Tube position:** Verify the tube is properly seated in the holder and the needle has penetrated the tube stopper. Reseat the tube if necessary.
- **Vacuum:** Tubes may have lost vacuum before the draw or during the draw if the needle bevel is not completely under the skin, in which case a short hissing sound is often heard and there may only be a spurt of blood into the tube. If it is suspected the tube has lost its vacuum, try a new tube.
- **Bevel against the vein wall** (Fig. 2-10B and C): If the needle bevel is up against a vein wall, tube vacuum can pull the wall against the bevel and block blood

text continues on page 60

PROCEDURE 2-1. ROUTINE ETS VENIPUNCTURE

Purpose: To obtain a blood specimen from an antecubital vein using the evacuated tube system

Equipment: Tourniquet; gloves; antiseptic prep pad; multisample needle, tube holder, ETS tubes; gauze pads; sharps container; permanent ink pen; bandage

Step 1: Review and Accession Test Request

Rationale/Explanation: Completeness of information, date, time, status, and collection priority must all be determined. The request must be recorded and assigned a number (accessioned) to identify the specimen and all related processes and paperwork

Step 2: Approach, Identify, and Prepare Patient

Rationale/Explanation: A successful approach requires organization and a professional bedside manner. Correct ID is vital to patient safety and meaningful test results. The patient must be informed of the procedure and consent to it.

Step 3: Verify Diet Restrictions and Latex Sensitivity



Latex precaution sign. (Courtesy of Brevis Corp, Salt Lake City, Utah.)

Rationale/Explanation: Test results can be misinterpreted and patient care compromised if diet requirements are not followed. Consult the physician or nurse before proceeding if this is the case. Exposure to latex can trigger a life-threatening reaction so it is vital that no latex items be used on a latex-sensitive patient or even brought into the room.

Step 4: Sanitize Hands



Hand sanitization. (Reprinted with permission from McCall R, Tankersley C. Phlebotomy essentials. 4th ed. Baltimore, Md.: Lippincott Williams & Wilkins, 2008.)

Rationale/Explanation: Proper hand hygiene plays a major role in infection control by protecting the phlebotomist, patient, and others from contamination. Gloves are sometimes put on at this point. Follow facility protocol.

Step 5: Position Patient, Apply Tourniquet, and Ask Patient to Make a Fist



Tourniquet application. (Reprinted with permission from McCall R, Tankersley C. Phlebotomy essentials. 4th ed. Baltimore, Md.: Lippincott Williams & Wilkins, 2008.)

Step 6: Select Vein, Release Tourniquet, and Ask Patient to Open Fist



Vein selection. (Reprinted with permission from McCall R, Tankersley C. Phlebotomy essentials. 4th ed. Baltimore, Md.: Lippincott Williams & Wilkins, 2008.)

PROCEDURE 2-1. ROUTINE ETS VENIPUNCTURE *(continued)*

Rationale/Explanation: Proper position is vital to patient comfort and venipuncture success. The arm should be downward in a straight line from shoulder to wrist to aid vein selection and avoid reflux. A tourniquet placed 3-4 inches above the antecubital area enlarges veins, making them easier to see, feel, and enter with a needle. A clenched fist helps keep them from rolling.

Rationale/Explanation: It is critical to select a large, well-anchored vein that does not overlie a pulse. The basilic vein should not be chosen unless no other vein is more prominent in either arm. Releasing the tourniquet and opening the fist prevents **hemoconcentration**.

Step 7: Clean and Air Dry Site

Site cleaning. (Reprinted with permission from McCall R, Tankersley C. *Phlebotomy essentials*. 4th ed. Baltimore, Md.: Lippincott Williams & Wilkins, 2008.)

Rationale/Explanation: Cleaning with an antiseptic such as 70% isopropyl alcohol helps avoid contaminating the specimen or patient with skin surface bacteria picked up by the needle during venipuncture. Letting the site dry naturally permits maximum antiseptic action, prevents contamination caused by wiping, avoids stinging on needle entry, and prevents hemolysis from residual alcohol.

Step 8: Prepare Equipment and Put on Gloves

Needle prep. (Reprinted with permission from McCall R, Tankersley C. *Phlebotomy essentials*. 4th ed. Baltimore, Md.: Lippincott Williams & Wilkins, 2008.)

Rationale/Explanation: Selecting appropriate equipment for the size, condition, and location of the vein is easier after vein selection. Preparing it while the site is drying saves time. Attach a needle to the holder. Put the first tube in the holder now or wait until after needle entry. The OSHA Bloodborne Pathogens Standards requires glove use during phlebotomy procedures.

Step 9: Reapply Tourniquet, Uncap and Inspect Needle

Tourniquet reapplication. (Reprinted with permission from McCall R, Tankersley C. *Phlebotomy essentials*. 4th ed. Baltimore, Md.: Lippincott Williams & Wilkins, 2008.)

Rationale/Explanation: The tourniquet aids needle entry. Pick up the tube holder with your dominant hand, placing your thumb on top near the needle end and fingers underneath. Uncap and inspect the

Step 10: Ask Patient to Remake a Fist, Anchor Vein, and Insert Needle

Needle insertion. (Reprinted with permission from McCall R, Tankersley C. *Phlebotomy essentials*. 4th ed. Baltimore, Md.: Lippincott Williams & Wilkins, 2008.)

(continued)

PROCEDURE 2-1. ROUTINE ETS VENIPUNCTURE *(continued)*

needle for defects, and discard it if flawed. Needles are mass produced and on rare occasions contain defects such as blocked, blunt, or bent tips or rough bevels or shafts that could injure a patient's vein, cause unnecessary pain, or result in venipuncture failure.

Rationale/Explanation: The fist aids needle entry. Anchoring stretches the skin so the needle enters easily with less pain, and keeps the vein from rolling. Anchor by grasping the arm just below the elbow, supporting it with your fingers. Place a thumb several inches below and slightly beside the vein, and pull the skin toward the wrist. Warn the patient. Align the needle with the vein and insert it with a smooth forward motion. Stop when you feel a "pop" or decrease in resistance, and press your fingers into the arm to anchor the holder.

Step 11: Establish Blood Flow, Release Tourniquet, and Ask Patient to Open Fist

Pushing tube on. (Reprinted with permission from McCall R, Tankersley C. *Phlebotomy essentials*. 4th ed. Baltimore, Md.: Lippincott Williams & Wilkins, 2008.)



Tourniquet removal. (Reprinted with permission from McCall R, Tankersley C. *Phlebotomy essentials*. 4th ed. Baltimore, Md.: Lippincott Williams & Wilkins, 2008.)

Step 12: Fill, Remove, and Mix Tubes in Order of Draw

Tube mixing. (Reprinted with permission from McCall R, Tankersley C. *Phlebotomy essentials*. 4th ed. Baltimore, Md.: Lippincott Williams & Wilkins, 2008.)

Rationale/Explanation: Fill additive tubes until the normal vacuum is exhausted to ensure correct blood-to-additive ratio, and mix them immediately upon removal from the holder using 3 to 8 gentle inversions (depending on type and manufacturer) to prevent clot formation. Follow CLSI order of draw to prevent additive carry-over between tubes.

(continued)

PROCEDURE 2-1. ROUTINE ETS VENIPUNCTURE *(continued)*

Rationale/Explanation: Blood will not flow until the needle pierces the tube stopper. Grasp the holder flanges with your middle and index fingers, pulling back slightly to keep the holder from moving, and use the thumb to push the tube onto the needle with a clockwise twist. The tourniquet must be released and the fist opened to allow venous flow to normalize. It must not be left on longer than 1 minute or hemoconcentration occurs.

Step 13: Place Gauze, Withdraw Needle, Activate Safety Feature, and Apply Pressure



Gauze placed. (Reprinted with permission from McCall R, Tankersley C. *Phlebotomy essentials*. 4th ed. Baltimore, Md.: Lippincott Williams & Wilkins, 2008.)



Needle removed. (Reprinted with permission from McCall R, Tankersley C. *Phlebotomy essentials*. 4th ed. Baltimore, Md.: Lippincott Williams & Wilkins, 2008.)

Step 14: Discard Needle and Holder Unit



Equipment discarding. (Reprinted with permission from McCall R, Tankersley C. *Phlebotomy essentials*. 4th ed. Baltimore, Md.: Lippincott Williams & Wilkins, 2008.)

Rationale/Explanation: According to OSHA, the needle and the tube holder must go into the sharps container as a unit because removing a needle from the holder exposes the user to sharps injury.

(continued)

PROCEDURE 2-1. ROUTINE ETS VENIPUNCTURE *(continued)*

Needle covered. (Reprinted with permission from McCall R, Tankersley C. *Phlebotomy essentials*. 4th ed. Baltimore, Md.: Lippincott Williams & Wilkins, 2008.)

Rationale/Explanation: Clean folded gauze is placed over the site so pressure can be applied after needle removal. Remove the needle in one smooth motion without lifting up or pressing down. Immediately apply pressure while simultaneously activating the needle safety feature to reduce the risk of a needle stick.

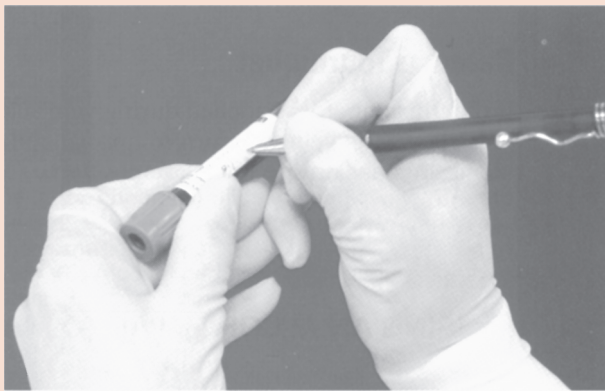
Step 15: Label Tubes

Tube labeling. (Reprinted with permission from McCall R, Tankersley C. *Phlebotomy essentials*. 4th ed. Baltimore, Md.: Lippincott Williams & Wilkins, 2008.)

Rationale/Explanation: To avoid mislabeling errors, label tubes before leaving the bedside or dismissing the patient.

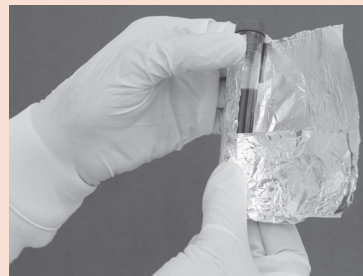
Step 16: Observe Special Handling Instructions

Covering tube with foil. (Reprinted with permission from McCall R, Tankersley C. *Phlebotomy essentials*. 4th ed. Baltimore, Md.: Lippincott Williams & Wilkins, 2008.)

Rationale/Explanation: For accurate results, some specimens require special handling such as cooling in crushed ice (e.g., ammonia), transportation at body temperature (e.g., cold agglutinin), or protection from light (e.g., bilirubin).

(continued)

PROCEDURE 2-1. ROUTINE ETS VENIPUNCTURE *(continued)***Step 17: Check Patient's Arm and Apply Bandage**

Rationale/Explanation: The arm must be examined to verify bleeding has stopped, including beneath the skin. If bleeding persists beyond 5 minutes, notify the nurse or physician. If bleeding stopped, apply a bandage and advise the patient to keep it on for at least 15 minutes.

Step 18: Dispose of Used Materials

Rationale/Explanation: Materials such as needle caps and wrappers are normally discarded in the regular trash. Some facilities require contaminated items such as blood-soaked gauze be discarded in biohazard containers.

Step 19: Thank Patient, Remove Gloves, and Sanitize Hands

Glove removal. (Reprinted with permission from McCall R, Tankersley C. *Phlebotomy essentials*. 4th ed. Baltimore, Md.: Lippincott Williams & Wilkins, 2008.)

Rationale/Explanation: Thanking the patient is courteous and professional. Gloves must be removed in an aseptic manner and hands washed or decontaminated with hand sanitizer as an infection control precaution.

Step 20: Transport Specimens to the Lab

Rationale/Explanation: Prompt delivery to the lab protects specimen integrity and is typically achieved by personal delivery, transportation via a pneumatic tube system, or a courier service.

Adapted with permission from Procedure 8-2, McCall R, Tankersley C. *Phlebotomy essentials*. 4th ed. Baltimore, Md.: Lippincott Williams & Wilkins, 2008.

PROCEDURE 2-2. VENIPUNCTURE OF A HAND VEIN USING A BUTTERFLY AND ETS HOLDER

Purpose: To obtain a blood specimen from a hand vein using a butterfly and ETS holder

Equipment: Tourniquet; gloves; antiseptic prep pad; butterfly needle with safety feature; ETS tube holder and tubes; gauze pads; sharps container; permanent ink pen; bandage

Steps 1–4: Same as ETS venipuncture

Rationale: Same as ETS venipuncture

Step 5: Position Hand, Apply Tourniquet, and Ask Patient to Close the Hand

Rationale/Explanation: Proper hand position is important to patient comfort and venipuncture success. It should be supported on the bed or armrest. A tourniquet is applied proximal to the wrist bone to aid vein selection. Closing the hand helps fix the veins and makes them easier to see and feel.

Step 6: Select Vein, Release Tourniquet, and Relax Hand

Rationale/Explanation: Choose an easily anchored vein with bounce or resilience. Finding a suitable vein can take a while. Releasing the tourniquet and opening the fist allows normal blood flow to return and minimizes effects of hemoconcentration.

(continued)

PROCEDURE 2-2. VENIPUNCTURE OF A HAND VEIN USING A BUTTERFLY AND ETS HOLDER *(continued)*

Step 7: Clean and Air Dry Site

Rationale/Explanation: Cleaning with an antiseptic such as 70% isopropyl alcohol helps avoid contaminating the specimen or bloodstream with skin surface bacteria picked up by the needle during venipuncture. Letting the site dry naturally permits maximum antiseptic action, prevents contamination caused by wiping, avoids stinging on needle entry, and prevents hemolysis from residual alcohol.

Step 9: Reapply Tourniquet, Uncap and Inspect Needle

Rationale/Explanation: The tourniquet is needed to aid needle entry. Hold the butterfly wings between your thumb and index finger or fold them upright and grasp them together. Cradle the tubing and holder in the palm of your dominant hand or lay it next to the patient's hand. Uncap and inspect the needle for defects, and discard it if flawed.

Step 8: Prepare Equipment and Put on Gloves

Rationale/Explanation: It is easier to select appropriate equipment after the vein is chosen. Preparing it while the site dries saves time. Attach a butterfly to an ETS holder. Grasp the tubing near the needle end and stretch it lightly to help keep it from coiling back up. Position the first tube in the holder now, or wait until after needle entry. OSHA mandates glove use during phlebotomy procedures.

Step 10: Anchor Vein and Insert Needle

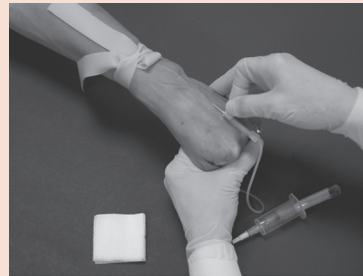

Needle insertion. (Reprinted with permission from McCall R, Tankersley C. *Phlebotomy essentials*. 4th ed. Baltimore, Md.: Lippincott Williams & Wilkins, 2008.)

Rationale/Explanation: Anchoring stretches the skin so the needle enters easily with less pain and keeps the vein from rolling. Use your nondominant hand to hold the patient's hand just below the knuckles. Pull the skin taut with your thumb, while bending the patient's fingers; or have the patient make a fist, encircle it with your fingers, and use your thumb to pull the skin over the knuckles. Insert the needle into the vein at a shallow angle (e.g., 10–15 degrees). A "flash" or small amount of blood appears in the tubing when the needle is in the vein. "Seat" the needle by slightly threading it within the vein to keep it from twisting out of it.

Step 11: Establish Blood Flow and Release Tourniquet

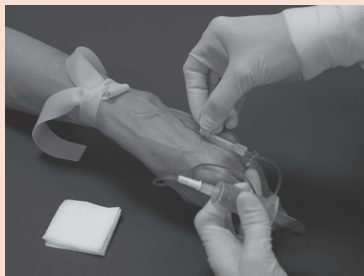

Tubes filling. (Reprinted with permission from McCall R, Tankersley C. *Phlebotomy essentials* 4th ed., Baltimore, Md.: Lippincott Williams & Wilkins, 2008)

Step 12: Fill, Remove, and Mix Tubes in Order of Draw

Rationale/Explanation: Maintain holder and tubing below the site so tubes fill from the bottom up, preventing reflux. Fill additive tubes until the vacuum is exhausted to ensure correct blood-to-additive ratio, remove them from the holder, and mix them immediately using 3 to 8 gentle inversions (depending on type and manufacturer) to prevent clot formation. Follow the order of draw to prevent additive carry-over between tubes. If a coagulation tube is the first or only tube collected, draw a discard tube first to remove air in the tubing and assure proper filling of the coagulation tube.

(continued)

PROCEDURE 2-2. VENIPUNCTURE OF A HAND VEIN USING A BUTTERFLY AND ETS HOLDER *(continued)*

Rationale/Explanation: A flash of blood in the tubing indicates vein entry, but blood will not flow until the needle pierces a tube stopper. Grasp the holder flanges with your middle and index fingers, pulling back slightly to keep the holder from moving, and use the thumb to push the tube onto the needle with a clockwise twist. The tourniquet must be released and the fist opened to allow venous flow to normalize. It must not be left on longer than 1 minute or hemoconcentration occurs.

Step 13: Place Gauze, Remove Needle, Activate Safety Device, and Apply Pressure



Placement of gauze. (Reprinted with permission from McCall R, Tankersley C. *Phlebotomy essentials*. 4th ed. Baltimore, Md.: Lippincott Williams & Wilkins, 2008.)



Needle removed. (Reprinted with permission from McCall R, Tankersley C. *Phlebotomy essentials*. 4th ed. Baltimore, Md.: Lippincott Williams & Wilkins, 2008.)

Rationale/Explanation: Clean folded gauze is placed over the site so pressure can be applied immediately on needle removal. The needle is removed in one smooth motion without lifting up or pressing down on it. Pressure is immediately applied with the free hand while the needle safety device is simultaneously activated with the other to reduce the risk of a needle stick.

Step 14: Discard Collection Unit

Rationale/Explanation: According to OSHA, the needle and tube holder must go into the sharps container as a unit because removing a needle from the holder exposes the user to sharps injury.

Steps 15–20: Same as routine ETS Venipuncture

Rationale/Explanation: See Procedure Box 2-1: Steps 15–20.

PROCEDURE 2-3. NEEDLE AND SYRINGE VENIPUNCTURE

Purpose: To obtain a blood specimen from an antecubital vein using a needle and syringe

Equipment: Tourniquet; gloves; antiseptic prep pad; syringe needle; syringe, transfer device, ETS tubes; gauze pads; sharps container; permanent ink pen; bandage

Steps 1-7: Same as Routine ETS Venipuncture, Procedure Box 2-1

Rationale/Explanation: See Procedure Box 2-1

Step 8: Prepare Equipment and Put on Gloves

Rationale/Explanation: Appropriate equipment is easier to select after the vein has been chosen. Preparing it while the site dries saves time. The needle size is selected according to the size, condition, and location of the vein; the syringe and tube size are selected according to the volume of blood required for the tests. Attach the needle to the syringe but do not remove the cap at this time. Hold the syringe as you would an ETS tube holder. OSHA mandates OSHA glove use during phlebotomy procedures.

Step 9: Reapply Tourniquet, Uncap and Inspect Needle

Rationale/Explanation: The tourniquet aids in venipuncture. Hold the syringe in your dominant hand as you would an ETS holder. Place your thumb on top near the needle end, and fingers underneath. Although it is rare, a needle can have defects. Uncap and inspect the needle for defects, and discard it if flawed.

Step 10: Have Patient Make a Fist, Anchor Vein, and Insert Needle



Needle insertion. (Reprinted with permission from McCall R, Tankersley C. *Phlebotomy essentials*. 4th ed. Baltimore, Md.: Lippincott Williams & Wilkins, 2008.)

Rationale/Explanation: The fist aids needle entry. Anchoring stretches the skin so the needle enters easily and with less pain, and keeps the vein from rolling. Anchor by grasping the arm just below the elbow, supporting the back of it with your fingers. Place your thumb 1 to 2 inches below and slightly beside the vein, and pull the skin toward the wrist. Warn the patient. Line the needle up with the vein and insert it into the skin using a smooth forward motion. Stop when you feel a decrease in resistance, often described as a "pop," and press your fingers into the arm to anchor the holder.

(continued)

PROCEDURE 2-3. NEEDLE AND SYRINGE VENIPUNCTURE *(continued)*

Step 11: Establish Blood Flow, Release Tourniquet, and Ask Patient to Open Fist



Pulling syringe plunger. (Reprinted with permission from McCall R, Tankersley C. *Phlebotomy essentials*. 4th ed. Baltimore, Md.: Lippincott Williams & Wilkins, 2008.)

Rationale/Explanation: Establishment of blood flow is normally indicated by blood in the hub of the syringe. In some cases blood will not flow until the syringe plunger is pulled back. Releasing the tourniquet and opening the fist allows blood flow to return to normal and prevent hemoconcentration.

Step 12: Fill Syringe

Rationale/Explanation: Venous blood will not automatically flow into a syringe. It must be filled by slowly pulling back on the plunger with your free hand. Steady the syringe as you would an ETS holder during routine venipuncture.

Step 13: Place Gauze and Withdraw Needle



Placement of gauze. (Reprinted with permission from McCall R, Tankersley C. *Phlebotomy essentials*. 4th ed. Baltimore, Md.: Lippincott Williams & Wilkins, 2008.)

Step 14: Activate Safety Device, Apply Pressure



Needle removed. (Reprinted with permission from McCall R, Tankersley C. *Phlebotomy essentials*. 4th ed. Baltimore, Md.: Lippincott Williams & Wilkins, 2008.)

(continued)

PROCEDURE 2-3. NEEDLE AND SYRINGE VENIPUNCTURE *(continued)*

Rationale/Explanation: Folded gauze is placed over the site to be ready for applying immediate pressure. The needle must be removed without lifting up or pressing down.

Rationale/Explanation: The safety device must be activated immediately upon needle removal while pressure is simultaneously applied to the site with the other hand.

Step 15: Discard Needle and Attach a Transfer Device, Rotating It to Ensure Secure Attachment

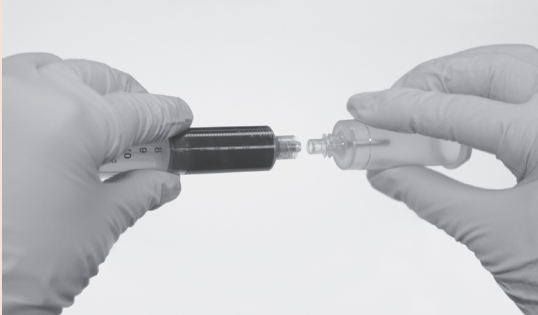

Transfer device attachment. (Reprinted with permission from McCall R, Tankersley C. *Phlebotomy essentials*. 4th ed. Baltimore, Md.: Lippincott Williams & Wilkins, 2008.)

Rationale/Explanation: The needle must be removed and discarded in the sharps container so the transfer device can be attached to the syringe. Secure attachment is necessary to prevent blood leakage during transfer.

Step 16: Hold the Syringe Vertically With the Tip Down and the Transfer Device at the Bottom

Rationale/Explanation: Ensures vertical placement of tubes so that they fill from bottom to top to prevent additive contact with the needle and cross-contamination of subsequent tubes.

Step 17: Place an ETS Tube in the Transfer Device in the Order of Draw, and Push It in All the Way



Tube placement. (Reprinted with permission from McCall R, Tankersley C. *Phlebotomy essentials*. 4th ed. Baltimore, Md.: Lippincott Williams & Wilkins, 2008.)

Step 18: Fill the Tubes Using the Vacuum Draw of the Tube; Do Not Push on the Syringe Plunger



Blood transfer. (Reprinted with permission from McCall R, Tankersley C. *Phlebotomy essentials*. 4th ed. Baltimore, Md.: Lippincott Williams & Wilkins, 2008.)

(continued)

PROCEDURE 2-3. NEEDLE AND SYRINGE VENIPUNCTURE *(continued)*

Rationale/Explanation: Order of Draw minimizes additive carry-over problems. The tube must be pushed all the way onto the internal needle for blood to flow into the tube.

Rationale/Explanation: The vacuum will pull blood into the tube automatically. Forcing blood into a tube by pushing the plunger can hemolyze the specimen or cause the tube stopper to pop off, splashing tube contents.

Tubes quickly fill until the vacuum is gone. To underfill a tube, hold back the plunger to stop blood flow before removing it. Several tubes can be filled as long as there is enough blood in the syringe.

Step 19: Mix Additive Tubes Upon Removal From the Transfer Device

Rationale/Explanation: Additive tubes must be mixed immediately for proper function, including preventing clot formation in anticoagulant tubes.

Step 20: Discard the Empty Syringe and Transfer Device Unit in a Sharps Container

Rationale/Explanation: Removing the transfer device from the syringe would expose the user to blood in the hubs of both units. The transfer device must go in the sharps because of the internal needle.

Adapted with permission from Procedures 8-4 and 8-5, McCall R, Tankersley C. *Phlebotomy essentials*. 4th ed. Baltimore, Md.: Lippincott Williams & Wilkins, 2008.

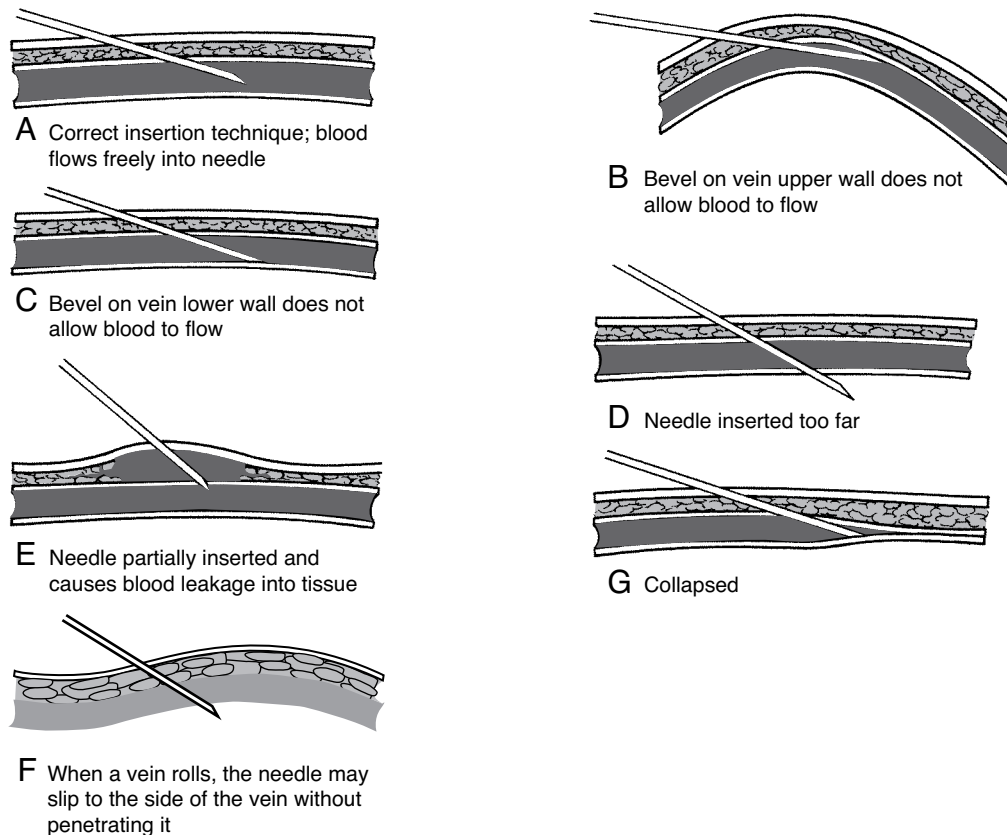

FIGURE 2-10. (A) Correct needle insertion technique. (Reprinted with permission from McCall R, Tankersley C. *Phlebotomy essentials*. 4th ed. Baltimore, Md.: Lippincott Williams & Wilkins, 2008.) (B) Bevel on upper vein wall. (C) Bevel on lower vein wall. (D) Needle inserted too far. (E) Needle partially inserted. (F) Needle slipped beside the vein. (G) Collapsed vein prevents blood flow.

flow. Remove the tube from the holder and retract the needle slightly. Rotating the bevel slightly may also help. *Do not* retract or rotate the needle with the tube in place or the vein may be injured.

- **Needle too deep** (Fig. 2-10D): The needle can go all the way through a vein on insertion or as a tube is engaged if the holder is not held securely. Withdraw the needle slightly to establish blood flow. Stop the draw if a **hematoma** forms.
- **Needle not deep enough** (Fig. 2-10E): Partial needle insertion causes slow blood flow. Gently advance the needle to establish correct flow. Stop the draw if a hematoma forms.
- **Needle beside the vein** (Fig. 2-10F): If a vein is not anchored well, it may roll and the needle may slip beside it instead of into it. Remove the tube to preserve its vacuum, withdraw the needle until the bevel is just under the skin, anchor the vein, and redirect the needle into it. If redirection is unsuccessful, do not probe. Discontinue the draw and choose a new site.
- **Collapsed vein** (Fig. 2-10G): If tube vacuum is too great for the vein, a syringe plunger is pulled too quickly, or the tourniquet is too tight or too close to the site, blood cannot be replaced as quickly as it is withdrawn and the vein collapses. A vein may also collapse when the tourniquet is removed during the draw, especially if the patient is elderly and has fragile veins. (Blood stoppage on tourniquet removal is not always the result of vein collapse. Needle position may have changed and readjustment is needed.) Use a smaller tube or pull the syringe plunger more slowly. If blood flow does not return, discontinue the draw and try again at another site.
- **Undetermined needle position**: If needle location in respect to the vein cannot be determined, one may have to relocate the vein. Remove the tube and withdraw the needle until the bevel is just under the skin. Palpate the arm above the needle entry site. *Do not* feel too near to the needle, as it is painful. Locate and anchor the vein, and redirect the needle into it. If the vein cannot be located, discontinue the draw. *Never* probe; it is painful and can damage nerves or puncture arteries.

Multiple Venipuncture Attempts

If you are unable to obtain a specimen on the first attempt, try again below the first site, on the other arm, or on a hand or wrist vein. If the second attempt is unsuccessful, ask someone else to take over. Unsuccessful venipuncture attempts frustrate both patient and phlebotomist. If a second person is unsuccessful on two attempts, give the patient a rest and try later unless the test is stat or timed. If a specimen is not obtained, notify the nurse or physician according to facility policy.

CASE STUDY 2-3

A phlebotomist in an outpatient collection center is asked to collect three tubes on an elderly female patient. As soon as the needle is inserted into her arm, the patient mentions that there is a tingling feeling that radiates to the end of the last two fingers. The phlebotomist, while continuing to seat the needle in the vein, immediately asks, “Is it OK now?” The patient answers, “Yes.” The phlebotomist then asks, “Would you like me to pull the needle out?” The woman states, “No. Go ahead.” The phlebotomist completes the collection, but later hears that the woman has lodged a complaint with the laboratory manager.

Questions

1. What error did the phlebotomist make?
2. What could have been the result of this error?
3. What would have been the correct way to handle the situation?

PEDIATRIC VENIPUNCTURE

Pediatric venipuncture requires the expertise and skill of an experienced phlebotomist. If a child is under age 2, venipuncture should be limited to superficial veins of the antecubital fossa and forearm, and never deep, hard-to-find veins. An infant or young child has a small blood volume and every effort must be made to collect the minimum amount of blood required for testing. Large amounts of blood removed at once or even small quantities on a regular basis can cause anemia. Removing 10% of blood volume at one time can lead to shock and cardiac arrest.

Interacting with a Child

Approach the child slowly and determine his or her degree of anxiety or fear before handling equipment or touching arms to look for a vein. Physically lower yourself to the child’s level to be less intimidating. Explain the procedure in terms the child can understand and answer questions honestly. Never tell a child it will not hurt; instead say it may hurt just a little, but it will be over quickly. Offer the child a reward for being brave, but do not put conditions on receiving it, such as if there is no crying. It is important to let the child know that it is all right to cry. Calm a crying child quickly, however, because crying can erroneously alter blood composition.



FIGURE 2-11. Seated adult restraining a toddler

Immobilizing a Child

Immobilization of pediatric patients is critical to successful venipuncture and helps ensure their safety. An infant can be wrapped in a blanket. Physical restraint may be needed for toddlers and young children. A toddler can be restrained while sitting on a parent's lap (Fig. 2-11). The parent uses one arm to support and steady the venipuncture arm and places the other arm around the child and the child's other arm. If the child is in a bed, a parent or helper leans over the child from the opposite side of the bed, reaching one arm around the child to support the venipuncture arm and the other over the child to secure the child's other arm. Older children do not usually need restraint, but a parent or someone else should help steady the arm.

Pediatric Venipuncture Equipment

Pediatric venipuncture is ideally performed with a 23-gauge butterfly and tube holder. The butterfly tubing allows flexibility if the child struggles during the draw. Small-volume tubes should be used to minimize the amount of blood drawn and reduce the risk of tube vacuum collapsing the vein. With difficult draws, a small amount of blood may be drawn by syringe and placed in **microtubes**. Because microtubes are assumed to contain capillary blood, which may have different reference values, they must be labeled as venous specimens.

GERIATRIC VENIPUNCTURE

Physical effects of aging can present challenges to a phlebotomist's interpersonal skills and technical expertise.

Physical effects, their challenges, and how to address them include the following:

- Alzheimer's disease and other forms of dementia can prevent meaningful communication and a caregiver's assistance may be required. Help may be needed to steady the patient's arm during the draw. Assume a patient is of sound mind, however, unless you know otherwise.
- Arthritis can lead to difficulty getting in and out of blood drawing chairs. Patients in wheelchairs may remain there to be drawn. Arthritis can cause the inability to open the hand or straighten the arm. Never use force to extend an arm or open a hand because it can cause pain and injury. A butterfly needle provides flexibility to access veins from awkward angles.
- Coagulation problems increase risk of prolonged bleeding and hematoma formation. Apply firm pressure until bleeding stops, but do not apply pressure so tightly that the patient is injured or bruised. Do not apply a pressure bandage in lieu of placing pressure.
- Clouding of the lens or cataracts result in dim vision. You may need to guide elderly patients to the drawing chair or escort them to the restroom if a urine specimen is requested.
- Hearing loss leads to difficulty answering questions and understanding instructions. Extra time to answer questions may be needed. Speak distinctly in a normal tone of voice; shouting raises the pitch, making it harder to understand. Confirm responses to avoid misunderstanding.
- Skin and veins are less elastic, increasing risk of injury. Veins are narrowed, more fragile, and apt to collapse. Anchor veins securely but gently and use appropriate equipment.
- Slower nerve conduction affects learning and reaction time and diminishes pain perception. Speak clearly and slowly. Allow the patient plenty of time to respond. Repeat information, if necessary. Be especially careful when verifying patient identification and diet compliance.
- Parkinson's disease and stroke can affect speech, presenting a barrier to effective communication and frustrating both patient and phlebotomist. Allow patients time to speak and, when possible, do not finish their sentences for them. Patients with tremors may require help to hold the arm still.

QUALITY ASSURANCE IN PHLEBOTOMY

A laboratory specimen must go through many phases before test results can be sent to the ordering physician. Specimen collection, handling, and processing fall under the preanalytic (prior to analysis) phase, an area of primary importance that needs special attention. Factors

associated with patient preparation, specimen collection technique, and specimen handling can affect specimen quality or jeopardize patient safety. To ensure patient safety and minimize or eliminate the risk of erroneous test results, specimen collection and handling procedures and policies should be based on standardized guidelines such as those established by CLSI, and anyone collecting specimens should strictly adhere to them.

PREANALYTIC CONSIDERATIONS

In addition to the technical skills necessary to collect a blood specimen, anyone who collects blood specimens must be able to recognize problem sites, identify procedural error risks, address certain patient conditions, and handle patient complications associated with blood collection to avoid or minimize any negative impact.

Problem Sites

Burns, Scars, and Tattoos

Scarred, burned, or tattooed areas should be avoided. They may be difficult to palpate and draw from, and the areas have impaired circulation that can affect test results. Recently burned or tattooed areas are susceptible to infection. Tattoos contain dyes that can interfere in testing; areas with dye should be avoided unless no other site is available.

Damaged Veins

Sclerosed (hardened) or **thrombosed** (clotted) veins are occluded (obstructed) so they feel hard and cordlike, lacking resiliency. They are difficult to puncture, have impaired blood flow that leads to erroneous test results, and should be avoided.

Edema

Edema, swelling caused by the abnormal accumulation of fluid in the tissues, makes veins harder to locate. Specimens collected from edematous areas may yield erroneous test results because the swelling alters blood composition. Choose another site if possible.

Hematoma

A swelling or mass of blood that escaped from a vein during or following venipuncture is called a hematoma. Never draw blood through a hematoma because it is painful and leads to inaccurate test results. If no other site is suitable, draw the specimen distal to the hematoma so that free-flowing blood is collected.

Mastectomy

A patient's physician should be consulted before drawing blood from an arm on the same side as a mastectomy. Lymph node removal, typically part of the procedure, can cause lymphostasis (stoppage of lymph flow), which makes the arm susceptible to swelling and infection.

Vascular Access Devices

It is not unusual for an inpatient to have some type of vascular access device (**VAD**). Only specially trained personnel should draw blood from a VAD, although a phlebotomist may assist by transferring the blood to the appropriate tubes. With the exception of intravenous (IV) lines in some instances, the phlebotomist must never apply a tourniquet or perform venipuncture on an arm that has a VAD. Each of the following is a type of VAD that a phlebotomist may encounter:

- **Arterial line:** commonly located in the radial artery and typically used to provide continuous blood pressure measurement. It may also be used to collect blood gases and other blood specimens.
- **Arteriovenous (AV) shunt or fistula:** created by a surgical procedure that permanently fuses a vein and artery together to provide access for dialysis. The connection forms a loop that can usually be easily seen. A vibration called a “thrill” is felt when it is palpated.
- **Heparin or saline lock:** a catheter connected to a stopcock, or a cap with a diaphragm, through which medication is given or blood drawn. It is typically placed in a lower forearm vein. Either type may be flushed with heparin to keep it from clotting. Heparin can adhere to the tubing, so a 5-mL discard tube should be collected first if drawing blood from either type.
- **Intravenous line:** tubing connected to a catheter inserted in a vein and used to administer fluids. It is best not to draw blood specimens from an arm with an IV line, especially above the IV access site, because IV fluid can contaminate the specimen and affect test results. A previous IV access site also should not be used for venipuncture within 24 to 48 hours of when an active IV line was removed, because it also is a potential source of error in testing. If no other site is available, draw the specimen below the IV access site. Follow facility protocol.
- **Central vascular access device (CVAD) or indwelling line:** a line inserted into a main vein or artery that is used primarily to administer fluids and medications, monitor blood pressure, and draw blood. Most CVADs are routinely flushed with heparin or saline to prevent clotting, so a small amount of blood must be drawn from the line and discarded prior to collecting blood specimens. Drawing coagulation specimens from CVADs is not recommended.

Three main types of CVADs are shown in Box 2-4.

Procedural Error Risks

The following can result from procedural error and have adverse effects on the patient.

- **Hematoma formation:** rapid swelling at or near the venipuncture site due to blood leaking into the tissues.

BOX 2-4. THREE MAIN TYPES OF CENTRAL VENOUS ACCESS DEVICES (CVADS)

Central venous catheter (CVC) or central venous line

Line inserted into a large vein such as the subclavian, and advanced into the superior vena cava. Several inches of tubing are surgically placed under the skin to an exit site in the chest where one or more lengths protrude from the skin.

Implanted port

Small chamber attached to an indwelling line that is surgically implanted under the skin in the upper chest or arm.

Peripherally inserted central catheter (PICC)

Line inserted into a vein in an extremity and threaded into a main vein leading to the heart. It is typically placed in either the basilic or cephalic vein with the exit just above the antecubital area.

(See Box 2-5 for situations that can trigger hematoma formation.) Venipuncture must be discontinued and pressure applied.

- **Iatrogenic anemia:** anemia as a result of treatment (e.g., frequent blood draws or removing large quantities at a time). Only minimum amounts of blood should be drawn from infants.
- **Inadvertent arterial puncture:** accidentally sticking an artery; often the result of deep or blind probing or attempting to draw from the basilic vein. Venipuncture must be discontinued and pressure applied for 5 minutes. Identify specimen as arterial blood if submitted for testing.
- **Infection of the site:** adverse effects of bacterial multiplication. Infection risk can be minimized by using aseptic technique, including cleaning the site properly and not touching it again before needle insertion.
- **Nerve injury:** results from poor site selection, inserting the needle too deeply or quickly, patient movement on needle insertion, excessive or lateral needle redirection,

or blind probing. Extreme pain, a burning or electric shock sensation, arm numbness, or pain radiating up or down the arm are all signs of nerve involvement that require immediate removal of the needle.

- **Reflux:** backflow of blood from the tube into the patient's vein that can occur if blood in the tube is in contact with the needle during a blood draw. To prevent reflux, the patient's arm must be in a downward position so that the collection tube fills from the bottom up.
- **Vein damage:** scar buildup that can result from many venipunctures in the same area for an extended period, improper redirection of the needle, or probing. Vein damage can impair vein **patency** and make it difficult to perform subsequent venipunctures.

Patient Conditions and Complications

Blood collection personnel must recognize and respond appropriately to patient conditions and complications that include the following:

- **Allergies to supplies or equipment:** Patients can be allergic to antiseptics (e.g., iodine), adhesive glue in bandages, and latex (which can cause a life-threatening reaction in those who are severely allergic) in items such as gloves and tourniquets. Use an alternate antiseptic if required. Paper tape placed over folded gauze or self-adhesive bandage material can be used in place of adhesive bandages. Never use latex items on latex-sensitive patients or even bring them into the room.
- **Excessive bleeding:** Some patients (e.g., patients on anticoagulant therapy) take longer than normal to stop bleeding. Apply pressure to the site until bleeding stops. If it continues beyond 5 minutes, notify appropriate personnel.
- **Fainting (syncope):** Warning signs that a person may faint include perspiration beads on the forehead, hyperventilation, and loss of color. Vasovagal syncope (fainting due to abrupt pain or trauma) comes on suddenly without warning.

BOX 2-5. SITUATIONS THAT CAN TRIGGER HEMATOMA FORMATION

- The vein is fragile or too small for the needle size.
- The needle penetrates all the way through the vein.
- The needle is only partly inserted into the vein.
- Excessive or blind probing is used to locate the vein.
- The needle is removed while the tourniquet is still on.
- Pressure is not adequately applied following venipuncture.

Reprinted with permission from McCall R, Tankersley C. *Phlebotomy essentials*. 4th ed. Baltimore, Md.: Lippincott Williams & Wilkins, 2008.

- **Nausea or vomiting:** Reassure a nauseous patient and provide a container of some sort to hold and as a precaution. Ask the patient to breathe slowly, and apply a cold compress to his or her forehead. If the patient vomits, terminate the procedure and notify first aid personnel.
- **Obese patients:** If there is no easily palpable vein in the antecubital area, ask the patient what sites have been successful for past blood draws. One area to focus on is the cephalic vein, which is more easily located by rotating the patient's arm. In doing so the weight of excess tissue often pulls downward, making the vein easier to see or palpate.
- **Pain:** A slight amount of pain is expected during a routine venipuncture or capillary puncture. A stinging sensation can be avoided by allowing the alcohol to dry completely after cleaning the site. Severe pain, a burning or electric shock sensation, numbness, or pain radiating up or down the arm during venipuncture indicates nerve involvement and the needle must be removed at once. If pain persists, apply an ice pack and notify appropriate personnel.
- **Petechiae:** When a tourniquet is applied to certain individuals, tiny red spots called petechiae appear on the arm below it. The spots are actually minute amounts of blood that escape from the capillaries and come to the surface of the skin as a result of platelet abnormalities or a defect in the capillary walls. They do not indicate that the phlebotomist has done anything wrong.
- **Seizures/convulsion:** Discontinue blood collection immediately if a patient has a seizure or goes into convulsions. Hold pressure over the site, if possible, without limiting the patient's movement, and immediately notify the first aid personnel.

CAPILLARY SPECIMEN COLLECTION

Drops of blood for testing can be obtained by puncturing the capillary bed of the skin with a lancet or other sharp device. Capillary specimen collection (also called dermal or skin puncture) is especially useful in pediatrics where removal of larger quantities of blood can have serious consequences. Collection sites include the fingers of adults and children over the age of 2 and the heels of infants.

Alcohol, Gauze, Bandages

CLSI recommends using 70% isopropyl alcohol to clean capillary puncture sites. Gauze or gauze-type pads are used to wipe away the first blood drop to eliminate alcohol residue and excess tissue fluid and to hold site pressure after specimen collection. Bandaging materials are used to cover the site after collection but are not to be used on infants under age 2 due to the danger of aspiration.

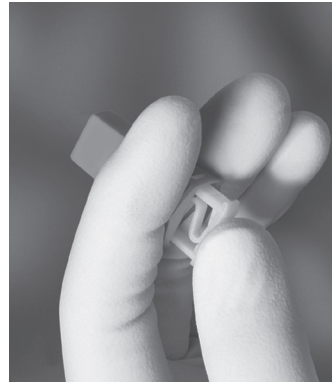

FIGURE 2-12. Vacutainer brand Genie lancet. (Courtesy of Becton Dickinson, Franklin Lakes, N.J.)

Lancets

Lancets are sterile, disposable, sharp instruments used for capillary puncture. Their blades or points must permanently retract to prevent sharps injuries. They come in a range of lengths and depths, selected according to patient age, collection site, and volume of blood required for the test. There are specific types for finger puncture (Fig. 2-12) and heel puncture (Fig. 2-13).

Warming Devices

Warming the site increases blood flow up to seven times and is especially important when performing heel sticks. A towel or diaper dampened with warm water can be used; however, water temperature must not exceed 42°C or it could scald the patient. Warming devices that provide an acceptable temperature are commercially available.

Microcollection Tubes

Microcollection tubes (microtubes) are special small plastic tubes (Fig. 2-14) often referred to as “bullets.”



FIGURE 2-13. BD QuikHeel infant lancet, also available in preemie version. (Courtesy of Becton Dickinson, Franklin Lakes, N.J.)



FIGURE 2-14. Capiject EDTA Capillary Blood Collection Tube. (Courtesy of Terumo, Somerset, N.J.)

Most have color-coded stoppers that correspond to color-coding of ETS tubes and markings for minimum and maximum fill levels typically measured in microliters (μL).

Microhematocrit Tubes

Microhematocrit tubes are narrow-bore capillary tubes (Fig. 2-15) primarily used for manual hematocrit (Hct) determinations. They come coated with heparin for collecting directly from a capillary puncture or “plain” to be used when filling with blood from an EDTA tube.

Sealants

Sealants are claylike substances used to seal one end of microhematocrit tubes. For safety reasons, manually pushing the tube into the sealant is no longer recommended.



FIGURE 2-15. Microhematocrit tubes. (Courtesy of Becton Dickinson, Franklin Lakes, N.J.)

Capillary Order of Draw

The order of draw for collecting multiple capillary specimens differs from venipuncture. Specimens must be collected quickly to minimize the effects of platelet clumping and microclot formation and to ensure that an adequate amount of specimen is collected before the site stops bleeding. Hematology specimens are collected first because they are most affected by clotting. Serum specimens are collected last since they are supposed to clot. The CLSI order of draw for capillary specimens is:

1. EDTA specimens
2. Other additive specimens
3. Serum specimens

Indications for Capillary Puncture

Capillary puncture can be a practical alternative to venipuncture if the test can be done on a small amount of blood. It is generally *not* appropriate for patients who are dehydrated or have poor circulation to the extremities from other causes such as shock, as specimens may be hard to obtain and may not be representative of blood elsewhere in the body. Capillary puncture can be appropriate for adults and older children under the following circumstances:

- There are no accessible veins.
- Available veins are fragile or must be saved for other procedures such as chemotherapy.
- The patient has thrombotic or clot-forming tendencies.
- Blood is to be obtained for POCT procedures such as glucose monitoring.

Capillary puncture is the preferred way to obtain blood from infants and very young children for the following reasons:

- Infants have a small blood volume; removing quantities of blood typical of venipuncture or arterial puncture can lead to anemia or threaten life if over 10% of blood volume is removed.
- Infant or child venipuncture is difficult and can damage veins and surrounding tissues.
- An infant or child can be injured by the restraining method used during venipuncture.
- Capillary blood is the preferred specimen for some tests, such as newborn screening tests.

CAPILLARY PUNCTURE PROCEDURES

The following procedures include the steps necessary to obtain a properly identified quality blood specimen by capillary puncture. Techniques illustrated include finger sticks (Procedure 2-4), the most common type of capillary puncture, and heel sticks (Procedure 2-5), performed on infants under 1 year of age.

text continues on page 70

PROCEDURE 2-4. FINGERSTICK PROCEDURE

Purpose: To obtain a blood specimen by finger puncture

Equipment: Gloves; warming device (optional), antiseptic prep pad; safety finger puncture lancet, microcollection tubes or other appropriate collection devices; gauze pads; sharps container; permanent ink pen; bandage

Steps 1-3: Same as Venipuncture Steps 1–3.

Rationale/Explanation: See Procedure Box 8-2, Steps 1–3

Step 4: Sanitize Hands and Put on Gloves

Rationale/Explanation: Proper hand hygiene plays a major role in infection control by protecting the phlebotomist, the patient, and others from contamination. Gloves are put on at this point.

Step 5: Position Patient

Rationale/Explanation: The patient's arm must be supported on a firm surface with the hand extended and the palm up. A young child can be held on the lap and restrained by a parent or guardian.

Step 6: Select the Puncture/Incision Site

Rationale/Explanation: Select a site in the central, fleshy portion and slightly to the side of center of a middle or ring finger that is warm, pink or normal color, and free of scars, cuts, bruises, infection, rashes, swelling, or previous punctures.

Step 7: Warm the Site if Applicable

Rationale/Explanation: Warming makes blood collection easier and faster, and reduces the tendency to squeeze the site. It is not normally part of routine fingersticks unless the hand is cold, in which case, it can be wrapped in a comfortably warm washcloth or towel or a commercial warming device applied for 3 to 5 minutes.

Step 8: Clean and Air Dry Site



Cleaning the finger. (Reprinted with permission from McCall R, Tankersley C. *Phlebotomy essentials*. 4th ed. Baltimore, Md.: Lippincott Williams & Wilkins, 2008.)

Rationale/Explanation: CLSI recommends cleaning capillary puncture sites with 70% isopropanol. Cleaning removes or inhibits skin flora that could infiltrate the puncture and cause infection. Letting the site dry naturally permits maximum antiseptic action, prevents contamination caused by wiping, avoids a stinging sensation, and prevents specimen hemolysis from residual alcohol.

Step 9: Prepare Equipment

Rationale/Explanation: Select a finger stick lancet according to the age of the patient and amount of blood needed for the test. Verify lancet sterility by making sure packaging is intact before opening; open and handle items aseptically to maintain sterility. Select collection devices according to the tests ordered. Place items within easy reach along with several layers of gauze or gauze-type pads. Remove or release any lancet locking mechanism and hold the lancet between the thumb and index finger, or per manufacturer instructions.

Step 10: Puncture the Site and Discard Lancet/Incision Device

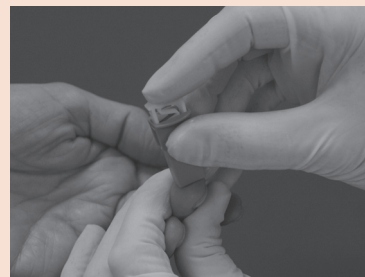

Sticking the finger. (Reprinted with permission from McCall R, Tankersley C. *Phlebotomy essentials*. 4th ed. Baltimore, Md.: Lippincott Williams & Wilkins, 2008.)

(continued)

PROCEDURE 2-4. FINGERSTICK PROCEDURE *(continued)*

Rationale/Explanation: Grasp the patient's finger between your nondominant thumb and index finger, holding it securely in case of sudden movement. Place the lancet flat against the skin in the central, fleshy pad of the finger, slightly to the side of center to avoid bone injury, and perpendicular to the fingerprint whorls so the blood will form easily collected drops and not run down the fingerprint. Warn the patient, parent, or guardian, trigger the puncture, and discard the lancet in a sharps container.

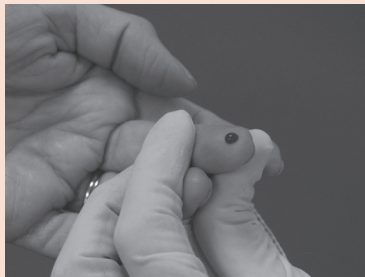
Step 11: Wipe Away the First Blood Drop

Blood drop. (Reprinted with permission from McCall R, Tankersley C. *Phlebotomy essentials*. 4th ed. Baltimore, Md.: Lippincott Williams & Wilkins, 2008.)

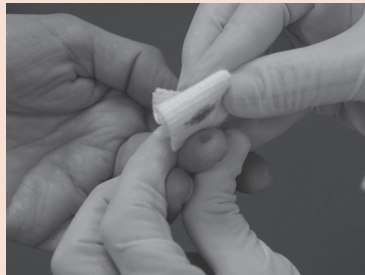

Wiping the drop. (Reprinted with permission from McCall R, Tankersley C. *Phlebotomy essentials*. 4th ed. Baltimore, Md.: Lippincott Williams & Wilkins, 2008.)

Rationale/Explanation: Gentle pressure is required until a blood drop forms. This first drop is wiped away with a clean gauze pad to prevent contamination of the specimen with excess tissue fluid, and residual alcohol. Alcohol residue can prevent well-rounded drops from forming and also hemolyze the specimen.

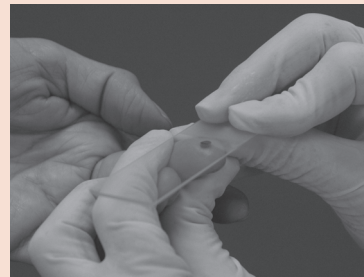
Step 12: Fill and Mix Tubes/Containers in the Order of Draw

Hct collection. (Reprinted with permission from McCall R, Tankersley C. *Phlebotomy essentials*. 4th ed. Baltimore, Md.: Lippincott Williams & Wilkins, 2008.)

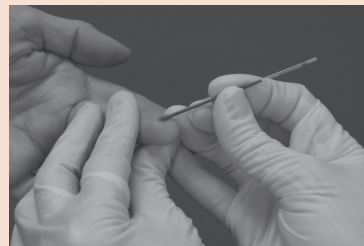

Bullet collection. (Reprinted with permission from McCall R, Tankersley C. *Phlebotomy essentials*. 4th ed. Baltimore, Md.: Lippincott Williams & Wilkins, 2008.)

Rationale/Explanation: Fill devices in the CLSI order of draw to minimize effects of clotting on specimens. Hold a microhematocrit tube above or beside the site and touch one end to the blood drop. Lower the opposite end slightly if needed, but do not remove it from the drop or an air space may be created that can compromise results. When the tube is full, plug the dry end with clay or suitable sealant.

Collect a microtube by holding it below the blood drop. Touch its scoop to the blood drop and let the blood run down the inside wall of the tube. The tube may need a gentle tap occasionally to settle blood to the bottom. Seal tubes when full and mix additive tubes by gently inverting them 8 to 10 times.

(continued)

PROCEDURE 2-4. FINGERSTICK PROCEDURE *(continued)***Step 13:** Place Gauze and Apply Pressure

Rationale/Explanation: Pressure must be applied and the site elevated to stop the bleeding.

Step 14: Label Specimen and Observe Special Handling Instructions

Rationale/Explanation: Specimens must be labeled with appropriate information. Labels may be affixed directly to microtubes. Microhematocrit tubes can be placed in a nonadditive or aliquot tube and the label placed on it. Any special handling must be followed to protect specimen integrity.

Step 15: Check the Site and Apply Bandage

Rationale/Explanation: The site must be examined to verify bleeding has stopped. Apply a bandage if the patient is an older child or adult, and advise that it be kept in place for at least 15 minutes. If bleeding persists beyond 5 minutes, notify the nurse or physician.

Step 16: Dispose of Used Materials

Rationale/Explanation: Discard equipment packaging and bandage wrappers in the trash. Follow facility protocol for discarding contaminated items such as blood-soaked gauze.

Step 17: Thank Patient, Remove Gloves, and Sanitize Hands

Rationale/Explanation: Thanking the patient is courteous and professional. Remove gloves aseptically and wash or decontaminate hands with sanitizer as an infection control precaution.

Step 18: Transport Specimen to the Lab

Rationale/Explanation: Prompt delivery to the lab is necessary to protect specimen integrity.

Adapted with permission from Procedure 10-1, McCall R, Tankersley C. *Phlebotomy essentials*. 4th ed. Baltimore, Md.: Lippincott Williams & Wilkins, 2008.

PROCEDURE 2-5. HEEL STICK PROCEDURE

Purpose: To obtain a blood specimen for patient diagnosis or monitoring from a heel puncture

Equipment: Gloves; warming device, antiseptic prep pad; safety heel puncture lancet, microcollection tubes or other appropriate collection devices; gauze pads; sharps container; permanent ink pen

Steps 1-3: See ETS Venipuncture Procedure, Steps 1-3

Rationale/Explanation: See Procedure Box 3-1, Steps 1-3

Step 4: Sanitize Hands and Put on Gloves

Rationale/Explanation: Proper hand hygiene plays a major role in infection control by protecting the phlebotomist, the patient, and others from contamination. Gloves should be put on at this point.

Step 5: Position Patient

Rationale/Explanation: For heel puncture an infant should be lying face up with the foot lower than the torso so gravity can assist blood flow.

Step 6: Select the Puncture/Incision Site

Rationale/Explanation: Select a site on the medial or lateral **plantar surface** of the heel that is warm, normal color, and free of cuts, bruises, infection, rashes, swelling, or previous punctures.

(continued)

PROCEDURE 2-5. HEEL STICK PROCEDURE *(continued)***Step 7: Warm the Site if Applicable**

Rationale/Explanation: Warming makes blood collection easier and faster, and reduces the tendency to squeeze the site. Warm the heel by wrapping it in a comfortably warm washcloth, towel, or diaper for 3 to 5 minutes or use a commercial heel warming device.

Step 8: Clean and Air Dry Site

Rationale/Explanation: CLSI recommends 70% isopropanol for cleaning capillary puncture sites. Cleaning removes or inhibits skin flora that could infiltrate the puncture and cause infection. Letting the site dry naturally permits maximum antiseptic action, prevents contamination caused by wiping, and avoids stinging on puncture and specimen hemolysis from residual alcohol.

Step 9: Prepare Equipment

Heelstick lancet. (Reprinted with permission from McCall R, Tankersley C. *Phlebotomy essentials*. 4th ed. Baltimore, Md.: Lippincott Williams & Wilkins, 2008.)



Preparing lancet. (Reprinted with permission from McCall R, Tankersley C. *Phlebotomy essentials*. 4th ed. Baltimore, Md.: Lippincott Williams & Wilkins, 2008.)

Rationale/Explanation: Select a heel puncture device. Verify packaging is intact to assure sterility. Open and handle aseptically to maintain sterility. Select blood collection devices according to the ordered tests. Place items within easy reach along with several layers of sterile gauze. Release any locking mechanism, and hold the lancet between the thumb and index finger.

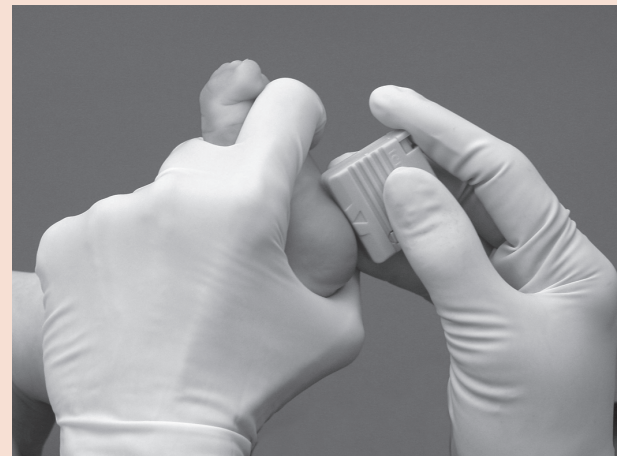
Step 10: Puncture Site and Discard Lancet/Incision Device

Placing lancet. (Reprinted with permission from McCall R, Tankersley C. *Phlebotomy essentials*. 4th ed. Baltimore, Md.: Lippincott Williams & Wilkins, 2008.)

Rationale/Explanation: Grasp the foot gently but firmly with your nondominant hand. Encircle the heel with your index finger around the arch, thumb around the bottom, and other fingers around the top of the foot. Place the lancet flat against the skin on the medial or lateral plantar surface of the heel, using enough pressure to keep it in place without deeply compressing the skin. Trigger the puncture, and discard the lancet in a sharps container.

(continued)

PROCEDURE 2-5. HEEL STICK PROCEDURE *(continued)***Step 11: Wipe Away the First Blood Drop**

Rationale/Explanation: Position the foot downward and apply gentle pressure to encourage blood flow. Wipe away the first blood drop with gauze to prevent excess tissue fluid from contaminating the specimen and rid the site of alcohol residue that could prevent formation of well-rounded drops and hemolyze the blood.

Step 12: Fill and Mix Tubes/Containers in Order of Draw

Rationale/Explanation: Collect subsequent blood drops using appropriate devices for the ordered tests and fill them in the same manner described in fingerstick procedure Step 12. Follow CLSI order of draw for capillary specimens to minimize effects of clotting.

Step 13: Place Gauze and Apply Pressure

Rationale/Explanation: Apply pressure with a clean gauze pad and elevate the foot until bleeding stops.

Step 14: Label Specimen and Observe Special Handling Instructions

Rationale/Explanation: Specimens must be labeled with the appropriate information. Affix labels directly to microtubes. Place microhematocrit tubes in a nonadditive or aliquot tube and place the label on that tube. Follow any special handling required.

Step 15: Check the Site

Rationale/Explanation: Examine the site to verify bleeding has stopped. If bleeding persists beyond 5 minutes, notify the nurse or physician. Do not apply a bandage to an infant as it can become a choking hazard and can also tear the skin when removed.

Step 16: Dispose of Used and Contaminated Materials

Rationale/Explanation: Discard equipment packaging and bandage wrappers in the trash. Follow facility protocol for discarding contaminated items such as blood-soaked gauze.

Step 17: Thank the Parent or Guardian, Remove Gloves, and Sanitize Hands

Rationale/Explanation: Saying thank you is courteous and professional. Remove gloves aseptically and wash or decontaminate hands with sanitizer as an infection control precaution.

Step 18: Transport Specimen to the Lab

Rationale/Explanation: Prompt delivery to the lab is necessary to protect specimen integrity.

Adapted with permission from Procedures 10-1 and 10-2, McCall R, Tankersley C. *Phlebotomy essentials*. 4th ed. Baltimore, Md.: Lippincott Williams & Wilkins, 2008.

Neonatal Bilirubin Collection

Proper collection of infant bilirubin specimens is crucial to accuracy of test results. Specimens must be collected carefully to avoid hemolysis, which can falsely decrease results, and as close as possible to the requested time so any rate of increase in bilirubin levels can be accurately determined. Light breaks down bilirubin and also falsely decreases results. To minimize light exposure, UV lights must be turned off and specimens collected as quickly as possible in amber microtubes. Protection from light is also required during transportation and handling.

Neonatal Screening

Blood samples for **newborn screening tests** are typically collected by heel puncture and placed within printed

circles on special filter paper that is part of the requisition. The first drop of blood is wiped away, the filter paper is brought close to the heel, and free-flowing blood is applied to the center of the first circle. Blood must be kept flowing until it spreads throughout the circle and penetrates the filter paper, which must not touch the heel or smearing, blotting, stoppage of blood flow, or incomplete filling of the circles can result. Circles must not be filled from both sides or by application of multiple drops as both cause layering of blood and possible misinterpretation of test results. All circles must be filled. Unfilled or incompletely filled circles can result in inability to perform all required tests.

Specimens must air dry in an elevated horizontal position away from heat or sunlight. They should not be hung or stacked together. Hanging can cause blood to

concentrate at the low end of the filter paper and lead to erroneous test results. Stacking leads to cross-contamination between specimens. When dry, the samples are typically sent to a state laboratory for testing.

SPECIMEN HANDLING AND PROCESSING

Proper handling and processing is another critical phase of the testing process and helps ensure that results obtained on the specimen accurately reflect the status of the patient. Improper handling or processing can negatively affect test results and cause delays in patient care.

Routine Handling

Mixing Tubes

Additive tubes must be mixed immediately after collection by inverting them from three to eight times depending on the additive type. If tubes are not quickly and thoroughly mixed, microclots can form in anticoagulant tubes, and clotting may be incomplete in clot activator tubes. Gentle inversion is essential, as vigorous mixing can cause hemolysis. Some tests, including potassium, magnesium, and most enzyme tests, cannot be performed on hemolyzed specimens.

Transporting Specimens

According to CLSI and Occupational Health and Safety Administration (OSHA) guidelines, blood specimen tubes must be transported to the laboratory in a plastic bag with a biohazard logo, a liquid-tight closure, and a slip pocket for paperwork. Specimens sent via pneumatic tube system must be in zipper-type plastic bags to contain spills and protected from shock. Regardless of delivery method, blood specimen tubes must always be transported carefully to prevent breakage and protect specimen integrity. They should be transported stopper up to reduce agitation, allow serum tubes to clot properly, and keep blood away from the stopper for safety reasons. Agitation or rough handling can cause hemolysis or lead to platelet activation that can affect coagulation tests.

Delivery Time Limits

Stat specimens must be transported, processed, and tested immediately. Routine blood specimens, however, should ideally be delivered to the laboratory within 45 minutes of collection and centrifuged within 1 hour of arrival if serum or plasma is needed. (The maximum time limit for serum or plasma separation according to CLSI standards is 2 hours after collection.) Specimens for some tests such as cortisol and potassium must be separated sooner.

Prompt separation is essential to minimize the effects of metabolic processes such as glycolysis. Unless an additive such as sodium fluoride chemically prevents it,

cellular glycolysis lowers glucose levels in a specimen at a rate of up to 200 mg/L per hour until the serum or plasma is physically separated from the cells. Glucose specimens collected in sodium fluoride tubes are stable at room temperature for 24 hours and up to 48 hours if refrigerated. Other analytes affected by cellular metabolism include aldosterone, calcitonin, enzymes, and phosphorus.

Special Handling

Analyte Protection

Some analytes are significantly affected by exposure to light or certain temperatures and require special specimen handling to protect them. For example, cooling below body temperature (37°C) can cause precipitation or agglutination in some specimens. These specimens are typically collected in prewarmed tubes and transported in 37°C heat blocks or wrapped in special warming material. Other specimens require chilling to slow down metabolic processes that can negatively affect an analyte. These specimens must be transported in crushed ice and water slurry. (Some specimens, such as potassium, are negatively affected by chilling and should be collected in a separate tube if other specimens collected require chilling.) A number of analytes can be broken down by light, resulting in false low values. Bilirubin, for example, can decrease by up to 50% after 1 hour of light exposure. Specimens for these analytes must be protected from light by being wrapped in foil, being collected in amber microtubes (e.g., infant bilirubin), or being placed in a light-blocking transport container. Required conditions must be maintained upon arrival in the laboratory.

Chain of Custody

Specimens collected for forensic or legal reasons require a special documentation protocol called chain of custody. A special form accompanies the specimen from collection to reporting of test results. The form identifies and is signed by the individual submitting to the test, a witness (if applicable), and all who handle it including those who collect, process, and test it. The date and time of receipt and the condition specimen must also be documented by all who handle it. Anyone participating in the chain of custody of a specimen can be summoned to participate in a related legal proceeding.

SPECIMEN PROCESSING

Large laboratories typically have a specific area (often called central processing) where specimens are received, **accessioned** (identified and logged), and prepared for testing. This includes evaluating specimen suitability for testing and sorting by department and type of processing required.

Processing Safety

OSHA regulations require the use of PPE including gloves, fully closed fluid-resistant lab coats or aprons, and protective face gear such as mask and goggles with side shields, or chin-length face shields, by specimen processors. In addition, all procedures involving blood must be performed in a manner that minimizes splashing, spraying, splattering, and generation of droplets.

Specimen Suitability

Properly identified, quality specimens are required for valid test results. Poor-quality or improperly identified specimens are normally rejected for testing, and new specimens are requested. Chemistry specimens are most frequently rejected for hemolysis. Other reasons include collection in the wrong tube, failure to follow special timing or handling requirements, QNS (quantity not sufficient), and clotting in whole blood or plasma specimens. Rejection criteria, such as hemolysis, may not be identified until processing has begun or even completed.

Centrifugation

Unless the test is performed on whole blood, a blood specimen must be centrifuged to separate the serum or plasma from the cells. Specimens for tests that require serum must be completely clotted before centrifugation. Incomplete clotting results in latent fibrin formation that can interfere with testing. At room temperature, complete clotting normally takes 30 to 60 minutes. Specimens that are chilled or are from patients who have high white blood cell counts or are on anticoagulant medication may take longer to clot. Heparinized and other anticoagulated specimens can be centrifuged right away. After centrifugation, specimens should be visually checked. The presence of hemolysis, **icterus** (yellow bilirubin pigment), and cloudiness or turbidity that could indicate **lipemia** (increased lipids), or any abnormality, should be noted.

Stopper Removal

When tube stoppers are removed to obtain the serum or plasma, stopper removal devices or robotics should be used, the processor should be wearing a full-length face shield, or the tube should be held behind a splash shield. Stoppers should be covered with gauze or tissue to catch blood drops or aerosol that may be released during removal and pulled straight up and off; they should not be popped off by a thumb roll technique.

Aliquot Preparation

An **aliquot** (portion of a specimen) is often created when multiple tests are ordered on a single specimen. An aliquot is prepared by transferring a portion of the specimen into one or more tubes labeled with the same ID information as the specimen tube. Aliquot preparation has an inherent risk of error, and each specimen must be carefully matched with the corresponding aliquot tube to avoid misidentified samples. Once transferred into an aliquot tube, serum and plasma are virtually indistinguishable. Because there can be both types of specimens for the same patient, it is important to match the correct specimen with the aliquot tube of the requested test as well with the patient. In addition, serum and plasma or plasma obtained from different types of anticoagulants must not be mixed together.

Aliquot tubes should be capped as soon as they are filled to prevent evaporation and protected from heat and light. If testing is to be delayed, most samples can be refrigerated at 4°C for up to 8 hours. Samples that are not stable at this temperature may need to be frozen at -20°C. For example, alkaline phosphatase levels increase and lactate dehydrogenase levels decrease at higher temperatures. Samples must not be stored in frost-free freezers as the continuous freezing and thawing cycles can damage specimens. Consult the procedure manual for specific instructions.

BIBLIOGRAPHY AND SUGGESTED READINGS

BD Vacutainer Systems. BD™ Blood Transfer Device product literature. Franklin Lakes, N.J.: BD Vacutainer Systems, 2008.

Brigden ML, Heathcote JC. Problems in interpreting laboratory tests: what do unexpected results mean? *Postgrad Med* 2000;107(7).

Burtis CA, Ashwood ER, Bruns DE. *Tietz fundamentals of clinical chemistry*, 6th ed. Philadelphia, Pa.: WB Saunders, 2007.

Cavalieri TA, Chopra A, Bryman PN. When outside the norm is normal: interpreting lab data in the aged. *Geriatrics* 1992;47:66-70.

Centers for Disease Control and Prevention (CDC)/HICPAC: Guideline for environmental infection control in health-care facilities. Recommendations of CDC and the Healthcare Infection Control Practices Advisory Committee (HICPAC). *Morb Mortal Wkly Rep MMWR* 2003;52(RR-10).

Centers for Disease Control and Prevention (CDC). Guideline for hand hygiene in health care settings. *Morb Mortal Wkly Rep MMWR* 2002;51(RR-16). (Complete report available at www.cdc.gov.)

Clapp J. *Random House Webster's dictionary of the law*. New York, N.Y.: Random House, 2000.

Clinical and Laboratory Standards Institute (CLSI). Blood collection on filter paper for newborn screening programs; approved standard. 5th ed. Wayne, Pa.: CLSI, 2007. (CLSI document no. LA4-A5.)

Clinical and Laboratory Standards Institute (CLSI). Procedures and devices for the collection of diagnostic capillary blood specimens; approved standard. 5th ed. Wayne, Pa.: CLSI, 2004. (CLSI document no. H4-A5.)

- Clinical and Laboratory Standards Institute (CLSI). Procedures for the collection of diagnostic blood specimens by venipuncture; approved standard. 6th ed. Wayne, Pa.: CLSI, 2007. (CLSI document no. H-3A6.)
- Clinical and Laboratory Standards Institute (CLSI). Procedures for the handling and processing of blood specimens; approved standard. Wayne, Pa.: CLSI, 2004. (CLSI document no. H18-A3.)
- Clinical and Laboratory Standards Institute (CLSI). Tubes and additives for blood specimen collection; approved standard. 5th ed. Wayne, Pa.: CLSI, 2003. (CLSI document no. H1-A5.)
- Clinical and Laboratory Standards Institute (CLSI). Protection of laboratory workers from occupationally acquired infections; approved standard. 3rd ed. Wayne, Pa.: CLSI, 2005. (CLSI document no. M29-A3.)
- College of American Pathologists (CAP). So you're going to collect a blood specimen. 11th ed. Northfield, Ill.: CAP, 2005.
- Dale JC. Preanalytical variables in laboratory testing. *Lab Med* September 1998.
- Ernst DJ. Applied phlebotomy. Baltimore, Md.: Lippincott Williams & Wilkins, 2005.
- Fischbach F, Dunning M. A manual of laboratory and diagnostic tests. 8th ed. Philadelphia, Pa.: Lippincott Williams & Wilkins, 2008.
- Fremgen BF. Medical law and ethics. Upper Saddle River, N.J.: Prentice Hall, 2005.
- Harmening D. Clinical hematology and fundamentals of hemostasis. 4th ed. Philadelphia, Pa.: FA Davis, 2002.
- HIPAA, Health Insurance Portability and Accountability Act. (August 17, 2000). *Federal Register*. 65:160.
- Hospital Infection Control Practices Advisory Committee (HICPAC) and CDC (1995) Guideline for Isolation Precautions in Hospitals. *MMWR* 1995; 44(No. RR-12):1-13.
- Johns ML. Health information management technology: an applied approach. 2nd ed. Chicago, Ill.: American Health Information Management Association, 2006.
- Joint Commission on the Accreditation of Healthcare Organizations. Comprehensive accreditation manual for pathology and clinical laboratory sciences, Joint Commission resources. Oakbrook Terrace, Ill.: Joint Commission, 2002.
- Joint Commission on the Accreditation of Healthcare Organizations. Accreditation manual for hospitals. Oakbrook Terrace, Ill.: Joint Commission, 2001.
- Lippi G, Salvagno GL, Montagnana M, Guidi GC. Short-term venous stasis influences routine coagulation testing. *Blood Coagul Fibrinol* 2005;16:453-458.
- Magee LS. Preanalytical variables in the chemistry laboratory. *Becton Dickinson Lab Notes* 2005;15(1).
- McCall R, Tankersley C. Phlebotomy essentials. 4th ed. Philadelphia, Pa.: Lippincott Williams & Wilkins, 2008.
- McPherson R, Pincus M. Henry's Clinical diagnosis and management by laboratory methods. 21st ed. Philadelphia, Pa.: WB Saunders, 2006.
- Mitchell J, Haroun L. Introduction to health care. Albany, N.Y.: Delmar, 2002.
- Molle E, Kronberger J, West-stack C. Clinical medical assisting. 2nd ed. Philadelphia, Pa., Lippincott Williams & Wilkins, 2005.
- Occupational Safety and Health Administration. Occupational exposure to bloodborne pathogens: final rule. 1991, 29 CFR Part 1910.1030.
- Occupational Safety and Health Administration. Occupational exposure to bloodborne pathogens: needlestick and other sharps injuries: final rule. 2001, 29 CFR Part 1910, Docket No. H370A, RIN 1218-AB85.
- Occupational Safety and Health Administration (OSHA). OSHA instruction (2001) Enforcement procedures for the occupational exposure to bloodborne pathogens, Directives Number CPL 2-2.69; Effective date 11/27/2001.
- Occupational Safety and Health Administration. Occupational exposure to bloodborne pathogens: needlestick and other sharps injuries; final rule. 29 CFR 1910. Fed Reg 2001;January 18:5318-5325.
- Occupational Safety and Health Administration. Bloodborne Pathogens Standard (29 CFR 1910.1030), the safe practice of phlebotomy and blood tube holder use (CPL2-2.9 at XIII.D.5).
- Occupational Safety and Health Administration (OSHA). OSHA disposal of contaminated needles and blood tube holders used in phlebotomy. *Safety and Health Information Bulletin*. Accessed September 16, 2008, at <http://www.osha.gov/dts/shib/shib101503.html>.
- Phillips LD. Manual of I.V. therapeutics. 4th ed. Philadelphia, Pa.: FA Davis, 2005.
- Sonpavde G, Hayes TG. Postural and venous stasis-induced changes in total calcium [letter to the editor]. *Mayo Clin Proc* 2005;80:1100-1101.
- Veatch R, Flack H. Case studies in allied health ethics. Upper Saddle River, N.J.: Prentice Hall, 1997.
- Warren M, Eason C, Burch P, Pfeiffer-Ewens J. Medical assisting, a commitment to service. St. Paul, Minn.: EMC Paradigm, 2002.
- Williams SJ. Essentials of health services. New York, N.Y.: Delmar Publishers, 2005.

Laboratory Safety and Regulations

Tolmie E. Wachter

CHAPTER

3

CHAPTER OUTLINE

- **LABORATORY SAFETY AND REGULATIONS**
 - Occupational Safety and Health Act (OSHA)
 - Other Regulations and Guidelines
- **SAFETY AWARENESS FOR CLINICAL LABORATORY PERSONNEL**
 - Safety Responsibility
 - Signage and Labeling
- **SAFETY EQUIPMENT**
 - Chemical Fume Hoods and Biosafety Cabinets
 - Chemical Storage Equipment
 - Personal Protective Equipment
- **BIOLOGIC SAFETY**
 - General Considerations
 - Spills
 - Bloodborne Pathogen
 - Airborne Pathogens
 - Shipping
- **CHEMICAL SAFETY**
 - Hazard Communication
 - Material Safety Data Sheet
 - OSHA Laboratory Standard
 - Toxic Effects from Hazardous Substances
 - Storage and Handling of Chemicals
- **RADIATION SAFETY**
 - Environmental Protection
 - Personal Protection
 - Nonionizing Radiation
- **FIRE SAFETY**
 - The Chemistry of Fire
 - Classification of Fires
 - Types and Applications of Fire Extinguishers
- **CONTROL OF OTHER HAZARDS**
 - Electrical Hazards
 - Compressed Gases Hazards
 - Cryogenic Materials Hazards
 - Mechanical Hazards
 - Ergonomic Hazards
- **DISPOSAL OF HAZARDOUS MATERIALS**
 - Chemical Waste
 - Radioactive Waste
 - Biohazardous Waste
- **ACCIDENT DOCUMENTATION AND INVESTIGATION**
- **SUGGESTED READINGS**

LABORATORY SAFETY AND REGULATIONS

All clinical laboratory personnel, by the nature of the work they perform, are exposed daily to a variety of real or potential hazards: electric shock, toxic vapors, compressed gases, flammable liquids, radioactive material, corrosive substances, mechanical trauma, poisons, and the inherent risks of handling biologic materials, to name a few. Each professional must be “safety conscious” at all times!

Laboratory safety necessitates the effective control of all hazards that exist in the clinical laboratory at any time. Safety begins with the recognition of hazards and is achieved through the application of common sense, a safety-focused attitude, good personal behavior, good housekeeping in all laboratory work and storage areas, and, above all, the continual practice of good laboratory technique. In most cases, accidents can be traced directly to two primary causes: unsafe acts (not always recog-

nized by personnel) and unsafe environmental conditions. This chapter discusses laboratory safety as it applies to the clinical laboratory.

Occupational Safety and Health Act (OSHA)

Public Law 91-596, better known as the **Occupational Safety and Health Act (OSHA)**, was enacted by the U.S. Congress in 1970. The goal of this federal regulation was to provide all employees (clinical laboratory personnel included) with a safe work environment. Under this legislation, the Occupational Safety and Health Administration (also known as OSHA) is authorized to conduct on-site inspections to determine whether an employer is complying with the mandatory standards. Safety is no longer only a moral obligation but also a federal law. In about half of the states, this law is administered by individual state agencies rather than by the federal OSHA. These states still fall

within delineated OSHA regions, but otherwise they bear all administrative, consultation, and enforcement responsibilities. The state regulations must be at least as stringent as the federal ones, and many states incorporate large sections of the federal regulations verbatim.

OSHA standards that regulate safety in the laboratory include the Bloodborne Pathogen Standard, Formaldehyde Standard, Laboratory Standard, Hazard Communication Standard, Respiratory Standard, Air Contaminants Standard, and Personal Protective Equipment Standard. Because laws, codes, and ordinances are updated frequently, current reference materials should be reviewed. Assistance can be obtained from local libraries, the Internet, and federal, state, and local regulatory agencies. The primary standards applicable to clinical laboratory safety are summarized next.

Bloodborne Pathogens [29 CFR 1910.1030]

This standard applies to all exposure to blood or other potentially infectious materials in any occupational setting. It defines terminology relevant to such exposures and mandates the development of an *exposure control plan*. This plan must cover specific preventative measures including exposure evaluation, engineering controls, work practice controls, and administrative oversight of the program. Universal precautions and personal protective equipment are foremost among these infection control measures. The *universal precautions* concept is basically an approach to infection control that presumes that all human blood, tissue, and most fluids are treated as if known to be infectious for the human immunodeficiency virus (HIV), hepatitis B virus (HBV), and other bloodborne pathogens. The standard also provides fairly detailed direction for decontamination and the safe handling of potentially infectious laboratory supplies and equipment, including practices for managing laundry and infectious wastes. Employee information and training are covered regarding recognition of hazards and risk of infection. There is also a requirement for HBV vaccination or formal declination within 10 days of assuming duties that present exposure. In the event of an actual exposure, the standard outlines the procedure for postexposure medical evaluation, counseling, and recommended testing or postexposure prophylaxis.

Hazard Communication [29 CFR 1910.1200]

This subpart to OSHA's Toxic and Hazardous Substances regulations is intended to ensure that the hazards of all chemicals used in the workplace have been evaluated and that this hazard information is successfully transmitted to employers and their employees who use the substances. Informally referred to as the OSHA "HazCom Standard," it defines *hazardous substances* and provides guidance for evaluating and communicating identified hazards. The primary means of communication are through proper

labeling, the development and use of material safety data sheets (MSDSs), and employee education.

Occupational Exposure to Hazardous Chemicals in Laboratories [29 CFR 1910.1450]

This second subpart to OSHA's Toxic and Hazardous Substances regulations is also known as "The OSHA Lab Standard." It was intended to address the shortcomings of the Hazard Communication Standard regarding its application peculiar to the handling of hazardous chemicals in laboratories, whose multiple small-scale manipulations differ from the industrial volumes and processes targeted by the original HazCom Standard. The Lab Standard requires the appointment of a *chemical hygiene officer* and the development of a *chemical hygiene plan* to reduce or eliminate occupational exposure to hazardous chemicals. This plan is required to describe the laboratory's methods of identifying and controlling physical and health hazards presented by chemical manipulations, containment, and storage. The chemical hygiene plan must detail engineering controls, personal protective equipment (PPE), safe work practices, and administrative controls, including provisions for medical surveillance and consultation, when necessary.

Other Regulations and Guidelines

There are other federal regulations relating to laboratory safety, such as the Clean Water Act, the Resource Conservation and Recovery Act, and the Toxic Substances Control Act. In addition, clinical laboratories are required to comply with applicable local and state laws, such as fire and building codes. The Clinical and Laboratory Standards Institute (CLSI, formerly National Committee for Clinical Laboratory Standards [NCCLS]) provides excellent general and infection control guidelines in their documents GP17-A2 (*Clinical Laboratory Safety; Approved Guideline*, Second Edition) and M29-A3 (*Protection of Laboratory Workers from Occupationally Acquired Infections; Approved Guideline*, Third Edition), respectively.

Safety is also an important part of the requirements for initial and continued accreditation of health care institutions and laboratories by voluntary accrediting bodies such as The Joint Commission (TJC) (formerly the Joint Commission on Accreditation of Health Care Organizations [JCAHO]) and the Commission on Laboratory Accreditation of the College of American Pathologists (CAP). TJC publishes a yearly accreditation manual for hospitals and *Accreditation Manual for Pathology and Clinical Laboratory Services*, which includes a detailed section on safety requirements. CAP publishes an extensive inspection checklist as part of their *Laboratory Accreditation Program*, which includes a section dedicated to laboratory safety.

SAFETY AWARENESS FOR CLINICAL LABORATORY PERSONNEL

Safety Responsibility

The employer and the employee share safety responsibility. The employer has the ultimate responsibility for safety and delegates authority for safe operations to supervisors. Safety management in the laboratory should start with a written safety policy. Laboratory supervisors, who reflect the attitudes of management toward safety, are essential members of the safety program.

Employer's Responsibilities

- Establish laboratory work methods and safety policies.
- Provide supervision and guidance to employees.
- Provide safety information, training, personal protective equipment, and medical surveillance to employees.
- Provide and maintain equipment and laboratory facilities that are adequate for the tasks required.

The employee also has a responsibility for his or her own safety and the safety of coworkers. Employee conduct in the laboratory is a vital factor in the achievement of a workplace without accidents or injuries.

Employee's Responsibilities

- Know and comply with the established laboratory work safety methods.
- Have a positive attitude toward supervisors, coworkers, facilities, and safety training.
- Give prompt notification of unsafe conditions or practices to the immediate supervisor and ensure that unsafe conditions and practices are corrected.
- Engage in the conduct of safe work practices and use of personal protective equipment.

Signage and Labeling

Appropriate signs to identify hazards are critical, not only to alert laboratory personnel to potential hazards, but also to identify specific hazards that arise because of emergencies such as fire or explosion. The **National Fire Protection Association (NFPA)** developed a standard hazards-identification system (diamond-shaped, color-coded symbol), which has been adopted by many clinical laboratories. At a glance, emergency personnel can assess health hazards (blue quadrant), flammable hazards (red quadrant), reactivity/stability hazards (yellow quadrant), and other special information (white quadrant). In addition, each quadrant shows the magnitude of severity, graded from a low of 0 to a high of 4, of the hazards within the posted area. (Note the NFPA hazard-code symbol in Fig. 3-1.)

Manufacturers of laboratory chemicals also provide precautionary labeling information for users. Information indicated on the product label includes statement of the

hazard, precautionary measures, specific hazard class, first aid instructions for internal/external contact, the storage code, the safety code, and personal protective gear and equipment needed. This information is in addition to specifications on the actual lot analysis of the chemical constituents and other product notes (Fig. 3-1). All in-house prepared reagents and solutions should be labeled in a standard manner and include the chemical identity, concentration, hazard warning, special handling, storage conditions, date prepared, expiration date (if applicable), and preparer's initials.

SAFETY EQUIPMENT

Safety equipment has been developed specifically for use in the clinical laboratory. The employer is required by law to have designated safety equipment available, but it is also the responsibility of the employee to comply with all safety rules and to use safety equipment.

All laboratories are required to have safety showers, eyewash stations, and fire extinguishers and to periodically test and inspect the equipment for proper operation. It is recommended that safety showers deliver 30 to 50 gallons of water per minute at 20 to 50 psi. Other items that must be available for personnel include fire blankets, spill kits, and first aid supplies.

Mechanical pipetting devices must be used for manipulating all types of liquids in the laboratory, including water. Mouth pipetting is strictly prohibited.

Chemical Fume Hoods and Biosafety Cabinets

Fume Hoods

Fume hoods are required to expel noxious and hazardous fumes from chemical reagents. Fume hoods should be visually inspected for blockages. A piece of tissue paper placed at the hood opening will indicate airflow direction. The hood should never be operated with the sash fully opened. Chemicals stored in hoods should not block airflow. Periodically, ventilation should be evaluated by measuring the face velocity with a calibrated velocity meter. The velocity at the face of the hood (with the sash in normal operating position) must be 100 to 120 feet per minute. Smoke testing is also recommended to locate no flow or turbulent areas in the working space. Additional monitoring should be in accordance with the chemical hygiene plan of the facility.

Biosafety Cabinets

Biohazard hoods remove particles that may be harmful to the employee who is working with infective biologic specimens. The Centers for Disease Control and Prevention (CDC) and the National Institutes of Health have described four levels of biosafety, which consist of

Cat. **C4324-5GL** Qty. **5 gallons (18.9L)**

Baxter

Scientific Products

SIP™ Methyl Alcohol

(Methanol - Anhydrous)
 CH_3OH FW 32.04

For Laboratory Use
 Store at 68-86°F (20-30°C)

Flash Point: 11°C (52°F Closed Cup)
 Maximum Limits and Specifications
 Methyl Alcohol: 99.8% Minimum by volume
 Residue after Evaporation: 0.001% Maximum
 Water: 0.10% Maximum
 CAS — (67-56-1);

Distributed by:
Baxter Healthcare Corporation
 Scientific Products Division
 McGaw Park, IL 60085-6787 USA
 Rev. 11/04

Made in USA

Lot No. **KEAM 8**

1 **DANGER! FLAMMABLE**

2 **DANGER! POISON**

3 **1 3 0**
 NFPA

When using, the following safety precautions are recommended:

3 **SAFETY GLASSES & SHIELD** **VENT HOOD**

5 **LAB COAT, APRON & GLOVES** **FIRE EXTINGUISHER**

6 **FLAMMABLE • VAPOR HARMFUL • MAY BE FATAL OR CAUSE BLINDNESS IF SWALLOWED • CANNOT BE MADE NON-POISONOUS • HARMFUL IF INHALED • CAUSES IRRITATION • NON-PHOTOCHEMICALLY REACTIVE**

Keep away from heat, sparks and flame. Keep container tightly closed and upright to prevent leakage. Avoid breathing vapor or spray mist. Avoid contact with eyes, skin and clothing. Use only with adequate ventilation. Wash thoroughly after handling. In case of fire, use water spray, alcohol foam, dry chemical or CO₂. In case of spillage, absorb and flush with large volumes of water immediately.

FIRST AID: In case of skin contact, flush with plenty of water; for eyes, flush with plenty of water for 15 minutes and get medical attention. If swallowed, if conscious, induce vomiting by giving two glasses of water and sticking finger down throat. Have patient lie down and keep warm. Cover eyes to exclude light. Never give anything by mouth to an unconscious person. If inhaled, remove to fresh air. If necessary, give oxygen or apply artificial respiration.

NOTE: It is unlawful to use this fluid in any food or drink or in any drug or cosmetic for internal or external use. Not for internal or external use on man or animal.

DOT Description: Methyl Alcohol, Flammable Liquid, UN1230

FIGURE 3-1. Sample chemical label: (1) statement of hazard; (2) hazard class; (3) safety precautions; (4) National Fire Protection Agency (NFPA) hazard code; (5) fire extinguisher type; (6) safety instructions; (7) formula weight; and (8) lot number.

Color of the diamond in the NFPA label indicates hazard:

Red = flammable. Store in an area segregated for flammable reagents.

Blue = health hazard. Toxic if inhaled, ingested, or absorbed through the skin. Store in a secure area.

Yellow = reactive and oxidizing reagents. May react violently with air, water, or other substances. Store away from flammable and combustible materials.

White = corrosive. May harm skin, eyes, or mucous membranes. Store away from red-, blue-, and yellow-coded reagents.

Gray = presents no more than moderate hazard in any of categories. For general chemical storage.

Exception = reagent incompatible with other reagents of same color bar. Store separately. Hazard code (4)—Following the NFPA use, each diamond shows a red segment (flammability), a blue segment (health; i.e., toxicity), and yellow (reactivity). Printed over each color-coded segment is a black number showing the degree of hazard involved. The fourth segment, as stipulated by the NFPA, is left blank. It is reserved for special warnings, such as radioactivity. The numeric ratings indicate degree of hazard: 4 = extreme; 3 = severe; 2 = moderate; 1 = slight; and 0 = none according to present data.

combinations of laboratory practices and techniques, safety equipment, and laboratory facilities. The biosafety level of a laboratory is based on the operations performed, the routes of transmission of the infectious agents, and the laboratory function or activity. Accordingly, biosafety cabinets are designed to offer various levels of protection, depending on the biosafety level of the specific laboratory (Table 3-1).

Chemical Storage Equipment

Safety equipment is available for the storage and handling of chemicals and compressed gases. Safety carriers should always be used to transport 500-mL bottles of acids, alkalis, or other solvents, and approved safety cans should be used for storing, dispensing, or disposing of flammables in volumes greater than 1 quart. Safety cabinets are required for the storage of flammable liquids, and only specially designed, explosion-proof refrigerators should be used to store flammable materials. Only the amount of chemical needed for that day should be

available at the bench. Gas-cylinder supports or clamps must be used at all times, and large tanks should be transported using handcarts.

Personal Protective Equipment

The parts of the body most frequently subject to injury in the clinical laboratory are the eyes, skin, and respiratory and digestive tracts. Hence, the use of PPE is very important. Safety glasses, goggles, visors, or work shields protect the eyes and face from splashes and impact. Contact lenses do not offer eye protection; it is strongly recommended that they not be worn in the clinical chemistry laboratory. If any solution is accidentally splashed into the eye(s), thorough irrigation is required.

Gloves and rubberized sleeves protect the hands and arms when using caustic chemicals. Gloves are required for routine laboratory use; however, polyvinyl or other nonlatex gloves are an acceptable alternative for people with latex allergies. Certain glove materials offer better protection against particular reagent formulations.

TABLE 3-1 COMPARISON OF BIOLOGIC SAFETY CABINETS

| TYPE | CABINETS | | APPLICATIONS | | |
|----------------------|----------------------|--|--------------------------------|--------------------|--------------------|
| | FACE VELOCITY (IFPM) | AIRFLOW PATTERN | RADIONUCLIDES/ TOXIC CHEMICALS | BIOSAFETY LEVEL(S) | PRODUCT PROTECTION |
| Class I,* open front | 75 | In at front; rear and top through HEPA filter | No | 2, 3 | No |
| Class II Type A | 75 | 70% Recirculated through HEPA; exhaust through HEPA | No | 2, 3 | Yes |
| Type B1 | 100 | 30% Recirculated through HEPA; exhaust via HEPA and hard-ducted | Yes (low levels/ volatility) | 2, 3 | Yes |
| Type B2 | 100 | No recirculation; total exhaust via HEPA and hard-ducted | Yes | 2, 3 | Yes |
| Type B3 | 100 | Same as IIA, but plenums under negative pressure to room and exhaust air is ducted | Yes | 2, 3 | Yes |
| Class III | NA | Supply air inlets and exhaust through 2 HEPA filters | Yes | 3, 4 | |

Source: Centers for Disease Control and Prevention and the National Institutes of Health. Biosafety in microbiological and biomedical laboratories. 4th ed. Washington, D.C.: U.S. Government Printing Office, 1999: Table 1, Comparison of Biological Safety Cabinets.

IFPM, Linear feet per minute

*Glove panels may be added and will increase face velocity to 150 lfpm; gloves may be added with an inlet air pressure release that will allow work with chemicals/radionuclides.

Nitrile gloves, for example, offer a wider range of compatibility with organic solvents than do latex gloves. Lab coats, preferably with knit-cuffed sleeves, should be full length and buttoned and made of liquid-resistant material. When performing manipulations prone to splash hazards, the lab coat should be supplemented with an impermeable apron and/or sleeve garters, constructed of suitable material to guard against the substances. Proper footwear is required; shoes constructed of porous materials, open-toed shoes, or sandals are considered ineffective against spilled hazardous liquids.

Respirators may be required for various procedures in the clinical laboratory. Whether used for biologic or chemical hazards, the correct type of respirator must be used for the specific hazard. Respirators with **high-efficiency particulate air (HEPA) filters** must be worn when engineering controls are not feasible, such as when working directly with patients with tuberculosis (TB) or when performing procedures that may aerosolize specimens of patients with a suspected or confirmed case of TB. Training, maintenance, and written protocol for use of respirators are required according to the respiratory protection standard.

Each employer must provide (at no charge) lab coats, gloves, or other protective equipment to all employees who may be exposed to biologic or chemical hazards. It is the employer's responsibility to clean and maintain all PPE. All contaminated PPE must be removed and properly disposed of before leaving the laboratory.

BIOLOGIC SAFETY

General Considerations

All blood samples and other body fluids should be collected, transported, handled, and processed using strict precautions. Gloves, gowns, and face protection must be used if splashing or splattering is likely to occur. Consistent and thorough hand washing is an essential component of infection control.

Centrifugation of biologic specimens produces finely dispersed aerosols that are a high-risk source of infection. Ideally, specimens should remain capped during centrifugation. As an additional precaution, the use of a centrifuge with an internal shield is recommended.

Spills

Any blood, body fluid, or other potentially infectious material spill must be cleaned up, and the area or equipment must be disinfected immediately. Cleanup includes the following recommendations:

- Wear appropriate protective equipment.
- Use mechanical devices to pick up broken glass or other sharp objects.
- Absorb the spill with paper towels, gauze pads, or tissue.
- Clean the spill site using a common aqueous detergent.
- Disinfect the spill site using approved disinfectant or 10% bleach, using appropriate contact time.

- Rinse the spill site with water.
- Dispose of all materials in appropriate biohazard containers.

Bloodborne Pathogens

In December 1991, OSHA issued the final rule for occupational exposure to **bloodborne pathogens**. To minimize employee exposure, each employer must have a written *exposure control plan*. The plan must be available to all employees whose reasonable anticipated duties may result in occupational exposure to blood or other potentially infectious materials. The exposure control plan must be discussed with all employees and be available to them while they are working. The employee must be provided with adequate training of all techniques described in the exposure control plan at initial work assignment and annually thereafter. All necessary equipment and supplies must be readily available and inspected on a regular basis.

Clinical laboratory personnel are knowingly or unknowingly in frequent contact with potentially biohazardous materials. In recent years, new and serious occupational hazards to personnel have arisen, and this problem has been complicated because of the general lack of understanding of the epidemiology, mechanisms of transmission of the disease, or inactivation of the causative agent. Special precautions must be taken when handling all specimens because of the continual increase in infectious samples received in the laboratory. Therefore, in practice, specimens from patients with confirmed or suspected hepatitis, acquired immunodeficiency syndrome (AIDS), Creutzfeldt-Jakob disease, or other potentially infectious diseases should be handled no differently than other routine specimens. Adopting a **standard precautions** policy, which considers blood and other body fluids from all patients as potentially infective, is required.

Airborne Pathogens

Because of the recent resurgence of TB, OSHA issued a statement in 1993 that the agency would enforce the CDC Guidelines for Preventing the Transmission of Tuberculosis in Health Care Facilities. The purpose of the guidelines is to encourage early detection, isolation, and treatment of active cases. A TB exposure control program must be established, and risks to laboratory workers must be assessed. In 1997, a proposed standard (29 CFR 1910.1035, Tuberculosis) was issued by OSHA. The standard mandates the development of a *tuberculosis exposure control plan* by any facility involved in the diagnosis or treatment of cases of confirmed infectious TB. TB isolation areas with specific ventilation controls must be established in health care facilities. Those workers in high-risk areas may be required to wear a respirator for protection. All health care workers considered to be at risk must be screened for TB infection.

Shipping

Clinical laboratories routinely ship regulated material. The U.S. Department of Transportation (DOT) and the International Air Transport Association (IATA) have specific requirements for carrying regulated materials. There are two types of specimen classifications. Known or suspect infectious specimens are labeled *infectious substances* if the pathogen can be readily transmitted to humans or animals and there is no effective treatment available. *Diagnostic specimens* are those tested as routine screening or for initial diagnosis. Each type of specimen has rules and packaging requirements. The DOT guidelines are found in *Code of Federal Regulations 49*; IATA publishes its own manual, *Dangerous Goods Regulations*.

CHEMICAL SAFETY

Hazard Communication

In the August 1987 issue of the *Federal Register*, OSHA published the new **Hazard Communication Standard** (Right to Know Law). The Right to Know Law was developed for employees who may be exposed to hazardous chemicals. Employees must be informed of the health risks associated with those chemicals. The intent of the law is to ensure that health hazards are evaluated for all chemicals that are produced and that this information is relayed to employees.

To comply with the regulation, clinical laboratories must:

- Plan and implement a written hazard communication program.
- Obtain **material safety data sheets (MSDSs)** for each hazardous compound present in the workplace and have the MSDSs readily accessible to employees.
- Educate all employees annually on how to interpret chemical labels, MSDSs, and health hazards of the chemicals and how to work safely with the chemicals.
- Maintain hazard warning labels on containers received or filled on site.

Material Safety Data Sheet

The MSDS is a major source of safety information for employees who may use **hazardous materials** in their occupations. Employers are responsible for obtaining from the chemical manufacturer or developing an MSDS for each hazardous agent used in the workplace. A standardized format is not mandatory, but all requirements listed in the law must be addressed. A summary of the MSDS information requirements includes the following:

- Product name and identification
- Hazardous ingredients

- Permissible exposure limit (PEL)
- Physical and chemical data
- Health hazard data and carcinogenic potential
- Primary routes of entry
- Fire and explosion hazards
- Reactivity data
- Spill and disposal procedures
- PPE recommendations
- Handling
- Emergency and first aid procedures
- Storage and transportation precautions
- Chemical manufacturer's name, address, and telephone number
- Special information section

The MSDS must be printed in English and provide the specific compound identity, together with all common names. All information sections must be completed, and the date that the MSDS was printed must be indicated. Copies of the MSDS must be readily accessible to employees during all shifts.

OSHA Laboratory Standard

Occupational Exposure to Hazardous Chemicals in Laboratories, also known as the **laboratory standard**, was enacted in May 1990 to provide laboratories with specific guidelines for handling hazardous chemicals. This OSHA standard requires each laboratory that uses hazardous chemicals to have a written **chemical hygiene plan**. This plan provides procedures and work practices for regulating and reducing exposure of laboratory personnel to hazardous chemicals. *Hazardous chemicals* are those that pose a physical or health hazard from acute or chronic exposure. Procedures describing how to protect employees against **teratogens** (substances that affect cellular development in a fetus or embryo), carcinogens, and other toxic chemicals must be described in the plan. Training in use of hazardous chemicals to include recognition of signs and symptoms of exposure, location of MSDS, a chemical hygiene plan, and how to protect themselves against hazardous chemicals must be provided to all employees. A chemical hygiene officer must be designated for any laboratory using hazardous chemicals. The protocol must be reviewed annually and updated when regulations are modified or chemical inventory changes. Remember that practicing consistent and thorough hand washing is an essential component of preventative chemical hygiene.

Toxic Effects from Hazardous Substances

Toxic substances have the potential of producing deleterious effects (local or systemic) by direct chemical action or interference with the function of body systems. They can cause acute or chronic effects related to the duration

of exposure (i.e., short-term, or single contact, versus long-term, or prolonged, repeated contact). Almost any substance, even the most harmless, can risk damage to a worker's lungs, skin, eyes, or mucous membranes following long- or short-term exposure and can be toxic in excess. Moreover, some chemicals are toxic at very low concentrations. Exposure to toxic agents can be through direct contact (absorption), inhalation, ingestion, or inoculation/injection.

In the clinical chemistry laboratory, personnel should be particularly aware of toxic vapors from chemical solvents, such as acetone, chloroform, methanol, or carbon tetrachloride, that do not give explicit sensory-irritation warnings, as do bromide, ammonia, and formaldehyde. Air sampling or routine monitoring may be necessary to quantify dangerous levels. Mercury is another frequently disregarded source of poisonous vapors. It is highly volatile and toxic and is rapidly absorbed through the skin and respiratory tract. Mercury spill kits should be available in areas where mercury thermometers are used. Most laboratories are phasing out the use of mercury and mercury-containing compounds. Laboratories should have a policy and method for legally disposing of mercury. Laboratory engineering controls, PPE, and procedural controls must be adequate to protect employees from these substances.

Storage and Handling of Chemicals

To avoid accidents when handling chemicals, it is important to develop respect for all chemicals and to have a complete knowledge of their properties. This is particularly important when transporting, dispensing, or using chemicals that, when in contact with certain other chemicals, could result in the formation of substances that are toxic, flammable, or explosive. For example, acetic acid is incompatible with other acids such as chromic and nitric, carbon tetrachloride is incompatible with sodium, and flammable liquids are incompatible with hydrogen peroxide and nitric acid.

Arrangements for the storage of chemicals will depend on the quantities of chemicals needed and the nature or type of chemicals. Proper storage is essential to prevent and control laboratory fires and accidents. Ideally, the storeroom should be organized so that each class of chemicals is isolated in an area that is not used for routine work. An up-to-date inventory should be kept that indicates location of chemicals, minimum/maximum quantities required, shelf life, and so on. Some chemicals deteriorate over time and become hazardous (e.g., ether forms explosive peroxides). Storage should not be based solely on alphabetical order because incompatible chemicals may be stored next to each other and react chemically. They must be separated for storage, as shown in Table 3-2.

TABLE 3-2 STORAGE REQUIREMENTS

| SUBSTANCE | STORED SEPARATELY |
|--|---------------------------|
| Flammable liquids | Flammable solids |
| Mineral acids | Organic acids |
| Caustics | Oxidizers |
| Perchloric acid | Water-reactive substances |
| Air-reactive substances | Others |
| Heat-reactive substances requiring refrigeration | |
| Unstable substances (shock-sensitive explosives) | |

Flammable/Combustible Chemicals

Flammable and combustible liquids, which are used in numerous routine procedures, are among the most hazardous materials in the clinical chemistry laboratory because of possible fire or explosion. They are classified according to flash point, which is the temperature at which sufficient vapor is given off to form an ignitable mixture with air. A flammable liquid has a flash point below 37.8°C (100°F) and combustible liquids, by definition, have a flash point at or above 37.8°C (100°F). Some commonly used flammable and combustible solvents are acetone, benzene, ethanol, heptane, isopropanol, methanol, toluene, and xylene. It is important to remember that flammable chemicals also include certain gases, such as hydrogen, and solids, such as paraffin.

Corrosive Chemicals

Corrosive chemicals are injurious to the skin or eyes by direct contact or to the tissue of the respiratory and gastrointestinal tracts if inhaled or ingested. Typical examples include acids (acetic, sulfuric, nitric, and hydrochloric) and bases (ammonium hydroxide, potassium hydroxide, and sodium hydroxide).

Reactive Chemicals

Reactive chemicals are substances that, under certain conditions, can spontaneously explode or ignite or that evolve heat or flammable or explosive gases. Some strong acids or bases react with water to generate heat (exothermic reactions). Hydrogen is liberated if alkali metals (sodium or potassium) are mixed with water or acids, and spontaneous combustion also may occur. The mixture of oxidizing agents, such as peroxides, and reducing agents, such as hydrogen, generate heat and may be explosive.

Carcinogenic Chemicals

Carcinogens are substances that have been determined to be cancer-causing agents. OSHA has issued lists of confirmed and suspected carcinogens and detailed

standards for the handling of these substances. Benzidine is a common example of a known carcinogen. If possible, a substitute chemical or different procedure should be used to avoid exposure to carcinogenic agents. For regulatory (OSHA) and institutional safety requirements, the laboratory must maintain an accurate inventory of carcinogens.

Chemical Spills

Strict attention to good laboratory technique can help prevent chemical spills. However, emergency procedures should be established to handle any accidents. If a spill occurs, the first step should be to assist/evacuate personnel, and then confinement and cleanup of the spill can begin. There are several commercial spill kits available for neutralizing and absorbing spilled chemical solutions (Fig. 3-2). However, no single kit is suitable for all types of spills. Emergency procedures for spills should also include a reporting system.

RADIATION SAFETY

Environmental Protection

A radiation safety policy should include environmental and personnel protection. All areas where **radioactive materials** are used or stored must be posted with caution signs, and traffic in these areas should be restricted to essential personnel only. Regular and systematic monitoring must be emphasized, and decontamination of laboratory equipment, glassware, and work areas should be scheduled as part of routine procedures. Records must be maintained as to the quantity of radioactive material on hand as well as the quantity that is



FIGURE 3-2. Spill cleanup kit.

disposed. A Nuclear Regulatory Commission (NRC) license is required if the total amount of radioactive material exceeds a certain level. The laboratory safety officer must consult with the institutional safety officer about these requirements.

Personal Protection

It is essential that only properly trained personnel work with radioisotopes and that users are monitored to ensure that the maximal permissible dose of radiation is not exceeded. Radiation monitors must be evaluated regularly to detect degree of exposure for the laboratory employee. Records must be maintained for the length of employment plus 30 years.

Nonionizing Radiation

Nonionizing forms of radiation are also a concern in the clinical laboratory. Equipment often emits a variety of wavelengths of electromagnetic radiation that must be protected against through engineered shielding or use of PPE (Table 3-3). These energies have varying biologic effects, depending on wavelength, power intensity, and duration of exposure. Laboratorians must be knowledgeable regarding the hazards presented by their equipment to protect themselves and ancillary personnel.

FIRE SAFETY

The Chemistry of Fire

Fire is basically a chemical reaction that involves the rapid oxidation of a combustible material or fuel, with the subsequent liberation of heat and light. In the clinical chemistry laboratory, all the elements essential for fire to begin are present—fuel, heat or ignition source, and oxygen (air). However, recent research suggests that a fourth factor is present. This factor has been classified

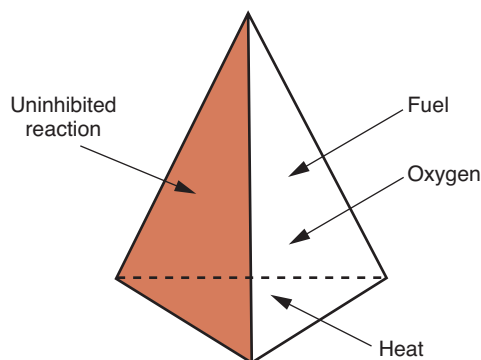

FIGURE 3-3. Fire tetrahedron.

as a reaction chain in which burning continues and even accelerates. It is caused by the breakdown and recombination of the molecules from the material burning with the oxygen in the atmosphere.

The fire triangle has been modified into a three-dimensional pyramid known as the **fire tetrahedron** (Fig. 3-3). This modification does not eliminate established procedures in dealing with a fire but does provide additional means by which fires may be prevented or extinguished. A fire will extinguish if any of the three basic elements (heat, air, or fuel) are removed.

Classification of Fires

Fires have been divided into four classes based on the nature of the combustible material and requirements for extinguishment:

- Class A: ordinary combustible solid materials, such as paper, wood, plastic, and fabric
- Class B: flammable liquids/gases and combustible petroleum products
- Class C: energized electrical equipment
- Class D: combustible/reactive metals, such as magnesium, sodium, and potassium

TABLE 3-3 EXAMPLES OF NONIONIZING RADIATION IN CLINICAL LABORATORIES

| TYPE | APPROXIMATE WAVELENGTH | SOURCE EQUIPMENT EXAMPLE | PROTECTIVE MEASURES |
|------------------|------------------------|--|---|
| Low frequency | 1 cm ⁺ | Radiofrequency coil in ICP-mass spectrometer | Engineered shielding and posted pacemaker warning |
| Microwaves | 3 m–3 mm | Energy-beam microwave used to accelerate tissue staining in histology-prep processes | Engineered shielding |
| Infrared | 750 nm–0.3 cm | Heat lamps, lasers | Containment and appropriate warning labels |
| Visible spectrum | 400–750 nm | General illumination and glare | Filters, diffusers, and nonreflective surfaces |
| Ultraviolet | 4–400 nm | Germicidal lamps used in biologic safety cabinets | Eye and skin protection; UV warning labels |

Types and Applications of Fire Extinguishers

Just as fires have been divided into classes, fire extinguishers are divided into classes that correspond to the type of fire to be extinguished. Be certain to choose the right type—using the wrong type of extinguisher may be dangerous. For example, do not use water on burning liquids or electrical equipment.

Pressurized-water extinguishers, as well as foam and multipurpose dry-chemical types, are used for Class A fires. Multipurpose dry-chemical and carbon dioxide extinguishers are used for Class B and C fires. Halogenated hydrocarbon extinguishers are particularly recommended for use with computer equipment. Class D fires present special problems, and extinguishment is left to trained firefighters using special dry-chemical extinguishers (Fig. 3-4). Personnel should know the location and type of portable fire extinguisher near their work area and know how to use an extinguisher before a fire occurs. In the event of a fire, first evacuate all personnel, patients, and visitors who are in immediate danger and then activate the fire alarm, report the fire, and attempt to extinguish the fire, if possible. Personnel should work as a team to carry out emergency procedures. Fire

drills must be conducted regularly and with appropriate documentation.

CONTROL OF OTHER HAZARDS

Electrical Hazards

Most individuals are aware of the potential hazards associated with the use of electrical appliances and equipment. Hazards of electrical energy can be direct and result in death, shock, or burns. Indirect hazards can result in fire or explosion. Therefore, there are many precautionary procedures to follow when operating or working around electrical equipment:

- Use only explosion-proof equipment in hazardous atmospheres.
- Be particularly careful when operating high-voltage equipment, such as electrophoresis apparatus.
- Use only properly grounded equipment (three-prong plug).
- Check for frayed electrical cords.
- Promptly report any malfunctions or equipment producing a “tingle” for repair.
- Do not work on “live” electrical equipment.







| CLASS OF FIRE | TYPE OF EXTINGUISHER | OPERATION |
|--|---|--|
|  <p>Class A Fires Use these types of extinguishers → Ordinary Combustibles: Wood, Paper, Cloth, etc.</p> |  <p>Pressurized Water Dry Chemical</p> | <p>PULL PIN</p> <p>AIM NOZZLE</p> <p>SQUEEZE TRIGGER</p> <p>SWEEP NOZZLE</p> |
|  <p>Class B Fires Use these types of extinguishers → Flammable Liquid Grease Gasoline Paints Oils, etc.</p> |  <p>Dry Chemical Carbon Dioxide</p> | |
|  <p>Class C Fires Use these types of extinguishers → Electrical equipment Motors Switches</p> |  <p>Carbon Dioxide Halon Dry Chemical</p> | |
|  <p>Class D Fires Use this type of agent → Flammable metals Magnesium</p> | <p>Metal X</p>  | |

FIGURE 3-4. Proper use of fire extinguishers. (Adapted with permission from the Clinical and Laboratory Safety Department, The University of Texas Health Science Center at Houston.)

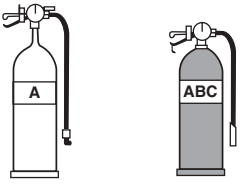
- Never operate electrical equipment with wet hands.
- Know the exact location of the electrical control panel for the electricity to your work area.
- Use only approved extension cords and do not overload circuits. (Some local regulations prohibit the use of any extension cord.)
- Have ground checks and other periodic preventive maintenance performed on equipment.

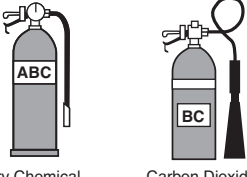
Compressed Gases Hazards

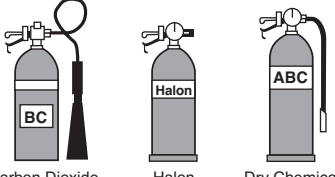
Compressed gases, which serve a number of functions in the laboratory, present a unique combination of hazards in the clinical laboratory: danger of fire, explosion, asphyxiation, or mechanical injuries. There are several general requirements for safely handling compressed gases:

- Know the gas that you will use.
- Store tanks in a vertical position.
- Keep cylinders secured at all times.
- Never store flammable liquids and compressed gases in the same area.
- Use the proper regulator for the type of gas in use.
- Do not attempt to control or shut off gas flow with the pressure relief regulator.
- Keep removable protection caps in place until the cylinder is in use.
- Make certain that acetylene tanks are properly piped (the gas is incompatible with copper tubing).
- Do not force a “frozen” or stuck cylinder valve.
- Use a hand truck to transport large tanks.
- Always check tanks on receipt and then periodically for any problems such as leaks.
- Make certain that the cylinder is properly labeled to identify the contents.
- Empty tanks should be marked “empty.”

Cryogenic Materials Hazards

Liquid nitrogen is probably one of the most widely used cryogenic fluids (liquefied gases) in the laboratory. There are, however, several hazards associated with the use of any **cryogenic material**: fire or explosion, asphyxiation, pressure buildup, embrittlement of materials, and tissue damage similar to that of thermal burns.

Only containers constructed of materials designed to withstand ultralow temperatures should be used for cryogenic work. In addition to the use of eye/face protection, hand protection to guard against the hazards of touching supercooled surfaces is recommended. The gloves, of impermeable material, should fit loosely so that they can be taken off quickly if liquid spills on or into them. Also, to minimize violent boiling/frothing and splashing, specimens to be frozen should always be inserted into the coolant very slowly. Cryogenic fluids should be stored in well-insulated but loosely stoppered containers that

minimize loss of fluid resulting from evaporation by boil-off and that prevent plugging and pressure buildup.

Mechanical Hazards

In addition to physical hazards such as fire and electric shock, laboratory personnel should be aware of the **mechanical hazards** of equipment such as centrifuges, autoclaves, and homogenizers.

Centrifuges, for example, must be balanced to distribute the load equally. The operator should never open the lid until the rotor has come to a complete stop. Safety locks on equipment should never be rendered inoperable.

Laboratory glassware itself is another potential hazard. Agents, such as glass beads, should be added to help eliminate bumping/boilover when liquids are heated. Tongs or gloves should be used to remove hot glassware from ovens, hot plates, or water baths. Glass pipets should be handled with extra care, as should sharp instruments such as cork borers, needles, scalpel blades, and other tools. A glassware inspection program should be in place to detect signs of wear or fatigue that could contribute to breakage or injury. All infectious *sharps* must be disposed in OSHA-approved containers to reduce the risk of injury and infection.

Ergonomic Hazards

Although increased mechanization and automation have made many tedious and repetitive manual tasks obsolete, laboratory processes often require repeated manipulation of instruments, containers, and equipment. These physical actions can, over time, contribute to repetitive strain disorders such as tenosynovitis, bursitis, and ganglion cysts. The primary contributing factors associated with repetitive strain disorders are position/posture, applied force, and frequency of repetition. Remember to consider the design of hand tools (e.g., ergonomic pipets), adherence to ergonomically correct technique, and equipment positioning when engaging in any repetitive task. Chronic symptoms of pain, numbness, or tingling in extremities may indicate the onset of repetitive strain disorders. Other hazards include acute musculoskeletal injury. Remember to lift heavy objects properly, keeping the load close to the body and using the muscles of the legs rather than the back. Gradually increase force when pushing or pulling, and avoid pounding actions with the extremities.

DISPOSAL OF HAZARDOUS MATERIALS

The safe handling and disposal of chemicals and other materials require a thorough knowledge of their properties and hazards. Generators of hazardous wastes have a moral and legal responsibility, as defined in applicable local, state, and federal regulations, to protect both the individual and the environment when disposing of waste. There are four basic waste-disposal techniques: flushing

down the drain to the sewer system, incineration, landfill burial, and recycling.

Chemical Waste

In some cases, it is permissible to flush water-soluble substances down the drain with copious quantities of water. However, strong acids or bases should be neutralized before disposal. Foul-smelling chemicals should never be disposed of down the drain. Possible reaction of chemicals in the drain and potential toxicity must be considered when deciding if a particular chemical can be dissolved or diluted and then flushed down the drain. For example, sodium azide, which is used as a preservative, forms explosive salts with metals, such as the copper, in pipes. Most institutions ban the use of sodium azide due to this hazard.

Other liquid wastes, including flammable solvents, must be collected in approved containers and segregated into compatible classes. If practical, solvents such as xylene and acetone may be filtered or redistilled for reuse. If recycling is not feasible, disposal arrangements should be made by specifically trained personnel. Flammable material also can be burned in specially designed incinerators with afterburners and scrubbers to remove toxic products of combustion.

Also, before disposal, hazardous substances that are explosive (e.g., peroxides) and carcinogens should be transformed to less hazardous forms whenever feasible. Solid chemical wastes that are unsuitable for incineration must be buried in a landfill. This practice, however, has created an environmental problem, and there is now a shortage of safe sites.

Radioactive Waste

The manner of use and disposal of isotopes is strictly regulated by the NRC and depends on the type of waste (soluble or nonsoluble), its level of radioactivity, and the radiotoxicity and half-life of the isotopes involved. The radiation safety officer should always be consulted about policies dealing with radioactive waste disposal. Many clinical laboratories transfer radioactive materials to a licensed receiver for disposal.

Biohazardous Waste

On November 2, 1988, President Reagan signed into law The Medical Waste Tracking Act of 1988. Its purpose was to (1) charge the Environmental Protection Agency with the responsibility to establish a program to track medical waste from generation to disposal, (2) define medical waste, (3) establish acceptable techniques for treatment and disposal, and (4) establish a department with jurisdiction to enforce the new laws. Several states have implemented the federal guidelines and incorporated additional requirements. Some entities covered by the

rules are any health care–related facility including, but not limited to, ambulatory surgical centers; blood banks and blood drawing centers; clinics, including medical, dental, and veterinary; clinical, diagnostic, pathologic, or biomedical research laboratories; emergency medical services; hospitals; long-term care facilities; minor emergency centers; occupational health clinics and clinical laboratories; and professional offices of physicians and dentists.

Medical waste is defined as *special waste from health care facilities* and is further defined as solid waste that, if improperly treated or handled, “may transmit infectious diseases.” (For additional information, see the TJC Web site: <http://www.jointcommission.org/>). It comprises animal waste, bulk blood and blood products, microbiologic waste, pathologic waste, and sharps. The approved methods for treatment and disposition of medical waste are incineration, steam sterilization, burial, thermal inactivation, chemical disinfection, or encapsulation in a solid matrix.

Generators of medical waste must implement the following procedures:

- Employers of health care workers must establish and implement an infectious waste program.
- All biomedical waste should be placed into a bag marked with the biohazard symbol and then placed into a leakproof container that is puncture resistant and equipped with a solid, tight-fitting lid. All containers must be clearly marked with the word **biohazard** or its symbol.
- All sharp instruments, such as needles, blades, and glass objects, should be placed into special puncture-resistant containers before placing them inside the bag and container.
- Needles should not be transported, recapped, bent, or broken by hand.
- All biomedical waste must then be disposed of according to one of the recommended procedures.
- Potentially biohazardous material, such as blood or blood products and contaminated laboratory waste, cannot be directly discarded. Contaminated combustible waste can be incinerated. Contaminated noncombustible waste, such as glassware, should be autoclaved before being discarded. Special attention should be given to the discarding of syringes, needles, and broken glass that also could inflict accidental cuts or punctures. Appropriate containers should be used for discarding these sharp objects.

ACCIDENT DOCUMENTATION AND INVESTIGATION

Any accidents involving personal injuries, even minor ones, should be reported immediately to a supervisor. Under OSHA regulations, employers are required to maintain records of occupational injuries and illnesses

for length of employment plus 30 years. The record-keeping requirements include a first report of injury, an accident investigation report, and an annual summary that is recorded on an OSHA injury and illness log (Form 300).

The first report of injury is used to notify the insurance company and the human resources or employee relations department that a workplace injury has occurred. The employee and the supervisor usually complete the report, which contains information on the employer and injured person, as well as the time and place, cause, and nature of the injury. The report is signed and dated; then, it is forwarded to the institution's risk manager or insurance representative.

The investigation report should include information on the injured person, a description of what happened, the cause of the accident (environmental or personal), other contributing factors, witnesses, the nature of the injury, and actions to be taken to prevent a recurrence. This report should be signed and dated by the person who conducted the investigation.

Annually, a log and summary of occupational injuries and illnesses should be completed and forwarded to the U.S. Department of Labor, Bureau of Labor Statistics OSHA injury and illness log (Form 300). The standardized form requests information similar to the first report of injury and the accident investigation report.

Information about every occupational death, nonfatal occupational illness, biologic or chemical exposure, and nonfatal occupational injury that involved loss of consciousness, restriction of work or motion, transfer to another job, or medical treatment (other than first aid) must be reported.

Because it is important to determine why and how an accident occurred, an accident investigation should be conducted. Most accidents can be traced to one of two underlying causes: environmental (unsafe conditions) or personal (unsafe acts). Environmental factors include inadequate safeguards, use of improper or defective equipment, hazards associated with the location, or poor housekeeping. Personal factors include improper laboratory attire, lack of skills or knowledge, specific physical or mental conditions, and attitude. The employee's positive motivation is important in all aspects of safety promotion and accident prevention.

It is particularly important that the appropriate authority be notified immediately if any individual sustains a needle puncture during blood collection or a cut during subsequent specimen processing or handling. For a summary of recommendations for the protection of laboratory workers, refer to *Protection of Laboratory Workers from Occupationally Acquired Infections; Approved Guideline, Third Edition*, M29-A3 (Clinical and Laboratory Standards Institute).

SUGGESTED READINGS

- Allocca JA, Levenson HE. Electrical and electronic safety. Reston, Va.: Reston Publishing Company, 1985.
- American Chemical Society, Committee on Chemical Safety. Smith GW, ed. Safety in academic chemistry laboratories. Washington, D.C.: American Chemical Society, 1985.
- Boyle MP. Hazardous chemical waste disposal management. *Clin Lab Sci* 1992;5:6.
- Brown JW. Tuberculosis alert: an old killer returns. *Med Lab Obs* 1993;25:5.
- Bryan RA. Recommendations for handling specimens from patients with confirmed or suspected Creutzfeldt-Jakob disease. *Lab Med* 1984;15:50.
- Centers for Disease Control and Prevention, National Institutes of Health. Biosafety in microbiological and biomedical laboratories. 3rd ed. Washington, D.C.: U.S. Government Printing Office, 1993.
- Chervinski D. Environmental awareness: it's time to close the loop on waste reduction in the health care industry. *Adv Admin Lab* 1994;3:4.
- Committee on Hazardous Substances in the Laboratory, Assembly of Mathematical and Physical Sciences, National Research Council. Prudent practices for handling hazardous chemicals in laboratories. Washington, D.C.: National Academies Press, 1981.
- Furr AK. Handbook of laboratory safety. 5th ed. Boca Raton, Fla.: CRC Press, 2000.
- Gile TJ. An update on lab safety regulations. *Med Lab Obs* 1995;27:3.

- Gile TJ. Hazard-communication program for clinical laboratories. *Clin Lab* 1988;1:2.
- Hayes DD. Safety considerations in the physician office laboratory. *Lab Med* 1994;25:3.
- Hazard communication. *Fed Reg* 1994;59(Feb 4):27.
- Karcher RE. Is your chemical hygiene plan OSHA proof? *Med Lab Obs* 1993;25:7.
- Le Sueur CL. A three-pronged attack against AIDS infection in the lab. *Med Lab Obs* 1989;21:37.
- Miller SM. Clinical safety: dangers and risk control. *Clin Lab Sci* 1992;5:6.
- National Committee for Clinical Laboratory Standards (NCCLS). Clinical laboratory safety (approved guideline). Villanova, Pa.: NCCLS, 1996.
- National Committee for Clinical Laboratory Standards (NCCLS). Clinical laboratory waste management (approved guideline). Villanova, Pa.: NCCLS, 1993.
- National Committee for Clinical Laboratory Standards (NCCLS). Protection of laboratory workers from instrument biohazards and infectious disease transmitted by blood, body fluids, and tissue (approved guideline, M29-A). Villanova, Pa.: NCCLS, 1997.
- National Institutes of Health, Radiation Safety Branch. Radiation: the National Institutes of Health safety guide. Washington, D.C.: U.S. Government Printing Office, 1979.
- National Regulatory Committee, Committee on Hazardous Substances in the Laboratory. Prudent practices for disposal of chemicals from laboratories. Washington, D.C.: National Academies Press, 1983.

- National Regulatory Committee, Committee on Hazardous Substances in the Laboratory. Prudent practices for the handling of hazardous chemicals in laboratories. Washington, D.C.: National Academies Press, 1981.
- National Regulatory Committee, Committee on the Hazardous Biological Substances in the Laboratory. Biosafety in the laboratory: prudent practices for the handling and disposal of infectious materials. Washington, D.C.: National Academies Press, 1989.
- National Safety Council (NSC). Fundamentals of industrial hygiene, 5th ed. Chicago, Ill.: NSC, 2002.
- Occupational exposure to bloodborne pathogens; final rule. Fed Reg 1991;56(Dec 6):235.
- Occupational Safety and Health Administration. Subpart Z 29CFR 1910.1000–.1450.
- Otto CH. Safety in health care: prevention of bloodborne diseases. Clin Lab Sci 1992;5:6.
- Pipitone DA. Safe storage of laboratory chemicals. New York, N.Y.: Wiley, 1984.
- Rose SL. Clinical laboratory safety. Philadelphia, Pa.: JB Lippincott, 1984.
- Rudmann SV, Jarus C, Ward KM, Arnold DM. Safety in the student laboratory: a national survey of university-based programs. Lab Med 1993;24:5.
- Stern A, Ries H, Flynn D, et al. Fire safety in the laboratory: part I. Lab Med 1993;24:5.
- Stern A, Ries H, Flynn D, et al. Fire safety in the laboratory: part II. Lab Med 1993;24:6.
- Wald PH, Stave GM. Physical and biological hazards of the workplace. New York, N.Y.: Van Nostrand Reinhold, 1994.

Method Evaluation and Quality Management

Christopher R. McCudden, Mike Rogers,
Jordan Erickson, Ronald Erickson,
Monte S. Willis

CHAPTER OUTLINE

■ BASIC CONCEPTS

Descriptive Statistics: Measures of Center, Spread, and Shape
Descriptive Statistics of Groups of Paired Observations
Inferential Statistics

■ REFERENCE INTERVAL STUDIES

Establishing Reference Intervals
Selection of Reference Interval Study Individuals
Preanalytic and Analytic Considerations
Determining Whether to Establish or Verify Reference Intervals
Analysis of Reference Values
Data Analysis to Establish a Reference Interval
Data Analysis to Verify a Reference Interval (Transference)

■ DIAGNOSTIC EFFICIENCY

Measures of Diagnostic Efficiency

■ METHOD EVALUATION

Regulatory Aspects of Method Evaluation (Alphabet Soup)
Method Selection
Method Evaluation
First Things First: Determine Imprecision and Inaccuracy

Measurement of Imprecision
Measurement of Inaccuracy
Recovery Studies
Interference Studies
Comparison-of-Methods Studies
Allowable Analytic Error

■ QUALITY CONTROL

Quality Control (QC) Charts
Operation of a Quality Control System
Multirules RULE!
Proficiency Testing

■ QUALITY MANAGEMENT

Quality Improvement: Lean Six Sigma
Improvement Methodology—DMAIC
Metrics—Lean and Six Sigma
Perspective: Patient Safety, Lean Six Sigma, and the Laboratory
Practical Application of Six Sigma Metrics

■ PRACTICE PROBLEMS

■ ONLINE RESOURCES

■ REFERENCES

It is widely accepted that the majority of medical decisions are made using laboratory data. It is therefore critical that results generated by the laboratory be accurate. Determining and maintaining **accuracy** requires considerable effort and cost, entailing the use of a series of approaches depending on the complexity of the test. To begin, one must appreciate what *quality* is and how quality is measured. To this end, it is vital to understand basic statistical concepts that enable the laboratorian to measure quality. Before implementing a new test, it is important to determine if the test is capable of performing acceptably; *method evaluation* is used to

verify the acceptability of new methods prior to reporting patient results. Once a method has been implemented, it is essential that the laboratory ensures it remains valid over time; this is achieved by a process known as **quality control** (QC). All of the concepts fall under the umbrella of *quality management* (QM), where the entire testing process is directed with the overall goal improving the accuracy of laboratory results. This chapter describes basic statistical concepts and provides an overview of the procedures necessary to implement a new method and ensure its continuing accuracy.

BASIC CONCEPTS

Each day, high-volume clinical laboratories generate thousands of results. This wealth of clinical laboratory data must be summarized in order to monitor test performance. The foundation for monitoring performance (known as QC) is **descriptive statistics**.

Descriptive Statistics: Measures of Center, Spread, and Shape

When examined closely, a collection of seemingly similar things always has at least slight differences for any given characteristic (e.g., smoothness, size, color, weight, volume, potency). Similarly, laboratory data will have at least slight measurement differences. For example, if glucose on a given specimen is measured 100 times in a row, there would be a range of data. Such differences in laboratory values can be a result of a variety of sources.

Although measurements will differ, their values form patterns that can be visualized and analyzed collectively. Laboratorians view and describe these patterns using graphical representations and descriptive statistics (Fig. 4-1).

When comparing and analyzing collections or sets of laboratory data, patterns can be described by their center, spread, and shape. Although comparing the center of data is most common, comparing the spread can be even more powerful. Data **dispersion** allows laboratorians to assess the predictability (and the lack of) in a laboratory test or measurement.

Measures of Center

The three most commonly used descriptions of the center (Fig. 4-2) are the mean, the median, and the mode. The *mean* is most commonly used and often referred to as the *average*. The *median* is the “middle” point of the data and is often used with skewed data. The *mode* is rarely used as a measure of the data’s center but is more often used to describe data that seem to have two centers (i.e., bimodal).

| SOURCES OF ANALYTIC VARIABILITY | |
|---------------------------------|--|
| Operator technique differences | Environmental conditions (e.g., temperature, humidity) |
| Instrument differences | Reagents |
| Test accessories | Power surges |
| Contamination | Matrix effects (hemolysis, lipemia, serum proteins) |

The mean is calculated by summing the observations and dividing by the number of the observations.

| | |
|----------------------|---|
| Σ | Add up . . . |
| $\sum_{i=1}^n x_i$ | the data points (the x’s) and . . . |
| $\sum_{i=1}^n x_i/n$ | divide by the total number of data points (n) |

$\bar{x} = \sum_{i=1}^n x_i/n$ to find the mean (“x bar”) (Eq. 4-1)

The summation sign, Σ , is an abbreviation for $(x_1 + x_2 + x_3 + \dots + x_n)$ and is used in many statistical formulas. Often, the mean of a specific dataset is referred to as \bar{x} , or “x bar”.

The median is the middle of the data after the data have been rank ordered. It is the value that divides the data in half. For example, given a sample of 5, 4, 6, 5, 3, 7, and 5, rank order the points: 3, 4, 5, 5, 5, 6, 7. Because there are an odd number of values in the sample, select the middle value: 5. The number 5 divides the data in half. Given another sample with an even number of values: 5, 4, 6, 8, 9, and 7, again rank order the points: 4, 5, 6, 7, 8, 9. Select the two “middle” values: 6 and 7. Then add

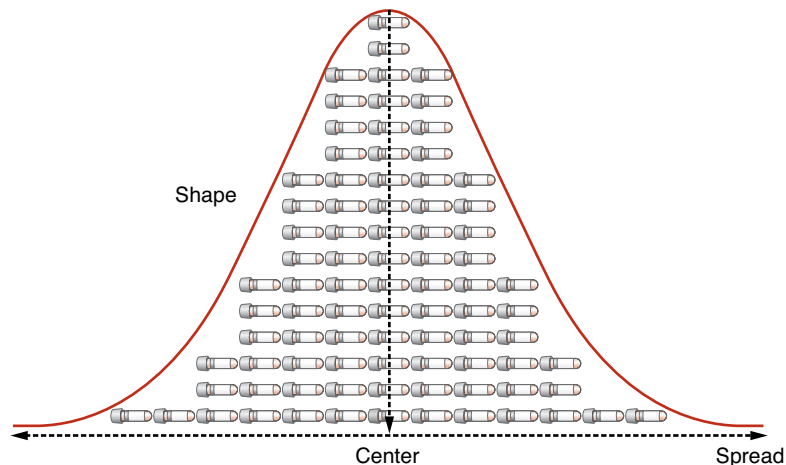

FIGURE 4-1. Basic measures of data include the center, spread, and shape.

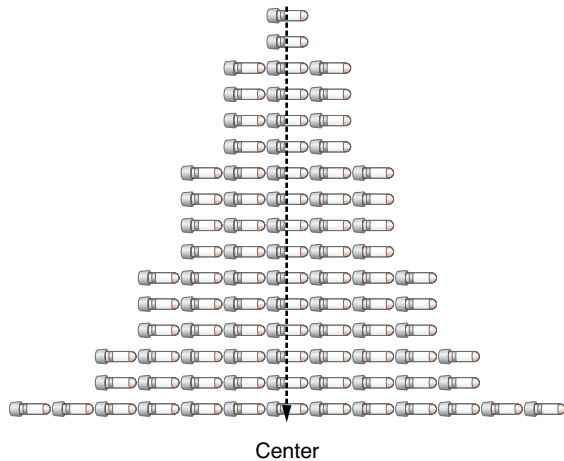

FIGURE 4-2. The center can be defined by the mean (\bar{x} character), median, or mode.

them: $6 + 7 = 13$; and divide by 2: $13/2 = 6.5$. As before, 6.5 divides the data in half.

The mode is the most frequently occurring value in a dataset. Although it is seldom used to describe data, it is referred to when in reference to the shape of data, a bimodal distribution, for example. In the sample: 3, 4, 5, 5, 5, 6, and 7, the value that occurs most often is 5. The mode of this set is then 5.

After describing the center of the dataset, it is very useful to indicate how the data are distributed (spread). The spread represents the relationship of all the data points to the mean (Fig. 4-3). There are three most commonly used descriptions of spread: (1) range, (2) SD, and (3) coefficient of variation (CV). The easiest measure of spread to understand is the range. The range is simply the largest value in the data minus the smallest value, which represents the extremes of data one might encounter. Standard deviation (also referred to as “s,” SD, or σ) is the most frequently used measure of variation. Although calculating SD can seem somewhat intimidating, the concept is straightforward. The SD and, more specifically, the vari-

ance represent the “average” distance from the center of the data (the mean) and every value in the data set. The CV allows a laboratorian to compare SDs with different units.

Range is one description of the spread of data. It is simply the difference between the highest and lowest data points: $\text{Range} = \text{High} - \text{Low}$. For the sample 5, 4, 6, 5, 3, 7, and 5, the range is $7 - 3 = 4$. The range is often a good measure of dispersion for small samples of data. It does have a serious drawback; the range is susceptible to extreme values or outliers.

In order to calculate the SD of a dataset, it is easiest to first determine the variance (s^2). Variance is similar to the mean in that it is an average. Variance is the average of the squared distances of all values from the mean:

$$s^2 = \sum_{i=1}^n (x_i - \bar{x})^2 / n - 1 \quad (\text{Eq. 4-2})$$

As a measure of dispersion, variance represents the difference between each value and the average of the data. Given the values 5, 4, 6, 5, 3, 7, and 5, variance can be calculated as shown below:

| | |
|--|---|
| \bar{x} | $(5 + 4 + 6 + 5 + 3 + 7 + 5) / 7 = 5$ |
| $(x_i - \bar{x})$ | $(5 - 5) + (4 - 5) + (6 - 5) + (5 - 5) + (3 - 5) + (7 - 5) + (5 - 5)$ |
| $(x_i - \bar{x})^2$ | $(0)^2 + (-1)^2 + (1)^2 + (0)^2 + (-2)^2 + (2)^2 + (0)^2$ |
| $\sum_{i=1}^n (x_i - \bar{x})^2$ | $0 + 1 + 1 + 0 + 4 + 4 + 0 = 10$ |
| $\sum_{i=1}^n (x_i - \bar{x})^2 / n - 1$ | $10 / (7 - 1) = 10/6$ |
| $s^2 = \sum_{i=1}^n (x_i - \bar{x})^2 / n - 1$ | 1.67 (Eq. 4-3) |

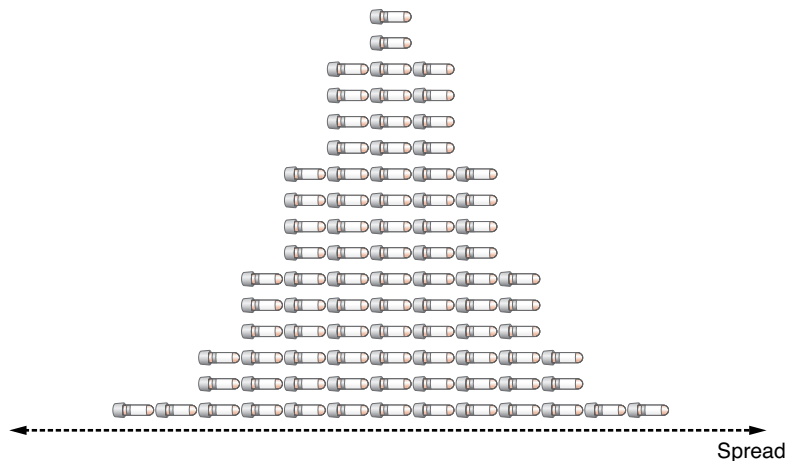

FIGURE 4-3. Spread is defined by the standard deviation and coefficient of variation.

TABLE 4-1 COMPARISON OF SD AND CV FOR TWO DIFFERENT ANALYTES

| FSH CONCENTRATION | SD | CV | β HCG CONCENTRATION | SD | CV |
|----------------------|------|-----|------------------------------|--------|-----|
| 1 | 0.09 | 9.0 | 10 | 0.8 | 8.0 |
| 5 | 0.25 | 5.0 | 100 | 5.5 | 5.5 |
| 10 | 0.40 | 4.0 | 1,000 | 52.0 | 5.2 |
| 25 | 1.20 | 4.8 | 10,000 | 500.00 | 5.0 |
| 100 | 3.80 | 3.8 | 100,000 | 4897.0 | 4.9 |

FSH, follicle-stimulating hormone; β hCG, β -human chorionic gonadotropin.

To calculate the SD (or “s”), simply take the square root of the variance:

$$s(\sigma) = \sqrt{s^2} = \sqrt{\sum_{i=1}^n (x_i - \bar{x})^2 / n - 1} \quad (\text{Eq. 4-4})$$

Although it is important to understand how these measures are calculated, many instruments, laboratory information systems, and software packages determine these automatically. SD describes the distribution of all data points around the mean.

Another way of expressing SD is in terms of the CV. The CV is calculated by dividing the SD by the mean and multiplying by 100 to express it as a percentage:

$$\text{CV (\%)} = \frac{100s}{x} \quad (\text{Eq. 4-5})$$

The CV simplifies comparison of SDs of test results expressed in different units and concentrations. As shown in Table 4-1, analytes measured at different concentrations can have a drastically different SD but a comparable CV. The CV is used extensively to summarize QC data. The CV of highly precise analyzers can be lower than 1%.

Measures of Shape

Although there are hundreds of different “shapes”—distributions—that datasets can exhibit, the most

commonly discussed is the gaussian distribution (also referred to as normal distribution; Fig. 4-4). The gaussian distribution describes many continuous laboratory variables and shares several unique characteristics: the mean, median, and mode are identical; the distribution is symmetric—meaning half the values fall to the left of the mean, and the other half fall to the right—and the symmetrical shape is often referred to as a “bell curve.”

The total area under the gaussian curve is 1.0, or 100%. Much of the area—68.3%—under the “normal” curve is between ± 1 SD ($\mu \pm 1\sigma$) (Fig. 4-5A). Most of the area—95.4%—under the “normal” curve is between ± 2 SDs ($\mu \pm 2\sigma$; Fig. 4-5B). And almost all of the area—99.7%—under the “normal” curve is between ± 3 SDs ($\mu \pm 3\sigma$) (Fig. 4-5C).

The “68–95–99 Rule” summarizes the above relationships between the area under a gaussian distribution and the SD. In other words, given any gaussian distributed data, $\approx 68\%$ of the data fall between ± 1 SD from the mean; $\approx 95\%$ of the data fall between ± 2 SDs from the mean; and $\approx 99\%$ fall between ± 3 SDs from the mean. Likewise, if you selected a value in a dataset that is gaussian distributed, there is a 0.68 chance of it lying between ± 1 SD from the mean; a 0.95 likelihood of it lying between ± 2 SDs; and a

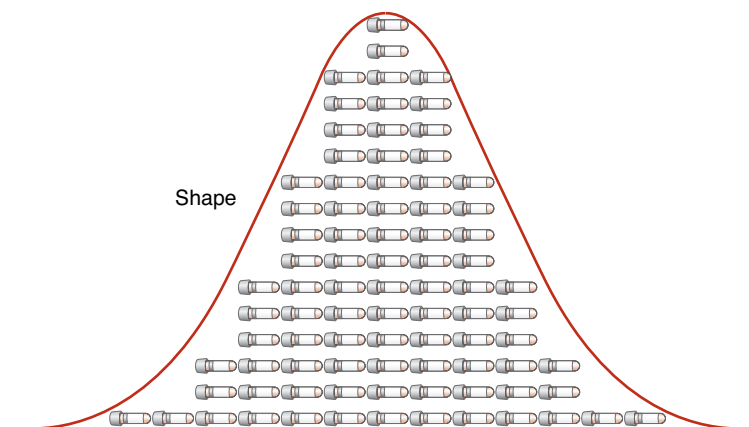

FIGURE 4-4. Shape is defined by how the distribution of data relates the center. This is an example of data that has “normal” or gaussian distribution.

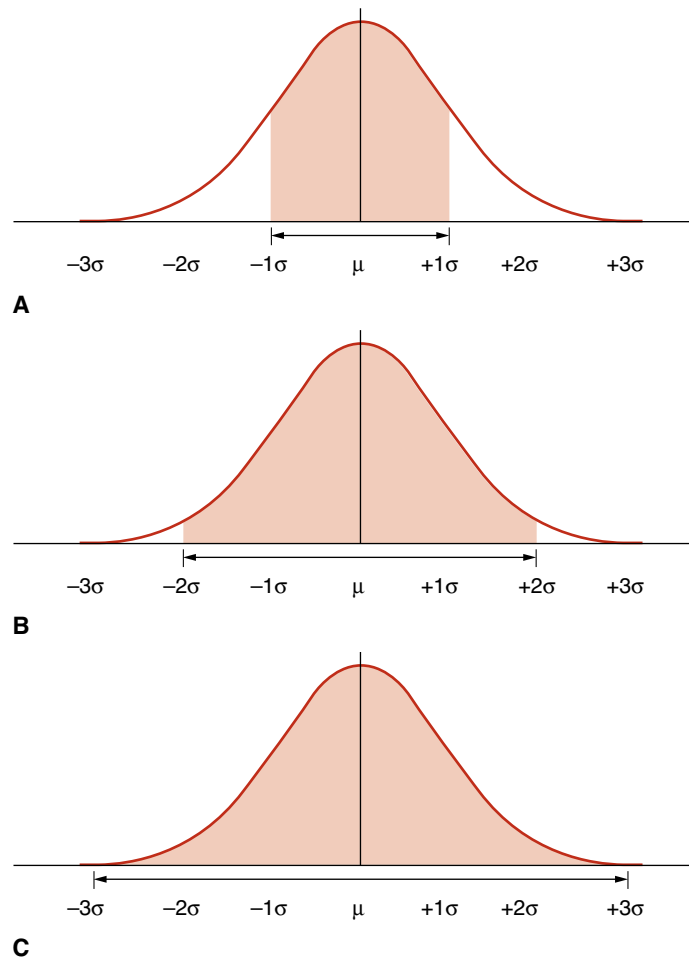

FIGURE 4-5. A normal distribution contains **(A)** $\approx 68\%$ of the results within ± 1 SD ($1s$ or 1σ), **(B)** 95% of the results within $\pm 2s$ (2σ), and **(C)** $\approx 99\%$ of the results within $\pm 3\sigma$.

0.99 probability of it lying between ± 3 SDs. [Note: the terms “chance,” “likelihood,” and “probability” are synonymous.]

As will be discussed in the **reference interval** section, most patient data are not normally distributed. These data may be skewed or exhibit multiple centers (bimodal, trimodal, etc.) as shown in Figure 4-6. Plotting data in **histograms** such as these are an easy way to visualize distribution. However, there are also mathematical analyses (e.g., normality tests) that can confirm if data fit a given distribution. The importance of recognizing whether data are or are not normally distributed is related to the way it can be statistically analyzed.

Descriptive Statistics of Groups of Paired Observations

While the use of basic descriptive statistics is satisfactory for examining a single method, laboratorians frequently need to compare two different methods. This is most

commonly encountered in comparison-of-methods (COM) experiments. A COM experiment involves measuring patient specimens by both an existing (reference) method and a new (test) method (described in the Reference Interval and Method Evaluation sections later). The data obtained from these comparisons consist of two measurements for each patient specimen. It is easiest to visualize and summarize the paired-method comparison data graphically (Fig. 4-7). By convention, the values obtained by the **reference method** are plotted on the x-axis and the values obtained by the test method are plotted on the y-axis.

In Figure 4-7, the agreement between the two methods is estimated from the straight line that best fits the points. Whereas visual estimation may be used to draw the line, a statistical technique known as **linear regression** analysis provides objective measures of the location and dispersion for the line. Three factors are generated in a linear regression—the slope, the y-intercept, and the correlation coefficient (r). In the figure (Fig. 4-7), there is a linear relationship between the two methods over the entire

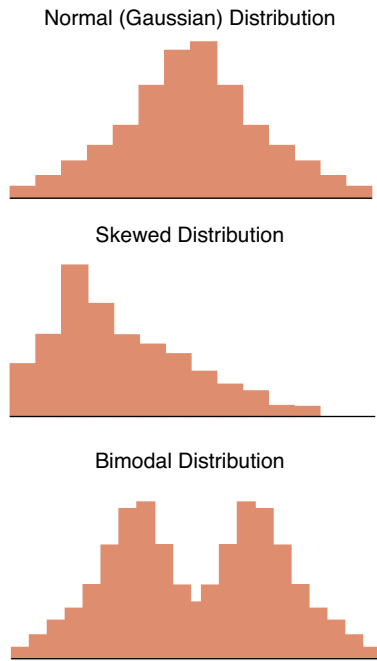

FIGURE 4-6. Examples of normal (gaussian), skewed, and bimodal distributions. The type of statistical analysis that is performed to analyze the data depends on the distribution (shape).

range of values. The linear regression is defined by the equation $y = mx + b$. The slope of the line is described by m , and the value of the y -intercept (b) is determined by plugging $x = 0$ into the equation and solving for y . The correlation coefficient is a measure of the strength of the relationship between the two methods. The correlation coefficient can have values from -1 to 1 , with the sign indicating the direction of relationship between the two variables. A positive r indicates that both variables increase and decrease together, whereas a negative r indicates that as one variable increases, the other decreases. An r value of 0 indicates no relationship, whereas $r = 1.0$ indicates a perfect relationship. Although many laboratorians equate high positive values of r (0.95 or higher) with excellent agreement between the test and comparative methods, most clinical chemistry comparisons should have correlation coefficients greater than 0.98 . When r is less than 0.99 , the regression formula can underestimate the slope and overestimate the y -intercept. The absolute value of the correlation coefficient can be increased by widening the concentration range of samples being compared. However, if the correlation coefficient remains less than 0.99 , then alternate regression statistics should be used to derive more realistic estimates of the regression, slope, and y -intercept.^{1,2}

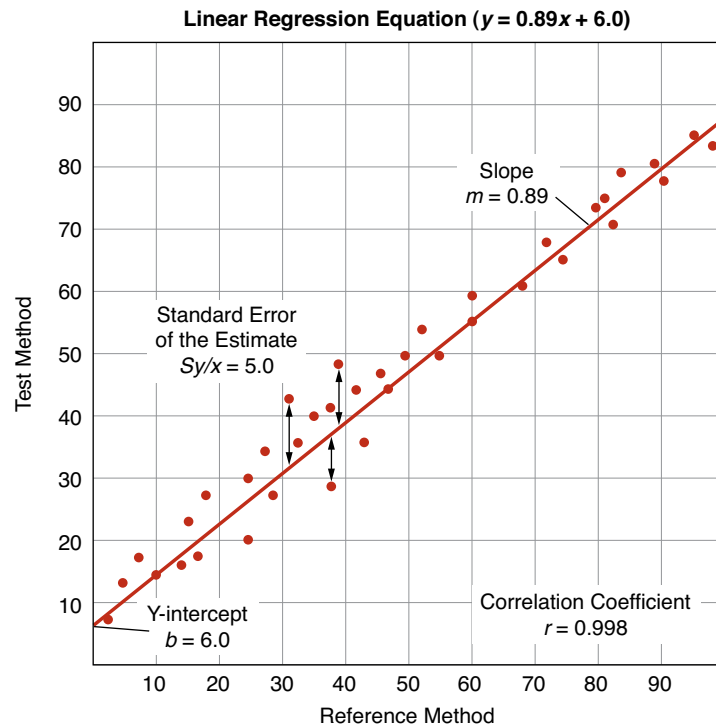

FIGURE 4-7. A generic example of a linear regression. A linear regression compares two tests and yields important information about systematic and random error. Systematic error is indicated by changes in the y -intercept (constant error) and the slope (proportional error). Random error is indicated by the standard error of the estimate ($S_{y/x}$); $S_{y/x}$ basically represents the distance of each point from the regression line. The correlation coefficient indicates the strength of the relationship between the tests.

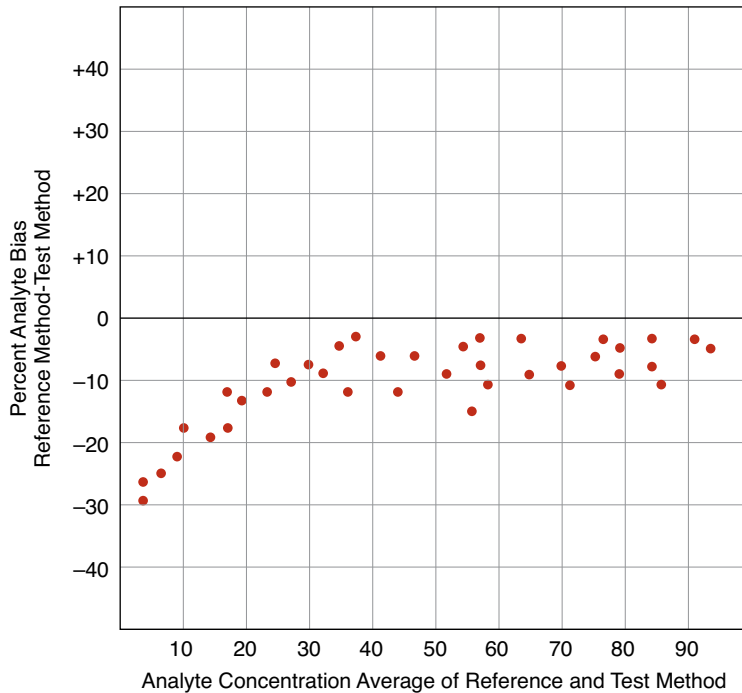

FIGURE 4-8. An example of a difference (Bland-Altman) plot. Difference plots are a useful tool to visualize concentration-dependent error.

An alternate approach to visualizing paired data is the difference plot, which is also known as the Bland-Altman plot (Fig. 4-8). A difference plot graphs either the percent or absolute **bias** (difference) between the reference and test method values over the average range of values. This approach permits simple comparison of the differences to previously established maximum limits. As is evident in Figure 4-8, it is easier to visualize any concentration-dependent differences than by linear regression analysis. In this example, the percent difference is clearly greatest at lower concentrations, which is not an obvious finding using the regression plot (see Fig. 4-7).

The difference between test- and reference-method results is called *error*. There are two kinds of error measured in COM experiments: random and systematic. **Random error** is present in all measurements and can be either positive or negative. As described earlier, random error can be a result of many factors including instrument, operator, reagent, and environmental variations. Random

error is calculated as the SD of the points about the regression line ($S_{y/x}$). $S_{y/x}$ essentially refers to average distance of the data from the regression line (Fig. 4-7). The higher the $S_{y/x}$, the wider is the scatter and the higher is the amount of random error.

| | |
|---|--|
| $S_{y/x}$ | Standard deviation of the regression line |
| $S_{y/x} = \Sigma$ | Add up |
| $S_{y/x} = \Sigma(y_i - Y_i)$ | The distance of each y-value from regression line |
| $S_{y/x} = \Sigma(y_i - Y_i)^2$ | Square each difference to make the sum a positive number |
| $S_{y/x} = [\Sigma(y_i - Y_i)^2/n - 2]$ | Divide the sum of the squares by the number of points and subtract 2 |
| $S_{y/x} = \text{sqrt} [\Sigma(y_i - Y_i)^2/n - 2]$ | Take the square root |

(Eq. 4-6)

In Figure 4-7, the $S_{y/x}$ is 5.0. If the points were perfectly in line with the linear regression the $S_{y/x}$ would equal 0.0 indicating there would not be any random error. $S_{y/x}$ is also known as the standard error of the estimate, S_E .

Systematic error influences observations consistently in one direction (higher or lower). The measures of slope and y-intercept provide estimates of the systematic error. Systematic error can be further broken down into **constant**

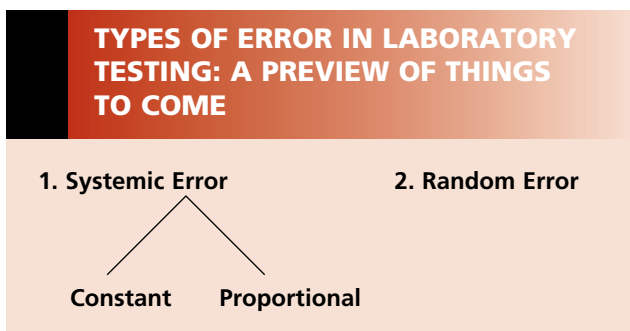

error and **proportional error**. Constant systematic error exists when there is a continual difference between the test method and the comparative method values, regardless of the concentration. In Figure 4-7, there is a constant difference of 6.0 between the test-method values and the comparative-method values. This constant difference, reflected in the y -intercept, is called *constant systematic error*. Proportional error exists when the differences between the test method and the comparative method values are proportional to the analyte concentration. Proportional error is present when the slope $\neq 1$. In the example, the slope of 0.89 represents the proportional error, where samples will be underestimated in a concentration-dependent fashion by the test method compared with the reference method; the error is proportional, because it will increase with the analyte concentration.

Inferential Statistics

The next level of complexity beyond paired descriptive statistics is inferential statistics. Inferential statistics are used to draw conclusions (inferences) regarding the means or SDs of two sets of data. Inferential statistical analyses are most commonly encountered in research studies but can be used in COM studies.

An important consideration for inferential statistics is the distribution of the data (shape). The distribution of the data determines what kind of inferential statistics that can be used to analyze the data. Normally distributed (gaussian) data are typically analyzed using what are known as “parametric” tests, which include a Student’s t -test or analysis of variance (ANOVA). Data that are not normally distributed require a “nonparametric” analysis. Nonparametric tests are encountered in reference interval studies, where population data are often skewed. While many software packages are capable of performing either parametric or nonparametric analyses, it is important the user understand that the type of data (shape) dictates which statistical test is appropriate for the analysis. An inappropriate analysis of sound data can yield the wrong conclusion.

REFERENCE INTERVAL STUDIES

Laboratory test data are used to make medical diagnoses, assess physiologic function, and manage therapy. When interpreting laboratory data, clinicians compare the measured test result from a patient with a reference interval.

DEFINITIONS BOX

Reference interval: A pair of medical decision points that span the limits of results expected for a given condition.

Reference intervals include all the data points that define the range of observations (e.g., if the interval is 5–10, a patient result of 5 would be considered within the interval). The upper and lower reference limits are set to define a specified percentage (usually 95%) of the values for a population; this means that a percentage (usually 5%) of patients will fall outside of the reference interval in the absence of any condition or disease. Reference intervals are sometimes erroneously referred to as “normal ranges.” While all normal ranges are in fact reference intervals, not all reference intervals are normal ranges. This is exemplified by the reference interval for therapeutic drug levels. In this case, a “normal” individual would not have any drug in their system, whereas a patient on therapy has a defined target range. Reference intervals are sometimes referred to as reference ranges; the preferred term is reference interval because range implies the absolute maximum and minimum values.

The theory for the development of reference intervals was the work of two main expert committees.^{3–6} These committees established the importance of standardizing collection procedures, the use of statistical methods for analysis of reference values and estimation of reference intervals, and the selection of reference populations. Reference intervals are usually established by the scientific community or the manufacturers of reagents and new methodologies. Developing reference intervals often has a financial impact on vendors and marketing of the laboratory products. Laboratorians must be aware of these scientific and economic forces when reviewing vendor data and determining the need for reference interval studies. The two main types of reference interval studies that are reviewed in this section are (1) establishing a reference interval and (2) verifying a reference interval.

DEFINITIONS BOX

Establishing a reference interval: A new reference interval is established when there is no existing analyte or methodology in the clinical or reference laboratory with which to conduct comparative studies. It is a costly and labor-intensive study that will involve laboratory resources at all levels and may require from 120 to as many as ≈ 700 study individuals.

Verifying a reference interval (transference): This is done to confirm the validity of an existing reference interval for an analyte using the same (identical) type of analytic system (method and/or instrument). These are the most common reference interval studies performed in the clinical laboratory and can require as few as 20 study individuals.

EXAMPLES OF CAP CHECKLIST QUESTIONS REGARDING REFERENCE INTERVALS FOR LABORATORY INSPECTION

Has the laboratory established or verified its reference intervals (normal values)?

Reference intervals are important to allow a clinician to assess patient results against an appropriate population. The reference range must be established or verified for each analyte and specimen source (e.g., blood, urine, cerebrospinal fluid [CSF]), when appropriate. For many analytes (e.g., therapeutic drugs and CSF total protein), literature references or a manufacturer's package insert information may be appropriate.⁷⁻⁹

Does the laboratory evaluate the appropriateness of its reference intervals, and take corrective action if necessary?

Criteria for evaluation of reference intervals include:

1. Introduction of a new analyte to the test repertoire
2. Change in analytic methodology
3. Change in patient population

If it is determined that the range is no longer appropriate for the patient population, corrective action must be taken.⁷⁻⁹

Adapted with permission from Sarewitz SJ ed. Laboratory accreditation program inspection checklists. Northfield, IL: College of American Pathologists.

The clinical laboratory is required by good laboratory practice and accreditation agencies (i.e., College of American Pathologists [CAP] checklist) to either verify or establish reference intervals for any new tests or significant changes in methodology.

The core protocols for both establishing and verifying reference ranges are reviewed in this section. Other terms are used for values or ranges that help the clinician determine the relationship of patients' test results to sta-

DEFINITIONS BOX

Medical decision level: Value for an analyte that represents the boundary between different therapeutic approaches.

Normal range: Range of results between two medical decision points that correspond to the central 95% of results from a healthy patient population. *Note:* Of the results, 2.5% will be above the upper limit and 2.5% will be below the lower limit of the normal range.

Therapeutic range: Reference interval applied to a therapeutic drug. Reference intervals are needed for all tests in the clinical laboratory, and the provision of reliable reference intervals is an important task for clinical laboratories and test manufacturers. The dynamic review of existing reference intervals by the health care team (scientific community, manufacturers, and clinical laboratory) is crucial to meeting the challenges of providing optimal laboratory data for patient care.

tistically determined values or ranges for the clinical condition under treatment.

Reference interval use can be grouped into three main categories: diagnosis of a disease or condition (Table 4-2), monitoring of a physiologic condition (Table 4-3), and therapeutic management (Table 4-4).

These tables demonstrate the complexity of reference intervals when multiple levels (partitions) of reference intervals are required by the clinician. The framework for verifying or establishing reference intervals is one that can be overwhelming for the clinical laboratory. The costs, personnel, and resource requirements mandate that the reference interval experiment be well defined and structured in such a manner to provide accurate and timely reference intervals for optimal clinical use. Where possible, the clinical laboratory director may determine that a review of literature references or manufacturer's package inserts is appropriate in assigning reference intervals for an analyte or this additional information

TABLE 4-2 THYROID-STIMULATING HORMONE FOR HYPOTHYROID OR HYPERTHYROID DISEASE

| PATIENTS | AGE | TSH REFERENCE RANGES (μ IU/ML) |
|-----------------------------|----------|-------------------------------------|
| Pediatric | 0-3 d | 1.00-20.00 |
| | 3-30 d | 0.50-6.50 |
| | 31 d-5 m | 0.50-6.00 |
| | 6 m-18 y | 0.50-4.50 |
| Adults, ambulatory, healthy | >18 y | 0.60-3.30 |

Based on Dugaw KA, Jack RM, Rutledge J. Pediatric reference ranges for TSH, free T4, total T4 total T3 and T3 uptake on the vitros Eci analyzer. Clin Chem 2001;47:A108.

TABLE 4-3 β HCG AT DEFINED GESTATIONAL AGE

| APPROXIMATE β HCG LEVELS AT DEFINED GESTATIONAL AGE UNITS MIU/ML (U/L) | | | |
|--|--------|----------------|-----|
| WEEKS OF PREGNANCY | MEAN | RANGE | N |
| 4 | 1,110 | 40–4,480 | 42 |
| 5 | 8,050 | 270–28,700 | 52 |
| 6 | 29,700 | 3,700–84,900 | 67 |
| 7 | 58,800 | 9,700–120,000 | 62 |
| 8 | 79,500 | 31,000–184,000 | 37 |
| 9 | 91,500 | 61,200–152,000 | 25 |
| 10 | 71,000 | 22,000–143,000 | 12 |
| 14 | 33,100 | 14,300–75,800 | 219 |
| 15 | 27,500 | 12,300–60,300 | 355 |
| 16 | 21,900 | 8,800–54,500 | 163 |
| 17 | 18,000 | 8,100–51,300 | 68 |
| 18 | 18,400 | 3,900–49,400 | 30 |
| 19 | 20,900 | 3,600–56,600 | 14 |

may allow for the shorter reference interval verification study (i.e., 20 study individuals).

Establishing Reference Intervals

The Clinical and Laboratory Standards Institute (CLSI, formerly National Committee for Clinical Laboratory Standards [NCCLS]) has published a preferred guideline/resource for in establishing or verification of reference

intervals.¹⁰ A summary of the CLSI recommendations is given next.

Selection of Reference Interval Study Individuals

The selection of individuals who can be included in a reference interval study requires defining detailed inclusion/exclusion criteria. Inclusion criteria define what factors (e.g., age, gender) are required to be used for the study, while exclusion criteria list factors that render individuals inappropriate for the study (Table 4-5). It is essential to select the appropriate individuals in order to obtain the optimal set of specimens with an acceptable level of confidence. Determination of the necessary inclusion and exclusion criteria for donor selection may require extensive literature searches and review with laboratory directors and clinicians. Initially, it must be exactly defined what is a “healthy”/“normal” donor for associated reference values. For example, for a β -human chorionic gonadotropin (β hCG) reference interval study, one would exclude pregnant women or those who may be pregnant, as well as individuals with β hCG-producing tumors. An important note to make is that laboratories are often challenged to locate donors outside of the laboratory working environment, who

To establish a reference range study:

1. Define an appropriate list of biological variations and analytic interferences from medical literature.
2. Choose selection and partition (e.g., age or gender) criteria.
3. Complete a written consent form and questionnaire to capture selection criteria.
4. Categorize the potential reference individuals based on the questionnaire findings.
5. Exclude individuals from the reference sample group based on exclusion criteria.
6. Define the number of reference individuals in consideration of desired confidence limits and statistical accuracy.
7. Standardize collection and analysis of reference specimens for the measurement of a given analyte consistent with the routine practice of patients.
8. Inspect the reference value data and prepare a histogram to evaluate the distribution of data.
9. Identify possible data errors and/or outliers and then analyze the reference values.
10. Document all of the previously mentioned steps and procedures.

TABLE 4-4 EXAMPLE OF THERAPEUTIC MANAGEMENT OF CLINICAL TREATMENTS FOR THE CARDIAC GLYCOSIDE DRUG DIGOXIN

| | |
|----------|--|
| Normal | 0.8–1.8 ng/mL (collected 6 h after dose) |
| Critical | >2.0 ng/mL |

TABLE 4-5 EXAMPLES OF POSSIBLE EXCLUSION FACTORS FOR A REFERENCE INTERVAL STUDY

| | |
|---|------------------|
| Fasting or nonfasting | Pregnancy |
| Genetic factors | Illness, recent |
| Drugs: prescription or over the counter | Exercise pattern |

may be largely females under 40 years of age. The use of donors who may not represent the population of interest has the potential to skew the evaluation data used to establish the reference interval. Inpatient samples should not be used for reference interval studies that are designed to reflect a population.

Capturing the appropriate information for the inclusion and exclusion criteria, such as donor health status, often requires a well-written confidential questionnaire and consent form. Shown is an example from our institution from a recent study to establish a creatinine clearance reference interval:

EXAMPLE QUESTIONNAIRE

Creatinine Clearance Example Time Urine Instructions Creatinine

Donor Number: _____
 Sex: _____
 Height: _____ Weight: _____
 Exercise routine: _____
 Pregnancy: Yes/No
 Medications: _____

Another consideration when selecting individuals for a reference interval study are additional factors that may require partitioning individuals into subgroups (Table 4-6). These subgroups may require separate reference interval studies. Fortunately, a large number of laboratory tests do not require partitioning and can be used with only one reference interval that is not dependent on a variety of factors (Table 4-7). These real examples are testimony to the complexity of conducting reference interval studies. The initial selection of individual donors is crucial to the successful evaluation of reference intervals.

TABLE 4-6 EXAMPLES OF POSSIBLE SUBGROUPS REQUIRING PARTITIONS FOR A REFERENCE INTERVAL STUDY

| | |
|---------------------------|--------------------|
| Age (adult and childhood) | Stage of pregnancy |
| Fasting or nonfasting | Sex |
| Diet | Tobacco use |

TABLE 4-7 EXAMPLE OF A SIMPLE REFERENCE INTERVAL FOR THE CARDIAC MARKER CK-MB

| | |
|--------------------------|---------------|
| CK-MB reference interval | 0.0–6.0 ng/mL |
|--------------------------|---------------|

Preanalytic and Analytic Considerations

Once individuals are selected for a reference interval study, it is important to consider both preanalytic and analytic variables that can affect specific laboratory tests (Table 4-8). Preanalytic and analytic variables must be controlled and standardized in order to generate a valid reference interval. To illustrate these points, we discuss establishing a reference interval for fasting glucose. An obvious preanalytic variable that should be addressed for this test is that individuals should not eat for at least 8 hours prior to sample collection. In terms of analytic factors, it is important to define acceptable levels of common interferences, such as hemolysis or lipemia. For fasting glucose, the laboratorian must define whether samples with excess hemolysis or lipemia will be included in the study; this depends, in part, on whether the interferences affect the methods (in this case, glucose). If specific interferences do affect the accuracy of the test, it is essential that interferences can be flagged, in order to appropriately deal with the results and interpretation. Hemolysis and lipemia can be detected automatically by large chemistry analyzers, but not small point-of-care tests; this could lead to errors when using point-of-care tests. It is also worth considering that some methods are more sensitive to interferences. Mass spectrometry, for example, can be relatively resistant to interferences, whereas chemical methods are at times highly sensitive to this problem. It is also necessary to consider what specific reagents are used in an assay. Changing to a new reagent lot in the middle of a reference study could widen the reference interval or change the data distribution (e.g., change from normal to bimodal). Thus, an effective reference interval study requires extensive knowledge of the analyte, analytic parameters, methodology, and instrumentation.

TABLE 4-8 PREANALYTIC AND ANALYTIC CONSIDERATIONS FOR REFERENCE INTERVAL STUDIES

| PREANALYTIC FACTORS | |
|--------------------------|-------------------------|
| Subject preparation | Sample storage |
| Prescription medications | Stress |
| Collection time | Food/beverage ingestion |
| ANALYTIC FACTORS | |
| Precision | Linearity |
| Accuracy | Interference |
| Lot-to-lot reagents | Recovery |

Determining Whether to Establish or Verify Reference Intervals

Whether to verify a reference interval or establish an entirely new reference interval for a new method/analyte depends on several factors, such as the presence of an existing reference interval for assay and on the results of a statistical analysis comparing the test method with the reference method. The most basic method comparison involves plotting a reference method against a test method and fitting a linear regression (described in Fig. 4-7). If the correlation coefficient is 1.0, slope is 1.000 and intercept is 0.000, the two methods agree and may not require new reference ranges. In this case, a simple reference interval verification study is all that may be required. Conversely, if the two methods differ considerably, then a new reference interval needs to be established.

Analysis of Reference Values

DEFINITIONS BOX

Nonparametric method: Statistical test that makes no specific assumption about the distribution of data. Nonparametric methods rank the reference data in order of increasing size. Because the majority of analytes are not normally (gaussian) distributed (see Fig. 4-6), nonparametric tests are the recommended analysis for most reference range intervals.

Parametric method: Statistical test that assumes the observed values, or some mathematical transformation of those values, follows a (normal) gaussian distribution (see Fig. 4-6).

Confidence interval: Range of values that include a specified probability, usually 90% or 95%. For example, consider a 95% confidence interval for slope = 0.972–0.988 from a method comparison experiment. If this same experiment were conducted 100 times, then slope would fall between 0.972 and 0.988 in 95 of the 100 times. Confidence intervals serve to convey the variability of estimates and quantify the variability.

Bias: Difference between the observed mean and the reference mean. Negative bias indicates that the test values tend to be lower than the reference value, whereas positive bias indicates test values are generally higher. Bias is a type of constant systematic error.

Data Analysis to Establish a Reference Interval

To establish a reference interval, it is recommended that the study include at least 120 individuals. This can be challenging and costly, but it may be necessary for esoteric and laboratory-developed tests. Once the raw data have been generated, the next step is to actually define the reference interval. The reference interval is calculated statistically using methods that depend on the distribution of the data. In the most basic sense, data may be either normally distributed (gaussian) or skewed (nongaussian) (see Fig. 4-6). If reference data are normally distributed, the reference interval can be determined using a parametric method. A parametric method defines the interval by the mean \pm 1.96 SDs; by centering on the mean, this formula will include the central 95% of values as given in the example in Figure 4-9A.

In reality, most analytes do not display a normal (gaussian) distribution. For example, the distribution of β hCG in pregnant individuals is skewed (Fig. 4-9B). Data that are not normally distributed (i.e., nongaussian) must be analyzed using nonparametric analyses. Nonparametric determination of the reference interval is analyzed using percentages, which do not depend on the distribution. The reference interval is determined by using the central 95% of values; the reference range is therefore defined by the 2.5th to the 97.5th percentiles, as demonstrated in Figure 4-9B. To calculate the interval, values are ranked from lowest to highest and the 2.5th and 97.5th percentiles are then calculated as follows:

$$n = \text{number of reference specimens}$$

$$2.5\text{th percentile} = 0.025(n + 1)$$

$$97.5\text{th percentile} = 0.975(n + 1) \quad (\text{Eq. 4-7})$$

Most reference interval analyses are determined using nonparametric analysis. This is because nonparametric analysis can be used on gaussian distributed data and it is the CLSI-recommended method¹⁰ (Fig. 4-9B).

With the development of statistical software packages such as EP Evaluator, MedCalc, GraphPad Prism, Minitab, JMP, and SAS/STAT, reference intervals are rarely determined manually. However, it is important to understand how basic statistical concepts are used by the software to generate their analyses. For more information on these software programs, the interested reader can access the references and online resources listed at the end of the chapter.

Data Analysis to Verify a Reference Interval (Transference)

When possible, clinical laboratories rely on assay manufacturers or on published primary literature to determine

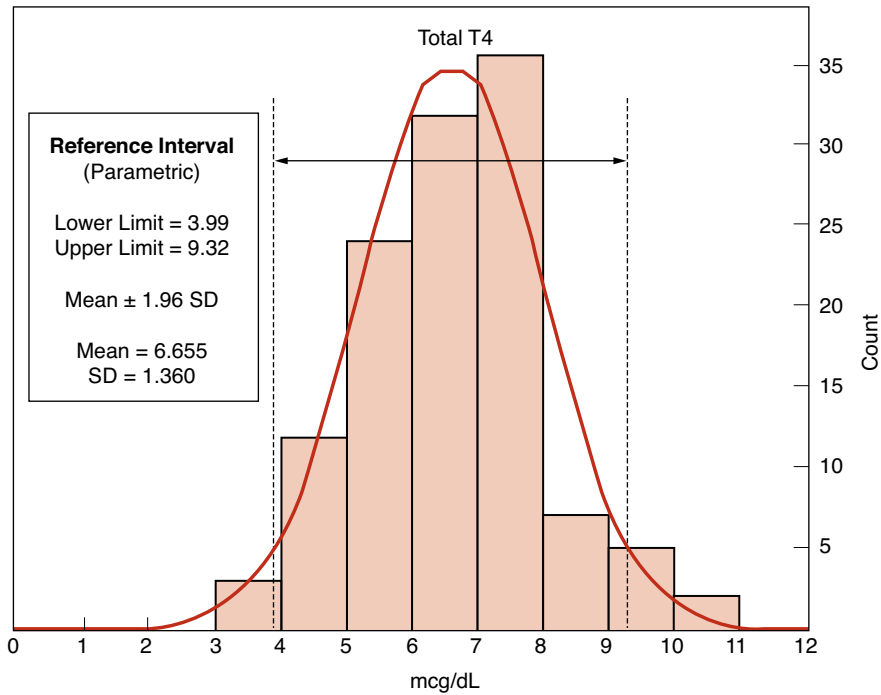

A

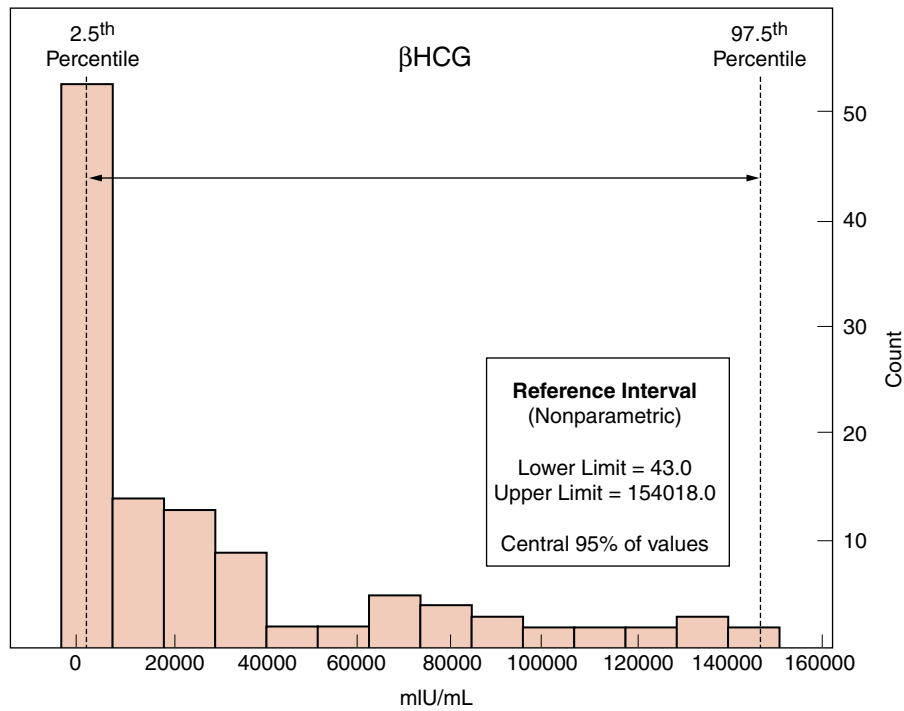

B

FIGURE 4-9. (A) Histogram of total thyroxine (TT₄) levels in a real population illustrating a shape indicative of a gaussian distribution, which is analyzed by parametric statistics. The reference interval is determined from the mean ± 1.96 SDs. **(B)** Histogram of beta-human chorionic gonadotropin (βhCG) levels in an actual population demonstrating nongaussian data and nonparametric determination of the reference interval. The reference interval is determined from percentiles to include the central 95% of values.

reference intervals. This avoids the expensive and lengthy process of establishing a reference range interval on a minimum of 120 healthy people. The CLSI allows less vigorous studies to verify a reference interval with as few as 20 subject specimens.¹⁰ Method verification studies can be used if the test method and study subjects are similar to the vendor's reference data and package insert information. The main assumption in using transference studies is that the reference method is of high quality and the subject populations are similar. The manufacturer's reported 95% reference limits may be considered valid if no more than 10% of the tested subjects fall outside the original reported limits. Figure 4-10 shows an example from our laboratory where we verify the manufacturer's reference range for free thyroxine (fT_4). In this example, fewer than 10% are outside the manufacturer's limits, enabling the reference interval to be adopted by the laboratory. If more than 10% of the values fall outside of the proposed interval, an additional 20 or more specimens should be analyzed. If the second attempt at verification fails, the laboratorian should reexamine the analytic procedure and identify any differences between the laboratory's population and the population used by the manufacturer for their analysis. If no differences are identified, the laboratory may need to establish the reference interval using at least

120 individuals. Figure 4-11 demonstrates a simple algorithm to verify reference intervals.

Once a reference interval is determined, it needs to be communicated to the physicians interpreting test results at the time the test results are reported. This is important given the slight variations in reference intervals seen even among testing facilities using similar methodologies. It is considered good laboratory practice to monitor reference intervals regularly. Some common problems that occur when determining reference intervals are given in Table 4-9. To help identify reference interval problems, the clinical laboratorian should be aware of common flags. These flags often come in the form of an event or communication that alerts the laboratory that there is a potential problem with a test. Based on our observations, flags for reference intervals can include vendor notifications, clinician queries of a particular test, and **shifts/trends** in large average numbers of patients over time. Any of these or other related factors may warrant a review of existing reference intervals.

DIAGNOSTIC EFFICIENCY

Ideally, healthy patients would have completely distinct laboratory values from patients with disease (Fig. 4-12A).

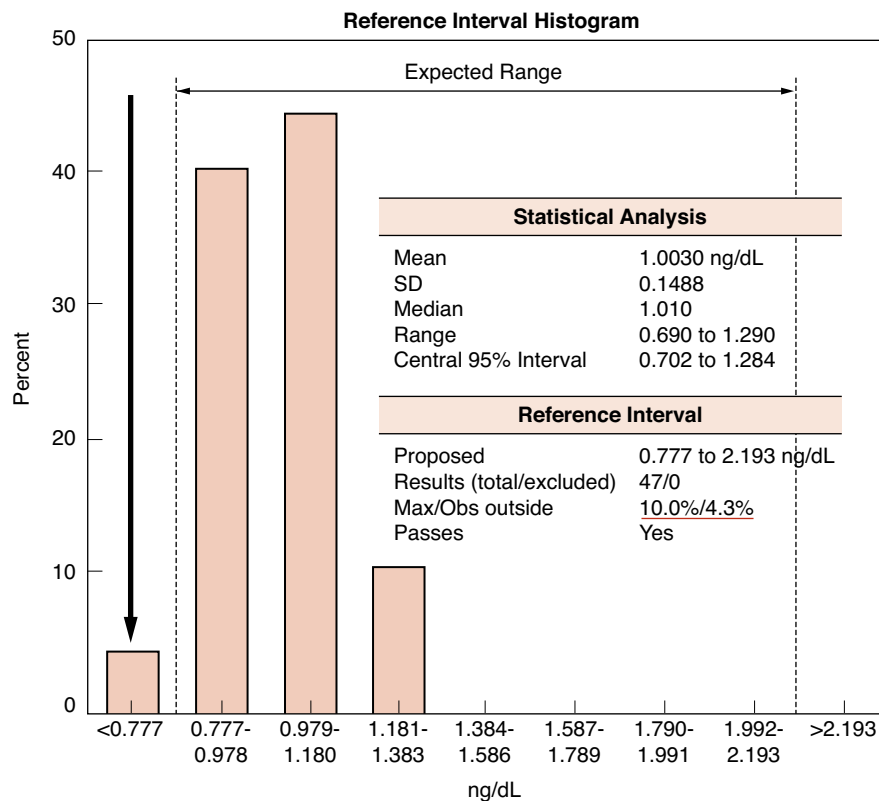

FIGURE 4-10. Reference verification test for free thyroxine (fT_4). Only 4.3% of the values are outside the expected range (arrow). The test passes because this is less the allowable number of outlying samples (10%) (underlined in red).

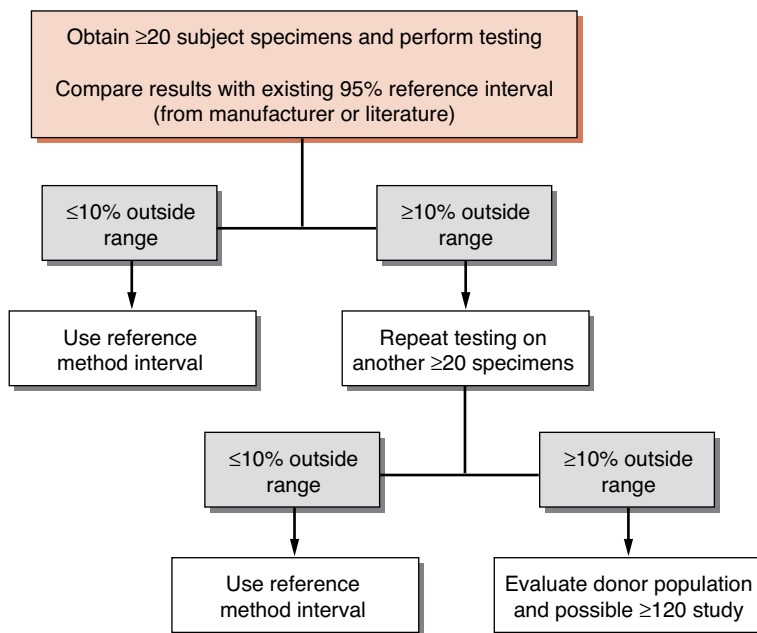

FIGURE 4-11. Algorithm to test whether a reference interval can be verified. A published reference interval (from a manufacturer or scientific literature) can be adopted if only a few samples fall outside the range. When possible, laboratory reference intervals are verified because of the time and expense of establishing a new interval.

However, the reality is that laboratory values usually overlap significantly between these populations (Fig. 4-12B). To determine how good a given test is at detecting and predicting the presence of disease (or a physiologic condition), there are a number of different parameters that are used. These parameters are broadly defined as *diagnostic efficiency*, which can be broken down into **sensitivity**, **specificity**, and **predictive values**.

DEFINITIONS BOX

Diagnostic sensitivity: Ability of a test to detect a given disease or condition.

Diagnostic specificity: Ability of a test to correctly identify the absence of a given disease or condition.

Positive predictive value: Chance of an individual having a given disease or condition if the test is abnormal.

Negative predictive value: Chance an individual does not have a given disease or condition if the test is within the reference interval.

Measures of Diagnostic Efficiency

Parameters of diagnostic efficiency are intended to quantify how useful a test is for a given disease or

condition.¹¹ For example, β hCG is used as a test to diagnose pregnancy. While β hCG is excellent for this purpose, there are instances where β hCG may be increased because of other causes, such as cancer (trophoblastic tumors), or below the cutoff, as is the case very early in pregnancy. It is important to recognize that there is both diagnostic and clinical sensitivity. Analytic sensitivity refers to the lower **limit of detection** for a given analyte (described in the Method Evaluation section), whereas clinical sensitivity refers to the proportion of individuals with that disease who test positively with the test. *Sensitivity* can be calculated from simple ratios (Fig. 4-13A). Patients with a condition who are correctly classified by a test to have the condition are called true positives (TPs). Patients with the condition who are classified by the test as not having the condition are called false negatives (FNs). Using

TABLE 4-9 COMMON PROBLEMS ENCOUNTERED WHEN MONITORING REFERENCE INTERVALS

Changes in reagent formulations by the vendor (e.g., new antibody)

Erroneous initial reference interval either by the vendor or laboratory

Minor changes in reagents due to lot-to-lot variations

Differences between reference interval and test populations

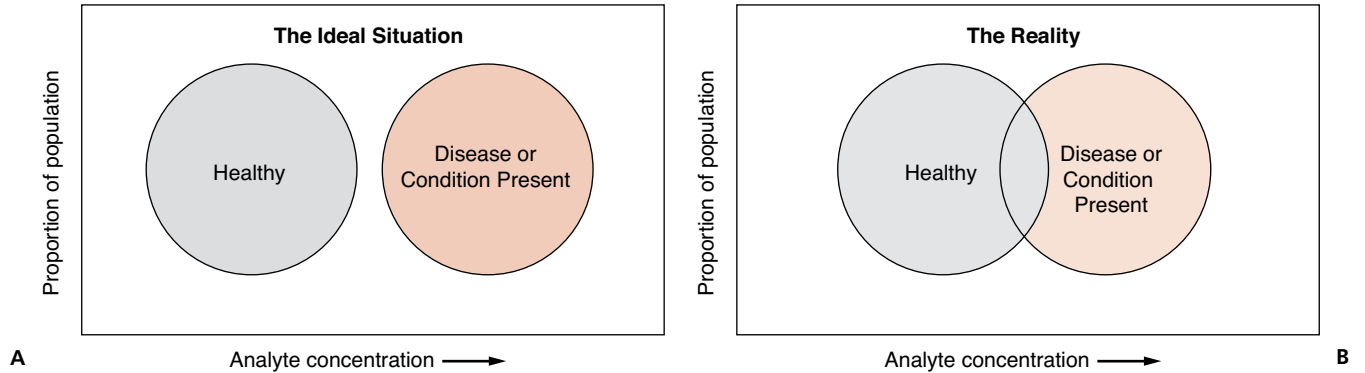

FIGURE 4-12. Comparison of an ideal and true laboratory values for healthy and abnormal populations. **(A)** In the ideal case, the healthy population is completely distinct from those with the condition. **(B)** In reality, values show significant overlap that affects the diagnostic efficiency of the test.

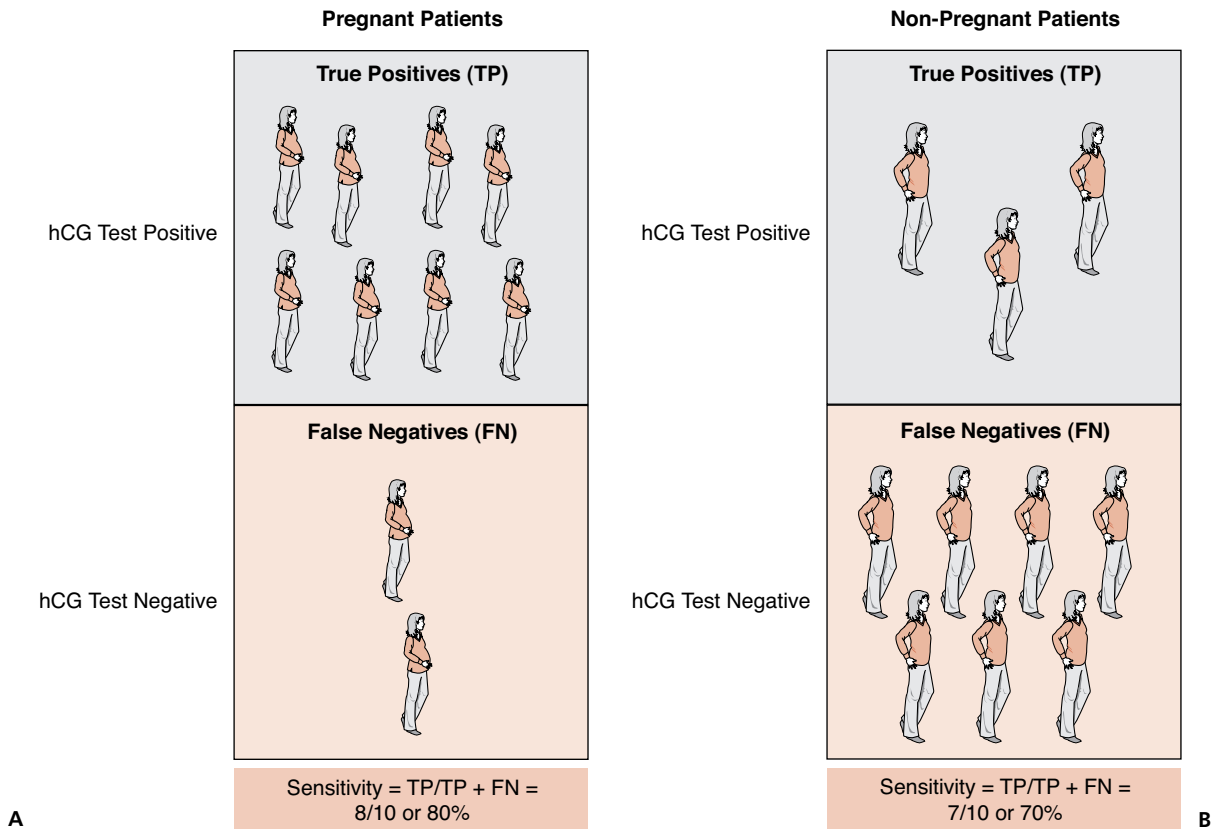

FIGURE 4-13. The sensitivity and specificity of beta-human chorionic gonadotropin (hCG) for pregnancy. **(A)** Sensitivity refers to the ability to detect pregnancy. **(B)** Specificity refers to the ability of the test to correctly classify nonpregnant women. FN, false negative; FP, false positive; TN, true negative; TP, true positive.

the β hCG test as an example, sensitivity can be calculated as follows:

$$\text{Diagnostic sensitivity (\%)} = \frac{(\text{no. pregnant with positive test})}{(\text{no. of pregnant individuals tested})} = \frac{(TP)}{(TP + FN)} \quad (\text{Eq. 4-8})$$

Another measure of clinical performance is diagnostic **specificity**. *Diagnostic specificity* is defined as the proportion of individuals without a condition who have a negative test for that condition (Fig. 4-13B). Note that there is also an analytic specificity (described in the Method Evaluation section), which refers to cross-reactivity with other substances. Continuing with β hCG as an example, diagnostic specificity refers to the percentage of nonpregnant individuals that have a negative test compared with the number of nonpregnant individuals tested. Patients who are not pregnant and have a negative β hCG test are called true negatives (TNs), whereas those who are incorrectly classified as pregnant by the test are called false positives (FPs). Clinical specificity can be calculated as follows:

$$\text{Specificity (\%)} = \frac{(\text{no. nonpregnant with negative test})}{(\text{no. of nonpregnant individuals tested})} = \frac{(TN)}{(TN + FP)} \quad (\text{Eq. 4-9})$$

For example, a sensitivity of 100% plus a specificity of 100% means that the test detects every patient with disease and that the test is negative for every patient without the disease. Because of the overlap in laboratory values between people with and without disease, this is, of course, almost never the case (see Fig. 4-12B).

There are other measures of diagnostic efficiency such as predictive values. There are predictive values for both positive and negative test results. The predictive value of a positive (PPV) test refers to the probability of an individual having the disease if the result is abnormal (“positive” for the condition). Conversely, the predictive value of a negative (NPV) test refers to the probability that a patient does not have a disease if a result is within the reference range (test is negative for the disease) (Fig. 4-14). Predictive values are also calculated using ratios of true positives, true negatives, false positives, and false negatives (FNs) as follows:

$$\text{PPV} = \frac{(\text{no. pregnant with positive test})}{(\text{no. with positive test})} = \frac{(TP)}{(TP + FP)} \quad (\text{Eq. 4-10})$$

$$\text{NPV} = \frac{(\text{no. nonpregnant with negative test})}{(\text{no. with negative test})} = \frac{(TN)}{(TN + FN)} \quad (\text{Eq. 4-11})$$

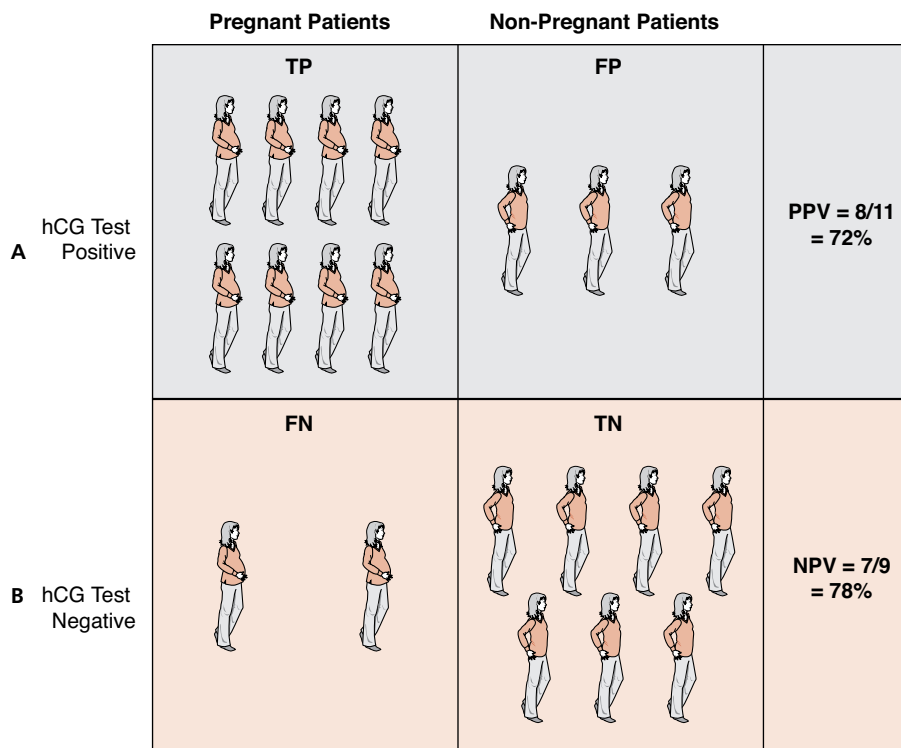

FIGURE 4-14. Positive and negative predictive values using beta-human chorionic gonadotropin (β hCG) as a test for pregnancy. **(A)** Predictive value of a positive test (PPV) indicates the probability of being pregnant if the test is positive. **(B)** Predictive value of a negative test (NPV) refers to the probability of being nonpregnant if the test is negative. FN, false negative; FP, false positive; TN, true negative; TP, true positive.

Using the data from Figure 4-14, if the β hCG test is “positive,” there is 72% chance the patient is pregnant; if the test is negative, then there is a 78% chance the patient is not pregnant. It is important to understand that unlike sensitivity and specificity, predictive values depend on the prevalence of the condition in the population studied. Prevalence refers to the proportion of individuals within a given population have a particular condition. If one were testing for β hCG, the prevalence of pregnancy would be quite different between female Olympic athletes and young women shopping for baby clothes (Table 4-10). Accordingly, the predictive values would change drastically, while the sensitivity and specificity of the test would remain unchanged.

Measures of diagnostic efficiency depend entirely on the distribution of test results for a population with and without the condition and the cutoff used to define abnormal levels. The laboratory does not have control of the overlap between populations but does have control of the test cutoff. Thus, we will consider what happens when the cutoff is adjusted. The test cutoff (also known as a “medical decision limit”) is the analyte concentration that separates a “positive” test from a “negative” one. For qualitative tests, such as a urine β hCG, the cutoff is defined by the manufacturer and can be visualized directly (Fig. 4-15). For quantitative tests, the cutoff is a concentration; in the case of pregnancy, a serum β hCG concentration greater than 5 mIU/mL could be considered “positive.” By changing the cutoff, from 8 mIU/mL (Fig. 4-16A), to 5 mIU/mL (Fig. 4-16B), or 2 mIU/mL (Fig. 4-16C), it becomes apparent that the diagnostic efficiency changes. As the cutoff is lowered, the sensitivity of the test for pregnancy improves from 40% (Fig. 4-16A) to 90% (Fig. 4-16C). However, this occurs at the expense of specificity, which decreases from 80% (Fig. 4-16A) to 60% (Fig. 4-16C) at the same cutoff. The best test with the wrong cutoff would be clinically useless. Accordingly, it is imperative to use an appropriate cutoff for the testing purpose. In the most rudimentary sense, a high sensitivity is desirable for a screening test, whereas a high specificity is appropriate for confirmation testing.

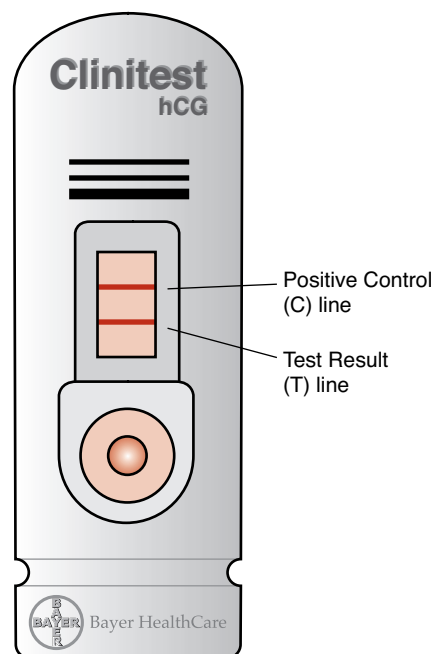

FIGURE 4-15. An example of a point-of-care (POC) device for beta-human chorionic gonadotropin (β hCG). This is an example of a qualitative test, where the test line (T) represents whether the patient has a positive test, and the control (C) line is used to indicate that the test was successful.

To define an appropriate cutoff, laboratorians often use a graphical tool called the receiver operator characteristic (ROC).¹² An ROC is generated by plotting the true-positive rate against the false-positive rate (sensitivity versus $1 - \text{specificity}$; Fig. 4-17). Each point on the curve represents an actual cutoff concentration. ROC curves can be used to determine the most efficient cutoff for a test and are an excellent tool for comparing two different tests. The area under the curve represents the efficiency of the test, that is, how often the test correctly classifies individuals as having a condition or not. The higher the area under the ROC curve, the higher is the efficiency. Figure 4-17 shows a hypothetical comparison of two tests used to diagnose pregnancy. The β hCG test has a larger area under the curve and has an overall higher performance than test B. Based on these ROC curves,

TABLE 4-10 DEPENDENCE OF PREDICTIVE VALUE ON CONDITION PREVALENCE*

| POPULATION ^a | PREVALENCE OF PREGNANCY | +PPV | NPV |
|-------------------------------------|-------------------------|--------|--------|
| Olympic athletes | 1/10,000 | 0.03% | 99.99% |
| Ob/gyn clinic patients aged 18–35 y | 1/50 | 5.16% | 99.42% |
| Babies “R” Us shoppers | 3/10 | 53.33% | 89.09% |

*Sensitivity, 80%; specificity, 70%.

^aHypothetical.

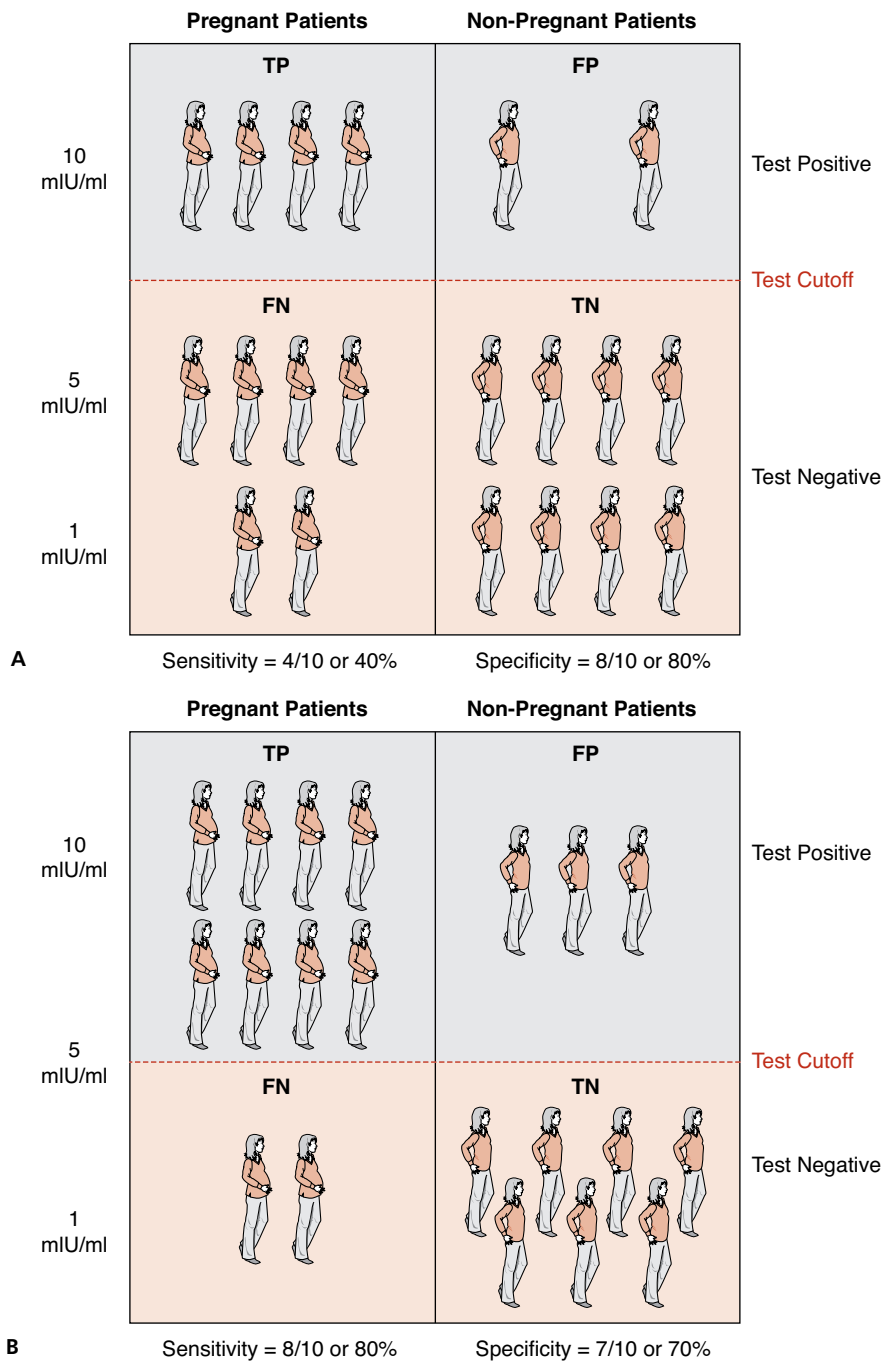

FIGURE 4-16. The effect of adjusting the beta-human chorionic gonadotropin (β hCG) test cutoff on sensitivity and specificity for pregnancy. **(A)** Using a high cutoff, sensitivity is low and specificity is high. **(B, C)** As the cutoff is lowered, the sensitivity improves at the expense of specificity. The predictive values also change as the cutoff is adjusted. (continued)

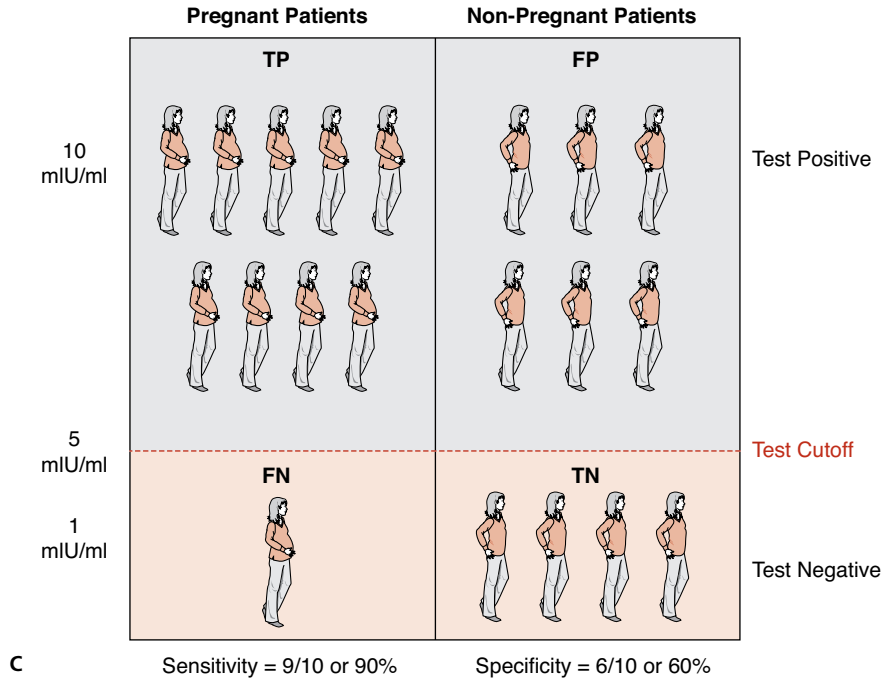

FIGURE 4-16. (Continued)

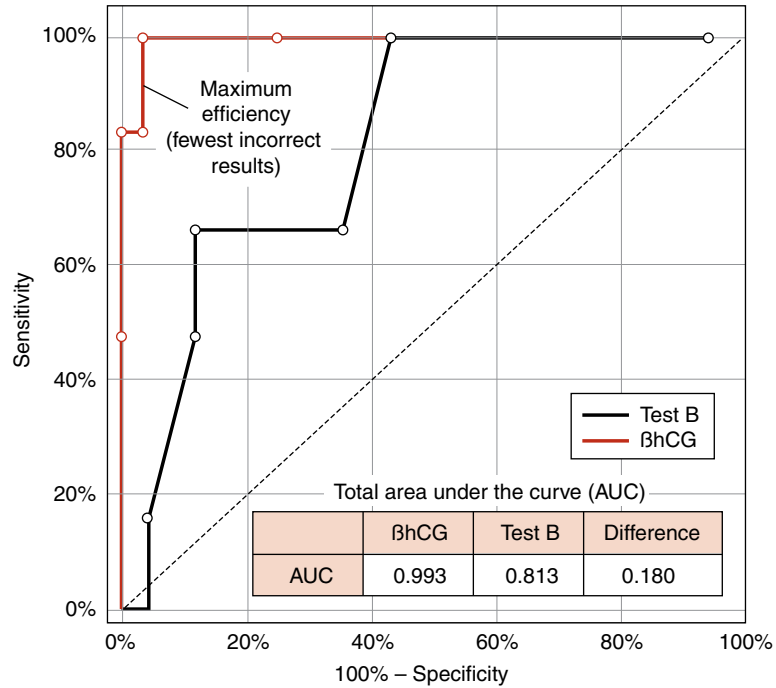

FIGURE 4-17. A receiver-operator-characteristic (ROC) curve for beta-human chorionic gonadotropin (βhCG) and a hypothetical “test B.” The area under the βhCG curve is greater than “test B” at all points, indicating that it is a superior test for pregnancy. The thin dotted line represents a test of no value (equal to diagnosis by a coin toss). The maximum (optimal) efficiency is indicated by the arrow and corresponds to the βhCG cutoff concentration with the fewest incorrect patient classifications.

β hCG represents a superior test compared with hypothetical test B, for diagnosing pregnancy.

ROC curves can also be used to determine the optimal cutoff point for a test. The optimal cutoff maximizes the number of correct tests (i.e., fewest false positives and false negatives). A perfect test would have an area under the curve of 1.0 and reach the top-left corner of the graph (where sensitivity and specificity equal 100%). Clinical evaluations of diagnostic tests frequently use ROC curves to establish optimal cutoffs and compare different tests.¹² As with the other statistical measures described, there are many software applications that can be used generate ROC curves.

In addition to sensitivity, specificity, and predictive values, there are a number of other measures of diagnostic efficiency. These include odds ratios, likelihood ratios, and multivariate analysis.^{13–15} While these have increasingly higher degrees of complexity, they all represent efforts to make clinical sense of data postanalytically. It is worth remembering the bigger picture, which is that laboratory values are not used in isolation. Laboratory tests are interpreted in the context of a patient's physical findings, symptoms, and clinical history to achieve a diagnosis.

METHOD EVALUATION

The value of clinical laboratory service is based on its ability to provide reliable, accurate test results. At the heart of providing these services is the performance of a testing method. To maximize the usefulness of a test, laboratorians undergo a process in which a method is selected and evaluated for its usefulness to those who will be using the test. This process is carefully undertaken in order to produce results within medically acceptable error to help physicians maximally benefit their patients.

At the present time, clinical laboratories more often select and evaluate methods that were commercially developed instead of developing their own. Most commercially developed tests have U.S. Food and Drug Administration (FDA) approval, only requiring a laboratory to provide a limited evaluation of a method to verify the manufacturer's performance claims and to see how well the method works specifically in your laboratory.

Regulatory Aspects of Method Evaluation (Alphabet Soup)

The Centers for Medicare and Medicaid Services (CMS) and the FDA are the primary government agencies that influence laboratory testing methods in the United States. The FDA regulates laboratory instruments and reagents, and the CMS regulates the Clinical Laboratory Improvement Amendments (CLIA).¹⁶ Most large labora-

tories in the United States are accredited by CAP and The Joint Commission (TJC; formerly the Joint Commission on Accreditation of Healthcare Organizations [JCAHO]), which impacts how method evaluations need to be performed. Professional organizations such as the National Academy of Clinical Biochemistry (NACB) and the American Association for Clinical Chemistry (AACC) also contribute important guidelines and method evaluations that influence how method evaluations are performed.

DEFINITIONS BOX

AACC: American Association for Clinical Chemistry

CAP: College of American Pathologists

CLIA: Clinical Laboratory Improvement Amendments

CLSI: Clinical Laboratory and Standards Institute (formerly NCCLS)

CMS: Centers for Medicare and Medicaid Services

FDA: Food and Drug Administration

TJC: The Joint Commission

NACB: National Academy of Clinical Biochemistry

OIVD: Office of In Vitro Diagnostic Device Evaluation and Safety

The FDA OIVD regulates in vitro diagnostics (IVDs). Tests are categorized into one of three groups: (1) waived, (2) moderate complexity, and (3) high complexity. Waived tests are cleared by the FDA to be so simple that they are most likely accurate and would not pose negligible risk of harm to the patient if not performed correctly; these methods include dipstick tests and glucose monitors. Most automated methods are rated as moderate complexity, while manual methods and methods requiring more interpretation are rated as high complexity. The CLIA final rule requires that waived tests simply follow the manufacturer's instructions. Both moderate and high complexity tests are validated on whether they are FDA approved or not. FDA-approved nonwaived tests must undergo a shorter validation process (Table 4-11), whereas a more extensive process is required for tests developed by laboratories (Table 4-11). While the major requirements for testing validation are driven by CLIA, TJC and CAP essentially require the same types of experiments to be performed, with a few additions. It is these rules that guide the way tests in the clinical chemistry laboratory are selected and validated.

TABLE 4-11 GENERAL CLIA REGULATIONS OF METHOD VALIDATION

| | |
|---|---|
| NONWAIVED FDA-APPROVED TESTS | <ol style="list-style-type: none"> 1. Demonstrate test performance comparable to that established by the manufacturer. <ol style="list-style-type: none"> a. Accuracy b. Precision c. Reportable range 2. Verify reference (normal) values appropriate for patient population. |
| NONWAIVED FDA-APPROVED TESTS MODIFIED OR DEVELOPED BY LABORATORY | <ol style="list-style-type: none"> 1. Determine <ol style="list-style-type: none"> a. Accuracy b. Precision c. Analytic sensitivity d. Analytic specificity (including interfering substances) e. Reportable range of test results f. Reference/normal ranges g. Other performance characteristic h. Calibration and control procedures |

From Clinical laboratory improvement amendments of 1988; final rule. Fed Reg 7164 [42 CFR 493 1253]; Department of Health and Human Services, Centers for Medicare and Medicaid Services; 1992.

Method Selection

Evaluating a method is a labor-intensive costly process—so why select a new method? There are many reasons, including reducing costs, improving the quality of results, increasing client satisfaction, and improving efficiency. Selecting a test method starts with the collection of technical information about a particular test from colleagues, scientific presentations, and the scientific literature. Practical considerations should also be addressed at this point, such as the type and volume of specimen to be tested, the required throughput and turnaround time, your testing needs, cost, calibration, QC approach, space needs, disposal needs, personnel requirements, and safety considerations. Most important, the test should be able to meet the clinical task by having specific analytic performance standards that will accurately assist in the diagnosis of patients. Specific information that should be discovered about a test you might bring into the laboratory includes analytic sensitivity, analytic specificity, linear range, interfering substances, and estimates of imprecision and inaccuracy. The process of method selection is the beginning of a process to bring in a new test for routine use (Fig. 4-18).

DEFINITIONS BOX

Analytic sensitivity: Ability of a method to detect small quantities of an analyte.

Analytic specificity: Ability of a method to detect only the analyte it is designed to determine.

Specificity: Ability of a method to measure only the analyte of interest.

AMR (analytic measurement range): Also known as linear or dynamic range. Range of analyte concentrations that can be directly measured without dilution, concentration, or other pretreatment.

CRR (clinically reportable range): Range of analyte that a method can quantitatively report, allowing for dilution, concentration, or other pretreatment used to extend AMR.

LoD (limit of detection): Lowest amount of analyte accurately detected by a method.

SDI (standard deviation index): Refers to the difference between the measured value and the mean expressed as a number of SDs. An SDI = 0 indicates the value is accurate or in 100% agreement; an SDI = 3 is 3 SDs away from the target (mean) and indicate inaccuracy. SDI may be positive or negative.

Method Evaluation

In advance of the complete evaluation, a short, initial evaluation should be carried out. This preliminary evaluation should include the analysis of a series of *standards* to verify the linear range and the replicate analysis (at least eight measurements) of two controls to obtain estimates of short-term imprecision. If any results fall short of the specifications published in the method's product information sheet (package insert), the method's manufacturer should be consulted. Without improvement in the method, more extensive evaluations are pointless.¹⁷

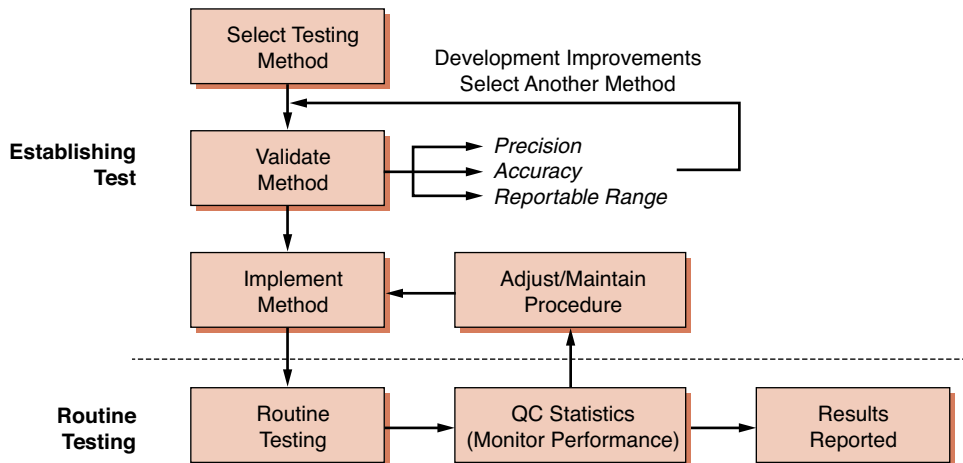

FIGURE 4-18. A flowchart on the process of method selection, evaluation, and monitoring. (Adapted with permission from Westgard JO, Quam E, Barry T. Basic QC practices: training in statistical quality control for healthcare laboratories. Madison, Wis.: Westgard Quality Corp, 1998.)

First Things First: Determine Imprecision and Inaccuracy

The first determinations (estimates) to be made in a method evaluation are the *imprecision* and *inaccuracy*, which should be compared with the maximum allowable error based on medical criteria. If the imprecision or inaccuracy exceeds the maximum allowable error, it is unacceptable and must be modified and re-evaluated or rejected. Imprecision is the dispersion of repeated measurements around a mean (true level), as shown in Figure 4-19A with the mean represented as the bull's eye. Random analytic error is the cause of imprecision in a test. Imprecision is estimated from studies in which multiple aliquots of the same specimen (with a constant concentration) are analyzed repetitively. Inaccuracy, or the difference between a measured value and its actual value, is due to the presence of a systemic error, as represented in Figure 4-19B. Systemic error can be due to constant or proportional error and is estimated from three types of study: (1) recovery, (2) interference, and (3) a COM study.

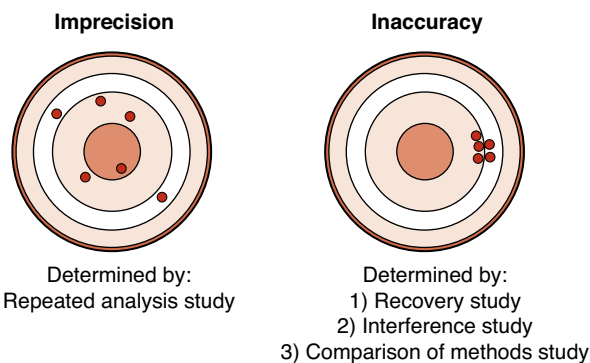

FIGURE 4-19. Graphic representation of (A) imprecision and (B) inaccuracy on a dartboard configuration with bull's eye in the center.

DEFINITIONS BOX

Imprecision: Dispersion of repeated measurements about the mean due to analytic error.

Inaccuracy: Difference between a measured value and its true value; due to systematic error, which can be either constant or proportional.

Systemic error: Error always in one direction.

Constant error: Type of systemic error in the sample direction and magnitude; the magnitude of change is constant and not dependent on amount of analyte.

Proportional error: Type of systemic error where the magnitude changes as a percent of the analyte present; error dependent on analyte concentration.

Random error: Error varies from sample to sample. Causes include instrument instability, temperature variations, reagent variation, handling techniques, and operator variables.

Total error: Random error plus systemic error.

Measurement of Imprecision

Method evaluation begins with a **precision** study. This estimates the random error associated with the test method and detects any problems affecting its reproducibility. It is recommended that this study be performed over a 10- to 20-day period, incorporating one or two analytic runs (runs with patient samples or QC materials) per day.^{18,19} A common precision study is a $2 \times 2 \times 10$ study, where two controls are run twice a day

for 10 days. The rationale for performing the evaluation of precision over many days is logical. Running multiple samples on the same day does a good job of estimating precision within a single day but underestimates long-term changes that occur over time. By running multiple samples on different days, a better estimation of the over time random error is given. It is important that more than one concentration be tested in these studies, with materials ideally spanning the clinically meaningful range of concentrations. For glucose, this might include samples in the hyperglycemic range (150 mg/dL) and the hypoglycemic range (50 mg/dL). After these data are collected, the mean, SD, and CV are calculated. An example of a precision study from our laboratory is shown in Figure 4-20.

The random error or imprecision associated with the test procedure is indicated by the SD and the CV. The within-run imprecision is indicated by the SD of the controls analyzed within one run. The total imprecision may be obtained from the SD of control data with one or two data points accumulated per day. The total imprecision is the most accurate assessment of performance that would affect the values a clinician might see and reflects differences in operators, pipettes, and variations in environmental changes such as temperature. In practice, however, run imprecision is used more commonly than

total imprecision. An inferential statistical technique, ANOVA, is then used to analyze the available precision data to provide estimates of the within-run, between-run, and total imprecision.²⁰

Acceptable Performance Criteria: Imprecision Studies

During a recent evaluation of vitamin B₁₂ in our laboratory, we performed an imprecision study on a new test (Fig. 4-20). We ran several concentrations of vitamin B₁₂, twice daily (in duplicate) for 10 days, as shown in Figure 4-20 (for simplicity, only one concentration is shown). The data are represented in the precision plot in Figure 4-20 (≈76 pg/mL). The amount of variability between runs is represented by different colors, over 10 days (x-axis). The CV was then calculated for within run, between run, and between days. The total SD, estimated at 2.3, is then compared with medical decision levels (MDLs) or medically required standards based on the analyte (Table 4-12). The acceptability of analytic error is based on how the test is to be used to make clinical interpretations.^{21,22} In this case, the medically required SD limit is 4.8. The determination of whether long-term precision is adequate is based on the total imprecision being less than one third of the total allowable error (total imprecision, in this case, 1.6; selection of

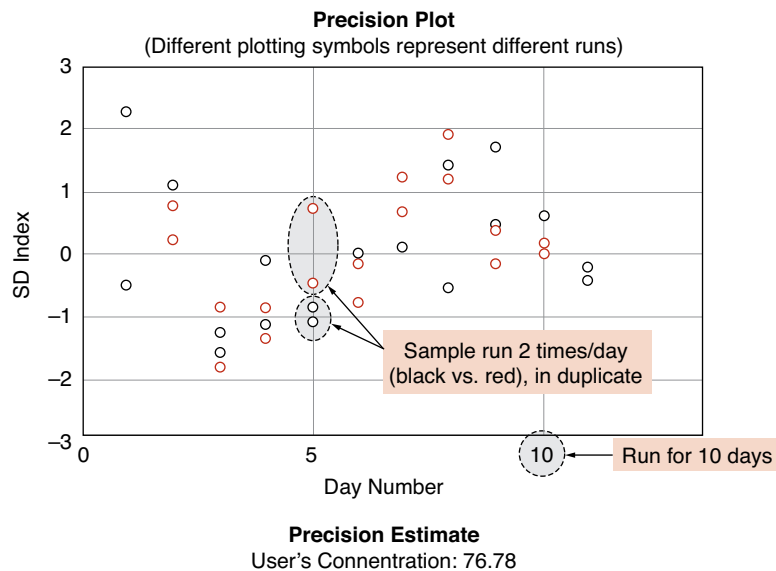

FIGURE 4-20. An example of a precision study for vitamin B₁₂. The data represent analysis of a control sample run in duplicate twice a day (*red* and *black* circles) for 10 days (x-axis). Data is presented as standard deviation index (SDI). SDI refers to the difference between the measured value and the mean expressed as a number of SDs. An imprecision study is designed to detect random error.

TABLE 4-12 PERFORMANCE STANDARDS FOR COMMON CLINICAL CHEMISTRY ANALYTES AS DEFINED BY CLIA

| | |
|--------------------|---|
| Calcium, total | Target ± 1.0 mg/dL |
| Chloride | Target $\pm 5\%$ |
| Cholesterol, total | Target $\pm 10\%$ |
| Cholesterol, HDL | Target $\pm 30\%$ |
| Glucose | Greater of target ± 6 mg/dL or $\pm 10\%$ |
| Potassium | Target ± 0.5 mmol/L |
| Sodium | Target ± 4 mmol/L |
| Total protein | Target $\pm 10\%$ |
| Triglycerides | Target $\pm 25\%$ |
| Urea nitrogen | Greater of target ± 2 mg/dL or $\pm 9\%$ |
| Uric acid | Target $\pm 17\%$ |

Reprinted with permission from Centers for Disease Control and Prevention (CDC), Centers for Medicare and Medicaid Services (CMS), Health and Human Services. Medicare, Medicaid, and CLIA programs; laboratory requirements relating to quality systems and certain personnel qualifications. Final rule. Fed Reg 2003;68:3639-3714.

one-third total allowable error for imprecision is based on Westgard²³). In the case that the value is greater than the total allowable error (1.79 in our example), the test can pass as long as the difference between one-third total allowable error and the determined allowable error are not statistically significant. In our case, the 1.79 was not statistically different from 1.6 ($\frac{1}{3} \times 4.8$), and the test passed our imprecision studies (Fig. 4-20).

DEFINITIONS BOX

Recovery: Ability of an analytic test to measure a known amount of analyte; a known amount of analyte is added to real sample matrices.

Interference: Effect of (a) compound(s) on the accuracy of detection of a particular analyte.

Interferents: Substances that cause interference.

Matrix: Body component (e.g., fluid, urine, etc.) in which the analyte is to be measured.

Measurement of Inaccuracy

Once method imprecision is estimated and deemed acceptable, the determination of accuracy can begin.¹⁹ Accuracy is estimated using three different types of studies: (1) recovery, (2) interference, and (3) patient-sample comparison.

Recovery Studies

Recovery studies will show whether a method is able to accurately measure an analyte. In a recovery experi-

ment, a small aliquot of concentrated analyte is added (spiked) into a patient sample (matrix) and then measured by the method being evaluated. The amount recovered is the difference between the spiked sample and the patient sample (unmodified). The purpose of this type of study is to determine how much of the analyte can be detected (recovered) in the presence of all the other compounds in the matrix. The original patient samples (matrix) should not be diluted more than 10% so that the matrix solution is minimally affected. An actual example of a recovery study for total calcium is illustrated in Figure 4-21; the results are expressed as percentage recovered. The performance standard for calcium, defined by CLIA, is the target value ± 1.0 mg/dL (see Table 4-12). Recovery of calcium in this example exceeds this standard at the two calcium levels tested (Fig. 4-21).

Interference Studies

Interference studies will determine if specific compounds affect the accurate determination of analyte concentrations. Common interferences include hemolysis and turbidity, which can obscure the absorbance of the measured analyte. Interferents, however, either can react with the analytic reagent or may alter the reaction between the analyte and the analytic reagents. An interference experiment is performed by adding the potential interferent (in the maximally elevated range) to the patient sample.²⁴ If an effect is observed, its concentration is lowered sequentially in order to determine the concentration at which test results are valid. By determining these cutoffs, accurate results can be reported when interferents are at levels below this. Similarly, results can

| | Ca ²⁺ Measured in Matrix | Ca ²⁺ Added | Ca ²⁺ Recovered | % Recovery |
|----------|-------------------------------------|------------------------|----------------------------|------------|
| Baseline | 7.5 mg/dL | NA | NA | NA |
| Sample 1 | 8.35 mg/dL | 0.95 mg/dL | 0.85 mg/dL | 89% |
| Sample 2 | 9.79 mg/dL | 2.38 mg/dL | 2.29 mg/dL | 96% |

Calculation of recovery

$$\text{Recovered} = \frac{\text{Recovered (Measured spiked sample-baseline)}}{\text{Concentration added}} \times 100$$

FIGURE 4-21. An example of a sample recovery study for total calcium. A sample is spiked with known amounts of calcium in a standard matrix, and recovery is determined as shown. Recovery studies are designed to detect proportional error in an assay.

be ignored if interferent levels are too high, owing to the fact that the results are inaccurate. An example of an interference study performed in our laboratory is shown in Figure 4-22. The potential interferents should be selected from literature reviews and specific references. Other excellent resources include Young²⁵ and Siest and Galteau.²⁶ Common interferences such as hemolysis, lipemia, bilirubin, anticoagulant, and preservatives are tested by the manufacturer. Glick and Ryder^{27,28} published “interferographs” for clinical chemistry instruments, which relate analyte concentration measure to interferent concentration. They have demonstrated that considerable expense can be saved by the acquisition of instruments that minimize hemoglobin, triglyceride, and bilirubin interference.²⁹

| Pooled TnT Concentration = 0.0295 ng/mL | | | |
|---|----------------------|-------------|--------|
| Sample # | Hemolysate (Hg) g/dL | TnT (units) | % Bias |
| 1 | <0.15 | 0.0295 | |
| 2 | 0.14 | 0.0255 | -13.6 |
| 3 | 0.25 | 0.0220 | -25.4 |
| 4 | 0.36 | 0.0205 | -30.5 |
| 5 | 0.48 | 0.0200 | -32.0 |
| 6 | 0.60 | 0.0180 | -39.0 |

Calculation of Interference

$$\text{Interference} = \frac{\text{Concentration with interference added}}{\text{Concentration without interference}}$$

$$\text{Bias} = \text{Interference} - \text{concentration without interference}$$

$$\text{Bias \%} = \text{Bias} * 100$$

FIGURE 4-22. An example of an interference study for troponin-T (TnT). Increasing amounts of hemolysate (lysed red blood cells, a common interference) were added to a sample with elevated TnT of 0.295 ng/mL. Bias is calculated based on the difference between the baseline and hemolyzed samples. The data are corrected for the dilution with hemolysate.

Comparison-of-Methods Studies

A COM experiment examines patient samples by the method being evaluated (test method) with a reference method. It is used primarily to estimate systemic error in actual patient samples, and it may offer the type of systematic error (proportional versus constant). Ideally, the test method is compared with a standardized reference method (gold standard), a method with acceptable accuracy in comparison with its imprecision. Many times reference methods are laborious and time consuming, as is the case with the ultracentrifugation methods of determining cholesterol. Because most laboratories are not staffed to perform reference methods, most test methods are compared with those routinely used. These routine tests have their own particular inaccuracies, so it is important to determine what inaccuracies they might have that are documented in the literature. If the new test method is to replace the routine method, differences between the two should be well characterized.

To compare a test method with a comparative method, it is recommended by Westgard et al.¹⁹ and CLIA³⁰ that 40 to 100 specimens be run by each method on the same day over 8 to 20 days (preferably within 4 hours), with specimens spanning the clinical range and representing a diversity of pathologic conditions. As an extra measure of QC, specimens should be analyzed in duplicate. Otherwise, experimental results must be checked by comparing test and comparative-method results immediately after analysis. Samples with large differences should be repeated to rule out technical errors as the source of variation. Daily analysis of two to five patient specimens should be followed for at least 8 days if 40 specimens are compared and for 20 days if 100 specimens are compared in replication studies.³⁰

A plot of the test-method data (y-axis) versus the comparative method (x-axis) helps to visualize the data generated in a COM test³¹ (Fig. 4-23A). As described earlier, if the two methods correlate perfectly, the data pairs plotted as concentrations values from the reference

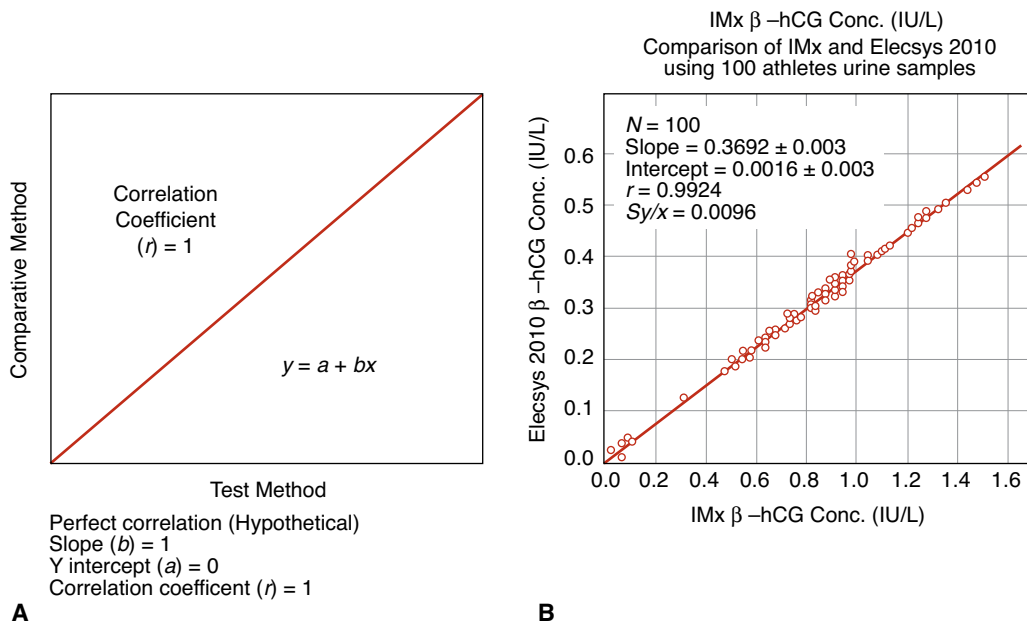

FIGURE 4-23. A comparison-of-methods experiment. **(A)** A model of a perfect method comparison. **(B)** An actual method comparison of beta-human chorionic gonadotropin (β hCG) between the Elecsys 2010 (Roche, Nutley, N.J.) and the IMx (Abbott Laboratories, Abbott Park, Ill.). (Reprinted with permission from Shahzad K, Kim DH, Kang MJ. Analytic evaluation of the beta-human chorionic gonadotropin assay on the Abbott IMx and Elecsys2010 for its use in doping control. Clin Biochem 2007;40:1259–1265.)

method (x) versus the evaluation method (y) will produce a straight line ($y = mx + b$), with a slope of 1.0, a y-intercept of 0, and a correlation coefficient (r) of 1. Data should be plotted daily and inspected for outliers so that original samples can be reanalyzed as needed. While linearity can be confirmed visually in most cases, it may be necessary to evaluate linearity more quantitatively.³²

DEFINITIONS BOX

Deming regression analysis: Linear regression analysis (least squares analysis) used to compare two methodologies using the best fit line through the data points.

Deming plot: Graphical representation of the Deming regression analysis (see Figs. 4-23 and 4-24).

Statistical Analysis of Comparison-of-Methods Studies

The data used to plot the test method versus the comparative method can be further statistically analyzed using a linear (also known as Deming) regression analysis. Linear regression generates statistical calculations of the slope (b), the y-intercept (a), and the SD of the points about the regression line ($S_{y/x}$), and the correlation coefficient (r). An example of these calculations can

be found in Figure 4-23, where a comparison of β hCG concentrations on the IMx system and the Elecsys2010 is given. The reason for calculating statistics is to determine the types and amounts of error that a method has, in order to decide if the test is still valid to make clinical decisions. Several types of errors can be seen looking at a plot of test method versus comparative method (Fig. 4-24). When random errors occur (Fig. 4-24A), points randomly move about the mean. Increases in the $S_{y/x}$ statistic reflect random error. Constant error (Fig. 4-24B) is seen visually as a shift in the y-intercept; a t -test analysis can be used to determine if these differences are significant. Proportional error (Fig. 4-24C) is reflected in alterations in line slope and can be also analyzed with a t -test (see Fig. 4-1).

Interpretation of experimental data is performed by using the results of the paired t -test and the correlation coefficient. The paired t -test is used to compare the magnitude of the bias (the difference between the means of the test and that of the comparative method) with that of the random error. The t -test indicates only whether a statistically significant difference exists between the two SDs or means, respectively. It does not provide information on the magnitude of the error compared in the context of clinically allowable limits of error.³³

A linear regression is performed to analyze COM studies (see Fig. 4-23). Hypothetically, when two tests perfectly give the same results (as in the linear relationship in Fig. 4-23A), the correlation coefficient (r) = 1. The

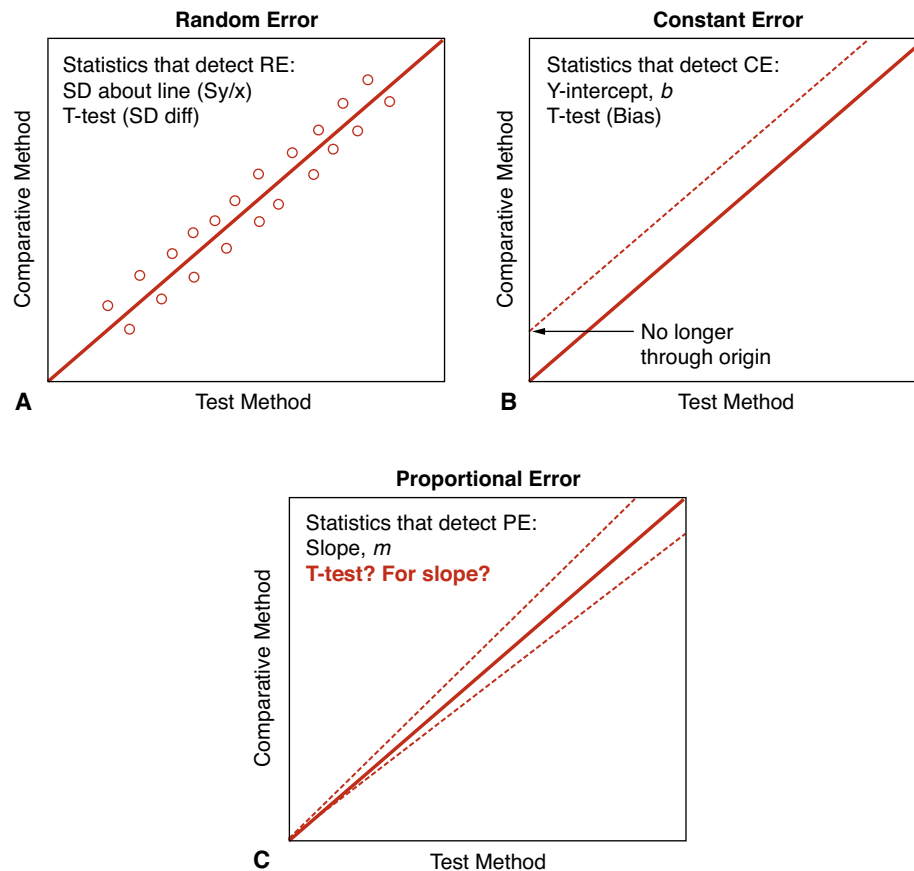

FIGURE 4-24. Examples of random, constant, and proportional error using linear regression analysis. (Adapted with permission from Westgard JO. Basic method evaluation. 2nd ed. Madison, Wis.: Westgard Quality Corp., 2003.)

correlation coefficient used in COM studies should be 0.99 (or greater), indicating the range of patient samples is adequate for the standard linear regression analysis (described in the section on Descriptive Statistics of Groups of Paired Observations). If r is less than 0.99, then alternative analyses should be used.^{34–36} Linear regression analysis is more useful than the t -test for evaluating COM studies,³³ as the constant systemic error can be determined by the y -intercept, and proportional systemic error can be determined by the slope. Random error can also be determined by the standard error of the estimate (Sy/x). Importantly, if a nonlinear relationship occurs between the test and comparative methods, linear regression analysis can be used only over the values in the linear range. To make accurate conclusions about the relationship between two tests, it is important to confirm that outliers are true outliers and not the result of technical errors.

To this point, we have described how we estimate error test methods in terms of imprecision and inaccuracy. However, tests are performed to answer clinical questions, so in order to assess how this error might affect clinical judgments, it is assessed in terms of *allowable (analytic) error* (E_a).³⁷ This allowable error is deter-

mined for each test and is based on the amount of error that will not negatively affect clinical judgments. If both random and systemic error (total error) is less than the E_a , then the performance of the test is considered acceptable. However, if the error is larger than the E_a , corrections must be made to reduce the error or the method rejected. This process ensures that laboratory tests give accurate, clinically relevant information to physicians to manage their patients effectively.

Allowable Analytic Error

Probably the most important aspect of method evaluation is to determine if the random and systemic error (total error) is less than the E_a . In the past, there have been several methodologies that have estimated medically E_a , including physiologic variation, multiples of the reference interval, and pathologist judgment.^{38–41} The Clinical Laboratory Improvement Amendments of 1988 (CLIA 88) have published E_a s for an array of clinical tests.⁴² The E_a limits published by CLIA specify the maximum error allowable by federally mandated **proficiency testing** (see examples in Table 4-12). These performance standards are

TABLE 4-13 SINGLE-VALUE CRITERIA OF WESTGARD ET AL.

| TYPE OF ERROR | TEST USED TO DETERMINE | CRITERIA |
|--------------------|----------------------------|---|
| Random error | Replication experiment | $2.58 s < E_a$ |
| Proportional error | Recovery experiment | $ (Recovery - 100) \times X_c/100 < E_a$ |
| Constant error | Interference experiment | $ Bias < E_a$ |
| Systemic error | Comparison of methods | $X_0 < E_a (y_0 + mX_c)$ |
| Total error | Replication and comparison | $2.58 s + y_0 + mX_c - X_c < E_a$ |

Based on National Committee for Clinical Laboratory Standards (NCCLS). Approved guideline for handling and processing of blood specimens. 3rd ed. Villanova, Pa.: NCCLS, 2004. (Document no. H18-A3.)

Medically acceptable error (E_a) based on performance standards set by CLIA, as shown in Table 4-12.

now being used to determine the acceptability of clinical chemistry analyzer performance.^{43,44}

The E_a is specifically calculated based on the types of studies described in the previous section (Table 4-13). While the specific mathematics are beyond the scope of this chapter, it is important to know that two sets of criteria are used in the evaluation of error: confidence-interval criteria and single-value criteria.^{22,37} An example of calculations made for the single-value criteria is shown in Table 4-13. Here, estimates of random and systematic error are calculated and then compared with the published allowable error at critical concentrations of the analyte. If the test does not meet the allowable error criteria, it must be modified to reduce error or rejected.

Comprehensive COM studies are demanding on personnel, time, and budgets. This has led to the description of abbreviated experiments that could be undertaken to estimate imprecision and inaccuracy.⁴⁵ CLIA has published guidelines for such an abbreviated application, which can be used by a laboratory to confirm that the precision and accuracy performance is consistent with manufacturer's reported claims. These studies can be completed in 5 working days, making it likely laboratories will use these guidelines to set up new methodologies.

DEFINITIONS BOX

Control limits: Threshold at which the value is statistically unlikely.

Control material: Material analyzed only for QC purposes.

Levey-Jennings control chart: Graphical representation of observed values of a control material over time in the context of the upper and lower control limits.

Multirule procedure: Decision criteria to determine if an analytic run is in-control; used to detect random and systemic error over time.

QUALITY CONTROL

QC in the laboratory involves the systematic monitoring of analytic processes in order to detect analytic errors that occur during analysis and to ultimately prevent the reporting of incorrect patient test results. In the context of what we have discussed so far, QC is part of the performance monitoring that occurs after a test has been established (see Fig. 4-18). In general, monitoring of analytic methods is performed by assaying stable control materials and comparing their determined values with their expected values. The expected values are represented by intervals of acceptable values with upper and lower limits, known as *control limits*. When the expected values are within the control limits, the operator can be assured that the analytic method is properly reporting values. However, when observed values fall outside of the control limits, the operator can be notified of possible problems and further analysis of the method can be made before potentially erroneously reporting patient results. The principles of statistically analyzing QC were initially applied to the clinical laboratory in the 1950s by Levey and Jennings.⁴⁶ Many important modifications have been made to these systems since that time, and they are discussed in general in this section.

Specimens analyzed for QC purposes are known as *QC materials*. These materials must be available in sufficient quantity to last at least a year and aliquoted in stable form.¹³ QC materials should be the same matrix as the specimens actually to be tested. For example, a glucose assay performed on serum should have QC materials that are prepared in serum. Variation between vials should be minimal so that differences seen over time can be attributed to the analytic method itself and not variation in the QC material. Control material concentrations should span the clinically important range of the analyte at appropriate decision levels. For example, sodium QC materials might be tested at 130 and 150 mmol/L, representing cutoff values for hyponatremia and hypernatremia, respectively. QC for

general chemistry assays generally use two levels of control, while immunoassays commonly use three. Today, laboratories more often purchase control materials from companies that manufacture products for QC, instead of preparing the materials themselves. These materials are often lyophilized (dehydrated to powder) for stability and can be reconstituted in specific diluents or matrices representing urine, blood, or CSF. Control materials can be purchased with or without previously assayed ranges. Assayed materials give expected target ranges, often including the mean and SD using common analytic methods. While these products are more expensive because of the additional characterization, they allow another external check of method accuracy.

Because most commercially prepared control materials are lyophilized and require reconstitution before use, the diluent should be carefully added and mixed. Incomplete mixing yields a partition of supernatant liquid and underlying sediment and will result in incorrect control values. Frequently, the reconstituted material will be more turbid (cloudy) than the actual patient specimen. Stabilized frozen controls do not require reconstitution but may behave differently from patient specimens in some analytic systems. It is important to carefully evaluate these stabilized controls with any new instrument system.

Quality Control (QC) Charts

A common method to assess the determination of control materials over time is by the use of a Levey-Jennings control chart (Fig. 4-25). Control charts graphically represent the observed values of a control material over time in the context of the upper and lower control limits. When the observed value falls within the control limits, it can be interpreted that the method is performed adequately. Points falling outside the control limits may suggest that problems may be developing. Control limits are expressed as the mean \pm SD using formulas previously described in this chapter. Control charts can detect errors in accuracy and imprecision over time (Fig. 4-25A). Analytic errors that can occur can be separated into random and systematic as discussed in a previous chapter. The underlying rationale for running repeated assays is to detect random errors that affect precision (Fig. 4-25B, *middle*). Random errors may be caused by variations in technique. Systemic errors arise from factors that contribute to constant differences between measurements; these errors may be either positive or negative (Fig. 4-25B, *right*). Systemic errors may be due to several factors, including poorly made standards, reagents, instrumentation problems, or poorly written procedures.

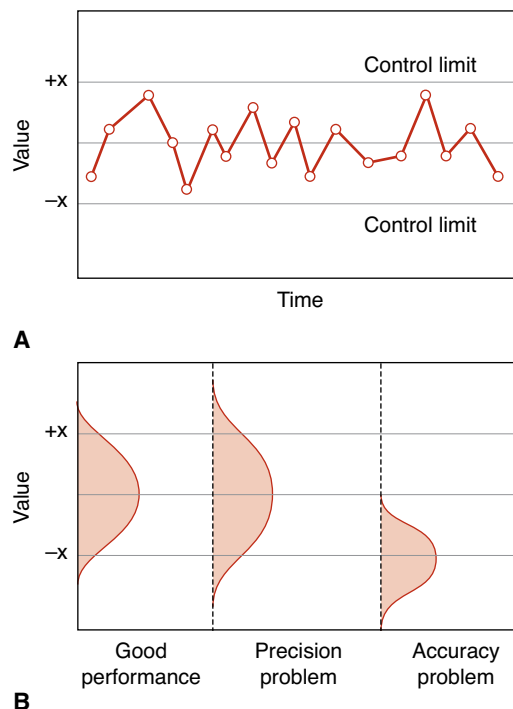

FIGURE 4-25. Levey-Jennings control chart. Data are plotted over time to identify quality control failures. (Adapted with permission from Westgard JO, Klee GG. Quality management. In: Tietz NW, Burtis CA, Ashwood ER, Bruns DE, eds. Tietz textbook of clinical chemistry and molecular diagnostics. 4th ed. St. Louis, Mo.: Elsevier Saunders; 2006:485–529.)

Operation of a Quality Control System

The QC system in the clinical laboratory is used to monitor the analytic variations that can occur. The QC program can be thought of as a three-stage process:

1. Establishing allowable statistical limits of variation for each analytic method
2. Using these limits as criteria for evaluating the QC data generated for each test
3. Taking action to remedy errors when indicated
 - a. Finding the cause(s) of error
 - b. Taking corrective action
 - c. Reanalyzing control and patient data

Establishment of a Statistical Quality Control

With a new instrument or with new lots of control material, the different levels of control material must be analyzed for 20 days. Exceptions include assays that are highly precise ($CV < 1\%$), such as blood gases, where 5 days is adequate. Analysis of the control materials allows the determination of the mean and SD of control materials. Initial estimates of the mean and control limits may be somewhat inaccurate because of the low number of data points. Therefore, estimates of the mean and SDs should be frequently updated to include accumulated

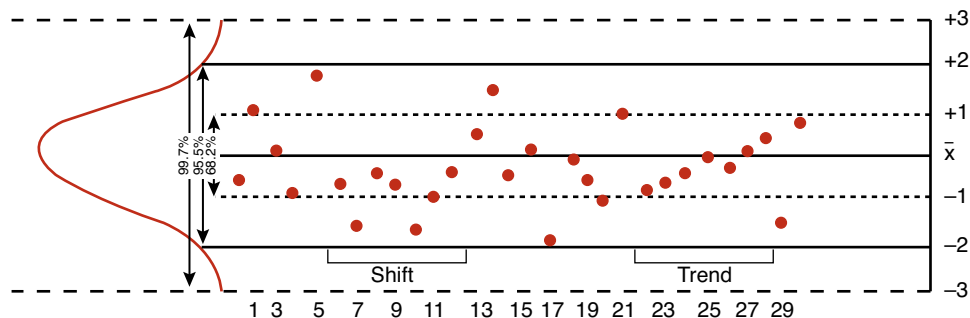

FIGURE 4-26. Control chart showing the relationship of control limits to the gaussian distribution. Daily control values are graphed, and they show examples of a shift, an abrupt change in the analytic process, and a trend, a gradual change in the analytic process.

data to produce more reliable data. When changing to a new lot of similar material, laboratorians use the newly obtained mean as the target mean but retain the previous SD. As more data are obtained, all data should be averaged to derive the best estimates of mean and SD.⁴⁷

The distribution of error is assumed to be symmetrical and bell shaped (gaussian) as shown in Figure 4-26. Control limits are set to include most observed values (95%–99.7%), corresponding to the mean \pm 2 or 3 SDs. Observation of values in the distribution tails should therefore be rare (1/20 for 2 SDs; 3/1,000 for 3 SDs). Observations outside the control limits suggest changes in the analytic methods. If the process is in control, no more than 0.3% of the points will be outside the 3 SDs (3s) limits. Analytic methods are considered in control if a symmetrical distribution of control values about the mean are seen, and few values outside the 2 SDs (2s) control limits are observed. Some laboratories define a method out of control if a control value exceeds the 2s limits. Other laboratories use the 2s limit as a warning limit and the 3s limit as an error limit. In this particular case, a control point between 2s and 3s would alert the technologist to a potential problem, while a point greater than 3s would require a corrective action. The selection

of control rules and numbers should be related to the goals set by the laboratory.⁴⁸ Understanding the problem of false rejections and its relationship to the control limits chosen for the Levey-Jennings plot is vital. False rejections can occur because of the control limits set and not actually identify a problem with the assay. The use of a 3s control limit reduces the false rejection problem, with a corresponding loss of error detection.

Multirules RULE!

The “multirule” procedure was developed by Westgard and Groth⁴⁹ to further judge whether control results indicate out-of-control situations. These rules established a criterion for judging whether an analytic process is out of control. To simplify the various control rules, Westgard and Groth⁴⁹ used abbreviations for the various control rules (Table 4-14). Control rules indicate the number of control observations per analytic run, followed by the control amount in subscript.⁵⁰ For example, the 1_{2s} rule indicates that a data point cannot exceed 2s more than once. If a method is in control, ideally none of the control rules should be violated and the analytic run will not be rejected. However, some analytic runs

TABLE 4-14 MULTI-RULE PROCEDURES

- 1_{2s} One control observation exceeding the mean \pm 2s. A warning rule that initiates testing of control data by other rules.
- 1_{3s} One control observation exceeding the mean \pm 3s. Allows high sensitivity to random error.
- 2_{2s} Two control observations consecutively exceeding the same + 2s or – 2s. Allows high sensitivity to systemic error.
- R_{4s} One control exceeding the +2s and another exceeding the –2s. Allows detection of random error.
- 4_{1s} Four consecutive control observations exceeding +1s or –1s. This allows the detection of systemic error.
- 10_x Ten consecutive control observations falling on one side or the other of the mean (no requirement for SD size). This allows the detection of systemic error.

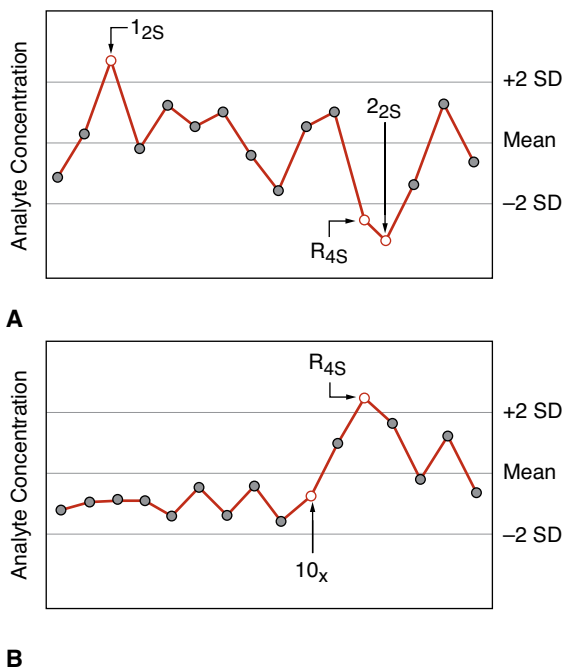

FIGURE 4-27. Application of multirule procedures. Multirules are used to identify errors while minimizing false-error detection. Multirules can help identify different types of errors that might occur (identified in red).

will be rejected as out of control even with additional analytic error (known as false rejection). The 1_{2s} rule, for example, will be outside the $2s$ limit in 5% of the runs with normal analytic variation (Fig. 4-27A). The 10_x rule is violated if 10 consecutive control observations fall on one side or the other of the mean (Fig. 4-27B). When more than one control is analyzed in an analytic run and no additional error is present, the probability becomes higher that at least one control is outside the $2s$ limits. When two controls are used, there is an approximately 10% chance that at least one control will be outside the $2s$ limits; when four controls are used, there is a 17% chance. For this reason, many analysts usually do not investigate the analytic method if a single control exceeds the $2s$ limits when two or more controls are used. They merely reassay the controls or the entire analytic run. Later, we describe a way to help select an appropriate number of control rules to minimize false rejection and maximize error detection.

Proficiency Testing

In addition to daily QC practices, laboratories are required to participate in external proficiency testing programs. Acceptable performance in proficiency testing programs is required by CAP, CLIA, and TJC to maintain laboratory accreditation. Even more important, proficiency testing is another tool in the ongoing process of monitoring test performance.

INDICATORS OF ANALYTIC PERFORMANCE

Proficiency testing
Laboratory inspections
(accreditation)
Clinical utilization

Internal quality control
Quality assurance
monitoring

The majority of clinical laboratories subscribe to the proficiency program provided by CAP. The CAP program has been in existence for 50 years and it is the gold standard for clinical laboratory proficiency testing. In our laboratory, the majority of analytes are monitored with the CAP proficiency surveys. Other proficiency testing programs are often used when analytes of interest are not tested through CAP (e.g., esoteric tests) or as a means to supplement CAP proficiency testing programs. Additional proficiency programs used in our laboratory include International Sirolimus Proficiency Testing Scheme (IST), the Binding Site, The American Proficiency Institute (API), and the Centers for Disease Control and Prevention (CDC). If there is no commercial proficiency testing program available for an analyte, the laboratory is required to implement a non-proficiency test scheme; this is reviewed at the end of this section.

DEFINITIONS BOX

Proficiency test: Method used to validate a particular measurement process. The results are compared with other external laboratories to give an objective indication of test accuracy.

Proficiency samples: Specimens that have known concentrations of an analyte for the test of interest. The testing laboratory does not know the targeted concentration when tested.

For a proficiency test, a series of unknown samples are sent to the laboratory from the program offering this analysis, such as CAP. The samples are analyzed in the same manner as patient specimens, and the results are reported to the proficiency program. The program then compiles the results from all of the laboratories participating in the survey and sends a performance report back to each participating laboratory. Each analyte has a defined performance criteria (e.g., ± 3 SDs to peer mean), where laboratories using the same method are graded by comparing them with the group. Some proficiency tests are not quantitative and are qualitatively compared with other laboratories. Areas of pathology other than clinical

EXAMPLE OF PROFICIENCY TEST RESULTS FOR β hCG

β hCG-08: CAP value = 75.58 SD = 4.80
 CV = 6.4% $n = 47$ peer laboratories
 Evaluation criteria: Peer group ± 3 SDs; acceptable range 65.7–85.2 mIU/mL
 Testing laboratory value = 71.54; SDI = -0.84 acceptable

chemistry are also subjected to mandatory proficiency qualitative/interpretive testing, including anatomic pathology, clinical microbiology, and clinical microscopy.

An example of a hypothetical survey is shown in the text box above. The β hCG survey was the eighth sample sent in that year (β hCG-08). The mean of all the laboratories using the same method was 75.58 mIU/mL. The SD and CV are indicated, as is the number of laboratories that participate in that survey ($n = 47$). The acceptance criteria were that the test result was within ± 3 SDs (i.e., between 65.7–85.2 mIU/mL). The laboratory's result was 71.54 mIU/mL, which is -0.84 SD from the mean and is within the acceptable limits.

When a laboratory performs proficiency testing, there are strict requirements as follows:

1. The laboratory must incorporate proficiency testing into its routine workflow as much as possible.
2. The test values/samples must not be shared with other laboratories at any time during the testing cycle.
3. Proficiency samples are tested by bench technical staff who normally conduct patient testing; there can be no unnecessary repeats or actions outside of how a patient sample would be tested and reported.
4. Testing should be completed within the usual time it would take for routine patient testing.

The bottom line is that the sample should be treated like a patient sample in order to yield a true indication of test accuracy. Unless a laboratory is in the practice of running every sample twice, then they cannot do this for the proficiency sample.

The acceptability criteria for proficiency testing are provided by the proficiency program. For regulated analytes, these criteria are often the CLIA limits (see Table 4-12). For nonregulated analytes, acceptable criteria are often determined by the scientific community at large. For example, the acceptability criterion for lactate dehydrogenase is $\pm 20\%$ or 3 SDs (whichever is greater) based on peer group data.

Proficiency testing allows each laboratory to compare its test results with those of other laboratories that use the same or similar instruments and methods. Proficiency testing provides performance data for a given

analyte at a specific point in time. Comparison of performance to a robust, statistically valid peer group is essential to identify areas for improvement. Areas of improvement that may be identified in a single proficiency testing event or over multiple events include variation from peer group results, imprecision, and/or results that trend above or below the mean consistently or at specific analyte concentrations. Use of these data allows laboratories to continuously improve their test performance. The proficiency testing samples also can serve as valuable troubleshooting aids when investigating problem analytes. In our hospital, proficiency samples are also included in the technologist competency program. Proficiency tests can also be beneficial in validating the laboratory's measurement method, technical training, and uncertainty budgets for new tests.

Proficiency testing programs require thorough investigation on discrepant results for any analyte (i.e., failure). Laboratories may be asked to submit information that could include current and historical proficiency testing reports, QC and equipment monitoring, analysis and corrective action of the problem that caused the failure, and the steps taken to ensure the reliability of patient test results. If the laboratory cannot resolve analyte testing discrepancies, the testing facility may be at risk of losing the authority to perform patient testing for the analyte(s) in question.

To develop and manage a successful proficiency testing program for the clinical laboratory, it is important to understand the documented requirements from the two main accreditation bodies. A large proficiency testing program often requires considerable personnel resources and costs for the laboratory and is an essential factor in providing a quality management system. As an example of the scale and volume of proficiency tests, our laboratory (for a 700-bed hospital with outreach clinics) performed ≈ 9000 proficiency tests in a year for ≈ 500 individual analytes. Besides meeting required accreditation standards, proficiency testing allows the laboratory to objectively ensure they report patient results accurately.

DEFINITIONS BOX

Quality management: Approach focusing on process improvement as a means to meet a set standard.

Quality assurance: Measurement of the broader dimensions of quality, from the perspective of the end-users. In the laboratory it might involve the monitoring of specimen acquisition, turnaround times, or proficiency testing of materials to determine analytic performance.

(continued)

DEFINITIONS BOX (continued)

Quality design: Activity of developing new processes required to meet customers' needs. Currently, these processes do not exist. [Quality design is beyond the scope of this book.]

Quality control: The main purpose of QC is to detect and repair performance—remove sporadic spikes—to the prior chronic level, either by prompt action to restore the status quo or, preferably, by preventing the damage from occurring in the first place.

Quality improvement: The purpose of quality improvement is to determine and address the root causes of problems identified by QC and quality assurance. In the laboratory, this might lead to identification of problem with a process that is likely to cause errors.

QUALITY MANAGEMENT**Quality Improvement: Lean Six Sigma**

In the previous sections, we discussed how laboratory tests are established by method evaluation and how their processes are continuously monitored by QC. In this section, we expand on these ideas to discuss the concept of quality improvement (Fig. 4-28). Quality improvement goes beyond monitoring, detecting, and preventing errors. Quality improvement achieves new levels of performance, not otherwise realized through QC and addresses chronic problems. Lean Six Sigma provides a culture, infrastructure, methodology, and metric for quality improvement.

A culture can be defined as a set of beliefs, norms, attitudes, and values. Lean Six Sigma begins with a belief in the relentless pursuit of continuous improvement to-

ward excellence in products or services, processes, and people. A pioneer in this field, Dr. J. M. Juran, taught that continuous improvement does not make an organization distinctive or “excellent.”⁵¹ It is the rate of improvement that distinguishes an organization.

Because few organizations relentlessly pursue continuous improvement, a shift in basic beliefs and attitudes is required. This will not happen by hoping for change. An infrastructure must support the Lean Six Sigma initiative through a coalition of senior members from the organization. These organizational leaders select and assign quality improvement projects to teams. Although there are various Lean Six Sigma team roles, the three most common are the project coaches/leaders (Black Belts), project team members (Green Belts), and project Sponsors (Blue Belts). Black Belts are full-time quality improvement project leaders who dedicate their time to proactively addressing process and quality problems. Green Belts participate on project teams while maintaining their normal jobs. Blue Belts are mid- to senior-level managers who review the project, remove organizational barriers, and encourage the team members. In the laboratory, a team may consist of experienced or specialist technologists, supervisors, directors, and an expert consultant who will lead the process.

All work is a process, and every process has variation and waste. Variation results in unpredictable and undesirable health outcomes. Waste results in delays and limits access. Lean Six Sigma uses a problem-cause-solution methodology to improve any process through waste elimination and variation reduction. The DMAIC (Define, Measure, Analyze, Improve, and Control) methodology is more than a series of phases and steps, or tools and techniques. It is the belief that quality improvement requires sound problem solving.

Problem solving begins with measuring the opportunity. Lean Six Sigma—the metric—represents a universal standard for both benchmarking and pursuing excellence.

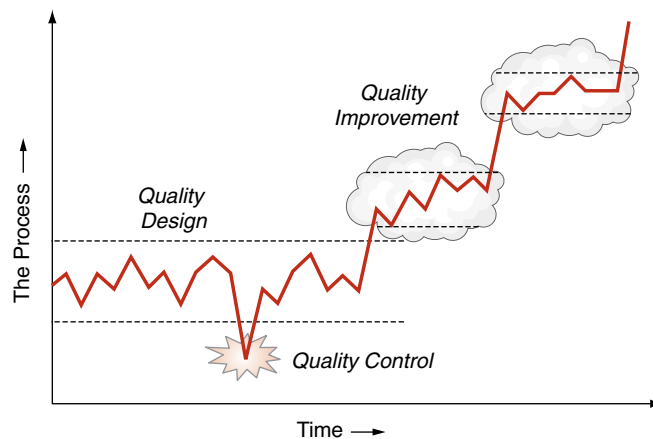

FIGURE 4-28. Quality improvement, design, and control as related to a process.

Improvement Methodology—DMAIC

DEFINITIONS BOX

DMAIC in the Clinical Laboratory

(D) Define. This process involves determining:

1. Who uses your services or products? For example, this might be mainly the physicians within a hospital.
2. What are the user's requirements and expectations? For example, an emergency department will have a need for a faster turnaround time to treat acutely ill patients than will a family physician's office.
3. What are the project boundaries? This might involve establishing who is responsible for the different parts required for generated test results (e.g., phlebotomy to draw the specimen).
4. The process to be improved by methods such as mapping the process flow. This involves determining how a process currently works by mapping all of the steps involved in performing the task.

(M) Measure: The performance of a process in the laboratory can be measured by:

1. Collecting data. In the laboratory, this might involve determining how long it takes to report the results of a cardiac marker from a specimen collected in the emergency department.
2. Determine defects. For example, this might include determining how often specimens are collected in the wrong tube.
3. Satisfaction determined by surveys of those using the process. This might involve determining if the needs of the physicians (or other end-users of test results) are being met.

(A) Analyze: Examine the data collected including the process map to identify the root causes of errors in the process being investigated.

(I) Improve: Improve the process by creative solutions to fix problems and prevent future ones from occurring.

(C) Control: This step keeps the implemented improvements from being forgotten or ignored by long term monitoring of the process over time. This may include continuous monitoring of the new plans.

Adapted from <http://www.isixsigma.com/dictionary/DMAIC-57htm>. September 2003. Accessed October 27, 2008.

The DMAIC methodology is a quality improvement team's project management road map. DMAIC's five phases also ensure sound problem solving and root cause analysis and establish the following:

1. A universally accepted framework for breakthrough improvement
2. Common language throughout the organization
3. A checklist to prevent skipping critical steps

The first and last phases—**Define** and **Control**—sandwich the three main phases of problem solving—**Measure**, **Analyze**, and **Improve**. In the **Measure** phase, the team collects data to measure the gap or size of the problem (Fig. 4-29). That is, they determine the difference between where the current process is and where you want it to be. In the **Analyze** phase, the team searches for the root causes for why the gap exists. In the **Improve** phase, the team pilots process changes that address those root causes.

Each DMAIC phase has one or two key objectives and corresponding tasks to be completed (also known as deliverables), as well as clearly identified steps to be taken using specific tools and techniques. By the end of the **Define** phase, both the project team and management have validated the “project charter”; this means that the team will have defined the overall purpose and potential impact, the scope of the project (what is included and what is not), its resources (e.g., who is on the team and how much money is available to implement changes), and expectations—what will be delivered and when. The **Measure** phase requires teams to map, measure, and assess the baseline process. For example, if the goal was to improve the time it takes phlebotomists to get specimens from the hospital inpatient population to the laboratory, then the **Measure** phase would consist of a detailed determination of how long this currently takes. The **Measure** phase allows the team to focus their charter and quantitatively measure the severity of the problem. In the **Analyze**

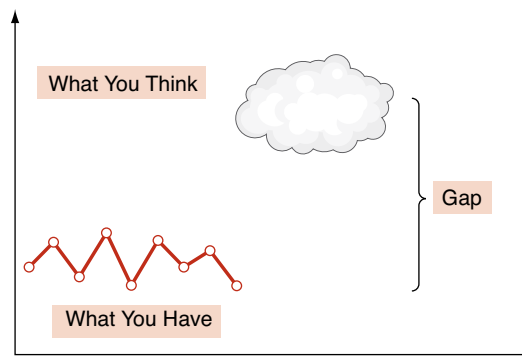

FIGURE 4-29. Graphical representation of the improvement process showing the relationship between the current status of a process and the ultimate goals. Examples of such processes in the laboratory include data accuracy, turnaround times for reporting, and many other measures.

phase, the team verifies the root causes of the problem through cause-effect data analysis. Continuing with the example of improving the time it takes phlebotomists to get inpatient specimens to the laboratory, this would involve analyzing the phlebotomist's process. If the phlebotomist collects 50 specimens before sending any of those to the laboratory, then there will be significant delays for the specimens that are drawn first. It is at the **Analyze** phase that such details of the process would be determined. At the completion of the **Improve** phase, a team must demonstrate that a process change has been implemented that addresses the causes found in the **Analyze** phase and solves the problem evaluated in the **Measure** phase. Again using the inpatient phlebotomy example, the process could be improved by sending specimens to the laboratory after every five collections to minimize the time each specimen waits before getting to the laboratory. The final **Control** phase ensures that the gains made by implemented improvements are maintained by QC mechanisms (previously discussed). To complete this example, this means that the laboratory must monitor how long it takes for specimens to arrive and ensure that phlebotomists follow the new procedures daily over time in order to ensure improvements stay in place over time.

Metrics—Lean and Six Sigma

Originally, Lean and Six Sigma were separate ideas designed to achieve two related metrics: *time* and *error*. Lean was designed to eliminate non-value-adding steps and Six Sigma aimed to reduce variation. The objective of Lean was to reduce cycle time; the objective of Six Sigma was to reduce error. Today, organizations combine both ideas to achieve a synergistic positive impact on process and quality performance.

Teams typically find that only 5% of the activities in any process add value; this means that a vast majority of activities do not contribute to the process. Graphically, this might look like the redundant and nonlinear process shown in Figure 4-30A. Lean Six Sigma measures the amount of non-value-adding steps in a process as part of its core metrics. In the **Define** phase, the team maps the process at a very high level; in the other phases, the team maps, measures, analyzes, changes, and controls the process at a granular level. With detailed study, most teams find complexity in the process. This complexity often contributes to a defect-prone process as well as elongated cycle times. Implemented solutions (based on your goals/what you want) might be represented in Figure 4-30B, where the inefficiency has been removed.

A process sigma represents the capability of a process to meet (or exceed) the process specifications (requirements). It reflects the number of defects (errors) per million opportunities (DPMO). The sigma (σ) refers to the number of SDs from the mean a process can be before it

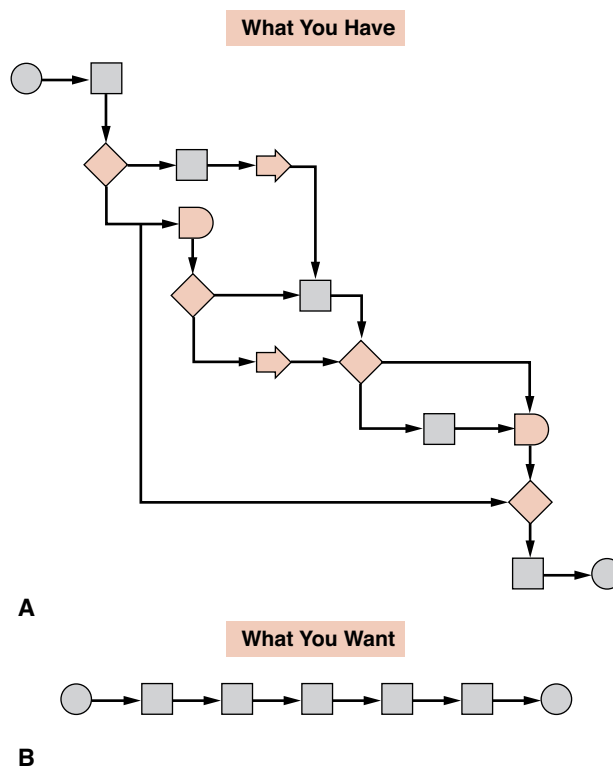

FIGURE 4-30. Schematic representing a current and a desired process. Red segments represent failures or undesired results. In a flawed process, there are unnecessary steps (waste), which delay results. In the laboratory, these correspond to longer turnaround times.

is outside the acceptable limits (Fig. 4-31). For example, if a sodium test has Six Sigma performance, then the mean could shift by six SDs (6σ) and still meet the laboratory requirements. A Six Sigma process test has a narrow process SD (i.e., it is very precise) and produces only three errors for every million tests. A three sigma (3σ) process has a much wider SD and produces about 26,674 errors per million tests (Fig. 4-31).

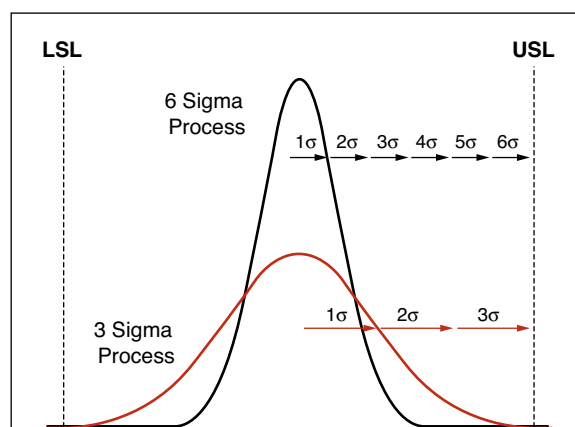

FIGURE 4-31. Comparison of Sigma performance to results distribution.

TABLE 4-15 DEFINITION OF "SIGMA" FOR A PROCESS WITH A GIVEN ERROR RATE

| YIELD | ERRORS PER 1 MILLION RESULTS | PROCESS SIGMA |
|----------|------------------------------|---------------|
| 99.9999% | 1 | 6.27 |
| 99.9997% | 3 | 6.04 |
| 99.999% | 10 | 5.77 |
| 99.99% | 100 | 5.22 |
| 99.9% | 1,000 | 4.59 |

There are various ways to calculate the sigma of a process. In order to calculate the sigma, defects must be clearly defined. In the laboratory, any test that does not meet its requirements (i.e., correctly quantified, delivered on time, etc.) is considered a defect. The most straightforward method uses the process yield—the percentage of times that a process is defect free. Another fairly simple method is to calculate the defects per million opportunities. Both of these methods then require finding the process sigma on the Process Sigma chart (Table 4-15).

Eliminating non-value-adding steps and reducing variation have a synergistic positive impact on process performance (Table 4-16). A couple of examples illustrate this concept. Assume that there are four steps involved in testing a specimen and each step is performed at a three sigma level (93.3% correctly quantified and results delivered on time). With this performance, only three of every four tests will be accurate and timely! Now imagine that a team improves the quality of the process so that each step is performed correctly and timely at a four sigma level (99.38% correctly quantified and delivered on time). The new level of performance produces 98% of the results accurately and on time. We will use another example, where a test has 10 steps, each of which operates at a three sigma level (93% correct and on time). With

TABLE 4-17 RATE OF LABORATORY ERROR DETECTION

| ESTIMATED LABORATORY ERROR RATE | ERRORS PER 1 MILLION |
|---|----------------------|
| 1:164 ⁵⁸ | 6,098 |
| 1:214 ⁶⁷ | 4,672 |
| 1:283 ⁶⁸ | 3,534 |
| 1:8300 ⁶¹ | 20 |
| Risk of dying in a plane crash: 1:7,000,000 passengers ⁵⁶ | 0.14 |

Table adapted with permission from Bonini P, Plebani M, Ceriotti F, et al. *Errors in laboratory medicine*. Clin Chem 2002;48:691–698.

these numerous slightly inaccurate steps, half of the tests will be inaccurate and late. Simply by eliminating unnecessary steps and maintaining the level of performance, the team can drastically reduce the number of errors. If the improvement team can both eliminate six steps and increase the quality of each step to a four sigma level, the process will improve so that 98% of the tests are accurate and on time (Table 4-16). These improvement strategies are designed to be continuous. Once improvements have been realized, the process should continue to make the system even better with each iteration.

Perspective: Patient Safety, Lean Six Sigma, and the Laboratory

For many decades, the prevailing perception has been that the health care system in the United States is safe and of high quality. However, recent studies have demonstrated that there is an emerging realization that medical errors occur with much more frequency than previously thought.^{53–57} As part of the health care system, the laboratory is a potential source of error. Error rates in laboratory tests have been estimated to occur between 1:164 and 1:8,300 results (Table 4-17).^{59–62} Using

TABLE 4-16 EXAMPLE OF YIELD AT GIVEN PERFORMANCE (σ): PERCENT OF DATA REPORTED CORRECTLY

| NO. OF STEPS | $\pm 3\sigma$ | $\pm 4\sigma$ | $\pm 5\sigma$ | $\pm 6\sigma$ |
|--------------|---------------|---------------|---------------|---------------|
| 1 | 93.3% | 99.38% | 99.977% | 99.9999% |
| 3 | 82.7% | 98.16% | 99.931% | 99.9953% |
| 4 | 77.4% | 97.56% | 99.908% | 99.9930% |
| 7 | 61.6% | 95.73% | 99.839% | 99.9976% |
| 10 | 50.1% | 93.96% | 99.768% | 99.9966% |
| 20 | 25.1% | 88.29% | 99.536% | 99.9932% |
| 40 | 6.3% | 77.94% | 99.074% | 99.9864% |
| 80 | 1.6% | 68.81% | 98.614% | 99.9796% |
| 100 | 0.4% | 60.75% | 98.156% | 99.9728% |

Six Sigma metrics, it is estimated that laboratory error rates occur at a rate of between 120 and 6,098 defects per 1 million opportunities (DPMO); this corresponds to a 4σ – 5σ Sigma rating. A 6σ quality level would require less than 3.4 DPMO⁶² (see Table 4-15).

While an estimated 12.5% of laboratory errors impact patient health,⁶³ only 37.5 of every 100,000 patients are placed at risk due to testing mistakes in private hospitals and the primary care setting.^{57,64} Previously, we focused on errors that occur in the analytic phase of testing. But it should be noted that analytic testing errors comprise only 4% to 32% of all errors in laboratory testing.⁶³ The majority of laboratory errors are due to processes occurring either before (preanalytic) or immediately after (postanalytic) the test. Preanalytic errors are estimated at between 32% and 75%, and postanalytic errors account for 9% to 55%.⁶³ As outlined in Figure 4-32, the preanalytic phase involves steps such as the actual ordering of the tests by physicians, as well as sample collection. Because many of the preanalytic errors are outside of the physical laboratory (i.e., phlebotomy), it is imperative that the process as a whole be considered when reorganizing laboratory processes to improve quality. With the current emphasis on quality improvement in the health care setting,^{53–57} clinical laboratories have been early adopters of Six Sigma and Lean processes⁶² in an effort, which will certainly be more prevalent in the future, to improve the quality of laboratory testing and ultimately that of health care in general.

Practical Application of Six Sigma Metrics

Although Six Sigma metrics have existed for some time in the business and manufacturing world, they have just recently been applied to health care and are considered at the cutting edge of quality management. As described, these principles can be applied to any aspect of the process, from patient identification to reporting laboratory test values. From a quality management perspective, Six Sigma metrics can determine how well an analytic process performs and assist in choosing appropriate QC rules based on this performance. For example, if a given

test has excellent performance (very precise and accurate over time), then fewer errors will occur. It would take a large shift in the mean for the test to fail the quality requirements. Accordingly, fewer QC rules would be needed to identify errors. Remember that these rules are designed to maximize the chance of detecting a problem, while simultaneously minimizing the chance of rejecting a run when it is actually correct (false rejection).

Six Sigma metrics can be plotted graphically using an operational process specification “OPSpecs” chart. This chart incorporates many of the measures described earlier in this chapter into one graph, including (1) total EA, (2) systematic error, and (3) imprecision (Fig. 4-33A). From the QC section, total EA is defined by CLIA regulations (see Table 4-12). Systematic error and imprecision are derived from the COM experiment, as described in the COM section (see Fig. 4-24). Using a hypothetical example for total calcium, we will use the systematic error from the linear regression equation $y = 0.97x + 0.2$ and an imprecision of 2%. From Table 4-12, the EA for calcium is 1 mg/dL. A medical decision level (where the physician might consider additional tests) for total calcium is 10 mg/dL. Entering 10 mg/dL into the regression equation ($y = 0.91 \times 10 + 0.2$) gives a systematic error of 0.7 mg/dL; this is 70% of the total allowable error (1 mg/dL). An imprecision of 2% at 10 mg/dL is 0.2 mg/dL; this is 20% of 1 mg/dL total EA. Plotting this decision point (1) on the chart (Fig. 4-33B) corresponds to a 2σ performance; this is considered poor performance and would require the maximum number control measurements and several multi-rules to detect the high number of errors; many rules are needed because it would only require a small shift in the mean to result in a failure (this principle is evident in Fig. 4-31). If the bias could be eliminated (as demonstrated with point 2, Fig. 4-33B), the performance would fall into the 5σ range, which is considered to be very good; only a few control measurements would be necessary with a minimal use of control rules to detect the low number of errors. This example highlights the importance of systematic error and imprecision when evaluating new methods. With respect to QC in the laboratory, Six Sigma metrics are generally

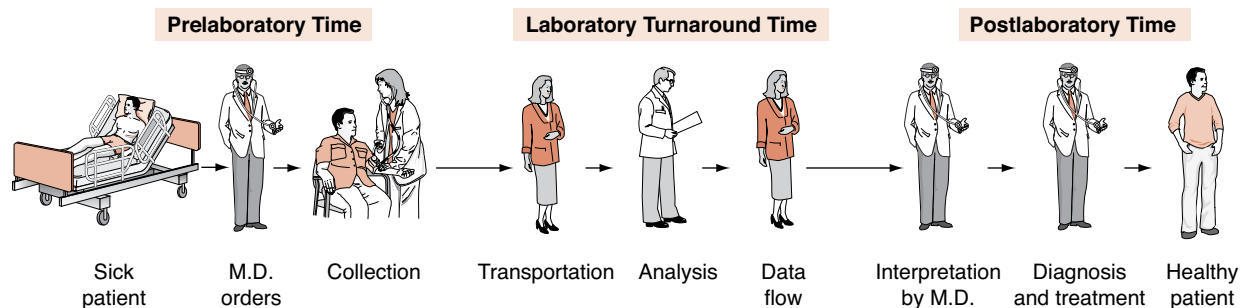

FIGURE 4-32. Schematic representation of the components involved in the general process of clinical laboratory testing.

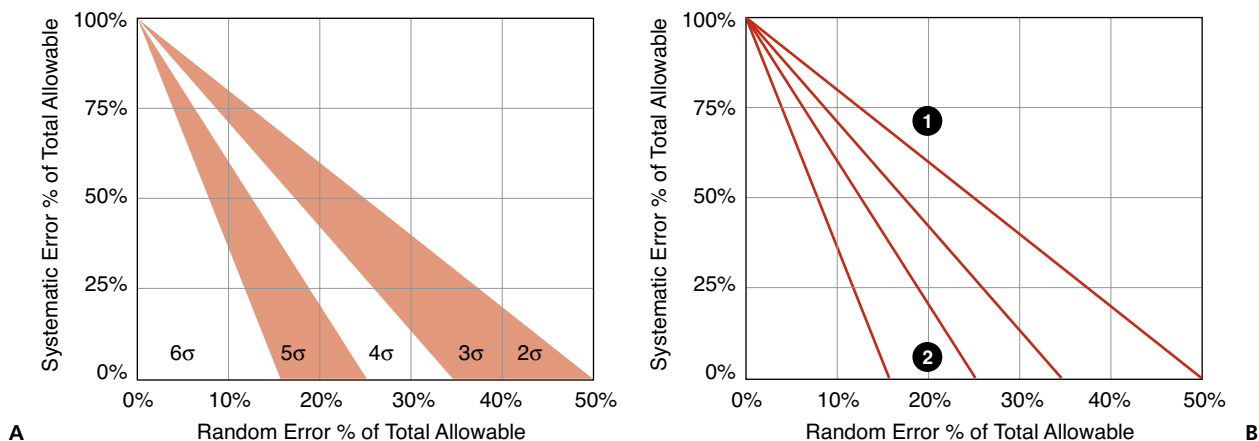

FIGURE 4-33. Six Sigma charts used in the determination of process performance. **(A)** The imprecision of the test is plotted against the systematic error as percentages of the total allowable error. **(B)** The performance of test for total calcium with **(1)** and without **(2)** systematic error as analyzed by a Six Sigma chart.

limited to selection of QC rules, because the laboratory often has little ability to change and improve the quality of a commercially purchased test. However, maximizing error detection and minimizing false rejection is in itself a very useful process; it will limit the number of wrong patient results reported and save the costs of repeating tests that are accurate. These results benefit both the laboratory and patient.

PRACTICE PROBLEMS

Problem 4-1. Calculation of Sensitivity and Specificity

α -Fetoprotein (AFP) levels are used by obstetricians to help diagnose neural tube defects (NTD) in early pregnancy. For the following data, calculate the sensitivity, specificity, and efficiency of AFP for detecting NTD, as well as the predictive value of a positive AFP.

NUMBER OF PREGNANCIES/INTERPRETATION OF AFP FINDINGS

| OUTCOME OF PREGNANCY | POSITIVE (NTD) | NEGATIVE (NO NTD) | TOTAL |
|----------------------|----------------|-------------------|-------|
| NTD | 5 | 3 | 8 |
| No NTD | 4 | 843 | 847 |
| Total | 9 | 846 | 855 |

Problem 4-2. A Management Decision in Quality Control

You are in charge of the clinical laboratory when a technologist presents you with the technologist's glucose worksheet. A 2_{2s} rule violation has occurred across runs and within materials on the high-concentration material.

You ask to see the patient data and the previous control data. They follow:

GLUCOSE WORKSHEET

| JANUARY GLUCOSE CONTROL VALUES | | | | |
|--------------------------------|---------|------|-----|------|
| Samples | Results | Date | Low | High |
| Control—High | 224 | 1/1 | 86 | 215 |
| Patient | 117 | 1/2 | 82 | 212 |
| Patient | 85 | 1/3 | 83 | 218 |
| Patient | 98 | 1/4 | 87 | 214 |
| Patient | 74 | 1/5 | 85 | 220 |
| Patient | 110 | 1/6 | 81 | 217 |
| Control—Low | 83 | 1/7 | 88 | 223 |
| Patient | 112 | 1/8 | 83 | 224 |
| Patient | 120 | | | |
| Patient | 97 | | | |
| Patient | 105 | | | |

1. Plot these control data.
2. What do you observe about these control data?
3. What might be a potential problem?
4. Should you report the patient data for today? Why or why not?

Problem 4-3. Interdepartmental Communication

You are having a problem with the medical intensive care unit (MICU) and the arterial blood gas specimens they submit to the laboratory. In the past 3 weeks, you have refused to perform blood gas analyses on six different

MICU specimens because of small clots found in the specimens. The MICU staff is furious with the rejection policy, yet you believe the analyses will be incorrect if these specimens are used.

1. Outline where the problem lies.
2. What can be done to remedy this problem?
3. Why would your present QC system not detect this sort of error?

The following problems represent the steps in a method-evaluation study. An abbreviated data set is used to encourage hand calculations by the student. Perform the calculations for the following experimental data, which were obtained from a glucose study. The test method is a coupled glucose oxidase procedure. The comparative method is the hexokinase method currently in use.

Problem 4-4. Precision (Replication)

For the following precision data, calculate the mean, SD, and CV for each of the two control solutions A and B. These control solutions were chosen because their concentrations were close to medical decision levels (X_C) for glucose: 120 mg/dL for control solution A and 300 mg/dL for control solution B.

Control solution A was analyzed daily, and the following values were obtained:

118, 120, 121, 119, 125, 118, 122, 116, 124, 123, 117, 117, 121, 120, 120, 119, 121, 123, 120, and 122 mg/dL.

Control solution B was analyzed daily and gave the following results:

295, 308, 296, 298, 304, 294, 308, 310, 296, 300, 295, 303, 305, 300, 308, 297, 297, 305, 292, and 300 mg/dL.

Problem 4-5. Recovery

For the following recovery data, calculate the percent recovery for each of the individual experiments and the average of all the recovery experiments. The experiments were performed by adding two levels of standard to each of five patient samples (A through E) with the following results:

| SAMPLE | 0.9 mL SERUM +0.1 mL WATER | 0.9 mL SERUM +0.1 mL 500 mg/dL STD | 0.9 mL SERUM +0.1 mL 1,000 mg/dL STD |
|--------|-------------------------------------|--|--|
| | A | 59 | 110 |
| B | 63 | 112 | 160 |
| C | 76 | 126 | 175 |
| D | 90 | 138 | 186 |
| E | 225 | 270 | 320 |

What do the results of this study indicate?

Problem 4-6. Interference

For the interference data that follow, calculate the concentration of ascorbic acid added, the interference for each individual sample, and the average interference for the group of patient samples. The experiments were performed by adding 0.1 mL of a 150-mg/dL ascorbic acid standard to 0.9 mL of five different patient samples (A through E). A similar dilution was prepared for each patient sample using water as the diluent. The results follow:

| SAMPLE | 0.9 mL SERUM + 0.1 mL WATER | 0.9 mL SERUM + 0.1 mL 150 mg/dL STD |
|--------|--------------------------------|--|
| A | 54 | 46 |
| B | 99 | 91 |
| C | 122 | 112 |
| D | 162 | 152 |
| E | 297 | 286 |

What do the results of this study indicate?

Problem 4-7. Sample Labeling

You receive a urine specimen in the laboratory with a request for a complete urinalysis. The cup is labeled and you begin your testing. You finish the testing and report the results to the ward. Several minutes later, you receive a telephone call from the ward informing you that the urine was reported on the wrong patient. You are told that the cup was labeled incorrectly before it was brought to the laboratory.

1. What is the problem in this case, and where did it occur?
2. Would your laboratory's QC system be able to detect or prevent this type of problem?

Problem 4-8. QC Program for POCT Testing

Your laboratory is in charge of overseeing the QC program for the glucometers (POCT) in use at your hospital. You notice that the ward staff is not following proper procedure for running QC. For example, in this case, the glucometer QC was rerun three times in a row in an effort to have the results in control. The first two runs were both 13s. The last run did return to less than 2 SDs. Explain the correct follow-up procedure for dealing with the out of control results.

Problem 4-9. QC Rule Interpretation

Explain the R_{4s} rule, including what type of error it detects.

ONLINE RESOURCES

| | |
|---|---|
| AACC: | http://aacc.org |
| Centers for Disease Control and Prevention: | http://www.cdc.gov |
| CLIA: | http://www.cms.hhs.gov/clia |
| CLSI: | http://www.clsi.org |
| College of American Pathologists: | http://CAP.org |
| EP Evaluator: | http://www.dgrhoads.com |
| FDA: | http://FDA.gov |
| GraphPAD: | http://www.graphpad.com |
| JMP: | http://www.jmp.com |
| Labs Online: | http://www.labtestsonline.org |
| McLendon Clinical Laboratories: | http://labs.unchealthcare.org |
| OVID: | http://www.fda.gov/CDRH/ovid |
| SAS: | http://www.sas.com |
| Westgard Laboratory pages: | http://www.westgard.com |

REFERENCES

- Westgard JO, de Vos DJ, Hunt MR, et al. Concepts and practices in the evaluation of clinical chemistry methods. V. Applications. *Am J Med Technol* 1978;44:803–813.
- Wakkers PJ, Hellendoorn HB, Op de Weegh GJ, et al. Applications of statistics in clinical chemistry. A critical evaluation of regression lines. *Clin Chim Acta* 1975;64:173–184.
- Solberg HE. The IFCC recommendation on estimation of reference intervals. The RefVal program. *Clin Chem Lab Med* 2004;42:710–714.
- Solberg HE. International Federation of Clinical Chemistry. Scientific Committee, Clinical Section. Expert Panel on Theory of Reference Values and International Committee for Standardization in Haematology Standing Committee on Reference Values. Approved recommendation (1986) on the theory of reference values. Part 1. The concept of reference values. *Clin Chim Acta* 1987;165:111–118.
- Solberg HE. International Federation of Clinical Chemistry (IFCC), Scientific Committee, Clinical Section, Expert Panel on Theory of Reference Values, and International Committee for Standardization in Haematology (ICSH), Standing Committee on Reference Values. Approved Recommendation (1986) on the theory of reference values. Part 1. The concept of reference values. *J Clin Chem Clin Biochem* 1987;25:337–342.
- Standardization of blood specimen collection procedure for reference values. International Committee for Standardization in Haematology (ICSH). *Clin Lab Haematol* 1982;4:83–86.
- Clinical laboratory improvement amendments of 1988; final rule. Fed Reg 7164 [42 CFR 493.1213]: Department of Health and Human Services, Centers for Medicare and Medicaid Services; 1992.
- van der Meulen EA, Boogaard PJ, van Sittert NJ. Use of small-sample-based reference limits on a group basis. *Clin Chem* 1994;40:1698–1702.
- National Committee for Clinical Laboratory Standards (NCCLS). How to define and determine reference intervals in the clinical laboratory; approved guideline C28-A2. Wayne, Pa.; NCCLS, 2000.
- Clinical and Laboratory Standards Institute (CLSI). C28-A2: How to define and determine reference intervals in the clinical laboratory; approved guideline. 2nd ed. Villanova, Pa.; CLSI, 2008.
- Galen RS, Gambino SR. Beyond normality: the predictive value and efficiency of medical diagnoses. New York, N.Y.: Wiley, 1975.
- Zweig MH, Campbell G. Receiver-operating characteristic (ROC) plots: a fundamental evaluation tool in clinical medicine [published erratum appears in *Clin Chem* 1993;39:1589]. *Clin Chem* 1993;39:561–577.
- Albert A. On the use and computation of likelihood ratios in clinical chemistry. *Clin Chem* 1982;28:1113–1119.
- van der Helm HJ, Hische EA, Bolhuis PA. Bayes' theorem and the estimation of the likelihood ratio. *Clin Chem* 1982;28:1250–1251.
- Reibnegger G, Fuchs D, Hausen A, et al. Generalized likelihood ratio concept and logistic regression analysis for multiple diagnostic categories. *Clin Chem* 1989;35:990–994.
- Centers for Disease Control and Prevention (CDC), Centers for Medicare and Medicaid Services (CMS), Health and Human Services. Medicare, Medicaid, and CLIA programs; laboratory requirements relating to quality systems and certain personnel qualifications. Final rule. *Fed Reg* 2003;68:3639–3714.
- Westgard JO, de Vos DJ, Hunt MR, et al. Concepts and practices in the evaluation of clinical chemistry methods. I. Background and approach. *Am J Med Technol* 1978;44:290–300.
- National Committee for Clinical Laboratory Standards (NCCLS). Approved guideline for precision performance of clinical chemistry devices. Villanova, Pa.: NCCLS, 1999. (Document no. EP05-A.)
- Westgard JO, de Vos DJ, Hunt MR, et al. Concepts and practices in the evaluation of clinical chemistry methods. II. Experimental procedures. *Am J Med Technol* 1978;44:420–430.
- Krouwer JS, Rabinowitz R. How to improve estimates of imprecision. *Clin Chem* 1984;30:290–292.
- Westgard JO, Burnett RW. Precision requirements for cost-effective operation of analytic processes. *Clin Chem* 1990;36:1629–1632.
- Westgard JO, Carey RN, Wold S. Criteria for judging precision and accuracy in method development and evaluation. *Clin Chem* 1974;20:825–833.
- Westgard JO. Basic method evaluation, 2nd ed. Madison, Wis.: Westgard Quality Corp, 2003.
- National Committee for Clinical Laboratory Standards (NCCLS). Proposed guideline for interference testing in clinical chemistry. Villanova, Pa.: NCCLS; 1986. (Document no. EP07-A.)
- Young DS. Effects of drugs on clinical laboratory tests. 4th ed. Washington, D.C.: American Association of Clinical Chemistry, 2000.
- Siest G, Galteau MM. Drug effects on laboratory tests. Littleton, Mass.: PSG Publishing, 1988.
- Glick MR, Ryder KW. Analytical systems ranked by freedom from interferences. *Clin Chem* 1987;33:1453–1458.
- Glick MR, Ryder KW, Jackson SA. Graphical comparisons of interferences in clinical chemistry instrumentation. *Clin Chem* 1986;32:470–475.
- Ryder KW, Glick MR. Erroneous laboratory results from hemolyzed, icteric, and lipemic specimens. *Clin Chem* 1993;39:175–176.
- National Committee for Clinical Laboratory Standards (NCCLS). Approved guideline for method comparison and bias estimation using patient samples. Villanova, Pa.: NCCLS, 2002. (Document no. EP09-A2.)
- Shahzad K, Kim DH, Kang MJ. Analytic evaluation of the beta-human chorionic gonadotropin assay on the Abbott IMx and Elecsys2010 for its use in doping control. *Clin Biochem* 2007;40:1259–1265.
- National Committee for Clinical Laboratory Standards (NCCLS). Proposed guideline for evaluation of linearity of quantitative analytical methods. Villanova, Pa.: NCCLS, 2001. (Document no. EP6-P2.)
- Westgard JO, Hunt MR. Use and interpretation of common statistical tests in method-comparison studies. *Clin Chem* 1973;19:49–57.
- Westgard JO. Precision and accuracy: concepts and assessment by method evaluation testing. *Crit Rev Clin Lab Sci* 1981;13:283–330.

35. Cornbleet PJ, Gochman N. Incorrect least-squares regression coefficients in method-comparison analysis. *Clin Chem* 1979;25:432–438.
36. Feldmann U, Schneider B, Klinkers H, et al. A multivariate approach for the biometric comparison of analytical methods in clinical chemistry. *J Clin Chem Clin Biochem* 1981;19:121–137.
37. Westgard JO, de Vos DJ, Hunt MR, et al. Concepts and practices in the evaluation of clinical chemistry methods: IV. Decisions of acceptability. *Am J Med Technol* 1978;44:727–742.
38. Barnett RN. Medical significance of laboratory results. *Am J Clin Pathol* 1968;50:671–676.
39. Fraser CG. Data on biological variation: essential prerequisites for introducing new procedures? *Clin Chem* 1994;40:1671–1673.
40. Fraser CG. *Biological variation: from principles to practice*. Washington, D.C.: AACC Press, 2001.
41. Tonks DB. A study of the accuracy and precision of clinical chemistry determinations in 170 Canadian laboratories. *Clin Chem* 1963;9:217–233.
42. Medicare, Medicaid and CLIA programs; regulations implementing the Clinical Laboratory Improvement Amendments of 1988 (CLIA)—HCFA. Final rule with comment period. *Fed Reg* 1992;57 :7002–7186.
43. Ehrmeyer SS, Laessig RH, Leinweber JE, et al. 1990 Medicare/CLIA final rules for proficiency testing: minimum intralaboratory performance characteristics (CV and bias) needed to pass. *Clin Chem* 1990;36 :1736–1740.
44. Westgard JO, Seehafer JJ, Barry PL. European specifications for imprecision and inaccuracy compared with operating specifications that assure the quality required by US CLIA proficiency-testing criteria. *Clin Chem* 1994;40(7 Pt 1):1228–1232.
45. Bland JM, Altman DG. Statistical methods for assessing agreement between two methods of clinical measurement. *Lancet* 1986;1 :307–310.
46. Levey S, Jennings ER. The use of control charts in the clinical laboratory. *Am J Clin Pathol* 1950;20 :1059–1066.
47. Westgard JO, Barry PL, Hunt MR, et al. A multi-rule Shewhart chart for quality control in clinical chemistry. *Clin Chem* 1981;27:493–501.
48. Clinical and Laboratory Standards Institute (CLSI). *Statistical quality control for quantitative measurements: principles and definitions*. Wayne, Pa.: CLSI, 2006.
49. Westgard JO, Groth T. Power functions for statistical control rules. *Clin Chem* 1979;25:863–869.
50. Westgard JO, Groth T, Aronsson T, et al. Performance characteristics of rules for internal quality control: probabilities for false rejection and error detection. *Clin Chem* 1977;23:1857–1867.
51. Juran JM. *Juran on leadership for quality: an executive handbook*. New York, N.Y.: Free Press, 2004.
52. <http://www.isixsigma.com/dictionary/DMAIC-57.htm>. September 2003. Accessed October 27, 2008.
53. Institute of Medicine, Committee on Quality of Health Care in America. *Crossing the quality chasm: a new health system for the 21st century*. Washington, D.C.: National Academies Press, 2001.
54. Institute of Medicine, Committee on Crossing the Quality Chasm: *Adaptation to mental health and addictive disorders. Improving the quality of health care for mental and substance-use conditions*. Washington, D.C.: National Academies Press, 2006.
55. Aspden P, Institute of Medicine, Committee on Data Standards for Patient Safety. *Patient safety: achieving a new standard for care*. Washington, D.C.: National Academies Press, 2004.
56. Kohn LT, Corrigan J, Donaldson MS. *To err is human: building a safer health system*. Washington, D.C.: National Academies Press, 2000.
57. Adams K, Corrigan JM, Institute of Medicine. *Priority areas for national action: transforming health care quality*. Washington, D.C.: National Academies Press, 2003.
58. Stahl M, Lund ED, Brandslund I. Reasons for a laboratory's inability to report results for requested analytical tests. *Clin Chem* 1998;44 :2195–2197.
59. Siebers R. Laboratory blunders revisited. *Ann Clin Biochem* 1994;31(Pt 4):390–391.
60. Chambers AM, Johnston J, O'Reilly DS. Laboratory blunders revisited. *Ann Clin Biochem* 1994;31(Pt 4):390; author reply 391.
61. Lapworth R, Teal TK. Laboratory blunders revisited. *Ann Clin Biochem* 1994;31(Pt 1):78–84.
62. Stankovic AK. The laboratory is a key partner in assuring patient safety. *Clin Lab Med* 2004;24 :1023–1035.
63. Bonini P, Plebani M, Ceriotti F, et al. Errors in laboratory medicine. *Clin Chem* 2002;48:691–698.
64. Nutting PA, Main DS, Fischer PM, et al. Toward optimal laboratory use. Problems in laboratory testing in primary care. *JAMA* 1996;275 :635–639.
65. KA D, RM J, J R. Pediatric reference ranges for TSH, free T4, total T4 total T3 and T3 uptake on the Vitros ECi analyzer. *Clin Chem* 2001(47):A108.
66. National Committee for Clinical Laboratory Standards (NCCLS). *Approved guideline for handling and processing of blood specimens*. 3rd ed. Villanova, Pa.: NCCLS, 2004. (Document no. H18-A3.)
67. Plebani M, Carraro P. Mistakes in a stat laboratory: types and frequency. *Clin Chem* 1997;43(8 Pt 1):1348–1351.
68. Hofgartner WT, Tait JF. Frequency of problems during clinical molecular-genetic testing. *Am J Clin Pathol* 1999;112:14–21.

Analytical Techniques

Julia C. Drees, Alan H. B. Wu

CHAPTER

5

CHAPTER OUTLINE

■ SPECTROPHOTOMETRY AND PHOTOMETRY

Beer's Law
Spectrophotometric Instruments
Components of a Spectrophotometer
Spectrophotometer Quality Assurance
Atomic Absorption Spectrophotometer
Flame Photometry
Fluorometry
Chemiluminescence
Turbidity and Nephelometry
Laser Applications

■ ELECTROCHEMISTRY

Galvanic and Electrolytic Cells
Half-Cells
Ion-Selective Electrodes
pH Electrodes
Gas-Sensing Electrodes
Enzyme Electrodes
Coulometric Chloridometers and Anodic Stripping
Voltametry

■ ELECTROPHORESIS

Procedure
Support Materials
Treatment and Application of Sample

Detection and Quantitation

Electroendosmosis
Isoelectric Focusing
Capillary Electrophoresis

■ CHROMATOGRAPHY

Modes of Separation
Chromatographic Procedures
High-Performance Liquid Chromatography
Gas Chromatography

■ MASS SPECTROMETRY

Sample Introduction and Ionization
Mass Analyzer
Detector
Applications of Mass Spectrometry in the Clinical
Laboratory

■ INSTRUMENTATION FOR PROTEOMICS

Two-dimensional Electrophoresis
MALDI-TOF and SELDI-TOF Mass Spectrometry

■ OSMOMETRY

Freezing-Point Osmometer

■ ANALYTIC TECHNIQUES FOR POINT-OF-CARE TESTING

■ REFERENCES

Analytic techniques and instrumentation provide the foundation for all measurements made in a modern clinical chemistry laboratory. The majority of techniques fall into one of four basic disciplines within the field of analytic chemistry: spectrometry (including **spectrophotometry**, **atomic absorption**, and **mass spectrometry** [MS]); luminescence (including fluorescence, **chemiluminescence**, and nephelometry); electroanalytic methods (including **electrophoresis**, potentiometry, and amperometry); and chromatography (including gas, liquid, and thin-layer). With the improvements in optics, electronics, and computerization, instrumentation has become miniaturized. This miniaturization has enabled the development of **point-of-care testing (POCT)** devices that produce results as accurate as those provided by large laboratory-based instrumentation.

SPECTROPHOTOMETRY AND PHOTOMETRY

The instruments that measure electromagnetic radiation have several concepts and components in common. Shared instrumental components are discussed in some detail in a later section. Photometric instruments measure light intensity without consideration of wavelength. Most instruments today use filters (photometers), prisms, or gratings (spectrometers) to select (isolate) a narrow range of the incident wavelength. Radiant energy that passes through an object will be partially reflected, absorbed, and transmitted.

Electromagnetic radiation is described as photons of energy traveling in waves. The relationship between wavelength and energy E is described by Planck's formula:

$$E = h\nu \quad (\text{Eq. 5-1})$$

where h is a constant (6.62×10^{-27} erg sec), known as Planck's constant, and ν is frequency.

Because the frequency of a wave is inversely proportional to the wavelength, it follows that the energy of electromagnetic radiation is inversely proportional to wavelength. Figure 5-1A shows this relationship. Electromagnetic radiation includes a spectrum of energy from short-wavelength, highly energetic gamma rays and x-rays on the left in Figure 5-1B to long-wavelength radiofrequencies on the right. Visible light falls in between, with the color violet at 400-nm and red at 700-nm wavelengths being the approximate limits of the visible spectrum.

The instruments discussed in this section measure either absorption or emission of radiant energy to determine concentration of atoms or molecules. The two phenomena, absorption and emission, are closely related. For a ray of electromagnetic radiation to be absorbed, it must have the same frequency as a rotational or vibrational frequency in the atom or molecule that it strikes. Levels of energy that are absorbed move in discrete steps, and any particular type of molecule or atom will absorb only certain energies and not others. When energy is absorbed, valence electrons move to an orbital with a higher energy level. Following energy absorption, the excited electron will fall back to the ground state by emitting a discrete amount of energy in the form of a characteristic wavelength of radiant energy.

Absorption or emission of energy by atoms results in a line spectrum. Because of the relative complexity of molecules, they absorb or emit a bank of energy over a large region. Light emitted by incandescent solids (tungsten or deuterium) is in a continuum. The three types of spectra are shown in Figure 5-2.¹⁻³

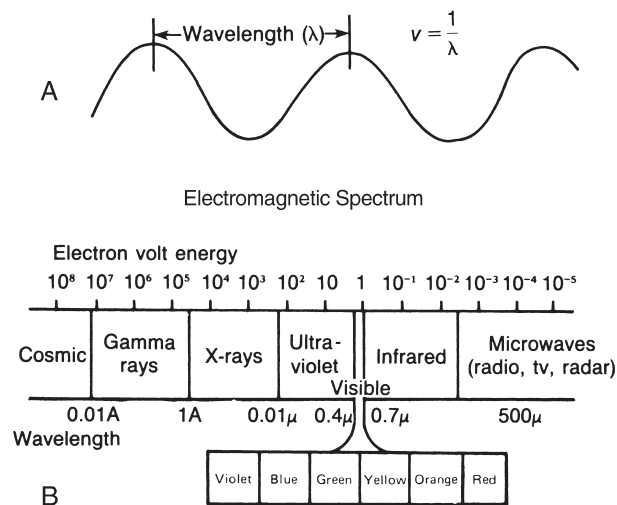

FIGURE 5-1. Electromagnetic radiation—relationship of energy and wavelength.

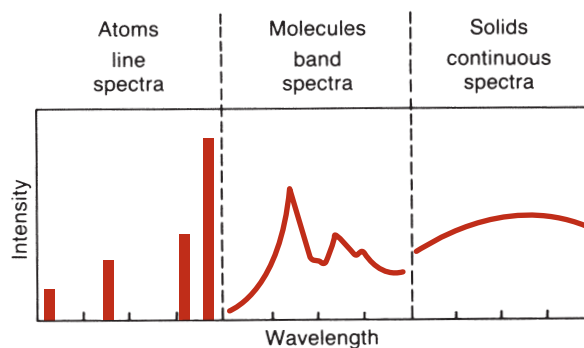

FIGURE 5-2. Characteristic absorption or emission spectra. (Reprinted with permission from Coiner D. Basic concepts in laboratory instrumentation. Bethesda, Md.: ASMT Education and Research Fund, 1975-1979.)

Beer's Law

The relationship between absorption of light by a solution and the concentration of that solution has been described by Beer and others. Beer's law states that the concentration of a substance is directly proportional to the amount of light absorbed or inversely proportional to the logarithm of the transmitted light. Percent transmittance (% T) and absorbance (A) are related photometric terms that are explained in this section.

Figure 5-3A shows a beam of monochromatic light entering a solution. Some of the light is absorbed. The remainder passes through, strikes a light detector, and is converted to an electric signal. Percent transmittance is the ratio of the radiant energy transmitted (T) divided by the radiant energy incident on the sample (I). All light absorbed or blocked results in 0% T. A level of 100% T is obtained if no light is absorbed. In practice, the solvent without the constituent of interest is placed in the light

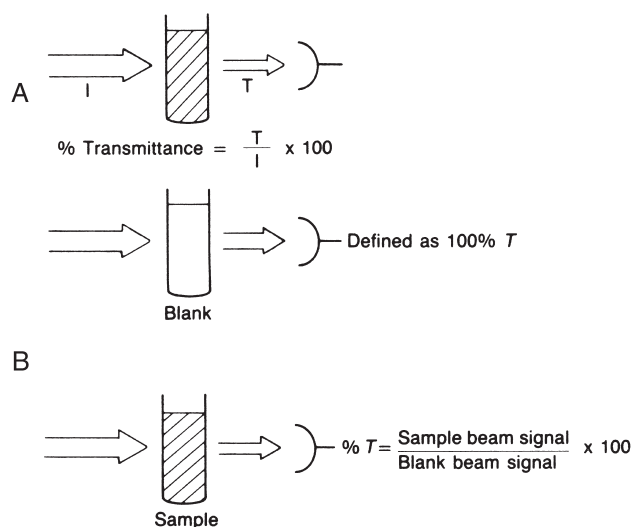

FIGURE 5-3. Percent transmittance (% T) defined.

path, as in Figure 5-3B. Most of the light is transmitted, but a small amount is absorbed by the solvent and cuvet or is reflected away from the detector. The electrical readout of the instrument is set arbitrarily at 100% T, while the light is passing through a “blank” or reference. The sample containing absorbing molecules to be measured is placed in the light path. The difference in amount of light transmitted by the blank and that transmitted by the sample is due only to the presence of the compound being measured. The % T measured by commercial spectrophotometers is the ratio of the sample transmitted beam divided by the blank transmitted beam.

Equal thicknesses of an absorbing material will absorb a constant fraction of the energy incident upon the layers. For example, in a tube containing layers of solution (Fig. 5-4A), the first layer transmits 70% of the light incident upon it. The second layer will, in turn, transmit 70% of the light incident upon it. Thus, 70% of 70% (49%) is transmitted by the second layer. The third layer transmits 70% of 49%, or 34% of the original light. Continuing on, successive layers transmit 24% and 17%, respectively. The % T values, when plotted on linear graph paper, yield the curve shown in Figure 5-4B. Considering each equal layer as many monomolecular layers, we can translate layers of material to concentration. If semilog graph paper is used to plot the same figures, a straight line is obtained (Fig. 5-4C), indicating

that, as concentration increases, % T decreases in a logarithmic manner.

Absorbance A is the amount of light absorbed. It cannot be measured directly by a spectrophotometer but rather is mathematically derived from % T as follows:

$$\%T = \frac{I}{I_0} \times 100 \quad (\text{Eq. 5-2})$$

where I_0 is incident light and I is transmitted light.

Absorbance is defined as follows:

$$\begin{aligned} A &= -\log(I/I_0) = \log(100\%) - \log \%T \\ &= 2 - \log \%T \end{aligned} \quad (\text{Eq. 5-3})$$

According to Beer's law, absorbance is directly proportional to concentration (Fig. 5-4D):

$$A = \epsilon \times b \times c \quad (\text{Eq. 5-4})$$

where ϵ = molar absorptivity, the fraction of a specific wavelength of light absorbed by a given type of molecule; b is the length of light path through the solution; and c is the concentration of absorbing molecules.

Absorptivity depends on molecular structure and the way in which the absorbing molecules react with different energies. For any particular molecular type, absorptivity changes as wavelength of radiation changes. The amount of light absorbed at a particular wavelength

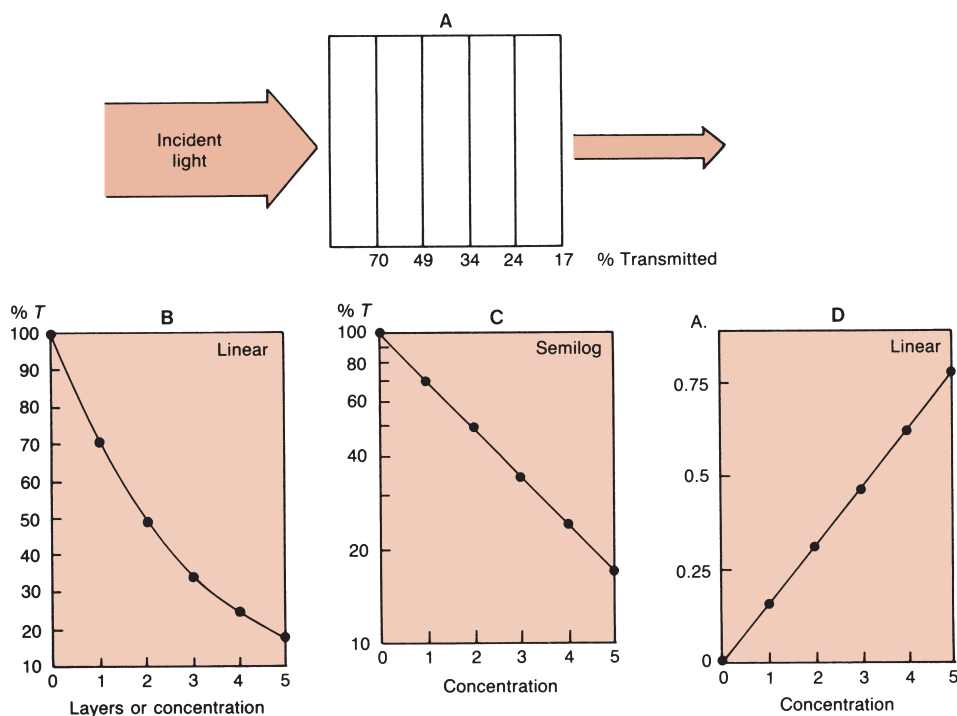

FIGURE 5-4. (A) Percent of original incident light transmitted by equal layers of light-absorbing solution. (B) Percent T versus concentration on linear graph paper. (C) Percent T versus concentration on semilog graph paper. (D) A versus concentration on linear graph paper.

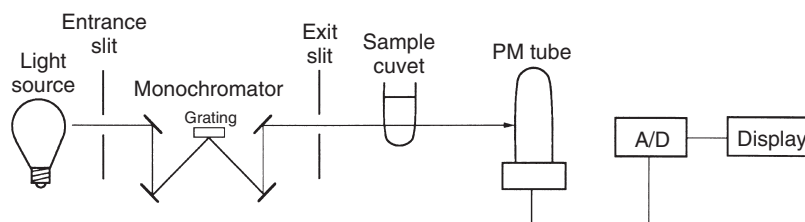

FIGURE 5-5. Single-beam spectrophotometer.

depends on the molecular and ion types present and may vary with concentration, pH, or temperature.

Because the path length and molar absorptivity are constant for a given wavelength,

$$A \sim C \quad (\text{Eq. 5-5})$$

Unknown concentrations are determined from a calibration curve that plots absorbance at a specific wavelength versus concentration for standards of known concentration. For calibration curves that are linear and have a zero y-intercept, unknown concentrations can be determined from a single calibrator. Not all calibration curves result in straight lines. Deviations from linearity are typically observed at high absorbances. The stray light within an instrument will ultimately limit the maximum absorbance that a spectrophotometer can achieve, typically 2.0 absorbance units.

Spectrophotometric Instruments

A spectrophotometer is used to measure the light transmitted by a solution to determine the concentration of the light-absorbing substance in the solution. Figure 5-5 illustrates the basic components of a single-beam spectrophotometer, which are described in subsequent sections.

Components of a Spectrophotometer

Light Source

The most common source of light for work in the visible and near-infrared region is the incandescent tungsten or tungsten-iodide lamp. Only about 15% of radiant energy emitted falls in the visible region, with most emitted as near-infrared.¹⁻³ Often, a heat-absorbing filter is inserted between the lamp and sample to absorb the infrared radiation.

The lamps most commonly used for ultraviolet (UV) work are the deuterium-discharge lamp and the mercury-arc lamp. Deuterium provides continuous emission down to 165 nm. Low-pressure mercury lamps emit a sharp-line spectrum, with both UV and visible lines. Medium and high-pressure mercury lamps emit a continuum from UV to the mid visible region. The most important factors for a light source are range, spectral distribution within the range, the source of radiant production, stability of the radiant energy, and temperature.

Monochromators

Isolation of individual wavelengths of light is an important and necessary function of a monochromator. The degree of wavelength isolation is a function of the type of device used and the width of entrance and exit slits. The bandpass of a monochromator defines the range of wavelengths transmitted and is calculated as width at more than half the maximum transmittance (Fig. 5-6).

Numerous devices are used for obtaining monochromatic light. The least expensive are colored-glass filters. These filters usually pass a relatively wide band of radiant energy and have a low transmittance of the selected wavelength. Although not precise, they are simple, inexpensive, and useful.

Interference filters produce monochromatic light based on the principle of constructive interference of waves. Two pieces of glass, each mirrored on one side, are separated by a transparent spacer that is precisely one-half the desired wavelength. Light waves enter one side of the filter and are reflected at the second surface. Wavelengths that are twice the space between the two glass surfaces will reflect back and forth, reinforcing others of the same wavelengths, and finally passing on through. Other wavelengths will cancel out because of phase differences (destructive interference). Because interference filters also transmit multiples of the desired

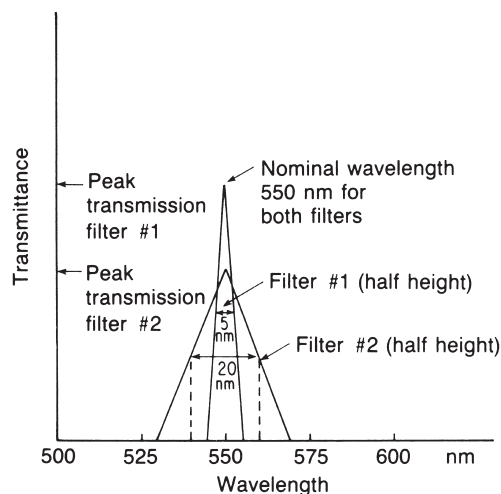

FIGURE 5-6. Spectral transmittance of two monochromators with band pass at half height of 5 nm and 20 nm.

wavelengths, they require accessory filters to eliminate these harmonic wavelengths. Interference filters can be constructed to pass a very narrow range of wavelengths with good efficiency.

The prism is another type of monochromator. A narrow beam of light focused on a prism is refracted as it enters the more dense glass. Short wavelengths are refracted more than long wavelengths, resulting in dispersion of white light into a continuous spectrum. The prism can be rotated, allowing only the desired wavelength to pass through an exit slit.

Diffraction gratings are most commonly used as monochromators. A diffraction grating consists of many parallel grooves (15,000 or 30,000 per inch) etched onto a polished surface. Diffraction, the separation of light into component wavelengths, is based on the principle that wavelengths bend as they pass a sharp corner. The degree of bending depends on the wavelength. As the wavelengths move past the corners, wave fronts are formed. Those that are in phase reinforce one another, whereas those not in phase cancel out and disappear. This results in complete spectra. Gratings with very fine line rulings produce a widely dispersed spectrum. They produce linear spectra, called orders, in both directions from the entrance slit. Because the multiple spectra have a tendency to cause stray light problems, accessory filters are used.

Sample Cell

The next component of the basic spectrophotometer is the sample cell or cuvet, which may be round or square. The light path must be kept constant to have absorbance proportional to concentration. This is easily checked by preparing a colored solution to read midscale when using the wavelength of maximum absorption. Fill each cuvet to be tested, take readings, and save those that match within an acceptable tolerance (e.g., $\pm 0.25\%$ T). Because it is difficult to manufacture round tubes with uniform diameters, they should be etched to indicate the position for use. Cuvets are sold in matched sets. Square cuvetts have plane-parallel optical surfaces and a constant light path. They have an advantage over round cuvetts in that there is less error from the lens effect, orientation in the spectrophotometer, and refraction. Cuvets with scratched optical surfaces scatter light and should be discarded. Inexpensive glass cuvetts can be used for applications in the visible range, but they absorb light in the UV region. Quartz cuvetts must, therefore, be used for applications requiring UV radiation.

Photodetectors

The purpose of the detector is to convert the transmitted radiant energy into an equivalent amount of electrical energy. The least expensive of the devices is known as a barrier-layer cell, or photocell. The photocell is

composed of a film of light-sensitive material, frequently selenium, on a plate of iron. Over the light-sensitive material is a thin, transparent layer of silver. When exposed to light, electrons in the light-sensitive material are excited and released to flow to the highly conductive silver. In comparison with the silver, a moderate resistance opposes the electron flow toward the iron, forming a hypothetical barrier to flow in that direction. Consequently, this cell generates its own electromotive force, which can be measured. The produced current is proportional to incident radiation. Photocells require no external voltage source but rely on internal electron transfer to produce a current in an external circuit. Because of their low internal resistance, the output of electrical energy is not easily amplified. Consequently, this type of detector is used mainly in filter photometers with a wide band-pass, producing a fairly high level of illumination so that there is no need to amplify the signal. The photocell is inexpensive and durable; however, it is temperature sensitive and nonlinear at very low and very high levels of illumination.

A phototube (Fig. 5-7) is similar to a barrier-layer cell in that it has photosensitive material that gives off electrons when light energy strikes it. It differs in that an outside voltage is required for operation. Phototubes contain a negatively charged cathode and a positively charged anode enclosed in a glass case. The cathode is composed of a material (e.g., rubidium or lithium) that acts as a resistor in the dark but emits electrons when exposed to light. The emitted electrons jump over to the positively charged anode, where they are collected and return through an external, measurable circuit. The cathode usually has a large surface area. Varying the cathode material changes the wavelength at which the phototube gives its highest response. The photocurrent is linear, with the intensity of the light striking the cathode as long as voltage between the cathode and anode

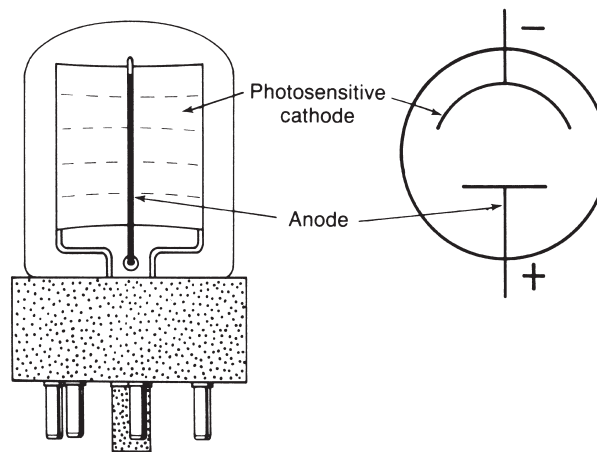

FIGURE 5-7. Phototube drawing and schematic.

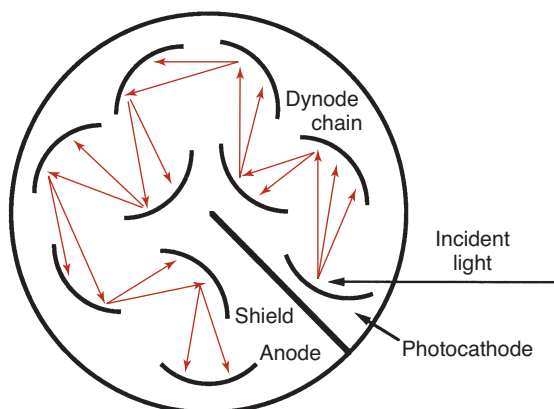

FIGURE 5-8. Dynode chain in a photomultiplier.

remains constant. A vacuum within the tubes avoids scattering of the photoelectrons by collision with gas molecules.

The third major type of light detector is the photomultiplier (PM) tube, which detects and amplifies radiant energy. As shown in Figure 5-8, incident light strikes the coated cathode, emitting electrons. The electrons are attracted to a series of anodes, known as dynodes, each having a successively higher positive voltage. These dynodes are of a material that gives off many secondary electrons when hit by single electrons. Initial electron emission at the cathode triggers a multiple cascade of electrons within the PM tube itself. Because of this amplification, the PM tube is 200 times more sensitive than the phototube. PM tubes are used in instruments designed to be extremely sensitive to very low light levels and light flashes of very short duration. The accumulation of electrons striking the anode produces a current signal, measured in amperes, that is proportional to the initial intensity of the light. The analog signal is converted first to a voltage and then to a digital signal through the use of an analog-to-digital (A/D) converter. Digital signals are processed electronically to produce absorbance readings.

In a photodiode, absorption of radiant energy by a reverse-biased pn-junction diode (*pn*, positive-negative) produces a photocurrent that is proportional to the incident radiant power. Although photodiodes are not as

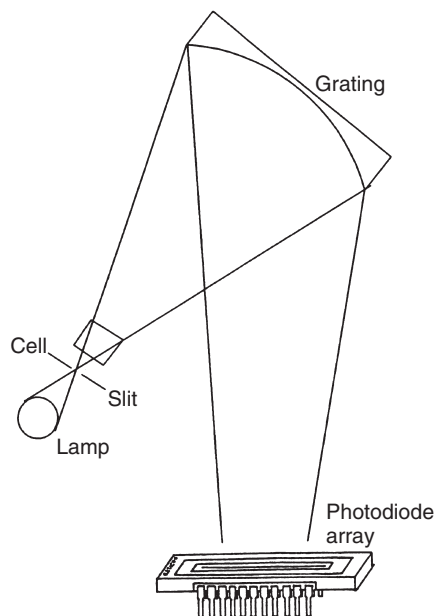

FIGURE 5-9. Photodiode array spectrophotometer illustrating the placement of the sample cuvet before the monochromator.

sensitive as PM tubes because of the lack of internal amplification, their excellent linearity (6–7 decades of radiant power), speed, and small size make them useful in applications where light levels are adequate.⁴ Photodiode array (PDA) detectors are available in integrated circuits containing 256 to 2,048 photodiodes in a linear arrangement. A linear array is shown in Figure 5-9. Each photodiode responds to a specific wavelength, and as a result, a complete UV/visible spectrum can be obtained in less than 1 second. Resolution is 1 to 2 nm and depends on the number of discrete elements. In spectrophotometers using PDA detectors, the grating is positioned after the sample cuvet and disperses the transmitted radiation onto the PDA detector (Fig. 5-9).

For single-beam spectrophotometers, the absorbance reading from the sample must be blanked using an appropriate reference solution that does not contain the compound of interest. Double-beam spectrophotometers permit automatic correction of sample and reference absorbance, as shown in Figure 5-10. Because the

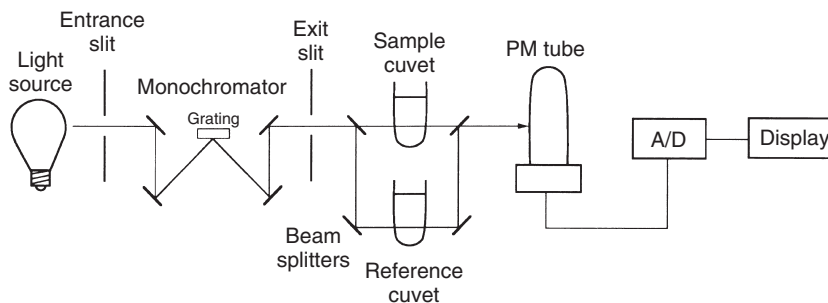

FIGURE 5-10. Double-beam spectrophotometer.

intensities of light sources vary as a function of wavelength, double-beam spectrophotometers are necessary when the absorption spectrum for a sample is to be obtained. Computerized, continuous zeroing, single-beam spectrophotometers have replaced most double-beam spectrophotometers.

Spectrophotometer Quality Assurance

Performing at least the following checks should validate instrument function: wavelength accuracy, stray light, and linearity. Wavelength accuracy means that the wavelength indicated on the control dial is the actual wavelength of light passed by the monochromator. It is most commonly checked using standard absorbing solutions or filters with absorbance maxima of known wavelength. Didymium or holmium oxide in glass is stable and frequently used as filters. The filter is placed in the light path and the wavelength control is set at the wavelength at which maximal absorbance is expected. The wavelength control is then rotated in either direction to locate the actual wavelength that has maximal absorbance. If these two wavelengths do not match, the optics must be adjusted to calibrate the monochromator correctly.

Some instruments with narrow bandpass use a mercury-vapor lamp to verify wavelength accuracy. The mercury lamp is substituted for the usual light source, and the spectrum is scanned to locate mercury emission lines. The wavelength indicated on the control is compared with known mercury emission peaks to determine the accuracy of the wavelength indicator control.

Stray light refers to any wavelengths outside the band transmitted by the monochromator. The most common causes of stray light are reflection of light from scratches on optical surfaces or from dust particles anywhere in the

light path and higher-order spectra produced by diffraction gratings. The major effect is absorbance error, especially in the high-absorbance range. Stray light is detected by using cutoff filters, which eliminate all radiation at wavelengths beyond the one of interest. To check for stray light in the near-UV region, for example, insert a filter that does not transmit in the region of 200 nm to 400 nm. If the instrument reading is greater than 0% T, stray light is present. Certain liquids, such as NiSO_4 , NaNO_2 , and acetone, absorb strongly at short wavelengths and can be used in the same way to detect stray light in the UV range.

Linearity is demonstrated when a change in concentration results in a straight-line calibration curve, as discussed under Beer's law. Colored solutions may be carefully diluted and used to check linearity, using the wavelength of maximal absorbance for that color. Sealed sets of different colors and concentrations are available commercially. They should be labeled with expected absorbance for a given bandpass instrument. Less than expected absorbance is an indication of stray light or of a bandpass that is wider than specified. Sets of neutral-density filters to check linearity over a range of wavelengths are also commercially available.

A routine system should be devised for each instrument to check and record each parameter. The probable cause of a problem and the maintenance required to eliminate it are generally described in the instrument's manual.

Atomic Absorption Spectrophotometer

The atomic absorption spectrophotometer is used to measure concentration by detecting absorption of electromagnetic radiation by atoms rather than by molecules. The basic components are shown in Figure 5-11. The

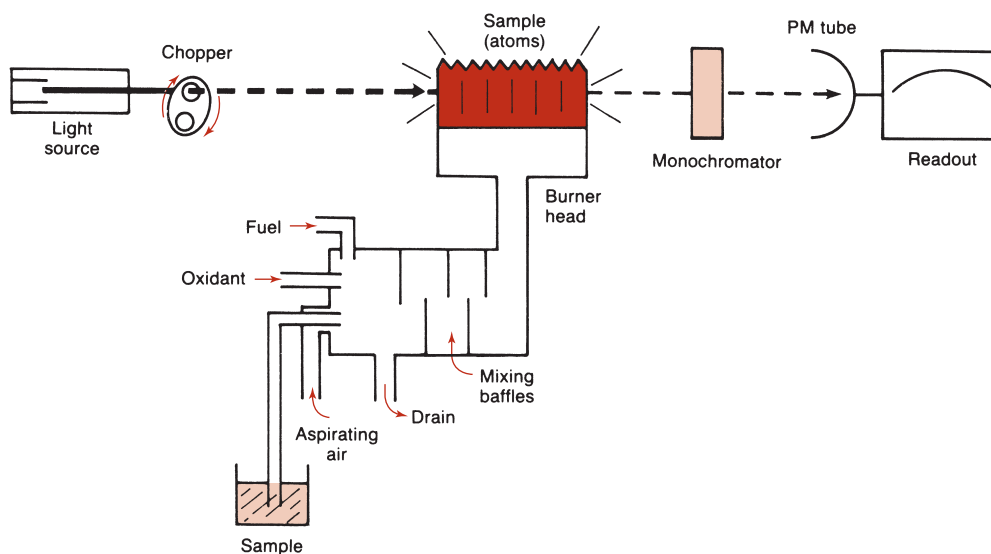

FIGURE 5-11. Single-beam atomic absorption spectrophotometer—basic components.

usual light source, known as a hollow-cathode lamp, consists of an evacuated gas-tight chamber containing an anode, a cylindrical cathode, and an inert gas, such as helium or argon. When voltage is applied, the filler gas is ionized. Ions attracted to the cathode collide with the metal, knock atoms off, and cause the metal atoms to be excited. When they return to the ground state, light energy is emitted that is characteristic of the metal in the cathode. Generally, a separate lamp is required for each metal (e.g., a copper hollow-cathode lamp is used to measure Cu).

Electrodeless discharge lamps are a relatively new light source for atomic absorption spectrophotometers. A bulb is filled with argon and the element to be tested. A radiofrequency generator around the bulb supplies the energy to excite the element, causing a characteristic emission spectrum of the element.

The analyzed sample must contain the reduced metal in the atomic vaporized state. Commonly, this is done by using the heat of a flame to break the chemical bonds and form free, unexcited atoms. The flame is the sample cell in this instrument, rather than a cuvet. There are various designs; however, the most common burner is the premix long-path burner. The sample, in solution, is aspirated as a spray into a chamber, where it is mixed with air and fuel. This mixture passes through baffles, where large drops fall and are drained off. Only fine droplets reach the flame. The burner is a long, narrow slit, to permit a longer path length for absorption of incident radiation. Light from the hollow-cathode lamp passes through the sample of ground-state atoms in the flame. The amount of light absorbed is proportional to the concentration. When a ground-state atom absorbs light energy, an excited atom is produced. The excited atom then returns to the ground state, emitting light of the same energy as it absorbed. The flame sample thus contains a dynamic population of ground-state and excited atoms, both absorbing and emitting radiant energy. The emitted energy from the flame will go in all directions, and it will be a steady emission. Because the purpose of the instrument is to measure the amount of light absorbed, the light detector must be able to distinguish between the light beam emitted by the hollow-cathode lamp and that emitted by excited atoms in the flame. To do this, the hollow-cathode light beam is modulated by inserting a mechanical rotating chopper between the light and the flame or by pulsing the electric supply to the lamp. Because the light beam being absorbed enters the sample in pulses, the transmitted light also will be in pulses. There will be less light in the transmitted pulses because part of it will be absorbed. There are, therefore, two light signals from the flame—an alternating signal from the hollow-cathode lamp and a direct signal from the flame emission. The

measuring circuit is tuned to the modulated frequency. Interference from the constant flame emission is electronically eliminated by accepting only the pulsed signal from the hollow cathode.

The monochromator is used to isolate the desired emission line from other lamp emission lines. In addition, it serves to protect the photodetector from excessive light emanating from flame emissions. A PM tube is the usual light detector.

Flameless atomic absorption requires an instrument modification that uses an electric furnace to break chemical bonds (electrothermal atomization). A tiny graphite cylinder holds the sample, either liquid or solid. An electric current passes through the cylinder walls, evaporates the solvent, ashes the sample and, finally, heats the unit to incandescence to atomize the sample. This instrument, like the spectrophotometer, is used to determine the amount of light absorbed. Again, Beer's law is used for calculating concentration. A major problem is that background correction is considerably more necessary and critical for electrothermal techniques than for flame-based atomic absorption methods. Currently, the most common approach uses a deuterium lamp as a secondary source and measures the difference between the two absorbance signals. However, there has also been extensive development of background correction techniques based on the Zeeman effect.¹ The presence of an intense static magnetic field will cause the wavelength of the emitted radiation to split into several components. This shift in wavelength is the Zeeman effect.

Atomic absorption spectrophotometry is sensitive and precise. It is routinely used to measure concentration of trace metals that are not easily excited. It is generally more sensitive than flame emission because the vast majority of atoms produced in the usual propane or air-acetylene flame remain in the ground state available for light absorption. It is accurate, precise, and specific. One disadvantage, however, is the inability of the flame to dissociate samples into free atoms. For example, phosphate may interfere with calcium analysis by formation of calcium phosphate. This may be overcome by adding cations that compete with calcium for phosphate. Routinely, lanthanum or strontium is added to samples to form stable complexes with phosphate. Another possible problem is the ionization of atoms following dissociation by the flame, which can be decreased by reducing the flame temperature. Matrix interference, due to the enhancement of light absorption by atoms in organic solvents or formation of solid droplets as the solvent evaporates in the flame, can be another source of error. This interference may be overcome by pretreatment of the sample by extraction.⁵

Recently, inductively coupled plasma (ICP) has been used to increase sensitivity for atomic emission. The

torch, an argon plasma maintained by the interaction of a radiofrequency field and an ionized argon gas, is reported to have used temperatures between 5,500 K and 8,000 K. Complete atomization of elements is thought to occur at these temperatures. Use of inductively coupled plasma as a source is recommended for determinations involving refractory elements such as uranium, zirconium, and boron. ICP with MS detection is the most sensitive and specific assay technique for all elements on the periodic chart. Atomic absorption spectrophotometry is used less frequently because of this newer technology.

Flame Photometry

The flame-emission photometer, which measures light emitted by excited atoms, was widely used to determine concentration of Na^+ , K^+ , or Li^+ . With the development of ion selective electrodes for these analytes, flame photometers are no longer routinely used in clinical chemistry laboratories. Discussion of this technique, therefore, is no longer included in this edition; the reader should refer to previous editions of this book.

Fluorometry

As seen with the spectrophotometer, light entering a solution may pass mainly on through or may be absorbed partly or entirely, depending on the concentration and the wavelength entering that particular solution. Whenever absorption occurs, there is a transfer of energy to the medium. Each molecular type possesses a series of electronic energy levels and can pass from a lower energy level to a higher level only by absorbing an integral unit (quantum) of light that is equal in energy to the difference between the two energy states. There are additional energy levels owing to rotation or vibration of molecular parts. The excited state lasts about 10^{-5} seconds before the electron loses energy and returns to the ground state. Energy is lost by collision, heat loss, transfer to other molecules, and emission of radiant energy. Because the molecules are excited by absorption of radiant energy and lose energy by multiple interactions, the radiant energy emitted is less than the absorbed energy. The difference between the maximum wavelengths, excitation, and emitted fluorescence is called Stokes shift. Both excitation (absorption) and fluorescence (emission) energies are characteristic for a given molecular type; for example, Figure 5-12 shows the absorption and fluorescence spectra of quinine in 0.1 N sulfuric acid. The dashed line on the left shows the short-wavelength excitation energy that is maximally absorbed, whereas the solid line on the right is the longer-wavelength (less energy) fluorescent spectrum.

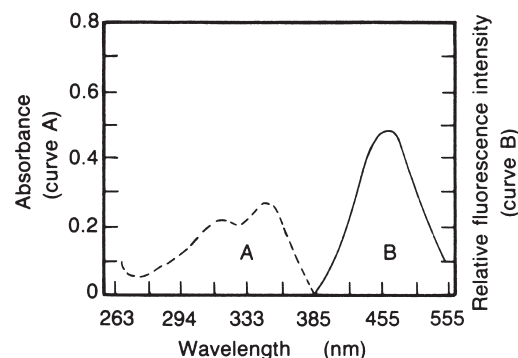

FIGURE 5-12. Absorption and fluorescence spectra of quinine in 0.1 N sulfuric acid. (Reprinted with permission from Coiner D. Basic concepts in laboratory instrumentation. Bethesda, Md.: ASMT Education and Research Fund, 1975–1979.)

Basic Instrumentation

Filter fluorimeters measure the concentrations of solutions that contain fluorescing molecules. A basic instrument is shown in Figure 5-13. The source emits short-wavelength high-energy excitation light. A mechanical attenuator controls light intensity. The primary filter, placed between the radiation source and the sample, selects the wavelength that is best absorbed by the solution to be measured. The fluorescing sample in the cuvet emits radiant energy in all directions. The detector (placed at right angles to the sample cell) and a secondary filter that passes the longer wavelengths of fluorescent light prevent incident light from striking the photodetector. The electrical output of the photodetector is proportional to the intensity of fluorescent energy. In spectrofluorimeters, the filters are replaced by prism or grating monochromators.

Gas-discharge lamps (mercury and xenon-arc) are the most frequently used sources of excitation radiant energy. Incandescent tungsten lamps are seldom used because they release little energy in the UV region. Mercury-vapor lamps are commonly used in filter fluorimeters. Mercury emits a characteristic line spectrum. Resonance lines at 365 nm to 366 nm are commonly used. Energy at wavelengths other than the resonance lines is provided by coating the inner surface of the lamp with a material that absorbs the 254-nm mercury radiation and emits a broad band of longer wavelengths. Most spectrofluorimeters use a high-pressure xenon lamp. Xenon has a good continuum, which is necessary for determining excitation spectra.

Monochromator fluorimeters use grating, prisms, or filters for isolation of incident radiation. Light detectors are almost exclusively PM tubes because of their higher sensitivity to low light intensities. Double-beam instruments are used to compensate for instability due to electric-power fluctuation.

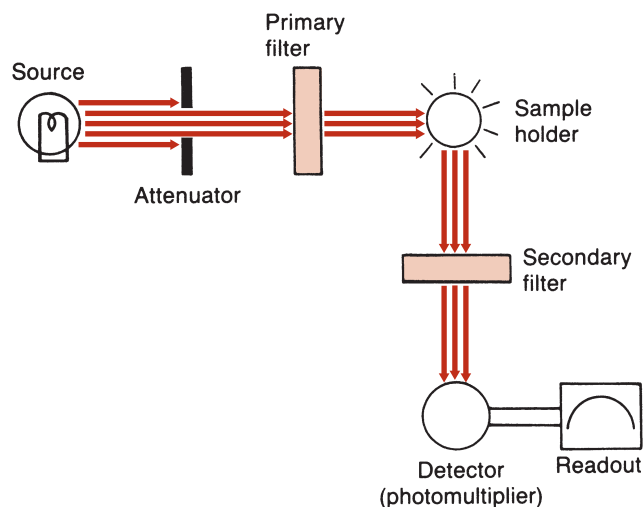

FIGURE 5-13. Basic filter fluorometer. (Reprinted with permission from Coiner D. Basic concepts in laboratory instrumentation. Bethesda, Md.: ASMT Education and Research Fund, 1975–1979.)

Fluorescence concentration measurements are related to molar absorptivity of the compound, intensity of the incident radiation, quantum efficiency of the energy emitted per quantum absorbed, and length of the light path. In dilute solutions with instrument parameters held constant, fluorescence is directly proportional to concentration. Generally, a linear response will be obtained until the concentration of the fluorescent species is so high that the sample begins to absorb significant amounts of excitation light. A curve demonstrating non-linearity as concentration increases is shown in Figure 5-14. The solution must absorb less than 5% of the exciting radiation for a linear response to occur.⁶ As with all quantitative measurements, a standard curve must be

prepared to demonstrate that the concentration used falls in a linear range.

In fluorescence polarization, radiant energy is polarized in a single plane. When the sample (fluorophor) is excited, it emits polarized light along the same plane as the incident light if the fluorophor is attached to a large molecule. In contrast, a small molecule emits depolarized light because it will rotate out of the plane of polarization during its excitation lifetime. This technique is widely used for the detection of therapeutic and abused drugs. In the procedure, the sample analyte is allowed to compete with a fluorophor-labeled analyte for a limited antibody to the analyte. The lower the concentration of the sample analyte, the higher is the macromolecular

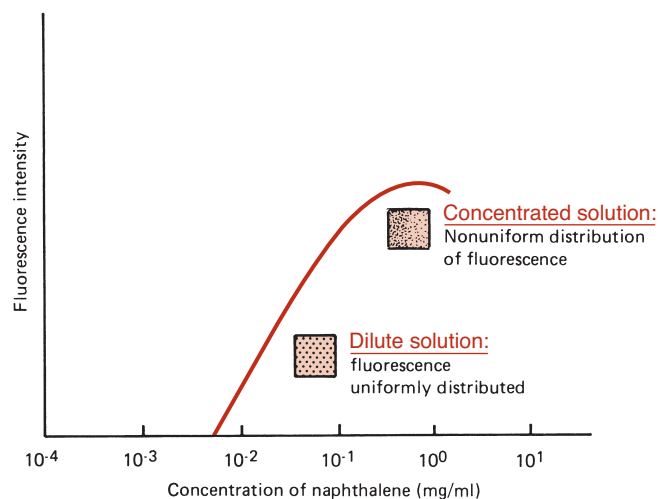

FIGURE 5-14. Dependence of fluorescence on the concentration of fluorophor. (Reprinted with permission from Guilbault GG. Practical fluorescence, theory, methods and techniques. New York, N.Y.: Marcel Dekker, 1973.)

antibody-analyte-fluorophor formed and the lower is the depolarization of the radiant light.

Advantages and Disadvantages of Fluorometry

Fluorometry has two advantages over conventional spectrophotometry: specificity and sensitivity. Fluorometry increases specificity by selecting the optimal wavelength for both absorption and fluorescence, rather than just the absorption wavelength seen with spectrophotometry.

Fluorometry is approximately 1,000 times more sensitive than most spectrophotometric methods.⁶ One reason is because emitted radiation is measured directly; it can be increased simply by increasing the intensity of the exciting radiant energy. In addition, fluorescence measures the amount of light intensity present over a zero background. In absorbance, however, the quantity of absorbed light is measured indirectly as the difference between the transmitted beams. At low concentrations, the small difference between 100% T and the transmitted beam is difficult to measure accurately and precisely, limiting the sensitivity.

The biggest disadvantage is that fluorescence is very sensitive to environmental changes. Changes in pH affect availability of electrons, and temperature changes the probability of loss of energy by collision rather than fluorescence. Contaminating chemicals or a change of solvents may change the structure. UV light used for excitation can cause photochemical changes. Any decrease in fluorescence resulting from any of these possibilities is known as quenching. Because so many factors may change the intensity or spectra of fluorescence, extreme care is mandatory in analytic technique and instrument maintenance.

Chemiluminescence

In chemiluminescence reactions, part of the chemical energy generated produces excited intermediates that decay to a ground state with the emission of photons.⁷ The emitted radiation is measured with a PM tube, and the signal is related to analyte concentration. Chemiluminescence is different than fluorescence in that no excitation radiation is required and no monochromators are needed because the chemiluminescence arises from one species. Most important, chemiluminescence reactions are oxidation reactions of luminol, acridinium esters, and dioxetanes characterized by a rapid increase in intensity of emitted light followed by a gradual decay. Usually, the signal is taken as the integral of the entire peak. Enhanced chemiluminescence techniques increase the chemiluminescence efficiency by including an enhancer system in the reaction of a chemiluminescent agent with an enzyme. The time course for the light intensity is much longer (60 minutes) than that for conventional chemiluminescent reactions, which last for about 30 seconds (Fig. 5-15).

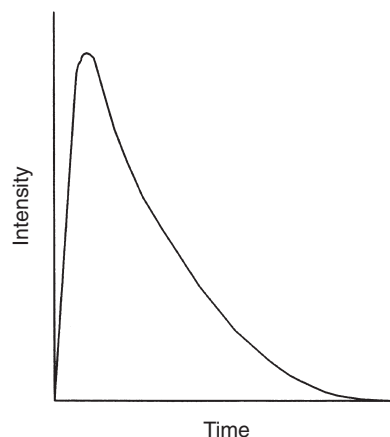

FIGURE 5-15. Representative intensity-versus-time curve for a transient chemiluminescence signal.

Advantages of chemiluminescence assays include subpicomolar detection limits, speed (with flash-type reactions, light is only measured for 10 seconds), ease of use (most assays are one-step procedures), and simple instrumentation.⁷ The main disadvantage is that impurities can cause a background signal that degrades sensitivity and specificity.

Turbidity and Nephelometry

Turbidimetric measurements are made with a spectrophotometer to determine concentration of particulate matter in a sample. The amount of light blocked by a suspension of particles depends not only on concentration but also on size. Because particles tend to aggregate and settle out of suspension, sample handling becomes critical. Instrument operation is the same as for any spectrophotometer.

Nephelometry is similar, except that light scattered by the small particles is measured at an angle to the beam incident on the cuvet. Figure 5-16 demonstrates two possible optical arrangements for a nephelometer. Light scattering depends on wavelength and particle size. For macromolecules with a size close to or larger than the

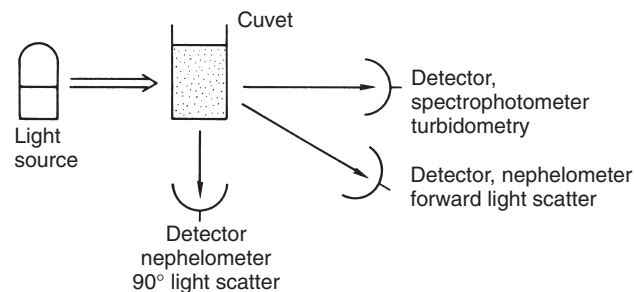

FIGURE 5-16. Nephelometer versus spectrophotometer—optical arrangements.

wavelength of incident light, sensitivity is increased by measuring forward light scatter.⁸ Instruments are available with detectors placed at various forward angles, as well as at 90 degrees to the incident light. Monochromatic light obtains uniform scatter and minimizes sample heating. Certain instruments use lasers as a source of monochromatic light; however, any monochromator may be used.

Measuring light scatter at an angle other than at 180 degrees in turbidimetry minimizes error from colored solutions and increases sensitivity. Because both methods depend on particle size, some instruments quantitate initial change in light scatter rather than total scatter. Reagents must be free of any particles, and cuvetts must be free of any scratches.

Laser Applications

Light amplification by stimulated emission of radiation (LASER) is based on the interaction of radiant energy and suitably excited atoms or molecules. The interaction leads to stimulated emission of radiation. The wavelength, direction of propagation, phase, and plane of polarization of the emitted light are the same as those of the incident radiation. Laser light is polarized and coherent and has narrow spectral width and small cross-sectional area with low divergence. The radiant emission can be very powerful and either continuous or pulsating.

Laser light can serve as the source of incident energy in a spectrometer or nephelometer. Some lasers produce bandwidths of a few kilohertz in both the visible and infrared regions, making these applications about three to six orders more sensitive than conventional spectrometers.⁹

Laser spectrometry also can be used for the determination of structure and identification of samples, as well as for diagnosis. Quantitation of samples depends on the spectrometer used. An example of the clinical application of the laser is the Coulter counter, which is used for differential analysis of white blood cells.¹⁰

ELECTROCHEMISTRY

Many types of electrochemical analyses are used in the clinical laboratory, including potentiometry, amperometry, coulometry, and polarography. The two basic electrochemical cells involved in these analyses are galvanic and electrolytic cells.

Galvanic and Electrolytic Cells

An electrochemical cell can be set up as shown in Figure 5-17. It consists of two half-cells and a salt bridge, which can be a piece of filter paper saturated with electrolytes. Instead of two as shown, the electrodes can be immersed in a single, large beaker containing a salt solution. In such a setup, the solution serves as the salt bridge.

In a galvanic cell, as the electrodes are connected, there is spontaneous flow of electrons from the electrode with the lower electron affinity (oxidation; e.g., silver). These electrons pass through the external meter to the cathode (reduction), where OH^- ions are liberated. This reaction continues until one of the chemical components is depleted, at which point, the cell is "dead" and cannot produce electrical energy to the external meter.

Current may be forced to flow through the dead cell only by applying an external electromotive force E . This is called an electrolytic cell. In short, a galvanic cell can be built from an electrolytic cell. When the external E is turned off, accumulated products at the electrodes will spontaneously produce current in the opposite direction of the electrolytic cell.

Half-Cells

It is impossible to measure the electrochemical activity of one half-cell; two reactions must be coupled and one reaction compared with the other. To rate half-cell reactions, a specific electrode reaction is arbitrarily assigned 0.00 V. Every other reaction coupled with this arbitrary zero reaction is either positive or negative, depending on the relative affinity for electrons. The electrode defined as 0.00 V is the standard hydrogen electrode: H_2

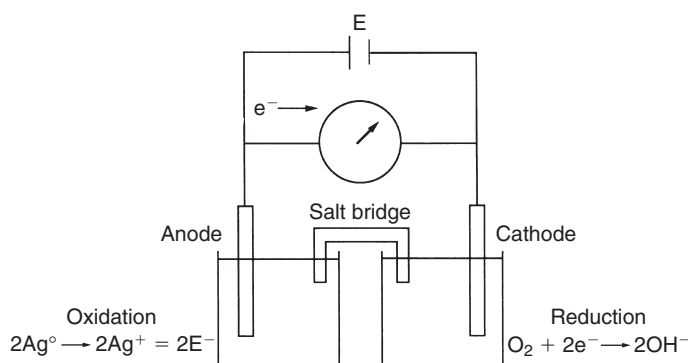

FIGURE 5-17. Electrochemical cell.

TABLE 5-1 STANDARD REDUCTION POTENTIALS

| | POTENTIAL, V |
|---|--------------|
| $\text{Zn}^{2+} + 2e \leftrightarrow \text{Z}$ | -0.7628 |
| $\text{Cr}^{2+} + 2e \leftrightarrow \text{Cr}$ | -0.913 |
| $\text{Ni}^{2+} + 2e \leftrightarrow \text{Ni}$ | -0.257 |
| $2\text{H}^+ + 2e \leftrightarrow \text{H}_2$ | 0.000 |
| $\text{Cu}^{2+} + 2e \leftrightarrow \text{Cu}$ | 0.3419 |
| $\text{Ag}^+ + e \leftrightarrow \text{Ag}$ | 0.7996 |

Data presented are examples from Lide DR. CRC handbook of chemistry and physics. 83rd ed. Boca Raton, Fla.: CRC Press, 2003–2004.

gas at 1 atmosphere (atm). The hydrogen gas in contact with H^+ in solution develops a potential. The hydrogen electrode coupled with a zinc half-cell is cathodic, with the reaction $2\text{H}^+ + 2e^- \rightarrow \text{H}_2$, because H_2 has a greater affinity than Zn for electrons. Cu, however, has a greater affinity than H_2 for electrons, and thus the anodic reaction $\text{H}_2 \rightarrow 2\text{H}^+ + 2e^-$ occurs when coupled to the Cu-electrode half-cell.

The potential generated by the hydrogen-gas electrode is used to rate the electrode potential of metals in 1 mol/L solution. Reduction potentials for certain metals are shown in Table 5-1.¹¹ A hydrogen electrode is used to determine the accuracy of reference and indicator electrodes, the stability of standard solutions, and the potentials of liquid junctions.

Ion-Selective Electrodes

Potentiometric methods of analysis involve the direct measurement of electrical potential due to the activity of free ions. Ion-selective electrodes (ISEs) are designed to be sensitive toward individual ions.

pH Electrodes

An ISE universally used in the clinical laboratory is the pH electrode. The basic components of a pH meter are presented in Figure 5-18.

Indicator Electrode

The pH electrode consists of a silver wire coated with AgCl, immersed into an internal solution of 0.1 mmol/L HCl, and placed into a tube containing a special glass membrane tip. This membrane is only sensitive to hydrogen ions (H^+). Glass membranes that are selectively sensitive to H^+ consist of specific quantities of lithium, cesium, lanthanum, barium, or aluminum oxides in silicate. When the pH electrode is placed into the test solution, movement of H^+ near the tip of the electrode produces a potential difference between the internal solution and the test solution, which is measured as pH and read by a voltmeter. The combination pH electrode

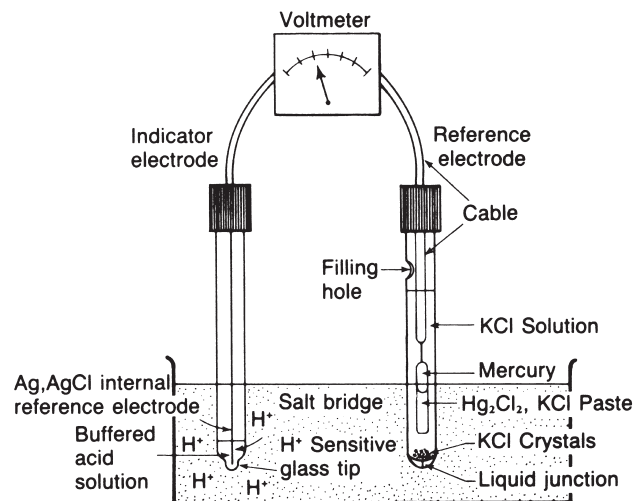

FIGURE 5-18. Necessary components of a pH meter.

also contains a built-in reference electrode, either Ag/AgCl or calomel ($\text{Hg}/\text{Hg}_2\text{Cl}_2$) immersed in a solution of saturated KCl.

The specially formulated glass continually dissolves from the surface. The present concept of the selective mechanism that causes formation of electromotive force at the glass surface is that an ion-exchange process is involved. Cationic exchange occurs only in the gel layer—there is no penetration of H^+ through the glass. Although the glass is constantly dissolving, the process is slow, and the glass tip generally lasts for several years. pH electrodes are highly selective for H^+ ; however, other cations in high concentration interfere, the most common of which is sodium. Electrode manufacturers should list the concentration of interfering cations that may cause error in pH determinations.

Reference Electrode

The reference electrode commonly used is the calomel electrode. Calomel, a paste of predominantly mercurous chloride, is in direct contact with metallic mercury in an electrolyte solution of potassium chloride. As long as the electrolyte concentration and the temperature remain constant, a stable voltage is generated at the interface of the mercury and its salt. A cable connected to the mercury leads to the voltmeter. The filling hole is needed for adding potassium chloride solution. A tiny opening at the bottom is required for completion of electric contact between the reference and indicator electrodes. The liquid junction consists of a fiber or ceramic plug that allows a small flow of electrolyte filling solution.

Construction varies, but all reference electrodes must generate a stable electrical potential. Reference electrodes generally consist of a metal and its salt in contact with a solution containing the same anion. Mercury/mercurous chloride, as in this example, is a frequently used

reference electrode; the disadvantage is that it is slow to reach a new stable voltage following temperature change and it is unstable above 80°C.^{1,2} Ag/AgCl is another common reference electrode. It can be used at high temperatures, up to 275°C, and the AgCl-coated Ag wire makes a more compact electrode than that of mercury. In measurements in which chloride contamination must be avoided, a mercury sulfate and potassium sulfate reference electrode may be used.

Liquid Junctions

Electrical connection between the indicator and reference electrodes is achieved by allowing a slow flow of electrolyte from the tip of the reference electrode. A junction potential is always set up at the boundary between two dissimilar solutions because of positive and negative ions diffusing across the boundary at unequal rates. The resultant junction potential may increase or decrease the potential of the reference electrode. Therefore, it is important that the junction potential be kept to a minimum reproducible value when the reference electrode is in solution.

KCl is a commonly used filling solution because K⁺ and Cl⁻ have nearly the same mobilities. When KCl is used as the filling solution for Ag/AgCl electrodes, the addition of AgCl is required to prevent dissolution of the AgCl salt. One way of producing a lower junction potential is to mix K⁺, Na⁺, NO₃⁻, and Cl⁻ in appropriate ratios.

Readout Meter

Electromotive force produced by the reference and indicator electrodes is in the millivolt range. Zero potential for the cell indicates that each electrode half-cell is generating the same voltage, assuming there is no liquid junction potential. The isopotential is that potential at which a temperature change has no effect on the response of the electrical cell. Manufacturers generally achieve this by making midscale (pH 7.0) correspond to 0 V at all temperatures. They use an internal buffer whose pH changes due to temperature compensate for the changes in the internal and external reference electrodes.

Nernst Equation

The electromotive force generated because of H⁺ at the glass tip is described by the Nernst equation, which is shown in a simplified form:

$$\varepsilon = \Delta\text{pH} \times \frac{RT \ln 10}{F} = \Delta\text{pH} \times 0.059 \text{ V} \quad (\text{Eq. 5-6})$$

where ε is the electromotive force of the cell, F is the Faraday constant (96,500 C/mol), R is the molar gas constant, and T is temperature, in Kelvin.

As the temperature increases, H⁺ activity increases and the potential generated increases. Most pH meters have a temperature-compensation knob that amplifies the millivolt response when the meter is on pH function. pH units on the meter scale are usually printed for use at room temperature. On the voltmeter, 59.16 is read as 1 pH unit change. The temperature compensation changes millivolt response to compensate for changes due to temperature from 54.2 at 0°C to 66.10 at 60°C. However, most pH meters are manufactured for greatest accuracy in the 10°C to 60°C range.

Calibration

The steps necessary to standardize a pH meter are fairly straightforward. First, balance the system with the electrodes in a buffer with a 7.0 pH. The balance or intercept control shifts the entire slope, as shown in Figure 5-19. Next, replace the buffer with one of a different pH. If the meter does not register the correct pH, amplification of the response changes the slope to match that predicted by the Nernst equation. If the instrument does not have a slope control, the temperature compensator performs the same function.

pH Combination Electrode

The most commonly used pH electrode has both the indicator and reference electrodes combined in one small probe, which is convenient when small samples are tested. It consists of an Ag/AgCl internal reference electrode sealed in a narrow glass cylinder with a pH-sensitive glass tip. The reference electrode is an Ag/AgCl wire

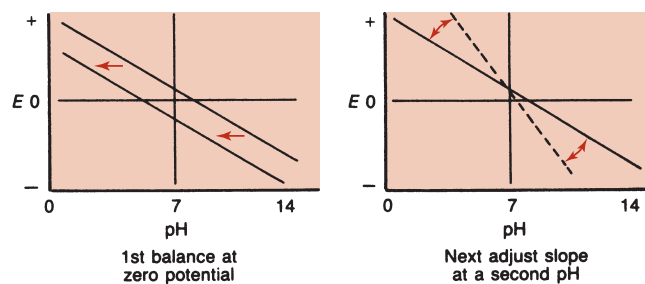

FIGURE 5-19. pH meter calibration. (Reprinted with permission from Willard HH, Merritt LL, Dean JA, Settle FA. Instrumental methods of analysis. Belmont, Calif.: Wadsworth, 1981.)

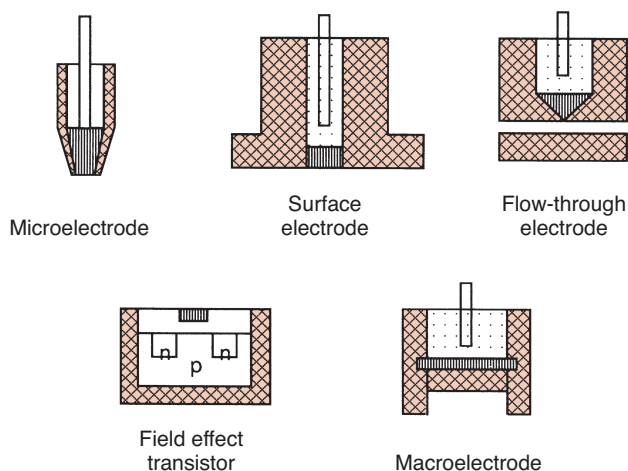

FIGURE 5-20. Other examples of ion-selective electrodes.

wrapped around the indicator electrode. The outer glass envelope is filled with KCl and has a tiny pore near the tip of the liquid junction. The solution to be measured must completely cover the glass tip. Examples of other ISEs are shown in Figure 5-20. The reference electrode, electrometer, and calibration system described for pH measurements are applicable to all ISEs.

There are three major ISE types: inert-metal electrodes in contact with a redox couple, metal electrodes that participate in a redox reaction, and membrane electrodes. The membrane can be solid material (e.g., glass), liquid (e.g., ion-exchange electrodes), or special membrane (e.g., compound electrodes), such as gas-sensing and enzyme electrodes.

The standard hydrogen electrode is an example of an inert-metal electrode. The Ag/AgCl electrode is an example of the second type. The electrode process $\text{AgCl} + e^- \rightarrow \text{Ag}^+ + \text{Cl}^-$ produces an electrical potential proportional to chloride ion (Cl^-) activity. When Cl^- is held constant, the electrode is used as a reference electrode. The electrode in contact with varying Cl^- concentrations is used as an indicator electrode to measure Cl^- concentration.

The H^+ -sensitive gel layer of the glass pH electrode is considered a membrane. A change in the glass formulation makes the membrane more sensitive to sodium ions (Na^+) than to H^+ , creating a sodium ISE. Other solid-state membranes consist of either a single crystal or fine crystals immobilized in an inert matrix such as silicone rubber. Conduction depends on a vacancy defect mechanism, and the crystals are formulated to be selective for a particular size, shape, and charge—for example, F^- -selective electrodes of LaF, Cl^- -sensitive electrodes with AgCl crystals, and AgBr electrodes for the detection of Br^- .

The calcium ISE is a liquid-membrane electrode. An ion-selective carrier, such as dioctylphenyl phosphate dissolved in an inert water-insoluble solvent, diffuses

through a porous membrane. Because the solvent is insoluble in water, the test sample cannot cross the membrane, but calcium ions (Ca^{2+}) are exchanged. The Ag/AgCl internal reference in a filling solution of CaCl_2 is in contact with the carrier by means of the membrane.

Potassium-selective liquid membranes use the antibiotic valinomycin as the ion-selective carrier. Valinomycin membranes show great selectivity for K^+ . Liquid-membrane electrodes are recharged every few months to replace the liquid ion exchanger and the porous membrane.

Gas-Sensing Electrodes

Gas electrodes are similar to pH glass electrodes but are designed to detect specific gases (e.g., CO_2 and NH_3) in solutions and are usually separated from the solution by a thin, gas-permeable hydrophobic membrane. Figure 5-21 shows a schematic illustration of the pCO_2 electrode. The membrane in contact with the solution is permeable only to CO_2 , which diffuses into a thin film of sodium bicarbonate solution. The pH of the bicarbonate solution is changed as follows:



The change in pH of the HCO_3^- is detected by a pH electrode. The pCO_2 electrode is widely used in clinical laboratories as a component of instruments for measuring serum electrolytes and blood gases.

In the NH_3 gas electrode, the bicarbonate solution is replaced by ammonium chloride solution, and the membrane is permeable only to NH_3 gas. As in the pCO_2 electrode, NH_3 changes the pH of NH_4Cl as follows:

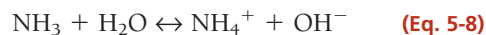

The amount of OH^- produced varies linearly with the log of the partial pressure of NH_3 in the sample.

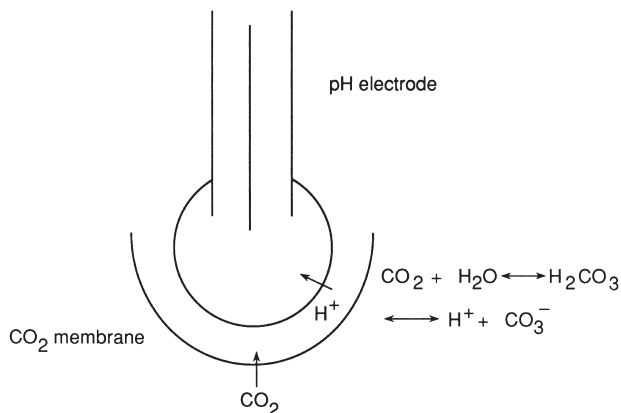
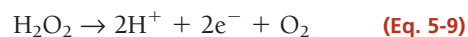

FIGURE 5-21. The pCO_2 electrode.

Other gas-sensing electrodes function on the basis of an amperometric principle—that is, measurement of the current flowing through an electrochemical cell at a constant applied electrical potential to the electrodes. Examples are the determination of pO_2 , glucose, and peroxidase.

The chemical reactions of the pO_2 electrode (Clark electrode), an electrochemical cell with a platinum cathode and an Ag/AgCl anode, are illustrated in Figure 5-17. The electrical potential at the cathode is set to -0.65 V and will not conduct current without oxygen in the sample. The membrane is permeable to oxygen, which diffuses through to the platinum cathode. Current passes through the cell and is proportional to the pO_2 in the test sample.

Glucose determination is based on the reduction in pO_2 during glucose oxidase reaction with glucose and oxygen. Unlike the pCO_2 electrode, the peroxidase electrode has a polarized platinum anode and its potential is set to $+0.6$ V. Current flows through the system when peroxide is oxidized at the anode as follows:



Enzyme Electrodes

The various ISEs may be covered by immobilized enzymes that can catalyze a specific chemical reaction. Selection of the ISE is determined by the reaction product of the immobilized enzyme. Examples include urease, which is used for the detection of urea, and glucose oxidase, which is used for glucose detection. A urea electrode must have an ISE that is selective for NH_4^+ or NH_3 , whereas glucose oxidase is used in combination with a pH electrode.

Coulometric Chloridometers and Anodic Stripping Voltammetry

Chloride ISEs have largely replaced coulometric titrations for determination of chloride in body fluids. Anodic stripping voltammetry was widely used for analysis of lead and is best measured by electrothermal (graphite furnace) atomic absorption spectroscopy or, preferably, ICP-MS.

ELECTROPHORESIS

Electrophoresis is the migration of charged solutes or particles in an electrical field. Iontophoresis refers to the migration of small ions, whereas zone electrophoresis is the migration of charged macromolecules in a porous support medium such as paper, cellulose acetate, or agarose gel film. An electrophoretogram is the result of zone electrophoresis and consists of sharply separated zones of a macromolecule. In a clinical laboratory, the

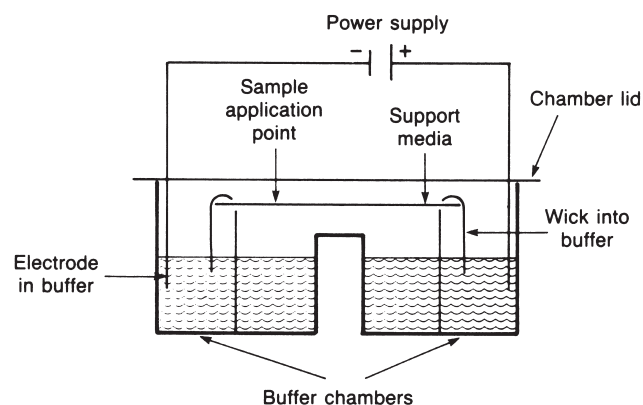

FIGURE 5-22. Electrophoresis apparatus—basic components.

macromolecules of interest are proteins in serum, urine, cerebrospinal fluid (CSF), and other biologic body fluids and erythrocytes and tissue.

Electrophoresis consists of five components: the driving force (electrical power), the support medium, the buffer, the sample, and the detecting system. A typical electrophoretic apparatus is illustrated in Figure 5-22.

Charged particles migrate toward the opposite charged electrode. The velocity of migration is controlled by the net charge of the particle, the size and shape of the particle, the strength of the electric field, chemical and physical properties of the supporting medium, and the electrophoretic temperature. The rate of mobility¹² of the molecule (μ) is given by

$$\mu = \frac{Q}{K} \leftrightarrow r \leftrightarrow n \quad (\text{Eq. 5-10})$$

where Q is net charge of particle, k is constant, r is ionic radius of the particle, and n is viscosity of the buffer.

From the equation, the rate of migration is directly proportional to the net charge of the particle and inversely proportional to its size and the viscosity of the buffer.

Procedure

The sample is soaked in hydrated support for approximately 5 minutes. The support is put into the electrophoresis chamber, which was previously filled with the buffer. Sufficient buffer must be added to the chamber to maintain contact with the support. Electrophoresis is carried out by applying a constant voltage or constant current for a specific time. The support is then removed and placed in a fixative or rapidly dried to prevent diffusion of the sample. This is followed by staining the zones with appropriate dye. The uptake of dye by the sample is proportional to sample concentration. After excess dye is washed away, the supporting medium may need to be placed in a clearing agent. Otherwise, it is completely dried.

Power Supply

Power supplies operating at either constant current or constant voltage are available commercially. In electrophoresis, heat is produced when current flows through a medium that has resistance, resulting in an increase in thermal agitation of the dissolved solute (ions) and leading to a decrease in resistance and an increase in current. The increase leads to increases in heat and evaporation of water from the buffer, increasing the ionic concentration of the buffer and subsequent further increases in the current. The migration rate can be kept constant by using a power supply with constant current. This is true because, as electrophoresis progresses, a decrease in resistance as a result of heat produced also decreases the voltage.

Buffers

Two buffer properties that affect the charge of ampholytes are pH and ionic strength. The ions carry the applied electric current and allow the buffer to maintain constant pH during electrophoresis. An ampholyte is a molecule, such as protein, whose net charge can be either positive or negative. If the buffer is more acidic than the isoelectric point (pI) of the ampholyte, it binds H^+ , becomes positively charged, and migrates toward the cathode. If the buffer is more basic than the pI, the ampholyte loses H^+ , becomes negatively charged, and migrates toward the anode. A particle without a net charge will not migrate, remaining at the point of application. During electrophoresis, ions cluster around a migrating particle. The higher the ionic concentration, the higher the size of the ionic cloud and the lower the mobility of the particle. Greater ionic strength produces sharper protein-band separation but leads to increased heat production. This may cause denaturation of heat-labile proteins. Consequently, the optimal buffer concentration should be determined for any electrophoretic system. Generally, the most widely used buffers are made of monovalent ions because their ionic strength and molality are equal.

Support Materials

Cellulose Acetate

Paper electrophoresis use has been replaced by cellulose acetate or agarose gel in clinical laboratories. Cellulose is acetylated to form cellulose acetate by treating it with acetic anhydride. Cellulose acetate, a dry, brittle film composed of about 80% air space, is produced commercially. When the film is soaked in buffer, the air spaces fill with electrolyte and the film becomes pliable. After electrophoresis and staining, cellulose acetate can be made transparent for densitometer quantitation. The dried transparent film can be stored for long periods. Cellulose acetate prepared to reduce electroendosmosis is available commercially. Cellulose acetate is also used in isoelectric focusing.

Agarose Gel

Agarose gel is another widely used supporting medium. Used as a purified fraction of agar, it is neutral and, therefore, does not produce electroendosmosis. After electrophoresis and staining, it is detained (cleared), dried, and scanned with a densitometer. The dried gel can be stored indefinitely. Agarose gel electrophoresis requires small amounts of sample (approximately 2 mL); it does not bind protein and, therefore, migration is not affected.

Polyacrylamide Gel

Polyacrylamide gel electrophoresis involves separation of protein on the basis of charge and molecular size. Layers of gel with different pore sizes are used. The gel is prepared before electrophoresis in a tube-shaped electrophoresis cell. The small-pore separation gel is at the bottom, followed by a large-pore spacer gel and, finally, another large-pore gel containing the sample. Each layer of gel is allowed to form a gelatin before the next gel is poured over it. At the start of electrophoresis, the protein molecules move freely through the spacer gel to its boundary with the separation gel, which slows their movement. This allows for concentration of the sample before separation by the small-pore gel. Polyacrylamide gel electrophoresis separates serum proteins into 20 or more fractions rather than the usual five fractions separated by cellulose acetate or agarose. It is widely used to study individual proteins (e.g., isoenzymes).

Starch Gel

Starch gel electrophoresis separates proteins on the basis of surface charge and molecular size, as does polyacrylamide gel. The procedure is not widely used because of technical difficulty in preparing the gel.

Treatment and Application of Sample

Serum contains a high concentration of protein, especially albumin and, therefore, serum specimens are routinely diluted with buffer before electrophoresis. In contrast, urine and CSF are usually concentrated. Hemoglobin hemolysate is used without further concentration. Generally, preparation of a sample is done according to the suggestion of the manufacturer of the electrophoretic supplies.

Cellulose acetate and agarose gel electrophoresis require approximately 2 to 5 mL of sample. These are the most common routine electrophoreses performed in clinical laboratories. Because most commercially manufactured plates come with a thin plastic template that has small slots through which samples are applied, overloading of agarose gel with sample is not a frequent problem. After serum is allowed to diffuse into the gel for approximately 5 minutes, the template is blotted to remove

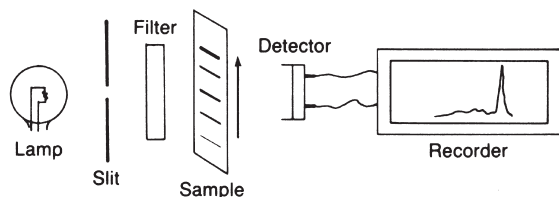

FIGURE 5-23. Densitometer—basic components.

excess serum before being removed from the gel surface. Sample is applied to cellulose acetate with a twin-wire applicator designed to transfer a small amount.

Detection and Quantitation

Separated protein fractions are stained to reveal their locations. Different stains come with different plates from different manufacturers. The simplest way to accomplish detection is visualization under UV light, whereas densitometry is the most common and reliable way for quantitation. Most densitometers will automatically integrate the area under a peak, and the result is printed as percentage of the total. A schematic illustration of a densitometer is shown in Figure 5-23.

Electroendosmosis

The movement of buffer ions and solvent relative to the fixed support is called endosmosis or electroendosmosis. Support media, such as paper, cellulose acetate, and agar gel, take on a negative charge from adsorption of hydroxyl ions. When current is applied to the electrophoresis system, the hydroxyl ions remain fixed while the free positive ions move toward the cathode. The ions are highly hydrated, resulting in net cathodic movement of solvent. Molecules that are nearly neutral are swept toward the cathode with the solvent. Support media such as agarose and acrylamide gel are essentially neutral, eliminating electroendosmosis. The position of proteins in any electrophoresis separation depends not only on the nature of the protein but also on all other technical variables.

Isoelectric Focusing

Isoelectric focusing is a modification of electrophoresis. An apparatus is used similar to that shown in Figure 5-24. Charged proteins migrate through a support medium that has a continuous pH gradient. Individual proteins move in the electric field until they reach a pH equal to their isoelectric point, at which point they have no charge and cease to move.

Capillary Electrophoresis

In capillary electrophoresis (CE), separation is performed in narrow-bore fused silica capillaries (inner diameter,

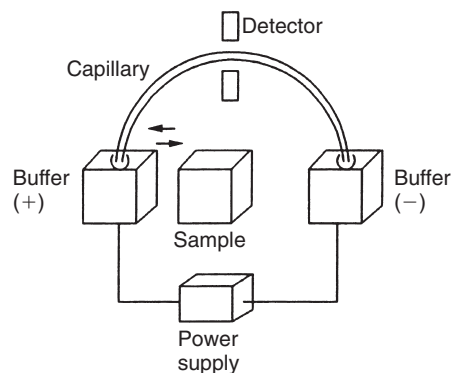

FIGURE 5-24. Schematic of capillary electrophoresis instrumentation. Sample is loaded on the capillary by replacing the anode buffer reservoir with the sample reservoir. (Reprinted with permission from Heiger DN. High-performance capillary electrophoresis. Waldbronn, Germany: Hewlett-Packard, 1992.)

2575 mm). Usually, the capillaries are only filled with buffer, although gel media can also be used. A CE instrumentation schematic is shown in Figure 5-24. Initially, the capillary is filled with buffer and then the sample is loaded; applying an electric field performs the separation. Detection can be made near the other end of the capillary directly through the capillary wall.¹³

A fundamental CE concept is the electro-osmotic flow (EOF). EOF is the bulk flow of liquid toward the cathode upon application of electric field and it is superimposed on electrophoretic migration. EOF controls the amount of time solutes remain in the capillary. Cations migrate fastest because both EOF and electrophoretic attraction are toward the cathode; neutral molecules are all carried by the EOF but are not separated from each other; and anions move slowest because, although they are carried to the cathode by the EOF, they are attracted to the anode and repelled by the cathode (Fig. 5-25). Widely used for monitoring separated analytes, UV-visible detection is performed directly on the capillary; however, sensitivity is poor because of the small dimensions of the capillary, resulting in a short path length. Fluorescence, laser-induced fluorescence, and chemiluminescence detection can be used for higher sensitivity.

CE has been used for the separation, quantitation, and determination of molecular weights of proteins and peptides; for the analysis of polymerase chain reaction (PCR) products; and for the analysis of inorganic ions, organic acids, pharmaceuticals, optical isomers, and drugs of abuse in serum and urine.¹⁴

CHROMATOGRAPHY

Chromatography refers to the group of techniques used to separate complex mixtures on the basis of different physical interactions between the individual compounds and the stationary phase of the system. The basic components

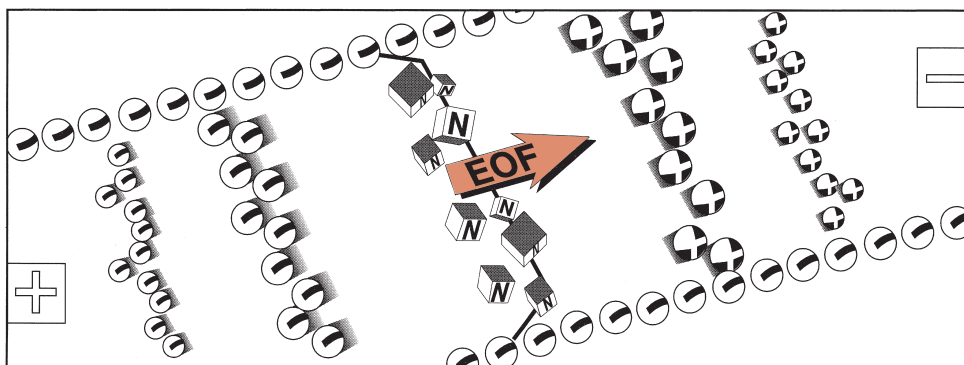

FIGURE 5-25. Differential solute migration superimposed on electro-osmotic flow in capillary zone electrophoresis. (Reprinted with permission from Heiger DN. High-performance capillary electrophoresis. France: Hewlett-Packard, 1992.)

in any chromatographic technique are the mobile phase (gas or liquid), which carries the complex mixture (sample); the stationary phase (solid or liquid), through which the mobile phase flows; the column holding the stationary phase; and the separated components (eluate).

Modes of Separation

Adsorption

Adsorption chromatography, also known as liquid-solid chromatography, is based on the competition between the sample and the mobile phase for adsorptive sites on the solid stationary phase. There is an equilibrium of solute molecules being adsorbed to the solid surface and desorbed and dissolved in the mobile phase. The molecules that are most soluble in the mobile phase, move fastest; the least soluble, move slowest. Thus, a mixture is typically separated into classes according to polar functional groups. The stationary phase can be either acidic polar (e.g., silica gel), basic polar (e.g., alumina), or nonpolar (e.g., charcoal). The mobile phase can be a single solvent or a mixture of two or more solvents, depending on the analytes to be desorbed. Liquid-solid chromatography is not widely used in clinical laboratories because of technical problems with the preparation of a stationary phase that has homogeneous distribution of absorption sites.

Partition

Partition chromatography is also referred to as liquid-liquid chromatography. Separation of solute is based on relative solubility in an organic (nonpolar) solvent and an aqueous (polar) solvent. In its simplest form, partition (extraction) is performed in a separatory funnel. Molecules containing polar and nonpolar groups in an aqueous solution are added to an immiscible organic solvent. After vigorous shaking, the two phases are allowed to separate. Polar molecules remain in the aqueous solvent; nonpolar molecules are extracted in the organic solvent.

This results in the partitioning of the solute molecules into two separate phases.

The ratio of the concentration of the solute in the two liquids is known as the partition coefficient:

$$K = \frac{\text{solute in stationary phase}}{\text{solute in mobile phase}} \quad (\text{Eq. 5-11})$$

Modern partition chromatography uses pseudo liquid stationary phases that are chemically bonded to the support or high-molecular-weight polymers that are insoluble in the mobile phase.¹⁵ Partition systems are considered normal phase when the mobile solvent is less polar than the stationary solvent and reverse phase when the mobile solvent is more polar.

Partition chromatography is applicable to any substance that may be distributed between two liquid phases. Because ionic compounds are generally soluble only in water, partition chromatography works best with nonionic compounds.

Steric Exclusion

Steric exclusion, a variation of liquid-solid chromatography, is used to separate solute molecules on the basis of size and shape. The chromatographic column is packed with porous material, as shown in Figure 5-26. A sample containing different-sized molecules moves down the column dissolved in the mobile solvent. Small molecules enter the pores in the packing and are momentarily trapped. Large molecules are excluded from the small pores and so move quickly between the particles. Intermediate-sized molecules are partially restricted from entering the pores and, therefore, move through the column at an intermediate rate that is between those of the large and small molecules.

Early methods used hydrophilic beads of cross-linked dextran, polyacrylamide, or agarose, which formed a gel when soaked in water. This method was termed gel filtration. A similar separation process using hydrophobic

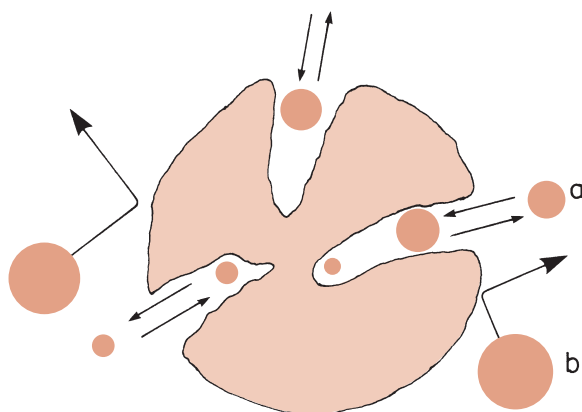

FIGURE 5-26. Pictorial concept of steric exclusion chromatography. Separation of sample components by their ability to permeate pore structure of column-packing material. Smaller molecules (a) permeating the interstitial pores; large excluded molecules (b). (Reprinted with permission from Parris NA. *Instrumental liquid chromatography: a practical manual on high performance liquid chromatographic methods*. New York, N.Y.: Elsevier, 1976.)

gel beads of polystyrene with a nonaqueous mobile phase was called gel permeation chromatography. Current porous packing uses rigid inorganic materials such as silica or glass. The term steric exclusion includes all these variations. Pore size is controlled by the manufacturer, and packing materials can be purchased with different pore sizes, depending on the size of the molecules being separated.

Ion-Exchange Chromatography

In ion-exchange chromatography, solute mixtures are separated by virtue of the magnitude and charge of ionic species. The stationary phase is a resin, consisting of large polymers of substituted benzene, silicates, or cellulose derivatives, with charge functional groups. The resin is insoluble in water, and the functional groups are immobilized as side chains on resin beads that are used to fill the chromatographic column. Figure 5-27A shows resin with sulfonate functional groups. Hydrogen⁺ ions are loosely held and free to react. This is an example of a

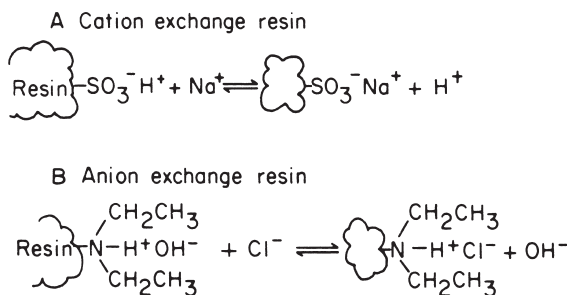

FIGURE 5-27. Chemical equilibrium of ion-exchange resins. (A) Cation exchange resin. (B) Anion exchange resin.

cation-exchange resin. When a cation such as Na⁺ comes in contact with these functional groups, an equilibrium is formed, following the law of mass action. Because there are many sulfonate groups, Na⁺ is effectively and completely removed from solution. The Na⁺ concentrated on the resin column can be eluted from the resin by pouring acid through the column, driving the equilibrium to the left.

Anion-exchange resins are made with exchangeable hydroxyl ions such as the diethylamine functional group illustrated in Figure 5-27B. They are used like cation-exchange resins, except that hydroxyl ions are exchanged for anions. The example shows Cl⁻ in sample solution exchanged for OH⁻ from the resin functional group. Anion and cation resins mixed together (mixed-bed resin) are used to deionize water. The displaced protons and hydroxyl ions combine to form water. Ionic functional groups other than the illustrated examples are used for specific analytic applications. Ion-exchange chromatography is used to remove interfering substances from a solution, to concentrate dilute ion solutions, and to separate mixtures of charged molecules, such as amino acids. Changing pH and ionic concentration of the mobile phase allows separation of mixtures of organic and inorganic ions.

Chromatographic Procedures

Thin-Layer Chromatography

Thin-layer chromatography (TLC) is a variant of column chromatography. A thin layer of sorbent, such as alumina, silica gel, cellulose, or cross-linked dextran, is uniformly coated on a glass or plastic plate. Each sample to be analyzed is applied as a spot near one edge of the plate, as shown in Figure 5-28. The mobile phase (solvent) is usually placed in a closed container until the atmosphere is saturated with solvent vapor. One edge of the plate is placed in the solvent, as shown. The solvent migrates up the thin layer by capillary action, dissolving and carrying sample molecules. Separation can be achieved by any of the four processes previously described, depending on the sorbent (thin layer) and solvent chosen. After the solvent reaches a predetermined height, the plate is removed and dried. Sample components are identified by comparison with standards on the same plate. The distance a component migrates, compared with the distance the solvent front moves, is called the retention factor, R_f:

$$R_f = \frac{\text{distance leading edge of component moves}}{\text{total distance solvent front moves}} \quad (\text{Eq. 5-12})$$

Each sample-component R_f is compared with the R_f of standards. Using Figure 5-28 as an example, standard A has an R_f value of 0.4, standard B has an R_f value of 0.6, and standard C has a value of 0.8. The first unknown

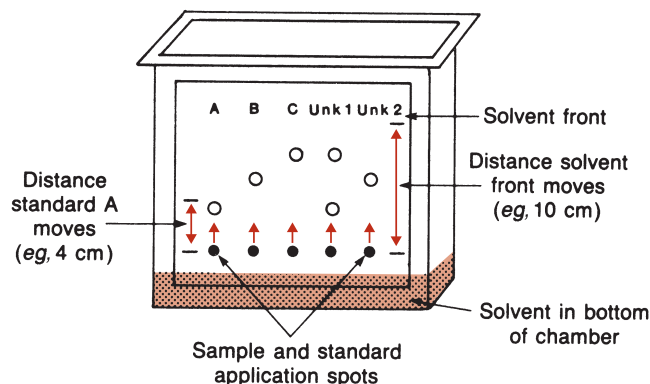

FIGURE 5-28. TLC plate in chromatographic chamber.

contains A and C, because the R_f values are the same. This ratio is valid only for separations run under identical conditions. Because R_f values may overlap for some components, further identifying information is obtained by spraying different stains on the dried plate and comparing colors of the standards.

TLC is most commonly used as a semiquantitative screening test. Technique refinement has resulted in the development of semiautomated equipment and the ability to quantitate separated compounds. For example, sample applicators apply precise amounts of sample extracts in concise areas. Plates prepared with uniform sorbent thickness, finer particles, and new

solvent systems have resulted in the technique of high-performance thin-layer chromatography (HPTLC).¹⁶ Absorbance of each developed spot is measured using a densitometer, and the concentration is calculated by comparison with a reference standard chromatographed under identical conditions.

High-Performance Liquid Chromatography

Modern **liquid chromatography** uses pressure for fast separations, controlled temperature, in-line detectors, and gradient elution techniques.^{17,18} Figure 5-29 illustrates the basic components.

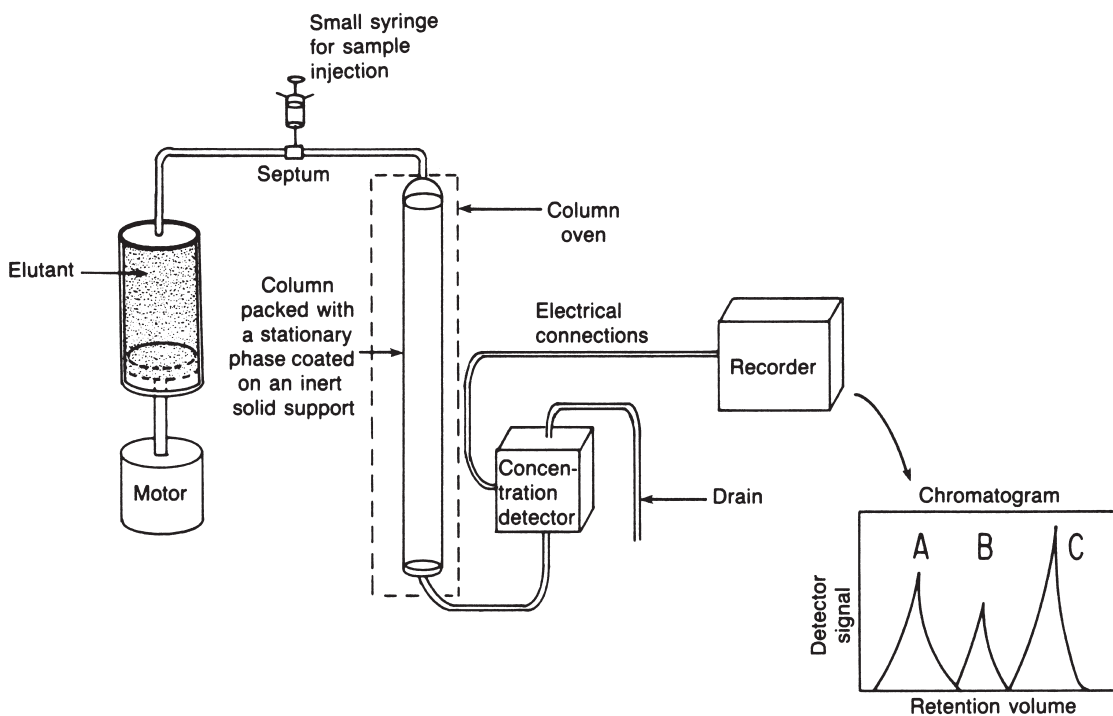

FIGURE 5-29. HPLC basic components. (Reprinted with permission from Bender GT. Chemical instrumentation: a laboratory manual based on clinical chemistry. Philadelphia, Pa.: WB Saunders, 1972.)

Pumps

A pump forces the mobile phase through the column at a much greater velocity than that accomplished by gravity-flow columns and includes pneumatic, syringe, reciprocating, or hydraulic amplifier pumps. The most widely used pump today is the mechanical reciprocating pump, which is now used as a multihead pump with two or more reciprocating pistons. During pumping, the pistons operate out of phase (180 degrees for two heads, 120 degrees for three heads) to provide constant flow. Pneumatic pumps are used for preoperative purposes; hydraulic amplifier pumps are no longer commonly used.

Columns

The stationary phase is packed into long stainless steel columns. HPLC is usually run at ambient temperatures, although columns can be put in an oven and heated to enhance the rate of partition. Fine, uniform column packing results in much less band broadening but requires pressure to force the mobile phase through. The packing also can be either pellicular (an inert core with a porous layer), inert and small particles, or macroporous particles. The most common material used for column packing is silica gel. It is very stable and can be used in different ways. It can be used as solid packing in liquid-solid chromatography or coated with a solvent, which serves as the stationary phase (liquid-liquid). As a result of the short lifetime of coated particles, molecules of the mobile-phase liquid are now bonded to the surface of silica particles.

Reversed-phase HPLC is now popular; the stationary phase is nonpolar molecules (e.g., octadecyl C-18 hydrocarbon) bonded to silica gel particles. For this type of column packing, the mobile phase commonly used is acetonitrile, methanol, water, or any combination of solvents. A reversed-phase column can be used to separate ionic, nonionic, and ionizable samples. A buffer is used to produce the desired ionic characteristics and pH for separation of the analyte. Column packings vary in size (3 to 20 mm), using smaller particles mostly for analytic separations and larger ones for preparative separations.

Sample Injectors

A small syringe can be used to introduce the sample into the path of the mobile phase that carries it into the column (Fig. 5-29). The best and most widely used method, however, is the loop injector. The sample is introduced into a fixed-volume loop. When the loop is switched, the sample is placed in the path of the flowing mobile phase and flushed onto the column.

Loop injectors have high reproducibility and are used at high pressures. Many HPLC instruments have loop injectors that can be programmed for automatic

injection of samples. When the sample size is less than the volume of the loop, the syringe containing the sample is often filled with the mobile phase to the volume of the loop before filling the loop. This prevents the possibility of air being forced through the column because such a practice may reduce the lifetime of the column packing material.

Detectors

Modern HPLC detectors monitor the eluate as it leaves the column and, ideally, produce an electronic signal proportional to the concentration of each separated component. Spectrophotometers that detect absorbances of visible or UV light are most commonly used. PDA and other rapid scanning detectors are also used for spectral comparisons and compound identification and purity. These detectors have been used for drug analyses in urine. Obtaining a UV scan of a compound as it elutes from a column can provide important information as to its identity. Unknowns can be compared against library spectra in a similar manner to MS. Unlike **gas chromatography** (GC)/MS, which requires volatilization of targeted compounds, liquid chromatography/photodiode array (LC/PDA) enables direct injection of aqueous urine samples.

Because many biologic substances fluoresce strongly, fluorescence detectors are also used, involving the same principles discussed in the section on spectrophotometric measurements. Another common HPLC detector is the amperometric or electrochemical detector, which measures current produced when the analyte of interest is either oxidized or reduced at some fixed potential set between a pair of electrodes.

A mass spectrometer (MS) can also be used as a detector, as described later.

Recorders

The recorder is used to record detector signal versus the time the mobile phase passed through the instrument, starting from the time of sample injection. The graph is called a chromatogram (Fig. 5-30). The retention time is used to identify compounds when compared with standard retention times run under identical conditions. Peak area is proportional to concentration of the compounds that produced the peaks.

When the elution strength of the mobile phase is constant throughout the separation, it is called isocratic elution. For samples containing compounds of widely differing relative compositions, the choice of solvent is a compromise. Early eluting compounds may have retention times close to zero, producing a poor separation (resolution), as shown in Figure 5-30A. Basic compounds often have low retention times because C-18 columns cannot tolerate high pH mobile phases. The addition of cation-pairing reagents to the mobile phase

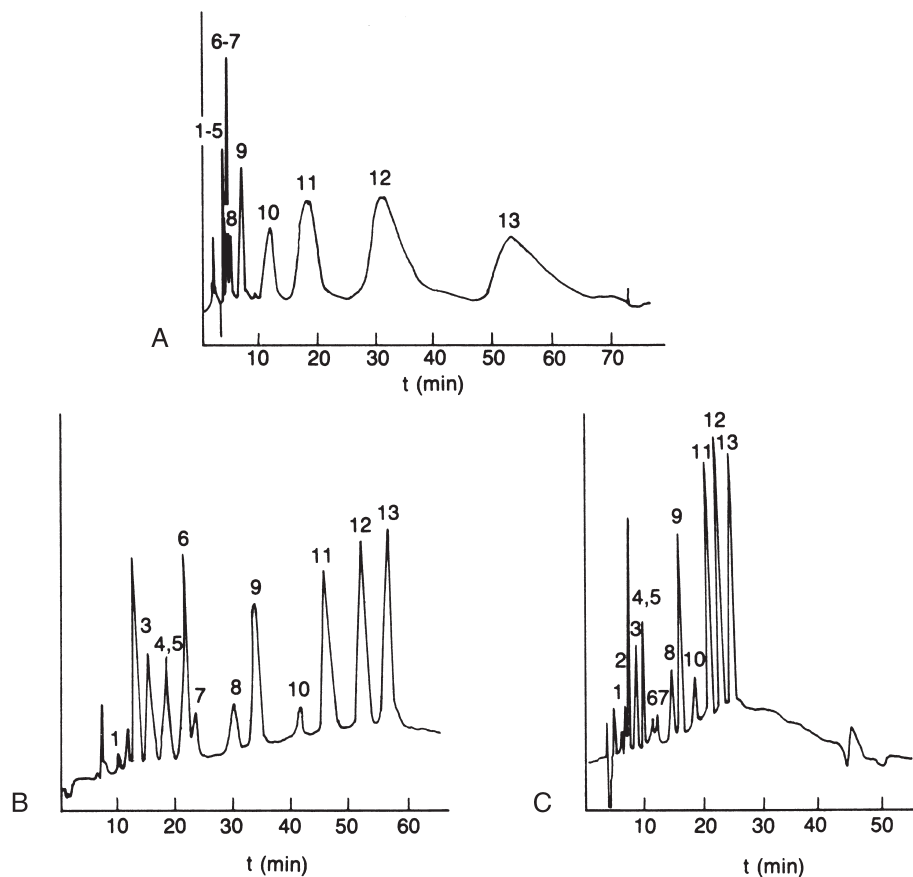

FIGURE 5-30. Chromatograms. (A) Isocratic ion-exchange separation mobile phase contains 0.055 mol/L NaNO₃. (B) Gradient elution mobile phase gradient from 0.01 to 0.1 mol/L NaNO₃ at 2% per minute. (C) Gradient elution—5% per minute. (Reprinted with permission from Horváth C. High performance liquid chromatography, advances and perspectives. New York, N.Y.: Academic Press, 1980.)

(e.g., octane sulfonic acid) can result in better retention of negatively charged compounds onto the column.

The late-eluting compounds may have long retention times, producing broad bands resulting in decreased sensitivity. In some cases, certain components of a sample may have such a great affinity for the stationary phase that they do not elute at all. Gradient elution is an HPLC technique that can be used to overcome this problem. The composition of the mobile phase is varied to provide a continual increase in the solvent strength of the mobile phase entering the column (Fig. 5-30B). The same gradient elution can be performed with a faster change in concentration of the mobile phase (Fig. 5-30C).

Gas Chromatography

Gas chromatography is used to separate mixtures of compounds that are volatile or can be made volatile.¹⁹ Gas chromatography may be gas-solid chromatography (GSC), with a solid stationary phase, or gas-liquid

chromatography (GLC), with a nonvolatile liquid stationary phase. GLC is commonly used in clinical laboratories. Figure 5-31 illustrates the basic components of a GC system. The setup is similar to HPLC, except that the mobile phase is a gas and samples are partitioned between a gaseous mobile phase and a liquid stationary phase. The carrier gas can be nitrogen, helium, or argon. The selection of a carrier gas is determined by the detector used in the instrument. The instrument can be operated at a constant temperature or programmed to run at different temperatures if a sample has components with different volatilities. This is analogous to gradient elution described for HPLC.

The sample, which is injected through a septum, must be injected as a gas or the temperature of the injection port must be above the boiling point of the components so that they vaporize upon injection. Sample vapor is swept through the column partially as a gas and partially dissolved in the liquid phase. Volatile compounds that are present mainly in the gas phase will have a low partition coefficient and will move

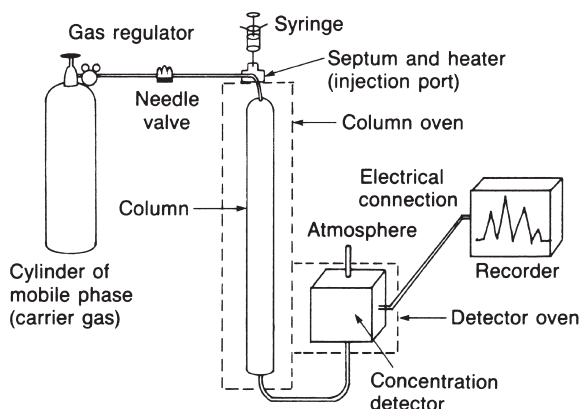

FIGURE 5-31. GLC basic components. (Reprinted with permission from Bender GT. *Chemical instrumentation: a laboratory manual based on clinical chemistry*. Philadelphia, Pa.: WB Saunders, 1972.)

quickly through the column. Compounds with higher boiling points will move slowly through the column. The effluent passes through a detector that produces an electric signal proportional to the concentration of the volatile components. As in HPLC, the chromatogram is used both to identify the compounds by the retention time and to determine their concentration by the area under the peak.

Columns

GLC columns are generally made of glass or stainless steel and are available in a variety of coil configurations and sizes. Packed columns are filled with inert particles such as diatomaceous earth or porous polymer or glass beads coated with a nonvolatile liquid (stationary) phase. These columns are usually $\frac{1}{8}$ to $\frac{1}{4}$ inch wide and 3 to 12 feet long. Capillary-wall coated open tubular columns have inside diameters in the range of 0.25 mm to 0.50 mm and are up to 60 m long. The liquid layer is coated on the walls of the column. A solid support coated with a liquid stationary phase may in turn be coated on column walls.

The liquid stationary phase must be nonvolatile at the temperatures used, must be thermally stable, and must not react chemically with the solutes to be separated. The stationary phase is termed nonselective when separation is primarily based on relative volatility of the compounds. Selective liquid phases are used to separate polar compounds based on relative polarity (as in liquid-liquid chromatography).

Detectors

Although there are many types of detectors, only thermal conductivity (TC) and flame ionization detectors are discussed because they are the most stable (Fig. 5-32). TC detectors contain wires (filaments) that change electrical

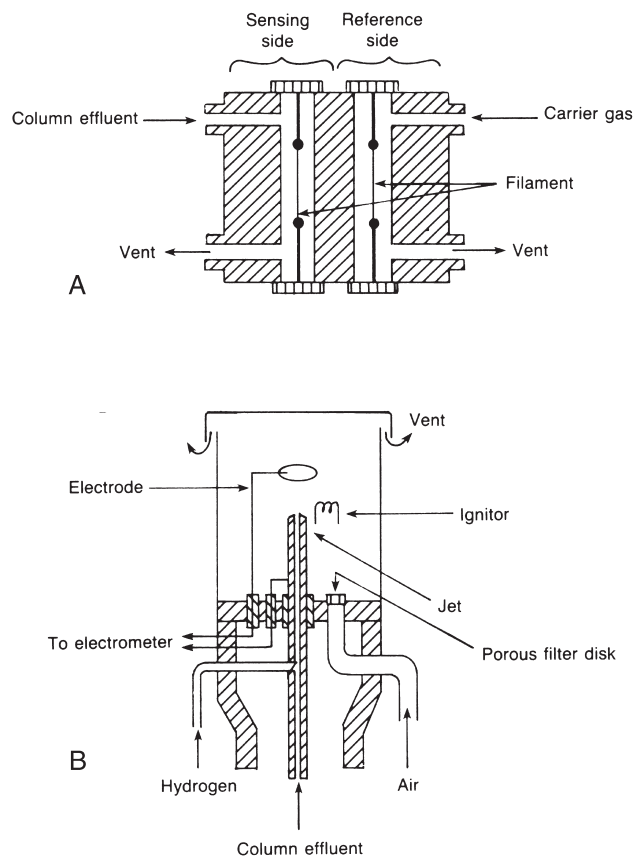

FIGURE 5-32. (A) Schematic diagram of a thermal conductivity detector. (B) Schematic diagram of a flame ionization detector. (Reprinted with permission from Tietz NW, ed. *Fundamentals of clinical chemistry*. Philadelphia, Pa.: WB Saunders, 1987.)

resistance with change in temperature. The filaments form opposite arms of a Wheatstone bridge and are heated electrically to raise their temperature. Helium, which has a high thermal conductivity, is usually the carrier gas. Carrier gas from the reference column flows steadily across one filament, cooling it slightly. Carrier gas and separated compounds from the sample column flow across the other filament. The sample components usually have a lower thermal conductivity, increasing the temperature and resistance of the sample filament. The change in resistance results in an unbalanced bridge circuit. The electrical change is amplified and fed to the recorder. The electrical change is proportional to the concentration of the analyte.

Flame ionization detectors are widely used in the clinical laboratory. They are more sensitive than TC detectors. The column effluent is fed into a small hydrogen flame burning in excess air or atmospheric oxygen. The flame jet and a collector electrode around the flame have opposite potentials. As the sample burns, ions form and move to the charged collector. Thus, a current

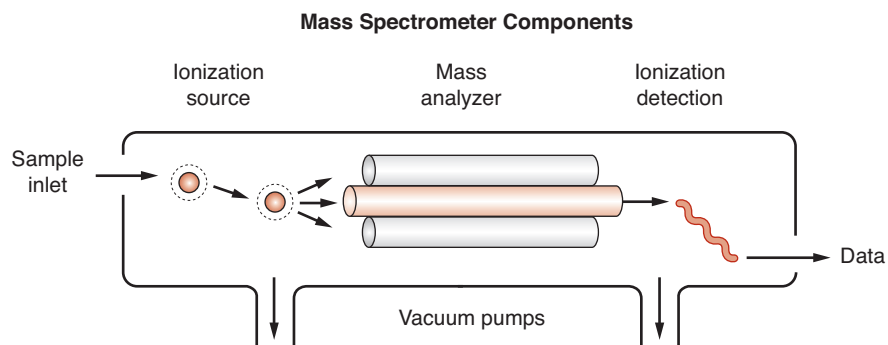

FIGURE 5-33. The components of a mass spectrometer. In this case, the ionization source pictured is electrospray ionization and the mass analyzer is a quadrupole.

proportional to the concentration of the ions is formed and fed to the recorder.

MASS SPECTROMETRY

Definitive identification of samples eluting from GC or HPLC columns is possible when an MS is used as a detector.²⁰ The coupled techniques, GC/MS and LC/MS, have powerful analytic capabilities with widespread clinical applications. The sample in an MS is first volatilized and then ionized to form charged molecular ions and fragments that are separated according to their mass-to-charge (m/z) ratio; the sample is then measured by a detector, which gives the intensity of the ion current for each species. These steps take place in the four basic components that are standard in all MSs: the sample inlet, ionization source, mass analyzer, and ion detector (Fig. 5-33). Ultimately, molecule identification is based on the formation of characteristic fragments. Figure 5-34 illustrates the mass spectrum of Δ^9 -carboxytetrahydrocannabinol, a metabolite of marijuana.

Sample Introduction and Ionization

Direct infusion is commonly used to interface a GC or LC with an MS; however, the challenge of introducing a liquid sample from an LC column into an MS was a significant barrier until recent technological advances in ionization techniques.

Electron Ionization

The most common form of ionization used in GC/MS is electron ionization (EI). This method requires a source of electrons in the form of a filament to which an electric potential is applied, typically at 70 electron volts.²¹ The molecules in the source are bombarded with high-energy electrons, resulting in the formation of charged molecular ions and fragments. Molecules break down into characteristic fragments according to their molecular structure (Fig. 5-35). The ions formed and their relative proportions are reproducible and can be used for qualitative identification of the compound. Since most instruments use the same 70 eV potential, the fragmentation of molecules on different days and different

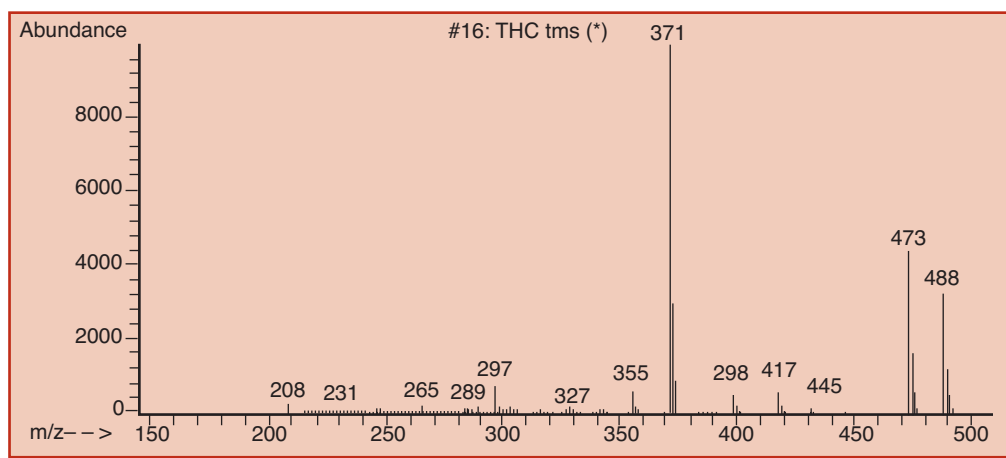

FIGURE 5-34. Mass spectrum of the trimethylsilane derivative of Δ^9 -carboxytetrahydrocannabinol (marijuana metabolite).

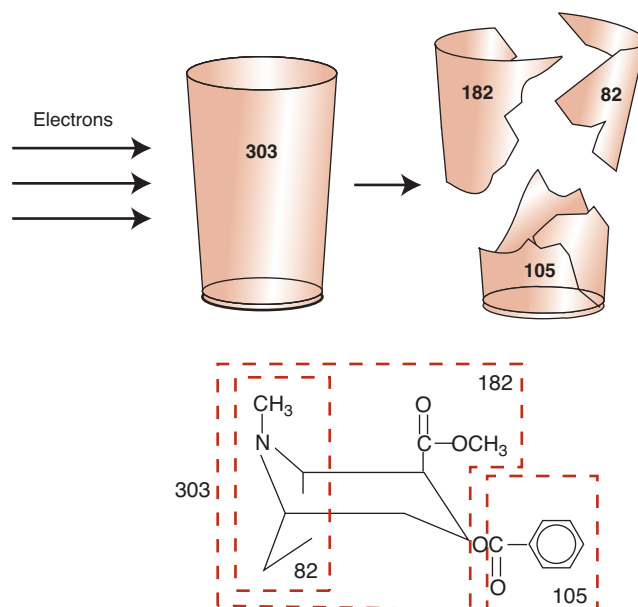

FIGURE 5-35. Electron bombardment breaks cocaine into fragments, with number and size quantified. Unlike the illustrative glass tumbler, the result of mass fragmentation of cocaine or other chemical compounds is both predictable and reproducible, especially with electron ionization.

instruments is remarkably similar, allowing the comparison of unknown spectra to spectra in a published reference library.²¹

Atmospheric Pressure Ionization

Unlike EI in GC/MS, most LC/MS ionization techniques are conducted at atmospheric pressure. As such, the ion source of this type of instrument is not included in the high vacuum region of the instrument. Two types of ionization for LC/MS will be discussed here: electrospray ionization (ESI) and atmospheric pressure chemical ionization (APCI), while matrix-assisted laser desorption (MALDI) and surface-enhanced laser desorption (SELDI) ionization will be discussed later in the section on proteomics. ESI and APCI also differ from EI in that they are “soft” ionization techniques that leave the molecular ion largely intact in the source. Many LC/MS techniques employ technologies after the source, in the mass analyzer, to fragment molecules and generate the “fingerprint” spectra used in identification. However, ionization techniques used in LC/MS produce fragments and therefore mass spectra that are somewhat less reproducible between instruments than EI used in GC/MS. This may prove to limit the utility of reference library spectra produced on other instruments.

Electrospray Ionization

Thanks to its wide mass range and high sensitivity, ESI can be applied to a wide range of biological macromolecules

in addition to small molecules and has become the most common ionization source for LC/MS.

ESI involves passing the LC effluent through a capillary to which a voltage has been applied. The energy is transferred to the solvent droplets, which become charged.²¹ Evaporation of the solvent through heat and gas causes the droplets to decrease in size, which increases the charge density on the surface. Eventually, the Coulombic repulsion of like charges lead to the ejection of ions from the droplet²² (Fig. 5-36). The individually charged molecules are drawn into the MS for mass analysis.

ESI is adept at forming singly charged small molecules, but larger molecules can also be ionized using this method. Larger molecules such as proteins become multiply charged in ESI, and since MSs measure the m/z , even these large molecules can be observed in an instrument with a relatively small mass range²² (Fig. 5-37).

Atmospheric Pressure Chemical Ionization

Another important ionization source is APCI, which is similar to ESI in that the liquid from LC is introduced directly into the ionization source. However, the droplets are not charged and the source contains a heated vaporizer to allow rapid desolvation of the drops.²² A high voltage is applied to a corona discharge needle, which emits a cloud of electrons to ionize compounds after they are converted to the gas phase.

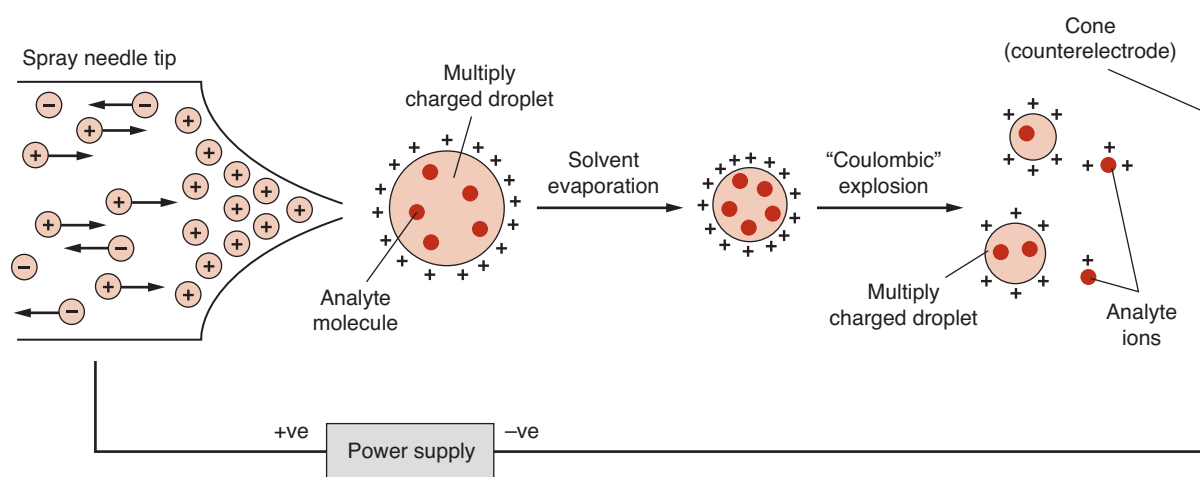

FIGURE 5-36. Diagram of electrospray ionization, the most common ionization source for LC/MS.

Mass Analyzer

The actual measuring of the m/z occurs when the gas phase ions pass into the mass analyzer. Two types of mass analyzers will be discussed here: the quadrupole and ion trap, while time-of-flight (TOF) will be discussed later in the proteomics section. Both quadrupole and ion trap mass analyzers contain rods or plates that are charged with varying AC and DC voltages to form electric fields. These electric fields manipulate the charged molecules to sort them according to their m/z .

Quadrupole

A diagram of a quadrupole MS is shown in Figure 5-38. The quadrupole is the most common mass analyzer in use today. The electric field on the two sets of diagonally opposed rods allows only ions of a single selected m/z value

to pass through the analyzer to the detector. All other ions are deflected into the rods. The rods can be scanned from low to high mass to allow ions of increasing mass to form stable sinusoidal orbits and traverse the filtering sector. This technique will generate a full scan mass spectrum. Alternatively, specific masses can be selected to monitor a few target analytes. This technique is called selected ion monitoring (SIM) and it allows for a longer dwell time (time spent monitoring a single ion) and therefore higher sensitivity.²¹ A full scan provides more information than SIM since ions not specifically selected in SIM are not detected. Therefore, a full scan would be preferable for general unknown screening while SIM analysis is more suitable for target compound analysis.

Ion Trap

The ion trap can be thought of as a modified quadrupole. A linear ion trap employs a stopping potential on the end

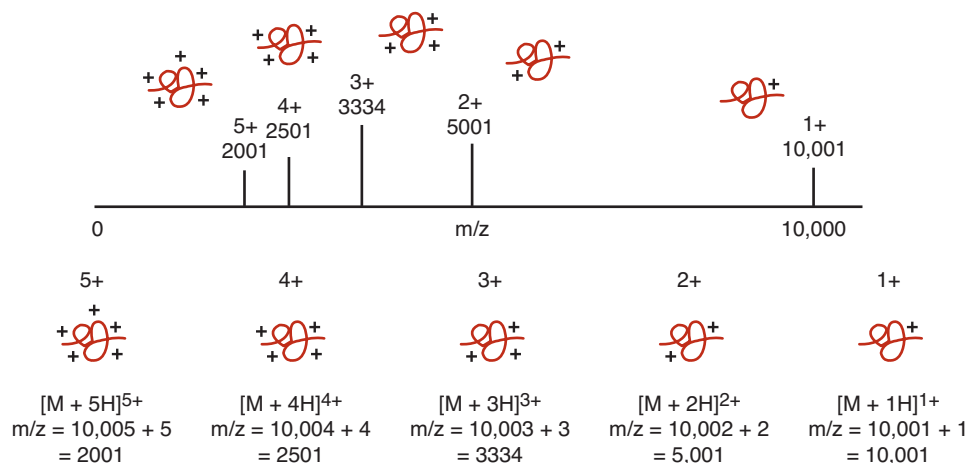

FIGURE 5-37. A theoretical protein with a molecular weight of 10,000 can be multiply charged, which will generate numerous peaks. A mass spectrometer with a relatively small mass range can still detect the multiply charged ions since the m/z is reduced.

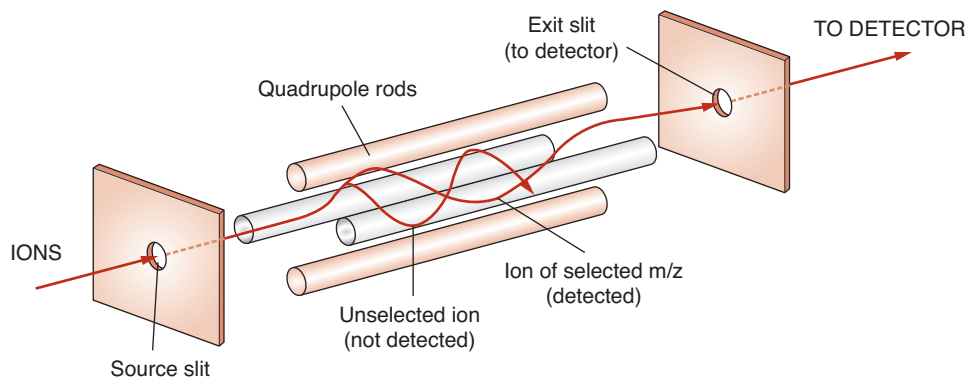

FIGURE 5-38. Single quadrupole mass spectrometer.

electrodes to confine ions along the two-dimensional axis of the quadrupoles. In a three-dimensional ion trap, the four rods, instead of being arranged parallel to each other, form a three-dimensional sphere in which ions are “trapped.” In all ion traps, after a period of accumulation, the electric field adjusts to selectively destabilize the trapped ions, which are mass-selectively ejected from the cavity to the detector based on their m/z .²¹ The unique feature of ion trap MSs is that they trap and store ions of interest and yielding a greater sensitivity.

MS/MS

Tandem MSs (GC/MS/MS and LC/MS/MS) can be used for greater selectivity and lower detection limits. A common form of MS/MS is to link three quadrupoles in series; such an instrument is referred to as a triple quad

(Fig. 5-39). Generally, each quadrupole has a separate function.²² Following an appropriate ionization method, the first quadrupole (Q1) is used to scan across a preset m/z range and select an ion of interest. The second quadrupole (Q2) functions as a collision cell. In a process called collision-induced dissociation (CID), the ions are accelerated to high kinetic energy and allowed to collide with neutral gas molecules (usually nitrogen, helium, or argon) to fragment the ions. The single ion passed through the first analyzer is called the precursor (or parent) ion while the ions formed during fragmentation of the precursor ions are called product (or daughter) ions. The third quadrupole (Q3) serves to analyze the product ions generated in Q2. This last quadrupole can be set to scan all of the product ions to produce a full product ion scan, or to selectively allow one or more of these product ions through to the

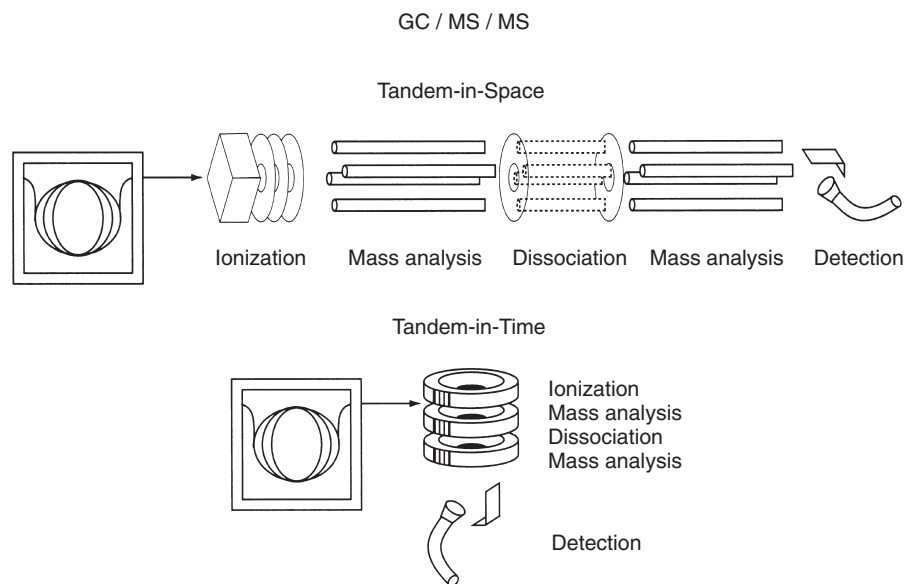

FIGURE 5-39. Triple quadrupole mass spectrometer.

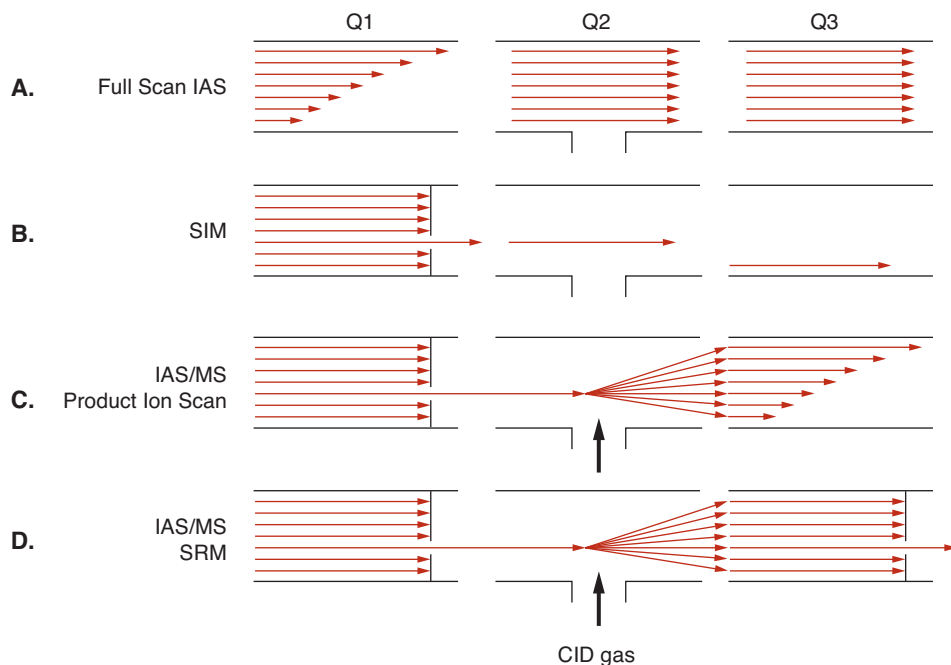

FIGURE 5-40. Scanning modes used in a triple quadrupole mass spectrometer. **(A)** Full scan MS detects all ions. **(B)** Selected ion monitoring (SIM) detects ions of one selected m/z . **(C)** Product ion scans select ions of one m/z in Q1 to pass on to Q2, the collision cell, where the ion is fragmented. All ion fragments are allowed to pass through to the detector. **(D)** Selected reaction monitoring (SRM) is similar to the product ion scan, but only fragments of one selected m/z are allowed to pass on to the detector. Both **C** and **D** are examples of tandem mass spectrometry (MS/MS).

detector in a process called selected reaction monitoring (SRM). Various scanning modes commonly used in a triple quad are shown in Figure 5-40. In some triple quad instruments, the third quadrupole can also function as a linear ion trap to add further sensitivity to MS/MS.

Detector

The most common means of detecting ions employs an electron multiplier (Fig. 5-41). In this detector, a series of dynodes with increasing potentials are linked. When ions strike the first dynode surface, electrons are emitted.

These electrons are attracted to the next dynode where more secondary electrons are emitted due to the higher potential of subsequent dynodes. A cascade of electrons is formed by the end of the chain of dynodes, resulting in overall signal amplification on the order of 1 million or greater.²²

Applications of Mass Spectrometry in the Clinical Laboratory

Mass spectrometers coupled to GC or LC can be used not only for the identification and quantitation of compounds but also for structural information and molecular weight

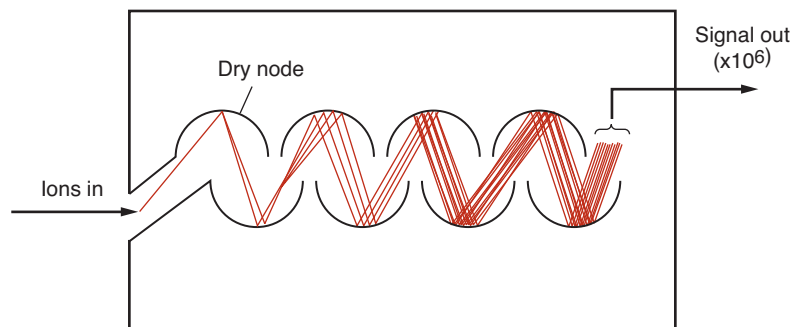

FIGURE 5-41. Diagram of an electron multiplier detector in a mass spectrometer.

determination.²³ GC/MS systems are widely used for measuring drugs of abuse in urine toxicology confirmations. Drugs and metabolites must be extracted from body fluids and typically reacted with derivatizing reagents to form compounds that are more volatile for the GC process. Computerized libraries and matching algorithms are available within the instrument to compare mass spectral results of an unknown substance obtained from a sample to the reference library.

Increasingly, LC/MS (including LC/MS/MS) technology is taking its place alongside GC/MS in clinical laboratories. LC offers a number of advantages over GC. Typically, LC requires less extensive extraction procedures and derivatization is rarely used, saving time and expense. In addition, polar and heat-labile compounds fare better in LC.²¹ However, the chromatography itself in LC can be somewhat less robust than in GC, resulting in wider peaks, more variable retention times and potentially requiring more frequent maintenance. Another disadvantage of LC/MS is the less reproducible mass spectra, as mentioned earlier.

Besides its use in toxicology, LC/MS also has great potential for measuring low-level and mixed-polarity analytes such as vitamin D, testosterone, and immunosuppressant drugs due to its superior sensitivity and specificity over immunoassays. In addition, LC/MS has the advantage of being able to detect multiple analytes (such as a panel of drugs or a series of metabolites) in one run. LC/MS is free from the antibody interferences seen in immunoassays, although LC/MS has its own type of interference in the form of ion suppression. This effect is seen when a co-eluting chemical in the sample prevents a compound of interest from being ionized, thereby reducing or eliminating its signal. LC/MS also requires highly skilled operators and is not nearly as automated as immunoassay instruments.

INSTRUMENTATION FOR PROTEOMICS

The next generation of biomarkers for human diseases will be discovered using techniques found within the research fields of genomics and proteomics. Genomics use the known sequences of the entire human genome for determining the role of genetics in certain human diseases. Proteomics is the investigation of the protein products encoded by these genes. Protein expression is equal to and, in many cases, more important for disease detection than genomics because these products determine what is currently occurring within a cell, rather than the genes, which indicate what a cell might be capable of performing. Moreover, many (posttranslational) changes can occur to the protein, as influenced by other proteins and enzymes that cannot be easily predicted by knowledge at the genomic level.

A “shotgun” approach is often used in the discovery of new biochemical markers. The proteins from samples (e.g., serum, urine, tissue extract) from normal individuals are compared with those derived from patients with the disease being studied. Techniques such as two-dimensional electrophoresis can be used to separate proteins into individual spots or bands. Proteins that only appear in either the normal or diseased specimens are further studied. Computer programs are available that digitally compare gels to determine spots or areas that are different. When candidate proteins have been found, the spots can be isolated and subjected to sophisticated MS analysis to identify the protein and possibly any post-translational modifications that may have occurred. Using this approach, the researcher does not have any preconceptions or biases as to what directions or particular proteins to look for.

Two-Dimensional Electrophoresis

This electrophoresis assay combines two different electrophoresis dimensions to separate proteins from complex matrices such as serum or tissue. In the first dimension, proteins are resolved according to their isoelectric points (pIs), using immobilized pH gradients. Commercial gradients are available in a variety of pH ranges. In the second dimension, proteins are separated according to their relative size (molecular weight), using sodium dodecyl sulfate-polyacrylamide gel electrophoresis (SDS-PAGE). A schematic of this procedure is shown in Figure 5-42. Gels can be run under denaturing or nondenaturing conditions (e.g., for the maintenance of enzyme activity) and visualized by a variety of techniques, including the use of colorimetric dyes (e.g., Coomassie blue or silver stain), radiographic, fluorometric, or chemiluminescence of appropriately labeled polypeptides. These latter techniques are considerably more sensitive than the colorimetric dyes.

MALDI-TOF and SELDI-TOF Mass Spectrometry

Matrix-assisted laser desorption ionization time-of-flight mass spectrometry (MALDI-TOF) is used for the analysis of biomolecules, such peptides and proteins. Protein samples, such as those isolated from a two-dimensional electrophoretogram, are mixed with an appropriate matrix solvent and spotted onto a stainless steel plate. The solvent is dried and the plate is introduced into the vacuum system of the MALDI-TOF analyzer. As shown in Figure 5-43, a laser pulse irradiates the sample causing desorption and ionization of both the matrix and sample. Because the monitored mass spectral range is high (>500 daltons), the ionization

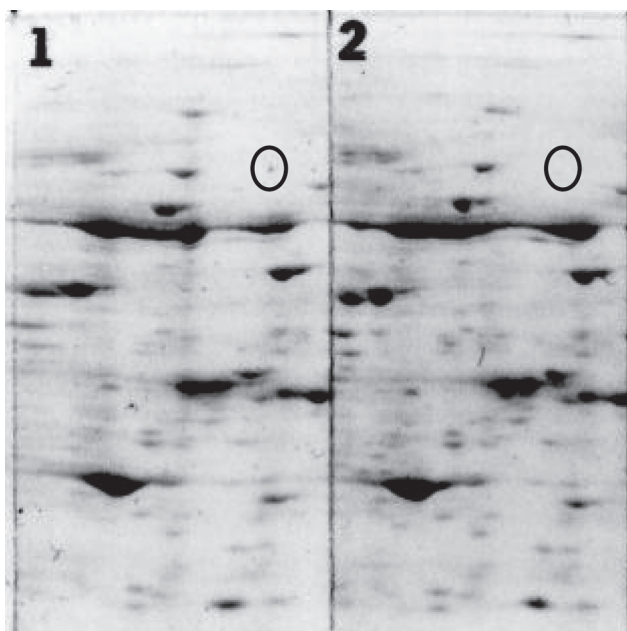

FIGURE 5-42. Hypothetical example of a two-dimensional electrophoretogram from a patient with a disease (*panel 1*) compared with a normal subject (*panel 2*). The patient exhibits a protein (*oval*) that is not expressed in the normal subject. This protein might be a potential marker for this disease. (Gels courtesy of Kendrick Laboratories, Madison, Wis.)

of the low-molecular-weight matrix can be readily distinguished from high-molecular-weight peptides and proteins and do not interfere with the assay of the protein. Ions from the sample are focused into the mass spectrum. The time required for a mass to reach the detector is a nonlinear function of the mass, with larger ions requiring more time than smaller ions. The molecular weight of the proteins acquired by mass spectrum is used to determine the identity of the sample and is helpful in determining posttranslational modifications that may have occurred. For very large proteins, samples can be pretreated with trypsin, which cleaves peptide bonds between lysine and arginine, to produce lower-molecular-weight fragments that can then be measured. The detection limit of this assay is about 10^{-15} to 10^{-18} moles. A modification of MALDI-TOF MS is surface-enhanced laser desorption ionization time-of-flight (SELDI-TOF) MS, in which proteins are directly captured on a chromatographic biochip without the need of sample preparation. Figure 5-44 illustrates the SELDI-TOF process.

OSMOMETRY

An osmometer is used to measure the concentration of solute particles in a solution. The mathematic definition is

$$\text{Osmolality} = \phi \times n \times C \quad (\text{Eq. 5-13})$$

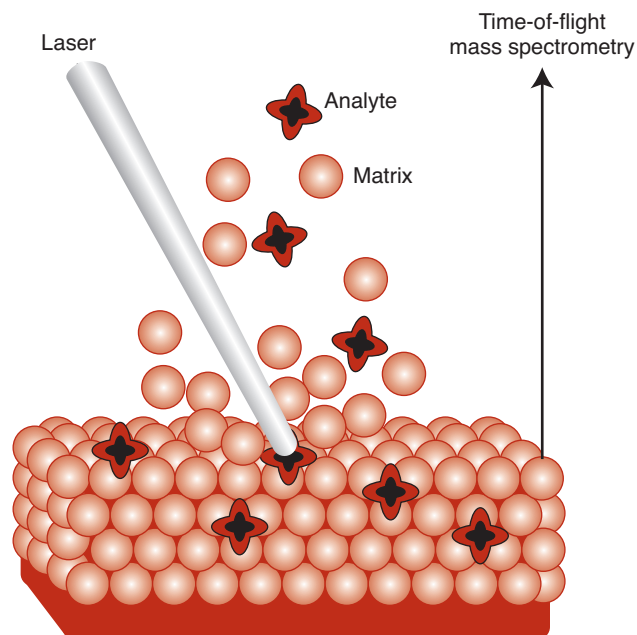

FIGURE 5-43. Sample desorption process prior to MALDI-TOF analysis. (Diagram courtesy of Stanford Research Systems, Sunnyvale, Ca.)

where ϕ is osmotic coefficient, n is number of dissociable particles (ions) per molecule in the solution, and C is = concentration in moles per kilogram of solvent.

The osmotic coefficient is an experimentally derived factor to correct for the fact that some of the molecules, even in a highly dissociated compound, exist as molecules rather than ions.

The four physical properties of a solution that change with variations in the number of dissolved particles in the solvent are osmotic pressure, vapor pressure, boiling point, and freezing point. Osmometers measure osmolality indirectly by measuring one of these colligative properties, which change proportionally with osmotic pressure. Osmometers in clinical use measure either freezing-point depression or vapor-pressure depression; results are expressed in milliosmolal per kilogram (mOsm/kg) units.

Freezing-Point Osmometer

Figure 5-45 illustrates the basic components of a freezing-point osmometer. The sample in a small tube is lowered into a chamber with cold refrigerant circulating from a cooling unit. A thermistor is immersed in the sample. To measure temperature, a wire is used to gently stir the sample until it is cooled to several degrees below its freezing point. It is possible to cool water to as low as -40°C and still have liquid water, provided no crystals or particulate matter are present. This is

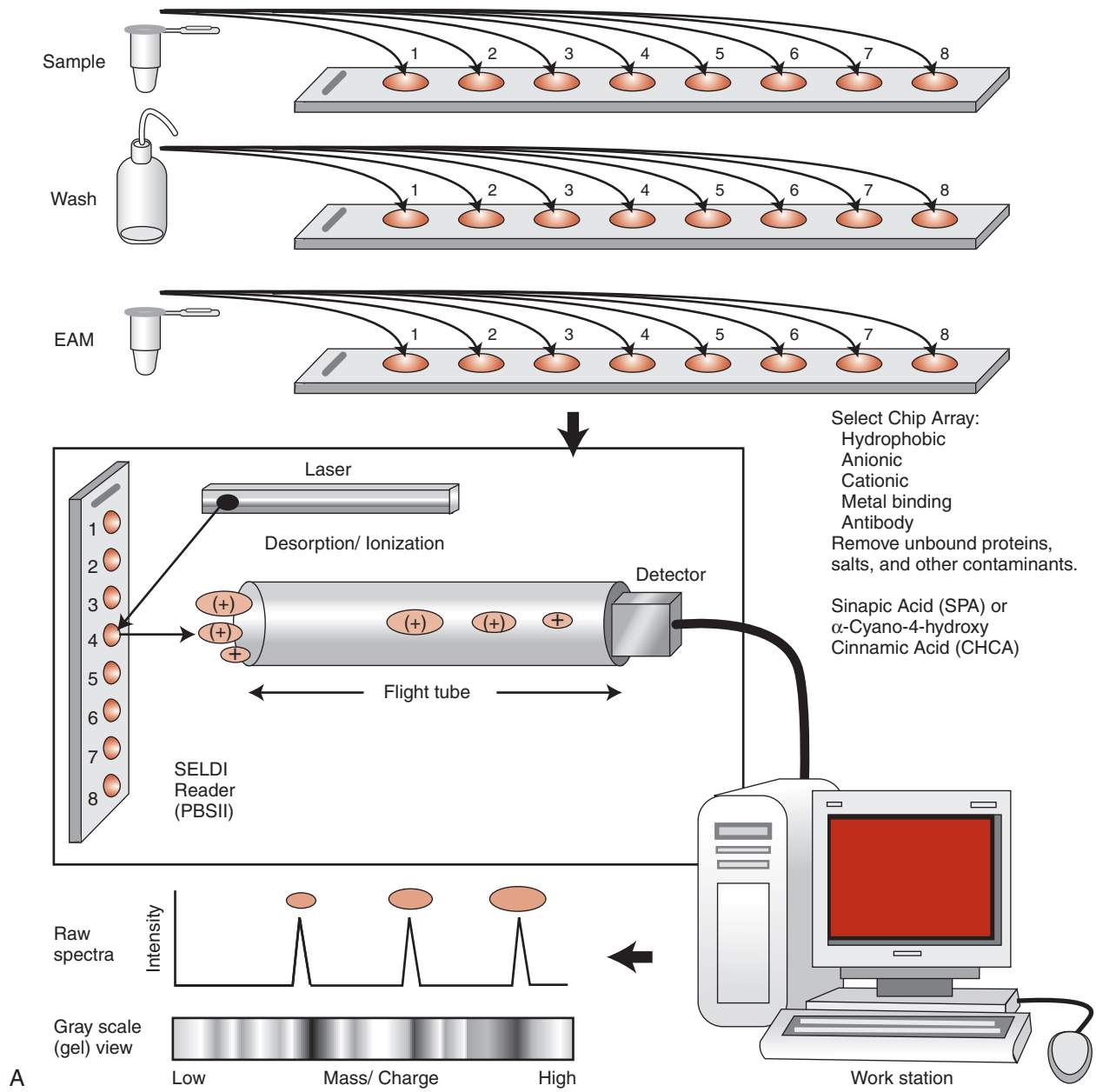
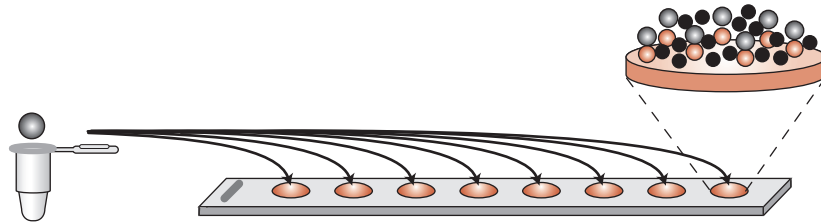

FIGURE 5-44. (A, B) Overview of the SELDI-TOF process. (Diagram courtesy of CIPHERGEN Biosystems, Fremont, Ca.) (continues)

1. Apply supernatant from CD8⁺ cells

Supernatant from stimulated and unstimulated CD8⁺ cell cultures from Normal, LTPN, and Progressors is added to a Protein Chip Array. Proteins bind to chemical or biological "docking" sites on the array surface through an affinity interaction.



2. Wash Protein Chip Array

Proteins that bind non-specifically and buffer contaminants are washed away, eliminating sample noise.

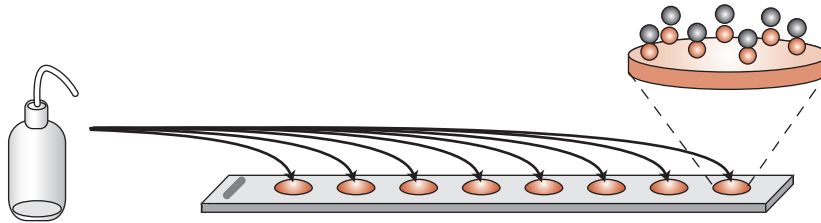

3. Add energy absorbing molecules or "matrix"

After sample processing, the array is dried and EAM is applied to each spot to facilitate desorption and ionization.

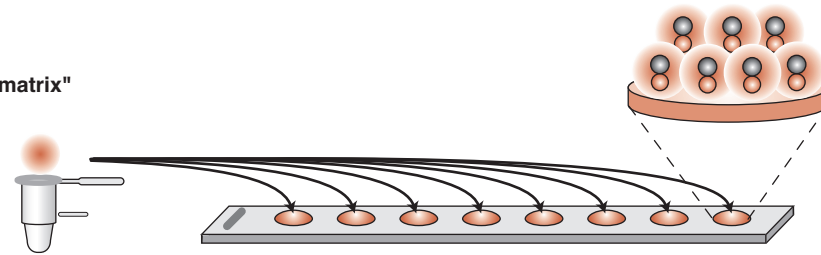

4. Analyze in a Protein Chip Reader

The proteins that are retained on the array are detected on the Protein Chip Reader.

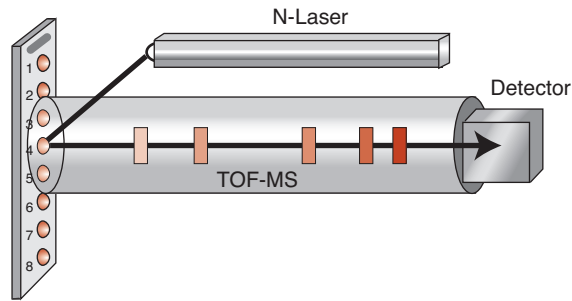

B

FIGURE 5-44. (Continued)

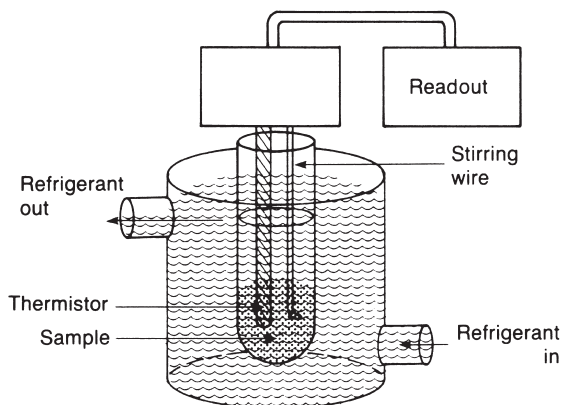

FIGURE 5-45. Freezing-point osmometer. (Reprinted with permission from Coiner D. Basic concepts in laboratory instrumentation. Bethesda, Md.: ASMT Education and Research Fund, 1975–1979.)

referred to as a supercooled solution. Vigorous agitation when the sample is supercooled results in rapid freezing. Freezing also can be started by “seeding” a supercooled solution with crystals. When the supercooled solution starts to freeze as a result of the rapid stirring, a slush is formed and the solution actually warms to its freezing-point temperature. The slush, an equilibrium of liquid and ice crystals, will remain at the freezing-point temperature until the sample freezes solid and drops below its freezing point.

Impurities in a solvent will lower the temperature at which freezing or melting occurs by reducing the bonding forces between solvent molecules so that the molecules break away from each other and exist as a fluid at a lower temperature. The decrease in the freezing-point

temperature is proportional to the number of dissolved particles present.

The thermistor is a material that has less resistance when the temperature increases. The readout uses a Wheatstone bridge circuit that detects temperature change as proportional to change in thermistor resistance. Freezing-point depression is proportional to the number of solute particles. Standards of known concentration are used to calibrate the instruments in mOsm/kg.

ANALYTIC TECHNIQUES FOR POINT-OF-CARE TESTING

Point-of-care testing (POCT) devices are widely used for a variety of clinical applications, including physician offices, emergency departments, intensive care units, and even for self-testing. Because analyses can be done at patient-side by primary caregivers, the major attraction of POCT is the reduced turnaround time needed to deliver results. In some cases, total costs can be reduced if the devices eliminate the need for laboratory-based instrumentation or if increased turnaround times lead to shorter hospital stays. POCT relies on the same analytic techniques as laboratory-based instrumentation: spectrometry, electroanalytic techniques, and chromatography. As such, the same steps needed to perform an analysis from the central laboratory are needed for POCT, including instrument validation, periodic assay calibration, quality control testing, operator training, and proficiency testing. Chapter 9 provides an in-depth discussion of this technology. The analytic techniques used in these devices are given in this section.

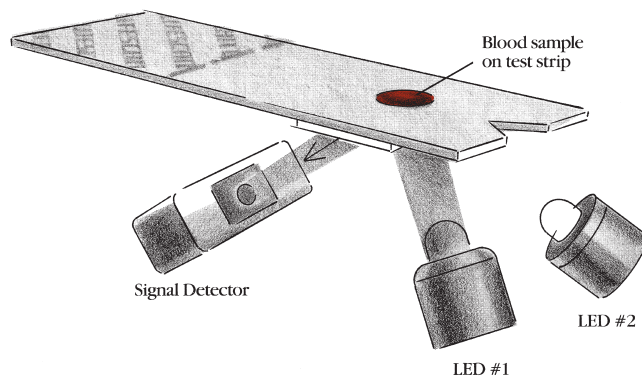

FIGURE 5-46. Dual-wavelength reflectance photometry used in point-of-care glucose monitors. A microporous hydrophilic membrane is used as a reservoir of the sample to filter out solid cellular material from the reservoir and provide a smooth, optical surface for reflectance measurements. (Figure courtesy of Lifescan Inc. One touch system technology. Challenges in diabetes management: clinical protocols for professional practice. New York, N.Y.: Health Education Technologies, 1988.)

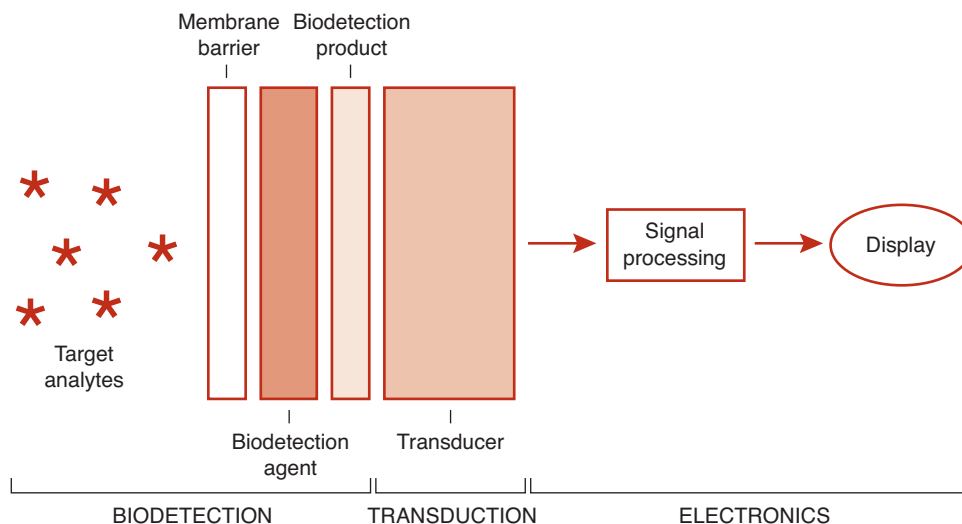

FIGURE 5-47. Schematic diagram of a biosensor. (Reprinted with permission from Rosen A. Biosensors: where do we go from here? MLO Med Lab Obs 1995;27:24.)

The most commonly used POCT devices used at bedside, in physician offices, and at home are the fingerstick blood glucose monitors. The first-generation devices use a photometric approach, whereby glucose produces hydrogen peroxide (H_2O_2) with glucose oxidase immobilized onto test strips. The H_2O_2 is coupled to peroxidase to produce a color whose intensity is measured as a function of concentration and measured using reflectance photometry. A schematic of this technique is shown in Figure 5-46. These strips are measured for glucose concentration without the need to wipe the blood off the strips.

The strip technology in a POCT platform can also be used to measure proteins and enzymes, such as cardiac markers. The separation of analytes from the matrix is accomplished by paper chromatography, in which specific antibodies immobilized onto the chromatographic surface capture the target analyte as it passes through. For qualitative analysis, detection is made by visual means. Reflectance meters similar to those used for glucose are also available for quantitative measurements.

The next generation of POCT devices use biosensors.²² A biosensor couples a specific biodeceptor, such as an enzyme, antibody, or nucleic acid probe, to a transducer for the direct measurement of a target analyte without the need to separate it from the matrix²⁴ (Fig. 5-47). The field has exploded in recent years with the development of microsilicon chip fabrication because biosensors can be miniaturized and made available at low costs. An array of biosensors can be produced onto a single silicon wafer to produce a multipanel of results, such as an electrolyte profile. Commercial POCT devices use electrochemical (e.g., microion-selective electrodes) and optical biosensors for the measurement of glucose, electrolytes, and arterial blood gases. With the immobilization of antibodies and specific DNA sequences, biosensor probes will soon be available for detection of hormones, drugs and drugs of abuse, and hard-to-culture bacteria and viruses such as *Chlamydia*, tuberculosis, or human immunodeficiency virus.²²

REFERENCES

1. Christian GD, et al. Instrumental analysis. 2nd ed. Boston, Mass.: Allyn and Bacon, 1986.
2. Willard HH, et al. Instrumental methods of analysis. Belmont, Calif.: Wadsworth, 1981.
3. Coiner D. Basic concepts in laboratory instrumentation. Bethesda, Md.: ASMT Education and Research Fund, 1975–1979.
4. Ingle JD, Crouch SR. Spectrochemical analysis. Upper Saddle River, N.J.: Prentice-Hall, 1988.
5. Holland JF, et al. Mass spectrometry on the chromatographic time scale: realistic expectations. *Anal Chem* 1983;55:997A.
6. Guilbault GG. Practical fluorescence, theory, methods and techniques. New York, N.Y.: Marcel Dekker, 1973.
7. Kricka LJ. Chemiluminescent and bioluminescent techniques. *Clin Chem* 1991;37:1472.
8. Wild D. The immunoassay handbook. London, UK: Macmillan Press, 1994.

9. Svelto O, et al. Principles of lasers. 2nd ed. New York, N.Y.: Plenum Press, 1982.
10. Coulter hematology analyzer: multidimensional leukocyte differential analysis, vol. 11 (1). Miami, Fla.: Beckman Coulter, 1989.
11. Weast RC. CRC handbook of chemistry and physics. 61st ed. Cleveland, Ohio: CRC Press, 1981.
12. Burtis CA. Tietz textbook of clinical chemistry. 2nd ed. Philadelphia, Pa.: WB Saunders, 1993.
13. Heiger DN. High-performance capillary electrophoresis: an introduction. 2nd ed. Waldbronn, Germany: Hewlett-Packard, 1992.
14. Monnig CA, Kennedy RT. Capillary electrophoresis. *Anal Chem* 1994;66:280R.
15. Parris NA. Instrumental liquid chromatography: a practical manual on high performance liquid chromatographic methods. New York, N.Y.: Elsevier, 1976.
16. Jurk H. Thin-layer chromatography. reagents and detection methods, vol. 1a. Weinheim, Germany: Verlagsgesellschaft, 1990.
17. Bender GT. Chemical instrumentation: a laboratory manual based on clinical chemistry. Philadelphia, Pa.: WB Saunders, 1972.
18. Horváth C. High performance liquid chromatography, advances and perspectives. New York, N.Y.: Academic Press, 1980.
19. Constantine E, et al. Mass spectrometry. New York, N.Y.: Ellis Horwood, 1990.
20. Kebarle E, Liang T. From ions in solution to ions in the gas phase. *Anal Chem* 1993;65:972A.
21. Karasek FW, Clement RE. Basic gas chromatography: mass spectrometry. New York, N.Y.: Elsevier, 1988.
22. Levine, B. Principles of forensic toxicology. Washington, D.C.: AACC Press, 2006.
23. Siuzdak, G. The expanding role of mass spectrometry in biotechnology. San Diego: MCC Press, 2006.
24. Rosen A. Biosensors: where do we go from here? *MLO Med Lab Obs* 1995;27:24.

Principles of Clinical Chemistry Automation

William L. Roberts

CHAPTER

6

CHAPTER OUTLINE

- HISTORY OF AUTOMATED ANALYZERS
- DRIVING FORCES TOWARD MORE AUTOMATION
- BASIC APPROACHES TO AUTOMATION
- STEPS IN AUTOMATED ANALYSIS
 - Specimen Preparation and Identification
 - Specimen Measurement and Delivery
 - Reagent Systems and Delivery
 - Chemical Reaction Phase
 - Measurement Phase
 - Signal Processing and Data Handling
- SELECTION OF AUTOMATED ANALYZERS
- TOTAL LABORATORY AUTOMATION
 - Preanalytic Phase (Sample Processing)
 - Analytic Phase (Chemical Analyses)
 - Postanalytic Phase (Data Management)
- FUTURE TRENDS IN AUTOMATION
- REFERENCES

The modern clinical chemistry laboratory uses a high degree of automation. Many steps in the analytic process that were previously performed manually can now be performed automatically, permitting the operator to focus on tasks that cannot be readily automated and increasing both efficiency and capacity. The analytic process can be divided into three major phases—preanalytic, analytic, and postanalytic—corresponding to sample processing, chemical analysis, and data management, respectively. Substantial improvements have occurred in all three areas during the past decade. Seven major diagnostics vendors sell automated analyzers and reagents. These vendors are continually refining their products to make them more functional and user friendly. The analytic phase is the most automated, and more research and development efforts are focusing on increasing automation of the preanalytic and postanalytic processes.

HISTORY OF AUTOMATED ANALYZERS

Following the introduction of the first automated analyzer by Technicon in 1957, automated instruments proliferated from many manufacturers.¹ This first “AutoAnalyzer” (AA) was a continuous-flow, single-channel, sequential batch analyzer capable of providing a single test result on approximately 40 samples per hour. The next generation of Technicon instruments to be developed was the Simultaneous Multiple Analyzer

(SMA) series. SMA-6 and SMA-12 were analyzers with multiple channels (for different tests), working synchronously to produce 6 or 12 test results simultaneously at the rate of 360 or 720 tests per hour. It was not until the mid-1960s that these continuous-flow analyzers had any significant competition in the marketplace.

In 1970, the first commercial centrifugal analyzer was introduced as a spin-off technology from NASA outer space research. Dr. Norman Anderson developed a prototype in 1967 at the Oak Ridge National Laboratory as an alternative to continuous-flow technology, which had significant carry over problems and costly reagent waste. He wanted to perform analyses in parallel and also take advantage of advances in computer technology. The second generation of these instruments (1975) was more successful as a result of miniaturization of computers and advances in the polymer industry for high-grade, optical plastic cuvetts.

The next major development that revolutionized clinical chemistry instrumentation occurred in 1970 with the introduction of the Automatic Clinical Analyzer (ACA) (DuPont [now Siemens]). It was the first non-continuous flow, discrete analyzer as well as the first instrument to have **random access** capabilities, whereby stat specimens could be analyzed out of sequence from the batch as needed. Plastic test packs, positive patient identification, and infrequent calibration were among the unique features of the ACA. Other major milestones were the introduction of thin film analysis technology in

1976 and the production of the Kodak Ektachem (now Vitros) Analyzer (now Ortho-Clinical Diagnostics) in 1978. This instrument was the first to use microsample volumes and reagents on slides for dry chemistry analysis and to incorporate computer technology extensively into its design and use.

Since 1980, several primarily discrete analyzers have been developed that incorporate such characteristics as ion-selective electrodes (ISEs), fiberoptics, polychromatic analysis, continually more sophisticated computer hardware and software for data handling, and larger test menus. The popular and more successful analyzers using these and other technologies since 1980 are Astra (now Synchron) analyzers (Beckman Coulter), which extensively used ISEs; Paramax (no longer available), which introduced primary tube sampling; and the Hitachi analyzers (Boehringer Mannheim, now Roche Diagnostics), with reusable reaction disks and fixed diode arrays for spectral mapping. Automated systems that are commonly used in clinical chemistry laboratories today are Aeroset and ARCHITECT analyzers (Abbott Laboratories), Advia analyzers (Siemens), Synchron analyzers (Beckman Coulter), Dimension analyzers (Siemens), AU analyzers (Olympus), Vitros analyzers (Ortho-Clinical Diagnostics), and several Roche analyzer lines.

Many manufacturers of these instrument systems have adopted the more successful features and technologies of other instruments, where possible, to make each generation of their product more competitive in the marketplace. The differences among the manufacturers' instruments, operating principles, and technologies are less distinct now than they were in the beginning years of laboratory automation.

DRIVING FORCES TOWARD MORE AUTOMATION

Since 1995, the pace of changes with current routine chemistry analyzers and the introduction of new ones has slowed considerably, compared with the first half of the 1990s. Certainly, analyzers are faster and easier to use as a result of continual re-engineering and electronic refinements. Methods are more precise, sensitive, and specific, although some of the same principles are found in today's instruments as in earlier models. Manufacturers have worked successfully toward automation with "walk-away" capabilities and minimal operator intervention.² Manufacturers have also responded to the physicians' desire to bring laboratory testing to the patient. The introduction of small, portable, easy-to-operate benchtop analyzers in physician office laboratories (POLs), as well as in surgical and critical care units that demand immediate laboratory results, has resulted in a hugely successful domain of point-of-care (POC) analyzers.³ Another special area with a rapidly developing arsenal of analyzers

is immunochemistry. Immunologic techniques for assaying drugs, specific proteins, tumor markers, and hormones have evolved to an increased level of automation. Instruments that use techniques such as fluorescence-polarization immunoassay (FPIA), nephelometry, and competitive and noncompetitive immunoassay with chemiluminescent detection have become popular in laboratories.

The most recent milestone in chemistry analyzer development has been the combination of chemistry and immunoassay into a single **modular analyzer**. The Dimension RxL analyzer with a heterogeneous immunoassay module was introduced in 1997. This design permits further workstation consolidation with consequent improvements in operational efficiency and further reductions in turnaround time. Modular analyzers combining chemistry and immunoassay capabilities are now available from several vendors (Fig. 6-1).

Other forces are also driving the market toward more focused automation. Higher volume of testing and faster turnaround time have resulted in fewer and more centralized core laboratories performing more comprehensive testing.⁴ The use of laboratory panels or profiles has declined, with more diagnostically directed individual tests as dictated by recent policy changes from Medicare and Medicaid. Researchers have known for many years that chemistry panels only occasionally lead to new diagnoses in patients who appear healthy.⁵ The expectation of quality results with higher accuracy and precision is ever present with the regulatory standards set by the Clinical Laboratory Improvement Amendments (CLIA), The Joint Commission (TJC) (formerly the Joint Commission on

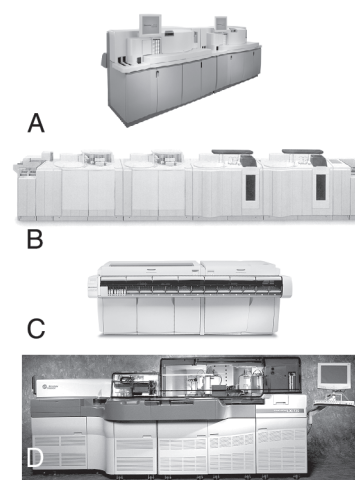

FIGURE 6-1. Modular chemistry/immunoassay analyzers. **(A)** Siemens Dimension Vista 3000T. (Photograph courtesy of Siemens.) **(B)** Roche MODULAR ANALYTICS. (Photograph courtesy of Roche Diagnostics.) **(C)** Abbott ARCHITECT ci8200. (Photograph courtesy of Abbott Diagnostics.) **(D)** Beckman Coulter Synchron LXi 725. (Photograph courtesy of Beckman Coulter.)

Accreditation of Healthcare Organizations [JCAHO]), the College of American Pathologists (CAP), and others. Intense competition among instrument manufacturers has driven automation into more sophisticated analyzers with creative technologies and unique features. Furthermore, escalating costs have spurred health care reform and, more specifically, managed care and capitation environments within which laboratories are forced to operate.

BASIC APPROACHES TO AUTOMATION

There are many advantages to automating procedures. One purpose is to increase the number of tests performed by one laboratorian in a given period. Labor is an expensive commodity in clinical laboratories. Through mechanization, the labor component devoted to any single test is minimized and this effectively lowers the cost per test. A second purpose is to minimize the variation in results from one laboratorian to another. By reproducing the components in a procedure as identically as possible, the coefficient of variation is lowered and reproducibility is increased. Accuracy is then not dependent on the skill or workload of a particular operator on a particular day. This allows better comparison of results from day to day and week to week. Automation, however, cannot correct for deficiencies inherent in methodology. A third advantage is gained because automation eliminates the potential errors of manual analyses such as volumetric pipetting steps, calculation of results, and transcription of results. A fourth advantage accrues because instruments can use very small amounts of samples and reagents. This allows less blood to be drawn from each patient. In addition, the use of small amounts of reagents decreases the cost of consumables.

There are three basic approaches with instruments: continuous flow, centrifugal analysis, and discrete analysis. All three can use batch analysis (i.e., large number of specimens in one run), but only discrete analyzers offer random access, or stat, capabilities.

In **continuous flow**, liquids (reagents, diluents, and samples) are pumped through a system of continuous tubing. Samples are introduced in a sequential manner, following each other through the same network. A series of air bubbles at regular intervals serve as separating and cleaning media. Continuous flow, therefore, resolves the major consideration of uniformity in performance of tests because each sample follows the same reaction path. Continuous flow also assists the laboratory that needs to run many samples requiring the same procedure. The more sophisticated continuous-flow analyzers used parallel single channels to run multiple tests on each sample—for example, SMA and SMAC. The major drawbacks that contributed to the eventual demise of traditional continuous-flow analyzers (i.e., AA, SMA, and SMAC) in the marketplace were significant carry-over

problems and wasteful use of continuously flowing reagents. Technicon's answer to these problems was a non-continuous-flow discrete analyzer (the RA1000), using random-access fluid (a hydrofluorocarbon liquid to reduce surface tension between samples/reagents and their tubing) and, thereby, reducing carry over. Later, the Chem 1 was developed by Technicon to use Teflon tubing and Teflon oil, virtually eliminating carry over problems. The Chem 1 was a continuous-flow analyzer but only remotely comparable to the original continuous-flow principle.

Centrifugal analysis uses the force generated by centrifugation to transfer and then contain liquids in separate cuvetts for measurement at the perimeter of a spinning **rotor**. Centrifugal analyzers are most capable of running multiple samples, one test at a time, in a batch. Batch analysis is their major advantage because reactions in all cuvetts are read virtually simultaneously, taking no longer to run a full rotor of about 30 samples than it would take to run a few. Laboratories with a high workload of individual tests for routine batch analysis may use these instruments. Again, each cuvet must be uniformly matched to each other to maintain quality handling of each sample. The Cobas-Bio (Roche Diagnostics), with a xenon flash lamp and longitudinal cuvetts,⁶ and the IL Monarch, with a fully integrated walk-away design, are two of the more successful centrifugal analyzers.

Discrete analysis is the separation of each sample and accompanying reagents in a separate container. Discrete analyzers have the capability of running multiple tests one sample at a time or multiple samples one test at a time. They are the most popular and versatile analyzers and have almost completely replaced continuous-flow and centrifugal analyzers. However, because each sample is in a separate reaction container, uniformity of quality must be maintained in each cuvet so that a particular sample's quality is not affected by the particular space that it occupies. The analyzers listed in Table 6-1 are examples of current discrete analyzers with random access capabilities.

STEPS IN AUTOMATED ANALYSIS

In clinical chemistry, **automation** is the mechanization of the steps in a procedure. Manufacturers design their instruments to mimic manual techniques. The major processes performed by an automated analyzer can be divided into specimen identification and preparation, chemical reaction, and data collection and analysis. An overview of these processes is provided in Table 6-2.

Each step of automated analysis is explained in this section, and several different applications are discussed. Several instruments have been chosen because they have components that represent either common features used in chemistry instrumentation or a unique

TABLE 6-1 SUMMARY OF FEATURES FOR SELECTED CLINICAL CHEMISTRY ANALYZERS

| | ABBOTT DIAGNOSTICS AEROSET | BAYER ADVIA 1650 | BECKMAN COULTER SYNCHRON LX 20 PRO | DADE BEHRING DIMENSION RXL | OLYMPUS AMERICA AU640 | ORTHO- CLINICAL DIAGNOSTICS VITROS 950 | ROCHE COBAS INTEGRA 800 | ROCHE DIAGNOSTICS MODULAR ANALYTICS P MODULE |
|--|----------------------------------|------------------------|---|-------------------------------------|-----------------------------|---|----------------------------------|--|
| First year sold in United States | 1998 | 1999 | 2001 | 1997 | 2002 | 1995 | 2001 | 1998 |
| Throughput (tests per hour, depends on test mix) | 1,600 | 600–1200 | 360–540 | 288–500 | 800 | 600–700 | 472–708 | 600–1,200 |
| No. of assays onboard simultaneously | 59 | 49 | 41/71 | 48/95 | 51 | 75 | 72 | 47 |
| No. of open channels | 100 | 62 | 41/71 | 10 | 95 | Closed system | Utility channels available | 5 |
| No. of ion-selective electrode channels | 3 | 3 | 5 | 4 | 3 | 3 | 4 | 3 |
| Minimum sample volume aspirated | 2 uL | 2 uL | 3 uL | 2 uL | 1 uL | 6 uL | 2 uL | 2 uL |
| Pediatric sample cup dead volume | 50 uL | 50 uL | 40 uL | 20 uL | Not available | 30 uL | 50 uL | 50 uL |
| Primary tube cap piercing | No | No | Yes | No | No | No | No | No |
| Minimum final reaction volume | 160 uL | 80 uL | 210 uL | 350 uL | 150 uL | Not applicable | 200 uL | 180 uL |
| Short sample detection | Yes | Yes | Yes | Yes | Yes | Yes | Yes | Yes |
| Clot detection | No | Yes | Yes | Yes | Yes | Yes | Yes | No |
| Index measurements | Yes | Yes | Yes | No | Yes | No | No | Yes |
| Automatic patient sample dilution and retest | Yes | Yes | Yes | Yes | Yes | No | Yes | Yes |
| Onboard test automatic inventory | Yes | Yes | Yes | Yes | Yes | Yes | Yes | Yes |
| Remote troubleshooting by modem | No | Yes | Yes | Yes | Yes | No | Yes | Yes |

Information obtained from Aller RD. Chemistry analyzers branching out. CAP Today 2002;July:84–106 and directly from vendors.

TABLE 6-2 SUMMARY OF CHEMISTRY ANALYZER OPERATIONS

| IDENTIFICATION AND PREPARATION | |
|--|---|
| 1. Sample identification | This is usually done by reading the bar code. This information can be entered manually. |
| 2. Determine test(s) to perform | The LIS communicates to the analyzer which test(s) have been ordered. |
| CHEMICAL REACTION | |
| 3. Reagent systems and delivery | One or more reagents can be dispensed into the reaction cuvet. |
| 4. Specimen measurement and delivery | A small aliquot of the sample is introduced into the reaction cuvet. |
| 5. Chemical reaction phase | The sample and reagents are mixed and incubated. |
| DATA COLLECTION AND ANALYSIS | |
| 6. Measurement phase | Optical readings may be initiated before or after all reagents have been added. |
| 7. Signal processing and data handling | The analyte concentration is estimated from a calibration curve that is stored in the analyzer. |
| 8. Send result(s) to LIS | The analyzer communicates results for the ordered tests to the LIS. |

Operations generally occur in the order listed from 1 to 8. However, there may be slight variations in the order. Some steps may be deleted or duplicated. Most analyzers have the capability to dilute the sample and repeat the testing process if the analyte concentration exceeds the linear range of the assay.

method of automating a step in a procedure. None of the representative instruments is completely described, but rather the important components are described in the text as examples.

Specimen Preparation and Identification

Preparation of the sample for analysis has been and remains a manual process in most laboratories. The clotting time (if using serum), centrifugation, and the transferring of the sample to an analyzer cup (unless using primary tube sampling) cause delay and expense in the testing process. One alternative to manual preparation is to automate this process by using **robotics**, or front-end automation, to “handle” the specimen through these steps and load the specimen onto the analyzer. Another option is to bypass the specimen preparation altogether by using whole blood for analysis—for example, Abbott-Vision. Robotics for specimen preparation has already become a reality in some clinical laboratories in the United States and other countries. Another approach is to use a plasma separator tube and perform primary tube sampling with heparin plasma. This eliminates the need both to wait for the sample to clot and to aliquot the sample. More discussion about preanalytic specimen processing, or front-end automation, appears later in this chapter.

The sample must be properly identified and its location in the analyzer must be monitored throughout the test. The simplest means of identifying a sample is by placing a manually labeled sample cup in a numbered analysis position on the analyzer, in accordance with a manually prepared worksheet or a computer-generated

load list. The most sophisticated approach that is commonly used today employs a **bar code** label affixed to the primary collection tube. This label contains patient demographics and also may include test requests.

The bar code–labeled tubes are then transferred to the loading zone of the analyzer, where the bar code is scanned and the information is stored in the computer’s memory. The analyzer is then capable of monitoring all functions of identification, test orders and parameters, and sample position. Certain analyzers may take test requests downloaded from the laboratory information system and run them when the appropriate sample is identified and ready to be pipetted.

Specimen Measurement and Delivery

Most instruments use either circular carousels or rectangular racks as specimen containers for holding disposable sample cups or primary sample tubes in the loading or pipetting zone of the analyzer. These cups or tubes hold standards, controls, and patient specimens to be pipetted into the reaction chambers of the analyzers. The slots in the trays or racks are usually numbered to aid in sample identification. The trays or racks move automatically in one-position steps at preselected speeds. The speed determines the number of specimens to be analyzed per hour. As a convenience, the instrument can determine the slot number containing the last sample and terminate the analysis after that sample. The instrument’s microprocessor holds the number of samples in memory and aspirates only in positions containing samples.

On the Vitros analyzer, sample cup trays are quadrants that hold 10 samples each in cups with conical bottoms.

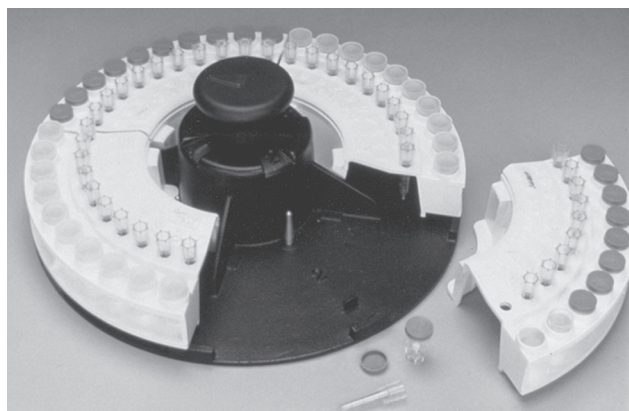

FIGURE 6-2. Vitros. The four quadrant trays, each holding ten samples, fit on a tray carrier. (Photograph courtesy of Ortho-Clinical Diagnostics.)

The four quadrants fit on a tray carrier (Fig. 6-2). Although the tray carrier accommodates only 40 samples, more trays of samples can be programmed and then loaded in place of completed trays while tests on other trays are in progress. A disposable sample tip is hand-loaded adjacent to each sample cup on the tray. Roche/Hitachi analyzers can use five-position racks to hold samples (Fig. 6-3). A modular analyzer can accommodate as many as 60 of these racks at one time.

Nearly all contemporary chemistry analyzers sample from primary collection tubes, or for limited volume samples, there are microsample tubes. The tubes are placed in either racks or carousels. Bar code labels for each sample, which include the patient name and identification number, can be printed on demand by the operator (Fig. 6-4). This allows samples to be loaded in any order. The Dimension analyzers make use of a continuous belt of flexible, disposable plastic cuvetts carried through the analyzer's water bath on a main drive track. The cuvetts are loaded onto the analyzer from a continuous

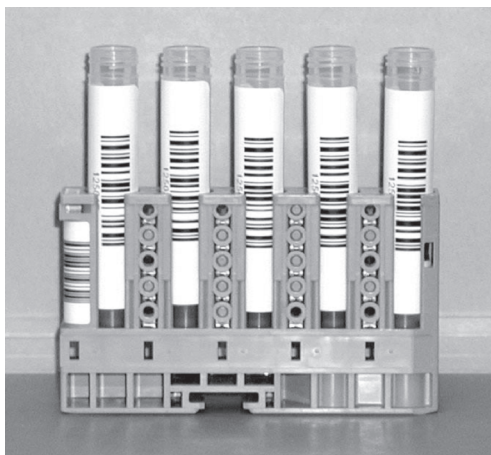

FIGURE 6-3. Roche/Hitachi five-position rack.



FIGURE 6-4. Sample collection tubes are identified with bar code labels. (Photograph courtesy of Dade International.)

spool. These cuvetts index through the instrument at the rate of one every 5 seconds and are cut into sections or groups as required. A schematic of the Dimension RxL cuvet production and reading system is shown in Figure 6-5. Exposure of the sample to air can lead to sample evaporation and produce errors in analysis. Evaporation of the sample may be significant and may cause the concentration of the constituents being analyzed to rise 50% in 4 hours.⁷ With instruments measuring electrolytes, the carbon dioxide present in the samples will be lost to the atmosphere, resulting in low carbon dioxide values. Manufacturers have devised a variety of mechanisms to minimize this effect—for example, lid covers for trays and individual caps that can be pierced, which includes **closed tube sampling** from primary collection tubes.⁸

The actual measurement of each aliquot for each test must be very accurate. This is generally done through aspiration of the sample into a **probe**. When the discrete instrument is in operation, the probe automatically dips into each sample cup and aspirates a portion of the liquid. After a preset, computer-controlled time interval, the probe quickly rises from the cup. Sampling probes on instruments using specific sampling cups are programmed or adjusted to reach a prescribed depth in those cups to maximize use of available sample. Those analyzers capable of aspirating sample from primary collection tubes usually have a parallel liquid level-sensing probe that will control entry of the sampling probe to a minimal depth below the surface of the serum, allowing full aliquot aspiration while avoiding clogging of the probe with serum separator gel or clot (Fig. 6-6).

In continuous-flow analyzers, when the sample probe rises from the cup, air is aspirated for a specified time to produce a bubble in between sample and reagent plugs of liquid. Then the probe descends into a container where wash solution is drawn into the probe and through the

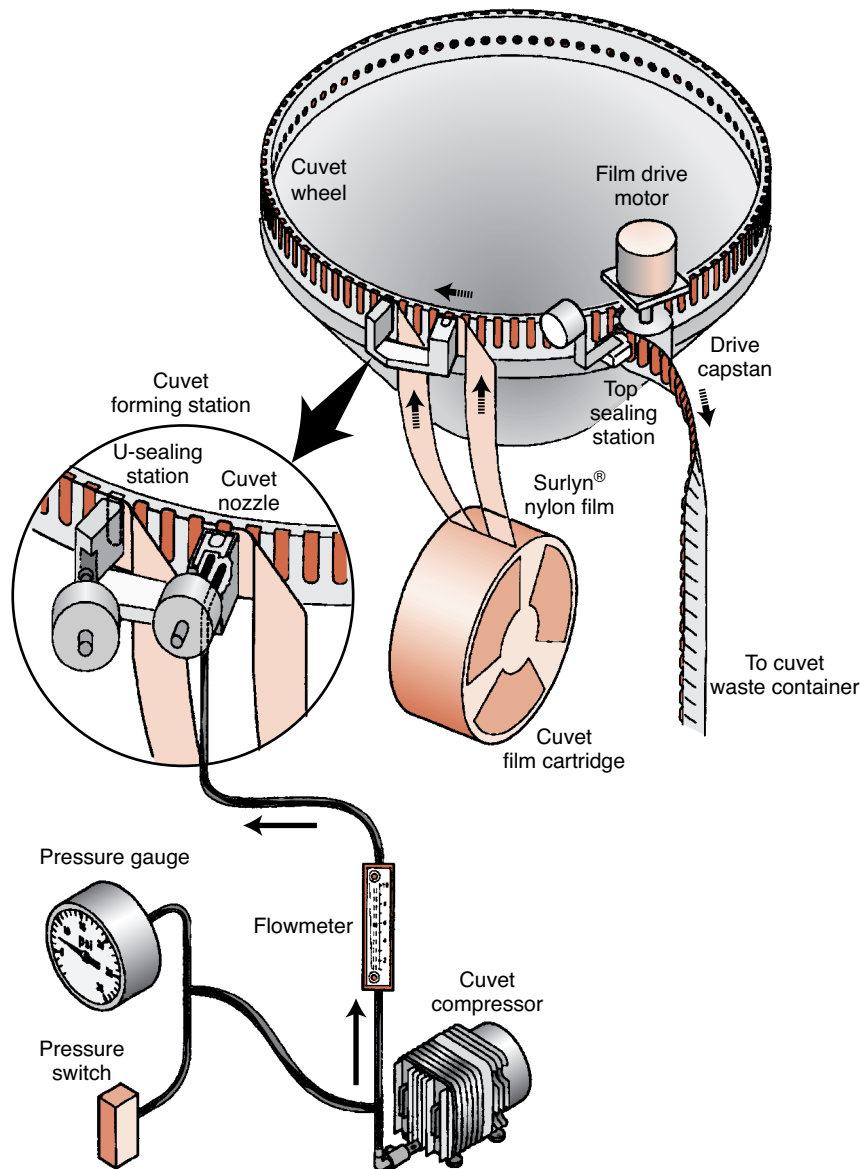

FIGURE 6-5. Analyzer production system for sealed cuvetts. (Photograph courtesy of Siemens.)

system. The wash solution is usually deionized water, possibly with a surfactant added. Remembering that all samples follow the same reaction path, the necessity for the wash solution between samples becomes obvious. Immersion of the probe into the wash reservoir cleanses the outside, whereas aspiration of an aliquot of solution cleanses the lumen. The reservoir is continually replenished with an excess of fresh solution. The wash aliquot, plus the previously mentioned air bubble, maintains sample integrity and minimizes sample carry over.

Certain pipettors use a disposable tip and an air-displacement syringe to measure and deliver reagent. When this is used, the pipettor may be reprogrammed to measure sample and reagent for batches of different tests comparatively easily. Besides eliminating the effort of

priming the reagent delivery system with the new solution, no reagent is wasted or contaminated because nothing but the pipet tip contacts it.

The cleaning of the probe and tubing after each dispensing to minimize the carry over of one sample into the next is a concern for many instruments. In some systems, the reagent or diluent is also dispersed into the cuvet through the same tubing and probe. Deionized water may be dispensed into the cuvet after the sample to produce a specified dilution of the sample and also to rinse the dispensing system. In the Technicon (now Siemens) RA1000, a random-access fluid is the separation medium. The fluorocarbon fluid is a viscous, inert, immiscible, nonwetting substance that coats the delivery system. The coating on the sides of the delivery system

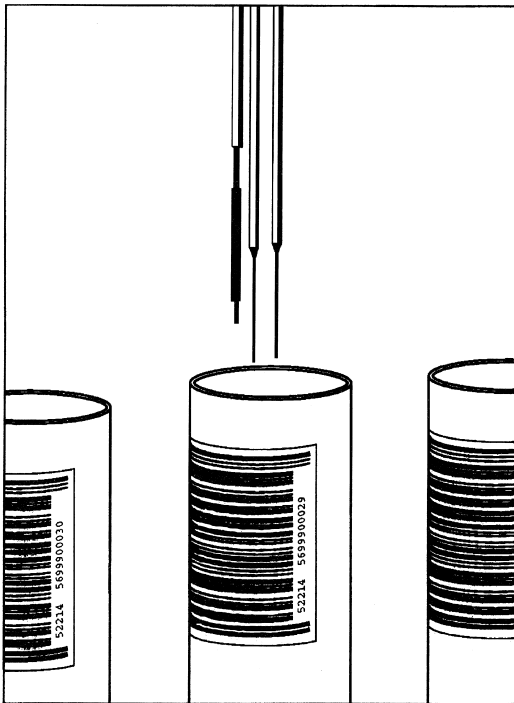

FIGURE 6-6. Dual sample probes of a chemistry analyzer. Note the liquid level sensor to the left of probes. (Photograph courtesy of Boehringer Mannheim.)

prevents carry over due to the wetting of the surfaces and, forming a plug of the solution between samples, prevents carry over by diffusion. A small amount (10 μL) of this fluid is dispensed into the cuvet with the sample. Surface tension leaves a coating of the fluid in the dispensing system.

If a separate probe or tip is used for each sample and discarded after use, as in the Vitros, the issue of carry-over is a moot point. Vitros has a unique sample-dispensing system. A proboscis presses into a tip on the sample tray, picks it up, and moves over the specimen to aspirate the volume required for the tests programmed for that sample. The tip is then moved over to the slide-metering block.

When a slide is in position to receive an aliquot, the proboscis is lowered so that a dispensed 10- μL drop touches the slide, where it is absorbed from the nonwetting tip. A stepper motor-driven piston controls aspiration and drop formation. The precision of dispensing is specified at $\pm 5\%$.

In several discrete systems, the probe is attached by means of nonwettable tubing to precision syringes. The syringes draw a specified amount of sample into the probe and tubing. Then the probe is positioned over a cuvet, into which the sample is dispensed. The Hitachi 736 used two sample probes to simultaneously aspirate a double volume of sample in each probe immersed in one specimen container and, thereby, deliver sample into four individual test channels, all in one operational step (Fig. 6-7). The loaded probes pass through a fine mist shower bath before delivery to wash off any sample residue adhering to the outer surface of the probes. After delivery, the probes move to a rinse bath for cleaning the inside and outside surfaces of the probes.

Many chemistry analyzers use computer-controlled stepping motors to drive both the sampling and washout syringes. Every few seconds, the sampling probe enters a specimen container, withdraws the required volume, moves to the cuvet, and dispenses the aliquot with a volume of water to wash the probe. The washout volume is adjusted to yield the final reaction volume. If a procedure's range of linearity is exceeded, the system will retrieve the original sample tube, repeat the test using one fourth the original sample volume for the repeat test, and calculate a new result, taking the dilution into consideration.

Economy of sample size is a major consideration in developing automated procedures, but methodologies have limitations to maintain proper levels of sensitivity and specificity. The factors governing sample and reagent measurement are interdependent. Generally, if sample size is reduced, then either the size of the reaction cuvet and final reaction volume must be decreased or the reagent concentration must be increased to ensure sufficient color development for accurate photometric readings.

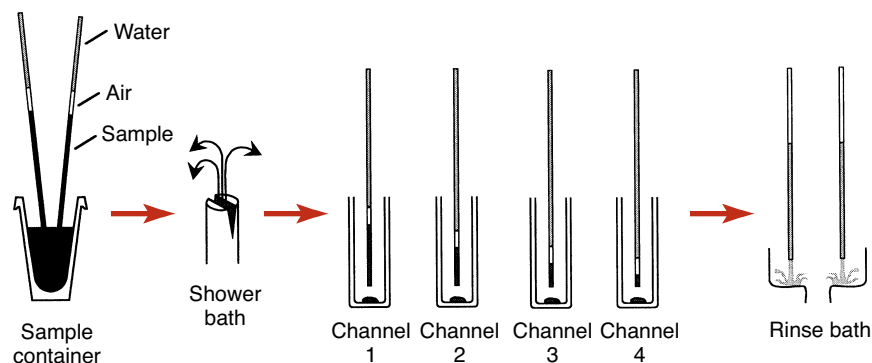

FIGURE 6-7. Sampling operation of the Hitachi 736 analyzer. (Courtesy of Boehringer Mannheim.)

Reagent Systems and Delivery

Reagents may be classified as liquid or dry systems for use with automated analyzers. Liquid reagents may be purchased in bulk volume containers or in unit dose packaging as a convenience for stat testing on some analyzers. Dry reagents are packaged in various forms. They may be bottled as lyophilized powder, which requires reconstitution with water or a buffer. Unless the manufacturer provides the diluent, the water quality available in the laboratory is important. A second and unique type of dry reagent is the multilayered **dry chemistry slide** for the Vitros analyzer. These slides have microscopically thin layers of dry reagents mounted on a plastic support. The slides are approximately the size of a postage stamp and not much thicker.

Reagent handling varies according to instrument capabilities and methodologies. Many test procedures use sensitive, short-lived working reagents; so contemporary analyzers use a variety of techniques to preserve them. One technique is to keep all reagents refrigerated until the moment of need and then quickly preincubate them to reaction temperature or store them in a refrigerated compartment on the analyzer that feeds directly to the dispensing area. Another means of preservation is to provide reagents in a dried, tablet form and reconstitute them when the test is to be run. A third is to manufacture the reagent in two stable components that will be combined at the moment of reaction. If this approach is used, the first component also may be used as a diluent for the sample. The various manufacturers often use combinations of these reagent-handling techniques.

Reagents also must be dispensed and measured accurately. Many instruments use bulk reagents to decrease the preparation and changing of reagents. Instruments that do not use bulk reagents have unique reagent packaging. In continuous-flow analyzers, reagents and diluents are supplied from bulk containers into which tubing is suspended. The inside diameter, or bore, of the tubing governs the amount of fluid that will be dispensed. A proportioning pump, along with a manifold, continuously and precisely introduces, proportions, and pumps liquids and air bubbles throughout the continuous-flow system.

To deliver reagents, many discrete analyzers use techniques similar to those used to measure and deliver the samples. Syringes, driven by a stepping motor, pipet the reagents into reaction containers. Piston-driven pumps, connected by tubing, may also dispense reagents. Another technique for delivering reagents to reaction containers uses pressurized reagent bottles connected by tubing to dispensing valves. The computer controls the opening and closing of the valves. The fill volume of reagent into the reaction container is determined by the precise amount of time the valve remains open.

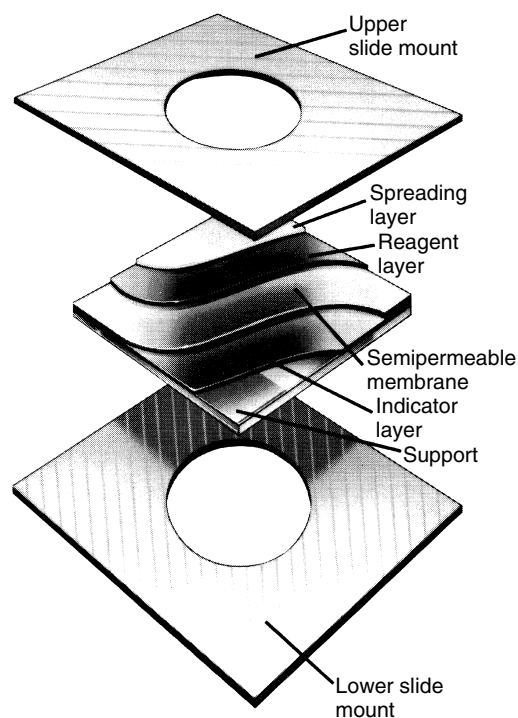

FIGURE 6-8. Vitros slide with multiple layers contains the entire reagent chemistry system. (Courtesy of Ortho-Clinical Diagnostics.)

The Vitros analyzers use slides to contain their entire reagent chemistry system. Multiple layers on the slide are backed by a clear polyester support. The coating itself is sandwiched in a plastic mount. There are three or more layers: (1) a spreading layer, which accepts the sample; (2) one or more central layers, which can alter the aliquot; and (3) an indicator layer, where the analyte of interest may be quantified (Fig. 6-8). The number of layers varies depending on the assay to be performed. The color developed in the indicator layer varies with the concentration of the analyte in the sample. Physical or chemical reactions can occur in one layer, with the product of these reactions proceeding to another layer, where subsequent reactions can occur. Each layer may offer a unique environment and the possibility to carry out a reaction comparable to that offered in a chemistry assay or it may promote an entirely different activity that does not occur in the liquid phase. The ability to create multiple reaction sites allows the possibility of manipulating and detecting compounds in ways not possible in solution chemistries. Interfering materials can be left behind or altered in upper layers.

Chemical Reaction Phase

This phase consists of mixing, separation, incubation, and reaction time. In most discrete analyzers, the chemical reactants are held in individual moving containers that are either disposable or reusable. These reaction containers

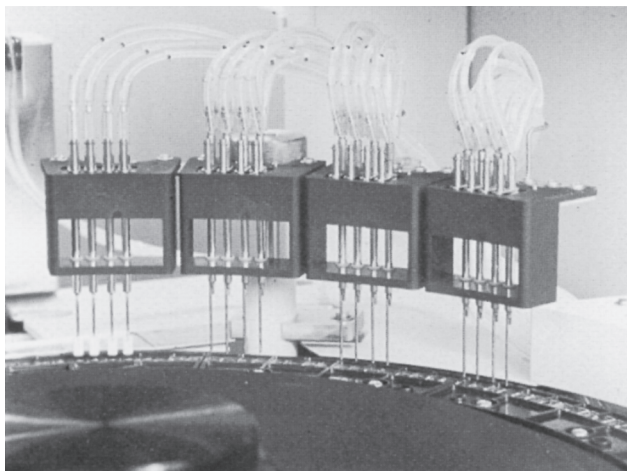

FIGURE 6-9. Wash stations on a chemistry analyzer perform the following: **(1)** aspirate reaction waste and dispense water; **(2)** aspirate and dispense rinse water; **(3)** aspirate rinse water and dispense water for measurement of cell blank; and **(4)** aspirate cell blank water to dryness. (Photograph courtesy of Boehringer Mannheim.)

also function as the cuvetts for optical analysis. If the cuvetts are reusable, then wash stations are set up immediately after the read stations to clean and dry these containers (Fig. 6-9). This arrangement allows the analyzer to operate continuously without replacing cuvetts. Examples of this approach include Advia (Siemens), Aeroset (Abbott Laboratories), Hitachi (Roche Diagnostics), AU (Olympus), and Synchron (Beckman Coulter) analyzers. Alternatively, the reactants may be placed in a stationary reaction chamber (e.g., Astra) in which a flow-through process of the reaction mixture occurs before and after the optical reading.

Mixing

A vital component of each procedure is the adequate mixing of the reagents and sample. Instrument manufacturers go to great lengths to ensure complete mixing. Nonuniform mixtures can result in noise in continuous-flow analysis and in poor precision in discrete analysis.

Mixing was accomplished in continuous-flow analyzers (e.g., the Chem 1) through the use of coiled tubing. When the reagent and sample stream go through coiled loops, the liquid rotates and tumbles in each loop. The differential rate of liquids falling through one another produces mixing in the coil.

RA1000 used a rapid start–stop action of the reaction tray. This causes a sloshing action against the walls of the cuvetts, which mixes the components. Centrifugal analyzers may use a start–stop sequence of rotation or bubbling of air through the sample and reagent to mix them while these solutions are moving from transfer disk to rotor. This process of transferring and mixing occurs in just a few seconds. The centrifugal force is responsible

for the mixing as it pushes sample from its compartment, over a partition into a reagent-filled compartment and, finally, into the cuvet space at the perimeter of the rotor.

In the Vitros slide technology, the spreading layer provides a structure that permits a rapid and uniform spreading of the sample over the reagent layer(s) for even color development.

Most automated wet chemistry analyzers use stirring paddles that dip into the reaction container for a few seconds to stir sample and reagents, after which they return to a wash reservoir (Fig. 6-10). Other instruments use forceful dispensing to accomplish mixing.

Separation

In chemical reactions, undesirable constituents that will interfere with an analysis may need to be separated from the sample before the other reagents are introduced into the system. Protein causes major interference in many analyses. One approach without separating protein is to use a very high reagent-to-sample ratio (the sample is highly diluted) so that any turbidity caused by precipitated protein is not sensed by the spectrophotometer. Another approach is to shorten reaction time to eliminate slower reacting interferents.

In the older continuous-flow systems, a dialyzer was the separation or filtering module. It performed the equivalent of the manual procedures of precipitation, centrifugation, and filtration, using a fine-pore cellophane membrane. In the Vitros slide technology, the spreading layer of the slide traps cells, crystals, and other small particulate matter but also retains large molecules, such as protein. In essence, what passes through the spreading layer is a protein-free filtrate.

Most contemporary discrete analyzers have no automated methodology by which to separate interfering substances from the reaction mixture. Therefore, methods

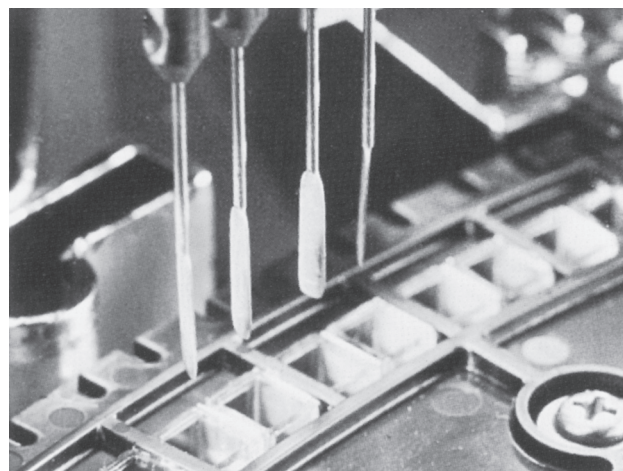

FIGURE 6-10. Stirring paddles on a chemistry analyzer. (Photograph courtesy of Boehringer Mannheim.)

have been chosen that have few interferences or that have known interferences that can be compensated for by the instrument (e.g., using correction formulas).

Incubation

A heating bath in discrete or continuous-flow systems maintains the required temperature of the reaction mixture and provides the delay necessary to allow complete color development. The principal components of the heating bath are the heat-transfer medium (i.e., water or air), the heating element, and the thermoregulator. A thermometer is located in the heating compartment of an analyzer and is monitored by the system's computer. On many discrete analyzer systems, the multicuvets incubate in a water bath maintained at a constant temperature of usually 37°C.

Slide technology incubates colorimetric slides at 37°C. There is a precondition station to bring the temperature of each slide close to 37°C before it enters the incubator. The incubator moves the slides at 12-second intervals in such a manner that each slide is at the incubator exit four times during the 5-minute incubation time. This feature is used for two-point rate methods and enables the first point reading to be taken part way through the incubation time. Potentiometric slides are held at 25°C. The slides are kept at this temperature for 3 minutes to ensure stability before reading.

Reaction Time

Before the optical reading by the spectrophotometer, the reaction time may depend on the rate of transport through the system to the "read" station, timed reagent additions with moving or stationary reaction chambers, or a combination of both processes. An environment conducive to the completion of the reaction must be maintained for a sufficient length of time before spectrophotometric analysis of the product is made. Time is a definite limitation. To sustain the advantage of speedy multiple analyses, the instrument must produce results as quickly as possible.

It is possible to monitor not only completion of a reaction but also the rate at which the reaction is proceeding. The instrument may delay the measurement for a predetermined time or may present the reaction mixtures for measurement at constant intervals of time. Use of rate reactions may have two advantages: the total analysis time is shortened and interfering chromogens that react slowly may be negated. Reaction rate is controlled by temperature; therefore, the reagent, timing, and spectrophotometric functions must be coordinated to work in harmony with the chosen temperature. The environment of the cuvettes is maintained at a constant temperature by a liquid bath, containing water or some other fluid with good heat transfer properties, in which the cuvettes move.

Measurement Phase

After the reaction is completed, the formed products must be quantified. Almost all available systems for measurement have been used, such as ultraviolet, fluorescent, and flame photometry; ion-specific electrodes; gamma counters; and luminometers. Still, the most common is visible and ultraviolet light spectrophotometry, although adaptations of traditional fluorescence measurement, such as fluorescence polarization, chemiluminescence, and bioluminescence, have become popular. The Abbott AxSYM, for example, is a popular instrument for drug analysis that uses fluorescence polarization to measure immunoassay reactions.

Analyzers that measure light require a monochromator to achieve the desired component wavelength. Traditionally, analyzers have used filters or filter wheels to separate light. The old AutoAnalyzers used filters that were manually placed in position in the light path. Many instruments still use rotating filter wheels that are microprocessor controlled so that the appropriate filter is positioned in the light path. However, newer and more sophisticated systems offer the higher resolution afforded by diffraction gratings to achieve light separation into its component colors. Many instruments now use such monochromators with either a mechanically rotating grating or a fixed grating that spreads its component wavelengths onto a fixed array of photo diodes—for example, Hitachi analyzers (Fig. 6-11). This latter grating arrangement, as well as rotating filter wheels, easily accommodates polychromatic light analysis, which offers improved sensitivity and specificity over

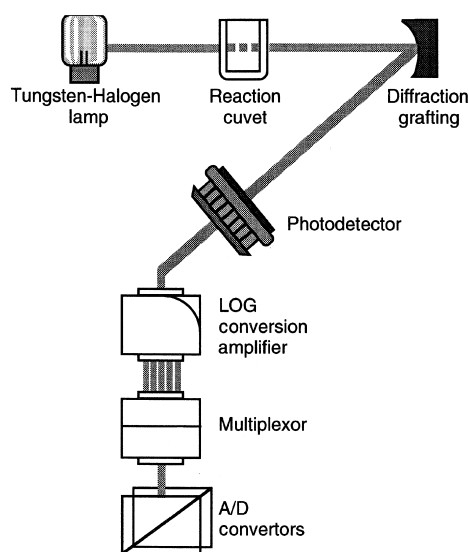

FIGURE 6-11. Photometer for a chemistry analyzer. Fixed diffraction grating separates light into specific wavelengths and reflects them onto a fixed array of 11 specific photodetectors. Photometer has no moving parts. (Courtesy of Boehringer Mannheim.)

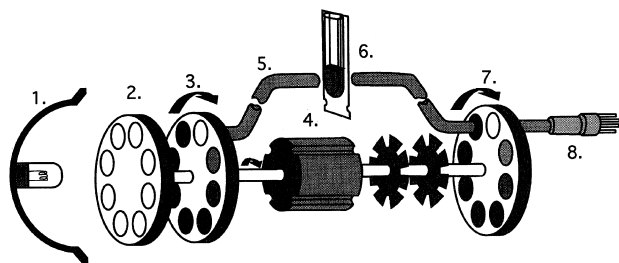

FIGURE 6-12. Photo-optical system for a chemistry analyzer: (1) source with reflector, (2) fixed focusing lens, (3) filter wheel, (4) double-shafted motor, (5) fiber optic bundle, (6) cuvet, (7) filter wheel, and (8) photomultiplier tube. (Courtesy of Dade International.)

monochromatic measurement. By recording optical readings at different wavelengths, the instrument's computer can then use these data to correct for reaction mixture interferences that may occur at adjacent, as well as desired, wavelengths.

Many newer instruments use fiber optics as a medium to transport light signals from remote read stations back to a central monochromator detector box for analysis of these signals. The fiber optic cables, or "light pipes" as they are sometimes called, are attached from multiple remote stations where the reaction mixtures reside, to a centralized filter wheel/detector unit that, in conjunction with the computer, sequences and analyzes a large volume of light signals from multiple reactions (Fig. 6-12).

The containers holding the reaction mixture also play a vital role in the measurement phase. In most discrete wet chemistry analyzers, the cuvet used for analysis is also the reaction vessel in which the entire procedure has occurred. The reagent volume and, therefore, sample size, speed of analysis, and sensitivity of measurement are some aspects influenced by the method of analysis. A beam of light is focused through the container holding the reaction mixture. The amount of light that exits from the container is dictated primarily by the absorbance of light by the reaction mixture. The exiting light strikes a photodetector, which converts the light into electrical energy. Filters and light-focusing components permit the desired light wavelength to reach the photodetector. The photometer continuously senses the sample photodetector output voltage and, as is the process in most analyzers, compares it with a reference output voltage. The electrical impulses are sent to a readout device, such as a printer or computer, for storage and retrieval.

Centrifugal analysis measurement occurs while the rotor is rotating at a constant speed of approximately 1,000 rpm. Consecutive readings are taken of the sample, the dark current (readings between cuvetts), and the reference cuvet. Each cuvet passes through the light source every few milliseconds. After all the data points have been determined, centrifugation stops and the results are printed. The rotor is removed from the analyzer and

discarded. For endpoint analyses, an initial absorbance is measured before the constituents have had time to react, usually a few seconds, and is considered a blank measurement. After enough time has elapsed for the reaction to be completed, another absorbance reading is taken. For rate analyses, the initial absorbance is measured, and then a lag time is allowed (preset into the instrument for each analysis). For each assay, several data points are determined at a programmed time interval. The instrument monitors the absorbance measurements at each data point and calculates a result.

Slide technology depends on reflectance spectrophotometry, as opposed to traditional transmittance photometry, to provide a quantitative result. The amount of chromogen in the indicator layer is read after light passes through the indicator layer, is reflected from the bottom of a pigment-containing layer (usually the spreading layer), and is returned through the indicator layer to a light detector. For colorimetric determinations, the light source is a tungsten-halogen lamp. The beam focuses on a filter wheel holding up to eight interference filters, which are separated by a dark space. The beam is focused at a 45-degree angle to the bottom surface of the slide, and a silicon photodiode detects the portion of the beam that reflects down. Three readings are taken for the computer to derive reflectance density. The three recorded signals taken are (1) the filter wheel blocking the beam, (2) reflectance of a reference white surface with the programmed filter in the beam, and (3) reflectance of the slide with the selected filter in the beam (Fig. 6-13).

After a slide is read, it is shuttled back in the direction from which it came, where a trap door allows it to drop into a waste bin. If the reading was the first for a two-point rate test, the trap door remains closed, and the slide reenters the incubator.

There are a number of fully automated, random access immunoassay systems, which use chemiluminescence or electrochemiluminescence technology for reaction analysis. In chemiluminescence assays, quantification of an analyte is based on emission of light resulting from a chemical reaction.⁹ The principles of chemiluminescent immunoassays are similar to those of radioimmunoassay (RIA) and immunoradiometric assay (IRMA), except that an acridinium ester is used as the tracer and paramagnetic particles are used as the solid phase. Sample, tracer, and paramagnetic particle reagent are added and incubated in disposable plastic cuvetts, depending on the assay protocol. After incubation, magnetic separation and washing of the particles is performed automatically. The cuvetts are then transported into a light-sealed luminometer chamber, where appropriate reagents are added to initiate the chemiluminescent reaction. On injection of the reagents into the sample cuvet, the system luminometer detects the chemiluminescent signal. Luminometers are similar to gamma counters in that they use a photomultiplier tube

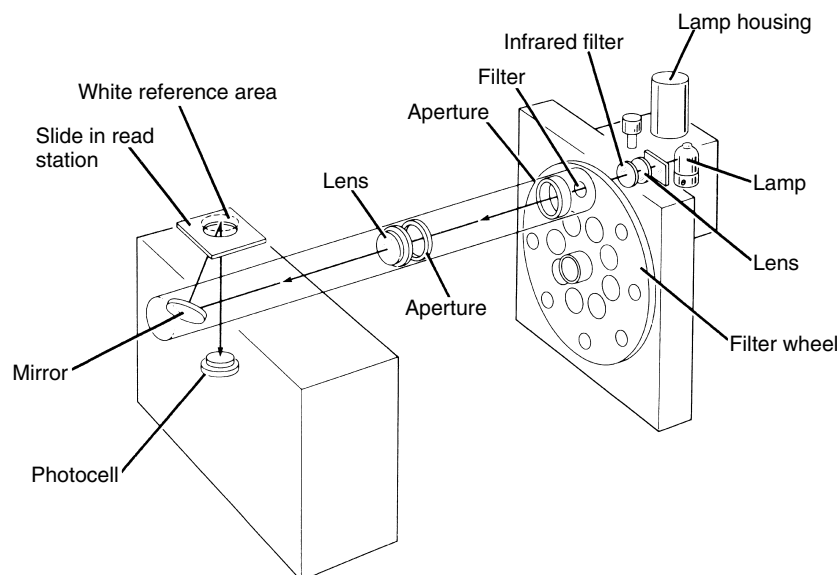

FIGURE 6-13. Components of the system for making colorimetric determinations with slide technology. (Courtesy of Ortho-Clinical Diagnostics.)

detector; however, unlike gamma counters, luminometers do not require a crystal to convert gamma rays to light photons. Light photons from the sample are detected directly, converted to electrical pulses, and then counted.

Signal Processing and Data Handling

Because most automated instruments print the results in reportable form, accurate calibration is essential to obtaining accurate information. There are many variables that may enter into the use of calibration standards. The matrices of the standards and unknowns may be different. Depending on the methodology, this may or may not present problems. If secondary standards are used to calibrate an instrument, the methods used to derive the standard's constituent values should be known. Standards containing more than one analyte per vial may cause interference problems. Because there are no primary standards available for enzymes, either secondary standards or calibration factors based on the molar extinction coefficients of the products of the reactions may be used.

Many times, a laboratory will have more than one instrument capable of measuring a constituent. Unless there are different normal ranges published for each method, the instruments should be calibrated so that the results are comparable. The advantage of calibrating an automated instrument is the long-term stability of the standard curve, which requires only monitoring with controls on a daily basis. Some analyzers use low- and high-concentration standards at the beginning of each run and then use the absorbances of the reactions produced by the standards to produce a standard curve

electronically for each run. Other instruments are self-calibrating after analyzing standard solutions.

The original continuous-flow analyzers used six standards assayed at the beginning of each run to produce a calibration curve for that particular batch. Now, continuous-flow analyzers use a single-level calibrator to calibrate each run with water used to establish the baseline.

The centrifugal analyzer uses standards pipetted into designated cuvetts in each run for endpoint analyses. After the delta absorbance for each sample has been obtained, the computer calculates the results by determining a constant for each standard. The constants are derived by dividing the concentration of the standard (pre entered into the computer) by the delta absorbance and averaging the constants for each of the standards to obtain a factor. The concentration of each control and unknown is determined by multiplying the delta absorbance of the unknown by the factor. If the concentration of an unknown exceeds the range of the standards, the result is printed with a **flag**. Enzyme activity is derived by a linear regression fit of the delta absorbance versus time. The slope of the produced line is multiplied by the enzyme factor (pre entered) to calculate the activity.

Slide technology requires more sophisticated calculations to produce results. The calibration materials require a protein-based matrix because of the necessity for the calibrators to behave as serum when reacting with the various layers of the slides. Calibrator fluids are bovine serum-based, and the concentration of each analyte is determined by reference methods. Endpoint tests require three calibrator fluids, blank-requiring tests need four calibrator fluids, and enzyme methods require three calibrators. Colorimetric tests use spline fits to produce

the standardization. In enzyme analysis, a curve-fitting algorithm estimates the change in reflection density per unit time. This is converted to either absorbance or transmission-density change per unit time. Then, a quadratic equation converts the change in transmission density to volume activity (U/L) for each assay.

Most automated analyzers retain the calibrations for each lot of a particular method until the laboratorian programs the instrument for recalibration. Instrument calibration is initiated or verified by assaying a minimum of three levels of primary standards or, in the case of enzymes, reference samples. The values obtained are compared with the known concentrations by using linear regression, with the *x*-axis representing the expected values and the *y*-axis representing the mean of the values obtained. The slope (scale factor) and *y*-intercept (offset) are the adjustable parameters. On earlier models of this instrument, the parameters were determined and entered manually into the instrument computer by the operator; however, on later, more automated models, the instrument performs calibration automatically on operator request. After calibration has been performed and the chemical or electrical analysis of the specimen is either in progress or completed, the instrument's computer goes into data acquisition and calculation mode. The process may involve signal averaging, which may entail hundreds of data pulses per second, as with a centrifugal analyzer, and blanking and correction formulas for interferents that are programmed into the computer for calculation of results.

All advanced automated instruments have some method of reporting printed results with a link to sample identification. In sophisticated systems, the demographic-sample information is entered in the instrument's computer together with the tests required. Then the sample identification is printed with the test results. Most laboratories use bar code labels printed by the laboratory's information system (LIS) to identify sample. Bar code-labeled samples can be loaded directed on the analyzer without the need to enter identifying information manually. Microprocessors control the tests, reagents, and timing, while verifying the bar code for each sample. This is the link between the results reported and the specimen identification. Even the simplest of systems sequentially number the test results to provide a connection with the samples.

Because most instruments now have either a built-in or attached video monitor, the sophisticated software programs that come with the instrument can be displayed for determining the status of different aspects of the testing process. Computerized monitoring is available for such parameters as reaction and instrument linearity, quality control data with various options for statistical display and interpretation, short sample sensing with flags on the printout, abnormal patient results

flagged, clot detection, reaction vessel or test chamber temperature, and reagent inventories. The printer can also display patients' results as well as various warnings previously mentioned. Most instrument manufacturers offer computer software for preventive maintenance schedules and algorithms for diagnostic troubleshooting. Some manufacturers also install phone modems on the analyzer for a direct communication link between the instrument and their service center for instant troubleshooting and diagnosis of problems.

SELECTION OF AUTOMATED ANALYZERS

Each manufacturer's approach to automation is unique. The instruments being evaluated should be rated according to previously identified needs. One laboratory may need a stat analyzer, whereas another's need may be a batch analyzer for high-test volumes. When considering cost, the price of the instrument and, even more importantly, the total cost of consumables, are significant. The high capital cost of an instrument may actually be small when divided by the large number of samples to be processed. It is also important to calculate the total cost per test for each instrument that is considered. Moreover, a break-even analysis to study the relationship of fixed costs, variable costs, and profits can be helpful in analyzing the financial justification and economic impact on a laboratory. Of course, the mode of acquisition, that is, purchase, lease, rental, and so on, must also be factored into this analysis. The variable cost of consumables will increase as more tests are performed or samples are analyzed. The ability to use reagents produced by more than one supplier (open versus closed reagent systems) can provide a laboratory with the ability to customize testing and, possibly, save money. The labor component also should be evaluated. With the large number of instruments available on the market, the goal is to find the right instrument for each situation.¹⁰

Another major concern toward the selection of an instrument is its analytic capabilities. What are the instrument's performance characteristics for accuracy, precision, linearity, specificity, and sensitivity (which may be method dependent), calibration stability, and stability of reagents (both shelf-life and onboard or reconstituted)? The best way to verify these performance characteristics of an analyzer before making a decision on an instrument is to see it in operation. Ideally, if a manufacturer will place an instrument in the prospective buyer's laboratory on a trial basis, then its analytic performance can be evaluated to the customer's satisfaction with studies to verify accuracy, precision, and linearity. At the same time, laboratory personnel can observe such design features as its test menus, true walk-away capability, user friendliness, and the space that the instrument and its consumables occupy in their laboratory.

Clinical chemistry instrumentation provides speed and precision for assays that would otherwise be performed manually. The chosen methodologies and adherence to the requirements of the assay provide accuracy. No one may assume that the result produced is the correct value. Automated methods must be evaluated completely before being accepted as routine. It is important to understand how each instrument actually works.

TOTAL LABORATORY AUTOMATION

The pressures of health care reform and managed care have caused increasing interest in improving productivity of the preanalytic and postanalytic phases of laboratory testing.¹¹ As for the analytic process itself, routine analyzers in clinical chemistry today have nearly all the mechanization they need. The next generation of automation will replicate the Japanese practice of “black box” labs, in which the sample goes in at one end and the printed result comes out the other end.¹² Much effort has been expended during the past decade on the development of automated “front-end” feeding of the sample into the analytic “box” and computerized/automated management of the data that come out the back end of the box. There have been many developments in the three phases of the laboratory testing process—that is, preanalytic (sample processing), analytic (chemical analyses), and postanalytic (data management) as they merge closer into an integrated **total laboratory automation** (TLA) system. Automation equipment vendors are developing

open architecture components that provide more flexibility in automation implementation.¹³ An example of a commercial TLA system is shown in Figure 6-14.

Preanalytic Phase (Sample Processing)

The sample handling protocol currently available on all major chemistry analyzers is to use the original specimen collection tube (primary tube sampling) of any size (after plasma or serum separation) as the sample cup on the analyzer and to use bar code readers, also on the analyzer, to identify the specimen. An automated process is gradually replacing manual handling and presentation of the sample to the analyzer. Increasing efficiency while decreasing costs has been a major impetus for laboratories to start integrating some aspects of total laboratory automation into their operations. Conceptually, TLA refers to automated devices and robots integrated with existing analyzers to perform all phases of laboratory testing. Most attention to date has been devoted to development of the front-end systems that can identify and label specimens, centrifuge the specimen and prepare aliquots, and sort and deliver samples to the analyzer or to storage.¹⁴ Back-end systems may include removal of specimens from the analyzer and transport to storage, retrieval from storage for retesting, re-aliquoting, or disposal, as well as comprehensive management of the data from the analyzer and interfacing with the LIS.

Dr. Sasaki and colleagues installed the first fully automated clinical laboratory in the world at Koshi Medical

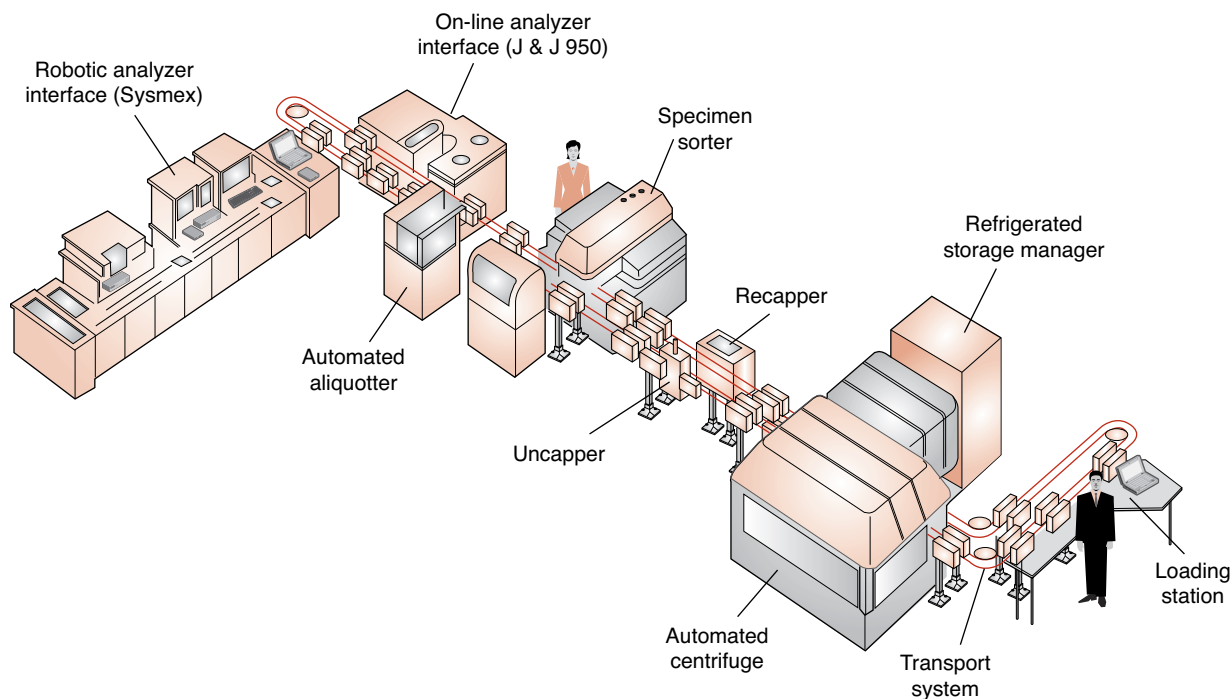

FIGURE 6-14. Schematic of total laboratory automation system. (Courtesy of Labotix Automation.)

School in Japan¹⁵; since then, the concept has gradually, but steadily, become a reality in the United States. The University of Nebraska and the University of Virginia have been pioneers for TLA system development. In 1992, a prototype of a laboratory automation platform was developed at the University of Nebraska, the key components being a conveyance system, bar-coded specimens, a computer software package to control specimen movement and tracking, and coordination of robots with the instruments as work cells.¹⁶ Some of the first automated laboratories in the United States have reported their experiences with front-end automation with a wealth of information for others interested in the technology.^{17,18} The first hospital laboratory to install an automated system was The University of Virginia Hospital in Charlottesville in 1995. Their Medical Automation Research Center cooperated with Johnson & Johnson and Coulter Corporation to use a Vitros 950 attached to a Coulter/IDS "U" lane for direct sampling from a specimen conveyor without using intervening robotics.¹⁹ The first commercially available turnkey system was the Hitachi Clinical Laboratory Automation System (CLAS) (Boehringer-Mannheim Diagnostics; now Roche Diagnostics). It couples the Hitachi line of analyzers to a conveyor belt system to provide a completely operational system with all interfaces.²⁰

Robotics and front-end automation are changing the face of the clinical laboratory.²¹ Much of the benefit derivable from TLA can be realized merely by automating the front end. The planning, implementation, and performance evaluation of an automated transport and sorting system by a large reference laboratory have been described in detail.^{22,23} Several instrument manufacturers are currently working on or are already marketing interfacing front-end devices together with software for their own chemistry analyzers. Johnson & Johnson introduced the Vitros 950 AT (Automation Technology) system in 1995 with an open architecture design to allow laboratories to select from many front-end automation systems rather than being locked into a proprietary interface. A Lab-Track interface is now available on the Dimension RxL (Siemens) that is compatible with major laboratory automation vendors and allows for direct sampling from a track system. Also, the technology now exists for microcentrifugal separators to be integrated into clinical chemistry analyzers.²⁴ Several other systems are now on the market, including the Advia LabCell system (Siemens), which uses a modular approach to automation. The Power Processor Core System (Beckman Coulter) performs sorting, centrifugation, and cap removal. The enGen Series Automation System (Ortho-Clinical Diagnostics) provides sorting, centrifugation, uncapping, and sample archiving functions and interface directly with a Vitros 950 AT analyzer. Three automation systems are available from Olympus that can perform

sorting, centrifugation, uncapping, aliquoting, and direct instrument interface capabilities.

Much of the benefit of TLA is derived from automation of the front end processing steps. Therefore, several manufacturers have developed stand-alone automated front processing systems. The Genesis FE500 (Tecan) is an example of a stand-alone front-end system that can centrifuge, uncap, aliquot into a labeled pour-off tube, and sort into analyzer racks. Systems with similar functionality are available from Labotix, Motoman, and PVT. An example of one such system is shown in Figure 6-15. Stand-alone automated sample uncappers and recappers are available from PVT and Sarstedt. These latter devices are less flexible than the complete stand-alone front-end systems and require samples to be presented to them in racks that will work with a single analyzer. Some laboratories have taken a modular approach with devices for only certain automated functions. Ciba-Corning Clinical Laboratories installed Coulter/IDS robotic systems in several regional laboratories.¹⁹ Recently, a thawing-mixing work cell that is compatible with a track system in a referral laboratory has been described.²⁵ The bottom line is that robotics and front-end automation are here to stay. As more and more clinical laboratories reengineer for total laboratory automation, they are building core laboratories containing all of their automated analyzers as the necessary first step to more easily link the different instruments into one TLA system.²⁶

Analytic Phase (Chemical Analyses)

There have been changes and improvements that are now common to many general chemistry analyzers. They include ever smaller microsampling and reagent dispensing with multiple additions possible from randomly replaced reagents; expanded onboard and total test menus, especially drugs and hormones; accelerated reaction times with chemistries for faster throughput and lower dwell time; higher resolution optics with grating monochromators and diode arrays for polychromatic analysis; improved flow-through electrodes; enhanced user-friendly interactive software for quality control, maintenance, and diagnostics; integrated modems for online troubleshooting; LIS-interfacing data management systems; reduced frequencies of calibration and controls; automated modes for calibration, dilution, rerun, and maintenance; as well as ergonomic and physical design improvements for operator ease, serviceability, and maintenance reduction. According to recent CAP survey data, the eight most popular general chemistry analyzers are Aeroset (Abbott Diagnostics), Advia (Siemens), AU systems (Olympus), Dimension (Siemens), Hitachi systems (Roche Diagnostics), Integra systems (Roche Diagnostics), Synchron systems (Beckman Instruments), and Vitros (Ortho-Clinical Diagnostics).²⁷ Features and

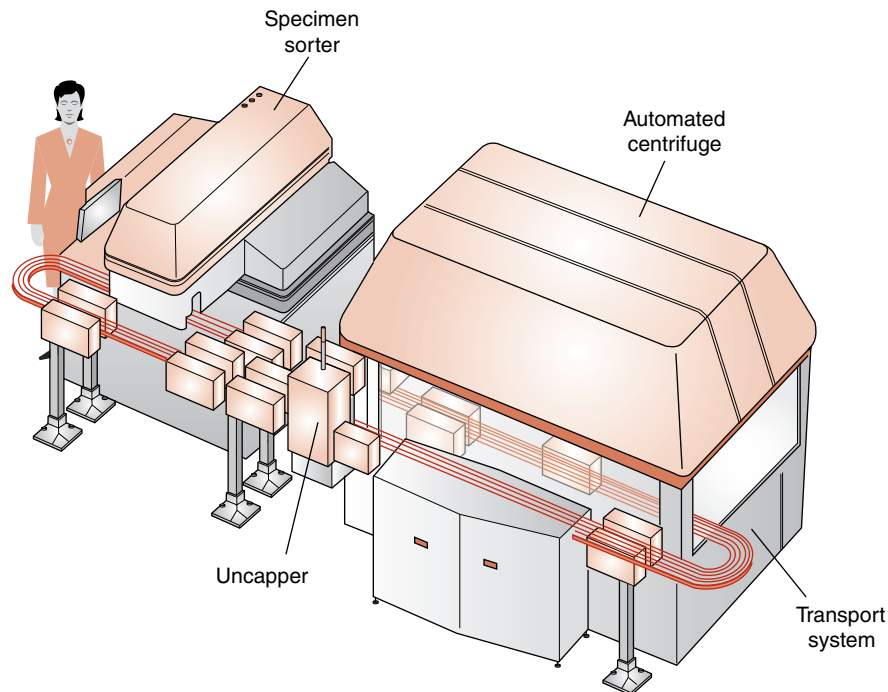

FIGURE 6-15. Schematic of preanalytic automation system. (Courtesy of Labotix Automation.)

specifications of these eight systems are summarized in Table 6-1. One main advantage of modular chemistry analyzers is scalability. As workload increases, additional modules can be added to increase throughput. A schematic of the MODULAR ANALYTICS system (Roche) is shown in Figure 6-16. This system can accommodate from one to four D, P, or E modules. This provides flexibility to adapt to changing workloads. Chemistry and immunoassay testing can be combined, obviating the need to split samples. Repeat testing can be accomplished automatically using the rerun buffer, which holds the samples until all testing is completed.

Postanalytic Phase (Data Management)

Although most of the attention in recent years in total laboratory automation concept has been devoted to front-end systems for sample handling, several manufacturers have been developing and enhancing back-end handling

of data. Bidirectional communication between the analyzer(s) and the host computer or LIS has become an absolutely essential link to request tests and enter patient demographics, automatically transfer this customized information to the analyzer(s), as well as post the results in the patient's record. Evaluation and management of data from the time of analysis until posting have become more sophisticated and automated with the integration of workstation managers into the entire communication system.²⁸ Most data management devices are personal computer-based modules with manufacturers' proprietary software that interfaces with one or more of their analyzers and the host LIS. They offer automated management of quality control data with storage and evaluation of quality control results against the laboratory's predefined quality control perimeters with multiple plotting, displaying, and reporting capabilities. Review and editing of patient results before verification and transmission to the host are enhanced by user-defined perimeters for reportable range limits, panic value limits, delta checks, and quality control comparisons for clinical change, repeat testing, and algorithm analysis. Reagent inventory and quality control, along with monitoring of instrument functions, are also managed by the workstation's software. Most LIS vendors have interfacing software available for all the major chemistry analyzers.

Some data handling needs associated with automation cannot be adequately handled by most current LISs. For example, most current analyzers are capable of assessing the degree of sample hemolysis, icterus, and lipemia (see

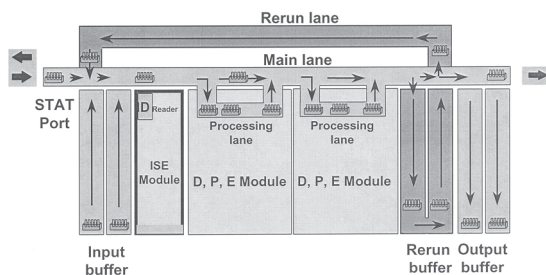

FIGURE 6-16. Schematic drawing of Roche MODULAR ANALYTICS system. (Courtesy of Roche Diagnostics.)

Table 6-1). However, making this information available and useful to either the clinician or laboratorian in an automated fashion requires additional manipulation of the data. Ideally, the tests ordered on the sample, the threshold for interference of each test by each of the three agents, and whether the interference is positive or negative needs to be determined. In the case of lipemia, the results for affected tests need to be held until the sample can be clarified and the tests rerun. It is difficult or impossible for current LIS systems to perform this latter task. There is a need for a “gap-filler” between the instrument and the LIS. One company, Data Innovations, has developed a system called Instrument Manager, which links the analyzer to the LIS and provides the ability for the user to define rules for release of information to the LIS. In addition, flags can be displayed to the instrument operator to perform additional operations, such as sample clarification and reanalysis. The ability to fully automate data review using rules-based analysis is a key factor in moving toward TLA.

FUTURE TRENDS IN AUTOMATION

Clinical chemistry automation will continue to evolve at a rapid pace in the 21st century as it has in the 1990s. With most of the same forces driving the automation market as those discussed in this chapter, analyzers will continue to perform more cost effectively and efficiently. More integration and miniaturization of components and systems will persist to accommodate more sophisticated portable analyzers for the successful POC testing market. Effective communications among all automation stakeholders for a given project are key to successful implementation.²⁹

More new tests for expanded menus will be developed, with a mixture of measurement techniques used on the analyzers to include more immunoassays and PCR-based assays. Spectral mapping, or multiple wavelength monitoring, with high-resolution photometers in analyzers will be routine for all specimens and tests as more instruments are designed with the monochromator device in the light path after the cuvet, not before. Spectral mapping capabilities will allow simultaneous analysis of multiple chemistry analytes in the same reaction vessel. This will have a tremendous impact on throughput and turnaround time of test results. Mass spectrometry and capillary electrophoresis will be used more extensively in clinical laboratories for identification and quantification of elements and compounds in extremely small concentrations. In the coming years, more system and workflow integration will occur with robotics and data management for more inclusive total laboratory automation.³⁰ To accomplish this, more companies will form alliances to place their instrumentation products in the laboratories. The incorporation of artificial intelligence into analytic systems will evolve, using both experts systems and neural networks.^{31,32} This will greatly advance the technologies of robotics, digital processing of data, computer-assisted diagnosis, and data integration with electronic patient records.

Finally, technologic advances in chip technology and biosensors will accelerate the development of noninvasive, in vivo testing.^{33–35} Transcutaneous monitoring is already available with some blood gases. “True” or dynamic values from in vivo monitoring of constituents in blood and other body fluids will revolutionize laboratory medicine as we know it today. It sounds futuristic, but so did the first AutoAnalyzer 50 years ago.

REFERENCES

- Hodnett J. Automated analyzers have surpassed the test of time. *Adv Med Lab* 1994;8.
- Schoeff L, et al. Principles of laboratory instruments. St. Louis, Mo.: Mosby-Year Book, 1993.
- Jacobs E, Simson E. Point of care testing and laboratory automation: the total picture of diagnostic testing at the beginning of the next century. *Clin Lab News* 1999;December:12–14.
- Boyce N. Why hospitals are moving to core labs. *Clin Lab News* 1996;22:1–2.
- Boyce N. Why labs should discourage routine testing. *Clin Lab News* 1996;22:1, 9.
- Eisenwiener H, Keller M. Absorbance measurement in cuvettes lying longitudinal to the light beam. *Clin Chem* 1979;25:117–121.
- Burtis CA. Factors influencing evaporation from sample cups, and assessment of their effect on analytic error. *Clin Chem* 1975;21:1907–1917.
- Burtis CA, Watson JS. Design and evaluation of an anti-evaporative cover for use with liquid containers. *Clin Chem* 1992;38:768–775.
- Dudley RF. Chemiluminescence immunoassay: an alternative to RIA. *Lab Med* 1990;21:216.
- Haboush L. Lab equipment management strategies: balancing costs and quality. *Clin Lab News* 1997;23:20–21.
- Schoeff L. Clinical instrumentation (general chemistry analyzers). *Anal Chem* 1997;69:200R–203R.
- Ringel M. National survey results: automation is everywhere. *MLO Med Lab Obs* 1996;28:38–43.
- Douglas L. Redefining automation: perspectives on today's clinical laboratory. *Clin Lab News* 1997;23:48–49.
- Felder R. Front-end automation. In: Kost G, ed. *Handbook of clinical laboratory automation and robotics*. New York, N.Y.: Wiley, 1995.
- Sasaki M. A fully automated clinical laboratory. *Lab Inform Mgmt* 1993;21:159–168.
- Markin R, Sasaki M. A laboratory automation platform: the next robotic step. *MLO Med Lab Obs* 1992;24:24–29.
- Bauer S, Teplitz C. Total laboratory automation: a view of the 21st century. *MLO Med Lab Obs* 1995;27:22–25.

18. Bauer S, Teplitz C. Laboratory automation, Part 2. Total lab automation: system design. *MLO Med Lab Obs* 1995;27:44–50.
19. Felder R. Cost justifying laboratory automation. *Clin Lab News* 1996;22:10–11, 17.
20. Felder R. Laboratory automation: strategies and possibilities. *Clin Lab News* 1996;22:10–11.
21. Boyd J, Felder R, Savory J. Robotics and the changing face of the clinical laboratory. *Clin Chem* 1996;42:1901–1910.
22. Hawker CD, Garr SB, Hamilton LT, et al. Automated transport and sorting system in a large reference laboratory: part 1. Evaluation of needs and alternatives and development of a plan. *Clin Chem* 2002;48:1751–1760.
23. Hawker CD, Roberts WL, Garr SB, et al. Automated transport and sorting system in a large reference laboratory: part 2. Implementation of the system and performance measures over three years. *Clin Chem* 2002;48:1761–1767.
24. Richardson P, Molloy J, Ravenhall R, et al. High speed centrifugal separator for rapid online sample clarification in biotechnology. *J Biotechnol* 1996;49:111–118.
25. Hawker CD, Roberts WL, DaSilva A, et al. Development and validation of an automated thawing and mixing workcell. *Clin Chem* 2007;53:2209–2211.
26. Zenie F. Re-engineering the laboratory. *Autom Chem* 1996;18:135–141.
27. College of American Pathologists (CAP). CAP Surveys, Proficiency Testing Program. Northfield, Ill.: CAP, 2002.
28. Saboe T. Managing laboratory automation. *J Autom Chem* 1995;17:83–88.
29. Fisher JA. Laboratory automation: communicating with all stakeholders is the key to success. *Clin Lab News* 2000; July:38–40.
30. Brzezicki L. Workflow integration: does it make sense for your lab? *Adv Lab* 1996;23:57–62.
31. Place J, Truchaud A, Ozawa K, et al. Use of artificial intelligence in analytical systems for the clinical laboratory. *J Autom Chem* 1995;17:1–15.
32. Boyce N. Neural networks in the lab: new hope or just hype? *Clin Lab News* 1997;23:2–3.
33. Boyce N. Tiny “lab chips” with huge potential? *Clin Lab News* 1996;22:21.
34. Rosen S. Biosensors: where do we go from here? *MLO Med Lab Obs* 1995;27:24–29.
35. Aller RD. Chemistry analyzers branching out. *CAP Today* 2002;July:84–106.

Immunoassays

Susan Orton

CHAPTER OUTLINE

■ IMMUNOASSAYS

General Considerations
Unlabeled Immunoassays
Labeled Immunoassays

■ REFERENCES

This chapter introduces the generic analytic methods used in many areas of the clinical laboratory—the binding of **antibody** (Ab) to **antigen** (Ag) for the specific and sensitive detection of an analyte. In immunoassays, an Ag binds to an Ab. The Ag–Ab interactions may involve unlabeled reactants in less analytically sensitive techniques or a labeled reactant in more sensitive techniques. The design, label, and detection system combine to create many different assays, which enable the measurement of a wide range of molecules.

This chapter reviews the concepts of binding, describes the nature of the reagents used, and discusses basic assay design of selected techniques used in the clinical laboratory; as such, it is intended to be an overview rather than an exhaustive review.

IMMUNOASSAYS

General Considerations

In an immunoassay, an *antibody* (Ab) molecule recognizes and binds to an *antigen* (Ag). The molecule of interest may be either an Ag or an Ab. This binding is related to the concentration of each reactant, the specificity of the Ab for the Ag, the **affinity** and **avidity** for the pair, and the environmental conditions. Although this chapter focuses on immunoassays that use an Ab molecule as the binding reagent, other assays, such as receptor assays and competitive binding protein assays, use receptor proteins or transport proteins as the binding reagent, respectively. The same principles apply to these assays. An Ab molecule is an immunoglobulin with a functional domain known as F(ab); this area of the immunoglobulin protein binds to a site on the Ag. An Ag is relatively large and complex and usually has multiple sites that can bind to antibodies (Abs) with different specificities; each site

on the Ag is referred to as an antigenic determinant or **epitope**. Some confusion exists in the terminology used: some immunologists refer to an *immunogen* as the molecule that induces the biologic response and synthesis of Ab, and some use *antigen* to refer to that which binds to Ab. However, all agree that the antigenic site to which an F(ab) can bind is the epitope.

The degree of binding is an important consideration in an immunoassay. The binding of an Ab to an Ag is directly related to the affinity and avidity of the Ab for the epitope, as well as the concentration of the Ab and epitope. Under standard conditions, the **affinity** of an Ab is measured using a **hapten** (Hp) because the Hp is a low-molecular-weight Ag considered to have only one epitope. The affinity for the Hp is related to the likelihood to bind or to the degree of complementary nature of each. The reversible reaction is summarized in Equation 7-1:

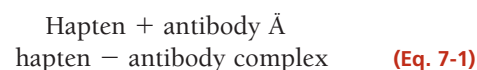

The binding between an Hp and the Ab obeys the law of mass action and is expressed mathematically in Equation 7-2:

$$K_a = \frac{k_1}{k_2} = \frac{[\text{Hp} - \text{Ab}]}{[\text{Hp}][\text{Ab}]} \quad (\text{Eq. 7-2})$$

K_a is the affinity or equilibrium constant and represents the reciprocal of the concentration of free Hp when 50% of the binding sites are occupied. The greater the affinity of the Hp for the Ab, the smaller is the concentration of Hp needed to saturate 50% of the binding sites of the Ab. For example, if the affinity constant of a **monoclonal** antibody (MAb) is 3×10^{11} L/mol, it means that an Hp concentration of 3×10^{-11} mol/L is needed to occupy half of the binding sites. Typically, the affinity constant of Abs used

in immunoassay procedures ranges from 10^9 to 10^{11} L/mol, whereas the affinity constant for transport proteins ranges from 10^7 to 10^8 L/mol and the affinity for receptors ranges from 10^8 to 10^{11} L/mol.

As with all chemical (molecular) reactions, the initial concentrations of the reactants and the products affect the extent of complex binding. In immunoassays, the reaction moves forward (to the right) (Eq. 7-1) when the concentration of reactants (Ag and Ab) exceeds the concentration of the product (Ag–Ab complex) and when there is a favorable affinity constant.

The forces that bring an antigenic determinant and an Ab together are noncovalent, reversible bonds that result from the cumulative effects of hydrophobic, hydrophilic, and hydrogen bonding and van der Waals forces. The most important factor that affects the cumulative strength of bonding is the goodness (or closeness) of fit between the Ab and the Ag. The strength of most of these interactive forces is inversely related to the distance between the interactive sites. The closer the Ab and Ag can physically approach one another, the greater are the attractive forces.

After the Ag–Ab complex is formed, the likelihood of separation (which is inversely related to the tightness of bonding) is referred to as *avidity*. The avidity represents a value-added phenomenon in which the strength of binding of all Ab–epitope pairs exceeds the sum of single Ab–epitope binding. In general, the stronger the affinity and avidity, the greater is the possibility of **cross-reactivity**.

The specificity of an Ab is most often described by the Ag that induced the Ab production, the homologous Ag. Ideally, this Ab would react only with that Ag. However, an Ab can react with an Ag that is structurally similar to the homologous Ag; this is referred to as *cross-reactivity*. Considering that an antigenic determinant can be five or six amino acids or one immunodominant sugar, it is not surprising that Ag similarity is common. The greater the similarity between the cross-reacting Ag and the homologous Ag, the stronger is the bond with the Ab.¹ Reagent Ab production is achieved by polyclonal or monoclonal techniques. In **polyclonal Ab** production, the stimulating Ag is injected in an animal responsive to the Ag; the animal detects this foreign Ag and mounts an immune response to eliminate the Ag. If part of this immune response includes strong Ab production, then blood is collected and Ab is harvested, characterized, and purified to yield the commercial antiserum reagent. This polyclonal Ab reagent is a mixture of Ab specificities. Some Abs react with the stimulating epitopes and some are endogenous to the host. Multiple Abs directed against the multiple epitopes on the Ag are present and can cross-link the multivalent Ag. Polyclonal Abs are often used as “capture” Abs in sandwich or indirect immunoassays.

In contrast, an immortal cell line produces *monoclonal* Abs; each line produces one specific Ab. This method developed as an extension of the hybridoma work published by Kohler and Milstein in 1975.² The process begins by selecting cells with the qualities that will allow the synthesis of a homogeneous Ab. First, a host (commonly, a mouse) is immunized with an Ag (the one to which an Ab is desired); later, the sensitized lymphocytes of the spleen are harvested. Second, an immortal cell line (usually a nonsecretory mouse myeloma cell line that is hypoxanthine guanine phosphoribosyltransferase deficient) is required to ensure that continuous propagation in vitro is viable. These cells are then mixed in the presence of a fusion agent, such as polyethylene glycol, that promotes the fusion of two cells to form a hybridoma. In a selective growth medium, only the hybrid cells will survive. B cells have a limited natural life span in vitro and cannot survive, and the unfused myeloma cells cannot survive due to their enzyme deficiency. If the viable fused cells synthesize Ab, then the specificity and isotype of the Ab are evaluated. MAb reagent is commercially produced by growing the hybridoma in tissue culture or in compatible animals. An important feature of MAb reagent is that the Ab is homogeneous (a single Ab, not a mixture of Abs). Therefore, it recognizes only one epitope on a multivalent Ag and cannot cross-link a multivalent Ag.

Unlabeled Immunoassays

Immune Precipitation in Gel

In one of the simplest unlabeled immunoassays introduced into the clinical laboratory, unlabeled Ab was layered on top of unlabeled Ag (both in the fluid phase); during the incubation period, the Ab and Ag diffused and the presence of precipitation was recorded. The precipitation occurred because each Ab recognized an epitope and the multivalent Ags were cross-linked by multiple Abs. When the Ag–Ab complex is of sufficient size, the interaction with water is limited so that the complex becomes insoluble and precipitates.

It has been observed that if the concentration of Ag is increased while the concentration of Ab remains constant, the amount of precipitate formed is related to the ratio of Ab to Ag. As shown in Figure 7-1, there is an optimal ratio of the concentration of Ab to the concentration of Ag that results in the maximal precipitation; this is the zone of equivalence. Outside the zone of equivalence, the amount of precipitate is diminished or absent because the ratio of Ab to Ag is out of proportion and the cross-linking of Ag is decreased. When Ab concentration is in excess and cross-linking is decreased, the assay is in **prozone**. Conversely, when Ag concentration is in excess and cross-linking is decreased, the assay is in **postzone**. Although originally described with precipitation reactions, this con-

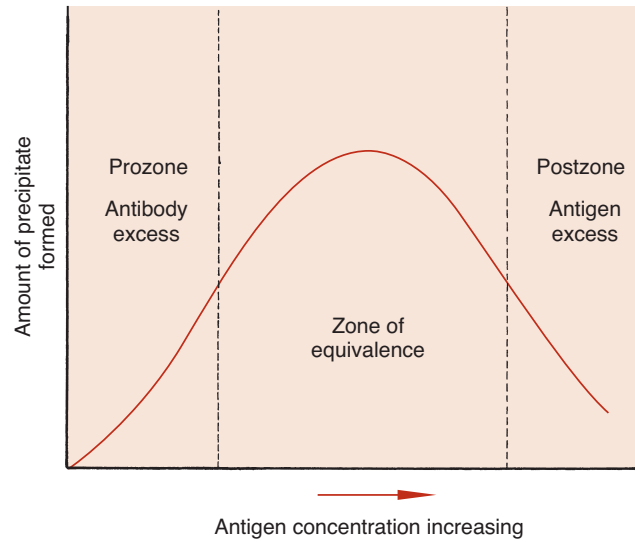

FIGURE 7-1. Precipitin curve showing the amount of precipitate versus antigen concentration. The concentration of antibody is constant.

cept applies to other assays in which the ratio of Ab to Ag is critical.

Precipitation reactions in gel are not as commonly performed in the clinical laboratory today. Gel is dilute agarose (typically less than 1%) dissolved in an aqueous buffer. This provides a semisolid medium through which soluble Ag and Ab can easily pass. Precipitated immune complexes are easier to discern in gel versus a liquid suspension. Immune precipitation methods in gel can be classified as passive methods or those using electrophoresis and are summarized in Table 7-1. The simplest and least sensitive method is double diffusion (the Ouchterlony technique).³ Agarose is placed on a solid surface and allowed to solidify. Wells are cut into the agarose. A common template is six Ab wells, surrounding a single Ag well in the center. Soluble Ag and soluble Ab are added to separate wells and diffusion occurs. The intensity and pattern

of the precipitation band are interpreted. As shown in Figure 7-2, the precipitin band of an unknown sample is compared with the precipitin band of a sample known to contain the Ab. A pattern of identity confirms the presence of the Ab in the unknown sample. Patterns of partial identity and nonidentity are ambiguous. This technique can be used to detect Abs associated with autoimmune diseases, such as Sm and RNP detected in systemic lupus erythematosus, SSA and SSB in Sjögren’s syndrome, and Scl-70 in progressive systemic sclerosis. However, most of these Abs are also detected using enzyme-linked immunoassays or multiplex bead array systems (Luminex).

TABLE 7-1 IMMUNE PRECIPITATION METHODS

| |
|---|
| Gel |
| <i>Passive</i> |
| Double diffusion (Ouchterlony technique) |
| Single diffusion (radial immunodiffusion) |
| <i>Electrophoresis</i> |
| Counterimmunoelectrophoresis |
| Immunoelectrophoresis |
| Immunofixation electrophoresis |
| Rocket electrophoresis |
| Soluble Phase |
| Turbidimetry |
| Nephelometry |

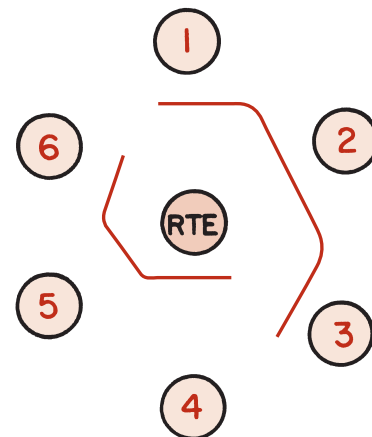

FIGURE 7-2. A schematic demonstrating the pattern of identity. The center well contains the antigen, rabbit thymus extract. Well 1 is filled with a serum known to contain Sm antibody. Test sera are in wells 2 and 3; the pattern of identity, the smooth continuous line between the three wells, confirms the presence of Sm antibody in the test sera. Well 4 is filled with a serum known to contain U1-RNP antibody. Test sera in wells 5 and 6 also contain U1-RNP antibody, confirmed by the pattern of identity between the known serum and the test sera.

The single-diffusion technique, **radial immunodiffusion (RID)**, is an immune precipitation method used to quantitate protein (the Ag). In this method, monospecific antiserum is added to the liquefied agarose; then the agarose is poured into a plate and cooled. Wells are cut into the solidified agarose. Multiple standards, one or more quality control samples, and patient samples are added to the wells. The Ag diffuses from the well in all directions, binds to the soluble Ab in the agarose, and forms a complex seen as a concentric precipitin ring (Fig. 7-3). The diameter of the ring is related to the concentration of the Ag that diffused from the well. A standard curve is constructed to determine the concentration in the quality control and patient samples. The usable analytic range is between the lowest and highest standards. If the ring is greater than the highest standard, the sample should be diluted and retested. If the ring is less than the lowest standard, the sample should be run on a low-level plate. Two variations exist: the endpoint (Mancini) method⁴ and the kinetic (Fahey-McKelvey) method.⁵ The endpoint method requires that all Ag diffuse from the well and the concentration of the Ag is related to the square of the diameter of the precipitin ring; the standard curve is plotted on linear graph paper and is the line of best fit. To ensure that all of the Ag has diffused, the incubation time is 48 to 72 hours, depending on the molecular weight of the Ag; for example, IgG quantitation requires 48 hours, and IgM requires 72 hours. In contrast, the kinetic method requires that all rings be measured at a fixed time of 18 hours; a sample with a greater concentration will diffuse at a faster rate and will be larger at a fixed time. Using semilogarithmic graph paper, the concentration of the Ag is plotted against the diameter of the precipitin ring; the line is drawn point to point. For those performing RID, the endpoint method is favored because of its stability and indifference to

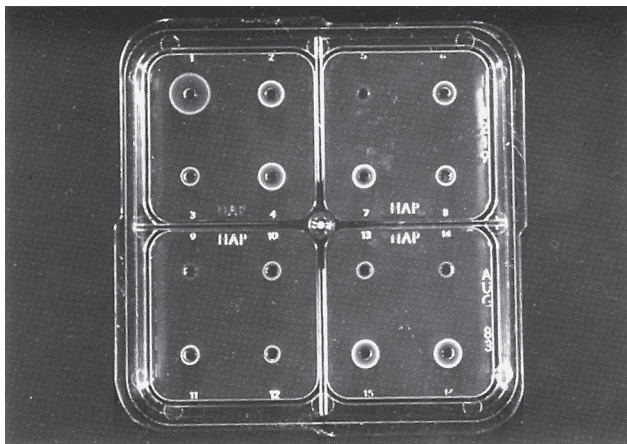

FIGURE 7-3. Radial immunodiffusion plate to detect haptoglobin. The diameter of the precipitin circle is related to the concentration of haptoglobin in the serum.

temperature variations; however, turnaround time is longer compared with the kinetic method.

Counterimmunoelectrophoresis is an immune precipitation method that uses an electrical field to cause the Ag and Ab to migrate toward each other. Two parallel lines of wells are cut into agarose; Ab is placed in one line and Ag is placed in the other. Ab will migrate to the cathode and the Ag to the anode; a precipitin line forms where they meet. This qualitative test is useful to detect bacterial antigens in cerebrospinal fluid and other fluids when a rapid laboratory response is needed.

Immunoelectrophoresis (IEP) and **immunofixation electrophoresis (IFE)** are two methods used in the clinical laboratory to characterize monoclonal proteins in serum and urine. In 1964, Grabar and Burtin⁶ published methods for examining serum proteins using electrophoresis coupled with immunochemical reactions in agarose. Serum proteins are electrophoretically separated and then reagent Ab is placed in a trough running parallel to the separated proteins. The Ab reagent and separated serum proteins diffuse; when the reagent Ab recognizes the serum protein and the reaction is in the zone of equivalence, a precipitin arc is seen (Fig. 7-4). The agarose plate is stained (typically, with a protein stain such as Amido black 10), destained, and dried to enhance the readability of precipitin arcs, especially weak arcs. The size, shape, density, and location of the arcs aid in the interpretation of the protein. All interpretation is made by comparing the arcs of the patient sample with the arcs of the quality control sample, a normal human serum. Because IEP is used to evaluate a monoclonal

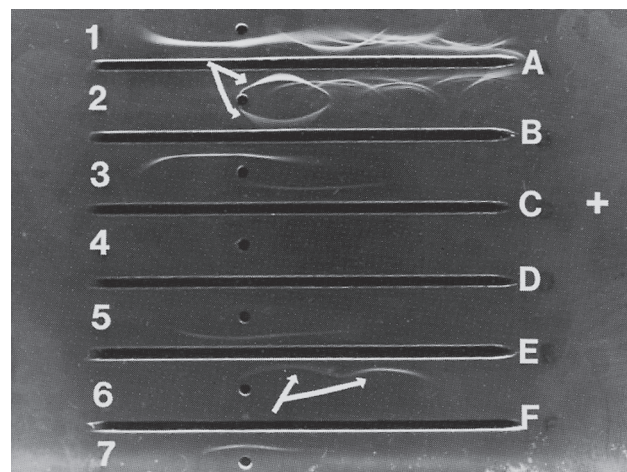

FIGURE 7-4. Immunoelectrophoresis. Wells 1, 3, 5, and 7 contain normal human serum, and wells 2, 4, and 6 contain the test serum. Antiserum reagent is in the troughs: antihuman whole serum (A), antihuman IgG (B), antihuman IgA (C), antihuman IgM (D), antihuman κ (E), and antihuman λ (F). The arrows at the top point to an abnormal γ chain that reacts with the anti-IgG reagent. A similar band is shown at the bottom with the anti- κ reagent. There is also a pattern of identity with the anti- κ reagent that shows free κ chains in the test serum.

protein, the heavy chain class and light chain type must be determined. To evaluate the most common monoclonal proteins, the following antisera are used: antihuman whole serum (which contains a mixture of Abs against the major serum proteins), antihuman IgG (γ -chain specific), antihuman IgM (μ -chain specific), antihuman IgA (α chain specific), antihuman λ (λ -chain specific), and antihuman κ (κ -chain specific). The test turnaround time and the subtlety in interpretation have discouraged the use of IEP as the primary method to evaluate MABs.

IFE has replaced IEP in many laboratories.⁷ A serum, urine, or cerebrospinal fluid sample is placed in all six lanes of an agarose gel and electrophoresed to separate the proteins. Cellulose acetate (or some other porous material) is saturated with Ab reagent and then applied to one lane of the separated protein. If the Ab reagent recognizes the protein, an insoluble complex is formed. After staining and drying of the agarose film, interpretation is based on the migration and appearance of bands. As shown in Figure 7-5, the monoclonal protein will appear as a discrete band (with both a heavy and a light chain monospecific antiserum occurring at the same position). Polyclonal proteins will appear as a diffuse band. The concentration of patient sample may need adjustment to ensure the reaction is in the zone of equivalence.

The last immune precipitation method in gel discussed is the **rocket technique** (Laurell technique, or electroimmunoassay).^{8,9} In this quantitative technique, reagent Ab is mixed with agarose; Ag is placed in the well and electrophoresed. As the Ag moves through the agarose, it reacts with the reagent Ab and forms a “rocket,” with stronger precipitation along the edges. The height of the

rocket is proportional to the concentration of Ag present; the concentration is determined based on a calibration curve. The narrow range of linearity may require dilution or concentration of the unknown sample.

Detection of Fluid-Phase Antigen–Antibody Complexes

A different strategy to quantitate Ag–Ab complexes is to use an instrument to detect the soluble Ag–Ab complexes as they interact with light. When Ag and Ab combine, complexes are formed that act as particles in suspension and thus can scatter light. The size of the particles determines the type of scatter that will dominate when the solution interacts with nearly monochromatic light.¹⁰ When the particle, such as albumin or IgG, is relatively small compared with the wavelength of incident light, the particle will scatter light symmetrically, both forward and backward. A minimum of scattered light is detectable at 90 degrees from the incident light. Larger molecules and Ag–Ab complexes have diameters that approach the wavelength of incident light and scatter light with a greater intensity in the forward direction. The wavelength of light is selected based on its ability to be scattered in a forward direction and the ability of the Ag–Ab complexes to absorb the wavelength of light.

Turbidimetry measures the light transmitted and **nephelometry** measures the light scattered. Turbidimeters (spectrophotometers or colorimeters) are designed to measure the light passing through a solution so the photodetector is placed at an angle of 180 degrees from the incident light. If light absorbance is insignificant, turbidity can be expressed as the absorbance, which is directly

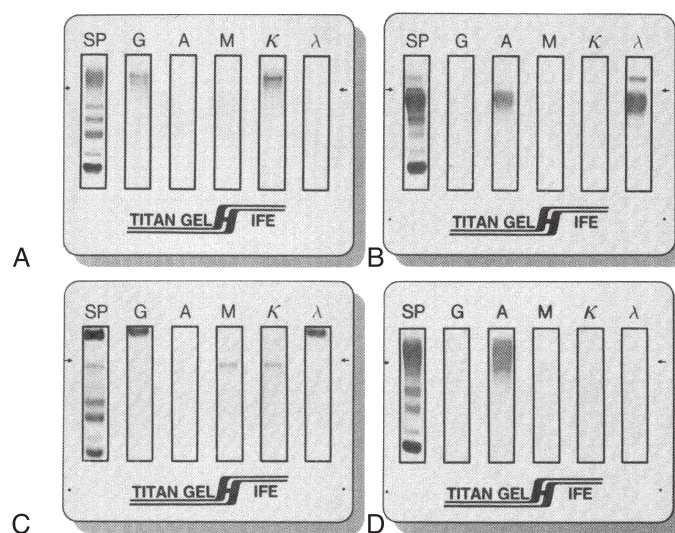

FIGURE 7-5. Immunofixation electrophoresis. (A) IgG κ monoclonal immunoglobulin. (B) IgA κ monoclonal immunoglobulin with free κ light chains. (C) IgG λ and IgM κ bivalent immunoglobulins. (D) Diffuse IgA heavy chain band without a corresponding light chain.

related to the concentration of suspended particles and path length. Nephelometers measure light at an angle other than 180 degrees from the incident light; most measure forward light scattered at less than 90 degrees because the sensitivity is increased (see Chapter 5). The relative concentration of the Ab reagent and Ag is critical to ensure that the size of the complex generated is best detected by the nephelometer or turbidimeter and that the immune reaction is not in postzone or prozone. Therefore, it may be important to test more than one concentration of patient sample, to monitor the presence of excess Ab, or to add additional antiserum and monitor the peak rate. Excess Ab would indicate that there is little Ag and that the reaction is underestimated.

For both turbidimetry and nephelometry, all reagents and sera must be free of particles that could scatter the light. Pretreatment of serum with polyethylene glycol, a nonionic, hydrophilic polymer, enhances the Ag–Ab interaction. Because the polymer is more hydrophilic than the Ag or Ab, water is attracted from the Ag and Ab to the polyethylene glycol. This results in a faster rate and greater quantity of Ag–Ab complex formation.

Both methods can be performed in an endpoint or a kinetic mode. In the endpoint mode, a measurement is taken at the beginning of the reaction (the background signal) and one is taken at a set time later in the reaction (plateau or endpoint signal); the concentration is determined using a calibration curve. In the kinetic mode, the rate of complex formation is continuously monitored and the peak rate is determined. The peak rate is directly related to the concentration of the Ag, although this is not necessarily linear. Thus, a calibration

curve is required to determine concentration in unknown samples.

Labeled Immunoassays

General Considerations

In all labeled immunoassays, a reagent (Ag or Ab) is usually labeled by attaching a particle or molecule that will better detect lower concentrations of Ag–Ab complexes. Therefore, the label improves analytic sensitivity. All assays have a binding reagent, which can bind to the Ag or ligand. If the binding reagent is an Ab, the assay is an immunoassay. If the binding agent is a receptor (e.g., estrogen or progesterone receptor), the assay is a receptor assay. If the binding reagent is a transport protein (e.g., thyroxine-binding globulin or transcortin), the assay may be called competitive protein-binding assay. Immunoassays are used today almost exclusively, with two notable exceptions: estrogen and progesterone receptor assays and the thyroid hormone-binding ratio, which uses thyroxine-binding globulin.

Immunoassays may be described based on the label—which reactant is labeled, the relative concentration and source of the Ab, the method used to separate free from bound-labeled reagents, the signal that is measured, and the method used to assign the concentration of analyte in the sample. Immunoassay design, therefore, has many variables to consider, leading to diverse assays.

Labels

The simplest way to identify an assay is by the label used. Table 7-2 lists the commonly used labels and the methods used to detect the label.

TABLE 7-2 LABELS AND DETECTION METHODS

| IMMUNOASSAY | COMMON LABEL | DETECTION METHOD |
|-------------|---|---|
| RIA | ^3H ^{125}I | Liquid scintillation counter Gamma counter |
| EIA | Horseradish peroxidase Alkaline phosphatase β -D-Galactosidase Glucose-6-phosphate dehydrogenase | Photometer, fluorometer, luminometer Photometer, fluorometer, luminometer Fluorometer, luminometer Photometer, luminometer |
| CLA | Isoluminol derivative Acridinium esters | Luminometer Luminometer |
| FIA | Fluorescein Europium Phycobiliproteins Rhodamine B Umbelliferone | Fluorometer Fluorometer Fluorometer Fluorometer Fluorometer |

CLA, chemiluminescent assay; EIA, enzyme immunoassay; FIA, fluorescent immunoassay; RIA, radioimmunoassay.

Radioactive Labels

Atoms with unstable nuclei that spontaneously emit radiation are radioactive and referred to as radionuclides. The emission is known as radioactive decay and is independent of chemical or physical parameters, such as temperature, pressure, or concentration. Of the three forms of radiation, only beta and gamma are used in the clinical laboratory. In beta emission, the nucleus can emit negatively charged electrons or positively charged particles called positrons. The emitted electrons are also known as beta particles. Tritium (^3H) is the radionuclide commonly used in cellular immunology assays for diagnosis and research.

Gamma emission is electromagnetic radiation with very short wavelengths originating from unstable nuclei. As a radionuclide releases energy and becomes more stable, it disintegrates or decays, releasing energy. A specific spectrum of energy levels is associated with each radionuclide. The standardized unit of radioactivity is the becquerel (Bq), which is equal to one disintegration per second. The traditional unit is the curie (Ci), which equals 3.7×10^{10} Bq; $1 \mu\text{Ci} = 37 \text{ kBq}$. The half-life of the radionuclide is the time needed for 50% of the radionuclide to decay and become more stable. The longer the half-life, the more slowly it decays, increasing the length of time it can be measured. For radioactive substances used in diagnostic tests, it is preferable that the emission have an appropriate energy level and that the long half-life be relatively long; ^{125}I satisfies these requirements and is the most commonly used gamma-emitting radionuclide in the clinical laboratory.

Gamma-emitting nuclides are detected using a crystal scintillation detector (also known as a gamma counter). The energy released during decay excites a fluor, such as thallium-activated sodium iodide. The excited fluor releases a photon of visible light, which is amplified and detected by a photomultiplier tube; the amplified light energy is then translated into electrical energy. Detectable decay of the radionuclide is expressed as counts per minute (CPM).

In immunoassays, one reactant is radiolabeled. In competitive assays, the Ag is labeled and called the **tracer**. The radiolabel must allow the tracer to be fully functional and to compete equally with the unlabeled Ag for the binding sites. When the detector Ab is radiolabeled, the Ag-combining site must remain biologically active and unhindered.

Enzyme Labels

Enzymes are commonly used to label the Ag/Hp or Ab.^{11,12} Horseradish peroxidase (HRP), alkaline phosphatase (ALP), and glucose-7-phosphate dehydrogenase are used most often. Enzymes are biologic catalysts that increase the rate of conversion of substrate to product and are not consumed by the reaction. As such, an enzyme can catalyze many substrate molecules, amplifying the amount of product generated. The enzyme activity may be monitored directly by measuring the product formed or by

measuring the effect of the product on a coupled reaction. Depending on the substrate used, the product can be photometric, fluorometric, or chemiluminescent. For example, a typical photometric reaction using HRP-labeled Ab (Ab-HRP) and the substrate (a peroxide) generate the product (oxygen). The oxygen can then oxidize a reduced chromogen (reduced orthophenylenediamine [OPD]) to produce a colored compound (oxidized OPD), which is measured using a photometer.



Fluorescent Labels

Fluorescent labels (fluorochromes or fluorophores) are compounds that absorb radiant energy of one wavelength and emit radiant energy of a longer wavelength in less than 10^{-4} seconds. Generally, the emitted light is detected at an angle of 90 degrees from the path of excitation light using a fluorometer or a modified spectrophotometer. The difference between the excitation wavelength and emission wavelength (Stokes shift) usually ranges between 20 nm and 80 nm for most fluorochromes. Some fluorescence immunoassays simply substitute a fluorescent label (such as fluorescein) for an enzyme label and quantitate the fluorescence.¹³ Another approach, time-resolved fluorescence immunoassay, uses a highly efficient fluorescent label, such as a europium chelate,¹⁴ which fluoresces approximately 1,000 times slower than the natural background fluorescence and has a wide Stokes shift. The delay allows the fluorescent label to be detected with minimal interference from background fluorescence. The long Stokes shift facilitates measurement of emission radiation while excluding the excitation radiation. The resulting assay is highly sensitive and time-resolved, with minimized background fluorescence.

Luminescent Labels

Luminescent labels emit a photon of light as the result of an electrical, biochemical, or chemical reaction.^{15,16} Some organic compounds become excited when oxidized and emit light as they revert to the ground state. Oxidants include hydrogen peroxide, hypochlorite, or oxygen. Sometimes a catalyst is needed, such as peroxidase, alkaline phosphatase, or metal ions.

Luminol, the first chemiluminescent label used in immunoassays, is a cyclic diacylhydrazide that emits light energy under alkaline conditions in the presence of peroxide and peroxidase. Because peroxidase can serve as the catalyst, assays may use this enzyme as the label; the chemiluminogenic substrate, luminol, will produce light that is directly proportional to the amount of peroxidase present (Eq. 7-4):

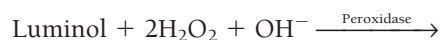

A popular chemiluminescent label, acridinium esters, is a triple-ringed organic molecule linked by an ester bond to an organic chain. In the presence of hydrogen peroxide and under alkaline conditions, the ester bond is broken and an unstable molecule (*N*-methylacridon) remains. Light is emitted as the unstable molecule reverts to its more stable ground state.

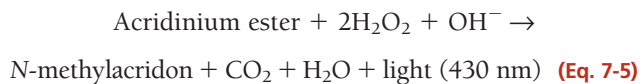

Alkaline phosphatase commonly conjugated to an Ab has been used in automated immunoassay analyzers to produce some of the most sensitive chemiluminescent assays. ALP catalyzes adamantyl 1,2-dioxetane aryl phosphate substrates (AMPPD) to release light at 477 nm. The detection limit approaches 1 zmol, or approximately 602 enzyme molecules.^{17,18}

Assay Design

Competitive Immunoassays

The earliest immunoassay was a **competitive immunoassay** in which the radiolabeled antigen (A^* ; also called the tracer) competed with unlabeled antigen (Ag) for a limited number of binding sites (Ab) (Fig. 7-6). The proportion of Ag and A^* binding with the Ab is related to the Ag and A^* concentration and requires limited Ab in the reaction. In the competitive assay, the A^* concentration is constant and limited. As the concentration of Ag increases, more binds to the Ab, resulting in less binding of A^* . These limited reagent assays were very sensitive because low concentrations of unlabeled Ag yielded a large measurable signal from the bound-labeled Ag. If the competitive assay is designed to reach equilibrium, the incubation times are often long.

The Ag–Ab reaction can be accomplished in one step when labeled antigen (A^*), unlabeled antigen (Ag), and reagent antibody (Ab) are simultaneously incubated to-

gether to yield bound-labeled antigen (A^*Ab), bound-unlabeled antigen (AgAb), and free-label (A^*) as shown in Figure 7-6 and Equation 7-6:

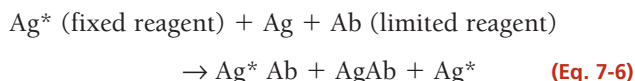

A generic, heterogeneous, competitive simultaneous assay begins by pipetting the test sample (quality control, calibrator, or patient) into test tubes. Next, labeled Ag and Ab reagents are added. After incubation and separation of free-labeled (unbound) Ag, the bound-labeled Ag is measured.

Alternatively, the competitive assay may be accomplished in sequential steps. First, labeled Ag is incubated with the reagent Ab and then labeled Ag is added. After a longer incubation time and a separation step, the bound-labeled Ag is measured. This approach increases the analytic sensitivity of the assay.

Consider the example in Table 7-3. A relatively small, yet constant, number of Ab combining sites is available to combine with a relatively large, constant amount of A^* (tracer) and calibrators with known Ag concentrations. Because the amount of tracer and Ab are constant, the only variable in the test system is the amount of unlabeled Ag. As the concentration of unlabeled Ag increases, the concentration (or percentage) of free tracer increases.

By using multiple calibrators, a dose response curve is established. As the concentration of unlabeled Ag increases, the concentration of tracer that binds to the Ab decreases. In the example presented in Table 7-3, if the amount of unlabeled Ag is zero, maximum tracer will combine with the Ab. When no unlabeled Ag is present, maximum binding by the tracer is possible; this is referred to as B_0 , B_{max} , maximum binding, or the zero standard. When the amount of unlabeled Ag is the same as the tracer, each will bind equally to the Ab. As the concentration of Ag increases in a competitive assay, the amount of

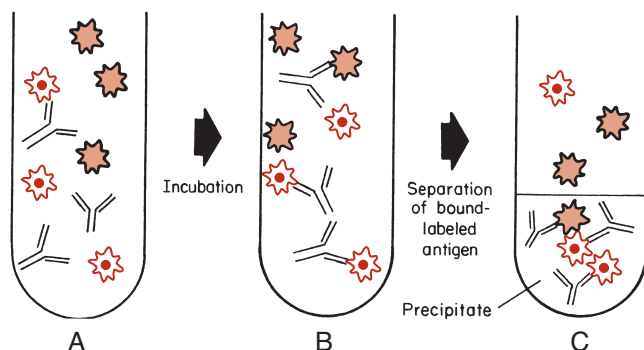

FIGURE 7-6. Competitive labeled immunoassay. During simultaneous incubation, labeled antigen and unlabeled antigen compete for the antibody-binding sites. The bound label in the precipitate is frequently measured.

TABLE 7-3 COMPETITIVE BINDING ASSAY EXAMPLE

| AG | + | AG* | + | AB | → | AGAB | + | AG*AB | + | AG* |
|----------------------------|---|------------------------|---|-----------------------|---|---------------------------|---|-------|---|-----|
| CONCENTRATION OF REACTANTS | | | | | | CONCENTRATION OF PRODUCTS | | | | |
| AG | | AG* | | AB | | AGAB | | AG*AB | | AG* |
| 0 | | 200 | | 100 | | 0 | | 100 | | 100 |
| 50 | | 200 | | 100 | | 20 | | 80 | | 120 |
| 100 | | 200 | | 100 | | 34 | | 66 | | 134 |
| 200 | | 200 | | 100 | | 50 | | 50 | | 150 |
| 400 | | 200 | | 100 | | 66 | | 34 | | 166 |
| SAMPLE CALCULATIONS | | | | | | | | | | |
| Dose of [Ag] | | % B | | B/F | | | | | | |
| 0 | | $\frac{100}{200} = 50$ | | $\frac{100}{100} = 1$ | | | | | | |
| 50 | | $\frac{80}{200} = 40$ | | $\frac{80}{120} = 67$ | | | | | | |
| 100 | | $\frac{66}{200} = 33$ | | $\frac{66}{134} = 33$ | | | | | | |
| 200 | | $\frac{50}{200} = 25$ | | $\frac{50}{150} = 33$ | | | | | | |
| 400 | | $\frac{34}{200} = 17$ | | $\frac{34}{166} = 20$ | | | | | | |

tracer that complexes with the binding reagent decreases. If the tracer is of low molecular weight, free tracer is often measured. If the tracer is of high molecular weight, the bound tracer is measured. The data may be plotted in one of three ways: bound/free versus the arithmetic dose of unlabeled Ag; percentage bound versus the log dose of unlabeled Ag; and logit bound/ B_0 versus the log dose of the unlabeled Ag (Fig. 7-7).

The bound fraction can be expressed in several different formats. Bound/free (B/F) is CPM of the bound fraction compared with the CPM of the free fraction. Percent bound (% B) is the CPM of the bound fraction compared with the CPM of maximum binding of the tracer (B_0) multiplied by 100. Logit B/B_0 transformation is the natural log of $(B/B_0)/(1 - B/B_0)$.

When using logit-log graph paper on which B/B_0 is plotted on the ordinate and the log dose of the unlabeled Ag is plotted on the abscissa, a straight line with a negative slope is produced. More often, microcomputers calculate the best straight line using linear regression; patient values may then be calculated by the computer using this relationship.

It is important to remember that the best type of curve-fitting technique is determined by experiment and that there is no assurance that a logit-log plot of the data will always generate a straight line. To determine the best method, several different methods of data plotting should

be tried when a new assay is introduced. Every time the assay is performed, a dose-response curve should be prepared to check the performance of the assay. Remember that the relative error for all radioimmunoassay (RIA) dose-response curves is minimal when $B/B_0 = 0.5$ and increases at both high and low concentrations of the plot. As shown in the plot of B/B_0 versus log of the Ag concentration (Fig. 7-7), a relatively large change in the concentration at either end of the curve produces little change in the B/B_0 value. Patient values derived from a B/B_0 value >0.9 or <0.1 should be interpreted with caution. When the same data are displayed using the logit-log plot, it is easy to overlook the error at either end of the straight line.

Noncompetitive Immunoassays

Sometimes known as immunometric assays, **noncompetitive immunoassays** use a labeled reagent Ab to detect the Ag. Excess labeled Ab is required to ensure that the labeled Ab reagent does not limit the reaction. The concentration of the Ag is directly proportional to the bound-labeled Ab as shown in Figure 7-8. The relationship is linear up to a limit and then is subject to the high-dose hook effect.

In the sandwich assay to detect Ag (also known as an Ag capture assay), immobilized unlabeled Ab captures the Ag. After washing to remove unreacted molecules,

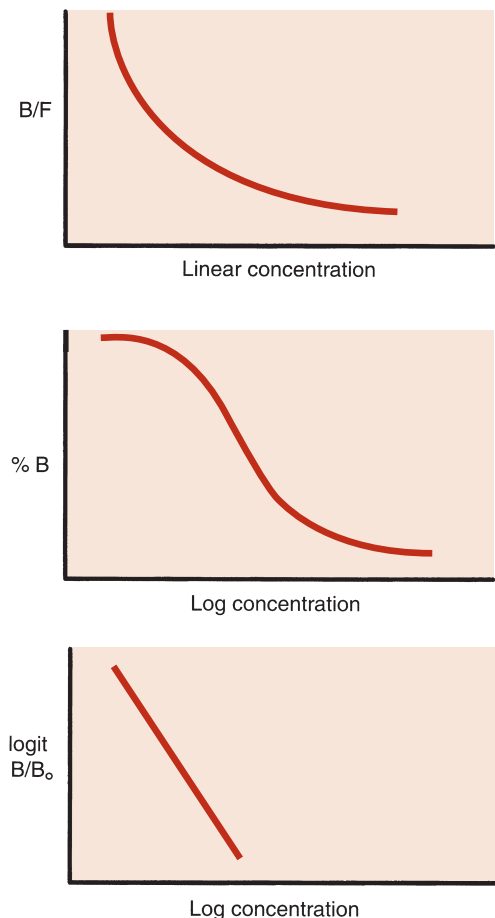

FIGURE 7-7. Dose-response curves in a competitive assay. B, bound-labeled antigen; F, free-labeled antigen; B₀, maximum binding; % B, B/B₀ × 100.

the labeled detector Ab is added. After another washing to remove free-labeled detector Ab, the signal from the bound-labeled Ab is proportional to the Ag captured. This format relies on the ability of the Ab reagent to react with a single epitope on the Ag. The specificity and quan-

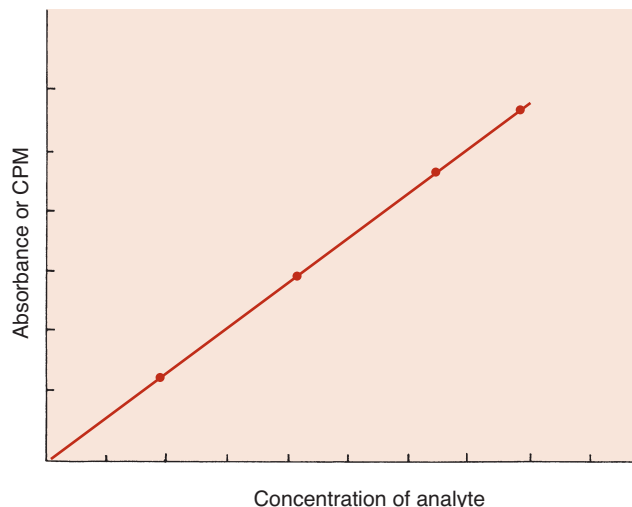

FIGURE 7-8. Dose-response curve in a noncompetitive immunoassay.

tity of MAbs have allowed the rapid expansion of diverse assays. A schematic is shown in Figure 7-9.

The sandwich assay is another noncompetitive assay used to detect Ab, in which the immobilized Ag captures specific Ab. After washing, the labeled detector Ab is added and binds to the captured Ab. The amount of bound-labeled Ab is directly proportional to the amount of specific Ab present (Fig. 7-10). This assay can be modified to determine the immunoglobulin class of the specific Ab present in serum. For example, if the detector Ab was labeled and monospecific (e.g., rabbit antihuman IgM [μ -chain specific]), it would detect and quantitate only human IgM captured by the immobilized Ag.

Separation Techniques

All immunoassays require that free-labeled reactant be distinguished from bound-labeled reactant. In *heterogeneous assays*, physical separation is necessary and is achieved by adsorption, precipitation, or interaction with a **solid phase** as listed in Table 7-4. The better the separation of bound

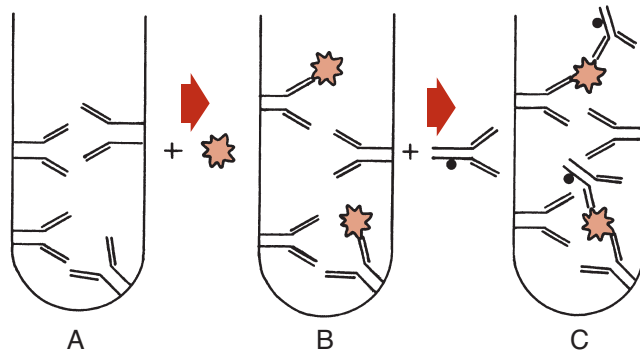

FIGURE 7-9. Two-site noncompetitive sandwich assay to detect antigen. Immobilized antibody captures the antigen. Then labeled antibody is added, binds to the captured antigen, and is detected.

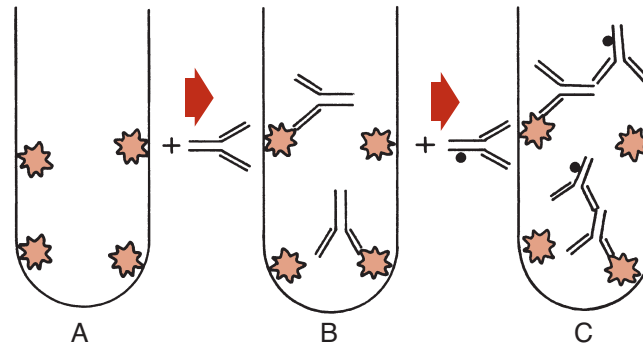

FIGURE 7-10. Two-site noncompetitive sandwich assay to detect antibody. Immobilized antigen captures the antibody. Then labeled antibody is added, binds to the captured antibody, and is detected.

from free reactant, the more reliable the assay will be. This is in contrast to *homogeneous assays*, in which the activity or expression of the label depends on whether the labeled reactant is free or bound. No physical separation step is needed in homogeneous assays.

Adsorption

Adsorption techniques use particles to trap small antigens, labeled or unlabeled. A mixture of charcoal and cross-linked dextran is most commonly used. Charcoal is porous and readily combines with small molecules to remove them from solution; dextran prevents nonspecific protein binding to the charcoal. The size of the dextran influences the size of the molecule that can be adsorbed; the lower the molecular weight of dextran used, the

smaller is the molecular weight of free Ag that can be adsorbed. Other adsorbents include silica, ion exchange resin, and Sephadex. After adsorption and centrifugation, the free-labeled Ag is found in the precipitate.

Precipitation

Nonimmune precipitation occurs when the environment is altered, affecting the solubility of protein. Compounds such as ammonium sulfate, sodium sulfate, polyethylene glycol, and ethanol precipitate protein nonspecifically; both free-Ab and Ag-Ab complexes will precipitate. Ammonium sulfate and sodium sulfate “salt out” free globulins and Ag-Ab complexes. Ethanol denatures protein and Ag-Ab complexes, causing precipitation. Polyethylene glycol precipitates larger protein molecules

TABLE 7-4 CHARACTERISTICS OF SEPARATION TECHNIQUES

| SEPARATION TECHNIQUE | EXAMPLE | ACTION |
|----------------------|---|--|
| Adsorption | Charcoal and dextran | Traps free-labeled antigen |
| | Silica Ion exchange resin Sephadex | Separation by centrifugation |
| Precipitation | | |
| Nonimmune | Ethanol | Denatures bound-labeled antigen |
| | Ammonium sulfate Sodium sulfate Polyethylene glycol | Separation by centrifugation |
| | Immune | Second antibody Staphylococcal protein A |
| Solid phase | Polystyrene Membranes | Separation by centrifugation One reactant is adsorbed or covalently attached to the inert surface |
| | Magnetized particles | Separation by washing |

with or without the Ag attached. Ideally, after centrifugation, all bound-labeled Ag will be in the precipitate, leaving free-labeled Ag in the supernatant.

Soluble Ag–Ab complexes can be precipitated by a second Ab that recognizes the primary Ab in the soluble complex. The result is a larger complex that becomes insoluble and precipitates. Centrifugation is again used to aid in the separation. This immune precipitation method is also known as the double-Ab or second-Ab method. For example, in a growth hormone assay, the primary or Ag-specific Ab produced in a rabbit recognizes growth hormone. The second Ab, produced in a sheep or goat, would recognize rabbit Ab. Labeled Ag–Ab complexes, unlabeled Ag–Ab complexes, and free primary Abs are precipitated by the second Ab. This separation method is more specific than nonimmune precipitation because only the primary Ab is precipitated. A similar separation occurs when staphylococcal protein A (SPA) replaces the second Ab. SPA binds to human IgG causing precipitation.

Solid Phase

The use of a *solid phase* to immobilize reagent Ab or Ag provides a method to separate free from bound-labeled reactant after washing. The solid-phase support is an inert surface to which reagent Ag or Ab is attached. The solid-phase support may be, but is not limited to, polystyrene surfaces, membranes, and magnetic beads. The immobilized Ag or Ab may be adsorbed or covalently bound to the solid-phase support; covalent linkage prevents spontaneous release of the immobilized Ag or Ab. Immunoassays using solid-phase separation are easier to perform and to automate and require less manipulation and time to perform than other immunoassays. However, a relatively large amount of reagent Ab or Ag is required to coat the

solid-phase surface, and consistent coverage of the solid phase is difficult to achieve. Solid-phase assays are more expensive to produce and require greater technical skill to perform to minimize intra-assay and interassay variability. Insufficient washing is a common source of error.

Examples of Labeled Immunoassays

Particle-enhanced turbidimetric inhibition immunoassay (PETINIA) is a homogeneous competitive immunoassay in which low-molecular-weight Hps bound to particles compete with unlabeled analyte for the specific Ab. The extent of particle agglutination is inversely proportional to the concentration of unlabeled analyte and is assessed by measuring the change in transmitted light in an Automatic Clinical Analyzer (ACA) (DuPont; now Siemens).¹⁹

Enzyme-linked **immunosorbent assays** (ELISAs), a popular group of **heterogeneous immunoassays**, have an enzyme label and use a solid phase as the separation technique. Four formats are available: a competitive assay using labeled Ag, a competitive assay using labeled Ab, a noncompetitive assay to detect Ag, and a noncompetitive assay to detect Ab.

One of the earliest **homogeneous assays** was enzyme multiplied immunoassay technique (EMIT), an enzyme immunoassay currently produced by Syva Corporation.²⁰ As shown in Figure 7-11, the reactants in most test systems include an enzyme-labeled Ag (commonly, a low-molecular-weight analyte, such as a drug), an Ab directed against the Ag, the substrate, and test Ag. The enzyme is catalytically active when the labeled Ag is free (not bound to the Ab). It is thought that when the Ab combines with the labeled Ag, the Ab sterically hinders the enzyme. The conformational changes that occur during Ag–Ab interaction inhibit the enzyme activity. In this homogeneous

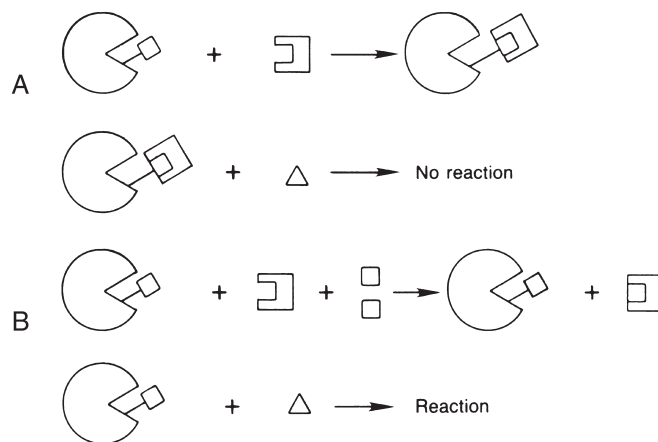

FIGURE 7-11. Enzyme multiplied immunoassay technique. **(A)** When enzyme-labeled antigen is bound to the antibody, the enzyme activity is inhibited. **(B)** Free patient antigen binds to the antibody and prevents antibody binding to the labeled antigen. The substrate indicates the amount of free-labeled antigen.

assay, the unlabeled Ag in the sample competes with the labeled Ag for the Ab-binding sites; as the concentration of unlabeled Ag increases, less enzyme-labeled Ag can bind to the Ab. Therefore, more labeled Ag is free, and the enzymatic activity is greater.

Cloned enzyme donor immunoassays (CEDIA) are competitive, homogeneous assays in which the genetically engineered label is β -galactosidase.²¹ The enzyme is in two inactive pieces: the enzyme acceptor and the enzyme donor. When these two pieces bind together, enzyme activity is restored. In the assay, the Ag labeled with the enzyme donor and the unlabeled Ag in the sample compete for specific Ab-binding sites. When the Ab binds to the labeled Ag, the enzyme acceptor cannot bind to the enzyme donor; therefore, the enzyme is not restored and the enzyme is inactive. More unlabeled Ag in the sample results in more enzyme activity.

Microparticle capture enzyme immunoassay (MEIA) is an automated assay available on the IMx (Abbott Laboratories). The microparticles serve as the solid phase, and a glass fiber matrix separates the bound-labeled reagent. Both competitive and noncompetitive assays are available. Although the label is an enzyme (alkaline phosphatase), the substrate (4-methylumbelliferyl phosphate) is fluorogenic.

Solid-phase fluorescence immunoassays (SPFIAs) are analogous to the ELISA methods except that the label fluoresces. Of particular note is FIAX (BioWhittaker). In this assay, fluid-phase unlabeled Ag is captured by Ab on the solid phase; after washing, the detector Ab (with a fluorescent label attached) reacts with the solid-phase captured Ag.

Particle concentration fluorescence immunoassay (PCFIA) is a heterogeneous, competitive immunoassay in which particles are used to localize the reaction and concentrate the fluorescence. Labeled Ag and unlabeled Ag in the sample compete for Ab bound to polystyrene particles. The particles are trapped and the fluorescence is measured. The assay can also be designed so that labeled Ab and unlabeled Ab compete for Ag fixed onto particles.

Fluorescence excitation transfer immunoassay (FETI) is a competitive, homogeneous immunoassay using two fluorophores (such as fluorescein and rhodamine).²² When the two labels are in close proximity, the emitted light from fluorescein will be absorbed by rhodamine. Thus, the emission from fluorescein is quenched. Fluorescein-labeled Ag and unlabeled Ag compete for rhodamine-labeled Ab. More unlabeled Ag lessens the amount of fluorescein-labeled Ag that binds; therefore, more fluorescence is present (less quenching).

Substrate-level fluorescence immunoassay (SLFIA) is another competitive, homogeneous assay. This time, the Hp is labeled with a substrate; when catalyzed by an appropriate enzyme, fluorescent product is generated.

Substrate-labeled Hp and unlabeled Hp in the sample compete with Ab; the bound-labeled Hp cannot be catalyzed by the enzyme.

Fluorescence polarization immunoassay (FPIA) is another assay that uses a fluorescent label.^{23,24} This homogeneous immunoassay uses polarized light to excite the fluorescent label. Polarized light is created when light passes through special filters and consists of parallel light waves oriented in one plane. When polarized light is used to excite a fluorescent label, the emitted light could be polarized or depolarized. Small molecules, such as free fluorescent-labeled Hp, rotate rapidly and randomly, interrupting the polarized light. Larger molecules, such as those created when the fluorescent-labeled Hp binds to an Ab, rotate more slowly and emit polarized light parallel to the excitation polarized light. The polarized light is measured at a 90-degree angle compared with the path of the excitation polarized light. In a competitive FPIA, fluorescent-labeled Hp and unlabeled Hp in the sample compete for limited Ab sites. When no unlabeled Hp is present, the labeled Hp binds maximally to the Ab, creating large complexes that rotate slowly and emit a high level of polarized light. When Hp is present, it competes with the labeled Hp for the Ab sites; as the Hp concentration increases, more labeled Hp is displaced and is free. The free-labeled Hp rotates rapidly and emits less polarized light. The degree of labeled Hp displacement is inversely related to the amount of unlabeled Hp present.

Dissociation-enhanced lanthanide fluoroimmunoassay (DELFIAs) is an automated system (Pharmacia) that measures time-delayed fluorescence from the label europium. The assay can be designed as a competitive, heterogeneous assay or a noncompetitive (sandwich), heterogeneous assay.²⁵

The classic RIA is a heterogeneous, competitive assay with a tracer.²⁶ When bound tracer is measured, the signal from the label (counts per minute) is inversely related to the concentration of the unlabeled Ag in the sample.

Rapid Immunoassay

The sensitivity and specificity of automated labeled assays and the trend for decentralized laboratory testing have led to the development of assays that are easy to use, simple (many classified as waived or moderately complex related to the Clinical Laboratory Improvement Amendments of 1988), fast, and site neutral and require no instrumentation. Those discussed here are representative of currently available commercial kits; however, this discussion is not intended to be exhaustive. Three categories of rapid immunoassays emerge: (1) latex particles for visualization of the reaction, (2) fluid flow and labeled reactant, and (3) changes in a physical or chemical property following Ag-Ab binding.

The earliest rapid tests were those in which a latex particle suspension was added to the sample; if the immunoreactive component attached to the particle recognized its counterpart in the sample, macroscopic agglutination occurred. Colored latex particles are now available to facilitate reading the reaction.

Self-contained devices that use the liquid nature of the specimen have evolved. In flowthrough systems, a capture reagent is immobilized onto a membrane, the solid phase. The porous nature of membranes increases the surface area to which the capture reagent can bind. The more capture reagent that binds to the membrane, the greater is the potential assay sensitivity. After the capture reagent binds to the membrane, other binding sites are saturated with a nonreactive blocking chemical to reduce nonspecific binding by substances in the patient sample. In the assay, the sample containing the analyte is allowed to pass through the membrane and the analyte is bound to the capture reagent. Commonly, the liquid is attracted through the membrane by an absorbent material. The analyte is detected by a labeled reactant, as well as the signal from the labeled reactant.

The next step in the development of self-contained, single-use devices was to incorporate internal controls. One scheme to detect human chorionic gonadotropin, the ImmunoConcentration Assay (ICON; Hybritech),^{27,28} creates three zones in which specifically treated particles are deposited. In the assay zone, particles are coated with reagent Ab specific for the assay; in the negative control zone, particles are coated with nonimmune Ab; and, in the positive control zone, particles are coated with an immune complex specific for the assay. The patient sample (serum or urine) passes through the membrane, and the analyte is captured by the specific reagent Ab in the assay zone. Next, a labeled Ab passes through the membrane, which fixes to the specific immune complex formed in the assay zone or the positive control zone. Following color development, a positive reaction is noted when the assay and positive zones are colored.

A second homogeneous immunoassay involves the tangential flow of fluid across a membrane. The fluid dissolves and binds to the dried capture reagent; the complex flows to the detection area, where it is concentrated and viewed.

A third homogeneous immunoassay, enzyme immunochromatography, involves vertical flow of fluid along a membrane.²⁹ This is quantitative and does not require any instrumentation. A dry paper strip with immobilized Ab is immersed in a solution of unlabeled analyte and an enzyme-labeled analyte; the liquid migrates up the strip by capillary action. As the labeled and unlabeled analyte migrate, they compete and bind to the immobilized Ab. A finite amount of labeled and unlabeled analyte mixture is absorbed. The migration distance of the labeled analyte is visualized when the strip reacts with a

substrate reagent and develops a colored reaction product. Comparing the migration distance of the sample with the calibrator allows the concentration of the unlabeled ligand to be assigned.

The next generation of rapid immunoassays involves change in physical or chemical properties after an Ag–Ab interaction occurs. One example is the Optical Immunoassay (OIA).³⁰ A silicon wafer is used to support a thin film of optical coating; this is then topped with the capture Ab. Sample is applied directly to the device. If an Ag–Ab complex forms, the thickness of the optical surface increases and changes the optical path of light. The color changes from gold to purple. Some studies suggest that this method has better analytic sensitivity than immunoassays, which rely on the fluid flow.

Immunoblots

Most assays described this far are designed to measure a single analyte. In some circumstances, it is beneficial to separate multiple antigens by electrophoresis so as to be able to simultaneously detect multiple serum Abs. The **Western blot** is a transfer technique used to detect specific Abs. As shown in Figure 7-12, multiple protein antigens (such as those associated with the human immunodeficiency virus [HIV]) are isolated, denatured, and separated by sodium dodecyl sulfate–polyacrylamide gel electrophoresis (SDS-PAGE). SDS denatures the protein and adds an overall negative charge proportional to the molecular weight of the protein. The PAGE of SDS-treated proteins allows the separation of protein based on molecular weight. The separated proteins are then transferred to a new medium (e.g., nylon, nitrocellulose, or polyvinylidene difluoride membrane). The separated proteins will be fixed on the new medium and may be stained to assure separation. Each lane on the membrane is then incubated with patient or control sample. The Ab recognizes and binds to the Ag, forming an insoluble complex. After washing, a labeled Ab reagent detects the complex. Depending on the label, it may yield a photometric, fluorescent, or chemiluminescent product that appears as a band. The bands from the patient sample are compared with those from the control containing Ab that will react with known antigens. Molecular weight markers are also separated and stained to provide a guide for interpretation of molecular weight.

Immunocytochemistry and Immunohistochemistry

When Ab reagents are used to detect antigens in cells or tissue, the methods are known as **immunocytochemistry** and **immunohistochemistry**, respectively. When the Ag is an integral part of the cell or tissue, this is direct testing. A second strategy, indirect testing, uses cells or tissue as a substrate (the source of Ag) to capture serum Ab; this complex is then detected using a labeled Ab reagent.

Fluorescent labels are most commonly used in immunocytochemistry and immunohistochemistry. When

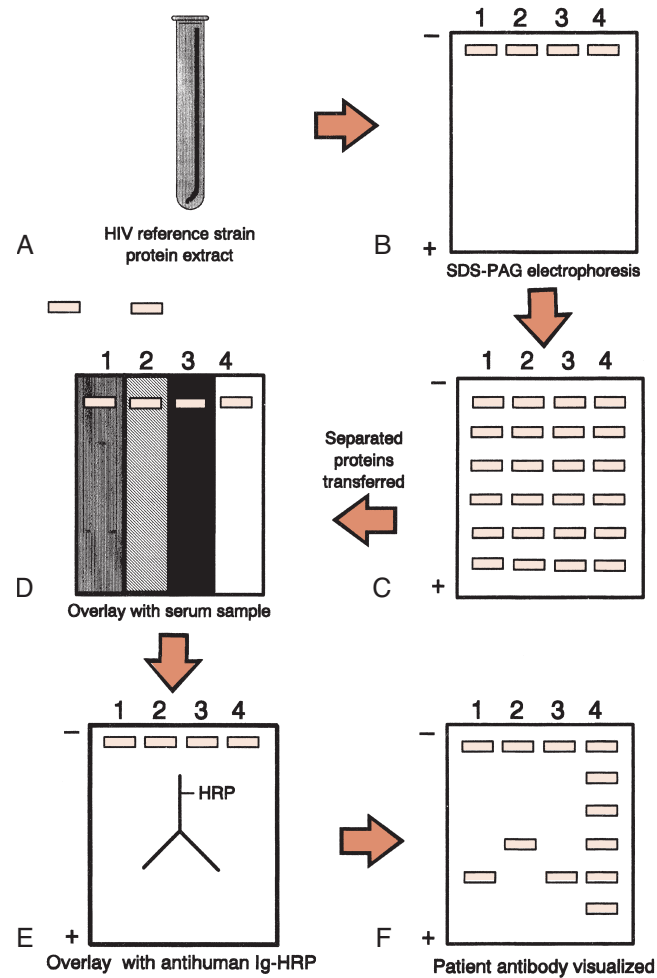

FIGURE 7-12. Immunoblot (Western blot) to detect antibodies to HIV antigens. **(A)** The HIV is disrupted and extracted to generate its antigens. **(B)** The HIV antigens are separated by sodium dodecyl sulfate–polyacrylamide gel electrophoresis. **(C)** The separated antigens are visualized and then transferred to a membrane. **(D)** Each lane of the membrane is overlaid with a patient or control serum. **(E)** After incubation and washing, a labeled antibody reagent is overlaid onto all lanes. **(F)** The bound-labeled antibody is detected.

used to microscopically identify bacteria or constituents in tissue (e.g., immune complexes deposited *in vivo*), the method is called **direct immunofluorescence (DIF)** or direct fluorescence assay (DFA). A specially configured fluorescence microscope is necessary. Appropriate wavelengths of light are selected by a filter monochromator to excite the fluorescent label; the fluorescent label emits light of a second wavelength that is selected for viewing by a second filter monochromator. Examples of DFA include detection of *Treponema pallidum* in lesional fluid or detection of immune complexes in glomerulonephritis associated with Goodpasture’s syndrome and lupus nephritis.

When a fluorescent label is used in indirect testing, this is *indirect immunofluorescence (IIF)* or an indirect im-

munofluorescence assay (IFA). The substrate is placed on a microscopic slide, serum is overlaid and allowed to react with the Ag, and the bound Ab is detected by the labeled antihuman globulin reagent. The slide is viewed using a fluorescence microscope. The most common IFA performed in the clinical laboratory detects Abs to nuclear antigens (ANA). Both the titer and pattern of fluorescence provide useful information to diagnose connective tissue disease. Other autoantibodies and Abs to infectious disease can be detected by IFA.

Immunophenotyping

An important and more recent advance in immunocytochemistry is the use of a flow cytometer to detect

intracellular and cell surface antigens. This technique, *immunophenotyping*, is used to classify cell lineage and identify the stage of cell maturation. In particular, immunophenotyping aids in the diagnosis of leukemias and lymphomas. Differentiating between acute myelogenous leukemia and acute lymphoblastic leukemia is difficult morphologically and requires additional information to identify the phenotypically expressed molecules. In lymphoid leukemias and lymphomas, identification of tumor cells as either T- or B-lymphocytes can be an important predictor of clinical outcome. Another application is to determine the CD4/CD8 ratio (the ratio of the number of helper T-lymphocytes to cytotoxic T-lymphocytes) and, more recently, the absolute number of CD4 positive (CD4⁺) cells. This is the standard method to diagnose infection and to initiate and monitor treatment, although viral load quantitation is considered by many to be a better marker.

Immunophenotyping begins with a living cell suspension. The cells may come from peripheral blood, bone marrow, or solid tissue. Leukocytes or mononuclear cells can be isolated using density gradient separation (centrifugation through Ficoll-Hypaque) or by red blood cell lysis. Tissue, such as lymph node and bone marrow, requires mechanical removal of cells from the tissue to collect a cell suspension. Based on patient history and type of specimen, a panel of fluorochrome-labeled MABs is used. Fluorochromes commonly used in immunophenotyping include fluorescein isothiocyanate, phycoerythrin, peridinin chlorophyll, CY-5, allophycocyanin, and tetramethyl rhodamine isothiocyanate. An aliquot of the cell suspension is incubated with one or more MAB, depending on the design of the flow cytometer. If the cell expresses the Ag, then the labeled MAB binds and the fluorescent label can be detected. **Flow cytometry** is based on cells transported under fluidic pressure passing one by one through a laser beam. The forward light scatter, side light scatter, and light emitted from fluorescent labels are detected by photomultiplier tubes. Forward light scatter is related to the size of the cell, and side light scatter is related to the granularity of the cell. When these two parameters are used together in a scattergram (two-parameter histogram), the desired cell population

can be electronically selected. This cell population is also evaluated for emission from the labeled MAB. For a single parameter, the frequency of cells versus the intensity of fluorescence (the channel number) is recorded and displayed as a single-parameter histogram. Alternatively, if two parameters are evaluated on the same cell, then a scattergram is generated that diagrams the expression of two antigens simultaneously. By using a panel of MABs, the cell can be identified and the relative or absolute number of the cell can be determined.

DNA Analysis by Flow Cytometry

In flow cytometry, another use of the flow cytometer is to measure the nuclear deoxyribonucleic acid (DNA) content and proliferative capacity of malignant cells. This helps to distinguish between benign and malignant disease, to monitor disease progression, and to predict response to treatment. Resting normal cells are in G₀ and G₁ phase of the cell cycle, and the nuclear DNA content is two sets of 23 chromosomes, known as *diploid*. As a cell prepares to replicate, the DNA is synthesized (S phase) and the DNA content is aneuploid. Mitosis (M phase) and cell division follow. The ploidy status reflected in the *DNA index (DI)* compares the amount of measured DNA in tumor cells with that in normal cells (Equation 7-7):

$$DI = \frac{\text{peak channel number of aneuploid G}_0/\text{G}_1 \text{ peak}}{\text{peak channel number of diploid G}_0/\text{G}_1 \text{ peak}} \quad (\text{Eq. 7-7})$$

If normal diploid cells were measured, then the DI is 1. If the DI is not 1, then the cells are aneuploid. If the DI is less than 1, the cells are hypodiploid; conversely, a DI greater than 1 is hyperploid. The percentage of cells in S phase is also determined and normally is less than 5%.

Fresh, alcohol-fixed cells or rehydrated cells removed from a paraffin block may be used. The cells are treated with a detergent to enable the stain to enter the nucleus. Stains, such as propidium iodide or ethidium bromide, intercalate the DNA, and the fluorescence is measured using the flow cytometer. The DNA content is related to the fluorescence intensity (channel number). Measuring the DI and percent S phase cells are prognostic indicators in breast, ovarian, bladder, and colorectal cancer.

REFERENCES

1. Sheehan C. An overview of antigen-antibody interaction and its detection. In: Sheehan C, ed. *Clinical immunology: principles and laboratory diagnosis*. 2nd ed. Philadelphia, Pa.: Lippincott-Raven Publishers, 1997:109.
2. Kohler G, Milstein C. Continuous cultures of fused cells secreting antibody of predefined specificity. *Nature* 1975;256:495.
3. Ouchterlony O. Antigen-antibody reactions in gel. *Acta Pathol Microbiol Scand* 1949;26:507.
4. Mancini G, Carbonara AO, Heremans JF. Immunochemical quantitation of antigens by single radial immunodiffusion. *Immunochemistry* 1965;2:235.
5. Fahey JL, McKelvey EM. Quantitative determination of serum immunoglobulins in antibody-agar plates. *J Immunol* 1965;98:84.
6. Grabar P, Burtin P. *Immuno-electrophoresis*. Amsterdam, the Netherlands: Elsevier, 1964.
7. Alper CC, Johnson AM. Immunofixation electrophoresis: a technique for the study of protein polymorphism. *Vox Sang* 1969;17:445.

8. Laurell CB. Quantitative estimation of proteins by electrophoresis in agarose gel containing antibodies. *Anal Biochem* 1966;15:45.
9. Laurell CB. Electroimmunoassay. *Scand J Clin Lab Invest* 1972;29 (suppl 124):21.
10. Kusnetz J, Mansberg HP. Optical considerations: nephelometry. In: Ritchie RF, ed. *Automated immunoanalysis. Part I*. New York, N.Y.: Marcel Dekker, 1978.
11. Engvall E, Perlmann P. *Immunochemistry* 1971;8:871.
12. Van Weemen BK, Schuurs AHWM. Immunoassay using antigen-enzyme conjugates. *FEBS Lett* 1971;15:232.
13. Nakamura RM, Bylund DJ. Fluorescence immunoassays. In: Rose NR, deMascario EC, Folds JD, Lane HC, Nakamura RM, eds. *Manual of Clinical Laboratory Immunology*, 5th ed. Washington, D.C.: ASM Press 1997;39.
14. Diamandis EP, Evangelista A, Pollack A, et al. Time-resolved fluoroimmunoassays with europium chelates as labels. *Am Clin Lab* 1989;8(8):26.
15. Kricka LJ. Chemiluminescent and bioluminescent techniques. *Clin Chem* 1991;37:1472.
16. Kricka LJ. Selected strategies for improving sensitivity and reliability of immunoassays. *Clin Chem* 1994;40:347.
17. Bronstein I, Juo RR, Voyta JC. Novel chemiluminescent adamantyl 1,2-dioxetane enzyme substrates. In: Stanley PE, Kricka LJ, eds. *Bioluminescence and chemiluminescence: current status*. Chichester, England: Wiley, 1991:73.
18. Edwards B, Sparks A, Voyta JC, et al. In: Campbell AK, Kricka LJ, Stanley PE, eds. *Bioluminescence and chemiluminescence: fundamentals and applied aspects*. Chichester, England: Wiley, 1994.
19. Litchfield WJ. Shell-core particles for the turbidimetric immunoassays. In: Ngo TT, ed. *Nonisotopic immunoassay*. New York, N.Y.: Plenum Press, 1988.
20. Rubenstein KE, Schneider RS, Ullman EF. "Homogeneous" enzyme immunoassay. A new immunochemical technique. *Biochem Biophys Res Commun* 1972;47:846.
21. Henderson DR, Freidman SB, Harris JD, et al. CEDIA, a new homogeneous immunoassay system. *Clin Chem* 1986;32:1637.
22. Ullman EF, Schwartzberg M, Rubinstein KD. Fluorescent excitation transfer assay: a general method for determination of antigen. *J Biol Chem* 1976;251:4172.
23. Dandliker WB, Dandiker BJ, Levison SA, et al. Fluorescence methods for measuring reaction equilibria and kinetics. *Methods Enzymol* 1978;48:380.
24. Dandliker WB, Kelly RJ, Dandiker BJ, et al. Fluorescence polarization immunoassay: theory and experimental methods. *Immunochemistry* 1973;10:219.
25. Diamandis EP. Immunoassays with time-resolved fluorescence spectroscopy: principles and applications. *Clin Biochem* 1988;21:139.
26. Yalow RS, Berson SA. Immunoassay of endogenous plasma insulin in man. *J Clin Invest* 1960;39:1157.
27. Valkirs GE, Barton R. ImmunoConcentration: a new format for solid-phase immunoassays. *Clin Chem* 1985;31:1427.
28. Rubenstein AS, Hostler RD, White CC, et al. Particle entrapment: application to ICON immunoassay. *Clin Chem* 1986;32:1072.
29. Zuk RF, Ginsberg VK, Houts T, et al. Enzyme immunochromatography: a quantitative immunoassay requiring no instrumentation. *Clin Chem* 1985;31:1144.
30. Harbeck RJ, Teague J, Crossen GR, et al. Novel, rapid optical immunoassay technique for detection of group A streptococci from pharyngeal specimens: comparison with standard culture methods. *J Clin Microbiol* 1993;31:839.

Molecular Theory and Techniques

Susan Orton

CHAPTER

8

CHAPTER OUTLINE

■ NUCLEIC ACID–BASED TECHNIQUES

Nucleic Acid Chemistry
Hybridization Techniques
DNA Sequencing
DNA Chip Technology

Target Amplification
Probe Amplification
Signal Amplification
Nucleic Acid Probe Applications

■ REFERENCES

Molecular techniques, assays that target nucleic acid instead of protein, are the latest development in clinical laboratory testing. This chapter introduces molecular techniques that at their core consist of the binding of a nucleic acid to its complementary target nucleic acid sequence. The target nucleic acid may or may not be amplified prior to detection and/or quantitation. Thus, nucleic acid–based methods are designed to detect changes at the **Deoxyribonucleic acid (DNA)** or **Ribonucleic acid (RNA)** level rather than to detect a synthesized gene product, such as a protein detected in immunoassays. Molecular techniques used in the clinical laboratory to identify unique nucleic acid sequences include enzymatic cleavage of nucleic acids, gel electrophoresis, enzymatic amplification of target sequences, and hybridization with nucleic acid probes. This chapter reviews the concepts of binding, describes the nature of the reagents used, and discusses basic assay design of selected techniques used in the clinical laboratory; as such, it is intended to be an overview rather than an exhaustive review.

NUCLEIC ACID–BASED TECHNIQUES

Molecular testing is a rapidly expanding area in the clinical laboratory. Research laboratories have used these techniques for many years; however, development of U.S. Food and Drug Administration (FDA)-approved assays for the detection and quantitation of DNA and RNA in clinical samples has only developed within the past 10 to 15 years. Key quality issues to be addressed in any clinical DNA-based assays include sample quality and preparation, sensitivity of reagents to inactivating contaminants, amplification bias and variability, selection of appropriate controls, restriction enzyme efficiency, and

reproducibility and cross-contamination of amplification reactions. Nucleic acids store all genetic information and direct the synthesis of specific proteins. By evaluating nucleic acids, insight into cellular changes may be realized before specific protein products are detectable. Genetically based diseases, presence of infectious organisms, differences between individuals for forensic and transplantation purposes, and altered cell growth regulation are areas that have been investigated using nucleic acid hybridization. The most recent development is the use of molecular arrays (up to 10^5 – 10^6 probes per single array) for high-speed analysis of multiple ligands and the analysis of gene expression.

Nucleic Acid Chemistry

DNA stores human genetic information and dictates the amino acid sequence of peptides and proteins. DNA is composed of two strands of nucleotides; each strand is a polymer of deoxyribose molecules linked by strong 3'-5' phosphodiester bonds that join the 3' hydroxyl group of one sugar to the 5' phosphate group of a second sugar. A purine or pyrimidine base is also attached to each sugar. The two strands are arranged in a double helix with the bases pointing toward the center. The strands are antiparallel, so that the 3'-5' end of one strand bonds with a strand in the 5' → 3' direction. Because the phosphate esters are strong acids and dissociated at neutral pH, the strand has a negative charge that is proportional to its length. The purine bases (adenine [A] and thymine [T]) and the pyrimidine bases (cytosine [C] and guanine [G]) maintain the double helix by forming hydrogen bonds between base pairs as shown in Figure 8-1. Adenine pairs with thymine with two hydrogen bonds and cytosine

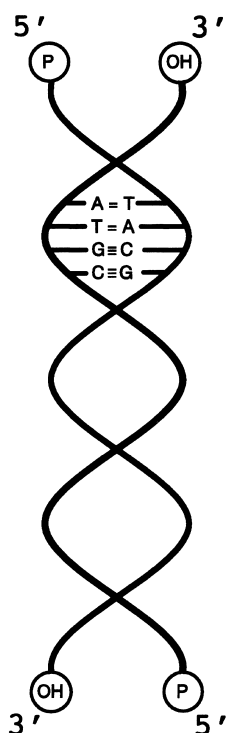

FIGURE 8-1. DNA molecule. The double helix of the DNA is shown along with details of how the bases, sugars, and phosphates connect to form the structure of the molecule. DNA is a double-stranded molecule twisted into a helix (think of a spiral staircase). Each spiraling strand, composed of a sugar–phosphate backbone and attached bases, is connected to a complementary strand by noncovalent hydrogen bonding between paired bases. The bases are adenine (A), thymine (T), cytosine (C), and guanine (G). A and T are connected by two hydrogen bonds. G and C are connected by three hydrogen bonds.

pairs with guanine with three hydrogen bonds. The strands are complementary due to the fixed manner by which the base pairs bond.

Under physiologic conditions, the helical structure of double-stranded DNA (dsDNA) is stable due to the numerous, although weak, hydrogen bonds between base pairs and the hydrophobic interaction between the bases in the center of the helix. However, the weak bonds can be broken in vitro by changing environmental conditions; the strands are denatured and separate from each other. Once denatured, the negative charge of each strand causes the strands to repel each other. The two complementary strands can be reassociated or reannealed if the conditions change and favor this process. The renaturation will follow the rules of base pairing so the original DNA molecule is recovered.

Ribonucleic acid (RNA) is also present in human cells and is chemically similar to DNA. RNA differs from DNA in three ways: (1) ribose replaces deoxyribose as the sugar; (2) uracil replaces thymine as a purine base; and (3) RNA is single-stranded. DNA and RNA work to-

gether to synthesize proteins. Genomic dsDNA is enzymatically split into its two strands, one of which serves as the template for synthesis of complementary **messenger RNA (mRNA)**. As mRNA is released from the template DNA, the DNA strands reanneal. The mRNA specifies the amino acid to be added to the peptide chain by transfer RNA, which transports the amino acid to the ribosome, where peptide chain elongates.

This discussion of protein synthesis highlights that physiologically DNA routinely is denatured, binds to RNA, and reanneals to reestablish the original DNA, always following base pair rules. These processes form the foundation of nucleic acid **hybridization** assays in which complementary strands of nucleic acid from unrelated sources bind together to form a hybrid or *duplex*. Molecular testing in the clinical laboratory consists of two major areas: (1) the use of DNA probes to directly detect or characterize a specific target and (2) the use of nucleic acid amplification technologies to detect or characterize a specific target DNA or RNA. Procedures that use probes include solid-phase assays (capture hybridization, Southern and Northern blotting), solution-based assays (protection assays, hybrid capture assays), and in situ hybridization assays. Amplification procedures include nucleic acid amplification (polymerase chain reaction, nucleic acid–based sequence amplification, transcription-mediated amplification, strand displacement amplification), probe amplification (ligase chain reaction), and signal amplification (branched-chain DNA assay).

Hybridization Techniques

A **nucleic acid probe** is a short strand of DNA or RNA of a known sequence that is well characterized and complementary for the base sequence on the test target. Probes may be fragments of genomic nucleic acids, cloned DNA (or RNA), or synthetic DNA. The genomic nucleic acids are isolated from purified organisms. Some probes are molecularly cloned in a bacterial host. First, the sequence of DNA to be used as the probe must be isolated using bacterial restriction endonucleases to cut the DNA at a specific base sequence. The desired base sequence (the probe) is inserted into a plasmid vector, circular dsDNA. The vector with the insert is incorporated into a host cell, such as *Escherichia coli*, where the vector replicates. The replicated desired base sequence is then isolated and purified. For short DNA segments, an oligonucleotide probe can be synthesized using an automated process; if the amino acid sequence of the protein is known, it is possible to determine the base sequence based on amino acid sequence.

In a hybridization reaction, the probe must be detected. The probe can be labeled directly with a radionuclide (such as ^{32}P), enzyme, or biotin. ^{32}P is detected by autoradiography when the radioactive label exposes x-ray

TABLE 8-1 PROBE TECHNIQUES

| UNAMPLIFIED |
|--|
| Southern blot |
| Northern blot |
| In situ hybridization |
| Restriction fragment length polymorphism (RFLP) |
| TARGET AMPLIFICATION |
| Polymerase chain reaction (PCR) |
| Reverse transcription–polymerase chain reaction (RT-PCR) |
| Transcription-based amplification systems (TAS) |
| Transcription-mediated amplification (TMA) |
| Nucleic acid sequence–based amplification (NASBA) |
| Strand displacement assay (SDA) |
| PROBE AMPLIFICATION |
| Ligase chain reaction (LCR) |
| SIGNAL AMPLIFICATION |
| Branched DNA assay (bDNA) |

film wherever the probe is located. If the probe is directly labeled with an enzyme, an appropriate substrate must be added to generate a colorimetric, fluorescent, or chemiluminescent product. Biotin labeled probes can bind to avidin, which is complexed to an enzyme (e.g., alkaline phosphatase or horseradish peroxidase); the enzyme activity can then be detected. Alternatively, the biotinylated probe can be detected by a labeled avidin antibody reagent.

The probe techniques to be discussed are listed in Table 8-1. Hybridization can take place either in a solid support medium or in solution.

Solid Support Hybridization

Dot-blot and sandwich hybridization assays are the simplest types of solid support hybridization assays.¹ In the dot-blot assay, clinical samples are applied directly to a membrane surface. The membrane is heated to denature or separate DNA strands, and then labeled probes are added. After careful washing to remove any unhybridized probe, presence of remaining probe is detected by autoradiography or enzyme assays. A positive result indicates presence of a specific sequence of interest. This permits qualitative testing of a clinical specimen because it only indicates presence or absence of a particular genetic sequence. It is much easier to handle multiple samples in this manner.² However, there may be difficulty with the interpretation of weak positive reactions because there can be background interference.³

Sandwich hybridization is a modification of the dot-blot procedure. It was designed to overcome some of the

background problems associated with the use of unpurified samples.⁴ The technique uses two probes, one of which is bound to the membrane and serves to capture target sample DNA. The second probe **anneals** to a different site on the target DNA, and it has a label for detection. The sample nucleic acid is thus sandwiched in between the capture probe on the membrane and the signal-generating probe.⁴ Because of the fact that two hybridization events must take place, specificity is increased. Sandwich hybridization assays have been developed using microtiter plates instead of membranes, which has made the procedure more adaptable to automation.⁴

A classic method for DNA analysis, attributed to E. M. Southern, is the **Southern blot**.⁵ In this method, DNA is extracted from a sample using a phenolic reagent and then enzymatically digested using restriction endonucleases to produce DNA fragments. These fragments are then separated by agarose gel electrophoresis. The separated DNA fragments are denatured and transferred to a solid support medium—most commonly, nitrocellulose or a charged nylon membrane. The transfer occurs by the capillary action of a salt solution, transferring DNA to the membrane, or using an electric current to transfer the DNA. When the DNA is on the membrane, a labeled probe is added that binds to the complementary base sequence and appears as a band. In a similar method, the **Northern blot**, RNA is extracted, digested, electrophoresed, blotted, and finally probed.

Restriction fragment length polymorphism (RFLP) is a technique that evaluates differences in genomic DNA sequences.⁶ This technique can help establish identity or nonidentity in forensic or paternity testing or to identify a gene associated with a disease. Genomic DNA is extracted from a sample (e.g., peripheral blood leukocytes) and is purified and quantitated. A restriction endonuclease, which cleaves DNA sequences at a specific site, is added. If there is a mutation or change in the DNA sequence, this may cause the length of the DNA fragment to be different from usual. Southern blotting can be used to identify the different lengths of the DNA fragments. A labeled specific probe could be used to identify a specific aberration. **Polymerase chain reaction (PCR)** can be used to amplify the target DNA sequence before RFLP analysis.

Solution Hybridization

Hybridization assays can also be performed in a solution phase. In this type of setting, both the target nucleic acid and the probe are free to interact in a reaction mixture, resulting in increased sensitivity compared with that of solid support hybridization. It also requires a smaller amount of sample, although the sensitivity is improved when target DNA is extracted and purified.³

For solution hybridizations, the probe must be single-stranded and incapable of self-annealing.² Several unique detection methods exist. In one of these, an S1 nuclease

is added to the reaction mix. This will only digest unannealed or single-stranded DNA, leaving the hybrids intact. Double-stranded DNA can then be recovered by precipitation with trichloroacetic acid or by binding it to hydroxyapatite columns.^{2,7}

A second and less technically difficult means of solution hybridization is the hybridization protection assay (HPA). For this assay, a chemiluminescent acridium ester is attached to a probe. After the hybridization reaction takes place, the solution is subjected to alkaline hydrolysis, which hydrolyzes the chemiluminescent ester if the probe is not attached to the target molecule. If the probe is attached to the target DNA, the ester is protected from hydrolysis. Probes that remain bound to a specific target sequence give off light when exposed to a chemical trigger such as hydrogen peroxide at the end of the assay.

Digene's Hybrid Capture 2 (Digene Corp., Gaithersburg, Md.) assay for detection of human papilloma virus (HPV) is a solution phase hybridization assay that uses an antibody specific for DNA/RNA hybrids to "capture" and detect the hybrids that are formed during the solution hybridization of HPV DNA in the sample with an unlabeled RNA probe.

Solution phase hybridization assays are fairly adaptable to automation, especially those using chemiluminescent labels. Assays can be performed in a few hours.² However, low positive reactions are difficult to interpret because of the possibility of cross-reacting target molecules.⁸

In situ hybridization is performed on cells, tissue, or chromosomes that are fixed on a microscope slide.⁹ After the DNA is heat denatured, a labeled probe is added and will hybridize the target sequence after the slide is cooled. Colorimetric or fluorescent products are generally used. One strength of this method is the morphologic context in which the localization of target DNA is viewed.

DNA Sequencing

DNA sequencing is considered the "gold standard" for many molecular applications from mutation detection to genotyping, but it requires proper methodology and interpretation to prevent misinterpretation. The sequence should be analyzed on both DNA strands to provide even greater accuracy. Patient sequences are compared with known reference sequences to detect mutations. Most sequencing strategies include **polymerase chain reaction (PCR)** amplification as the first step to amplify the region of interest to be sequenced. The sequencing reaction itself is based on the dideoxy chain termination reaction developed by Sanger and colleagues in 1977.¹⁰ This reaction generates fragments of newly synthesized DNA, which upon incorporation of one of four **dideoxynucleotides** halts synthesis of the new DNA. The fragments are of varying lengths due to incorporation of the dideoxynucleotides. These nucleotides lack the 3' and 2'

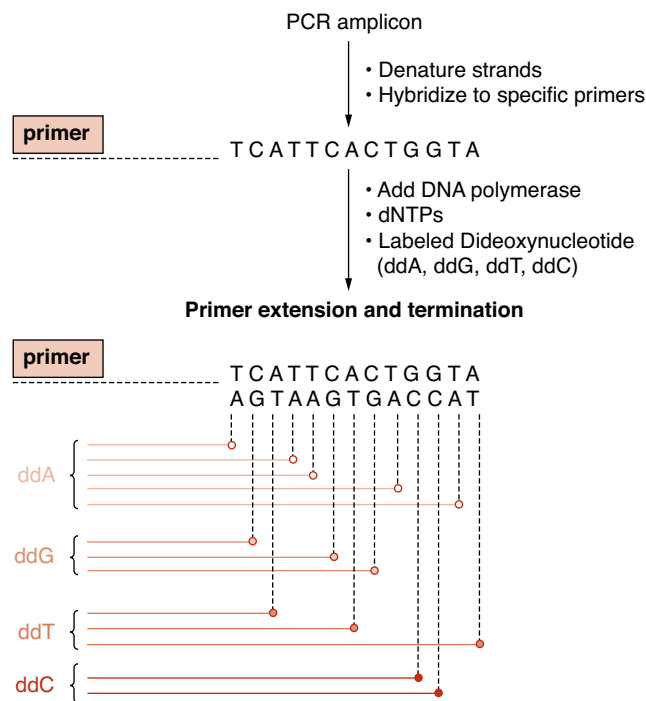

FIGURE 8-2. Sanger dideoxy DNA sequencing. The region of interest is first amplified using PCR. Sequence-specific primers then hybridize with the denatured amplicons, followed by extension of the new strand by DNA polymerase. At various points in the DNA extension, a dideoxy base (ddA, ddG, ddT, or ddC) is incorporated, which stops further extension of DNA. This results in a mixture of newly synthesized products of various lengths. Each dideoxy terminator base is labeled with a specific fluorescent tag, which can be detected with a fluorescent detector. The fragments are separated based upon their size, and fluorescence is read on each strand, resulting in the sequence of the DNA.

hydroxyl (OH) group on the pentose ring, and because DNA chain elongation requires the addition of deoxynucleotides to the 3'-OH group, incorporation of the dideoxynucleotide terminates chain length. Varying lengths of DNA are synthesized, all with a dideoxynucleotide at the end. The reaction mixture is then run on a gel, separating the various DNA fragments by size, and the sequence is read directly from the gel. The most commonly used form of this sequencing method in the clinical laboratory uses "cycle sequencing," which is similar to a PCR in that the steps involved include denaturation, annealing of a primer, chain extension, and termination by varying the temperature of the reaction. The newly generated fragments are tagged with a fluorescent dye and separated, based upon size, by denaturing gel or capillary electrophoresis and detected by fluorescence detectors as the fragments pass through the detector. Using this automated method with capillary electrophoresis, about 600 base pairs can be sequenced in a 2½-hour period (Fig. 8-2). DNA sequencing is most commonly used to detect mutations. For example, in infectious

disease, testing such as sequencing of the human immunodeficiency virus (HIV) for drug resistance and of the hepatitis C virus (HCV) is used to establish appropriate therapy and treatment decisions.

DNA Chip Technology

Previously, genetic studies examined individual gene expression by Northern blotting or polymorphisms by gel-based restriction digests and sequence analysis, but with advances in microchips and bead-based array technologies, high throughput analysis of genetic variation is now possible. Biochips, also called microarrays, are very small devices used to examine DNA, RNA, and other substances. These chips allow thousands of biological reactions to be performed at once.¹¹ Typically, a biochip consists of a small rectangular solid surface that is made of glass or silicon with short DNA or RNA probes anchored to the surface.¹² The number of probes on a biochip surface can vary from 10 to 20 up to hundreds of thousands.^{11,12} Usually, the nucleic acid in the sample is amplified before analysis. After amplification, the sample, labeled with a fluorescent tag, is loaded onto the chip. Hybridization occurs on the surface of the chip, allowing thousands of hybridization reactions to occur at one time. Unbound strands of the target sample are then washed away. The fluorescent tagged hybridized samples are detected using a fluorescent detector.¹¹ The intensity of the fluorescent signal at a particular location is proportional to the sequence homology at a particular locus. Complete sequence matches result in bright fluorescence, while single-base mismatches result in a dimmer signal, indicative of a point mutation. Because most single nucleotide polymorphisms (SNPs) are silent and have no apparent functional consequence, the challenge is to identify the set of SNPs that are directly related to or cause disease. Detection of point mutations can be used for classification of leukemias, molecular staging of tumors, and characterization of microbial agents.¹³ One prime example is the determination of genes associated with drug resistance in HIV testing. Identification of such genes guides the physician in selecting a proper drug regimen for a particular patient.

Currently, Affymetrix, Inc. has developed Gene Chips, proprietary, high-density microarrays that contain 10,000 to 400,000 different short DNA probes on a 1.2- × 1.2-cm glass wafer. GeneChips are available for HIV-1 genotyping,¹³ human *p53* tumor suppressor gene mutation analysis, and human cytochrome *p450* gene mutation analysis, with other GeneChips currently under development.

Target Amplification

Target amplification systems are in vitro methods for the enzymatic replication of a target molecule to levels at which it can be readily detected.³ This allows the target sequence to be identified and further characterized.

There are numerous different types of target amplification. Examples include PCR, **transcription-mediated amplification (TMA)**, strand displacement amplification (SDA), and **nucleic acid sequence-based amplification (NASBA)**. Of these, PCR is by far the best known and most widely used technique in clinical laboratories.¹⁴ However, the other non-PCR methods have become more popular in recent years.

The PCR developed by K. B. Mullis of Cetus Company^{15,16} is an amplified hybridization technique that enzymatically synthesizes millions of identical copies of the target DNA to increase the analytic sensitivity. The test reaction mixture includes the test DNA sample (lysed cells or tissue enzymatically digested with RNase and proteinase and then extracted), oligonucleotide primers, thermostable DNA polymerase (e.g., *Taq* polymerase, from *Thermus aquaticus*), and nucleotide triphosphates (ATP, GTP, CTP, and TTP) in a buffer. The process, shown in Figure 8-3, begins by heating the target DNA to denature

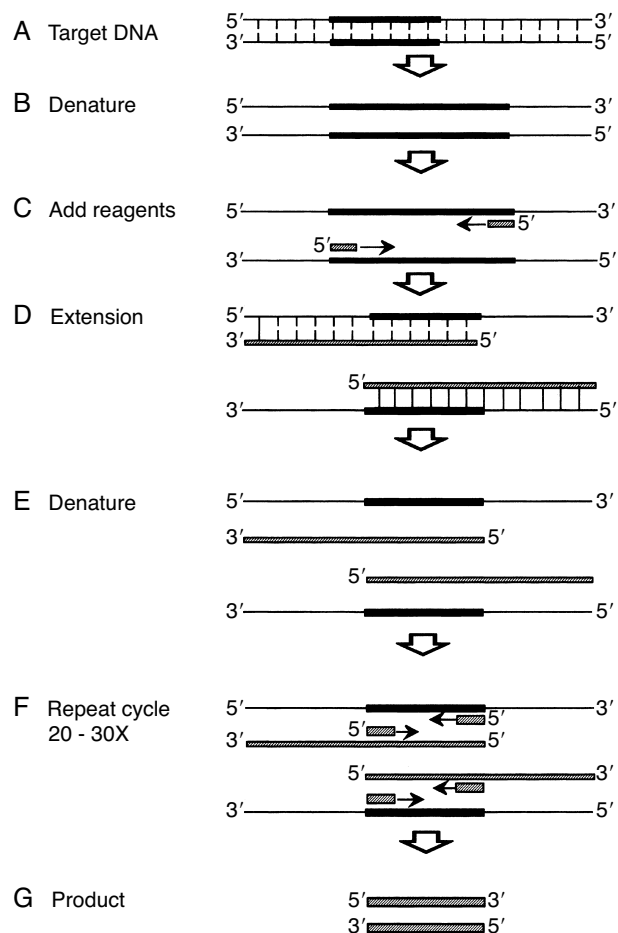

FIGURE 8-3. Polymerase chain reaction. **(A)** Target DNA sequence is indicated by the *bold line*. **(B)** Double-stranded DNA is denatured (separated) by heating. **(C)** Reagents are added, and the primer binds to the target DNA sequence. **(D)** Polymerase extends the primers. **(E–G)** Heating, annealing of the primer, and extension are repeated.

it, separating the strands. Two oligonucleotide primers (probes) that recognize the edges of the target DNA are added and anneal to the target DNA. Thermostable DNA polymerase and nucleotide triphosphates extend the primer. The process of heat denaturation, cooling to allow the primers to anneal and heating again to extend the primers, is repeated manyfold (15–30 times or more). PCR is an exponential amplification reaction in which after n cycles, there is $(1 + x)^n$ times as much target as was present initially, where x is the mean efficiency of the reaction for each cycle. Theoretically, as few as 20 cycles would yield approximately 1 million times the amount of target DNA initially present. However, in reality, the theoretical maxima are never reached and more cycles are necessary to achieve such levels of amplification. The amplified target DNA sequences, known as **amplicons**, can be analyzed by gel electrophoresis, by Southern blot, sequencing, or using directly labeled probes.

When the target is microbial RNA or mRNA, the RNA must be enzymatically converted to DNA by reverse transcriptase; the product, complementary DNA (cDNA), can then be analyzed by PCR. This method is referred to as a **reverse transcription–polymerase chain reaction (RT-PCR)**. Initially, PCR was a qualitative assay, but assays have been developed that allowed for quantitation of amplicons. Quantitative RT-PCR is used to measure viral loads in HIV- and HCV-infected patients. These numbers allow physicians to determine disease status and evaluate efficacy of antiviral treatments.

The latest PCR innovation is the development of “real-time” RT-PCR, which allows for direct measurement of amplicon accumulation during the exponential phase of the reaction. Two important findings led to the discovery of real-time PCR: (1) finding that the *Taq* polymerase possesses 5' → 3'-exonuclease activity^{17,18} and (2) the construction of dual-labeled oligonucleotide probes that emit a fluorescence signal only on cleavage, based on the principle of *fluorescence resonance energy transfer (FRET)*.¹⁹ FRET involves the nonradioactive transfer of energy from a donor molecule to an acceptor molecule. Probe-based systems, such as TaqMan probes,²⁰ molecular beacons,²¹ and scorpion primers,²² rely on the close proximity of donor fluorophores and nonfluorophore acceptor molecules (quenchers) in the unhybridized probe, so that little or no signal is generated as the fluorescence of the donor is quenched by the acceptor. Upon hybridization to the target, the fluorophore and quencher become separated through either conformational changes (molecular beacons and scorpion primers) or enzymatic cleavage of the fluorophore from the quencher as a result of the 5'-to-3' nuclease activity of *Taq* polymerase. Real-time detection occurs when the fluorescence emission of the reporter probe (driven by the accumulation of amplicons) is monitored cycle by cycle. The results are available immediately and,

more importantly, there is no manipulation of the post-amplification sample, reducing the chance of contaminating other samples with amplified products.

PCR is limited by expense, the need for special thermocyclers, potential aerosol contamination from one sample to another, nonspecific annealing, and degree of stringency. Stringency is related to the stability of the bonding between target DNA or RNA and the probe and is based on the degree of match and the length of the probe. Stability of the duplex is strongly influenced by temperature, pH, and ionic strength of the hybridization solution. Under low stringency conditions (low temperature or increased ionic strength), imperfect binding occurs.

Transcription-Based Amplification

Other techniques have evolved to overcome some of these shortcomings, to standardize methods for use in clinical laboratories, or to provide new proprietary approaches. Amplification of the target, probe, and signal has been described. The classic target amplification method, PCR, increases the number of target nucleic acids so that simple signal detection systems can be used. Another target amplification method is **self-sustained sequence replication (3SR)** or *transcription-based amplification system (TAS)*, which detects target RNA and involves continuous isothermic cycles of reverse transcription.^{23,24} The first non-PCR nucleic acid amplification method developed was a TAS by Kwok et al. in 1989 that amplified an RNA target.²⁵ The principle of the reaction was a two-step process that involved generation of cDNA from the target RNA followed by reverse transcription of the cDNA template into multiple copies of RNA. Multiple cycles results in amplification of the target (Fig. 8-4). From this system, two other non-PCR target amplification methods have been developed that are currently used in clinical assays: nucleic acid sequence–based amplification (NASBA) and transcription-mediated amplification (TMA). The advantages of these two methods are that they are both isothermal reactions that do not require the use of a thermal cycler.

Strand Displacement Amplification (SDA) was originally developed and patented by Becton Dickinson, Inc. (Franklin Lakes, N.J.) in 1991.^{26,27} One set of primers incorporates a specific restriction enzyme site that is later attacked by an endonuclease. The resulting “nick” created in only one strand by the restriction enzyme allows for displacement of the amplified strands that then, in turn, serve as targets for further amplification and nick digestion. A modified deoxynucleotide (dATP α S; one of the oxygen molecules in the triphosphate moiety has been replaced with sulfur) is used to synthesize a double-stranded, hemiphosphorothioated DNA recognition site for the restriction enzyme cleavage that allows only single-strand nicking of the unmodified strand instead of cutting through both strands. Becton Dickinson currently

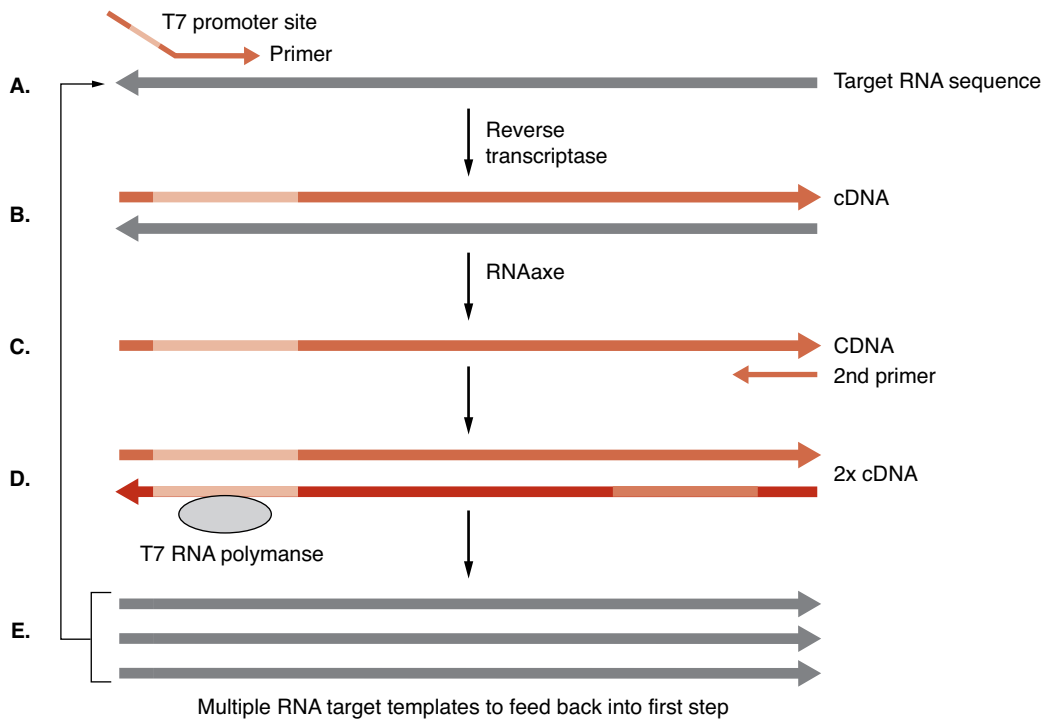

FIGURE 8-4. Transcription-based amplification systems. Non-PCR method of amplifying RNA targets. NASBA and TMA are based upon this methodology; NASBA uses three enzymes (reverse transcriptase, RNase H, and T7 DNA-dependent RNA polymerase), while TMA only uses RNA polymerase and a reverse transcriptase with inherent RNase H activity. Initial steps in the procedure involve generation of cDNAs from the target RNA using primers (which incorporate a T7 RNA polymerase binding site) (**A** and **B**). RNase H then destroys the initial strands of target RNA from the RNA cDNA hybrids (**C**). The cDNA then serves as template for the generation of double-stranded cDNA, with one strand (containing the T7 binding site) serving as the template for reverse transcription and synthesis of multiple copies of RNA using the T7 RNA polymerase (**D**). The RNAs then serve as templates for more cDNA templates to be made, and the cycles continue (**E**).

markets this methodology under the label BD ProbeTec, and it is FDA approved for the detection of *Legionella pneumophila*, with a combination kit for *Chlamydia trachomatis* and *Neisseria gonorrhoeae*.²⁸

Probe Amplification

Rather than directly amplifying the target, there are several techniques that amplify the detection molecule or probe itself. The ligase chain reaction is an example of this technique. The **ligase chain reaction (LCR)** is a probe amplification technique that uses two pairs of labeled probes that are complementary for two, short-target DNA sequences in close proximity.²⁹ After hybridization, the DNA ligase interprets the break between the ends as a nick and links the probe pairs.

Signal Amplification

Signal amplification methods are designed to increase the signal strength by increasing the concentration of the label. This technique uses multiple probes and several simultaneous hybridization steps. It has been compared to

decorating a Christmas tree, and it involves several sandwich hybridizations. In the first step, target-specific oligonucleotide probes capture the target sequence to a solid support. Then a second set of target-specific probes called extenders hybridize to adjoining sequences and act as binding sites for a large piece called the branched amplification multimer. Each branch of the amplification multimer has multiple side branches capable of binding numerous (up to 10,000) enzyme-labeled oligonucleotides onto each target molecule (Fig. 8-5). Perhaps the best known of the signal amplification systems is the **branched chain signal amplification (bDNA)** system originally developed by Chiron Corporation and now sold through Siemens Healthcare Diagnostics (Tarrytown, N.J.).³⁰ The most recent bDNA system has high specificity and can provide quantitative detection over a range of several orders of magnitude (10^2 – 10^5 copies per mL).^{31,32} Branched chain systems are well suited for the detection of nucleic acid target with sequence heterogeneity, such as HCV and HIV, because if one or two of the capture or extender probes fail to hybridize, the signal-generating capacity is not lost as a result of the presence of several remaining

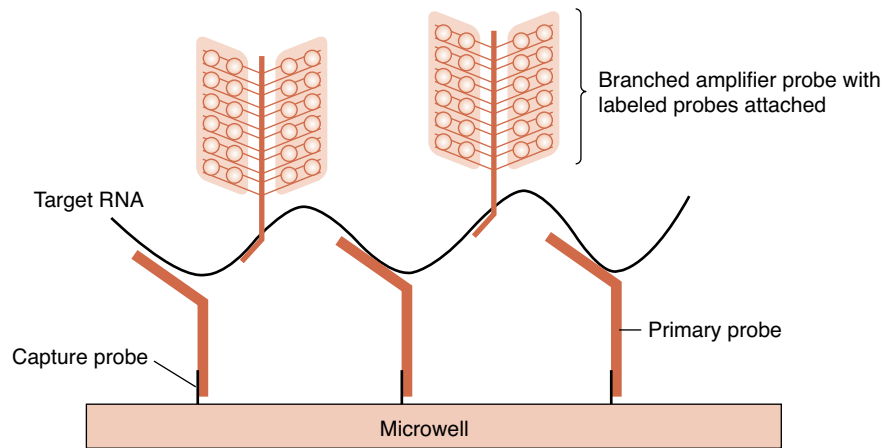

FIGURE 8-5. Branched chain amplification. Several different probes are used to amplify the signal rather than the target DNA itself. The first probe captures the target. Amplifier 1 binds in a different place and forms the base for amplifier 2, the branched chain. Amplifier 3 contains the signal.

probe complexes. Additionally, the need for several independent probe-target hybridization events provides a great deal of specificity. The danger of false-positive results caused by carry over of target material is decreased because the target itself is not amplified. However, non-specific localization of reagents can result in background amplification.³² Assays for hepatitis B virus, HCV, HIV-1, and cytomegalovirus have been developed using this method.³¹ This system is also used to quantitate HIV-1 with a lower limit of detection at 75 copies per mL.²⁸ It has been validated for the quantitation of viral load testing of all the subtypes. Therefore, this technique can be used for quantitation and to help monitor the therapeutic response.

Nucleic Acid Probe Applications

Nucleic acid probes are used to detect infectious organisms; to detect gene rearrangements, chromosomal translocations, or chromosomal breakage; to detect changes in oncogenes and tumor suppressor factors; to aid in prenatal diagnosis of an inherited disease or carrier status; to identify polymorphic markers used to establish identity or nonidentity; and to aid in donor selection. Nucleic acid probes are useful in identifying microorganisms in a patient specimen or confirming an organism isolated in culture. Probes are currently available to confirm *Mycobacterium* sp., *Legionella* sp., *Salmonella*, diarrheogenic *Escherichia coli* strains, *Shigella*, and *Campylobacter* sp.. Probes also are available to identify fungi such as *Blastomyces dermatitidis*, *Coccidioides immitis*, *Cryptococcus neoformans*, and *Histoplasma capsulatum*. Direct identification of microorganisms in patient specimens includes *Chlamydia trachomatis*, *Neisseria gonorrhoea*, cytomegalovirus, Epstein-Barr virus, and herpes simplex virus. In addition,

viral load testing for HIV and HCV is detected using probe technology. Detection of multidrug-resistant strains of *Mycobacterium tuberculosis* may lead to more timely public health control measures. Identification of genes for antimicrobial resistance in other organisms will help in more effective treatment for severe infections.³³ HCV genotyping and pretreatment viral load testing in newly diagnosed infections provide the physician with valuable information to determine therapy regimens.³⁴ HIV viral load testing can play a role in diagnosis of HIV in neonates born to HIV-infected mothers as well as in the diagnosis of acute HIV infections, which are defined as the period after exposure to the virus but before seroconversion.³⁵

Gene rearrangement studies by Southern blot are helpful to distinguish between T- and B-lymphocyte lineage.³⁶ Also, the chromosome translocation associated with most follicular, non-Hodgkin's lymphomas and certain diffuse, large-cell lymphomas has been detected and monitored. The Philadelphia chromosome in chronic myelogenous leukemia is associated with the translocation that results in the detection of the *bcr/abl* fusion gene.³⁷ Other mutations associated with hematologic and solid tumors are being described daily.

Prenatal diagnosis of genetic diseases such as sickle cell anemia, cystic fibrosis,³⁸ Huntington's chorea,³⁹ Duchenne-type muscular dystrophy,⁴⁰ and von Willebrand's disease⁴¹ has been made possible using probe technology. In addition, the carrier status in Duchenne-type muscular dystrophy and von Willebrand's disease can be determined.

PCR has been used to detect major histocompatibility complex class I and class II polymorphism.⁴² The increased accuracy of detecting differences in the genes, rather than the gene product, has been used to improve transplant compatibility.

REFERENCES

1. Parslow TG. Molecular genetic techniques for clinical analysis of the immune system. In: Stites DP, Terr AI, Parslow TG, eds. *Medical immunology*. 9th ed. Stamford, Conn.: Appleton & Lange, 1997:309–318.
2. Podzorski RP. Molecular methods. In: Detrick B, Hamilton RG, Folds JD, et al. (eds). *Manual of molecular and clinical laboratory immunology*. 7th ed. Washington, DC: American Society for Microbiology, 2006:26–52.
3. Tenover FC, Unger ER. Nucleic acid probes for detection and identification of infectious agents. In: Persing DH, Smith TF, Tenover FC, et al., eds. *Diagnostic molecular microbiology: principles and applications*. Washington, D.C., American Society for Microbiology, 1993:3–25.
4. Lo DYM, Chiu RWK. Principles of molecular biology. In: Burtis CA, Ashwood ER, Bruns DE, eds. *Tietz textbook of clinical chemistry and molecular diagnostics*. 4th ed. St. Louis, Mo.: Elsevier Saunders, 2006:1393–1406.
5. Southern EM. Detection of specific sequences among DNA fragments separated by gel electrophoresis. *J Mol Biol* 1975;98:503.
6. Saiki RK, Scharf S, Faloona F, et al. Enzymatic amplification of beta-globulin genomic sequences and restriction site analysis for diagnosis of sickle cell anemia. *Science* 1985;230:1350–1354.
7. Hansen CA. Clinical applications of molecular biology in diagnostic hematology. *Lab Med* 24:562, 1993.
8. Unger ER, Piper MA. Molecular diagnostics: Basic principles and techniques. In: Henry, JB, ed. *Clinical diagnosis and management by laboratory methods*. 20th ed. Philadelphia, Pa.: WB Saunders, 2001:1275–1295.
9. Hankin RC. In situ hybridization: principles and applications. *Lab Med* 1992;23:764.
10. Sanger F, Nicklen S, Coulson AR. DNA sequencing with chain terminating inhibitors. *Proc Natl Acad Sci USA* 1977;74:5463.
11. Friedrich MJ. New chip on the block. *Lab Med* 30:180, 1999.
12. Check W. Clinical microbiology eyes nucleic acid-based technologies. *ASM News* 1998;64:84.
13. Vahey M, Nau ME, Barrick S, et al. Performance of the Affymetrix GeneChip HIV PRT 440 platform for antiretroviral drug resistance genotyping of human immunodeficiency virus type 1 clades and viral isolates with length polymorphisms. *J Clin Microbiol* 1999;37:2533.
14. Forbes BA, Sahm DF, Weissfeld AS. *Bailey and Scott's diagnostic microbiology*. 10th ed. St. Louis, Mo.: Mosby, 1998:188–207.
15. Mullis KB, Faloona FA. Specific synthesis of DNA in vitro via a polymerase-catalyzed chain reaction. *Methods Enzymol* 1987; 155:335.
16. Mullis KB. The unusual origin of the polymerase chain reaction. *Sci Am* 1990;262:56.
17. Foy CA, Parkes HC. Emerging homogenous DNA-based technologies in the clinical laboratory. *Clin Chem* 2001;47:990.
18. Holland PA, Abramson RD, Watson R, Gelfand DH. Detection of specific polymerase chain reaction by utilizing the 5' to 3' exonuclease activity of *Thermus aquaticus* DNA polymerase. *Proc Natl Acad Sci USA* 1991;88:7276.
19. Szollosi J, Damjanovich S, Matyus L. Application of fluorescence resonance energy transfer in the clinical laboratory: routine and research. *Cytometry* 1998;15:159.
20. Livak K, Flood S, Marmaro J, et al. Oligonucleotides with fluorescent dyes at opposite ends provide a quenched probe system useful for detecting PCR product and nucleic acid hybridization. *PCR Meth Appl* 1995;4:357.
21. Tyagi S, Kramer F. Molecular beacons: probes that fluoresce upon hybridization. *Nat Biotechnol* 1996;14:303.
22. Whicombe D, Theaker J, Guy S, et al. Detection of PCR products using self-probing amplicons and fluorescence. *Nat Biotechnol* 1999;17:804.
23. Guatelli JC, Whitfield KM, Kwoh DY, et al. Isothermal in vitro amplification of nucleic acids by a multienzyme reaction modeled after retroviral replication. *Proc Natl Acad Sci USA* 1990;87:1874.
24. Fahy E, Kwoh DY, Gingeras TR. Self-sustained sequence replication (3SR): an isothermal transcription-based amplification system alternative to PCR. *PCR Meth Appl* 1991;1:25.
25. Kwoh DY, Davis GR, Whitfield KM, et al. Transcription-based amplification system and detection of amplified human immunodeficiency virus type 1 with a bead-based sandwich hybridization format. *Proc Natl Acad Sci USA* 1989;86:1173–1177.
26. Little MC, Andrews J, Moore R, et al. Strand displacement amplification and homogenous real-time detection incorporated in a second-generation DNA probe system, BDProbe TecET. *Clin Chem* 1999;45:777–784.
27. Walker G, Fraiser M, Schram J, et al. Strand displacement amplification: an isothermal in vitro DNA amplification technique. *Nucl Acid Res* 1992;20:1691–1696.
28. <http://www.amp.com/resources>, accessed November 30, 2007.
29. Barany F. Genetic disease detection and DNA amplification using cloned thermostable ligase. *Proc Natl Acad Sci USA* 1991;88:189.
30. Wiedbrauk DL. Molecular methods for virus detection. *Lab Med* 1992;23:737.
31. Persing DH. In vitro nucleic acid amplification techniques. In: Persing DH, Smith TF, Tenover FC, et al., eds. *Diagnostic molecular microbiology: principles and applications*. Washington, D.C., American Society for Microbiology, 1993:51–87.
32. Lo DYM, Chiu RWK. Principles of molecular biology. In: Burtis CA, Ashwood ER, Bruns DE, eds. *Tietz textbook of clinical chemistry and molecular diagnostics*. 4th ed. St. Louis, Mo.: Elsevier Saunders, 2006:1393–1406.
33. Mitchell PS, Persing DH. Current trends in molecular microbiology. *Lab Med* 1999;30:263.
34. Zein NN. Clinical significance of hepatitis C virus genotypes. *Clin Micro Rev* 2000;13:223–235.
35. Ferreira-Gonzalez A, Versalovic J, Habecub S, Caliendo AM. Molecular methods in diagnosis and monitoring of infectious diseases. In: Bruns DE, Ashwood ER, Burtis CA, eds. *Fundamentals of molecular diagnostics*. St. Louis, Mo.: Saunders Elsevier, 2007: 171–196.
36. Farkas DH. The Southern blot: application to the B- and T-cell gene rearrangement test. *Lab Med* 1992;23:723.
37. Ni H, Blajchman MA. Understanding the polymerase chain reaction. *Transf Med Rev* 1994;8:242.
38. Gasparini P, Novelli G, Savoia A, et al. First-trimester prenatal diagnosis of cystic fibrosis using the polymerase chain reaction: report of eight cases. *Prenat Diagn* 1989;9:349.
39. Thies U, Zuhlke C, Bockel B, et al. Prenatal diagnosis of Huntington's disease (HD): experience with six cases and PCR. *Prenat Diagn* 1992;12:1055.
40. Clemens PR, Fenwick RG, Chamberlain JS, et al. Carrier detection and prenatal diagnosis in Duchenne and Becker muscular dystrophy families, using dinucleotide repeat polymorphism. *Am J Hum Genet* 1991;49:951.
41. Peake IR, Bowen D, Bignell P. Family studies and prenatal diagnosis in severe von Willebrand disease by polymerase chain reaction amplification of variable number tandem repeat region of the von Willebrand factor gene. *Blood* 1990;76:555.
42. Erlich H, Tugawan T, Begovich AB, et al. HLA-DR, DQ, and DP typing using PCR amplification and immobilized probes. *Eur J Immunogenet* 1991;18:33.

Point-of-Care Testing

Elizabeth E. Porter

CHAPTER OUTLINE

■ ADMINISTRATION AND STRUCTURE

CLIA License and Regulation
Support Staff
Standardization
Oversight Structure

■ COMMUNICATION

Handling a Request for New or Additional Point-of-Care Testing
Preliminary Selection of Devices/Methods
Validation
Contract Negotiation
Implementation

■ PROFICIENCY TESTING

■ POINT-OF-CARE APPLICATIONS

Point-of-Care Glucose
Point-of-Care Chemistries and Blood Gases
Point-of-Care Coagulation
Point-of-Care Hematology
Point-of-Care Connectivity

■ REFERENCES

Point-of-care testing (POCT) has been defined by the College of American Pathologists (CAP) as “those analytical patient-testing activities provided within the institution, but performed outside the physical facilities of the clinical laboratories.”¹

Nursing, perfusion, or respiratory therapy staff or resident or attending physicians may perform POCT. These health care staff members are not usually specifically trained in clinical laboratory science. Clinical laboratory and professional laboratory scientists are uniquely qualified to support, assist, and provide oversight for such testing. In so doing, the quality of POCT results and the quality of patient care are improved and enhanced. Today’s laboratories, laboratorians, and health care institutions can accomplish this by:

1. Building an **administration and structure** to support and facilitate quality POCT.
2. Maintaining the **knowledge and skill base** to appropriately implement POCT.
3. Bringing preexisting POCT into regulatory compliance and production of high-quality patient results.

ADMINISTRATION AND STRUCTURE

The components essential for establishing a POCT program are included in Box 9-1.

CLIA License and Regulation

There is a common misconception that POCT may at times be exempt from the body of regulation that applies to testing performed in the clinical laboratory. All testing, regardless of location, falls within the scope of the **Clinical Laboratory Improvement Amendments of 1988 (CLIA 88)**. CLIA 88 is a body of U.S. federal regulation. Historically, CLIA 88 was implemented, in part, as a response to the perceived Papanicolaou (Pap) test “scandal” of the 1980s. Certain clinical laboratories and physician office laboratories had problematic testing operations, including lack of documentation and poor-quality test results that resulted in a lack of clinician confidence.

CLIA 88 oversight and enforcement occur via the U.S. Food and Drug Administration (FDA) and Centers for Medicare and Medicaid Services (CMS) (formerly Health Care Financing Administration [HCFA]). CLIA 88 includes quality control (QC) regulations and personnel standards and divides testing into basic complexity categories.

Waived testing consists of “simple” tests. The original waived test list contained methodologies for only nine analytes; now, many additional analytes are included. Table 9-1 lists currently waived tests. **Moderately complex testing** includes about 75% of approximately 12,000 test methods. These tests are not modified from the

BOX 9-1. POINT-OF-CARE TESTING PROGRAM COMPONENTS

Appropriate CLIA license(s)
 Chosen inspecting/certifying agency
 Support staff
 Standardization
 Structure defining authority, responsibility, and accountability
 Interdisciplinary communication and relationships (Network!)

manufacturer's instructions, reagents are readily available, and few operator decision-making steps are required. The remaining 25% are highly complex test methods. **Highly complex testing** may be either modified from the manufacturer's instructions or developed within the individual laboratory or may require significant operator skill and decision making.

The CLIA license must fit the testing that is actually being performed (i.e., appropriate complexity). The institution also must make several choices regarding CLIA licensure. The institution may choose to perform POCT under the clinical laboratory's license. Alternatively, a separate CLIA license may be obtained for POCT.

TABLE 9-1 CURRENTLY WAIVED ANALYTES

| ANALYTE NAME | |
|---|--|
| Adenovirus | Ethanol (alcohol) |
| Aerobic/anaerobic organisms, vaginal | Fecal occult blood |
| Alanine aminotransferase (ALT) (SGPT) | Fern test, saliva |
| Albumin | Follicle-stimulating hormone (FSH) |
| Albumin, urinary | Fructosamine |
| Alcohol, saliva | Gamma-glutamyltransferase (GGT) |
| Alkaline phosphatase (ALP) | Gastric occult blood |
| Amines | Gastric pH |
| Amphetamines | Glucose |
| Amylase | Glucose monitoring devices (FDA cleared/home use) |
| Aspartate aminotransferase (AST) (SGOT) | Glucose monitoring devices (prescription use only) |
| B-type natriuretic peptide (BNP) | Glucose, fluid (approved by FDA for prescription home use) |
| Barbiturates | Glycated hemoglobin, total |
| Benzodiazepines | Glycosylated hemoglobin (Hb _{A1c}) |
| Bilirubin, total | hCG, urine |
| Bladder tumor-associated antigen | HDL cholesterol |
| Blood lead | <i>Helicobacter pylori</i> |
| Calcium, ionized | <i>Helicobacter pylori</i> antibodies |
| Calcium, total | Hematocrit |
| Cannabinoids (THC) | Hemoglobin |
| Carbon dioxide, total (CO ₂) | Hemoglobin by copper sulfate, nonautomated |
| Catalase, urine | Hgb, single analyte inst. with self-control |
| Chloride | HIV antibodies |
| Cholesterol | HIV-1 and HIV-2 antibodies |
| Cocaine metabolites | HIV-1 antibody |
| Collagen type I crosslink, N-telopeptides (NTX) | Infectious mononucleosis antibodies ("mono") |
| Creatinine | Influenza A |
| Erythrocyte sedimentation rate, nonautomated waived | Influenza A/B |
| Estrone-3 glucuronide | Influenza B |

(continued)

| ANALYTE NAME | |
|--|---|
| Ketone, blood | Semen |
| Ketone, urine | Sodium |
| Lactic acid (lactate) | Spun microhematocrit |
| LDL cholesterol | <i>Streptococcus</i> , group A |
| Leukocyte esterase, urinary | Thyroid-stimulating hormone (TSH) |
| Lithium | <i>Trichomonas</i> |
| Luteinizing hormone (LH) | Tricyclic antidepressants |
| Lyme disease antibodies (<i>Borrelia burgdorferi</i> Abs) | Triglyceride |
| Methadone | Urea (BUN) |
| Methamphetamine/amphetamine | Uric acid |
| Methamphetamines | Urine dipstick or tablet analytes, nonautomated |
| Methylenedioxymethamphetamine (MDMA) | Urine hCG by visual color comparison tests |
| Microalbumin | Urine qualitative dipstick ascorbic acid |
| Morphine | Urine qualitative dipstick bilirubin |
| Nicotine and/or metabolites | Urine qualitative dipstick blood |
| Nitrite, urine | Urine qualitative dipstick chemistries |
| Opiates | Urine qualitative dipstick creatinine |
| Ovulation test (LH) by visual color comparison | Urine qualitative dipstick glucose |
| Oxycodone | Urine qualitative dipstick ketone |
| pH | Urine qualitative dipstick leukocytes |
| Phencyclidine (PCP) | Urine qualitative dipstick nitrite |
| Platelet aggregation | Urine qualitative dipstick pH |
| Potassium | Urine qualitative dipstick protein |
| Propoxyphene | Urine qualitative dipstick specific gravity |
| Protein, total | Urine qualitative dipstick urobilinogen |
| Prothrombin time (PT) | Vaginal pH |
| Respiratory syncytial virus | |

From FDA, Center for Devices and Radiological Health. Clinical Laboratory Improvement Amendments. Available online at <http://www.fda.gov/cdrh/cliia>. Database updated March 6, 2008.

The institution must decide which inspecting and certifying agencies apply to their POCT program. Some agencies have “deemed” status, which means that accreditation awarded by these agencies is acceptable under CLIA 88. These agencies include The Joint Commission (TJC; formerly the Joint Commission on Accreditation of Healthcare Organizations [JCAHO]), College of American Pathologists (CAP), and Commission on Office Laboratory Accreditation (COLA). All institutions, and particularly institutions not accredited by a deemed agency, are subject to CMS or state inspection of testing (Table 9-2).

Provider-Performed Microscopy Testing Requirements

Provider-performed microscopy (PPM) is a subcategory of moderate complexity testing. These tests require use of a microscope. QC materials usually do not exist for

these tests. Generally, the specimens are labile and cannot survive transport to a clinical laboratory. The site must have PPM certification (at the minimum). Competency may be assumed for physicians or dentists within the scope of their specialty. Midlevel personnel (i.e., personnel who are not physicians or dentists) must have a minimum of a high school diploma, together with specific training and orientation to perform the test.

Support Staff

The following positions are useful in establishing and maintaining a quality POCT program:

- **Director.** A laboratory scientist or pathologist with a PhD, MD, or DO degree usually fills this position. Responsibilities include policy, administrative, finan-

TABLE 9-2 CENTERS FOR MEDICARE AND MEDICAID SERVICES OR STATE INSPECTION OF TESTING

| WAIVED | MODERATE | HIGH |
|--|---|--|
| CLIA waiver certificate is required. | Certificate of accreditation is required. | Certificate of accreditation is required. |
| Personnel have specific training orientation to perform the test. | Personnel have specific training and orientation to perform the test. | Personnel have specific training and orientation to perform the test. |
| | Continuing competency must be documented. | Continuing competency must be documented. |
| | Personnel must have minimum of high school diploma. | Personnel must have minimum of associate degree or equivalent. |
| | Must have a laboratory director/technical consultant/clinical consultant. | Must have a laboratory director/technical consultant/clinical consultant. |
| Must have a laboratory director/technical instructions when performing the test. | Must follow the manufacturer's instructions when performing the test. | If manufacturer's instructions are not followed, many requirements must be met to validate the test. |
| | At least 2 levels of control material daily. | At least 2 levels of control material daily. |
| | Calibration verification every 6 months. | Calibration verification every 6 months. |
| | Proficiency testing. | Proficiency testing. |
| | Defined standards: procedure manual, corrective action, record-keeping. | Defined standards: procedure manual, corrective action, record-keeping. |
| | | Many additional stringent standards, which are difficult to meet outside of the clinical laboratory. Seldom performed as POCT. |

cial, and technical decisions. The director provides liaison with high-level administration for the health care institution. A good director will be skilled at problem resolution, involving both technical issues and personnel interactions.

- **Point-of-care coordinator (POCC).** The POCC coordinator is responsible for implementing and coordinating point-of-care (POC) patient testing and facilitating compliance with procedures and policies and regulatory requirements. The POCC performs on-site review of patient testing, QC, and maintenance logs and reports problems and regulatory noncompliance to appropriate management personnel. The POCC facilitates and ensures documentation of competency training and oversees completion of proficiency testing programs. The POCC coordinates problem resolution for POCT and provides on-site technical resource assistance to POC personnel for problem solving related to QC and instrument performance. In addition, he or she facilitates communication between the POCT testing personnel and the clinical laboratory staff. The POCC facilitates adequate POC inventory con-

trol. Also, the POCC should exhibit excellent customer service skills, including superior communication skills and good analytic and problem-solving skills. Time management, planning, and organizational skills are also important. Any individual seeking the position of POCC should be self-motivated and not require continual oversight by management to ensure job performance. The POCC must exhibit high-level technical skills and have excellent interpersonal skills.

- **Designated contacts or trainers in nonlaboratory departments.** For each unit/floor/clinic that performs POCT, it is important to have a designated contact person or trainer. This person greatly facilitates the efficient POCT program and is a communication link between the POCC and the testing staff. He or she also helps ease training and competency activities when a "train-the-trainer" process is used. (In the train-the-trainer process, the POCC may train the designated contact/trainer, who then trains other POC staff in the department.) This is especially helpful for issues involving off-shifts and weekends.

Standardization

Standardization is the consistent use of the same instrument/reagent/test method for any particular analyte throughout the designated health care system. Standardization produces the following benefits:

- **Comparability of results across locations produces improved patient care.** This reduces clinician confusion about interpretation of varying test results for the same analyte, regardless of where the test is performed.
- **Decreases cost.** Nearly all vendors negotiate pricing based on expected test volumes. When standardization is present, the test volumes will be higher for the chosen vendor than if multiple vendors were used. Major cost savings may be achieved.
- **Saves work and time.** With standardization, there is only one test method, rather than multiple test methods, for which procedures, training and recertification checklists, paper logs, and comparabilities must be maintained.
- **Facilitates regulatory compliance.** Multiple methods present in a single institution cause difficulty maintaining the above-mentioned factors and also make consistent regulatory compliance nearly impossible with regard to test result comparability.

Oversight Structure

It is important to establish a structure for POCT that defines authority, responsibility, and accountability. The purposes of such a structure are:

- To facilitate timely and accurate performance of patient testing when such testing is being performed outside the laboratory.
- To facilitate compliance with regulatory agencies (e.g., TJH, CAP, CLIA 88).
- To facilitate a process of standardization across the multiple facilities and sites performing POCT, resulting in improved quality of testing, efficiency, and cost containment.
- To coordinate and facilitate communication between the laboratory; nursing; and vendors of POC instruments, supplies, reagents, or QC materials.
- To facilitate the education of POCT personnel by providing materials for training and/or recertification.

The components of such a structure usually include methods and/or steering committees. Such committees may oversee compliance, utilization, method/instrument selection, standardization, procedural issues, and decisions on expansion or limitation of testing. These committees function best when they are multidisciplinary and multihospital where applicable (i.e., hospital systems). Their structure and function should be documented by written policy.

COMMUNICATION

The structure described earlier forms the formal portion of the program. Networking is the informal portion of the program. Networking is equally important to a fully functional POCT program and should cross disciplines (e.g., laboratory, nursing, perfusion, respiratory therapy). Networking is facilitated when staff is skilled in communication and diplomacy as well as technical issues. The effective POCT program places a high priority on building and maintaining relationships.

Handling a Request for New or Additional Point-of-Care Testing

Document the request, preferably via a standardized request form. Box 9-2 indicates some needed information. Evaluate the request, using the program structure previously described. There may be a variety of clinical justification(s) for implementing POCT. Prior to establishing any POC test, it is important to consider whether comparable testing is available in the central clinical laboratory. Some questions to consider include:

- What are the average turnaround time and average cost for testing performed by the clinical laboratory versus POCT?
- If POCT can reduce turnaround time, will the shorter turnaround time result in decreased length of stay or increased patient satisfaction?
- Will a shorter turnaround time result in improved operational efficiency for the department?
- What other option(s) exist for achieving the desired objectives, in addition to performance of the test as POC?

Institutions should also consider other options, such as transporting specimens to the central laboratory via pneumatic tube systems, using “runners” to transport specimens, or re-engineering the workflow. It is important to determine whether POCT can achieve a favorable

BOX 9-2. INFORMATION REQUIREMENTS FOR NEW POINT-OF-CARE TESTING REQUEST

Test(s) requested

Objective(s)

Who will perform the test?

Estimated test volume

How will test results be documented and/or charged?

Is this test presently being performed by another method? If so, what are the problems with the current method?

cost-to-benefit ratio. For example, if the expected test volume is small, it may not be cost effective to train personnel, maintain and document competency, purchase QC reagents, and oversee the testing.

Preliminary Selection of Devices/Methods

Make a preliminary selection of method and instrumentation to perform the requested testing. Review the multiple options that are on the market and limit your selection to several methods or instruments. Criteria for selection may include ease of use, cost, test menu, comparability to clinical laboratory instrumentation, buying group contracts, and software features. Data management and connectivity (see “Point-of-Care Connectivity” in this chapter) are important criteria for consideration, with an emphasis on the ability to interface the data produced by the POC device.

Perform a literature search for existing data on the performance of the method/instrument. Vendor literature may be helpful, but it should always be verified with additional data. Also, contact other users for references and possible sharing of validation data. Perform a preliminary, limited validation, including a minicorrelation to your clinical laboratory instrumentation. You can review proficiency test provider literature for expected coefficient of variation (CV). Precision and linearity studies may also be useful on a limited basis. At this point, a test method/instrument selection should be made, preferably using the POC program structure previously described.

Validation

The importance of method validation cannot be overemphasized. Besides the regulatory requirements that must be met, method validation is necessary to insure the reliable test results that are necessary for quality patient care. Method validation includes the following (as applicable):

- Accuracy (clinically correct result)
- Precision (clinically same result repeatedly)
- Sensitivity and specificity, including interfering substances (the likelihood that a positive test is truly positive and a negative test is truly negative)
- Reportable range/linearity (upper and lower limits of the test)
- Reference range (expected results for a normal individual)
- Split-sample correlation versus reference method

Methods and instruments should also be validated. Perform split-sample correlations to determine agreement between POCT and the methods used in the laboratory. Be aware of variability between products from different vendors. Agreement between POCT and clinical laboratory testing is more likely if both venues are using products from the same vendor. However, even when the same vendor is used, there may be variation between

different instruments. When performing validations, it is important to include both positive and negative samples or high and low values for all analytes that will be reported. Moreover, to obtain the most reliable results, any delay between the analysis on the laboratory instrument and the POC instrument should be minimized.

Contract Negotiation

Only after the test method has been fully validated should a contract be negotiated with the vendor. Most institutions have purchasing departments to assist with this process. Many institutions are also part of buying or purchasing groups; these contracts must be considered throughout the process.

Implementation

Collect Materials

The following materials should be collected before beginning the implementation process:

- Instrument manual(s)
- Package insert(s) for reagents
- Package insert(s) for quality controls
- Materials safety data sheet (MSDS)
- Sample procedure from vendor
- Sample training materials from vendor
- Other institution's procedure for test
- Applicable regulatory or certifying standards (i.e., CLSI [Clinical and Laboratory Standards Institute] standards, TJC laboratory standards, CAP checklist)

Procedure/Policy

The first step in the implementation process is the writing of the procedure/policy for the test or method. Start with your institution's format template. (*Note:* POCT procedures frequently must comply with the format requirements of nonlaboratory departments in addition to meeting the basic requirements with which laboratorians are familiar.) Do not make assumptions about the testing process, but detail the required steps. The level of writing should be understood by a nonlaboratorian. CLSI format should also be followed.

- **Principle.** Briefly state the type of reaction(s) that is occurring. It is also helpful to include the clinical reason for performing the test.
- **Testing personnel.** Describe who is qualified to perform the test (job category, competency requirements, color discrimination). CLIA 88 regulations and the institution's inspecting agency regulations must be followed. For waived testing, personnel must have specific training and orientation to perform the test. For moderately complex testing, personnel must have a high school diploma and the administration must designate laboratory director/technical consultant/clinical

consultant positions. As always, all of this must be documented. Each institution must determine whether all staff—including nurses and nursing assistants—will receive training or if training will be limited to certain areas of responsibility and qualifications. The smaller the number of staff members and the more frequently a staff member performs testing, the higher the quality of testing is likely to be. However, staffing and scheduling needs must also be considered. It may be useful to have the nursing department designate trainers (e.g., train-the-trainer approach).

- **Specimen.** Include requirements for patient preparation, type of specimen required, stability and storage requirements (or the requirement to run the specimen immediately), criteria for specimen acceptability, and handling considerations.
- **Reagents, supplies, and equipment.** List all required reagents, supplies, and equipment. Include storage and stability requirements, including dating and labeling requirements and any applicable safety warnings.
- **Maintenance.** Provide instructions for maintaining the instrument, including required frequency.
- **Power.** Describe the power source(s) for the instrument (AC versus battery, or both). If batteries are used, identify them. If rechargeable batteries are applicable, explain how to recharge.
- **Calibration/calibration verification.** Identify required materials and required frequency.
- **Quality control.** Identify QC materials, frequency, the process for performing QC, how to determine QC success or failure, and the process for troubleshooting QC failure. (Be sure to include both liquid QC and electronic QC instructions when appropriate.)
- **Patient testing procedure.** Write detailed instructions in a stepwise manner. Do not omit simple steps on the basis of assumption.
- **Reference and therapeutic ranges, technical limits, critical values.** These values (preferably in table format) must be included.
- **Reporting results.** Describe in specific detail how your institution will record and report patient results.
- **Data transfer, electronic documentation, configurations.** It is helpful to document these items (specific to your institution) in the procedure. This will serve as a useful reference tool and will also facilitate standardization, especially in multihospital systems.
- **Limitations, notes.** Include interfering substances and test limitations. Special precautions may be listed. Information regarding possible sources of error, clinical situations influencing results, and clinical applications may be included.
- **Proficiency testing.** Document the proficiency testing requirements and process.
- **Reagent and control lot receipt.** Identify the process to be followed for receipt of reagents and controls.
- **Quality improvement (QI).** Describe your institution's QI process for the test/method.
- **Troubleshooting.** Explain how to troubleshoot unexpected results, errors, and instrument problems.
- **Alternative method.** State the process to be followed if the instrument or test is not available. For POCT, this usually involves borrowing a spare or replacement instrument or sending the specimen to the clinical laboratory for testing.
- **References.** Include the manufacturer's product literature, textbook references used, standards publications, and any applicable scientific literature references.

Training Checklist

Start with your checklist template. The training checklist must be clear and sufficiently detailed that nonlaboratory trainer will be reminded to explain clearly all training items. The training checklist should document all operator training. It is most efficient to use a two-copy system: one copy for the employee's continuing education file and the second copy for the POC office.

The following items should be included in the training checklist:

- Read procedure
- Maintenance
- Reagents
- QC
- Specimen requirements
- Direct observation (perform a "mock" patient test)
- Reporting results: software and/or paper documentation, reference and critical ranges
- Safety
- Operator information (name, operator ID no., floor)
- Trainer signature
- May supplement with quiz

Recertification Checklist

CLIA and other certifying agencies also require documentation of continuing competency for personnel performing testing, or recertification. The recertification checklist may be shorter than the training checklist. It should be tailored or modified to the problems and issues observed as testing is performed. Wait until testing has been in progress for a while so these issues can be observed.

Create Paper Forms/Logs

Unless the test/instrument has full electronic documentation/connectivity, paper forms will be necessary for compliance and monitoring. Some, or all, of the following forms may be needed:

- QC log
- Patient testing log
- Problem/corrective action log
- QI form

Most, if not all, of these forms may be eliminated with good connectivity.

PROFICIENCY TESTING

Proficiency testing (PT) is a part of good laboratory practice that verifies the ability to produce reliable patient test results. It also is required by many regulatory and certifying agencies. To meet these objectives, the following steps facilitate organization and documentation:

- Be sure to have a structure.
- Order the appropriate testing.
- Document receipt of PT shipments.
- Schedule distribution.
- Distribute to POC department.
- Report results to PT supplier.
- Maintain documentation.

Communication

Before implementing the new test or method, it is important to notify all affected parties and users of the implementation, including physicians, nursing departments, administrators, and clinical laboratorians. The notification should include a short description of the test or method and the expected uses.

Keeping Up

Certain clerical or administrative processes should be monitored to ensure regulatory compliance and good basic laboratory practices, including:

- Adding serial numbers to your instrument list
- Adding to your schedule for comparabilities and calibration verifications
- Adding required reagents/supplies to your ordering information list
- Adding the test to your test volume tally log
- Adding the test to proficiency testing schedule

Performance Improvement

As with all laboratory testing, a **performance improvement** (PI) process should be in place to ensure quality. Items that should be monitored include QC. Was QC performed? Was it within acceptable range? Mean and standard deviation values should be monitored regularly. The QC items are important because QC evaluates the instrument, reagents, operator (person performing the test), and testing process. The same personnel who are testing patient samples should perform QC. It should be noted that QC for POCT is equally important as clinical laboratory testing. Basic QC theory states that when a test is working properly and specimens of known concentration are run over time, there is a gaussian distribution of values.² It is not the function of this chapter to detail the QC process (for additional information, refer to Chapter 4).

Performance should also be observed for non-QC monitors. Competency of persons performing POCT (i.e., valid operators) should be monitored. Use of correct patient identification in performing POCT should be documented. Track to ensure that instrument maintenance is performed appropriately.

The performance improvement process should include communication with the POC unit/manager, a corrective action process, and clear follow-up. This process will facilitate operator confidence in the test results produced and clinician confidence in patient test results.

Reporting Results

Patient test and QC results must be documented. Manual testing generally implies documentation on paper logs, although some electronic systems for recording manual testing are in development. Manual recording in patient charts introduces the possibility of transcription errors. Results must be recorded in a manner that complies with applicable regulations, including date and time of testing, person performing the test, units of measure, and reference ranges. This all requires training and cooperation from those performing the tests. Today, much instrumented testing has the capability of electronic transfer to a data manager and, possibly, an interface to the laboratory information system (LIS). A detailed discussion follows in the POC connectivity section of this chapter.

POINT-OF-CARE APPLICATIONS

Point-of-Care Glucose

POC glucose is the highest-volume POC test in most health care institutions. It is frequently used to monitor the glucose level for patients with diabetes, but it may be used for other purposes. Most of today's institutional POC glucose meters include the ability to document testing electronically. Many home-use glucose meters are also available; glucose is the most frequently used home POC test.

A small drop of blood, most frequently obtained via capillary puncture, is applied to a test strip. A reaction occurs between the blood and reagents in the test strip. The meter measures the reaction and converts the reaction to a quantitative result. The actual reaction varies among manufacturers.

POC glucose continues to increase in importance in today's health care systems, with a growing body of evidence supporting the value of glycemic control for hospitalized patients. Research demonstrates improved patient outcomes, both during the hospital stay and after dismissal, when blood glucose is carefully managed.³

Point-of-Care Chemistries and Blood Gases

Several different manufacturers offer instrumentation designed to measure POC chemistries (most frequently electrolytes) and/or blood gases. Most operate on the principle

of measuring potentiometric, amperometric, or conductometric changes via sensors (electrodes). This has been accomplished by both nondisposable and disposable sensors. Instruments with disposable sensors may be configured for multispecimen analysis before disposal of the multisample reagent pack, which includes the sensors as well as all required reagents. Alternatively, some POC instruments use a single-sample disposable cartridge that contains all of the system's components (reagents, sensors, and waste container). In these devices, the instrument itself receives the outputs from the sensors as an electrical output and converts the electrical output to a result.

Point-of-Care Coagulation

The most common POC coagulation test is activated clotting time (ACT). ACT, first described by Hattersley in 1966,⁴ is used for monitoring heparin therapy. Although heparin therapy is essential in maintaining hemostasis during many medical procedures, patients can vary greatly in their response to heparin. Overdosing heparin can result in bleeding, and underdosing heparin can allow a blood clot to form. This may be avoided by monitoring heparin therapy with an ACT.

In vivo coagulation occurs as the result of a complex interaction of vascular, cellular, and noncellular (coagulation cascade) components. ACT provides an in vitro, nonspecific measurement of the cellular and noncellular components of the coagulation process.

The first POC clotting times were performed by drawing fresh whole blood, then periodically manually mixing or inverting the tube and visually observing for clot formation. More recently, the large variability in this process has been reduced by (1) the addition of an activator (Celite, silica, kaolin, or glass particles), (2) maintenance of a stable temperature (37°C) during the clotting/measuring process, and (3) a mechanical agitation and/or clot detection system. The newest POC coagulation instruments with microsampling techniques further reduce variability by further automation of the process, requiring less operator technique to perform the test. Newer POC coagulation instruments may also have the capability to perform additional tests, such as PT-INR and activated partial thromboplastin time (aPTT).

Point-of-Care Hematology

At the present time, only minimal hematology POCT has been available. In past years, the spun hematocrit was the most common POC hematology test. More recently, many institutions are eliminating the spun hematocrit due to safety concerns and because the variability in operator technique can result in significant variation in test results. Many institutions now use a

system consisting of disposable cuvetts and an analyzer. The cuvet cavity contains reagents deposited on its inner walls that hemolyze the red cells when the blood sample is drawn into the cavity via capillary action. The released hemoglobin is converted to azide methemoglobin. The cuvet is then placed in the analyzer, where absorbance is measured and the hemoglobin level is calculated.⁵

Point-of-Care Connectivity

Connectivity has been the most significant recent development in POCT. Traditionally, POCT results have been written manually in the patient's medical record or, occasionally, recorded via an instrument printout that has been placed in the medical record. **Connectivity** is the ability to electronically document testing. Generally, the instrument itself has the ability to store a certain amount of data. This is the *device* segment of connectivity. Multiple instruments can then upload data via computer network to a centrally located workstation. This workstation is the *data management* portion of connectivity. The next step in the connectivity process is transmittal of test results from the data manager to the LIS and/or hospital information system (HIS). This is the *interface* portion of connectivity. Standards exist for POCT connectivity, known as POCT 1-A2 standards.⁶ POCT 1-A2 standards apply to instrumentation (devices) as well as to data management workstations and interfaces.^{7,8}

Many connectivity systems are vendor or instrument specific. However, the newer, more sophisticated systems manage results from multiple vendors via a single integrated system. Such a system allows the POCC to oversee testing, QC, instruments, and operators for multiple types of equipment from a single workstation. Some advantages of such a system are as follows:

- Electronic documentation of patient results reduces errors in transcription and ensures that all patient test results are correctly documented in the medical record.
- Electronic documentation allows a practical system for billing for POCT.
- Standardized instrument configurations can be maintained throughout the system.
- Regulatory compliance is improved.
- Paper recording is eliminated or greatly reduced.
- Monitoring all testing in a practical and time-effective manner results in improved quality.
- All test results can run through a single interface.
- Operators for many different devices from many different locations, together with their appropriate competency documentation, can be managed in an integrated manner.

REFERENCES

1. CAP Commission on Laboratory Accreditation, Laboratory Accreditation Program. Point-of-care testing checklist. Northfield, Ill.: September 2007.
2. Westgard QC. Basic QC practices. Madison, Wis.: Westgard QC, 2008. (Accessed September 19, 2008, at www.westgard.com.)
3. Medical Automation Systems. Glycemiccontrol.net. Charlottesville, Va., 2007. (Accessed September 19, 2008, at www.glycemiccontrol.net.)
4. Hattersley P. Activated coagulation time of whole blood. *JAMA* 1966;136:436–439.
5. HemoCue. Hb 201+ analyzer. Mission Viejo, Calif.: HemoCue, 2008. (Accessed September 19, 2008, at www.hemocue.com.)
6. Clinical and Laboratory Standards Institute (CLSI). Point-of-care connectivity; approved standard. Wayne, Pa.: CLSI, 2006. (CLSI document POCT1-A2, vol. 26, no. 28 [ISSN 0273-3099].)
7. The Joint Commission (TJC). Comprehensive accreditation manual for laboratory and point-of-care testing (CAMLAB). Oakbrook Terrace, Ill.: TJC, 2007.
8. Price CP, Hicks JM, eds. Point-of-care testing. Washington, D.C.: AACC Press, 1999.

PART

2

Clinical Correlations And Analytic Procedures

Amino Acids and Proteins

Lynda L. Tymchak

CHAPTER

10

CHAPTER OUTLINE

■ AMINO ACIDS

- Overview
- Basic Structure
- Metabolism
- Essential Amino Acids
- Nonessential Amino Acids
- Two New Amino Acids?
- Aminoacidopathies
- Amino Acid Analysis

■ PROTEINS

- Importance
- Molecular Size
- Synthesis
- Catabolism and Nitrogen Balance
- Structure
- Nitrogen Content
- Charge and Isoelectric Point
- Solubility
- Classification

■ PLASMA PROTEINS

- Prealbumin (Transthyretin)
- Albumin
- Globulins

■ OTHER PROTEINS OF IMPORTANCE

- Myoglobin
- Troponin (cTn)
- Brain Natriuretic Peptide and N-Terminal-Brain

- Natriuretic Peptide
- Fibronectin
- Adiponectin
- β -Trace Protein
- Cross-Linked C-Telopeptides
- Cystatin C
- Amyloid

■ TOTAL PROTEIN ABNORMALITIES

- Hypoproteinemia
- Hyperproteinemia

■ METHODS OF ANALYSIS

- Total Nitrogen
- Total Proteins
- Fractionation, Identification, and Quantitation of Specific Proteins
- Serum Protein Electrophoresis
- High-Resolution Protein Electrophoresis
- Capillary Electrophoresis
- Isoelectric Focusing
- Immunochemical Methods

■ PROTEINS IN OTHER BODY FLUIDS

- Urinary Protein
- Cerebrospinal Fluid Proteins

■ REFERENCES

AMINO ACIDS

Overview

Amino acids are the building blocks of proteins. The precise amino acid content, and the sequence of those amino acids, of a specific protein is determined by the sequence of the bases in the gene that encodes that protein. The chemical properties of the amino acids of proteins determine the biologic activity of the protein.¹ Growth, repair, and maintenance of all cells are dependent on amino acids. The chemical properties of the amino acids of proteins determine the biologic activity of

the protein. Proteins catalyze almost all of the reactions in living cells, controlling virtually all cellular processes.

Basic Structure

An amino acid contains at least one of both amino and carboxylic acid functional groups. The basic structure of an amino acid is depicted in Figure 10-1. The N-terminal end amino group ($-\text{NH}_2$) and the C-terminal end carboxyl group ($-\text{COOH}$) bond to the α -carbon with the amino group of one amino acid linking with the carboxyl group of another, forming a **peptide bond** (Fig. 10-2).

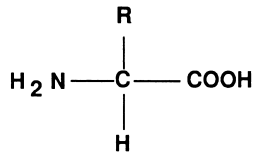

FIGURE 10-1. General structure of an α -amino acid.

A chain of amino acids is known as a *polypeptide*, and a large polypeptide constitutes a *protein*. In human serum, proteins average about 100–150 amino acids in the polypeptide chains. Amino acids differ from one another by the chemical composition of their R group (side chains). The R groups found on the 20 different amino acids used in building proteins are shown in Table 10-1.

Metabolism

About half of the 20 amino acids needed by humans cannot be synthesized at a rapid enough rate to support growth; they must be supplied in food. These nutritionally essential amino acids must be supplied by the diet in the form of proteins. The essential amino acids are arginine (often called semiessential as it is required for the young but not for adults and can be synthesized in high enough amounts that the body needs), histidine, isoleucine, leucine, lysine, methionine, phenylalanine, threonine, tryptophan, and valine. The 10 amino acids that the body can produce are alanine, asparagine, aspartic acid, cysteine, glutamic acid, glutamine, glycine, proline, serine, and tyrosine. Tyrosine is produced from phenylalanine, so if the diet is deficient in phenylalanine, tyrosine will be required as well. Humans do not have all the enzymes required for the biosynthesis of all of the amino acids. Under normal circumstances, proteolytic enzymes, such as pepsin and trypsin, completely digest dietary proteins into their constituent amino acids. Amino acids are then rapidly absorbed from the intestine into the blood and subsequently become part of the body's pool of amino acids. Amino acids are also released by the normal breakdown of body proteins.

The primary purpose of amino acids is for the synthesis of body proteins, including plasma, intracellular, and structural proteins. Amino acids are also used for the synthesis of nonprotein nitrogen-containing compounds such as purines, pyrimidines, porphyrins, creatine, hista-

mine, thyroxine, epinephrine, and the coenzyme NAD. In addition, protein provides 12%–20% of the total daily body energy requirement. The amino group is removed from amino acids by either deamination or transamination. The resultant ketoacid can enter into a common metabolic pathway with carbohydrates and fats. Glucogenic amino acids generate precursors of glucose, such as pyruvate or a citric acid cycle intermediate. Examples include alanine, which can be deaminated to pyruvate; arginine, which is converted to α -ketoglutarate; and aspartate, which is converted to oxaloacetate. Ketogenic amino acids generate ketone bodies. They are degraded to acetyl-CoA or acetoacetyl-CoA (e.g., leucine or lysine), with some amino acids being both ketogenic and glucogenic. The ammonium ion that is produced during deamination of the amino acids is converted into urea via the urea cycle in the liver.²

Essential Amino Acids

Arginine (Arg)

Arginine is a complex amino acid that is often found at the catalytic (active) site in proteins and enzymes due to its amine-containing side chain. Arginine plays an important role in cell division, the healing of wounds, stimulation of protein synthesis, immune function, and the release of hormones. Arginine is required for the generation of urea, which is necessary for the removal of toxic ammonia from the body and is also required for the synthesis of creatine, which degrades to creatinine, a waste product that is cleared from the body by the kidney.

Histidine (His)

Histidine is one of the basic (by pH) amino acids due to its imidazole side chain. It is the direct precursor of histamine, one of the proteins involved in the immune response. Histidine is also an important source of carbon atoms in the synthesis of purines, one of the two groups of nitrogen bases that make up DNA and RNA. Histidine is needed to help grow and repair body tissues and to maintain the myelin sheaths that protect nerve cells. It also helps manufacture red and white blood cells and helps to protect the body from heavy metal toxicity. Histamine stimulates the secretion of the digestive enzyme gastrin and acts as a catalytic site in certain enzymes.

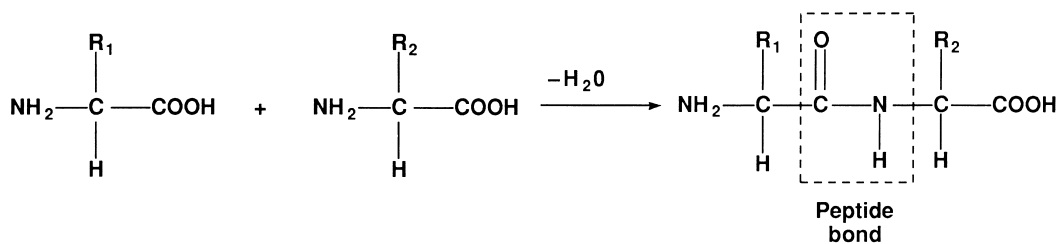

FIGURE 10-2. Formation of a dipeptide.

TABLE 10-1 AMINO ACIDS REQUIRED IN THE SYNTHESIS OF PROTEINS

| AMINO ACID | R | AMINO ACID | R |
|----------------------|--|------------------|---|
| Glycine (Gly) | —H | Glutamine (Gln) | |
| Alanine (Ala) | —CH ₃ | Serine (Ser) | |
| Valine (Val)* | | Threonine (Thr)* | |
| Leucine (Leu)* | | Tyrosine (Tyr) | |
| Isoleucine (Ile)* | | Lysine (Lys)* | |
| Cysteine (Cys) | —CH ₂ —SH | Arginine (Arg) | |
| Methionine (Met)* | —CH ₂ —CH ₂ —S—CH ₃ | Histidine (His) | |
| Tryptophan (Trp)* | | Aspartate (Asp) | —CH ₂ —COOH |
| Phenylalanine (Phe)* | | Glutamate (Glu) | —CH ₂ —CH ₂ —COOH |
| Asparagine (Asn) | | Proline (Pro)*† | |

The R group is the group attached to the α carbon.

*Nutritionally essential.

†Exception to attachment of R group is proline.

Isoleucine (Ile)

Isoleucine is in the group of branched-chain amino acids that are needed to help maintain, heal, and repair muscle tissue, skin, and bones. Isoleucine is needed for hemoglobin formation, and it helps to regulate blood glucose levels and maintain energy levels.

Leucine (Leu)

Leucine is also in the group of branched-chain amino acids, along with valine and isoleucine. Leucine is the second most common amino acid found in protein beside glycine. Leucine, in conjunction with valine and isoleucine, boosts the healing of muscle, skin, and bones; aids in recovery from surgery; and lowers blood glucose levels. Leucine is necessary for the optimal growth of infants and for **nitrogen balance** in adults.

Lysine (Lys)

Lysine has a net positive charge, which makes it one of the three basic (by charge) amino acids. Lysine plays a role in the production of antibodies and lowers triglyceride levels.

Lysine is needed for proper growth and bone development in children and to maintain a proper nitrogen balance in adults. Lysine helps in the absorption and conservation of calcium and plays an important role in the formation of collagen, a component of cartilage and connective tissue.

Methionine (Met)

Methionine is an important amino acid that helps to initiate translation of messenger RNA by being the first amino acid incorporated into the N-terminal position of all proteins.³ Methionine is a source of sulfur, required by the body for normal metabolism and growth. Methionine assists the breakdown of fats, helps to detoxify lead and other heavy metals, helps diminish muscle weakness, and prevents brittle hair. Methionine reacts with adenosine triphosphate to contribute to the synthesis of many important substances, including epinephrine and choline.

Phenylalanine (Phe)

Phenylalanine is classified as a nonpolar amino acid because of the hydrophobic nature of its benzyl side chain. It

promotes alertness and vitality, elevates mood, decreases pain, aids memory and learning, and is used to treat arthritis and depression. Phenylalanine is used by the brain to produce norepinephrine, a neurotransmitter that transmits signals between nerve cells. Phenylalanine uses an active transport channel to cross the blood-brain barrier and, in large quantities, interferes with the production of serotonin, another neurotransmitter. Phenylalanine is part of the composition of aspartame, a common sweetener used in prepared foods as a sugar replacement. Phenylalanine plays a key role in the biosynthesis of other amino acids.

Threonine (Thr)

Threonine is an alcohol-containing amino acid that is an important component in the formation of protein, collagen, elastin (a connective tissue protein), and tooth enamel. It is also important in the production of neurotransmitters and health of the nervous system. Threonine helps maintain proper protein balance in the body and it aids liver function, metabolism, and assimilation.

Tryptophan (Trp)

Tryptophan is formed from proteins during digestion by the action of proteolytic enzymes. Tryptophan is also a precursor for serotonin and melatonin, a neurohormone and powerful antioxidant. Tryptophan is a natural relaxant; it helps alleviate insomnia by inducing sleep, soothes anxiety, and reduces depression. It is used in the treatment of migraine headaches, aids in weight control by reducing appetite, and helps control hyperactivity in children.

Valine (Val)

Valine is another branched-chain amino acid that is a constituent of fibrous protein in the body. Valine is needed for muscle metabolism and coordination, tissue repair, and maintenance of nitrogen balance. It is used by muscle tissue as an energy source. Valine is used in treatments for muscle, mental, and emotional problems; insomnia; anxiety; and liver and gallbladder disease.

Nonessential Amino Acids

Alanine (Ala)

Alanine is one of the simplest of the amino acids and is involved in the energy-producing breakdown of glucose. Alanine itself is a product of the breakdown of DNA or the dipeptides anserine and carnosine, and the conversion of pyruvate, a pivotal compound in carbohydrate metabolism.⁴ Alanine plays a major role in the transfer of nitrogen from peripheral tissue to the liver, helps in reducing the buildup of toxic substances that are released into muscle cells when muscle protein is broken down quickly to meet energy needs, and strengthens the immune system through production of antibodies.

Asparagine (Asn)

Asparagine was first isolated in 1806 from asparagus juice, naturally, from where it got its name, becoming the

first amino acid to be isolated. Asparagine is one of the principal and frequently the most abundant of the amino acids involved in the transport of nitrogen. Asparagine is the β -amide of aspartic acid synthesized from aspartic acid and adenosine triphosphate (ATP).⁴ The main function of asparagine is converting one amino acid into another via amination, the process by which an amine group is introduced into an organic molecule, and transamination, the reaction when an amino acid is transferred to an α -ketoacid. Asparagine is required by the nervous system and plays an important role in the synthesis of ammonia.

Aspartic Acid (Asp)

Aspartic acid is alanine with one of the β hydrogens replaced by a carboxylic acid group. Aspartic acid plays a vital role in metabolism during construction of other amino acids and metabolites in the citric acid cycle. Among the amino acids that are synthesized from aspartic acid are asparagine, arginine, lysine, methionine, threonine, isoleucine, and several nucleotides. Aspartic acid is also a metabolite in the urea cycle and participates in gluconeogenesis, the generation of glucose from non-sugar carbon substrates.

Cysteine (Cys)

Cysteine is classified as a nonessential amino acid, but cysteine may be essential for infants, the elderly, and individuals with certain metabolic diseases or malabsorption syndromes. Cysteine is an important structural and functional component of many proteins and enzymes. Cysteine is named after cystine, its oxidized dimer.⁵ Cysteine is potentially toxic and is catabolized in the gastrointestinal tract and blood. In opposition, cysteine is absorbed during digestion as cystine, which is more stable in the gastrointestinal tract. It is cystine that travels to cells, where it is reduced to two cysteine molecules upon cell entry. Cysteine is used as a constituent in the food, pharmaceutical, and personal care industries. One of its largest applications is in the production of flavors.

Glutamic Acid (Glu)

Glutamic acid is synthesized from a number of amino acids, and when an amino group is added to glutamic acid, it forms the important amino acid glutamine. Glutamic acid is one of the two amino acids that have a net negative charge (by pH), making it a very polar molecule. Glutamic acid has been linked to epileptic seizures, is a neurotransmitter, is important in the metabolism of sugars and fats, and aids transporting potassium into the spinal fluid. Glutamic acid is present in a wide variety of foods and is responsible for one of the five basic tastes of the human sense of taste (umami). Glutamic acid is often used as a food additive and flavor enhancer in the form of its sodium salt, monosodium glutamate (MSG).

Glutamine (Gln)

Glutamine is the most abundant amino acid in the body, being involved in more metabolic processes than any other amino acid. Over 61% of skeletal muscle tissue is glutamine. Glutamine is converted to glucose when more glucose is required for energy and aids in immune function. Glutamine assists in maintaining the proper acid/alkaline balance in the body, provides fuel for a healthy digestive tract,⁶ and is the basis of the building blocks for the synthesis of RNA and DNA. Studies have shown glutamine to be useful in treatment of serious illnesses, injury, trauma, burns, and cancer treatment–related side effects and in wound healing for postoperative patients.⁷ Glutamine is also marketed as a supplement used for muscle growth in weightlifting and bodybuilding. Glutamine transports ammonia, the toxic metabolic byproduct of protein breakdown, to the liver, where it is converted into less toxic urea and then excreted by the kidneys.

Glycine (Gly)

Glycine is the simplest amino acid synthesized in the body and is the only amino acid that is not optically active because it has no stereoisomers (any of a group of isomers [compounds with the same molecular formula but a different structural formula] in which atoms are linked in the same order but differ in their spatial arrangement). Glycine is essential for the synthesis of nucleic acids, bile acids, proteins, peptides, purines, ATP, porphyrins, hemoglobin, glutathione, creatine, bile salts, glucose, glycogen, and other amino acids. The liver uses glycine to help in the detoxification of compounds and to help in the synthesis of bile acids. Glycine has a sweet taste and is used as a sweetener/taste enhancer. Glycine is an inhibitory neurotransmitter in the central nervous system (CNS), is a metal complexing agent, retards muscle degeneration, improves glycogen storage, and promotes healing.

Proline (Pro)

Proline is the precursor of hydroxyproline, which is manufactured into collagen, tendons, ligaments, and heart muscle by the body. Proline is involved in wound healing, plays important roles in molecular recognition, and is an important component in certain medical wound dressings that use collagen to stimulate wound healing. Proline helps in the healing of cartilage and the strengthening of joints, tendons, and heart muscle, and it works with vitamin C to promote healthy connective tissues.

Serine (Ser)

Serine is the second amino acid that is also an alcohol because of its methyl side chain, which contains a hydroxy group. Serine is needed for the proper metabolism of fats and fatty acids and plays an important role in the body's synthetic pathways for pyrimidines, purines (making it important for DNA and RNA function), creatine, and porphyrins. It is highly concentrated in all cell membranes, is

a component of the protective myelin sheaths surrounding nerve fibers, and aids in the production of immunoglobulins and antibodies for the maintenance of a healthy immune system.

Tyrosine (Tyr)

Tyrosine is metabolically synthesized from the important amino acid phenylalanine to become the para-hydroxy derivative of phenylalanine. Tyrosine is a precursor of the adrenal hormones epinephrine, norepinephrine, and dopamine and the thyroid hormones, including thyroxine. It is important in overall metabolism, aiding in the functions of the adrenal, thyroid, and pituitary glands. Tyrosine stimulates metabolism and the nervous system, acts as a mood elevator, suppresses the appetite, and helps reduce body fat, making it useful in the treatment of chronic fatigue, narcolepsy, anxiety, depression, low sex drive, allergies, and headaches.

Two New Amino Acids?

Selenocysteine (Sec)

Selenocysteine is recognized as the 21st amino acid but, unlike other amino acids present in proteins, it is not coded for directly in the genetic code. Selenocysteine is encoded by a UGA codon, which is normally a stop codon; however, like the other amino acids used by cells, selenocysteine has a specialized transfer RNA (tRNA). Selenocysteine was named as an amino acid in 2002 and found to be the selenium analogue of cysteine, in which a selenium atom replaces sulfur. Selenocysteine is present in several enzymes, such as formate dehydrogenases, glycine reductases, and some hydrogenases. It has been discovered that HIV-1 encodes a functional selenoprotein, and patients with HIV infection have been shown to have a lower-than-average blood plasma selenium level.^{8,9}

Pyrrolysine (Pyl)

Pyrrolysine is the 22nd naturally occurring genetically encoded amino acid used by some archaea (prokaryotic [lacking a membrane bound nucleus] and single-celled microorganisms) in enzymes that are part of their methane-producing metabolism. This lysine derivative is encoded by the UAG codon, normally a stop codon, possibly modified by the presence of a specific downstream sequence forcing the incorporation of pyrrolysine instead of terminating translation.¹⁰

Aminoacidopathies

Aminoacidopathies are a class of inherited errors of metabolism in which there is an enzyme defect that inhibits the body's ability to metabolize certain amino acids. The abnormalities exist either in the activity of a specific enzyme in the metabolic pathway or in the membrane transport system for amino acids. **Phenylketonuria (PKU)**, an

aminoacidopathy, was the first newborn screening test introduced in the early 1960s. Now, some states require screening tests for up to 26 amino acids.¹¹ More than 100 diseases have been identified that result from inherited errors of amino acid metabolism. The aminoacidopathy disorders cause severe medical complications due to the buildup of toxic amino acids and/or byproducts of amino acid metabolism in the blood.

Phenylketonuria

Phenylketonuria (PKU) is inherited as an autosomal recessive trait and occurs in about 1 in 15,000 births. The metabolic defect in the classic form of PKU is an absence of activity of the enzyme phenylalanine hydroxylase (PAH), which catalyzes the conversion of phenylalanine to tyrosine (Fig. 10-3). In the absence of the enzyme, phenylalanine levels are usually greater than 1200 $\mu\text{mol/L}$. In the newborn, the upper limit of normal for a phenylalanine level is 120 $\mu\text{mol/L}$ (2 mg/dL).¹² In untreated classic PKU, blood levels as high as 2.4 mM/L can be found. Chronically high levels of phenylalanine and some of its metabolites—e.g., phenylpyruvic acid, phenylpyruvate (also known as phenylketone), and phenyllactic acid—can cause significant brain problems.

All of these compounds are found in both the blood and the urine of a PKU patient, giving the urine a characteristic musty odor. Partial deficiencies of PAH activity are typically classified as mild PKU if phenylalanine levels are between 600–1200 $\mu\text{mol/L}$ or as non-PKU mild hyperphenylalaninemia if phenylalanine levels are in the range of 180–600 $\mu\text{mol/L}$ and there is no accompanying accumulation of phenylketones.

In infants and children with this inherited defect, retarded mental development and microcephaly occur as a result of the toxic effects on the brain of phenylalanine or its metabolic byproducts. Brain damage can be avoided if the disease is detected at birth and the infant is maintained on a diet containing very low levels of phenylalanine. Also, women with PKU who are untreated during pregnancy almost always have babies who are microcephalic and mentally retarded. The fetal effects of maternal PKU are preventable if the mother is maintained on a phenylalanine-restricted diet from before conception through term.

Hyperphenylalaninemia cases occur that are not the result of the lack of the PAH enzyme. The defect in these cases is a deficiency in the enzymes needed for the regeneration and synthesis of tetrahydrobiopterin (BH_4). BH_4 is a cofactor required for the enzymatic hydroxylation of the aromatic amino acids phenylalanine, tyrosine, and tryptophan. A deficiency of BH_4 results in elevated blood levels of phenylalanine and deficient production of neurotransmitters from tyrosine and tryptophan. Although cofactor defects account for only 1–5% of all cases of elevated phenylalanine levels, they must be identified so that appropriate treatment of the

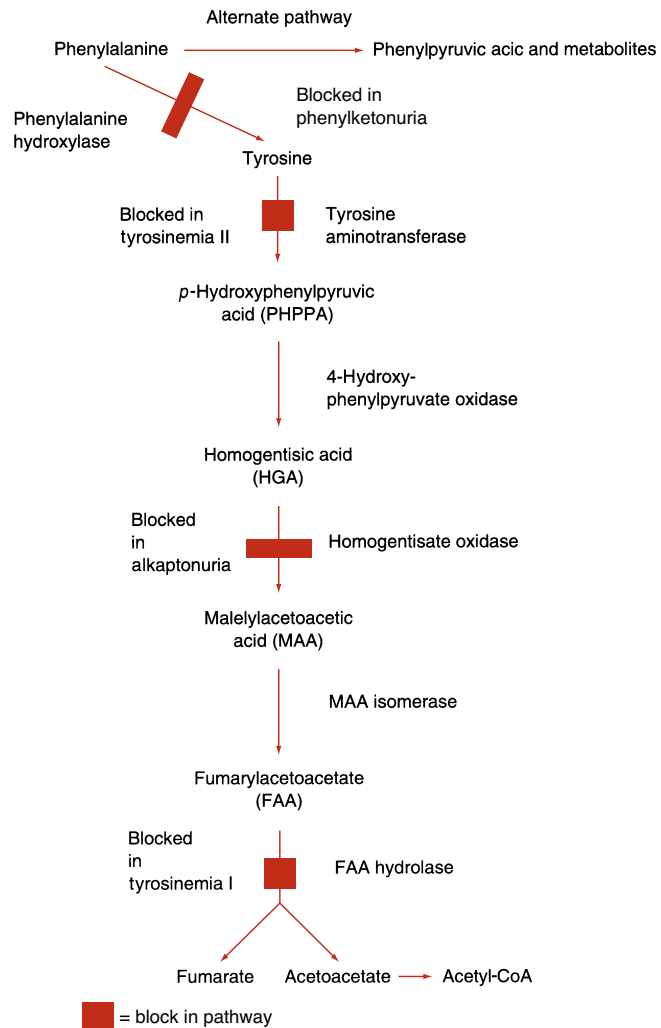

FIGURE 10-3. Metabolism of phenylalanine and tyrosine.

active cofactor along with the neurotransmitter precursors L-DOPA and 5-OH tryptophan can be initiated.¹³

Every state now screens the blood phenylalanine level of all newborns at about 3 days of age. If the screening test is abnormal, other tests are needed to confirm or exclude PKU. Newborn screening allows early identification and implementation of treatment. The goal of PKU treatment is to maintain the blood level of phenylalanine between 2 and 10 mg/dL (120–600 $\mu\text{mol/L}$). Some phenylalanine is needed for normal growth, so a diet that has some phenylalanine but in much lower amounts than normal is the recommended treatment. High-protein foods, such as meat, fish, poultry, eggs, cheese, and milk, are avoided. Instead, calculated amounts of cereals, starches, fruits, and vegetables, along with a milk substitute, are usually recommended.

In December 2007, the U.S. Food and Drug Administration (FDA) approved Kuvan (sapropterin dihydrochloride), the first drug to help manage PKU.¹⁴ The drug helps reduce phenylalanine levels by increasing the activity of the PAH enzyme. Kuvan is effective only

in patients who have some PAH activity and who continue to follow a phenylalanine-restricted diet and have their phenylalanine levels monitored.

Tests for PKU

The Guthrie test is a semiquantitative, bacterial inhibition assay for phenylalanine that uses the ability of phenylalanine to facilitate bacterial growth in a culture medium with an inhibitor. Newborn infant blood is collected on a piece of filter paper, and a small disk of the filter paper is punched out and placed on an agar gel plate containing *Bacillus subtilis* and β -2-thienylalanine. The agar gel is able to support bacterial growth but the B-2-thienylalanine inhibits bacterial growth. In the presence of extra phenylalanine leached from the impregnated filter paper disk, the inhibition is overcome and the bacteria grow. The Guthrie assay is sensitive enough to detect serum phenylalanine levels of 180–240 $\mu\text{mol/L}$ (3–4 mg/dL). The test has been widely used throughout North America and Europe as one of the core newborn screening tests since the late 1960s. In recent years, it is gradually being replaced in many areas by newer techniques, such as tandem mass spectrometry, that can detect a wider variety of congenital diseases. In addition, the Guthrie test may provide false-negative results due to the infant not being at least 24 hours old, which ensures adequate time for enzyme and amino acid levels to develop, and due to the sample not being taken before the administration of antibiotics or transfusion of blood or blood products.

Another approach to the screening for PKU involves a microfluorometric assay for the direct measurement of phenylalanine in dried blood filter disks. This method yields quantitative results, is more adaptable to automation, and is not affected by the presence of antibiotics. The procedure is based on the fluorescence of a complex formed of phenylalanine-ninhydrin-copper in the presence of a dipeptide. The test requires pretreatment of the filter paper specimen with trichloroacetic acid (TCA). The extract is then reacted in a microtiter plate with a mixture of ninhydrin, succinate, and leucylalanine in the presence of copper tartrate. The fluorescence of the complex is measured using excitation/emission wavelengths of 360 nm and 530 nm, respectively.¹⁵

Any positive results found in screening tests must be verified. The reference method for quantitative serum phenylalanine is high-performance liquid chromatography (HPLC); however, both fluorometric and enzymatic methods are available. Now, tandem mass spectrometry (MS/MS) is being used in screening for inherited disorders in newborns. Mass spectrometry is an analytical technique that measures the mass-to-charge ratio of charged particles.¹⁶ It is most generally used to find the composition of a physical sample by generating a mass spectrum representing the masses of the sample's components. Because both the increase in phenylalanine and the decrease in tyrosine levels seen in PKU can be identified, the ratio of

phenylalanine to tyrosine (Phe/Try) can be calculated. Using the ratio between metabolites rather than an individual level increases the specificity of the measurement and lowers the false-positive rate for PKU to less than 0.01%. The MS/MS method has a greater sensitivity, detecting lower levels of phenylalanine and allowing for diagnosis of PKU as early as the first day of life. Because MS/MS has the ability to detect more than 25 different genetic disorders with a single specimen, this method is replacing the multiple procedures currently used in newborn screening programs.

Another fast diagnostic procedure for neonatal PKU was developed in 2005 using microwave-assisted silylation followed by gas chromatography–mass spectrometry (GC/MS). Amino acids are extracted from neonatal blood samples and rapidly derivatized with *N,O*-bis(trimethylsilyl)-trifluoroacetamide under microwave irradiation. The derivatives are then analyzed by GC/MS.

Prenatal diagnosis and detection of carrier status in families with PKU are now available using DNA analysis. PKU results from multiple independent mutations (more than 400 identified) at the PAH locus.

Tyrosinemia

The inborn metabolic disorders of tyrosine catabolism are characterized by the excretion of tyrosine and tyrosine catabolites in urine. There are three types of tyrosinemia, each with distinctive symptoms and caused by the deficiency of a different enzyme.

Type I tyrosinemia is the most severe form of this aminoacidopathy and is found in about 1 in 100,000 births. Type I tyrosinemia is caused by low levels of the enzyme fumarylacetoacetate hydrolase, the fifth of five enzymes needed to break down tyrosine. Symptoms of type I tyrosinemia include failure to thrive, diarrhea, vomiting, jaundice, cabbage-like odor, distended abdomen, swelling of legs, and increased predisposition for bleeding. Type I tyrosinemia can lead to liver and kidney failure, problems affecting the nervous system, and an increased risk of cirrhosis or liver cancer later in life.

Type II tyrosinemia is caused by a deficiency of the enzyme tyrosine aminotransferase. Type II tyrosinemia occurs in fewer than 1 in 250,000 births. Tyrosine aminotransferase is the first in a series of five enzymes that converts tyrosine to smaller molecules, which are excreted by the kidneys or used in energy producing reactions. About half of individuals with type II tyrosinemia are mentally retarded and have symptoms of excessive tearing, photophobia (abnormal sensitivity to light), eye pain and redness, and painful skin lesions on the palms and soles of the feet.

Type III tyrosinemia is a rare disorder (only a few cases have been reported) caused by a deficiency of the enzyme 4-hydroxyphenylpyruvate dioxygenase. This enzyme is found mainly in the liver with lesser amounts found in the kidneys. It, too, is one of the series of enzymes needed to break down tyrosine. The clinical picture of type III

tyrosinemia patients includes mild mental retardation, seizures, and periodic loss of balance and coordination.

Diagnostic criteria include an elevated tyrosine level using MS/MS coupled with a confirmatory test for an elevated level of the abnormal metabolite succinylacetone.¹⁷ Treatment for tyrosinemia is a low-protein diet; the drug nitisinone (NTBC), which prevents the formation of maleylacetoacetic acid and fumarylacetoacetic acid, which can be converted to succinyl acetone, a toxin that damages the liver and kidneys; or full or partial liver transplant. Since nitisinone's first use for tyrosinemia in 1991, it has replaced liver transplantation as the first-line treatment for this rare condition.

Alkaptonuria

Alkaptonuria is an inborn metabolic disease transmitted as an autosomal recessive gene, the *HGD* gene, which causes the lack of the enzyme homogentisate oxidase, which is needed in the metabolism of tyrosine and phenylalanine. This disorder occurs in about 1 of 250,000 births. A predominant clinical manifestation of alkaptonuria is that the patient's urine turns brownish-black when it mixes with air. This phenomenon is due to an accumulation in the urine of homogentisic acid (HGA), which oxidizes to produce this dark pigment. Alkaptonuric patients have no immediate problems; however, late in the disease, the high level of HGA gradually accumulates in connective tissue, causing ochronosis (pigmentation of these tissues), an arthritis-like degeneration from the buildup of homogentisic acid in the cartilage, dark spots on the sclera (white of the eye), and deposition of pigment in the cartilage of the ears, nose, and tendons of the extremities.

Urinalysis is done to test for alkaptonuria. When ferric chloride is added to the urine, it will turn the urine black in patients with alkaptonuria. Treatment for alkaptonuria is high-dose vitamin C, which has been shown to decrease the buildup of brown pigment in the cartilage and may slow the development of arthritis.

Maple Syrup Urine Disease

Maple syrup urine disease (MSUD) results from an absence or greatly reduced activity of the enzyme branched-chain α -ketoacid decarboxylase, blocking the normal metabolism of the three essential branched-chain amino acids leucine, isoleucine, and valine. MSUD is an autosomal recessive genetic inherited disorder. Newborn screening for MSUD has been part of several state screening programs since the mid-1970s with a reported prevalence of 1 in 150,000 births in the general population. The most striking feature of this hereditary disease is the characteristic maple syrup or burnt sugar odor of the urine, breath, and skin. The result of this enzyme defect is an accumulation of the branched-chain amino acids and their corresponding ketoacids in the blood, urine, and cerebrospinal fluid (CSF).

Infants with MSUD seem normal at birth but, within a week, develop lethargy, vomiting, lack of appetite, and signs of failure to thrive. CNS symptoms follow, including muscle rigidity, stupor, and respiratory irregularities. The disease progresses to cause severe mental retardation, seizures, acidosis, and hypoglycemia. If treatment is not given, the disease can lead to death. Intermediate forms of MSUD have been reported where the activity of the decarboxylase is approximately 25% of normal. Although this still results in a persistent elevation of the branched-chain amino acids, the levels frequently can be controlled by restricting the diet of leucine, isoleucine, and valine.

A modified Guthrie test is commonly used for neonatal screening. The metabolic inhibitor to *B. subtilis*, included in the growth media, is 4-azaleucine. A microfluorometric assay for the three branched-chain amino acids uses a filter paper specimen treated with a solvent mixture of methanol and acetone to denature the hemoglobin. Leucine dehydrogenase is added to an aliquot of the extract, and the fluorescence of the NADH produced in the subsequent reaction is measured at 450 nm, with an excitation wavelength of 360 nm.¹⁸ A leucine level above 4 mg/dL is indicative of MSUD. MS/MS is also being used in testing for MSUD. Prenatal diagnosis of MSUD is made by testing the decarboxylase enzyme concentration in cells cultured from amniotic fluid.

Isovaleric Acidemia

Isovaleric acidemia is an autosomal recessive metabolic disorder from a deficiency of the enzyme isovaleryl-CoA dehydrogenase, preventing normal metabolism of the branched-chain amino acid leucine. The prevalence of Isovaleric acidemia is approximately 1 in 250,000 births in the United States, caused by mutations in the isovaleryl-CoA dehydrogenase (*IVD*) gene.

A characteristic feature of isovaleric acidemia is a distinctive odor of sweaty feet caused by the buildup of isovaleric acid. Health problems related to isovaleric acidemia range from very mild to life-threatening, but when severe, it can damage the brain and nervous system. Clinical manifestations of this disorder become apparent a few days after birth and include failure to thrive, vomiting, and lethargy that can progress to seizures, coma, and possibly death. Some people with gene mutations that cause isovaleric acidemia are asymptomatic and never experience any signs and symptoms of the condition.

Treatment includes a protein-restrictive diet to lower the levels of accumulating isovaleric acid, which is toxic to the CNS. Oral administration of glycine and carnitine supplementation may be prescribed because they interact with isovaleric acid to form nontoxic, readily excreted products.

The urine of newborns can be screened for isovaleric acidemia using MS/MS or chromatography. Laboratory

results reveal metabolic acidosis, mild to moderate ketonuria, hyperammonemia, thrombocytopenia, and neutropenia.

Homocystinuria

Homocystinuria is yet another inherited autosomal recessive disorder of amino acid metabolism. In homocystinuria, it is the lack of the enzyme cystathionine- β synthetase, necessary for the metabolism of the amino acid methionine, that results in elevated plasma and urine levels of methionine and of the precursor homocysteine. The incidence of this disease is about 1 in 200,000 births. Infants seem to be healthy, and early symptoms, if any, are indistinct. Associated clinical findings in late childhood include osteoporosis, dislocated lenses in the eye resulting from the lack of cysteine synthesis essential for collagen formation, and, frequently, mental retardation.¹⁹ This defect leads to a multisystemic disorder of the connective tissue, muscles, CNS, thinning and weakening of bones, and thrombosis resulting from the toxicity of homocysteine to the vascular endothelium if it goes untreated.

Treatment is a dietary restriction of methionine (low protein) as well as high doses of vitamin B₆. Slightly less than 50% of patients respond to this treatment and need to intake supplemental vitamin B₆ for the rest of their lives. Those who do not respond to this usual treatment need trimethylglycine, and a normal dose of folic acid supplement and sometimes cysteine added in the diet is helpful.

Neonatal screening consists of the Guthrie test using L-methionine sulfoximine as the metabolic inhibitor. Increased plasma methionine levels from affected infants will result in bacterial growth. HPLC is the test used as the confirmatory method, with a methionine level greater than 2 mg/dL confirming positive results from the screening test. MS/MS is also used in screening programs to test for methionine levels. Alternatively, elevations in urinary total homocysteine can be measured in high testing volumes and provide a rapid turn around by using liquid chromatography electrospray–tandem mass spectrometry (LC-MS/MS). This method is based on the analysis of 100 μ L of either plasma or urine with homocysteine (2 nmol) added as the internal standard. After sample reduction and deproteinization, the analysis is performed in the multiple reaction monitoring mode with detection through the transition from the precursor to the production. A batch of 40 specimens can be completed in less than 1 hour and can be automated.²⁰

Elevations of homocysteine are also of interest in the investigation of cardiovascular risk. Approximately 50% of individuals with untreated homocystinuria and significantly elevated levels of plasma homocysteine (200–300 mmol/L) experience a thromboembolic event before the age of 30. Furthermore, mild homocysteine elevation (>15 mmol/L) occurs in 20%–30% of patients with atherosclerotic disease. In addition to the cystathio-

nine β -synthase deficiency described earlier, hyperhomocystinemia can be caused by low folate concentrations, vitamin B₁₂ deficiency, decline in renal function, and a genetic alteration in the enzyme methylenetetrahydrofolate reductase (MTHFR), which converts homocysteine back to methionine.

Citrullinemia

Citrullinemia belongs to a class of genetic diseases called urea cycle disorders. The urea cycle is a metabolic sequence that takes place in liver cells to process excess nitrogen that is generated when protein is used by the body. The excess nitrogen is used in urea formation, which is then excreted in urine.

Citrullinemia is inherited in an autosomal recessive pattern. Type I citrullinemia is the most common form of the disorder, affecting about 1 in 57,000 births. Type II citrullinemia is found primarily in the Japanese population, where it occurs in an estimated 1 in 100,000 to 230,000 people.

Type I citrullinemia is the metabolic defect caused by the lack of the enzyme argininosuccinic acid synthetase, which causes a buildup of the amino acid citrulline as well as ammonia in the blood. In affected infants, clinical symptoms include lack of appetite, failure to thrive, vomiting, lethargy, seizures, and coma, as ammonia builds up in the body. If not treated promptly, the result is severe brain damage or death. Less commonly, a milder form of type I citrullinemia can develop later in childhood or adulthood.

Type II citrullinemia is caused by a mutation of the gene that would otherwise provide instructions for making the protein citrin. Citrin helps transport molecules inside cells that are used in the production and breakdown of simple sugars, the production of proteins, and the urea cycle. Molecules transported by citrin are also involved in the production of nucleotides, the building blocks of DNA and RNA. In type II citrullinemia, cells are prevented from making citrin, which inhibits the urea cycle and disrupts the production of proteins and nucleotides. The resulting buildup of ammonia and other toxic substances leads to clinical symptoms affecting the nervous system. These symptoms can be life threatening and are known to be triggered by certain medications, infections, surgery, and alcohol intake in people with adult-onset type II citrullinemia.

Treatment of citrullinemia includes a high-caloric, protein-restrictive diet; arginine supplementation; and administration of sodium benzoate and sodium phenylacetate.

Argininosuccinic Aciduria

Argininosuccinic aciduria (ASA) is inherited in an autosomal recessive pattern that also belongs to a class of genetic diseases, the urea cycle disorders. Argininosuccinic aciduria occurs in approximately 1 in 70,000 newborns. Babies born with argininosuccinic acidemia lack the en-

CASE STUDY 10-1

Victoria and Rusty were worried about their infant Bailey since his first trip to the hospital at 3 weeks of age. That time he had a temperature of 103°F and a runny nose. The emergency physician checked Bailey over but sent him home saying it was only a common cold, probably brought home by his older siblings, and that all would be fine. But Bailey's health has not been fine as he has been having an unusual number of bacterial infections and he is not yet quite 1 year old. The antibiotics that Bailey's physician prescribed have cleared up his bacterial respiratory infections but another infection always follows.

Now that Bailey is back at the hospital with pneumonia, his physician has ordered a number of other laboratory tests as he is now worried about Bailey's immune system. The studies showed that Bailey had normal levels of B cells and T cells, with his

immunoglobulin levels and hematology results listed in the chart that follows.

Questions

1. List the immunoglobulin types, Bailey's level as normal or abnormal, and the function(s) of each type.
2. Why do Bailey's recurring bacterial infections correlate with these laboratory results?
3. What is immunoglobulin isotype switching? How does isotype switching explain the lack of IgG, IgA, and IgE in Bailey's blood?
4. List the immunoglobulin type and the age it appears in the blood of a baby from birth to 18 months.
5. What treatment can be given to Bailey? Immediately? In the future?

CASE STUDY 10-1 LABORATORY RESULTS

| TEST | BAILEY'S VALUE | REFERENCE RANGE |
|---------------|---------------------------------|---|
| Hct | 35% | 6 months–2 years: 30.9–37.0% |
| Hgb | 11.9 g/dL | 6 months–2 years: 10.3–12.4 g/dL |
| WBC | $14.0 \times 10^3/\mu\text{mL}$ | 6 months–2 years: $6.2\text{--}14.5 \times 10^3/\mu\text{mL}$ |
| IgG | 153 mg/dL | 1–3 years: 507–1,407 mg/dL |
| IgM | 576 mg/dL | 1–3 years: 18–171 mg/dL |
| IgA | 11 mg/dL | 1–3 years: 63–298 mg/dL |
| IgD | 0 mg/dL | Newborn to adult: 0–8 mg/dL |
| IgE | 1 kIU/L | 1–3 years: <90 kIU/L |
| Total protein | 8.7 g/dL | 1 year: 5.4–7.5 g/dL |
| Albumin | 3.8 g/dL | 1–3 years: 3.4–4.2 g/dL |

zyme argininosuccinic acid lyase, which prevents the conversion of argininosuccinic acid into arginine. Elevated levels of argininosuccinic also cause buildup of the amino acid citrulline in the blood. Due to the mutation of the *ASL* gene, the cause of argininosuccinic aciduria, the urea cycle cannot proceed normally and nitrogen accumulates in the blood in the form of ammonia. Ammonia is especially damaging to the nervous system, as well as causing eventual damage to the liver. Argininosuccinic aciduria usually becomes evident while the newborn is still in the hospital. Clinical symptoms of argininosuccinic aciduria may begin with lethargy and unwillingness to eat.

Treatment of ASA includes a high-calorie, protein-restrictive diet; arginine supplementation; and administration of sodium benzoate and sodium phenylacetate. It should be noted that the newborn screening test

cannot differentiate citrullinemia from argininosuccinic acidemia.²¹

Cystinuria

Cystinuria is an inherited autosomal recessive defect that is caused by a defect in the amino acid transport system rather than a metabolic enzyme deficiency. Cystinuria is characterized by the inadequate reabsorption of cystine during the filtering process in the kidneys, resulting in an excessive concentration of this amino acid. Cystine precipitates out of the urine and forms stones in the kidneys, ureters, or bladder. The kidney stones often recur throughout a patient's lifetime and are directly or indirectly responsible for all of the signs and symptoms of the disease, including hematuria, pain in the side due to kidney pain, and urinary tract infections.

Treatment for cystinuria is to prevent the formation of cystine stones. This is mainly accomplished by increasing the volume of urine to reduce the concentration of cystine in the urine and reduce its precipitating from the urine and forming stones. High fluid intake means an absolute minimum of 4 liters of water per day. When a consistent high fluid intake does not stop the formation of stones, the drug penicillamine is prescribed. Penicillamine forms a more soluble complex with cystine, because cystine, itself, is relatively insoluble. Percutaneous nephrolithotripsy (PNL) has been performed as an alternative to surgery to remove the kidney stones.

Cystinuria can be diagnosed by testing the urine for cystine using cyanide nitroprusside, which produces a red-purple color on reaction with sulfhydryl groups. False-positive results as a result of homocystine must be ruled out. Another laboratory finding is a large amount of urinary levels of three other amino acids with a similar structure to cystine—lysine, arginine, and ornithine. Ion exchange chromatography can be used for quantitative analysis of amino acids in urine or plasma.

Amino Acid Analysis

Blood samples for amino acid analysis should be drawn after at least a 6- to 8-hour fast to avoid the effect of absorbed amino acids originating from dietary proteins. The sample is collected in a heparin tube with the plasma promptly removed from the cells, taking care not to aspirate the platelet and white cell layer to prevent contamination with platelet or leukocyte amino acids. White blood cell levels of aspartic acid and glutamic acid, for example, are about 100 times higher than those in plasma. Hemolysis is unacceptable for the same reason. Deproteinization should be performed within 30 minutes of sample collection, and analysis should be performed immediately or the sample frozen at -20°C to -40°C .

Urinary amino acid analysis can be performed on a random specimen for screening purposes. For quantitation, a 24-hour urine sample preserved with thymol or organic solvents is required. Amniotic fluid also may be analyzed.

For a screening test, the method of choice is thin-layer chromatography. The application of either one- or two-dimensional separations depends on the purpose of the analysis. If searching for a particular category of amino acids, such as branched-chain amino acids or even a single amino acid, usually one-dimensional separations are sufficient. For more general screening, two-dimensional chromatography is essential. The amino acids migrate along one solvent front and then the chromatogram is rotated 90 degrees and a second solvent migration occurs. A variety of solvents have been used, including butanol, acetic acid, water and ethanol, and ammonia and water

mixtures. The chromatogram is viewed by staining with ninhydrin, which gives most amino acids a blue color. Amino acids can be separated and quantitated by ion exchange chromatography, an HPLC reversed-phase system equipped with fluorescence detection,²² or capillary electrophoresis. Another technique that provides a highly specific and sensitive method for the measurement of amino acids is MS/MS.²³

PROTEINS

Importance

Every function in the living cell depends on proteins. From the few examples of the functions of proteins given next, is it easy to see that proteins are truly the physical basis of life.²⁴ Motion and locomotion depend on contractile proteins—muscle movement, for example.

- All biochemical reactions are catalyzed by enzymes, which contain protein.
- The structure of cells and the extracellular matrix that surrounds all cells is largely made of the protein group collagens. Collagens are the most abundant protein in the human body.
- The transport of materials in body fluids depends on proteins such as transferrin, receptors for hormones are transmembrane proteins, and transcription factors, needed to initiate the transcription of a gene, are proteins.
- Proteins make up antibodies, which are a major component of the immune system.

Molecular Size

Proteins are macromolecules (a molecule with a molecular mass of several thousand or more). They are polymers built from one or more unbranched chains of amino acids. A typical protein contains 200–300 amino acids, but some are much smaller (peptides) and some are much larger (titin, in muscle) and range in molecular mass from approximately 6000 for insulin to several million for some structural proteins.

Synthesis

Most plasma proteins are synthesized in the liver and secreted by the hepatocyte into the circulation. The immunoglobulins are exceptions because they are synthesized in plasma cells. It is the information encoded in genes, specified by the nucleotide sequence, that provides each protein with its own unique amino acid sequence. This amino acid sequence of a polypeptide chain is determined by a corresponding sequence of bases (guanine, cytosine, adenine, and thymine) in the DNA contained in the specific gene. This genetic code is sets of three nucleotides known as codons with each three-nucleotide combination

standing for a specific amino acid. Because DNA contains four nucleotides, the total number of possible codons is 64; therefore, some redundancy in the genetic code allows for some amino acids to be specified by more than one codon. The double-stranded DNA unfolds in the nucleus, and one strand is used as a template for the formation of a complementary strand of messenger RNA (mRNA). This first process is known as *transcription*, when genes encoded in DNA are first used to produce a mature messenger RNA (mRNA). The mRNA is then used as a template for protein synthesis by the ribosome. The mRNA is manufactured in the cell nucleus and then translocated across the nuclear membrane into the cytoplasm where it attaches to ribosomes, for protein synthesis to take place.

The process of synthesizing a protein from an mRNA template is known as translation. The mRNA is loaded onto the ribosome and is read three nucleotides at a time by matching each codon to its base pairing anticodon located on a tRNA molecule, which carries the amino acid corresponding to the codon it recognizes to the ribosome. This process continues until the mRNA message is read and all amino acids are in the specific sequence to form the polypeptide chain. The code on the mRNA also contains initiation and termination codons for the peptide chain.

The next step in protein synthesis is getting the amino acid to the ribosomes. First, the amino acid is activated in a reaction that requires energy and a specific enzyme for each amino acid. This activated amino acid complex is then attached to another kind of RNA, tRNA, with the subsequent release of the activating enzyme and adenosine monophosphate (AMP). The tRNA is a short chain of RNA that occurs free in the cytoplasm. Each amino acid has a specific tRNA that contains three bases that correspond to the three bases in the mRNA. The tRNA carries its particular amino acid to the ribosome and attaches to the mRNA in accordance with the matching codon. In this manner, the amino acids are aligned in sequence. As each new tRNA brings in the next amino acid, the preceding amino acid is transferred onto the amino group of the new amino acid and enzymes located in the ribosomes form a peptide bond. The tRNA is released into the cytoplasm, where it can pick up another amino acid, and the cycle repeats. When the terminal codon is reached, the peptide chain is detached and the ribosome and mRNA dissociate. Figure 10-4 illustrates protein synthesis. Intracellular proteins are generally synthesized on free ribosomes, whereas proteins made by the liver for secretion are made on ribosomes attached to the rough endoplasmic reticulum. Protein syn-

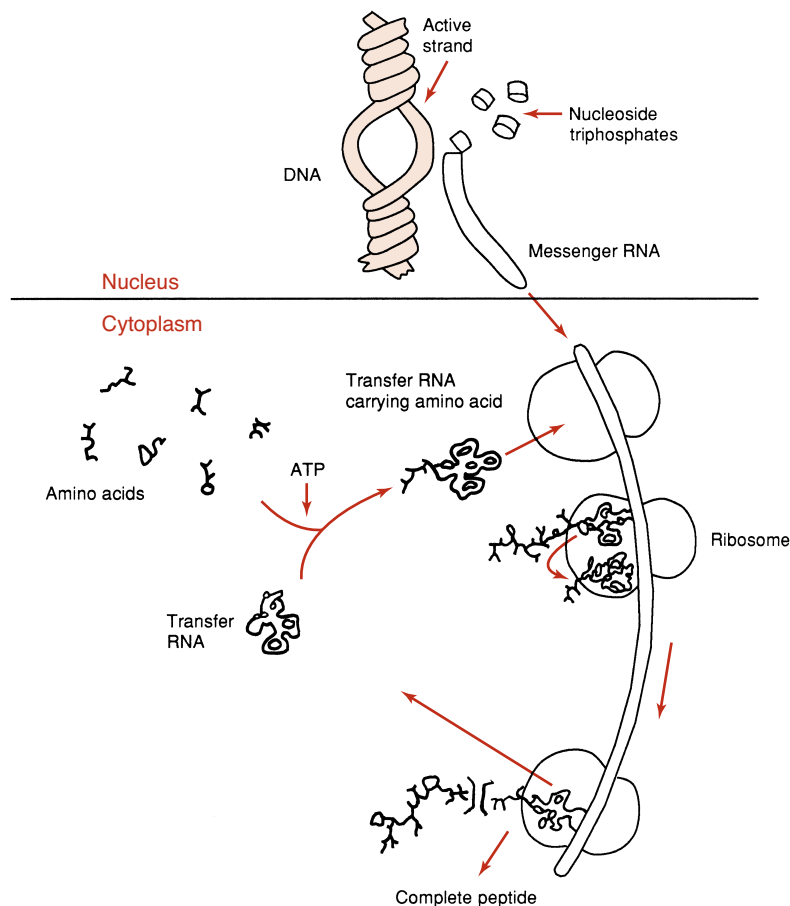

FIGURE 10-4. Schematic summary of protein synthesis.

thesis occurs at the rate of approximately two to six peptide bonds per second. The hormones that assist in controlling protein synthesis are thyroxine, growth hormone, insulin, and testosterone. The hormones that assist in controlling protein catabolism are glucagon and cortisol.

Catabolism and Nitrogen Balance

Unlike fats and carbohydrates, nitrogen has no designated storage depots in the body. The biologic value of dietary proteins is related to the extent to which they provide all the necessary amino acids.

Insufficient dietary quantities of even one amino acid can quickly limit the synthesis and lower the body levels of many essential proteins.²⁵ Most proteins in the body are constantly being repetitively synthesized and then degraded. Ordinarily, a balance exists between protein anabolism (synthesis) and catabolism (breakdown). Normally, this turnover totals about 125–220 g of protein each day, with the rate of individual proteins widely varying. For example, the plasma proteins and most intracellular proteins are rapidly degraded, having half-lives of hours or days; some of the structural proteins, such as collagen, are metabolically stable and have half-lives of years. Normal, healthy adults are generally in nitrogen balance, with intake and excretion being equal. Pregnant women, growing children, and adults recovering from major illness are often in positive nitrogen balance. Their intake of nitrogen exceeds their loss as net protein synthesis proceeds. When more nitrogen is excreted than is incorporated into the body, an individual is in negative nitrogen balance, and this occurs in conditions in which there is excessive tissue destruction, such as burns, wasting diseases, continual high fevers, or starvation.

The disintegration of protein occurs in the digestive tract, kidneys, and, particularly, the liver. Nitrogen elimination begins intracellularly with protein degradation. There are two main routes for converting intracellular proteins to free amino acids: a lysosomal pathway, which degrades extracellular and some intracellular proteins, and cytosolic pathways, which are important in degrading intracellular proteins.

The central reactions that remove amino acid nitrogen from the body are known as transaminations. Transaminations involve moving an α -amino group from a donor α -amino acid to the keto carbon of an acceptor α -ketoacid. These reversible reactions are catalyzed by a group of intracellular enzymes known as *transaminases*. These reactions move nitrogen from all free amino acids into a small number of compounds from there being oxidatively deaminated, producing ammonia and ketoacids. The ammonia is converted to urea by the urea cycle in hepatocytes and excreted in the urine, and the ketoacids are oxidized by means of the citric acid cycle and converted to glucose or fat.

Structure

There are four distinct levels of a protein's structure: primary, secondary, tertiary, and quaternary. *Primary structure* represents the number and types of amino acids in the specific amino acid sequence. In order to function properly, proteins must have the correct sequence of amino acids. For example, when the amino acid valine is substituted for glutamic acid in the α chain of hemoglobin A, hemoglobin S is formed, which results in sickle cell disease.

Secondary structure is regularly repeating structures stabilized by hydrogen bonds between the amino acids within the protein. Common secondary structures are the α helix, β pleated sheet, and turns with most serum proteins forming a helix.²⁶ Secondary structures add new properties to a protein such as strength and flexibility (Fig. 10-5).

Tertiary structure refers to the overall shape, or conformation, of the protein molecule. The conformation is known as the *fold*, or the spatial relationship of the secondary structures to one another. Tertiary structures are three-dimensional. Tertiary structure results from the interaction of side chains and is stabilized through the hydrophobic effect, ionic attraction, hydrogen bonds, and disulfide bonds. The function, physical, and chemical properties of a protein depend on its tertiary structure.²⁷

Quaternary structure is defined as the shape or structure that results from the interaction of more than one protein molecule, or protein subunits, held together by noncovalent forces such as hydrogen bonds and electrostatic interactions, which are part of the larger protein complex with a precise three-dimensional configuration.

When the secondary, tertiary, or quaternary structure of a protein is disturbed, the protein may lose its functional and chemical characteristics. This loss of its native, or naturally occurring, folded structure is called **denaturation**. Denaturation can be caused by heat, hydrolysis by strong acid or alkali, enzymatic action, exposure to urea or other substances, or exposure to ultraviolet light.

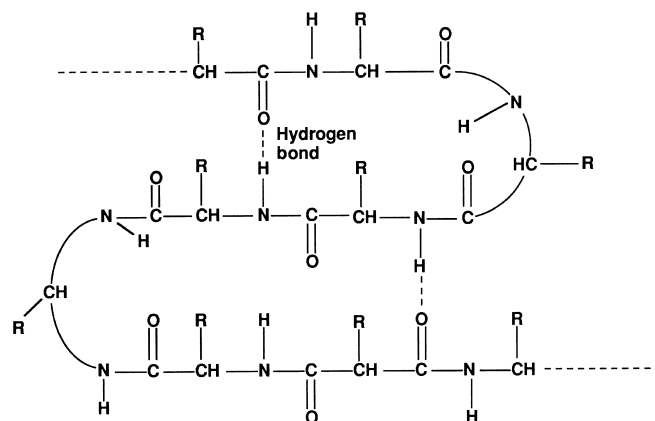

FIGURE 10-5. Secondary structure of proteins.

Nitrogen Content

Proteins consist of the elements carbon, oxygen, hydrogen, nitrogen, and sulfur. It is the fact that proteins contain nitrogen that sets them apart from pure carbohydrates and lipids, which do not contain nitrogen atoms. The nitrogen content of serum protein is, on average, approximately 16%. This measurement of nitrogen content is used in one method for total protein.

Charge and Isoelectric Point

Proteins contain many ionizable groups on the side chains of their amino acids as well as their N- and C-terminal ends. Because of this, proteins can be positively and negatively charged. The acid or basic groups that are not involved in the peptide bond can exist in different charged forms, depending on the pH of the surrounding environment (Fig. 10-6).

The side chains of lysine, arginine, and histidine include basic groups, and acidic groups are found on the side chains of glutamate, aspartate, cysteine, and tyrosine. The pH of the solution, the pK of the side chain, and the side chain's environment influence the charge on each side chain. The relationship between pH, pK, and charge for individual amino acids can be described by the Henderson-Hasselbach equation:

$$\text{pH} = \text{pK} + \log \frac{[\text{conjugate base}]}{[\text{conjugate acid}]} \quad (\text{Eq. 10-1})$$

In general terms, as the pH of a solution increases, deprotonation of the acidic and basic groups on proteins occurs, so that carboxyl groups are converted to carboxylate anions (R-COOH to R-COO^-) and ammonium groups are converted to amino groups (R-NH_3^+ to R-NH_2).

The pH at which an amino acid or protein has no net charge is known as its **isoelectric point (pI)**. When the $\text{pH} > \text{pI}$, a protein has a net negative charge, and when the $\text{pH} < \text{pI}$, a protein has a net positive charge. Therefore, the pI is the point at which the number of positively charged groups equals the number of negatively charged groups in a protein. If a protein is placed in a solution that has a pH greater than the pI, the protein will be negatively charged; at a pH less than the pI, the protein will be positively charged. Proteins differ in their pI values, but for most proteins it occurs in the pH range of 5.5–8. Because proteins carry different net charges at any given pH, this difference in size of the charge is the basis for several procedures for separating and quantifying proteins.

Solubility

Soluble proteins have a charge on their surfaces. The surface of a protein has a net charge that depends on the number and types of its amino acids and on pH. A protein has its lowest solubility at its isoelectric point. If there is

a charge at the protein surface, the protein is hydrophilic (prefers to interact with water), rather than with other protein molecules. This charge makes it more soluble. Without a net charge, protein–protein interactions and precipitation are more likely. The solubility of proteins in blood requires a pH in the range of 7.35–7.45. Methods have been developed to separate proteins based on their solubility.

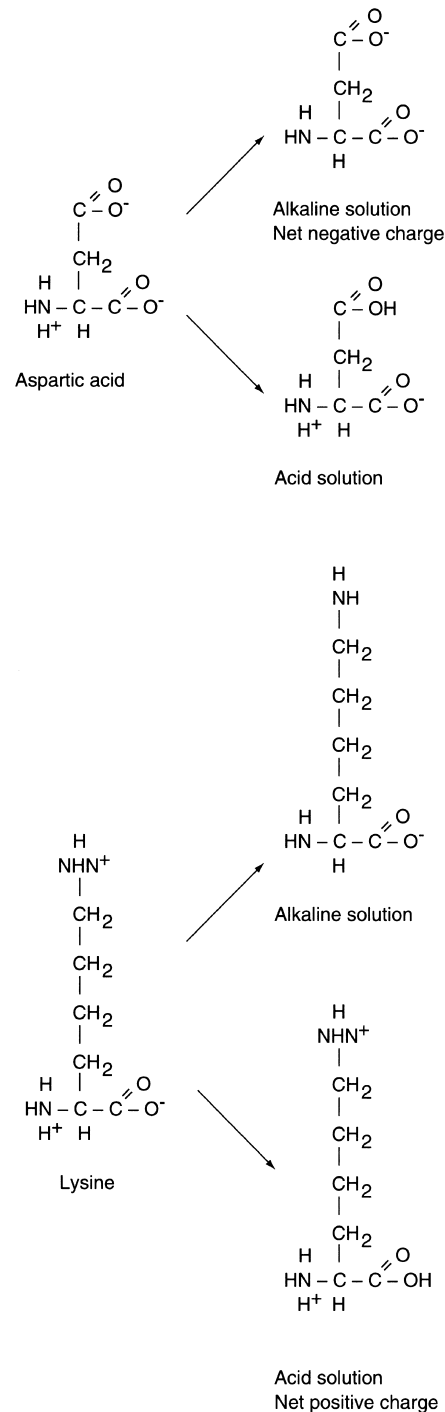

FIGURE 10-6. Charged states of amino acids.

Classification

During 2003–2005, the Human Plasma Proteome Project directed by the Human Plasma Proteome Organization (HUPO) prepared and distributed reference specimens of human serum and plasma to 55 participating laboratories worldwide. Some of the long-term goals of this project are the comprehensive analysis of plasma and serum protein constituents in people and their physiologic, pathologic, and pharmacologic applications. Protocols used combinations of depletion, fractionation, mass spectrometry, and immunoassay methods linked via search engines and annotation groups to gene and protein databases. A new human plasma proteome database was created with, obviously, much work yet to be done.²⁸ The findings from the collaborative project and from laboratory-specific ancillary projects are published in a special issue of *Proteomics*, “Exploring the Human Plasma Proteome” in August 2005.

Classification by Protein Functions

Generally speaking, proteins do everything in the living cells.²⁹ Proteins are responsible for many different functions in a cell, making function one of the common classifications of proteins.

- **Enzymes**—proteins that catalyze chemical reactions. Enzymes are normally found inside cells but are released to the blood in tissue damage, making enzyme measurement a very important diagnostic tool. Examples of groups of enzymes tested in the clinical laboratory are the transaminases, dehydrogenases, and phosphatases.
- **Hormones**—proteins that are chemical messengers that control the actions of specific cells or organs. Hormones affect growth and development, metabolism, sexual function, reproduction, and behavior. Examples of hormones testing in the clinical laboratory in blood, urine, or saliva are insulin, testosterone, growth hormone, follicle-stimulating hormone, and cortisol.
- **Transport proteins**—proteins that transport movement of ions, small molecules, or macromolecules, such as hormones, vitamins, minerals, and lipids, across a biologic membrane. Examples of commonly measured transport proteins are hemoglobin, albumin, and transferrin.
- **Immunoglobulins (antibodies)**—proteins produced by B-cells (lymphocytes) in the bone marrow that mediate the humoral immune response to identify and neutralize foreign objects. Examples of immunoglobulins are IgG, IgM, and IgA.
- **Structural proteins**—fibrous proteins are the structures of cells and tissues such as muscle, tendons, and bone matrix. Collagen, elastin, and keratin are examples of structural proteins.
- **Storage proteins**—proteins that serve as reserves of metal ions and amino acids that can be released and

used later without harm occurring to cells during the time of storage. The most widely studied and tested storage protein is ferritin, which stores iron to be later used in the manufacture of hemoglobin.

- **Energy source**—plasma proteins serve as a reserve source of energy for tissues and muscle.
- **Osmotic force**—plasma proteins function in the distribution of water throughout the compartments of the body. Their colloid osmotic force, due to their size, does not allow protein to cross the capillary membranes. As a result, water is absorbed from the tissue into the venous portion of the capillary. When the concentration of plasma proteins is significantly decreased, the concomitant decrease in the plasma colloidal osmotic (oncotic) pressure results in increased levels of interstitial fluid and edema. This is often seen in renal disease when **proteinuria** results in a decreased plasma protein concentration and swelling of the hands and feet.

Protein functions are summarized in Table 10-2.

Classification by Protein Structure

- **Database (manual)** – The Structural Classification of Proteins (SCOP) database is created by manual inspection and aided by a battery of automated methods. The goal of SCOP is to provide a detailed and comprehensive description of the structural domains based on similarities of their amino acid sequences and three-dimensional structures. SCOP utilizes four levels of structural classification: class, fold, superfamily, and family. Originally published in 1995, SCOP is usually updated at least once yearly by Alexei G. Murzin et al., upon whose expertise the classification rests.³⁰
- **Database (automated)** – Families of Structurally Similar Proteins (FSSP) is also known as Fold classification based on Structure–Structure alignment of Proteins. The FSSP protein classification is based on a

TABLE 10-2 FUNCTIONS OF PROTEINS

| |
|--|
| Energy—tissue nutrition |
| Osmotic force—maintenance of water distribution between cells and tissue, interstitial compartments, and the vascular system of the body |
| Acid-base balance—participation as buffers to maintain pH |
| Transport—metabolic substances |
| Antibodies—part of immune defense system |
| Hormones—hormones and receptors |
| Structure—connective tissue |
| Enzymes—catalysts |
| Hemostasis—participation in coagulation of blood |

three-dimensional structure comparison of protein structures in the Protein Data Bank (PDB). Alignments and classification are done automatically and are updated continuously by the Dali (Distance matrix ALignment) server, which is an automatic server that makes a three-dimensional comparison of protein structures.³¹

- **Simple proteins** – **Simple proteins** contain peptide chains composed of only amino acids. Simple proteins may be globular or fibrous in shape. Globular proteins are globelike, symmetrical proteins that are soluble in water. Globular proteins are transporters, enzymes, and messengers. Examples of globular proteins are albumin, hemoglobin, and the immunoglobulins IgG, IgA, and IgM. Fibrous proteins form long protein filaments or subunits, are asymmetrical and usually inert, and are generally water insoluble due to their hydrophobic R groups. Fibrous proteins are structural, such as connective tissues, tendons, bone, and muscle. Examples of fibrous proteins include tropinin and collagen.
- **Conjugated Proteins** – **Conjugated proteins** consist of a protein and a nonprotein (prosthetic) group. The prosthetic group is the nonamino part of a conjugated protein. The prosthetic group may be lipid, carbohydrate, porphyrins, metals, and others. It is the prosthetic groups that define the characteristics of these proteins. Examples of conjugated proteins are the metalloproteins, glycoproteins, lipoproteins, and nucleoproteins. Metalloproteins have a metal ion attached to the protein, either directly, as in ferritin (which contains iron) and ceruloplasmin (which contains copper), or as complex metals (metal plus another prosthetic group), such as hemoglobin and flavoproteins. Lipoproteins have lipids such as cholesterol and triglyceride linked to proteins, such as high-density lipoproteins (HDL) and very low density lipoproteins (VLDL). Several protein groups are used to describe carbohydrates joined to proteins. Generally, those molecules with 10%–40% carbohydrate are called glycoproteins. Examples of glycoproteins are haptoglobin and α_1 -antitrypsin. When the percentage of carbohydrate linked to protein is higher, the proteins are called mucoproteins or proteoglycans. An example of a mucoprotein is mucin, a lubricant that protects body surfaces from friction or erosion. Increased mucin production occurs in many adenocarcinomas, including cancer of the pancreas, lung, breast, ovary, and colon. Moreover, mucins are also being investigated for their potential as diagnostic markers.³² Nucleoproteins are those proteins that are combined with nucleic acids, DNA or RNA. Chromatin is an example of a nucleoprotein that is the complex of DNA and protein that makes up chromosomes.

PLASMA PROTEINS

The plasma proteins are the most frequently analyzed of all the proteins. The major measured plasma proteins are divided into two groups: albumin and **globulins**. There are four major types of globulins, each with specific properties and actions. A typical blood panel will provide four different measurements—total protein, albumin, globulins, and the albumin/globulin ratio. Some of the more significant plasma proteins and their functions, structures, and relation to disease states are discussed later. Characteristics of selected plasma proteins are listed in Table 10-3.

Prealbumin (Transthyretin)

Prealbumin is so named because it migrates ahead of albumin in the classic electrophoresis of serum or plasma proteins. It can also be separated by high-resolution electrophoresis (HRE) or immunoelectrophoresis techniques. Prealbumin is the transport protein for thyroxine and triiodothyronine (thyroid hormones); it also binds with retinol-binding protein to form a complex that transports retinol (vitamin A) and is rich in tryptophan. Prealbumin is decreased in hepatic damage, acute-phase inflammatory response, and tissue necrosis. A low prealbumin level is a sensitive marker of poor nutritional status. When a diet is deficient in protein, hepatic synthesis of proteins is reduced with the resulting decrease in the level of the proteins originating in the liver, including prealbumin, albumin, and β -globulins. Because prealbumin has a short half-life of approximately 2 days, it decreases more rapidly than do other proteins. Prealbumin is increased in patients receiving steroids, in alcoholism, and in chronic renal failure.

Albumin

Albumin is synthesized in the liver from 585 amino acids at the rate of 9–12 grams per day with no reserve or storage. It is the protein present in highest concentration in the plasma. Albumin also exists in the extravascular (interstitial) space. In fact, the total extravascular albumin exceeds the total intravascular amount by 30%, but the concentration of albumin (plasma albumin concentration = intravascular albumin mass/plasma volume) in the blood is much greater than its concentration is in the interstitial space. Albumin leaves the circulation at a rate of 4%–5% of total intravascular albumin per hour. This rate of movement is known as the transcapillary escape rate (TER), which measures systemic capillary efflux of albumin. Albumin is responsible for nearly 80% of the colloid osmotic pressure of the intravascular fluid, which maintains the appropriate fluid balance in the tissue. Albumin also buffers pH and is a negative acute-phase reactant protein.

TABLE 10-3 CHARACTERISTICS OF SELECTED PLASMA PROTEINS

| | REFERENCE VALUE (ADULT, G/L) | MOLECULAR MASS (D) | ISOELECTRIC POINT, PI | ELECTROPHORETIC MOBILITY PH 8.6, I 5 0.1 | |
|---|------------------------------------|-----------------------|--------------------------|--|--|
| Prealbumin | 0.1–0.4 | 55,000 | 4.7 | 7.6 | Indicator of nutrition; binds thyroid hormones and retinol-binding protein |
| Albumin | 35–55 | 66,300 | 4.9 | 5.9 | Binds bilirubin, steroids, fatty acids; major contributor to oncotic pressure |
| α₁-GLOBULINS | | | | | |
| α ₁ -Antitrypsin | 2–4 | 53,000 | 4.0 | 5.4 | Acute-phase reactant; protease inhibitor |
| α ₁ -Fetoprotein | 1 × 10 ⁵ | 76,000 | 2.7 | 6.1 | Principal fetal protein Elevated levels indicate risk for spina bifida |
| α ₁ -Acid glycoprotein (orosomuroid) | 0.55–1.4 | 44,000 | | 5.2 | Acute-phase reactant, may be related to immune response |
| α ₁ -Lipoprotein | 2.5–3.9 | 200,000 | | 4.4–5.4 | Transports lipids (HDL) |
| α ₁ -Anti-chymotrypsin | 0.3–0.6 | 68,000 | | Inter α | Inhibits serine proteinases |
| Inter-α-trypsin inhibitor | 0.2–0.7 | 160,000 | | Inter α | Inhibits serine proteinases |
| Gc-globulin | 0.2–0.55 | 59,000 | | Inter α | Transports vitamin D and binds actin |
| α₂-GLOBULINS | | | | | |
| HAPTOGLOBINS | | | | | |
| Type 1-1 | 1.0–2.2 | 100,000 | | 4.5 | Acute-phase reactant; binds hemoglobin |
| Type 2-1 | 1.6–3.0 | 200,000 | 4.1 | 3.5–4.0 | Binds hemoglobin |
| Type 2-2 | 1.2–1.6 | 400,000 | | 3.5–4.0 | Binds hemoglobin |
| Ceruloplasmin | 0.15–0.60 | 134,000 | 4.4 | 4.6 | Acute Phase reactant, oxidase activity; contains copper |
| α ₂ -Macroglobulin | 1.5–4.2 | 725,000 | 5.4 | 4.2 | Inhibits proteases |
| β-GLOBULINS | | | | | |
| Pre-β-lipoprotein | 1.5–2.3 | 250,000 | | 3.4–4.3 | Transports lipids (primarily VLDL triglyceride) |
| Transferrin | 2.04–3.60 | 76,000 | 5.9 | 3.1 | Transports iron |
| Hemopexin | 0.5–1.0 | 57,000–80,000 | | 3.1 | Binds heme |
| β-Lipoprotein | 2.5–4.4 | 3,000,000 | | 3.1 | Transports lipids (primarily LDL cholesterol) |
| β ₂ -Microglobulin (B2M) | 0.001–0.002 | 11,800 | | β ₂ | Component of leukocyte antigen (HLA) molecules |
| C4 complement | 0.20–0.65 | 206,000 | | 0.8–1.4 | Immune response |
| C3 complement | 0.55–1.80 | 180,000 | | 0.8–1.4 | Immune response |
| C1q complement | 0.15 | 400,000 | | | Immune response |
| Fibrinogen | 2.0–4.5 | 341,000 | 5.8 | 2.1 | Precursor of fibrin clot |

(continued)

TABLE 10-3 CHARACTERISTICS OF SELECTED PLASMA PROTEINS (continued)

| | REFERENCE VALUE (ADULT, G/L) | MOLECULAR MASS (D) | ISOELECTRIC POINT, PI | ELECTROPHORETIC MOBILITY PH 8.6, I 5 0.1 | |
|--------------------------|------------------------------------|-----------------------|--------------------------|--|--|
| C-reactive protein (CRP) | 0.01 | 118,000 | 6.2 | | Acute-phase reactant, motivates phagocytosis in inflammatory disease |
| γ-GLOBULINS | | | | | |
| Immunoglobulin G | 8.0–12.0 | 150,000 | 5.8–7.3 | 0.5–2.6 | Antibodies |
| Immunoglobulin A | 0.7–3.12 | 180,000 | | 2.1 | Antibodies (in secretions) |
| Immunoglobulin M | 0.5–2.80 | 900,000 | | 2.1 | Antibodies (early response) |
| Immunoglobulin D | 0.005–0.2 | 170,000 | | 1.9 | Antibodies |
| Immunoglobulin E | 6×10^4 | 190,000 | | 2.3 | Antibodies (reagins, allergy) |

Another prime function of albumin is its capacity to bind various substances in the blood. There are four binding sites on albumin, and these have varying specificity for different substances. Albumin transports thyroid hormones; other hormones, particularly fat-soluble ones; iron; and fatty acids. For example, albumin binds unconjugated bilirubin, salicylic acid (aspirin), fatty acids, calcium (Ca^{2+}) and magnesium (Mg^{2+}) ions, and many drugs and serum albumin levels can affect the half-life of drugs. This binding characteristic is also exhibited with certain dyes, providing a method for the quantitation of albumin.

Several recent studies have focused on the significance of the clinical applicability of glycated albumin as a more sensitive indicator of short-term hyperglycemic control than glycosylated hemoglobin in diabetes because of the shorter in vivo half-life of glycated albumin. Affinity-chromatographic methods based on specific interaction of boronic acids with glycated proteins have also been applied to determine serum concentrations of glycated albumin.³³

Decreased concentrations of serum albumin may be caused by the following:

- An inadequate source of amino acids that occurs in malnutrition and malabsorption
- Liver disease, resulting in decreased synthesis by the hepatocytes. Note that the increase in globulins that occurs in early cirrhosis, however, balances the loss in albumin to give a total protein concentration within acceptable limits.
- Protein-losing enteropathy or gastrointestinal loss as interstitial fluid leaks out in inflammation and disease of the intestinal tract as in diarrhea
- Kidney loss to the urine in renal disease. Albumin is normally excreted in very small amounts. This excess excretion occurs when the glomerulus no longer functions to restrict the passage of proteins from the blood as in nephrotic syndrome.

- Skin loss in the absence of the skin barrier such as in burns or exfoliative dermatitis
- Hypothyroidism
- Dilution by excess: polydipsia (drinking too much water) or excess administration of intravenous fluids
- Acute disease states
- Mutation resulting from an autosomal recessive trait causing analbuminemia (absence of albumin) or bisalbuminemia (the presence of albumin that has unusual molecular characteristics) demonstrated by the presence of two albumin bands instead of the single band usually seen by electrophoresis. Both are rare.
- Redistribution by hemodilution, increased capillary permeability (increased interstitial albumin), or decreased lymph clearance. In sepsis, there is a profound reduction in plasma albumin associated with marked fluid shifts.

Abnormally high albumin levels are seldom clinically important. Increased serum albumin levels are seen only with dehydration or after excessive albumin infusion.³⁴

Globulins

The globulin group of proteins consists of α_1 , α_2 , β , and γ fractions. Each fraction consists of a number of different proteins with different functions. The following subsections describe selected examples of the globulins.

α_1 -Antitrypsin

α_1 -Antitrypsin (AAT), a glycoprotein mainly synthesized in the liver, has as its most important function the inhibition of the protease neutrophil elastase. Mutations in the *SERPINA1* gene cause α_1 -antitrypsin deficiency. Neutrophil elastase is released from leukocytes to fight infection, but it can destroy alveoli, which can lead to emphysema if not controlled by α_1 -antitrypsin. Mutations in the *SERPINA1* gene can lead to a deficiency of α_1 -antitrypsin protein or an abnormal form of the

protein that cannot control neutrophil elastase. The abnormal form of α_1 -antitrypsin can also accumulate in the liver and can cause cirrhosis. α_1 -Antitrypsin is an acute-phase reactant. Increased levels of α_1 -antitrypsin are seen in inflammatory reactions, pregnancy, and contraceptive use. Several phenotypes of α_1 -antitrypsin deficiency have been identified. The most common phenotype is MM (allele Pi^M) and is associated with normal antitrypsin activity. Other alleles are Pi^S , Pi^Z , Pi^F , and Pi^- (null). The homozygous phenotype ZZ individual is most at risk for liver and lung disease from a deficiency of α_1 -antitrypsin. Protein replacement therapy, using purified AAT protein from pooled plasma samples, and smoking cessation can dramatically slow disease progression.

Abnormal α_1 -antitrypsin levels are most often found in the laboratory by the lack of an α_1 -globulin band on protein electrophoresis because it is the major component (approximately 90%) of the fraction of serum proteins that migrates immediately following albumin. Quantitative methods used to confirm electrophoresis findings are radial immunodiffusion and automated immunonephelometric assays. Phenotyping is done using immunofixation.³⁵

α_1 -Fetoprotein

α_1 -Fetoprotein (AFP) is synthesized in the developing embryo and fetus and then by the parenchymal cells of the liver. AFP levels decrease gradually after birth, reaching adult levels by 8–12 months; however, AFP has no known function in normal adults. In normal fetuses, AFP binds the hormone estradiol. It has an electrophoretic mobility between that of albumin and α_1 -globulin.

The physiologic function of AFP has not been completely identified, but it has been proposed that the protein protects the fetus from immunologic attack by the mother. Conditions associated with an elevated AFP level include spina bifida, neural tube defects, abdominal wall defects, anencephaly (absence of the major portion of the brain), and general fetal distress. Low levels of maternal AFP indicate an increased risk for Down syndrome and trisomy 18, while it is increased in the presence of twins and neural tube defects.

AFP screening is done between 15 and 20 weeks' gestational age when the maternal AFP increases gradually; therefore, interpretation requires accurate dating of the pregnancy. Measurements of AFP can be affected by laboratory technique, resulting in difficulty comparing absolute results between centers. AFP levels are also affected by maternal weight, race, and diabetes, so test results need to be adjusted for these variables. Because multiples of the median (MoM) is a reflection of an individual patient's value compared with the median, it is used to compensate for these issues. MoM is calculated by dividing the patient's AFP value by the median reference value for that gestational age. Most screening laboratories use 2.0 MoM

CASE STUDY 10-2

Immediately following the birth of a baby girl, the attending physician requested a protein electrophoretic examination of the mother's serum. This was done on a sample that was obtained on the mother's admission to the hospital the previous day. An electrophoretic examination was also performed on the cord-blood specimen. Laboratory reports are shown in the following chart.

The appearance of the mother's electrophoretic pattern was within that expected for a healthy person. The electrophoretic pattern of the cord-blood serum resembled the one shown in Figure 10-9C.

Questions

1. What protein fraction(s) is/are abnormal in the mother's serum and the cord blood serum?
2. An abnormality in this/these fraction(s) is/are most often associated with what disease?
3. What other test(s) may be done to confirm this abnormality?

CASE STUDY 10-2 ELECTROPHORESIS VALUES (G/DL)

| | ADULT REFERENCE VALUES | MOTHER'S SERUM | CORD BLOOD |
|-----------------------|------------------------------|-------------------|---------------|
| Albumin | 3.5–5.0 | 4.2 | 3.3 |
| α_1 -Globulins | 0.1–0.4 | 0.3 | 0.0 |
| α_2 -Globulins | 0.3–0.8 | 1.2 | 0.4 |
| β -Globulins | 0.6–1.1 | 1.3 | 0.7 |
| γ -Globulins | 0.5–1.7 | 1.3 | 1.0 |

as the upper limit and 0.5 MoM as the lower limit of normal for maternal serum. The methods commonly used for AFP determinations are radioimmunoassay (RIA) and enzyme-labeled immunoassay (EIA). Maternal screening tests have been established as a triple or quadruple test group using a mathematical calculation involving the levels of these three or four substances (AFP, hCG, unconjugated estriol, and inhibin A) to determine a numeric risk for chromosomal abnormalities in the fetus. This risk is compared with an established cutoff. The interpretation of a test result should be provided by a genetic counselor or clinician to help women and their physicians make decisions about the management of their pregnancies.

AFP can be fractionated by affinity electrophoresis into three isoforms—L1, L2, and L3—based on their

reactivity with the lectin *Lens culinaris* agglutinin (LCA). AFP-L3 is now being considered as a tumor marker for the North American population for screening chronic liver disease patients for hepatocellular carcinoma (HCC). Results for AFP-L3 are reported as a ratio of LCA-reactive AFP to total AFP (AFP-L3%). Studies have shown that AFP-L3% test results of greater than 10% are associated with a sevenfold increase in the risk of developing HCC within the next 21 months.³⁶

α₁-Acid Glycoprotein (Orosomucoid)

α₁-Acid glycoprotein, a major plasma glycoprotein, is negatively charged even in acid solutions, a fact that gave it its name. This protein is produced by the liver and is an acute-phase reactant. The possibility that AAG regulates immune responses has been suggested by several findings.³⁷ There is a strong similarity in the amino acid sequences between AAG and immunoglobulin. It is elevated following stress, inflammation and tissue damage, acute myocardial infarction, trauma, pregnancy, cancer, pneumonia, rheumatoid arthritis, and surgery. Serum AAG levels also provide a useful diagnostic tool in neonates with bacterial infections. In the past decade, the binding of drugs to this plasma protein has increasingly become important in regard to drug action, distribution, and disposition. The analytic methods used most commonly for the determination of AAG are radial immunodiffusion, immunoturbidity, and nephelometry. Immunofixation has been used to study inherited variants. The normal range for healthy individuals is 50–120 mg/dL.

α₁-Antichymotrypsin

α₁-Antichymotrypsin is an *α* globulin glycoprotein that is a member of the serine proteinase inhibitor (serpin) family. It inhibits the activity of the enzymes cathepsin G, pancreatic elastase, mast cell chymase, and chymotrypsin by cleaving them into a different shape (conformation). *α₁-Antichymotrypsin* is produced in the liver and is an acute-phase protein that is increased during inflammation.

Deficiency of this protein has been associated with liver disease. Mutations have been identified in patients with Parkinson disease and chronic obstructive pulmonary disease. *α₁-Antichymotrypsin* is also associated with the pathogenesis of Alzheimer disease as it is an integral component of the amyloid deposits in Alzheimer disease.³⁸

Inter-α-trypsin Inhibitor

Inter-α-trypsin inhibitors (ITIs) are a family of serine protease inhibitors, assembled from two precursor proteins: a light chain (bikunin) and either one or two heavy chains. While there is only one type of light chain, there are five different homologous heavy chains (ITIHS). ITIH molecules have been shown to play a particularly important role in inflammation and carcinogenesis.³⁹ Elevations are seen in inflammatory disorders.

Gc-globulin (Group-Specific Component; Vitamin D-Binding Protein)

Gc-globulin, synthesized mainly by hepatocytes, is the major carrier protein of vitamin D and its metabolites in the circulation and also transports components such as fatty acids and endotoxin. Due to genetic polymorphism in the Gc gene (codominant alleles), three major electrophoretic variants of Gc exist (Gc2, Gc1s, and Gc1f). Elevations of *Gc-globulin* are seen in the third trimester of pregnancy and in patients taking estrogen oral contraceptives. Severe liver disease and protein-losing syndromes are associated with low levels.

Gc binds actin released from cells upon injury, and the Gc-actin complexes are rapidly cleared from the circulation, thereby preventing the harmful effects of actin filaments in blood vessels. The resulting decrease in Gc concentration makes Gc usable as a prognostic indicator of survival of patients with significant tissue injury after trauma and among patients with hepatic failure.⁴⁰

Gc may be of importance for bone formation and in the immune system. Gc may act as a co-chemotactic factor in facilitating chemotaxis of neutrophils and monocytes in inflammation. Immunonephelometry, which can be automated, is the method of choice for measurement in the laboratory.

Haptoglobin

Haptoglobin (Hp), an *α₂-glycoprotein*, is synthesized in the hepatocytes. The mature haptoglobin molecule is a tetramer, consisting of two *α* and two *β* chains. *Haptoglobin* is considered an acute-phase protein that is elevated in many inflammatory diseases, such as ulcerative colitis, acute rheumatic disease, heart attack, and severe infection. It is one of the proteins used to evaluate the rheumatic diseases. Increases are also seen in conditions such as burns and nephrotic syndrome when large amounts of fluid and lower-molecular-weight proteins have been lost. (*Haptoglobin* testing is not generally used to help diagnose or monitor these conditions.) *Haptoglobin* phenotype has also been reported as an independent risk factor for cardiovascular disease (CVD) in individuals with type 2 diabetes mellitus.⁴¹

Three phenotypes of Hp are found in humans: Hp1-1, Hp2-1, and Hp2-2. Homozygous haptoglobin 1-1 gives one band. The peptide chains form polymers with each other and with haptoglobin 1 chains to provide the other two electrophoretic patterns, which have been designated as Hp 2-1 and Hp 2-2 phenotypes. The function of haptoglobin is to bind free hemoglobin to prevent the loss of hemoglobin and its constituent, iron, into the urine. Free hemoglobin is not contained within red blood cells. When the haptoglobin and hemoglobin attach, the reticuloendothelial cells (mainly in the spleen) remove the haptoglobin-hemoglobin complex from circulation within minutes of its formation, with iron and amino acids being recycled. The haptoglobin is destroyed.

Haptoglobin testing is used primarily to help detect and evaluate hemolytic anemia and to distinguish it from anemia due to other causes. When haptoglobin levels are decreased, along with an increased reticulocyte count and usually also a decreased red blood cell (RBC) count, hemoglobin, and hematocrit, then it is likely that the patient has hemolytic anemia. Haptoglobin has been used to evaluate the degree of intravascular hemolysis that has occurred in transfusion reactions or hemolytic disease of the newborn. If the haptoglobin is normal and the reticulocyte count is increased, then RBC destruction may be occurring in organs such as the spleen and liver. Because the freed hemoglobin is not released into the bloodstream, the haptoglobin is not used up and so is normal. If the haptoglobin concentrations are normal and the reticulocyte count is not increased, then it is likely that any anemia present is not due to RBC breakdown. If haptoglobin levels are decreased without any signs of hemolytic anemia, then it is possible that the liver is not producing adequate amounts of haptoglobin. Radial immunodiffusion and immunonephelometric methods have been used for the quantitative determination of haptoglobin.

Ceruloplasmin

Ceruloplasmin is a copper-containing, α_2 -glycoprotein enzyme that is synthesized in the liver. Ceruloplasmin is an acute-phase reactant. It is frequently elevated in inflammation, severe infection, and tissue damage and may be increased with some cancers. It may be increased during pregnancy and with the use of estrogen, oral contraceptives, and medications such as carbamazepine, phenobarbital, and valproic acid. Ninety percent or more of total serum copper is found in ceruloplasmin; the other 10% is bound to albumin.

Ceruloplasmin is primarily ordered along with blood and/or urine copper tests to help diagnose Wilson's disease, an autosomal recessive inherited disorder associated with decreased levels (typically 0.1 g/L) of ceruloplasmin and excess storage of copper in the liver, brain, and other organs resulting in hepatic cirrhosis and neurologic damage. Total serum copper is decreased, but the direct reacting fraction is elevated and the urinary excretion of copper is increased. Copper also deposits in the cornea, producing the characteristic Kayser-Fleischer rings. Low ceruloplasmin is also seen in malnutrition; malabsorption; severe liver disease; nephrotic syndrome; and Menkes syndrome (kinky hair disease), in which a decreased absorption of copper results in a decrease in ceruloplasmin.

The early analytic method of ceruloplasmin determination was based on its copper oxidase activity. Most assays today use immunochemical methods, including radial immunodiffusion and nephelometry.

α_2 -Macroglobulin

α_2 -Macroglobulin (A2M), a large protein, is synthesized by the liver and is a major component of the α_2 band in

protein electrophoresis. It is a tetramer of four identical subunits that inhibits proteases such as trypsin, thrombin, kallikrein, and plasmin by means of a bait region that can entrap proteinases, reducing the accessibility of the proteinase functional sites, particularly to large molecules, but not completely inactivating them. After binding with and inhibiting proteases, it is removed by the reticuloendothelial tissues.

In nephrosis, the levels of serum A2M may increase as much as 10 times because its large size aids in its retention. The protein is also increased in diabetes and liver disease. Use of contraceptive medications and pregnancy increase the serum levels by 20%. The analytic methods that have been used for the assay of this protein are radial immunodiffusion, immunonephelometry, enzyme-linked immunosorbent assay (ELISA), and latex agglutination immunoassay.

Transferrin (Siderophilin)

Transferrin, a glycoprotein, is a negative acute-phase protein synthesized primarily by the liver. Two molecules of ferric iron can bind to each molecule of transferrin which binds iron very tightly but reversibly. Although iron bound to transferrin is less than 0.1% (4 mg) of the total body iron, dynamically it is the most important iron pool. Normally, only about 20%–50% of the iron-binding sites on transferrin are occupied. Transferrin is the major component of the β -globulin fraction and appears as a distinct band on high-resolution serum protein electrophoresis.

The major functions of transferrin are the transport of iron and the prevention of loss of iron through the kidney. Its binding of iron prevents iron deposition in the tissue during temporary increases in absorbed iron or free iron. Transferrin transports iron to its storage sites, where it is incorporated into apoferritin, another protein, to form ferritin. Transferrin also carries iron to cells, such as bone marrow, that synthesize hemoglobin and other iron-containing compounds.

Transferrin levels are tested for to determine the cause of anemia, to gauge iron metabolism, and to determine the iron-carrying capacity of the blood. Low transferrin can impair hemoglobin production and lead to anemia. A decreased transferrin level can be due to poor production of transferrin as seen in liver disease or malnutrition or excessive loss of transferrin through the kidneys into the urine in protein-losing disorders such as nephrotic syndrome. Many conditions, including infection and malignancy, can depress transferrin levels.

Transferrin is abnormally high in iron deficiency anemia. A deficiency of plasma transferrin may result in the accumulation of iron in apoferritin or in histiocytes, or it may precipitate in tissue as hemosiderin. Transferrin is also decreased in inflammation. An increase of iron bound to transferrin is found in a hereditary disorder of iron metabolism, hemochromatosis, in which excess iron is deposited in the tissue, especially the liver and the pancreas.

This disorder is associated with bronze skin, cirrhosis, diabetes mellitus, and low plasma transferrin levels.

Atransferrinemia is inherited as an autosomal recessive trait due to mutation of both transferrin genes with a resulting absence of transferrin. It is characterized by anemia and hemosiderosis (iron deposition) in the heart and liver. The iron damage to the heart can lead to heart failure. This disease can be effectively treated by plasma infusions of transferrin.

The analytic methods used for the quantitation of transferrin are immunodiffusion and immunonephelometry. Total iron binding capacity (TIBC) is typically measured along with serum iron to evaluate either iron deficiency or iron overload. The iron concentration divided by TIBC gives the transferrin saturation, which is a more useful indicator of iron status than iron or TIBC alone. In iron deficiency, iron is low, but TIBC is increased, and transferrin saturation becomes very low. In iron overload, iron is high and TIBC is low or normal, causing the transferrin saturation to increase. It is customary to test for transferrin (rather than TIBC) when evaluating nutritional status or liver function. Because it is made in the liver, transferrin is low in liver disease or when there is not enough protein in the diet.⁴²

Hemopexin

The parenchymal cells of the liver synthesize hemopexin, which migrates electrophoretically in the β -globulin region and is an acute-phase reactant. The function of hemopexin is to scavenge the heme released or lost by the turnover of heme proteins such as hemoglobin, which protects the body from the oxidative damage that free heme can cause. Hemopexin binds heme with the highest affinity of any known protein. When free heme (ferroprotoporphyrin IX) is formed during the breakdown of hemoglobin, myoglobin, or catalase, it binds to hemopexin in a 1:1 ratio. The heme-hemopexin complex is carried to the liver, where the complex is destroyed. In this manner, hemopexin preserves the body's iron. Hemopexin also induces intracellular antioxidant activities. Increased concentrations are also found in inflammation, diabetes mellitus, Duchenne-type muscular dystrophy, and some malignancies, especially melanomas. Low hemopexin levels are diagnostic of a hemolytic anemia. Hemopexin can be determined by radial immunodiffusion.⁴³

Lipoproteins

Lipoproteins are complexes of proteins and lipids whose function is to transport cholesterol, triglycerides, and phospholipids in the blood. Lipoproteins are subclassified according to the apoprotein and specific lipid content into chylomicrons, VLDL, intermediate-density lipoproteins (IDL), low-density lipoproteins (LDL) and lipoprotein(a), and HDL. On high-resolution serum protein electrophoresis, HDL migrates between the albumin and α_1 -globulin zone; VLDL migrate at the beginning of

the β -globulin fraction (pre- β); and LDL appear as a separate band in the β -globulin region. For a more detailed discussion of structure, function, and laboratory methods, refer to Chapter 14.

β_2 -Microglobulin

β_2 -Microglobulin (B2M) is the light chain component of the major histocompatibility complex (HLA). This protein is found on the surface of most nucleated cells and is present in high concentrations on lymphocytes. Because of its small size (molecular weight, 11,800), B2M is filtered by the renal glomerulus, but most (>99%) is reabsorbed and catabolized in the proximal tubules. Elevated serum levels are the result of impaired clearance by the kidney or overproduction of the protein that occurs in a number of inflammatory diseases, such as rheumatoid arthritis and systemic lupus erythematosus (SLE). In patients with human immunodeficiency virus (HIV), a high B2M level in the absence of renal failure indicates a large lymphocyte turnover rate, which suggests the virus is killing lymphocytes. B2M may sometimes be seen on HRE but, because of its low concentration, it is usually measured by immunoassay.

Complement

The complement system is one of the natural defense mechanisms that protects the human body from infections. These proteins are synthesized in the liver as single polypeptide chains and circulate in the blood as nonfunctional precursors. Complement C3 is the most abundant complement protein in human serum, with complement C4 being the second. In the classic pathway, activation of these proteins begins when the first complement factor, C1q, binds to an antigen-antibody complex. Each complement protein (C2-C9) is then activated sequentially and can bind to the membrane of the cell to which the antigen-antibody complex is bound, leading to the final result—lysis of the cell. An alternate pathway (properdin pathway) for complement activation exists in which the early components are bypassed and the process begins with C3. This pathway is triggered by different substances (does not require the presence of an antibody); however, the lytic attack on membranes is the same (sequence C5-C9).

Complement is increased in inflammatory states and decreased in malnutrition and hemolytic anemia. Inherited deficiencies of individual complement proteins also have been described. Complements C3 and C4 are the components most frequently measured. Complement C3 is used as a screening test because of its pivotal position in the complement cascade; C3 is consumed by activation of either the classic or alternative pathway. However, C3 levels are not the most sensitive indicators of classic pathway activation, and a decreased complement C4 level is frequently found to be a more sensitive measure of mild classic pathway activation.

Decreased levels of C3 are associated with autoimmune disease, neonatal respiratory distress syndrome, bacteremia, tissue injury, and chronic hepatitis. Complement C3 is important in the pathogenesis of age-related macular degeneration. This finding further underscores the influence of the complement pathway in the pathogenesis of this disease.⁴⁴

Decreased levels of C4 may indicate disseminated intravascular coagulation (DIC), acute glomerular nephritis, chronic hepatitis, and SLE. Increased levels of both C3 and C4 are linked to acute inflammatory disease and tissue inflammation. Methods for measuring C3 and C4 include nephelometric immunoassay and turbidimetry.

Fibrinogen

Fibrinogen is one of the largest proteins in blood plasma. It is synthesized in the liver, and it is classified as a glycoprotein because it has considerable carbohydrate content. On plasma electrophoresis, fibrinogen is seen as a distinct band between the β - and γ -globulins. The function of fibrinogen is to form a fibrin clot when activated by thrombin; therefore, fibrinogen is virtually all removed in the clotting process and is not seen in serum.

Fibrinogen customarily has been determined as clottable protein. Fibrinogen concentration is proportional to the time required to form a clot after the addition of thrombin to citrated plasma. Fibrin split products (degradation products of fibrinogen and fibrin) are determined by immunoassay methods such as radial immunodiffusion, nephelometry, and RIA.

Fibrinogen is one of the acute-phase reactants, a term that refers to proteins that are significantly increased in plasma during the acute phase of the inflammatory process. Fibrinogen levels also rise with pregnancy and the use of oral contraceptives. Decreased values generally reflect extensive coagulation, during which the fibrinogen is consumed.

C-Reactive Protein

C-reactive protein (CRP) is synthesized in the liver and is one of the first acute-phase proteins to rise in response to inflammatory disease. CRP received its name because it precipitates with the C substance, a polysaccharide of pneumococci. CRP rises sharply whenever there is tissue necrosis, whether the damage originates from a pneumococcal infection or some other source. CRP bound to bacteria and fungi promotes the binding of complement, which facilitates their uptake by phagocytes. This protein-coating process to enhance phagocytosis is known as **opsonization**. Inflammation, the process by which the body responds to injury or an infection, has been demonstrated through many studies to be important in atherosclerosis (the fatty deposits that build up in the inner lining of arteries). Atherosclerosis, in addition to being a disease of lipid accumulation, also represents a chronic inflammatory process. Elevated levels of CRP stimulate

the production of tissue factor that initiates coagulation, activates complement, and binds to LDL in the atherosclerotic plaque—evidence that points to a causal relationship between CRP levels and cardiovascular disease. Furthermore, interventions such as weight loss, diet, exercise, and smoking cessation and administration of pharmacologic agents such as statins all lead to both reduced CRP levels and reduced vascular risk. The major factors that promote atherosclerosis—cigarette smoking, hypertension, plaque causing lipoproteins, and hyperglycemia—are well established.⁴⁵ These risk factors contribute to the release of chemicals and the activation of cells involved in the inflammatory process and contribute to the formation of plaque but may also contribute to plaque breaking off the artery wall, resulting in the formation of a blood clot.

The American Heart Association and the Centers for Disease Control and Prevention published a joint scientific statement in 2003 on the use of inflammatory markers in clinical and public health practice. This statement was developed after systematically reviewing the evidence of association between inflammatory markers (mainly CRP) and coronary heart disease and stroke.⁴⁶ Most studies to date have focused on heart disease, but new research shows that having CRP in the high-normal range may also be associated with other diseases such as colon cancer, complications of diabetes, obesity, and the risk of developing type 2 diabetes.⁴⁷ Individuals with CRP levels greater than 3 mg/L have a risk of the development of diabetes 4 to 6 times higher than that of individuals with lower levels of CRP. Part of the link between heart disease and diabetes is due to inflammation.

CRP is not specific but does have value as a general indicator. Normally, there are minimal levels of CRP in blood. A high or increasing amount of CRP suggests an acute infection or inflammation. Although a result above 1 mg/dL is usually considered high for CRP, most infections and inflammations result in CRP levels above 10 mg/dL. In cases of inflammatory rheumatic diseases, such as rheumatoid arthritis and SLE, the CRP test is used to assess the effectiveness of a specific arthritis treatment and monitor periods of disease eruption. However, even in known cases of inflammatory disease, a low CRP level is possible and is not indicative of absence of inflammation. It is significantly elevated in acute rheumatic fever, bacterial infections, myocardial infarctions, rheumatoid arthritis, carcinomatosis, gout, and viral infections. CRP is generally measured by immunologic methods, including nephelometry and EIA. The traditional methods have a sensitivity of approximately 3–5 mg/L.

High-Sensitivity C-Reactive Protein

High-sensitivity CRP (hsCRP) is the same protein but is named for the newer, monoclonal antibody-based test methodologies that can detect CRP at levels below 1 mg/L. The hsCRP test determines risk of cardiovascular disease.

Using the hsCRP assay, levels of less than 1, 1 to 3, and greater than 3 mg/L correspond to low-, moderate-, and high-risk groups for future cardiovascular events.⁴⁸ High levels of hsCRP consistently predict recurrent coronary events in patients with unstable angina and acute myocardial infarction. Higher hsCRP levels also are associated with lower survival rates in these patients. Studies also suggest that higher levels of hsCRP may increase the risk that an artery will reclose after it has been opened with balloon angioplasty. A more detailed discussion of cardiac risk factors is found in Chapter 25.

Immunoglobulins

The immunoglobulins (antibodies [Igs]) are glycoproteins composed of 82%–96% protein and 4%–18% carbohydrate produced by white blood cells, known as B cells, that confer humoral immunity. These proteins consist of two identical heavy (H) and two identical light (L) chains linked by two disulfide bonds that can be in the form of monomers with one unit, dimers with two units, or pentamers with five units. There are five classes of immunoglobulins (IgG, IgA, IgM, IgD, and IgE) or isotypes based on the type of heavy chain they possess. The heavy chains are γ , α , μ , δ , and ϵ , respectively. Each heavy chain has two regions—the constant region and the variable region. The constant region is identical in all antibodies of the same isotype but differs in antibodies of different isotypes. The variable region of the heavy chain differs in antibodies produced by different B cells but is the same for all antibodies produced by a single B cell or B-cell clone. There are two types of light chains—kappa (κ) and lambda (λ) chains. The ratio of κ to λ chains is 2:1, which is sometimes used as a marker of immune abnormalities. Four distinct heavy chain subgroups (subclasses 1, 2, 3, and 4) of IgG were first demonstrated in the 1960s based on their relative concentration in normal serum.

The N-terminal regions of the heavy and light chains exhibit highly variable amino acid composition referred to as VH and VL, respectively. This variable region is involved in antigen binding. In contrast to the variable region, the constant domains of light and heavy chains are referred to as CL and CH, respectively. The constant regions are involved in complement binding, placental passage, and binding to cell membrane. For example, IgG has two γ -type H chains and two identical L chains (either κ or λ).

Multiple genes for the variable regions contain three distinct types of segments encoded in the human genome. For example, the immunoglobulin heavy chain region contains 65 *Variable* (V) genes plus 27 *Diversity* (D) genes and six functional *Joining* (J) genes.⁴⁹ The light chains also possess numerous V and J genes but do not have D genes. By the mechanism of DNA rearrangement of these regional genes, it is possible to generate an

antibody repertoire of more than 10^7 possible combinations. V(D)J recombination is a mechanism of genetic recombination that randomly selects and assembles segments of genes encoding specific proteins, which generates a diverse repertoire of T-cell receptor (TCR) and immunoglobulin (Ig) molecules that are necessary for the recognition of diverse antigens from bacterial, viral, and parasitic invaders and from dysfunctional cells such as tumor cells.⁵⁰

Immunoglobulin class switching (or isotype switching) is a biologic mechanism that changes an antibody from one class to another, for example, from an isotype IgM to an isotype IgG. This process occurs after activation of the B cell, which allows the cell to produce different classes of antibody. Only the constant region of the antibody heavy chain changes during class switching. Because the variable region does not change, class switching does not affect the antigens that are bound by the antibody. Instead, the antibody retains affinity for the same antigens but can interact with different effector molecules (any regulatory molecule that binds to a protein and alters the activity of that protein).⁵¹

The antibody molecule has a “Y” shape, with the tip being the site that binds antigen and, therefore, recognizes specific foreign objects. This region of the antibody is called the Fab (fragment, antigen binding) region. It is composed of one constant and one variable domain from each heavy and light chain of the antibody. The base of the Y is called the Fc (fragment, crystallizable) region and is composed of two heavy chains that contribute two or three constant domains depending on the class of the antibody.⁵² By binding to specific proteins, the Fc region ensures that each antibody generates an appropriate immune response for a given antigen. The Fc region also binds to various cell receptors, such as Fc receptors, and other immune molecules, such as complement proteins. By doing this, it mediates different physiologic effects including opsonization, cell lysis, and degranulation of mast cells, basophils, and eosinophils.⁵³

The immunoglobulins are not synthesized to any extent by the neonate. IgG crosses the placenta; the IgG present in the newborn's serum is that synthesized by the mother. IgM does not cross the placenta but rather is the only immunoglobulin synthesized by the neonate. IgA is generally higher in males than in females; IgM and IgG levels are somewhat higher in females. IgE levels vary with the allergic condition of the individual.

The immunoglobulins have been determined using radial immunodiffusion, nephelometry, turbidimetry, electrochemiluminescent immunoassay (ECLIA), and RIA. Fluorescent immunoassay techniques and immunonephelometric assays also have been used. The automated immunonephelometric method is available for IgG, IgA, and IgM. Monoclonal increases are seen on serum protein electrophoresis patterns as spikes.

IgG is the most abundant class of antibodies found in blood plasma and lymph. Immunoglobulin G antibodies act on bacteria, fungi, viruses, and foreign particles by agglutination, opsonization (the process by which a pathogen is marked for ingestion and destruction by a phagocyte), by activating complement, and by neutralizing toxins. IgG is increased in liver disease, infections, IgG myeloma, parasitic disease, and many rheumatic diseases. Decreased IgG levels are associated with acquired immunodeficiency, an increased susceptibility to infections, hereditary deficiency, protein-losing states, and non-IgG myeloma.

IgA is the main immunoglobulin found in mucous secretions, including tears, saliva, colostrum, vaginal fluid, and secretions from the respiratory and gastrointestinal mucosa. It is also found in small amounts in blood. It exists in two isotypes, IgA1 (90%) and IgA2 (10%). IgA1 is found in serum and made by bone marrow B cells, while IgA2 is made by B cells located in the mucosae. IgA is also classified based upon location—serum IgA and secretory IgA. IgA found in secretions is a specific form known as secretory IgA, polymers of two to four IgA monomers linked by two additional chains, one being the J chain (Joining chain), which is a polypeptide-containing cysteine and completely different structurally from other immunoglobulin chains. Secretory IgA is resistant to enzyme degradation and remains active in the digestive and respiratory tracts to provide antibody protection in body secretions. Increases in the serum IgA are found in liver disease, infections, and autoimmune diseases. Decreased serum concentrations are found in depressed protein synthesis and immunodeficiency.

IgM is the first antibody that appears in response to antigenic stimulation. IgM is present on B cells. Because the J chain is found in pentameric IgM, it is also important as a secretory immunoglobulin. IgM is the naturally occurring antibody, anti-A and anti-B, to red cell antigens, in rheumatoid factors, and are heterophile antibodies. Increased IgM concentration is found in toxoplasmosis, primary biliary cirrhosis, cytomegalovirus, rubella, herpes, syphilis, and various bacterial and fungal diseases. A monoclonal increase is seen in Waldenström's macroglobulinemia as a spike in the vicinity of the late β zone on protein electrophoresis. Decreases are seen in protein-losing conditions and hereditary immunodeficiency.

IgD molecules are present on the surface of most, but not all, B cells early in their development, but little IgD is ever released into the circulation. IgD may help regulate B cell function; however, the function of circulating IgD is largely unknown. Its concentration is increased in infections, liver disease, and connective-tissue disorders.⁵⁴

IgE is produced by B cells and plasma cells and is the immunoglobulin associated with allergic and anaphylac-

tic reactions. In contrast to other immunoglobulins, the concentration of IgE in the circulation is very low. An elevated IgE concentration is not diagnostic of any single condition. Elevated IgE levels are observed in many inflammatory and infectious diseases, including asthma and hay fever. Monoclonal increases are seen in IgE myeloma, a rare disease. Solid-phase displacement RIAs, double-antibody RIAs, solid-phase sandwich RIAs, and nephelometry are all used to measure IgE.⁵⁵

OTHER PROTEINS OF IMPORTANCE

Myoglobin

Myoglobin is a single-chain globular protein of 153 amino acids, containing a heme (iron-containing) prosthetic group. Myoglobin is the primary oxygen-carrying protein (approximately 2% of total muscle protein) found in striated skeletal and cardiac muscle. It can reversibly bind oxygen similarly to the hemoglobin molecule, but myoglobin requires a very low oxygen tension to release the bound oxygen. Most of the myoglobin found in cells is dissolved in the cytoplasm.

As a cardiac biomarker, myoglobin is used in conjunction with troponin to help diagnose or rule out a heart attack. When striated muscle is damaged, myoglobin is released, elevating the blood levels. In an acute myocardial infarction (AMI), this increase is seen within 2–3 hours of onset and reaches peak concentration in 8–12 hours. For the diagnosis of AMI, serum myoglobin should be measured serially. If a repeated myoglobin level doubles within 1–2 hours after the initial value, it is highly diagnostic of an AMI.⁵⁶ Its advantage over other markers is that it turns positive sooner than troponin and is useful in determining patients who would benefit from thrombolytic therapy. Myoglobin is a small molecule freely filtered by the kidneys allowing levels to return to normal in 18–30 hours after the AMI. Because of the speed of appearance and clearance of myoglobin, it also is a useful marker for monitoring the success or failure of reperfusion. Although the diagnostic sensitivity of myoglobin elevations following an AMI has been reported to be between 75% and 100%, myoglobin is not cardiac specific. Elevations are also seen in conditions such as progressive muscular dystrophy and crushing injury in which skeletal muscle is damaged. Myoglobin is toxic to the kidneys and in severe muscle injury, levels of myoglobin may rise very quickly and the kidneys may be damaged by the increased amounts. Renal failure can also elevate the level of serum myoglobin. Table 10-4 lists some of the causes of a myoglobin elevation.

Latex agglutination, ELISA, immunonephelometry, ECLIA, and fluoroimmunoassays for myoglobin are used in the clinical laboratory for myoglobin measurement. A qualitative spot test using immunochromatography is also available.

TABLE 10-4 CAUSES OF MYOGLOBIN ELEVATIONS

| |
|-----------------------------|
| Acute myocardial infarction |
| Angina without infarction |
| Rhabdomyolysis |
| Muscle trauma |
| Renal failure |
| Myopathies |
| Vigorous exercise |
| Intramuscular injections |
| Open heart surgery |
| Seizures (tonic-clonic) |
| Electric shock |
| Arterial thrombosis |
| Certain toxins |

Troponin (cTn)

Cardiac troponin (cTn) has established itself firmly as the “gold standard” in the diagnosis of ACS. cTn should be measured in all patients presenting with symptoms suggestive of ACS, in conjunction with physical examination and ECG.⁵⁷ Because of the specificity of cTn for myocardial damage, a single cTn above the decision limit, along with clinical evidence, is indicative of myocardial injury.

The American College of Cardiology and the European Society of Cardiology in conjunction with the National Academy of Clinical Biochemistry recommend the use of a decision limit for myocardial injury at the 99th percentile of the reference population for cTnT and cTnI.⁵⁶ Although it is acceptable to use the manufacturer’s decision limits, each laboratory should, if possible, define its own cutoff value based on its reference population. Furthermore, assays should ideally not exceed a total imprecision of 10% at the diagnostic cutoff. TnI or a TnT can be performed by itself or along with other cardiac biomarkers, such as creatine kinase (CK), CK-MB, and myoglobin. TnI and TnT tests have begun to replace CK and CK-MB tests because they are more specific for heart injury (versus skeletal muscle injury) and are elevated for a longer period of time.⁵⁷ If CK, CK-MB, and myoglobin concentrations are normal but troponin levels are increased, then it is likely that either a lesser degree of heart injury is present or that the injury took place more than 24 hours in the past. If the first troponin performed is normal but subsequent (6- and 12-hour samples) troponin tests are increased, then the heart injury likely occurred within a couple of hours prior to the first test and had not had time to increase. When a CK test is elevated but a CK-MB (which is more heart specific than CK) and

troponin test are normal, then it is likely that whatever symptoms are present are due to another cause, such as skeletal muscle injury.

Cardiac troponins can be measured on serum or heparinized plasma by ELISA or immunoenzymometric assays using two monoclonal antibodies directed against different epitopes (antigenic determinants) on the protein. The reference interval for cTnT is <0.1 ng/mL (mg/L). The cutoff concentration for cTnI immunoassays varies 0.1–3.1 ng/mL (mg/L) (see Chapter 25 for a detailed discussion of cardiac markers).

Brain Natriuretic Peptide and N-Terminal–Brain Natriuretic Peptide

The natriuretic peptides are a family of structurally related hormones that include atrial natriuretic peptide (ANP), B-type (or brain) natriuretic peptide (BNP), C-type natriuretic peptide (CNP), and dendroaspis natriuretic peptide (DNP). B-type natriuretic peptides are produced initially as a 134–amino acid pre pro peptide, which is cleaved into proBNP108, a precursor molecule stored myocytes. Upon release, proBNP108 is cleaved by the protease, furin, into N-terminal (NT)-proBNP (a 76–amino acid biologically inert portion), and BNP (which is biologically active). NT-proBNP and BNP are found in largest concentration in the left ventricular myocardium but are also detectable in atrial tissue as well as in the myocardium of the right ventricle.

In the past few years, BNP has become a popular marker for congestive heart failure.⁵⁸ The natriuretic peptides are neurohormones that affect body fluid homeostasis (through natriuresis and diuresis) and blood pressure (through decreased angiotensin II, norepinephrine synthesis), both major components in the pathology of congestive heart failure.

Methods for BNP and NT-proBNP include immunoradiometric assay, microparticle enzyme immunoassay, and ECLIA.

Fibronectin

Fibronectin is a glycoprotein composed of two nearly identical subunits. Although fibronectin is the product of a single gene, the resulting protein can exist in multiple forms due to splicing of a single pre-mRNA. The variants demonstrate a wide variety of cellular interactions, including roles in cell adhesion, tissue differentiation, growth, and wound healing. These proteins are found in plasma and on cell surfaces and can be synthesized by the liver hepatocytes, endothelial cells, peritoneal macrophages, and fibroblasts. Plasma fibronectin has been used as a nutritional marker.

Fetal fibronectin (fFN) is a glycoprotein used to help predict the short-term risk of premature delivery. fFN is produced at the boundary between the amniotic sac and

the decidua (the lining of the uterus) and functions to maintain the adherence of the placenta to the uterus. Fetal fibronectin is thought to help maintain the integrity of this boundary. fFN is normally detectable in amniotic fluid and placental tissue during early pregnancy, and in a normal pregnancy it is no longer detectable after 24 weeks. fFN should not be detectable between 22 and 36 weeks of pregnancy. Elevated levels during this period reflect a disturbance at the uteroplacental junction and have been associated with an increased risk of preterm labor and delivery.

Adiponectin

Adiponectin is a 247–amino acid fat hormone composed of an N-terminal collagen-like domain and a C-terminal globular domain produced by adipocytes. Adiponectin exists in trimers, hexamers, and multimers in the blood. Recent studies have shown an inverse correlation between body mass index (BMI) and adiponectin values. Lower levels of adiponectin correlate with an increased risk of heart disease, type 2 diabetes, and metabolic syndrome, and obesity.⁵⁹

β -Trace Protein

β -Trace protein (synonym prostaglandin D synthase) is a 168–amino acid, low-molecular-mass protein in the lipocalin protein family. Recently, it was verified that β -trace protein (BTP) was established as an accurate marker of CSF leakage. It has also been reported recently as a potential marker in detecting impaired renal function, although no more sensitive than cystatin C.⁶⁰ BTP serum values correlate significantly with serum cystatin C, glomerular filtration rate, and urine microproteins, but BTP is not a diagnostic efficient test for glomerular filtration rate. The benefit of BTP measurement could be findings that β -trace protein concentrations, in contrast to cystatin C concentrations, are not influenced by glucocorticoid therapy. BTP might be a promising marker in the diagnosis of perilymphatic fluid fistulas.

Cross-Linked C-Telopeptides

Cross-linked C-telopeptides (CTX) are proteolytic fragments of collagen I formed during bone resorption (turnover). CTX is a biochemical marker of bone resorption that can be detected in serum and urine. The bone turnover rate increases at menopause. After an effective 3–6 months of antiresorptive therapy, CTX concentrations drop 35%–55% from baseline levels. Limitations of measuring CTX values are (1) the need to establish a baseline level, (2) that CTX levels may vary due to a patient's diet, exercise, time of day, etc., and (3) it cannot replace bone mineral density (BMD) to diagnose osteoporosis.

The CTX test is most useful for monitoring the response to antiresorptive therapy; it is noninvasive and can be repeated often. ECLIA technology is used to measure CTX in the laboratory. It can also be automated.

Cystatin C

Cystatin C, a low molecular mass protein with 120 amino acids is a cysteine proteinase inhibitor. It is produced and destroyed at a constant rate making it a recently proposed new marker for the early assessment of changes to the glomerular filtration rate. Cystatin C is freely filtered by the glomerulus and almost completely reabsorbed and catabolized by the proximal tubular cells. Cystatin C has been recently proposed as a new sensitive endogenous serum marker for in the glomerular filtration rate. When the rate at which the fluid filtrate is formed is reduced, indicating decreased kidney function, blood levels of substances removed by them (such as cystatin C) increase and are an indication of kidney function. Cystatin C levels are not affected by muscle mass, gender, age, or race unlike creatinine, nor are they generally affected by most drugs, infections, diet, or inflammation. Cystatin C may be used as an alternative to creatinine and creatinine clearance to screen for and monitor kidney dysfunction. While there are growing data and literature supporting the use of cystatin C, there is still a degree of uncertainty about when and how it should be used.⁶¹ It may be especially useful in those cases where creatinine measurement is not appropriate, such as in patients with cirrhosis, obesity, or malnutrition or who have a reduced muscle mass. In addition to kidney dysfunction, it has been associated with an increased risk of cardiovascular disease and heart failure in the elderly.⁷² Cystatin C levels require particle-enhanced immunoturbidimetry or immunonephelometric laboratory methods for their measurement. These methods have been FDA approved and can also be automated.

Amyloid

Amyloid is insoluble fibrous protein aggregates formed due to an alteration in their secondary structure known as β pleated sheets. Amyloid characteristically stains with Congo red. Amyloidosis refers to a variety of conditions in which amyloid proteins are abnormally deposited in organs and/or tissues. Amyloid fibrils may infiltrate many organs, including the heart and blood vessels, brain and peripheral nerves, kidneys, liver, spleen, and intestines, causing localized or widespread organ failure. Amyloidosis can be inherited or due to different diseases, for example, chronic infections, malignancies, and rheumatologic disorders, which cause overabundant or abnormal protein production.

Amyloid β 42 (A β 42) and Tau protein tests are not currently part of a typical patient assessment but can be used as supplemental tests to help differentiate a diagnosis

of Alzheimer disease from other forms of dementia. Abnormal forms of Tau, a brain phosphoprotein, make up part of the structure of neurofibrillary tangles (twisted protein fragments that clog nerve cells), while A β 42, which is formed from β amyloid precursor protein, is associated with the creation of senile plaques. Tau protein and A β 42 tests are performed primarily in research settings (the specimen used is CSF). In a symptomatic patient, low A β 42 along with high Tau reflects an increased likelihood of Alzheimer disease, but it does not mean that the person definitely has Alzheimer disease. If a patient does not have abnormal levels of these proteins, then the dementia is more likely due to a cause other than Alzheimer disease.

TOTAL PROTEIN ABNORMALITIES

The total protein test is a rough measure of all of the proteins in the plasma. Total protein measurements can reflect nutritional status, kidney disease, liver disease, and many other conditions. If total protein is abnormal, further tests must be performed to identify which protein fraction is abnormal, so that a specific diagnosis can be made.

Hypoproteinemia

Hypoproteinemia, a total protein level less than the reference interval, occurs in any condition where a negative

nitrogen balance exists. One cause of a low level of plasma proteins is excessive loss. Plasma proteins can be lost by excretion in the urine in renal disease; leakage into the gastrointestinal tract in inflammation of the digestive system; and the loss of blood in open wounds, internal bleeding, or extensive burns. Another circumstance producing hypoproteinemia is decreased intake either because of malnutrition or through intestinal malabsorption as seen in sprue. Without adequate dietary intake of proteins, there is a deficiency of certain essential amino acids and protein synthesis is impaired. A decrease in serum proteins as a result of decreased synthesis is also seen in liver disease (site of all nonimmune protein synthesis) or in inherited immunodeficiency disorders, in which antibody production is diminished. Additionally, hypoproteinemia may result from accelerated catabolism of proteins, such as occurs in burns, trauma, or other injuries.

Hyperproteinemia

Hyperproteinemia, an increase in total plasma proteins, is not an actual disease state but is the result of the underlying cause, dehydration. When excess water is lost from the vascular system, the proteins, because of their size, remain within the blood vessels. Although the absolute quantity of proteins remains unchanged, the concentration is elevated due to a decreased volume of

TABLE 10-5 PROTEIN LEVELS IN SELECTED DISEASE STATES

| TOTAL PROTEIN | ALBUMIN | GLOBULIN | DISEASE |
|---------------|---------|----------|--|
| N, ↓ | ↓ | ↑ | Hepatic damage <ul style="list-style-type: none"> • Cirrhosis β-γ bridging • Hepatitis ↑ γ-globulins • Obstructive jaundice ↑ α_2-, β-globulins |
| | | | Burns, trauma |
| | | | Infections <ul style="list-style-type: none"> • Acute ↑ α_1-, α_2-globulins • Chronic ↑ α_1-, α_2-, γ-globulins |
| ↓ | ↓ | N | Malabsorption |
| | | | Inadequate diet |
| | | | Nephrotic syndrome ↑ α_2 -, β -globulins; ↓ γ -globulins |
| ↓ | N | ↓ | Immunodeficiency syndromes |
| ↓ | ↓ | ↓ | Salt retention syndrome |
| ↑ | ↑ | ↑ | Dehydration |
| ↑ | N | ↑ | Multiple myeloma |
| | | | Monoclonal and polyclonal gammopathies |

↑, increased; ↓, decreased; N, normal levels.

CASE STUDY 10-3

A 76-year-old woman was admitted to the hospital with gangrene of her right toe. She was disoriented and had difficulty finding the right words to express herself. On evaluation, it was revealed she lived alone and was responsible for her own cooking. A daughter who lived in the area said her mother was a poor eater, even with much encouragement. An ECG, performed on admission, showed possible ectopic rhythm with occasional premature supraventricular contractions. The cardiologist suspected a possible inferior myocardial

infarction of undetermined age. Laboratory results are shown in the following chart.

Questions

1. In this patient, what is the clinical value of the troponin I measurements?
2. What is a possible explanation for the elevated myoglobin?
3. What condition is indicated by the low prealbumin value?

CASE STUDY 10-3 LABORATORY RESULTS

| DAY 1 | RESULTS | REFERENCE RANGE |
|-------------------------------|----------------|------------------------------|
| CK total | 187 U/L | 40–325 U/L |
| CK-MB mass | 6 μ g/L | <8 μ g/L |
| Troponin I | 16.3 μ g/L | 0–2 μ g/L |
| NT-proBNP | 60 pmol/L | 2-50 pmol/L (generic cutoff) |
| Prealbumin | 15 mg/dL | 17–42 mg/dL |
| Albumin | 2.7 g/dL | 3.7–4.9 g/dL |
| REPEAT (5 HOURS LATER) | | |
| CK total | 180 U/L | |
| CK-MB mass | 5.4 μ g/L | |
| Troponin I | 17.5 μ g/L | |
| NT-proBNP | 100.5 pmol/L | |
| DAY 2 | | |
| CK total | 177 U/L | |
| CK-MB mass | 4.5 μ g/L | |
| Troponin I | 13.7 μ g/L | |
| NT-proBNP | 143 pmol/L | |
| Myoglobin | <500 μ g/L | (<76) |

solvent water. Dehydration results from a variety of conditions, including vomiting, diarrhea, excessive sweating, diabetic acidosis, and hypoaldosteronism.

In addition to dehydration, hyperproteinemia may be a result of excessive production, primarily of the γ -globulins. Some disorders are characterized by the appearance of a monoclonal protein or paraprotein in the serum and often in the urine as well. This protein is an intact immunoglobulin molecule, or occasionally, κ or λ light chains only. The most common disorder is multiple myeloma, in which the neoplastic plasma cells proliferate in the bone marrow. The paraprotein in this case is usually IgG, IgA, or κ or λ light chains. IgD and IgE paraproteins

rarely occur. Paraproteins in multiple myeloma may reach a serum concentration of several grams per deciliter. IgM paraprotein is found in patients with Waldenström's macroglobulinemia, a rare type of slow-growing, non-Hodgkin lymphoma. Many disorders, including chronic inflammatory states, collagen vascular disorders, and other neoplasms, may be associated with paraproteins. Polyclonal increases in immunoglobulins, which would be represented by increases in both κ or λ chains, are seen in the serum and urine in many chronic diseases.

Table 10-5 summarizes the disease states affecting total protein levels with the relative changes in the albumin and globulin fractions.

METHODS OF ANALYSIS

Total Nitrogen

A total nitrogen determination measures all chemically bound nitrogen in the sample. The method can be applied to various biologic samples, including plasma and urine. In plasma, both the total protein and nonprotein nitrogenous compounds, such as urea and creatinine, are measured. The analysis of total nitrogen level is useful in assessing nitrogen balance. Monitoring the nitrogen nutritional status is particularly important in patients receiving total parenteral nutrition, such as individuals with neurologic injuries who are sustained on intravenous fluids for an extended period.

The method for total nitrogen analysis uses chemiluminescence.⁶² The sample, in the presence of oxygen, is heated to a high temperature ($1100 \pm 20^\circ\text{C}$). Any chemically bound nitrogen is oxidized to nitric oxide. The nitric oxide is then mixed with ozone (O_3) to form an excited nitrogen dioxide molecule (NO_2). When this molecule decays to the ground state, it emits chemiluminescent light, which is detected, amplified, and converted to an electronic signal, proportional to the total nitrogen content in sample. This chemiluminescence signal is compared with that of a standard for quantitation.

Total Proteins

The specimen most often used to determine the total protein is serum rather than plasma. A fasting specimen is not needed. Interferences in some of the methods occur in the presence of lipemia; hemolysis falsely elevates the total protein result because of the release of RBC proteins into the serum.

The reference interval for serum total protein is 6.5–8.3 g/dL (65–83 g/L) for ambulatory adults. In the recumbent position, the serum total protein concentration is 6.0–7.8 g/dL (60–78 g/L). This lower normal range is a result of shifts in water distribution in the extracellular compartments. The total protein concentration is lower at birth, reaching adult levels by age 3 years. There is a slight

decrease with age. Lower total protein levels are also seen in pregnancy. Methods for the determination of total protein are described below and summarized in Table 10-6.

Kjeldahl

The classic method for quantitation of total protein is the Kjeldahl method, which determines nitrogen. This method is not used in the clinical laboratory because it is time consuming and too tedious for routine use. In this method, an average of 16% nitrogen mass in protein is assumed to calculate the protein concentration. The actual nitrogen content of serum proteins varies from 15.1% to 16.8%. Therefore, error is introduced if a protein standard (calibrated with the Kjeldahl method) is used that differs in composition from the serum specimen to be analyzed, because the percentage of nitrogen will not be the same. The method also requires the assumption that no proteins of significant concentration in the unknown specimen are lost in the precipitation step.

The serum proteins are precipitated with an organic acid such as TCA or tungstic acid. The nonprotein nitrogen is removed with the supernatant. The protein pellet is digested in H_2SO_4 with heat ($340\text{--}360^\circ\text{C}$) and a catalyst, such as cupric sulfate, to speed the reaction. Potassium sulfate is also introduced to increase the boiling point to improve the efficiency of digestion. The H_2SO_4 oxidizes the C, H, and S in protein to CO_2 , CO , H_2O , and SO_2 . The nitrogen in the protein is converted to ammonium bisulfite (NH_4HSO_4), which is then measured by adding alkali and distilling the ammonia into a standard boric acid solution. The ammonium borate ($\text{NH}_4\text{H}_2\text{BO}_3$) formed is then titrated with a standard solution of HCL to determine the amount of nitrogen in the original protein solution.

Refractometry

Refractometry is useful when a rapid, easy method that requires a small volume of serum is needed. The velocity of light is changed as it passes the boundary between two transparent layers (air and water), causing the light to be refracted (bent). When a solute is added to the

TABLE 10-6 TOTAL PROTEIN METHODS

| METHOD | PRINCIPLE | COMMENT |
|---------------|---|--|
| Kjeldahl | Digestion of protein; measurement of nitrogen content | Reference method; assume average nitrogen content of 16% |
| Refractometry | Measurement of refractive index due to solutes in serum | Rapid and simple; assume nonprotein solids are present in same concentration as in the calibrating serum |
| Biuret | Formation of violet-colored chelate between Cu^{2+} ions and peptide bonds | Routine method; requires at least two peptide bonds and an alkaline medium |
| Dye binding | Protein binds to dye and causes a spectral shift in the absorbance maximum of the dye | Research use |

water, the refractive index at 20°C of 1.330 for pure water is increased by an amount proportional to the concentration of the solute in solution. Because the majority of the solids dissolved in serum are protein, the refractive index reflects the concentration of protein. Although it is practical for many purposes to estimate total serum protein by refractometric methods, certain points should be kept in mind.⁶³

In addition to protein, serum contains several nonprotein solids, such as electrolytes, urea, and glucose, that contribute to the refractive index of serum. Therefore, the built-in scale in the refractometer must be calibrated with a serum of a known protein concentration that also has the nonprotein constituents present. An assumption is made that the test samples contain these other solutes in nearly the same concentration as in the calibrating serum. Error is introduced when these substances are increased or when the sample is icteric, lipemic, or hemolyzed. The refractive index is also temperature dependent, and some refractometers incorporate a built-in temperature correction.

The total protein is commonly measured with a hand-held refractometer. A drop of serum is placed by capillary action between a coverglass and the prism. The refractometer is held so that light is refracted through the serum layer. The refracted rays cause part of the field of view to be light, producing a point at which there is a sharp line between light and dark. The number of grams per liter at this line on the internal scale is read. The temperature is corrected in the TS meter (American Optical Corp, Scientific Instruments Division; Buffalo, N.Y.) by a liquid crystal system.

Biuret

The biuret procedure is the most widely used method and the one recommended by the International Federation of Clinical Chemistry expert panel for the determination of total protein. In this reaction, cupric ions (Cu^{2+}) complex with the groups involved in the peptide bond. In an alkaline medium and in the presence of at least two peptide bonds, a violet-colored chelate (a bound metal in complex) is formed. The reagent also contains sodium potassium tartrate, to complex cupric ions to prevent their precipitation in the alkaline solution, and potassium iodide, which acts as an antioxidant. The absorbance of the colored chelate formed is measured at 540 nm. When small peptides react, the color of the chelate produced has a different shade than that seen with larger peptides. The color varies from a pink to a reddish violet. The color that is formed is proportional to the number of peptide bonds present and reflects the total protein level. However, in the presence of abnormally small proteins, such as those seen in multiple myeloma, the C-protein concentration is underestimated due to the lighter shade of color produced. Lipemia in the sample is an interferent.⁶⁴

In addition to the NHCO group that occurs in the peptide bond, cupric ions will react with any compound that has two or more of the following groups: NHCH_2 and NHCS . The method was named because a substance called biuret ($\text{NH}_2\text{CONHCONH}_2$) reacted with cupric ions in the same manner. There must be a minimum of two of the reactive groups; therefore, amino acids and dipeptides will not react.

Dye Binding

The dye-binding methods are based on the ability of most proteins in serum to bind dyes, although the affinity with which they bind may vary. Bromphenol blue, Ponceau S, amido black 10B, lissamine green, and Coomassie brilliant blue have been used to stain protein bands after electrophoresis. A dye-binding method, Coomassie brilliant blue 250, relies on the binding of Coomassie brilliant blue 250 to protein causing a shift in the absorbance maximum of the dye from 465 to 595 nm. The increase in absorbance at 595 is used to determine the protein concentration. Although the method is simple and fast, the unequal dye-binding responses of individual proteins require caution when applying this test to the complex mixture of protein found in serum.

Fractionation, Identification, and Quantitation of Specific Proteins

In the assay of total serum proteins, useful diagnostic information can be obtained by determining the albumin fraction and the globulins. A reversal or significant change in the ratio of albumin and total globulin, the albumin/globulin (A/G) ratio, is found in diseases of the kidney and liver. To determine the A/G ratio, total protein and albumin are measured and globulins are calculated by subtracting the albumin from the total protein (total protein/albumin = globulins). The following are methods for measuring protein fractions.

Salt Fractionation

Fractionation of proteins is done using precipitation. Globulins are separated from albumin by salting out, using sodium salt to cause precipitation of the globulins. The albumin that remains in solution in the supernatant is then measured by any of the routine total protein methods. Salting out is not used today because direct methods are available that react specifically with albumin in a mixture of proteins.

Albumin

The most widely used methods for determining albumin are dye-binding procedures. The pH of the solution is adjusted so that albumin is positively charged. The albumin is attracted to and binds to an anionic dye by electrostatic forces. When bound to albumin, the dye has a different absorption maximum than the free dye. The amount of

albumin is calculated by measurement of the absorbance of the albumin–dye complex. A variety of dyes have been used, including methyl orange, 2,4'-hydroxy-azobenzenebenzoic acid (HABA), bromocresol green (BCG), and bromocresol purple (BCP). Methyl orange is nonspecific for albumin; β -lipoproteins and some α_1 - and α_2 -globulins also will bind to this dye. HABA has a low sensitivity but is more specific for albumin. In addition, several compounds, such as salicylates, penicillin, conjugated bilirubin, and sulfonamides, interfere with the binding of albumin to HABA. BCG is not affected by interfering substances such as bilirubin and salicylates; however, hemoglobin binds to BCG. For every 100 mg/dL of hemoglobin, albumin is increased by 0.1 g/dL.⁶⁵ BCG has been reported to overestimate low albumin values in patients when the low albumin level was accompanied by an elevated α -globulin fraction, such as occurs in nephrotic syndrome or end-stage renal disease.⁶⁶ It was found that the α -globulins react with BCG, giving a color intensity that is approximately one third of the reaction seen with albumin. The specificity of the reaction for albumin can be improved by taking absorbance readings within a standardized short interval (<5 minutes due to α -globulins contributing significantly to the absorbance at long incubation) after mixing.⁶⁷

BCP is an alternate dye used for albumin determinations, binding specifically to albumin. BCP is not subject to most interferences, is precise, and exhibits excellent correlation with immunodiffusion reference methods. The BCP method, however, is not without its disadvantages. In patients with renal insufficiency, the BCP method underestimates the serum albumin.⁶⁸ The serum of these patients appears to contain either a substance tightly bound to albumin or a structurally altered albumin that affects the binding of BCP. Bilirubin interferes with BCP binding to albumin while BCG binding is

unaffected. Today, both the BCG and BCP methods are used to quantitate albumin with BCP commonly preferred. Albumin methods are summarized in Table 10-7.

Total Globulins

Another approach to fractionation of proteins is the measurement of total globulins. Albumin can then be calculated by subtraction of the globulin from total protein. The total globulin level in serum is determined by a direct colorimetric method using glyoxylic acid. Glyoxylic acid, in the presence of Cu^{2+} and in an acid medium (acetic acid and H_2SO_4), condenses with tryptophan found in globulins to produce a purple color. Albumin has approximately 0.2% tryptophan, compared with 2%–3% for the serum globulins. When calibrated using a serum of known albumin and globulin concentrations, the total globulins can be determined. The measurement of globulins based on their tryptophan content has never come into common use because of the ease and simplicity of the dye-binding methods for albumin.

Electrophoresis

When an abnormality is found in the total protein or albumin, an electrophoresis is usually performed. If an abnormality is seen on the electrophoretic pattern, an analysis of the individual proteins within the area of abnormality is made.

Electrophoresis separates proteins on the basis of their electric charge densities. Protein, when placed in an electric current, will move according to their charge density, which is determined by the pH of a surrounding buffer. At a pH greater than the pI, the protein is negatively charged ($\text{AA}\sim\text{COO}^-$) and vice versa ($\text{AA}\sim\text{NH}_3^+$). The direction of movement depends on whether the charge is positive or negative; cations (positive net charge) migrate to the cathode (negative terminal), whereas anions (negative net charge) migrate to the anode (positive terminal).

TABLE 10-7 ALBUMIN METHODS

| METHOD | PRINCIPLE | COMMENT |
|---|--|---|
| Salt precipitation | Globulins are precipitated in high salt concentrations; albumin in supernatant is quantitated by biuret reaction | Labor intensive |
| DYE BINDING | | |
| Methyl orange | Albumin binds to dye; causes shift in absorption maximum | Nonspecific for albumin |
| HABA [2,4'-hydroxyazobenzene)-benzoic acid] | Albumin binds to dye; causes shift in absorption maximum | Many interferences (salicylates, bilirubin) |
| BCG (bromocresol green) | Albumin binds to dye; causes shift in absorption maximum | Sensitive; overestimates low albumin levels; most commonly used dye |
| BCP (bromocresol purple) | Albumin binds to dye; causes shift in absorption maximum | Specific, sensitive, precise |
| Electrophoresis | Proteins separated based on electric charge | Accurate; gives overview of relative changes in different protein fractions |

The speed of the migration can be estimated from the difference between the pI of the protein and the pH of the buffer. The more the pH of the buffer differs from the pI, the greater is the magnitude of the net charge of that protein and the faster it will move in the electric field. In addition to the charge density, the velocity of the movement also depends on the electric field strength, size, and shape of the molecule; temperature and on the characteristics of the buffer such as pH, qualitative composition, and ionic

strength (Fig. 10-7). The specific electrophoretic mobility (μ of a protein) is calculated by:

$$\mu = \frac{(s / t)}{F} \quad \text{(Eq. 10-2)}$$

where

s is distance traveled in cm, t is time of migration in seconds, and F is field strength in $V\text{ cm}^{-1}$.

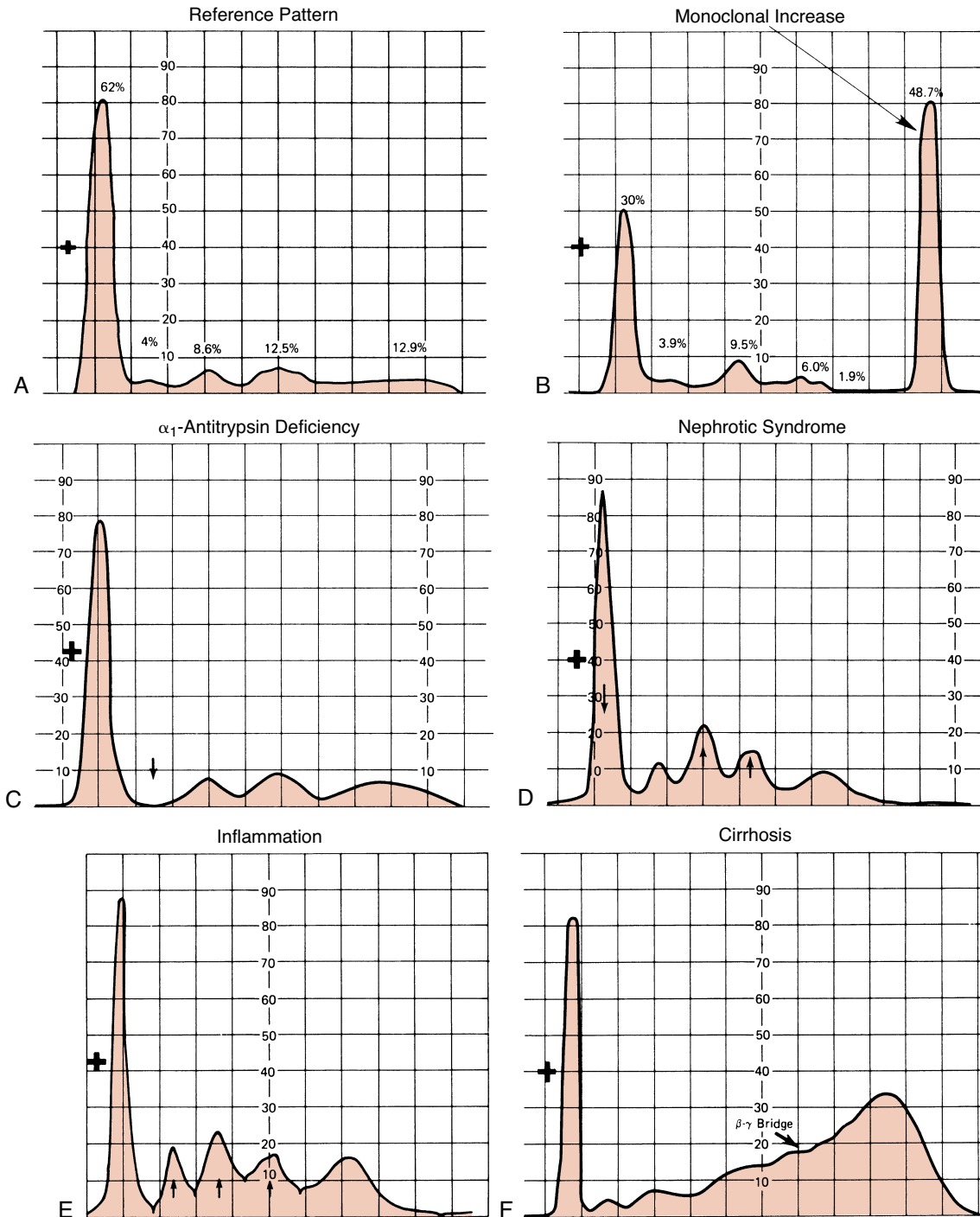

FIGURE 10-7. Schematic of amino acid electrophoresis.

CASE STUDY 10-4

A 60-year-old woman with a history of rheumatoid arthritis, smoking of 60 packs/year, chronic obstructive pulmonary disease, and treated hypertension underwent a screening colonoscopy and then felt poorly for a week. She saw her family physician, who referred her to her local hospital clinic, where they did the tests listed in the chart. Her creatinine and BUN levels 2 weeks after the colonoscopy were 4.6 and 46 mg/dL, respectively; a baseline (from previous physician's office testing) serum creatinine was 0.9 mg/dL. Laboratory results are shown in the chart.

Questions

1. What disease state is the most likely explanation for the patient's laboratory results?
2. What is the significance of the polyclonal hypergammaglobulinemia with no monoclonal immunoglobulin spike identified on SPE?
3. Is the patient's urine protein normal?
4. Describe the immunofixation electrophoresis method.

CASE STUDY 10-4 LABORATORY RESULTS

| TEST | RESULTS | REFERENCE RANGE |
|--|-------------|------------------|
| Creatinine | 3.7 mg/dL | Women <1.2 mg/dL |
| BUN | 35 mg/dL | 5–20 mg/dL |
| Creatinine clearance | 12.5 mL/min | 75–115 mL/min |
| C3 | 148 mg/dL | 80–200 mg/dL |
| C4 | 19 mg/dL | 15–80 mg/dL |
| Albumin | 4.1 g/dL | 3.5–5.0 g/dL |
| Calcium | 9 mg/dL | 8–10 mg/dL |
| Phosphorous | 4.6 mg/dL | 2.5–4.5 mg/dL |
| Cryoglobulin screen | Negative | |
| Serum protein electrophoresis—polyclonal hypergammaglobulinemia with no monoclonal immunoglobulin spike identified | | |
| Urine protein electrophoresis—protein 15.9 mg/dL with normal immunofixation electrophoresis | | |
| Urine sediment—no RBCs, 4–8 WBCs/hpf, granular and hyaline casts | | |

Cellulose acetate or agarose gel is the support media used in today's laboratories. Historically, electrophoresis using an aqueous medium was called *moving boundary electrophoresis*. Later, paper was used as a solid medium in the process known as *zone electrophoresis*.

Serum Protein Electrophoresis

In the standard method for serum protein electrophoresis (SPE), serum samples are applied close to the cathode end of a support medium that is saturated with an alkaline buffer (pH 8.6). The support medium is connected to two electrodes and a current is passed through the medium to separate the proteins. All major serum proteins carry a net negative charge at pH 8.6 and migrate toward the anode. Using standard SPE methods, serum proteins appear in five bands: albumin travels farthest to the anode, followed by α_1 -globulins, α_2 -globulins, β -globulins, and γ -globulins, in that order. The width of the band of proteins in a fraction depends on the number of proteins present in that fraction. Homogeneous protein gives a narrow band.

After separation, the protein fractions are fixed by immersing the support medium in an acid solution (e.g., acetic acid) to denature the proteins and immobilize them on the support medium. In the next step, the proteins are stained. A variety of dyes have been used, including Ponceau S, Amido black, and Coomassie blue. The proteins appear as bands on the support medium. Typical cellulose acetate electrophoretic patterns are shown in Figures 10-8A and 10-8B shows the patterns obtained using agarose gel as the support medium.

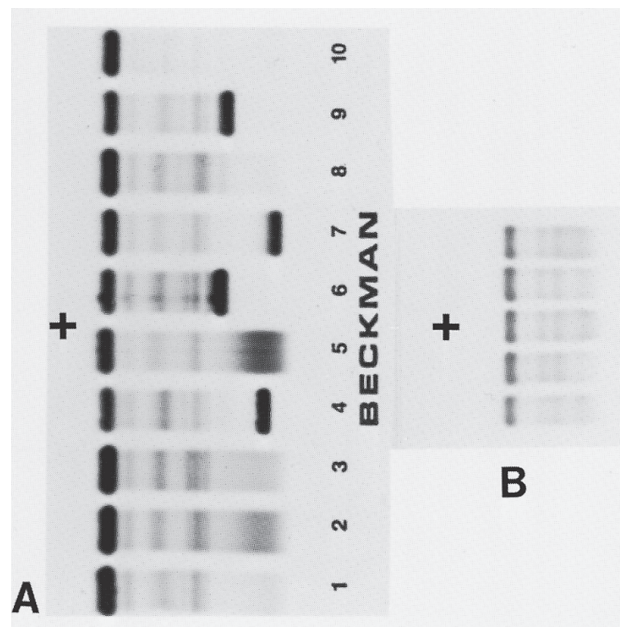

FIGURE 10-8. Serum protein electrophoretic patterns on agarose and cellulose acetate. **(A)** Agarose gel—note the monoclonal γ -globulin. **(B)** Cellulose acetate. (Courtesy of Department of Laboratory Medicine, The University of Texas M.D. Anderson Hospital, Drs. Liu, Fritsche, and Trujillo and Ms. McClure, Supervisor.)

Visual inspection of the membrane can be done, but usually the cleared transparent medium is placed in a scanning densitometer for reading. Reflectance measurements also may be made on the uncleared membranes. The pattern on the membrane moves past a slit

through which light is transmitted to a phototube to record the absorbance of the dye that is bound to each protein fraction. This absorbance is normally recorded on a strip-chart recorder to obtain a pattern of the fractions (Fig. 10-9).

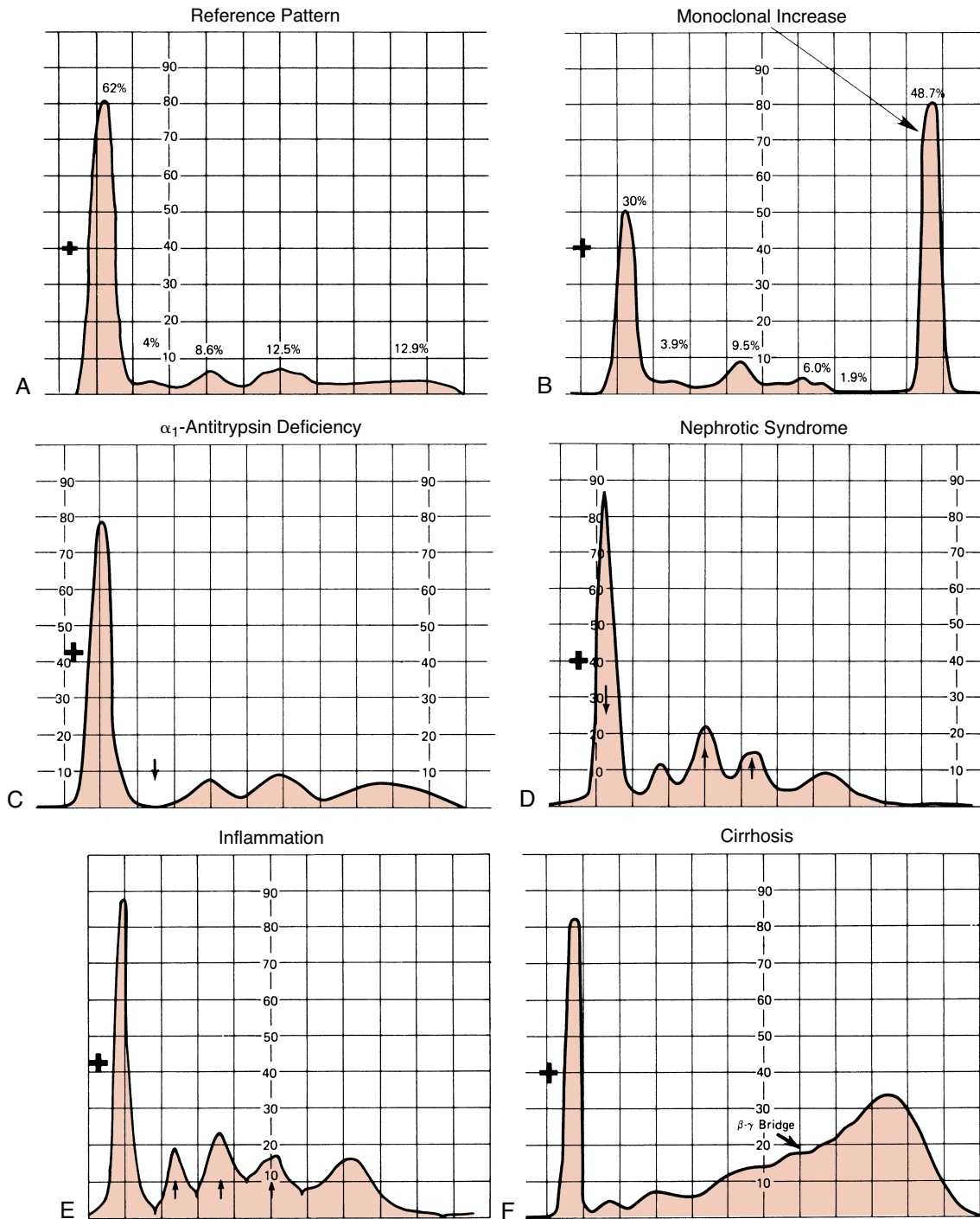

FIGURE 10-9. Selected densitometric patterns of protein electrophoresis. Albumin is at the anodal (+) end followed by α_1 -, α_2 -, β -, and γ -globulin fractions. Arrows indicate decrease or increase in fractions. **(A)** Reference pattern (agarose). **(B)** Monoclonal increase in γ area (agarose). **(C)** α_1 -Antitrypsin deficiency (cellulose acetate). **(D)** Nephrotic syndrome (cellulose acetate). **(E)** Inflammation (cellulose acetate). **(F)** Cirrhosis (cellulose acetate). (A and B are courtesy of Drs. Liu and Fritsche and Jose Trujillo, Director, and Ms. McClure of the Department of Laboratory Medicine, The University of Texas M.D. Anderson Hospital. Others are courtesy of Dr. Wu of the Hermann Hospital Laboratory/The University of Texas Medical School.)

Many scanning densitometers compute the area under the absorbance curve for each band and the percentage of total dye that appears in each fraction. The concentration is then calculated as a percentage of the total protein that was determined by one of the protein methods, such as the biuret procedure.

The computation also may be made by cutting out the small bands from the membrane and eluting the dye from each band in 0.1 mol/L NaOH. The absorbances are added to obtain the total absorbance, and the percentage of the total absorbance found in each fraction is then calculated.

A reference serum control is processed with each electrophoretic run (Figure 10-9A). Reference values for each fraction are as follows:

Albumin, 53–65% of the total protein (3.5–5.0 g/dL)
 α_1 -Globulin, 2.5–5% (0.1–0.3 g/dL)
 α_2 -Globulin, 7–13% (0.6–1.0 g/dL)
 β -Globulin, 8–14% (0.7–1.1 g/dL)
 γ -Globulin, 12–22% (0.8–1.6 g/dL)

Inadvertent use of plasma will result in a narrow band in the β_2 -globulin region because of the presence of fibrinogen. The presence of free hemoglobin will cause a blip in the pattern in the late α_2 or early β zone, and the presence of hemoglobin-haptoglobin complexes will cause a small blip in the α_2 zone. The great advantage of electrophoresis compared with the quantitation of specific proteins is the overview it provides. The electrophoretic pattern can give information about the relative increases and decreases within the protein population, as well as information about the homogeneity of a fraction.

Probably the most significant finding from an electrophoretic pattern is **monoclonal immunoglobulin** disease. The densitometric scan shows a sharp peak if the increase in immunoglobulins is a result of a monoclonal increase (Fig. 10-9B). A spike in the γ , β , or, sometimes, α_2 region signals the need for examination of the immunoglobulins and observation for clinical signs of myelomatosis. A deficiency of the predominant immunoglobulin, IgG, is seen as a much paler stain in the γ area. Another significant finding is a decrease in α_1 -antitrypsin (Fig. 10-9C).

In nephrotic syndrome, the patient loses serum albumin and low-molecular-weight proteins in the urine. Some IgG is also lost. At the same time, an increase occurs in α_2 -macroglobulin, β -lipoprotein, complement components, and haptoglobin. These two events lead to a dramatic decrease in the relative amount of albumin and a significant increase in the relative amounts of α_2 -globulin and β -globulin fractions (Fig. 10-9D).

An inflammatory pattern indicating an inflammatory condition is seen when there is a decrease in albumin and an increase in the α_1 -globulins (α_1 -acid glycopro-

tein, α_1 -antitrypsin), α_2 -globulins (ceruloplasmin and haptoglobin), and β -globulin band (C-reactive protein) (Fig. 10-9E). This pattern, also called an acute-phase reactant pattern, is seen in trauma, burns, infarction, malignancy, and liver disease. Acute-phase reactants are so named because they are increased in the serum within days following trauma or exposure to inflammatory agents. Fibrinogen, haptoglobin, ceruloplasmin, and serum amyloid A increase severalfold, whereas CRP and α_2 -macroglobulin are increased several hundredfold. Chronic infections also produce a decrease in the albumin, but the globulin increase is found in the γ fraction as well as the α_1 , α_2 , and β fractions.

The electrophoretic pattern of serum proteins in liver disease shows the decrease in serum albumin concentration and the increase in γ -globulin. In the pattern in cirrhosis of the liver, there are some fast-moving γ -globulins that prevent resolution of the β - and γ -globulin bands. This is known as the β - γ bridge of cirrhosis (Fig. 10-9F).

In infectious hepatitis, the γ -globulin fraction rises with increasing hepatocellular damage. In obstructive jaundice, there is an increase in the α_2 - and β -globulins. Also noted in obstructive jaundice is an increased concentration of lipoproteins, which is an indicator of its biliary origin. This is especially the case when there is little or no decrease of the serum albumin.

High-Resolution Protein Electrophoresis

Standard SPE separates the protein into five distinct bands but, by modifying the electrophoretic parameters, proteins can be further separated into as many as 12 bands. The modification, known as HRE, uses a higher voltage coupled with a cooling system in the electrophoretic apparatus and a more concentrated buffer. The support medium most commonly used is agarose gel. To obtain the HRE patterns, samples are applied on the agarose gel, electrophoresed in a chamber cooled by a gel block, stained, and then visually inspected. Each band is compared with the same band on a reference pattern for color density, appearance, migration rates, and appearance of abnormal bands or regions of density. A normal serum HRE pattern is shown in Figure 10-10. As with SPE, the patterns may be scanned with a densitometer to obtain semiquantitative estimates of the protein found in each band. HRE is particularly useful in detecting small monoclonal bands and differentiating unusual bands or prominent increases of normal bands that can be confused with a monoclonal gammopathy.⁶⁹

Capillary Electrophoresis

Capillary electrophoresis is a collection of techniques in which the separation of molecules takes place in silica

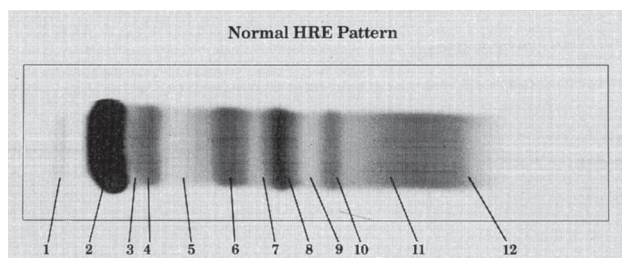

| Zones | Serum proteins found in zones |
|--------------------------------------|--|
| 1. PREALBUMIN ZONE | -Prealbumin |
| 2. ALBUMIN ZONE | -Albumin |
| 3. ALBUMIN- α_1 INTERZONE | - α -Lipoprotein (α -Fetoprotein) |
| 4. α_1 ZONE | - α_1 -Antitrypsin, α_1 -Acid glycoprotein |
| 5. α_1 - α_2 INTERZONE | -Gc-globulin, inter- α - trypsin inhibitor, α_1 - antichymotrypsin |
| 6. α_2 ZONE | - α_2 -Macroglobulin, Haptoglobin |
| 7. α_2 - β_1 INTERZONE | -Cold insoluble globulin, (Hemoglobin) |
| 8. β_1 ZONE | -Transferrin |
| 9. β_1 - β_2 INTERZONE | - β -Lipoprotein |
| 10. β_2 ZONE | -C3 |
| 11. γ_1 ZONE | -IgA (Fibrinogen), IgM (Monoclonal Igs, light chains) |
| 12. γ_2 ZONE | -IgC (C-reactive protein) (Monoclonal Igs, light chains) |

Proteins listed in () are normally found in too low a concentration to be visible in a normal pattern.

FIGURE 10-10. High-resolution electrophoretic pattern of serum. (Courtesy of Helena Laboratories, Beaumont, TX.)

capillaries. The capillaries are typically 30–50 cm long, with an internal diameter between 25 and 100 μm . In capillary zone electrophoresis, the capillaries are filled with a conducting solution, usually an aqueous buffer. The detection end of the capillary is grounded and the sample injection end is connected to a high voltage power supply. When a positive voltage is applied, the positively charged buffer molecules flow to the detection end, which is negative relative to the injection end. The net flow of buffer is called electro-osmotic flow (EOF). When sample is injected, all molecules have a tendency to move toward the detector (negative) end of the capillary due to EOF; however, the negatively charged molecules in the specimen also have a tendency to migrate back toward the injector (positive) end. This is referred to as *electrophoretic mobility*. EOF is usually stronger than electrophoretic mobility, and all ions (positively charged, neutral, and negatively charged) migrate to the detector end but with different net mobilities based on

size and charge differences. The separated molecules are detected by their absorbance as they pass through a small window near the detection end of the capillary. Use of the capillaries allows heat to be effectively dissipated, which means that higher operating voltages can be used and, therefore, analysis times are faster. Additionally, the sample size required is small (nanoliters).

Isoelectric Focusing

Isoelectric focusing (IEF) is zone electrophoresis that separates proteins on the basis of pI. IEF uses constant power and polyacrylamide or agarose gel mediums, which contain a pH gradient. The pH gradient is established by the incorporation of small polyanions and polycations (ampholytes, or molecules that contain both acidic and basic groups) in the gel. The varying pIs of the polyions cause them, in the presence of an electric field, to seek their place in the gradient and to remain there. The pH gradient may range from 3.5 to 10.

When a protein is electrophoresed in the gel, it migrates to a place on the gel where the pH is the same as its pI. The protein becomes focused there because, if it should diffuse in either direction, it leaves its pI and gains a net charge. When this occurs, the electric current once again carries it back to its point of no charge, or its pI.

The clinical applications of IEF include phenotyping of α_1 -antitrypsin deficiencies, determination of genetic variants of enzymes and hemoglobins, detection of paraproteins in serum and oligoclonal bands in CSF, and isoenzyme determinations.

Immunochemical Methods

Specific proteins may be identified by immunochemical assays in which the reaction of the protein (antigen) and its antibody is measured. Methods using various modifications of this principle include radial immunodiffusion (RID), immunoelectrophoresis (IEP), immunofixation electrophoresis (IFE) (Fig. 10-11), electroimmunodiffusion, immunoturbidimetry, and immunonephelometry. These techniques are discussed in Chapter 7.

PROTEINS IN OTHER BODY FLUIDS

The development of a disease-oriented relational database for proteins found in body fluids has been stimulated by the development of computers capable of handling large amounts of data and the development of high-resolution methods for the quantitative analysis of proteins in body fluids.⁷⁰

Body fluids now being studied for their protein content include peritoneal, pleural, seminal, and vaginal fluids and tears. This section includes a discussion of the two fluids whose protein contents are studied most often—urine and CSF.

CASE STUDY 10-5

A male patient aged 47 years came to the clinic after a minor work accident. He worked as a painter, and he had fallen off a 12-foot scaffold and hurt his ankle. He had a complicated medical history that included severe diabetes, diagnosed a decade earlier, with peripheral neuropathy and retinopathy; chronic renal insufficiency; hypertension for the past 20 years; and hyperlipidemia. At this clinic visit, the patient was noted to have mild hepatomegaly. The patient's blood showed a normochromic normocytic anemia. An SPE with immunofixation demonstrated a monoclonal IgG κ of less than 100 mg/dL. A urine protein electrophoresis was negative for light chains (Bence Jones protein). Although his ankle was not sprained, the patient continued to have breathing

problems over the next several months and returned to the clinic often. Among many other tests, a follow-up SPE and a UPE with immunofixation were performed. The results are shown below.

Questions

1. What does the presence of the monoclonal IgG κ band indicate?
2. What further information is obtained from the urine protein electrophoresis?
3. Was this patient's SPE finding consistent with his complicated medical history?
4. What is MGUS?

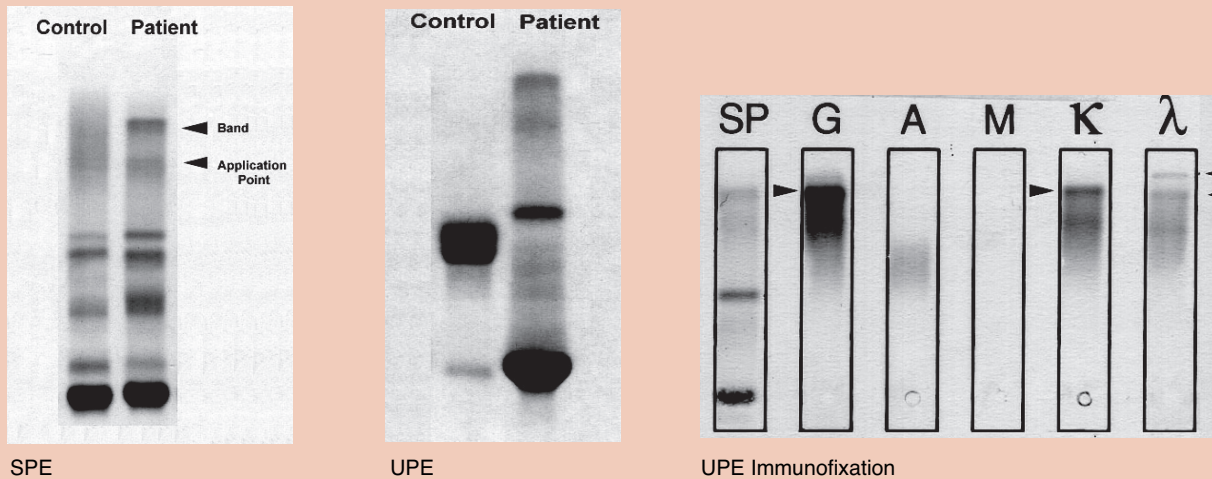

Urinary Protein

Proteins found in the urine are from the blood; however, urinary proteins can originate from the kidney and urinary tract and from extraneous sources such as the vagina and prostate. Plasma proteins appear in the urine because they have passed through the renal glomerulus and have not been reabsorbed by the renal tubules. The qualitative tests for proteinuria are commonly performed using a reagent test strip. These methods are based on the change of an indicator dye in the presence of protein, known as protein error of indicators (ability of protein to alter the color of some acid-base indicators without altering the pH). In an acid pH, the indicator that is yellow in the absence of protein progresses through various shades of green and finally to blue as the concentration of protein increases. A protein concentration of 6 mg/dL or greater produces a color change.

Most quantitative assays are performed on urine specimens of 12 or 24 hours. The 24-hour timing allows for circadian rhythmic changes in excretion at certain times of day. The patient should void, completely emptying the bladder, and discard this urine. Urine is collected from that time for the next 24 hours. At the end of the 24-hour period, the bladder is completely emptied and that urine included in the sample. The volume of the timed specimen is measured accurately and recorded. The results are reported generally in terms of weight of protein per 24 hours by calculating the amount of protein present in the total volume of urine collected during that time.

There are several precipitation methods for the determination of total protein in urine and other body fluids, including the measurement of turbidity when urinary proteins are mixed with an anionic organic acid such as sulfosalicylic acid, TCA, or benzethonium chloride. These

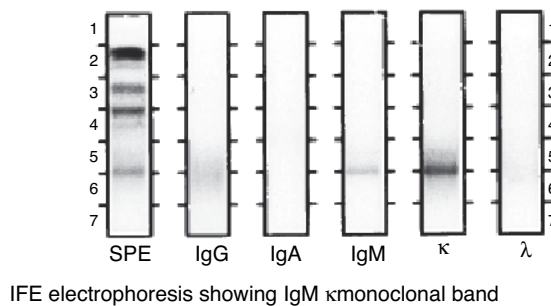
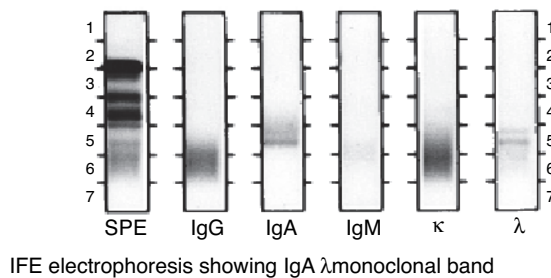
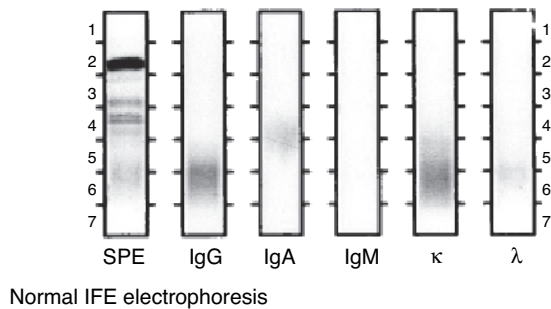

FIGURE 10-11. Patterns of immunofixation electrophoresis (IFE).

methods are sensitive, but the reagent does not react equally with each protein fraction. This is particularly true of sulfosalicylic acid, which produces four times more turbidity with albumin than with α -globulin.

A quantitative method consists of precipitation of the urine proteins, dissolution of the protein precipitate, and color formation with biuret reagent. Another chemical procedure for urinary protein uses the Folin-Ciocalteu reagent, which is a phosphotungstomolybdic acid solution, frequently called phenol reagent because it oxidizes phenolic compounds. The reagent changes color from yellow to blue during reaction with tyrosine, tryptophan, and histidine residues in protein. This method is about 10 times more sensitive than the biuret method. Lowry et. al. increased the sensitivity of the Folin-Ciocalteu reaction by incorporating a biuret reaction as the initial step. After the binding of the Cu^{2+} to the peptide bonds, the Folin-Ciocalteu reagent is added. As the Cu^{2+} -protein complex is oxidized, the reagent is reduced, forming

CASE STUDY 10-6

A 55-year-old man with no history of illness suffered a blow to the head. He was unconscious when admitted to the hospital and remained in that state until his death 15 days later. A nasogastric tube was inserted to administer the required nutrients (protein, carbohydrates, fat, minerals, and vitamins). The total water intake was 1,500 mL/day. Starting on day 5, his blood pressure gradually fell. The 24-hour urine volumes recorded from an indwelling catheter were as follows:

| DAY AFTER ADMISSION | URINE VOLUME (ml/24 hr) |
|---------------------|-------------------------|
| 6 | 1,500 |
| 8 | 1,300 |
| 10 | 1,200 |
| 12 | 1,100 |
| 14 | 900 |

The patient's hemoglobin and hematocrit were elevated.

Blood chemistry analysis on day 13 revealed the following:

| | |
|----------------------|-----------------|
| TOTAL PROTEIN | 9.4 g/dL |
| Albumin | 6.0 g/dL |
| BUN | 80 mg/dL |
| Na^+ | 175 mmol/L |
| K^+ | 4.0 mmol/L |
| Cl^- | 134 mmol/L |

Questions

1. What is the probable cause of the elevated proteins?
2. What other results support this conclusion?
3. Why is the BUN elevated?

the chromogens tungsten blue and molybdenum blue. This increased the sensitivity to 100 times greater than that of the biuret method alone. Another modification uses a pyrogallol red-molybdate complex that reacts with protein to produce a blue-purple complex. This procedure is easily automated.

Dye-binding methods using Coomassie blue and Ponceau S have also been used to determine the quantitative total protein content of urine. However, dye-bind-

TABLE 10-8 URINE PROTEIN METHODS

| METHOD | PRINCIPLE | COMMENT |
|---|--|---|
| Turbidimetric methods (sulfosalicylic acid, trichloroacetic acid, or benzethonium chloride) | Proteins are precipitated as fine particles, turbidity is measured spectrophotometrically | Rapid, easy to use; unequal sensitivity for individual proteins |
| Biuret | Proteins are concentrated by precipitation, redissolved in alkali, then reacted with Cu^{2+} ; Cu^{2+} forms colored complex with peptide bonds | Accurate |
| Folin-Lowry | Initial biuret reaction; oxidation of tyrosine, tryptophan, and histidine residues by Folin phenol reagent (mixture of phosphotungstic and phosphomolybdic acids): measurement of resultant blue color | Very sensitive |
| Dye binding (Coomassie blue, Ponceau S) | Protein binds to dye, causes shift in absorption maximum | Limited linearity; unequal sensitivity for individual proteins |

ing assays are too insensitive for urine microalbumin (MAU) testing, making immunochemical assays the most widely used MAU methods.⁷¹ These immunoassays include immunoturbidimetry, immunofluorescence, ELISA, RIA, and zone immunoelectrophoresis. Table 10-8 summarizes the various methods for measurement of urinary total protein.

The reference values or intervals for urinary proteins are highly method dependent, ranging from 100 to 250 mg every 24 hours. Because of ease of use, speed, and sensitivity, the techniques used most frequently today are turbidimetric procedures. Immunochemical, chromatographic, and liquid chromatography–mass spectrometry (LC-MS) methods for quantifying urine albumin are being used. Even a fluorescence resonance energy transfer assay for point-of-care testing of urinary albumin has been developed.⁷²

Cerebrospinal Fluid Proteins

CSF is formed in the choroid plexus of the ventricles of the brain by ultrafiltration of the blood plasma. Protein measurement is one test that is usually requested on CSF, in addition to glucose level and differential cell count, culture, and sensitivity. The accepted reference interval for patients between 10 and 40 years of age is 15–45 mg/dL of CSF protein.

Abnormally increased total CSF proteins may be found in conditions in which there is an increased permeability of the capillary endothelial barrier through which ultrafiltration occurs. Examples of such conditions include bacterial, viral, and fungal meningitis; traumatic tap; multiple sclerosis; obstruction; neoplasm; disk herniation; and cerebral infarction. The degree of permeability can be evaluated by measuring the CSF albumin and comparing it with the serum albumin. Albumin is usually used as the

reference protein for permeability because it is not synthesized to any degree in the CNS. The reference value for the CSF albumin–serum albumin ratio is less than 2.7–7.3; a value greater than this indicates that the increase in the CSF albumin came from plasma due to a damaged blood-

CASE STUDY 10-7

An 84-year-old woman resident of a nursing home was admitted to the hospital for treatment of lower back pain resulting from a fall. Radiologic examination revealed a vertebral compression fracture. Because she demonstrated signs of general deterioration, further medical evaluation was performed. A neurologic examination and CT scan were normal. Serologic examinations for collagen vascular disease were also negative, although the CRP showed a modest increase. Serum protein electrophoresis was done to rule out multiple myeloma. The serum protein fractions were as follows: albumin, 3.2 g/dL; α_1 -globulins, 0.31 g/dL; α_2 -globulins, 1.59 g/dL (elevated in a tight band); β -globulins, 0.72 g/dL; and γ -globulins, 0.96 g/dL.

Questions

1. What would the next step be in the evaluation of this patient?
2. Given the following additional result (haptoglobin: 416 mg/dL), what condition would explain her abnormal protein electrophoresis pattern?
3. What other proteins would you expect to be abnormal?

brain barrier. Low CSF protein values are found in hyperthyroidism and when fluid is leaking from the CNS.

The total CSF protein may be determined by several of the more sensitive chemical or spectrophotometric methods referred to earlier in the discussion on urinary proteins. The most frequently used procedures are turbidimetric using TCA, sulfosalicylic acid with sodium sulfate, or benzethonium chloride. Also available are dye-binding methods (e.g., Coomassie brilliant blue), a kinetic biuret reaction, and the Lowry method using a Folin phenol reagent.

Although total protein levels in the CSF are informative, diagnosis of specific disorders often requires measurement of individual protein fractions. The pattern of types of proteins present can be seen by electrophoresis of CSF that has been concentrated. This may be performed on cellulose acetate or agarose gel. The normal CSF pattern shows prealbumin, a prominent albumin band, α_1 -globulin composed predominantly of α_1 -antitrypsin, an α_2 band consisting primarily of haptoglobin and ceruloplasmin, a β_1 band composed principally of transferrin, and a CSF-specific transferrin that is deficient in carbohydrate, referred to as τ protein, in the β_2 zone. The globulin present in the γ band is typically IgG with a small amount of IgA.

Electrophoretic patterns of CSF from patients who have multiple sclerosis have multiple, distinct oligoclonal bands in the γ zone (Fig. 10-12). The identification of discrete bands in the γ region that are present in the CSF but not in the serum is consistent with production of IgG in the CSF. These bands cannot be seen on routine cellulose acetate electrophoresis but require a high-resolution technique in which agarose is usually used. More than 90% of patients with multiple sclerosis have oligoclonal bands, although the bands also have been found in inflammatory conditions and infectious neurologic diseases such as Guillain-Barre syndrome, bacterial meningitis, viral encephalitis, subacute sclerosing panencephalitis (SSPE), and neurosyphilis.⁷³



Normal CSF protein electrophoresis

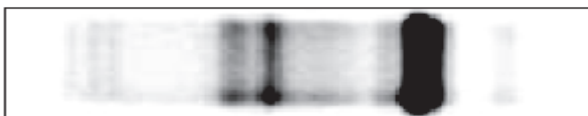

3 X Oligoclonal bands in CSF protein electrophoresis

FIGURE 10-12. Patterns of CSF protein electrophoresis.

To distinguish raised CSF IgG due to local CNS production from leakage of plasma into the CSF, the laboratory can compare CSF and serum IgG levels with reference to albumin, a value known as the IgG index. A CSF IgG:albumin ratio higher than that of serum (raised IgG index) is indicative of local CNS production of IgG. A serum IgG:albumin ratio much higher than that of CSF (low IgG index) is suggestive of hypergammaglobulinemia or low serum albumin. The reference range for IgG index is 0.26–0.70. To identify the source of the elevated CSF IgG levels, the IgG-albumin index can be calculated as follows:

CSF IgG index

$$= \frac{\text{CSF IgG (mg/dL)} \times \text{serum albumin (g/dL)}}{\text{serum IgG (g/dL)} \times \text{CSF albumin (mg/dL)}} \quad (\text{Eq. 10-3})$$

The CSF albumin concentration corrects for increased permeability. Another index to aid in discriminating the

CASE STUDY 10-8

A 36-year-old woman complained of intermittent blurred vision and numbness and weakness in her left leg that had persisted for longer than 3 weeks. On examination, vertical nystagmus (involuntary back-and-forth or circular movements of eyes) was noted on upward gaze. CSF was drawn and the specimen was clear and colorless with normal cell count. The CSF total protein level was 49 mg/dL with an IgG of 8.1 mg/dL. Electrophoresis of the patient's serum and CSF revealed the following pattern: more than two oligoclonal bands in CSF (seen in Fig. 10-8) and a polyclonal pattern on SPE.

Questions

1. What is the significance of the CSF protein bands indicated by the arrows?
2. What conditions would produce this type of CSF protein electrophoresis pattern?
3. What other tests would be helpful in the investigation of this patient's diagnosis?
4. What laboratory test can be useful for monitoring the course of this patient's condition?



source of the IgG in the CSF is the IgG synthesis rate calculation using the formula of Tourtellotte.⁷⁴ The reference interval for the synthesis rate is -9.9 to $+3.3$ mg/day.

In the investigation of multiple sclerosis, myelin basic proteins present in the CSF are also assayed because these proteins can provide an index of active demyelination. Myelin basic proteins are constituents of myelin, the sheath that surrounds many of the CNS axons. In

very active demyelination, concentrations of myelin basic proteins of 17–100 ng/mL are found on RIA. In slow demyelination, values of 6–16 ng/mL occur and, in remission, the values are less than 4 ng/mL. In addition to multiple sclerosis, other conditions that induce CNS demyelination and therefore elevated levels of myelin basic protein include meningoencephalitis, SLE of CNS, diabetes mellitus, and chronic renal failure.

REFERENCES

- Baldwin A, Lapointe M. The chemistry of amino acids. The Biology Project. 2004. Retrieved from www.biology.arizona.edu/biochemistry/problem_sets/aa/aa.html.
- Brosnan J. Interorgan amino acid transport and its regulation. *J Nutr* 2003;133(6 suppl 1):2068S–2072S.
- Nelson DL, Cox MM. *Lehninger's Principles of biochemistry* (3rd ed.). New York: Worth Publishing, 2000.
- IUPAC-IUBMB Joint Commission on Biochemical Nomenclature. Nomenclature and symbolism for amino acids and peptides. Recommendations on organic & biochemical nomenclature, symbols & terminology etc. www.iupac.org/publications/pac/1984/pdf/5605x0595.pdf. Accessed May 17, 2007.
- Wear JE, Keevil BG. Measurement of cystine in urine by liquid chromatography–tandem mass spectrometry. *Clin Chem* 2005;51:787–789.
- Boza JJ, Dangin M, Moennoz D, et al. Free and protein-bound glutamine have identical splanchnic extraction in healthy human volunteers. *Am J Physiol Gastrointest Liver Physiol* 2001;281:267–274.
- Morlion BJ, Stehle P, Wachtler P, et al. Total parenteral nutrition with glutamine dipeptide after major abdominal surgery: a randomized, double-blind, controlled study. *Ann Surg* 1998;227:302–308.
- Francesconi KA, Pannier F. Selenium metabolites in urine: A critical overview of past work and current status. *Clin Chem* 2004;50:2240–2253.
- Gill M, Grupta S, Zichittella L. Selenocysteine: The 21st amino acid. Retrieved October 4, 2008, from www.albany.edu/faculty/cs812/bio366/selenocysteine_ppt.pdf.
- Atkins JF, Gesteland R. *Biochemistry. The 22nd amino acid.* Science 2002;296:1409–1410.
- National Newborn Screening and Genetics Resource Center. Current newborn conditions by state. Retrieved March 2008 from <http://genes-r-us.uthscsa.edu>.
- Chace DH, et al. Rapid diagnosis of phenylketonuria by quantitative analysis for phenylalanine and tyrosine in neonatal blood spots by tandem mass spectrometry. *Clin Chem* 1993;39:66–71.
- American College of Medical Genetics. Newborn screening: Toward a uniform screening panel and system report, main report. 2006;8(Suppl).
- Food and Drug Administration (FDA). FDA approves Kuvan for treatment of phenylketonuria (PKU). December 13, 2007. Retrieved from <http://www.fda.gov/bbs/topics/news/2007/new01761.html>.
- Yamaguchi A, Mizushima Y, Fukushi M, et al. Microassay system for newborn screening for phenylketonuria, maple syrup urine disease, homocystinuria, histidinemia and galactosemia with use of a fluorometric microplate reader. *Screening* 1992;1:49.
- Sparkman OD. *Mass spectrometry desk reference.* Pittsburgh, Pa.: Global View Pub., 2000.
- Pass KA, Morrissey M. Enhancing newborn screening for tyrosinemia type I. *Clin Chem* 2008;54:627–629.
- Oglesbee D, Sanders KA, Lacey JM, et al. Second-tier test for quantification of alloisoleucine and branched-chain amino acids in dried blood spots to improve newborn screening for maple syrup urine disease (MSUD). *Clin Chem* 2008;54:542–549.
- Picker JD, Levy HL. Homocystinuria caused by cystathionine beta-synthase deficiency. In GeneReviews at GeneTests: Medical genetics information resource (database online) (updated 29 March 2006). Copyright, University of Washington, Seattle. 1997–2008. Retrieved April 2, 2008, from <http://www.genetests.org>.
- Magera MJ, Lacey JM, Casetta B, Rinaldo P. Method for the determination of total homocysteine in plasma and urine by stable isotope dilution and electrospray tandem mass spectrometry. *Clin Chem* 1999;45:1517–1522.
- Thoene JG. Citrullinemia type I. In GeneReviews at GeneTests: Medical genetics information resource (database online) (updated 22 December 2006). Copyright, University of Washington, Seattle. 1997–2008. Retrieved April 2, 2008, from <http://www.genetests.org>.
- Turnell DC, Cooper JD. Rapid assay for amino acids in serum or urine by pre-column derivatization and reversed-phase liquid chromatography. *Clin Chem* 1982;28:527–531.
- Chace DH. Use of tandem mass spectrometry for multianalyte screening of dried blood specimens from newborns. *Clin Chem* 2003;49:1797–1817.
- Kimball J. *Biology.* 6th ed. Dubuque, IA: William C. Brown, 1995.
- Branden C, Tooze J. *Introduction to protein structure.* 2nd ed. New York, NY: Garland Publishing, 1999.
- Proteins: introduction. Retrieved October 2, 2008, from <http://www.elmhurst.edu/~chm/vchembook/565proteins.html>.
- Proteins, peptides, and amino acids. Retrieved October 2, 2008, from <http://www.cem.msu.edu/~reusch/VirtualText/proteins.htm>.
- Omenn GS, States DJ, Adamski M, et al. Overview of the HUPO Plasma Proteome Project: Results from the pilot phase with 35 collaborating laboratories and multiple analytical groups, generating a core dataset of 3020 proteins and a publicly-available database. *Proteomics* 2005;5.
- Petsko GA, Ringe D. *Protein structure and function.* London: New Science Press in association with Sinauer Associates and Blackwell Science, 2003:180.
- Lo Conte L, Brenner SE, Hubbard TJ, et al. SCOP database in 2002: Refinements accommodate structural genomics. *Nucleic Acids Res* 2002;30:264–267.

31. Holm L, Ouzounis C, Sander C, et al. A database of protein structure families with common folding motifs. *Prot Sci* 1992;1:1691–1698.
32. Singh AP, et al. Inhibition of MUC4 expression suppresses pancreatic tumor cell growth and metastasis. *Cancer Res* 2004;64:622–630.
33. Kazuyoshi I, Yuichiro S, Yukie K, et al. Determination of glycosylated albumin by enzyme-linked boronate immunoassay (ELBIA). *Clinical Chem* 1998;44:256–263.
34. Albumin: The test sample. Retrieved October 2, 2008, from <http://labtestsonline.org/understanding/analytes/albumin/sample.html>.
35. Technical Bulletin. Alpha-1-antitrypsin deficiency, genotyping: DNA test for the S and Z alleles and protein measurement. Salt Lake City, UT: ARUP Laboratories, 2007.
36. Technical Bulletin. AFP-L3% in serum (includes total alpha fetoprotein): For risk assessment of hepatocellular carcinoma in patients with chronic liver disease. Salt Lake City, UT: ARUP Laboratories, 2007.
37. Israili ZH, Dayton PG. Human alpha-1-glycoprotein and its interactions with drugs. *Drug Metab Rev* 2001;3:161–235.
38. Nilsson LNG, Bales KR, DiCarlo G, et al. (2001) α -1-Antichymotrypsin promotes β -sheet amyloid plaque deposition in a transgenic mouse model of Alzheimer's disease. *J Neurosci* 2001;21:1444–1451.
39. Hamm A, Veeck J, Bektas N, et al. Frequent expression loss of Inter-alpha-trypsin inhibitor heavy chain (ITIH) genes in multiple human solid tumors: A systematic expression analysis. *BMC Cancer* 2008;8:25.
40. Lis Lauridsen A, Vestergaard P, Nexø E. Mean serum concentration of vitamin D-binding protein (Gc globulin) is related to the Gc phenotype in women. *Clin Chem* 2001;47:753–756.
41. Levy A. Haptoglobin phenotype and prevalent coronary heart disease in the Framingham offspring cohort. *Atherosclerosis* 2003;172:361–365.
42. TIBC and transferrin. Retrieved October 2, 2008, from <http://labtestsonline.org/understanding/analytes/tibc/glance.html>.
43. Tolosano E, Altruda F. Hemopexin: Structure, function, and regulation. *DNA Cell Biol* 2002;21:297–306.
44. Yates JR, Sepp T, Matharu BK, et al. Complement C3 variant and the risk of age-related macular degeneration. *N Engl J Med* 2007;357:553–561.
45. Wong SS. Strategic utilization of cardiac markers for the diagnosis of acute myocardial infarction. *Ann Clin Lab Sci* 1996;26:301.
46. Ridker PM. Clinical application of C-reactive protein for cardiovascular disease detection and prevention. *Circulation* 2003;107:363–369.
47. King DE, Mainous AG, Buchanan TA, Pearson WS. C-reactive protein and glycemic control in adults with diabetes. *Diabetes Care* 2003;26:1535–1539.
48. Ridker PM. C-reactive protein: A simple test to help predict risk of heart attack and stroke. *Circulation* 2003;108:e81.
49. Matsuda F, Ishii K, Bourvagnet P, et al. The complete nucleotide sequence of the human immunoglobulin heavy chain variable region locus. *J Exp Med* 1998;188:2151–2162.
50. Abbas AK, Lichtman AH. Cellular and molecular immunology. 5th ed. Philadelphia, Pa.: WB Saunders, 2003.
51. Tangye SG, Ferguson A, Avery DT, et al. Isotype switching by human B cells is division-associated and regulated by cytokines. *J Immunol* 2002;169:4298–4306.
52. Janeway CA Jr, et al. Immunobiology. 5th ed, New York, NY: Garland Publishing, 2001.
53. Woof J, Burton D. Human antibody-Fc receptor interactions illuminated by crystal structures. *Nat Rev Immunol* 2004;4:89–99.
54. Preud'homme JL, Petit I, Barra A, et al. Structural and functional properties of membrane and secreted IgD. *Mol Immunol* 2000;37:871–887.
55. Winter WE, Hardt MS, Fuhrman S. Immunoglobulin E: Importance in parasitic infections and hypersensitivity responses. *Arch Pathol Lab Med* 2000;124:1382–1385.
56. Morrow DA, Cannon CP, Jesse RL, et al. National Academy of Clinical Biochemistry Laboratory Medicine Practice Guidelines: clinical characteristics and utilization of biochemical markers in acute coronary syndromes. *Clin Chem* 2007;53:552–574.
57. Chiu A, Chan W-K, Cheng S-H, et al. Troponin-I, myoglobin, and mass concentration of creatine kinase-MB in acute myocardial infarction. *J Med* 1999;92:711–718.
58. Sakhuja R, Januzzi JL. NT-proBNP: A new test for diagnosis, prognosis and management of congestive heart failure. *Cardiology* 2004;August.
59. Nakamura Y, et al. Implications of plasma concentrations of adiponectin in patients with coronary artery disease. *Heart* 2004;90:528–533.
60. Huber AR, Risch L. Recent developments in the evaluation of glomerular filtration rate: Is there a place for beta-trace? *Clin Chem* 2005;51:1329–1330.
61. Shlipak MG, Sarnak MJ, Katz R, et al. Cystatin C and the risk of death and cardiovascular events among elderly persons. *N Engl J Med* 2005;352:2049–2060.
62. Peters T Jr, Biamonte ET, Doumas BT. Protein (total) in serum, urine, cerebrospinal fluid, albumin in serum. In Faulkner WR, Meites S, eds. Selected methods in clinical chemistry. Vol. 9. Washington, D.C.: American Association for Clinical Chemistry, 1982:317.
63. Reichert TS-METER. Total solids refractometer model 1310400A instruction manual 2003. Depew, NY: Reichert, Inc (publication 10400A-101 Rev. D).
64. Chromy V, Fischer J. Photometric determination of total protein in lipemic serum. *Clin Chem* 1977;23:754.
65. Doumas BT, Watson WA, Biggs HG. Albumin standards and the measurement of serum albumin with bromocresol green. *Clin Chem Acta* 1971;31:87.
66. Speicher CE, Widish JR, Gaudot FJ, et al. An evaluation of the overestimation of serum albumin by bromocresol green. *Am J Clin Pathol* 1978;69:347.
67. Gustafsson JEC. Improved specificity of serum albumin determination and estimation of acute phase reactants by use of the bromocresol green reaction. *Clin Chem* 1976;22:616.
68. Clase CM, St Pierre MW, Churchill DN. Conversion between bromocresol green- and bromocresol purple-measured albumin in renal disease. *Nephrol Dial Transplant* 2001;16:1925–1929.
69. Keren D. High resolution electrophoresis aids detection of gammopathies. *Clin Chem News* 1989;14.
70. Merrill CR, Goldstein MP, Myrick JE, et al. The Protein Disease Database of human body fluids: I. Rationale for the development of this database. *Appl Theor Electrophor* 1995;5:49–54.
71. Choi S, Choi EY, Kim HS, Sang WO. On-site quantification of human urinary albumin by a fluorescence immunoassay. *Clin Chem* 2004;50:1052–1055.
72. Qin Q-P, Peltola O, Pettersson K. Time-resolved fluorescence resonance energy transfer assay for point-of-care testing of urinary albumin. *Clin Chem* 2003;49:1105–1113.
73. Fact Sheet Immunopathology. CSF electrophoresis and the detection of oligoclonal bands. *Inst Clin Pathol Med Res* 2002 (9/02 0119).
74. Tourtellotte WW, Staugaitis SM, Walsh MJ, et al. The basis of intrablood-brain-barrier IgG synthesis. *Ann Neurol* 1985;17:21–27.

Nonprotein Nitrogen Compounds

Elizabeth L. Frank

CHAPTER

11

CHAPTER OUTLINE

■ UREA

Introduction
Physiology
Clinical Application
Methods
Specimen Requirements and Interfering Substances
Reference Intervals
Pathophysiology

■ URIC ACID

Introduction
Physiology
Clinical Application
Methods
Specimen Requirements and Interfering Substances
Reference Intervals
Pathophysiology

■ CREATININE/CREATINE

Introduction
Physiology

Clinical Application
Methods
Specimen Requirements and Interfering Substances
Sources of Error
Reference Intervals
Pathophysiology

■ AMMONIA

Introduction
Physiology
Clinical Applications
Methods
Specimen Requirements and Interfering Substances
Sources of Error
Reference Intervals
Pathophysiology

■ REFERENCES

The determination of nonprotein nitrogenous substances in the blood has traditionally been used to monitor renal function. The term **nonprotein nitrogen (NPN)** originated in the early days of clinical chemistry when analytic methodology required removal of protein from the sample before analysis. The concentration of nitrogen-containing compounds in this **protein-free filtrate** was quantified spectrophotometrically by converting nitrogen to **ammonia** and subsequent reaction with Nessler's reagent (HgI_2/KI) to produce a yellow color.¹ This method is technically difficult but provides an accurate determination of total NPN concentration. Although measurement of total urinary nitrogen is of value in the assessment of nitrogen balance for nutritional management,² more useful clinical information is obtained by analyzing a patient's specimen for individual components of the NPN fraction.

The NPN fraction comprises about 15 compounds of clinical interest (Table 11-1). The majority of these

compounds arise from the catabolism of proteins and nucleic acids. The biochemistry, clinical utility, and analytical methods for measurement of the NPN compounds **urea**, **uric acid**, **creatinine**, **creatine**, and ammonia are presented in this chapter.

UREA

Introduction

The NPN compound present in highest concentration in the blood is urea (Fig. 11-1). Urea is the major excretory product of protein metabolism.⁴ It is formed in the liver from amino groups ($-\text{NH}_2$) and free ammonia generated during protein catabolism.⁵ Since historic assays for urea were based on measurement of nitrogen, the term *blood urea nitrogen (BUN)* has been used to refer to urea determination. *Urea nitrogen (urea N)* is a more appropriate term.⁶

TABLE 11-1 CLINICALLY SIGNIFICANT NONPROTEIN NITROGEN COMPOUNDS

| COMPOUND | APPROXIMATE PLASMA CONCENTRATION (% OF TOTAL NPN) | APPROXIMATE URINE CONCENTRATION (% OF EXCRETED NITROGEN) |
|-------------|---|--|
| Urea | 45–50 | 86.0 |
| Amino acids | 25 | — |
| Uric acid | 10 | 1.7 |
| Creatinine | 5 | 4.5 |
| Creatine | 1–2 | — |
| Ammonia | 0.2 | 2.8 |

Physiology

Protein metabolism produces amino acids that can be oxidized to produce energy or stored as fat and glycogen. These processes release nitrogen, which is converted to urea and excreted as a waste product. Following synthesis in the liver, urea is carried in the blood to the kidney, where it is readily filtered from the plasma by the glomerulus. Most of the urea in the glomerular filtrate is excreted in the urine, although some urea is reabsorbed by passive diffusion during passage of the filtrate through the renal tubules. The amount reabsorbed depends on urine flow rate and extent of hydration. Small quantities of urea (<10% of the total) are excreted through the gastrointestinal tract and skin. The concentration of urea in the plasma is determined by renal function and perfusion, the protein content of the diet, and the rate of protein catabolism.⁷

Clinical Application

Measurement of urea is used to evaluate renal function, to assess hydration status, to determine nitrogen balance, to aid in the diagnosis of renal disease, and to verify adequacy of dialysis.⁴

Assays for urea were originally performed on a protein-free filtrate of whole blood and based on measuring

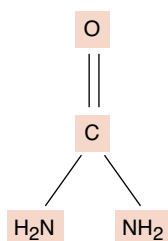
**FIGURE 11-1.** Structure of urea.

the amount of nitrogen in the sample. Current analytic methods have retained this custom and urea often is reported in terms of nitrogen concentration rather than urea concentration. Urea nitrogen concentration can be converted to urea concentration by multiplying by 2.14, as shown in Equation 11-1.

$$\frac{1 \text{ mg urea N}}{\text{dL}} \times \frac{1 \text{ mmol N}}{14 \text{ mg N}} \times \frac{1 \text{ mmol urea}}{2 \text{ mmol N}} \times \frac{60 \text{ mg urea}}{1 \text{ mmol urea}} = \frac{2.14 \text{ mg urea}}{\text{dL}} \quad (\text{Eq. 11-1})$$

In the International System of Units (SI), urea is reported in units of millimoles per liter. Urea nitrogen concentration expressed in milligrams per deciliter may be converted to urea concentration in millimoles per liter by multiplying by 0.357.⁸

Methods

Several analytic approaches have been used to assay for urea. Enzymatic methods are used most frequently in clinical laboratories.⁹ The enzyme urease (urea amidohydrolase, EC 3.5.1.5) hydrolyzes urea in the sample and the ammonium ion (NH_4^+) produced in the reaction is quantified.¹⁰ The most common method couples the urease reaction with glutamate dehydrogenase (GLDH, EC 1.4.1.3) and the rate of disappearance of nicotinamide adenine dinucleotide (reduced, NADH) at 340 nm is measured¹¹ (Fig. 11-2).

Ammonium from the urease reaction also can be measured by the color change associated with a pH indicator. This approach has been incorporated into instruments using liquid reagents, a multilayer film format, and reagent strips.^{12–14}

A method that uses an electrode to measure the rate of increase in conductivity as ammonium ions are produced from urea is in use in approximately 20% of laboratories in the United States.^{9,15} Because the rate of change in conductivity is measured, ammonia contamination is not a problem as it is in other methods.

A reference method using isotope-dilution mass spectrometry has been developed.¹⁶ Analytic methods are summarized in Table 11-2.

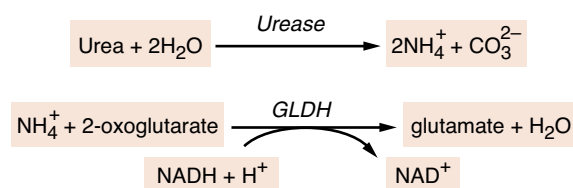

GLDH = glutamate dehydrogenase (EC 1.4.1.3)

FIGURE 11-2. Enzymatic assay for urea.

TABLE 11-2 SUMMARY OF ANALYTIC METHODS—UREA

| ENZYMATIC METHODS | | |
|------------------------------------|--|---|
| Methods use similar first step | Urease $\text{Urea} + 2 \text{H}_2\text{O} \rightarrow 2 \text{NH}_4^+ + \text{CO}_3^{2-}$ | |
| GLDH coupled enzymatic | GLDH $\text{NH}_4^+ + 2\text{-oxoglutarate} + \text{NADH} + \text{H}^+ \rightleftharpoons \text{glutamate} + \text{NAD}^+ + \text{H}_2\text{O}$ | Used on many automated instruments; best as kinetic measurement |
| Indicator dye | $\text{NH}_4^+ + \text{pH indicator} \rightarrow$ color change | Used in automated systems, multilayer film reagents, and dry reagent strips |
| Conductimetric | Conversion of unionized urea to NH_4^+ and CO_3^{2-} results in increased conductivity | Specific and rapid |
| OTHER METHODS | | |
| Isotope dilution mass spectrometry | Detection of characteristic fragments following ionization; quantification using isotopically labeled compound | Proposed reference method |

Specimen Requirements and Interfering Substances

Urea concentration may be measured in plasma, serum, or urine. If plasma is collected, ammonium ions and high concentrations of sodium citrate and sodium fluoride must be avoided; citrate and fluoride inhibit urease. Although the protein content of the diet influences urea concentration, the effect of a single protein-containing meal is minimal and a fasting sample is not required usually. A nonhemolyzed sample is recommended. Urea is susceptible to bacterial decomposition, so samples (particularly urine) that cannot be analyzed within a few hours should be refrigerated. Timed urine samples should be refrigerated during the collection period. Methods for plasma or serum may require modification for use with urine specimens because of high urea concentration and the presence of endogenous ammonia.⁸

Reference Intervals

UREA NITROGEN⁸

| ADULT | | | |
|-----------------|-------------|--------------------------|--|
| Plasma or serum | 6–20 mg/dL | (2.1–7.1 mmol urea/day) | |
| Urine, 24-h | 12–20 g/day | (0.43–0.71 mol urea/day) | |

Pathophysiology

An elevated concentration of urea in the blood is called **azotemia**. Very high plasma urea concentration accompanied by renal failure is called **uremia**, or **the uremic syndrome**. This condition is eventually fatal if not treated by dialysis or transplantation. Conditions causing increased plasma urea are classified according to cause into three main categories: **prerenal**, renal, and **postrenal**.⁷

Prerenal azotemia is caused by reduced renal blood flow. Less blood is delivered to the kidney; consequently, less urea is filtered. Causative factors include congestive heart failure, shock, hemorrhage, dehydration, and other factors resulting in a significant decrease in blood volume. The amount of protein metabolism also induces prerenal changes in blood urea concentration. A high-protein diet or increased protein catabolism, such as occurs in stress, fever, major illness, corticosteroid therapy, and gastrointestinal hemorrhage, may increase urea concentration.

Decreased renal function causes an increase in plasma urea concentration as a result of compromised urea excretion. Renal causes of elevated urea include acute and chronic renal failure, glomerular nephritis, tubular necrosis, and other intrinsic renal disease (see Chapter 26).

Postrenal azotemia can be due to obstruction of urine flow anywhere in the urinary tract by renal calculi, tumors of the bladder or prostate, or severe infection.

The major causes of decreased plasma urea concentration include low protein intake and severe liver disease. Plasma urea concentration is decreased during late pregnancy and infancy as a result of increased protein synthesis. The conditions affecting plasma urea concentration are summarized in Table 11-3.

Differentiation of the cause of abnormal urea concentration is aided by calculation of the **urea nitrogen/creatinine ratio**, which is normally 10:1 to 20:1. Prerenal conditions tend to elevate plasma urea, whereas plasma creatinine remains normal, causing a high urea N/creatinine ratio. A high urea N/creatinine ratio with an elevated creatinine is usually seen in postrenal conditions. A low urea N/creatinine ratio is observed in conditions associated with decreased urea production, such as low protein intake, acute tubular necrosis, and severe liver disease.¹⁷

TABLE 11-3 CAUSES OF ABNORMAL PLASMA UREA CONCENTRATION

| INCREASED CONCENTRATION | |
|--------------------------------|---|
| Prerenal | Congestive heart failure Shock, hemorrhage Dehydration Increased protein catabolism High-protein diet |
| Renal | Acute and chronic renal failure Renal disease, including glomerular nephritis, tubular necrosis |
| Postrenal | Urinary tract obstruction |
| DECREASED CONCENTRATION | |
| | Low protein intake Severe vomiting and diarrhea Liver disease Pregnancy |

CASE STUDY 11-1

A 65-year-old man was first admitted for treatment of chronic obstructive lung disease, renal insufficiency, and significant cardiomegaly. Pertinent laboratory data on admission (5/31) are shown in Case Study Table 11-1.1.

Because of severe respiratory distress, the patient was transferred to the intensive care unit, placed on a respirator, and given diuretics and intravenous (IV) fluids to promote diuresis. This treatment brought about a significant improvement in both cardiac output and renal function, as shown by laboratory results several days later (6/3). After 2 additional days on a respirator with IV therapy, the patient's renal function had returned to normal and, at discharge, his laboratory results were normal (6/7).

The patient was readmitted 6 months later because of the increasing inability of his family to arouse him. On admission, he was shown to have a tremendously enlarged heart with severe pulmonary disease, heart failure, and probable renal failure. Laboratory studies on admission were as shown in Case Study Table 11-1.2. Numerous attempts were made to improve the patient's cardiac and pulmonary function, all to no avail, and the patient died 4 days later.

Question

1. What is the most likely cause of the patient's elevated urea nitrogen? Which data support your conclusion?

**CASE STUDY TABLE 11-1.1
LABORATORY RESULTS—FIRST ADMISSION**

| TEST | 5/31 | 6/3 | 6/7 |
|--------------------------|------|------|------|
| Urea N, mg/dL | 45 | 24 | 11 |
| Creatinine, mg/dL | 1.8 | 1.3 | 0.9 |
| Urea N/creatinine | 25 | 18.5 | 12.2 |
| pH | 7.22 | 7.5 | |
| pCO ₂ , mm Hg | 74.4 | 48.7 | |
| po ₂ , mm Hg | 32.8 | 57.6 | |
| O ₂ sat, % | 51.3 | 91.0 | |

**CASE STUDY TABLE 11-1.2
LABORATORY RESULTS—SECOND ADMISSION**

| | |
|--------------------------|------|
| Urea N, mg/dL | 90 |
| Creatinine, mg/dL | 3.9 |
| Uric acid, mg/dL | 12.0 |
| Urea N/creatinine | 23 |
| pH | 7.35 |
| pCO ₂ , mm Hg | 59.9 |
| po ₂ , mm Hg | 34.6 |
| O ₂ sat, % | 63.7 |

URIC ACID

Introduction

Uric acid is the product of catabolism of the purine nucleic acids.¹⁸ Although it is filtered by the glomerulus and secreted by the distal tubules into the urine, most uric acid is reabsorbed in the proximal tubules and reused.⁷ Uric acid is relatively insoluble in plasma and, at high concentrations, can be deposited in the joints and tissue, causing painful inflammation.

Physiology

Purines, such as adenosine and guanine from the breakdown of ingested nucleic acids or from tissue destruction, are converted into uric acid, primarily in the liver. Uric acid is transported in the plasma from the liver to the kidney, where it is filtered by the glomerulus.

Reabsorption of 98% to 100% of the uric acid from the glomerular filtrate occurs in the proximal tubules. Small amounts of uric acid are secreted by the distal tubules into the urine. Renal excretion accounts for about 70% of uric acid elimination; the remainder passes into the gastrointestinal tract and is degraded by bacterial enzymes.⁷

Nearly all of the uric acid in plasma is present as monosodium urate. At the pH of plasma (pH \approx 7), urate is relatively insoluble; at concentrations greater than 6.8 mg/dL, the plasma is saturated. As a result, urate crystals may form and precipitate in the tissues. In acidic urine (pH $<$ 5.75), uric acid is the predominant species and uric acid crystals may form.⁷

Clinical Application

Uric acid is measured to assess inherited disorders of purine metabolism, to confirm diagnosis and monitor treatment of **gout**, to assist in the diagnosis of renal calculi, to prevent uric acid nephropathy during chemotherapeutic treatment, and to detect kidney dysfunction.¹⁹

Methods

In higher primates, such as humans and apes, uric acid is the final breakdown product of purine metabolism.⁴ Most other mammals have the ability to catabolize purines to allantoin, a more water-soluble end product. This reaction is shown in Figure 11-3. Uric acid is readily oxidized to allantoin and, therefore, can function as a reducing agent in chemical reactions. This property was exploited in early analytic procedures for the determination of uric acid. The most common method of this type is the Caraway method, which is based on the oxidation of uric acid in a protein-free filtrate, with subsequent reduction of phosphotungstic acid in alkaline solution to tungsten blue.²⁰ This method lacks specificity.

Methods using uricase (urate oxidase, EC 1.7.3.3), the enzyme that catalyzes the oxidation of uric acid to allantoin, are more specific and are used almost exclusively in clinical laboratories. The simplest of these methods measures the differential absorption of uric acid and allantoin at 293 nm.²¹ The difference in absorbance before and after incubation with uricase is proportional to the uric acid concentration. Proteins can cause high background absorbance, reducing sensitivity; hemoglobin and xanthine can cause negative interference in these methods.²²

Coupled enzyme methods measure the hydrogen peroxide produced as uric acid is converted to allantoin.^{23,24} Peroxidase or catalase (EC 1.11.1.6) is used to catalyze a chemical indicator reaction. The color produced is proportional to the quantity of uric acid in the specimen. Enzymatic methods of this kind have been adapted for use on traditional wet chemistry analyzers and for dry chemistry slide analyzers. Bilirubin and ascorbic acid, which destroy peroxide, if present in sufficient quantity, can interfere. Commercial reagent preparations often include potassium ferricyanide and ascorbate oxidase to minimize these interferences.

Isotope dilution mass spectrometry has been proposed as a candidate reference method.²⁵ Analytic methods are summarized in Table 11-4.

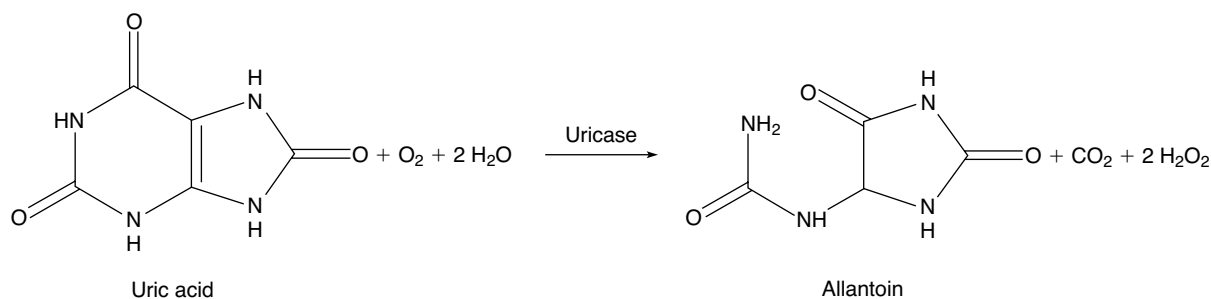

FIGURE 11-3. Conversion of uric acid to allantoin.

TABLE 11-4 SUMMARY OF ANALYTIC METHODS—URIC ACID

| CHEMICAL METHODS | | |
|--|---|---|
| Phosphotungstic acid | $\text{Na}_2\text{CO}_3/\text{OH}^-$ Uric acid + $\text{H}_3\text{PW}_{12}\text{O}_{40}$ + $\text{O}_2 \rightarrow$ allantoin + tungsten blue + CO_2 | Nonspecific; requires protein removal |
| ENZYMATIC METHODS | | |
| Similar first step | Uricase Uric acid + $\text{O}_2 + 2 \text{H}_2\text{O}$ \rightarrow allantoin + CO_2 + H_2O_2 | Very specific |
| Spectrophotometric | Decrease in absorbance at 293 nm measured | Hemoglobin and xanthine interfere |
| Coupled enzymatic (I) | Catalase $\text{CH}_3\text{OH} + \text{H}_2\text{O}_2 \rightarrow \text{H}_2\text{CO} +$ $2 \text{H}_2\text{O}$ $\text{CH}_2\text{O} + 3 \text{C}_5\text{H}_8\text{O}_2 +$ $\text{NH}_3 \rightarrow$ colored compound + $3 \text{H}_2\text{O}$ | Commonly automated method; negative bias with reducing agents |
| Coupled enzymatic (II) | Peroxidase $\text{H}_2\text{O}_2 +$ indicator dye \rightarrow colored compound + $2 \text{H}_2\text{O}$ | Readily automated; reducing agents interfere |
| OTHER METHODS | | |
| Isotope dilution mass spectrometry (IDMS) | Detection of characteristic fragments following ionization; quantification using isotopically labeled compound | Proposed reference method |

Specimen Requirements and Interfering Substances

Uric acid may be measured in heparinized plasma, serum, or urine. Serum should be removed from cells as quickly as possible to prevent dilution by intracellular contents. Diet may affect uric acid concentration overall, but a recent meal has no significant effect and a fasting specimen is unnecessary. Gross lipemia should be avoided. High bilirubin concentration may falsely decrease results obtained by peroxidase methods. Significant hemolysis, with concomitant glutathione release, may result in low values. Drugs such as salicylates and thiazides have been shown to increase values for uric acid.²⁶

Uric acid is stable in plasma or serum after red blood cells have been removed. Serum samples may be stored refrigerated for 3 to 5 days. Ethylenediaminetetraacetic acid (EDTA) or fluoride additives should not be used for specimens that will be tested by a uricase method. Urine specimens must be alkaline (pH 8).⁸

Reference Intervals

URIC ACID (URICASE METHOD)⁸

| | | | |
|--------------|-----------------|----------------|--------------------|
| Adult Male | Plasma or serum | 3.5–7.2 mg/dL | (0.21–0.43 mmol/L) |
| Adult Female | Plasma or serum | 2.6–6.0 mg/dL | (0.16–0.36 mmol/L) |
| Child | Plasma or serum | 2.0–5.5 mg/dL | (0.12–0.33 mmol/L) |
| Adult | Urine, 24-h | 250–750 mg/day | (1.5–4.4 mmol/day) |

Results expressed in conventional units of milligrams per deciliter can be converted to international units using the molecular mass of uric acid (168 g/mol).

Pathophysiology

Inherited disorders of purine metabolism are associated with significant increases in physiological uric acid concentrations. Lesch-Nyhan syndrome is an X-linked genetic disorder (seen only in males) caused by the complete deficiency of hypoxanthine guanine phosphoribosyltransferase (HGPRT, EC 2.4.2.8), an important enzyme in the biosynthesis of purines. Lack of this enzyme prevents the reutilization of purine bases in the nucleotide salvage pathway and results in increased de novo synthesis of purine nucleotides and high plasma and urine concentrations of uric acid.⁷ Neurologic symptoms, mental retardation, and self-mutilation characterize this extremely rare disease. Mutations in the first enzyme in the purine synthesis pathway, phosphoribosylpyrophosphate synthetase (PRPP synthetase, EC 2.7.6.1), also cause elevated uric acid concentration.⁶ Increased uric acid is found secondary to glycogen storage disease (deficiency of glucose-6-phosphatase, EC 3.1.3.9) and fructose intolerance (deficiency of fructose-1-phosphate aldolase, EC 2.1.2.13).²⁷ Metabolites such as lactate and triglycerides are produced in excess and compete with urate for renal excretion in these diseases.

Elevated plasma uric acid concentration is found in gout, increased catabolism of nucleic acids, and renal disease.⁷ Gout is a disease found primarily in men and usually is first diagnosed between 30 and 50 years of age. Affected individuals have pain and inflammation of the joints caused by precipitation of sodium urates. In 25% to 30% of these patients, **hyperuricemia** is a result of overproduction of uric acid, although hyperuricemia may be exacerbated by a purine-rich diet, drugs, and alcohol. Plasma uric acid concentration in affected individuals is usually greater than 6.0 mg/dL. Patients with gout are very susceptible to the development of renal calculi, although not all persons with high serum urate concentrations develop this complication. In women, urate concentration rises after menopause. Postmenopausal women may develop hyperuricemia and gout. In severe cases, deposits of crystalline uric acid and urates called *tophi* form in tissue, causing deformities.

Another common cause of elevated plasma uric acid concentration is increased metabolism of cell nuclei, as occurs in patients on chemotherapy for such proliferative diseases as leukemia, lymphoma, multiple myeloma, and polycythemia. Monitoring uric acid concentration in these patients is important to avoid nephrotoxicity. Allopurinol, which inhibits xanthine oxidase (EC 1.1.3.22), an enzyme in the uric acid synthesis pathway, is used as treatment.

Chronic renal disease causes increased uric acid concentration because filtration and **secretion** are impaired.

However, uric acid is not useful as an indicator of renal function because many other factors affect its plasma concentration.

Patients with hemolytic or megaloblastic anemia may exhibit elevated uric acid concentration. Hyperuricemia is a common feature of toxemia of pregnancy (preeclampsia) and lactic acidosis, presumably as a result of competition for binding sites in the renal tubules. Increased urate concentrations may be found following ingestion of a diet rich in purines (liver, kidney, sweetbreads, shellfish) or as a result of increased tissue catabolism due to inadequate dietary intake (starvation).⁷

Hypouricemia is less common than hyperuricemia and is usually secondary to severe liver disease or defective tubular reabsorption, as in Fanconi syndrome. Hypouricemia can be caused by chemotherapy with 6-mercaptopurine or azathioprine, inhibitors of de novo purine synthesis, and as a result of overtreatment with allopurinol. The conditions affecting plasma urate concentrations are shown in Table 11-5.⁷

TABLE 11-5 CAUSES OF ABNORMAL PLASMA URIC ACID

INCREASED CONCENTRATION

Enzyme deficiencies

Lesch-Nyhan syndrome (hypoxanthine guanine phosphoribosyltransferase deficiency)

Phosphoribosylpyrophosphate synthetase deficiency

Glycogen storage disease type I (glucose-6-phosphatase deficiency)

Fructose intolerance (fructose-1-phosphate aldolase deficiency)

Gout

Treatment of myeloproliferative disease with cytotoxic drugs

Hemolytic and proliferative processes

Chronic renal disease

Toxemia of pregnancy

Lactic acidosis

Drugs and poisons

Purine-rich diet

Increased tissue catabolism or starvation

DECREASED CONCENTRATION

Liver disease

Defective tubular reabsorption (Fanconi syndrome)

Chemotherapy with azathioprine or 6-mercaptopurine

Overtreatment with allopurinol

CREATININE/CREATINE

Introduction

Creatinine is formed from creatine and creatine phosphate in muscle and is excreted into the plasma at a constant rate related to muscle mass. Plasma creatinine is inversely related to **glomerular filtration rate (GFR)** and, although an imperfect measure, it is commonly used to assess renal filtration function.²⁸

Physiology

Creatine is synthesized primarily in the liver from arginine, glycine, and methionine.⁴ It is then transported to other tissues, such as muscle, where it is converted to creatine phosphate, which serves as a high-energy source. Creatine phosphate loses phosphoric acid and creatine loses water to form the cyclic compound, creatinine, which diffuses into the plasma and is excreted in the urine.²⁸ The structures and relationship of these compounds are shown in Figure 11-4.

Creatinine is released into the circulation at a relatively constant rate that has been shown to be proportional to an individual's muscle mass. It is removed from the circulation by glomerular filtration and excreted in the urine.²⁸ Small amounts of creatinine are

secreted by the proximal tubule and reabsorbed by the renal tubules.⁶ Daily creatinine excretion is fairly stable.

Clinical Application

Measurement of creatinine concentration is used to determine sufficiency of kidney function and the severity of kidney damage and to monitor the progression of kidney disease.²⁹

Plasma creatinine concentration is a function of relative muscle mass, the rate of creatine turnover, and renal function. The amount of creatinine in the bloodstream is reasonably stable, although the protein content of the diet does influence the plasma concentration. Because of the constancy of endogenous production, urinary creatinine excretion has been used as a measure of the completeness of 24-hour urine collections in a given individual, although the uncertainty associated with this practice may exceed that introduced by the use of urine volume and collection time for standardization.³⁰ Urinary constituents may be expressed as a ratio to creatinine quantity rather than as mass excreted per day.

Creatinine clearance, a measure of the amount of creatinine eliminated from the blood by the kidneys, and GFR are used to gauge renal function.²⁹ The GFR is the

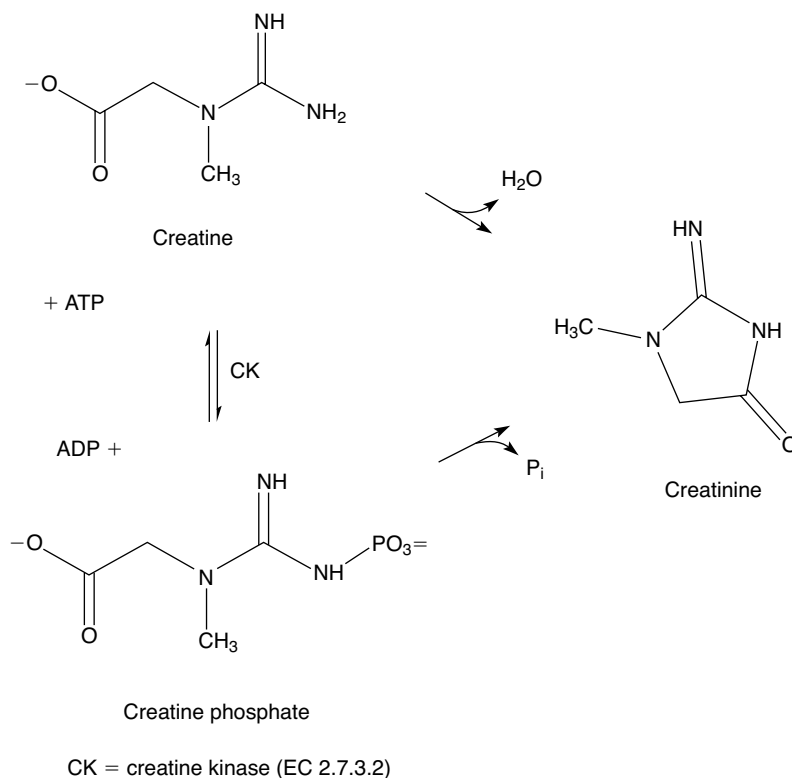

FIGURE 11-4. Interconversion of creatine, creatine phosphate, and creatinine.

volume of plasma filtered (V) by the glomerulus per unit of time (t).

$$\text{GFR} = \frac{V}{t} \quad (\text{Eq. 11-2})$$

Assuming a substance, S , can be measured and is freely filtered at the glomerulus and neither secreted nor reabsorbed by the tubules, the volume of plasma filtered would be equal to the mass of S filtered (M_S) divided by its plasma concentration (P_S).

$$V = \frac{M_S}{P_S} \quad (\text{Eq. 11-3})$$

The mass of S filtered is equal to the product of its urine concentration (U_S) and the urine volume (V_U).

$$M_S = U_S V_U \quad (\text{Eq. 11-4})$$

If the urine and plasma concentrations of S , the volume of urine collected, and the time over which the sample was collected are known, the GFR can be calculated.

$$\text{GFR} = \frac{U_S V_U}{P_S t} \quad (\text{Eq. 11-5})$$

The clearance of a substance is the volume of plasma from which that substance is removed per unit time. The formula for creatinine clearance (CrCl) is given as follows, where U_{Cr} is urine creatinine concentration and P_{Cr} is plasma creatinine concentration.

$$\text{CrCl} = \frac{U_{Cr} V_U}{P_{Cr} t} \quad (\text{Eq. 11-6})$$

Creatinine clearance is usually reported in units of mL/minute and can be corrected for body surface area (see Chapter 26). Creatinine clearance overestimates GFR because a small amount of creatinine is reabsorbed by the renal tubules and up to 10% of urine creatinine is secreted by the tubules. However, CrCl provides a reasonable approximation of GFR.²⁹

This relationship between plasma creatinine and GFR and the observation that creatinine concentrations are relatively constant should make the analyte a good endogenous filtration marker. However, measurement of plasma creatinine does not provide sufficient sensitivity for the detection of mild renal dysfunction. Measured creatinine concentration used in combination with other variables in one of several empirically determined equations provides a better assessment of renal disease, in part because the equations estimate GFR, not creatinine clearance.

The abbreviated Modification of Diet in Renal Disease (MDRD) equation is advocated by the National Kidney Foundation.³¹ The equation includes four variables—serum (plasma) creatinine concentration, age, gender (sex), and ethnicity—and makes the assumption that all filtered creatinine is excreted.³² The MDRD

equation is most useful when serum creatinine results are produced in an assay that has been calibrated to be traceable to an isotope dilution mass spectrometry (IDMS) method.³³

When serum creatinine is measured using an IDMS-traceable method, the MDRD equation for **estimated glomerular filtration rate (eGFR)** is³⁴:

$$\text{eGFR (mL/min/1.73 m}^2\text{)} = 175 \times (S_{Cr})^{-1.154} \times (\text{Age})^{-0.203} \times (0.742 \text{ if female}) \times (1.210 \text{ if African-American}) \quad (\text{Eq. 11-7})$$

where S_{Cr} is serum (plasma) creatinine concentration in mg/dL and age is in years.

Results are normalized to a standard body surface area (1.73 m²). The equation is valid for adults older than 18 years and younger than 70 years of age.³³ The equation was developed using data from nonhospitalized patients known to have chronic kidney disease and is reasonably accurate for this population. Effectiveness of the equation in other groups is being investigated. Clinical laboratories have been strongly encouraged to report eGFR when serum creatinine is ordered as a means to increase detection of kidney disease and improve patient care.³²

Methods

Creatinine

The methods most frequently used to measure creatinine are based on the Jaffe reaction first described in 1886.³⁵ In this reaction, creatinine reacts with picric acid in alkaline solution to form a red-orange chromogen. The reaction was adopted for the measurement of blood creatinine by Folin and Wu in 1919.³⁶ The reaction is non-specific and subject to positive interference by a large number of compounds, including acetoacetate, acetone, ascorbate, glucose, and pyruvate. More accurate results are obtained when creatinine in a protein-free filtrate is adsorbed onto Fuller's earth (aluminum magnesium silicate) or Lloyd's reagent (sodium aluminum silicate) then eluted and reacted with alkaline picrate.³⁷ Because this method is time consuming and not readily automated, it is not used routinely.

Two approaches have been developed to increase the specificity of assay methods for creatinine: a **kinetic Jaffe method** and reaction with various enzymes. In the kinetic Jaffe method, serum is mixed with alkaline picrate and the rate of change in absorbance is measured.³⁸ Although this method eliminates some of the nonspecific reactants, it is subject to interference by α -keto (2-oxo) acids and cephalosporins.³⁹ Bilirubin and hemoglobin may cause a negative bias, probably a result of their destruction in the strong base used. The kinetic Jaffe method is used despite these problems because it is rapid, inexpensive, and easy to perform.

In an effort to enhance the specificity of the Jaffe reaction, several **coupled enzymatic methods** have been developed.^{40,41} The method using creatininase (creatinine amidohydrolase, EC 3.5.2.10), creatinase (creatine amidohydrolase, EC 3.5.3.3), sarcosine oxidase (EC 1.5.3.1), and peroxidase (EC 1.11.1.7) was adapted for use on a dry slide analyzer.⁴²

IDMS is now used as a reference method.³³ Assays used on automated analyzers are designated as “traceable” (calibrated) to an IDMS method. Analytic methods for creatinine are summarized in Table 11-6.

Specimen Requirements and Interfering Substances

Creatinine may be measured in plasma, serum, or urine. Hemolyzed and icteric samples should be avoided, particularly if a Jaffe method is used. Lipemic samples may yield erroneous results in some methods. A fasting sample is not required, although high protein ingestion may transiently elevate serum concentrations. Urine should be refrigerated after collection or frozen if longer storage than 4 days is required.⁸

Sources of Error

Ascorbate, glucose, α -ketoacids, and uric acid may increase creatinine concentration measured by the Jaffe reaction, especially at temperatures above 30°C. This interference is significantly decreased when kinetic measurement is applied. Depending on the concentration of reactants and measuring time, interference from α -ketoacids may persist in kinetic Jaffe methods. Some of these substances interfere in enzymatic methods for creatinine measurement. Bilirubin causes a negative bias in both Jaffe and enzymatic methods. Ascorbate will interfere in enzymatic methods that use peroxidase as a reagent.⁸

Patients taking cephalosporin antibiotics may have falsely increased results when the Jaffe reaction is used. Other drugs have been shown to increase creatinine results. Dopamine, in particular, is known to affect both Jaffe and enzymatic methods. Lidocaine causes a positive bias in some enzymatic methods.²⁶

Creatine

The traditional method for creatine measurement relies on analysis of the sample using an endpoint Jaffe method for creatinine before and after it is heated in acid solution. Heating converts creatine to creatinine and the difference between the two sample measurements is the creatine concentration. High temperatures may result in the formation of additional chromogens and the precision of this method is poor. Several enzymatic methods have been developed; one is the creatininase assay. The initial enzyme is omitted and creatine kinase (EC 2.7.3.2), pyruvate kinase (EC 2.1.7.40), and lactate dehydrogenase (EC 1.1.1.27) are

CASE STUDY 11-2

An 80-year-old woman was admitted with a diagnosis of hypertension, congestive heart failure, anemia, possible diabetes, and chronic renal failure. She was treated with diuretics and IV fluids and released 4 days later. Her laboratory results are shown in Case Study Table 11-2.1.

Five months later, she was readmitted for treatment of repeated bouts of dyspnea. She was placed on a special diet and medication to control her hypertension and was discharged. Medical staff believed that she had not been taking her medication as prescribed, and she was counseled regarding the importance of regular doses.

Questions

1. What is the most probable cause of the patient's elevated urea nitrogen? Which data support your conclusion?
2. Note that this patient's admitting diagnosis is “possible diabetes.” If the patient had truly been a diabetic, with an elevated blood glucose and a positive acetone, what effect would this have had on the measured values of creatinine? Explain.

CASE STUDY TABLE 11-2.1 LABORATORY RESULTS

| | FIRST ADMISSION | | SECOND ADMISSION | |
|-------------------|--------------------|------|---------------------|------|
| | 2/11 | 2/15 | 7/26 | 7/28 |
| Urea N, mg/dL | 58 | * | * | 61.0 |
| Creatinine, mg/dL | 6.2 | 6.2 | 6.4 | 6.0 |
| Uric acid, mg/dL | 10.0 | * | * | 9.2 |
| Urea N/creatinine | 9.4 | * | * | 10.1 |
| Glucose, mg/dL | 86 | 80 | 113 | * |

*Indicates test not performed.

coupled to produce a measurable colored product.⁴³ Creatine can be measured by high performance liquid chromatography (HPLC).^{44,45}

Reference Intervals

Reference intervals vary with assay type, age, and gender. Creatinine concentration decreases with age beginning in the fifth decade of life.

Results expressed in conventional units of milligrams per deciliter can be converted to international units using the molecular mass of creatinine (113 g/mol).

CREATININE⁸

| POPULATION | PLASMA, SERUM, OR URINE | JAFFE METHOD | ENZYMATIC METHOD |
|--------------|-------------------------|---|--|
| Adult Male | Plasma or serum | 0.9–1.3 mg/dL (80–115 $\mu\text{mol/L}$) | 0.6–1.1 mg/dL (55–96 $\mu\text{mol/L}$) |
| Adult Female | Plasma or serum | 0.6–1.1 mg/dL (53–97 $\mu\text{mol/L}$) | 0.5–0.8 mg/dL (40–66 $\mu\text{mol/L}$) |
| Child | Plasma or serum | 0.3–0.7 mg/dL (27–62 $\mu\text{mol/L}$) | 0.0–0.6 mg/dL (0–52 $\mu\text{mol/L}$) |
| Adult Male | Urine 24-H | 800–2,000 mg/day (7.1–17.7 mmol/day) | |
| Adult Female | Urine 24-H | 600–1,800 mg/day (5.3–15.9 mmol/day) | |

Pathophysiology**Creatinine**

Elevated creatinine concentration is associated with abnormal renal function, especially as it relates to glomerular function. Plasma concentration of creati-

nine is inversely proportional to clearance of creatinine. Therefore, when plasma creatinine concentration is elevated, GFR is decreased, indicating renal damage. Plasma creatinine is a relatively insensitive marker and may not be measurably increased until renal function has deteriorated more than 50%.⁴

TABLE 11-6 SUMMARY OF ANALYTIC METHODS—CREATININE**CHEMICAL METHODS BASED ON JAFFE REACTION**

| | OH^- Creatinine + picrate \rightarrow red-orange complex | |
|-------------------------|--|--|
| Jaffe-kinetic | Jaffe reaction performed directly on sample; detection of color formation timed to avoid interference of noncreatinine chromogens | Positive bias from α -ketoacids and cephalosporins; requires automated equipment for precision |
| Jaffe with adsorbent | Creatinine in protein-free filtrate adsorbed onto Fuller's earth (aluminum magnesium silicate); then reacted with alkaline picrate to form colored complex | Adsorbent improves specificity; previously considered reference method |
| Jaffe without adsorbent | Creatinine in protein-free filtrate reacts with alkaline picrate to form colored complex | Positive bias from ascorbic acid, glucose, glutathione, α -ketoacids, uric acid, and cephalosporins |

ENZYMATIC METHODS

| | | |
|--------------------------------------|--|---|
| Creatininase-CK | Creatininase Creatinine + $\text{H}_2\text{O} \rightarrow$ creatine CK Creatine + ATP \rightleftharpoons creatine phosphate + ADP PK Phosphoenolpyruvate + ADP \rightarrow pyruvate + ATP LD Pyruvate + NADH + $\text{H}^+ \rightleftharpoons$ lactate + NAD^+ | Requires large sample; not used widely |
| Creatininase- H_2O_2 | Creatininase Creatinine + $\text{H}_2\text{O} \rightarrow$ creatine Creatininase Creatine $\text{H}_2\text{O} \rightarrow$ sarcosine + urea Sarcosine oxidase Sarcosine + O_2 + $\text{H}_2\text{O} \rightarrow$ glycine + CH_2O + H_2O_2 Peroxidase H_2O_2 + colorless substrate \rightarrow colored product + H_2O | Adapted for use as dry slide method; potential to replace Jaffe; no interference from acetoacetate or cephalosporins; some positive bias due to lidocaine |

OTHER METHODS

| | | |
|---|--|--|
| Isotope dilution mass spectrometry (IDMS) | Detection of characteristic fragments following ionization; quantification using isotopically-labeled compound | Highly specific; accepted reference method |
|---|--|--|

CASE STUDY 11-3

A 3-year-old girl was admitted with a diagnosis of acute lymphocytic leukemia. Her admitting laboratory data are shown in Case Study Table 11-3.1. After admission, she was treated with packed cells, two units of platelets, IV fluids, and allopurinol. On the second hospital day, chemotherapy was begun, using IV vincristine and prednisone and intrathecal injections of methotrexate, prednisone, and cytosine arabinoside. She was discharged for home care 5 days later. She was continued on prednisone and allopurinol at home. She received additional chemotherapy 1 month later (11/1) and again on 11/14. On 12/6, she was readmitted because she had painful sores in her mouth and was unable to eat.

Questions

1. How would you explain the significant elevations of uric acid on admission?
2. What two factors are responsible for the normal levels of uric acid seen in subsequent admissions?
3. What is the most likely cause of the abnormally low level of urea nitrogen observed on 12/6? What other laboratory result would be useful to confirm your suspicions?

CASE STUDY TABLE 11-3.1 LABORATORY RESULTS

| | 10/1 | 10/2 | 10/3 | 10/4 | 11/14 | 12/6 | 6/20 |
|----------------------|--------|------|------|-------|-------|-------|------|
| Urea N, mg/dL | 12.0 | * | * | 15 | 4.0 | 2.0 | * |
| Creatinine, mg/dL | 0.7 | * | * | 1.0 | 0.7 | * | 0.7 |
| Uric acid, mg/dL | 12.0 | 9.2 | 4.0 | 1.9 | 2.3 | * | 3.1 |
| WBC, mm ³ | 56,300 | | | 3,700 | 2,800 | 3,700 | |

*Indicates test not performed.

Creatine

In muscle disease such as muscular dystrophy, poliomyelitis, hyperthyroidism, and trauma, both plasma creatine and urinary creatinine are often elevated. Plasma creatinine concentrations usually are normal in these patients. Measurement of creatine kinase is used typically for the diagnosis of muscle disease because analytic methods for creatine are not readily available in most clinical laboratories. Plasma creatine concentration is not elevated in renal disease.⁶

AMMONIA**Introduction**

Ammonia is formed in the deamination of amino acids during protein metabolism.⁵ It is removed from the circulation and converted to urea in the liver. Free ammonia is toxic; however, ammonia is present in the plasma in low concentrations.

Physiology

Ammonia (NH₃) is produced in the catabolism of amino acids and by bacterial metabolism in the lumen of the intestine.⁷ Some ammonia results from anaerobic metabolic reactions that occur in skeletal muscle during exercise. Ammonia is consumed by the parenchymal cells of

the liver in the production of urea. At normal physiologic pH, most ammonia in the blood exists as ammonium ion (NH₄⁺). Figure 11-5 shows the pH-dependent equilibrium between NH₃ and NH₄⁺. Ammonia is excreted as ammonium ion by the kidney and acts to buffer urine.²⁸

Clinical Applications

Clinical conditions in which blood ammonia concentration provides useful information are hepatic failure, Reye's syndrome, and inherited deficiencies of urea cycle enzymes. Severe liver disease is the most common cause of disturbed ammonia metabolism. The monitoring of blood ammonia may be used to determine prognosis, although correlation between the extent of hepatic encephalopathy and plasma ammonia concentration is not always consistent. Arterial ammonia concentration is a better indicator of the severity of disease.⁴⁶

Reye's syndrome, occurring most commonly in children, is a serious disease that can be fatal. Frequently, the disease is preceded by a viral infection and the administration of aspirin. Reye's syndrome is an acute metabolic disorder of the liver, and autopsy findings

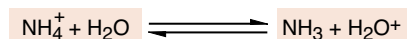

FIGURE 11-5. Interconversion of ammonium ion and ammonia.

show severe fatty infiltration of that organ.⁷ Blood ammonia concentration can be correlated with both the severity of the disease and prognosis. Survival reaches 100% if plasma NH_3 concentration remains below five times normal.⁴⁷

Ammonia is of use in the diagnosis of inherited deficiency of urea cycle enzymes. Testing should be considered for any neonate with unexplained nausea, vomiting, or neurological deterioration associated with feeding.¹⁹

Assay of blood ammonia can be used to monitor hyperalimentation therapy and measurement of urine ammonia can be used to confirm the ability of the kidneys to produce ammonia.⁸

Methods

The accurate laboratory measurement of ammonia in plasma is complicated by its low concentration, instability, and pervasive contamination. Two approaches have been used for the measurement of plasma ammonia. One is a two-step approach in which ammonia is isolated from the sample and then assayed. The second involves direct measurement of ammonia by an enzymatic method or ion-selective electrode. Assays detect NH_3 or NH_4^+ .

One of the first analytic methods for ammonia, developed by Conway in 1935, exploited the volatility of ammonia to separate the compound in a microdiffusion chamber.⁴⁸ Ammonia gas from the sample diffuses into a separate compartment and is absorbed in a solution containing a pH indicator. The amount of ammonia was determined by titration.

Ammonia can be measured by an enzymatic method using glutamate dehydrogenase. This method is convenient and the most common technique used currently.⁴⁹ The decrease in absorbance at 340 nm as nicotinamide adenine dinucleotide phosphate (reduced, NADPH) is consumed in the reaction is proportional to the ammonia concentration in the specimen. NADPH is the preferred

coenzyme because it is used specifically by glutamate dehydrogenase; NADH will participate in reactions of other endogenous substrates, such as pyruvate. Adenosine diphosphate (ADP) is added to the reaction mixture to increase the rate of the reaction and to stabilize GLDH.⁵⁰ This method is used on many automated systems and is available as a prepared kit from numerous manufacturers.

A dry slide automated system uses a thin film colorimetric assay.⁵¹ In this method, ammonia reacts with an indicator to produce a colored compound that is detected spectrophotometrically. Direct measurement using an ion-selective electrode has been developed.⁵² The electrode measures the change in pH of a solution of ammonium chloride as ammonia diffuses across a semipermeable membrane. Analytic methods for ammonia are summarized in Table 11-7.

Specimen Requirements and Interfering Substances

Careful specimen handling is extremely important for plasma ammonia assays. Whole blood ammonia concentration increases rapidly following specimen collection because of *in vitro* amino acid deamination. Venous blood should be obtained without trauma and placed on ice immediately. Heparin and EDTA are suitable anticoagulants. Commercial collection containers should be evaluated for ammonia interference before a new lot is put into use. Samples should be centrifuged at 0°C to 4°C within 20 minutes of collection and the plasma or serum removed. Specimens should be assayed as soon as possible or frozen. Frozen plasma is stable for several days at -20°C. Erythrocytes contain two to three times as much ammonia as plasma; hemolysis should be avoided.

Cigarette smoking by the patient is a significant source of ammonia contamination. It is recommended that patients do not smoke for several hours before the sample is collected.⁸

TABLE 11-7 SUMMARY OF ANALYTIC METHODS—AMMONIA

| CHEMICAL METHODS | | |
|-------------------------|---|--|
| Ion-selective electrode | Diffusion of NH_3 through selective membrane into NH_4Cl causing pH change, which is measured potentiometrically | Good accuracy and precision; membrane stability may be a problem |
| Spectrophotometric | $\text{NH}_3 + \text{bromophenol blue} \rightarrow \text{blue dye}$ | |
| ENZYMATIC METHODS | | |
| GLDH | GLDH $\text{NH}_4^+ + 2\text{-oxoglutarate} + \text{NADPH} + \text{H}^+ \rightleftharpoons \text{glutamate} + \text{NADP}^+ + \text{H}_2\text{O}$ | Most common on automated instruments; accurate and precise |

Many substances influence the in vivo ammonia concentration.^{8,22} Ammonium salts, asparaginase, barbiturates, diuretics, ethanol, hyperalimentation, narcotic analgesics, and some other drugs may increase ammonia in plasma. Diphenhydramine, *Lactobacillus acidophilus*, lactulose, levodopa, and several antibiotics decrease values. Glucose at concentrations greater than 600 mg/dL (33 mmol/L) interferes in dry slide methods.

Sources of Error

Ammonia contamination is a potential problem in the laboratory measurement of ammonia.¹⁹ Precautions must be taken to minimize contamination in the laboratory in which the assay is performed. Elimination of sources of ammonia contamination can significantly improve the accuracy of ammonia assay results. Sources of contamination include tobacco smoke, urine, and ammonia in detergents, glassware, reagents, and water.

The ammonia content of serum-based control material is unstable. Frozen aliquots of human serum albumin containing known amounts of ammonium chloride or ammonium sulfate may be used. Solutions containing known amounts of ammonium sulfate are commercially available.

Reference Interval

Values obtained vary somewhat with the method used. Higher concentrations are seen in newborns.

AMMONIA⁸

| | | | |
|--------------------------------|--------|--------------|----------------|
| Adult | Plasma | 19–60 μg/dL | (11–35 μmol/L) |
| Child (10 days– 2 years) | Plasma | 68–136 μg/dL | (40–80 μmol/L) |

Results are expressed in conventional units of micrograms per deciliter and can be converted to international units using the molecular mass of ammonia (17 g/mol).

Pathophysiology

In severe liver disease in which there is significant collateral circulation or if parenchymal liver cell function is severely impaired, ammonia is not removed from the circulation and blood concentration increases. High concentrations of NH₃ are neurotoxic and often associated with encephalopathy. Toxicity may be partly a result of increased extracellular glutamate concentration and subsequent depletion of adenosine triphosphate (ATP) in the brain.⁵³

Hyperammonemia is associated with inherited deficiency of enzymes of the urea cycle.⁵⁴ Measurement of plasma ammonia is important in the diagnosis and monitoring of these inherited metabolic disorders (see Chapter 34).

REFERENCES

- Gentzkow CJ. An accurate method for determination of blood urea nitrogen by direct nesslerization. *J Biol Chem* 1942;143:531.
- Matthews DE. Proteins and amino acids. In Shils ME, ed. *Modern nutrition in health and disease*. 10th ed. Philadelphia, Pa.: Lippincott Williams & Wilkins, 2006:23.
- Montgomery R, Conway TW, Spector AA, Chappell D. *Biochemistry: A case-oriented approach*. 6th ed. St. Louis, Mo.: Mosby, 1996.
- Oh MS. Evaluation of renal function, water, electrolytes and acid-base balance. In Pincus MR, Lifshitz MS, eds. *Henry's clinical diagnosis and management by laboratory methods*. 21st ed. Philadelphia, Pa.: WB Saunders, 2006:147.
- Coomes MW. Amino acid metabolism. In Devlin TM, ed. *Textbook of biochemistry with clinical correlations*. 6th ed. Hoboken, N.J.: Wiley-Liss, 2006:743.
- Lamb E, Newman DJ, Price CP. Kidney function tests. In Burtis CA, Ashwood ER, Bruns DE, eds. *Tietz Textbook of clinical chemistry and molecular diagnostics*. 4th ed. Philadelphia, Pa.: WB Saunders, 2005:797.
- Harrison's Online. Retrieved spring 2008 from www.harrisonsonline.com/.
- Wu AHB. *Tietz clinical guide to laboratory tests*. 4th ed. St. Louis, Mo.: WB Saunders, 2006.
- Surveys 2007: C-B chemistry/therapeutic drug monitoring and U-B urine chemistry. Northfield, Ill.: College of American Pathologists, 2007.
- Berthelot MPE. Report. *Chim Appl* 1859,1:282.
- Talke H, Schubert GE. Enzymatische hamstoffbestimmung im blut und serum im optischen test nach warburg. *Klin Wochenschr* 1965;43:174.
- Orsonneau J, Massoubre C, Cabanes M, et al. Simple and sensitive determination of urea in serum and urine. *Clin Chem* 1992;38: 619.
- Ohkubo A, Kamei S, Yamanaka M, et al. Multilayer-film analysis for urea nitrogen in blood, serum, or plasma. *Clin Chem* 1984;30: 1222.
- Akai T, Naka K, Yoshikawa C, et al. Salivary urea nitrogen as an index to renal function: a test-strip method. *Clin Chem* 1983;29: 1825.
- Paulson G, Ray R, Sternberg J. A rate sensing approach to urea measurement. *Clin Chem* 1971;17:644.
- Kessler A, Siekmann L. Measurement of urea in human serum by isotope dilution mass spectrometry: A reference procedure. *Clin Chem* 1999;45:1523.
- Dufour DR. *Clinical use of laboratory data: A practical guide*. Baltimore, Md.: Williams & Wilkins, 1998.
- Cory JG. Purine and pyrimidine nucleotide metabolism. In Devlin TM, ed. *Textbook of biochemistry with clinical correlations*. 6th ed. Hoboken, N.J.: Wiley-Liss, 2006:789.
- Jacobs DS, DeMott WR, Oxley DK. *Jacobs & DeMott laboratory test handbook*. Hudson, Ohio: Lexi-Comp, 2001.
- Caraway WT. Uric acid. In Seligson D, ed. *Standard methods of clinical chemistry*. New York: Academic Press, 1965:239.

21. Feichtmeier TV, Wrenn HT. Direct determination of uric acid using uricase. *Am J Clin Pathol* 1955;25:833.
22. Young DS. Effects of preanalytical variables on clinical laboratory tests. 3rd ed. Washington, D.C.: American Association for Clinical Chemistry Press, 2007.
23. Gochman N, Schmitz JM. Automated determination of uric acid with use of a uricase-peroxidase system. *Clin Chem* 1971;17:1154.
24. Kageyama N. A direct colorimetric determination of uric acid in serum and urine with uricase-catalase system. *Clin Chim Acta* 1971;31:421.
25. Ellerbe P, Cohen A, Welch MJ, et al. Determination of serum uric acid by isotope dilution mass spectrometry as a new candidate reference method. *Anal Chem* 1990;62:2173.
26. Young DS. Effects of drugs on clinical laboratory tests. 5th ed. Washington, D.C.: American Association for Clinical Chemistry Press, 2000.
27. eMedicine. Retrieved Spring 2008 from <http://www.emedicine.com>.
28. Apps DK, Cohen BB, Steel CM. Biochemistry: A concise text for medical students. 5th ed. London: WB Saunders, 1992.
29. Assessment of kidney function: Serum creatinine, BUN, and GFR. Retrieved Spring 2008 from <http://www.uptodate.com>.
30. Garde AH, Hansen AM, Kristiansen J, Knudsen LE. Comparison of uncertainties related to standardization of urine samples with volume and creatinine concentration. *Ann Occup Hyg* 2004;48:171.
31. Levey AS, Coresh J, Balk E, et al. National Kidney Foundation practice guidelines for chronic kidney disease: Evaluation, classification, and stratification. *Ann Intern Med* 2003;139:137.
32. National Kidney Disease Education Program. Retrieved Spring 2008 from www.nkdep.nih.gov.
33. Myers GL, Miller WG, Coresh J, et al. Recommendations for improving serum creatinine measurement: A report from the Laboratory Working Group of the National Kidney Disease Education Program. *Clin Chem* 2006;52:5.
34. Levey AS, Coresh J, Greene T, et al. Expressing the Modification of Diet in Renal Disease Study Equation for estimating glomerular filtration rate with standardized serum creatinine values. *Clin Chem* 2007;53:766.
35. Jaffe M. Über den niederschlag welchen pikrinsäure in normalen harn erzeugt und über eine neue reaktion des kreatinins. *Z Physiol Chem* 1886;10:391.
36. Folin O, Wu H. System of blood analysis. *J Biol Chem* 1919;31:81.
37. Haeckel R. Assay of creatinine in serum with use of Fuller's earth to remove interferents. *Clin Chem* 1981;27:179.
38. Larsen K. Creatinine assay by a reaction kinetic principle. *Clin Chem Acta* 1972;41:209.
39. Bowers LD, Wong ET. Kinetic serum creatinine assays. II. A critical evaluation and review. *Clin Chem* 1980;26:555.
40. Moss GA, Bondar RJL, Buzzelli DM. Kinetic enzymatic method for determining serum creatinine. *Clin Chem* 1975;21:1422.
41. Fossati P, Prencipe L, Berti G. Enzymic creatinine assay: a new colorimetric method based on hydrogen peroxide measurement. *Clin Chem* 1983;29:1494.
42. Creatinine test methodology. Kodak Ektachem clinical chemistry products. Rochester, N.Y.: Eastman Kodak Company, 1992 (Publication no. MP2-49).
43. Beyer, C. Creatine measurement in serum and urine with an automated enzymatic method. *Clin Chem* 1993;39:1613.
44. Murakita H. Simultaneous determination of creatine and creatinine in serum by high-performance liquid chromatography. *J Chromatogr* 1988;431:471.
45. Yang YD. Simultaneous determination of creatine, uric acid, creatinine and hippuric acid in urine by high performance liquid chromatography. *Biomed Chromatogr* 1998;12:47.
46. Pincus MR, Tierno P, Dufour DR. Evaluation of liver function. In Pincus MR, Lifshitz MS, eds. *Henry's clinical diagnosis and management by laboratory methods*. 21st ed. Philadelphia, Pa.: WB Saunders, 2006:263.
47. Fitzgerald JF, Clark JH, Angelides AG, et al. The prognostic significance of peak ammonia levels in Reye's syndrome. *Pediatrics* 1982;70:997.
48. Conway EJ, O'Malley E. Microdiffusion methods: Ammonia and urea using buffered absorbents (Revised methods for ranges greater than 10 $\mu\text{g N}$). *Biochem* 1942;36:655.
49. Mondzac A, Ehrlich GE, Seegmiller JE. An enzymatic determination of ammonia in biological fluids. *J Lab Clin Med* 1965;66:526.
50. Ammonia test methodology. Roche/Hitachi products. Indianapolis, Ind.: Roche Diagnostics Corp, 2001.
51. VITROS AMON Slides. Instructions for use. VITROS Chemistry Products. Rochester, N.Y.: Ortho-Clinical Diagnostics, 2002 (Publication no. MP2-90).
52. Willems D, Steenssens W. Ammonia determined in plasma with a selective electrode. *Clin Chem* 1988;34:2372.
53. Monfort P, Kosenko E, Erceg S, et al. Molecular mechanism of acute ammonia toxicity: role of NMDA receptors. *Neurochem Int* 2002;41:95.
54. Rinaldo P, Hahn S, Matern D. Inborn errors of amino acid, organic acid, and fatty acid metabolism. In Burtis CA, Ashwood ER, Bruns DE, eds. *Tietz textbook of clinical chemistry and molecular diagnostics*. 4th ed. Philadelphia, Pa.: WB Saunders, 2005:2207.

Enzymes

Kamisha Johnson-Davis, Gwen A. McMillin

CHAPTER

12

CHAPTER OUTLINE

■ GENERAL PROPERTIES AND DEFINITIONS

■ ENZYME CLASSIFICATION AND NOMENCLATURE

■ ENZYME KINETICS

Catalytic Mechanism of Enzymes
Factors That Influence Enzymatic Reactions
Measurement of Enzyme Activity
Calculation of Enzyme Activity
Measurement of Enzyme Mass
Enzymes as Reagents

■ ENZYMES OF CLINICAL SIGNIFICANCE

Creatine Kinase
Lactate Dehydrogenase

Aspartate Aminotransferase

Alanine Aminotransferase

Alkaline Phosphatase

Acid Phosphatase

γ -Glutamyltransferase

Amylase

Lipase

Glucose-6-Phosphate Dehydrogenase

Drug-Metabolizing Enzymes

■ REFERENCES

Enzymes are specific biologic proteins that catalyze biochemical reactions without altering the equilibrium point of the reaction or being consumed or changed in composition. The other substances in the reaction are converted to products. The catalyzed reactions are frequently specific and essential to physiologic functions, such as the hydration of carbon dioxide, nerve conduction, muscle contraction, nutrient degradation, and energy use. Found in all body tissue, enzymes frequently appear in the serum following cellular injury or, sometimes, in smaller amounts, from degraded cells. Certain enzymes, such as those that facilitate coagulation, are specific to plasma and, therefore, are present in significant concentrations in plasma. Plasma or serum enzyme levels are often useful in the diagnosis of particular diseases or physiologic abnormalities. This chapter discusses the general properties and principles of enzymes, aspects relating to the clinical diagnostic significance of specific physiologic enzymes, and assay methods for those enzymes.

GENERAL PROPERTIES AND DEFINITIONS

Enzymes catalyze many specific physiologic reactions. These reactions are facilitated by the enzyme structure and several other factors. As a protein, each enzyme contains a specific amino acid sequence (*primary structure*),

with the resultant polypeptide chains twisting (*secondary structure*), which then folds (*tertiary structure*) and results in structural cavities. If an enzyme contains more than one polypeptide unit, the *quaternary structure* refers to the spatial relationships between the subunits. Each enzyme contains an *active site*, often a water-free cavity, where the substance on which the enzyme acts (the *substrate*) interacts with particular charged amino acid residues. An *allosteric site*—a cavity other than the active site—may bind regulator molecules and, thereby, be significant to the basic enzyme structure.

Even though a particular enzyme maintains the same catalytic function throughout the body, that enzyme may exist in different forms within the same individual. The different forms may be differentiated from each other based on certain physical properties, such as electrophoretic mobility, solubility, or resistance to inactivation. The term **isoenzyme** is generally used when discussing such enzymes; however, the International Union of Biochemistry (IUB) suggests restricting this term to multiple forms of genetic origin. An **isoform** results when an enzyme is subject to posttranslational modifications. Isoenzymes and isoforms contribute to heterogeneity in properties and function of enzymes.

In addition to the basic enzyme structure, a nonprotein molecule, called a **cofactor**, may be necessary for enzyme activity. Inorganic cofactors, such as chloride or

TABLE 12-1 CLASSIFICATION OF FREQUENTLY QUANTITATED ENZYMES

| CLASS | RECOMMENDED NAME | COMMON ABBREVIATION | STANDARD ABBREVIATION | EC CODE NO. | SYSTEMATIC NAME |
|-----------------|-----------------------------------|---|-----------------------|-------------|--|
| Oxidoreductases | Lactate dehydrogenase | LDH | LDH | 1.1.1.27 | L-Lactate:NAD ⁺ oxidoreductase |
| | Glucose-6-phosphate dehydrogenase | G-6-PDH | G-6-PD | 1.1.1.49 | D-Glucose-6-phosphate:NADP ⁺ 1-oxidoreductase |
| | Glutamate dehydrogenase | GLD | GLD | 1.4.1.3 | L-glutamate:NAD(P) oxidoreductase, deaminase |
| Transferases | Aspartate amino-transferase | GOT (glutamate oxaloacetate transaminase) | AST | 2.6.1.1 | L-Aspartate:2-oxaloglutarate aminotransferase |
| | Alanine amino-transferase | GPT (glutamate transaminase) | ALT | 2.6.1.2 | L-Alanine:2-oxaloglutarate aminotransferase |
| | Creatine kinase | CPK (creatine phosphokinase) | CK | 2.7.3.2 | ATP:creatine <i>N</i> -phosphotransferase |
| | γ-Glutamyl-transferase | GGTP | GGT | 2.3.2.2 | (5-Glutamyl)peptide: amino acid-5-glutamyltransferase |
| | Glutathione-S-transferase | α-GST | GST | 2.5.1.18 | Glutathione transferase |
| | Glycogen phosphorylase | GP | GP | 2.4.1.1 | 1,4-α-D-Glucan: orthophosphate α-D-glucosyltransferase |
| | Pyruvate kinase | PK | PK | 2.7.1.40 | Pyruvate kinase |
| Hydrolases | Alkaline phosphatase | ALP | ALP | 3.1.3.1 | Orthophosphoric monoester phosphohydrolase (alkaline optimum) |
| | Acid phosphatase | ACP | ACP | 3.1.3.2 | Orthophosphoric monoester phosphohydrolase (acid optimum) |
| | α-Amylase | AMY | AMS | 3.2.1.1 | 1,4-D-Glucan glucanohydrolase |
| | Cholinesterase | PCHE | CHE | 3.1.1.8 | Acylcholine acylhydrolase |
| | Chymotrypsin | CHY | CHY | 3.4.21.1 | Chymotrypsin |
| | Elastase-1 | E1 | E1 | 3.4.21.36 | Elastase |
| | 5-Nucleotidase | NTP | NTP | 3.1.3.5 | 5'-Ribonucleotide phosphohydrolase |
| | Triacylglycerol lipase | | LPS | 3.1.1.3 | Triacylglycerol acylhydrolase |
| Trypsin | TRY | TRY | 3.4.21.4 | Trypsin | |
| Lyases | Aldolase | ALD | ALD | 4.1.2.13 | D-D-Fructose-1,6-bisdiphosphate D-glyceraldehyde-3-phosphate-lyase |
| Isomerases | Triosephosphate isomerase | TPI | TPI | 5.3.1.1 | Triose-phosphate isomerase |
| Ligase | Glutathione Synthetase | GSH-S | GSH-S | 6.3.2.3 | Glutathione synthase |

Adapted with permission from Competence Assurance, ASMT. *Enzymology*, an educational program. Bethesda, Md.: RMI Corporation, 1980.

magnesium ions, are called **activators**. A **coenzyme** is an organic cofactor, such as nicotinamide adenine dinucleotide (NAD). When bound tightly to the enzyme, the coenzyme is called a *prosthetic group*. The enzyme portion (**apoenzyme**), with its respective coenzyme, forms a complete and active system, a **holoenzyme**.

Some enzymes, mostly digestive enzymes, are originally secreted from the organ of production in a structurally inactive form, called a *proenzyme* or **zymogen**. Other enzymes later alter the structure of the proenzyme to make active sites available by hydrolyzing specific amino acid residues. This mechanism prevents digestive enzymes from digesting their place of synthesis.

ENZYME CLASSIFICATION AND NOMENCLATURE

To standardize enzyme nomenclature, the Enzyme Commission (EC) of the IUB adopted a classification system in 1961; the standards were revised in 1972 and 1978. The IUB system assigns a *systematic name* to each enzyme, defining the substrate acted on, the reaction catalyzed, and, possibly, the name of any coenzyme involved in the reaction. Because many systematic names are lengthy, a more usable, trivial, *recommended name* is also assigned by the IUB system.¹

In addition to naming enzymes, the IUB system identifies each enzyme by an EC numerical code containing four digits separated by decimal points. The first digit places the enzyme in one of the following six classes:

1. **Oxidoreductases**. Catalyze an oxidation–reduction reaction between two substrates
2. **Transferases**. Catalyze the transfer of a group other than hydrogen from one substrate to another
3. **Hydrolases**. Catalyze hydrolysis of various bonds
4. **Lyases**. Catalyze removal of groups from substrates without hydrolysis; the product contains double bonds
5. **Isomerases**. Catalyze the interconversion of geometric, optical, or positional isomers
6. **Ligases**. Catalyze the joining of two substrate molecules, coupled with breaking of the pyrophosphate bond in adenosine triphosphate (ATP) or a similar compound

The second and third digits of the EC code number represent the subclass and subclass of the enzyme, respectively, divisions that are made according to criteria specific to the enzymes in the class. The final number is the serial number specific to each enzyme in a subclass. Table 12-1 provides the EC code numbers, as well as the systematic and recommended names, for enzymes frequently measured in the clinical laboratory.

Table 12-1 also lists common and standard abbreviations for commonly analyzed enzymes. Without IUB recommendation, capital letters have been used as a con-

venience to identify enzymes. The common abbreviations, sometimes developed from previously accepted names for the enzymes, were used until the standard abbreviations listed in the table were developed.^{2,3} These standard abbreviations are used in the United States and are used later in this chapter to indicate specific enzymes.

ENZYME KINETICS

Catalytic Mechanism of Enzymes

A chemical reaction may occur spontaneously if the free energy or available kinetic energy is higher for the reactants than for the products. The reaction then proceeds toward the lower energy if a sufficient number of the reactant molecules possess enough excess energy to break their chemical bonds and collide to form new bonds. The excess energy, called **activation energy**, is the energy required to raise all molecules in 1 mole of a compound at a certain temperature to the transition state at the peak of the energy barrier. At the transition state, each molecule is equally likely to either participate in product formation or remain an unreacted molecule. Reactants possessing enough energy to overcome the energy barrier participate in product formation.

One way to provide more energy for a reaction is to increase the temperature and thus increase intermolecular collisions; however, this does not normally occur physiologically. Enzymes catalyze physiologic reactions by lowering the activation energy level that the reactants (*substrates*) must reach for the reaction to occur (Fig. 12-1). The reaction may then occur more readily to a state of equilibrium in which there is no net forward or reverse reaction, even though the equilibrium constant of the

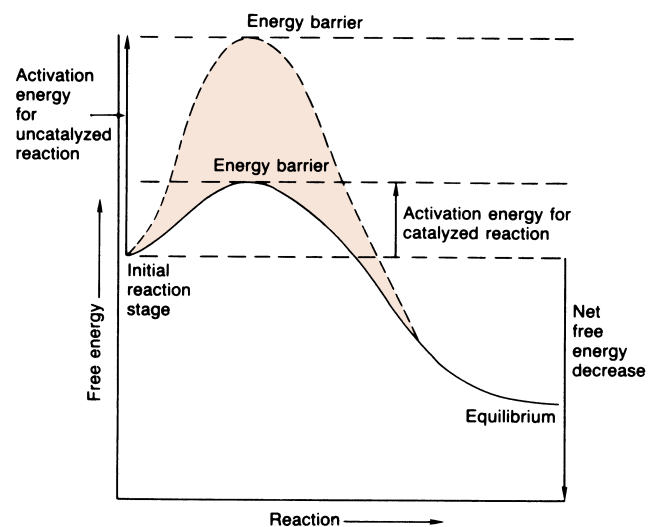

FIGURE 12-1. Energy versus progression of reaction, indicating the energy barrier that the substrate must surpass to react with and without enzyme catalysis. The enzyme considerably reduces the free energy needed to activate the reaction.

reaction is not altered. The extent to which the reaction progresses depends on the number of substrate molecules that pass the energy barrier.

The general relationship among enzyme, substrate, and product may be represented as follows:



where E is enzyme, S is substrate, ES is enzyme–substrate complex, and P is product.

The ES complex is a physical binding of a substrate to the active site of an enzyme. The structural arrangement of amino acid residues within the enzyme makes the three-dimensional active site available. At times, the binding of ligand drives a rearrangement to make the active site. The transition state for the ES complex has a lower energy of activation than the transition state of S alone, so that the reaction proceeds after the complex is formed. An actual reaction may involve several substrates and products.

Different enzymes are specific to substrates in different extents or respects. Certain enzymes exhibit *absolute specificity*, meaning that the enzyme combines with only one substrate and catalyzes only the one corresponding reaction. Other enzymes are *group specific* because they combine with all substrates containing a particular chemical group, such as a phosphate ester. Still other enzymes are specific to chemical bonds and thereby exhibit *bond specificity*.

Stereoisometric specificity refers to enzymes that predominantly combine with only one optical isomer of a certain compound. In addition, an enzyme may bind more than one molecule of substrate, and this may occur in a cooperative fashion. Binding of one substrate molecule, therefore, may facilitate binding of additional substrate molecules.

Factors That Influence Enzymatic Reactions

Substrate Concentration

The rate at which an enzymatic reaction proceeds and whether the forward or reverse reaction occurs depend on several reaction conditions. One major influence on enzymatic reactions is substrate concentration. In 1913, Michaelis and Menten hypothesized the role of substrate concentration in formation of the **enzyme–substrate (ES) complex**. According to their hypothesis, represented in Figure 12-2, the substrate readily binds to free enzyme at a low-substrate concentration. With the amount of enzyme exceeding the amount of substrate, the reaction rate steadily increases as more substrate is added. The reaction is following **first-order kinetics** because the reaction rate is directly proportional to substrate concentration. Eventually, however, the substrate concentration is high enough to saturate all available enzyme, and the reaction velocity reaches its maximum.

When product is formed, the resultant free enzyme immediately combines with excess free substrate. The reaction is in **zero-order kinetics**, and the reaction rate depends only on enzyme concentration.

The **Michaelis-Menten constant** (K_m), derived from the theory of Michaelis and Menten, is a constant for a specific enzyme and substrate under defined reaction conditions and is an expression of the relationship between the velocity of an enzymatic reaction and substrate concentration. The assumptions are made that equilibrium among E, S, ES, and P is established rapidly and that the $E + P \rightarrow ES$ reaction is negligible. The rate-limiting step is the formation of product and enzyme from the ES complex. Then, maximum velocity is fixed, and the reaction rate is a function of only the enzyme concentration. As designated in Figure 12-2, K_m is specifically the substrate concentration at which the enzyme yields half the possible maximum velocity. Therefore, K_m indicates the amount of substrate needed for a particular enzymatic reaction.

The Michaelis-Menten hypothesis of the relationship between reaction velocity and substrate concentration can be represented mathematically as follows:

$$V = \frac{V_{\max}[S]}{K_m + [S]} \quad (\text{Eq. 12-2})$$

where V is measured velocity of reaction, V_{\max} is maximum velocity, $[S]$ is substrate concentration, and K_m is Michaelis-Menten constant of enzyme for specific substrate.

Theoretically, V_{\max} and then K_m could be determined from the plot in Figure 12-2. However, V_{\max} is difficult to determine from the hyperbolic plot and often not actually achieved in enzymatic reactions because enzymes may not function optimally in the presence of

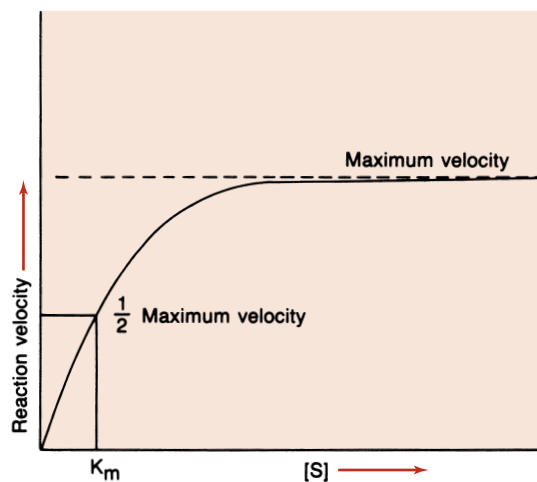

FIGURE 12-2. Michaelis-Menten curve of velocity versus substrate concentration for enzymatic reaction. K_m is the substrate concentration at which the reaction velocity is half of the maximum level.

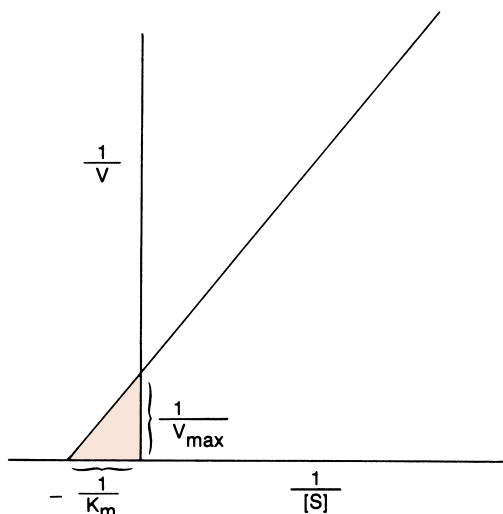

FIGURE 12-3. Lineweaver-Burk transformation of Michaelis-Menten curve. V_{max} is the reciprocal of the x -intercept of the straight line. K_m is the negative reciprocal of the x -intercept of the same line.

excessive substrate. A more accurate and convenient determination of V_{max} and K_m may be made through a Lineweaver-Burk plot, a double-reciprocal plot of the Michaelis-Menten constant, which yields a straight line (Fig. 12-3). The reciprocal is taken of both the substrate concentration and the velocity of an enzymatic reaction. The equation becomes

$$\frac{1}{V} = \frac{K_m}{V_{max}} \frac{1}{[S]} + \frac{1}{V_{max}} \quad (\text{Eq. 12-3})$$

Enzyme Concentration

Because enzymes catalyze physiologic reactions, the enzyme concentration affects the rate of the catalyzed reaction. As long as the substrate concentration exceeds the enzyme concentration, the velocity of the reaction is proportional to the enzyme concentration. The higher the enzyme level, the faster the reaction will proceed because more enzyme is present to bind with the substrate.

pH

Enzymes are proteins that carry net molecular charges. Changes in pH may denature an enzyme or influence its ionic state, resulting in structural changes or a change in the charge on an amino acid residue in the active site. Hence, each enzyme operates within a specific pH range and maximally at a specific pH. Most physiologic enzymatic reactions occur in the pH range of 7.0 to 8.0, but some enzymes are active in wider pH ranges than others. In the laboratory, the pH for a reaction is carefully controlled at the optimal pH by means of appropriate buffer solutions.

Temperature

Increasing temperature usually increases the rate of a chemical reaction by increasing the movement of mole-

cules, the rate at which intermolecular collisions occur, and the energy available for the reaction. This is the case with enzymatic reactions until the temperature is high enough to denature the protein composition of the enzyme. For each 10° increase in temperature, the rate of the reaction will approximately double until, of course, the protein is denatured.

Each enzyme functions optimally at a particular temperature, which is influenced by other reaction variables, especially the total time for the reaction. The optimal temperature is usually close to that of the physiologic environment of the enzyme; however, some denaturation may occur at the human physiologic temperature of 37°C. The rate of denaturation increases as the temperature increases and is usually significant at 40° to 50°C.

Because low temperatures render enzymes reversibly inactive, many serum or plasma specimens for enzyme measurement are refrigerated or frozen to prevent activity loss until analysis. Storage procedures may vary from enzyme to enzyme because of individual stability characteristics. Repeated freezing and thawing, however, tends to denature protein and should be avoided.

Because of their temperature sensitivity, enzymes should be analyzed under strictly controlled temperature conditions. Incubation temperatures should be accurate within $\pm 0.1^\circ\text{C}$. Laboratories usually attempt to establish an analysis temperature for routine enzyme measurement of 25°, 30°, or 37°C. Attempts to establish a universal temperature for enzyme analysis have been futile and, therefore, reference ranges for enzyme levels may vary significantly among laboratories. In the United States, however, 37°C is most commonly used.

Cofactors

Cofactors are nonprotein entities that must bind to particular enzymes before a reaction occurs. Common *activators* (inorganic cofactors) are metallic (Ca^{2+} , Fe^{2+} , Mg^{2+} , Mn^{2+} , Zn^{2+} , and K^+) and nonmetallic (Br^- and Cl^-). The activator may be essential for the reaction or may only enhance the reaction rate in proportion with concentration to the point at which the excess activator begins to inhibit the reaction. Activators function by alternating the spatial configuration of the enzyme for proper substrate binding, linking substrate to the enzyme or coenzyme, or undergoing oxidation or reduction.

Some common coenzymes (organic cofactors) are nucleotide phosphates and vitamins. Coenzymes serve as second substrates for enzymatic reactions. When bound tightly to the enzyme, coenzymes are called *prosthetic groups*. For example, NAD as a cofactor may be reduced to nicotinamide adenine dinucleotide phosphate (NADP) in a reaction in which the primary substrate is oxidized. Increasing coenzyme concentration will increase the velocity of an enzymatic reaction in a manner synonymous with increasing substrate concentration.

When quantitating an enzyme that requires a particular cofactor, that cofactor should always be provided in excess so that the extent of the reaction does not depend on the concentration of the cofactor.

Inhibitors

Enzymatic reactions may not progress normally if a particular substance, an *inhibitor*, interferes with the reaction. *Competitive inhibitors* physically bind to the active site of an enzyme and compete with the substrate for the active site. With a substrate concentration significantly higher than the concentration of the inhibitor, the inhibition is reversible because the substrate is more likely than the inhibitor to bind the active site and the enzyme has not been destroyed.

A *noncompetitive inhibitor* binds an enzyme at a place other than the active site and may be reversible in the respect that some naturally present metabolic substances combine reversibly with certain enzymes. Noncompetitive inhibition also may be *irreversible* if the inhibitor destroys part of the enzyme involved in catalytic activity. Because the inhibitor binds the enzyme independently from the substrate, increasing substrate concentration does not reverse the inhibition.

Uncompetitive inhibition is another kind of inhibition in which the inhibitor binds to the ES complex—increasing substrate concentration results in more ES complexes to which the inhibitor binds and, thereby, increases the inhibition. The enzyme–substrate–inhibitor complex does not yield product.

Each of the three kinds of inhibition is unique with respect to effects on the V_{\max} and K_m of enzymatic reactions (Fig. 12-4). In competitive inhibition, the effect of the inhibitor can be counteracted by adding excess sub-

strate to bind the enzyme. The amount of the inhibitor is then negligible by comparison, and the reaction will proceed at a slower rate but to the same maximum velocity as an uninhibited reaction. The K_m is a constant for each enzyme and cannot be altered. However, because the amount of substrate needed to achieve a particular velocity is higher in the presence of a competing inhibitor, the K_m appears to increase when exhibiting the effect of the inhibitor.

The substrate and inhibitor, commonly a metallic ion, may bind an enzyme simultaneously in noncompetitive inhibition. The inhibitor may inactivate either an ES complex or just the enzyme by causing structural changes in the enzyme. Even if the inhibitor binds reversibly and does not inactivate the enzyme, the presence of the inhibitor when it is bound to the enzyme slows the rate of the reaction. Thus, for noncompetitive inhibition, the maximum reaction velocity cannot be achieved. Increasing substrate levels has no influence on the binding of a noncompetitive inhibitor, so the K_m is unchanged.

Because uncompetitive inhibition requires the formation of an ES complex, increasing substrate concentration increases inhibition. Therefore, maximum velocity equal to that of an uninhibited reaction cannot be achieved, and the K_m appears to be decreased.

Measurement of Enzyme Activity

Because enzymes are usually present in very small quantities in biologic fluids and often difficult to isolate from similar compounds, a convenient method of enzyme quantitation is measurement of catalytic activity. Activity is then related to concentration. Common methods might photometrically measure an increase in product

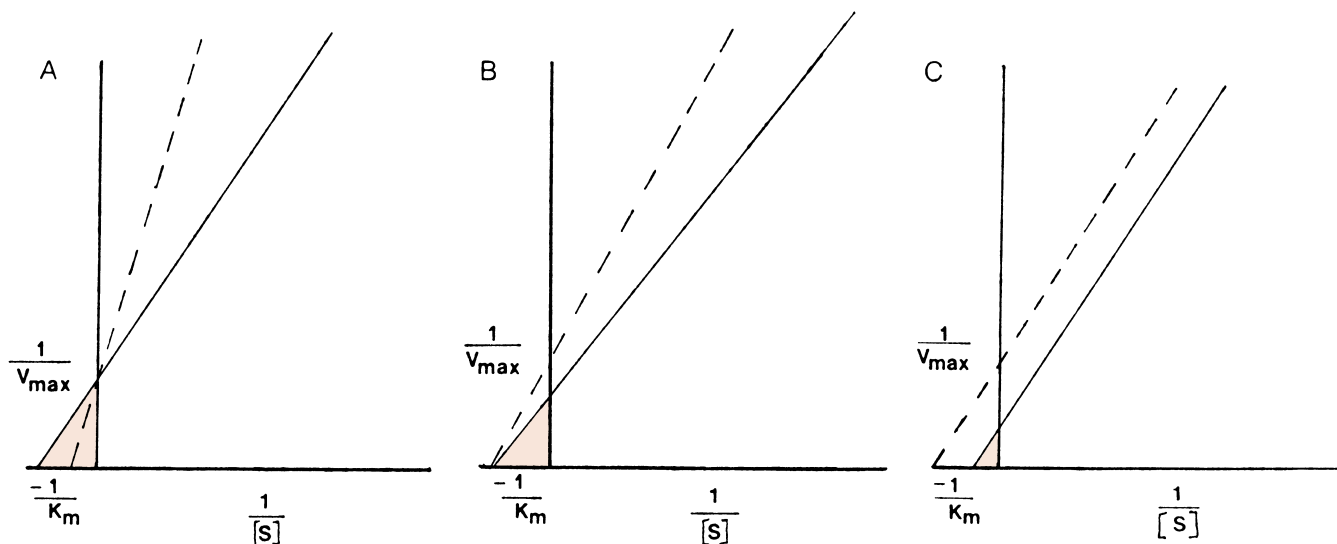

FIGURE 12-4. Normal Lineweaver-Burk plot (solid line) compared with each type of enzyme inhibition (dotted line). (A) Competitive inhibition V_{\max} unaltered; K_m appears increased. (B) Noncompetitive inhibition V_{\max} decreased; K_m unchanged. (C) Uncompetitive inhibition V_{\max} decreased; K_m appears decreased.

concentration, a decrease in substrate concentration, a decrease in coenzyme concentration, or an increase in the concentration of an altered coenzyme.

If the amount of substrate and any coenzyme is in excess in an enzymatic reaction, the amount of substrate or coenzyme used, or product or altered coenzyme formed, will depend only on the amount of enzyme present to catalyze the reaction. Enzyme concentrations, therefore, are always performed in zero-order kinetics, with the substrate in sufficient excess to ensure that no more than 20% of the available substrate is converted to product. Any coenzymes also must be in excess. NADH is a coenzyme frequently measured in the laboratory. NADH absorbs light at 340 nm, whereas NAD does not, and a change in absorbance at 340 nm is easily measured.

In specific laboratory methodologies, substances other than substrate or coenzyme are necessary and must be present in excess. NAD or NADH is often convenient as a reagent for a *coupled-enzyme* assay when neither NAD nor NADH is a coenzyme for the reaction. In other coupled-enzyme assays, more than one enzyme is added in excess as a reagent and multiple reactions are catalyzed. After the enzyme under analysis catalyzes its specific reaction, a product of that reaction becomes the substrate on which an intermediate *auxiliary enzyme* acts. A product of the intermediate reaction becomes the substrate for the final reaction, which is catalyzed by an *indicator enzyme* and commonly involves the conversion of NAD to NADH or vice versa.

When performing an enzyme quantitation in zero-order kinetics, inhibitors must be lacking and other variables that may influence the rate of the reaction must be carefully controlled. A constant pH should be maintained by means of an appropriate buffer solution. The temperature should be constant within $\pm 0.1^\circ\text{C}$ throughout the assay at a temperature at which the enzyme is active (usually, 25° , 30° , or 37°C).

During the progress of the reaction, the period for the analysis also must be carefully selected. When the enzyme is initially introduced to the reactants and the excess substrate is steadily combining with available enzyme, the reaction rate rises. After the enzyme is saturated, the rates of product formation, release of enzyme, and recombination with more substrate proceed linearly. After a time, usually 6 to 8 minutes after reaction initiation, the reaction rate decreases as the substrate is depleted, the reverse reaction is occurring appreciably, and the product begins to inhibit the reaction. Hence, enzyme quantitations must be performed during the linear phase of the reaction.

One of two general methods may be used to measure the extent of an enzymatic reaction: (1) fixed-time and (2) continuous-monitoring or kinetic assay. In the *fixed-time method*, the reactants are combined, the reaction proceeds for a designated time, the reaction is stopped

(usually by inactivating the enzyme with a weak acid), and a measurement is made of the amount of reaction that has occurred. The reaction is assumed to be linear over the reaction time; the larger the reaction, the more enzyme is present.

In *continuous-monitoring* or **kinetic assays**, multiple measurements, usually of absorbance change, are made during the reaction, either at specific time intervals (usually every 30 or 60 seconds) or continuously by a continuous-recording spectrophotometer. These assays are advantageous over fixed-time methods because the linearity of the reaction may be more adequately verified. If absorbance is measured at intervals, several data points are necessary to increase the accuracy of linearity assessment. Continuous measurements are preferred because any deviation from linearity is readily observable.

The most common cause of deviation from linearity occurs when the enzyme is so elevated that all substrate is used early in the reaction time. For the remainder of the reaction, the rate change is minimal, with the implication that the coenzyme concentration is very low. With continuous monitoring, the laboratorian may observe a sudden decrease in the reaction rate (deviation from zero-order kinetics) of a particular determination and may repeat the determination using less patient sample. The decrease in the amount of patient sample operates as a dilution, and the answer obtained may be multiplied by the dilution factor to obtain the final answer. The sample itself is not diluted so that the diluent cannot interfere with the reaction. (Sample dilution with saline may be necessary to minimize negative effects in analysis caused by hemolysis or lipemia.) Enzyme activity measurements may not be accurate if storage conditions compromise integrity of the protein, if enzyme inhibitors are present, or if necessary cofactors are not present.

Calculation of Enzyme Activity

When enzymes are quantitated relative to their activity rather than a direct measurement of concentration, the units used to report enzyme levels are *activity units*. The definition for the activity unit must consider variables that may alter results (e.g., pH, temperature, substrate). Historically, specific method developers frequently established their own units for reporting results and often named the units after themselves (i.e., Bodansky and King units). To standardize the system of reporting quantitative results, the EC defined the **international unit (IU)** as the amount of enzyme that will catalyze the reaction of 1 μmol of substrate per minute under specified conditions of temperature, pH, substrates, and activators. Because the specified conditions may vary among laboratories, reference values are still often laboratory specific. Enzyme concentration is usually expressed in units per liter (IU/L). The unit of enzyme activity recognized by

the International System of Units (Système International d'Unités [SI]) is the katal (mol/s). The mole is the unit for substrate concentration, and the unit of time is the second. Enzyme concentration is then expressed as katal per liter (kat/L) ($1.0 \text{ IU} = 17 \text{ nkat}$).

When enzymes are quantitated by measuring the increase or decrease of NADH at 340 nm, the molar absorptivity ($6.22 \times 10^3 \text{ mol/L}$) of NADH is used to calculate enzyme activity.

Measurement of Enzyme Mass

Immunoassay methodologies that quantify enzyme concentration by mass are also available and are routinely used for quantification of some enzymes, such as creatine kinase (CK)-MB. Immunoassays may overestimate active enzyme as a result of possible cross-reactivity with inactive enzymes, such as zymogens, inactive isoenzymes, macroenzymes, or partially digested enzyme. The relationship between enzyme activity and enzyme quantity is generally linear but should be determined for each enzyme. Enzymes may also be determined and quantified by electrophoretic techniques, which provide resolution of isoenzymes and isoforms.

Ensuring the accuracy of enzyme measurements has long been a concern of laboratorians. The Clinical Laboratory Improvement Amendment of 1988 (CLIA '88) has established guidelines for quality control and profi-

ciency testing for all laboratories. Problems with quality control materials for enzyme testing have been a significant issue. Differences between clinical specimens and control sera include species of origin of the enzyme, integrity of the molecular species, isoenzyme forms, matrix of the solution, addition of preservatives, and lyophilization processes. Many studies have been conducted to ensure accurate enzyme measurements and good quality control materials.⁴

Enzymes as Reagents

Enzymes may be used as reagents to measure many nonenzymatic constituents in serum. For example, glucose, cholesterol, and uric acid are frequently quantitated by means of enzymatic reactions, which measure the concentration of the analyte due to the specificity of the enzyme. Enzymes are also used as reagents for methods of quantitating analytes that are substrates for corresponding enzyme quantitations. One example, lactate dehydrogenase (LDH), may be a reagent when lactate or pyruvate concentrations are evaluated. For such methods, the enzyme is added in excess in a quantity sufficient to provide a complete reaction in a short period.

Immobilized enzymes are chemically bonded to adsorbents, such as agarose or certain types of cellulose, by azide groups, diazo, and triazine. The enzymes act as recoverable reagents. When substrate is passed through the preparation, the product is retrieved and analyzed, and the enzyme is present and free to react with more substrate. Immobilized enzymes are convenient for batch analyses and are more stable than enzymes in a solution. Enzymes are also commonly used as reagents in competitive and noncompetitive immunoassays, such as those used to measure human immunodeficiency virus (HIV) antibodies, therapeutic drugs, and cancer antigens. Commonly used enzymes include horseradish peroxidase, alkaline phosphatase, glucose-6-phosphate dehydrogenase, and β -galactosidase. The enzyme in these assays functions as an indicator that reflects either the presence or absence of the analyte.

CASE STUDY 12-1

A 51-year-old, overweight white man visits his family physician with a symptom of "indigestion" of 5 days' duration. He has also had bouts of sweating, malaise, and headache. His blood pressure is 140/105 mm Hg; his family history includes a father with diabetes who died at age 62 of AMI secondary to diabetes mellitus. An electrocardiogram revealed changes from one performed 6 months earlier. The results of the patient's blood work are as follows:

| | | |
|-------|------------|---------------|
| CK | 129 U/L | (30–60) |
| CK-MB | 4% | (<6%) |
| LDH | 280 U/L | (100–225) |
| LDH | Isoenzymes | LDH-1 > LDH-2 |
| AST | 35 U/L | (5–30) |

Questions

1. Can a diagnosis of AMI be ruled out in this patient?
2. What further cardiac markers should be run on this patient?
3. Should this patient be admitted to the hospital?

ENZYMES OF CLINICAL SIGNIFICANCE

Table 12-2 lists the commonly analyzed enzymes, including their systematic names and clinical significance. Each enzyme is discussed in this chapter with respect to tissue source, diagnostic significance, assay method, source of error, and reference range.

Creatine Kinase

CK is an enzyme with a molecular weight of approximately 82,000 that is generally associated with ATP regeneration in contractile or transport systems. Its predominant physiological function occurs in muscle cells,

TABLE 12-2 MAJOR ENZYMES OF CLINICAL SIGNIFICANCE

| ENZYME | CLINICAL SIGNIFICANCE |
|--|--|
| Acid phosphatase (ACP) | Prostatic carcinoma |
| Alanine aminotransferase (ALT) | Hepatic disorder |
| Aldolase (ALD) | Skeletal muscle disorder |
| Alkaline phosphatase (ALP) | Hepatic disorder Bone disorder |
| Amylase (AMS) | Acute pancreatitis |
| Angiotensin-converting enzyme (ACE) | Blood pressure regulation |
| Aspartate amino-transferase (AST) | Myocardial infarction Hepatic disorder Skeletal muscle disorder |
| Chymotrypsin (CHY) | Chronic pancreatitis insufficiency |
| Creatine kinase (CK) | Myocardial infarction Skeletal muscle disorder |
| Elastase-1 (E1) | Chronic pancreatitis insufficiency |
| Glucose-6-phosphate dehydrogenase (G-6-PD) | Drug-induced hemolytic anemia |
| Glutamate dehydrogenase (GLD) | Hepatic disorder |
| γ -Glutamyltransferase (GGT) | Hepatic disorder |
| Glutathione-S-transferase (GST) | Hepatic disorder |
| Glycogen phosphorylase (GP) | Acute myocardial infarction |
| Lactate dehydrogenase (LDH) | Myocardial infarction Hepatic disorder Hemolysis Carcinoma |
| Lipase (LPS) | Acute pancreatitis |
| 5'-Nucleotidase | Hepatic disorder |
| Pseudochoolinesterase (PChE) | Organophosphate poisoning Genetic variants Hepatic disorder Suxamethonium sensitivity |
| Pyruvate kinase (PK) | Hemolytic anemia |
| Trypsin (TRY) | Acute pancreatitis |

where it is involved in the storage of high-energy creatine phosphate. Every contraction cycle of muscle results in creatine phosphate use, with the production of ATP. This results in relatively constant levels of muscle ATP. The reversible reaction catalyzed by CK is shown in Equation 12-4.

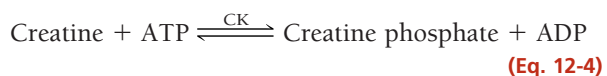

Tissue Source

CK is widely distributed in tissue, with highest activities found in skeletal muscle, heart muscle, and brain tissue.

CK is present in much smaller quantities in other tissue sources, including the bladder, placenta, gastrointestinal tract, thyroid, uterus, kidney, lung, prostate, spleen, liver, and pancreas.

Diagnostic Significance

Because of the high concentrations of CK in muscle tissue, CK levels are frequently elevated in disorders of cardiac and skeletal muscle. The CK level is considered a sensitive indicator of acute myocardial infarction (AMI) and muscular dystrophy, particularly the Duchenne type. Striking elevations of CK occur in Duchenne-type muscular dystrophy, with values reaching 50 to 100 times the upper limit of normal (ULN). Although total

CK levels are sensitive indicators of these disorders, they are not entirely specific indicators inasmuch as CK elevation is found in various other abnormalities of cardiac and skeletal muscle. Levels of CK also vary with muscle mass and, therefore, may depend on gender, race, degree of physical conditioning, and age.

Elevated CK levels are also occasionally seen in central nervous system disorders such as cerebrovascular accident, seizures, nerve degeneration, and central nervous system shock. Damage to the blood-brain barrier must occur to allow enzyme release to the peripheral circulation.

Other pathophysiologic conditions in which elevated CK levels occur are hypothyroidism, malignant hyperpyrexia, and Reye's syndrome. Table 12-3 lists the major disorders associated with abnormal CK levels. Serum CK levels and CK/progesterone ratio have been useful in the diagnosis of ectopic pregnancies.⁵ Total serum CK levels have also been used as an early diagnostic tool to identify patients with *Vibrio vulnificus* infections.⁶

Because enzyme elevation is found in numerous disorders, the separation of total CK into its various isoenzyme fractions is considered a more specific indicator of various disorders than total levels. Typically, the clinical relevance of CK activity depends more on isoenzyme fractionation than on total levels.

CK occurs as a dimer consisting of two subunits that can be separated readily into three distinct molecular forms. The three isoenzymes have been designated as CK-BB (brain type), CK-MB (hybrid type), and CK-MM (muscle type). On electrophoretic separation, CK-BB will migrate fastest toward the anode and is therefore called *CK-1*. CK-BB is followed by CK-MB (*CK-2*) and, finally, by CK-MM (*CK-3*), exhibiting the slowest mobility (Fig. 12-5). Table 12-3 indicates the tissue localization of the isoenzymes and the major conditions associated with elevated levels. Separation of CK isoforms may also be visualized by high-voltage electrophoretic separation. Isoforms occur following cleavage of the carboxyl-termi-

TABLE 12-3 CREATINE KINASE ISOENZYMES—TISSUE LOCALIZATION AND SOURCES OF ELEVATION

| ISOENZYME | TISSUE | CONDITION |
|-----------|---|---|
| CK-MM | Heart Skeletal muscle | Myocardial infarction Skeletal muscle disorder Muscular dystrophy Polymyositis Hypothyroidism Malignant hyperthermia Physical activity Intramuscular injection |
| CK-MB | Heart Skeletal muscle | Myocardial infarction Myocardial injury Ischemia Angina Inflammatory heart disease Cardiac surgery Duchenne-type muscular dystrophy Polymyositis Malignant hyperthermia Reye's syndrome Rocky Mountain spotted fever Carbon monoxide poisoning |
| CK-BB | Brain Bladder Lung Prostate Uterus Colon Stomach Thyroid | Central nervous system shock Anoxic encephalopathy Cerebrovascular accident Seizure Placental or uterine trauma Carcinoma Reye's syndrome Carbon monoxide poisoning Malignant hyperthermia Acute and chronic renal failure |

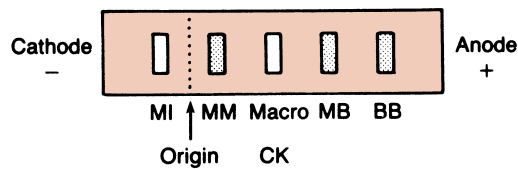

FIGURE 12-5. Electrophoretic migration pattern of normal and atypical CK isoenzymes.

nal amino acid from the M subunit by serum carboxypeptidase N. Three isoforms have been described for CK-MM and two isoforms for CK-MB; the clinical significance is not well established.

The major isoenzyme in the sera of healthy people is the MM form. Values for the MB isoenzyme range from undetectable to trace (<6% of total CK). It also appears that CK-BB is present in small quantities in the sera of healthy people; however, the presence of CK-BB in serum depends on the method of detection. Most techniques cannot detect CK-BB in normal serum.

CK-MM is the major isoenzyme fraction found in striated muscle and normal serum. Skeletal muscle contains almost entirely CK-MM, with a small amount of CK-MB. The majority of CK activity in heart muscle is also attributed to CK-MM, with approximately 20% a result of CK-MB.⁷ Normal serum consists of approximately 94% to 100% CK-MM. Injury to both cardiac and skeletal muscle accounts for the majority of cases of CK-MM elevations (Table 12-3). Hypothyroidism results in CK-MM elevations because of the involvement of muscle tissue (increased membrane permeability), the effect of thyroid hormone on enzyme activity, and, possibly, the slower clearance of CK as a result of slower metabolism.

Mild to strenuous activity may contribute to elevated CK levels, as may intramuscular injections. In physical activity, the extent of elevation is variable. However, the degree of exercise in relation to the exercise capacity of the individual is the most important factor in determining the degree of elevation.⁸ Patients who are physically well conditioned show lesser degrees of elevation than do patients who are less conditioned. Levels may be elevated for as long as 48 hours following exercise.

CK elevations are generally less than five times ULN following intramuscular injections and usually not apparent after 48 hours, although elevations may persist for 1 week. The predominant isoenzyme is CK-MM.

The quantity of CK-BB in the tissue (Table 12-3) is usually small. The small quantity, coupled with its relatively short half-life (1–5 hours), results in CK-BB activities that are generally low and transient and not usually measurable when tissue damage occurs. Highest concentrations are found in the central nervous system, the gastrointestinal tract, and the uterus during pregnancy.

Although brain tissue has high concentrations of CK, serum rarely contains CK-BB of brain origin. Because of its molecular size (80,000), its passage across the blood–brain barrier is hindered. However, when extensive damage to the brain has occurred, significant amounts of CK-BB can sometimes be detected in the serum.

It has been observed that CK-BB may be significantly elevated in patients with carcinoma of various organs. It has been found in association with untreated prostatic carcinoma and other adenocarcinomas. These findings indicate that CK-BB may be a useful tumor-associated marker.⁹

The most common causes of CK-BB elevations are central nervous system damage, tumors, childbirth, and the presence of macro-CK, an enzyme–immunoglobulin complex. In most of these cases, the CK-BB level is greater than 5 U/L, usually in the range of 10–50 U/L. Other conditions listed in Table 12-3 usually show CK-BB activity below 10 U/L.¹⁰

The value of CK isoenzyme separation can be found principally in detection of myocardial damage. Cardiac tissue contains significant quantities of CK-MB, approximately 20% of all CK-MB. Whereas CK-MB is found in small quantities in other tissue, myocardium is essentially the only tissue from which CK-MB enters the serum in significant quantities. Demonstration of elevated levels of CK-MB, greater than or equal to 6% of the total CK, is considered a good indicator of myocardial damage, particularly AMI. Other nonenzyme proteins, called troponins, have been found to be even more specific and may elevate in the absence of CK-MB elevations. Following myocardial infarction, the CK-MB levels begin to rise within 4 to 8 hours, peak at 12 to 24 hours, and return to normal levels within 48 to 72 hours. This time frame must be considered when interpreting CK-MB levels.

CK-MB activity has been observed in other cardiac disorders (Table 12-3). Therefore, increased quantities are not entirely specific for AMI but probably reflect some degree of ischemic heart damage. The specificity of CK-MB levels in the diagnosis of AMI can be increased if interpreted in conjunction with LDH isoenzymes and/or troponins and if measured sequentially over a 48-hour period to detect the typical rise and fall of enzyme activity seen in AMI (Fig. 12-6).

The MB isoenzyme also has been detected in the sera of patients with noncardiac disorders. CK-MB levels found in these conditions probably represent leakage from skeletal muscle, although in Duchenne-type muscular dystrophy, there may be some cardiac involvement as well. CK-MB levels in Reye's syndrome also may reflect myocardial damage.

Despite the findings of CK-MB levels in disorders other than myocardial infarction, its presence still remains a significant indicator of AMI.¹¹ The typical time course of CK-MB elevation following AMI is not found in other conditions.

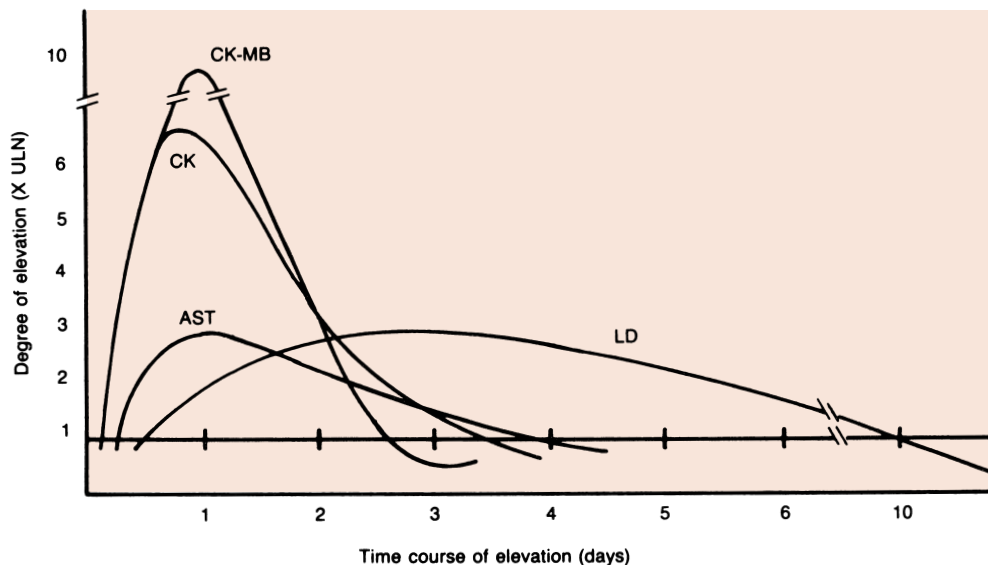

FIGURE 12-6. Time-activity curves of enzymes in myocardial infarction for AST, CK, CK-MB, and LDH. CK, specifically the MB fraction, increases initially, followed by AST and LDH. LDH is elevated the longest. All enzymes usually return to normal within 10 days.

Nonenzyme proteins (troponin I and troponin T) have been used as a more sensitive and specific marker of myocardial damage. These proteins are released into the bloodstream earlier and persist longer than CK and its isoenzyme CK-MB. More information on these protein markers of AMI can be found in Chapter 10 and 25.

Numerous reports have been made describing the appearance of unusual CK isoenzyme bands displaying electrophoretic properties that differ from the three major isoenzyme fractions¹²⁻¹⁶ (Fig. 12-5). These atypical forms are generally of two types and are referred to as macro-CK and mitochondrial CK.

Macro-CK appears to migrate to a position midway between CK-MM and CK-MB. This type of macro-CK largely comprises CK-BB complexed with immunoglobulin. In most instances, the associated immunoglobulin is IgG, although a complex with IgA also has been described. The term *macro-CK* has also been used to describe complexes of lipoproteins with CK-MM.

The incidence of macro-CK in sera ranges from 0.8% to 1.6%. Currently, no specific disorder is associated with its presence, although it appears to be age and sex related, occurring most frequently in women older than age 50.

Mitochondrial CK (CK-Mi) is bound to the exterior surface of the inner mitochondrial membranes of muscle, brain, and liver. It migrates to a point cathodal to CK-MM and exists as a dimeric molecule of two identical subunits. It occurs in serum in both the dimeric state and in the form of oligomeric aggregates of high molecular weight (350,000). CK-Mi is not present in normal serum and is typically not present following

myocardial infarction. The incidence of CK-Mi ranges from 0.8%–1.7%. For it to be detected in serum, extensive tissue damage must occur, causing breakdown of the mitochondrion and cell wall. Its presence does not correlate with any specific disease state but appears to be an indicator of severe illness. CK-Mi has been detected in cases of malignant tumor and cardiac abnormalities.

In view of the indefinite correlation between these atypical CK forms and a specific disease state, it appears that their significance relates primarily to the methods used for detecting CK-MB. In certain analytic procedures, these atypical forms may be measured as CK-MB, resulting in erroneously high CK-MB levels.

Methods used for measurement of CK isoenzymes include electrophoresis; ion-exchange chromatography; and several immunoassays, including radioimmunoassay (RIA) and immunoinhibition methods. Although mass methods are more sensitive and preferred for quantitation of CK-MB, electrophoresis has been the reference method. The electrophoretic properties of the CK isoenzymes are shown in Figure 12-5. Generally, the technique consists of performing electrophoresis on the sample, measuring the reaction using an overlay technique, and then visualizing the bands under ultraviolet light. With electrophoresis, the atypical bands can be separated, allowing their detection apart from the three major bands. Often a strongly fluorescent band appears, which migrates in close proximity to the CK-BB form. The exact nature of this fluorescence is unknown, but it has been attributed to the binding of fluorescent drugs or bilirubin by albumin.

In addition to visualizing atypical CK bands, other advantages of electrophoresis methods include detecting an unsatisfactory separation and allowing visualization of adenylate kinase (AK). AK is an enzyme released from erythrocytes in hemolyzed samples and appearing as a band cathodal to CK-MM. AK may interfere with chemical or immunoinhibition methods, causing a falsely elevated CK or CK-MB value.

Ion-exchange chromatography has the potential for being more sensitive and precise than electrophoretic procedures performed with good technique. On an unsatisfactory column, however, CK-MM may merge into CK-MB and CK-BB may be eluted with CK-MB. Also, macro-CK may elute with CK-MB.

Antibodies against both the M and B subunits have been used to determine CK-MB activity. Anti-M inhibits all M activity but not B activity. CK activity is measured before and after inhibition. Activity remaining after M inhibition is a result of the B subunit of both MB and BB activity. The residual activity after inhibition is multiplied by 2 to account for MB activity (50% inhibited). The major disadvantage of this method is that it detects BB activity, which, although not normally detectable, will cause falsely elevated MB results when BB is present. In addition, the atypical forms of CK-Mi and macro-CK are not inhibited by anti-M antibodies and also may cause erroneous results for MB activity.

Immunoassays detect CK-MB reliably with minimal cross-reactivity. Immunoassays measure the concentration of enzyme protein rather than enzymatic activity and can, therefore, detect enzymatically inactive CK-MB. This leads to the possibility of permitting detection of infarction earlier than other methods. A double-antibody immunoinhibition assay is also available. This technique allows differentiation of MB activity due to adenylate kinase and the atypical isoenzymes, resulting in a more specific analytic procedure for CK-MB.¹⁷ Point-of-care assay systems for CM-MB are available but not as widely used as those for troponins.

Assay Enzyme Activity

As indicated by Equation 12-4, CK catalyzes both forward and reverse reactions involving phosphorylation of creatine or ADP. Typically, for analysis of CK activity, this reaction is coupled with other enzyme systems and a change in absorbance at 340 nm is determined. The forward reaction is coupled with the pyruvate kinase-LDH-NADH system and proceeds according to Equation 12-5:

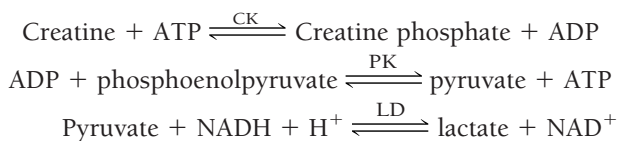

(Eq. 12-5)

The reverse reaction is coupled with the hexokinase-glucose-6-phosphate dehydrogenase-NADP system, as indicated in Equation 12-6:

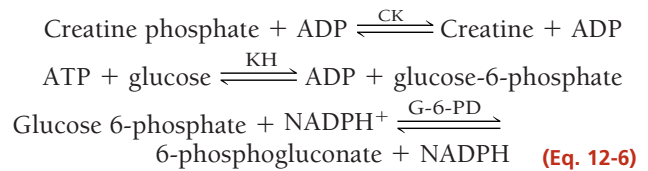

The reverse reaction proposed by Oliver and modified by Rosalki is the most commonly performed method in the clinical laboratory.¹³ The reaction proceeds two to six times faster than the forward reaction, depending on the assay conditions and there is less interference from side reactions. The optimal pH for the reverse reaction is 6.8; for the forward reaction, it is 9.0.

CK activity in serum is unstable, being rapidly inactivated because of oxidation of sulfhydryl groups. Inactivation can be partially reversed by the addition of sulfhydryl compounds to the assay reagent. Compounds such as *N*-acetylcysteine, mercaptoethanol, thioglycerol, and dithiothreitol are among those used.

Source of Error

Hemolysis of serum samples may be a source of elevated CK activity. Erythrocytes are virtually devoid of CK; however, they are rich in AK activity. AK reacts with ADP to produce ATP, which is then available to participate in the assay reaction, causing falsely elevated CK levels. This interference can occur with hemolysis of greater than 320 mg/L hemoglobin, which releases sufficient AK to exhaust the AK inhibitors in the reagent. Trace hemolysis causes little, if any, CK elevation. Serum should be stored in a dark place because CK is inactivated by light. Activity can be restored after storage in the dark at 4°C for 7 days or at -20°C for 1 month when the assay is conducted using a sulfhydryl activator.¹⁸ Because of the effect of muscular activity and muscle mass on CK levels, it should be noted that people who are physically well trained tend to have elevated baseline levels and that patients who are bedridden for prolonged periods may have decreased CK activity.

Reference Range

Total CK:

Male, 15–160 U/L (37°C)

Female, 15–130 U/L (37°C)

CK-MB: <6% total CK

The higher values in males are attributed to increased muscle mass. Note that enzyme reference ranges are subject to variation, depending on the method used and the assay conditions.

Lactate Dehydrogenase

LDH is an enzyme that catalyzes the interconversion of lactic and pyruvic acids. It is a hydrogen-transfer en-

zyme that uses the coenzyme NAD^+ according to Equation 12-7:

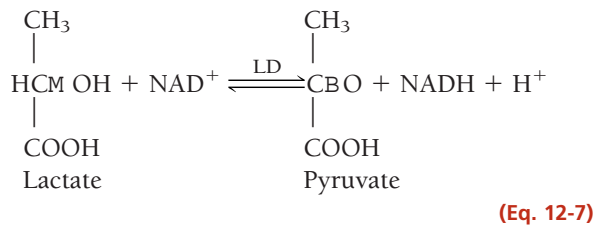

Tissue Source

LDH is widely distributed in the body. High activities are found in the heart, liver, skeletal muscle, kidney, and erythrocytes; lesser amounts are found in the lung, smooth muscle, and brain.

Diagnostic Significance

Because of its widespread activity in numerous body tissue, LDH is elevated in a variety of disorders. Increased levels are found in cardiac, hepatic, skeletal muscle, and renal diseases, as well as in several hematologic and neoplastic disorders. The highest levels of total LDH are seen in pernicious anemia and hemolytic disorders. Intramedullary destruction of erythroblasts causes elevation as a result of the high concentration of LDH in erythrocytes. Liver disorders, such as viral hepatitis and cirrhosis, show slight elevations of two to three times ULN. AMI and pulmonary infarct also show slight elevations of approximately the same degree (2–3× ULN). In AMI, LDH levels begin to rise within 12 to 24 hours, reach peak levels within 48 to 72 hours, and may remain elevated for 10 days. Skeletal muscle disorders and some leukemias contribute to increased LDH levels. Marked

elevations can be observed in most patients with acute lymphoblastic leukemia in particular.

Because of the many conditions that contribute to increased activity, an elevated total LDH value is a rather nonspecific finding. LDH assays, therefore, assume more clinical significance when separated into isoenzyme fractions. The enzyme can be separated into five major fractions, each comprising four subunits. It has a molecular weight of 128,000 daltons. Each isoenzyme comprises four polypeptide chains with a molecular weight of 32,000 daltons each. Two different polypeptide chains, designated H (heart) and M (muscle), combine in five arrangements to yield the five major isoenzyme fractions.

Table 12-4 indicates the tissue localization of the LDH isoenzymes and the major disorders associated with elevated levels. LDH-1 migrates most quickly toward the anode, followed in sequence by the other fractions, with LDH-5 migrating the slowest.

In the sera of healthy individuals, the major isoenzyme fraction is LDH-2, followed by LDH-1, LDH-3, LDH-4, and LDH-5 (for the isoenzyme ranges, see Table 12-5). LDH-1 and LDH-2 are present to approximately the same extent in the tissues listed in Table 12-4. However, cardiac tissue and red blood cells contain a higher concentration of LDH-1. Therefore, in conditions involving cardiac necrosis (AMI) and intravascular hemolysis, the serum levels of LDH-1 will increase to a point at which they are present in greater concentration than LDH-2, resulting in a condition known as the **LDH flipped pattern** ($\text{LDH-1} > \text{LDH-2}$).¹⁹ This flipped pattern is suggestive of AMI. However, LDH is not specific to cardiac tissue and is not a preferred marker of diagnosis of AMI. LDH-1/LDH-2 ratios greater than 1 also may

TABLE 12-4 LACTATE DEHYDROGENASE (LDH) ISOENZYMES—TISSUE LOCALIZATION AND SOURCES OF ELEVATION

| ISOENZYME | TISSUE | DISORDER |
|--------------|---|--|
| LDH-1 (HHHH) | Heart Red blood cells | Myocardial infarction Hemolytic anemia |
| LDH-2 (HHHM) | Heart Red blood cells | Megaloblastic anemia Acute renal infarct Hemolyzed specimen |
| LDH-3 (HHMM) | Lung Lymphocytes Spleen Pancreas | Pulmonary embolism Extensive Pulmonary pneumonia Lymphocytosis Acute pancreatitis Carcinoma |
| LDH-4 (HMMM) | Liver | Hepatic injury or inflammation |
| LDH-5 (MMMM) | Skeletal muscle | Skeletal muscle injury |

TABLE 12-5 LACTATE DEHYDROGENASE (LDH) ISOENZYMES AS A PERCENTAGE OF TOTAL LDH

| ISOENZYME | % |
|-----------|-------|
| LDH-1 | 14–26 |
| LDH-2 | 29–39 |
| LDH-3 | 20–26 |
| LDH-4 | 8–16 |
| LDH-5 | 6–16 |

Reprinted with permission from Lott JA, Stang JM. Serum enzymes and isoenzymes in the diagnosis and differential diagnosis of myocardial ischemia and necrosis. *Clin Chem* 1980;26:1241.

be observed in hemolyzed serum samples.²⁰ Elevations of LDH-3 occur most frequently with pulmonary involvement and are also observed in patients with various carcinomas. The LDH-4 and LDH-5 isoenzymes are found primarily in liver and skeletal muscle tissue, with LDH-5 being the predominant fraction in these tissues. LDH-5 levels have greatest clinical significance in the detection of hepatic disorders, particularly intrahepatic disorders. Disorders of skeletal muscle will reveal elevated LDH-5 levels, as depicted in the muscular dystrophies.

A sixth LDH isoenzyme has been identified, which migrates cathodic to LDH-5.^{21–23} LDH-6 is alcohol dehydrogenase. In reporting studies, LDH-6 has been present in patients with arteriosclerotic cardiovascular failure. It is believed that its appearance signifies a grave prognosis and impending death. LDH-5 is elevated concurrently with the appearance of LDH-6, probably representing hepatic congestion due to cardiovascular disease. It is suggested, therefore, that LDH-6 may reflect liver injury secondary to severe circulatory insufficiency.

LDH has been shown to complex with immunoglobulins and to reveal atypical bands on electrophoresis. LDH complexed with IgA and IgG usually migrates between LDH-3 and LDH-4. This macromolecular complex is not associated with any specific clinical abnormality.

Analysis of LDH isoenzymes can be accomplished by electrophoresis, by immunoinhibition or chemical inhibition methods, or by differences in substrate affinity. Because of limited clinical utility, such tests are not commonly used. The electrophoretic procedure has been widely used historically. After electrophoretic separation, the isoenzymes can be detected either fluorometrically or colorimetrically. LDH can use other substrates in addition to lactate, such as α -hydroxybutyrate. The H subunits have a greater affinity for α -hydroxybutyrate than to the M subunits. This has led to the use of this substrate in an attempt to measure the LDH-1 activity, which consists entirely of H subunits.

The chemical assay, known as the measurement of α -hydroxybutyrate dehydrogenase activity (α -HBD), is outlined in Equation 12-8.

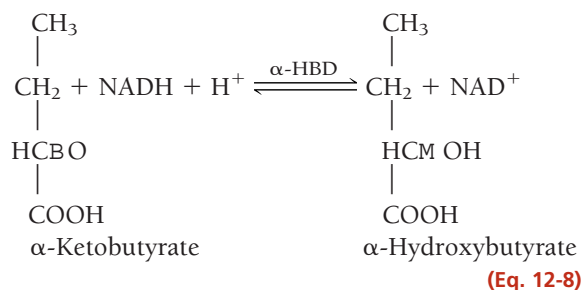

α -HBD is not a separate and distinct enzyme but is considered to represent the LDH-1 activity of total LDH. However, α -HBD activity is not entirely specific for the LDH-1 fraction because LDH-2, LDH-3, and LDH-4 also contain varying amounts of the H subunit. HBD activity is increased in those conditions in which the LDH-1 and LDH-2 fractions are increased.

LDH is commonly used to measure lactic and pyruvic acids or as a coupled reaction.

Assay for Enzyme Activity

LDH catalyzes the interconversion of lactic and pyruvic acids using the coenzyme NAD^+ . The reaction sequence is outlined in Equation 12-9:

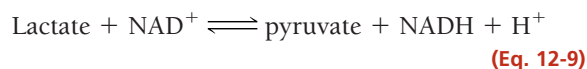

The reaction can proceed in either a forward (lactate [L]) or reverse (pyruvate [P]) direction. Both reactions have been used in clinical assays. The rate of the reverse reaction is approximately three times faster, allowing smaller sample volumes and shorter reaction times. However, the reverse reaction is more susceptible to substrate exhaustion and loss of linearity. The optimal pH for the forward reaction is 8.3 to 8.9; for the reverse reaction, it is 7.1 to 7.4.

Source of Error

Erythrocytes contain an LDH concentration approximately 100 to 150 times that found in serum. Therefore, any degree of hemolysis should render a sample unacceptable for analysis. LDH activity is unstable in serum regardless of the temperature at which it is stored. If the sample cannot be analyzed immediately, it should be stored at 25°C and analyzed within 48 hours. LDH-5 is the most labile isoenzyme. Loss of activity occurs more quickly at 4°C than at 25°C. Serum samples for LDH isoenzyme analysis should be stored at 25°C and analyzed within 24 hours of collection.

Reference Range

LDH, 100–225 U/L (37°C)

Aspartate Aminotransferase

Aspartate aminotransferase (AST) is an enzyme belonging to the class of **transferases**. It is commonly referred to as a *transaminase* and is involved in the transfer of an amino group between aspartate and α -keto acids. The older terminology, *serum glutamic-oxaloacetic transaminase* (SGOT, or GOT), may also be used. Pyridoxal phosphate functions as a coenzyme. The reaction proceeds according to Equation 12-10:

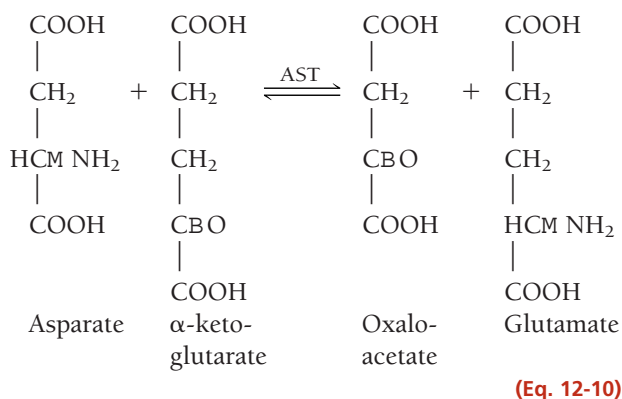

The transamination reaction is important in intermediary metabolism because of its function in the synthesis and degradation of amino acids. The ketoacids formed by the reaction are ultimately oxidized by the tricarboxylic acid cycle to provide a source of energy.

Tissue Source

AST is widely distributed in human tissue. The highest concentrations are found in cardiac tissue, liver, and skeletal muscle, with smaller amounts found in the kidney, pancreas, and erythrocytes.

Diagnostic Significance

The clinical use of AST is limited mainly to the evaluation of hepatocellular disorders and skeletal muscle involvement. In AMI, AST levels begin to rise within 6 to 8 hours, peak at 24 hours, and generally return to normal within 5 days. However, because of the wide tissue distribution, AST levels are not useful in the diagnosis of AMI.

AST elevations are frequently seen in pulmonary embolism. Following congestive heart failure, AST levels also may be increased, probably reflecting liver involvement as a result of inadequate blood supply to that organ. AST levels are highest in acute hepatocellular disorders. In viral hepatitis, levels may reach 100 times ULN. In cirrhosis, only moderate levels—approximately four times ULN—are detected (see Chapter 24). Skeletal muscle disorders, such as the muscular dystrophies, and inflammatory conditions also cause increases in AST levels (4–8 \times ULN).

AST exists as two isoenzyme fractions located in the cell cytoplasm and mitochondria. The intracellular concentration of AST may be 7,000 times higher than the

extracellular concentration. The cytoplasmic isoenzyme is the predominant form occurring in serum. In disorders producing cellular necrosis, the mitochondrial form may be significantly increased. Isoenzyme analysis of AST is not routinely performed in the clinical laboratory.

Assay for Enzyme Activity

Assay methods for AST are generally based on the principle of the Karmen method, which incorporates a coupled enzymatic reaction using malate dehydrogenase (MD) as the indicator reaction and monitors the change in absorbance at 340 nm continuously as NADH is oxidized to NAD⁺ (Eq. 12-11). The optimal pH is 7.3 to 7.8.

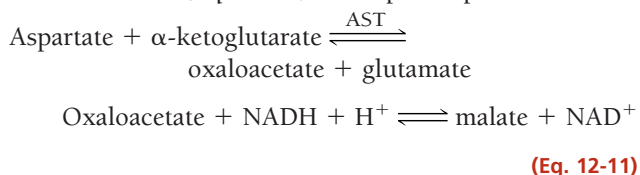

Source of Error

Hemolysis should be avoided because it can dramatically increase serum AST concentration. AST activity is stable in serum for 3 to 4 days at refrigerated temperatures.

Reference Range

AST, 5 to 30 U/L (37°C)

Alanine Aminotransferase

Alanine aminotransferase (ALT) is a transferase with enzymatic activity similar to that of AST. Specifically, it catalyzes the transfer of an amino group from alanine to α -ketoglutarate with the formation of glutamate and pyruvate. The older terminology was serum *glutamic-pyruvic transaminase* (SGPT, or GPT). Equation 12-12 indicates the transferase reaction. Pyridoxal phosphate acts as the coenzyme.

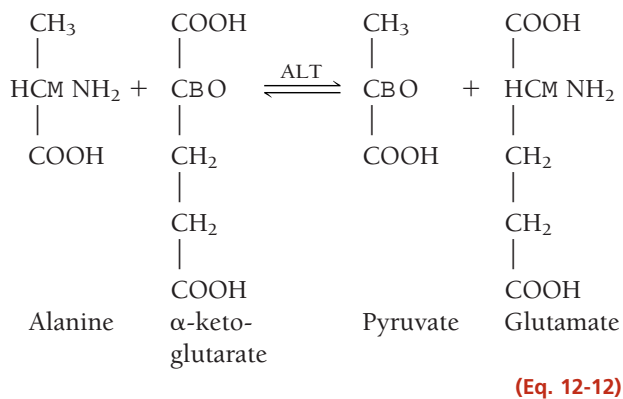

Tissue Source

ALT is distributed in many tissues, with comparatively high concentrations in the liver. It is considered the more liver-specific enzyme of the transferases.

Diagnostic Significance

Clinical applications of ALT assays are confined mainly to evaluation of hepatic disorders. Higher elevations are found in hepatocellular disorders than in extrahepatic or intrahepatic obstructive disorders. In acute inflammatory conditions of the liver, ALT elevations are frequently higher than those of AST and tend to remain elevated longer as a result of the longer half-life of ALT in serum (16 and 24 hours, respectively).

Cardiac tissue contains a small amount of ALT activity, but the serum level usually remains normal in AMI unless subsequent liver damage has occurred. ALT levels have historically been compared with levels of AST to help determine the source of an elevated AST level and to detect liver involvement concurrent with myocardial injury.

Assay for Enzyme Activity

The typical assay procedure for ALT consists of a coupled enzymatic reaction using LDH as the indicator enzyme, which catalyzes the reduction of pyruvate to lactate with the simultaneous oxidation of NADH. The change in absorbance at 340 nm measured continuously is directly proportional to ALT activity. The reaction proceeds according to Equation 12-13. The optimal pH is 7.3 to 7.8.

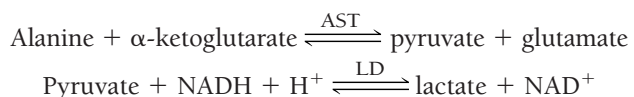

(Eq. 12-13)

Source of Error

ALT is stable for 3 to 4 days at 4°C. It is relatively unaffected by hemolysis.

Reference Range

ALT, 6–37 U/L (37°C)

Alkaline Phosphatase

Alkaline phosphatase (ALP) belongs to a group of enzymes that catalyze the hydrolysis of various phosphomonoesters at an alkaline pH. Consequently, ALP is a nonspecific enzyme capable of reacting with many different substrates. Specifically, ALP functions to liberate inorganic phosphate from an organic phosphate ester with the concomitant production of an alcohol. The reaction proceeds according to Equation 12-14:

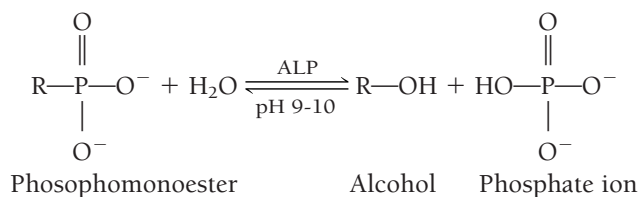

(Eq. 12-14)

CASE STUDY 12-2

While a 71-year-old woman is walking home from a shopping center, she faints and falls. She is driven home by a friend. When home, she realizes that she is bleeding from her mouth and is slightly disoriented. She appears injured from the fall, but she does not remember tripping or falling. The woman is taken to a local emergency department. The examining physician determines that there was a loss of consciousness; to determine the reason, he orders a head CT and ECG and the following laboratory tests: CBC, PT, aPTT, CK, LDH, AST, and troponin T and troponin I. All tests are within normal limits. The woman is sutured for the mouth injuries and admitted to a 24-hour observation unit.

Questions

1. What possible diagnoses is the physician considering?
2. What laboratory tests would be elevated at 6, 12, and 24 hour if this patient had an AMI?
3. What isoenzyme tests would be useful with this patient?

The optimal pH for the reaction is 9.0 to 10.0, but optimal pH varies with the substrate used. The enzyme requires Mg^{2+} as an activator.

Tissue Source

ALP activity is present on cell surfaces in most human tissue. The highest concentrations are found in the intestine, liver, bone, spleen, placenta, and kidney. In the liver, the enzyme is located on both sinusoidal and bile canalicular membranes; activity in bone is confined to the osteoblasts, those cells involved in the production of bone matrix. The specific location of the enzyme within this tissue accounts for the more predominant elevations in certain disorders.

Diagnostic Significance

Elevations of ALP are of most diagnostic significance in the evaluation of hepatobiliary and bone disorders. In hepatobiliary disorders, elevations are more predominant in obstructive conditions than in hepatocellular disorders; in bone disorders, elevations are observed when there is involvement of osteoblasts.

In biliary tract obstruction, ALP levels range from 3 to 10 times ULN. Increases are primarily a result of increased synthesis of the enzyme induced by cholestasis. In contrast, hepatocellular disorders, such as hepatitis and cirrhosis, show only slight increases, usually less

than three times ULN. Because of the degree of overlap of ALP elevations that occurs in the various liver disorders, a single elevated ALP level is difficult to interpret. It assumes more diagnostic significance when evaluated along with other tests of hepatic function (see Chapter 24).

Elevated ALP levels may be observed in various bone disorders. Perhaps the highest elevations of ALP activity occur in Paget's disease (osteitis deformans). Other bone disorders include osteomalacia, rickets, hyperparathyroidism, and osteogenic sarcoma. In addition, increased levels are observed in healing bone fractures and during periods of physiologic bone growth.

In normal pregnancy, increased ALP activity, averaging approximately 1½ times ULN, can be detected between weeks 16 and 20. ALP activity increases and persists until the onset of labor. Activity then returns to normal within 3 to 6 days.²⁴ Elevations also may be seen in complications of pregnancy such as hypertension, preeclampsia, and eclampsia, as well as in threatened abortion.

ALP levels are significantly decreased in the inherited condition of hypophosphatasia. Subnormal activity is a result of the absence of the bone isoenzyme and results in inadequate bone calcification.

ALP exists as a number of isoenzymes, which have been studied by a variety of techniques. The major isoenzymes, which are found in the serum and have been most extensively studied, are those derived from the liver, bone, intestine, and placenta.²⁵

Electrophoresis is considered the most useful single technique for ALP isoenzyme analysis. However, because there may still be some degree of overlap between the fractions, electrophoresis in combination with another separation technique may provide the most reliable information. A direct immunochemical method for the measurement of bone-related ALP is now available; this has made ALP electrophoresis unnecessary in most cases.

The liver fraction migrates the fastest, followed by bone, placental, and intestinal fractions. Because of the similarity between liver and bone phosphatases, there often is not a clear separation between them. Quantitation with use of a densitometer is sometimes difficult because of the overlap between the two peaks. The liver isoenzyme can actually be divided into two fractions—the major liver band and a smaller fraction called *fast liver*, or α_1 liver, which migrates anodal to the major band and corresponds to the α_1 fraction of protein electrophoresis. When total ALP levels are increased, the major liver fraction is the most frequently elevated. Many hepatobiliary conditions cause elevations of this fraction, usually early in the course of the disease. The fast-liver fraction has been reported in metastatic carcinoma of the liver, as well as in other hepatobiliary diseases. Its presence is regarded as a valuable indicator of obstructive liver disease. However, it is occasionally present in the absence of any detectable disease state.

The bone isoenzyme increases due to osteoblastic activity and is normally elevated in children during periods of growth and in adults older than age 50. In these cases, an elevated ALP level may be difficult to interpret.²⁶

The presence of intestinal ALP isoenzyme in serum depends on the blood group and secretor status of the individual. Individuals who have B or O blood group and are secretors are more likely to have this fraction. Apparently, intestinal ALP is bound by erythrocytes of group A. Furthermore, in these individuals, increases in intestinal ALP occur after consumption of a fatty meal. Intestinal ALP may increase in several disorders, such as diseases of the digestive tract and cirrhosis. Increased levels are also found in patients undergoing chronic hemodialysis.

Difference in heat stability is the basis of a second approach used to identify the isoenzyme source of an elevated ALP. Typically, ALP activity is measured before and after heating the serum at 56°C for 10 minutes. If the residual activity after heating is less than 20% of the total activity before heating, then the ALP elevation is assumed to be a result of bone phosphatase. If greater than 20% of the activity remains, the elevation is probably a result of liver phosphatase. These results are based on the finding that placental ALP is the most heat stable of the four major fractions, followed by intestinal, liver, and bone fractions in decreasing order of heat stability. Placental ALP will resist heat denaturation at 65°C for 30 minutes.

Heat inactivation is an imprecise method for differentiation because inactivation depends on many factors, such as correct temperature control, timing, and analytic methods sensitive enough to detect small amounts of residual ALP activity. In addition, there is some degree of overlap between heat inactivation of liver and bone fractions in both liver and bone diseases.

A third approach to identification of ALP isoenzymes is based on selective chemical inhibition. Phenylalanine is one of several inhibitors that have been used. Phenylalanine inhibits intestinal and placental ALP to a much greater extent than liver and bone ALP. With phenylalanine use, however, it is impossible to differentiate placental from intestinal ALP or liver from bone ALP.

In addition to the four major ALP isoenzyme fractions, certain abnormal fractions are associated with neoplasms. The most frequently seen are the Regan and Nagao isoenzymes. They have been referred to as *carcinoplacental alkaline phosphatases* because of their similarities to the placental isoenzyme. The frequency of occurrence ranges from 3% to 15% in cancer patients. The Regan isoenzyme has been characterized as an example of an ectopic production of an enzyme by malignant tissue. It has been detected in various carcinomas, such as lung, breast, ovarian, and colon, with the highest incidences in ovarian and gynecologic cancers. Because of its low incidence in cancer patients, diagnosis of malignancy is rarely based on its

presence. It is, however, useful in monitoring the effects of therapy because it will disappear on successful treatment.

The Regan isoenzyme migrates to the same position as the bone fraction and is the most heat stable of all ALP isoenzymes, resisting denaturation at 65°C for 30 minutes. Its activity is inhibited by phenylalanine.

The Nagao isoenzyme may be considered a variant of the Regan isoenzyme. Its electrophoretic, heat-stability, and phenylalanine-inhibition properties are identical to those of the Regan fraction. However, Nagao also can be inhibited by L-leucine. Its presence has been detected in metastatic carcinoma of pleural surfaces and in adenocarcinoma of the pancreas and bile duct.

Assay for Enzyme Activity

Because of the relative nonspecificity of ALP with regard to substrates, a variety of methodologies for its analysis have been proposed and are still in use today. The major differences between these relate to the concentration and types of substrate and buffer used and the pH of the reaction. A continuous-monitoring technique based on a method devised by Bowers and McComb allows calculation of ALP activity based on the molar absorptivity of *p*-nitrophenol. The reaction proceeds according to Equation 12-15:

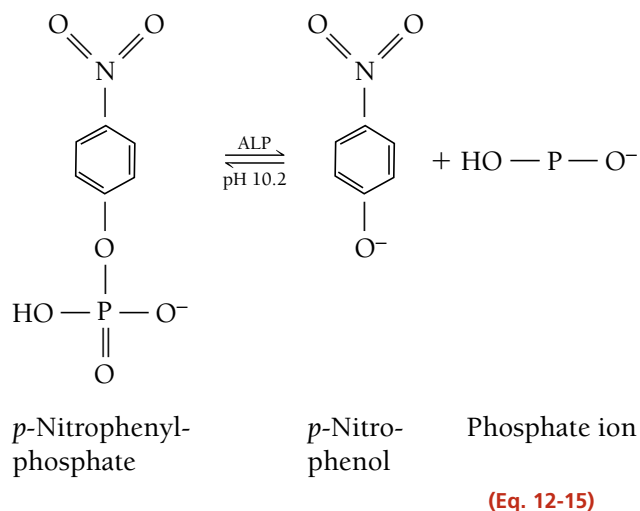

p-Nitrophenylphosphate (colorless) is hydrolyzed to *p*-nitrophenol (yellow), and the increase in absorbance at 405 nm, which is directly proportional to ALP activity, is measured.

Source of Error

Hemolysis may cause slight elevations because ALP is approximately six times more concentrated in erythrocytes than in serum. ALP assays should be run as soon as possible after collection. Activity in serum increases approximately 3% to 10% on standing at 25°C or 4°C for several hours. Diet may induce elevations in ALP activity of blood group B and O individuals who are secretors. Values may be 25% higher following ingestion of a high-fat meal.

Reference Range

ALP, 30 to 90 U/L (30°C)

Acid Phosphatase

Acid phosphatase (ACP) belongs to the same group of phosphatase enzymes as ALP and is a **hydrolase** that catalyzes the same type of reactions. The major difference between ACP and ALP is the pH of the reaction. ACP functions at an optimal pH of approximately 5.0. Equation 12-16 outlines the reaction sequence:

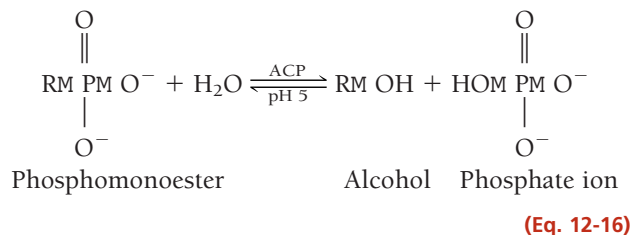

Tissue Source

ACP activity is found in the prostate, bone, liver, spleen, kidney, erythrocytes, and platelets. The prostate is the richest source, with many times the activity found in other tissue.

Diagnostic Significance

Historically, ACP measurement has been used as an aid in the detection of prostatic carcinoma, particularly metastatic carcinoma of the prostate. Total ACP determinations are relatively insensitive techniques, detecting elevated ACP levels resulting from prostatic carcinoma in the majority of cases only when the tumor has metastasized. Newer markers, such as prostate-specific antigen (PSA), are more useful screening and diagnostic tools (see Chapter 31).

One of the most specific substrates for prostatic ACP is thymolphthalein monophosphate. Chemical-inhibition methods used to differentiate the prostatic portion most frequently use tartrate as the inhibitor. The prostatic fraction is inhibited by tartrate. Serum and substrate are incubated both with and without the addition of L-tartrate. ACP activity remaining after inhibition with L-tartrate is subtracted from total ACP activity determined without inhibition, and the difference represents the prostatic portion:

$$\begin{array}{l}
 \text{Total ACP} - \text{ACP after tartrate inhibition} \\
 = \text{prostatic ACP}
 \end{array}
 \quad (\text{Eq. 12-17})$$

The reaction is not entirely specific for prostatic ACP, but other tissue sources are largely uninhibited.

Neither of these methods of ACP determination is sensitive to prostatic carcinoma that has not metastasized. Values are usually normal in the majority of cases and, in fact, may be elevated only in about 50% of cases of prostatic carcinoma that has metastasized.

One technique with much improved sensitivity over conventional ACP assays is the immunologic approach using antibodies that are specific for the prostatic portion. Immunochemical techniques, however, are not of value as screening tests for prostatic carcinoma.

PSA is more likely than ACP to be elevated at each stage of prostatic carcinoma, even though a normal PSA level may be found in stage D tumors. PSA is particularly useful to monitor the success of treatment; however, PSA is controversial as a screening test for prostatic malignancy because PSA elevation may occur in conditions other than prostatic carcinoma, such as benign prostatic hypertrophy and prostatitis.^{27–29}

Other prostatic conditions in which ACP elevations have been reported include hyperplasia of the prostate and prostatic surgery. There are conflicting reports of elevations following rectal examination and prostate massage. Certain studies have reported ACP elevations; others have indicated no detectable change. When elevations are found, levels usually return to normal within 24 hours.³⁰

ACP assays have proved useful in forensic clinical chemistry, particularly in the investigation of rape. Vaginal washings are examined for seminal fluid–ACP activity, which can persist for up to 4 days.³¹ Elevated activity is presumptive evidence of rape in such cases.

Serum ACP activity may frequently be elevated in bone disease. Activity has been shown to be associated with the osteoclasts.³² Elevations have been noted in Paget's disease, in breast cancer with bone metastases, and in Gaucher's disease, in which there is an infiltration of bone marrow and other tissue by Gaucher cells rich in ACP activity. Because of ACP activity in platelets, elevations are observed when platelet damage occurs, as in the thrombocytopenia resulting from excessive platelet destruction from idiopathic thrombocytopenic purpura.

Assay for Enzyme Activity

Assay procedures for total ACP use the same techniques as in ALP assays but are performed at an acid pH:

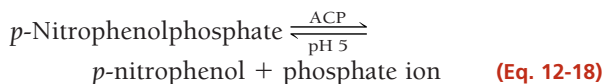

The reaction products are colorless at the acid pH of the reaction, but the addition of alkali stops the reaction and transforms the products into chromogens, which can be measured spectrophotometrically.

Some substrate specificities and chemical inhibitors for prostatic ACP measurements have been discussed previously. Thymolphthalein monophosphate is the substrate of choice for quantitative endpoint reactions. For continuous monitoring methods, α -naphthyl phosphate is preferred.

Immunochemical techniques for prostatic ACP use several approaches, including RIA, counterimmunoelectrophoresis, and immunoprecipitation. Also, an immunoenzymatic assay (Tandem E) includes incubation with

an antibody to prostatic ACP followed by washing and incubation with *p*-nitrophenylphosphate. The *p*-nitrophenol formed, measured photometrically, is proportional to the prostatic ACP in the sample.

Source of Error

Serum should be separated from the red cells as soon as the blood has clotted to prevent leakage of erythrocyte and platelet ACP. Serum activity decreases within 1 to 2 hours if the sample is left at room temperature without the addition of a preservative. Decreased activity is a result of a loss of carbon dioxide from the serum, with a resultant increase in pH. If not assayed immediately, serum should be frozen or acidified to a pH lower than 6.5. With acidification, ACP is stable for 2 days at room temperature. Hemolysis should be avoided because of contamination from erythrocyte ACP.

RIA procedures for measurement of prostatic ACP require nonacidified serum samples. Activity is stable for 2 days at 4°C.

Reference Range

Prostatic ACP, 0 to 3.5 ng/mL

γ -Glutamyltransferase

γ -Glutamyltransferase (GGT) is an enzyme involved in the transfer of the γ -glutamyl residue from γ -glutamyl peptides to amino acids, H₂O, and other small peptides. In most biologic systems, glutathione serves as the γ -glutamyl donor. Equation 12-19 outlines the reaction sequence:

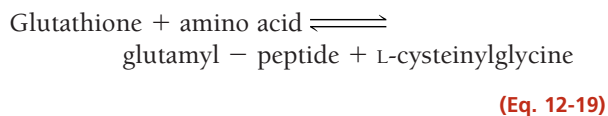

The specific physiologic function of GGT has not been clearly established, but it is suggested that GGT is involved in peptide and protein synthesis, regulation of tissue glutathione levels, and the transport of amino acids across cell membranes.³³

Tissue Source

GGT activity is found primarily in tissue of the kidney, brain, prostate, pancreas, and liver. Clinical applications of assay, however, are confined mainly to evaluation of liver and biliary system disorders.

Diagnostic Significance

In the liver, GGT is located in the canaliculi of the hepatic cells and particularly in the epithelial cells lining the biliary ductules. Because of these locations, GGT is elevated in virtually all hepatobiliary disorders, making it one of the most sensitive of enzyme assays in these conditions (see Chapter 24). Higher elevations are generally observed in biliary tract obstruction.

Within the hepatic parenchyma, GGT exists to a large extent in the smooth endoplasmic reticulum and is, therefore, subject to hepatic microsomal induction.

Therefore, GGT levels will be increased in patients receiving enzyme-inducing drugs such as warfarin, phenobarbital, and phenytoin. Enzyme elevations may reach levels four times ULN.

Because of the effects of alcohol on GGT activity, elevated GGT levels may indicate alcoholism, particularly chronic alcoholism. Generally, enzyme elevations in persons who are alcoholics or heavy drinkers range from two to three times ULN, although higher levels have been observed. GGT assays are useful in monitoring the effects of abstinence from alcohol and are used as such by alcohol treatment centers. Levels usually return to normal within 2 to 3 weeks after cessation but can rise again if alcohol consumption is resumed. Because of the susceptibility to enzyme induction, any interpretation of GGT levels must be done with consideration of the consequent effects of drugs and alcohol.

GGT levels are also elevated in other conditions, such as acute pancreatitis, diabetes mellitus, and myocardial infarction. The source of elevation in pancreatitis and diabetes is probably the pancreas, but the source of GGT in myocardial infarction is unknown. GGT assays are of limited value in the diagnosis of these conditions and are not routinely requested.

GGT activity is useful in differentiating the source of an elevated ALP level because GGT levels are normal in skeletal disorders and during pregnancy. It is particularly useful in evaluating hepatobiliary involvement in adolescents because ALP activity will invariably be elevated as a result of bone growth.

Assay for Enzyme Activity

The most widely accepted substrate for use in GGT analysis is γ -glutamyl-*p*-nitroanilide. The γ -glutamyl residue is transferred to glycylglycine, releasing *p*-nitroaniline, a chromogenic product with a strong absorbance at 405 to 420 nm. The reaction, which can be used as a continuous-monitoring or fixed-point method, is outlined in Equation 12-20:

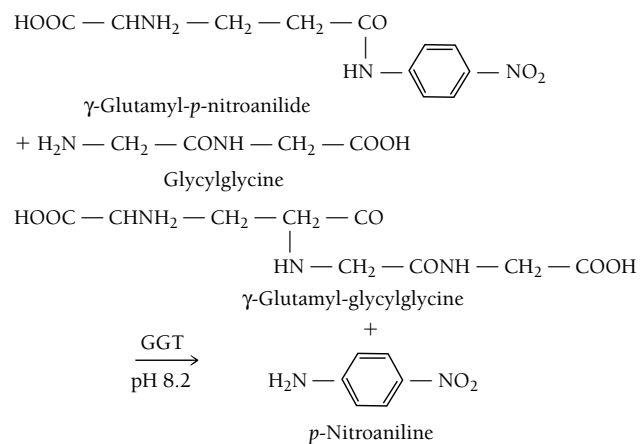

(Eq. 12-20)

Source of Error

GGT activity is stable, with no loss of activity for 1 week at 4°C. Hemolysis does not interfere with GGT levels because the enzyme is lacking in erythrocytes.

Reference Range

GGT: male, 6–45 U/L (37°C); female, 5–30 U/L (37°C)

Values are lower in females, presumably because of suppression of enzyme activity resulting from estrogenic or progestational hormones.

Amylase

Amylase (AMS) is an enzyme belonging to the class of hydrolases that catalyze the breakdown of starch and glycogen. Starch consists of both amylose and amylopectin. Amylose is a long, unbranched chain of glucose molecules, linked by α , 1–4 glycosidic bonds; amylopectin is a branched-chain polysaccharide with α , 1–6 linkages at the branch points. The structure of glycogen is similar to that of amylopectin but is more highly branched. α -AMS attacks only the α , 1–4 glycosidic bonds to produce degradation products consisting of glucose; maltose; and intermediate chains, called *dextrins*, which contain α , 1–6 branching linkages. Cellulose and other structural polysaccharides consisting of linkages are not attacked by α -AMS. AMS is therefore an important enzyme in the physiologic digestion of starches. The reaction proceeds according to Equation 12-21:

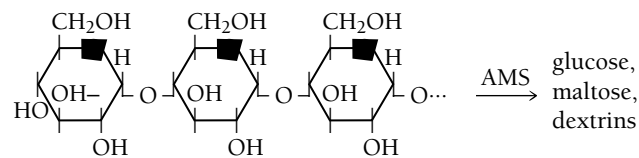

(Eq. 12-21)

AMS requires calcium and chloride ions for its activation.

Tissue Source

The acinar cells of the pancreas and the salivary glands are the major tissue sources of serum AMS. Lesser concentrations are found in skeletal muscle and the small intestine and fallopian tubes. AMS is the smallest enzyme, with a molecular weight of 50,000 to 55,000. Because of its small size, it is readily filtered by the renal glomerulus and also appears in the urine.

Digestion of starches begins in the mouth with the hydrolytic action of salivary AMS. Salivary AMS activity, however, is of short duration because, on swallowing, it is inactivated by the acidity of the gastric contents. Pancreatic AMS then performs the major digestive action of starches once the polysaccharides reach the intestine.

Diagnostic Significance

The diagnostic significance of serum and urine AMS measurements is in the diagnosis of acute pancreatitis.³⁴ Disorders of tissue other than the pancreas can also produce elevations in AMS levels. Therefore, an elevated AMS level is a nonspecific finding. However, the degree of elevation of AMS is helpful, to some extent, in the differential diagnosis of acute pancreatitis. In addition, other laboratory tests (e.g., measurements of urinary AMS levels, AMS clearance studies, AMS isoenzyme studies, and measurements of serum lipase [LPS] levels), when used in conjunction with serum AMS measurement, increase the specificity of AMS measurements in the diagnosis of acute pancreatitis.

In acute pancreatitis, serum AMS levels begin to rise 2 to 12 hours after the onset of an attack, peak at 24 h, and return to normal levels within 3 to 5 days. Values generally range from 250 to 1,000 Somogyi units per dL ($2.55 \times \text{ULN}$). Values can reach much higher levels.

Other disorders causing an elevated serum AMS level include salivary gland lesions, such as mumps and parotitis, and other intra-abdominal diseases, such as perforated peptic ulcer, intestinal obstruction, cholecystitis, ruptured ectopic pregnancy, mesenteric infarction, and acute appendicitis. In addition, elevations have been reported in renal insufficiency and diabetic ketoacidosis. Serum AMS levels in intra-abdominal conditions other than acute pancreatitis are usually less than 500 Somogyi units per dL.

An apparently asymptomatic condition of hyperamylasemia has been noted in approximately 1% to 2% of the population. This condition, called *macroamylasemia*, results when the AMS molecule combines with immunoglobulins to form a complex that is too large to be filtered across the glomerulus. Serum AMS levels increase because of the reduction in normal renal clearance of the enzyme and, consequently, the urinary excretion of AMS is abnormally low. The diagnostic significance of macroamylasemia lies in the need to differentiate it from other causes of hyperamylasemia.

Much interest has been focused recently on the possible diagnostic use of AMS isoenzyme measurements.^{34,35} Serum AMS is a mixture of a number of isoenzymes that can be separated on the basis of differences in physical properties, most notably electrophoresis, although chromatography and isoelectric focusing also have been applied. In normal human serum, two major bands and as many as four minor bands may be seen. The bands are designated as P-type and S-type isoamylase. P isoamylase is derived from pancreatic tissue; S isoamylase is derived from salivary gland tissue, as well as the fallopian tube and lung. The isoenzymes of salivary origin (S1, S2, S3) migrate most quickly, whereas those of pancreatic origin

(P1, P2, P3), are slower. In normal human serum, the isoamylases migrate in regions corresponding to the β - to α -globulin regions of protein electrophoresis. The most commonly observed fractions are P2, S1, and S2.

In acute pancreatitis, there is typically an increase in P-type activity, with P3 being the most predominant isoenzyme. However, P3 also has been detected in cases of renal failure and, therefore, is not entirely specific for acute pancreatitis. S-type isoamylase represents approximately two-thirds of AMS activity of normal serum, whereas P-type predominates in normal urine.

Assay for Enzyme Activity

AMS can be assayed by a variety of different methods, which are summarized in Table 12-6. The four main approaches are categorized as amyloclastic, saccharogenic, chromogenic, and continuous monitoring.

In the amyloclastic method, AMS is allowed to act on a starch substrate to which iodine has been attached. As AMS hydrolyzes the starch molecule into smaller units, the iodine is released and a decrease occurs in the initial dark-blue color intensity of the starch-iodine complex. The decrease in color is proportional to the AMS concentration.

The saccharogenic method uses a starch substrate that is hydrolyzed by the action of AMS to its constituent carbohydrate molecules that have reducing properties. The amount of reducing sugars is then measured where the concentration is proportional to AMS activity. The saccharogenic method, the classic reference method for determining AMS activity, is reported in Somogyi units. Somogyi units are an expression of the number of milligrams of glucose released in 30 minutes at 37°C under specific assay conditions.

Chromogenic methods use a starch substrate to which a chromogenic dye has been attached, forming an insoluble dye-substrate complex. As AMS hydrolyzes the starch substrate, smaller dye-substrate fragments are produced, and these are water soluble. The increase in

TABLE 12-6 AMYLASE METHODOLOGIES

| | |
|-----------------------|---|
| Amyloclastic | Measures the disappearance of starch substrate |
| Saccharogenic | Measures the appearance of the product |
| Chromogenic | Measures the increasing color from production of product coupled with a chromogenic dye |
| Continuous monitoring | Coupling of several enzyme systems to monitor amylase activity |

color intensity of the soluble dye-substrate solution is proportional to AMS activity.

Recently, coupled-enzyme systems have been used to determine AMS activity by a continuous-monitoring technique in which the change in absorbance of NAD^+ at 340 nm is measured. Equation 12-22 is an example of a continuous-monitoring method. For AMS activity, the optimal pH is 6.9.

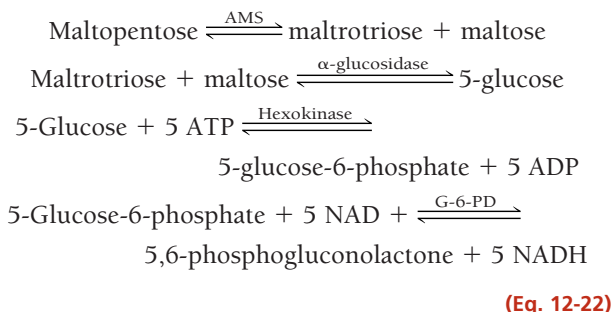

Because salivary AMS is preferentially inhibited by wheat germ lectin, salivary and pancreatic AMS can be estimated by measuring total AMS in the presence and absence of lectin. Specific immunoassays are also available for measuring isoenzymes of AMS.

Source of Error

AMS in serum and urine is stable. Little loss of activity occurs at room temperature for 1 week or at 4°C for 2 months. Because plasma triglycerides suppress or inhibit serum AMS activity, AMS values may be normal in acute pancreatitis with hyperlipemia.

The administration of morphine and other opiates for pain relief before blood sampling will lead to falsely elevated serum AMS levels. The drugs presumably cause constriction of the sphincter of Oddi and of the pancreatic ducts, with consequent elevation of inarticulate pressure causing regurgitation of AMS into the serum.

Reference Range

AMS: serum, 25–130 U/L; urine, 1–15 U/h

Because of the various AMS procedures currently in use, activity is expressed according to each procedure. There is no uniform expression of AMS activity, although Somogyi units are frequently used. The approximate conversion factor between Somogyi units and international units is 1.85.

Lipase

Lipase (LPS) is an enzyme that hydrolyzes the ester linkages of fats to produce alcohols and fatty acids. Specifically, LPS catalyzes the partial hydrolysis of dietary triglycerides in the intestine to the 2-monoglyceride intermediate, with the production of long-chain

fatty acids. The reaction proceeds according to Equation 12-23:

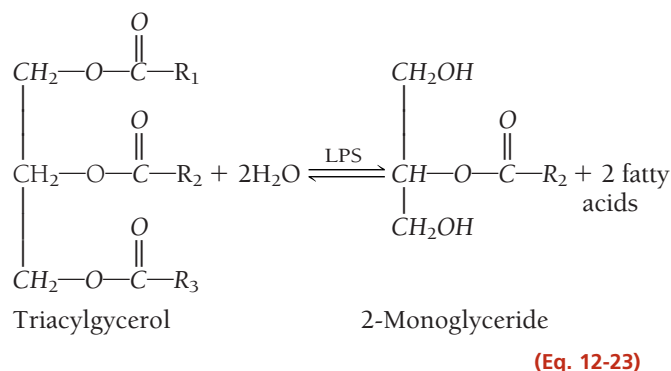

The enzymatic activity of pancreatic LPS is specific for the fatty acid residues at positions 1 and 3 of the triglyceride molecule, but substrate must be an emulsion for activity to occur. The reaction rate is accelerated by the presence of colipase and a bile salt.

Tissue Source

LPS concentration is found primarily in the pancreas, although it is also present in the stomach and small intestine.

Diagnostic Significance

Clinical assays of serum LPS measurements are confined almost exclusively to the diagnosis of acute pancreatitis. It is similar in this respect to AMS measurements but is considered more specific for pancreatic disorders than AMS measurement. Both AMS and LPS levels rise quickly, but LPS elevations persist for approximately 5 days in acute pancreatitis, whereas AMS elevations persist for only 2 to 3 days. The extent of elevations does not correlate with severity of disease. Elevated LPS levels also may be found in other intra-abdominal conditions but with less frequency than elevations of serum AMS. Elevations have been reported in cases of penetrating duodenal ulcers and perforated peptic ulcers, intestinal obstruction, and acute cholecystitis. In contrast to AMS levels, LPS levels are normal in conditions of salivary gland involvement. Therefore, LPS levels are useful in differentiating serum AMS elevation as a result of pancreatic versus salivary involvement. Of the three lipase isoenzymes, L2 is thought to be the most clinically specific and sensitive.

Assay for Enzyme Activity

Procedures used to measure LPS activity include estimation of liberated fatty acids and turbidimetric methods. The reaction is outlined in Equation 12-24:

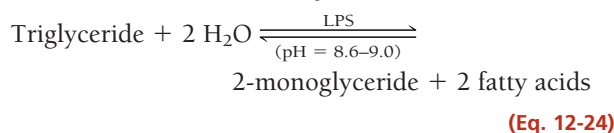

Early methods for LPS were historically poor. The classic Cherry-Crandall method used an olive oil substrate

and measured the liberated fatty acids by titration after a 24-h incubation. Modifications of the Cherry-Crandall method have been complicated by the lack of stable and uniform substrates. However, triolein is one substrate now used as a more pure form of triglyceride.

Turbidimetric methods are simpler and more rapid than titrimetric assays. Fats in solution create a cloudy emulsion. As the fats are hydrolyzed by LPS, the particles disperse, and the rate of clearing can be measured as an estimation of LPS activity. Colorimetric methods are also available and are based on coupled reactions with enzymes such as peroxidase or glycerol kinase.

Source of Error

LPS is stable in serum, with negligible loss in activity at room temperature for 1 week or for 3 weeks at 4°C. Hemolysis should be avoided because hemoglobin inhibits the activity of serum LPS, causing falsely low values.

Reference Range

LPS, 0–1.0 U/mL

Glucose-6-Phosphate Dehydrogenase

Glucose-6-phosphate dehydrogenase (G-6-PD) is an **oxidoreductase** that catalyzes the oxidation of glucose-6-phosphate to 6-phosphogluconate or the corresponding lactone. The reaction is important as the first step in the pentose-phosphate shunt of glucose metabolism with the ultimate production of NADPH. The reaction is outlined in Equation 12-25:

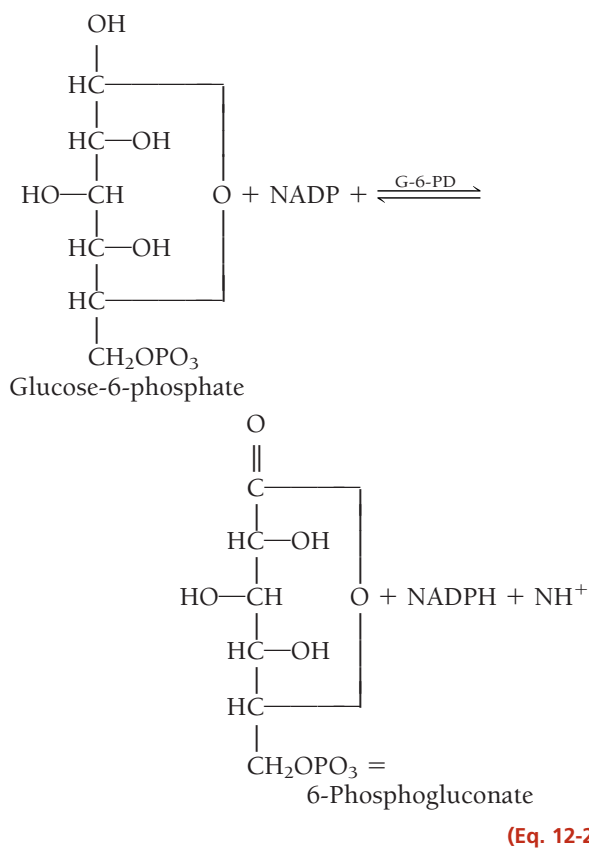

Tissue Source

Sources of G-6-PD include the adrenal cortex, spleen, thymus, lymph nodes, lactating mammary gland, and erythrocytes. Little activity is found in normal serum.

Diagnostic Significance

Most of the interest of G-6-PD focuses on its role in the erythrocyte. Here, it functions to maintain NADPH in reduced form. An adequate concentration of NADPH is required to regenerate sulfhydryl-containing proteins, such as glutathione, from the oxidized to the reduced state. Glutathione in the reduced form, in turn, protects hemoglobin from oxidation by agents that may be present in the cell. A deficiency of G-6-PD results in an inadequate supply of NADPH and, ultimately, in the inability to maintain reduced glutathione levels. When erythrocytes are exposed to oxidizing agents, hemolysis occurs because of oxidation of hemoglobin and damage of the cell membrane.

G-6-PD deficiency is an inherited sex-linked trait. The disorder can result in several different clinical manifestations, one of which is drug-induced hemolytic anemia. When exposed to an oxidant drug such as primaquine, an antimalarial drug, affected individuals experience a hemolytic episode. The severity of the hemolysis is related to the drug concentration. G-6-PD deficiency is most common in African Americans but has been reported in virtually every ethnic group.

Increased levels of G-6-PD in the serum have been reported in myocardial infarction and megaloblastic anemias. No elevations are seen in hepatic disorders. G-6-PD levels, however, are not routinely performed as diagnostic aids in these conditions.

Assay for Enzyme Activity

The assay procedure for G-6-PD activity is outlined in Equation 12-26:

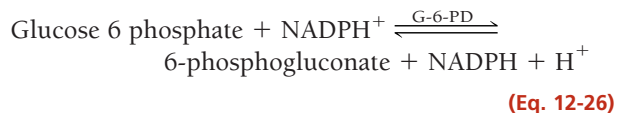

A red cell hemolysate is used to assay for deficiency of the enzyme; serum is used for evaluation of enzyme elevations.

Reference Range

G-6-PD, 10–15 U/g Hgb

Macroenzymes

Macroenzymes are high-molecular-mass forms of the serum enzymes (ACP, ALP, ALT, amylase, AST, CK, GGT, LDH, lipase) that can be bound to either an immunoglobulin (macroenzyme type 1) or a nonimmunoglobulin substance (macroenzyme type 2). Macroenzymes are usually found in patients who have an unexplained persistent increase of enzyme concentrations in serum.³⁶ The presence of macroenzymes can also increase with increasing age.³⁷

Enzymes can bind to immunoglobulins in a nonspecific manner, but there is also evidence that the enzyme-immunoglobulin complex can be formed by specific interactions between circulating autoantibodies and serum enzymes.³⁶ The reason for the formation of antienzyme antibodies is not known, but there are two theories to explain their formation. According to the “antigen-driven theory,” the self-antigen becomes immunogenic by being altered or released from a sequestered site and reacts with an antibody that is initially formed against a foreign antigen.³⁸ The dysregulation of immune tolerance theory explains the formation of enzymes with autoantibodies in patients with autoimmune disorders.³⁸ To date, there has not been a strong correlation between the presence of anti-enzyme antibodies and the pathogenesis of disease.³⁶ However, the presence of macroenzymes should be documented in the patient’s medical records because macroenzymes can persist for long periods.³⁶

Macroenzymes accumulate in plasma because their high molecular masses prevent them from being filtered out of the plasma by the kidneys. The detection of macroenzymes is clinically significant because the presence of macroenzymes can cause difficulty in the interpretation of diagnostic enzyme results. The formation of high-molecular-weight enzyme complexes can cause false elevations in plasma enzymes, or they can falsely decrease the activity of the enzyme by blocking the activity of the bound enzyme.³⁶

The principal method to identify enzymes that are bound to immunoglobulins and nonimmunoglobulins is protein electrophoresis. The binding of enzymes to high-molecular-weight complexes can alter the normal electrophoretic pattern of enzymes (see Fig. 12-5 for an example). Antienzyme antibodies can cause the formation of new enzyme bands on a gel, they can alter the intensity of enzyme bands, and they can cause band broadening on the gel.³⁶ Other test methods used to determine the presence of macroenzymes include gel filtration, immunoprecipitation, immunoelectrophoresis, counterimmunoelectrophoresis, and immunofixation. Last, the immunoinhibition test can also be used to determine the presence of macro-CK.

Drug-Metabolizing Enzymes

Drug-metabolizing enzymes function primarily to transform xenobiotics into inactive, water-soluble compounds for excretion through the kidneys. Metabolic enzymes can also transform inactive prodrugs into active drugs, convert xenobiotics into toxic compounds, or prolong the elimination half-life. Drug-metabolizing enzymes catalyze addition or removal of functional groups through hydroxylation, oxidation, dealkylation, dehydrogenation, reduction, deamination, and desulfuration reactions. These transformation reactions are referred to as phase I reactions and are often mediated by cytochrome P450 (CYP

CASE STUDY 12-3

A 36-year-old Hispanic woman presents to the emergency department with abdominal pain, weakness, and loss of appetite. She had not traveled in recent months. She has not been well for several days.

Questions

1. What laboratory tests should be ordered to help diagnose this patient?
2. What enzyme tests will be useful in diagnosing this patient?
3. What two diagnoses are most likely for this patient?

450) enzymes. Xenobiotics can also become transformed into more polar compounds through enzyme-mediated conjugation reactions, also known as phase II reactions, in which xenobiotics are conjugated with glucuronide (UDP-glucuronyltransferase 1A1 [UGT1A1]), acetate (*N*-acetyltransferase [NAT]), glutathione (glutathione-S-transferase [GST]), sulfate (sulfotransferase), and methionine groups.³⁹

CYP 450 enzymes are a superfamily of isoenzymes that are involved in the metabolism of more than 50% of all drugs. These enzymes that contain heme molecules, and they are given the name CYP 450 because they absorb the maximum amount of light at 450 nm. More than 500 CYP 450 enzymes that have been identified, and they are classified into families according to their homology to other enzymes.⁴² There are at least four CYP 450 (CYP1, 2, 3, and 4) families that are expressed primarily in the liver, but some isoforms are also expressed in extrahepatic tissues such as the lung, kidney, gastrointestinal tract, skin, and placenta.³⁹ The specific isozyme is classified by not only its family number but also by a subfamily letter, a number for an individual isozyme within the subfamily, and, if applicable, an asterisk followed by a number for each genetic (allelic) variant. Genetic variants have been identified that lead to complete enzyme deficiency (e.g., a frame shift, splice variant, stop codon, or a complete gene deletion), reduced enzyme function or expression, or enhanced enzyme function or expression. Recognition of genetic variants can explain interindividual differences in drug response and pharmacokinetics.^{40–43} For example, four phenotypes are recognized for CYP2D6: ultra-metabolizers, extensive metabolizers, intermediate metabolizers, and poor metabolizers. Patients who are poor metabolizers for the CYP2D6 enzyme are at risk for therapeutic failure when inactive prodrugs such as tamoxifen require CYP2D6 for drug activation. Tricyclic antidepressants such as nortriptyline require CYP2D6 for inactivation. Thus, CYP2D6 poor metabolizers may require lower dose requirements than will patients with

TABLE 12-7 COMMON SUBSTRATES FOR DRUG-METABOLIZING ENZYMES

| ENZYME | SUBSTRATES | INDUCERS | INHIBITORS |
|---------|--|--|---|
| CYP1A1 | (R)-Warfarin | Omeprazole TCDD Benzo[a]pyrene, 3MC | |
| CYP1A2 | Acetaminophen Caffeine (R)-Warfarin Estradiol Theophylline | Insulin Tobacco Polycyclic-aromatic hydrocarbons | Ciprofloxacin Cimetidine Amiodarone Fluoroquinolones |
| CYP2A6 | Cyclophosphamide Halothane Zidovudine Coumarin | Dexamethasone | Pilocarpine Coumarin |
| CYP2B6 | Cyclophosphamide Diazepam Bupropion | Phenobarbital Rifampin | Ticlopidine |
| CYP2C9 | (S)-Warfarin Ibuprofen Tolbutamide Diclofenac Losartan Phenytoin | Rifampin Secobarbital | Fluconazole Amiodarone Isoniazid Probenicid Sertraline Sulfamethoxazole |
| CYP2C19 | Diazepam Omeprazole Chloripramine Indomethacin | Barbituate Phenytoin | Omeprazole Chloramphenicol Cimetidine Ketoconazole Indomethacin |
| CYP2D6 | Carvedilol Amitriptyline Haloperidol Amphetamine Chlorpromazine Dextromethorphan Codeine | Dexamethasone Rifampin | Bupropion Fluoxetine Quinidine Amiodarone Sertraline Celecoxib Chlorpromazine |
| CYP2E1 | Acetaminophen Chlorzoazone Halothane Ethanol | Ethanol Isoniazid | Disulfiram Diethyldithiocarbamate |
| CYP3A4 | Erythromycin Quinidine Diazepam Cortisol Cyclosporine Indinavir Chlorpheniramine Nifedipine Lovastatin Testosterone Cocaine Fentanyl Tamoxifen | HIV antivirals Barbiturates Carbamazepine Phenobarbital Phenytoin Rifampin St. John's Wort Troglitazone | HIV antivirals Ketoconazole Erythromycin Grapefruit juice Cimetidine Chloramphenicol |
| TPMT | Azithioprine 6-Mercaptopurine | | Naproxen Furosemide |

Reprinted with permission from Rendic S, Di Carlo FJ. Human cytochrome P450 enzymes: a status report summarizing their reactions, substrates, inducers, and inhibitors. *Drug Metab Rev* 1997;29:413-580.

extensive (“normal”) metabolism and may be at high risk for adverse drug reactions.^{39,41}

In addition to xenobiotic metabolism, CYP 450 enzymes are also involved in the biosynthesis of endogenous compounds. The CYP5 family consists of thromboxane synthases that catalyze the reaction that leads to platelet aggregation. CYP7 and CYP27 families catalyze the hydroxylation of cholesterol for the biosynthesis of bile acids. The CYP24 family catalyzes the hydroxylation and inactivation of vitamin D₃. CYP 450 enzymes are also found in steroid-producing tissues and function to synthesize steroid hormones from cholesterol (CYP11, 17, 19, and 21).⁴²

Genetic variants that affect drug-metabolizing enzyme function and expression are recognized for other enzymes such as NAT, UGT1A1, GST, and TPMT. These variants are associated with distinct extensive (fast), intermediate, or poor (slow) metabolizer phenotypes, which could lead to adverse drug reactions or therapeutic failure. For example, two phenotypes—fast or slow acetylators—are recognized for *N*-acetyltransferase 2 (NAT2). NAT2 is the primary enzyme involved in the acetylation of isoniazid, a drug used to treat tuberculosis. Acetylation is the primary mechanism for the elimination of isoniazid and, therefore, patients with low NAT2 activity will not be able to inactivate isoniazid, putting those patients at increased risk for adverse drug reactions.³⁹ UGT1A1 has polymorphisms that can lead to a nonfunctioning enzyme. UGT1A1 is responsible for the metabolism of bilirubin; patients with nonfunctioning UGT1A1 are at risk for hyperbilirubinemia.⁴³ Last, thiopurine methyltransferase (TPMT) is an enzyme that can be found in bone marrow and erythrocytes and functions to inactivate chemotherapeutic

thiopurine drugs like azathioprine and 6-mercaptopurine. The TPMT enzyme has genetic polymorphisms, which causes variable responses (normal, intermediate, and low activity) to thiopurine metabolism. Patients with low TPMT activity are at risk of developing severe bone marrow toxicity when the standard dose therapy for thiopurine drugs is administered; thus, genetic testing is essential for identifying patients with metabolizing enzyme polymorphisms.⁴³

Pharmacogenetic testing is often used prior to drug therapy to assist clinicians in identifying patients with genetic polymorphisms, to guide drug and dose selection. Pharmacogenetic testing can be performed through phenotype tests that measure metabolic enzyme activity, through administration of a probe drug and subsequent evaluation of metabolic ratios, or through genotype testing that identifies clinically significant genetic variants.

The activity of drug-metabolizing enzymes can also be altered by food, nutritional supplements, or other drugs. Compounds that stimulate an increase in the synthesis of CYP 450 enzymes are called *inducers*. Inducers will increase the metabolism of drugs and reduce the bioavailability of the parent compound. Compounds that reduce the expression or activity of a drug-metabolizing enzyme are referred to as *inhibitors*. For example, inhibitors can compete with substrates for the active site of the CYP 450 and thereby decrease the metabolism of drugs and increase the bioavailability of the parent compound, or block activity or expression through noncompetitive means.³⁹ Table 12-7 lists the common families of CYP 450 enzymes along with some of their substrates and drugs that can induce or inhibit enzyme activity.

REFERENCES

1. Enzyme Nomenclature 1978, Recommendations of the Nomenclature Committee of the International Union of Biochemistry on the Nomenclature and Classification of Enzymes. New York, N.Y.: Academic Press, 1979.
2. Baron DN, Moss DW, Walker PG, et al. Abbreviations for names of enzymes of diagnostic importance. *J Clin Pathol* 1971;24:656.
3. Baron DN, Moss DW, Walker PG, et al. Revised list of abbreviations for names of enzymes of diagnostic importance. *J Clin Pathol* 1975;28:592.
4. Rej R. Accurate enzyme measurements. *Arch Pathol Lab Med* 1998;117:352.
5. Spitzer M, Pinto A. Early diagnosis of ectopic pregnancy: can we do it accurately using a chemical profile? *J Women's Health Gender Based Med* 2000;9:537.
6. Na Kafusa J, et al. The importance of serum creatine phosphokinase levels in the early diagnosis, and as a prognostic factor, of *Vibrio vulnificus* infection. *Br Med J* 2001;145:2.
7. Galen RS. The enzyme diagnosis of myocardial infarction. *Hum Pathol* 1975;6:141.
8. Wilkinson JH. The principles and practice of diagnostic enzymology. Chicago, Ill.: Year Book Medical Publishers, 1976:395.
9. Silverman LM, Dermer GB, Zweig MH, et al. Creatine kinase BB: a new tumor-associated marker. *Clin Chem* 1979;25:1432.
10. Lang H, ed. Creatine kinase isoenzymes: pathophysiology and clinical application. Berlin, Germany: Springer-Verlag, 1981.
11. Irvin RG, Cobb FR, Roe CR. Acute myocardial infarction and MB creatine phosphokinase: relationship between onset of symptoms of infarction and appearance and disappearance of enzyme. *Arch Intern Med* 1980;140:329.
12. Bark CJ. Mitochondrial creatine kinase—a poor prognostic sign. *JAMA* 1980;243:2058.
13. Batsakis J, Savory J, eds. Creatine kinase. *Crit Rev Clin Lab Sci* 1982;16:291.
14. Lang H, Wurzburg U. Creatine kinase, an enzyme of many forms. *Clin Chem* 1982;28:1439.
15. Lott JA. Electrophoretic CK and LDH isoenzyme assays in myocardial infarction. *Lab Mgmt* 1983;Feb:23.
16. Pesce MA. The CK isoenzymes: findings and their meaning. *Lab Mgmt* 1982;Oct:25.
17. Roche Diagnostics. Isomune-CK package insert. Nutley, N.J.: Hoffman-La Roche, 1979.

18. Faulkner WR, Meites S, eds. Selected methods for the small clinical chemistry laboratory: selected methods of clinical chemistry. Vol. 9. Washington, D.C.: American Association for Clinical Chemistry, 1982:475.
19. Lott JA, Stang JM. Serum enzymes and isoenzymes in the diagnosis and differential diagnosis of myocardial ischemia and necrosis. *Clin Chem* 1980;26:1241.
20. Leung FY, Henderson AR. Influence of hemolysis on the serum lactate dehydrogenase-1/lactate dehydrogenase-2 ratio as determined by an accurate thin-layer agarose electrophoresis procedure. *Clin Chem* 1981;27:1708.
21. Bhagavan NV, Darm JR, Scottolini AG. A sixth lactate dehydrogenase isoenzyme (LDH-6) and its significance. *Arch Pathol Lab Med* 1982;106:521.
22. Cabello B, Lubin J, Rywlin AM, et al. Significance of a sixth lactate dehydrogenase isoenzyme (LDH₆). *Am J Clin Pathol* 1980;73:253.
23. Goldberg DM, Werner M, eds. LDH-6, a sign of impending death from heart failure, selected topics in clinical enzymology. New York, N.Y.: Walter de Gruyter, 1983:347.
24. Posen S, Doherty E. The measurement of serum alkaline phosphatase in clinical medicine. *Adv Clin Chem* 1981;22:165.
25. Warren BM. The isoenzymes of alkaline phosphatase. Beaumont, Tex.: Helena Laboratories, 1981.
26. Fleisher GA, Eickelberg ES, Elveback LR. Alkaline phosphatase activity in the plasma of children and adolescents. *Clin Chem* 1977;23:469.
27. Gittes RF. Carcinoma of the prostate. *N Engl J Med* 1991;324:236.
28. Gittes RF. Prostate specific antigen. *N Engl J Med* 1987;318:954.
29. Oesterling JE. Prostate specific antigen: a critical assessment of the most useful tumor marker for adenocarcinoma of the prostate. *J Urol* 1991;145:907.
30. Griffiths JC. The laboratory diagnosis of prostatic adenocarcinoma. *Crit Rev Clin Lab Sci* 1983;19:187.
31. Lantz RK, Berg MJ. From clinic to court: acid phosphatase testing. *Diagn Med* 1981;Mar/Apr:55.
32. Yam LT. Clinical significance of the human acid phosphatases. A review. *Am J Med* 1974;56:604.
33. Rosalki SB. Gamma-glutamyl transpeptidase. *Adv Clin Chem* 1975;17:53.
34. Salt WB II, Schenker S. Amylase: its clinical significance. A review of the literature. *Medicine* 1976;4:269.
35. Murthy U, et al. Hyperamylasemia in patients with acquired immunodeficiency syndrome. *Am J Gastroenterol* 1992;87:332.
36. Remaley AT, Wilding P. Macroenzymes: biochemical characterization, clinical significance, and laboratory detection. *Clin Chem* 1989;35:2261–2270.
37. Turecky L. Macroenzymes and their clinical significance. *Bratisl Lek Listy* 2004;105:260–263.
38. Theofilopoulous AN. Autoimmunity. In: Stites DP, Stobo JD, Wells JV, eds. Basic and clinical immunology. 6th ed. Norwalk, Conn.: Appleton & Lange, 1987:128–158.
39. Hardman JG, Limbird LE, eds. Goodman and Gilman's The pharmacological basis of therapeutics. 9th ed. New York, N.Y.: McGraw-Hill, 1996:11–16.
40. Wilkinson GR. Drug metabolism and variability among patients in drug response. *N Engl J Med* 2005;352:2211–2221.
41. Nebert DW, Dieter MZ. The evolution of drug metabolism. *Pharmacology* 2000;61:124–135.
42. Rendic S, Di Carlo FJ. Human cytochrome P450 enzymes: a status report summarizing their reactions, substrates, inducers, and inhibitors. *Drug Metab Rev* 1997;29:413–580.
43. McMillin GA. Pharmacogenetics fundamental of molecular diagnostics. St Louis, Mo.: WB Saunders, 2007:197–215.

Carbohydrates

Vicki S. Freeman

CHAPTER

13

CHAPTER OUTLINE

■ GENERAL DESCRIPTION OF CARBOHYDRATES

- Classification of Carbohydrates
- Stereoisomers
- Monosaccharides, Disaccharides, and Polysaccharides
- Chemical Properties of Carbohydrates
- Glucose Metabolism
- Fate of Glucose
- Regulation of Carbohydrate Metabolism

■ HYPERGLYCEMIA

- Diabetes Mellitus
- Pathophysiology of Diabetes Mellitus
- Criteria for Testing for Prediabetes and Diabetes
- Criteria for the Diagnosis of Diabetes Mellitus
- Criteria for the Testing and Diagnosis of Gestational Diabetes Mellitus

■ HYPOGLYCEMIA

- Genetic Defects in Carbohydrate Metabolism

■ ROLE OF LABORATORY IN DIFFERENTIAL DIAGNOSIS AND MANAGEMENT OF PATIENTS WITH GLUCOSE METABOLIC ALTERATIONS

- Methods of Glucose Measurement
- Self-Monitoring of Blood Glucose
- Glucose Tolerance and 2-Hour Postprandial Tests
- Glycosylated Hemoglobin/Hemoglobin A_{1c}
- Ketones
- Microalbuminuria
- Islet Autoantibody and Insulin Testing

■ REFERENCES

Organisms rely on the oxidation of complex organic compounds to obtain energy. Three general types of such compounds are carbohydrates, amino acids, and lipids. Although all three are used as a source of energy, carbohydrates are the primary source for brain, erythrocytes, and retinal cells in humans. Carbohydrates are the major food source and energy supply of the body and are stored primarily as liver and muscle glycogen. Disease states involving carbohydrates are split into groups—hyperglycemia and hypoglycemia. Early detection of diabetes mellitus is the aim of the American Diabetes Association (ADA) guidelines established in 1997. Acute and chronic complications may be avoided with proper diagnosis, monitoring, and treatment. The laboratory plays an important role through periodic measurements of glycosylated hemoglobin and microalbumin.

GENERAL DESCRIPTION OF CARBOHYDRATES

Carbohydrates are compounds containing C, H, and O. The general formula for a carbohydrate is $C_x(H_2O)_y$. All carbohydrates contain C=O and —OH functional groups. There are some derivatives from this basic

formula because carbohydrate derivatives can be formed by the addition of other chemical groups, such as phosphates, sulfates, and amines. The classification of carbohydrates is based on four different properties: (1) the size of the base carbon chain, (2) the location of the CO function group, (3) the number of sugar units, and (4) the stereochemistry of the compound.

Classification of Carbohydrates

Carbohydrates can be grouped into generic classifications based on the number of carbons in the molecule. For example, **trioses** contain three carbons, tetroses contain four, pentoses contain five, and hexoses contain six. In actual practice, the smallest carbohydrate is glyceraldehyde, a three-carbon compound.

Carbohydrates are hydrates of aldehyde or ketone derivatives based on the location of the CO functional group (Fig. 13-1). The two forms of carbohydrates are aldose and ketose (Fig. 13-2). The aldose form has a terminal carbonyl group ($O=CH^-$) called an aldehyde group, whereas the ketose form has a carbonyl group ($O=C$) in the middle linked to two other carbon atoms (called a ketone group).



FIGURE 13-1. Pathways in glucose metabolism.

Several models are used to represent carbohydrates. The **Fisher projection** of a carbohydrate has the aldehyde or ketone at the top of the drawing. The carbons are numbered starting at the aldehyde or ketone end. The compound can be represented as a straight chain or might be linked to show a representation of the cyclic, hemiacetal form (Fig. 13-3). The **Haworth projection** represents the compound in the cyclic form that is more representative of the actual structure. This structure is formed when the functional (carbonyl) group (ketone or aldehyde) reacts with an alcohol group on the same sugar to form a ring called either a *hemaketal* or *hemiacetal ring*, respectively (Fig. 13-4).

Stereoisomers

The central carbons of a carbohydrate are asymmetric (chiral)—four different groups are attached to the carbon atoms. This allows for various spatial arrangements around each asymmetric carbon (also called stereogenic centers) forming molecules called *stereoisomers*. Stereoisomers have the same order and types of bonds but different spatial arrangements and different properties. For each asymmetric carbon, there are 2^n possible isomers; therefore, there are 2^1 , or two, forms of glyceraldehyde. Because an aldohexose contains four asymmetric carbons, there are 2^4 , or 16, possible isomers. A monosaccharide is assigned to the D or the L series according to the configuration at the highest-numbered asymmetric carbon. This asymmetrically substituted carbon atom is called the “configurational atom” or chiral center. Thus, if the hydroxy group (or the oxygen bridge of the ring form) projects to the right in the Fisher projection, the sugar belongs to the D series and receives the prefix D-, and if it projects to the left, then it belongs to the L series and receives the prefix L-. These stereoisomers, called enantiomers, are images that cannot be overlapped and are nonsuperimposable. In Figure 13-5, D-glucose is represented in the Fisher projection with the hydroxy group on carbon number 5 positioned on the right. L-Glucose

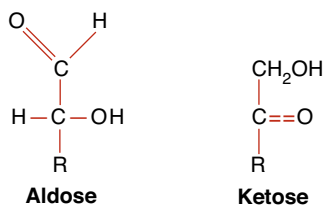

FIGURE 13-2. Two forms of carbohydrates.

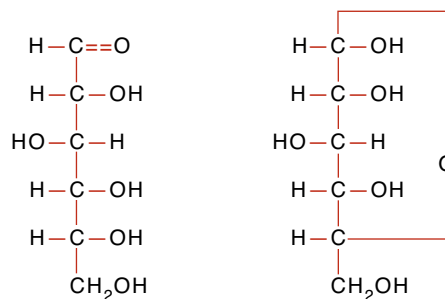

FIGURE 13-3. Fisher projection of glucose. (Left) Open chain Fisher projections. (Right) Cyclic Fisher projection.

has the hydroxy group of carbon number 5 positioned on the left. Most sugars in humans are in the D-form.

Monosaccharides, Disaccharides, and Polysaccharides

Another classification of carbohydrates is based on number of sugar units in the chain: monosaccharides, disaccharides, oligosaccharides, and polysaccharides. This chaining of sugars relies on the formation of glycoside bonds that are bridges of oxygen atoms. When two carbohydrate molecules join, a water molecule is produced. When they split, one molecule of water is used to form the individual compounds. This reaction is called *hydrolysis*. The glycoside linkages of carbohydrate can involve any number of carbons; however, certain carbons are favored, depending on the carbohydrate.

Monosaccharides are simple sugars that cannot be hydrolyzed to a simpler form. These sugars can contain three, four, five, and six or more carbon atoms (known as trioses, tetroses, pentoses, and hexoses, respectively). The most common include glucose, fructose, and galactose.

Disaccharides are formed when two monosaccharide units are joined by a glycosidic linkage. On hydrolysis, disaccharides will be split into two monosaccharides by disaccharide enzymes (e.g., lactase) located on the microvilli of the intestine. These monosaccharides are then actively absorbed. The most common disaccharides are maltose (comprising 2- β -D-glucose molecules in a 1 \rightarrow 4 linkage), lactose, and sucrose.

Oligosaccharides are the chaining of 2 to 10 sugar units, whereas **polysaccharides** are formed by the linkage

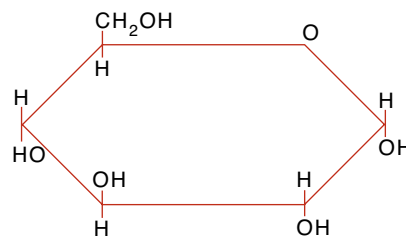

FIGURE 13-4. Haworth projection of glucose.

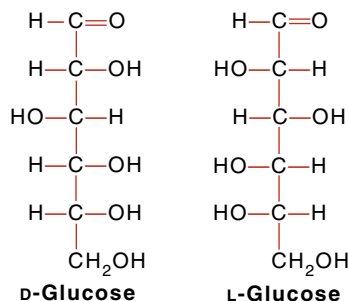

FIGURE 13-5. Stereoisomers of glucose.

of many monosaccharide units. On hydrolysis, polysaccharides will yield more than 10 monosaccharides. Amylase hydrolyzes starch to disaccharides in the duodenum. The most common polysaccharides are starch (glucose molecules) and glycogen (Fig. 13-6).

Chemical Properties of Carbohydrates

Some carbohydrates are reducing substances; these carbohydrates can reduce other compounds. To be a reducing substance, the carbohydrate must contain a ketone or an aldehyde group. This property was used in many laboratory methods in the past in the determination of carbohydrates.

Carbohydrates can form glycosidic bonds with other carbohydrates and with noncarbohydrates. Two sugar molecules can be joined in tandem forming a glycosidic bond between the hemiacetal group of one molecule and the hydroxyl group on the other molecule. In forming the glycosidic bond, an acetal is generated on one sugar (at carbon 1) in place of the hemiacetal. If the bond forms with one of the other carbons on the carbohydrate other than the anomeric (reducing) carbon, the anomeric carbon is unaltered and the resulting compound remains a reducing substance. Examples of reducing substances include glucose, maltose, fructose, lactose, and galactose. If the bond is formed with the anomeric carbon on the other carbohydrate, the resulting compound is *no longer* a reducing substance. Nonreducing carbohydrates *do not* have an active ketone or aldehyde group. They *will not* reduce other compounds. The most common nonreducing sugar is sucrose—table sugar (Fig. 13-7).

All monosaccharides and many disaccharides are reducing agents. This is because a free aldehyde or ketone (the open chain form) can be oxidized under the proper conditions. As disaccharide remains a reducing agent

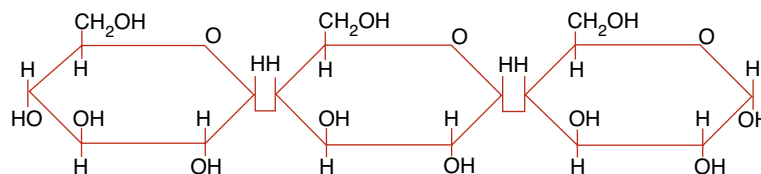

FIGURE 13-6. Linkage of monosaccharides.

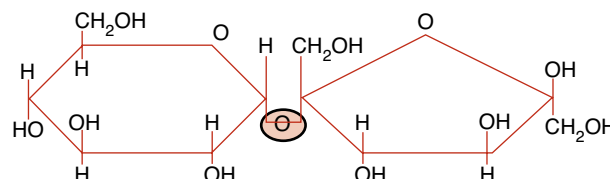

FIGURE 13-7. Haworth projection of sucrose.

when the hemiacetal or ketal hydroxyl group is not linked to another molecule. Both maltose and lactose are reducing agents, whereas sucrose is not.

Glucose Metabolism

Glucose is a primary source of energy for humans. The nervous system, including the brain, totally depends on glucose from the surrounding extracellular fluid (ECF) for energy. Nervous tissue cannot concentrate or store carbohydrates; therefore, it is critical to maintain a steady supply of glucose to the tissue. For this reason, the concentration of glucose in the ECF must be maintained in a narrow range. When the concentration falls below a certain level, the nervous tissue loses the primary energy source and are incapable of maintaining normal function.

Fate of Glucose

Most of our ingested carbohydrates are polymers, such as starch and **glycogen**. Salivary amylase and pancreatic amylase are responsible for the digestion of these nonabsorbable polymers to dextrins and disaccharides, which are further hydrolyzed to monosaccharides by maltase, an enzyme released by the intestinal mucosa. Sucrase and lactase are two other important gut-derived enzymes that hydrolyze sucrose to glucose and fructose and lactose to glucose and galactose.

When disaccharides are converted to monosaccharides, they are absorbed by the gut and transported to the liver by the hepatic portal venous blood supply. Glucose is the only carbohydrate to be directly used for energy or stored as glycogen. Galactose and fructose must be converted to glucose before they can be used. After glucose enters the cell, it is quickly shunted into one of three possible metabolic pathways, depending on the availability of substrates or the nutritional status of the cell. The ultimate goal of the cell is to convert glucose to carbon dioxide and water. During this process, the cell obtains the

high-energy molecule adenosine triphosphate (ATP) from inorganic phosphate and adenosine diphosphate (ADP). The cell requires oxygen for the final steps in the electron transport chain (ETC). Nicotinamide adenine dinucleotide (NAD) in its reduced form (NADH) will act as an intermediate to couple glucose oxidation to the ETC in the mitochondria where much of the ATP is gained.

The first step for all three pathways requires glucose to be converted to glucose-6-phosphate using the high-energy molecule, ATP. This reaction is catalyzed by the enzyme hexokinase (Fig. 13-8). Glucose-6-phosphate can enter the **Embden-Myerhof pathway** or the *hexose monophosphate pathway* or can be converted to glycogen (Fig. 13-8). The first two pathways are important for the generation of energy from glucose; the conversion to glycogen pathway is important for the storage of glucose.

In the Embden-Myerhof pathway, glucose is broken down into two, three-carbon molecules of pyruvic acid

that can enter the *tricarboxylic acid cycle* (TCA cycle) on conversion to acetyl-coenzyme A (acetyl-CoA). This pathway requires oxygen and is called the *aerobic pathway* (Fig. 13-8). Other substrates have the opportunity to enter the pathway at several points. Glycerol released from the hydrolysis of triglycerides can enter at 3-phosphoglycerate, and fatty acids and ketones and some amino acids are converted or catabolized to acetyl-CoA, which is part of the TCA cycle. Other amino acids enter the pathway as pyruvate or as deaminated α -ketoacids and α -oxoacids. The conversion of amino acids by the liver and other specialized tissue, such as the kidney, to substrates that can be converted to glucose is called **gluconeogenesis**. Gluconeogenesis also encompasses the conversion of glycerol, lactate, and pyruvate to glucose.

Anaerobic **glycolysis** is important for tissue such as muscle, which often have important energy requirements without an adequate oxygen supply. These tissues can

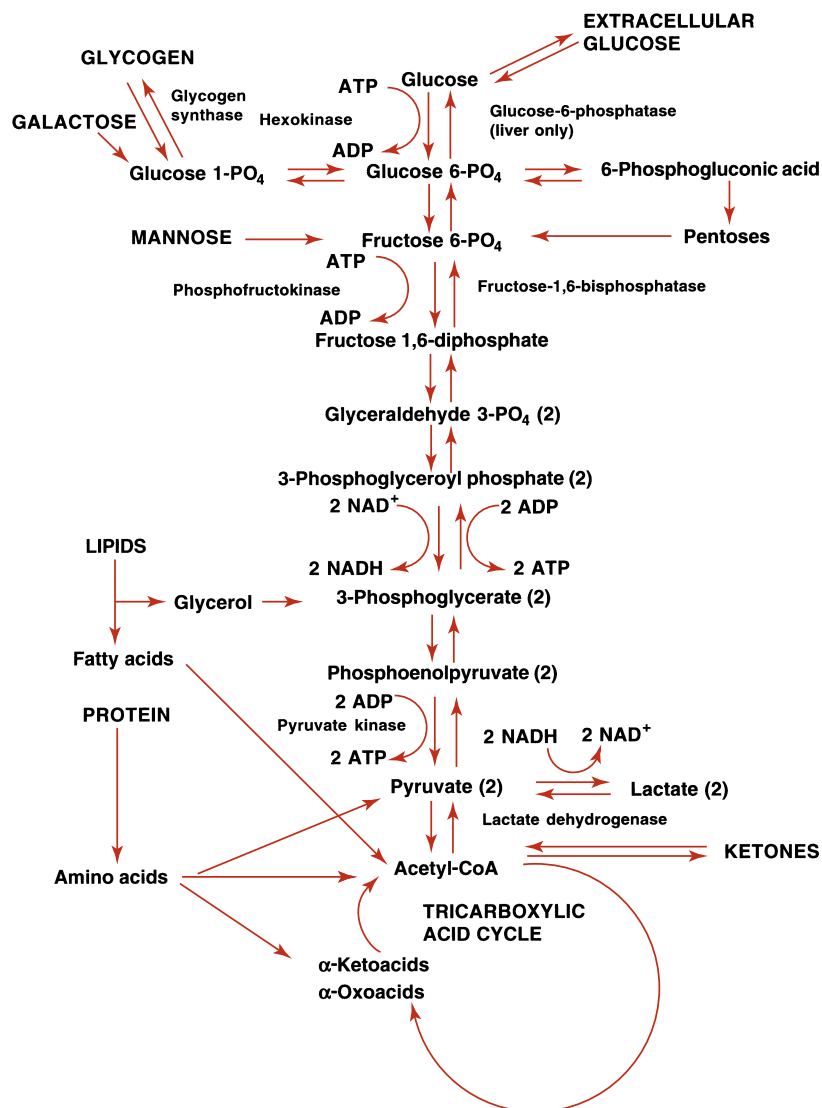

FIGURE 13-8. The Embden-Meyerhof pathway for anaerobic glycolysis.

derive ATP from glucose in an oxygen-deficient environment by converting pyruvic acid into lactic acid. The lactic acid diffuses from the muscle cell, enters the systemic circulation, and is then taken up and used by the liver (Fig. 13-8). For anaerobic glycolysis to occur, 2 moles of ATP must be consumed for each mole of glucose; however, 4 moles of ATP are directly produced, resulting in a net gain of 2 moles of ATP. Further gains of ATP result from the introduction of pyruvate into the TCA cycle and NADH into the ETC.

The second energy pathway is the *hexose monophosphate shunt* (HMP shunt), which is actually a detour of glucose-6-phosphate from the glycolytic pathway to become 6-phosphogluconic acid. This oxidized product permits the formation of ribose-5-phosphate and NADP in its reduced form (NADPH). NADPH is important to erythrocytes that lack mitochondria and are therefore incapable of the TCA cycle. The reducing power of NADPH is required for the protection of the cell from oxidative and free radical damage. Without NADPH, the lipid bilayer membrane of the cell and critical enzymes would eventually be destroyed, resulting in cell death. The HMP shunt also permits pentoses, such as ribose, to enter the glycolytic pathway.

When the cell's energy requirements are being met, glucose can be stored as glycogen. This third pathway, which is called *glycogenesis*, is relatively straightforward. Glucose-6-phosphate is converted to glucose-1-phosphate, which is then converted to uridine diphosphoglucose and then to glycogen by glycogen synthase. Several tissues are capable of the synthesis of glycogen, especially the liver and muscles. Hepatocytes are capable of releasing glucose from glycogen or other sources to maintain the blood glucose concentration. This is because the liver synthesizes the enzyme glucose-6-phosphatase. Without this enzyme, glucose is trapped in the glycolytic pathway. Muscle cells do not synthesize glucose-6-phosphatase and, therefore, they are incapable of dephosphorylating glucose. Once glucose enters a muscle cell, it remains as glycogen unless it is catabolized. **Glycogenolysis** is the process by which glycogen is converted back to glucose 6-phosphate for entry into the glycolytic pathway. Table 13-1

outlines the major energy pathways involved either directly or indirectly with glucose metabolism.

Overall, dietary glucose and other carbohydrates either can be used by the liver and other cells for energy or can be stored as glycogen for later use. When the supply of glucose is low, the liver will use glycogen and other substrates to elevate the blood glucose concentration. These substrates include glycerol from triglycerides, lactic acid from skin and muscles, and amino acids. If the lipolysis of triglycerides is unregulated, it results in the formation of ketone bodies, which the brain can use as a source of energy through the TCA cycle. The synthesis of glucose from amino acids is gluconeogenesis. This process is used in conjunction with the formation of ketone bodies when glycogen stores are depleted—conditions normally associated with starvation. The principal pathway for glucose oxidation is through the Embden-Myerhof pathway. NADPH can be synthesized through the HMP shunt, which is a side pathway from the anaerobic glycolytic pathway (Fig. 13-8).

Regulation of Carbohydrate Metabolism

The liver, pancreas, and other endocrine glands are all involved in controlling the blood glucose concentrations within a narrow range. During a brief fast, glucose is supplied to the ECF from the liver through glycogenolysis. When the fasting period is longer than 1 day, glucose is synthesized from other sources through gluconeogenesis. Control of blood glucose is under two major hormones: insulin and glucagon, both produced by the pancreas. Their actions oppose each other. Other hormones and neuroendocrine substances also exert some control over blood glucose concentrations, permitting the body to respond to increased demands for glucose or to survive prolonged fasts. It also permits the conservation of energy as lipids when excess substrates are ingested.

Insulin is the primary hormone responsible for the entry of glucose into the cell. It is synthesized by the cells of islets of Langerhans in the pancreas. When these cells detect an increase in body glucose, they release insulin. The release of insulin causes an increased movement of glucose into the cells and increased glucose metabolism.

TABLE 13-1 PATHWAYS IN GLUCOSE METABOLISM

| | |
|-----------------|--|
| Glycolysis | Metabolism of glucose molecule to pyruvate or lactate for production of energy |
| Gluconeogenesis | Formation of glucose-6-phosphate from noncarbohydrate sources |
| Glycogenolysis | Breakdown of glycogen to glucose for use as energy |
| Glycogenesis | Conversion of glucose to glycogen for storage |
| Lipogenesis | Conversion of carbohydrates to fatty acids |
| Lipolysis | Decomposition of fat |

TABLE 13-2 THE ACTION OF HORMONES**ACTION OF INSULIN**

Increases glycogenesis and glycolysis: Glucose → glycogen → pyruvate → acetyl-CoA

Increases lipogenesis

Decreases glycogenolysis

ACTION OF GLUCAGON

Increases glycogenolysis: Glycogen → glucose

Increases gluconeogenesis: Fatty acids → acetyl-CoA → ketone, Proteins → amino acids

Insulin is normally released when glucose levels are high and is *not* released when glucose levels are decreased. It decreases plasma glucose levels by increasing the transport entry of glucose in muscle and adipose tissue by way of nonspecific receptors. It also regulates glucose by increasing glycogenesis, lipogenesis, and glycolysis and inhibiting glycogenolysis. Insulin is the only hormone that decreases glucose levels and can be referred to as a **hypoglycemic** agent (Table 13-2).

Glucagon is the primary hormone responsible for increasing glucose levels. It is synthesized by the β cells of islets of Langerhans in the pancreas and released during stress and fasting states. When these cells detect a decrease in body glucose, they release glucagon. Glucagon acts by increasing plasma glucose levels by glycogenolysis in the liver and an increase in gluconeogenesis. It can be referred to as a **hyperglycemic** agent (Table 13-2).

Two hormones produced by the adrenal gland affect carbohydrate metabolism. *Epinephrine*, produced by the adrenal medulla, increases plasma glucose by inhibiting insulin secretion, increasing glycogenolysis, and promoting lipolysis. Epinephrine is released during times of stress. *Glucocorticoids*, primarily cortisol, are released from the adrenal cortex on stimulation by adrenocorticotropic hormone (ACTH). Cortisol increases plasma glucose by decreasing intestinal entry into the cell and increasing gluconeogenesis, liver glycogen, and lipolysis.

Two anterior pituitary hormones, growth hormone and ACTH, promote increased plasma glucose. *Growth hormone* increases plasma glucose by decreasing the entry of glucose into the cells and increasing glycolysis. Its release from the pituitary is stimulated by decreased glucose levels and inhibited by increased glucose. Decreased levels of cortisol stimulate the anterior pituitary to release ACTH. ACTH, in turn, stimulates the adrenal cortex to release cortisol and increases plasma glucose levels by converting liver glycogen to glucose and promoting gluconeogenesis.

Two other hormones affect glucose levels: thyroxine and somatostatin. The thyroid gland is stimulated by the production of thyroid-stimulating hormone (TSH) to release *thyroxine* that increases plasma glucose levels by increasing glycogenolysis, gluconeogenesis, and intestinal absorption of glucose. *Somatostatin*, produced by the β cells of the islets of Langerhans of the pancreas, increases plasma glucose levels by the inhibition of insulin, glucagon, growth hormone, and other endocrine hormones.

HYPERGLYCEMIA

Hyperglycemia is an increase in plasma glucose levels. In healthy patients, during a hyperglycemia state, insulin is secreted by the β cells of the pancreatic islets of Langerhans. Insulin enhances membrane permeability to cells in the liver, muscle, and adipose tissue. It also alters the glucose metabolic pathways. Hyperglycemia, or increased plasma glucose levels, is caused by an imbalance of hormones.

Diabetes Mellitus

Diabetes mellitus is actually a group of metabolic diseases characterized by hyperglycemia resulting from defects in insulin secretion, insulin action, or both. In 1979, the National Diabetes Data Group developed a classification and diagnosis scheme for diabetes mellitus.¹ This scheme included dividing diabetes into two broad categories: type 1, insulin-dependent diabetes mellitus (IDDM); and type 2, non-insulin-dependent diabetes mellitus (NIDDM).

Established in 1995, the International Expert Committee on the Diagnosis and Classification of Diabetes Mellitus, working under the sponsorship of the American Diabetes Association, was given the task of updating the 1979 classification system. The proposed changes included eliminating the older terms of IDDM and NIDDM. The categories of type 1 and type 2 were retained, with the adoption of Arabic numerals instead of Roman numerals² (Table 13-3).

CASE STUDY 13-1

An 18-year-old, male high school student who had a 4-year history of diabetes mellitus was brought to the emergency department because of excessive drowsiness, vomiting, and diarrhea. His diabetes had been well controlled with 40 units of NPH insulin daily until several days ago, when he developed excessive thirst and polyuria. For the past 3 days, he has also had headaches, myalgia, and a low-grade fever. Diarrhea and vomiting began 1 day ago.

Questions

1. What is the probable diagnosis of this patient based on the data presented?
2. What laboratory test(s) should be performed to follow this patient and aid in adjusting insulin levels?
3. Why are the urine ketones positive?
4. What methods are used to quantitate urine ketones? Which ketone(s) do they detect?

URINALYSIS RESULTS

| | |
|------------------|-------|
| Specific gravity | 1.012 |
| pH | 5.0 |
| Glucose | 4+ |
| Ketone | Large |

CHEMISTRY TEST RESULTS

| | |
|----------------|-----------|
| Sodium | 126 mEq/L |
| Potassium | 6.1 mEq/L |
| Chloride | 87 mEq/L |
| Bicarbonate | 6 mEq/L |
| Plasma glucose | 600 mg/dL |
| BUN | 48 mg/dL |
| Creatinine | 2.0 mg/dL |
| Serum ketones | 4+ |

TABLE 13-3 CLASSIFICATION OF DIABETES MELLITUS

| DIABETES MELLITUS CLASSIFICATION | PATHOGENESIS |
|----------------------------------|--|
| Type 1 | <ul style="list-style-type: none"> β-Cell destruction Absolute insulin deficiency Autoantibodies <ul style="list-style-type: none"> • Islet cell autoantibodies • Insulin autoantibodies • Glutamic acid decarboxylase autoantibodies • Tyrosine phosphatase IA-2 and IA-2B autoantibodies |
| Type 2 | <ul style="list-style-type: none"> Insulin resistance with an insulin secretory defect Relative insulin deficiency |
| Other | <ul style="list-style-type: none"> Associated with secondary conditions <ul style="list-style-type: none"> • Genetic defects of β-cell function • Pancreatic disease • Endocrine disease • Drug or chemical induced • Insulin receptor abnormalities • Other genetic syndromes |
| Gestational | <ul style="list-style-type: none"> Glucose intolerance during pregnancy Due to metabolic and hormonal changes |

Therefore, the ADA/World Health Organization (WHO) guidelines recommend the following categories of diabetes:

- Type 1 diabetes
- Type 2 diabetes
- Other specific types of diabetes
- Gestational diabetes mellitus (GDM)

Type 1 diabetes is characterized by inappropriate hyperglycemia primarily a result of pancreatic islet β -cell destruction and a tendency to ketoacidosis. Type 2 diabetes, in contrast, includes hyperglycemia cases that result from insulin resistance with an insulin secretory defect. An intermediate stage, in which the fasting glucose is increased above-normal limits but not to the level of diabetes, has been named *impaired fasting glucose*. Use of the term *impaired glucose tolerance* to indicate glucose tolerance values above normal but below diabetes levels was retained. Also, the term *gestational diabetes mellitus* was retained for women who develop glucose intolerance during pregnancy.

Type 1 diabetes mellitus is a result of cellular-mediated autoimmune destruction of the β cells of the pancreas, causing an absolute deficiency of insulin secretion. Upper limit of 110 mg/dL on the fasting plasma glucose is designated as the upper limit of normal blood glucose. Type 1 constitutes only 10% to 20% of all cases of diabetes and commonly occurs in childhood and adolescence. This disease is usually initiated by an environmental factor or infection (usually a virus) in individuals with a genetic predisposition and causes the immune destruction of the β cells of the pancreas and, therefore, a decreased production of insulin. Characteristics of type 1 diabetes include abrupt onset, insulin dependence, and ketosis tendency. This diabetic type is genetically related. One or more of the following markers are found in 85% to 90% of individuals with fasting hyperglycemia: islet cell autoantibodies, insulin autoantibodies, glutamic acid decarboxylase autoantibodies, and tyrosine phosphatase IA-2 and IA-2B autoantibodies.

Signs and symptoms include polydipsia (excessive thirst), polyphagia (increased food intake), polyuria

(excessive urine production), rapid weight loss, hyperventilation, mental confusion, and possible loss of consciousness (due to increased glucose to brain). Complications include microvascular problems such as nephropathy, neuropathy, and retinopathy. Increased heart disease is also found in patients with diabetes. Table 13-4 lists the laboratory findings in hyperglycemia. *Idiopathic type 1 diabetes* is a form of type 1 diabetes that has no known etiology, is strongly inherited, and does not have β -cell autoimmunity. Individuals with this form of diabetes have episodic requirements for insulin replacement.

Type 2 diabetes mellitus is characterized by hyperglycemia as a result of an individual's resistance to insulin with an insulin secretory defect. This resistance results in a relative, not an absolute, insulin deficiency. Type 2 constitutes the majority of the diabetes cases. Most patients in this type are obese or have an increased percentage of body fat distribution in the abdominal region. This type of diabetes often goes undiagnosed for many years and is associated with a strong genetic predisposition, with patients at increased risk with an increase in age, obesity, and lack of physical exercise. Characteristics usually include adult onset of the disease and milder symptoms than in type 1, with ketoacidosis seldom occurring. However, these patients are more likely to go into a hyperosmolar coma and are at an increased risk of developing macrovascular and microvascular complications.

Other specific types of diabetes are associated with certain conditions (secondary), including genetic defects of β -cell function or insulin action, pancreatic disease, diseases of endocrine origin, drug- or chemical-induced insulin receptor abnormalities, and certain genetic syndromes. The characteristics and prognosis of this form of diabetes depend on the primary disorder. Maturity-onset diabetes of youth (MODY) is a rare form of diabetes that is inherited in an autosomal dominant fashion.³

GDM is "any degree of glucose intolerance with onset or first recognition during pregnancy."⁴ Causes of GDM include metabolic and hormonal changes. Patients with GDM frequently return to normal postpartum. However, this disease is associated with increased perinatal complications and an increased risk for development of diabetes in later years. Infants born to mothers with diabetes are at increased risk for respiratory distress syndrome, hypocalcemia, and hyperbilirubinemia. Fetal insulin secretion is stimulated in the neonate of a mother with diabetes. However, when the infant is born and the umbilical cord is severed, the infant's oversupply of glucose is abruptly terminated, causing severe hypoglycemia.

TABLE 13-4 LABORATORY FINDINGS IN HYPERGLYCEMIA

| |
|--|
| Increased glucose in plasma and urine |
| Increased urine specific gravity |
| Increased serum and urine osmolality |
| Ketones in serum and urine (ketonemia and ketonuria) |
| Decreased blood and urine pH (acidosis) |
| Electrolyte imbalance |

Pathophysiology of Diabetes Mellitus

In both type 1 and type 2 diabetes, the individual will be hyperglycemic, which can be severe. Glucosuria can also

occur after the renal tubular transporter system for glucose becomes saturated. This happens when the glucose concentration of plasma exceeds roughly 180 mg/dL in an individual with normal renal function and urine output. As hepatic glucose overproduction continues, the plasma glucose concentration reaches a plateau around 300 to 500 mg/dL (17–28 mmol/L). Provided renal output is maintained, glucose excretion will match the overproduction, causing the plateau.

The individual with type 1 diabetes has a higher tendency to produce ketones. Patients with type 2 diabetes seldom generate ketones but instead have a greater tendency to develop hyperosmolar nonketotic states. The difference in glucagon and insulin concentrations in these two groups appears to be responsible for the generation of ketones through increased β -oxidation. In type 1, there is an absence of insulin with an excess of glucagon. This permits gluconeogenesis and lipolysis to occur. In type 2, insulin is present, as is (at times) hyperinsulinemia; therefore, glucagon is attenuated. Fatty acid oxidation is inhibited in type 2. This causes fatty acids to be incorporated into triglycerides for release as very low density lipoproteins (VLDL).

The laboratory findings of a patient with diabetes with ketoacidosis tend to reflect dehydration, electrolyte disturbances, and acidosis. Acetoacetate, β -hydroxybutyrate, and acetone are produced from the oxidation of fatty acids. The two former ketone bodies contribute to the acidosis. Lactate, fatty acids, and other organic acids can also contribute to a lesser degree. Bicarbonate and total carbon dioxide are usually decreased due to Kussmaul-Kien respiration (deep respirations). This is a compensatory mechanism to blow off carbon dioxide and remove hydrogen ions in the process. The anion gap in this acidosis can exceed 16 mmol/L. Serum osmolality is high as a result of hyperglycemia; sodium concentrations tend to be lower due in part to losses (polyuria) and in part to a shift of water from cells because of the hyperglycemia. The sodium value should not be falsely underestimated because of hypertriglyceridemia. Grossly elevated triglycerides will displace plasma volume and give the appearance of decreased electrolytes when flame photometry or prediluted, ion-specific electrodes are used for sodium determinations. Hyperkalemia is almost always present as a result of the displacement of potassium from cells in acidosis. This is somewhat misleading because the patient's total body potassium is usually decreased.

More typical of the untreated patient with type 2 diabetes is the nonketotic hyperosmolar state. The individual presenting with this syndrome has an overproduction of glucose; however, there appears to be an imbalance between production and elimination in urine. Often, this state is precipitated by heart disease, stroke, or pancreatitis. Glucose concentrations exceed 300 to 500 mg/dL

(17–28 mmol/L) and severe dehydration is present. The severe dehydration contributes to the inability to excrete glucose in the urine. Mortality is high with this condition. Ketones are not observed because the severe hyperosmolar state inhibits the ability of glucagon to stimulate lipolysis. The laboratory findings of nonketotic hyperosmolar coma include plasma glucose values exceeding 1,000 mg/dL (55 mmol/L), normal or elevated plasma sodium and potassium, slightly decreased bicarbonate, elevated blood urea nitrogen (BUN) and creatinine, and an elevated osmolality (greater than 320 mOsm/dL). The gross elevation in glucose and osmolality, the elevation in BUN, and the absence of ketones distinguish this condition from diabetic ketoacidosis.

Other forms of impaired glucose metabolism that do not meet the criteria for diabetes mellitus include impaired fasting glucose and impaired glucose tolerance. These forms are discussed in the following section.

Criteria for Testing for Prediabetes and Diabetes

The testing criteria for asymptomatic adults for type 2 diabetes mellitus were modified by the ADA Expert Committee to allow for earlier detection of the disease.

CASE STUDY 13-2

A 58-year-old, obese man with frequent urination is seen by his primary care physician. The following laboratory work was performed, and the following results were obtained:

| | | | |
|------------------------------|------------|--------------------|----------|
| CASUAL PLASMA GLUCOSE | | 225 mg/dL | |
| URINALYSIS RESULTS | | | |
| Color and appearance | Pale/clear | Blood | Negative |
| pH | 6.0 | Bilirubin | Negative |
| Specific Gravity | 1.025 | Urobilinogen | Negative |
| Glucose | 2+ | Nitrites | Negative |
| Ketones | Negative | Leukocyte esterase | Negative |

Questions

1. What is the probable diagnosis of this patient?
2. What other test(s) should be performed to confirm this? Which is the preferred test?
3. After diagnosis, what test(s) should be performed to monitor his condition?

CASE STUDY 13-3

A 14-year-old, male student was seen by his physician. His chief complaints were fatigue, weight loss, and increases in appetite, thirst, and frequency of urination. For the past 3 to 4 weeks, he had been excessively thirsty and had to urinate every few hours. He began to get up 3 to 4 times a night to urinate. The patient has a family history of diabetes mellitus.

LABORATORY DATA

| | | |
|------------------------|------------------|----------|
| Fasting plasma glucose | 160 mg/dL | |
| Urinalysis | Specific gravity | 1.040 |
| | Glucose | 4+ |
| | Ketones | Moderate |

Questions

1. Based on the preceding information, can this patient be diagnosed with diabetes?
2. What further tests might be performed to confirm the diagnosis?
3. According to the American Diabetes Association, what criteria are required for the diagnosis of diabetes?
4. Assuming this patient has diabetes, which type would be diagnosed?

According to ADA recommendations, all adults older than 45 years should have a measurement of fasting blood glucose every 3 years unless the individual is otherwise diagnosed with diabetes. Testing should be carried out at an earlier age or more frequently in individuals who display overweight tendencies (i.e., body mass index [BMI] ≥ 25 kg/m² [at-risk BMI may be lower in some ethnic groups]) and have additional risk factors, as follows:

- Habitually physically inactive
- Family history of diabetes in a first-degree relative
- In a high-risk minority population (e.g., African American, Latino, Native American, Asian American, and Pacific Islander)
- History of GDM or delivering a baby weighing more than 9 lb (4.1 kg)
- Hypertension (blood pressure $\geq 140/90$ mm Hg)
- Low high-density lipoprotein (HDL) cholesterol concentrations (< 35 mg/dL [0.90 mmol/L])
- Elevated triglyceride concentrations > 250 mg/dL (2.82 mmol/L)

- History of impaired fasting glucose/impaired glucose tolerance
- Women with polycystic ovarian syndrome (PCOS)
- Other clinical conditions associated with insulin resistance (e.g., severe obesity and acanthosis nigricans)
- History of cardiovascular disease

In the absence of the above criteria, testing for prediabetes and diabetes should begin at age 45 years. If results are normal, testing should be repeated at least at 3-year intervals, with consideration of more frequent testing depending on initial results and risk status.

As the incidence of adolescent type 2 diabetes has risen dramatically in the past few years, criteria for the testing for type 2 diabetes in asymptomatic children have been developed. This criteria include initiation of testing at the age 10 years or at onset of puberty, if puberty occurs at a younger age, with follow-up testing every 2 years.

- Overweight (BMI > 85 th percentile for age and sex, weight for height > 85 th percentile, or weight $> 120\%$ of ideal for height) plus any two of the following risk factors:
 - Family history of type 2 diabetes in first or second-degree relative
 - Race/ethnicity (e.g., Native American, African American, Latino, Asian American, and Pacific Islander)
 - Signs of insulin resistance or conditions associated with insulin resistance (e.g., acanthosis nigricans, hypertension, dyslipidemia, or PCOS)
 - Maternal history of diabetes or GDM

Criteria for the Diagnosis of Diabetes Mellitus

Three methods of diagnosis are suggested: (1) symptoms of diabetes plus a random plasma glucose level of ≥ 200 mg/dL, (2) a fasting plasma glucose of ≥ 126 mg/dL, or (3) an oral glucose tolerance test (OGTT) with a 2-hour postload (75-g glucose load) level ≥ 200 mg/dL, each of which must be confirmed on a subsequent day by any one of the three methods (Tables 13-5, 13-6, and 13-7). The preferred test for diagnosing diabetes is measurement of the fasting plasma glucose level.

TABLE 13-5 DIAGNOSTIC CRITERIA FOR DIABETES MELLITUS

- | |
|---|
| 1. Random plasma glucose ≤ 200 mg/dL (≤ 11.1 mmol/L), + symptoms of diabetes |
| 2. Fasting plasma glucose ≤ 126 mg/dL (≤ 7.0 mmol/L) |
| 3. Two-h plasma glucose ≤ 200 mg/dL (≤ 11.1 mmol/L) during an OGTT |

In absence of unequivocal hyperglycemia, these criteria should be confirmed by repeat testing on a different day. The third measure (OGTT) is not recommended for routine clinical use.

TABLE 13-6 CATEGORIES OF FASTING PLASMA GLUCOSE (FPG)

| | |
|--------------------------------|------------------------------------|
| Normal fasting glucose | FPG <100 mg/dL (<5.6 mmol/L) |
| Impaired fasting glucose | FPG 100–125 mg/dL (5.6–6.9 mmol/L) |
| Provisional diabetes diagnosis | FPG ≤126 mg/dL (≤7.0 mmol/L)* |

*Must be confirmed.

An intermediate group who did not meet the criteria of diabetes mellitus but who had glucose levels above normal was defined by two methods. First, those patients with fasting glucose levels ≥ 100 mg/dL but < 126 mg/dL were called the impaired fasting glucose group. Another set of patients who had 2-hour OGTT levels of ≥ 140 mg/dL but < 200 mg/dL was defined as having impaired glucose tolerance. Patients with impaired fasting glucose and/or impaired glucose tolerance are referred to as having “pre-diabetes,” indicating the relatively high risk for the development of diabetes in these patients.

Criteria for the Testing and Diagnosis of Gestational Diabetes Mellitus

The diagnostic criteria for gestational diabetes follow the guidelines established by the American College of Obstetrics and Gynecology. Only high-risk patients should be screened for GDM. The criteria for women at high risk include any of the following: age older than 25 years, overweight, strong family history of diabetes, history of abnormal glucose metabolism, history of a poor obstetric outcome, presence of glycosuria, diagnosis of PCOS, or a member of an ethnic/racial group with a high prevalence of diabetes (e.g., Hispanic American, Native American, Asian American, African American, Pacific Islander).

TABLE 13-7 CATEGORIES OF ORAL GLUCOSE TOLERANCE

| | |
|--------------------------------|--|
| Normal glucose tolerance | 2-h PG <140 mg/dL (<7.8 mmol/L) |
| Impaired glucose tolerance | 2-h PG 140–199 mg/dL (7.8–11.1 mmol/L) |
| Provisional diabetes diagnosis | 2-h PG ≤200 mg/dL (≤11.1 mmol/L)* |

PG, plasma glucose.

*Must be confirmed.

CASE STUDY 13-4

A 13-year-old girl collapsed on a playground at school. When her mother was contacted, she mentioned that her daughter had been losing weight and making frequent trips to the bathroom in the night. The emergency squad noticed a fruity breath. On entrance to the emergency department, her vital signs were as follows:

| | |
|----------------|-------------|
| Blood pressure | 98/50 mm Hg |
| Respirations | Rapid |
| Temperature | 99°F |

Stat lab results included:

| RANDOM URINE | | SERUM CHEMISTRIES | |
|--------------|----------|-------------------|-----------|
| pH | 5.5 | Glucose | 500 mg/dL |
| Protein | Negative | Ketones | Positive |
| Glucose | 4+ | BUN | 6 mg/dL |
| Ketones | Moderate | Creatinine | 0.4 mg/dL |
| Blood | Negative | | |

Questions

1. Identify this patient's most likely type of diabetes.
2. Based on your identification, circle the common characteristics associated with that type of diabetes in the case study above.
3. What is the cause of the fruity breath?

The first step in screening for gestational diabetes should be performance of fasting plasma glucose (as indicated earlier) with a confirmation test if needed for diagnosis. In the absence of a positive confirmation, evaluation for gestational diabetes in women with average or high-risk characteristics should follow one of two approaches. The one-step approach would be the immediate performance of a 3-hour OGTT without prior screening. In the two-step approach, an initial measurement of plasma glucose at 1 hour postload (50-g glucose load) is performed. A plasma glucose value ≥ 7.8 mmol/L (≥ 140 mg/dL) indicates the need to perform a 3-hour OGTT using a 100-g glucose load. A value of > 7.2 mmol/L (> 130 mg/dL) may be used because it will detect approximately 10% additional diabetic patients. GDM is diagnosed when any two of the following four values are met or exceeded: fasting, > 95 mg/dL; 1 hour, ≥ 180 mg/dL; 2 hours, ≥ 155 mg/dL; or 3 hours, ≥ 140 mg/dL. This test should be performed in the

morning after an overnight fast of between 8 and 14 h, after at least 3 days of unrestricted diet (≥ 150 g carbohydrate per day) and unlimited physical activity.

HYPOGLYCEMIA

Hypoglycemia involves decreased plasma glucose levels and can have many causes—some are transient and relatively insignificant, but others can be life threatening. The plasma glucose concentration at which glucagon and other glycemic factors are released is between 65 and 70 mg/dL (3.6–3.9 mmol/L); at about 50 to 55 mg/dL (2.8–3.0 mmol/L), observable symptoms of hypoglycemia appear. The warning signs and symptoms of hypoglycemia are all related to the central nervous system. The release of epinephrine into the systemic circulation and of norepinephrine at nerve endings of

TABLE 13-8 CAUSES OF HYPOGLYCEMIA

| PATIENT APPEARS HEALTHY | |
|-------------------------|---|
| No coexisting disease | Drugs Insulinoma Islet hyperplasia/ nesidioblastosis Factitious hypoglycemia from insulin or sulfonylurea Severe exercise Ketotic hypoglycemia |
| Compensated coexistent | Drugs/disease |
| PATIENT APPEARS ILL | |
| Drugs | |
| Predisposing illness | |
| Hospitalized patient | |

CASE STUDY 13-5

A 28-year-old woman delivered a 9.5-lb infant. The infant was above the 95th percentile for weight and length. The mother's history was incomplete; she claimed to have had no medical care through her pregnancy. Shortly after birth, the infant became lethargic and flaccid. A whole blood glucose and ionized calcium were performed in the nursery with the following results:

| | |
|---|-----------|
| Whole blood glucose | 25 mg/dL |
| Ionized calcium | 4.9 mg/dL |
| Plasma glucose was drawn and analyzed in the main laboratory to confirm the whole blood findings. | |
| Plasma glucose | 33 mg/dL |
| An intravenous glucose solution was started and whole blood glucose was measured hourly. | |

Questions

1. Give the possible explanation for the infant's large birth weight and size.
2. If the mother was a gestational diabetic, why was her baby hypoglycemic?
3. Why was there a discrepancy between the whole blood glucose concentration and the plasma glucose concentration?
4. If the mother had been monitored during pregnancy, what laboratory tests should have been performed and what criteria would have indicated that she had gestational diabetes?

specific neurons act in unison with glucagon to increase plasma glucose. Glucagon is released from the islet cells of the pancreas and inhibits insulin. Epinephrine is released from the adrenal gland and increases glucose metabolism and inhibits insulin. In addition, cortisol and growth hormone are released and increase glucose metabolism.

Historically, hypoglycemia was classified as postabsorptive (fasting) and postprandial (reactive) hypoglycemia. However, the reactive hypoglycemia only described the timing of hypoglycemia, not the etiology. Current approaches suggest classification based on clinical characteristics. This classification separates patients into those who appear healthy and those who are sick⁵ (Table 13-8). Among healthy-appearing patients are those with and without a compensated coexistent disease. This category includes individuals in whom medications may be the cause of hypoglycemia through accidental ingestion by dispensing error. Sick persons may have an illness that predisposes to hypoglycemia or may experience drug and illness interaction leading to hypoglycemia. Hypoglycemia in hospitalized patients can often be ascribed to iatrogenic factors. Symptoms of hypoglycemia are increased hunger, sweating, nausea and vomiting, dizziness, nervousness and shaking, blurring of speech and sight, and mental confusion. Laboratory findings include decreased plasma glucose levels during hypoglycemic episode and extremely elevated insulin levels in patients with pancreatic β -cell tumors (insulinoma). To investigate an insulinoma, the patient is required to fast under controlled conditions. Men and women have different metabolic patterns in prolonged fasts. The healthy male will maintain plasma glucose of 55 to 60 mg/dL (3.1–3.3 mmol/L) for several days. Healthy females will produce ketones more readily and permit plasma glucose to decrease to 40 mg/dL

(2.2 mmol/L) or lower. Diagnostic criteria for an insulinoma include a change in glucose level of ≥ 25 mg/dL (1.4 mmol/L) coincident with an insulin level of ≥ 6 μ U/mL (36 pmol/L), C-peptide levels of ≥ 0.2 nmol/L, proinsulin levels of ≥ 5 pmol/L, and/or β -hydroxybutyrate levels of ≤ 2.7 mmol/L.⁶

Genetic Defects in Carbohydrate Metabolism

Glycogen storage diseases are result of the deficiency of a specific enzyme that causes an alternation of glycogen metabolism. The most common congenital form of glycogen storage disease is glucose-6-phosphatase deficiency type 1, which is also called von Gierke disease, an autosomal recessive disease. This disease is characterized by severe hypoglycemia that coincides with metabolic acidosis, ketonemia, and elevated lactate and alanine. Hypoglycemia occurs because glycogen cannot be converted back to glucose by way of hepatic glycogenolysis. A glycogen buildup is found in the liver, causing hepatomegaly. The patients usually have severe hypoglycemia, hyperlipidemia, uricemia, and growth retardation. A liver biopsy will show a positive glycogen stain. Although the glycogen accumulation is irreversible, the disease can be kept under control by avoiding the development of hypoglycemia. Liver transplantation corrects the hypoglycemic condition. Other enzyme defects or deficiencies that cause hypoglycemia include glycogen synthase, fructose-1,6-bisphosphatase, phosphoenolpyruvate carboxykinase, and pyruvate carboxylase. Glycogen debrancher enzyme deficiency does not cause hypoglycemia but does cause hepatomegaly.

Galactosemia, a cause of failure to thrive syndrome in infants, is a congenital deficiency of one of three enzymes involved in galactose metabolism, resulting in increased levels of galactose in plasma. The most common enzyme deficiency is galactose-1-phosphate uridyl transferase. Galactosemia occurs because of the inhibition of glycogenolysis and is accompanied by diarrhea and vomiting. Galactose must be removed from the diet to prevent the development of irreversible complications. If left untreated, the patient will develop mental retardation and cataracts. The disorder can be identified by measuring erythrocyte galactose-1-phosphate uridylyltransferase activity. Laboratory findings include hypoglycemia, hyperbilirubinemia, and galactose accumulation in the blood, tissue, and urine following milk ingestion. Another enzyme deficiency, fructose-1-phosphate aldolase deficiency, causes nausea and hypoglycemia after fructose ingestion.

Specific inborn errors of amino acid metabolism and long-chain fatty acid oxidation are also responsible for hypoglycemia. There are also alimentary and idiopathic hypoglycemias. Alimentary hypoglycemia appears to be caused by an increase in the release of insulin in response to rapid absorption of nutrients after a meal or the rapid

CASE STUDY 13-6

Laboratory tests were performed on a 50-year-old lean white woman during an annual physical examination. She has no family history of diabetes or any history of elevated glucose levels during pregnancy.

LABORATORY RESULTS

| | |
|-----------------------|-----------|
| Fasting blood glucose | 90 mg/dL |
| Cholesterol | 140 mg/dL |
| HDL | 40 mg/dL |
| Triglycerides | 90 mg/dL |

Questions

1. What is the probable diagnosis of this patient?
2. Describe the proper follow-up for this patient.
3. What is the preferred screening test for diabetes in nonpregnant adults?
4. What are the risk factors that would indicate a potential of this patient's developing diabetes?

secretion of insulin-releasing gastric factors. Idiopathic postprandial hypoglycemia is a controversial diagnosis that may be overused.⁷

ROLE OF LABORATORY IN DIFFERENTIAL DIAGNOSIS AND MANAGEMENT OF PATIENTS WITH GLUCOSE METABOLIC ALTERATIONS

The demonstration of hyperglycemia or hypoglycemia under specific conditions is used to diagnose diabetes mellitus and hypoglycemic conditions. Other laboratory tests have been developed to identify insulinomas and to monitor glycemic control and the development of renal complications.

Methods of Glucose Measurement

Glucose can be measured from serum, plasma, or whole blood. Today, most glucose measurements are performed on serum or plasma. The glucose concentration in whole blood is approximately 11% lower than the glucose concentration plasma. Serum or plasma must be refrigerated and separated from the cells within 1 h to prevent substantial loss of glucose by the cellular fraction, particularly if the white blood cell count is elevated. Sodium fluoride ions (gray-top tubes) are often used as an anti-coagulant and preservative of whole blood, particularly if

CASE STUDY 13-7

For 3 consecutive months, a fasting glucose and glycosylated hemoglobin were performed on a patient. The results are as follows:

| | QUARTER 1 | QUARTER 2 | QUARTER 3 |
|-------------------------|-----------|-----------|----------------|
| Plasma glucose, fasting | 280 mg/dL | 85 mg/dL | 91 mg/dL (FPG) |
| Glycosylated hemoglobin | 7.8% | 15.3% | 8.5% |

Questions

1. In which quarter was the patient's glucose the best controlled? The least controlled?
2. Do the fasting plasma glucose and glycosylated hemoglobin match? Why or why not?
3. What methods are used to measure glycosylated hemoglobin?
4. What potential conditions might cause erroneous results?

analysis is delayed. The fluoride inhibits glycolytic enzymes. However, although fluoride maintains long-term glucose stability, the rates of decline of glucose in the first hour after sample collection in tubes with and without fluoride are virtually identical. Therefore, the plasma should be separated from the cells as soon as possible. Fasting blood glucose (FBG) should be obtained in the morning after an approximately 8- to 10-hours fast (not longer than 16 hours). Fasting plasma glucose values have a diurnal variation with the mean FBG higher in the morning than in the afternoon.⁸ Diabetes in patients tested in the afternoon may be missed because of this variation. Cerebrospinal fluid and urine can also be analyzed. Urine glucose measurement is not used in diabetes diagnosis; however, some patients use this measurement for monitoring purposes.

The ability of glucose to function as a reducing agent has been useful in the detection and quantitation of carbohydrates in body fluids. Glucose and other carbohydrates are capable of converting cupric ions in alkaline

solution to cuprous ions. The solution loses its deep-blue color and a red precipitate of cuprous oxide forms. Benedict's and Fehling's reagents, which contain an alkaline solution of cupric ions stabilized by citrate or tartrate, respectively, have been used to detect reducing agents in urine and other body fluids. Another chemical characteristic that used to be exploited to quantitate carbohydrates is the ability of these molecules to form Schiff bases with aromatic amines. *O*-Toluidine in a hot acidic solution will yield a colored compound with an absorbance maxima at 630 nm. Galactose, an aldohexose, and mannose, an aldopentose, will also react with *O*-toluidine and produce a colored compound that can interfere with the reaction. The Schiff base reaction with *O*-toluidine is of historical interest only and has been replaced by more specific enzymatic methods, which are discussed in the following section.

The most common methods of glucose analysis use the enzyme glucose oxidase or hexokinase (Table 13-9). Glucose oxidase is the most specific enzyme reacting

TABLE 13-9 METHODS OF GLUCOSE MEASUREMENT

| | |
|-----------------|---|
| Glucose oxidase | $\text{Glucose} + \text{O}_2 + \text{H}_2\text{O} \xrightarrow{\text{glucose oxidase}} \text{gluconic acid} + \text{H}_2\text{O}_2$ |
| | $\text{H}_2\text{O}_2 + \text{reduced chromogen} \xrightarrow{\text{peroxidase}} \text{oxidized chromogen} + \text{H}_2\text{O}$ |
| Hexokinase | $\text{Glucose} + \text{ATP} \xrightarrow{\text{hexokinase}} \text{glucose 6-PO}_4 + \text{ADP}$ |
| | $\text{Glucose 6-PO}_4 + \text{NADP} \xrightarrow{\text{G-6-PD}} \text{NADPH} + \text{H}^+ + \text{6-phosphogluconate}$ |
| Clinitest | $\text{Reducing substance} + \text{Cu}^{+2} \longrightarrow \text{Cu}^{+1}\text{O}$ |

with only β -D-glucose. Glucose oxidase converts β -D-glucose to gluconic acid. Mutarotase may be added to the reaction to facilitate the conversion of α -D-glucose to β -D-glucose. Oxygen is consumed and hydrogen peroxide (H_2O_2) is produced. The reaction can be monitored polarographically either by measuring the rate of disappearance of oxygen using an oxygen electrode or by consuming H_2O_2 in a side reaction. Horseradish peroxidase is used to catalyze the second reaction, and the H_2O_2 is used to oxidize a dye compound. Two commonly used chromogens are 3-methyl-2-benzothiazolinone hydrazone and *N,N*-dimethylaniline. The shift in absorbance can be monitored spectrophotometrically and is proportional to the amount of glucose present in the specimen. This coupled reaction is known as the Trinder reaction. However, the peroxidase coupling reaction used in the glucose oxidase method is subject to positive and negative interference. Increased levels of uric acid, bilirubin, and ascorbic acid can cause falsely decreased values as a result of these substances being oxidized by peroxidase, which then prevents the oxidation and detection of the chromogen. Strong oxidizing substances, such as bleach, can cause falsely increased values. An oxygen consumption electrode can be used to perform the direct measurement of oxygen by the polarographic technique, which avoids this interference. Oxygen depletion is measured and is proportional to the amount of glucose present. Polarographic glucose analyzers measure the rate of oxygen consumption because glucose is oxidized under first-order conditions using glucose oxidase reagent. The H_2O_2 formed must be eliminated in a side reaction to prevent the reaction from reversing. Molybdate can be used to catalyze the oxidation of iodide to iodine by H_2O_2 or catalase can be used to catalyze oxidation of ethanol by H_2O_2 , forming acetaldehyde and H_2O .

The hexokinase method is considered more accurate than the glucose oxidase methods because the coupling reaction using glucose-6-phosphate dehydrogenase is highly specific; therefore, it has less interference than the coupled glucose oxidase procedure. Hexokinase in the presence of ATP converts glucose to glucose-6-phosphate. Glucose-6-phosphate and the cofactor NADP^+ are converted to 6-phosphogluconate and NADPH by glucose-6-phosphate dehydrogenase. NADPH has a strong absorbance maxima at 340 nm, and the rate of appearance of NADPH can be monitored spectrophotometrically and is proportional to the amount of glucose present in the sample. Generally accepted as the reference method, this method is not affected by ascorbic acid or uric acid. Gross hemolysis and extremely elevated bilirubin may cause a false decrease in results. The hexokinase method may be performed on serum or plasma collected using heparin, ethylenediaminetetraacetic acid (EDTA), fluoride, oxalate, or citrate.

The method can also be used for urine, cerebrospinal fluid, and serous fluids.

Nonspecific methods of measuring glucose are still used in the urinalysis section of the laboratory primarily to detect reducing substances other than glucose. The method given next is the Benedict's modification, also called the Clinitest reaction.

Self-Monitoring of Blood Glucose

The ADA has recommended that individuals with diabetes monitor their blood glucose levels in an effort to maintain levels as close to normal as possible. For persons with type 1 diabetes, the recommendation is 3 to 4 times/day; for persons with type 2 diabetes, the optimal frequency is unknown. It is important that patients be taught how to use control solutions and calibrators to ensure the accuracy of their results.⁹ Urine glucose testing should be replaced by self-monitoring of blood glucose; however, urine ketone testing will remain for type 1 and gestational diabetes.

Glucose Tolerance and 2-Hour Postprandial Tests

Guidelines for the performance and interpretation of the 2-hour postprandial test were set by the Expert Committee. A variation of this test is to use a standardized load of glucose. A solution containing 75 g of glucose is administered, and a specimen for plasma glucose measurement is drawn 2 hours later. Under this criterion, the patient drinks a standardized (75 g) glucose load and a glucose measurement is taken 2 hours later. If that level is ≥ 200

CASE STUDY 13-8

A 25-year-old, healthy, female patient complains of dizziness and shaking 1 hour after eating a large, heavy-carbohydrate meal. The result of a random glucose test performed via fingerstick was 60 mg/dL.

Questions

1. Identify the characteristics of hypoglycemia in this case study.
2. What test(s) should be performed next to determine this young woman's problem?
3. To which category of hypoglycemia would this individual belong?
4. What criteria would be used to diagnose a potential insulinoma?

mg/dL and is confirmed on a subsequent day by either an increased random or fasting glucose level, the patient is diagnosed with diabetes (see earlier discussion).

The *oral glucose tolerance test* (OGTT) is not recommended for routine use under the ADA guidelines. This procedure is inconvenient to patients and is not being used by physicians for diagnosing diabetes. However, if the OGTT is used, WHO recommends the criteria listed in Table 13-7. It is important that proper patient preparation be given before this test is performed. The patient should be ambulatory and on a normal-to-high carbohydrate intake for 3 days before the test. The patient should be fasting for at least 10 hours and not longer than 16 hours, and the test should be performed in the morning because of the hormonal diurnal effect on glucose. Just before tolerance and while the test is in progress, patients should refrain from exercise, eating, drinking (except that the patient may drink water), and smoking. Factors that affect the tolerance results include medications such as large doses of salicylates, diuretics, anticonvulsants, oral contraceptives, and corticosteroids. Also, gastrointestinal problems, including malabsorption problems, gastrointestinal surgery, and vomiting and endocrine dysfunctions, can affect the OGTT results. The guidelines recommend that only the fasting and the 2-hour sample be measured, except when the patient is pregnant. The adult dose of glucose solution (glucola) is 75 g; children receive 1.75 g/kg of glucose to a maximum dose of 75 g.

Glycosylated Hemoglobin/Hemoglobin A_{1c}

The aim of diabetic management is to maintain the blood glucose concentration within or near the nondiabetic range with a minimal number of fluctuations. Serum or plasma glucose concentrations can be measured by laboratories in addition to patient self-monitoring of whole blood glucose concentrations. Long-term blood glucose regulation can be followed by measurement of glycosylated hemoglobin.

Glycosylated hemoglobin is the term used to describe the formation of a hemoglobin compound produced when glucose (a reducing sugar) reacts with the amino group of hemoglobin (a protein). The glucose molecule attaches nonenzymatically to the hemoglobin molecule to form a ketoamine. The rate of formation is directly proportional to the plasma glucose concentrations. Because the average red blood cell lives approximately 120 days, the glycosylated hemoglobin level at any one time reflects the average blood glucose level over the previous 2 to 3 months. Therefore, measuring the glycosylated hemoglobin provides the clinician with a time-averaged picture of the patient's blood glucose concentration over the past 3 months.

TABLE 13-10 ESTIMATED CORRELATION BETWEEN MEAN PLASMA GLUCOSE LEVELS AND A_{1c} LEVELS

| MEAN PLASMA GLUCOSE | A _{1c} (%) |
|-------------------------|---------------------|
| 65 mg/dL (3.5 mmol/L) | 4 |
| 100 mg/dL (5.5 mmol/L) | 5 |
| 135 mg/dL (7.5 mmol/L) | 6 |
| 170 mg/dL (9.5 mmol/L) | 7 |
| 205 mg/dL (11.5 mmol/L) | 8 |
| 240 mg/dL (13.5 mmol/L) | 9 |
| 275 mg/dL (15.5 mmol/L) | 10 |
| 310 mg/dL (17.5 mmol/L) | 11 |
| 345 mg/dL (19.5 mmol/L) | 12 |

Reprinted with permission from Higgs PJ, Bunn HF. Kinetic analysis of the nonenzymatic glycosylation of hemoglobin. *J Biol Chem* 1981;256:5204–5208.

Hemoglobin A_{1c} (HbA_{1c}), the most commonly detected glycosylated hemoglobin, is a glucose molecule attached to one or both N-terminal valines of the β -polypeptide chains of normal adult hemoglobin.¹¹ HbA_{1c} is a more reliable method of monitoring long-term diabetes control than random plasma glucose. Normal values range from 4.5 to 8.0. Using a linear regression model, Rohlfing et al.¹² determined that for every 1% change in the HbA_{1c} value, there is a 35 mg/dL (2 mmol/L) change in the mean plasma glucose (Table 13-10). However, this information needs to be used carefully, as a recent study has shown that the relationship between average plasma glucose and HbA_{1c} can differ substantially depending on the glycemic control of the population studied.¹³ It is also important to remember that two factors determine the glycosylated hemoglobin levels: the average glucose concentration and the red blood cell life span. If the red blood cell life span is decreased because of another disease state such as hemoglobinopathies, the hemoglobin will have less time to become glycosylated and the glycosylated hemoglobin level will be lower.

Current ADA guidelines recommend that an HbA_{1c} test be performed at least two times a year with patients who are meeting treatment goals and who have stable glycemic control. For patients whose therapy has changed or who are not meeting glycemic goals, a quarterly HbA_{1c} test quarterly is recommended. The use of point-of-care testing for HbA_{1c} allows for more timely decisions on therapy changes and has been shown to result in tighter glycemic control.¹⁴ Lowering HbA_{1c} to an average of less than 7% has clearly been shown to reduce the microvascular, retinopathic, and neuropathic complications of diabetes. Therefore, the HbA_{1c} goal for

nonpregnant adults in general is less than 7%. Further studies have shown a small benefit to lowering HbA_{1c} to less than 6%, making this a goal for selected individual patients if possible without significant hypoglycemia.

The specimen requirement for HbA_{1c} measurement is an EDTA whole blood sample. Before analysis, a hemolysate must be prepared. The methods of measurement are grouped into two major categories: (1) based on charge differences between glycosylated and nonglycosylated hemoglobin (cation-exchange chromatography, electrophoresis, and isoelectric focusing) and (2) structural characteristics of glycogroups on hemoglobin (affinity chromatography and immunoassay).

In the clinical laboratory, affinity chromatography is the preferred method of measurement. In this method, the glycosylated hemoglobin attaches to the boronate group of the resin and is selectively eluted from the resin bed using a buffer. This method is not temperature dependent and not affected by hemoglobin F, S, or C. Another method of measurement uses cation exchange chromatography in which the negatively charged hemoglobins attach to the positively charged resin bed. The glycosylated hemoglobin is selectively eluted from the resin bed using a buffer of specific pH in which the glycohemoglobins are the most negatively charged and elute first from the column. However, this method is highly temperature dependent and affected by hemoglobinopathies. The presence of hemoglobin F yields false increased levels, and the presence of hemoglobins S and C yields false decreased levels. A common point-of-care instrument HbA_{1c} assay is based on a latex immunoagglutination inhibition methodology. In this method, both the concentration of HbA_{1c} specifically and the concentration of total hemoglobin are

measured, and the ratio reported as percent HbA_{1c}. In this method, glycosylated hemoglobin F is not measured, so at a very high levels of hemoglobin F (>10%), the amount of HbA_{1c} will be lower than expected because a greater proportion of the glycosylated hemoglobin will be in the form of glycosylated hemoglobin F. High-performance liquid chromatography (HPLC) and electrophoresis methods are also used to separate the various forms of hemoglobin. With high-performance liquid chromatography, all forms of glycosylated hemoglobin—A_{1a}, A_{1b}, and A_{1c}—can be separated.

Standardization of glycosylated hemoglobin has been a continuing problem; there was no consensus on the reference method and no single standard is available to be used in the assays. Because of this, HbA_{1c} values vary with the method and laboratory performing them (Table 13-11). The International Federation of Clinical Chemistry and Laboratory Medicine (IFCC) developed a common definition for HbA_{1c} and a reference method that specifically measures the concentration of only one molecular species of glycosylated A_{1c}, the glycosylated N-terminal residue of the β-chain of hemoglobin. This method, using either HPLC/electrospray mass spectrometry (HPLC-ESI/MS) or HPLC/capillary electrophoresis (HPLC-CE), is only used to standardize A_{1c} assays and cannot be used for the clinical measurement of HbA_{1c}.¹⁵ Additionally, recent international consensus groups have determined that HbA_{1c} results will be represented worldwide in IFCC units (mmol/mol) and derived National Glycohemoglobin Standardization Program (NGSP) units (%) using the IFCC-NGSP master equation [NGSP (%) = 0.09148 IFCC (mmol/mol) + 2.152].¹⁶ HbA_{1c} reagent and instrument manufacturers are now required to document their traceability to the IFCC reference system with both the IFCC

TABLE 13-11 METHODS OF GLYCATED HEMOGLOBIN MEASUREMENT

METHODS BASED ON STRUCTURAL DIFFERENCES

| | | |
|-------------------------|---|--|
| Immunoassays | Polyclonal or monoclonal antibodies toward the glycosylated N-terminal group of the β chain of hemoglobin | |
| Affinity chromatography | Separates based on chemical structure using borate to bind glycosylated proteins | Not temperature dependent Not affected by other hemoglobins |

METHODS BASED ON CHARGE DIFFERENCES

| | | |
|--|---|--|
| Ion-exchange chromatography | Positive-charge resin bed | Highly temperature dependent Affected by hemoglobinopathies |
| Electrophoresis | Separation is based on differences in charge | Hemoglobin F values >7% interferes |
| Isoelectric focusing | Type of electrophoresis using isoelectric point to separate | Pre-HbA _{1c} interferes |
| High-pressure liquid chromatography (HPLC) | A form of ion-exchange chromatography | Separates of all forms of glycosylated hemoglobin: A _{1a} , A _{1b} , A _{1c} |

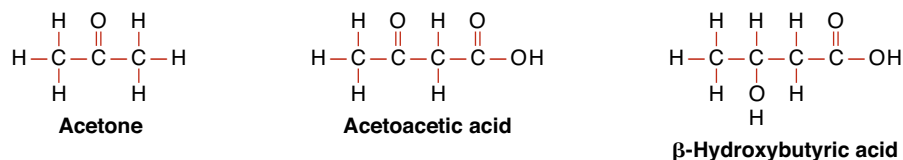

FIGURE 13-9. The three ketone bodies.

units (mmol/mol) and derived NGSP units (%). With these developments, HbA_{1c} measurements should become a more reliable indicator of the long-term patient blood glucose regulation with more consistency in the results from laboratory to laboratory.

Ketones

The **ketone** bodies are produced by the liver through metabolism of fatty acids to provide a ready energy source from stored lipids at times of low carbohydrate availability. The three ketone bodies are acetone (2%), acetoacetic acid (20%), and 3- β -hydroxybutyric acid (78%). A low level of ketone bodies are present in the body at all times. However, in cases of carbohydrate deprivation or decreased carbohydrate use such as diabetes mellitus, starvation/fasting, high-fat diets, prolonged vomiting, and glycogen storage disease, blood levels increase to meet energy needs. The term *ketonemia* refers to the accumulation of ketones in blood, and the term *ketonuria* refers to accumulation of ketones in urine (Fig. 13-9). The measurement of ketones is recommended for patients with type 1 diabetes during acute illness, stress, pregnancy, or elevated blood glucose levels above 300 mg/dL or when the patient has signs of ketoacidosis.

The specimen requirement is *fresh* serum or urine; the sample should be tightly stoppered and analyzed immediately. No method used for determination of ketones reacts with all three ketone bodies. The historical test (Gerhardt's) that used ferric chloride reacted with acetoacetic acid to produce a red color. The procedure had many interfering substances, including salicylates. A more common method using sodium nitroprusside (NaFe[CN]₅NO) reacts with acetoacetic acid in an alkaline pH to form a purple color. If the reagent contains glycerin, then acetone is also detected. This method is used with the urine reagent strip test and Acetest tablets. A newer enzymatic method adapted to some automated instruments

uses the enzyme β -hydroxybutyrate dehydrogenase to detect either β -hydroxybutyric acid or acetoacetic acid, depending on the pH of the solution. A pH of 7.0 causes the reaction to proceed to the right (decreasing absorbance); a pH of 8.5 to 9.5 causes the reaction to proceed to left (increasing absorbance, Table 13-12).

Microalbuminuria

Diabetes mellitus causes progressive changes to the kidneys and ultimately results in diabetic renal nephropathy. This complication progresses over years and may be delayed by aggressive glycemic control. An early sign that nephropathy is occurring is an increase in urinary albumin. Microalbumin measurements are useful to assist in diagnosis at an early stage and before the development of proteinuria. An annual assessment of kidney function by the determination of urinary albumin excretion is recommended for diabetic patients. **Microalbuminuria** is defined as persistent albuminuria in the range of 30 to 299 mg/24 h or an albumin-creatinine ratio of 30 to 300 $\mu\text{g}/\text{mg}$. Clinical proteinuria or macroalbuminuria is established with an albumin-creatinine ratio of ≥ 300 mg/24 h or an albumin-creatinine ratio of ≥ 300 $\mu\text{g}/\text{mg}$.

Although three methods for microalbuminuria screening are available, the use of a random spot collection for the measurement of the albumin-creatinine ratio is the preferred method.¹⁷ Using the spot method, without the simultaneous creatinine measurement, may result in false-positive and negative results because of urine concentration variation. The two other alternatives, a 24-hour collection or a timed 4-hour overnight collection, which are more burdensome to the patient and add little to prediction or accuracy, are seldom required. A patient is determined to have microalbuminuria when two of three specimens collected within a 3- to 6-month period are abnormal. Factors that may elevate the urinary excretion of albumin include exercise within

TABLE 13-12 METHODS OF KETONE MEASUREMENT

| | |
|---------------|--|
| Nitroprusside | Acetoacetic acid + nitroprusside $\xrightarrow{\text{alkaline pH}}$ purple color |
| Enzymatic | $\text{NADH} + \text{H}^+ + \text{acetoacetic acid} \xleftarrow{\beta\text{-HBD}} \text{NAD} + \beta\text{-hydroxybutyric acid}$ |

β -HBD, β -Hydroxybutyrate dehydrogenase.

24 hours, infection, fever, congestive heart failure, marked hyperglycemia, and marked hypertension.¹⁸

Islet Autoantibody and Insulin Testing

The presence of autoantibodies to the β islet cells of the pancreas is characteristic of type 1 diabetes. However, islet autoantibody testing is not currently recommended for routine screening for diabetes diagnosis. In the future, this testing might identify at-risk, prediabetic patients. Insulin measurements are not required for the diagnosis of diabetes mellitus, but in certain hypoglycemic states, it is important to know the concentration of insulin in relation to the plasma glucose concentration.

CASE STUDY 13-9

A nurse caring for patients with diabetes performed a fingerstick glucose test on the Accu-Chek glucose monitor and obtained a value of 200 mg/dL. A plasma sample, collected at the same time by a phlebotomist and performed by the laboratory, resulted in a glucose value of 225 mg/dL.

Questions

1. Are these two results significantly different?
2. Explain.

REFERENCES

1. National Diabetes Data Group. Classification and diagnosis of diabetes mellitus and other categories of glucose tolerance. *Diabetes* 1979;28:1039–1057.
2. Expert Committee on the Diagnosis and Classification of Diabetes Mellitus. Report of the Expert Committee on the Diagnosis and Classification of Diabetes Mellitus. *Diabetes Care* 2003;26(Suppl 1):S7.
3. Malchoff CD. Diagnosis and classification of diabetes mellitus. *Conn Med* 1991;55:625.
4. Expert Committee on the Diagnosis and Classification of Diabetes Mellitus. Report of the Expert Committee on the Diagnosis and Classification of Diabetes Mellitus. *Diabetes Care* 2008;31:S55–S60.
5. Service FJ. Classification of hypoglycemic disorders. *Endocrinol Metab Clin* 1999;28:501–517.
6. Service FJ. Medical progress: hypoglycemic disorders. *N Engl J Med* 1995;332:1144–1152.
7. Cryer PE. Glucose homeostasis and hypoglycemia. In: Wilson JD, Foster DW, eds. *Williams Textbook of endocrinology*. Philadelphia, Pa.: WB Saunders, 1992.
8. Troisi RJ, Cowie CC, Harris MI. Diurnal variation in fasting plasma glucose: implications for diagnosis of diabetes in patients examined in the afternoon. *JAMA* 2000;284:3157–3159.
9. American Diabetes Association. Tests of glycemia in diabetes. *Diabetes Care* 2004;27(Suppl 1):S91–S93.
10. Higgs PJ, Bunn HF. Kinetic analysis of the nonenzymatic glycosylation of hemoglobin. *J Biol Chem* 1981;256:5204–5208.
11. Eckfeldt JH, Bruns DE. Another step towards standardization of methods for measuring hemoglobin A_{1c}. *Clin Chem* 1997;43:1811–1813.
12. Rohlfing CL, Wiedmeyer HM, Little RR, et al. Defining the relationship between plasma glucose and HbA_{1c}. *Diabetes Care* 2002;25:275–278.
13. Kilpatrick ES, Rigby AS, Atkin SL. Variability in the relationship between mean plasma glucose and HbA_{1c}: implications for the assessment of glycemic control. *Clin Chem* 2007;53: 897–901.
14. American Diabetes Association. Standards of medical care in diabetes—2008. *Diabetes Care* 2008;31(Suppl 1):S12–S54.
15. Jeppsson JO, Kobold U, Barr J, et al; International Federation of Clinical Chemistry and Laboratory Medicine (IFCC). Approved IFCC reference method for the measurement of HbA_{1c} in human blood. *Clin Chem Lab Med* 2002;40:78–89.
16. Consensus Statement on the Worldwide Standardization of the Hemoglobin A_{1c} Measurement. American Diabetes Association, European Association for the Study of Diabetes, International Federation of Clinical Chemistry and Laboratory Medicine and International Diabetes Federation Consensus Committee. *Diabetes Care* 2007;30:2399–2400.
17. KDOQI Clinical Practice Guidelines and Clinical Practice Recommendations for Diabetes and Chronic Kidney Disease. *Am J Kidney Dis* 2007;49(Suppl 2):S12–S154.
18. American Diabetes Association. Standards of medical care for patients with diabetes mellitus. *Diabetes Care* 2008;31: S12–S54.

Lipids and Lipoproteins

Amar A. Sethi, G. Russell Warnick,
Alan T. Remaley

CHAPTER

14

CHAPTER OUTLINE

■ LIPID CHEMISTRY

- Fatty Acids
- Triglycerides
- Phospholipids
- Cholesterol

■ GENERAL LIPOPROTEIN STRUCTURE

- Chylomicrons
- Very Low Density Lipoproteins
- Low-Density Lipoproteins
- Lipoprotein(a)
- High-Density Lipoproteins

■ LIPOPROTEIN PHYSIOLOGY AND METABOLISM

- Lipid Absorption
- Exogenous Pathway
- Endogenous Pathway
- Reverse Cholesterol Transport Pathway

■ LIPID AND LIPOPROTEIN POPULATION DISTRIBUTIONS

■ DIAGNOSIS AND TREATMENT OF LIPID DISORDERS

- Arteriosclerosis
- Hyperlipoproteinemia
- Hypercholesterolemia
- Hypertriglyceridemia
- Combined Hyperlipoproteinemia

- Lipoprotein(a) Elevation
- Hypolipoproteinemia
- Hypoalphalipoproteinemia

■ LIPID AND LIPOPROTEIN ANALYSES

- Lipid Measurement
- Cholesterol Measurement
- Triglyceride Measurement
- Lipoprotein Methods
- High-Density Lipoprotein Methods
- Low-Density Lipoprotein Methods
- Compact Analyzers
- Apolipoprotein Methods
- Phospholipid Measurement
- Fatty Acid Measurement

■ STANDARDIZATION OF LIPID AND LIPOPROTEIN ASSAYS

- Precision
- Accuracy
- Matrix Interactions
- CDC Cholesterol Reference Method Laboratory Network
- Analytic Performance Goals
- Quality Control
- Specimen Collection

■ REFERENCES

Lipoproteins constitute the body's "petroleum industry." Like the great oil tankers that travel the oceans of the world transporting petroleum for fuel needs, chylomicrons are large, lipid-rich transport vessels that ferry dietary triglycerides, the main oil in the body, throughout the circulatory system to cells, finally docking at the liver as chylomicron remnants. The very low density lipoproteins (**VLDL**) are like tanker trucks, carrying triglycerides assembled in the liver to cells for energy needs or storage as fat. The low-density lipoproteins (**LDL**), rich in cholesterol, are the nearly empty tankers that deliver cholesterol to peripheral cells and liver after the triglycerides have been off-loaded. The high-density lipoproteins (**HDL**) are the cleanup crew, gathering up

excess cholesterol for transport back to the liver. Cholesterol is used by the body for such useful functions as facilitating triglyceride transport by lipoproteins, for maintaining the normal structure and integrity of cell membranes, and as a precursor for steroid hormone synthesis, but when in excess, it can lead to cardiovascular disease.

Lipids and lipoproteins, which are central to the energy metabolism of the body, have become increasingly important in clinical practice, primarily because of their association with coronary heart disease (CHD). Numerous epidemiologic studies have demonstrated that, especially in affluent countries with high fat consumption, there is a clear association between the blood

lipid levels and the development of atherosclerosis. Decades of basic research have also contributed to knowledge about the nature of the lipoproteins and their lipid and protein constituents, as well as their role in the pathogenesis of the atherosclerotic process.

The accurate measurement of the various lipid and lipoprotein parameters is critical in the diagnosis and treatment of patients with **dyslipidemia**. International efforts to reduce the impact of CHD on public health have focused attention on improving the reliability and convenience of the lipid and lipoprotein assays. Expert panels have developed guidelines for detection and treatment of high cholesterol, as well as laboratory performance goals of accuracy and precision for the measurement of the lipid and lipoprotein analytes. This chapter begins with a review of lipid chemistry and lipoprotein metabolism, followed by the diagnosis and treatment of dyslipidemia. Finally, the clinical laboratory measurement of lipids and lipoproteins will be discussed in the context of the guidelines from the National Cholesterol Education Program (NCEP).

LIPID CHEMISTRY

Lipids, commonly referred to as fats, have a dual role. First, because they are composed of mostly carbon—hydrogen (C—H) bonds, they are a rich source of energy and an efficient way for the body to store excess calories. Because of their unique physical properties, lipids are also an integral part of cell membranes and, therefore, also play an important structural role in cells. The lipids transported by lipoproteins, namely triglycerides, phospholipids, cholesterol, and cholesteryl esters, are also the principal lipids found in cells and the main focus of this section.

Fatty Acids

Fatty acids, as seen in the structure shown in Figure 14-1, are simply linear chains of C—H bonds that terminate with a carboxyl group (—COOH).¹ In plasma, only a relatively small amount of fatty acids exists in the free or unesterified form, most of which is bound to albumin. The majority of plasma fatty acids are instead found as a

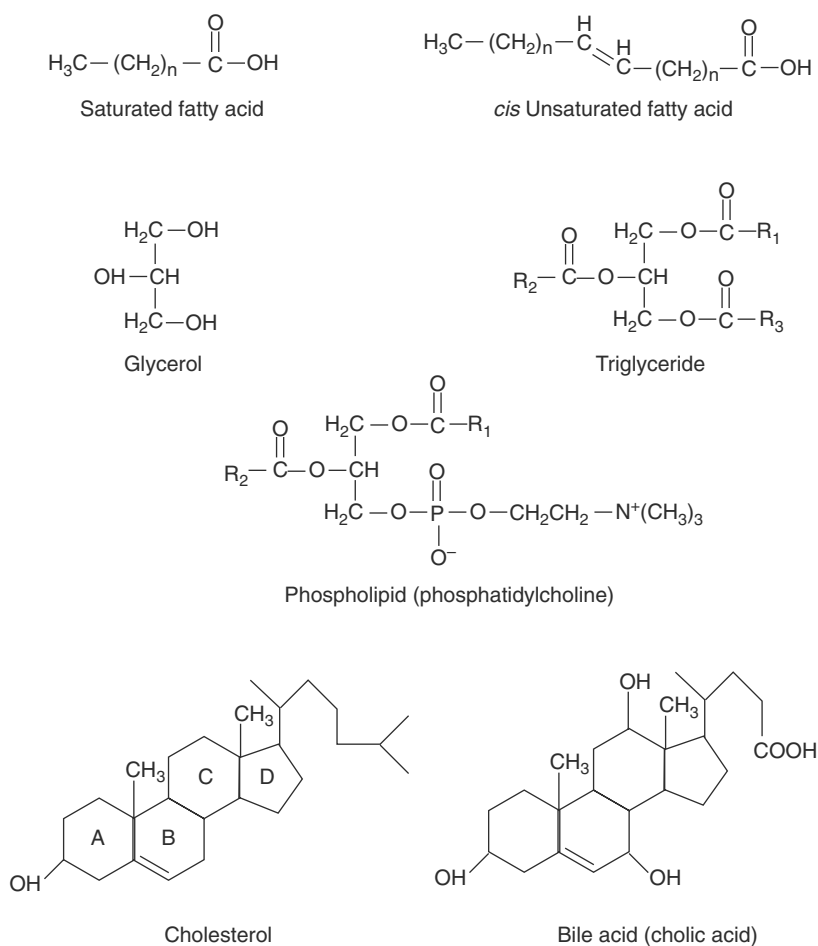

FIGURE 14-1. Chemical structures of lipids. Fatty acids are abbreviated as (R) for triglycerides and phospholipids.

constituent of triglycerides or phospholipids (Fig. 14-1). Fatty acids are covalently attached to the glycerol backbone of triglycerides and phospholipids by an ester bond that forms between the carboxyl group on the fatty acid and the hydroxyl group (—OH) on glycerol (Fig. 14-1). Fatty acids are variable in length and can be classified as short-chain (4–6 carbon atoms), medium-chain (8–12 carbon atoms), or long-chain (more than 12 carbon atoms) fatty acids. Most fatty acids in our diet are of the long-chain variety and contain an even number of carbon atoms. Not all of the carbon atoms on fatty acids are fully saturated or bonded with hydrogen atoms; some of them may instead form carbon=carbon (C=C) double-bonds. Depending on the number of C=C double-bonds, fatty acids can be classified as being saturated (no double-bonds), monounsaturated (one double-bond), or polyunsaturated (two or more double-bonds). The C=C double-bonds of unsaturated fatty acids are typically arranged in the *cis* form, with both hydrogen atoms on the same side of the C=C double-bond, which causes a bend in their structure (Fig. 14-1). These bends increase the space that unsaturated fatty acids require when packed in a lipid layer and, as a result, these fatty acids are more fluid because they do not as readily self-associate. Fatty acid C=C double-bonds can also occur in the *trans* configuration, with both hydrogen atoms on opposite side of the C=C double-bond. Because of the spatial orientation of their double bonds, *trans* fatty acids do not bend and have physical properties more similar to saturated fatty acids. The *trans* fatty acids are not commonly found in nature; however, they are present in our diet because the chemical hydrogenation treatment used in food processing for converting polyunsaturated plant oils into solid margarine introduces *trans* double bonds.

Triglycerides

As can be inferred from the name, **triglycerides** contain three fatty acid molecules attached to one molecule of glycerol by ester bonds² (Fig. 14-1). Each fatty acid in the triglyceride molecule can potentially be different in structure, thus producing many possible structural forms of triglycerides. Triglycerides containing saturated fatty acids, which do not have bends in their structure (Fig. 14-1), pack together more closely and tend to be solid at room temperature. In contrast, triglycerides, containing *cis* unsaturated fatty acids (Fig. 14-1), typically form oils at room temperature. Most triglycerides from plant sources, such as corn, sunflower seeds, and safflower seeds, are rich in polyunsaturated fatty acids and are oils, whereas triglycerides from animal sources contain mostly saturated fatty acids and are usually solid at room temperature. As can be seen by inspecting the structure of triglycerides (Fig. 14-1), there are no charged groups or polar hydrophilic groups, making it very

hydrophobic and virtually water insoluble. Because it has no charge, triglyceride is classified as a neutral lipid.

Phospholipids

Phospholipids are similar in structure to triglycerides except that they only have two esterified fatty acids³ (Fig. 14-1). The third position on the glycerol backbone instead contains a phospholipid head group. There are several types of phospholipid head groups, such as choline, inositol, serine, and ethanolamine, which are all hydrophilic in nature. The various types of phospholipids are named based on the type of phospholipid head group present. Phosphatidylcholine (Fig. 14-1), for example, has a choline head group and is the most common phospholipid found on lipoproteins and in cell membranes. The two fatty acids in phospholipids are normally 14 to 24 carbon atoms long, with one fatty acid commonly saturated and the other unsaturated.

Because phospholipids contain both hydrophobic fatty acid C—H chains and a hydrophilic head group, they are by definition amphipathic lipid molecules and, as such, are found on the surface of lipid layers. The polar hydrophilic head group faces outward toward the aqueous environment, whereas the fatty acid chains face inward away from the water in a perpendicular orientation with respect to the lipid surface.

Cholesterol

Cholesterol is an unsaturated steroid alcohol containing four rings (A, B, C, and D), and it has a single C—H side chain tail similar to a fatty acid in its physical properties⁴ (Fig. 14-1). The only hydrophilic part of cholesterol is the hydroxyl group in the A-ring. Cholesterol is, therefore, also an amphipathic lipid and is found on the surface of lipid layers along with phospholipids. Cholesterol is oriented in lipid layers so that the four rings and the side chain tail are buried in the membrane in a parallel orientation to the fatty acid acyl chains on adjacent phospholipid molecules. The polar hydroxyl group on the cholesterol A-ring faces outward, away from the lipid layer, allowing it to interact with water by noncovalent hydrogen bonding.

Cholesterol can also exist in an esterified form called cholesteryl ester, with the hydroxyl group conjugated by an ester bond to a fatty acid, in the same way as in triglycerides. In contrast to free cholesterol, there are no polar groups on cholesteryl esters, making them very hydrophobic. Because it is not charged, cholesteryl esters are classified as a neutral lipid and are not found on the surface of lipid layers but instead are located in the center of lipid drops and lipoproteins, along with triglycerides.

Cholesterol is almost exclusively synthesized by animals, but plants do contain other sterols similar in

structure to cholesterol. Cholesterol is also unique in that, unlike other lipids, it is not readily catabolized by most cells and, therefore, does not serve as a source of fuel. Cholesterol can, however, be converted in the liver to primary bile acids, such as cholic acid (Fig. 14-1) and chenodeoxycholic acid, which promote fat absorption in the intestine by acting as detergents. A small amount of cholesterol can also be converted by some tissue, such as the adrenal gland, testis, and ovary, to steroid hormones, such as glucocorticoids, mineralocorticoids, and estrogens. Finally, a small amount of cholesterol, after first being converted to 7-dehydrocholesterol, can also be transformed to vitamin D₃ in the skin by irradiation from sunlight.

GENERAL LIPOPROTEIN STRUCTURE

The prototypical structure of a lipoprotein particle is shown in Figure 14-2. Lipoproteins are typically spherical in shape and range in size from 10 to 1200 nm (Table 14-1). As the name implies, lipoproteins are composed of both lipids and proteins, called apolipoproteins.⁵⁻⁷ The amphipathic cholesterol and phospholipid molecules are primarily found on the surface of lipoproteins as a single monolayer, whereas the hydrophobic and neutral triglyceride and cholesteryl ester molecules are found in the central or core region (Fig. 14-2). Because the main role of lipoproteins is the delivery of fuel to peripheral cells, the core of the lipoprotein particle essentially represents the cargo that is being transported by lipoproteins. The size of the lipoprotein particle correlates with its lipid

content. The larger lipoprotein particles have correspondingly larger core regions and, therefore, contain relatively more triglyceride and cholesteryl ester. The larger lipoprotein particles also contain more lipid relative to protein and thus are lighter in density. The various lipoprotein particles were originally separated by ultracentrifugation into different density fractions (chylomicrons [chylos], VLDL, LDL, and HDL), which still form the basis for the most commonly used lipoprotein classification system (Table 14-1).

Apolipoproteins are primarily located on the surface of lipoprotein particles (Table 14-2). They help maintain the structural integrity of lipoproteins and also serve as ligands for cell receptors and as activators and inhibitors of the various enzymes that modify lipoprotein particles (Table 14-2). Apolipoproteins contain a structural motif called an amphipathic helix,⁸ which accounts for the ability of these proteins to bind to lipids. Amphipathic helices are protein segments arranged in coils so that the hydrophobic amino acids residues interact with lipids, whereas the part of the helix containing hydrophilic amino acids faces away from the lipids and toward the aqueous environment.

Apolipoprotein (apo) A-I, the major protein on HDL, is frequently used as an index of the amount of the antiatherogenic HDL present in plasma.⁹ Apo B is a large protein with a molecular weight of approximately 500 kD and the principal protein on LDL, VLDL, and chylomicrons.¹⁰ Apo B exists in two forms: apo B-100 and apo B-48. Apo B-100 is found on LDL and VLDL and is a ligand for the LDL receptor,¹¹ and it is, therefore, critical

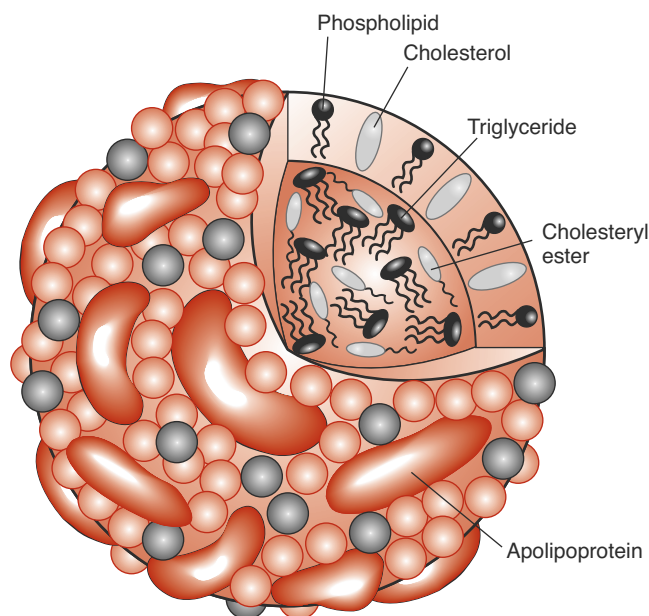

FIGURE 14-2. Model of lipoprotein structure.

TABLE 14-1 CHARACTERISTICS OF THE MAJOR HUMAN LIPOPROTEINS

| CHARACTERISTICS | CHYLOS | VLDL | LDL | HDL |
|---------------------------------|-----------------------|----------------------|-------------------|-------------------------|
| Density (g/mL) | <0.93 | 0.93–1.006 | 1.019–1.063 | 1.063–1.21 |
| Molecular weight (kD) | $(0.4-30) \cdot 10^9$ | $(10-80) \cdot 10^6$ | $2.75 \cdot 10^6$ | $(1.75-3.6) \cdot 10^5$ |
| Diameter (nm) | 80–1,200 | 30–80 | 18–30 | 5–12 |
| Total lipid (% by weight) | 98 | 89–96 | 77 | 50 |
| Triglyceride (% by weight) | 84 | 44–60 | 11 | 3 |
| Total cholesterol (% by weight) | 7 | 16–22 | 62 | 19 |

in the uptake of LDL by cells. Apo B-48, exclusively found in chylomicrons, is essentially the first 48% or half of the apo B molecule and is produced by posttranscriptional editing of the apo B-100 mRNA. Apo B-100 can also be found covalently linked to apo (a),¹² a plasminogen-like protein that is found in a proatherogenic lipoprotein particle called lipoprotein (a) (Lp(a)). Apo E, another important apolipoprotein found on many types of lipoproteins (LDL, VLDL, and HDL), also serves as a ligand for the LDL receptor and the chylomicron remnant receptor.¹³ There are three major isoforms of apo E: apo E2, E3, and E4. The apo E isoforms affect lipoprotein metabolism because they differ in their ability to interact with the LDL receptor.^{14,15} For example, patients who are homozygous for the apo E2 isoform are at an increased risk for developing type III hyperlipoproteinemia. The connection with lipid metabolism is not

completely understood, but individuals with the apo E4 isoform have been shown to have an increased risk for developing Alzheimer's disease.^{16,17}

Chylomicrons

Chylomicrons, which contain apo B-48, are the largest and the least dense of the lipoprotein particles, having diameters as large as 1200 nm¹³ (Table 14-1). Because of their large size, they reflect light and account for the turbidity of postprandial plasma. Because they are so light, they also readily float to the top of stored plasma and form a creamy layer, which is a hallmark for the presence of chylomicrons. Chylomicrons are produced by the intestine, where they are packaged with absorbed dietary lipids. Once they enter the circulation, triglycerides and cholesteryl esters in chylomicrons are rapidly hydrolyzed

TABLE 14-2 CHARACTERISTICS OF THE MAJOR HUMAN APOLIPOPROTEINS

| APOLIPOPROTEIN | MOLECULAR WEIGHT (kD) | PLASMA CONCENTRATION (mg/dL) | MAJOR LIPOPROTEIN LOCATION | FUNCTION |
|----------------|-----------------------------|------------------------------|----------------------------|--|
| Apo A-I | 28,000 | 100–200 | HDL | Structural, LCAT activator, ABCA1 lipid acceptor |
| Apo A-II | 17,400 | 20–50 | HDL | Structural |
| Apo A-IV | 44,000 | 10–20 | Chylos, VLDL, HDL | Structural |
| Apo B-100 | 5.4×10^5 10^5 | 70–125 | LDL, VLDL | Structural, LDL receptor ligand |
| Apo B-48 | 2.6×10^5 | <5 | Chylos | Structural, remnant receptor ligand |
| Apo C-I | 6,630 | 5–8 | Chylos, VLDL, HDL | Structural |
| Apo C-II | 8,900 | 3–7 | Chylos, VLDL, HDL | Structural, LPL cofactor |
| Apo C-III | 9,400 | 10–12 | Chylos, VLDL, HDL | Structural, LPL inhibitor |
| Apo E | 34,400 | 3–15 | VLDL, HDL | Structural, LDL receptor ligand |
| Apo(a) | $(3-7) \cdot 10^5$ | <30 | Lp(a) | Structural, plasminogen inhibitor |

by lipases and, within a few hours, they are transformed into chylomicron remnant particles, which are recognized by proteoglycans and remnant receptors in the liver, facilitating their uptake.¹³ The principal role of chylomicrons is the delivery of dietary lipids to hepatic and peripheral cells.

Very Low Density Lipoproteins

VLDL is produced by the liver and contains apo B-100, apo E, and apo Cs; like chylomicrons, they are also rich in triglycerides.^{18,19} They are the major carriers of endogenous (hepatic-derived) triglycerides and transfer triglycerides from the liver to peripheral tissue. Like chylomicrons, they also reflect light and account for most of the turbidity observed in fasting hyperlipidemic plasma specimens, although they do not form a creamy top layer like chylomicrons, because they are smaller and less buoyant (Table 14-1). Excess dietary intake of carbohydrate, saturated fatty acids, and trans fatty acids enhances the hepatic synthesis of triglycerides, which in turn increases VLDL production.

Low-Density Lipoproteins

LDL primarily contains apo B-100 and is more cholesterol rich than other apo B-containing lipoproteins (Table 14-1). They form as a consequence of the lipolysis of VLDL. LDL is readily taken up by cells via the LDL receptor in the liver and peripheral cells.²⁰ In addition, because LDL particles are significantly smaller than VLDL particles and chylomicrons, they can infiltrate into the extracellular space of the vessel wall, where they can be oxidized and taken up by macrophages through various scavenger receptors.²¹ Macrophages that take up too much lipid become filled with intracellular lipid drops and turn into foam cells,²² which is the predominant cell type of fatty streaks, an early precursor of atherosclerotic plaques.

LDL particles can exist in various sizes and compositions and have been separated into as many as eight subclasses through density ultracentrifugation or gradient gel electrophoresis.^{23–25} The LDL subclasses differ largely in their content of core lipids; the smaller particles are denser and have relatively more triglyceride than cholesteryl esters. Recently, there has been great interest in measuring LDL subfractions, because small, dense, LDL particles have been shown to be more proatherogenic and may be a better marker for coronary heart disease risk.²⁶

Lipoprotein(a)

Lipoprotein(a) particles are LDL-like particles that contain one molecule of apo (a) linked to apo B-100 by a disulfide bond.^{12,27} Lp(a) particles are heterogeneous in

both size and density, as a result of a differing number of repeating peptide sequences, called kringles, in the apo (a) portion of the molecule. The concentration of Lp(a) is inversely related to the size of the isoform. Plasma levels of Lp(a) vary widely among individuals in a population but remain relatively constant within an individual.

Elevated levels of Lp(a) are thought to confer increased risk for premature coronary heart disease and stroke. Because the kringle domains of Lp(a) have a high level of homology with plasminogen, a protein that promotes clot lysis, it has been proposed that Lp(a) may compete with plasminogen for binding sites, thereby promoting clotting, a key contributor to both myocardial infarction and stroke.^{20,22}

High-Density Lipoproteins

HDL, the smallest and most dense lipoprotein particle, is synthesized by both the liver and intestine^{28,29} (Table 14-1). HDL can exist as either disk-shaped particles or, more commonly, spherical particles.²⁹ Discoidal HDL typically contains two molecules of apo A-I, which form a ring around a central lipid bilayer of phospholipid and cholesterol. Discoidal HDL is believed to represent nascent or newly secreted HDL and is the most active form in removing excess cholesterol from peripheral cells. The ability of HDL to remove cholesterol from cells, called reverse cholesterol transport, is one of the main mechanisms proposed to explain the antiatherogenic property of HDL. When discoidal HDL has acquired additional lipid, cholesteryl esters and triglycerides form a core region between its phospholipid bilayer, which transforms discoidal HDL into spherical HDL. HDL is highly heterogeneous separable into as many as 13 or 14 different subfractions. There are two major types of spherical HDL based on density differences: HDL₂ and HDL₃. HDL₂ particles are larger in size and richer in lipid than HDL₃ and may reflect better efficiency in delivering lipids to the liver.^{30,31}

LIPOPROTEIN PHYSIOLOGY AND METABOLISM

The four major pathways involved in lipoprotein metabolism are shown in Figure 14-3. The lipid absorption pathway, the **exogenous pathway**, and the **endogenous pathway**, which all depend on apo B-containing lipoprotein particles, can be viewed as means to transport dietary lipid and hepatic-derived lipid to peripheral cells. In terms of energy metabolism, these three pathways are critical in the transport to peripheral cells of fatty acids, which are generated during the lipolysis of triglycerides and, to a lesser degree, cholesteryl esters on lipoproteins. In regard to the pathogenesis of atherosclerosis, the net result of these three pathways is also the net delivery or

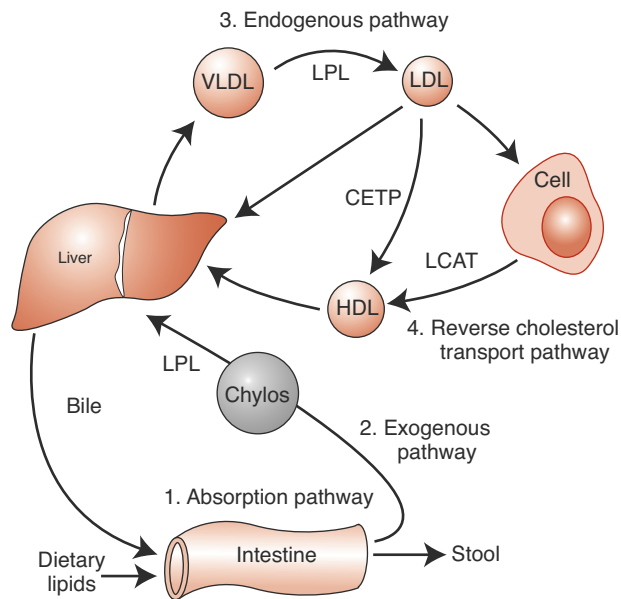

FIGURE 14-3. Diagram of major lipoprotein metabolism pathways.

forward transport of cholesterol to peripheral cells, which can lead to atherosclerosis when the cells in the vessel wall accumulate too much cholesterol.^{20,22} Peripheral cells are prone to accumulating cholesterol because they also synthesize their own cholesterol, and, unlike liver cells, they do not have the enzymatic pathways to catabolize cholesterol. Furthermore, cholesterol is relatively water insoluble and cannot readily diffuse away from its site of deposition or synthesis.

One principal way that peripheral cells maintain their cholesterol equilibrium is the reverse cholesterol transport pathway (Fig. 14-3), which is mediated by HDL. In this pathway, excess cholesterol from peripheral cells is transported back to the liver, where it can be excreted into the bile as free cholesterol or after being converted to bile acids. The liver is, therefore, involved in both forward and reverse cholesterol transport pathways and, in many ways, acts as a buffer in helping the body maintain its overall cholesterol level. There are several genetic defects in the genes that encode for proteins in the forward and reverse cholesterol transport pathways that result in a predisposition for atherosclerosis.^{32,33} The majority of individuals with coronary artery disease, however, do not have a clear, single, genetic defect but instead multiple genetic variations or gene polymorphisms that most likely interact with various lifestyle habits,³⁴ such as exercise, diet, and smoking, to cause a predisposition for disease.

Lipid Absorption

Because fats are water insoluble, special mechanisms are required to facilitate the intestinal absorption of the 60

to 130 g of fat per day in a typical Western diet. During the process of digestion, pancreatic lipase, by cleaving off fatty acids, first converts dietary lipids into more polar compounds with amphipathic properties.³⁵ Thus, triglycerides are transformed into monoglycerides and diglycerides; cholesterol esters are transformed into free cholesterol; and phospholipids are transformed into lysophospholipids. These amphipathic lipids in the intestinal lumen form large aggregates with bile acids called micelles. Lipid absorption occurs when the micelles come in contact with the microvillus membranes of the intestinal mucosal cells. Absorption of some of these lipids may occur via a passive transfer process; however, recent evidence suggests that, in some cases, it might also be facilitated by specific transporters, such as the NPC1L-1 transporter for cholesterol.^{36,37} Short-chain free fatty acids, with 10 or fewer carbon atoms, can readily pass directly into the portal circulation and are carried by albumin to the liver. The absorbed long-chain fatty acids, monoglycerides, and diglycerides are reesterified in intestinal cells to form triglycerides and cholesteryl esters. The newly formed triglycerides and cholesteryl esters are then packaged into chylomicrons, along with apo B-48.

Triglyceride absorption is efficient; greater than 90% of dietary triglycerides are taken up by the intestine. In contrast, only about half of the 500 mg of cholesterol in the typical diet is absorbed each day. Even a smaller fraction of plant sterols are absorbed by the intestine. Recently, a specific transport system, involving the ABCG5 and ABCG8 transporters, has been described that prevents excess absorption of dietary cholesterol and plant sterols.³⁸ Individuals with defective ABCG5 or ABCG8 transporters have a disease called sitosterolemia and have a predisposition for atherosclerosis because of increased cholesterol and plant sterol absorption.³⁸

Exogenous Pathway

The newly synthesized chylomicrons in the intestine (Fig. 14-3) are initially secreted into the lymphatic ducts and eventually enter the circulation by way of the thoracic duct.^{13,39,40} After entering the circulation, chylomicrons interact with proteoglycans, such as heparan sulfate, on the surface of capillaries in various tissues, such as skeletal muscle, heart, and adipose tissue. The proteoglycans on capillaries also promote the binding of lipoprotein lipase (LPL),⁴¹ which hydrolyzes triglycerides on chylomicrons. The free fatty acids and glycerol generated by the hydrolysis of triglycerides by LPL can then be taken up by cells and used as a source of energy. Excess fatty acids, particularly in fat cells (adipocytes), are re-esterified into triglycerides for long-term storage in intracellular lipid drops. Hormone-

sensitive lipase inside adipose cells can release free fatty acids from triglycerides in stored fat when energy sources from carbohydrates are insufficient for the body's energy needs. The hormones epinephrine and cortisol play a key role in the mobilization and hydrolysis of triglycerides from adipocytes, whereas insulin prevents lipolysis by adipocytes and promotes fat storage and glucose utilization.

During lipolysis of chylomicrons, there is a transfer of lipid and apolipoproteins onto HDL, and chylomicrons are converted within a few hours after a meal into chylomicron remnant particles. Chylomicron remnants are rapidly taken up by the liver through interaction of apo E with specific remnant receptors on the surface of liver cells. Once in the liver, lysosomal enzymes break down the remnant particles to release free fatty acids, free cholesterol, and amino acids. Some cholesterol is converted to bile acids. Both bile acids and free cholesterol are directly excreted into the bile but not all of the excreted cholesterol and bile salt exit the body. As previously described, approximately half of the excreted biliary cholesterol is reabsorbed by the intestine, with the remainder appearing in the stool, as fecal neutral steroids. In the case of bile acids, almost all of the bile acids are reabsorbed and reused by the liver for bile production.

Endogenous Pathway

Most triglycerides in the liver that are packaged into VLDL are derived from the diet after recirculation from adipose tissue.^{18,42} Only a small fraction is synthesized *de novo* in the liver from dietary carbohydrate. VLDL particles, once secreted into the circulation, undergo a lipolytic process similar to that of chylomicrons (Fig. 14-3). VLDL loses core lipids causing dissociation and transfer of apolipoproteins and phospholipids to other lipoprotein particles, primarily by the action of LPL. During this process, VLDL is converted to VLDL remnants, which can be further transformed by lipolysis into LDL. About half of VLDL is eventually completely converted to LDL, and the remainder is taken up as VLDL remnants by the liver remnant receptors.

LDL particles are the major lipoproteins responsible for the delivery of exogenous cholesterol to peripheral cells due to the efficient uptake of LDL by the LDL receptors.¹¹ Once bound to LDL receptors, they are endocytosed by cells and transported to the lysosome, where they are degraded. The triglycerides in LDL are converted by acid lipase into free fatty acids and glycerol and further metabolized by the cell for energy or are reesterified and stored in lipid drops for later use. Free cholesterol derived from degraded LDL can be used for membrane biosynthesis, and excess cholesterol is converted by acyl-CoA:cholesterol acyltrans-

ferase (ACAT) into cholesteryl esters and stored in intracellular lipid drops.⁴³ The regulation of cellular cholesterol biosynthesis is, in part, coordinated by the availability of cholesterol delivered by the LDL receptor.¹¹ Many enzymes in the cholesterol biosynthetic pathway (e.g., HMG-CoA reductase, the main target for the cholesterol-lowering statin-type drugs) are down-regulated, along with the LDL receptor, when there is excess cellular cholesterol by a complex mechanism involving both gene regulation and post-transcriptional gene regulation.⁴⁴

Abnormalities in LDL receptor function result in elevation of LDL in the circulation and lead to hypercholesterolemia and premature atherosclerosis.^{11,45} Patients who are heterozygous for a disease called familial hypercholesterolemia, with an incidence of approximately 1:500, have only approximately half the normal LDL receptors, which results in decreased hepatic uptake of LDL by the liver and increased hepatic cholesterol biosynthesis. The LDL that accumulates in the plasma of these individuals often leads to the development of coronary heart disease by mid-adulthood in heterozygotes and even earlier for homozygotes.^{11,45}

Reverse Cholesterol Transport Pathway

As previously described, one of the major roles of HDL is to maintain the equilibrium of cholesterol in peripheral cells by the reverse cholesterol transport pathway^{46,47} (Fig. 14-3). HDL is believed to remove excess cholesterol from cells by multiple pathways. In the aqueous diffusion pathway,⁴⁸ HDL acts as a sink for the small amount of cholesterol that can diffuse away from the cells. Although cholesterol is relatively water insoluble, because it is an amphipathic lipid, it is soluble in plasma in micromolar amounts and can spontaneously dissociate from the surface of cell membranes and enter the extracellular fluid. Some free cholesterol will then bind to HDL in the extracellular space, and, once bound, it becomes trapped in lipoproteins after it is converted to cholesteryl ester by lecithin:cholesterol acyltransferase (LCAT),⁴⁹ which resides on HDL. HDL can then directly deliver cholesterol to the liver by the SR-BI receptor⁴⁹ and, possibly, other receptors.⁵ Approximately half of the cholesterol on HDL is returned to the liver by the LDL receptor, after first being transferred from HDL to LDL by the cholesteryl ester transfer protein (CETP),⁵⁰ which connects the forward and reverse cholesterol transport pathways (Fig. 14-3). Cholesterol that reaches the liver is then directly excreted into the bile or first converted to a bile acid before excretion.

Another pathway in which HDL mediates the removal of cholesterol from cells, involves the ABCA1 transporter.⁵¹ The ABCA1 transporter is a member of

CASE STUDY 14-1

A 52-year-old man went to his physician for a physical examination. The patient had been a district manager for an automobile insurance company for the past 10 years and was 24 pounds overweight. He had missed his last two appointments with the physician because of business. The urinalysis dipstick finding was not remarkable. His blood pressure was elevated. The blood chemistry results are listed in Case Study Table 14-1.1.

Questions

1. Given the abnormal tests, what additional information would you like to have?
2. If this patient had triglycerides of 100 mg/dL (1.1 mmol/L) and an HDL cholesterol of 23 mg/dL (0.6 mmol/L), what would be his calculated LDL cholesterol value?
3. If, however, his triglycerides were 476 mg/dL (5.4 mmol/L), with an HDL cholesterol of 23 mg/dL (0.6 mmol/L), what would be his calculated LDL cholesterol value?

CASE STUDY TABLE 14-1.1 LABORATORY RESULTS

| ANALYTE | PATIENT VALUE | REFERENCE RANGE |
|-------------------------|---------------|-----------------|
| Na ⁺ | 151 | 135–143 mEq/L |
| K ⁺ | 4.5 | 3.0–5.0 mEq/L |
| Cl ⁻ | 106 | 98–103 mEq/L |
| CO ₂ content | 13 | 22–27 mmol/L |
| Total protein | 5.7 | 6.5–8.0 g/dL |
| Albumin | 1.6 | 3.5–5.0 g/dL |
| Ca ²⁺ | 7.9 | 9.0–10.5 mg/dL |
| Cholesterol | 210 | 140–200 mg/dL |
| Uric acid | 6.2 | 3.5–7.9 mg/dL |
| Creatinine | 2.5 | 0.5–1.2 mg/dL |
| BUN | 95 | 7–25 mg/dL |
| Glucose | 88 | 75–105 mg/dL |
| Total bilirubin | 1.2 | 0.2–1.0 mg/dL |
| Alkaline phosphatase | 27 | 7–59 IU/L |
| Lactate dehydrogenase | 202 | 90–190 IU/L |
| Aspartate transaminase | 39 | 8–40 IU/L |
| Amylase | 152 | 76–375 IU/L |

the ATP-binding cassette transporter family⁵² that pumps various ligands across the plasma membrane. Defects in the gene for the ABCA1 transporter lead to Tangier disease, a disorder associated with low HDL and a predisposition to premature coronary heart disease.⁵³ The exact mechanism of the ABCA1 transporter is not known, but it is believed that the transporter modifies the plasma membrane by transporting a lipid, which then enables apo A-I that has dissociated from HDL to bind to the cell membrane. In a detergent-like extraction mechanism, apo A-I then removes excess cholesterol and phospholipid from the plasma membrane of cells to form a discoidal-shaped HDL particle.⁵⁴ The newly formed HDL is then competent to accept additional cholesterol by the aqueous diffusion pathway and is eventually converted into spherical HDL by the action of LCAT (Fig. 14-3). Recently, ABCG1, another ABC transporter, has been described to facilitate the efflux of cholesterol to lipid-rich spherical HDL via a mechanism that appears to be different than the ABCA1 transporter.⁵⁵

LIPID AND LIPOPROTEIN POPULATION DISTRIBUTIONS

Serum lipoprotein concentrations differ between adult men and women, primarily as a result of differences in sex hormone levels, with women having, on average, higher HDL cholesterol levels and lower total cholesterol and triglyceride levels than men.⁵⁶ The difference in total cholesterol, however, disappears after menopause as estrogen decreases.⁵⁷ Men and women both show a tendency toward increased total cholesterol, LDL cholesterol, and triglyceride concentrations with age. HDL cholesterol concentrations generally remain stable after the onset of puberty and do not drop in women with the onset of menopause. General adult reference ranges are shown in Table 14-3.

Circulating levels of total cholesterol, LDL cholesterol, and triglycerides in young children are generally much lower than those seen in adults.⁵⁸ In addition, concentrations do not significantly differ between boys and girls. HDL cholesterol levels for both boys and girls are

TABLE 14-3 ADULT REFERENCE RANGES FOR LIPIDS

| ANALYTE | REFERENCE RANGE |
|-------------------|-----------------|
| Total cholesterol | 140–200 mg/dL |
| HDL cholesterol | 40–75 mg/dL |
| LDL cholesterol | 50–130 mg/dL |
| Triglyceride | 60–150 mg/dL |

comparable to those of adult women. At the onset of puberty, however, HDL cholesterol concentrations in boys fall to adult male levels, a drop of approximately 20%, whereas those of girls do not change. It is the lower concentration of HDL cholesterol in men, combined with their higher LDL cholesterol and triglyceride levels, that accounts for much of the increased risk of premature heart disease in men.

The incidence of heart disease is strongly associated with serum cholesterol concentration.⁵⁹ Comparisons across different societies show that eating less animal fat and more grains, fruits, and vegetables, as is common in many Asian populations, is associated with lower LDL cholesterol and lower rates of heart disease compared with societies that ingest more fat, particularly animal fat, and are more sedentary.^{60,61} These differences can be attributed to both genetic and lifestyle factors in the various countries and ethnic groups. The importance of diet was clearly shown in a study that compared the dietary patterns and heart disease rates in Japanese men living in Japan, Hawaii, and California.⁶² In this study, as dietary intake became more westernized, with increased consumption of fat and cholesterol, the LDL cholesterol concentrations increased, as did the rates of heart disease. Japanese men living in California were found to have much higher rates of heart disease than Japanese men living in Japan; those in Hawaii were intermediate. Within societies in which diet tends to be more homogeneous, LDL cholesterol levels become somewhat less discriminatory as a risk factor, and HDL cholesterol levels become more important as a negative risk factor.

The National Cholesterol Education Program (NCEP) was formed to alert the American population to the risk factors associated with heart disease. NCEP has used panels of experts, including Adult Treatment Panels (ATPs), the Children and Adolescents Treatment Panel, and the Laboratory Standardization Panel, to produce various recommendations.^{58,63–66} In 1988, the first NCEP ATP developed a list of heart disease risk factors. These guidelines were most recently updated by ATP III in 2002.⁶⁶ The current list of risk factors is shown in Table 14-4. ATP III also has recommended that all adults (20 years and older) have a fasting lipoprotein profile performed (total, LDL, and HDL cholesterol and triglycerides) once every 5 years and has developed guidelines for the diagnosis and follow-up treatment of individuals with abnormal levels (Table 14-5). The Children and Adolescents Treatment Panel has developed similar guidelines for the pediatric population.⁵⁸

The NCEP Laboratory Standardization Panel and its successor, the Lipoprotein Measurement Working Group,^{63–65} set laboratory guidelines for acceptable precision and accuracy when measuring total cholesterol, triglycerides, and lipoprotein cholesterol (HDL and LDL cholesterol) (Table 14-6).

Obviously, the best way to reduce the prevalence of heart disease is through prevention. Learning and practicing good dietary and exercise patterns early in life, maintaining these patterns throughout life,⁵⁶ refraining from smoking, and controlling blood pressure are important means for reducing the incidence of CHD and stroke.⁶⁷ Lipoprotein profile measurements provide a method of identifying individuals who may have levels

TABLE 14-4 CORONARY HEART DISEASE RISK FACTORS DETERMINED BY THE NCEP ADULT TREATMENT PANELS

POSITIVE RISK FACTORS

- Age: ≥ 45 years for men; ≥ 55 years or premature menopause for women
- Family history of premature CHD
- Current cigarette smoking
- Hypertension (blood pressure $\geq 140/90$ mm Hg or taking antihypertensive medication)
- LDL cholesterol concentration ≥ 160 mg/dL (≥ 4.1 mmol/L), with ≤ 1 risk factor
- LDL cholesterol concentration ≥ 130 mg/dL (3.4 mmol/L), with ≥ 2 risk factors
- LDL cholesterol concentration ≥ 100 mg/dL (2.6 mmol/L), with CHD or risk equivalent
- HDL cholesterol concentration > 40 mg/dL (< 1.0 mmol/L)
- Diabetes mellitus = CHD risk equivalent
- Metabolic syndrome (multiple metabolic risk factors)

NEGATIVE RISK FACTORS

- HDL cholesterol concentration ≥ 60 mg/dL (≥ 1.6 mmol/L)
- LDL cholesterol < 100 mg/dL (< 2.6 mmol/L)

TABLE 14-5 TREATMENT GUIDELINES ESTABLISHED BY THE NCEP ADULT TREATMENT PANELS (INITIAL TESTING SHOULD CONSIST OF FASTING FOR ≥12 HOURS)

| RISK CATEGORY AND ACTION | | |
|--|-------------------------|-------------------------|
| Total cholesterol (TC), <200 mg/dL (5.2 mmol/L); triglycerides (TG), <150 mg/dL (<1.7 mmol/L); LDL cholesterol (LDLC), <130 mg/dL (<3.4 mmol/L); HDL cholesterol (HDLC), ≥40 mg/dL (≥1.0 mmol/L) | | |
| Repeat within 5 years | | |
| Provide risk reduction information | | |
| TC, 200–239 mg/dL (5.2–6.2 mmol/L); TG, 150–199 mg/dL (1.7–2.2 mmol/L); LDLC, 130–159 mg/dL (3.4–4.1 mmol/L); HDLC, ≥40 mg/dL (1.0 mmol/L); and 0–1 risk factors | | |
| Provide therapeutic lifestyle changes (TLC) diet and physical activity information and reevaluate in 1 year | | |
| Provide risk reduction information | | |
| TC, ≥200 mg/dL (5.2–6.2 mmol/L); TG, ≥200 mg/dL (≥2.2 mmol/L); LDLC, 130–159 mg/dL (3.4–4.1 mmol/L); HDLC, <40 mg/dL (1.0 mmol/L); and ≥2 risk factors | | |
| Do clinical evaluation, including family history | | |
| Start dietary therapy (see below) | | |
| TC, ≥240 mg/dL (6.2 mmol/L) | | |
| Perform lipoprotein analysis (see below) | | |
| TREATMENT DECISIONS | | |
| RISK CATEGORY | ACTION LEVEL | GOAL |
| DIETARY THERAPY | | |
| No CHD; 0–1 risk factors | ≥160 mg/dL (4.1 mmol/L) | <160 mg/dL (4.1 mmol/L) |
| No CHD; ≥2 risk factors (10-year risk, ≥20%) | ≥130 mg/dL (3.4 mmol/L) | <130 mg/dL (3.4 mmol/L) |
| CHD; CHD risk equivalent (10-year risk, >20%) | >100 mg/dL (2.6 mmol/L) | <100 mg/dL (2.6 mmol/L) |
| DRUG THERAPY | | |
| No CHD; 0–1 risk factors | ≥190 mg/dL (4.9 mmol/L) | <160 mg/dL (4.1 mmol/L) |
| No CHD; 2 risk factors (10-year risk, ≤10%) | ≥160 mg/dL (4.1 mmol/L) | <130 mg/dL (3.4 mmol/L) |
| No CHD; ≥2 risk factors (10-year risk, 10–20%) | ≥130 mg/dL (4.1 mmol/L) | <100 mg/dL (3.4 mmol/L) |
| CHD; CHD risk equivalent | ≥130 mg/dL (3.4 mmol/L) | <100 mg/dL (2.6 mmol/L) |

that put them at risk so that they can receive appropriate treatment. Treatment of other diseases that may affect lipoproteins, such as diabetes mellitus, hypothyroidism, and renal disease, is also important. A prudent diet, low in fat and cholesterol, with a caloric intake adjusted to meet and maintain ideal body weight, along with regular

exercise, can significantly reduce the risk of heart disease, stroke, diabetes, and cancer.⁶⁸ Dietary intake of fat and cholesterol has been shown to have a synergistic effect, such that dietary cholesterol is more efficiently absorbed when in the presence of fat. Additionally, saturated fat is more atherogenic than unsaturated fat.⁵⁶ The

TABLE 14-6 NCEP ANALYTIC PERFORMANCE GOALS

| | PRECISION | BIAS | TOTAL ERROR |
|-------------------|-----------|------------|-------------|
| Total cholesterol | 3% CV | ±3% | ±8.9% |
| HDL cholesterol | | | |
| ≥42 mg/dL | 4% CV | ±5% | ±12.8% |
| <42 mg/dL | SD | <1.7 mg/dL | |
| LDL cholesterol | 4% CV | ±4% | ±11.8% |
| Triglycerides | 5% CV | ±5% | ±14.8% |

TABLE 14-7 COMPOSITION OF THE THERAPEUTIC LIFESTYLE CHANGES DIET RECOMMENDED BY THE NCEP ADULT TREATMENT PANEL III (COMPARED WITH THE AVERAGE AMERICAN DIET)

| DIETARY NUTRIENT | TLC DIET | AVERAGE AMERICAN DIET |
|------------------|-------------|------------------------|
| Total fat | 25–35% | 36% (% total calories) |
| Saturated | <7% | 15% |
| Monounsaturated | ≤20% | 15% |
| Polyunsaturated | ≤10% | 6% |
| Cholesterol | | >400 mg/day |
| Carbohydrate | 50–60% | |
| Fiber | 20–30 g/day | |
| Protein | <15% | |

American Heart Association has recommended dietary guidelines for the intake of fat and cholesterol for most adult Americans (Table 14-7).

DIAGNOSIS AND TREATMENT OF LIPID DISORDERS

Diseases associated with abnormal lipid concentrations are referred to as dyslipidemias. They can be caused directly by genetic abnormalities or through environmental/lifestyle imbalances, or they can develop secondarily, as a consequence of other diseases.^{69,70} Dyslipidemias are generally defined by the clinical characteristics of patients and the results of laboratory tests and are not necessarily defined by the specific genetic defect associated with the abnormality. Many, but not all, dyslipidemias, regardless of etiology, are associated with CHD, or arteriosclerosis.

Arteriosclerosis

In the United States and many other developed countries, **arteriosclerosis** is the single leading cause of death and disability. The mortality rate has decreased in the United States in the past few years, partly as a result of advances in diagnosis and treatment but also because of changes in lifestyle in the American population. This increased awareness of the importance of diet and exercise in preventing CHD has resulted in an overall decrease in the average serum cholesterol concentration and in a lower prevalence of heart disease; however, it still exceeds all other causes of death combined. Although as many women as men develop arteriosclerosis, they typically develop it 10 years later than men.

The relationship between heart disease and dyslipidemias stems from the deposition of lipids, mainly in the form of esterified cholesterol, in artery walls. This lipid deposition first results in fatty streaks, which are

thin streaks of excess fat in macrophages in the subendothelial space. Autopsy studies have shown that fatty streaks occur in almost everyone older than age 15.⁷¹ Fatty streaks can develop over time into plaques that contain increased number of smooth muscle cells, extracellular lipid, calcification, and fibrous tissue, which can partially block or occlude blood flow. Also, established plaque for unknown reasons can become vulnerable to rupture or erosion, triggering a thrombosis that can block circulation. When plaque develops in arteries of the arms or legs, it is called peripheral vascular disease (PVD); when it develops in the heart, it is referred to as coronary artery disease (CAD); and, when it develops in the vessels of the brain, it is called cerebrovascular disease (CVD). CAD is associated with angina and myocardial infarction, and CVD is associated with stroke. Many genetic and acquired dyslipidemias may also lead to lipid deposits in the liver and kidney, resulting in impaired function of these vital organs. Lipid deposits in skin form nodules called xanthomas, which are often a clue to the presence of an underlying genetic abnormality.

Plaque formation involves repeated cycles of cell injury, followed by infiltration and cell proliferation to repair the site. LDL is believed to play a central role in initiating and promoting plaque formation. It is deposited into the subendothelial space where it is taken up by various cells, including macrophages. This alters the gene and protein expression pattern of these cells and can promote an inflammatory response, particularly when LDL becomes oxidized.⁷² Injury signals from the evolving plaque trigger the expression of adhesion proteins on endothelial cells and the production of soluble chemotactic proteins from resident macrophages, which promotes the attachment and infiltration of additional macrophages, lymphocytes, and platelets to the plaque. Continual injury and repair lead to additional narrowing of the vessel

CASE STUDY 14-2

A 30-year-old man with chest pain was brought to the emergency department after a softball game. He was placed in the coronary care unit when his ECG showed erratic waves in the ST region. A family history revealed that his father died of a heart attack at the age of 45 years. The patient had always been athletic in high school and college, so he had not concerned himself with a routine physical. The laboratory tests listed in Case Study Table 14-2.1 were run.

Questions

1. Given the symptoms and the family history, what additional tests should be recommended?
2. If his follow-up total cholesterol remains in the same range after he is released from the hospital, and his triglycerides and HDL cholesterol are within the normal range, what course of treatment should be recommended?

CASE STUDY TABLE 14-2.1 LABORATORY RESULTS

| PATIENT ANALYTE | VALUES | RANGE |
|-------------------------|--------|----------------|
| Na ⁺ | 139 | 135–143 mEq/L |
| K ⁺ | 4.1 | 3.0–5.0 mEq/L |
| Cl ⁻ | 101 | 98–103 mEq/L |
| CO ₂ content | 29 | 22–27 mmol/L |
| Total protein | 6.9 | 6.5–8.0 g/dL |
| Albumin | 3.2 | 3.5–5.0 g/dL |
| Ca ²⁺ | 9.3 | 9.0–10.5 mg/dL |
| Cholesterol | 278 | 140–200 mg/dL |
| Uric acid | 5.9 | 3.5–7.9 mg/dL |
| Creatinine | 1.1 | 0.5–1.2 mg/dL |
| BUN | 20 | 7–25 mg/dL |
| Glucose | 97 | 75–105 mg/dL |
| Total bilirubin | 0.8 | 0.2–1.0 mg/dL |
| Alkaline phosphatase | 20 | 7–59 IU/L |
| Lactate dehydrogenase | 175 | 90–190 IU/L |
| Aspartate transaminase | 35 | 8–40 IU/L |
| Amylase | 98 | 76–375 IU/L |

opening, or lumen, causing the blood to circulate in a nonlaminar manner under greater and greater pressure, which further aggravates plaque formation. The final event leading to complete occlusion of blood flow occurs when there is a hemorrhage into the plaque, which results in the formation of a thrombus that blocks blood flow and precipitates a myocardial infarction.

Because lipid deposits in the vessel walls are frequently associated with increased serum concentrations of LDL cholesterol or decreased HDL cholesterol, lowering LDL is an important step in preventing and treating CHD.^{73–75} It is estimated that for every 1% decrease in LDL cholesterol concentration, there is a 2% decrease in the risk of developing arteriosclerosis.⁷⁶ For patients with established heart disease, studies have shown that aggressive treatment to reduce LDL cholesterol levels below 100 mg/dL (2.6 mmol/L) or even lower is effective in the stabilization and sometimes regression of plaques.⁷⁷ Stabilization of plaque is thought to be at least as important as plaque regression in terms of rupture potential.⁷⁸

In some individuals, high levels of blood cholesterol or triglycerides are caused by genetic abnormalities in which either too much is synthesized or too little is removed.^{79–82} High levels of cholesterol and/or triglycerides in most people, however, are a result of increased consumption of foods rich in fat and cholesterol, smoking, and lack of exercise or a result of other disorders or disease states that affect lipid metabolism, such as diabetes, hypertension, hypothyroidism, obesity, liver and kidney diseases, and alcoholism. Low levels of HDL cholesterol are also associated with increased risk of heart disease, but there are currently limited ways to pharmacologically raise HDL cholesterol levels. Existing drugs for increasing HDL-C are primarily fibric acid derivatives (fibrates) and niacin-containing compounds.^{83,84} Newer drugs that raise HDL-C by inhibiting CETP may play a role in the future; however, a recent clinical trial with the first CETP inhibitor drug unexpectedly showed increased CHD events.⁸⁵ Other drugs using reconstituted HDL particles or administration of apo AI mimetic peptides are also being actively investigated.⁸⁶

Laboratory analyses are an important adjunct to managing patients with dyslipidemia, because accurate measurement of total, HDL, and LDL cholesterol and triglyceride levels is needed to determine the most appropriate diet or diet and drug therapy. As shown in Table 14-5, individuals on a low-fat diet, who continue to have LDL cholesterol levels of 190 mg/dL (4.9 mmol/L) or higher on repeated measurement will likely benefit from drug intervention. If they have two or more CAD risk factors and continue to have LDL cholesterol levels of 160 mg/dL (4.1 mmol/L) or higher, they also would benefit from drug therapy. And, if they have already been

previously diagnosed with heart disease, drug therapy should be considered when the LDL cholesterol level is 130 mg/dL (3.4 mmol/L) or higher. The average of at least two measurements, taken 1 to 8 weeks apart, should be used to determine the best treatment approach.⁶⁶

Classic bile-acid sequestrant drug treatments, such as cholestyramine, work by sequestering cholesterol in the gut so that it is not absorbed and, until recently, were considered to be the only safe drugs for use in children.⁷⁶ Bile-acid sequestrants have uncomfortable adverse effects such as bloating and constipation and are poorly tolerated. The most effective class of drugs for managing patients with dyslipidemia are the HMG-CoA reductase drug inhibitors, such as lovastatin, simvastatin, pravastatin, fluvastatin, atorvastatin, and rosuvastatin. These drugs, commonly known as statins, block intracellular cholesterol synthesis by inhibiting HMG-CoA reductase, a rate-limiting enzyme in cholesterol biosynthesis. The reduced level of cholesterol in hepatocytes increases the expression of the LDL receptor, which removes LDL from the circulation, thus reducing the deposition of LDL into vessels and the formation of plaques. The major safety issues with statins are myositis and hepatotoxic effects; however, patient monitoring in clinical trials has shown that fewer than 2% of patients have sustained increases in liver enzymes. These drugs typically reduce LDL cholesterol by as much as 20% to 40% and are generally well tolerated.^{73,87} Niacin is also a potent drug for reducing LDL cholesterol and is the only effective drug at this time for significantly raising HDL cholesterol levels; however, it causes flushing and diarrhea in many patients and can be hepatotoxic.⁸⁸ Newer slow-release formulations of niacin and combination drugs to reduce the flushing have been developed to improve compliance.⁸³ Fibrates, such as clofibrate, gemfibrozil, fenofibrate, and etiofibrate, are most often used to reduce triglyceride and VLDL cholesterol levels and increase HDL cholesterol levels.^{84,88} Ezetimibe is a new drug that inhibits the absorption of cholesterol by inhibiting the NPC1-L1 transporter in the intestine, and it is used often in conjunction with a statin.⁸⁹

Hyperlipoproteinemia

Disease states associated with abnormal serum lipids are generally caused by malfunctions in the synthesis, transport, or catabolism of lipoproteins.^{80,88} Dyslipidemias can be subdivided into two major categories: hyperlipoproteinemias, which are diseases associated with elevated lipoprotein levels, and hypolipoproteinemias, which are associated with decreased lipoprotein levels. The hyperlipoproteinemias can be subdivided into hypercholesterolemia, hypertriglyceridemia, and combined hyperlipidemia with elevations of both cholesterol and triglycerides.

Hypercholesterolemia

Hypercholesterolemia is the lipid abnormality most closely linked to heart disease.⁵⁹ One form of the disease, which is associated with genetic abnormalities that predispose affected individuals to elevated cholesterol levels, is called familial hypercholesterolemia (FH). Homozygotes for FH are fortunately rare (1:1 million in the population) and can have total cholesterol concentrations as high as 800 to 1,000 mg/dL (20–26 mmol/L). These patients frequently have their first heart attack when still in their teenage years.⁹⁰ Heterozygotes for the disease are seen much more frequently (1:500 in the

CASE STUDY 14-3

A 43-year-old white man was diagnosed with hyperlipidemia at age 13 years, when his father died of a myocardial infarction at age 34 years. The man's grandfather had died at age 43 years, also of a myocardial infarction. Currently, the man is active and asymptomatic with regard to CHD. He is taking 40 mg of lovastatin (Mevacor), 2 times/day (maximum dose). He had previously taken niacin but could not tolerate it because of flushing and gastrointestinal distress, nor could he tolerate cholestyramine resin (Questran). His physical examination is remarkable for bilateral Achilles tendon thickening/xanthomas and a right carotid bruit.

Questions

1. What is his diagnosis?
2. Does he need further workup?
3. What other laboratory tests should be done?
4. Does he need further drug treatment? If so, what?

CASE STUDY TABLE 14-3.1 LABORATORY RESULTS

| | |
|----------------------------------|-----------|
| Triglycerides | 91 mg/dL |
| Total cholesterol | 269 mg/dL |
| HDL cholesterol | 47 mg/dL |
| LDL cholesterol | 204 mg/dL |
| Aspartate aminotransferase (AST) | 34 U/L |
| Alanine aminotransferase (ALT) | 36 U/L |
| Alkaline phosphatase (ACP) | 53 U/L |
| Electrolytes and fasting glucose | Normal |

population) because it is an autosomal codominant disorder; a defect in just one of the two copies of the LDL receptor can adversely affect lipid levels. Heterozygotes tend to have total cholesterol concentrations in the range of 300–600 mg/dL (8–15 mmol/L) and, if not treated, become symptomatic for heart disease in their 20s to 50s. Approximately 5% of patients younger than age 50 with CAD are FH heterozygotes. Other symptoms associated with FH include tendinous and tuberous xanthomas, which are cholesterol deposits under the skin, and arcus, which are cholesterol deposits in the cornea.⁸⁰

In both homozygotes and heterozygotes, the cholesterol elevation is primarily associated with an increase in LDL cholesterol. These individuals synthesize intracellular cholesterol normally but lack, or are deficient in, active LDL receptors. Consequently, LDL builds up in the circulation because there are insufficient receptors to bind the LDL and transfer the cholesterol into the cells. Cells, however, which require cholesterol for use in cell membrane and hormone production, synthesize cholesterol intracellularly at an increased rate to compensate for the lack of cholesterol from the receptor mediated mechanism.

In FH heterozygotes and other forms of hypercholesterolemia, reduction in the rate of internal cholesterol synthesis, by inhibition of HMG-CoA reductase with statin drugs, stimulates the production of additional LDL receptors, particularly in the liver, which removes LDL from the circulation. Homozygotes, however, do not usually benefit from this type of therapy, because they typically do not have enough functional receptors to stimulate. Homozygotes can be treated by a technique called LDL pheresis, a method similar to the dialysis treatment, in which blood is periodically drawn from the patient, processed to remove LDL, and returned to the patient.^{90,91}

Most individuals with elevated LDL cholesterol levels do not have FH but are still at increased risk for premature CHD^{59,66,76} and should be maintained on a low-fat, low-cholesterol diet and receive statin treatment when necessary (Table 14-5). Regular physical activity should also be incorporated, with drug therapy (Table 14-5).

Hypertriglyceridemia

The NCEP ATP has identified borderline high triglycerides as levels of 150–200 mg/dL (1.7–2.3 mmol/L), high as 200–500 mg/dL (2.3–5.6 mmol/L), and very high as greater than 500 mg/dL (>5.6 mmol/L).⁶⁶ Hypertriglyceridemia can be a consequence of genetic abnormalities, called familial hypertriglyceridemia, or the result of secondary causes, such as hormonal abnormalities associated with the pancreas, adrenal glands, and pituitary, or of diabetes mellitus or nephrosis.

Diabetes mellitus leads to increased shunting of glucose into the pentose pathway, causing increased fatty acid synthesis. Renal failure depresses the removal of large-molecular-weight constituents like triglycerides, causing increased serum levels. Hypertriglyceridemia is generally a result of an imbalance between synthesis and clearance of VLDL in the circulation.^{92,93} In some studies, hypertriglyceridemia has not been statistically implicated as an independent risk factor for CHD, but many CHD patients have moderately elevated triglycerides in conjunction with decreased HDL cholesterol levels.⁹⁴ It is often difficult to separate the risk associated with increased triglycerides from that of decreased HDL cholesterol, but hypertriglyceridemia is now generally considered an important and potentially treatable risk factor for CHD.

Triglycerides are influenced by a number of hormones, such as insulin, glucagon, pituitary growth hormone, adrenocorticotropic hormone (ACTH), thyrotropin, and adrenal medulla epinephrine and norepinephrine from the nervous system. Epinephrine and norepinephrine influence serum triglyceride levels by triggering production of hormone-sensitive lipase, which is located in adipose tissue.⁹⁵ Other body processes that trigger hormone-sensitive lipase activity are cell growth (growth hormone), adrenal stimulation (ACTH), thyroid stimulation (thyrotropin), and fasting (glucagon). Each process, through its action on hormone-sensitive lipase, results in an increase in serum triglyceride values.

Although severe hypertriglyceridemia (>500 mg/dL [>5.6 mmol/L]) is usually not associated with high risk for CHD, it is a potentially life-threatening abnormality because it can cause acute and recurrent pancreatitis (inflammation of the pancreas).^{88,96} It is, therefore, imperative that these patients be diagnosed and treated with triglyceride-lowering medication and that they are closely monitored. Severe hypertriglyceridemia is generally caused by a deficiency of LPL or by a deficiency in apolipoprotein C-II, which is a necessary cofactor for LPL activity.⁹⁷ Normally, LPL hydrolyzes triglycerides carried in chylomicrons and VLDL to provide cells with free fatty acids for energy from exogenous and endogenous triglyceride sources. A deficiency in LPL or apo C-II activity keeps chylomicrons from being cleared and serum triglycerides remain extremely elevated, even when the patient has fasted for longer than 12 to 14 hours.

Treatment of hypertriglyceridemia consists of dietary modifications, fish oil, and or triglyceride-lowering drugs (primarily, fibric acid derivatives) in cases of severe hypertriglyceridemia or when accompanied with low HDL cholesterol.^{98,99} It is possible that a certain subspecies of chylomicrons and VLDL are atherogenic. Remnants of chylomicrons and VLDL represent subspecies that have been partially hydrolyzed by lipases and are thought to be potentially atherogenic.¹⁰⁰

Combined Hyperlipoproteinemia

Combined hyperlipoproteinemia is generally defined as the presence of elevated levels of serum total cholesterol and triglycerides. Individuals presenting with this syndrome are considered at increased risk for CHD. In one genetic form of this condition, called familial combined hyperlipoproteinemia (FCH), individuals from an affected kindred may only have elevated cholesterol, whereas others only have elevated triglycerides, and yet others, elevations of both. Another rare genetic form of combined hyperlipoproteinemia is called familial dysbetalipoproteinemia, or type III hyperlipoproteinemia. The name type III hyperlipoproteinemia is a holdover from a lipoprotein typing system developed by Fredrickson et al.¹⁰¹ that is otherwise generally no longer used. The disease results from an accumulation of cholesterol-rich VLDL and chylomicron remnants as a result of defective catabolism of those particles. The disease is associated with the presence of a relatively rare form of apo E, called apo E2/2. Individuals with type III will frequently have total cholesterol values of 200–300 mg/dL (5–8 mmol/L) and triglycerides of 300–600 mg/dL (3–7 mmol/L). To distinguish them from other forms of combined hyperlipoproteinemias, it is first necessary to isolate the VLDL fraction with ultracentrifugation. A ratio derived from the cholesterol concentration in VLDL to total serum triglycerides will be greater than >0.30 in the presence of type III hyperlipoproteinemia. If the VLDL fraction is analyzed by agarose electrophoresis, the particles will migrate in a broad β region, rather than in the normal pre- β region. Definitive diagnosis requires a determination of apo E isoforms by isoelectric focusing or DNA typing, resulting in either apo E2/2 homozygosity or, rarely, apo E mutation or deficiency. Treatment does not totally rely on a diagnosis because these patients, as those with other dyslipidemias, can be treated with niacin, gemfibrozil, HMG-CoA reductase inhibitors, or just a low-fat diet. Because of the cholesterol-enriched composition of these particles, use of the Friedewald equation¹⁰² to calculate LDL cholesterol levels will result in an underestimation of VLDL cholesterol and, therefore, an overestimation of LDL cholesterol, compared with beta-quantification.¹⁰³

Lipoprotein(a) Elevation

Elevations in the serum concentration of Lp(a), especially in conjunction with elevations of LDL, increase the risk of CHD and CVD.^{104,105} Higher Lp(a) levels have been observed more frequently in patients with CHD than in normal control subjects,¹⁰⁶ although prospective studies have not conclusively determined this positive association.¹⁰⁷ Lp(a) are variants of LDL with an extra apolipoprotein, called apo (a); the size and serum concentrations of Lp(a) are largely genetically determined.¹⁰⁸ Because apo (a) has a high degree of homology

CASE STUDY 14-4

A 60-year-old woman came to her physician because she was having problems with urination. Her previous history included hypertension and episodes of edema. The physician ordered various laboratory tests on blood drawn in his office. The results are shown in Case Study Table 14-4.1.

Questions

1. What are the abnormal results in this case?
2. Why do you think the triglycerides are abnormal?
3. What is the primary disease exhibited by this patient's laboratory data?

CASE STUDY TABLE 14-4.1
LABORATORY RESULTS

| PATIENT ANALYTE | VALUES | REFERENCE RANGE |
|-------------------------|--------|-----------------|
| Na ⁺⁺ | 149 | 135–143 mEq/L |
| K ⁺⁺ | 4.5 | 3.0–5.0 mEq/L |
| Cl ⁻ | 120 | 98–103 mEq/L |
| CO ₂ content | 12 | 22–27 mmol/L |
| Total protein | 5.7 | 6.5–8.0 g/dL |
| Albumin | 2.3 | 3.5–5.0 g/dL |
| Ca ²⁺ | 7.6 | 9.0–10.5 mg/dL |
| Cholesterol | 201 | 140–200 mg/dL |
| Uric acid | 15.4 | 3.5–7.9 mg/dL |
| Creatinine | 4.5 | 0.5–1.2 mg/dL |
| BUN | 87 | 7–25 mg/dL |
| Glucose | 88 | 75–105 mg/dL |
| Total bilirubin | 1.3 | 0.2–1.0 mg/dL |
| Triglycerides | 327 | 65–157 mg/dL |
| Lactate dehydrogenase | 200 | 90–190 IU/L |
| Aspartate transaminase | 45 | 8–40 IU/L |
| Amylase | 380 | 76–375 IU/L |

with the coagulation factor, plasminogen,¹⁰⁹ it has been proposed that it competes with plasminogen for fibrin binding sites, thus increasing plaque formation.^{110,111} Most LDL-lowering drugs have no effect on Lp(a) concentration, even when LDL cholesterol is significantly lowered. The two drugs shown to have some effect are

niacin and estrogen replacement in postmenopausal women. Until prospective studies confirm Lp(a) atherogenicity, treatment with niacin to treat elevated Lp(a) is not advised except in conjunction with other dyslipidemic conditions in which niacin is also indicated.

Hypolipoproteinemia

Hypolipoproteinemias, or low levels of lipoproteins, exist in two forms: hypoalphalipoproteinemia and hypobetalipoproteinemia. Hypobetalipoproteinemia is associated with isolated low levels of LDL cholesterol but, because it is not generally associated with CHD, it is not discussed further here.

Hypoalphalipoproteinemia

Hypoalphalipoproteinemia indicates an isolated decrease in circulating HDL, currently defined by the NCEP as an HDL cholesterol concentration less than 40 mg/dL (1.0 mmol/L),⁶⁶ without the presence of hypertriglyceridemia. The term alpha denotes the region in which HDL migrate on agarose electrophoresis. There are several defects, often genetically determined, that are associated with hypoalphalipoproteinemia.^{112,113} Virtually all of these defects are associated with increased risk of premature CHD. An extreme form of hypoalphalipoproteinemia, Tangier disease, is associated with HDL cholesterol concentrations as low as 1–2 mg/dL (0.03–0.05 mmol/L) in homozygotes, accompanied by total cholesterol concentrations of 50 to 80 mg/dL (1.3–2.1 mmol/L).

Treatment options of individuals with isolated decreases of HDL cholesterol are limited. Niacin is somewhat effective but can have adverse effects, such as flushing or even hepatotoxicity, that sometimes precludes its use, although newer, timed-release preparations may ameliorate those effects.^{80,88,114} Lifestyle modifications and treatment of any coexisting disorders that increase CHD risk are also important in these patients.

Acute, transitory hypoalphalipoproteinemia can be seen in cases of severe physiologic stress, such as acute infections (primarily viral), other acute illnesses, and surgical procedures. HDL cholesterol, as well as total cholesterol concentrations, can be significantly reduced under these conditions but will return to normal levels as recovery proceeds. For this reason, lipoprotein concentrations drawn during hospitalization or with a known disease state should be reassessed in the healthy, non-hospitalized state before intervention is considered.

LIPID AND LIPOPROTEIN ANALYSES

Lipid Measurement

Lipids and lipoproteins are important indicators of CHD risk, which is a major reason for their measurement in research, as well as in clinical practice. For individual

laboratories or diagnostic manufacturers to establish their own cutpoints, as is commonly done for other analytes, this is impractical with the lipids. Rather, decision cutpoints used to characterize CHD risk have been developed by the NCEP based on consideration of population distributions from large epidemiologic studies, intervention studies that demonstrated the efficacy of treatment regimens and cost-effectiveness.⁶⁶ To improve the reliability of the analytic measurements, standardization programs were implemented for the research laboratories performing the population and intervention studies, which helped to make results comparable among laboratories and over time.¹¹⁵ More recently, standardization programs have been extended to diagnostic manufacturers and routine clinical laboratories to facilitate reliable classification of patients using the national decision cutpoints. Thus, accuracy and standardization of results are especially important with the lipid and lipoprotein analytes.

Cholesterol Measurement

The lipid workup traditionally has begun with measurement of total serum cholesterol. Early analytic methods used strong acids (e.g., sulfuric and acetic) sometimes together with other chemicals (e.g., acetic anhydride or ferric chloride) to produce a measurable color with cholesterol.¹¹⁶ Because the strong acid reactions are relatively nonspecific, partial or full extraction by organic solvents was sometimes used to improve specificity. The current reference method for cholesterol uses hexane extraction after hydrolysis with alcoholic KOH followed by reaction with Liebermann-Burchard color reagent, which comprises sulfuric and acetic acids and acetic anhydride.^{117,118} This multistep manual method is complicated but gives good agreement with the gold standard method developed and applied at the U.S. National Institute for Standards and Technology, the so-called Definitive Method, using isotope dilution mass spectrometry.¹¹⁹

Enzymatic reagents have generally replaced strong acid chemistries in the routine laboratory. Enzymes, selected for specificity to the analyte of interest, provide reasonably accurate quantitation without the necessity for extraction or other pretreatment. Enzymatic reagents are mild compared with the earlier acid reagents and better suited for automated chemistry analyzers. The lipoproteins, HDL and LDL, are generally quantified based on their cholesterol content. Thus, the common lipid panel, including measurements of total, LDL, and HDL cholesterol, together with triglycerides, can be completed routinely using chemistry analyzers.

Although several enzymatic reaction sequences have been described, one sequence (Fig. 14-4) is most common for measuring cholesterol.^{120,121} The enzyme

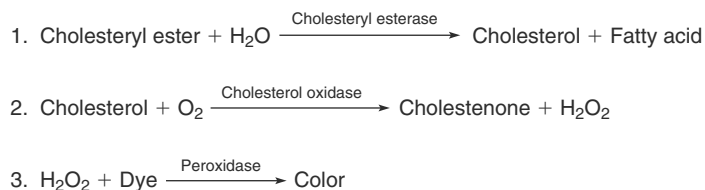

FIGURE 14-4. Enzymic assay sequence—cholesterol.

cholesteryl ester hydrolase cleaves the fatty acid residue from cholesteryl esters, which comprise about two thirds of circulating cholesterol, converting them to unesterified or free cholesterol. The free cholesterol is reacted by the second enzyme, cholesterol oxidase, producing hydrogen peroxide, a substrate for a common enzymatic color reaction using horseradish peroxidase to couple two colorless chemicals into a colored compound. The intensity of the resulting color, proportional to the amount of cholesterol, can be measured by a spectrophotometer, usually at a wavelength around 500 nm. Enzymes and reagents have improved so that most appropriately calibrated commercial reagents can be expected to give reliable results. This reaction sequence is generally used on serum without an extraction step but can be subject to interference. For example, vitamin C and bilirubin are reducing agents that could interfere with the peroxidase-catalyzed color reaction, unless appropriate additional enzyme systems are added to eliminate the interference.¹²²

Triglyceride Measurement

Measurement of serum triglycerides in conjunction with cholesterol is useful in detecting certain genetic and other types of metabolic disorders, as well as in characterizing risk of CVDs. The triglyceride value is also commonly used in the estimation of LDL cholesterol by the Friedewald equation. Several enzymatic reaction sequences are available for triglyceride measurement, all including lipases to cleave fatty acids from the glycerol backbone.¹²³ The freed glycerol participates in any one of several enzymatic sequences. One of the more common earlier reactions, ending in a product measured in the ultraviolet (UV) region, used glycerol kinase and

pyruvate kinase, culminating in the conversion of NADH to NAD⁺ with an associated decrease in absorbence.¹²⁴ This reaction is susceptible to interference and side reactions. The UV endpoint is also less convenient for modern analyzers, so this and other UV reaction sequences have been replaced by a second sequence (Fig. 14-5), involving glycerol kinase and glycerol-phosphate oxidase, coupled to the same peroxidase color reaction described for cholesterol.¹²⁵

The enzymatic triglyceride reaction sequences also react with any endogenous free glycerol, which is universally present in serum and can be a significant source of interference.¹²⁶ In most specimens, the endogenous free glycerol contributes a 10–20 mg/dL overestimation of triglycerides. About 20% of specimens will have higher glycerol, with levels increased in certain conditions, such as diabetes and liver disease or from glycerol-containing medications. Reagents are available that correct for endogenous free glycerol and are used by many research laboratories, but such methods are less efficient, and hence uncommon in clinical laboratories. The most common correction, designated “double-cuvet blank,” is accomplished with a second parallel measurement using the triglyceride reagent without the lipase enzyme to quantify only the free glycerol blank. The glycerol blank measurement is subtracted from the total glycerol measurement obtained with the complete reagent to determine a net or blank-corrected triglyceride result.¹²⁷ Another approach, designated “single-cuvet blank,” begins with the lipase-free reagent. After a brief incubation, a blank reading is taken to measure only endogenous free glycerol. The lipase enzyme is then added as a second separate reagent and, after additional incubation, a final reading is taken that, after correcting for the blank by the instrument, gives a net or glycerol-blanked triglyceride

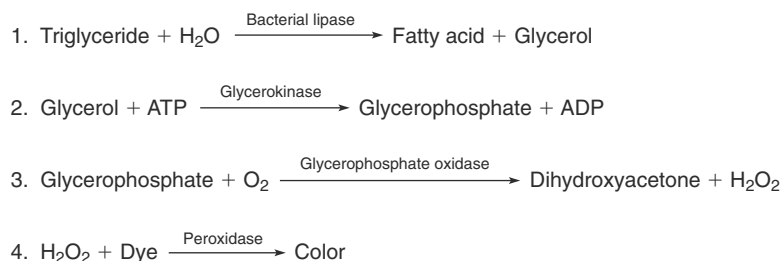

FIGURE 14-5. Enzymic assay sequence—triglycerides.

value.¹²⁸ A convenient and easily implemented alternative that does not increase cost—designated calibration blanking—can be done by simply adjusting the calibrator set points to net or blank corrected values, compensating for the average free glycerol content of specimens. This approach, which is used by some diagnostic reagent companies, is usually reasonably accurate because free glycerol levels are generally relatively low and fairly consistent in most specimens. Most specimens will be blank-corrected reasonably well and only a few specimens will be undercorrected but will still be better than without the calibration adjustment.

The triglyceride reference method involves alkaline hydrolysis, solvent extraction, and a color reaction with chromotropic acid,¹²⁹ an assay that is tedious, poorly characterized, and only applied in the lipid standardization laboratory at the Centers for Disease Control and Prevention (CDC) and a few other standardization laboratories. A simplified Designated Comparison Method coupling solvent extraction with an optimized enzymatic assay has been developed and recently adopted by some standardization laboratories.

However, it must be noted that accuracy in triglyceride measurements for clinical purposes might be considered less relevant than that for cholesterol because the physiologic variation is so large, with the coefficient of variation (CV) in the range of 25% to 30%, making the contribution of analytic variation relatively insignificant.

Lipoprotein Methods

Various methods have been used for the separation and quantitation of serum lipoproteins, taking advantage of physical properties, such as density, size, charge, and apolipoprotein content. The range in density observed among the lipoprotein classes is a function of the relative lipid and protein content and enables fractionation by density, using ultracentrifugation. Electrophoretic separations take advantage of differences in charge and size. Chemical precipitation methods, once common in clinical laboratories and now primarily used in research laboratories, depend on particle size, charge, and differences in the apolipoprotein content. Antibodies specific to apolipoproteins can be used to bind and separate lipoprotein classes. Chromatographic methods take advantage of size differences in molecular sieving methods or composition in affinity methods, using, for example, heparin Sepharose. Most common in clinical laboratories are direct homogeneous reagents designed for fully automated use with chemistry analyzers, using combinations of detergents and, in some cases, antibodies to selectively assay cholesterol in lipoprotein classes.

Many ultracentrifugation methods have been used in the research laboratory, but ultracentrifugation is uncommon in the clinical laboratory. The most common

approach, called preparative ultracentrifugation, uses sequential density adjustments of serum to fractionate major and minor lipoprotein classes.¹³⁰ Density gradient methods, either nonequilibrium techniques in which separations are based on the rate of flotation or equilibrium techniques in which the lipoproteins separate based on their density, permit fractionation of several or all classes in a single run.^{131–133} The available methods use different types of ultracentrifuge rotors: swinging bucket, fixed angle, vertical, and zonal. Newer methods have trended toward smaller scale separations in small rotors, using tabletop ultracentrifuges.^{134,135} Ultracentrifugation, although tedious, expensive, and technically demanding, remains a workhorse for separation of lipoproteins for quantitative purposes and preparative isolations. Ultracentrifugation is also used in the reference methods for lipoprotein quantitation, because lipoproteins are classically defined in terms of hydrated density.

Electrophoretic methods allow separation and quantitation of major lipoprotein classes, as well as subclasses, and provide a visual display useful in detecting unusual or variant patterns.^{136,137} Agarose gel has been the most common medium for separation of intact lipoproteins, providing a clear background and convenience in use.^{138,139} Electrophoretic methods, in general, were considered useful for qualitative analysis but less than desirable for lipoprotein quantitation because of poor precision and large systematic biases, compared with other methods.¹⁴⁰ Using newer commercial automated electrophoretic systems, lipoprotein determinations can be precise and accurate.¹⁴¹

Electrophoresis in polyacrylamide gels is used for separation of lipoprotein classes,¹⁴² subclasses, and the apolipoproteins.¹⁴³ Of particular interest are methods that fractionate LDL subclasses to characterize the more atherogenic smaller, denser, lipid-depleted fractions versus the larger, lighter subclasses.¹⁴⁴

Chemical precipitation, usually with polyanions, such as heparin and dextran sulfate, together with divalent cations, such as manganese or magnesium, can be used to separate any of the lipoproteins but are most common for HDL.^{145,146} Apo B in VLDL and LDL is rich in positively charged amino acids, which preferentially form complexes with polyanions. The addition of divalent cations neutralizes the charged groups on the lipoproteins, making them aggregate and become insoluble, resulting in their precipitation leaving HDL in solution. At appropriate concentrations of polyanion and divalent cation, the separation is reasonably specific.

Immunochemical methods, using antibodies specific to epitopes on the apolipoproteins, have been useful in both research and routine methods.^{147,148} Antibodies have been immobilized on solid supports, such as a column matrix or latex beads. For example, the apo B-containing lipoproteins as a group can be bound by antibodies to apo B.

Selectivity within the apo B–containing lipoproteins, such as removing VLDL while retaining LDL, can be obtained by including antibodies to minor apolipoproteins. HDL can be selectively bound using antibodies to apo A-I, the major protein of HDL. As another example, immobilized monoclonal antibodies have been used to separate a fraction of remnant lipoproteins designated RLP (remnant-like particles), shown to be particularly atherogenic.¹⁴⁹

High-Density Lipoprotein Methods

The measurement of HDL cholesterol has assumed progressively greater importance in the NCEP treatment guidelines. In the earliest guidelines, HDL cholesterol was measured as a risk factor but otherwise was not considered in treatment decisions. Following recommendations of a National Institutes of Health–sponsored consensus panel,⁷⁴ the 1993 NCEP ATP II guidelines included HDL cholesterol measurement with total cholesterol in the first medical workup, which was reinforced by the 2001 ATP III guidelines.⁶⁶ Because the risk associated with HDL cholesterol is expressed over a relatively small concentration range, accuracy in the measurement is especially important.

For routine diagnostic purposes, HDL for many years was separated almost exclusively by chemical precipitation, involving a two-step procedure with manual pretreatment. A precipitation reagent added to serum or plasma aggregated non-HDL lipoproteins, which were sedimented by centrifugation, at forces of approximately 1500g (gravity) with lengthy centrifugation times of 10 to 30 minutes or higher forces of 10,000 to 15,000g, decreasing centrifugation times to 3 minutes. HDL is then quantified as cholesterol in the supernate, usually by one of the enzymatic assays modified for the lower HDL cholesterol range.

The earliest common precipitation method used heparin in combination with manganese to precipitate the apo B–containing lipoproteins.^{150,151} Because manganese interfered with enzymatic assays, alternative reagents were developed.¹⁵² Sodium phosphotungstate¹⁵³ with magnesium became commonly used, but because of its sensitivity to reaction conditions and greater variability, it was largely replaced by dextran sulfate (a synthetic heparin) with magnesium.¹⁵⁴ The earliest dextran sulfate methods used material of 500 kD, which was replaced by a 50-kD material, considered to be more specific.¹⁴⁵ Polyethylene glycol also precipitates lipoproteins, but it requires 100-fold higher reagent concentrations with highly viscous reagents, which are difficult to pipet precisely.¹⁵⁵ Numerous commercial versions of these precipitation reagents became available, which in earlier years often gave quite different results but gradually became more comparable as standardization programs were implemented.

CASE STUDY 14-5

A 49-year-old woman was referred for a lipid evaluation by her dermatologist after she developed a papular rash over her trunk and arms. The rash consisted of multiple, red, raised lesions with yellow centers. She had no previous history of such a rash and no family history of lipid disorders or CHD. She is postmenopausal, on standard estrogen replacement therapy, and otherwise healthy.

Questions

1. What is the rash? What is the cause of her rash?
2. Is her oral estrogen contributing?
3. Is her glucose contributing?
4. What treatments are warranted, and what is her most acute risk?

CASE STUDY TABLE 14-5.1 LABORATORY RESULTS

| SERUM | GROSSLY LIPEMIC |
|---------------------------------------|-----------------|
| Triglycerides | 6,200 mg/dL |
| Total cholesterol | 458 mg/dL |
| Fasting glucose | 160 mg/dL |
| Liver function tests and electrolytes | Normal |

A significant problem with HDL precipitation methods is interference from elevated triglyceride levels.¹⁵⁶ When triglyceride-rich VLDL and chylomicrons are present, the low density of the aggregated lipoproteins may prevent them from sedimenting or may even cause floating during centrifugation. This incomplete sedimentation, indicated by cloudiness, turbidity, or particulate matter floating in the supernate, results in overestimation of HDL cholesterol. High-speed centrifugation reduces the proportion of turbid supernate. Predilution of the specimen promotes clearing but may lead to errors in the cholesterol analysis. Turbid supernates may also be cleared by ultrafiltration, a method that is reliable but tedious and inefficient. Because of these drawbacks and the fact that the laborious pretreatment step is not amenable to full automation, the precipitation methods became increasingly out of step with the modern automated clinical laboratory.

The result has been development of a new class of direct, sometimes termed homogeneous, methods, which automate the HDL quantification, making them better suited for the modern chemistry laboratory. Specific

polymers, detergents, and even modified enzymes are used to suppress the enzymatic cholesterol reaction in lipoproteins other than HDL.¹⁵⁷ In general, a first reagent is added to “block” non-HDL lipoproteins, followed by a second reagent with the enzymes to quantify the accessible (HDL) cholesterol. Homogeneous assays, which appear to be highly precise and reasonably accurate, have generally replaced pretreatment methods in the routine laboratory.¹⁵⁸ However, the methods have been shown to lack specificity for HDL in unusual specimens, for example, from patients with liver or kidney conditions.¹⁵⁹ Also, the reagents have been subject to frequent modifications by the manufacturers in an effort to improve performance, which can affect results in long-term studies. For these reasons, the methods have not been recommended for use in research laboratories.

The accepted reference method for HDL cholesterol is a three-step procedure developed at the CDC. This method involves ultracentrifugation to remove VLDL, heparin manganese precipitation from the 1.006 g/mL infranate to remove LDL, and analysis of supernatant cholesterol by the Abell-Kendall assay.¹¹⁸ Because this method is tedious and expensive, a simpler, direct precipitation method has been validated by the CDC Network Laboratory Group as a designated comparison method, using direct dextran sulfate (50 kD) precipitation of serum with Abell-Kendall cholesterol analysis.¹¹⁵

Low-Density Lipoprotein Methods

LDL cholesterol, well validated as a treatable risk factor for CHD, is the primary basis for treatment decisions in the NCEP clinical guidelines.⁶⁶ The most common research method for LDL cholesterol quantitation and the basis for the reference method has been designated beta-quantification, in which beta designation refers to the electrophoretic term for LDL. Beta-quantification combines ultracentrifugation and chemical precipitation.^{151,160} Ultracentrifugation of serum at the native density of 1.006 g/L is used to float VLDL and any chylomicrons for separation. The fractions are recovered by pipetting after separating the fractions by slicing the tube. Ultracentrifugation has been preferred for VLDL separation because other methods, such as precipitation, are not as specific for VLDL and may be subject to interference from chylomicrons. In general, ultracentrifugation is a robust but tedious technique that can give reliable results provided the technique is meticulous.

In a separate step, chemical precipitation is used to separate HDL from either the whole serum or the infranate obtained from ultracentrifugation. Cholesterol is quantified in serum, in the 1.006 g/mL infranate, and in the HDL supernate by enzymatic or other assay methods. LDL cholesterol is calculated as the difference between cholesterol measured in the infranate and in the HDL

fraction. VLDL cholesterol is usually calculated as the difference between that in whole serum and the amount in the infranate fraction. The requirement for the need of an ultracentrifuge has generally limited beta-quantification to lipid specialty laboratories. Beta-quantification is also the basis for the accepted reference method for LDL. The method is the same as that described for HDL above with the measured HDL cholesterol subtracted from that in the bottom fraction to obtain LDL cholesterol.

A more common approach, bypassing ultracentrifugation and commonly used in routine and sometimes research laboratories, is the **Friedewald calculation**.¹⁰² HDL cholesterol is quantified either after precipitation or using one of the direct methods, and total cholesterol and triglycerides are measured in the serum. VLDL cholesterol is estimated as the triglyceride level divided by 5 (when using mg/dL units), an approximation that works reasonably well in most normolipemic specimens. The presence of elevated triglycerides (400 mg/dL is the accepted limit), chylomicrons, and β -VLDL characteristic of the rare type III hyperlipoproteinemia precludes this estimation. The estimated VLDL cholesterol and measured HDL cholesterol are subtracted from total serum cholesterol to estimate or derive LDL cholesterol. Thus, $\text{LDL cholesterol} = \text{total cholesterol} - \text{HDL} - \text{Trig}/5$. This method, commonly performed as the lipid panel, is widely used in estimating LDL cholesterol in routine clinical practice, having been recommended in the NCEP guidelines. Investigations in lipid specialty laboratories have suggested that the method is reasonably reliable for patient classification, provided the underlying measurements are made with appropriate accuracy and precision.¹⁶¹ There has been concern about the reliability in routine laboratories, however, because the error in calculating LDL cholesterol combines the error in the underlying measurements: total cholesterol, triglycerides, and HDL cholesterol. The NCEP Laboratory Expert Panel, considering performance as represented by proficiency surveys, concluded that the level of analytic performance required to derive LDL cholesterol accurately enough to meet clinical needs was beyond the capability of most routine laboratories. To meet the NCEP precision goal of 4% CV for LDL cholesterol (Table 14-6), a laboratory would be required to achieve half the NCEP goals for each of the underlying measurements. The NCEP panel concluded that better methods are needed for routine diagnostic use, preferably methods that directly separate LDL for cholesterol quantitation.⁶⁴

In response to the NCEP request, direct LDL cholesterol methods have been developed or refined for general use, similar to the homogeneous assays for HDL cholesterol.^{160,162} Besides achieving full automation of the challenging LDL cholesterol separation, these assays have the potential to streamline the measurement while improving precision. However, separating LDL with adequate

specificity from other lipoproteins in this manner is more challenging even than that for HDL, and the few evaluations of the direct methods have not been encouraging.¹⁶³ More experience will be required, especially with specimens of unusual composition, to judge the adequacy of the homogeneous separations.¹⁶⁴

Compact Analyzers

The common lipids and lipoproteins can be measured with compact analysis systems designed for use in point-of-care testing at the patient's bedside, in the physician's office, in wellness centers, and even in the home.¹⁶⁵ The earliest systems, introduced in the 1980s, were relatively large and measured cholesterol and triglycerides as well as other common analytes, usually separately and sequentially. Newer systems have become smaller and more sophisticated, offering integrated separation of HDL and analysis of cholesterol and triglycerides simultaneously from a fingerstick blood. Systems can measure cholesterol, triglycerides, HDL cholesterol, and glucose simultaneously from a fingerstick sample. Noninstrumented systems are also available. These new technologies offer the capability of measuring lipids and lipoproteins with reasonable reliability outside the conventional laboratory.

Apolipoprotein Methods

Lipids by nature tend to be insoluble in the aqueous environment of the circulation; hence, the lipoproteins include various protein constituents, designated apolipoproteins, that enhance solubility, as well as playing other functional roles (Table 14-2). Apolipoproteins are commonly measured in research, and some specialty laboratories supporting cardiovascular practices or clinical studies measure them routinely in addition to the lipoproteins. For clinical diagnostic purposes, three apolipoproteins in particular have been of interest. Apo B, the major protein of LDL and VLDL, is an indicator of combined LDL and VLDL concentration that can be measured directly in serum by immunoassay.¹⁶⁶ Studies suggest that apo B may be a better indicator of atherogenic particles than LDL cholesterol.¹⁶⁷ Apo A-I, as the major protein of HDL, could be measured directly in serum in place of separation and analysis of HDL cholesterol; however, because quantification in terms of cholesterol content is more common, the latter practice has prevailed. Lp(a), the variant of LDL, shown to be an independent indicator of CHD risk, is sometimes determined in managing patients. Measurement of these three apolipoproteins, considered to be emerging markers, can be useful in patient management by experienced practitioners.

Lp(a) has pre- β mobility on agarose electrophoresis and can be quantified by this technique. However, the apolipoproteins are commonly measured by immunoas-

says of various types, with several commercial kit methods available.¹⁶⁶ Most common in routine laboratories are turbidimetric assays for chemistry analyzers or nephelometric assays for dedicated nephelometers. Especially for apo B and Lp(a), these light-scattering assays may be subject to interference from the larger triglyceride-rich lipoproteins (chylomicrons) and VLDL. Enzyme-linked immunosorbent assay (ELISA), radial immunodiffusion (RID), and radioimmunoassay (RIA) methods have also been available, but the latter two methods are becoming less common. Antibodies used in the immunoassays may be polyclonal or monoclonal. International efforts to develop reference materials and standardization programs for the assays are in progress. Because Lp(a) is genetically heterogeneous and the levels and CHD risk correlate with the isoform size, qualitative assessment of isoform distribution may also be useful.¹⁰⁸

Phospholipid Measurement

Quantitative measurements of phospholipids are primarily done for research but not commonly as part of routine laboratory assessments of lipids and lipoproteins. The choline-containing phospholipids lecithin, lysolecithin, and sphingomyelin, which account for at least 95% of total phospholipids in serum, can be measured by an enzymic reaction sequence using phospholipase D, choline oxidase, and horseradish peroxidase.¹⁶⁸

Fatty Acid Measurement

Although studies suggest that fatty acids have potential in assessing CHD risk (e.g., the n-3 fatty acids), analysis is primarily used in research laboratories for studies of diet. Less common is their measurement in the diagnosis of rare genetic conditions. Fatty acids are commonly analyzed by gas-liquid chromatography—after extraction, alkaline hydrolysis, and conversion to methyl esters of diazomethane. A reference standard typically contains laurate, myristate, palmitate, palmitoleate, phytanate, stearate, oleate, linoleate, arachidate, and arachidonate.¹⁶⁹

STANDARDIZATION OF LIPID AND LIPOPROTEIN ASSAYS

Precision

Precision is a prerequisite for accuracy; a method may have no overall systematic error or bias, but if it is imprecise, it will still be inaccurate on some individual measurements. With the shift to modern automated analyzers, analytic variation has generally become less of a concern than biologic and other sources of preanalytic variation. Cholesterol levels are affected by many factors that can be categorized into biologic, clinical, and sampling sources.¹⁷⁰ Changes in lifestyle that affect diet, exercise,

CASE STUDY 14-6

Three patients are seen in clinic:

- Patient 1 is a 40-year-old man with hypertension, who also smokes, but has not been previously diagnosed with CHD. His father developed CHD at age 53 years. He is fasting, and the results of his lipids include a total cholesterol concentration of 210 mg/dL, triglycerides of 150 mg/dL, and an HDL cholesterol value of 45 mg/dL. He has a fasting glucose level of 98 mg/dL.
- Patient 2 is a 60-year-old woman with no family history of CHD, who is normotensive and does not smoke, with a total cholesterol concentration of 220 mg/dL, triglycerides of 85 mg/dL, and an HDL cholesterol value of 80 mg/dL. Her fasting glucose level is 85 mg/dL.
- Patient 3 is a 49-year-old man with no personal or family history of CHD, and who is not hypertensive and does not smoke. His fasting total cholesterol level is 260 mg/dL, his triglycerides are 505 mg/dL, his HDL cholesterol is 25 mg/dL, and his glucose level is 134 mg/dL.

Questions

For each patient seen in clinic:

1. What is the LDL cholesterol level, as calculated using the Friedewald calculation?
2. Which patient, if any, should have his or her LDL cholesterol measured, rather than calculated? Why?
3. How many known CHD risk factors does each patient have?
4. Based on what is known, are these patients recommended for lipid therapy (diet or drug) and, if so, on what basis?

weight, and smoking patterns can result in fluctuations in the observed cholesterol and triglyceride values and the distribution of the lipoproteins. Similarly, the presence of clinical conditions, various diseases, or the medications used in their treatment can affect the circulating lipoproteins. Conditions present during blood collection, such as fasting status, posture, the choice of anticoagulant in the collection tube, and storage conditions, can alter the measurements. Typical observed biologic variation for more than 1 year for total cholesterol averages approximately 6.1% CV. In the average patient, measurements made over the course of a year would fall 66% of the time within $\pm 6.1\%$ of the mean cholesterol concentration and

95% of the time within twice this range. Some patients may exhibit substantially more biologic variation. Thus, preanalytic variation generally is relatively large in relation to the usual analytic variation, which is typically less than 3% CV, and must be considered in interpreting cholesterol results. Some factors, such as posture and blood collection, can be standardized to minimize the variation. The NCEP guidelines recommend averaging at least two successive measurements to reduce the effects of both preanalytic and analytic sources.⁶⁶ The use of stepped cutpoints also reduces the practical effect of variation.

Accuracy

Accuracy or trueness is ensured by demonstrating traceability or agreement through calibration to the respective “gold standard” reference system. With cholesterol, the reference system is advanced and complete, having served as a model for standardization of other laboratory analytes.^{115,120} The definitive method at the National Institute of Standards and Technology provides the ultimate accuracy target but is too expensive and complicated for frequent use.¹¹⁹ The reference method developed and applied at the CDC, and calibrated by an approved primary reference standard to the definitive method, provides a transferable, practical reference link.¹¹⁸ The reference method has been made conveniently accessible through a network of standardized laboratories, the Cholesterol Reference Method Laboratory Network. This network was established in the United States and other countries to extend standardization to manufacturers and clinical laboratories.¹¹⁵ The network provides accuracy comparisons leading to certification of performance using fresh native serum specimens, necessary for reliable accuracy transfer because of analyte–matrix interaction problems on processed reference materials.^{171,172}

Matrix Interactions

In the early stages of cholesterol standardization, which were directed toward diagnostic manufacturers and routine laboratories, commercial lyophilized or freeze-dried materials were used. These materials, made in large quantities, often with spiking or artificial addition of analytes, were assayed by the definitive and/or reference methods and distributed widely for accuracy transfer. Subsequently, biases were observed with some systems on fresh patient specimens even though they appeared to be accurate on the reference materials. Although such manufactured reference materials are convenient, stable, and amenable to shipment at ambient temperatures, the manufacturing process, especially spiking and lyophilization, altered the measurement properties in enzymatic assays such that results were not representative of those on patient specimens. To achieve reliable feedback on

accuracy and facilitate transfer of the accuracy base, direct comparisons with the reference methods on actual patient specimens were determined to be necessary.¹¹⁵

CDC Cholesterol Reference Method Laboratory Network

In response, the CDC cholesterol reference method laboratory network program was organized. (Information is available at: <http://www.cdc.gov/labstandards/crmln.htm>.) The network offers formal certification programs for total, HDL, and LDL cholesterol and triglycerides whereby laboratories and manufacturers can document traceability to the national reference systems.¹¹⁵ Through this program, clinical laboratories are able to identify certified commercial methods. Certification does not ensure all aspects of quality in a reagent system but primarily ensures that the accuracy is traceable to reference methods within accepted limits and that precision can meet the NCEP targets. The certification process is somewhat tedious and, thus, most efficient through manufacturers, but individual laboratories desiring to confirm the performance of their systems can complete a scaled-down certification protocol for cholesterol.

Analytic Performance Goals

The NCEP laboratory panels have established analytic performance goals based on clinical needs for routine measurements^{63–65,120} (Table 14-6). For analysis of total cholesterol, the performance goal for total error is 8.9%. That is, the overall error should be such that each individual cholesterol measurement falls within $\pm 8.9\%$ of the reference method value. Actually, because the goals are based on 95% certainty, 95 of 100 measurements should fall within the total error limit. One can assay a specimen many times and calculate the mean to determine the usual value or the central tendency. The scatter or random variation around the mean is described by the standard deviation, an interval around the mean that includes, by definition, two thirds of the observations. In the laboratory, because the scatter or imprecision is often proportional to the concentration, random variation is usually specified in relative terms as CV—the coefficient of variation or relative standard deviation, calculated as the standard deviation divided by the mean. Overall accuracy or systematic

error is described as bias or trueness, the difference between the mean and the true value. Bias is primarily a function of the method's calibration and may vary by concentration. Of greatest concern in this context is bias at the NCEP decision cutpoints. The bias and CV targets presented in Table 14-6 are representative of performance that will meet the NCEP goals for total error.

Quality Control

Achieving acceptable analytic performance requires the use of reliable quality control materials, which should preferably closely emulate actual patient specimens. Commercial control materials have improved in recent years but may not approximate results with patients' specimens. Control materials can also be prepared in-house from freshly collected patient serum, aliquoted into securely sealed vials, quick frozen, and stored at -70°C . Such pools of fresh frozen serum are less subject to matrix interactions than the usual commercial materials, which is most important in monitoring accuracy in lipoprotein separation and analysis and preferable for monitoring cholesterol and other lipid measurements. At least two pools should be analyzed, preferably with levels at or near decision points for each analyte.

Specimen Collection

Serum, usually collected in serum separator vacuum tubes with clotting enhancers, has been the fluid of choice for lipoprotein measurement in the routine clinical laboratory. Ethylenediaminetetraacetic acid (EDTA) plasma was the traditional choice in lipid research laboratories, especially for lipoprotein separations, because the anticoagulant was thought to enhance stability by chelating metal ions. EDTA, however, has potential disadvantages that discourage routine use. Microclots, which can form in plasma during storage, could plug the sampling probes on the modern chemistry analyzers. EDTA also osmotically draws water from red cells, diluting the plasma constituents, and the dilution effect can vary depending on such factors as fill volume, the analyte being measured, and the extent of mixing. Because the NCEP cutpoints are based on serum values, cholesterol measurements made on EDTA plasma require correction by the factor of 1.03.

REFERENCES

1. Laposata M. Fatty acids. Biochemistry to clinical significance. *Am J Clin Pathol* 1995;104:172–179.
2. Kritchevsky D. Effects of triglyceride structure on lipid metabolism. *Nutr Rev* 1988;46:177–181.
3. Ridgway ND, Byers DM, Cook HW, et al. Integration of phospholipid and sterol metabolism in mammalian cells. *Prog Lipid Res* 1999;38:337–360.
4. Barenholz Y. Cholesterol and other membrane active sterols: from membrane evolution to “rafts.” *Prog Lipid Res* 2002;41:1–5.

5. Pauciuolo P. Lipoprotein transport and metabolism: a brief update. *Nutr Metab Cardiovasc Dis* 2002;12:90–97.
6. Gursky O. Apolipoprotein structure and dynamics. *Curr Opin Lipidol* 2005;16:287–294.
7. Hevonoja T, Pentikainen MO, Hyvonen MT, et al. Structure of low density lipoprotein (LDL) particles: basis for understanding molecular changes in modified LDL. *Biochim Biophys Acta* 2000;1488:189–210.
8. Anantharamaiah GM, Brouillette CG, Engler JA, et al. Role of amphipathic helices in HDL structure/function. *Adv Exp Med Biol* 1991;285:131–140.
9. Segrest JP, Li L, Anantharamaiah GM, et al. Structure and function of apolipoprotein A-I and high-density lipoprotein. *Curr Opin Lipidol* 2000;11:105–115.
10. Burnett JR, Barrett PH. Apolipoprotein B metabolism: tracer kinetics, models, and metabolic studies. *Crit Rev Clin Lab Sci* 2002;39:89–137.
11. Javitt NB. Cholesterol homeostasis: role of the LDL receptor. *FASEB J* 1995;9:1378–1381.
12. Kostner KM, Kostner GM. Lipoprotein(a): still an enigma? *Curr Opin Lipidol* 2002;13:391–396.
13. Cooper AD. Hepatic uptake of chylomicron remnants. *J Lipid Res* 1997;38:2173–2192.
14. Mahley RW, Rall SC Jr. Apolipoprotein E: far more than a lipid transport protein. *Annu Rev Genomics Hum Genet* 2000;1:507–537.
15. Walden CC, Hegele RA. Apolipoprotein E in hyperlipidemia. *Ann Intern Med* 1994;120:1026–1036.
16. Lane RM, Farlow MR. Lipid homeostasis and apolipoprotein E in the development and progression of Alzheimer's disease. *J Lipid Res* 2005;46:949–968.
17. Corder EH, Lannfelt L, Bogdanovic N, et al. The role of APOE polymorphisms in late-onset dementias. *Cell Mol Life Sci* 1998;54:928–934.
18. Gruffat D, Durand D, Graulet B, et al. Regulation of VLDL synthesis and secretion in the liver. *Reprod Nutr Dev* 1996;36:375–389.
19. Griffin BA, Packard CJ. Metabolism of VLDL and LDL subclasses. *Curr Opin Lipidol* 1994;5:200–206.
20. Ginsberg HN. Lipoprotein metabolism and its relationship to atherosclerosis. *Med Clin North Am* 1994;78:1–20.
21. Kruth HS. Sequestration of aggregated low-density lipoproteins by macrophages. *Curr Opin Lipidol* 2002;13:483–488.
22. Plenz G, Robenek H. Monocytes/macrophages in atherosclerosis. *Eur Cytokine Netw* 1998;9:701–703.
23. Warnick GR, McNamara JR, Boggess CN, et al. Polyacrylamide gradient gel electrophoresis of lipoprotein subclasses. *Clin Lab Med* 2006;26:803–846.
24. Kulkarni KR. Cholesterol profile measurement by vertical auto profile method. *Clin Lab Med* 2006;26:787–802.
25. McNamara JR, Small DM, Li Z, et al. Differences in LDL sub-species involve alterations in lipid composition and conformational changes in apolipoprotein B. *J Lipid Res* 1996;37:1924–1935.
26. Carmena R, Duriez P, Fruchart JC. Atherogenic lipoprotein particles in atherosclerosis. *Circulation* 2004;109(Suppl III):III2–III7.
27. Erbagci AB, Tarakcioglu M, Aksoy M, et al. Diagnostic value of CRP and Lp(a) in coronary heart disease. *Acta Cardiol* 2002;57:197–204.
28. Lund-Katz S, Liu L, Thuahnai ST, et al. High density lipoprotein structure. *Front Biosci* 2003;8:d1044–d1054.
29. Segrest JP, Li L, Anantharamaiah GM, et al. Structure and function of apolipoprotein A-I and high-density lipoprotein. *Curr Opin Lipidol* 2000;11:105–115.
30. Morgan J, Carey C, Lincoff A, et al. High-density lipoprotein sub-fractions and risk of coronary artery disease. *Curr Atheroscler Rep* 2004;6:359–365.
31. Patsch JR, Prasad S, Gotto AM Jr, et al. Postprandial lipemia. A key for the conversion of high density lipoprotein2 into high density lipoprotein3 by hepatic lipase. *J Clin Invest* 1984;74:2017–2023.
32. Lusis AJ, Mar R, Pajukanta P. Genetics of atherosclerosis. *Annu Rev Genom Hum Genet* 2004;5:189–218.
33. Seo DM, Goldschmidt-Clermont PJ. Unraveling the genetics of atherosclerosis: implications for diagnosis and treatment. *Exp Rev Mol Diagn* 2007;7:45–51.
34. Fruchart JC, Nierman MC, Stroes ES, et al. New risk factors for atherosclerosis and patient risk assessment. *Circulation* 2004;109(Suppl III):III15–III19.
35. Levy E, Spahis S, Sinnett D, et al. Intestinal cholesterol transport proteins: an update and beyond. *Curr Opin Lipidol* 2007;18:310–318.
36. Davis HR, Veltri EP. Zetia: inhibition of Niemann-Pick C1 Like 1 (NPC1L1) to reduce intestinal cholesterol absorption and treat hyperlipidemia. *J Atheroscler Thromb* 2007;14:99–108.
37. Huff MW, Pollex RL, Hegele RA. NPC1L1: evolution from pharmacological target to physiological sterol transporter. *Arterioscler Thromb Vasc Biol* 2006;26:2433–2438.
38. Lee MH, Lu K, Patel SB. Genetic basis of sitosterolemia. *Curr Opin Lipidol* 2001;12:141–149.
39. van Greevenbroek MM, de Bruin TW. Chylomicron synthesis by intestinal cells in vitro and in vivo. *Atherosclerosis* 1998;141(Suppl 1):S9–S16.
40. Zannis VI, Chroni A, Kypreos KE, et al. Probing the pathways of chylomicron and HDL metabolism using adenovirus-mediated gene transfer. *Curr Opin Lipidol* 2004;15:151–166.
41. Mead JR, Irvine SA, Ramji DP. Lipoprotein lipase: structure, function, regulation, and role in disease. *J Mol Med* 2002;80:753–769.
42. Parhofer KG, Barrett PH. Thematic review series: patient-oriented research. What we have learned about VLDL and LDL metabolism from human kinetics studies. *J Lipid Res* 2006;47:1620–1630.
43. Akopian D, Medh JD. Genetics and molecular biology: macrophage ACAT depletion—mechanisms of atherogenesis. *Curr Opin Lipidol* 2006;17:85–88.
44. Osborne TF. Cholesterol homeostasis: clipping out a slippery regulator. *Curr Biol* 1997;7:R172–R174.
45. Hobbs HH, Brown MS, Goldstein JL. Molecular genetics of the LDL receptor gene in familial hypercholesterolemia. *Hum Mutat* 1992;1:445–466.
46. Lewis GF, Rader DJ. New insights into the regulation of HDL metabolism and reverse cholesterol transport. *Circ Res* 2005;96:1221–1232.
47. Toth PP. Reverse cholesterol transport: high-density lipoprotein's magnificent mile. *Curr Atheroscler Rep* 2003;5:386–393.
48. Rothblat GH, de la Llera-Moya M, Atger V, et al. Cell cholesterol efflux: integration of old and new observations provides new insights. *J Lipid Res* 1999;40:781–796.
49. Zannis VI, Chroni A, Krieger M. Role of apoA-I, ABCA1, LCAT, and SR-BI in the biogenesis of HDL. *J Mol Med* 2006;84:276–294.
50. Yamashita S, Hirano K, Sakai N, et al. Molecular biology and pathophysiological aspects of plasma cholesteryl ester transfer protein. *Biochim Biophys Acta* 2000;1529:257–275.
51. Cavelier C, Lorenzi I, Rohrer L, et al. Lipid efflux by the ATP-binding cassette transporters ABCA1 and ABCG1. *Biochim Biophys Acta* 2006;1761:655–666.
52. Dean M, Hamon Y, Chimini G. The human ATP-binding cassette (ABC) transporter superfamily. *J Lipid Res* 2001;42:1007–1017.
53. Nofer JR, Remaley AT. Tangier disease: still more questions than answers. *Cell Mol Life Sci* 2005;62:2150–2160.
54. Vedhachalam C, Duong PT, Nickel M, et al. Mechanism of ATP-binding cassette transporter A1-mediated cellular lipid efflux to apolipoprotein A-I and formation of high density lipoprotein particles. *J Biol Chem* 2007;282:25123–25130.

55. Wang N, Lan D, Chen W, et al. ATP-binding cassette transporters G1 and G4 mediate cellular cholesterol efflux to high-density lipoproteins. *Proc Natl Acad Sci U S A* 2004;101:9774–9779.
56. Schaefer EJ, Lichtenstein AH, Lamon-Fava S, et al. Lipoproteins, nutrition, aging, and atherosclerosis. *Am J Clin Nutr* 1995;61:726S–740S.
57. Hall G, Collins A, Csemiczky G, et al. Lipoproteins and BMI: a comparison between women during transition to menopause and regularly menstruating healthy women. *Maturitas* 2002;41:177–185.
58. National Cholesterol Education Program (NCEP): highlights of the report of the Expert Panel on Blood Cholesterol Levels in Children and Adolescents. *Pediatrics* 1992;89:495–501.
59. Castelli WP, Garrison RJ, Wilson PW, et al. Incidence of coronary heart disease and lipoprotein cholesterol levels. The Framingham Study. *JAMA* 1986;256:2835–2838.
60. Stamler J, Stamler R, Shekelle RB. Regional differences in prevalence, incidence, and mortality from atherosclerotic coronary heart disease. In: deHaas JH, Hemker HC, Snellen HA, editors. *Ischemic heart disease*. Leiden, the Netherlands: Leiden University Press, 1970.
61. Thom TJ, Epstein FH, Feldman JJ. Total mortality and mortality from heart disease, cancer, stroke from 1950–1987 in 27 countries. 1992. Washington, DC.
62. Kato H, Tillotson J, Nichaman MZ, et al. Epidemiologic studies of coronary heart disease and stroke in Japanese men living in Japan, Hawaii and California. *Am J Epidemiol* 1973;97:372–385.
63. Warnick GR, Wood PD. National Cholesterol Education Program recommendations for measurement of high-density lipoprotein cholesterol: executive summary. The National Cholesterol Education Program Working Group on Lipoprotein Measurement. *Clin Chem* 1995;41:1427–1433.
64. Bachorik PS, Ross JW. National Cholesterol Education Program recommendations for measurement of low-density lipoprotein cholesterol: executive summary. The National Cholesterol Education Program Working Group on Lipoprotein Measurement. *Clin Chem* 1995;41:1414–1420.
65. Stein EA, Myers GL. National Cholesterol Education Program recommendations for triglyceride measurement: executive summary. The National Cholesterol Education Program Working Group on Lipoprotein Measurement. *Clin Chem* 1995;41:1421–1426.
66. Third Report of the National Cholesterol Education Program (NCEP) Expert Panel on Detection, Evaluation, and Treatment of High Blood Cholesterol in Adults (Adult Treatment Panel III): final report. *Circulation* 2002;106:3143–3421.
67. Rea TD, Heckbert SR, Kaplan RC, et al. Smoking status and risk for recurrent coronary events after myocardial infarction. *Ann Intern Med* 2002;137:494–500.
68. Niebauer J, Hambrecht R, Velich T, et al. Attenuated progression of coronary artery disease after 6 years of multifactorial risk intervention: role of physical exercise. *Circulation* 1997;96:2534–2541.
69. Coleman MP, Key TJ, Wang DY, et al. A prospective study of obesity, lipids, apolipoproteins and ischaemic heart disease in women. *Atherosclerosis* 1992;92:177–185.
70. Genest JJ Jr, Martin-Munley SS, McNamara JR, et al. Familial lipoprotein disorders in patients with premature coronary artery disease. *Circulation* 1992;85:2025–2033.
71. Stary HC. Macrophages, macrophage foam cells, and eccentric intimal thickening in the coronary arteries of young children. *Atherosclerosis* 1987;64:91–108.
72. Keaney JF Jr. Atherosclerosis: from lesion formation to plaque activation and endothelial dysfunction. *Mol Aspects Med* 2000;21:99–166.
73. Randomised trial of cholesterol lowering in 4444 patients with coronary heart disease: the Scandinavian Simvastatin Survival Study (4S). *Lancet* 1994;344:1383–1389.
74. National Institutes of Health Consensus Conference. Triglyceride, HDL cholesterol and coronary heart disease. *JAMA* 1993;269:505.
75. Shepherd J, Cobbe SM, Ford I, et al. Prevention of coronary heart disease with pravastatin in men with hypercholesterolemia 1995. *Atheroscler Suppl* 2004;5:91–97.
76. Lipid Research Clinics program: the Lipid Research Clinics Coronary Primary Prevention Trial. I. Reduction in incidence of coronary heart disease. *JAMA* 1984;251:351.
77. Matthan NR, Giovanni A, Schaefer EJ. Impact of simvastatin niacin with and without antioxidants on plasma cholesterol absorption and synthesis markers in coronary artery disease patients with low HDL. *J Lipid Res* 2003;44:800.
78. Yamagishi M, Terashima M, Awano K, et al. Morphology of vulnerable coronary plaque: insights from follow-up of patients examined by intravascular ultrasound before an acute coronary syndrome. *J Am Coll Cardiol* 2000;35:106–111.
79. Genest JJ Jr, Ordovas JM, McNamara JR, et al. DNA polymorphisms of the apolipoprotein B gene in patients with premature coronary artery disease. *Atherosclerosis* 1990;82:7–17.
80. Schaefer EJ, McNamara JR. Overview of the diagnosis and treatment of lipid disorders. In: Rifai N, Warnick GR, editors. *Handbook of lipoprotein testing*. Washington, DC: AACC Press, 1997.
81. Clee SM, Zwinderman AH, Engert JC, et al. Common genetic variation in ABCA1 is associated with altered lipoprotein levels and a modified risk for coronary artery disease. *Circulation* 2001;103:1198–1205.
82. Russo GT, Meigs JB, Cupples LA, et al. Association of the Sst-I polymorphism at the APOC3 gene locus with variations in lipid levels, lipoprotein subclass profiles and coronary heart disease risk: the Framingham Offspring Study. *Atherosclerosis* 2001;158:173–181.
83. Guyton JR. Niacin in cardiovascular prevention: mechanisms, efficacy, and safety. *Curr Opin Lipidol* 2007;18:415–420.
84. Rubins HB, Robins SJ, Collins D, et al. Gemfibrozil for the secondary prevention of coronary heart disease in men with low levels of high-density lipoprotein cholesterol. Veterans Affairs High-Density Lipoprotein Cholesterol Intervention Trial Study Group. *N Engl J Med* 1999;341:410–418.
85. Nissen SE, Tardif JC, Nicholls SJ, et al. Effect of torcetrapib on the progression of coronary atherosclerosis. *N Engl J Med* 2007;356:1304–1316.
86. Sethi AA, Amar M, Shamburek RD, et al. Apolipoprotein AI mimetic peptides: possible new agents for the treatment of atherosclerosis. *Curr Opin Investig Drugs* 2007;8:201–212.
87. Shepherd J, Cobbe SM, Ford I, et al. Prevention of coronary heart disease with pravastatin in men with hypercholesterolemia. West of Scotland Coronary Prevention Study Group. *N Engl J Med* 1995;333:1301–1307.
88. Batiste MC, Schaefer EJ. Diagnosis and management of lipoprotein abnormalities. *Nutr Clin Care* 2002;5:115–123.
89. Levy E, Spahis S, Sinnett D, et al. Intestinal cholesterol transport proteins: an update and beyond. *Curr Opin Lipidol* 2007;18:310–318.
90. Marais AD, Firth JC, Blom DJ. Homozygous familial hypercholesterolemia and its management. *Semin Vasc Med* 2004;4:43–50.
91. Palcoux JB, Meyer M, Jouanel P, et al. Comparison of different treatment regimens in a case of homozygous familial hypercholesterolemia. *Thromb Apher* 2002;6:136–139.
92. Kovar J, Havel RJ. Sources and properties of triglyceride-rich lipoproteins containing apoB-48 and apoB-100 in postprandial blood plasma of patients with primary combined hyperlipidemia. *J Lipid Res* 2002;43:1026–1034.
93. Couillard C, Bergeron N, Pascot A, et al. Evidence for impaired lipolysis in abdominally obese men: postprandial study of

- apolipoprotein B-48- and B-100-containing lipoproteins. *Am J Clin Nutr* 2002;76:311–318.
94. Genest J Jr, Cohn J. Plasma triglyceride-rich lipoprotein and high density lipoproteins disorders associated with atherosclerosis. *J Invest Med* 1998;46:351–358.
95. Reynisdottir S, Eriksson M, Angelin B, et al. Impaired activation of adipocyte lipolysis in familial combined hyperlipidemia. *J Clin Invest* 1995;95:2161–2169.
96. Yadav D, Pitchumoni CS. Issues in hyperlipidemic pancreatitis. *J Clin Gastroenterol* 2003;36:54–62.
97. Jackson RL, McLean LR, Demel RA. Mechanism of action of lipoprotein lipase and hepatic triglyceride lipase. *Am Heart J* 1987;113:551–554.
98. Pschierer V, Richter WO, Schwandt P. Primary chylomicronemia in patients with severe familial hypertriglyceridemia responds to long-term treatment with (n-3) fatty acids. *J Nutr* 1995;125:1490–1494.
99. Santamarina-Fojo S. The familial chylomicronemia syndrome. *Endocrinol Metab Clin North Am* 1998;27:551–567, viii.
100. McNamara JR, Shah PK, Nakajima K, et al. Remnant-like particle (RLP) cholesterol is an independent cardiovascular disease risk factor in women: results from the Framingham Heart Study. *Atherosclerosis* 2001;154:229–236.
101. Fredrickson DS, Levy RI, Lees RS. Fat transport in lipoproteins—an integrated approach to mechanisms and disorders. *N Engl J Med* 1967;276:273–281.
102. Friedewald WT, Levy RI, Fredrickson DS. Estimation of the concentration of low-density lipoprotein cholesterol in plasma, without use of the preparative ultracentrifuge. *Clin Chem* 1972;18:499–502.
103. Jialal I, Hirany SV, Devaraj S, et al. Comparison of an immunoprecipitation method for direct measurement of LDL-cholesterol with beta-quantification (ultracentrifugation). *Am J Clin Pathol* 1995;104:76–81.
104. Schaefer EJ, Lamon-Fava S, Jenner JL, et al. Lipoprotein(a) levels and risk of coronary heart disease in men. The lipid Research Clinics Coronary Primary Prevention Trial. *JAMA* 1994;271:999–1003.
105. Hopkins PN, Hunt SC, Schreiner PJ, et al. Lipoprotein(a) interactions with lipid and non-lipid risk factors in patients with early onset coronary artery disease: results from the NHLBI Family Heart Study. *Atherosclerosis* 1998;141:333–345.
106. Kamstrup PR, Benn M, Tybjaerg-Hansen A, et al. Extreme lipoprotein(a) levels and risk of myocardial infarction in the general population. The Copenhagen City Heart Study. *Circulation* 2008;117:176–184.
107. Ridker PM, Hennekens CH, Stampfer MJ. A prospective study of lipoprotein(a) and the risk of myocardial infarction. *JAMA* 1993;270:2195–2199.
108. Marcovina SM, Koschinsky ML. Lipoprotein (a): structure, measurement, and clinical significance. In: Rifai N, Warnick GR, Dominczak MH, editors. *Handbook of lipoprotein testing*. 2nd ed. Washington, DC: AACC Press, 2000.
109. McLean JW, Tomlinson JE, Kuang WJ, et al. cDNA sequence of human apolipoprotein(a) is homologous to plasminogen. *Nature* 1987;330:132–137.
110. Miles LA, Fless GM, Levin EG, et al. A potential basis for the thrombotic risks associated with lipoprotein(a). *Nature* 1989;339:301–303.
111. Hajjar KA, Gavish D, Breslow JL, et al. Lipoprotein(a) modulation of endothelial cell surface fibrinolysis and its potential role in atherosclerosis. *Nature* 1989;339:303–305.
112. Mott S, Yu L, Marcil M, et al. Decreased cellular cholesterol efflux is a common cause of familial hypoalphalipoproteinemia: role of the ABCA1 gene mutations. *Atherosclerosis* 2000;152:457–468.
113. Baldassarre D, Amato M, Pustina L, et al. Increased carotid artery intima-media thickness in subjects with primary hypoalphalipoproteinemia. *Arterioscler Thromb Vasc Biol* 2002;22:317–322.
114. McCormack PL, Keating GM. Prolonged-release nicotinic acid: a review of its use in the treatment of dyslipidaemia. *Drugs* 2005;65:2719–2740.
115. Myers GL, Cooper GR, Greenberg N, et al. Standardization of lipid and lipoprotein measurements. In: Rifai N, Warnick GR, Dominczak MH, editors. *Handbook of lipoprotein testing*. 2nd ed. Washington, DC: AACC Press, 2000.
116. Zak B. Cholesterol methodologies: a review. *Clin Chem* 1977;23:1201–1214.
117. Abell LL, Levy BB, Brody BB, et al. A simplified method for the estimation of total cholesterol in serum and demonstration of its specificity. *J Biol Chem* 1952;195:357.
118. Duncan IW, Mather A, Cooper GR. The procedure for the proposed cholesterol reference method. Atlanta, Ga.: Division of Environmental Health Laboratory Sciences, Center for Environmental Health, Centers for Disease Control and Prevention, 1985.
119. Cohen A, Hertz HS, Mandel J, et al. Total serum cholesterol by isotope dilution/mass spectrometry: a candidate definitive method. *Clin Chem* 1980;26:854–860.
120. Report from the Laboratory Standardization Panel of the National Cholesterol Education Program. Recommendations for improving cholesterol measurement. Bethesda, MD: National Institutes of Health, 1990. (No. 902964.)
121. Allain CC, Poon LS, Chan CS, et al. Enzymatic determination of total serum cholesterol. *Clin Chem* 1974;20:470–475.
122. McGowan MW, Artiss JD, Zak B. Spectrophotometric study on minimizing bilirubin interference in an enzyme reagent mediated cholesterol reaction. *Microchem J* 1983;27:564.
123. Klotzsch SG, McNamara JR. Triglyceride measurements: a review of methods and interferences. *Clin Chem* 1990;36:1605–1613.
124. Bucolo G, Yabut J, Chang TY. Mechanized enzymatic determination of triglycerides in serum. *Clin Chem* 1975;21:420–424.
125. McGowan MW, Artiss JD, Strandbergh DR, et al. A peroxidase-coupled method for the colorimetric determination of serum triglycerides. *Clin Chem* 1983;29:538–542.
126. Stinshoff K, Weisshaar D, Staehler F, et al. Relation between concentrations of free glycerol and triglycerides in human sera. *Clin Chem* 1977;23:1029–1032.
127. Warnick GR. Enzymatic methods for quantification of lipoprotein lipids. *Methods Enzymol* 1986;129:101–123.
128. Sullivan DR, Kruijswijk Z, West CE, et al. Determination of serum triglycerides by an accurate enzymatic method not affected by free glycerol. *Clin Chem* 1985;31:1227–1228.
129. Lofland HB Jr. A semiautomated procedure for the determination of triglycerides in serum. *Anal Biochem* 1964;9:393–400.
130. Havel RJ, Eder HA, Bragdon JH. The distribution and chemical composition of ultracentrifugally separated lipoproteins in human serum. *J Clin Invest* 1955;34:1345–1353.
131. Chapman MJ, Goldstein S, Lagrange D, et al. A density gradient ultracentrifugal procedure for the isolation of the major lipoprotein classes from human serum. *J Lipid Res* 1981;22:339–358.
132. Patsch JR, Patsch W. Zonal ultracentrifugation. *Methods Enzymol* 1986;129:3–26.
133. Kulkarni KR. Cholesterol profile measurement by vertical auto profile method. *Clin Lab Med* 2006;26:787–802.
134. Brousseau T, Clavey V, Bard JM, et al. Sequential ultracentrifugation micromethod for separation of serum lipoproteins and assays of lipids, apolipoproteins, and lipoprotein particles. *Clin Chem* 1993;39:960–964.

135. Wu LL, Warnick GR, Wu JT, et al. A rapid micro-scale procedure for determination of the total lipid profile. *Clin Chem* 1989;35:1486–1491.
136. Lewis LA, Oppl J. *CRC handbook of electrophoresis*. Boca Raton, FL: CRC Press, 1980.
137. Schmitz G, Boettcher A, Barlage S. New approaches to the use of lipoprotein electrophoresis in the clinical laboratory. In: Rifai N, Warnick GR, Dominczak MH, editors. *Handbook of lipoprotein testing*. 2nd ed. Washington, DC: AACC Press, 2000.
138. Warnick GR, Nguyen T, Bergelin RO, et al. Lipoprotein quantification: an electrophoretic method compared with the Lipid Research Clinics method. *Clin Chem* 1982;28:2116–2120.
139. Greenspan P, Mao FW, Ryu BH, et al. Advances in agarose gel electrophoresis of serum lipoproteins. *J Chromatogr A* 1995;698:333–339.
140. Rifai N, Warnick GR, McNamara JR, et al. Measurement of low-density-lipoprotein cholesterol in serum: a status report. *Clin Chem* 1992;38:150–160.
141. Warnick GR, Leary ET, Goetsch J. Electrophoretic quantification of LDL-cholesterol using the Helena REP. *Clin Chem* 1993;39:1122.
142. Muniz N. Measurement of plasma lipoproteins by electrophoresis on polyacrylamide gel. *Clin Chem* 1977;23:1826–1833.
143. Li Z, McNamara JR, Ordovas JM, et al. Analysis of high density lipoproteins by a modified gradient gel electrophoresis method. *J Lipid Res* 1994;35:1698–1711.
144. Krauss RM, Lindgren FT, Ray RM. Interrelationships among subgroups of serum lipoproteins in normal human subjects. *Clin Chim Acta* 1980;104:275–290.
145. Warnick GR, Benderson J, Albers JJ. Dextran sulfate-Mg²⁺ precipitation procedure for quantitation of high-density-lipoprotein cholesterol. *Clin Chem* 1982;28:1379–1388.
146. Burstein M, Legmann P. Lipoprotein precipitation. *Monogr Atheroscler* 1982;11:1–131.
147. Kerscher L, Schiefer S, Draeger B, et al. Precipitation methods for the determination of LDL-cholesterol. *Clin Biochem* 1985;18:118–125.
148. Schumaker VN, Robinson MT, Curtiss LK, et al. Anti-apoprotein B monoclonal antibodies detect human low density lipoprotein polymorphism. *J Biol Chem* 1984;259:6423–6430.
149. Nakajima K, Saito T, Tamura A, et al. Cholesterol in remnant-like lipoproteins in human serum using monoclonal anti apo B-100 and anti apo A-I immunoaffinity mixed gels. *Clin Chim Acta* 1993;223:53–71.
150. Fredrickson DS, Levy RI, Lindgren FT. A comparison of heritable abnormal lipoprotein patterns as defined by two different techniques. *J Clin Invest* 1969;47:2446–2457.
151. National Institutes of Health. *Manual of laboratory operations, Lipid Research Clinics Program, lipid and lipoprotein analysis*. Washington, DC: U.S. Department of Health and Human Services, 1983.
152. Steele BW, Koehler DF, Azar MM, et al. Enzymatic determinations of cholesterol in high-density-lipoprotein fractions prepared by a precipitation technique. *Clin Chem* 1976;22:98–101.
153. Lopes-Virella MF, Stone P, Ellis S, et al. Cholesterol determination in high-density lipoproteins separated by three different methods. *Clin Chem* 1977;23:882–884.
154. Warnick GR, Cheung MC, Albers JJ. Comparison of current methods for high-density lipoprotein cholesterol quantitation. *Clin Chem* 1979;25:596–604.
155. Demacker PN, Vos-Janssen HE, Hijmans AG, et al. Measurement of high-density lipoprotein cholesterol in serum: comparison of six isolation methods combined with enzymic cholesterol analysis. *Clin Chem* 1980;26:1780–1786.
156. Warnick GR, Albers JJ, Bachorik PS, et al. Multilaboratory evaluation of an ultrafiltration procedure for high density lipoprotein cholesterol quantification in turbid heparin-manganese supernates. *J Lipid Res* 1981;22:1015–1020.
157. Sugiuchi H, Uji Y, Okabe H, et al. Direct measurement of high-density lipoprotein cholesterol in serum with polyethylene glycol-modified enzymes and sulfated alpha-cyclodextrin. *Clin Chem* 1995;41:717–723.
158. Harris N, Galpchian V, Rifai N. Three routine methods for measuring high-density lipoprotein cholesterol compared with the reference method. *Clin Chem* 1996;42:738.
159. Warnick GR, Nauck M, Rifai N. Evolution of methods for measurement of HDL-cholesterol: from ultracentrifugation to homogeneous assays. *Clin Chem* 2001;47:1579–1596.
160. Bachorik PS. Measurement of low-density lipoprotein cholesterol. In: Rifai N, Warnick GR, Dominczak MH, editors. *Handbook of lipoprotein testing*. 2nd ed. Washington, DC: AACC Press, 2000.
161. Warnick GR, Knopp RH, Fitzpatrick V, et al. Estimating low-density lipoprotein cholesterol by the Friedewald equation is adequate for classifying patients on the basis of nationally recommended cutpoints. *Clin Chem* 1990;36:15–19.
162. Sugiuchi H, Irie T, Uji Y, et al. Homogeneous assay for measuring low-density lipoprotein cholesterol in serum with triblock copolymer and alpha-cyclodextrin sulfate. *Clin Chem* 1998;44:522–531.
163. Rifai N, Iannotti E, DeAngelis K, et al. Analytical and clinical performance of a homogeneous enzymatic LDL-cholesterol assay compared with the ultracentrifugation-dextran sulfate-Mg²⁺ method. *Clin Chem* 1998;44:1242–1250.
164. Nauck M, Warnick GR, Rifai N. Methods for measurement of LDL-cholesterol: a critical assessment of direct measurement by homogeneous assays versus calculation. *Clin Chem* 2002;48:236–254.
165. Bachorik PS. Lipid and lipoprotein analysis with desktop analyzers. In: Rifai N, Warnick GR, Dominczak MH, editors. *Handbook of lipoprotein testing*. 2nd ed. Washington, DC: AACC Press, 2000.
166. Bhatnager D, Durrington PN. Measurement and clinical significance of apolipoproteins A-I and B. In: Rifai N, Warnick GR, Dominczak MH, editors. *Handbook of lipoprotein testing*. 2nd ed. Washington, DC: AACC Press, 2000.
167. Barter PJ, Ballantyne CM, Carmena R, et al. Apo B versus cholesterol in estimating cardiovascular risk and in guiding therapy: report of the thirty-person/ten-country panel. *J Intern Med* 2006;259:247–258.
168. McGowan MW, Artiss JD, Zak B. A procedure for the determination of high-density lipoprotein choline-containing phospholipids. *J Clin Chem Clin Biochem* 1982;20:807–812.
169. Hellerstein MK. Methods for measurement of fatty acid and cholesterol metabolism. *Curr Opin Lipidol* 1995;6:172–181.
170. Cooper GR, Myers GL, Smith SJ, et al. Blood lipid measurements. Variations and practical utility. *JAMA* 1992;267:1652–1660.
171. Bernert JT Jr, Akins JR, Cooper GR, et al. Factors influencing the accuracy of the National Reference System Total Cholesterol Reference Method. *Clin Chem* 1991;37:2053–2061.
172. Eckfeldt JH, Copeland KR. Accuracy verification and identification of matrix effects. The College of American Pathologists' Protocol. *Arch Pathol Lab Med* 1993;117:381–386.

Electrolytes

Joan E. Polancic

CHAPTER

15

CHAPTER OUTLINE

■ WATER

Osmolality

■ THE ELECTROLYTES

Sodium

Potassium

Chloride

Bicarbonate

Magnesium

Calcium

Phosphate

Lactate

■ ANION GAP

■ ELECTROLYTES AND RENAL FUNCTION

■ REFERENCES

Electrolytes are ions capable of carrying an electric charge. They are classified as anions or cations based on the type of charge they carry. These names were determined years ago based on how the ion migrates in an electric field. Anions have a negative charge and move toward the anode, whereas cations migrate in the direction of the cathode because of their positive charge.

Electrolytes are an essential component in numerous processes, including volume and osmotic regulation (sodium $[\text{Na}^+]$, chloride $[\text{Cl}^-]$, potassium $[\text{K}^+]$); myocardial rhythm and contractility (K^+ , magnesium $[\text{Mg}^{2+}]$, calcium $[\text{Ca}^{2+}]$); cofactors in enzyme activation (e.g., Mg^{2+} , Ca^{2+} , zinc $[\text{Zn}^{2+}]$); regulation of adenosine triphosphatase (ATPase) ion pumps (Mg^{2+}); acid-base balance (bicarbonate $[\text{HCO}_3^-]$, K^+ , Cl^-); blood coagulation (Ca^{2+} , Mg^{2+}); neuromuscular excitability (K^+ , Ca^{2+} , Mg^{2+}); and the production and use of ATP from glucose (e.g., Mg^{2+} , phosphate $[\text{PO}_4^-]$). Because many of these functions require electrolyte concentrations to be held within narrow ranges, the body has complex systems for monitoring and maintaining electrolyte concentrations.

This chapter explores both the metabolic physiology and regulation of each electrolyte and relates these factors to the clinical significance of electrolyte measurements. In addition, methodologies used in determining concentrations of the individual analytes are discussed.

WATER

The average water content of the human body varies from 40% to 75% of total body weight, with values declining with age and especially with obesity. Women have lower

average water content than men as a result of a higher fat content. Water is the solvent for all processes in the human body. It transports nutrients to cells, determines cell volume by its transport into and out of cells, removes waste products by way of urine, and acts as the body's coolant by way of sweating. Water is located in intracellular and extracellular compartments. **Intracellular fluid (ICF)** is the fluid inside the cells and accounts for about two thirds of total body water. **Extracellular fluid (ECF)** accounts for the other one third of total body water and can be subdivided into the *intravascular extracellular fluid (plasma)* and the *interstitial cell fluid* that surrounds the cells in the tissue. Normal plasma is about 93% water, with the remaining volume occupied by lipids and proteins. The concentrations of ions within cells and in plasma are maintained both by energy-consuming active transport processes and by diffusion or passive transport processes.

Active transport is a mechanism that requires energy to move ions across cellular membranes. For example, maintaining a high intracellular concentration of K^+ and a high extracellular (plasma) concentration of Na^+ requires use of energy from ATP in ATPase-dependent ion pumps. **Diffusion** is the passive movement of ions across a membrane. It depends on the size and charge of the ion being transported and on the nature of the membrane through which it is passing. The rate of diffusion of various ions also may be altered by physiologic and hormonal processes.

By maintaining the concentration of proteins and electrolytes in a controlled yet somewhat flexible environment, the distribution of water in these compartments also can be controlled. Because most biologic membranes are

freely permeable to water but not to ions or proteins, the concentration of ions and proteins on one side of the membrane or the other will influence the flow of water across a membrane (an osmoregulator). In addition to the osmotic effects of Na^+ , other ions, proteins, and blood pressure influence the flow of water across a membrane.

Osmolality

Osmolality is a physical property of a solution that is based on the concentration of solutes (expressed as millimoles) per kilogram of solvent (w/w). Osmolality is related to several changes in the properties of a solution relative to pure water, such as freezing point depression and vapor pressure decrease. These colligative properties (see Chapter 1) are the basis for routine measurements of osmolality in the laboratory. The term **osmolarity** is still occasionally used, with results reported in milliosmoles per liter (w/v), but it is inaccurate in cases of hyperlipidemia or hyperproteinemia; for urine specimens; or in the presence of certain osmotically active substances, such as alcohol or mannitol. Both the sensation of thirst and arginine vasopressin hormone (AVP), formerly called antidiuretic hormone (ADH), secretion are stimulated by the hypothalamus in response to an increased osmolality of blood. The natural response to the thirst sensation is to consume more fluids, increasing the water content of the ECF, diluting the elevated solute (Na^+) levels, and decreasing the osmolality of the plasma. Thirst, therefore, is important in mediating fluid intake. The other means of controlling osmolality is by secretion of AVP. This hormone is secreted by the posterior pituitary gland and acts on the cells of the collecting ducts in the kidneys to increase water reabsorption. As water is conserved, osmolality decreases, turning off AVP secretion.¹

Clinical Significance of Osmolality

Osmolality in plasma is important because it is the parameter to which the hypothalamus responds. The regulation of osmolality also affects the Na^+ concentration in plasma, largely because Na^+ and its associated anions account for approximately 90% of the osmotic activity in plasma. Another important process affecting the Na^+ concentration in blood is the regulation of blood volume. As discussed later, although osmolality and volume are regulated by separate mechanisms (except for AVP and thirst), they are related because osmolality (Na^+) is regulated by changes in water balance, whereas volume is regulated by changes in Na^+ balance.¹

To maintain a normal plasma osmolality (≈ 275 – 295 mOsm/kg of plasma H_2O), osmoreceptors in the hypothalamus respond quickly to small changes in osmolality. A 1%–2% increase in osmolality causes a fourfold increase in the circulating concentration of AVP, and a

1%–2% decrease in osmolality shuts off AVP production. AVP acts by increasing the reabsorption of water in the cortical and medullary collecting tubules. AVP has a half-life in the circulation of only 15 to 20 minutes.

Renal water regulation by AVP and thirst play important roles in regulating plasma osmolality. Renal water excretion is more important in controlling water excess, whereas thirst is more important in preventing water deficit or dehydration. Consider what happens in several conditions.

Water Load

As excess intake of water (e.g., in polydipsia) begins to lower plasma osmolality, both AVP and thirst are suppressed. In the absence of AVP, water is not reabsorbed, causing a large volume of dilute urine to be excreted, as much as 10 to 20 L daily, well above any normal intake of water. Therefore, hyposmolality and hyponatremia usually occur only in patients with impaired renal excretion of water.¹

Water Deficit

As a deficit of water begins to increase plasma osmolality, both AVP secretion and thirst are activated. Although AVP contributes by minimizing renal water loss, thirst is the major defense against hyperosmolality and hypernatremia. Although hypernatremia rarely occurs in a person with a normal thirst mechanism and access to water, it becomes a concern in infants, unconscious patients, or anyone who is unable to either drink or ask for water. Osmotic stimulation of thirst progressively diminishes in people who are older than age 60. In the older patient with illness and diminished mental status, dehydration becomes increasingly likely. As an example of the effectiveness of thirst in preventing dehydration, a patient with diabetes insipidus (no AVP) may excrete 10 L of urine per day; however, because thirst persists, water intake matches output and plasma Na^+ remains normal.¹

Regulation of Blood Volume

Adequate blood volume is essential to maintain blood pressure and ensure good perfusion to all tissue and organs. Regulation of both Na^+ and water are interrelated in controlling blood volume. The renin-angiotensin-aldosterone system responds primarily to a decreased blood volume. Renin is secreted near the renal glomeruli in response to decreased renal blood flow (decreased blood volume or blood pressure). Renin converts angiotensinogen to angiotensin I, which then becomes angiotensin II. Angiotensin II causes vasoconstriction, which quickly increases blood pressure, and secretion of aldosterone, which increases retention of Na^+ and the water that accompanies the Na^+ . The effects of blood volume and osmolality on Na^+ and water metabolism are shown in Figure 15-1. Changes in blood volume (actually pressure) are initially detected by a series of stretch

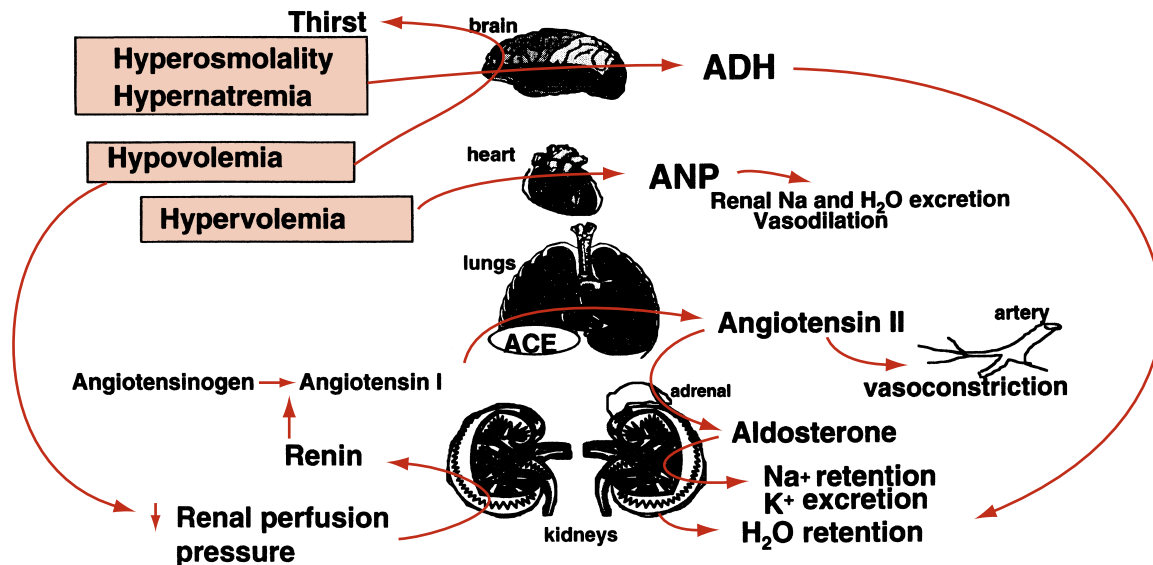

FIGURE 15-1. Responses to changes in blood osmolality and blood volume. ANP, atrial natriuretic peptide. The primary stimuli are shown in boxes (e.g., hypovolemia).

receptors located in areas such as the cardiopulmonary circulation, carotid sinus, aortic arch, and glomerular arterioles. These receptors then activate a series of responses (effectors) that restore volume by appropriately varying vascular resistance, cardiac output, and renal Na^+ and water retention.¹

Four other factors affect blood volume: (1) atrial natriuretic peptide (ANP), released from the myocardial atria in response to volume expansion, promotes Na^+ excretion in the kidney (B-type natriuretic peptide [BNP] and ANP act together in regulating blood pressure and fluid balance); (2) volume receptors independent of osmolality stimulate the release of AVP, which conserves water by renal reabsorption; (3) glomerular filtration rate (GFR) increases with volume expansion and decreases with volume depletion; and (4) all other things equal, an increased plasma Na^+ will increase urinary Na^+ excretion and vice versa. The normal reabsorption of 98% to 99% of filtered Na^+ by the tubules conserves nearly all of the 150 L of glomerular filtrate produced daily. A 1% to 2% reduction in tubular reabsorption of Na^+ can increase water loss by several liters per day.

Urine osmolality values may vary widely depending on water intake and the circumstances of collection. However, it is generally decreased in diabetes insipidus (inadequate AVP) and **polydipsia** (excessive H_2O intake) and increased in conditions such as the syndrome of inappropriate ADH (AVP) secretion (SIADH) and **hypovolemia** (although urinary Na^+ is usually decreased).

Determination of Osmolality

Specimen

Osmolality may be measured in serum or urine. Plasma use is not recommended because osmotically active

substances may be introduced into the specimen from the anticoagulant.

Discussion

The methods for determining osmolality are based on properties of a solution that are related to the number of molecules of solute per kilogram of solvent (colligative properties), such as changes in freezing point and vapor pressure. An increase in osmolality decreases the freezing point temperature and the vapor pressure. Measurement of freezing point depression and vapor pressure decrease (actually, the dew point) are the two most frequently used methods of analysis. For detailed information on theory and methodology, consult Chapter 5 or the operator's manual of the instrument being used.

Samples must be free of particulate matter to obtain accurate results. Turbid serum and urine samples should be centrifuged before analysis to remove any extraneous particles. If reusable sample cups are used, they should be thoroughly cleaned and dried between each use to prevent contamination.

Osmometers that operate by freezing point depression are standardized using sodium chloride reference solutions. After calibration, the appropriate amount of sample is pipetted into the required cuvet or sample cup and placed in the analyzer. The sample is then supercooled to -7°C and seeded to initiate the freezing process. When temperature equilibrium has been reached, the freezing point is measured, with results for serum and urine osmolality reported as milliosmoles per kilogram.

Calculation of osmolality has some usefulness either as an estimate of the true osmolality or to determine the *osmolal gap*, which is the difference between the measured osmolality and the calculated osmolality. The osmolal gap

TABLE 15-1 REFERENCE RANGES FOR OSMOLALITY

| | |
|-------------------|-----------------|
| Serum | 275–295 mOsm/kg |
| Urine (24-h) | 300–900 mOsm/kg |
| Urine/serum ratio | 1.0–3.0 |
| Random urine | 50–1200 mOsm/kg |
| Osmolal gap | 5–10 mOsm/kg |

indirectly indicates the presence of osmotically active substances other than Na^+ , urea, or glucose, such as ethanol, methanol, ethylene glycol, lactate, or β -hydroxybutyrate.

Two formulas are presented, each having theoretic advantages and disadvantages. Both are adequate for the purpose previously described. For more discussion, the reader may consult other references.²

$$2 \text{ Na} + \frac{\text{glucose (mg/dL)}}{20} + \frac{\text{BUN (mg/dL)}}{3}$$

$$1.86 \text{ Na} + \frac{\text{glucose}}{18} + \frac{\text{BUN}}{2.8} + 9 \quad (\text{Eq. 15-1})$$

Reference Ranges

See Table 15-1.³

THE ELECTROLYTES

Sodium

Na^+ is the most abundant cation in the ECF, representing 90% of all extracellular cations, and largely determines the osmolality of the plasma. A normal plasma osmolality is approximately 295 mmol/L, with 270 mmol/L being the result of Na^+ and associated anions.

Na^+ concentration in the ECF is much larger than inside the cells. Because a small amount of Na^+ can diffuse through the cell membrane, the two sides would eventually reach equilibrium. To prevent equilibrium from occurring, active transport systems, such as ATPase ion pumps, are present in all cells. K^+ (see *Potassium*) is the major intracellular cation. Like Na^+ , K^+ would eventually diffuse across the cell membrane until equilibrium is reached. The Na^+, K^+ -ATPase ion pump moves three Na^+ ions out of the cell in exchange for two K^+ ions moving into the cell as ATP is converted to ADP. Because water follows electrolytes across cell membranes, the continual removal of Na^+ from the cell prevents osmotic rupture of the cell by also drawing water from the cell.

Regulation

The plasma Na^+ concentration depends greatly on the intake and excretion of water and, to a somewhat lesser degree, the renal regulation of Na^+ . Three processes are of primary importance: (1) the intake of water in response to

CASE STUDY 15-1

A 32-year-old woman was admitted to the hospital following 2½ days of severe vomiting. Before this episode, she was reportedly well. Physical findings revealed decreased skin turgor and dry mucous membranes. Admission study results were as follows:

SERUM

- Na^+ : 129 mmol/L
- K^+ : 5.0 mmol/L
- Cl^- : 77 mmol/L
- HCO_3^- : 9 mmol/L
- Osmolality: 265 mOsm/kg

URINE

- Na^+ : 8 mmol/day
- Ketones: trace

Questions

1. What is the cause for each abnormal plasma electrolyte result?
2. What is the significance of the urine sodium and serum osmolality results?

thirst, as stimulated or suppressed by plasma osmolality; (2) the excretion of water, largely affected by AVP release in response to changes in either blood volume or osmolality; and (3) the blood volume status, which affects Na^+ excretion through aldosterone, angiotensin II, and ANP (atrial natriuretic peptide). The kidneys have the ability to conserve or excrete large amounts of Na^+ , depending on the Na^+ content of the ECF and the blood volume. Normally, 60% to 75% of filtered Na^+ is reabsorbed in the proximal tubule; electroneutrality is maintained by either Cl^- reabsorption or hydrogen ion (H^+) secretion. Some Na^+ is also reabsorbed in the loop and distal tubule and (controlled by aldosterone) exchanged for K^+ in the connecting segment and cortical collecting tubule. The regulation of osmolality and volume has been summarized in Figure 15-1.

Clinical Applications

Hyponatremia

Hyponatremia is defined as a serum/plasma level less than 135 mmol/L.⁴ Hyponatremia is one of the most common electrolyte disorders in hospitalized and nonhospitalized patients.^{5,6} Levels below 130 mmol/L are clinically significant. Hyponatremia can be assessed by the cause for the decrease or with the osmolality level.

Decreased levels may be caused by increased Na^+ loss, increased water retention, or water imbalance

TABLE 15-2 CAUSES OF HYPONATREMIA

| INCREASED SODIUM LOSS |
|----------------------------------|
| Hypoadrenalism |
| Potassium deficiency |
| Diuretic use |
| Ketonuria |
| Salt-losing nephropathy |
| Prolonged vomiting or diarrhea |
| Severe burns |
| INCREASED WATER RETENTION |
| Renal failure |
| Nephrotic syndrome |
| Hepatic cirrhosis |
| Congestive heart failure |
| WATER IMBALANCE |
| Excess water intake |
| SIADH |
| Pseudohyponatremia |

(Table 15-2). Increased Na^+ loss in the urine can occur with decreased aldosterone production, certain diuretics (thiazides), with ketonuria (Na^+ lost with ketones), or a salt-losing nephropathy (with some renal tubular disorders). K^+ deficiency also causes Na^+ loss because of the inverse relationship of the two ions in the renal tubules. When serum K^+ levels are low, the tubules will conserve K^+ and excrete Na^+ in exchange for the loss of the monovalent cation. Each disorder results in an increased urine Na^+ level (≥ 20 mmol per day), which exceeds the amount of water loss.⁷

Prolonged vomiting or diarrhea or severe burns can result in Na^+ loss. Urine Na^+ levels are usually less than 20 mmol per day in these disorders, which can be used to differentiate among causes for urinary loss.

Increased water retention causes dilution of serum/plasma Na^+ as with acute or chronic renal failure. In nephrotic syndrome and hepatic cirrhosis, plasma proteins are decreased, resulting in a decreased colloid osmotic pressure (COP) in which intravascular fluid migrates to the tissue (edema results). The low plasma volume causes AVP (arginine vasopressin, formerly called ADH) to be produced, causing fluid retention and resulting dilution of Na^+ . This compensatory mechanism is also seen with congestive heart failure (CHF) as a result of increased venous pressure. Urine Na^+ levels can be used to differentiate the cause for increased water retention. When urine Na^+ is ≥ 20 mmol per day, acute or chronic renal failure is the likely cause. When urine levels are less than 20 mmol per day,

water retention may be a result of nephrotic syndrome, hepatic cirrhosis, or CHF.⁷

Water imbalance can occur as a result of excess water intake, as with polydipsia (increased thirst). The increased intake must be chronic before water imbalance occurs, which may cause mild or severe hyponatremia. In a normal individual, excess intake will not affect Na^+ levels. Syndrome of inappropriate AVP secretion (SIADH) causes an increase in water retention because of increased AVP (ADH) production. A defect in AVP regulation has been associated with pulmonary disease, malignancies, central nervous system (CNS) disorders, infections (e.g., *Pneumocystis carinii* pneumonia), or trauma.⁷ Pseudohyponatremia can occur when Na^+ is measured using indirect ion-selective electrodes (ISEs) in a patient who is hyperproteinemic or hyperlipidemic. An indirect ISE dilutes the sample prior to analysis and as a result of plasma/serum water displacement; the ion levels are falsely decreased. (For detailed information on the theory of water displacement with indirect ISEs, consult Chapter 5.)

Hyponatremia can also be classified according to plasma/serum osmolality (Table 15-3). Because Na^+ is a major contributor to osmolality, both levels can assist in identifying the cause of hyponatremia. There are three categories of hyponatremia—low osmolality, normal osmolality, or high osmolality.⁴ Most instances of **hyponatremia** occur with decreased osmolality. This may be a result of Na^+ loss or water retention, as previously mentioned.

TABLE 15-3 CLASSIFICATION OF HYPONATREMIA BY OSMOLALITY

| WITH LOW OSMOLALITY |
|---|
| Increased sodium loss |
| Increased water retention |
| WITH NORMAL OSMOLALITY |
| Increased nonsodium cations |
| Lithium excess |
| Increased γ -globulins—cationic (multiple myeloma) |
| Severe hyperkalemia |
| Severe hypermagnesemia |
| Severe hypercalcemia |
| Pseudohyponatremia |
| Hyperlipidemia |
| Hyperproteinemia |
| Pseudohyperkalemia as a result of in vitro hemolysis |
| WITH HIGH OSMOLALITY |
| Hyperglycemia |
| Mannitol infusion |

TABLE 15-4 CAUSES OF HYPERNATREMIA**EXCESS WATER LOSS**

Diabetes insipidus

Renal tubular disorder

Prolonged diarrhea

Profuse sweating

Severe burns

DECREASED WATER INTAKE

Older persons

Infants

Mental impairment

INCREASED INTAKE OR RETENTION

Hyperaldosteronism

Sodium bicarbonate excess

Dialysis fluid excess

Hyponatremia with a normal osmolality may be a result of a high increase in nonsodium cations as listed in Table 15-4. In multiple myeloma, the cationic γ -globulins replace some Na^+ to maintain the electroneutrality; however, because it is a multivalent cation, it has little effect on osmolality.

Pseudohyponatremia, as mentioned earlier, may also be seen with *in vitro* hemolysis, considered the most common cause for a false decrease.⁴ When red blood cells (RBCs) lyse, Na^+ , K^+ , and water are released. Na^+ concentration is lower in RBCs, resulting in a false decrease. *Hyponatremia with a high osmolality* is associated with hyperglycemia. This high solute causes a shift of water from the cells to the blood, resulting in a dilution of Na^+ .

Symptoms of hyponatremia. Symptoms depend on the serum level. Between 125 and 7130 mmol/L, symptoms are primarily gastrointestinal (GI). More severe neuropsychiatric symptoms are seen below 125 mmol/L, including nausea and vomiting, muscular weakness, headache, lethargy, and ataxia. More severe symptoms also include seizures, coma, and respiratory depression.⁷ A level below 120 mmol/L for 48 hours or less (acute hyponatremia) is considered a medical emergency.⁸ Serum and urine electrolytes are monitored as treatment to return Na^+ levels to normal occurs.⁹

Treatment of hyponatremia. Treatment is directed at correction of the condition that caused either water loss or Na^+ loss in excess of water loss. In addition, the onset of hyponatremia—acute or chronic (less than or more than 48 hours)—and the severity of hyponatremia are considered in treatment. Conventional treatment of

hyponatremia involves fluid restriction and providing hypertonic saline and/or other pharmacologic agents that may take several days to reach the desired effect and may have deleterious side effects.⁵ Correcting severe hyponatremia too rapidly can cause cerebral myelinolysis and too slowly can cause cerebral edema.⁹ Appropriate management of fluid administration is critical. Fluid administration and monitoring is required during treatment of the underlying cause of the hyponatremia.

A newer type of pharmacologic agent, an AVP receptor (AVPR) antagonist, has been found to be an effective treatment for euvolemic or hypervolemic hyponatremia. Conivaptan has been approved by the U.S. Food and Drug Administration (FDA) for use in the United States and blocks the action of AVP in the collecting ducts of the nephron, thus decreasing water reabsorption.¹⁰ This AVP receptor antagonist tends to restore Na^+ levels within 24 hours.⁵ Euvolemic hyponatremia is associated with SIADH, hypothyroidism, and adrenal insufficiency.⁶ Hypervolemic hyponatremia is associated with liver cirrhosis with ascites, CHF, and overhydrated postoperative patients.⁸ Conivaptan is not an effective treatment with hypovolemic hyponatremia because the increased water loss would accentuate the volume depletion problem.¹⁰

Hypernatremia

Hypernatremia (increased serum Na^+ concentration) results from excess loss of water relative to Na^+ loss, decreased water intake, or increased Na^+ intake or retention. Hypernatremia is less commonly seen in hospitalized patients than hyponatremia.⁷

Loss of hypotonic fluid may occur either by the kidney or through profuse sweating, diarrhea, or severe burns.

Hypernatremia may result from loss of water in diabetes insipidus, either because the kidney cannot respond to AVP (nephrogenic diabetes insipidus) or because AVP secretion is impaired (central diabetes insipidus). Diabetes insipidus is characterized by copious production of dilute urine (3–20 L/day). Because people with diabetes insipidus drink large volumes of water, hypernatremia usually does not occur unless the thirst mechanism is also impaired. Partial defects of either AVP release or the response to AVP may also occur. In such cases, urine is concentrated to a lesser extent than appropriate to correct the hypernatremia. Excess water loss may also occur in renal tubular disease, such as acute tubular necrosis, in which the tubules become unable to fully concentrate the urine.

The measurement of urine osmolality is necessary to evaluate the cause of hypernatremia. With renal loss of water, the urine osmolality is low or normal. With extrarenal fluid losses, the urine osmolality is increased. Interpretation of the urine osmolality in hypernatremia is shown in Table 15-5.

Water loss through the skin and by breathing (insensible loss) accounts for about 1 L of water loss per day in

TABLE 15-5 HYPERNATREMIA (150 mmol/L) RELATED TO URINE OSMOLALITY

| |
|---|
| URINE OSMOLALITY <300 mOsm/kg |
| Diabetes insipidus (impaired secretion of AVP or kidneys cannot respond to AVP) |
| URINE OSMOLALITY 300–700 mOsm/kg |
| Partial defect in AVP release or response to AVP |
| Osmotic diuresis |
| URINE OSMOLALITY >700 mOsm/kg |
| Loss of thirst |
| Insensible loss of water (breathing, skin) |
| GI loss of hypotonic fluid |
| Excess intake of sodium |

adults. Any condition that increases water loss, such as fever, burns, diarrhea, or exposure to heat, will increase the likelihood of developing hypernatremia. Commonly, hypernatremia occurs in those persons who may be thirsty but who are unable to ask for or obtain water, such as adults with altered mental status and infants. When urine cannot be fully concentrated (e.g., in neonates, young children, older persons, and certain patients with renal insufficiency), a relatively lower urine osmolality may occur.

Chronic hypernatremia in an alert patient is indicative of hypothalamic disease, usually with a defect in the osmoreceptors rather than from a true resetting of the osmostat. A reset osmostat may occur in primary hyperaldosteronism, in which excess aldosterone induces mild hypervolemia that retards AVP release, shifting plasma Na^+ upward by approximately 3–5 mmol/L.¹

Hypernatremia may be from excess ingestion of salt or administration of hypertonic solutions of Na^+ , such as sodium bicarbonate or hypertonic dialysis solutions. Neonates are especially susceptible to hypernatremia from this cause. In these cases, AVP response is appropriate, resulting in urine osmolality of greater than 800 mOsm/kg (Table 15-5).

Symptoms of hypernatremia. Symptoms most commonly involve the CNS as a result of the hyperosmolar state. These symptoms include altered mental status, lethargy, irritability, restlessness, seizures, muscle twitching, hyperreflexes, fever, nausea or vomiting, difficult respiration, and increased thirst. Serum Na^+ of more than 160 mmol/L is associated with a mortality rate of 60%–75%.⁷

Treatment of hypernatremia. Treatment is directed at correction of the underlying condition that caused the water depletion or Na^+ retention. The speed of correction depends on the rate with which the condition developed. Hypernatremia must be corrected gradually

because too rapid a correction of serious hypernatremia (≥ 160 mmol/L) can induce cerebral edema and death, the maximal rate should be 0.5 mmol/L per hour.¹

Determination of Sodium

Specimen

Serum, plasma, and urine are all acceptable for Na^+ measurements. When plasma is used, lithium heparin, ammonium heparin, and lithium oxalate are suitable anticoagulants. Hemolysis does not cause a significant change in serum or plasma values as a result of decreased levels of intracellular Na^+ . However, with marked hemolysis, levels may be decreased as a result of a dilutional effect.

Whole blood samples may be used with some analyzers. Consult the instrument operation manual for acceptability. The specimen of choice in urine Na^+ analyses is a 24-hour collection. Sweat is also suitable for analysis. Sweat collection and analysis are discussed in Chapter 28.

Methods

Through the years, Na^+ has been measured in various ways, including chemical methods, flame emission spectrophotometry (FES), atomic absorption spectrophotometry (AAS), and ISEs. Chemical methods are outdated because of large sample volume requirements and lack of precision. ISEs are the most routinely used method in clinical laboratories.

ISE method uses a semipermeable membrane to develop a potential produced by having different ion concentrations on either side of the membrane. In this type system, two electrodes are used. One electrode has a constant potential, making it the reference electrode. The difference in potential between the reference and measuring electrodes can be used to calculate the “concentration” of the ion in solution. However, it is the activity of the ion, not the concentration that is being measured (see Chapter 5).

Most analyzers use a glass ion-exchange membrane in its ISE system for Na^+ measurement (Fig. 15-2). There are two types of ISE measurement, based on sample preparation: direct and indirect. Direct measurement provides an undiluted sample to interact with the ISE membrane. With the indirect method, a diluted sample is used for measurement. There is no significant difference in results, except when samples are hyperlipidemic or hyperproteinemic. Excess lipids or proteins displace plasma water, which leads to a falsely decreased measurement of ionic activity in millimoles per liter of plasma, whereas the direct method measures in plasma water only. In these cases, direct ISE is more accurate.

One source of error with ISEs is protein buildup on the membrane through continuous use. The protein-coated membranes cause poor selectivity, which results in poor reproducibility of results.

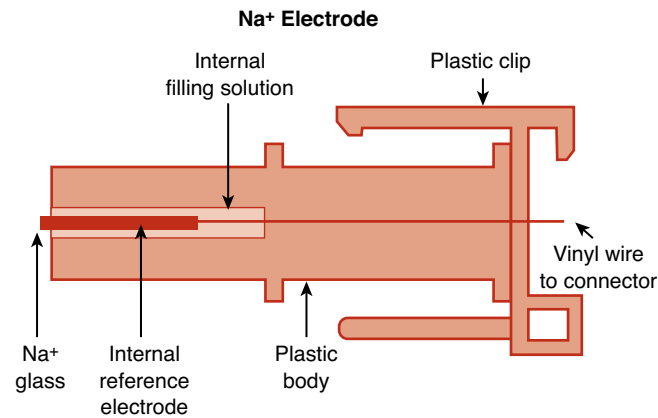

FIGURE 15-2. Diagram of sodium ISE with glass capillary membrane. (Courtesy of Nova Biomedical, Waltham, Mass.)

Vitros analyzers (Ortho-Clinical Diagnostics) use a single-use direct ISE potentiometric system. Each disposable slide contains a reference and measuring electrode (Fig. 15-3). A drop of sample fluid and a drop of reference fluid are simultaneously applied to the slide, and the potential difference between the two is measured which is proportional to the Na⁺ concentration.¹¹

Reference Ranges

See Table 15-6.³

Potassium

Potassium (K⁺) is the major intracellular cation in the body, with a concentration 20 times greater inside the cells than outside. Many cellular functions require that the body maintain a low ECF concentration of K⁺ ions. As a result, only 2% of the body's total K⁺ circulates in

the plasma. Functions of K⁺ in the body include regulation of neuromuscular excitability, contraction of the heart, ICF volume, and H⁺ concentration.¹

The K⁺ concentration has a major effect on the contraction of skeletal and cardiac muscles. An elevated plasma K⁺ decreases the resting membrane potential (RMP) of the cell (the RMP is closer to zero), which decreases the net difference between the cell's resting potential and threshold (action) potential. A lower than normal difference increases cell excitability, leading to muscle weakness. Severe hyperkalemia can ultimately cause a lack of muscle excitability (as a result of a higher RMP than action potential), which may lead to paralysis or a fatal cardiac arrhythmia.¹ Hypokalemia decreases cell excitability by increasing the RMP, often resulting in an arrhythmia or paralysis.¹ The heart may cease to contract in extreme cases of either hyperkalemia or hypokalemia.

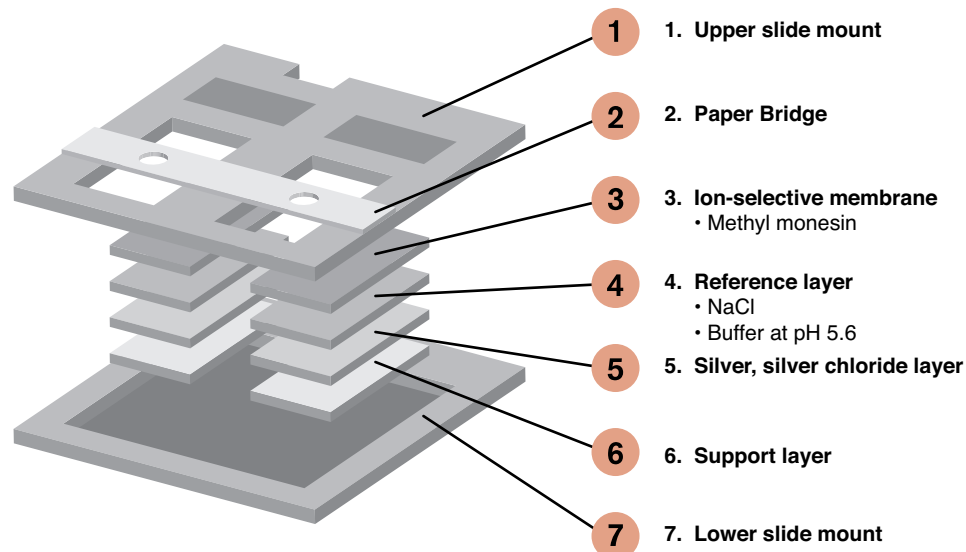

FIGURE 15-3. Schematic diagram of the ISE system for the potentiometric slide on the Vitros. (Courtesy of OCD, a Johnson & Johnson company, Rochester, N.Y.)

TABLE 15-6 REFERENCE RANGES FOR SODIUM

| | |
|---------------|-----------------------------------|
| Serum, plasma | 136–145 mmol/L |
| Urine (24-h) | 40–220 mmol/day, varies with diet |
| CSF | 136–150 mmol/L |

K^+ concentration also affects the H^+ concentration in the blood. For example, in hypokalemia (low serum K^+), as K^+ is lost from the body, Na^+ and H^+ move into the cell. The H^+ concentration is, therefore, decreased in the ECF, resulting in alkalosis.

Regulation

The kidneys are important in the regulation of K^+ balance. Initially, the proximal tubules reabsorb nearly all the K^+ . Then, under the influence of aldosterone, additional K^+ is secreted into the urine in exchange for Na^+ in both the distal tubules and the collecting ducts. Thus, the distal nephron is the principal determinant of urinary K^+ excretion. Most individuals consume far more K^+ than needed; the excess is excreted in the urine but may accumulate to toxic levels if renal failure occurs.

K^+ uptake from the ECF into the cells is important in normalizing an acute rise in plasma K^+ concentration due to an increased K^+ intake. Excess plasma K^+ rapidly enters the cells to normalize plasma K^+ . As the cellular K^+ gradually returns to the plasma, it is removed by urinary excretion. Note that chronic loss of cellular K^+ may result in cellular depletion before there is an appreciable change in the plasma K^+ concentration because excess K^+ is normally excreted in the urine.

Three factors that influence the distribution of K^+ between cells and ECF are (1) K^+ loss frequently occurs whenever the Na^+ , K^+ -ATPase pump is inhibited by conditions such as hypoxia, hypomagnesemia, or digoxin overdose; (2) insulin promotes acute entry of K^+ into skeletal muscle and liver by increasing Na^+ , K^+ -ATPase activity; and (3) catecholamines, such as epinephrine (β_2 -stimulator), promote cellular entry of K^+ , whereas propranolol (β -blocker) impairs cellular entry of K^+ . Dietary deficiency or excess is rarely a primary cause of hypokalemia or hyperkalemia. However, with a pre-existing condition, dietary deficiency (or excess) can enhance the degree of hypokalemia (or hyperkalemia).

Exercise

K^+ is released from cells during exercise, which may increase plasma K^+ by 0.3–1.2 mmol/L with mild to moderate exercise and by as much as 2 to 3 mmol/L with exhaustive exercise. These changes are usually reversed after several minutes of rest. Forearm exercise during venipuncture can cause erroneously high plasma K^+ concentrations.¹²

Hyperosmolality

Hyperosmolality, as with uncontrolled diabetes mellitus, causes water to diffuse from the cells, carrying K^+ with the water, which leads to gradual depletion of K^+ if kidney function is normal.

Cellular Breakdown

Cellular breakdown releases K^+ into the ECF. Examples are severe trauma, tumor lysis syndrome, and massive blood transfusions.

Clinical Applications

Hypokalemia

Hypokalemia is a plasma K^+ concentration below the lower limit of the reference range. Hypokalemia can occur with GI or urinary loss of K^+ or with increased cellular uptake of K^+ . Common causes of hypokalemia are shown in Table 15-7. Of these, therapy with thiazide-type diuretics is the most common.¹³ GI loss occurs when GI fluid is lost through vomiting, diarrhea, gastric suction, or discharge from an intestinal fistula. Increased K^+ loss in the stool also occurs with certain tumors, malabsorption, cancer therapy (chemotherapy or radiation therapy), and large doses of laxatives.

Renal loss of K^+ can result from kidney disorders such as K^+ -losing nephritis and renal tubular acidosis (RTA). In RTA, as tubular excretion of H^+ decreases, K^+ excretion increases. Because aldosterone promotes Na^+ retention

TABLE 15-7 CAUSES OF HYPOKALEMIA

GI LOSS

Vomiting

Diarrhea

Gastric suction

Intestinal tumor

Malabsorption

Cancer therapy—chemotherapy, radiation therapy

Large doses of laxatives

RENAL LOSS

Diuretics—thiazides, mineralocorticoids

Nephritis

Renal tubular acidosis (RTA)

Hyperaldosteronism

Cushing's syndrome

Hypomagnesemia

Acute leukemia

CELLULAR SHIFT

Alkalosis

Insulin overdose

DECREASED INTAKE

and K^+ loss, hyperaldosteronism can lead to hypokalemia and metabolic alkalosis.¹ Hypomagnesemia can lead to hypokalemia by promoting urinary loss of K^+ . Mg^{2+} deficiency also diminishes the activity of Na^+, K^+ -ATPase and enhances the secretion of aldosterone. Effective treatment requires supplementation with both Mg^{2+} and K^+ .¹ Renal K^+ loss also occurs with acute myelogenous leukemia, acute myelomonocytic leukemia, and acute lymphocytic leukemia.¹³ Although reduced dietary intake of K^+ rarely causes hypokalemia in healthy persons, decreased intake may intensify hypokalemia caused by use of diuretics, for example.

Both alkalemia and insulin increase the cellular uptake of K^+ . Because alkalemia promotes intracellular loss of H^+ to minimize elevation of intracellular pH, both K^+ and Na^+ enter cells to preserve electroneutrality. Plasma K^+ decreases by about 0.4 mmol/L per 0.1-unit rise in pH.¹ Insulin promotes the entry of K^+ into skeletal muscle and liver cells. Because insulin therapy can sometimes uncover an underlying hypokalemic state, plasma K^+ should be monitored carefully whenever insulin is administered to susceptible patients.¹ A rare cause of hypokalemia is associated with a blood sample from a leukemic patient with a significantly elevated white blood cell count. The K^+ present in the sample is taken up by the white cells if the sample is left at room temperature for several hours.¹³

Symptoms of hypokalemia. Symptoms (e.g., weakness, fatigue, and constipation) often become apparent as plasma K^+ decreases below 3 mmol/L. Hypokalemia can lead to muscle weakness or paralysis, which can interfere with breathing. The dangers of hypokalemia concern all patients, but especially those with cardiovascular disorders because of an increased risk of arrhythmia, which may cause sudden death in certain patients. Mild hypokalemia (3.0–3.4 mmol/L) is usually asymptomatic.

Treatment of hypokalemia. Treatment typically includes oral KCl replacement of K^+ over several days. In some instances, intravenous (IV) replacement may be indicated. In some cases, chronic mild hypokalemia may be corrected simply by including food in the diet with high K^+ content, such as dried fruits, nuts, bran cereals, bananas, and orange juice. Plasma electrolytes are monitored as treatment to return K^+ levels to normal occurs.

Hyperkalemia

The most common causes of hyperkalemia are shown in Table 15-8. Patients with **hyperkalemia** often have an underlying disorder, such as renal insufficiency, diabetes mellitus, or metabolic acidosis, that contributes to hyperkalemia.¹² For example, during administration of KCl, a person with renal insufficiency is far more likely to develop hyperkalemia than is a person with normal renal function. The most common cause of hyperkalemia in

TABLE 15-8 CAUSES OF HYPERKALEMIA

DECREASED RENAL EXCRETION

Acute or chronic renal failure (GFR, <20 mL/min)

Hypoaldosteronism

Addison's disease

Diuretics

CELLULAR SHIFT

Acidosis

Muscle/cellular injury

Chemotherapy

Leukemia

Hemolysis

INCREASED INTAKE

Oral or IV potassium replacement therapy

ARTIFACTUAL

Sample hemolysis

Thrombocytosis

Prolonged tourniquet use or excessive fist clenching

hospitalized patients is due to therapeutic K^+ administration. The risk is greatest with IV K^+ replacement.¹²

In healthy persons, an acute oral load of K^+ will briefly increase plasma K^+ because most of the absorbed K^+ rapidly moves intracellularly. Normal cellular processes gradually release this excess K^+ back into the plasma, where it is normally removed by renal excretion. Impairment of urinary K^+ excretion is usually associated with chronic hyperkalemia.¹

If a shift of K^+ from cells into plasma occurs too rapidly to be removed by renal excretion, acute hyperkalemia develops. In diabetes mellitus, insulin deficiency promotes cellular loss of K^+ . Hyperglycemia also contributes by producing a hyperosmolar plasma that pulls water and K^+ from cells, promoting further loss of K^+ into the plasma.¹

In metabolic acidosis, as excess H^+ moves intracellularly to be buffered, K^+ leaves the cell to maintain electroneutrality. Plasma K^+ increases by 0.2–1.7 mmol/L for each 0.1-unit reduction of pH.¹ Because cellular K^+ often becomes depleted in cases of acidosis with hyperkalemia (including diabetic ketoacidosis), treatment with agents such as insulin and bicarbonate can cause a rapid intracellular movement of K^+ , producing severe hypokalemia.

Various drugs may cause hyperkalemia, especially in patients with either renal insufficiency or diabetes mellitus. These drugs include captopril (inhibits angiotensin converting enzyme), nonsteroidal anti-inflammatory agents (inhibit aldosterone), spironolactone (K^+ -sparing diuretic), digoxin (inhibits Na^+ - K^+ pump), cyclosporine

(inhibits renal response to aldosterone), and heparin therapy (inhibits aldosterone secretion).

Hyperkalemia may result when K^+ is released into the ECF during enhanced tissue breakdown or catabolism, especially if renal insufficiency is present. Increased cellular breakdown may be caused by trauma, administration of cytotoxic agents, massive hemolysis, tumor lysis syndrome, and blood transfusions. In banked blood, K^+ is gradually released from erythrocytes during storage, often causing elevated K^+ concentration in plasma supernatant.

Patients on cardiac bypass may develop mild elevations in plasma K^+ during warming after surgery because warming causes cellular release of K^+ . Hypothermia causes movement of K^+ into cells.

Symptoms of hyperkalemia. Hyperkalemia can cause muscle weakness, tingling, numbness, or mental confusion by altering neuromuscular conduction. Muscle weakness does not usually develop until plasma K^+ reaches 8 mmol/L.¹

Hyperkalemia disturbs cardiac conduction, which can lead to cardiac arrhythmias and possible cardiac arrest. Plasma K^+ concentrations of 6–7 mmol/L may alter the electrocardiogram, and concentrations more than 10 mmol/L may cause fatal cardiac arrest.¹

Treatment of hyperkalemia. Treatment should be immediately initiated when serum K^+ is 6.0 to 6.5 mmol/L or greater or if there are ECG changes.¹² To offset the effect of K^+ , which lowers the resting potential of myocardial cells, Ca^{2+} may be given to reduce the threshold potential of myocardial cells. Therefore, Ca^{2+} provides immediate but short-lived protection to the myocardium against the effects of hyperkalemia. Substances that acutely shift K^+ back into cells, such as sodium bicarbonate, glucose, or insulin, may also be administered. K^+ may be quickly removed from the body by use of diuretics (loop), if renal function is adequate, or sodium polystyrene sulfonate (Kayexalate) enemas, which binds to K^+ secreted in the colon. Hemodialysis can be used if other measures fail.¹² Patients treated with these agents must be monitored carefully to prevent hypokalemia as K^+ moves back into cells or is removed from the body.

Collection of Samples

Proper collection and handling of samples for K^+ analysis is extremely important because there are many causes of artifactual hyperkalemia. First, the coagulation process releases K^+ from platelets, so that serum K^+ may be 0.1–0.7 mmol/L higher than plasma K^+ concentrations.² If the patient's platelet count is elevated (thrombocytosis), serum K^+ may be further elevated. Second, if a tourniquet is left on the arm too long during blood collection or if patients excessively clench their fists or otherwise exercise their forearms before venipuncture, cells may release K^+ into the plasma. The first situation may be avoided by

using a heparinized tube to prevent clotting of the specimen and the second by using proper care in the drawing of blood. Third, because storing blood on ice promotes the release of K^+ from cells,¹⁴ whole blood samples for K^+ determinations should be stored at room temperature (never iced) and analyzed promptly or centrifuged to remove the cells. Fourth, if hemolysis occurs after the blood is drawn, K^+ may be falsely elevated—the most common cause of artifactual hyperkalemia. Slight hemolysis (≈ 50 mg/dL of hemoglobin) can cause an increase of approximately 3% while gross hemolysis (>500 mg/dL of hemoglobin) can cause an increase of up to 30%.²

Determination of Potassium

Specimen

Serum, plasma, and urine may be acceptable for analysis. Hemolysis must be avoided because of the high K^+ content of erythrocytes. Heparin is the anticoagulant of choice. Whereas serum and plasma generally give similar K^+ levels, serum reference intervals tend to be slightly higher. Significantly elevated platelet counts may result in the release of K^+ during clotting from rupture of these cells, causing a spurious hyperkalemia. In this case, plasma is preferred. Whole blood samples may be used with some analyzers. Consult the instrument's operations manual for acceptability. Urine specimens should be collected over a 24-hour period to eliminate the influence of diurnal variation.

Methods

As with Na^+ , the current method of choice is ISE. For ISE measurements, a valinomycin membrane is used to selectively bind K^+ , causing an impedance change that can be correlated to K^+ concentration. KCl is the inner electrolyte solution.

Reference Ranges

See Table 15-9.³

Chloride

Chloride (Cl^-) is the major extracellular anion. Its precise function in the body is not well understood; however, it is involved in maintaining osmolality, blood volume, and electric neutrality. In most processes, Cl^- shifts secondarily to a movement of Na^+ or HCO_3^- .

Cl^- ingested in the diet is almost completely absorbed by the intestinal tract. Cl^- is then filtered out by the

TABLE 15-9 REFERENCE RANGES FOR POTASSIUM

| | |
|--------------|-------------------------|
| Serum | 3.5–5.1 mmol/L |
| Plasma | Males: 3.5–4.5 mmol/L |
| | Females: 3.4–4.4 mmol/L |
| Urine (24-h) | 25–125 mmol/day |

glomerulus and passively reabsorbed, in conjunction with Na^+ , by the proximal tubules. Excess Cl^- is excreted in the urine and sweat. Excessive sweating stimulates aldosterone secretion, which acts on the sweat glands to conserve Na^+ and Cl^- .

Cl^- maintains electrical neutrality in two ways. First, Na^+ is reabsorbed along with Cl^- in the proximal tubules. In effect, Cl^- acts as the rate-limiting component, in that Na^+ reabsorption is limited by the amount of Cl^- available. Electroneutrality is also maintained by Cl^- through the *chloride shift*. In this process, carbon dioxide (CO_2) generated by cellular metabolism within the tissue diffuses out into both the plasma and the red cell. In the red cell, CO_2 forms carbonic acid (H_2CO_3), which splits into H^+ and HCO_3^- (bicarbonate). Deoxyhemoglobin buffers H^+ , whereas the HCO_3^- diffuses out into the plasma and Cl^- diffuses into the red cell to maintain the electric balance of the cell (Fig. 15-4).

Clinical Applications

Cl^- disorders are often a result of the same causes that disturb Na^+ levels because Cl^- passively follows Na^+ . There are a few exceptions. **Hyperchloremia** may also occur when there is an excess loss of HCO_3^- as a result of GI losses, RTA, or metabolic acidosis. **Hypochloremia** may also occur with excessive loss of Cl^- from prolonged vomiting, diabetic ketoacidosis, aldosterone deficiency, or salt-losing renal diseases such as pyelonephritis. A low serum level of Cl^- may also be encountered in conditions associated with high serum HCO_3^- concentrations, such as compensated respiratory acidosis or metabolic alkalosis.

Determination of Chloride

Specimen

Serum or plasma may be used, with lithium heparin being the anticoagulant of choice. Hemolysis does not cause a significant change in serum or plasma values as a result of decreased levels of intracellular Cl^- . However, with marked hemolysis, levels may be decreased as a result of a dilutional effect.

Whole blood samples may be used with some analyzers. Consult the instrument's operation manual for acceptability. The specimen of choice in urine Cl^- analyses is 24-hour collection because of the large diurnal variation. Sweat is also suitable for analysis. Sweat collection and analysis are discussed in Chapter 28.

Methods

There are several methodologies available for measuring Cl^- , including ISEs, amperometric-coulometric titration, mercurimetric titration, and colorimetry. The most commonly used is ISE. For ISE measurement, an ion-exchange membrane is used to selectively bind Cl^- ions.

Amperometric-coulometric titration is a method using coulometric generation of silver ions (Ag^+), which combine with Cl^- to quantitate the Cl^- concentration.



When all Cl^- in a patient is bound to Ag^+ , excess or free Ag^+ is used to indicate the endpoint. As Ag^+ accumulates, the coulometric generator and timer are turned off. The elapsed time is used to calculate the concentration of Cl^- in the sample. The digital (Cotlove)

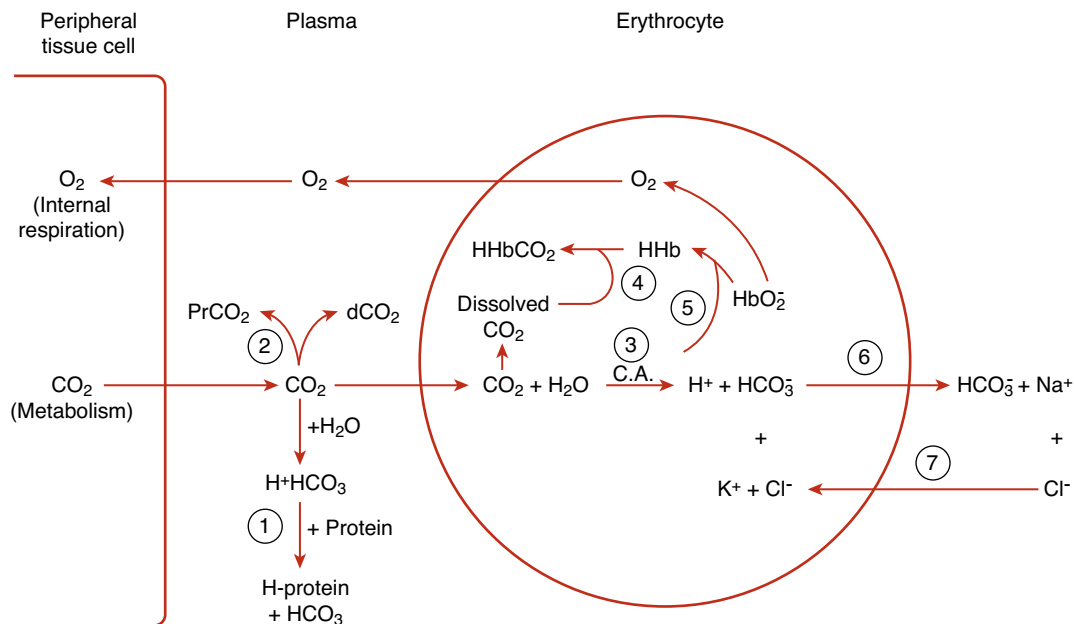

FIGURE 15-4. Chloride shift mechanism. See text for details. (Reprinted with permission from Burtis CA, Ashwood ER, eds. Tietz textbook of clinical chemistry. 2nd ed. Philadelphia, Pa.: WB Saunders, 1994.)

TABLE 15-10 REFERENCE RANGES FOR CHLORIDE

| | |
|---------------|------------------------------------|
| Plasma, serum | 98–107 mmol/L |
| Urine (24-h) | 110–250 mmol/day, varies with diet |

chloridometer (Labconco Corporation) uses this principle in Cl^- analysis.

Reference Ranges

See Table 15-10.³

Bicarbonate

Bicarbonate is the second most abundant anion in the ECF. Total CO_2 comprises the bicarbonate ion (HCO_3^-), carbonic acid (H_2CO_3), and dissolved CO_2 , with HCO_3^- accounting for more than 90% of the total CO_2 at physiologic pH. Because HCO_3^- composes the largest fraction of total CO_2 , total CO_2 measurement is indicative of HCO_3^- measurement.

HCO_3^- is the major component of the buffering system in the blood. Carbonic anhydrase in RBCs converts CO_2 and H_2O to carbonic acid, which dissociates into H^+ and HCO_3^- .



CA, carbonic anhydrase (Eq. 15-3)

HCO_3^- diffuses out of the cell in exchange for Cl^- to maintain ionic charge neutrality within the cell (chloride shift; see Fig. 15-4). This process converts potentially toxic CO_2 in the plasma to an effective buffer: HCO_3^- . HCO_3^- buffers excess H^+ by combining with acid, then eventually dissociating into H_2O and CO_2 in the lungs where the acidic gas CO_2 is eliminated.

Regulation

Most of the HCO_3^- in the kidneys (85%) is reabsorbed by the proximal tubules, with 15% being reabsorbed by the distal tubules. Because tubules are only slightly permeable to HCO_3^- , it is usually reabsorbed as CO_2 . This happens as HCO_3^- , after filtering into the tubules, combines with H^+ to form carbonic acid, which then dissociates into H_2O and CO_2 . The CO_2 readily diffuses back into the ECF. Normally, nearly all the HCO_3^- is reabsorbed from the tubules, with little lost in the urine. When HCO_3^- is filtered in excess of H^+ available, almost all excess HCO_3^- flows into the urine.

In alkalosis, with a relative increase in HCO_3^- compared to CO_2 , the kidneys increase excretion of HCO_3^- into the urine, carrying along a cation such as Na^+ . This loss of HCO_3^- from the body helps correct pH.

Among the responses of the body to acidosis is an increased excretion of H^+ into the urine. In addition, HCO_3^- reabsorption is virtually complete, with 90% of

the filtered HCO_3^- reabsorbed in the proximal tubule and the remainder in the distal tubule.¹

Clinical Applications

Acid-base imbalances cause changes in HCO_3^- and CO_2 levels. A decreased HCO_3^- may occur from metabolic acidosis as HCO_3^- combines with H^+ to produce CO_2 , which is exhaled by the lungs. The typical response to metabolic acidosis is compensation by hyperventilation, which lowers pCO_2 . Elevated total CO_2 concentrations occur in metabolic alkalosis as HCO_3^- is retained, often with increased pCO_2 as a result of compensation by hypoventilation. Typical causes of metabolic alkalosis include severe vomiting, hypokalemia, and excessive alkali intake.

Determination of Carbon Dioxide

Specimen

This chapter deals specifically with venous serum or plasma determinations. For discussion of arterial and whole blood pCO_2 measurements, refer to Chapter 16.

Serum or lithium heparin plasma is suitable for analysis. Although specimens should be anaerobic for the highest accuracy, many current analyzers (excluding blood gas analyzers) do not permit anaerobic sample handling. In most instances, the sample is capped until the serum or plasma is separated and the sample is analyzed immediately. If the sample is left uncapped before analysis, CO_2 escapes. Levels can decrease by 6 mmol/L per hour.²

Carbon dioxide measurements may be obtained in several ways; however, the actual portion of the total CO_2 being measured may vary with the method used. Two common methods are ISE and an enzymatic method.

One type of ISE for measuring total CO_2 uses an acid reagent to convert all the forms of CO_2 to CO_2 gas and is measured by a pCO_2 electrode (see Chapter 16).

The enzyme method alkalizes the sample to convert all forms of CO_2 to HCO_3^- . HCO_3^- is used to carboxylate phosphoenolpyruvate (PEP) in the presence of phosphoenolpyruvate (PEP) carboxylase, which catalyzes the formation of oxaloacetate.

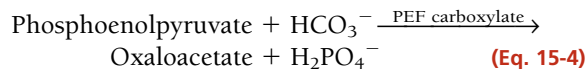

This is coupled to the following reaction, in which NADH is consumed as a result of the action of malate dehydrogenase (MDH).

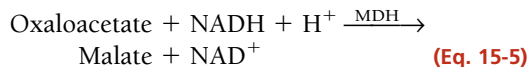

The rate of change in absorbance of NADH is proportional to the concentration of HCO_3^- .

Reference Ranges

Carbon dioxide, venous 23 to 29 mmol/L (plasma, serum).³

Magnesium

Magnesium Physiology

Magnesium (Mg^{2+}) is the fourth most abundant cation in the body and second most abundant intracellular ion. The average human body (70 kg) contains 1 mole (24 g) of Mg^{2+} . Approximately 53% of Mg^{2+} in the body is found in bone, 46% in muscle and other organs and soft tissue, and less than 1% is present in serum and red blood cells.¹⁵ Of the Mg^{2+} present in serum, about one third is bound to protein, primarily albumin. Of the remaining two thirds, 61% exists in the free or ionized state and about 5% is complexed with other ions, such as PO_4^- and citrate. Similar to Ca^{2+} , it is the free ion that is physiologically active in the body.¹⁶

The role of Mg^{2+} in the body is widespread. It is an essential cofactor of more than 300 enzymes, including those important in glycolysis, transcellular ion transport, neuromuscular transmission, synthesis of carbohydrates, proteins, lipids, and nucleic acids, and release of and response to certain hormones.

The clinical usefulness of serum Mg^{2+} levels has greatly increased in the past 10 years as more information about the analyte has been discovered. The most significant findings are the relationship between abnormal serum Mg^{2+} levels and cardiovascular, metabolic, and neuromuscular disorders. Although serum levels may not reflect total body stores of Mg^{2+} , serum levels are useful in determining acute changes in the ion.

Regulation

Rich sources of Mg^{2+} in the diet include raw nuts, dry cereal, and “hard” drinking water; other sources include vegetables, meats, fish, and fruit.¹⁵ Processed foods, an ever-increasing part of the average U.S. diet, have low levels of Mg^{2+} that may cause an inadequate intake. This in turn may increase the likelihood of Mg^{2+} deficiency. The small intestine may absorb 20%–65% of the dietary Mg^{2+} , depending on the need and intake.

The overall regulation of body Mg^{2+} is controlled largely by the kidney, which can reabsorb Mg^{2+} in deficiency states or readily excrete excess Mg^{2+} in overload states. Of the nonprotein-bound Mg^{2+} that gets filtered by the glomerulus, 25%–30% is reabsorbed by the proximal convoluted tubule (PCT), unlike Na^+ , in which 60%–75% is absorbed in the PCT. Henle’s loop is the major renal regulatory site, where 50%–60% of filtered Mg^{2+} is reabsorbed in the ascending limb. In addition, 2%–5% is reabsorbed in the distal convoluted tubule.¹⁷ The renal threshold for Mg^{2+} is approximately 0.60–0.85 mmol/L (≈ 1.46 – 2.07 mg/dL). Because this is close to normal serum concentration, slight excesses of Mg^{2+} in serum are rapidly excreted by the kidneys. Normally, only about 6% of filtered Mg^{2+} is excreted in the urine per day.¹⁵

Mg^{2+} regulation appears to be related to that of Ca^{2+} and Na^+ . Parathyroid hormone (PTH) increases the renal reabsorption of Mg^{2+} and enhances the absorption of Mg^{2+} in the intestine. However, changes in ionized Ca^{2+} have a far greater effect on PTH secretion. Aldosterone and thyroxine apparently have the opposite effect of PTH in the kidney, increasing the renal excretion of Mg^{2+} .¹⁶

Clinical Applications

Hypomagnesemia

Hypomagnesemia is most frequently observed in hospitalized individuals in intensive care units or those receiving diuretic therapy or digitalis therapy. These patients most likely have an overall tissue depletion of Mg^{2+} as a result of severe illness or loss, which leads to low serum levels. Hypomagnesemia is rare in nonhospitalized individuals.¹⁶

There are many causes of hypomagnesemia; however, it can be grouped into general categories (Table 15-11). Reduced intake is least likely to cause severe deficiencies in the United States. An Mg^{2+} -deficient diet as a result of starvation, chronic alcoholism, or Mg^{2+} -deficient IV therapy can cause a loss of the ion.

Various GI disorders may cause decreased absorption by the intestine, which can result in an excess loss of Mg^{2+} via the feces. Malabsorption syndromes; intestinal resection or bypass surgery; nasogastric suction; pancreatitis; and prolonged vomiting, diarrhea, or laxative use may lead to an Mg^{2+} deficiency. Neonatal hypomagnesemia has been reported as a result of various surgical procedures. A primary deficiency has also been reported in infants as a result of a selective malabsorption of the ion.¹⁶ A chronic congenital hypomagnesemia with secondary hypocalcemia (autosomal recessive disorder) has also been reported; molecular studies have revealed a specific transport protein defect in the intestine.¹⁸

Mg^{2+} loss due to increased excretion by way of the urine can occur as a result of various renal and endocrine disorders or the effects of certain drugs on the kidneys. Renal tubular disorders and other select renal disorders may result in excess amounts of Mg^{2+} being lost through the urine because of decreased tubular reabsorption.

Several endocrine disorders can cause a loss of Mg^{2+} . Hyperparathyroidism and hypercalcemia may cause increased renal excretion of Mg^{2+} as a result of excess Ca^{2+} ions. Excess serum Na^+ levels caused by hyperaldosteronism may also cause increased renal excretion of Mg^{2+} . A pseudohypomagnesemia may also be the result of hyperaldosteronism caused by increased water reabsorption. Hyperthyroidism may result in an increased renal excretion of Mg^{2+} and may also cause an intracellular shift of the ion. In persons with diabetes, excess urinary loss of Mg^{2+} is associated with glycosuria. Hypomagnesemia can aggravate the neuromuscular and vascular complications commonly found in this disease. Some studies have shown a relationship between Mg^{2+}

TABLE 15-11 CAUSES OF HYPOMAGNESEMIA**REDUCED INTAKE**

Poor diet/starvation

Prolonged magnesium-deficient IV therapy

Chronic alcoholism

DECREASED ABSORPTION

Malabsorption syndrome

Surgical resection of small intestine

Nasogastric suction

Pancreatitis

Vomiting

Diarrhea

Laxative abuse

Neonatal

Primary

Congenital

INCREASED EXCRETION—RENAL

Tubular disorder

Glomerulonephritis

Pyelonephritis

INCREASED EXCRETION—ENDOCRINE

Hyperparathyroidism

Hyperaldosteronism

Hyperthyroidism

Hypercalcemia

Diabetic ketoacidosis

INCREASED EXCRETION—DRUG INDUCED

Diuretics

Antibiotics

Cyclosporin

Digitalis

MISCELLANEOUS

Excess lactation

Pregnancy

Adapted with permission from Polancic JE. Magnesium: Metabolism, clinical importance, and analysis. *Clin Lab Sci* 1991;4(2):105–109.

deficiency and insulin resistance; however, Mg^{2+} is not thought to play a role in the pathophysiology of diabetes mellitus. The American Diabetes Association has issued a statement regarding dietary intake of Mg^{2+} and measurement of serum Mg^{2+} in patients with diabetes.¹⁹

Several drugs, including diuretics, gentamicin, cisplatin, and cyclosporine, increase renal loss of Mg^{2+} and frequently result in hypomagnesemia. The loop diuretics,

such as furosemide, are especially effective in increasing renal loss of Mg^{2+} . Thiazide diuretics require a longer period of use to cause hypomagnesemia. Cisplatin has a nephrotoxic effect that inhibits the ability of the renal tubule to conserve Mg^{2+} . Cyclosporine, an immunosuppressant, severely inhibits the renal tubular reabsorption of Mg^{2+} and has many adverse effects, including nephrotoxicity, hypertension, hepatotoxicity, and neurologic symptoms such as seizures and tremors. Cardiac glycosides, such as digoxin and digitalis, can interfere with Mg^{2+} reabsorption. The resulting hypomagnesemia is a significant finding because the decreased level of Mg^{2+} can amplify the symptoms of digitalis toxicity.¹⁶

Excess lactation has been associated with hypomagnesemia as a result of increased use and loss through milk production. Mild deficiencies have been reported in pregnancy, which may cause a hyperexcitable uterus, anxiety, and insomnia.

Symptoms of hypomagnesemia. A patient who is hypomagnesemic may be asymptomatic until serum levels fall below 0.5 mmol/L.¹⁶ A variety of symptoms can occur. The most frequent involve cardiovascular, neuromuscular, psychiatric, and metabolic abnormalities (Table 15-12). The cardiovascular and neuromuscular symptoms result primarily from the ATPase enzyme's requirement for Mg^{2+} . Mg^{2+} loss leads to decreased intracellular K^+ levels because of a faulty Na^+-K^+ pump (ATPase). This change in cellular RMP causes increased excitability that may lead to cardiac arrhythmias. This condition may also lead to digitalis toxicity.

TABLE 15-12 SYMPTOMS OF HYPOMAGNESEMIA

| CARDIOVASCULAR | PSYCHIATRIC |
|--------------------|------------------|
| Arrhythmia | Depression |
| Hypertension | Agitation |
| Digitalis toxicity | Psychosis |
| Neuromuscular | Metabolic |
| Weakness | Hypokalemia |
| Cramps | Hypocalcemia |
| Ataxia | Hypophosphatemia |
| Tremor | Hyponatremia |
| Seizure | |
| Tetany | |
| Paralysis | |
| Coma | |

Adapted with permission from Polancic JE. Magnesium: Metabolism, clinical importance, and analysis. *Clin Lab Sci* 1991;4(2):105–109.

Muscle contraction also requires Mg^{2+} and ATPase for normal Ca^{2+} uptake following contraction. Normal nerve and muscle cell stimulation requires Mg^{2+} to assist with the regulation of acetylcholine, a potent neurotransmitter. Hypomagnesemia can cause a variety of symptoms from weakness to tremors, tetany, paralysis, or coma. The CNS can also be affected, resulting in psychiatric disorders that range from subtle changes to depression or psychosis.

Metabolic disorders are associated with hypomagnesemia. Studies have indicated that approximately 40% of hospitalized patients with hypokalemia are also hypomagnesemic.¹⁷ In addition, 20%–30% of patients with hyponatremia, hypocalcemia, or hypophosphatemia are also hypomagnesemic.¹⁷ Mg^{2+} deficiency can impair PTH release and target tissue response, resulting in hypocalcemia. Replenishing any of these deficient ions alone, often does not remedy the disorder unless Mg^{2+} therapy is provided. Mg^{2+} therapy alone may restore both ion levels to normal; serum levels of the ions must be monitored during treatment.

Treatment of hypomagnesemia. The preferred form of treatment is by oral intake using magnesium lactate, magnesium oxide, or magnesium chloride or an antacid that contains Mg^{2+} . In severely ill patients, an $MgSO_4$ solution is given parenterally. Before initiation of therapy, renal function must be evaluated to avoid inducing hypermagnesemia during treatment.¹⁷

Hypermagnesemia

Hypermagnesemia is observed less frequently than hypomagnesemia.¹⁶ Causes for elevated serum Mg^{2+} levels

TABLE 15-13 CAUSES OF HYPERMAGNESEMIA

| |
|---|
| Decreased excretion |
| Acute or chronic renal failure |
| Hypothyroidism |
| Hypoadosteronism |
| Hypopituitarism (\downarrow GH) |
| Increased intake |
| Antacids |
| Enemas |
| Cathartics |
| Therapeutic—eclampsia, cardiac arrhythmia |
| Miscellaneous |
| Dehydration |
| Bone carcinoma |
| Bone metastases |

Adapted with permission from Polancic JE. Magnesium: Metabolism, clinical importance, and analysis. *Clin Lab Sci* 1991;4(2):105–109.

CASE STUDY 15-2

A 60-year-old man entered the emergency department after 2 days of “not feeling so well.” History revealed a myocardial infarction 5 years ago, when he was prescribed digoxin. Two years ago, he was prescribed a diuretic after periodic bouts of edema. An electrocardiogram at time of admission indicated a cardiac arrhythmia. Admitting lab results are shown in Case Study Table 15-2.1.

Questions

1. Because the digoxin level is within the therapeutic range, what may be the cause for the arrhythmia?
2. What is the most likely cause for the hypomagnesemia?
3. What is the most likely cause for the decreased potassium and ionized calcium levels?
4. What type of treatment would be helpful?

CASE STUDY TABLE 15-2.1 LABORATORY RESULTS

VENOUS BLOOD

Digoxin: 1.4 ng/mL, therapeutic 0.5–2.2 (1.8 nmol/L, therapeutic 0.6–2.8)

Na^+ : 137 mmol/L

K^+ : 2.5 mmol/L

Cl^- : 100 mmol/L

HCO_3^- : 25 mmol/L

Mg^{2+} : 0.4 mmol/L

Ion/free Ca^{2+} : 1.0 mmol/L

are summarized in Table 15-13; the most common is renal failure (GFR, <30 mL/min). The most severe elevations are usually a result of the combined effects of decreased renal function and increased intake of commonly prescribed Mg^{2+} -containing medications, such as antacids, enemas, or cathartics. Nursing home patients are at greatest risk for this occurrence.¹⁶

Hypermagnesemia has been associated with several endocrine disorders. Thyroxine and growth hormone cause a decrease in tubular reabsorption of Mg^{2+} , and a deficiency of either hormone may cause a moderate elevation in serum Mg^{2+} . Adrenal insufficiency may cause a mild elevation as a result of decreased renal excretion of Mg^{2+} .¹⁶

$MgSO_4$ may be used therapeutically with preeclampsia, cardiac arrhythmia, or myocardial infarction. Mg^{2+} is a vasodilator, and can decrease uterine hyperactivity in

eclamptic states and increase uterine blood flow. This therapy can lead to maternal hypermagnesemia, as well as neonatal hypermagnesemia due to the immature kidney of the newborn. Premature infants are at greater risk to develop actual symptoms.¹⁶ Studies have shown that IV Mg^{2+} therapy in myocardial infarction patients may reduce early mortality.¹⁵

Dehydration can cause a pseudohypermagnesemia, which can be corrected with rehydration. Because of increased bone loss, mild serum Mg^{2+} elevations can occur in individuals with multiple myeloma or bone metastases.

Symptoms of hypermagnesemia. Symptoms of hypermagnesemia typically do not occur until the serum level exceeds 1.5 mmol/L.¹⁶ The most frequent symptoms involve cardiovascular, dermatologic, GI, neurologic, neuromuscular, metabolic, and hemostatic abnormalities (Table 15-14). Mild to moderate symptoms, such as hypotension, bradycardia, skin flushing, increased skin temperature, nausea, vomiting, and lethargy may occur when serum levels are 1.5–2.5 mmol/L.¹⁶ Life-threatening symptoms, such as electrocardiogram changes, heart block, asystole, sedation, coma, respiratory depression or arrest, and paralysis, can occur when serum levels reach 5.0 mmol/L.¹⁶

Elevated Mg^{2+} levels may inhibit PTH release and target tissue response. This may lead to hypocalcemia and hypercalcuria.¹⁶ Normal hemostasis is a Ca^{2+} -dependent process that may be inhibited as a result of competition between increased levels of Mg^{2+} and Ca^{2+} ions. Thrombin

generation and platelet adhesion are two processes in which interference may occur.¹⁶

Treatment of hypermagnesemia. Treatment of Mg^{2+} excess associated with increased intake is to discontinue the source of Mg^{2+} . Severe symptomatic hypermagnesemia requires immediate supportive therapy for cardiac, neuromuscular, respiratory, or neurologic abnormalities. Patients with renal failure require hemodialysis. Patients with normal renal function may be treated with a diuretic and IV fluid.

Determination of Magnesium

Specimen

Nonhemolyzed serum or lithium heparin plasma may be analyzed. Because the Mg^{2+} concentration inside erythrocytes is 10 times greater than that in the ECF, hemolysis should be avoided and the serum should be separated from the cells as soon as possible. Oxalate, citrate, and ethylenediaminetetraacetic acid (EDTA) anticoagulants are unacceptable because they will bind with Mg^{2+} . A 24-hour urine sample is preferred for analysis because of a diurnal variation in excretion. The urine must be acidified with HCl to avoid precipitation.

Methods

The three most common methods for measuring total serum Mg^{2+} are colorimetric: calmagite, formazen dye, and methylthymol blue. In the calmagite method, Mg^{2+} binds with calmagite to form a reddish-violet complex that may be read at 532 nm. In the formazen dye method, Mg^{2+} binds with the dye to form a colored complex that may be read at 660 nm. In the methylthymol blue method, Mg^{2+} binds with the chromogen to form a colored complex. Most methods use a Ca^{2+} shelter to prohibit interference from this divalent cation. The reference method for measuring Mg^{2+} is AAS.

Although the measurement of total Mg^{2+} concentrations in serum remains the usual diagnostic test for detection of Mg^{2+} abnormalities, it has limitations. First, because approximately 25% of Mg^{2+} is protein bound, total Mg^{2+} may not reflect the physiologically active free ionized Mg^{2+} . Second, because Mg^{2+} is primarily an intracellular ion, serum concentrations will not necessarily reflect the status of intracellular Mg^{2+} . Even when tissue and cellular Mg^{2+} is depleted by as much as 20%, serum Mg^{2+} concentrations may remain normal.

Reference Ranges

See Table 15-15.³

TABLE 15-15 REFERENCE RANGE FOR MAGNESIUM

| | |
|---------------------|-----------------------------------|
| Serum, colorimetric | 0.63–1.0 mmol/L (1.26–2.10 mEq/L) |
|---------------------|-----------------------------------|

TABLE 15-14 SYMPTOMS OF HYPERMAGNESEMIA

| CARDIOVASCULAR | NEUROMUSCULAR |
|----------------|-------------------------------|
| Hypotension | Decreased reflexes |
| Bradycardia | Dysarthria |
| Heart block | Respiratory depression |
| | Paralysis |
| Dermatologic | Metabolic |
| Flushing | Hypocalcemia |
| Warm skin | |
| GI | Hemostatic |
| Nausea | Decreased thrombin generation |
| Vomiting | Decreased platelet adhesion |
| Neurologic | |
| Lethargy | |
| Coma | |

Adapted with permission from Polancic JE. Magnesium: Metabolism, clinical importance, and analysis. Clin Lab Sci 1991;4(2):105–109.

Calcium

Calcium Physiology

In 1883, Ringer showed that Ca^{2+} was essential for myocardial contraction.²⁰ While attempting to study how bound and free forms of Ca^{2+} affected frog heart contraction, McLean and Hastings showed that the ionized/free Ca^{2+} concentration was proportional to the amplitude of frog heart contraction, whereas protein-bound and citrate-bound Ca^{2+} had no effect.²¹ From this observation, they developed the first assay for ionized/free Ca^{2+} using isolated frog hearts. Although the method had poor precision by today's standards, the investigators were able to show that blood-ionized Ca^{2+} was closely regulated and had a mean concentration in humans of about 1.18 mmol/L. Because decreased ionized Ca^{2+} impairs myocardial function, it is important to maintain ionized Ca^{2+} at a near normal concentration during surgery and in critically ill patients. Decreased ionized Ca^{2+} concentrations in blood can cause neuromuscular irritability, which may become clinically apparent as irregular muscle spasms, called **tetany**.

Regulation

Three hormones, PTH, vitamin D, and calcitonin, are known to regulate serum Ca^{2+} by altering their secretion rate in response to changes in ionized Ca^{2+} . The actions of these hormones are shown in Figure 15-5.

PTH secretion in blood is stimulated by a decrease in ionized Ca^{2+} and, conversely, PTH secretion is stopped by an increase in ionized Ca^{2+} . PTH exerts three major effects on both bone and kidney. In the bone, PTH activates a process known as *bone resorption*, in which activated osteoclasts break down bone and subsequently release Ca^{2+} into the ECF. In the kidneys, PTH conserves Ca^{2+} by increasing tubular reabsorption of Ca^{2+} ions. PTH also stimulates renal production of active vitamin D.

Vitamin D₃, a cholecalciferol, is obtained from the diet or exposure of skin to sunlight. Vitamin D₃ is then converted in the liver to 25-hydroxycholecalciferol (25-OH-D₃), still an inactive form of vitamin D. In the kidney, 25-OH-D₃ is specifically hydroxylated to form 1,25-dihydroxycholecalciferol (1,25-[OH]₂-D₃), the biologically active form. This active form of vitamin D increases Ca^{2+} absorption in the intestine and enhances the effect of PTH on bone resorption.

Calcitonin, which originates in the medullary cells of the thyroid gland, is secreted when the concentration of Ca^{2+} in blood increases. Calcitonin exerts its Ca^{2+} -lowering effect by inhibiting the actions of both PTH and vitamin D. Although calcitonin is apparently not secreted during normal regulation of the ionized Ca^{2+} concentration in blood, it is secreted in response to a hypocalcemic stimulus.

CASE STUDY 15-3

An 84-year-old nursing home resident was seen in the emergency department with the following symptoms: nausea, vomiting, decreased respiration, hypotension, and low pulse rate (46). Physical examination showed the skin was warm to the touch and flushed. Admission laboratory data are found in Case Study Table 15-3.1.

Questions

1. What is the most likely cause for the patient's symptoms?
2. What is the most likely cause for the hypermagnesemia?
3. What could be the cause for the hypocalcemia?

CASE STUDY TABLE 15-3.1 LABORATORY RESULTS

| | | RESULT | REFERENCE RANGE |
|--------|-------------------------------|------------|-----------------|
| Serum | Total protein | 5.6 g/dL | 6.0–8.0 g/dL |
| | Albumin | 3.0 g/dL | 3.5–5.0 g/dL |
| | Total Ca^{2+} | 8.2 g/dL | 8.6–10.0 g/dL |
| | BUN | 45 mg/dL | 5–20 mg/dL |
| Plasma | Creatinine | 2.3 mg/dL | 0.7–1.5 mg/dL |
| | Mg ²⁺ | 4.0 mmol/L | 0.63–1.0 mmol/L |
| | Na ⁺ | 129 mmol/L | 136–145 mmol/L |
| | K ⁺ | 5.3 mmol/L | 3.4–5.0 mmol/L |
| | Cl ⁻ | 96 mmol/L | |
| | HCO ₃ ⁻ | 16 mmol/L | |

Distribution

About 99% of Ca^{2+} in the body is part of bone. The remaining 1% is mostly in the blood and other ECF. Little is in the cytosol of most cells. In fact, the concentration of ionized Ca^{2+} in blood is 5,000 to 10,000 times higher than in the cytosol of cardiac or smooth muscle cells. Maintenance of this large gradient is vital to maintain the essential rapid inward flux of Ca^{2+} .

Ca^{2+} in blood is distributed among several forms. About 45% circulates as free Ca^{2+} ions (referred to as ionized Ca^{2+}), 40% is bound to protein, mostly albumin, and 15% is bound to anions, such as HCO₃⁻, citrate, PO₄⁻, and lactate. Clearly, this distribution can change in disease. It is noteworthy that concentrations of citrate,

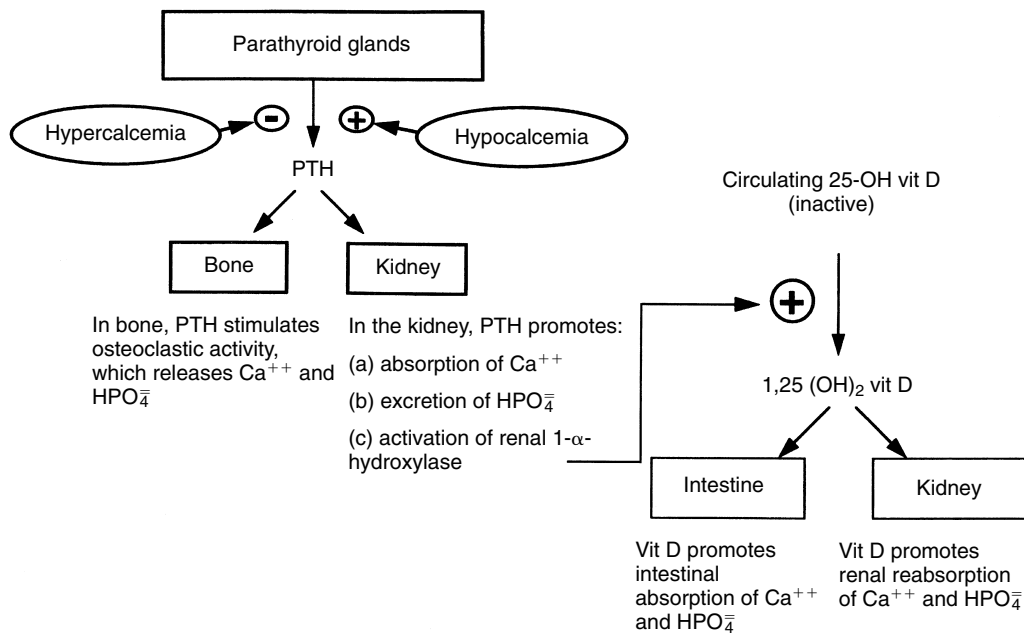

FIGURE 15-5. Hormonal response to hypercalcemia and hypocalcemia. PTH, parathyroid hormone; 25-OH vit D, 25-hydroxy vitamin D; 1,25(OH) $_2$ vit D, dihydroxy vitamin D.

HCO_3^- , lactate, PO_4^- , and albumin can change dramatically during surgery or critical care. This is why ionized Ca^{2+} cannot be reliably calculated from total Ca^{2+} measurements, especially in acutely ill individuals.

Clinical Applications

Tables 15-16 and 15-17 summarize causes of hypocalcemic and hypercalcemic disorders. Although both total Ca^{2+} and ionized Ca^{2+} measurements are available in many laboratories, ionized Ca^{2+} is usually a more sensitive and specific marker for Ca^{2+} disorders.

Hypocalcemia

When PTH is not present, as with *primary hypoparathyroidism*, serum Ca^{2+} levels are not properly regulated.

TABLE 15-16 CAUSES OF HYPOCALCEMIA

Primary hypoparathyroidism—glandular aplasia, destruction, or removal

Hypomagnesemia

Hypermagnesemia

Hypoalbuminemia (total calcium only, ionized not affected by)—chronic liver disease, nephrotic syndrome, malnutrition

Acute pancreatitis

Vitamin D deficiency

Renal disease

Rhabdomyolysis

Pseudohypoparathyroidism

Bone tends to “hang on” to its storage pool and the kidney increases excretion of Ca^{2+} . Because PTH is also required for normal vitamin D metabolism, the lack of vitamin D’s effects also leads to a decreased level of Ca^{2+} . Parathyroid gland aplasia, destruction, or removal are obvious reasons for primary hypoparathyroidism.

Because hypomagnesemia has become more frequent in hospitalized patients, chronic hypomagnesemia has also become recognized as a frequent cause of **hypocalcemia**. Hypomagnesemia may cause hypocalcemia by three mechanisms: (1) it inhibits the glandular secretion of PTH across the parathyroid gland membrane, (2) it impairs PTH action at its receptor site on bone, and (3) it causes vitamin D resistance.¹⁵ Elevated Mg^{2+} levels may inhibit PTH release and target tissue response, perhaps leading to hypocalcemia and hypercalciuria.¹⁶

TABLE 15-17 CAUSES OF HYPERCALCEMIA

Primary hyperparathyroidism—adenoma or glandular hyperplasia

Hyperthyroidism

Benign familial hypocalciuria

Malignancy

Multiple myeloma

Increased vitamin D

Thiazide diuretics

Prolonged immobilization

When total Ca^{2+} is the only result reported, hypocalcemia can appear with hypoalbuminemia. Common causes are associated with chronic liver disease, nephrotic syndrome, and malnutrition. In general, for each 1 g/dL decrease in serum albumin, there is a 0.2 mmol/L (0.8 mg/dL) decrease in total Ca^{2+} levels.²²

About one half of the patients with acute pancreatitis develop hypocalcemia. The most consistent cause appears to be a result of increased intestinal binding of Ca^{2+} as increased intestinal lipase activity occurs.²² Vitamin D deficiency and malabsorption can cause decreased absorption, which leads to increased PTH production or secondary hyperparathyroidism.

Patients with renal disease caused by glomerular failure often have altered concentrations of Ca^{2+} , PO_4^- , albumin, Mg^{2+} , and H^+ (pH). In chronic renal disease, secondary hyperparathyroidism frequently develops as the body tries to compensate for hypocalcemia caused either by hyperphosphatemia (PO_4^- binds and lowers ionized Ca^{2+}) or altered vitamin D metabolism. Monitoring and controlling ionized Ca^{2+} concentrations may avoid problems due to hypocalcemia, such as osteodystrophy, unstable cardiac output or blood pressure, or problems arising from hypercalcemia, such as renal stones and other calcifications. Rhabdomyolysis, as with major crush injury and muscle damage, may cause hypocalcemia as a result of increased PO_4^- release from cells, which bind to Ca^{2+} ions.²²

Pseudohypoparathyroidism is a rare hereditary disorder in which PTH target tissue response is decreased (end organ resistance). PTH production responds normally to loss of Ca^{2+} ; however, without normal response (decreased cAMP [cyclic adenosine 3',5'-phosphate] production), Ca^{2+} is lost in the urine or remains in the bone storage pool. Patients often have common physical features, including short stature, obesity, shortened metacarpals and metatarsals, and abnormal calcification.

Surgery and intensive care. Because appropriate Ca^{2+} concentrations promote good cardiac output and maintain adequate blood pressure, the maintenance of a normal ionized Ca^{2+} concentration in blood is beneficial to patients in either surgery or intensive care. Controlling Ca^{2+} concentrations may be critical in open heart surgery when the heart is restarted and during liver transplantation because large volumes of citrated blood are given.

Because these patients may receive large amounts of citrate, HCO_3^- , Ca^{2+} salts, or fluids, the greatest discrepancies between total Ca^{2+} and ionized Ca^{2+} concentrations may be seen during major surgical operations. Consequently, ionized Ca^{2+} measurements are the Ca^{2+} measurement of greatest clinical value.

Hypocalcemia occurs commonly in critically ill patients, that is, those with sepsis, thermal burns, renal failure, or cardiopulmonary insufficiency. These patients frequently have abnormalities of acid-base regulation

and losses of protein and albumin, which are best suited to monitoring Ca^{2+} status by ionized Ca^{2+} measurements. Normalization of ionized Ca^{2+} may have beneficial effects on cardiac output and blood pressure.

Neonatal monitoring. Typically, blood-ionized Ca^{2+} concentrations in neonates are high at birth and then rapidly decline by 10%–20% after 1–3 days. After about 1 week, ionized Ca^{2+} concentrations in the neonate stabilize at levels slightly higher than in adults.²³

The concentration of ionized Ca^{2+} may decrease rapidly in the early neonatal period because the infant may lose Ca^{2+} rapidly and not readily reabsorb it. Several possible etiologies have been suggested: abnormal PTH and vitamin D metabolism, hypercholesterolemia, hypophosphatemia, and hypomagnesemia.

Symptoms of hypocalcemia. Neuromuscular irritability and cardiac irregularities are the primary groups of symptoms that occur with hypocalcemia. Neuromuscular symptoms include paresthesia, muscle cramps, tetany, and seizures. Cardiac symptoms may include arrhythmia or heart block. Symptoms usually occur with severe hypocalcemia, in which total Ca^{2+} levels are below 1.88 mmol/L (7.5 mg/dL).²²

Treatment of hypocalcemia. Oral or parenteral Ca^{2+} therapy may occur, depending on the severity of the decreased level and the cause. Vitamin D may sometimes be administered in addition to oral Ca^{2+} to increase absorption. If hypomagnesemia is a concurrent disorder, Mg^{2+} therapy should also be provided.

Hypercalcemia

Primary hyperparathyroidism is the main cause of **hypercalcemia**.²² Hyperparathyroidism, or excess secretion of PTH, may show obvious clinical signs or may be asymptomatic. The patient population seen most frequently with primary hyperparathyroidism is older women.²² Although either total or ionized Ca^{2+} measurements are elevated in serious cases, ionized Ca^{2+} is more frequently elevated in subtle or asymptomatic hyperparathyroidism. In general, ionized Ca^{2+} measurements are elevated in 90% to 95% of cases of hyperparathyroidism, whereas total Ca^{2+} is elevated in 80% to 85% of cases.

The second leading cause of hypercalcemia is associated with various types of malignancy, with hypercalcemia sometimes being the sole biochemical marker for disease.²² Many tumors produce PTH-related peptide (PTH-rP), which binds to normal PTH receptors and causes increased Ca^{2+} levels. Assays to measure PTH-rP are available because this abnormal protein is not detected by most PTH assays.

Because of the proximity of the parathyroid gland to the thyroid gland, hyperthyroidism can sometimes cause

hyperparathyroidism. A rare, benign, familial hypocalcemia has also been reported. Thiazide diuretics increase Ca^{2+} reabsorption, leading to hypercalcemia. Prolonged immobilization may cause increased bone resorption. Hypercalcemia associated with immobilization is further compounded by renal insufficiency.

Symptoms of hypercalcemia. A mild hypercalcemia (2.62–3.00 mmol/L [10.5–12 mg/dL]) is often asymptomatic.²² Moderate or severe Ca^{2+} elevations include neurologic, GI, and renal symptoms. Neurologic symptoms may include mild drowsiness or weakness, depression, lethargy, and coma. GI symptoms may include constipation, nausea, vomiting, anorexia, and peptic ulcer disease. Hypercalcemia may cause renal symptoms of nephrolithiasis and nephrocalcinosis. Hypercalciuria can result in nephrogenic diabetes insipidus, which causes polyuria that results in hypovolemia, which further aggravates the hypercalcemia.²² Hypercalcemia can also cause symptoms of digitalis toxicity.

Treatment of hypercalcemia. Treatment of hypercalcemia depends on the level of hypercalcemia and the cause. Often people with primary hyperparathyroidism are asymptomatic. Estrogen deficiency in postmenopausal women has been implicated in primary hyperparathyroidism in older women.²² Often, estrogen replacement therapy reduces Ca^{2+} levels. Parathyroidectomy may be necessary in some hyperparathyroidic patients. Patients with moderate to severe hypercalcemia are treated to reduce Ca^{2+} levels. Salt and water intake is encouraged to increase Ca^{2+} excretion and avoid dehydration, which can compound the hypercalcemia. Thiazide diuretics should be discontinued. Biphosphanates (a derivative of pyrophosphate) are the main drug class used to lower Ca^{2+} levels, achieved by its binding action to bone, which prevents bone resorption.²²

Determination of Calcium

Specimen

The preferred specimen for total Ca^{2+} determinations is either serum or lithium heparin plasma collected without venous stasis. Because anticoagulants such as EDTA or oxalate bind Ca^{2+} tightly and interfere with measurement, they are unacceptable for use.

The proper collection of samples for ionized Ca^{2+} measurements requires greater care. Because loss of CO_2 will increase pH, samples must be collected anaerobically. Although heparinized whole blood is the preferred sample, serum from sealed evacuated blood-collection tubes may be used if clotting and centrifugation are done quickly (<30 minutes) and at room temperature. No liquid heparin products should be used. Most heparin anticoagulants (Na^+ , lithium) partially bind to Ca^{2+} and lower ionized Ca^{2+} concentrations. A heparin concentration of 25 IU/mL, for example, decreases ionized Ca^{2+} by about 3%. Dry heparin products are available titrated with

small amounts of Ca^{2+} or Zn^{2+} or with small amounts of heparin dispersed in an inert “puff” that essentially eliminates the interference by heparin.

For analysis of Ca^{2+} in urine, an accurately timed urine collection is preferred. The urine should be acidified with 6 mol/L HCl, with approximately 1 mL of the acid added for each 100 mL of urine.

Methods

The two commonly used methods for total Ca^{2+} analysis use either ortho-cresolphthalein complexone (CPC) or arsenzo III dye to form a complex with Ca^{2+} . Prior to the dye-binding reaction, Ca^{2+} is released from its protein carrier and complexes by acidification of the sample. The CPC method uses 8-hydroxyquinoline to prevent Mg^{2+} interference. AAS remains the reference method for total Ca^{2+} , although is rarely used in the clinical setting.

Current commercial analyzers that measure ionized/free Ca^{2+} use ISEs for this measurement. These systems may use membranes impregnated with special molecules that selectively, but reversibly, bind Ca^{2+} ions. As Ca^{2+} binds to these membranes, an electric potential develops across the membrane that is proportional to the ionized Ca^{2+} concentration. A diagram of one such electrode is shown in Figure 15-6.

Reference Ranges

For total Ca^{2+} , the reference range varies slightly with age.³ In general, Ca^{2+} concentrations are higher through adolescence when bone growth is most active. Ionized/free Ca^{2+} concentrations can change rapidly from day 1 to day 3 of life. Following this, they stabilize at relatively high levels, with a gradual decline through adolescence; see Table 15-18.

Phosphate

Phosphate Physiology

Found everywhere in living cells, phosphate compounds participate in many of the most important biochemical processes. The genetic materials deoxyribonucleic acid (DNA) and ribonucleic acid (RNA) are complex phosphodiesteres. Most coenzymes are esters of phosphoric or pyrophosphoric acid. The most important reservoirs of biochemical energy are ATP, creatine phosphate, and phosphoenolpyruvate. Phosphate deficiency can lead to ATP depletion, which is ultimately responsible for many of the clinical symptoms observed in hypophosphatemia.

Alterations in the concentration of 2,3-bisphosphoglycerate (2,3-BPG) in red blood cells affect the affinity of hemoglobin for oxygen, with an increase facilitating the release of oxygen in tissue and a decrease making oxygen bound to hemoglobin less available. By affecting the formation of 2,3-BPG, the concentration of inorganic phosphate indirectly affects the release of oxygen from hemoglobin.

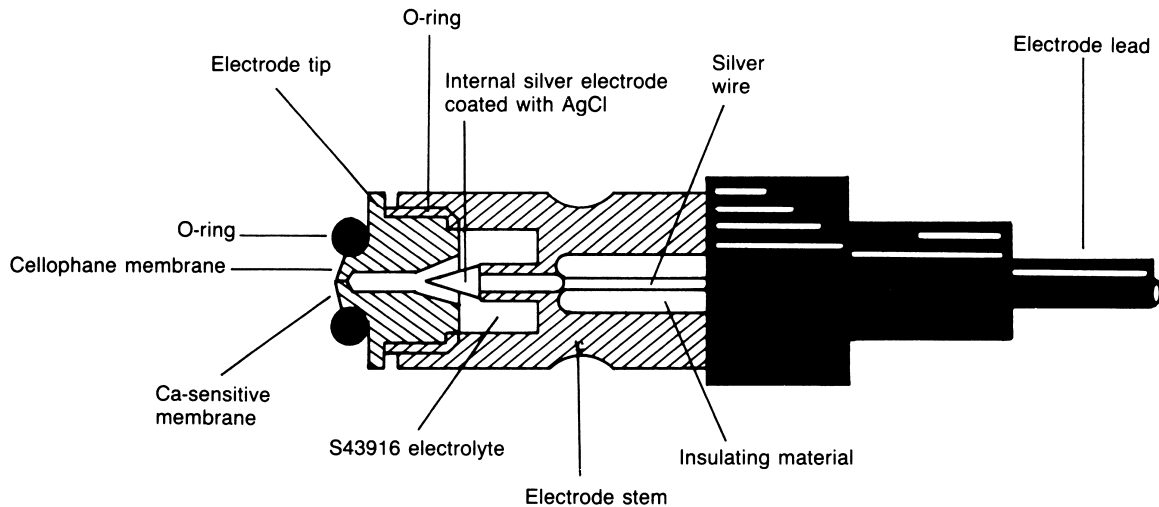

FIGURE 15-6. Diagram of ionized calcium electrode for the ICA ionized calcium analyzer. (Courtesy of Radiometer America, Westlake, Ohio.)

Understanding the cause of an altered phosphate concentration in the blood is often difficult because transcellular shifts of phosphate are a major cause of hypophosphatemia in blood. That is, an increased shift of phosphate into cells can deplete phosphate in the blood. Once phosphate is taken up by the cell, it remains there to be used in the synthesis of phosphorylated compounds. As these phosphate compounds are metabolized, inorganic phosphate slowly leaks out of the cell into the blood, where it is regulated principally by the kidney.

Regulation

Phosphate in blood may be absorbed in the intestine from dietary sources, released from cells into blood, and lost from bone. In healthy individuals, all these processes are relatively constant and easily regulated by renal excretion or reabsorption of phosphate.

Disturbances to any of these processes can alter phosphate concentrations in the blood; however, the loss of regulation by the kidneys will have the most profound effect. Although other factors, such as vitamin D, calcitonin, growth hormone, and acid-base status, can affect renal regulation of phosphate, the most important factor is PTH, which overall lowers blood concentrations by increasing renal excretion.

Vitamin D acts to increase phosphate in the blood. Vitamin D increases both phosphate absorption in the intestine and phosphate reabsorption in the kidney.

Growth hormone, which helps regulate skeletal growth, can affect circulating concentrations of phosphate. In cases of excessive secretion or administration of growth hormone, phosphate concentrations in the blood may increase because of decreased renal excretion of phosphate.

Distribution

Although the concentration of all phosphate compounds in blood is about 12 mg/dL (3.9 mmol/L), most of that is organic phosphate and only about 3 to 4 mg/dL is inorganic phosphate. Phosphate is the predominant intracellular anion, with intracellular concentrations varying, depending on the type of cell. About 80% of the total body pool of phosphate is contained in bone, 20% in soft tissues, and less than 1% is active in the serum/plasma.

Clinical Applications

Hypophosphatemia

Hypophosphatemia occurs in about 1% to 5% of hospitalized patients.²⁴ The incidence of hypophosphatemia increases to 20% to 40% in patients with the following disorders: diabetic ketoacidosis, chronic obstructive pulmonary disease (COPD), asthma, malignancy, long-term treatment with total parenteral nutrition (TPN),

TABLE 15-18 REFERENCE RANGES FOR CALCIUM

| TOTAL CALCIUM—SERUM, PLASMA | |
|-----------------------------|---|
| Child, <12 years | 2.20–2.70 mmol/L (8.8–10.8 mg/dL) |
| Adult | 2.15–2.50 mmol/L (8.6–10.0 mg/dL) |
| IONIZED CALCIUM—SERUM | |
| Child | 1.20–1.38 mmol/L (4.8–5.5 mg/dL) |
| Adult | 1.16–1.32 mmol/L (4.6–5.3 mg/dL) |
| IONIZED CALCIUM—PLASMA | |
| Adult | 1.03–1.23 mmol/L (4.1–4.9 mg/dL) |
| IONIZED CALCIUM—WHOLE BLOOD | |
| Adult | 1.15–1.27 mmol/L (4.6–5.1 mg/dL) |
| TOTAL CALCIUM—URINE (24-h) | |
| | 2.50–7.50 mmol/day (100–300 mg/day), varies with diet |

inflammatory bowel disease, anorexia nervosa, and alcoholism. The incidence increases to 60% to 80% in ICU patients with sepsis. In addition, hypophosphatemia can also be caused by increased renal excretion, as with hyperparathyroidism, and decreased intestinal absorption, as with vitamin D deficiency or antacid use.²⁴

Although most cases are moderate and seldom cause problems, severe hypophosphatemia (<1.0 g/dL or 0.3 mmol/L) requires monitoring and possible replacement therapy. There is a 30% mortality rate in those who are severely hypophosphatemic versus a 15% rate in those with normal or mild hypophosphatemia.²⁴

Hyperphosphatemia

Patients at greatest risk for **hyperphosphatemia** are those with acute or chronic renal failure.²⁴ An increased intake of phosphate or increased release of cellular phosphate may also cause hyperphosphatemia. Because they may not yet have developed mature PTH and vitamin D metabolism, neonates are especially susceptible to hyperphosphatemia caused by increased intake, such as from cow's milk or laxatives. Increased breakdown of cells can sometimes lead to hyperphosphatemia, as with severe infections, intensive exercise, neoplastic disorders, or intravascular hemolysis. Because immature lymphoblasts have about four times the phosphate content of mature lymphocytes, patients with lymphoblastic leukemia are especially susceptible to hyperphosphatemia.

Determination of Inorganic Phosphorus

Specimen

Serum or lithium heparin plasma is acceptable for analysis. Oxalate, citrate, or EDTA anticoagulants should not be used because they interfere with the analytic method. Hemolysis should be avoided because of the higher concentrations inside the red cells. Circulating phosphate levels are subject to circadian rhythm, with highest levels in late morning and lowest in the evening. Urine analysis for phosphate requires a 24-hour sample collection because of significant diurnal variations.

Methods

Most of the current methods for phosphorus determination involve the formation of an ammonium phosphomolybdate complex. This colorless complex can be measured by ultraviolet absorption at 340 nm or can be reduced to form molybdenum blue, a stable blue chromophore, which is read between 600 and 700 nm.

Reference Ranges

Phosphate values vary with age. Divided into age groups, the ranges are shown in Table 15-19.

Lactate

Lactate Biochemistry and Physiology

Lactate is a by-product of an emergency mechanism that produces a small amount of ATP when oxygen delivery

TABLE 15-19 REFERENCE RANGES FOR INORGANIC PHOSPHORUS

| SERUM | |
|-----------------|----------------------------------|
| Neonate | 1.45–2.91 mmol/L (4.5–9.0 mg/dL) |
| Child ≤15 years | 1.07–1.74 mmol/L (3.3–5.4 mg/dL) |
| Adult | 0.78–1.42 mmol/L (2.4–4.4 mg/dL) |
| Urine (24-h) | 13–42 mmol/day (0.4–1.3 g/day) |

is severely diminished. Pyruvate is the normal end product of glucose metabolism (glycolysis). The conversion of pyruvate to lactate is activated when a deficiency of oxygen leads to an accumulation of excess NADH (Fig. 15-7). Normally, sufficient oxygen maintains a favorably high ratio of NAD to NADH. Under these conditions, pyruvate is converted to acetyl-coenzyme A (CoA), which enters the citric acid cycle and produces 38 moles of ATP for each mole of glucose oxidized. However, under hypoxic conditions, acetyl-CoA formation does not occur and NADH accumulates, favoring the conversion of pyruvate to lactate through anaerobic metabolism. As a result, only 2 moles of ATP are produced for each mole of glucose metabolized to lactate, with the excess lactate released into the blood. This release of lactate into blood has clinical importance because the accumulation of excess lactate in blood is an early, sensitive, and quantitative indicator of the severity of oxygen deprivation (Fig. 15-8).

Regulation

Because lactate is a by product of anaerobic metabolism, it is not specifically regulated, as with K^+ or Ca^{2+} , for example. As oxygen delivery decreases below a critical level, blood lactate concentrations rise rapidly and indicate tissue hypoxia earlier than pH. The liver is the major organ for removing lactate by converting lactate back to glucose by a process called *gluconeogenesis*.

Clinical Applications

Measurements of blood lactate are useful for metabolic monitoring in critically ill patients, for indicating the severity of the illness, and for objectively determining patient prognosis.

There are two types of lactic acidosis. Type A is associated with hypoxic conditions, such as shock, myocardial infarction, severe congestive heart failure, pulmonary edema, or severe blood loss. Type B is of metabolic origin, such as with diabetes mellitus, severe infection, leukemia, liver or renal disease, and toxins (ethanol, methanol, or salicylate poisoning).

Determination of Lactate

Specimen Handling

Special care should be practiced when collecting and handling specimens for lactate analysis. Ideally, a tourniquet

Aerobic Metabolism

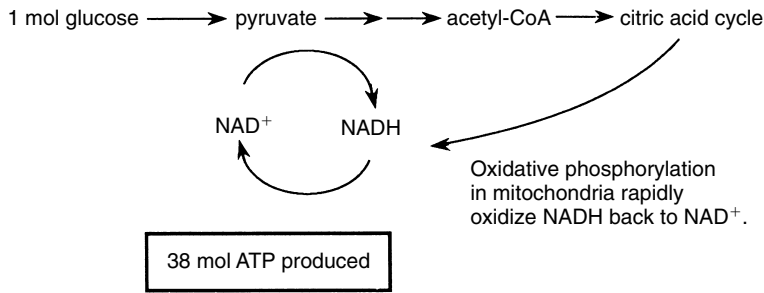

Anaerobic Metabolism

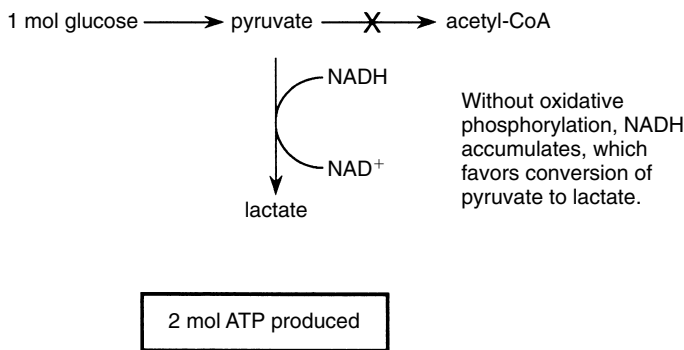

FIGURE 15-7. Aerobic versus anaerobic metabolism of glucose.

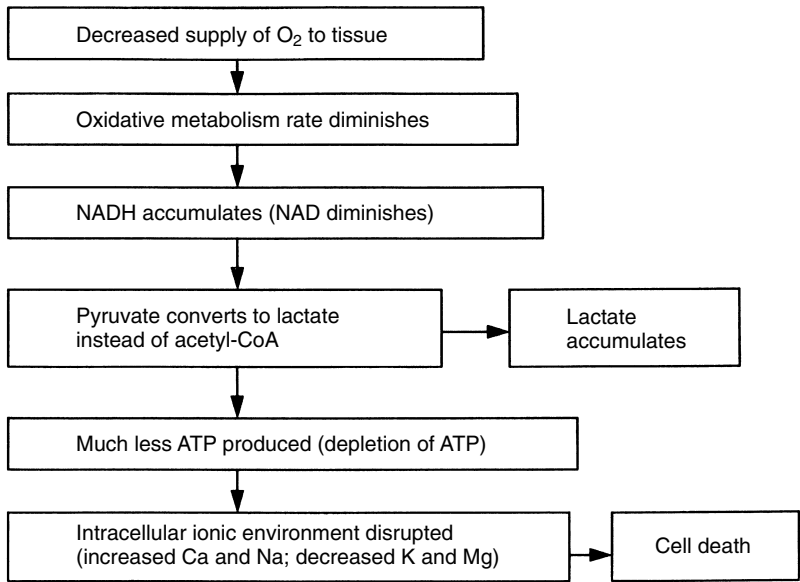

FIGURE 15-8. Metabolic effects of hypoxia, leading to cell death.

TABLE 15-20 REFERENCE RANGES FOR LACTATE

| | ENZYMATIC METHOD, PLASMA | COLORIMETRIC, WHOLE BLOOD |
|----------|---------------------------------|---------------------------------|
| Venous | 0.5–2.2 mmol/L (4.5–19.8 mg/dL) | 0.9–1.7 mmol/L (8.1–15.3 mg/dL) |
| Arterial | 0.5–1.6 mmol/L (4.5–14.4 mg/dL) | <1.3 mmol/L (<11.3 mg/dL) |
| CSF | 1.0–2.9 mmol/L (9–26 mg/dL) | |

should not be used because venous stasis will increase lactate levels. If a tourniquet is used, blood should be collected immediately and the patient should not exercise the hand before or during collection.¹⁴ After sample collection, glucose is converted to lactose by way of anaerobic glycolysis and should be prevented. Heparinized blood may be used but must be delivered on ice and the plasma must be quickly separated. Iodoacetate or fluoride, which inhibit glycolysis without affecting coagulation, are usually satisfactory additives, but the specific method directions must be consulted.

Methods

Although lactate is a sensitive indicator of inadequate tissue oxygenation, the use of blood lactate measurements has been hindered because older methods were slow and laborious. Other means of following perfusion or oxygenation have been used, such as indwelling catheters that measure blood flow, pulse oximeters, base-excess determinations, and measurements of oxygen consumption (VO₂). Current enzymatic methods make lactate determination readily available.

The most commonly used enzymatic method uses lactate oxidase to produce pyruvate and H₂O₂.

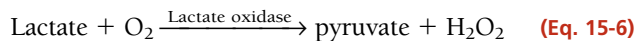

One of two couple reactions may then be used. Peroxidase may be used to produce a colored chromogen from H₂O₂.

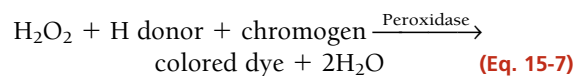

Reference Ranges

See Table 15-20.³

ANION GAP

Routine measurement of electrolytes usually involves only Na⁺, K⁺, Cl⁻, and HCO₃⁻ (as total CO₂). These values may be used to approximate the **anion gap (AG)**, which is the difference between unmeasured anions and unmeasured cations. There is never a “gap” between total cationic charges and anionic charges. The AG is created by the concentration difference between commonly

CASE STUDY 15-4

Consider the following laboratory results from three adult patients:

Questions

- Which set of laboratory results (Case A, B, or C) is most likely associated with each of the following diagnoses:

- Primary hyperparathyroidism
- Malignancy
- Hypomagnesemic hypocalcemia

CASE STUDY TABLE 15-4.1 LABORATORY RESULTS

| | REFERENCE RANGES | | | | |
|------|---|--|---|----------------------|--|
| Case | Ion Ca ²⁺ 1.16–1.32 mmol/L | Total Mg ²⁺ 0.63–1.0 mmol/L | PO ₄ ⁻ 0.87–1.45 mmol/L | Hematocrit 35–45% | Intact Parathyroid Hormone 13–64 ng/L |
| A | 1.44 | 0.90 | 0.85 | 42 | 100 |
| B | 1.08 | 0.50 | 0.90 | 40 | 25 |
| C | 1.70 | 0.98 | 1.43 | 30 | 12 |

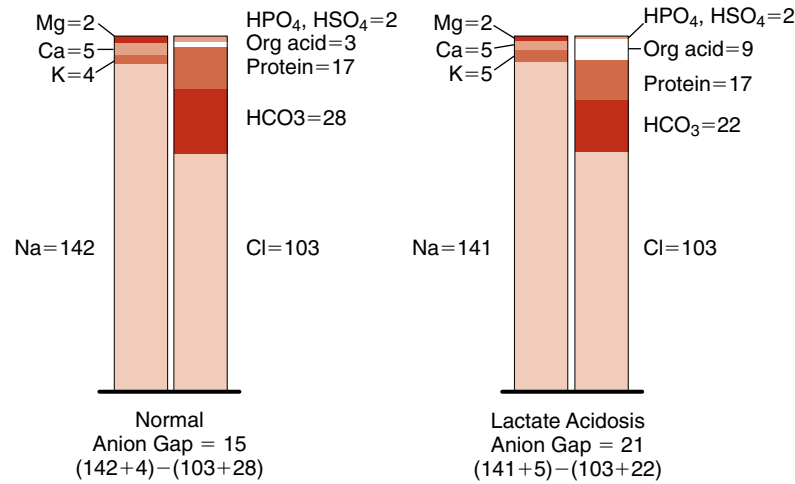

FIGURE 15-9. Demonstration of anion gap from concentrations of anions and cations in normal state and in lactate acidosis.

measured cations (Na+K) and commonly measured anions (Cl+HCO₃), as shown in Figure 15-9. AG is useful in indicating an increase in one or more of the unmeasured anions in the serum and also as a form of quality control for the analyzer used to measure these electrolytes. Consistently abnormal anion gaps in serum from healthy persons may indicate an instrument problem.

There are two commonly used methods for calculating the anion gap. The first equation is

$$Ag^{2+} = Na^+ - (Cl^- + HCO_3^-) \quad (\text{Eq. 15-8})$$

It is equivalent to unmeasured anions minus the unmeasured cations in this way:

$$(PO_4^- + 2SO_4^{2-}) - (K^+ + 2Ca^{2+} + Mg^{2+}) \quad (\text{Eq. 15-9})$$

The reference range for the Ag²⁺ using this calculation is 7–16 mmol/L.³ The second calculation method is

$$Ag^{2+} = (Na^+ + K^+) - (Cl^- + HCO_3^-) \quad (\text{Eq. 15-10})$$

It has a reference range of 10–20 mmol/L.³

An elevated anion gap may be caused by uremia/renal failure, which leads to PO₄⁻ and SO₄²⁻ retention; ketoacidosis, as seen in cases of starvation or diabetes; methanol, ethanol, ethylene glycol poisoning, or salicylate; lactic acidosis; hypernatremia; and instrument error. Low anion gap values are rare but may be seen with hypoalbuminemia (decrease in unmeasured anions) or severe hypercalcemia (increase in unmeasured cations).

ELECTROLYTES AND RENAL FUNCTION

The kidney is central to the regulation and conservation of electrolytes in the body. For a review of kidney structure, refer to Figure 15-10 and Chapter 26. The following is a

summary of electrolyte excretion and conservation in a healthy individual:

1. Glomerulus: This portion of the nephron acts as a filter, retaining large proteins and protein-bound constituents while most other plasma constituents pass into the filtrate. The concentrations in the filtered

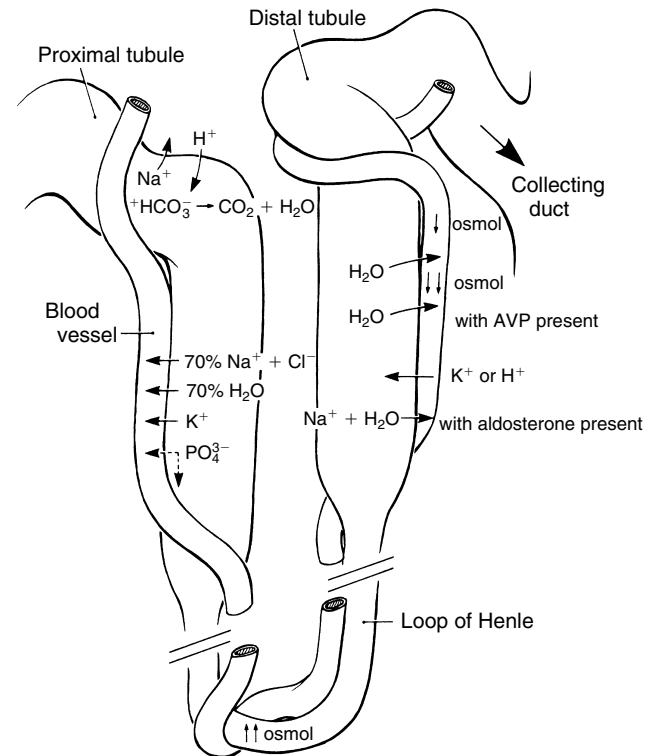

FIGURE 15-10. Summary of electrolyte movements in the renal tubules.

CASE STUDY 15-5

A 15-year-old girl in a coma was brought to the emergency department by her parents. She has diabetes and has been insulin dependent for 7 years. Her parents stated that there have been several episodes of hypoglycemia and ketoacidosis in the past and that their daughter has often been “too busy” to take her insulin injections. The laboratory results obtained on admission are shown in Case Study Table 15-5.1.

Questions

1. What is the diagnosis?
2. Calculate the anion gap. What is the cause of the anion gap result in this patient?
3. Why are chloride and bicarbonate decreased? What is the significance of the elevated potassium value?
4. What is the significance of the plasma osmolality?

CASE STUDY TABLE 15-5.1 LABORATORY RESULTS

| | | RESULT | REFERENCE RANGE |
|----------------|-------------------------------|---------------|-------------------|
| Venous blood | Na ⁺ | 145 mmol/L | 136–145 mmol/L |
| | K ⁺ | 5.8 mmol/L | 3.4–5.0 mmol/L |
| | Cl ⁻ | 87 mmol/L | 98–107 mmol/L |
| | HCO ₃ ⁻ | 8 mmol/L | 22–29 mmol/L |
| | Glucose | 1050 mg/dL | 70–110 mg/dL |
| | Urea nitrogen | 35 mg/dL | 7–18 mg/dL |
| | Creatinine | 1.3 mg/dL | 0.5–1.3 mg/dL |
| | Lactate | 5 mmol/L | 0.5–2.2 mmol/L |
| | Osmolality | 385 mOsmol/kg | 275–295 mOsmol/kg |
| Arterial blood | pH | 7.11 | 7.35–7.45 |
| | pO ₂ | 98 mm Hg | 83–100 mm Hg |
| | pCO ₂ | 20 mm Hg | 35–45 mm Hg |
| Urine | | Normal | |
| | Glucose | 4+ | Negative |
| | Ketones | 4+ | Negative |

plasma should be approximately equal to ECF without protein.

- Renal tubules:
 - Phosphate reabsorption is inhibited by PTH and increased by 1,25-dihydroxycholecalciferol. Excretion of PO₄ is stimulated by calcitonin.
 - Ca²⁺ is reabsorbed under the influence of PTH and 1,25-dihydroxycholecalciferol. Calcitonin stimulates excretion of Ca²⁺.
 - Mg²⁺ reabsorption occurs largely in the thick ascending limb of Henle's loop.
 - Sodium reabsorption can occur through three mechanisms:

Approximately 70% of the Na⁺ in the filtrate is reabsorbed in the proximal tubules by iso-osmotic reabsorption. It is limited, however, by the availability of Cl⁻ to maintain electrical neutrality.

Na⁺ is reabsorbed in exchange for H⁺. This reaction is linked with HCO₃⁻ and depends on carbonic anhydrase.

Stimulated by aldosterone, Na⁺ is reabsorbed in exchange for K⁺ in the distal tubules. (H⁺ competes with K⁺ for this exchange.)

- Cl⁻ is reabsorbed, in part, by passive transport in the proximal tubule along the concentration gradient created by Na⁺.
- K⁺ is reabsorbed by two mechanisms:
 - Active reabsorption in the proximal tubule almost completely conserves K⁺.
 - Exchange with Na⁺ is stimulated by aldosterone. H⁺ competes with K⁺ for this exchange.
- Bicarbonate is recovered from the glomerular filtrate and converted to CO₂ when H⁺ is excreted in the urine.

Henle's loop: With normal AVP function, it creates an osmotic gradient that enables water reabsorption to be increased or decreased in response to body fluid changes in osmolality.

Collecting ducts: Also under AVP influence, this is where final adjustment of water excretion is made.

REFERENCES

1. Rose BD, ed. *Clinical physiology of acid-base and electrolyte disorders*. 5th ed. New York: McGraw-Hill, 2001:163–228, 241–257, 372–402, 696–793, 836–930.
2. Burtis CA, Ashwood ER, Bruns DE, eds. *Tietz textbook of clinical chemistry and molecular diagnostics*. 4th ed. St. Louis, Mo.: Elsevier Saunders, 2006:49, 985, 991–992.
3. Wu HB, ed. *Tietz Clinical Guide to Laboratory Tests*, 4th ed. St. Louis: Elsevier Saunders, 2006:118, 214, 198–200, 234–237, 650–653, 706–707, 786–789, 852–855, 880–883, 992–996.
4. Oh MS. Pathogenesis and diagnosis of hyponatremia. *Nephron* 2002;92(Suppl 1):2–8.
5. Munger MA. New agents for managing hyponatremia in hospitalized patients. *Am J Health Syst Pharm* 2007;64:253–265.
6. Oh MS. Management of hyponatremia and clinical use of vasopressin antagonists. *Am J Med Sci* 2007;333:101–105.
7. Kumar S, Tomas B. Sodium. *Lancet* 1998;352:220–228.
8. Patel GP, Balk RA. Recognition and treatment of hyponatremia in acutely ill hospitalized patients. *Clin Ther* 2007;29:211–229.
9. Crook M. The investigation and management of severe hyponatremia. *J Clin Pathol* 2002;55:883.
10. Verbalis JG, et al. Hyponatremia treatment guidelines 2007: Expert panel recommendations. *Am J Med* 2007;120:S1–S21.
11. Vitros Na⁺ package insert, Version 4.0. Rochester, NY: Ortho-Clinical Diagnostics, 2004.
12. Gennari FJ. Disorders of potassium homeostasis: Hypokalemia and hyperkalemia. *Crit Care Clin* 2002;18:273–288.
13. Gennari FJ. Hypokalemia. *N Engl J Med* 1998;339:451–458.
14. Burtis CA, Ashwood ER, Bruns DE, eds. *Tietz fundamentals of clinical chemistry*. 6th ed. St. Louis, Mo.: Elsevier Saunders, 2008:394, 433.
15. Elin RJ. Magnesium: The fifth but forgotten electrolyte. *Am J Clin Pathol* 1994;102:616–622.
16. Polancic JE. Magnesium: Metabolism, clinical importance, and analysis. *Clin Lab Sci* 1991;4:105–109.
17. Whang R. Clinical disorders of magnesium metabolism. *Comp Ther* 1997;23:168–173.
18. Schlingman KP, Weber S, et al. Hypomagnesemia with secondary hypocalcemia is caused by mutations in TRPM6, a new member of the TRPM gene family. *Nat Genet* 2002;31:166–170.
19. Whang R, Sims G. Magnesium and potassium supplementation in the prevention of diabetic vascular disease. *Med Hypoth* 2000;55:263–265.
20. Ringer S. A further contribution regarding the influence of different constituents of blood on contractions of the heart. *J Physiol* 1883;4:29.
21. McLean FC, Hastings AB. A biological method for estimation of calcium ion concentration. *J Biol Chem* 1934;107:337.
22. Bushinsky DA, Monk RD. Calcium. *Lancet* 1998;352:23.
23. Wandrup J. Critical analytical and clinical aspects of ionized calcium in neonates. *Clin Chem* 1989;35:2027.
24. Shiber JR, Mattu A. Serum phosphate abnormalities in the emergency department. *J Emerg Med* 2002;23:395–400.

Blood Gases, pH, and Buffer Systems

Sharon S. Ehrmeyer, Ronald H. Laessig,
John J. Ancy

CHAPTER

16

CHAPTER OUTLINE

■ DEFINITIONS: ACID, BASE, BUFFER

■ ACID-BASE BALANCE

Maintenance of H^+
Buffer Systems: Regulation of H^+
Regulation of Acid-Base Balance: Lungs
and Kidneys

■ ASSESSMENT OF ACID-BASE HOMEOSTASIS

The Bicarbonate Buffering System and the
Henderson-Hasselbalch Equation
Acid-Base Disorders: Acidosis and Alkalosis

■ OXYGEN AND GAS EXCHANGE

Oxygen and Carbon Dioxide
Oxygen Transport
Quantities Associated With Assessing a Patient's
Oxygen Status
Hemoglobin–Oxygen Dissociation

■ MEASUREMENT

Spectrophotometric (Cooximeter) Determination
of Oxygen Saturation
Blood Gas Analyzers: pH, pCO_2 , and pO_2
Measurement of pO_2
Measurement of pH and pCO_2
Types of Electrochemical Sensors
Optical Sensors
Calibration
Calculated Parameters
Correction for Temperature

■ QUALITY ASSURANCE

Preanalytic Considerations
Analytic Assessments: Quality Control and
Proficiency Testing
Interpretation of Results

■ REFERENCES

An important aspect of clinical biochemistry is information on a patient's acid-base balance and blood gas homeostasis. These data often are used to assess patients in life-threatening situations. Because the test parameters are interrelated, test sites are expected to provide panels of tests frequently supplemented with calculated parameters. Focusing on only one test result can be misleading.

This chapter discusses exchange of gases, carbon dioxide and oxygen, together with the body's mechanisms to maintain acid-base balance. The interpretation of data, from measurement of pH and other blood gas parameters, and the techniques and instrumentation used in these measurements are also described. Preanalytic considerations—sample collection and handling—that greatly affect the quality of test results are addressed. Quality assurance approaches to blood gas analysis also are presented.

DEFINITIONS: ACID, BASE, BUFFER

A discussion of acid-base balance requires a review of several basic concepts—acid, base, buffer, pH, and pK—and the principles of equilibrium and the law of mass action.

An *acid* is a substance that can yield a hydrogen ion (H^+) or hydronium ion when dissolved in water. A *base* is a substance that can yield hydroxyl ions (OH^-). The relative strengths of acids and bases, their ability to dissociate in water, are described by their dissociation constant (also ionization constant K value). Tables can be found in most biochemistry texts. The pK, defined as the negative log of the ionization constant, is also the pH in which the protonated and unprotonated forms are present in equal concentrations. Strong acids have pK values of less than 3.0, whereas strong bases have pK values greater than 9.0. For acids, raising the pH above the pK will cause the acid to dissociate and yield an H^+ . For bases, lowering the pH below the pK will cause the base to release OH^- . Many species have more than one pK, meaning they can accept or donate more than one H^+ .

A *buffer*, the combination of a weak acid or weak base and its salt, is a system that resists changes in pH. The effectiveness of a buffer depends on the pK of the buffering system and the pH of the environment in which it is placed. In plasma, the bicarbonate–carbonic

acid system, having a pK of 6.1, is one of the principal buffers.

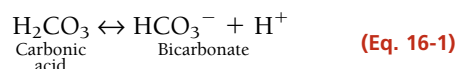

The reference value for blood plasma pH is 7.40. Weisberg cited an example to demonstrate the effectiveness of the blood buffers.¹ If the pH of 100 mL of distilled water is 7.35 and one drop of 0.05 mol/L HCl is added, the pH will change to 7.00. To change 100 mL of normal blood from a pH of 7.35 to a pH of 7.00, approximately 25 mL of 0.05 mol/L HCl is needed. With 5.5 L of blood in the average body, more than 1300 mL of HCl would be required to make this same change in pH.

ACID-BASE BALANCE

Maintenance of H⁺

The normal concentration of H⁺ in the extracellular body fluid ranges from 36–44 nmol/L (pH, 7.34–7.44); however, through metabolism, the body produces much greater quantities of H⁺. Through exquisite mechanisms that involve the lungs and kidneys, the body controls and excretes H⁺ in order to maintain pH homeostasis. Any H⁺ value outside this range will cause alterations in the rates of chemical reactions within the cell and affect the many metabolic processes of the body and can lead to alterations in consciousness, neuromuscular irritability, tetany, coma, and death.

The logarithmic pH scale expresses H⁺ concentration (*c* is concentration):

$$\text{pH} = \log \frac{1}{c\text{H}^+} = -\log c\text{H}^+ \quad (\text{Eq. 16-2})$$

The reference value for arterial blood pH is 7.40 and is equivalent to an H⁺ concentration of 40 nmol/L. Because pH is the negative log of the cH⁺, an increase in H⁺ concentration decreases the pH, whereas a decrease in H⁺ concentration increases the pH. A pH below the reference range (<7.34) is referred to as **acidosis**, whereas a pH above the reference range (>7.44) is referred to as **alkalosis**. Technically, the suffix *-osis* refers to a process in the body; the suffix *-emia* refers to the corresponding state in blood (*-osis* is the cause of the *-emia*).

The arterial pH is controlled by systems that regulate the production and retention of acids and bases. These include buffers, the respiratory center and lungs, and the kidneys.

Buffer Systems: Regulation of H⁺

The body's first line of defense against extreme changes in H⁺ concentration is the buffer systems present in all body fluids. All buffers consist of a weak acid, such as

carbonic acid (H₂CO₃), and its salt or conjugate base, bicarbonate (HCO₃⁻), for the bicarbonate–carbonic acid buffer system. H₂CO₃ is a weak acid because it does not completely dissociate into H⁺ and HCO₃⁻. (In contrast, a strong acid, such as HCl, completely dissociates into H⁺ and Cl⁻ in solution.) When an acid is added to the bicarbonate–carbonic acid system, the HCO₃⁻ will combine with the H⁺ from the acid to form H₂CO₃. When a base is added, H₂CO₃ will combine with the OH⁻ group to form H₂O and HCO₃⁻. In both cases, there is a smaller change in pH than would result from adding the acid or base to an unbuffered solution.

Although the bicarbonate–carbonic acid system has low buffering capacity, it still is an important buffer for three reasons: (1) H₂CO₃ dissociates into CO₂ and H₂O, allowing CO₂ to be eliminated by the lungs and H⁺ as water; (2) changes in CO₂ modify the ventilation (respiratory) rate; and (3) HCO₃⁻ concentration can be altered by the kidneys. In addition, this buffering system immediately counters the effects of fixed nonvolatile acids (H⁺A⁻) by binding the dissociated hydrogen ion (H⁺A⁻ + HCO₃⁻ = H₂CO₃ + A⁻). The resultant H₂CO₃ then dissociates, and the H⁺ is neutralized by the buffering capacity of hemoglobin. Figure 16-1 shows the interrelationship of hemoglobin in the red blood cells and the H⁺ from the bicarbonate buffering system.

Other buffers also are important. The phosphate buffer system (HPO₄⁻² – H₂PO₄⁻) plays a role in plasma and red blood cells and is involved in the exchange of sodium ion in the urine H⁺ filtrate. Plasma protein, especially the imidazole groups of histidine, also forms an important buffer system in plasma. Most circulating proteins have a net negative charge and are capable of binding H⁺.

The lungs and kidneys play important roles in regulating blood pH. The interrelationship of the lungs and kidneys in maintaining pH is depicted by the Henderson-Hasselbalch equation (Eq. 16-4). The numerator (HCO₃⁻) denotes kidney function, whereas the denominator (pCO₂, which represents H₂CO₃) denotes lung function. The lungs regulate pH through retention or elimination of CO₂ by changing the rate and volume of ventilation. The kidneys regulate pH by excreting acid, primarily in the ammonium ion, and by reclaiming HCO₃⁻ from the glomerular filtrate.

Regulation of Acid-Base Balance: Lungs and Kidneys

Carbon dioxide, the end product of most aerobic metabolic processes, easily diffuses out of the tissue where it is produced and into the plasma and red cells in the surrounding capillaries. In plasma, a small amount of CO₂ is physically dissolved or combined with proteins to form

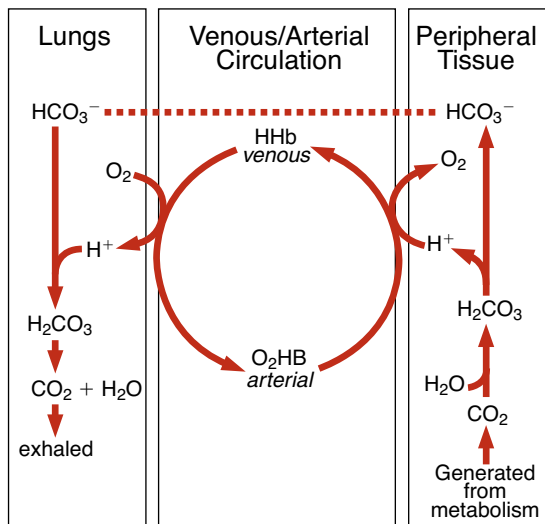

FIGURE 16-1. Interrelationship of the bicarbonate and hemoglobin buffering systems.

carbamino compounds. Most of the CO_2 combines with H_2O to form H_2CO_3 , which quickly dissociates into H^+ and HCO_3^- (Fig. 16-1). The reaction is accelerated by the enzyme carbonic anhydrase found in the red cell membrane. The dissociation of H_2CO_3 causes the HCO_3^- concentration to increase in the red cells and diffuse into the plasma. To maintain electroneutrality (the same number of positively and negatively charged ions on each side of the red cell membrane), chloride diffuses into the cell. This is known as the *chloride shift*. Plasma proteins and plasma buffers combine with the freed H^+ to maintain a stable pH.

In the lungs, the process is reversed. Inspired O_2 diffuses from the alveoli into the blood and is bound to hemoglobin, forming oxyhemoglobin (O_2Hb). The H^+ that was carried on the (reduced) hemoglobin in the venous blood is released to recombine with HCO_3^- to form H_2CO_3 , which dissociates into H_2O and CO_2 . The CO_2 diffuses into the alveoli and is eliminated through ventilation. The net effect of the interaction of these two buffering systems is a minimal change in H^+ concentration between the venous and arterial circulation. When the lungs do not remove CO_2 at the rate of its production (as a result of decreased ventilation or disease), it accumulates in the blood, causing an increase in H^+ concentration. If, however, CO_2 removal is faster than production (hyperventilation), the H^+ concentration will be decreased. Consequently, ventilation affects the pH of the blood. A change in the H^+ concentration of blood that results from nonrespiratory disturbances causes the respiratory center to respond by altering the rate of ventilation in an effort to restore the blood pH to normal. The lungs, by responding within seconds, together with the buffer systems, provide the first line of defense to changes in acid-base status.

The kidneys are also able to excrete variable amounts of acid or base, making them an important player in the regulation of acid-base balance. The kidney's main role in maintaining acid-base homeostasis is to reclaim HCO_3^- from the glomerular filtrate. Without this reclamation, the loss of HCO_3^- in the urine would result in an excessive acid gain in the blood. The main site for HCO_3^- reclamation is the proximal tubules (Fig. 16-2). The glomerular filtrate contains essentially the same HCO_3^- levels as plasma. The process is not a direct transport of HCO_3^- across the tubule membrane into the blood. Instead, sodium (Na^+) in the glomerular filtrate is exchanged for H^+ in the tubular cell. The H^+ combines with HCO_3^- in the filtrate to form H_2CO_3 , which is converted to H_2O and CO_2 by carbonic anhydrase. The CO_2 easily diffuses into the tubule and reacts with H_2O to reform H_2CO_3 and then HCO_3^- , which is reabsorbed into the blood along with sodium. With alkalotic conditions, the kidney excretes HCO_3^- to compensate for the elevated blood pH. The exchange between H^+ and Na^+ suggests, in part, why clinicians order pH and blood gases together, along with electrolytes (Na^+ , K^+ , and Cl^-), to assess the patient. (*Reabsorption* or *reclamation* refers to the process of reentering the blood. *Secretion* or *excretion* by the tubule cells concentrate or remove substances from the filtrate. These reactions determine the pH of the urine, as well as the pH of the blood.)

Under normal conditions, the body produces a net excess (50–100 mmol/L) of acid (H^+) each day that must be excreted by the kidney. Because the minimum urine pH is approximately 4.5, the kidney excretes little nonbuffered H^+ . The remainder of the urinary H^+ combines with dibasic phosphate ($\text{HPO}_4^{=}$) and ammonia (NH_3) and is excreted as dihydrogen phosphate (H_2PO_4^-) and ammonium (NH_4^+). The amount of $\text{HPO}_4^{=}$ available for combining with H^+ is fairly constant; therefore, the daily excretion of H^+ in urine largely depends on the amount of NH_4^+ formed. Because the renal tubular cells are able to generate NH_3 from glutamine and other amino acids, the concentration of NH_3 will increase in response to a decreased blood pH.

Various factors affect the reabsorption of HCO_3^- . When the blood or plasma HCO_3^- level is higher than 26–30 mmol/L, HCO_3^- will be excreted. It is unlikely that the plasma will exceed an HCO_3^- value of 30 mmol/L unless these excretory capabilities fail (e.g., kidney failure occurs). However, a frequent exception to this is compensatory retention of HCO_3^- for chronic **hypercarbia** as seen with chronic lung disease.

The HCO_3^- level may increase if an excessive amount of lactate, acetate, or HCO_3^- is intravenously infused. It also may increase if there is an excessive loss of chloride without replacement (as occurs with

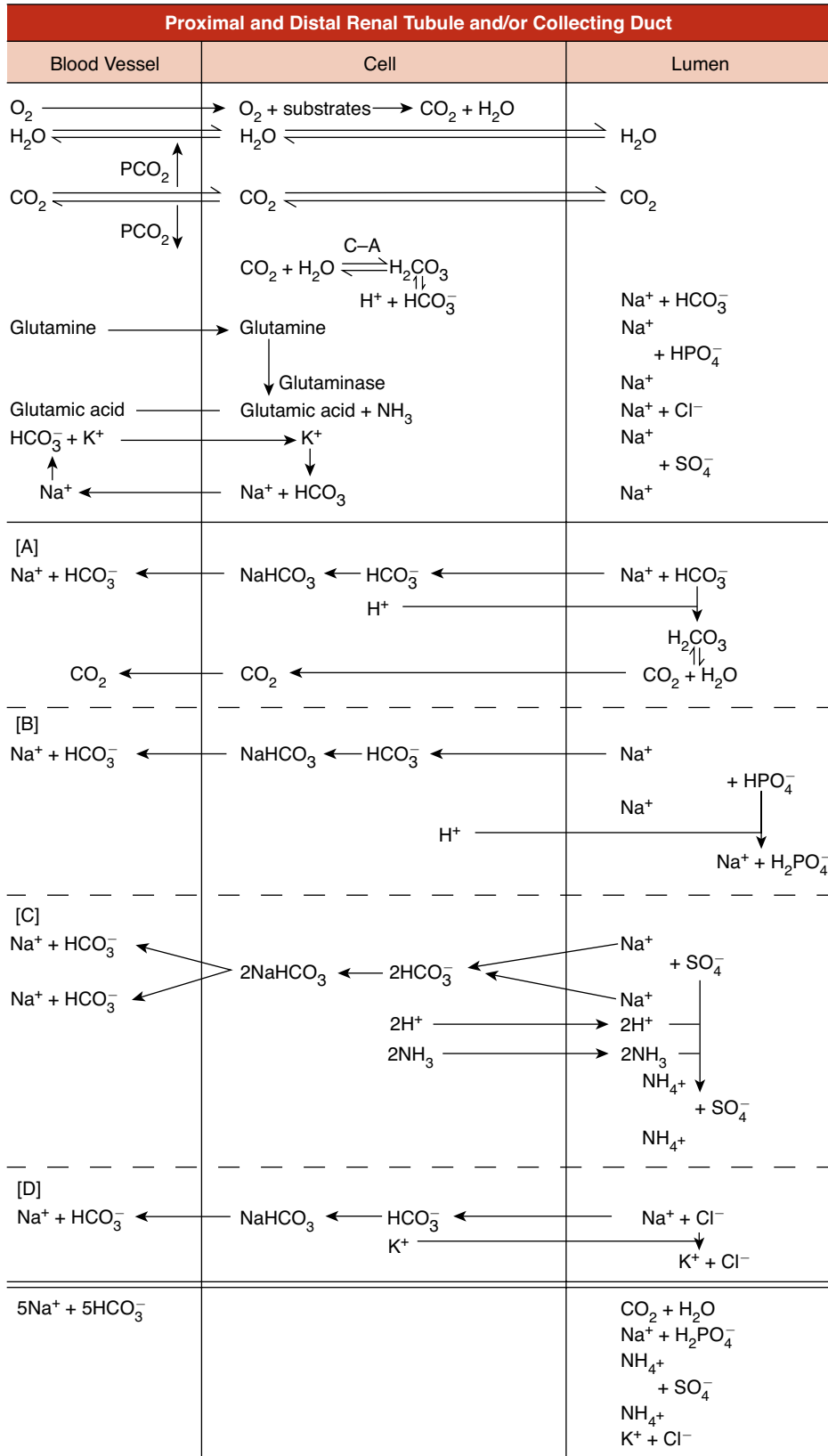

FIGURE 16-2. Bicarbonate reabsorption by the proximal tubule cell. C-A, carbonic anhydrase.

sweating, vomiting, or prolonged nasogastric suction) because the HCO_3^- will be retained by the tubule to preserve electroneutrality.

Several factors may result in decreased HCO_3^- levels. Most diuretics, regardless of mechanism of action, favor the excretion of HCO_3^- . Reduced HCO_3^- reabsorption also occurs in conditions in which there is an excessive loss of cations. In kidney dysfunction (such as chronic nephritis or infections), HCO_3^- reabsorption may be impaired.

ASSESSMENT OF ACID-BASE HOMEOSTASIS

The Bicarbonate Buffering System and the Henderson-Hasselbalch Equation

In assessing acid-base homeostasis, components of the bicarbonate buffering system are measured and calculated. From the data, inferences can be made pertaining to the other buffers and the systems that regulate the production, retention, and excretion of acids and bases. For the bicarbonate buffering system, the dissolved CO_2 (dCO_2) is in equilibrium with CO_2 gas, which can be expelled by way of the lungs. Therefore, the bicarbonate buffering system is referred to as an *open* system, and the dCO_2 , which is controlled by the lungs, is the *respiratory component*. The lungs participate rapidly in the regulation of blood pH through hypoventilation or hyperventilation. Mainly, the kidneys, the nonrespiratory or formerly known as the metabolic component, control the bicarbonate concentration.

CASE STUDY 16-1

A 50-year-old man came to the emergency department after returning from foreign travel. His symptoms included persistent diarrhea (over the past 3 days) and rapid respiration (tachypnea). Blood gases were drawn with the following results:

| | |
|-------------------------------|--|
| pH | 7.21 |
| pCO ₂ | 19 mm Hg |
| pO ₂ | 96 mm Hg |
| HCO ₃ ⁻ | 7 mmol/L |
| SO ₂ | 96% (calculated) (reference range, >95%) |

Questions

1. What is the patient's acid-base status?
2. Why is the HCO_3^- level so low?
3. Why does the patient have rapid respiration?

The *Henderson-Hasselbalch equation* expresses acid-base relationships in a mathematical formula:

$$\text{pH} = \text{pK}' + \log \frac{cA^-}{cHA} \quad (\text{Eq. 16-3})$$

where A^- is proton acceptor, or base (e.g., HCO_3^-), HA is proton donor, or weak acid (e.g., H_2CO_3), and pK' is pH at which there is an equal concentration of protonated and unprotonated species. Knowing any of the three variables allows for the calculation of the fourth.

In plasma and at body temperature (37°C), the pK' of the bicarbonate buffering system is 6.1. The equilibrium between H_2CO_3 and CO_2 in plasma is approximately 1:800. The concentration of H_2CO_3 is proportional to the partial pressure exerted by the dissolved CO_2 . In plasma at 37°C, the value for the combination of the solubility constant for pCO_2 and the factor to convert mm Hg to millimoles per liter is $0.0307 \text{ mmol} \cdot \text{L}^{-1} \cdot \text{mm Hg}^{-1}$. Temperature and the solvent affect the constant. If either of these changes, the solubility constant also will change. Both pH and pCO_2 are measured in blood gas analysis, and the pK' is a constant; therefore, HCO_3^- can be calculated:

$$\text{pH} = \text{pK}' + \log \frac{c\text{HCO}_3^-}{0.0307 \times \text{PCO}_2} \quad (\text{Eq. 16-4})$$

In health, when the kidneys and lungs are functioning properly, a 20:1 ratio of HCO_3^- to H_2CO_3 will be maintained (resulting in a pH of 7.40). This is illustrated by substituting normal values (Table 16-1) for HCO_3^- and pCO_2 into the preceding equation:

$$\frac{24 \text{ mmol/L}}{(0.0307 \text{ mmol/L} \cdot \text{mm Hg}) \times 40 \text{ mm Hg}} = \frac{24}{1.2} = \frac{20}{1} \quad (\text{Eq. 16-5})$$

Adding the log of 20 (1.3) to the pK' of the bicarbonate system yields a normal pH of 7.40 ($7.40 = 6.1 + 1.3$).

TABLE 16-1 ARTERIAL BLOOD GAS REFERENCE RANGE AT 37°C

| | |
|--|-----------|
| pH | 7.35–7.45 |
| pCO ₂ (mm Hg) | 35–45 |
| HCO ₃ ⁻ (mmol/L) | 22–26 |
| Total CO ₂ content (mmol/L) | 23–27 |
| pO ₂ (mmol/L) | 80–110 |
| SO ₂ (%) | >95 |
| O ₂ Hb (%) | >95 |

Acid-Base Disorders: Acidosis and Alkalosis

Acid-base disorders result from a variety of pathologic conditions. When blood pH is less than the reference range, it is termed **acidemia**, which reflects excess acid or H^+ concentration. A pH greater than the reference range is termed **alkalemia**, or excess base. A disorder caused by ventilatory dysfunction (a change in the pCO_2 , the respiratory component) is termed *primary respiratory acidosis* or *alkalosis*. A disorder resulting from a change in the bicarbonate level (a renal or metabolic function) is termed a *nonrespiratory disorder*. Mixed respiratory and nonrespiratory disorders occasionally arise from more than one pathologic process and represent the most serious of medical conditions as compensation for the primary disorder is failing.

Because the body's cellular and metabolic activities are pH dependent, the body tries to restore acid-base homeostasis whenever an imbalance occurs. This action by the body is termed **compensation**—the body accomplishes this by altering the factor *not primarily* affected by the pathologic process. For example, if the imbalance is of nonrespiratory origin, the body compensates by altering ventilation. For disturbances of the respiratory component, the kidneys compensate by selectively excreting or reabsorbing anions and cations. The lungs can compensate immediately, but the response is short term and often incomplete. The kidneys are slower to respond (2–4 days), however, but the response is long term and potentially complete. *Fully compensated* implies that the pH has returned to the normal range (the 20:1 ratio has been restored); *partially compensated* implies that the pH is approaching normal. While compensation may successfully return the ratio to the normal 20:1, the primary abnormality is not corrected.

Acidosis may be caused by a primary nonrespiratory abnormality or by a primary respiratory problem. In primary nonrespiratory acidosis, there is a decrease in bicarbonate (<24 mmol/L), resulting in a decreased pH as a result of the ratio for the nonrespiratory to respiratory component in the Henderson-Hasselbalch equation being less than 20:1:

$$pH \propto \frac{\downarrow cHCO_3^-}{N(0.0307 \times PCO_2)} < \frac{20}{1} \quad (\text{Eq. 16-6})$$

where N is normal value and \propto indicates proportional.

Nonrespiratory acidosis may be caused by the direct administration of an acid-producing substance, such as ammonium chloride or calcium chloride, or by excessive formation of organic acids as seen with diabetic ketoacidosis and starvation. Nonrespiratory acidosis is also seen with reduced excretion of acids, as in renal tubular acidosis, and with excessive loss of bicarbonate from diarrhea or drainage from a biliary, pancreatic, or intestinal fistula.

CASE STUDY 16-2

An 80-year-old woman fell on the ice and fractured her femur. After several hours, when she arrived at the emergency department, she was anxious, panting, and complaining of severe chest pain and not being able to breathe. Her pulse was rapid (tachycardia) as was her respiration rate (tachypnea). Blood gases were drawn and yielded the following results:

| | |
|-----------|--|
| pH | 7.31 |
| pCO_2 | 27 mm Hg |
| pO_2 | 62 mm Hg |
| HCO_3^- | 12 mmol/L |
| SO_2 | 78% (calculated) (reference range, $>95\%$) |

Questions

1. What is the patient's acid-base status?
2. Why is the HCO_3^- level so low?
3. What clinically caused the acid-base imbalance?

The body compensates for nonrespiratory acidosis through *hyperventilation*, which is an increase in the rate or depth of breathing. By “blowing off” CO_2 , the base-to-acid ratio will return toward normal. Secondary compensation occurs when the “original” organ (the kidneys, in this case) begins to correct the ratio by retaining bicarbonate.

Primary *respiratory acidosis* results from a decrease in alveolar ventilation (*hypoventilation*), causing a decreased elimination of CO_2 by the lungs:

$$pH \propto \frac{NcHCO_3^-}{\uparrow(0.0307 \times PCO_2)} > \frac{20}{1} \quad (\text{Eq. 16-7})$$

Respiration is regulated in the medulla of the brain. Chemoreceptors present in the aortic arch and the carotid sinus respond to levels of H^+ (pH), O_2 , and CO_2 in the blood and cerebrospinal fluid. There are several situations, including many lung diseases, in which CO_2 is not effectively removed from the blood. In certain patients with chronic obstructive pulmonary disease (COPD), for example, destructive changes in the airways and alveolar walls increase the size of the alveolar air spaces, with the resultant reduction of the lung surface area available for gas exchange. As a result, CO_2 is retained in the blood, causing chronic hypercarbia (elevated pCO_2). In bronchopneumonia, gas exchange is impeded because of the secretions, white blood cells, bacteria, and fibrin in the alveoli. Hypoventilation caused by drugs such as

CASE STUDY 16-3

A 24-year-old graduate student was brought to the emergency department in a comatose state after being found in his room unconscious. A bottle of secobarbital was on his bed stand. He did not respond to painful stimuli, his respiration was barely perceptible, and his pulse was weak. Blood gases were drawn, and yielded the following results:

| | |
|-------------------------------|-----------------------------|
| pH | 7.10 |
| pCO ₂ | 70 mm Hg |
| pO ₂ | 58 mm Hg |
| HCO ₃ ⁻ | 20 mmol/L |
| O ₂ Hb | 80% (reference range, >95%) |

Questions

1. What is the patient's acid-base status?
2. What caused the profound hypoventilation?
3. Once the respiratory component returns to normal, what will be the patient's expected acid-base status?

CASE STUDY 16-4

A 24-year-old Himalayan man was accepted to graduate school in the United States. Before leaving home, he had an extensive physical exam that included various blood tests. When the medical staff at the U.S. university reviewed his medical records, it was noted that all test results were normal except the HCO₃⁻, which was 15 mmol/L (reference range, 22–26 mmol/L). The HCO₃⁻ was done separately on a serum sample. It was not part of a blood gas panel. To rule out nonrespiratory acidosis, the university physician wanted the HCO₃⁻ repeated. The repeated value was 24 mmol/L.

Questions

1. Was the initial assumption of a nonrespiratory acidosis valid?
2. What would be a better description of the acid-base disturbance?
3. Why, on repeat testing, did the HCO₃⁻ return to normal?

barbiturates, morphine, or alcohol will increase blood pCO₂ levels, as will mechanical obstruction or asphyxiation (strangulation or aspiration). Decreased cardiac output, such as that seen with congestive heart failure, also will result in less blood presented to the lungs for gas exchange and, therefore, an elevated pCO₂.

In primary respiratory acidosis, the compensation occurs through nonrespiratory processes. The kidneys increase the excretion of H⁺ and increase the reclamation of HCO₃⁻. Although the renal compensation begins immediately, it takes days to weeks for maximal compensation to occur. When the HCO₃⁻ in the blood increases as a result of the action of the kidneys, the base-to-acid ratio will be altered and the pH will return toward normal.

As with acidosis, alkalosis can result from nonrespiratory and respiratory causes. Primary *nonrespiratory alkalosis* results from a gain in HCO₃⁻, causing an increase in the nonrespiratory component and pH:

$$pH \propto \frac{\uparrow c\text{HCO}_3^-}{N(0.0307 \times \text{PCO}_2)} > \frac{20}{1} \quad (\text{Eq. 16-8})$$

This condition may result from the excess administration of sodium bicarbonate or through ingestion of bicarbonate-producing salts, such as sodium lactate, citrate, or acetate. Excessive loss of acid through vomiting, nasogastric suctioning, or prolonged use of diuretics that augment renal excretion of H⁺ can produce an apparent increase in HCO₃⁻. The body responds by depressing the respiratory center. The resulting hypoventilation increases the retention of CO₂.

Primary *respiratory alkalosis* from an increased rate of alveolar ventilation causes excessive elimination of CO₂ by the lungs:

$$pH \propto \frac{Nc\text{HCO}_3^-}{\downarrow(0.0307 \times \text{PCO}_2)} > \frac{20}{1} \quad (\text{Eq. 16-9})$$

The causes of respiratory alkalosis include **hypoxemia**; chemical stimulation of the respiratory center by drugs, such as salicylates; an increase in the environmental temperature; fever; hysteria (hyperventilation); pulmonary emboli; and pulmonary fibrosis. The kidneys compensate by excreting HCO₃⁻ in the urine and reclaiming H⁺ to the blood. The popular treatment for hysterical hyperventilation, breathing into a paper bag, is self explanatory.

OXYGEN AND GAS EXCHANGE

Oxygen and Carbon Dioxide

The role of oxygen in metabolism is crucial to all life. In cell mitochondria, electron pairs from the oxidation of NADH and FADH₂ are transferred to molecular oxygen, causing release of the energy used to synthesize ATP

from the phosphorylation of ADP. Although measurement of intracellular O_2 is not feasible with current technology, evaluation of a patient's oxygen status is possible using the partial pressure of oxygen (pO_2) measured along with pH and pCO_2 in the blood gas analysis.

For adequate tissue oxygenation, the following seven conditions are necessary: (1) available atmospheric oxygen, (2) adequate ventilation, (3) gas exchange between the lungs and arterial blood, (4) loading of O_2 onto hemoglobin, (5) adequate hemoglobin, (6) adequate transport (cardiac output), and (7) release of O_2 to the tissue. Any disturbances in these conditions can result in poor tissue oxygenation.

The amount of O_2 available in atmospheric air depends on the barometric pressure (BP). At sea level, the BP is 760 mm Hg. (In the International System of Units, 1 mm Hg = 0.133 kPa, where 1 Pa = 1 N/m².) Dalton's law states that total atmospheric pressure is the sum of the individual gas pressures. One atmosphere exerts 760 mm Hg pressure and is made up of O_2 (20.93%), CO_2 (0.03%), nitrogen (78.1%), and inert gases (approximately 1%). The percentage for each gas is the same at all altitudes; the *partial pressure* for each gas in the atmosphere is equal to the BP at a particular altitude times the appropriate percentage for each gas. The vapor pressure of water (47 mm Hg at 37°C) must be accounted for in calculating the partial pressure for the individual gases (Fig. 16-3). In

the body, these gases are always fully saturated with water. For example,

$$\begin{aligned} \text{Partial pressure of } O_2 \text{ at sea level (in the body)} \\ &= (760 \text{ mm Hg} - 47 \text{ mm Hg}) \times 20.93\% \\ &= 149 \text{ mm Hg (at } 37^\circ\text{C)} \end{aligned}$$

$$\begin{aligned} \text{Partial pressure of } CO_2 \text{ at sea level (in the body)} \\ &= (760 \text{ mm Hg} - 47 \text{ mm Hg}) \times 0.03\% \\ &= 2 \text{ mm Hg (at } 37^\circ\text{C)} \end{aligned}$$

Air is moved into the lungs through expansion of the thoracic cavity, which creates a temporary negative pressure gradient, causing air to move into the numerous tracheal branches and the alveoli. At the beginning of inspiration, these airways still are filled with air (gas) retained from the previously expired breath. This air, termed *dead space air*, dilutes the air being inspired. The inspired air, in addition to being somewhat diluted, is warmed to 37°C and fully saturated with water vapor. The pO_2 in the alveoli averages is about 110 mm Hg instead of the potential 150 mm Hg (expected with no dilution from dead space air and not accounting for the vapor pressure of water). Three other factors can influence pO_2 in the alveoli: (1) The percentage of O_2 in the inspired air, or fraction of inspired oxygen (FiO_2), can be increased by breathing gas mixtures up to 100% O_2 ; (2) the amount of pCO_2 in the expired air dilutes the inspired air so that a patient with increased metabolism (e.g., hyperthermia) may produce more CO_2 than can be eliminated, increasing both the pCO_2 in the blood and the expired gas; and (3) the ratio of the volume of inspired air to the volume of the dead space air. The volume of dead space (in the airways) is usually constant because it is controlled by the person's anatomy; people with shallow breaths have less "fresh" air entering the lungs than those breathing deeply.

There are many factors that can influence the amount of O_2 that moves through the alveoli into the blood and then to the tissue. Among the more common are:

- **Destruction of the alveoli.** The normal surface area of the alveoli is as big as a tennis court. When the surface area is destroyed to a critically low value by diseases such as emphysema, an inadequate amount of O_2 will move into the blood.
- **Pulmonary edema.** Gas diffuses from the alveoli to the capillary through a small space. With pulmonary edema, fluid "leaks" into this space, increasing the distance between the alveoli and capillary walls and causing a barrier to diffusion.
- **Airway blockage.** Airways can be blocked, preventing the air from the atmosphere from reaching the alveoli. Asthma and bronchitis are more common causes of this type of problem.

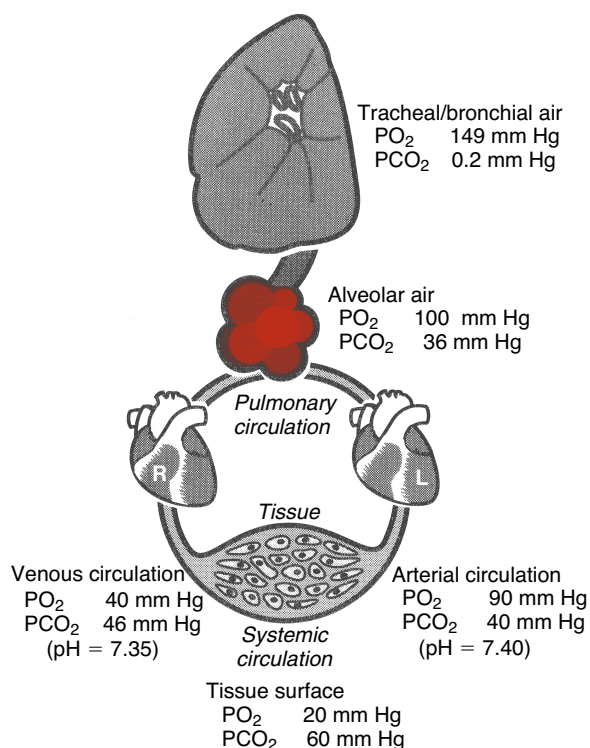

FIGURE 16-3. Gas content in lungs and pulmonary and systemic circulation.

- **Inadequate blood supply.** When the blood supply to the lung is inadequate, O₂ enters the blood in the lungs, but not enough blood is being carried away to the tissue where it is needed. This may be the consequence of a blockage in a pulmonary blood vessel (pulmonary embolism), pulmonary hypertension, or a failing heart.
- **Diffusion of CO₂ and O₂.** Because O₂ diffuses 20 times slower than CO₂, it is more sensitive to problems with diffusion. Structural or physiologic alterations to the alveolar-capillary bed impair O₂ uptake with minimal alteration of CO₂ excretion. This type of hypoxemia is generally treated with supplemental O₂. The percentage of O₂ can be increased temporarily when needed; however, 60% or higher O₂ concentrations must be used with caution because it can be toxic to the lungs.

Oxygen Transport

Most O₂ in arterial blood is transported to the tissue by hemoglobin. Each adult hemoglobin (A₁) molecule can combine reversibly with up to four molecules of O₂. The actual amount of O₂ loaded onto hemoglobin depends on the availability of O₂; the concentration and type(s) of hemoglobin present; the presence of interfering substances, such as carbon monoxide (CO); the pH; the temperature of the blood; and the levels of pCO₂ and 2,3-diphosphoglycerate (2,3-DPG). With adequate atmospheric and alveolar O₂ available, and with normal diffusion of O₂ to the arterial blood, more than 95% of “functional” hemoglobin (hemoglobin capable of reversibly binding O₂) will bind O₂. Increasing the FiO₂ to the blood further saturates the hemoglobin. However, once the hemoglobin is 100% saturated, an increase in O₂ to the alveoli serves only to increase the concentration of dissolved (dO₂) in the arterial blood. This offers minimal increase in oxygen delivery. Prolonged administration of high concentrations of O₂ may cause oxygen toxicity and, in some cases, decreased ventilation that leads to hypercarbia. The ability of hemoglobin to carry O₂ can be affected significantly by other molecules. Normally, blood hemoglobin exists in one of four conditions:

1. Oxyhemoglobin (O₂Hb) describes O₂ reversibly bound to hemoglobin.
2. Deoxyhemoglobin (HHb; reduced hemoglobin) is hemoglobin not bound to O₂ but capable of forming a bond when O₂ is available.
3. Carboxyhemoglobin (COHb) is hemoglobin bound to CO. The bond between CO and Hb is reversible but is 200 times as strong as the bond between O₂ and Hb.
4. Methemoglobin (MetHb) is hemoglobin unable to bind O₂ because iron (Fe) is in an oxidized rather than reduced state. The Fe³⁺ can be reduced by the enzyme methemoglobin reductase, which is found in red blood cells.

Dedicated spectrophotometers (cooximeters), which are discussed later in this chapter, are used to determine the relative concentrations (relative to total hemoglobin) of each of these species of hemoglobin.

Quantities Associated With Assessing a Patient's Oxygen Status

Four parameters commonly used to assess a patient's oxygen status are oxygen saturation (SO₂); measured fractional (percent) oxyhemoglobin (FO₂Hb); trends in oxygen saturation assessed by transcutaneous, pulse oximetry (SpO₂) assessments; and the amount of O₂ dissolved in plasma (pO₂).

Oxygen saturation SO₂ represents the ratio of O₂ that is bound to the carrier protein, hemoglobin, compared with the total amount of hemoglobin capable of binding O₂.²

$$SO_2 = \frac{cO_2Hb}{(cO_2Hb + cHHb)} \times 100 \quad (\text{Eq. 16-10})$$

Software included with blood gas instruments can calculate SO₂ from pO₂, pH, and temperature of the sample. These calculated results, however, can differ significantly from those determined by direct cooximeter measurement due to the assumption that only adult hemoglobin is present and the oxyhemoglobin dissociation curve has a specific shape and location. These algorithms for the calculation do not account for the other hemoglobin species, such as COHb and MetHb, that are incapable of reversibly binding O₂. Because of the potential for generating erroneous information, calculated SO₂ should not be used to assess oxygenation status.^{2,3}

Fractional (or percent) oxyhemoglobin (FO₂Hb) is the ratio of the concentration of oxyhemoglobin to the concentration of total hemoglobin (ctHb),

$$FO_2Hb = \frac{cO_2Hb}{ctHb} = \frac{cO_2Hb}{cO_2Hb + cHHb + cdysHb} \quad (\text{Eq. 16-11})$$

where the cdysHb represents hemoglobin derivatives, such as COHb, that cannot reversibly bind with O₂ but are still part of the “total” hemoglobin measurement.

These two terms, SO₂ and FO₂Hb, can be confused because, in most healthy individuals (and even those individuals with some disease states), the numeric values for SO₂ are close to those for FO₂Hb. However, the values for FO₂Hb and SO₂ will deviate when dyshemoglobins are present and even when the patient is a smoker, owing to the preferential binding of CO to hemoglobin and the resultant loss of hemoglobin to bind O₂.

Partial pressure of oxygen dissolved in plasma (pO₂) accounts for little of the body's O₂ stores. A healthy adult breathing room air will have a pO₂ of 90 to 95 mm Hg. For an adult blood volume of 5 L, only 13.5 mL of O₂ will

be available from pO_2 in plasma, compared with more than 1,000 mL of O_2 carried as O_2Hb .

Noninvasive measurements for following “trends” in oxygenation are attained with *pulse oximetry* (SpO_2). These devices pass light of two or more wavelengths through the tissue in the capillary bed of the toe, finger, or ear. Until recently, pulse oximetry technology could *not* measure COHB and MetHb. For those pulse oximeters that calculate oxyhemoglobin saturation based only on oxyhemoglobin and deoxyhemoglobin, oxyhemoglobin saturation will be overestimated when one or more dyshemoglobins are present. In addition, the accuracy of pulse oximetry can be compromised by many factors, including poor perfusion and severe anemia.

The maximum amount of O_2 that can be carried by hemoglobin in a given quantity of blood is the *hemoglobin oxygen (binding) capacity*. The molecular weight of tetramer hemoglobin is 64,458 g/mol. One mole of a perfect gas occupies 22,414 mL. Therefore, each gram of hemoglobin carries 1.39 mL of O_2 :

$$\frac{22,414 \text{ mL/mol}_4}{64,458 \text{ g/mol}} = 1.39 \text{ mL/g} \quad (\text{Eq. 16-12})$$

When the total hemoglobin (tHb) is 15 g/dL and the hemoglobin is 100% saturated with O_2 , the O_2 capacity is:

$$\begin{aligned} 15 \text{ g/100 mL} \times 1.39 \text{ mL/g} \\ = 20.8 \text{ mL } O_2/100 \text{ mL of blood} \end{aligned} \quad (\text{Eq. 16-13})$$

Oxygen content is the total O_2 in blood and is the sum of the O_2 bound to hemoglobin (O_2Hb) and the amount dissolved in the plasma (pO_2). (Because pO_2 and pCO_2 are only indices of gas-exchange efficiency in the lungs, they do not reveal the *content* of either gas in the blood.) For every mm Hg pO_2 , 0.00314 mL of O_2 will be dissolved in 100 mL of plasma at 37°C. For example, if the pO_2 is 100 mm Hg, 0.3 mL of O_2 will be dissolved in every 100 mL of blood plasma. The amount of dissolved O_2 is usually not clinically significant. However, with low tHb or at hyperbaric conditions, it may become a significant source of O_2 to the tissue. Normally, 97% to 99% of the available hemoglobin is saturated with O_2 . Assuming a tHb of 15 g/dL, the O_2 content for every 100 mL of blood plasma becomes

$$0.3 \text{ mL} + (20.8 \text{ mL} \times 0.97) = 20.5 \text{ mL} \quad (\text{Eq. 16-14})$$

Hemoglobin–Oxygen Dissociation

In addition to adequate ventilation and gas exchange with the pulmonary circulation, O_2 must be released at the tissues. Hemoglobin transports O_2 . The increased H^+ concentration and pCO_2 levels at the tissue from cellular metabolism change the molecular configuration of O_2Hb , facilitating O_2 release.

Oxygen dissociates from adult hemoglobin (A_1) in a characteristic fashion. If this dissociation is graphed

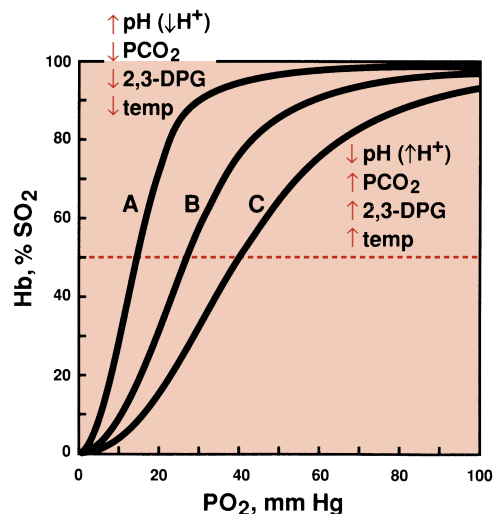

FIGURE 16-4. Oxygen-dissociation curves. Curve *B* is the normal human curve. Curves *A* and *C* are from blood with increased affinity and decreased affinity, respectively.

(Fig. 16-4) with pO_2 on the x-axis and percent SO_2 on the y-axis, the resulting curve is sigmoid, or slightly S-shaped. Hemoglobin “holds on” to O_2 until the O_2 tension in the tissue is reduced to about 60 mm Hg. Below this tension, the O_2 is released rapidly. The position of the oxygen dissociation curve reflects the *affinity* that hemoglobin has for O_2 and affects the rate of this dissociation.

Hydrogen ion activity, pCO_2 and CO levels, body temperature, and 2,3-DPG can affect the position and shape of the oxygen-dissociation curve as well as the affinity of hemoglobin for O_2 . In actively metabolizing tissue, the conditions in the microenvironment promote release of oxygen. Oxidative metabolism increases the temperature, H^+ , CO_2 , and 2,3-DPG concentrations in the tissue, which results in a right shift of the dissociation curve. This decreased affinity of hemoglobin for O_2 promotes release of oxygen to the tissue and allows patients, even those with low pO_2 and hemoglobin levels, to benefit from released O_2 . In the lungs, temperature, H^+ , pCO_2 , and 2,3-DPG decrease relative to tissue levels, shifting the oxygen-dissociation curve slightly to the left. This enhances O_2 binding to hemoglobin and improves O_2 uptake. The metabolic byproduct, 2,3-DPG, also is involved in two seemingly unrelated adaptations to potentially hypoxic conditions. When the β chains of the hemoglobin molecule bind 2,3-DPG, oxyhemoglobin dissociation shifts to the right, with subsequent enhancement of oxygen release. Many patients with slow onset of anemia demonstrate elevated levels of 2,3-DPG, which may partially explain why patients with extremely low hemoglobin values are able to function. In addition, 2,3-DPG levels increase as an adaptation to high altitude.

Hemoglobin is a remarkable molecule. Its unique structure allows it to act as both an acid-base buffer and

O₂ buffer. As hemoglobin courses through the body, exposure to the various microenvironments promotes appropriate association and dissociation of O₂, CO₂, and H⁺. In tissue, exposure to elevated CO₂ and H⁺ results in enhanced O₂ release (oxygen buffering). This release of oxygen from hemoglobin accelerates the uptake of CO₂ and H⁺ by hemoglobin (acid-base buffering). In the lungs, the microenvironment promotes uptake of O₂ and release of CO₂.

Dyshemoglobins, such as COHb or MetHb, can also affect oxyhemoglobin dissociation. An elevation in CO from cigarette smoking or carbon monoxide exposure causes the curve to shift to the left. As the percentage of COHb increases, the shape of the curve loses some of its sigmoid characteristics and shifts to the left, making the release of O₂ bound to hemoglobin much more difficult.

The preceding discussion refers to normal adult (A₁) hemoglobin. In patients with hemoglobinopathies and in newborns, the pattern of dissociation may differ. For example, fetal hemoglobin causes a shift to the left, but with little change in the sigmoid shape.

MEASUREMENT

Spectrophotometric (Cooximeter) Determination of Oxygen Saturation

The *actual percent oxyhemoglobin* (O₂Hb) can be determined spectrophotometrically using a cooximeter designed to directly measure the various hemoglobin species. Each species of hemoglobin has a characteristic absorbance curve (Fig. 16-5). The number of hemoglobin species measured will depend on the number and specific wavelengths incorporated into the instrumentation. For example, two-wavelength instrument systems can measure only two hemoglobin species (i.e., O₂Hb and HHb), which are expressed as a fraction or percentage of the total hemoglobin.

Instruments, at a minimum, should have four wavelengths for measurements of HHb, O₂Hb, and the two

most common dyshemoglobins, COHb, and MetHb. Instruments with more than four wavelengths can recognize dyes and pigments, turbidity, other hemoglobin species, and abnormal proteins. Some newer cooximeters employ hundreds of wavelengths, which has greatly reduced measurement interferences. Microprocessors control the sequencing of multiple wavelengths of light through the sample and apply the necessary matrix equations after absorbance readings are made to calculate the percentage of the individual hemoglobin species:

$$\text{O}_2\text{Hb} = a_1A_1 + a_2A_2 + \dots + a_nA_n$$

$$\text{HHb} = b_1A_1 + \dots + b_nA_n$$

$$\text{COHb} = c_1A_1 + c_2A_2 + \dots + c_nA_n$$

$$\text{MetHb} = d_1A_1 + d_2A_2 + d_nA_n \quad (\text{Eq. 16-15})$$

where a_1 , a_n , b_n , etc., are coefficients that are analogues of the absorption constant (a) that are derived from established methods, and A_1 , A_2 , and so on are the absorbances of the sample. The matrix equations will change depending on the number of wavelengths of light (which is manufacturer specific) passed through the sample. (The "calculation" made by these instruments should not be confused with a calculated SO₂ from a blood gas analyzer, which, in reality, *estimates* the value from a measured pO₂ and an empirical equation for the location and shape of the oxygen-hemoglobin dissociation curve. Only O₂Hb values reflect the patient's true status because calculated SO₂ and O₂Hb values will be vastly different in the presence of dyshemoglobins. In CO poisoning, for example, SO₂ will likely be normal with a significantly decreased O₂Hb value.)

As with any spectrophotometric measurement, potential sources of error exist, including faulty calibration of the instrument and spectral-interfering substances. The presence of any substances absorbing light at the wavelengths used in the measurement of any hemoglobin pigment has the potential of being a source of error. Product claims for specific instruments must be consulted for specific interferences.

Because the primary purpose of determining O₂Hb is to assess oxygen transport from the lungs, it is best to stabilize the patient's ventilation status before blood sample collection. An appropriate waiting period before the sample is drawn should follow changes in supplemental O₂ or mechanical ventilation. All blood samples should be collected under anaerobic conditions and mixed immediately with heparin or other appropriate anticoagulant. If the blood gas analysis is not being done on the same sample, ethylenediaminetetraacetic acid (EDTA) can be used as an anticoagulant. All samples should be analyzed promptly to avoid changes in saturation resulting from the consumption of oxygen by metabolizing cells.^{2,4}

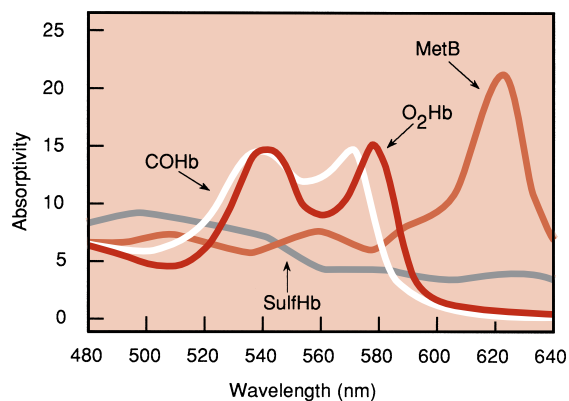

FIGURE 16-5. Optical absorption of hemoglobin fractions. (Reproduced with permission from Clin Chem News 1990[January].)

Blood Gas Analyzers: pH, pCO₂, and pO₂

Blood gas analyzers use *electrodes* (macroelectrochemical or microelectrochemical sensors) as sensing devices to measure pO₂, pCO₂, and pH. The pO₂ measurement is amperometric, meaning that the amount of current flow is an indication of the oxygen present. The pCO₂ and pH measurements are potentiometric, in which a change in voltage indicates the activity of each analyte. Advances in microsensor technology has greatly expanded the analytic menus of whole blood analyzers. In addition to pH and blood gasses, many manufacturers offer instruments that offer menus that include hemoglobin and/or hematocrit, electrolytes, metabolites (glucose, lactate, creatinine and BUN), and cooximetry.

The *cathode* can be defined in at least three ways: (1) the negative electrode, (2) a site to which cations tend to travel, or (3) a site at which reduction occurs. *Reduction* is the gain of electrons by a particle (atom, molecule, or ion). The *anode* is the positive electrode, the site to which anions migrate or the site at which oxidation occurs. *Oxidation* is the loss of electrons by a particle. An *electrochemical cell* is formed when two opposite electrodes are immersed in a liquid that will conduct the current. The blood gas analyzer can calculate several additional parameters: bicarbonate, total CO₂, **base excess**, and SO₂.

Measurement of pO₂

pO₂ electrodes, called *Clarke electrodes*, measure the amount of current flow in a circuit that is related to the amount of O₂ being reduced at the cathode. A gas-permeable membrane covering the tip of the electrode selectively allows the O₂ to diffuse into an electrolyte and contact the cathode. Electrons are drawn from the anode surface to the cathode surface to reduce the O₂. A small, constant polarizing potential (typically, -0.65 V) is applied between the anode and cathode. A *microammeter* placed in the circuit between the anode and cathode measures the movement of electrons (current). Four electrons are drawn for every mole of O₂ reduced, making it possible to determine pO₂. The semipermeable membrane also will allow other gases to pass, such as CO₂ and N₂, but these gases will not be reduced at the cathode if the polarizing voltage is tightly controlled.

The primary source of error for pO₂ measurement is associated with the buildup of protein material on the surface of the membrane. This buildup retards diffusion and slows the electrode response. Bacterial contamination within the measuring chamber, although uncommon, will consume O₂ and cause low and drifting values. Other errors are mostly associated with a system malfunction, such as incorrect calibration.

Nonanalytic concerns, including sample collection and handling, are addressed later in this chapter. However, it

CASE STUDY 16-5

A 37-year-old man was admitted to the emergency department. He was short of breath, dizzy, flushed (hyperemic), sweating (diaphoretic), and nauseous. Shortly after being admitted, blood gases were drawn:

| | |
|-------------------------------|--|
| pH | 7.48 |
| pCO ₂ | 32 mm Hg |
| pO ₂ | 96 mm Hg |
| HCO ₃ ⁻ | 24 mmol/L |
| SO ₂ | 98% (calculated) |
| SpO ₂ | 99% (pulse oximetry oxygen saturation) |

After a few hours, the patient's symptoms receded and he was released. Two weeks later, the same patient was again admitted to the emergency department with the same symptoms. This time, arterial blood was drawn for both blood gases and cooximetry measurements. The results were as follows:

| | |
|-------------------------------|---|
| pH | 7.49 |
| pCO ₂ | 33 mm Hg |
| pO ₂ | 95 mm Hg |
| HCO ₃ ⁻ | 23 mmol/L |
| SO ₂ | 98% (calculated) (reference range, >95%) |
| SpO ₂ | -99% (pulse oximetry oxygen saturation) (reference range, >95%) |

Spectrophotometric (cooximeter) measurement of hemoglobin species:

| | |
|-------------------|--|
| Hb | 13.5 g/L |
| O ₂ Hb | 73% (reference range, >95%) |
| COHb | -22% (reference range, <2%; higher with smokers) |
| MetHb | 1% (reference range, <1.5%) |

Questions

1. Is the patient hypoxic on the first admission to the ED?
2. Considering the new laboratory data, is this patient hypoxic on the second admission to the ED?
3. Why is there a discrepancy between calculated SO₂, SpO₂, and O₂Hb?
4. What is a possible cause of this patient's shortness of breath and low O₂Hb?

is particularly important not to expose the sample to room air when collecting, transporting, and making O₂ measurements. Contamination of the sample with room air (pO₂ ≅ 150 mm Hg) can result in significant error. Even after the sample is drawn, leukocytes continue to metabolize O₂. Unless the sample is analyzed immediately after being drawn, low pO₂ values may be seen with high white blood cell counts.

Continuous measurements for pO₂ also are possible using *transcutaneous (TC) electrodes* placed directly on the skin. Measurement depends on oxygen diffusing from the capillary bed through the tissue to the electrode. Although most commonly used with neonates and infants, this non-invasive approach is not without problems. Skin thickness and tissue perfusion with arterial blood can significantly affect the results. Heating the electrode placed on the skin can enhance diffusion of O₂ to the electrode; however, burns can result unless the electrodes are moved regularly. Although pO₂ measured by these electrodes may *reflect* the arterial pO₂, the two values are not equivalent. Oxygen

consumption by tissue at the electrode site, the effects of heating the tissue, and possible hypoperfusion from cardiovascular instability can all contribute to the unpredictability of the arterial tissue O₂ gradient.

Measurement of pH and pCO₂

To understand potentiometric measurements, it is helpful to think of atoms and ions as having a chemical energy. An increased concentration or *activity* of the ions leads to an increase in force exerted by those ions.

To measure how much force—energy or potential—a given ion possesses, certain elements in the measuring device are required; namely, two electrodes (the measuring electrode responsive to the ion of interest and the reference electrode) and a voltmeter, which measures the potential difference (ΔE) between the two electrodes. The potential difference is related to the concentration of the ion of interest by the Nernst equation:

$$\Delta E = \Delta E^\circ + \frac{0.05916}{n} \log a_i \text{ at } 25^\circ\text{C} \quad (\text{Eq. 16-16})$$

where ΔE° is standard potential of the electrochemical cell, n is charge of the analyte ion i , and a_i is activity of the analyte ion i .

To measure pH, a glass membrane sensitive to H⁺ is placed around an internal Ag–AgCl electrode to form a measuring electrode. The potential that develops at the glass membrane as a result of H⁺ from the unknown solution diffusing into the membrane's surface is proportional to the difference in cH⁺ between the unknown sample and the buffer solution inside the electrode. For the potential developed at the glass membrane to be measured, a reference electrode must be introduced into the solution and both electrodes must be connected to a pH (volt) meter. The reference electrode (commonly either a calomel [Hg–HgCl] or an Ag–AgCl half-cell) provides a steady reference voltage against which voltage changes from the measuring electrode are compared. The pH meter reflects the potential difference between the two electrodes.

For the cell described, the Nernst equation predicts that a change of +59.16 mV, at 25°C, is the result of a 10-fold increase in H⁺ activity or a decrease of an entire pH unit (e.g., pH 7.0–6.0). Changing the temperature affects the response. At 37°C, a change of 1 pH unit elicits a 61.5 mV change. The glass membrane of the measuring electrode must be kept free from protein buildup because coating of the membrane causes sluggish or erratic responses.

pCO₂ is determined with a modified pH electrode, called a *Severinghaus electrode*. An outer semipermeable membrane that allows CO₂ to diffuse into a layer of electrolyte, usually a bicarbonate buffer, covers the glass pH electrode. The CO₂ that diffuses across the membrane reacts with the buffer, forming *carbonic acid*, which then dissociates into bicarbonate plus H⁺. The change in

CASE STUDY 16-6

A 48-year-old man with diabetes with a history of alcohol abuse was admitted to the emergency department. He had an elevated heart rate (tachycardia) and was experiencing extreme shortness of breath. Blood was drawn for glucose and blood gases and urine collected for ketones:

| | |
|-------------------------------|-----------------------------------|
| Glucose | 570 mg/dL |
| Urinary ketones | Large (reference range, negative) |
| pH | 7.00 |
| pCO ₂ | 48 mm Hg |
| pO ₂ | 68 mm Hg |
| HCO ₃ [−] | 12 mmol/L |
| SO ₂ | 81% (calculated) |
| tHb | 10 g/dL |

Questions

1. Is the patient's acidemia a result of respiratory or nonrespiratory disturbances or a combination of both?
2. If the patient was not having respiratory problems, how would you classify the acid-base disturbance?
3. What is the significance of shortness of breath, tachycardia, and elevated pCO₂?
4. What is the significance of the urinary ketones result in terms of identifying the type of diabetes?

activity of the H^+ is measured by the pH electrode and related to pCO_2 .

As with the other electrodes, the buildup of protein material on the membrane will affect diffusion and cause errors. pCO_2 electrodes are the slowest to respond because of the chemical reaction that must be completed. Other error sources include erroneous calibration caused by incorrect or contaminated calibration materials.

Types of Electrochemical Sensors

Macroelectrode sensors have been used in blood gas instruments since the beginning of the clinical measurement of blood gases. These have been modified over time in an effort to simplify their use and minimize the required sample volume and maintenance. *Microelectrodes* basically are miniaturized macroelectrodes. Miniaturization became possible with better manufacturing capabilities and with the development of the sophisticated electronics required to handle minute changes in signal.

Thick and thin film technology is a further modification of electrochemical sensors. Although the measurement principle is identical, the sensors are reduced to tiny wires embedded in a printed circuit card. The special card has etched grooves to separate components. A special paste material containing the required components (similar in function to the electrolytes of macroelectrodes) is spread over the sensors. To reduce the required sample volume, several sensors can be placed on a single small card. These sensors are disposable and less expensive to manufacture, which reduces maintenance.

Optical Sensors

Another technology for blood gas measurements is based on the fact that certain fluorescent dyes will react predictably with specific chemicals, such as O_2 , CO_2 , and H^+ . The dye is separated from the sample by a membrane, as with electrodes, and the analyte diffuses into the dye, causing either an increase in or a quenching of fluorescence proportional to the amount of analyte. Calibration is used to establish the relationship between concentration and fluorescence. Normally, a single calibration will suffice for long periods because this technology is not subject to the drifts seen in electrochemical technology.

Optical technology has been applied to indwelling blood gas systems. Fiberoptic bundles carry light to sensors positioned in the tip of catheters and other bundles carry light back, allowing changes in fluorescence to be measured in a catheter within the patient's arterial system. The commercial development of indwelling systems has been limited by the increased probability of thrombogenesis and protein buildup on the membrane, separating the sample from the fluorescing dyes. This

CASE STUDY 16-7

A 64-year-old woman with chronic obstructive pulmonary disease (COPD) was admitted to the emergency department with extreme shortness of breath. She had a bluish color that was particularly pronounced on her lips and nail beds and she displayed a weak and persistent cough with diminished, but rattling breath sounds. Home medications included bronchodilators, steroids, Lasix (a loop diuretic that does not conserve plasma potassium), and digitalis. Vital signs: heart rate, 148 bpm; blood pressure, 100/88 mm Hg; temperature, 37°C; and respiratory rate, 38. Initial blood gas results on room air were:

| | |
|-----------|-----------|
| pH | 7.289 |
| pCO_2 | 91 mm Hg |
| pO_2 | 53 mm Hg |
| HCO_3^- | 43 mmol/L |

Questions

1. What is the patient's acid-base status?
2. Would the pH be normal if the patient was able to decrease her pCO_2 to 50 mm Hg?
3. In addition to COPD, what condition likely contributed to her poor gas exchange (hypercarbia and hypoxemia)?

She was treated with a bolus of Lasix intravenously and two albuterol (bronchodilator) respiratory treatments. Her vital signs improved: heart rate, 124 bpm; blood pressure, 120/80 mm Hg; and respiratory rate, 22. Blood gases were repeated with the patient breathing 28% O_2 ($FiO_2 = 0.28$):

| | |
|-----------|-----------|
| pH | 7.306 |
| pCO_2 | 75 mm Hg |
| pO_2 | 78 mm Hg |
| HCO_3^- | 36 mmol/L |

Questions

1. Should more oxygen be administered to this patient?
2. How did Lasix administration and respiratory treatment benefit the patient?
3. Which critical electrolyte should be closely monitored in the management of this case?

buildup impedes free sample diffusion into the measuring chamber.

Calibration

Temperature is an important factor in the measurement of pH and blood gases. The Nernst equation specifies the expected voltage output of an electrochemical cell at a given temperature. If the temperature of the measurement system changes, the output (voltage) will change. The solubility of gases in a liquid medium also depends on the temperature: as the temperature goes down, the solubility of the gas increases. Because pH and blood gas measurements are extremely sensitive to temperature, it is critical that the electrode sample chamber be maintained at constant temperature for all measurements. All blood gas analyzers have electrode chambers thermostatically controlled to $37^{\circ} \pm 0.1^{\circ}\text{C}$.

The pH electrode is usually calibrated with two buffer solutions traceable to standards prepared by the National Institute of Standards and Technology (NIST). *Traceable* usually means that the actual value of the calibrator has been determined using an NIST standard as a reference. Usually, one calibrator is near 6.8 and the other is near 7.38 because most pH electrodes produce “0” voltage at this point. The calibrators must be stored at the stated temperature and not exposed to room air because pH changes with the absorption of CO_2 .

Calibration of any blood gas analyzer will vary depending on the manufacturer. Normally, two gas mixtures are used for pCO_2 and pO_2 . One gas has no O_2 to set the zero point of the O_2 electrode (which is usually a stable point). The same gas has approximately 5% CO_2 because this is the null (zero potential and stable) point for the CO_2 electrode. The other gas sets the gain, that is, the amount of change in the electrode signal relative to the change for the analyte. The gas can have any value.

Most instruments are self-calibrating (calibrate automatically at specified time intervals) and are programmed to indicate a calibration error if the electronic signal from the electrode is inconsistent with the programmed expected value. For example, if the value(s) obtained during calibration exceed(s) a programmed tolerance limit, flagging of a *drift* error will occur at the time of calibration, and corrective action will need to be taken before patient samples can be analyzed.

Calculated Parameters

Several acid-base parameters can be calculated from measured pH and pCO_2 values. Manufacturers of blood gas instruments include algorithms to perform the calculations. No calculated parameter is universally used; many physicians have “favorite” parameters for identifying various pathologies.

The calculation of HCO_3^- is based on the Henderson-Hasselbalch equation. This can be calculated when pH and pCO_2 are known. One basic assumption is that the pK' of the bicarbonate buffer system in plasma at 37°C is 6.1.

Carbonic acid concentration can be calculated using the solubility coefficient of CO_2 in plasma at 37°C . The solubility constant to convert pCO_2 to millimoles per liter of H_2CO_3 is 0.0307. If the temperature or the composition of plasma changes (e.g., an increase in lipids, in which gases are more soluble), the constant will change.

Total carbon dioxide content (ctCO_2) is the bicarbonate plus the dissolved CO_2 (carbonic acid) plus the associated CO_2 with proteins (carbamates). A blood gas analyzer approximates ctCO_2 by adding the bicarbonate and carbonic acid values ($\text{ctCO}_2 = \text{cHCO}_3^- + [0.0307 \text{ pCO}_2]$).

Some clinicians use *base excess* to assess the nonrespiratory (metabolic) component of a patient's acid-base disorder. Base excess is calculated from an algorithm that uses the patient's pH, pCO_2 , and hemoglobin. A positive value (base excess) indicates an excess of bicarbonate or relative deficit of noncarbonic acid and suggests *nonrespiratory (metabolic) alkalosis*. A negative value (base deficit) indicates a deficit of bicarbonate or relative excess of noncarbonic acids and suggests *nonrespiratory (metabolic) acidosis*. Because the indicated nonrespiratory alkalosis or acidosis may be a result of primary disturbances or compensatory mechanisms, base excess values should not be used alone in assessing a patient's acid-base status.

Correction for Temperature

Values for pH, pCO_2 , and pO_2 are temperature dependent. By convention, all of these measurements are made at 37°C . The question becomes, “When the patient's body temperature differs from 37°C , should the blood gas values be ‘corrected’ to the actual temperature of the patient?” Although the blood gas instrument software can easily perform the correction, the data may be confusing because appropriate reference ranges *for the patient's temperature* must be used for proper interpretation. For reference, results usually also are reported at 37°C when values are reported at actual patient temperature.

QUALITY ASSURANCE

Preanalytic Considerations

Blood gas measurements, like all laboratory measurements, are subject to preanalytic, analytic, and postanalytic errors. Few other measurements, however, are as affected by **preanalytic errors**—those introduced during the collection and transport of samples before analysis.^{2,4}

Figure 16-6 depicts the quality assurance cycle. The steps included in the analytic area are under the direct control of the laboratory. Because much of the quality assurance cycle lies outside the laboratory, the laboratorian must take an active role in educating *all* people involved in developing policies and procedures for controlling all the processes in the cycle to ensure quality. The preanalytic considerations start with proper patient identification, which is absolutely essential before any blood specimen is collected. Once collected the specimen must be correctly labeled and accompanied by accurate information needed for result interpretation.

Only personnel who have experience with the drawing equipment and technique and have knowledge of the possible sources of error should draw samples for pH and blood gas analyses. Because collection may be painful and result in patient hyperventilation, which lowers the $p\text{CO}_2$ and increases the pH, the ability to reassure the patient is essential. The choice of site—radial, brachial, femoral, or temporal artery—is usually customary within an institution, depending on the predominant patient population (e.g., pediatric patients, burn patients, outpatients). The Clinical and Laboratory Standards Institute (CLSI) publication *Procedures for the Collection of Arterial Blood Specimens* is an excellent reference.⁴

The use of arterial samples for pH and blood gas studies is recommended. However, peripheral venous samples can be used if pulmonary function or O_2 transport is not being assessed. For venous samples, the source of the specimen must be clearly identified and the appropriate (venous) reference ranges included with the results for data interpretation. Depending on the patient, capillary blood may need to be collected to assess pH and $p\text{CO}_2$. Although the correlation with arterial blood is good for pH and $p\text{CO}_2$, capillary $p\text{O}_2$ values, even with warming of the skin before drawing the sample, do not correlate well with arterial $p\text{O}_2$ values as a result of sample exposure to room air. Central venous (pulmonary artery) blood samples are obtained to assess O_2 consumption, which is calculated from the difference between the O_2 content of arterial blood and pulmonary artery blood times the cardiac output. For sample collection from an indwelling arterial line, an appropriate blood volume must initially be withdrawn and discarded to assure that the actual sample collected contains only arterial blood. The proper flushing procedure minimizes the chance of specimen contamination with intravenous solutions (i.e., liquid heparin, medication, or electrolyte fluids that may be in the line).²

Sources of error in the collection and handling of blood gas specimens include the collection device, form and concentration of heparin used for anticoagu-

CASE STUDY 16-8

A 23-year-old woman with a history of asthma was brought to the emergency department by ambulance. She was extremely short of breath. Her level of consciousness was diminished greatly, and she was only able to respond to questions with nods or one-word responses. She had a weak cough, with nearly inaudible breath sounds. After drawing blood gases, she was placed on supplemental oxygen. Vital signs: heart rate, 160 bpm; blood pressure, 120/84 mm Hg; temperature, 37°C; and respiratory rate, 36. Her initial blood gas and total hemoglobin results were:

| | |
|------------------|-----------|
| pH | 7.330 |
| $p\text{CO}_2$ | 25 mm Hg |
| $p\text{O}_2$ | 58 mm Hg |
| HCO_3^- | 13 mmol/L |
| tHb | 12.4 g/L |

Questions

1. What is the patient's acid-base and oxygenation status?
2. What is the cause of the acid-base disturbance?
3. Would the pH be normal if the patient's $p\text{CO}_2$ increased to 40 mm Hg?
4. Does asthma typically present in this manner?
5. What clinical findings are most indicative of this patient's impending failure?

lation, speed of syringe filling, maintenance of the anaerobic environment, mixing of the sample to ensure dissolution and distribution of the heparin, and transport and storage time before analysis. For proper interpretation of blood gas results, the patient's status—ventilation (on room air or supplemental O_2) and body temperature—at the time the sample is collected must be documented.

In most instances, the ideal collection device for arterial blood sampling is a 1- to 3-mL self-filling, plastic, disposable syringe, containing the appropriate type and amount of anticoagulant. Evacuated collection tubes are not appropriate for blood gases. While both dry (lyophilized) and liquid heparin are acceptable anticoagulants, the liquid form is not recommended because excessive amounts can dilute the sample and possibly contaminate the sample if equilibrated with room air.^{2,4} Once drawn, the blood in the syringe must be mixed

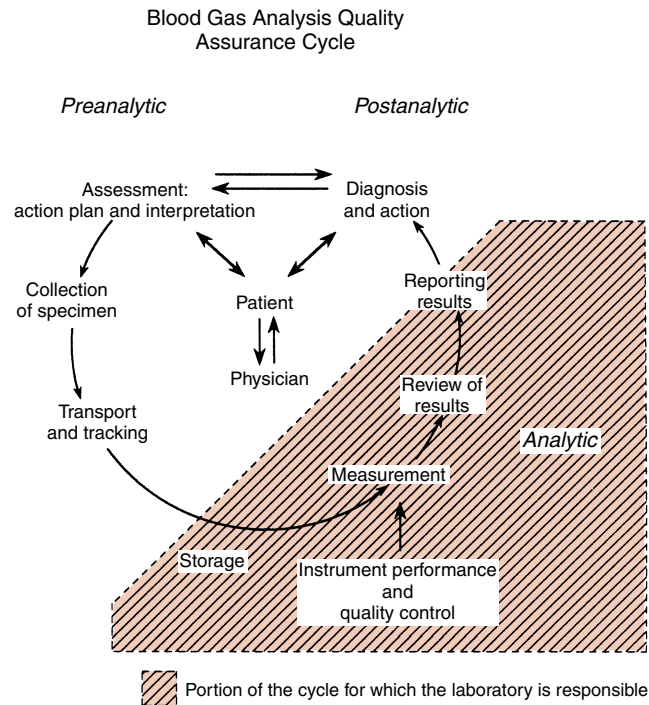

© Robert F. Moran

FIGURE 16-6. Blood gas analysis quality assurance cycle.
(Courtesy of Robert F. Moran.)

thoroughly with the heparin to prevent microclots from forming. Adequate mixing is again important to resuspend the settled cells immediately before the sample is analyzed. Although sodium and lithium salts of heparin are recommended for pH and blood gas analysis, other forms are available: ammonium, zinc, electrolyte balanced, and calcium titrated. Selection of the proper type of heparin is particularly important with instruments combining blood gas, electrolyte, and metabolite measurements. It is important to consult the manufacturer's product insert.

Slow filling of the syringe may be caused by a mismatch of syringe and needle sizes. Although too small a needle reduces patient's pain and, therefore, the likelihood of arteriospasm and hematoma, it may produce bubbles that affect $p\text{CO}_2$ and $p\text{O}_2$ values as well as hemolysis, which is important when potassium is measured along with pH and blood gases. Maintenance of an anaerobic environment is critical to correct results. Any air trapped in the syringe during the draw should be immediately expelled at the completion of the draw.

Transport time prior to analysis should be minimal to reduce cell metabolism, which results in oxygen and glucose consumption and carbon dioxide and lactate production. While placing the filled syringe in an

ice-water slurry immediately after the draw minimizes metabolism, there is a potential for $p\text{O}_2$ to increase due to oxygen diffusing through the pores of the plastic syringe. In addition, lower temperatures cause increased oxygen solubility in blood and a left-shift in the oxyhemoglobin curve resulting in more oxygen combining with hemoglobin. As a consequence when the sample is heated by the blood gas analyzer, the measured $p\text{O}_2$ is falsely elevated.⁵ The best practice in avoiding many of the preanalytic errors is to analyze the sample as quickly as possible. Oxygen and carbon dioxide levels in blood kept at cool room temperatures for 20–30 minutes or less are minimally affected except in the presence of an elevated leukocyte or platelet count. The CLSI guidelines advocate samples be kept at room temperature and analyzed in less than 30 minutes.² Consideration should be given to the additional sources of preanalytic errors for samples that are to be analyzed on multi analyte instruments. For example, prolonged ice water slurry storage can result in falsely elevated potassium in whole blood samples. Consult manufacturer manuals for preanalytic considerations.

Because sample procurement and handling are the source of many possible errors in blood gas analysis, it is necessary that procedures and policies are carefully constructed and adherence monitored to ensure quality. No

quality control product can monitor the preanalytic aspects of blood gas analysis.

Analytic Assessments: Quality Control and Proficiency Testing

Quality control (QC) assesses the analytic phase of the three-part—preanalytic, analytic, and postanalytic—testing process. Ideally, to evaluate the performance of a test method, a control should closely mimic actual patient samples, this is impossible for blood gases. There are several approaches for blood gas QC.² All have limitations.

Surrogate liquid control materials are the basis of most of traditional QC practices.⁶ Usually, these are sold in sealed glass ampules or bags that contain solutions equilibrated with gases of known concentration. The ampules can be snapped and the contents analyzed by the analyst like a patient's sample or instrument devices can automatically pierce the ampule at programmed intervals for analysis. Surrogate liquid controls typically are available in at least three levels, corresponding to values observed with low, expected or "normal," and elevated values for each of the measured analytes, which may include additional analytes, such as sodium, potassium, chloride, lactate, ionized calcium and magnesium, and glucose. The materials vary in stability and are susceptible to temperature variation in storage and handling. Each must be handled as described by the manufacturer to eliminate precision errors caused by improper handling of the material. Because liquid control materials have significantly different matrices than fresh whole blood, the laboratorian must be aware that they may not detect problems that affect patient samples, or they may detect errors induced by improper handling of the commercial controls. Aqueous-based controls, the most commonly used QC material, have low O₂ solubility, making them sensitive to factors that affect the determination of pO₂. Aqueous controls must be at room temperature for analysis and manufacturer recommendations must be followed closely or pO₂ values may be unreliable. Hemoglobin-containing and emulsion-based controls have increased O₂ solubility to better resist O₂ changes. Several manufacturers have devised onboard QC systems that greatly reduce operator handling errors. Advances in computer technology and software monitoring algorithms now can continuously monitor instrument performance for improved reliability and error detection in blood gas and multianalyte instruments.

Tonometry is the equilibration of a fluid with gases of known concentration and under controlled conditions, such as constant temperature, barometric pressure, humidification.² When whole blood is used, it is considered the reference procedure to establish the accuracy for pCO₂

and pO₂. However, tonometry is rarely used today because the technique is considered to be too cumbersome and time consuming and it can be potentially hazardous when whole blood is used.

Duplicate assays using two or more instruments for simultaneous analysis of a patient sample is another technique. The delta checks, or the difference in values obtained on the two instruments, often pick up problems that might be missed by routine QC. The allowable difference in duplicates should be tighter than those observed with surrogate liquid controls and discrepancies between results provide no clue regarding which data point is wrong or which instrument is malfunctioning. Consequently, the duplicate assay approach cannot be used as the sole method of QC, but it can be a useful technique for detecting errors and also for troubleshooting instruments.

Nonsurrogate QC is becoming particularly popular for testing devices used at point of care. This category includes a variety of quality assurance mechanisms that are integrated into the design of the device, such as electronic QC (which simulates sensor signals to test electronic components), automated procedural controls (which ensure that certain steps of the method occur appropriately), and automated internal checks (which may, for example, ensure the quality of a raw electronic signal). Such controls may check all, but usually just a portion of the test system's analytic components each time the test is performed.

Whatever the QC approach, the QC needs of the blood gas laboratory contrast sharply with those of the general laboratory, which analyzes many patient samples as a group and includes multiple control specimens with each run. In the blood gas laboratory, the critical nature of the measurements and the limited patient sample volume do not always allow for repeat analyses if problems exist. Consequently, the blood gas laboratory must perform *prospective* QC because instruments must be *prequalified* to ensure proper performance before the patient sample arrives for analysis.

Participating in external, interlaboratory surveys or proficiency testing programs is another essential component of ensuring the quality of blood gas measurements.⁷ Ongoing comparisons of results through proficiency testing help ensure that systematic (accuracy) errors do not slowly increase and go undetected by internal QC procedures. A rigorous internal QC program ensures internal consistency. Good performance in a proficiency testing program ensures the absence of significant bias relative to other laboratories and confirms the validity of a laboratory's patient results. If an individual analyzer does not produce proficiency testing results consistent with its peer laboratories (those using the same method/instrument) or if the differences

between values change over time, suspicion of the instrument's performance is warranted.

Interpretation of Results

Laboratory professionals need certain knowledge, attitudes, and skills for obtaining and analyzing specimens for pH and blood gases. Although the patient's physician assimilates all results—laboratory, radiology, nuclear medicine, surgical pathology findings, and so on, along

with the patient's clinical history—laboratory personnel must immediately assess patient results and make preliminary judgments about the “fit,” that is, do the results make sense? Simple evaluation of the data may reveal an instrument problem (possible bubble in the sample chamber or fibrin plug) or a possible sample handling problem (pO₂ out of line with previous results and current inspired FiO₂ levels). The application of knowledge saves time. The ability to correlate data quickly reduces turnaround time and prevents mistakes.

REFERENCES

1. Weisberg HF. Water, electrolyte, and acid-base balance. 2nd ed. Baltimore, Md.: Williams & Wilkins, 1962.
2. D'Orazio P, et al. Blood gas and pH analysis and related measurements. Wayne, Pa.: Clinical and Laboratory Standards Institute, 2008. (Publication no. C46-A2.)
3. Ehrmeyer S, Ancy J, Laessig R. Oxygenation: measure the right thing. *Respir Ther* 1998;11(3):25–28.
4. Blonshine S, et al. Procedures for the collection of arterial blood specimens. Wayne, Pa.: Clinical and Laboratory Standards Institute, 2004. (Publication no. H11-A4.)
5. Ancy J. Preventing preanalytical error in blood gas analysis. The Blood Gas Laboratory. Retrieved from www.foocus.com/pdfs/Articles/MarApr06/John%20Ancy.pdf.
6. Westgard JO, et al. Statistical quality control for quantitative measurements: principles and definitions. Wayne, Pa.: Clinical and Laboratory Standards Institute, 2006. (Publication no. C24-A3.)
7. Laessig RH, Ehrmeyer SS. Lab 2000: Fundamental features—proficiency testing—then, now and the future. *Clin Chem News* 1999;25:18–20.

Trace Elements

Alan L. Rockwood, Elzbieta (Ela) Bakowska

CHAPTER

17

CHAPTER OUTLINE

■ INSTRUMENTATION AND METHODS

Sample Collection and Processing
Atomic Emission Spectroscopy
Atomic Absorption Spectroscopy
Inductively Coupled Plasma Mass Spectrometry
Interferences
Elemental Speciation
Alternative Analytic Techniques

■ ARSENIC

Health Effects
Absorption, Transport, and Excretion
Toxicity
Laboratory Evaluation of Arsenic Status

■ CADMIUM

Health Effects
Absorption, Transport, and Excretion
Toxicity
Laboratory Evaluation of Cadmium Status

■ LEAD

Health Effects
Absorption, Transport, and Excretion
Toxicity
Laboratory Evaluation of Lead Status

■ MERCURY

Health Effects
Absorption, Transport, and Excretion
Toxicity
Laboratory Evaluation of Mercury Status

■ CHROMIUM

Health Effects
Absorption, Transport, and Excretion
Deficiency
Toxicity
Laboratory Evaluation of Chromium Status

■ COPPER

Health Effects
Absorption, Transport, and Excretion
Deficiency

Toxicity
Laboratory Evaluation of Copper Status

■ IRON

Health Effects
Absorption, Transport, and Excretion
Deficiency
Toxicity
Laboratory Evaluation of Iron Status
Total Iron Content (Serum Iron)
Total Iron-Binding Capacity
Percent Saturation
Transferrin and Ferritin

■ MANGANESE

Health Effects
Absorption, Transport, and Excretion
Deficiency
Toxicity
Laboratory Evaluation of Manganese Status

■ MOLYBDENUM

Health Effects
Absorption, Transport, and Excretion
Deficiency
Toxicity
Laboratory Evaluation of Molybdenum Status

■ SELENIUM

Health Effects
Absorption, Transport, and Excretion
Deficiency
Toxicity
Laboratory Evaluation of Selenium Status

■ ZINC

Health Effects
Absorption, Transport, and Excretion
Deficiency
Toxicity
Laboratory Evaluation of Zinc Status

■ BIBLIOGRAPHY

■ REFERENCES

Almost half of the elements listed in the periodic table have been found in the human body.¹

The essential and nonessential toxic trace elements included in this chapter all have biochemical importance, whether minor or major. The **essential trace elements** are usually associated with an enzyme (**metalloenzyme**) or another protein (**metalloprotein**) as an essential component or **cofactor**. Deficiencies typically impair one or more biochemical functions and excess concentrations are associated with at least some degree of toxicity. Although *trace elements*, such as iron, copper, and zinc, are found in mg/L concentrations, **ultratrace elements**, such as selenium, chromium, and manganese, are found in less than µg/L concentrations. An element is considered essential if a deficiency impairs a biochemical or functional process and replacement of the element corrects this impairment. Decreased intake, impaired absorption, increased excretion, and genetic abnormalities are examples of conditions that could result in deficiency of trace elements. The World Health Organization has established the dietary requirement for nutrients as the smallest amount of the nutrient needed to maintain optimal function and health. Any element that is not considered essential is classified as nonessential. **Nonessential trace elements** are of medical interest primarily because many of them are toxic.

This chapter presents information on the laboratory techniques for trace element determination. The absorption, transport, distribution, and removal biochemical functions will be described and related to the clinical significance of disease states or toxicity.

INSTRUMENTATION AND METHODS

For many years, the most commonly used instrumentation for trace metal analysis has been the atomic absorption spectrometer, either with flame (FAAS) or flameless (i.e., graphite furnace, GFAAS) atomization. Atomic emission spectrometry is also useful for some elements, particularly if used in the form of **inductively**

coupled plasma atomic emission spectroscopy (ICP-AES) for atomization and excitation. Recently, inductively coupled plasma mass spectrometry (ICP-MS) is becoming more widely used because of its sensitivity, wide range of elements covered, and relative freedom from interferences. There is no single technique that is best for all purposes. A matrix summarizing the relative advantages and disadvantages of the main techniques is given in Table 17-1.

Sample Collection and Processing

Specimens for analysis of trace elements must be collected with scrupulous attention to details such as anticoagulant, collection apparatus, and specimen type (serum, plasma, or blood). By the low concentration in biologic specimens and the ubiquitous presence in the environment, extraordinary measures are required to prevent contamination of the specimen. This includes using special sampling and collection devices, specially cleaned glassware, and water and reagents of high purity. The selection of needles, evacuated blood collection tubes, anticoagulants and other additives, water and other reagents, pipettes, and sample cups must be carefully evaluated for use in trace and ultratrace analyses. In addition, the laboratory environment must be carefully controlled. Recommended measures include placing the trace elements laboratory in a separate room incorporating rigorous contamination control features, such as sticky mats at doors, nonshedding ceiling tiles, carefully controlled air flow to minimize particulate contamination, disposable booties worn over shoes, particle monitoring equipment, etc. Many useful measures are borrowed from those employed in semiconductor clean rooms.

Atomic Emission Spectroscopy

The simplified principle of the **atomic emission spectroscopy** (AES) instruments is presented in Figure 17-1.

TABLE 17-1 RELATIVE ADVANTAGES AND DISADVANTAGES OF MAIN TECHNIQUES FOR ELEMENTAL ANALYSIS

| | FLAME AA | GFAA | ICP-AES | ICP-MS |
|----------------------------|-----------|-----------|----------|-----------|
| Sensitivity | Moderate | Excellent | Moderate | Excellent |
| Selectivity | Excellent | Good | Poor | Good |
| Elemental coverage | Moderate | Good | Good | Excellent |
| Speed for one analyte | Fast | Slow | Fast | Fast |
| Multi-element capabilities | No | No | Yes | Yes |
| Initial cost of instrument | Low | Moderate | Moderate | High |
| Cost of consumables | Very Low | Very High | Low | Moderate |
| Ease of operation | Excellent | Poor | Moderate | Moderate |

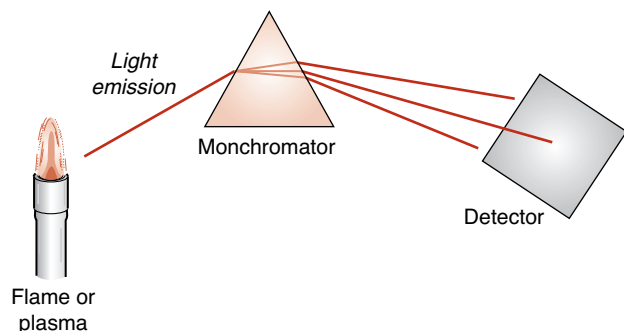

FIGURE 17-1. Simplified schematic of AES.

The three most important components of AE spectrophotometer are:

1. A source, in which the sample is atomized in a sufficiently hot source to produce an excited-state species. Those species will emit radiation upon relaxation back to the ground state.
2. A wavelength selecting device (**monochromator**), for the spectral dispersion of the radiation and separation of the analytic line from other radiation
3. A detector permitting measurement of radiation intensity

A liquid sample, containing element(s) of interest, is converted into an aerosol and delivered into the source, where it receives energy sufficient to emit radiation. The intensity of the emitted radiation is correlated to the concentration of an analyte and is basis for quantitation. The most commonly currently used sources in AES are flame and inductively coupled plasma. Flames are capable of producing temperatures up to 3000 K. Typical fuel gases include hydrogen and acetylene, while oxidant gases include air, oxygen, and nitrous oxide. The gases are combined in a specially designed mixing chamber. A sample is also introduced into the mixing chamber using a nebulizer that converts liquid into a fine spray. The mixing chamber and burner assembly are shown in Figure 17-2. The same assembly can be used for atomic absorption instrumentation. Inductively coupled plasma torches (described in more detail in a later section) are capable of much higher temperatures and are therefore applicable to a wider range of elements.

In AES, both atomic and ionic excited states can be produced (depending on the element and the source), which leads to production of complicated emission spectrum. The “emission spectrum” of an element is composed of a series of very narrow peaks (sometimes known as “lines”), with each line at a different wavelength and each line matched to a specific transition. Each element has its own characteristic emission spectrum. For example, sodium can be detected by tuning the monochromator to a wavelength of 589 nm. Ideally, each emission line of a given element would be distinct from

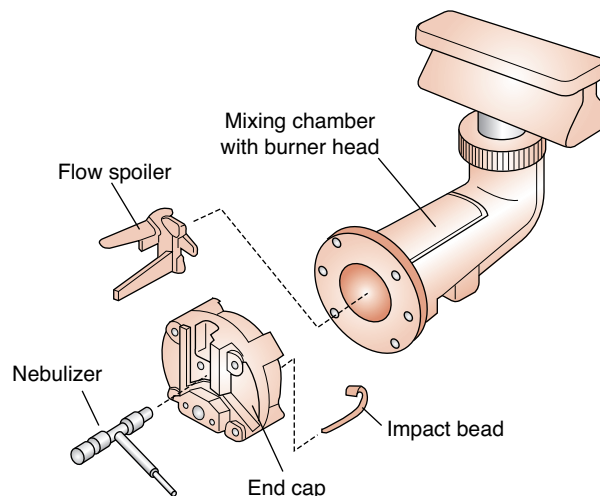

FIGURE 17-2. Mixing chamber burner for flame AA. (Courtesy of Perkin-Elmer, Waltham, MA.)

all other emission lines of all other elements. However, there are many cases where emission lines from certain elements overlap the emission lines of certain other elements, resulting in interferences. The choice of interference-free wavelength (atomic or ionic line) may be challenging. While there are several possible wavelengths for a given element, wavelengths producing suitable analytic performance, such as limit of quantitation, freedom from interferences, robustness, etc. are selected.

The first detectors in AES used photographic film. Contemporary AES instruments feature photomultiplier tubes or array-based detector systems.

Atomic Absorption Spectroscopy

Atomic absorption spectroscopy (AAS) is an analytic procedure for the quantitative determination of elements through the absorption of optical radiation by free atoms in the gas phase. The spectra of the atoms are line spectra that are specific for the absorbing elements.

Absorption is governed by the Beer-Lambert law:

$$A = -\log_{10} \left(\frac{I_1}{I_0} \right) \varepsilon L C_g \quad (\text{Eq. 17-1})$$

where A is the absorbance of the sample, I_0 is the incident light intensity, I_1 is the transmitted light intensity, ε is the molar absorptivity of the target analyte for the wavelength being used, L is the path length, and C_g is the gas-phase concentration of the target analyte. Under some simplifying assumptions, this equation takes the form:

$$A = KC \quad (\text{Eq. 17-2})$$

where K is a constant determined by calibration, and C is the solution phase concentration of the analyte.

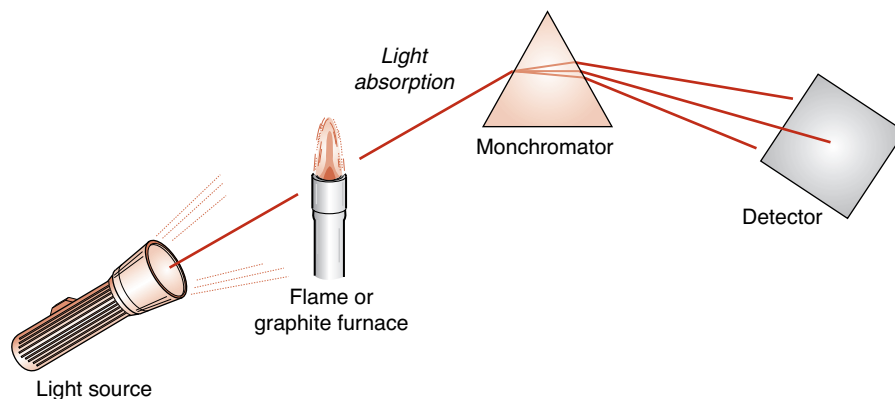

FIGURE 17-3. Simplified schematic of AAS instrumentation.

The simplified principle of the AAS instruments is presented in Figure 17-3.

The four most important components of AA spectrophotometer are :

1. Radiation (light) source, which emits the spectrum of the analyte element
2. Atomizer, in which the atoms of the element of interest in the sample are formed
3. Monochromator, for the spectral dispersion of the radiation and separation of the analytic line from other radiation
4. Detector permitting measurement of radiation intensity

Typical radiation sources for AAS are hollow cathode lamps (HCLs) and electrodeless discharge lamps (EDLs). The HCL contains a quantity of the target element in the form of a hollow cylinder. During operation, a small quantity of the target element is vaporized, and some of the gas-phase atoms of the target element become electronically excited and emit photons with the right wavelength to be absorbed by atoms of the target element in the atomizer. While HCLs are an ideal source for determining most elements by atomic absorption, for volatile elements the use of electrodeless discharge lamps is recommended.

The most common sources in AAS are flame (FAAS) and graphite furnace (GFAAS, also called flameless or electrothermal AAS). The mixing chamber burner, which produces laminar flames of high optical transparency, was already described in the section on AES in this chapter. Copper, iron, and zinc are often measured by FAAS.

The graphite tubes are most commonly used atomizers in flameless AAS. Tubes are made of high-purity polycrystalline electrographite and coated with pyrolytic graphite and can be heated to a high temperature by an electrical current. A small aliquot (usually 20 μL) of liquid sample is placed in the tube at the ambient temperature. The heating program (specifying the temperatures and times) is designed to first dry the sample, then pyrolyze, vaporize, and atomize the sample, followed by a cleaning step.

Selenium and cadmium are often measured by GFAAS. GFAAS allows for measurements of both liquid and solid samples. A common problem in GFAAS is that analyte volatility depends on the molecular form of the analyte and the sample's matrix. To overcome this limitation, chemical modifiers (palladium nitrate, magnesium nitrate, or mixture of both) are frequently added to samples, calibrators, and controls.

Hydride Generation and Cold Vapor AAS

There are two techniques of chemical vapor generation: cold vapor (CVAAS) and hydride generation (HGAAS). CVAAS is used exclusively for the determination of mercury. Mercury is reduced to its elemental form and transferred into a vapor phase, concentrated with the assistance of amalgamation, and measured in the absorption cell. In HGAAS the sample undergoes a chemical reaction; as a result, the analyte is converted into a gaseous hydride. The hydrides are then atomized either in flame or graphite furnace. This technique is only applicable to determination of antimony, arsenic, bismuth, selenium, tellurium, and tin.

The specificity of the chemical vapor generation techniques can allow for the speciation of the analytes. If the parameters are chosen properly, it may be possible to distinguish between different forms of the analytes, especially between their organic and inorganic forms.

Inductively Coupled Plasma Mass Spectrometry

Inductively coupled plasma mass spectrometry (ICP-MS) is a state-of-the-art analytic technique for elemental analysis. The term *plasma* in ICP refers to an **ionized gas** (almost always argon), in which a certain proportion of **electrons** are free.

Like other **mass spectrometers**, the ICP-MS measures the **mass-to-charge ratio** (molecular mass divided by ionic charge [m/z]) of selected analyte ions) and includes the following components: (1) an ion source, (2)

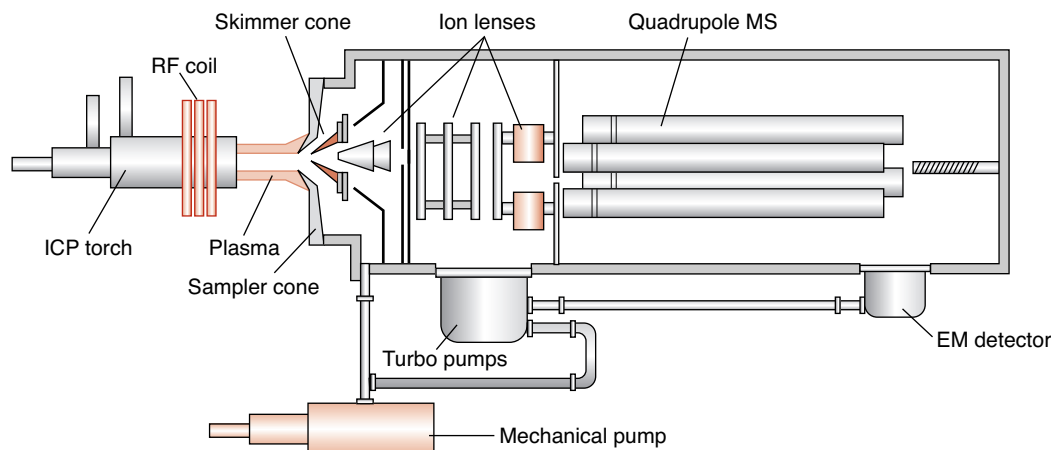

FIGURE 17-4. Simplified schematic of ICP-MS instrumentation.

a mass-to-charge ratio (m/z) analyzer, and (3) an ion detector. A simplified schematic of an ICP-MS is given in Figure 17-4.

The argon plasma induced by commercial ICP instruments (both ICP-AES and ICP-MS) generates high temperature, such as approximately 6,000 K to approximately 10,000 K, and serves several purposes. First, it dries the droplets produced by the nebulizer, and then it vaporizes the dried particles. This step is followed by atomization of any molecular species. Finally, atoms are thermally ionized, at which point they are ready for introduction into the mass spectrometer.

Nearly all ICP torches consist of three concentric quartz tubes surrounded by a coil carrying radiofrequency power. The middle tube of the torch carries the argon (Ar) that forms the plasma.

Quantitative analysis for clinical samples is best performed with the use of an internal standard. All patient samples, calibrators, and controls are diluted with an internal standard, usually a solution of an uncommon element (such as yttrium) that is different than the target element. Rather than using the raw signal level of the target elements as the basis for quantitation, the signal for each of target element is divided by the signal of the internal standard to give signal ratios (i.e., normalized intensities).

Quadrupole Mass Spectrometers

The typical mass spectrometer used for ICP-MS is a quadrupole mass spectrometer. The analyzer consists of four parallel conducting rods arranged in a square array. By superposition of radiofrequency (RF) and constant (DC) voltages applied to the rods, the instrument can be tuned so that only ions of a specific m/z ratio can pass through the device to reach the detector. This type of instrument tends to be relatively simple to use and maintain, but the resolution (the ability to discriminate between closely spaced m/z values) is limited, being able to

well resolve peaks separated by one m/z unit but not able to resolve peaks separated by a small fraction of an m/z unit.

High-Resolution Mass Spectrometers

Other ICP-MS instruments incorporate high-resolution mass spectrometers. These are usually “double focusing sector field” instruments. Such instruments separate ions of different m/z values via deflection in a magnetic field, with ions of greater m/z being deflected to a lesser degree than those of lower m/z . The magnetic field is adjusted so as to allow only ions of a selected m/z to reach the detection system at any given point in time. A second device known as an electrostatic analyzer corrects for certain nonideal effects, allowing the instrument to achieve high resolution. Commercially available high-resolution ICP-MS instruments are capable of a resolution of 10,000 (10% valley). This is enough to resolve, for example $^{75}\text{As}^+$ from $^{75}\text{ArCl}^+$, both nominally 75 m/z units, but which differ by 10×10^{-3} units when viewed at high resolution. However, magnetic sector instruments are not capable to resolve elemental isobaric interferences such as $^{115}\text{Sn}/^{115}\text{In}$ or $^{40}\text{Ca}/^{40}\text{Ar}$, which would require resolution much higher than 10,000.

Interferences

In general, the interferences in elemental analysis are classified as spectroscopic or nonspectroscopic.

Spectroscopic

Spectral interferences generally result from a spectral overlap with the spectrum of the target analyte. For example, in AA certain molecular species may have broad absorption spectra that may overlap the line spectra of the elements of interest, leading to false elevations of the target element concentrations. A much less common occurrence would be for the absorption spectrum of one element to overlap with that of another.

Various strategies are used to deal with spectral interferences in AAS. A continuum source background corrector may be included in the instrument design at the cost of some instrument complication. Another alternative is Zeeman background correction, which relies on shifting the atomic spectral lines by the application of a magnetic field.

In ICP-MS, spectral interferences include polyatomic species whose m/z may overlap m/z of the target analyte. For example, $^{56}(\text{ArO}^+)$ has the same nominal m/z as $^{56}\text{Fe}^+$. The argon oxide ion, which can be a significant component of plasma generated by an ICP torch, can potentially interfere with iron analysis by ICP-MS. Another well known polyatomic interference is argon chloride ion $^{75}(\text{ArCl})^+$ on determination of $^{75}\text{As}^+$. An extensive table of polyatomic interferences in ICP-MS has been published.²

A second source of spectral interferences in ICP-MS arises from nearby elements in the periodic table. For example, tin (Sn) and cadmium (Cd) both have isotopes at 114 Da (amu), so they could potentially interfere with each other if the instrument is set to measure 114 m/z . This can usually be handled by using a different isotope for the analysis. For example, cadmium also has an isotope at 111 Da, and this one is free from isobaric elemental interferences.

A third source of spectral interferences in ICP-MS comes from doubly charged ions. For example, $^{136}\text{Ba}^{2+}$ appears at the same m/z as $^{68}\text{Zn}^+$ ($136/2$ equals $68/1$). These are relatively uncommon and can usually be avoided, such as by choosing a different isotope for analysis or tuning the torch to reduce multiply charged ions.

Nonspectroscopic

Matrix interferences involve the bulk physical properties of the sample to be analyzed. The aqueous samples may behave differently than organic and biological specimens, depending upon the technology used and the analyte of interest. The properties of significance are viscosity, presence of easily ionized elements (EIE), and presence of carbon. Matrix matching of the calibrators, controls, and specimens helps to overcome matrix interferences. Dilution of the specimens helps to minimize matrix effect, but it is only applicable to certain analytic techniques and to the determination of analytes with higher concentrations.

Anything that could interfere with atomization of the sample could be classified as a nonspectral interference. For example, in AA, a flame may not be hot enough for efficient atomization. Difference in sample viscosity between standards and unknown samples, resulting in differing rates of sample introduction, is another example of a nonspectral interference. In AES, anything that would prevent the efficient excitation or emission of spectral lines used for the analysis would constitute a

nonspectral interference. A flame that was too cool would be an example.

Elemental Speciation

The toxicity of elements may depend on its chemical form. For example, arsenobetaine is a relatively nontoxic form of arsenic. Methylated forms of arsenic are intermediate in toxicity, and inorganic arsenic, such as As(V) and As(III), are highly toxic. In the medical evaluation of patients, it can be important to know whether an elevated arsenic level is due to relatively innocuous forms, such as arsenobetaine, perhaps from a seafood meal ingested up to 3 days before the specimen collection, or by dangerous forms such as inorganic arsenic. In addition, the concentrations of methylated forms may be useful information for monitoring recovery from toxic exposure. The methodologies for elemental analysis discussed in previous sections are generally not capable of specifying the chemical form of the target elements.

So-called hyphenated techniques allow for the speciation determinations. In a hyphenated analysis, the combination of two or more complementary analytic techniques is used to measure the specific form of an analyte. A classic example of this approach is liquid chromatography-ICP-MS (LC-ICP-MS). The sample is injected into a liquid chromatograph, which separates the different chemical forms of the analyte, with each form eluting at a different retention time. Concurrently, the eluting sample is continuously analyzed by a mass spectrometer. In this combination of instrumentation, the LC serves to separate the sample, which contains a mixture of analytes, into nominally pure fractions. The retention time partially identifies the analytes, and the mass spectrometer further identifies the element. The integrated intensities yield quantitative information. In some cases, AA may substitute for MS in elemental speciation schemes. Methods for elemental speciation are becoming more common, especially in Europe. Despite clinical matrices being probably the most difficult for the speciation, several applications are reported; among them are the following:

Arsenic speciation in urine by LC-ICP-MS and HG-GFAAS

Copper in urine by size exclusion chromatography (SEC)-ICP-MS

Copper in red blood cells (RBCs) by SEC-ICP-MS

Lead in blood by gas chromatography (GC)-GFAAS

Selenium in serum by SEC-GFAAS

Zinc in urine by anion exchange chromatography (AEC)-ICP-MS

Alternative Analytic Techniques

Additional methods are used for elemental analysis of clinical samples. Neutron activation analysis (NAA) is

losing its popularity due to the limitations of the technology (analyte losses and contamination issues, slow turnaround times, and high cost of the analysis) and the requirement of a nuclear facility.

Voltametric methods, such as anodic stripping voltametry (ASV) and adsorptive stripping voltametry (ADSV), are used in determination of selected metals in urine. Ion chromatography (IC) can be used for the determination of copper, iron, and zinc in blood, serum, and plasma and for the determination of zinc in urine.

Gas chromatography–mass spectrometry (GC-MS) is capable of determination of cadmium, chromium, cobalt, copper, lead, and selenium in urine, copper in serum, and lead in blood.

The methods accommodating direct analysis of solid samples, for instance, laser ablation ICP-MS (LA-ICP-MS), are gaining recognition for selected clinical applications.

ARSENIC

Much of the following information on arsenic was adapted from the web page <http://arupconsult.com>, which was based on primary references.^{3–8} Arsenic is an element with both metallic and nonmetallic properties. Arsenic is ubiquitous. Its content in earth's crust is estimated at 1.5–2.0 mg/kg. The predominant natural sources are volcanoes and weathering of minerals. Anthropogenic sources of arsenic (production of metals, burning of coal, fossil fuels, timber and its use in agriculture) release three times more arsenic than do natural sources.

Currently, the main use for inorganic arsenic is as a wood preservative. Other current or past uses of arsenic include pesticides, pigments, poison gases, ammunition manufacturing, semiconductor processing, and medicines.

Health Effects

Arsenic is currently considered to be nonessential, with no known function in human physiology. Therefore, arsenic is of medical interest principally due to its toxicity. However, there have been no studies on the role of arsenic in human nutrition, and some studies have indicated that it may be essential for certain mammals and birds.⁹

In 2000, the U.S. Food and Drug Administration (FDA) approved the use of arsenic trioxide for the treatment of acute promyelocytic leukemia (APL), which is diagnosed in 1,500 people in the United States every year.

Absorption, Transport, and Excretion

The main routes of exposure are ingestion of arsenic-containing foods, water, and beverages or inhalation of contaminated air. Arsenic is commonly found in fish and

seafood. However, the forms found in fish and seafood are relatively nontoxic. Arsenic exposure may come from dietary supplements and well water. Several industries continue to use arsenic in the production of pesticides, preservatives, metal alloys, glasses, enamels, semiconductors, and other items. Exposure controls are required for workers at risk. Arsenic intoxication is rare, except in suicides or accidents.

Nontoxic, organic forms, primarily arsenobetaine and arsenocholine, are cleared rapidly (1–2 days). Arsenobetaine, the main arsenic species in seafood, is a common cause for increased total arsenic concentration in urine. Toxic inorganic forms include pentavalent [As(V)], trivalent [As(III)], and methylated forms. Methylated arsenic compounds such as monomethyl arsine (MMA) and dimethylarsine (DMA) are formed by hepatic metabolism of As(III) and As(V). The methylated inorganic forms are considered less toxic than As(III) and As(V); however, they are eliminated slowly (1–3 weeks). The Biological Exposure Index established by the American Conference of Governmental Industrial Hygienists (ACGIH) for the sum of inorganic and methylated metabolites of arsenic is 35 $\mu\text{g/L}$. However, clinical symptoms may not be evident at 35 $\mu\text{g/L}$. Toxic thresholds are not well established. Arsenic deficiency has been documented in rats, goats, poultry, and minipigs,¹⁰ but it is not known in humans.

Toxicity

Arsenic exposure can lead to acute and chronic intoxication. Arsenic is a widely distributed element that exists in more than 30 chemical forms or species that can be grouped into inorganic [e.g., arsenite, As(III), arsenate, As(V)], methylated (e.g., monomethylarsinic acid [MMA], dimethylarsinic acid [DMA]), and organic (e.g., arsenobetaine, arsenocholine) fractions.

The toxicity of arsenic compounds varies widely among the forms. Inorganic species of arsenic are highly toxic and occur naturally in rocks, soil, and groundwater. They are also found in many synthetic products, poisons, and industrial processes. Methylated species are intermediate in toxicity and arise primarily from metabolism of inorganic species, but small amounts may arise directly from food. Organic species are relatively nontoxic and occur primarily in fish, seaweed, and shellfish consumed as foods.

The white powder of arsenic trioxide is one of the best known poisons in human history. It is odorless and tasteless. Doses of 0.01 to 0.05 g produce toxic symptoms. The lethal dose is reported to be between 0.12 and 0.3 g. However, recoveries from higher doses have been reported.¹¹

The relation of clinical signs and symptoms to arsenic exposure depends on the duration and extent of the

exposure to inorganic and methylated species of arsenic, as well as underlying clinical status of the patient. Acute exposure can result in death. If exposure occurred within 24 h or for patients who cannot provide a urine specimen (e.g., dialysis patient), arsenic can be detected in blood. However, in most cases it is best detected by urine due to the short half-life of arsenic in blood.

Symptoms are many and varied and can include a variety of organ systems. For acute exposure, these may include gastrointestinal (nausea, emesis, abdominal pain, rice water diarrhea), bone marrow (pancytopenia, anemia, basophilic stippling), cardiovascular (electrocardiographic changes), central nervous system (CNS) (encephalopathy, polyneuropathy), renal (renal insufficiency, renal failure), and hepatic (hepatitis) systems and symptoms. Chronic exposure may include dermatologic, hepatic, cardiovascular, CNS, and malignant changes.

Laboratory Evaluation of Arsenic Status

Arsenic is primarily measured using ICP-MS, GFAAS, or HGAAS. When arsenic speciation is required (typically if a high total arsenic value is measured by ICP-MS, AA, or AES), a separation method may be used prior to elemental analysis. This may include extraction of the sample into several different fractions representing different chemical forms of arsenic, followed by an elemental analysis by ICP-MS, AA, or AES. Alternatively, an online separation/analysis scheme can be used, such as liquid chromatography, followed by an elemental analysis such as MS (e.g., LC-ICP-MS).

Due to the wide range of symptoms related to arsenic exposure, many being relatively nonspecific, laboratory testing plays a key role in patient evaluation and diagnosis. For acute exposure, urine is generally the preferred sample due to the short half-life of arsenic in blood. For very recent exposure (<24 h), serum arsenic testing may be helpful. For chronic or past exposures (>3 weeks), analysis of hair or nails may be useful.

Toxic thresholds are not well established. The Biological Exposure Index established by the ACGIH for the sum of inorganic and methylated metabolites of arsenic is 35 $\mu\text{g/L}$. However, clinical symptoms may not be evident at 35 $\mu\text{g/L}$. Furthermore, due to the wide difference in toxicities of inorganic compared to methylated arsenic species, a simple cutoff may be an oversimplification, and further work on toxic thresholds seems warranted.

Reference Intervals for Arsenic

*Arsenic in blood*¹²

Normal: <23 $\mu\text{g/L}$

Critical value for chronic poisoning: 100–500 $\mu\text{g/L}$

Critical value for acute poisoning: 600–9,300 $\mu\text{g/L}$

*Arsenic in urine*¹²

Normal: <50 $\mu\text{g/L}$ or <0.50 $\mu\text{g/day}$ (for 24-h collection)

Chronic industrial exposure: >100 $\mu\text{g/L}$

Critical value: toxic >850 $\mu\text{g/L}$

CADMIUM

Cadmium (Cd) is a soft, bluish-white metal, which is easily cut with a knife. Principal industrial uses of cadmium include manufacture of pigments and batteries, as well as in the metal-plating and plastics industries. In the United States, the burning of fossil fuels such as coal or oil and the incineration of municipal waste materials constitute the largest sources of airborne cadmium exposure, along with zinc, lead, or copper smelters in some locations. Cadmium-containing waste products and soil contamination, primarily as a result of human activity, are becoming of concern, and the U.S. Environmental Protection Agency (EPA) has established loading rates of 20 kg/ha for high cation exchange capacity soils with a pH of 6.5 and a lower rate of 5 kg/ha for acid soils.¹³

Health Effects

Cadmium has no known role in normal human physiology. Cadmium forms protein-Cd adducts. These are believed to exhibit cadmium toxicity via denaturation of the cadmium-bound proteins, resulting in a loss of function.¹⁴

Newborn babies are practically free of cadmium. Cadmium concentrations in organs increase with age. Accumulations are established for the liver, kidney cortex, kidney medulla, urine bladder, muscles, lungs and glottis. Smoking increases accumulation of cadmium. The placenta can accumulate cadmium as well. Smoking during pregnancy enhances cadmium levels as compared with nonsmokers.

Absorption, Transport, and Excretion

Smokers of tobacco products have about twice the cadmium abundance in their bodies as nonsmokers. For nonsmokers, the primary exposure to cadmium is through ingested food.¹⁵ Regulatory numbers for inhalation exposure can be found at <http://www.epa.gov/ttn/atw/hlthef/cadmium.html>. Based on renal function (development of proteinuria), the reference dose for cadmium in drinking water is 0.0005 mg per kg per day (mg/kg/day), and the dose for dietary exposure to cadmium is 0.001 mg/kg/day.¹⁶ The absorption of inhaled cadmium in air is 10%–50%. The absorption of cadmium in cigarette smoke is also 10%–50%. Gastrointestinal absorption of cadmium is estimated to be 5%. Absorption of cadmium is higher in females than in males, due to differences in iron stores. Excretion of cadmium via the feces is about 90%.¹⁴

In blood, cadmium is bound mostly (70%) to the RBCs. Cadmium in blood reflects the average uptake during the past few months and can be used for monitoring purposes. Urinary excretion is about 0.001% and 0.01% of the body burden per 24 hours. At low exposure, urine cadmium reflects the total accumulation

Toxicity

Renal dysfunction is a common presentation for chronic cadmium exposure, often resulting in slow-onset proteinuria. Breathing of cadmium vapors can also result in nasal epithelial damage and lung damage similar to emphysema.¹⁴ Cadmium exposure can also affect the liver, bone, immune, blood, and nervous systems.^{15,17} Acute effects of inhalation of fumes containing cadmium include respiratory distress due to chemical pneumonitis and edema and can cause death. Ingestion of high amounts of cadmium may lead to a rapid onset with severe nausea, vomiting, and abdominal pain.¹⁴

Laboratory Evaluation of Cadmium Status

Cadmium is usually quantified by GFAAS, and ICP-MS; ICP-AES is also used.

Reference Intervals for Cadmium^{18,19}

Cadmium in urine: for random urine less than 2.6 $\mu\text{g/L}$ or less than 3.0 $\mu\text{g/g}$ creatinine, and for 24-h collection, 3.3 $\mu\text{g/day}$

Cadmium in blood: less than 5.0 $\mu\text{g/L}$

Contamination of the sample must be guarded against. In particular, one should avoid the use of containers containing colored plastics; yellow-colored plastic in particular often contains cadmium.

LEAD

Much of the following information on lead was adapted from the web page <http://arupconsult.com>, which was based on primary references.^{21–29} Lead is a heavy metal commonly found in the environment. It can be both an acute and a chronic toxin. Metallic lead is soft, bluish white, highly malleable, and ductile. It is a poor conductor of electricity and heat and is resistant to corrosion. When lead is exposed to moist air, a protective film is formed on its surface.

Lead is widely distributed in earth's crust. The main lead ores are galena, cerussite, and anglesite.³⁰ Lead is used in production of storage batteries, ammunition, solder, and foils. Tetraethyl lead was once used extensively as an additive in gasoline (petrol) for its ability to increase the fuel's octane rating. Lead is present in many paints manufactured before 1970. The manufacture of lead-based household paints was banned in 1972, but lead is still used in paints intended for nondomestic use.

Lead is found in areas adjacent to homes painted with lead-based paints and around highways, where it has accumulated from the past use of leaded gasoline. Recently, there were massive recalls of toys produced in China, due to their high lead contents.

Health Effects

Lead plays no known role in normal human physiology.

Absorption, Transport, and Excretion

Exposure to lead is primarily respiratory or gastrointestinal. Inhalation results in 30% to 40% absorption efficiency. Enhance gastrointestinal absorption may occur in children younger than 6 years of age. Gut absorption depends on a variety of factors, including age and nutritional status. Certain substances, such as iron, calcium, magnesium, alcohol, and fat, may impair lead absorption. Low dietary zinc, ascorbic acid, and citric acid enhance the absorption of lead.³⁰ Lead is transported to the blood, where 94% is transferred to the erythrocytes (RBCs) and primarily bound to hemoglobin and about 6% is in the plasma. The half-life in whole blood is 2 to 3 weeks. Lead is then primarily distributed to soft tissues, such as liver, kidneys, and brain, and the final storage of lead is in soft tissue (5%–30%, typically 5%) and bone (70%–95%, typically 95%). Absorbed lead is excreted primarily in urine (76%) and feces (16%), and the remaining 8% is excreted in hair, sweat, nails, and others.³⁰

Toxicity

The clinical presentation of lead toxicity is variable. In children, overt symptoms are usually seen at blood levels of 60 $\mu\text{g/dL}$ or higher, but they may occur at much lower levels. IQ declines are seen in children with blood lead levels of 10 $\mu\text{g/dL}$ or higher. Other CNS symptoms of lead toxicity in children may include clumsiness, gait abnormalities, headache, behavioral changes, seizures, and severe cognitive and behavioral problems. Gastrointestinal symptoms include abdominal pain, constipation, and colic. Other conditions may include acute nephropathy and anemia. In adults, the following may be observed: peripheral neuropathies, motor weakness, chronic renal insufficiency and systolic hypertension, and anemia.

The American Academy of Pediatrics recommends screening for all children receiving Medicaid who are 1 and 2 years of age, although the U.S. Preventive Services Task Force found insufficient evidence for or against screening.

The U.S. Centers for Disease Control and Prevention (CDC) estimates an incidence of more than 450,000 for children with blood lead levels higher than 10 $\mu\text{g/dL}$. Lead exposure primarily arises in two settings: childhood exposure, usually through paint chips, and adult occu-

pational exposure in the smelting, mining, ammunitions, soldering, plumbing, ceramic glazing, and construction industries. Other sources include lead-glazed ceramics and certain Asian herbal remedies. U.S. government web sites contain extensive information on the health and environmental impacts of lead.³

Laboratory Evaluation of Lead Status

The most common specimen type is whole venous blood. This is preferred over plasma and serum because circulating lead is predominantly associated with RBCs. Elevated lead levels in capillary blood specimens should be confirmed with a venous specimen to avoid the potential contribution of external contamination. A variety of other sample types are sometimes used, such as hair, nails, and urine.

Urine lead may be useful for detecting recent exposures to lead or to monitor chelation therapy. Other testing, such as plasma aminolevulinic acid, whole blood zinc protoporphyrin (ZPP), or free erythrocyte protoporphyrins, may be useful for screening in occupational exposures. Noninvasive measurements of lead in bone may be available via x-ray fluorescence. Removal of further lead exposure and chelation therapy are the mainstays of patient management for lead poisoning.

ICP-MS is a preferred method of analysis, although ICP-AES and AA may also be used.

Reference Intervals for Lead

Lead in blood

Current CDC guidelines consider levels of 10 $\mu\text{g}/\text{dL}$ or higher to be excessive for children and child-bearing females. The Biological Exposure Index (ACGIH Guidelines, 2007) for whole blood lead in nonpregnant adults is 30 $\mu\text{g}/\text{dL}$.

Lead in urine¹²

Normal range: $<80 \mu\text{g}/24 \text{ hours}$

Critical values: $>125 \mu\text{g}/24 \text{ hours}$

MERCURY

Mercury (Hg), also called quicksilver, is a heavy, silvery **metal**. Mercury is one of two (the other is bromine) elements that are **liquid** at room temperature and pressure. Extremely toxic mercury compound, dimethyl mercury, looks like water but is three times as dense. There are three naturally occurring oxidation states of mercury: Hg(0), Hg(I), and Hg(II). Organic mercury refers to forms of mercury bound to a carbon atom, with mercury usually in Hg(II) oxidation state.

Mercury is released to atmosphere as a product of the natural out gassing of rock (30,000 tons per year) and as a fungicide (6,000 tons per year), and it is incorporated

into dental amalgams (90 tons per year). Mercury is also used in electrical switches.

Health Effects

Mercury has no known function in normal human physiology. Mercury and its compounds have been used in medicine, although they are much less common today than they once were, now that the toxic effects of mercury and its compounds are more widely understood. **Mercury(I) chloride** has traditionally been used as a **diuretic**, topical **disinfectant**, and **laxative**. The mercury-containing organohalide **Mercurochrome** is still widely used but has been banned in the United States and some other countries.

Since the 1930s, some **vaccines** have contained the preservative **thiomersal**—mercury compound. Although it was widely speculated that this mercury-based preservative can cause or trigger **autism** in children, scientific studies showed no evidence supporting any such link. Nevertheless, thiomersal has been removed from or reduced to trace amounts in all U.S. vaccines recommended for children 6 years of age and younger, with the exception of inactivated influenza vaccine.

The use of mercury in medicine has greatly declined in all respects, especially in developed countries. However, mercury compounds are found in some over-the-counter drugs, including topical antiseptics, stimulant laxatives, diaper-rash ointment, eye drops, and nasal sprays. Mercury is widely used in the production of mascara.

Absorption, Transport, and Excretion

Routes of exposure include (1) inhalation, primarily as elemental mercury vapor but occasionally as dimethyl mercury; (2) ingestion, as HgCl_2 , and also consumption of high-mercury foods such as certain fish species; (3) cutaneous, methyl mercury is rapidly absorbed through skin, even through latex gloves; and (4) injection, liquid mercury and mercury-containing tattoo pigments are relatively inert due to low water solubility. Water-soluble forms of mercury can cause rapid tissue destruction. (5) Dental amalgams likely cause a slight increase in blood and urine mercury levels with uncertain but probably have insignificant health consequences. Inhaled mercury vapor is retained in the lungs to about 80%, whereas liquid metallic mercury passes the gastrointestinal tract almost unabsorbed.³²

Mercury enters the food chain primarily by volcanic activity and manmade sources such as coal combustion and smelting. Most of the dietary intake comes from consumption of meat and fish products, with an estimated dietary intake of approximately 3 $\mu\text{g}/\text{day}$.³³

There is relatively little bioaccumulation of mercury. Half-lives vary according to the form of mercury and the fluid sampled, from 5 days in blood for phenylmercury to

90 days in urine for chronic exposure to inorganic mercury. Normally, the highest accumulation of mercury is in kidney, liver, spleen, and brain. Mercury can accumulate in pituitary and thyroid glands, the pancreas, and the reproductive organs.

The kidney is the major storage organ after elemental or inorganic mercury exposure. However, large amounts are transported to the brain after the inhalation of elemental mercury or methyl mercury (MeHg). Methyl mercury is efficiently absorbed from the gastrointestinal tract, and distribution to tissues, including the brain, appears complete in 48 hours. Movement of MeHg across the blood-brain barrier appears to be dependent on coupling with the amino acid cysteine.³⁴

Fecal and urinary excretions are the main elimination routes for inorganic and organic mercury. A special form of elimination is the transfer of mercury from a mother through the placenta to the fetus.

Toxicity

The toxicity of mercury is primarily through reaction with sulfhydryl groups (MSH), primarily by inactivating proteins by binding to cysteine groups in proteins. Liquid elemental mercury is essentially nontoxic, but elemental mercury vapor is toxic. Inorganic, ionized forms of mercury are toxic. Further bioconversion to an alkyl mercury, such as methyl mercury, yields a very toxic species of mercury that is highly selective for lipid-rich mediums such as the neuron.³⁵

Toxicities have been observed following inhalation, ingestion, and dermal absorption of mercury compounds. Organic mercury and elemental mercury vapor are toxic to both the central and peripheral nervous systems. Mercury attacks the CNS well before a victim shows symptoms. There is a report of a Czechoslovakian scientist dying from dimethyl mercury poisoning in 1971.³⁶

Elemental mercury readily vaporizes, and its inhalation can produce harmful effects on the nervous, digestive, and immune systems and the lungs and kidneys. The inorganic salts of mercury can affect the skin, eyes, gastrointestinal tract, and kidneys.

A review provides 24 case reports of toxicity by mercury of various forms from various sources.³⁷ There seem to be two primary general modes of mercury toxicity, both of which result from binding of mercury to proteins: (1) direct toxicity and (2) immunogenic reaction to altered proteins resulting in sensitization. Mercury intoxication can manifest in many signs and symptoms that affect several organ systems, including headache, tremor, impaired coordination, abdominal cramps, diarrhea, dermatitis, polyneuropathy, proteinuria, and hepatic dysfunction.³⁸ Because many of these are relatively nonspecific signs and symptoms, laboratory testing provides a key role in assessing mercury intoxication.

Laboratory Evaluation of Mercury Status

Mercury is usually determined as total mercury levels in blood and urine without regard to chemical form. Analytic methods include CVAAS and ICP-MS.

Reference Intervals for Mercury¹²

Mercury in urine: 0–15 $\mu\text{g}/\text{day}$ for 24-hour collection

Mercury in random urine: <35 $\mu\text{g}/\text{g}$ creatinine

Urine levels >150 $\mu\text{g}/\text{L}$ are generally considered toxic.

People with high seafood consumption may have urine levels up to 50 $\mu\text{g}/\text{L}$ without clinical signs of toxicity.

Mercury in blood: 0–60 $\mu\text{g}/\text{L}$ ³⁷

CHROMIUM

Chromium (Cr), from the Greek word *chroma* (“color”), makes rubies red and emeralds green.

Chromium is used in the manufacture of stainless steel. Chromium exists in two main valency states: trivalent and hexavalent. Chromium(VI) is better absorbed and more toxic than chromium(III) and has also been listed as a carcinogen implicated in lung cancer.

Occupational exposure to chromium occurs in wood treatment, stainless steel welding, chrome plating, the leather tanning industry, and the use of lead chromate or strontium chromate paints.

Health Effects

Cr(III), an essential dietary element, plays a role in maintaining normal metabolism of glucose, fat, and cholesterol.

Chromium nutritional role has not been thoroughly explained. The estimated safe and adequate daily intake

CASE STUDY 17-1³⁹

A 20-year-old man ingested a quantity of fungicide containing dimethyl mercury. Blood mercury level was 2,800 $\mu\text{g}/\text{L}$ at 2 hours after ingestion, declining to less than half this value at 12 hours. Chelation therapy commenced at approximately 4.5 hours. Hemodialysis with *N*-acetylcysteine infusion was initiated at 1½ days. The patient survived with normal results for a series of neurologic examinations extending to 1 year.

Questions

1. Discuss the biochemical transport and biochemical transformations that mercury may have undergone in this patient.
2. Discuss the chemical/biochemical basis for chelation therapy.

of chromium for adults is in the range of 50–200 $\mu\text{g}/\text{day}$, although data are insufficient to establish a recommended daily allowance.⁴¹

Absorption, Transport, and Excretion

Cr(VI) compounds, which are powerful oxidizing agents and thus tend to be irritating and corrosive, appear to be much more toxic systemically than Cr(III) compounds, given similar amounts and solubilities. Although mechanisms of biological interaction are uncertain, this variation in toxicity may be related to the ease with which Cr(VI) can pass through cell membranes and its subsequent intracellular reduction to reactive intermediates.

Once absorbed, chromium in the blood is bound to transferrin. Studies have shown that transferrin has two binding sites: A and B. Chromium binds exclusively to the B site. Both transferrin and albumin are involved in chromium absorption and transport.⁴² Transferrin binds the newly absorbed chromium, while albumin acts as an acceptor and transporter of chromium, if the transferrin sites are saturated.⁴³ Other plasma proteins, including γ - and β -globulins and lipoproteins, bind chromium.

Research indicates that when transferrin is saturated with iron, chromium is not efficiently bound to plasma protein.⁴⁴

Deficiency

Dietary chromium deficiency is reactively uncommon; most cases occur in persons with special problems such as

total parenteral nutrition, diabetes, or malnutrition. Chromium deficiency is characterized by glucose intolerance, glycosuria, hypercholesterolemia, decreased longevity, decreased sperm counts, and impaired fertility.⁴¹

Toxicity

Severe dermatitis and skin ulcers can result from contact with Cr(VI) salts. Up to 20% of chromium workers develop contact dermatitis. Allergic dermatitis with eczema has been reported in printers, cement workers, metal workers, painters, and leather tanners. Data suggest that a Cr(III)–protein complex is responsible for the allergic reaction.⁴¹

When inhaled, Cr(VI) is a respiratory tract irritant, resulting in airway irritation, airway obstruction, and possibly lung cancer. The target organ of inhaled chromium is the lung; the kidneys, liver, skin, and immune system may also be affected.

Low-dose, chronic chromium exposure typically results only in transient renal effects. Elevated urinary β_2 -microglobulin levels (an indicator of renal tubular damage) have been found in chrome platers, and higher levels have generally been observed in younger persons exposed to higher Cr(VI) concentrations.⁴¹

Laboratory Evaluation of Chromium Status

Chromium may be determined by GFAAS, NAA, or ICP-MS. Some researchers suggest that plasma, serum and urine do not indicate the total body status of the individual, whereas urine levels may be useful for metabolic studies.⁴²

In the 1970s, the chromium in serum values ranged from 0.14–150 $\mu\text{g}/\text{L}$. In mid 1980s, the range of 0.01–0.3 $\mu\text{g}/\text{L}$ was accepted for chromium in serum.⁴² The original values were incorrect due to incorrect analytic methodology and not recognized contamination issues. A suggested urinary threshold for nephrotoxic effects is 15 μg chromium per gram of creatinine.⁴¹

The daily excretion values for chromium in urine were reported as 3–10 $\mu\text{g}/\text{L}$ until 1978 and as less than 1.0 $\mu\text{g}/\text{day}$ since then.⁴²

Reference Intervals for Chromium⁴⁵

Chromium in whole blood: 0.7–28.0 $\mu\text{g}/\text{L}$

Chromium in serum: <0.05–0.5 $\mu\text{g}/\text{L}$

Chromium in urine: 0.1–2.0 $\mu\text{g}/24$ hr

Chromium in RBCs: 20–36 $\mu\text{g}/\text{L}$

COPPER

Copper (Cu) is a relatively soft yet tough metal with excellent electrical and heat conducting properties. Copper is widely distributed in nature both in its elemental form and in compounds. Copper forms alloys with zinc

CASE STUDY 17-2

A 45-year-old woman who had been treated for type 2 diabetes for 2 years relayed to her physician a continued noncompliance with dietary restrictions and suggested exercise regimen. After obtaining a laboratory report (fasting blood glucose, 138 mg/dL; total cholesterol, 289 mg/dL), her physician prescribed a chromium picolinate supplement (500 μg twice daily). After 4 months, her fasting blood glucose decreased to 102 mg/dL and her total cholesterol decreased to 243 mg/dL.

Questions

1. Besides glucose intolerance, list three other effects that can be caused by chromium deficiency.
2. Are the form and dose of chromium administered related to its biologic activity?
3. Is Cr(III) toxic? Is it more or less toxic than Cr(VI) ?

(brass), tin (bronze), and nickel (cupronickel, widely used in coins).

Health Effects

The copper content in the normal human adult is 50–120 mg.⁴⁶ Copper is distributed through the body with the highest concentrations found in liver, brain, heart, and kidneys. Hepatic copper accounts for about 10% of the total copper in the body.⁴⁶ Copper is also found in cornea, spleen, intestine, and lung.

Copper is a component of several metalloenzymes, including ceruloplasmin, cytochrome C oxidase, superoxide dismutase, tyrosinase, metallothionein, dopamine- β -hydroxylase, lysyl oxidase, clotting factor V, and an unknown enzyme that cross-links keratin in hair.

Ceruloplasmin is the best known yet the least understood copper protein. It is an α_2 -globulin, and each 132,000-molecular-weight molecule contains six atoms of copper.⁴⁶ Ceruloplasmin levels are influenced by hormones.

Absorption, Transport, and Excretion

An average day's diet may contain 10 mg or more of copper.⁴⁶ The amount of copper absorbed from the intestine is 50%–80% of ingested copper.⁴¹ About half of dietary copper is excreted in feces. The exact mechanisms by which copper is absorbed and transported by the intestine are unknown. Copper absorption is impaired in severe diffuse diseases of small bowel, lymph sarcoma, and scleroderma.⁴⁶ Copper losses in the urine and sweat are approximately 3% of dietary intake.⁴¹ Menstrual losses of copper are minor.

Deficiency

Copper deficiency is observed in premature infants. Copper deficiency is related to malnutrition, malabsorption, chronic diarrhea, hyperalimentation, and prolonged feeding with low-copper, total-milk diets. Signs of copper deficiency include (1) neutropenia and hypochromic anemia in the early stages, (2) osteoporosis and various bone and joint abnormalities that reflect deficient copper-dependent cross-linking of bone collagen and connective tissue, (3) decreased pigmentation of the skin and general pallor, and (4), in the later stages, possible neurologic abnormalities (hypotonia, apnea, psychomotor retardation).⁴¹

Subclinical copper depletion contributes to an increased risk of coronary heart disease. An extreme form of copper deficiency is seen in Menkes disease. This invariably fatal, progressive brain disease is characterized by peculiar hair, called kinky or steely, and retardation of growth. Clinical forms include progressive mental

deterioration, coarse feces, disturbance of muscle tone, seizures, and episodes of severe hypothermia.

Symptoms of Menkes disease usually appear at the age of 3 months and death usually occurs in 5-year-olds.

Toxicity

Wilson's disease is a genetically determined copper accumulation disease that usually presents between the ages of 6 and 40 years. Its manifestations include neurologic disorders, liver dysfunction, and Kayser-Fleischer rings (green-brown discoloration) in the cornea caused by copper deposition. Early diagnosis of Wilson's disease is important because complications can be effectively prevented and in some cases the disease can be halted with use of zinc acetate or chelation therapy.⁴¹

Laboratory Evaluation of Copper Status

Copper is measured by flame AAS, ICP-MS, ICP-AES, and ASV. Serum copper and urine copper are used to monitor the nutritional adequacy and to screen for Wilson's disease, copper toxicity in premature children, and in children with Indian childhood cirrhosis (ICC), which is not limited to Indian children.

Reference Intervals for Copper

Copper in serum: 700–1500 $\mu\text{g/L}$ ¹²; mean levels for copper serum in women and children are slightly higher; values for blacks are 8–12% higher.⁴⁵

Copper in serum (pregnancy at term): 118–320 $\mu\text{g/L}$ ⁴⁵

Copper in urine: 15–60 $\mu\text{g}/24$ hours¹² or 3–35 $\mu\text{g}/24$ hours or 2–80 $\mu\text{g/L}$ ⁴⁵

Copper in RBCs: 90–150 $\mu\text{g/L}$ ⁴⁵

Table 17-2 presents the relationships between copper levels in serum and urine and selected health problems.

TABLE 17-2 INTERPRETATION OF COPPER TESTING RESULTS

| | SERUM COPPER | URINE COPPER |
|----------------------------------|-----------------|-----------------|
| Nutritional deficiency | ↓ | ↓ |
| Menkes syndrome | ↓ | ↑ |
| Acute copper toxicity | ↑ ↑↑ | ↑ |
| Chronic copper toxicity | ↑ | ↑ |
| Indian childhood cirrhosis (ICC) | ↑ | ↑ |
| Wilson's disease | N or ↓ | ↑ ↑↑ |
| Smoking, inflammatory conditions | ↑ ↑↑ | N |
| Estrogen, pregnancy | ↑ ↑↑ | N |

Note. N, normal; ↓, decreased; ↑, increased; ↑↑, significantly increased. Adapted with permission from Jacobs DS, ed. *Laboratory test handbook*. Boca Raton, Fla.: Lexi-Comp Inc, 1996.

IRON

Iron is fourth most abundant element in the earth's crust. Pure iron is a soft, lustrous, ferromagnetic metal. Methods of extracting iron from ore have been known for centuries. The uses of iron are so widespread and well known that one can say that modern economies are based largely on the many uses of iron. The physical properties of iron alloys can be varied over an enormous range by appropriate alloying and heat treating methods, giving a range of strength, hardness, toughness, corrosion resistance (in the form of stainless steels), and magnetic properties and ability to take and hold a sharp edge.

Although highly abundant in the earth's crust, iron is classified as a trace element in the body. Iron ions readily form complexes with certain ligands and are able to participate in redox chemistry between the ferrous (Fe(II)) and ferric (Fe(III)) states, allowing iron to fill many biochemical roles as a carrier of other biochemically active substances (e.g., oxygen) and as an agent in redox and electron transfer reactions (e.g., via various cytochromes). Iron's high activity is a two-edged sword, and free iron ions in the body also participate in destructive chemistry, primarily in catalyzing the formation of toxic free radicals. Hence, very little free iron is normally found in the body.

Health Effects

Of the 3 to 5 g of iron in the body, approximately 2 to 2.5 g of iron is in hemoglobin, mostly in RBCs and red cell precursors. A moderate amount of iron (\approx 130 mg) is in myoglobin, the oxygen-carrying protein of muscle. A small (8 mg), but extremely important, pool is in tissue where iron is bound to several enzymes that require iron for full activity. These include peroxidases, cytochromes, and many of the Krebs cycle enzymes. Iron is also stored as ferritin and hemosiderin, primarily in the bone marrow, spleen, and liver. This critical pool of iron may be the first to become diminished in iron deficiency states.⁴⁸ Only 3 to 5 mg of iron is found in plasma, almost all of it associated with transferrin, albumin, and free hemoglobin.⁴⁹

Absorption, Transport, and Excretion

Absorption of iron from the intestine is the primary means of regulating the amount of iron within the body. Typically, only about 10% of the 1 g/day of dietary iron is absorbed. To be absorbed by intestinal cells, iron must be in the Fe(II) (ferrous) oxidation state and bound to protein. Because Fe(III) is the predominant form of iron in foods, it must first be reduced to Fe(II) by agents such as vitamin C before it can be absorbed. In the intestinal mucosal cell, Fe(II) is bound by apoferritin, then oxidized by ceruloplasmin to Fe(III) bound to ferritin. From

there, iron is absorbed into the blood by apotransferrin, which becomes transferrin as it binds two Fe(III) ions. In plasma, transferrin carries and releases Fe to the bone marrow, where it is incorporated into hemoglobin of RBCs. After about 4 months in circulation, red cells are degraded by the spleen, liver, and macrophages, which return Fe to the circulation, where it is bound and carried by transferrin for reuse. Ferroportin controls the release of iron from cells. The recently discovered peptide hormone hepcidin largely controls iron metabolism by its ability to modulate the release of iron from cells by inhibiting ferroportin.⁴⁹ Iron regulation is primarily through modified absorption from the upper gastrointestinal tract.⁵⁰ Absorption and transport capacity can be increased in conditions such as iron deficiency, anemia, or hypoxia. Iron is lost primarily by desquamation and red cell loss to urine and feces. With each menstrual cycle, women lose approximately 20 to 40 mg of iron.

Deficiency

Iron deficiency affects about 15% of the worldwide population. Those with a higher than average risk of iron deficiency anemia include pregnant women, young children and adolescents, and women of reproductive age.⁵¹ Increased blood loss, decreased dietary iron intake, or decreased release from ferritin may result in iron deficiency. Reduction in iron stores usually precedes both a reduction in circulating iron and anemia, as demonstrated by a decreased red blood cell count, mean corpuscular hemoglobin concentration, and microcytic RBCs.

Toxicity

Iron overload states are collectively referred to as hemochromatosis, whether or not tissue damage is present. Primary Fe overload is most frequently associated with hereditary hemochromatosis (HH). HH is a single-gene homozygous recessive disorder leading to abnormally high Fe absorption, culminating in Fe overload. Secondary Fe overload may result from excessive dietary, medicinal, or transfusional Fe intake or be due to metabolic dysfunction. Hemosiderosis has been used to specifically designate a condition of iron overload as demonstrated by an increased serum iron and total iron binding capacity (TIBC) or transferrin, but without demonstrable tissue damage.

HH causes tissue accumulation of iron, affects liver function, and often leads to hyperpigmentation of the skin. Some conditions associated with severe hemochromatosis include diabetes mellitus, arthritis, cardiac arrhythmia or failure, cirrhosis, hypothyroidism, impotence, and liver cancer. Treatment may include therapeutic phlebotomy or administration of *chelators*, such as deferoxamine. Transferrin can be administered in the case of atransferrinemia.⁵⁰

Iron may play a role as a *prooxidant*, by contributing to lipid peroxidation,^{53,54} atherosclerosis,^{54,55} deoxyribonucleic acid (DNA) damage,^{53,56} carcinogenesis,^{57,58} and neurodegenerative diseases,^{59,60} Fe(III), released from binding proteins, can enhance production of free radicals to cause oxidative damage. In iron-loaded individuals with thalassemia who are treated with chelators to bind and mobilize iron, intake of ascorbic acid may actually promote the generation of free radicals.⁶¹ It seems likely that tissue damage caused by free iron is the underlying reason for the elaborate set of carrier proteins involved in iron transport and metabolism.

Laboratory Evaluation of Iron

Disorders of iron metabolism are evaluated primarily by packed cell volume, hemoglobin, red cell count and indices, total iron and TIBC, percent saturation, transferrin, and ferritin.⁶²

Total Iron Content (Serum Iron)

Measurement of serum iron concentration refers specifically to the Fe⁺³ bound to transferrin and not to the iron circulating as free hemoglobin in serum. The specimen may be collected as serum without anticoagulant or as plasma with heparin. Oxalate, citrate, or ethylenediaminetetraacetic acid binds Fe ions and all are unacceptable anticoagulants. Early morning sampling is preferred because of the diurnal variation in iron concentration. Specimens with visible hemolysis should be rejected.

Spectrophotometric determinations have been adapted to automated analysis. These procedures generally have the following steps: Fe⁺³ is released from binding proteins by acidification, reduced to Fe⁺² by ascorbate or a similar reducing agent, and complexed with a color reagent such as ferrozine, ferene, or bathophenanthroline.

Total Iron-Binding Capacity

Total iron-binding capacity (TIBC) refers to the amount of iron that could be bound by saturating transferrin and

other minor iron-binding proteins present in the serum or plasma sample. Typically, about one-third of the iron-binding sites on transferrin are saturated.

TIBC is determined by adding sufficient Fe⁺³ to saturate the binding sites on transferrin, with the excess iron removed by addition of MgCO₃ to precipitate any Fe⁺³ remaining in solution. After centrifugation to remove the precipitated Fe⁺³, the supernatant solution containing the soluble iron bound to proteins is analyzed for total iron content. This is the TIBC, which ranges from around 250 to 425 µg/dL.

Percent Saturation

The percent saturation, also called the transferrin saturation, is the ratio of serum iron to TIBC. The normal range for this is approximately 20% to 50%, but it varies with age and sex (Table 17-3).

Transferrin and Ferritin

Transferrin is measured by immunochemical methods such as nephelometry. Transferrin or TIBC is increased in iron deficiency and decreased in iron overload and hemochromatosis. Transferrin (TIBC) may also be decreased in chronic infections and malignancies (Table 17-4). Transferrin is primarily monitored as an indicator of nutritional status. As a negative acute-phase protein, its concentration decreases in inflammatory conditions.

Ferritin is measured in serum by immunochemical methods, such as Immunoradiometric assay (IRMA), enzyme-linked immunosorbent assay (ELISA), and chemiluminescent techniques. Several manufacturers provide kits for measuring serum ferritin by either manual or automated means. Ferritin is decreased in iron-deficiency anemia and increased in iron overload and hemochromatosis. Ferritin is often increased in several other conditions, such as chronic infections, malignancy, and viral hepatitis.

The trace metals laboratory has a limited role in the evaluation of hemochromatosis. As part of the algorithm, a liver biopsy sample is digested and analyzed for iron by

TABLE 17-3 REFERENCE INTERVALS FOR PARAMETERS USED TO ASSESS IRON STATUS^{47,84}

| PATIENT POPULATION | SERUM IRON (mg/dL) | TRANSFERRIN (mg/dL) | FERRITIN (mg/dL) | PERCENT SATURATION | TIBC (µg/DL) |
|---------------------|--------------------|---------------------|------------------|--------------------|--------------|
| Newborn | 100–250 | 130–275 | 25–200 | 12–50 | 100–400 |
| Infant | 40–100 | 200–360 | 200–600 | 12–50 | 100–400 |
| Child | 50–120 | 200–360 | 7–140 | 12–50 | 100–400 |
| Male, adult | 50–160 | 200–380 | 20–250 | 20–55 | 250–425 |
| Female, 16–40 years | 45–150 | 200–380 | 10–120 | 15–50 | 250–425 |
| Female, >40 years | | | | | 10–250 |

TABLE 17-4 LABORATORY MARKERS OF IRON STATUS IN SEVERAL DISEASE STATES

| CONDITION | SERUM IRON | TRANSFERRIN | FERRITIN | PERCENT SATURATION | TIBS |
|----------------------|-------------------------|--------------------|------------------------|----------------------|--------------------------|
| Normal intervals | 50–160 $\mu\text{g/dL}$ | 200–400 mg/dL | 20–250 $\mu\text{g/L}$ | 20%–50% | 250–350 $\mu\text{g/dL}$ |
| Iron deficiency | Decreased | Increased | Decreased | Decreased | Increased |
| Iron overdose | Increased | Decreased | Increased | Increased | Decreased |
| Hematochromatosis | Increased | Slightly decreased | Increased | Increased | Slightly decreased |
| Malnutrition | Decreased | Decreased | Decreased | Variable | Decreased |
| Malignancy | Decreased | Decreased | Increased | Decreased | Decreased |
| Chronic infection | Decreased | Decreased | Increased | Decreased | Decreased |
| Viral hepatitis | Increased | Increased | Increased | Normal/ increased | Increased |
| Acute liver disease | Increased | Variable/increased | Increased | Increased | Variable/increase |
| Chronic anemia | Decreased | Normal/decreased | Normal/ increased | Decreased | Normal/decreased |
| Sideroblastic anemia | Increased | Normal/decreased | Increased | Increased | Normal/decreased |

Source: Adapted with permission from Jacobs DS, ed. *Laboratory test handbook*. Boca Raton, Fla.: Lexi-Comp Inc, 1996.

AAS or ICP-MS.⁶³ Iron quantification in liver is not used for evaluation of acute iron toxicity. Hepcidin testing has not yet been shown to be clinically useful.

Table 17-4 presents laboratory markers for iron status in several diseases. Table 17-3 presents reference intervals for parameters used to assess iron status.

MANGANESE

As the twelfth most abundant element in the earth's crust, manganese (Mn) is found in over 250 minerals, of

which 15 are of commercial importance. Nearly all the elemental manganese is used in the production of ferromanganese. Ferromanganese, which contains up to 80% of manganese, is used as a scavenger during steel production. It also affects hardness of the steel. Other uses of elemental manganese are as both scavenger and a component in copper and aluminum alloys and in a production of dry cell batteries. Various manganese compounds are widely used in fertilizers, animal feeds, pharmaceutical products, dyes, paint dryers, catalysts, and wood preservatives and in production of glass and ceramics. A

CASE STUDY 17-3

A 65-year-old woman with a history of diabetes was seen by her physician for weight loss, anorexia, and general fatigue. As part of the physical examination, both “bronze” skin pigmentation (hyperpigmentation) and enlarged liver were noted. Her initial chemistry panel showed the following relevant results:

| | |
|-----------------|-------------------------------|
| Albumin | 3.7 g/dL (3.8–5.0) |
| A LP | 180 U/L (30–135) |
| A LT | 200 U/L (10–60) |
| Total bilirubin | 2.5 mg/dL (0.2–1.2) |
| Serum iron | 180 $\mu\text{g/dL}$ (45–150) |

Further testing for the elevated iron showed the following:

| | |
|--------------------------|-------------------------------|
| Serum iron | 170 $\mu\text{g/dL}$ (45–150) |
| Transferrin | 210 mg/dL (200–380) |
| Ferritin | 300 $\mu\text{g/L}$ (10–250) |
| % Transferrin saturation | 80 |

The patient was diagnosed with hemochromatosis that caused iron overload.

Questions

1. What happens to serum ferritin in this condition?
2. Are this patient's conditions and symptoms typical of hemochromatosis?
3. What is a treatment plan for iron overload, and what is the main goal?

manganese-based compound (MMT) was used as a supplement to tetraethyl lead in gasoline.⁶⁴

Health Effects

Manganese is biochemically essential as a constituent of metalloenzymes and as an enzyme activator. Manganese-containing enzymes include arginase, pyruvate carboxylase, and manganese superoxide dismutase in mitochondria. Manganese-activated enzymes include hydrolases, kinases, decarboxylases, and transferases. Many of these activations are nonspecific, so other metal ions (magnesium, iron, or copper) can replace manganese as an activator. Such activation masks the effects of manganese deficiency.⁴¹

Absorption, Transport, and Excretion

Dietary manganese is poorly absorbed (from 2%–15%), mainly from the small intestine. Dietary factors that affect manganese absorption include iron, calcium, phosphates, and fiber.⁴¹

Deficiency

Blood clotting defects, hypocholesterolemia, dermatitis, and elevated serum calcium, phosphorus, and alkaline phosphatase activity have occurred in some subjects who underwent experimental manganese depletion.⁴¹ Low levels of manganese are associated with epilepsy.¹² Manganese deficiency was suggested as an underlying factor in hip abnormalities, joint disease, and congenital malformation.⁴¹ Manganese deficiency can cause heart and bone problems and, in children, stunted growth.⁶⁵

Toxicity

Manganese toxicity causes nausea, vomiting, headache, disorientation, memory loss, anxiety, and compulsive laughing or crying. In chronic form, manganese toxicity resembles Parkinson's disease with akinesia, rigidity, tremors, and masklike faces.¹² A clinical condition named *locura manganica* (manganese madness) has been described in Chilean manganese miners who have experienced acute manganese aerosol intoxication.⁶⁶

Laboratory Evaluation of Manganese Status

Manganese is measured by ICP-MS, GFAAS, and NAA. Urine manganese is used in conjunction with serum manganese to evaluate possible toxicity or deficiency. It has been suggested that whole blood manganese may best reflect manganese stored in tissues.

Reference Intervals for Manganese¹²

Manganese in serum: 0.43–0.76 $\mu\text{g/L}$
 Manganese in whole blood: 10–11 $\mu\text{g/L}$
 Manganese in urine: <2.0 $\mu\text{g/L}$

MOLYBDENUM

Molybdenum (Mo) is a silvery white metal that is very hard. Molybdenum does not occur in elemental form but occurs as molybdenite, wulfenite, and powellite.

Most of molybdenum is used for the production of alloys. Some molybdenum compounds are used as catalysts, corrosion inhibitors, flame retardants, smoke repressants, lubricants, and molybdenum blue pigments.

Health Effects

Molybdenum is vital to human health through its inclusion in at least three enzymes: xanthine oxidase, aldehyde oxidase, and sulfite oxidase. The active site of these enzymes binds molybdenum in the form of a cofactor “molybdopterin.”¹²

Absorption, Transport, and Excretion

Between 25% and 80% of ingested molybdenum is absorbed, mainly in the stomach and small intestine, via mechanisms that are not clear.⁴¹ Molybdenum is mostly retained in the liver, skeleton, and kidney. Molybdenum is rapidly eliminated via urine and is also excreted in the bile. Molybdenum can cross the placental barrier. High levels of molybdenum in the diet of the mother can increase the molybdenum in the liver of the neonate.⁶⁷

Deficiency

Molybdenum cofactor deficiency is a recessively inherited error of metabolism. The symptoms include seizures, anterior lens dislocation, decreased brain weight, and usually death prior to age 1 year.¹²

Toxicity

Molybdenum is rarely reported, because there are few known cases of human exposure to excess molybdenum. High dietary and occupational exposures to molybdenum have been linked to elevated uric acid in blood and an increased incidence of gout.⁴¹

The urine is a major route of excretion of molybdenum. About 10% of the absorbed molybdenum leaves the liver via the gallbladder and is excreted into the intestines.⁶⁷

Laboratory Evaluation of Molybdenum Status

Molybdenum levels are measured by ICP-MS, GFAAS, and NAA. Blood level parallels molybdenum intake. Apparently normal individuals vary from each other by over 100-fold from 0.5–60 $\mu\text{g/L}$, depending on molybdenum intake; 170 $\mu\text{g/L}$ borders on the toxic level.

Seventy-five percent of the U.S. population has levels at or below 5 $\mu\text{g/L}$, but some geographical areas show 70% of the population with levels above 5 $\mu\text{g/L}$.¹²

Reference Intervals for Molybdenum

Molybdenum in whole blood: <60 $\mu\text{g/L}$ ¹²

Molybdenum in serum: 0.1–3.0 $\mu\text{g/L}$ ⁴⁵

Molybdenum in red cells: 18 $\mu\text{g/L}$ ⁶⁸

Molybdenum in urine: 8–34 $\mu\text{g/L}$ ⁶⁸

SELENIUM

Selenium (Se) is a metalloid with many chemical and physical properties similar to those of sulfur. Selenium occurs naturally in the environment. Selenium is rarely found in native form as metallic gray to black hexagonal crystals. It is a major constituent of 40 minerals and a minor constituent of 37 others.⁶⁹ Most processed selenium is used in the electronics industry, but it is also used as a nutritional supplement; in the glass industry; as a component of pigments in plastics, paints, enamels, inks, and rubber; in the preparation of pharmaceuticals; as a nutritional feed additive for poultry and livestock; in pesticide formulations; in rubber production; as an ingredient in antidandruff shampoos; and as a constituent of fungicides. Radioactive selenium is used in diagnostic medicine.⁷⁰

Health Effects

In the 1930s, selenium was considered a toxic element; in the 1940s, a carcinogen; in the 1950s, it was declared an essential element; and since the 1960s and especially the 1970s, it has been viewed as an anticarcinogen. Glutathione peroxidase (in the form of selenocysteine) is part of the cellular antioxidant defense system against free radicals.⁴¹ Selenium is also involved in the metabolism of thyroid hormones⁷¹ (e.g., deiodinase enzymes and thioredoxin reductase).⁷⁰

Absorption, Transport, and Excretion

Selenium is well absorbed from the gastrointestinal tract (>50%). Selenium exposure occurs primarily from food and is sometimes found in drinking water, usually in the form of inorganic sodium selenate or sodium selenite. Selenium homeostasis is largely achieved by excretion via urine and feces. Other routes of elimination include sweat and, at very high intakes, exhalation of volatile forms of selenium.⁷⁰

Deficiency

Selenium deficiency has been associated with cardiomyopathy, skeletal muscle weakness, and osteoarthritis. A

significant negative correlation was observed between selenium intakes and cancer of the large intestine, rectum, prostate, breast, ovary, and lungs and leukemia.⁶⁹

Keshan disease, an endemic cardiomyopathy that affects mostly children and women in childbearing age in certain areas in China, has been associated with selenium deficiency. Symptoms include dizziness, malaise, loss of appetite, nausea, chills, abnormal electrocardiograms, cardiogenic shock, cardiac enlargements, and congestive heart failure. Selenium supplementation has been shown to effectively control Keshan disease.⁴¹ Kashin-Beck disease, an endemic osteoarthritis that occurs during adolescent and preadolescent years, is another disease linked to low selenium status in northern China, North Korea, and eastern Siberia.⁷⁰

The current RDA for selenium is 55 $\mu\text{g/day}$ for adults, and the Tolerable Upper Intake Level is 400 $\mu\text{g/day}$.⁷⁰

Toxicity

The EPA has determined that one specific form of selenium, selenium sulfide, is a probable human carcinogen. Selenium sulfide is not present in foods and is a very different chemical from the organic and inorganic selenium compounds found in foods and in the environment.⁷⁰

In Hubei Province (China) during 1961 through 1964, almost half of the population of many villages died from chronic selenosis. The most common signs of selenium poisoning were loss of hair and nails, skin lesions, tooth decay, and abnormalities of the nervous system.⁶⁹

In 1984, 12 cases of selenium toxicity were reported to the FDA and CDC, because of the ingestion of overly potent selenium supplements, which contained selenium levels almost 200 times higher than stated on the label. The most common symptoms reported in these cases were nausea and vomiting, nail changes, hair loss, fatigue, abdominal cramps, watery diarrhea, and garlicky breath. No abnormalities of blood chemistry were seen in 67% of the victims, and renal and liver functions were normal. The person who ingested the highest doses for the longest time was also taking large doses of vitamin C, which may have minimized the selenium toxicity, since the ascorbic acid could reduce selenite (the form mostly present in this supplement) to the poorly absorbed elemental selenium.⁷²

Acute oral exposure to extremely high levels of selenium may produce gastrointestinal symptoms (nausea, vomiting, and diarrhea) and cardiovascular symptoms such as tachycardia. Chronic exposure to very high levels can cause dermal effects, including diseased nails and skin and hair loss, as well as neurologic problems such as unsteady gait or paralysis. A more complete discussion of

selenium toxicity can be found in the Toxicological Profile for Selenium.⁷⁰

Laboratory Evaluation of Selenium Status

Selenium may be determined by ICP-MS, AAS (HGAAS or GFAAS), or NAA. The determination of urinary and blood selenium are useful measures of selenium status. Plasma levels of less than 15 $\mu\text{g/L}$ or greater than 150 $\mu\text{g/L}$ represent unusually low or high intake, without necessarily representing illness.¹²

Reference Intervals for Selenium in Adults

Selenium in plasma: 46–143 $\mu\text{g/L}$ ⁶⁸

Selenium in serum: 95–165 $\mu\text{g/L}$ ¹²

Selenium in whole blood: 58–234 $\mu\text{g/L}$ ⁶⁸

Selenium in RBCs: 75–240 $\mu\text{g/L}$ ⁶⁸

ZINC

Zinc (Zn) is a bluish white, lustrous metal. Zinc is stable in dry air and becomes covered with a white coating when exposed to moisture. Zinc is the fourth most used metal (after iron, aluminum, and copper). Zinc and its compounds are used in a production of alloys, especially brass (with copper), in galvanizing steel, in die casting, in paints, in skin lotions, in treatment of Wilson's disease, and in many over-the-counter (OTC) medications.

Health Effects

Zinc is second only to iron in importance as an essential trace element. The main biochemical role of zinc is its influence on the activity of more than 300 enzymes (from the classes of oxidoreductases, transferases, hydrolases, lyases, isomerases, and ligases). Zinc can be essential for the structure, regulation, and catalytic action of an enzyme. Zinc occurs in enzymes that realize the synthesis and metabolism of DNA and RNA. Zinc influences the synthesis and metabolism of proteins, participates in glycolysis and cholesterol metabolism, maintains membrane structures, effects functions of insulin, and affects growth factor.⁷³

Chronic oral zinc supplementation interferes with copper absorption and may cause copper deficiency. This ability to interfere with copper absorption is also the basis for using zinc to treat Wilson's disease. Copper status should be monitored in patients on long-term zinc therapy.^{12,74}

Absorption, Transport, and Excretion

The body content in a normal individual is about 2.5 g zinc, which is mainly in muscles (60%) and skeleton

(30%). The remaining 10% is distributed in all tissues with highest concentrations in eyes, prostate, and hair. All tissue levels depend on age.⁷³ Zinc absorption mainly occurs in the small intestine and especially in the jejunum.⁷³ In blood, the absorbed zinc is distributed between RBCs (80%), plasma (17%), and white blood cells (3%).⁷⁵ Different factors modify the absorption of zinc. The factors increasing zinc absorption include: presence of animal proteins⁷⁶ and amino acids in a meal,⁷⁷ intake of calcium,⁷⁸ and unsaturated fatty acids.⁷⁹

The factors decreasing zinc absorption include intake of iron,^{80,81} taking zinc on empty stomach,⁷⁹ presence of copper at high levels,⁸² and age.⁷⁴

In normal dietary circumstances, about 90% of zinc is excreted in feces.⁸³

Deficiency

Nutritional zinc deficiency is widespread all over the world. Zinc deficiency causes growth retardation, slows skeletal maturation, causes testicular atrophy, and reduces taste perception. Old age, pregnancy, lactation, and alcoholism are also associated with poor zinc nutrition.⁴¹

Infants with acrodermatitis enteropathica (zinc malabsorption) usually first develop characteristic facial and diaper rash. Untreated, symptoms progress and include growth retardation, diarrhea, impaired T-cell immunity, insufficient wound healing, infections, delayed testicular development in adolescence, and early death.¹² Zn deficiency in adolescents is manifested by slow growth or weight loss, altered taste, delayed puberty, dwarfism, impaired dark adaptation, alopecia, emotional instability, and tremors. In severe cases, lymphopenia may occur; death follows an overwhelming infection.¹²

Toxicity

Zinc is relatively nontoxic. Nevertheless, high doses (1 g) or repetitive doses of 100 mg/day for several months may lead to disorders, especially gastrointestinal tract symptoms, decrease in heme synthesis due to an induced copper deficiency, and hyperglycemia.⁷³ Exposure to ZnO fumes and dust may cause "zinc fume fever." The symptoms include chemically induced pneumonia, severe pulmonary inflammation, fever, hyperpnea, coughing, pains in legs and chest, and vomiting.⁷³

Laboratory Evaluation of Zinc Status

Zinc is measured by flame AAS, ICP-AES, and ICP-MS. Low urine zinc levels in presence of low serum zinc levels, usually confirms zinc deficiency.¹² Low serum zinc in an apparently healthy (nonstressed, nonseptic) patient

who has normal serum albumin levels can be used as evidence of zinc deficiency, especially if urine zinc levels are also low. Normal serum zinc cannot be interpreted as evidence of normal zinc stores.

Zinc concentration in red blood cells is approximately 10 times that in serum.⁴¹

Reference Intervals for Zinc

Zinc in serum: 70–120 $\mu\text{g}/\text{dL}$ ⁴⁵

Zinc in urine of normal subjects: 140–800 $\mu\text{g}/24$ hours¹²

Zinc in urine of compliant patients on oral zinc therapy for Wilson's disease: >2,000 $\mu\text{g}/24$ hours¹²

BIBLIOGRAPHY

- Beatty RD, Kerber JD. Concepts, instrumentation and techniques in atomic absorption spectrophotometry. Waltham, Ma.: Perkin-Elmer, 2002.
- ICP-MS: Inductively coupled plasma mass spectrometry. A primer. Santa Clara, Ca.: Agilent Technologies, 2005.
- Krull IS, ed. Trace metal analysis and speciation. J Chromatogr Libr. St. Louis, Mo.: Elsevier, 1991;49–73.
- Lobinski R, Marczenko Z. Spectrochemical trace analysis for metals and metalloids. In Weber SG, ed. Wilson & Wilson's comprehensive analytical chemistry (Vol. XXX). Philadelphia, Pa.: Elsevier, 1996.
- Quevauviller P. Method performance studies for speciation analysis. London, Eng.: R Soc Chem 1998.
- Seiler HG, Sigel A, Sigel H, eds. Handbook on metals in clinical and analytical chemistry. New York: Marcel Dekker, 1994.
- Willard HH, Merritt LL, Dean JA, Settle FA. Instrumental methods of analysis. 6th ed. Princeton, NJ.: Van Nostrand Company, 1981.

REFERENCES

- Rodushkin I, Odman F, Branth S. Multielemental analysis of whole blood by high resolution inductively coupled plasma mass spectrometry. Fresenius J Anal Chem 1999;364:338–346.
- May TW, Wiedmeyer RH. A table of polyatomic interferences in ICP-MS. Atomic Spectrosc 1998;19:150–155.
- Boffetta P, Nyberg F. Contribution of environmental factors to cancer risk. Br Med Bull 2003;68:71–94.
- Ibrahim D, Froberg B, Wolf A, Rusyniak DE. Heavy metal poisoning: Clinical presentations and pathophysiology. Clin Lab Med 2006;26:67–97, viii.
- Jarup L. Hazards of heavy metal contamination. Br Med Bull 2003;68:167–182.
- Tchounwou PB, Centeno JA, Patlolla AK. Arsenic toxicity, mutagenesis, and carcinogenesis: A health risk assessment and management approach. Mol Cell Biochem 2004;255:47–55.
- Yoshida T, Yamachi H, Fan Sun G. Chronic health effects in people exposed to arsenic via the drinking water: Dose-response relationships in review. Toxicol Appl Pharmacol 2004;198:243–252.
- Bornhorst JA, Hunt JW, Urry FM, McMillin GA. Comparison of sample preservation methods for clinical trace element analysis by inductively coupled plasma mass spectrometry. Am J Clin Pathol 2005;123:578–583.
- www.epa.gov/ttn/atw/hlthef/arsenic.html. Retrieved May 2008.
- Anke M. Arsenic. In Mertz W, ed. Trace elements in human and animal nutrition (vol. 2). 5th ed. St. Louis, Mo.: Academic Press, 1986:347–372.
- Iffland R. Arsenic. In Seiler HG, Sigel A, Sigel H, eds. Handbook on metals in clinical and analytical chemistry. New York: Marcel Dekker, 1994;237–253.
- Jacobs DS, ed. Laboratory test handbook. Cleveland, Ohio: Lexi-Comp, 1996.
- Pais I, Jones LB Jr. The handbook of trace elements. Boca Raton, Fla.: St. Lucie Press, 1997.
- Moyer TP, Burritt MF, Butz J. Toxic metals. In Burtis CA, Ashwood ER, Bruns DE, eds. Tietz textbook of clinical chemistry and molecular diagnostics. 4th ed. Philadelphia, Pa.: Elsevier Saunders, 2006:1377–1378.
- Agency for Toxic Substances and Disease Registry (ATSDR). Toxicological profile for cadmium. Draft for public comment. Atlanta, Ga.: Public Health Service, U.S. Department of Health and Human Services, 1997.
- U.S. Environmental Protection Agency. Integrated risk information system (IRIS) on cadmium. Washington, DC: National Center for Environmental Assessment, Office of Research and Development, 1999.
- Herber RFM. Cadmium. In Seiler HG, Sigel A, Sigel H, eds. Handbook on metals in clinical and analytical chemistry. New York: Marcel Dekker, 1994:283–297.
- Calabrese EJ, Kenyon EM. Air toxics and risk assessment. New York: CRC Press, Lewis Publishers, 1991.
- www.aruplab.com/guides/ug/tests/0025040.jsp. Retrieved June 2008.
- www.aruplab.com/guides/ug/tests/0099675.jsp. Retrieved May 2008.
- Denham AC, Collins LJ, Fashner J. Clinical inquiries. Is screening for lead poisoning justified? J Fam Pract 2003;52:722–724.
- Duderstadt KG. Environmental health policy & children's health. J Pediatr Health Care 2006;20:411–413.
- Feinberg AN, Cummings CK. Blood lead screening. Clin Pediatr (Phila) 2005;44:569–574.
- D, Ibrahim Froberg B, Wolf A, Rusyniak DE. Heavy metal poisoning: Clinical presentations and pathophysiology. Clin Lab Med 2006;26:67–97, viii.
- Needleman H. Lead poisoning. Annu Rev Med 2004;55:209–222.
- Papanikolaou NC, Hatzidaki EG, Belivanis S, et al. Lead toxicity update. A brief review. Med Sci Monit 2005;11:RA329–RA336.
- Patrick L. Lead toxicity, a review of the literature. Part I: Exposure, evaluation, and treatment. Altern Med Rev 2006;11:2–22.
- Risshitelli G, Nygren P, Bougatsos C, et al. Screening for elevated lead levels in childhood and pregnancy: An updated summary of evidence for the US Preventive Services Task Force. Pediatrics 2006;118:e1867–e1895.
- Bornhorst JA, Hunt JW, Urry FM, McMillin GA. Comparison of sample preservation methods for clinical trace element analysis by inductively coupled plasma mass spectrometry. Am J Clin Pathol 2005;123:578–583.
- Christensen JM, Kristiansen J. Lead. In Seiler HG, Sigel A, Sigel H, eds. Handbook on metals in clinical and analytical chemistry. New York: Marcel Dekker, 1994:425–440.
- www.atsdr.cdc.gov/toxprofiles/tp13.html, www.atsdr.cdc.gov/toxprofiles/tp13.pdf, www.epa.gov/lead/pubs/leadinfo.htm. Retrieved June 2008.
- Drash GA. Mercury. In Seiler HG, Sigel A, Sigel H, eds. Handbook on metals in clinical and analytical chemistry. New York: Marcel Dekker, 1994:479–493.
- Pais I, Jones LB Jr. The handbook of trace elements. Boca Raton, Fla.: St. Lucie Press, 1997:121–122.
- Goyer RA, Klaassen CD, Waalkes MP, Verity MA, eds. Nervous system in metal toxicology. St. Louis, Mo.: Academic Press, 1995:199–235.

35. Porter WH, Moyer TP. Clinical toxicology. In Burtis CA, Ashwood ER, eds. Tietz fundamentals of clinical chemistry. 4th ed. Philadelphia, Pa.: WB Saunders, 1996:427–456.
36. Associated Press News. Dartmouth researcher dies from mercury poisoning. June 11, 1997. Available online at <http://ehs.okstate.edu/NEWS/KARENT.htm>.
37. Nuttall KL. Interpreting mercury in blood and urine of individual patients. *Ann Clin Lab Sci* 2004;34:235–250.
38. Ashwood ER, ed. Clinical testing. New York: ARUP Laboratories, 2004:101–102.
39. Lund ME, Banner W, Clarkson TW, Berlin M. Treatment of acute methylmercury ingestion by hemodialysis with N-acetylcysteine (mucomyst) infusion and 2,3-dimercaptopropane sulfonate. *Clin Toxicol* 1984;22:31–40.
40. http://www.atsdr.cdc.gov/csem/chromium/physiologic_effects.html. Retrieved June 2008.
41. Milne DB. Trace elements. In Burtis CA, Ashwood ER, eds. Tietz fundamentals of clinical chemistry. 4th ed. Philadelphia, Pa.: WB Saunders, 1996:485–496.
42. Herold DA, Fitzgerald RL. Chromium. In Seiler HG, Sigel A, Sigel H, eds. Handbook on metals in clinical and analytical chemistry. New York: Marcel Dekker, 1994:321–332.
43. Offenbacher EG, Pi-Sunyer FX. Chromium in human nutrition. *Annu Rev Nutr* 1988;5:43.
44. Sargent T, Lim TH, Jenson RL. Reduced chromium retention in patients with hemochromatosis, a possible basis of hemochromatotic diabetes. *Metabolism* 1979;28:70–79.
45. Painter PC, Cope JY, Smith JL. Appendix (Chapter 40). In Burtis CA, Ashwood ER, eds. Tietz fundamentals of clinical chemistry. 4th ed. Philadelphia, Pa.: WB Saunders, 1996:766–830.
46. Sarkar B. Copper. In Seiler HG, Sigel A, Sigel H, eds. Handbook on metals in clinical and analytical chemistry. New York: Marcel Dekker, 1994:339–347.
47. Fairbanks VF, Klee GG. Biochemical aspects of hematology. In Burtis CA, Ashwood ER, eds. Tietz textbook of clinical chemistry. 3rd ed. Philadelphia, Pa.: WB Saunders, 1999:1642–1710.
48. Kratz A, Lee-Lewandrowski E, Lewandrowski K. The plasma proteins. In Lewandrowski K, ed. Clinical chemistry: Laboratory management and clinical correlations. Philadelphia, Pa.: Lippincott Williams & Wilkins, 2002:531–560.
49. Rossi E. Hpcidin: The iron regulatory hormone. *Clin Biochem Rev* 2005;26:47–49.
50. Higgins T, Beutler E, Doumas BT. Hemoglobin, iron, and bilirubin. In Tietz textbook of clinical chemistry and molecular diagnostics. 4th ed. St. Louis, Mo.: Elsevier, 1187–1188.
51. Beard J, Dawson B, Pinero D. Iron metabolism: A comprehensive review. *Nutr Rev* 1996;54:295–317.
52. Bottomly S. Secondary iron overload disorders. *Semin Hematol* 1998;35:77–86.
53. Meneghini R. Iron homeostasis, oxidative stress, and DNA damage. *Free Radic Biol Med* 1997;23:783–792.
54. Smith C, Mitchinson MJ, Aruoma OI. Stimulation of lipid peroxidation and hydroxyl-radical generation by the contents of human atherosclerotic lesions. *Biochem J* 1992;286:901–915.
55. Schwartz CJ, Valente AJ, Sprague EA, et al. The pathogenesis of atherosclerosis: An overview. *Clin Cardiol* 1991;14:1–16.
56. Halliwell B, Aruoma OI. DNA damage by oxygen-derived species: Its mechanism and measurement in mammalian system. *FEBS Lett* 1991;281:9–19.
57. Weinberg ED. Cellular iron metabolism in health and disease. *Drug Metab Rev* 1990;22:531–579.
58. Anghileri L. Iron, intracellular calcium ion, lipid peroxidation and carcinogenesis. *Anticancer Res* 1995;15:1395–1400.
59. Smith MA, Perry G. Free radical damage, iron, and Alzheimer's disease. *J Neurol Sci* 1995;134S:92–94.
60. McCord J. Iron, free radicals, and oxidative injury. *Semin Hematol* 1998;35:5–12.
61. Herbert V, Shaw S, Jayatilke E. Vitamin C-driven free radical generation from iron. *J Nutr* 1996;126:1213S–1220S.
62. Tofaletti JG. Trace elements. In Bishop ML, Fody EP, Schoeff LE, eds. Clinical chemistry: Principles, procedures, correlations. 5th ed. Philadelphia, Pa.: Lippincott, Williams & Wilkins, 2004.
63. <http://www.arupconsult.com/Algorithms/Hemochromatosis.pdf#xml=http://websearchnew.aruplab.net/isysquery/78118f36-e200-4b2c-9162-220090b7ad8c/4/hilite/>. Retrieved May 2008.
64. Chiswell B, Johnson D. Manganese. In Seiler HG, Sigel A, Sigel H, eds. Handbook on metals in clinical and analytical chemistry. New York: Marcel Dekker, 1994:467–478.
65. Kaiser J. Manganese: A high octane dispute. *Science* 2003;300:326.
66. Donaldson J. The physiopathologic significance of manganese in brain: Its relation to schizophrenia and neurodegenerative disorders. *Neurotoxicology* 1987;8:451.
67. Anke M, Giel M. Molybdenum. In Seiler HG, Sigel A, Sigel H, eds. Handbook on metals in clinical and analytical chemistry. New York: Marcel Dekker, 1994:495–501.
68. Milne DB. Trace elements. In Burtis CA, Ashwood ER, eds. Tietz textbook of clinical chemistry. 3rd ed. Philadelphia, Pa.: WB Saunders, 1999:1029–1055.
69. Magee RG, James BD. Selenium. In Seiler HG, Sigel A, Sigel H, eds. Handbook on metals in clinical and analytical chemistry. New York: Marcel Dekker, 1994:551–562.
70. Agency for Toxic Substances and Disease Registry. Toxicological profile for selenium. Washington, DC: U.S. Department of Health and Human Services, Public Health Service, 2003.
71. Gladyshev VN, Jeang KT, Stadtman TC. Selenocysteine, identified as the penultimate C-terminal residue in human T-cell thioredoxin reductase, corresponds to TGA in the human placental gene. *Proc Natl Acad Sci USA* 1996;93: 6146–6151.
72. Levander OA. Selenium. In Mertz W, ed. Trace elements in human and animal nutrition (Vol. 2). 5th ed. St. Louis, Mo.: Academic Press, 1986: 209–279.
73. Thunus L, Lejeune R. Zinc. In Seiler HG, Sigel A, Sigel H, eds. Handbook on metals in clinical and analytical chemistry. New York: Marcel Dekker, 1994:667–674.
74. Bales CW, Steinman LC, Freeland-Graves JH, et al. The effect of age on plasma zinc uptake and taste acuity. *Am J Clin Nutr* 1986;44:664–669.
75. Fisher GL. Function and homeostasis of copper and zinc in mammals. *Sci Total Environ* 1975;4:373–412.
76. Solomons NW. Biological availability of zinc in humans. *Am J Clin Nutr* 1982;35:1048–1075.
77. Sandström B, Cederblad Å. Zinc absorption from composite meals. II. Influence of the main protein source. *Am J Clin Nutr* 1980;33:1778–1783.
78. Sandström B, Arvidsson B, Cederblad A, Bjorn-Rasmussen E. Zinc absorption from composite meals. I. The significance of wheat extraction rate, zinc, calcium and protein content in meals based on bread. *Am J Clin Nutr* 1980;33:739–745.
79. Cunnane SC. Maternal essential fatty acid supplementation increases zinc absorption in neonatal rats: Relevance to the defect in zinc absorption in acrodermatitis Enteropathica. *Pediatr Res* 1982;16:599–603.
80. Solomons NW. Competitive interaction of iron and zinc in the diet: Consequences for human nutrition. *J Nutr* 1986;116:927–935.
81. Sandström B, Davidsson L, Cederblad A, Lönnerdal B. Oral iron, dietary ligands and zinc absorption. *J Nutr* 1985;115:411–414.
82. Lönnerdal B. Iron-copper-zinc interactions. In Micronutrient interactions. Impact on child health and nutrition. Washington, DC: ILSI Press, 1996:3–10.
83. Hambridge KM, Casey CE, Krebs NF. Zinc. In Mertz W, ed. Trace elements in human and animal nutrition (Vol. 2). 5th ed. St. Louis, Mo.: Academic Press, 1986:1–137.
84. Jacobs DS, Oxley DK, DeMott WR. Jacobs & DeMott laboratory test handbook. 5th ed. Cleveland, Ohio: Lexi-Comp, 2001.

Porphyrins and Hemoglobin

Louann W. Lawrence, Larry A. Broussard

CHAPTER

18

CHAPTER OUTLINE

■ PORPHYRINS

Role in the Body
Chemistry of Porphyrins
Porphyrin Synthesis
Clinical Significance and Disease Correlation
Methods of Analyzing Porphyrins

■ HEMOGLOBIN

Role in the Body
Structure of Hemoglobin

Synthesis and Degradation of Hemoglobin
Clinical Significance and Disease Correlation
Methodology
DNA Technology

■ MYOGLOBIN

Structure and Role in the Body
Clinical Significance
Methodology

■ REFERENCES

Because of chemical similarities, porphyrins, hemoglobin, and myoglobin are discussed together in this chapter. These compounds all contain the porphyrin ring, which comprises four pyrrole groups bonded by methene bridges (Fig. 18-1). Porphyrins are able to chelate metals to form the functional groups that participate in oxidative metabolism. The analysis of porphyrins in the laboratory aids in the diagnosis of a group of disorders resulting from disturbances in heme synthesis called the **porphyrias**. Each defective enzyme that causes porphyria may be assayed by various methods. Hemoglobin molecules are specially designed to bind, deliver, and release oxygen. Qualitative defects in the hemoglobin molecule result in a group of disorders called **hemoglobinopathies**, such as sickle cell anemia. Quantitative defects in production of normal hemoglobin molecules lead to another group of disorders, called **thalassemias**. Analytic methods to diagnose these disorders are discussed. **Myoglobin** is a simple heme protein found only in skeletal and cardiac muscle, which may be analyzed to aid in diagnosis of acute myocardial infarction.

PORPHYRINS

Role in the Body

Porphyrins are chemical intermediates in the synthesis of hemoglobin, myoglobin, and other respiratory pigments called **cytochromes**. They also form part of the peroxidase and catalase enzymes, which contribute to

the efficiency of internal respiration. Iron is chelated within porphyrins to form heme. Heme is then incorporated into proteins to become biologically functional hemoproteins. Porphyrins are analyzed in clinical chemistry to aid in the diagnosis of *porphyrias*, which result from disturbances in heme synthesis. Excess amounts of these intermediate compounds in urine, feces, or blood indicate a metabolic block in heme synthesis.

Chemistry of Porphyrins

The porphyrins found in nature are all compounds in which side chains are substituted for the eight hydrogen atoms found in the four **pyrrole** rings that make up porphyrin (Fig. 18-1). Because of the wide variety of substitutions, many porphyrins have been described in nature. The pigment chlorophyll is a magnesium porphyrin and is essential for plants to use light energy to synthesize carbohydrates. Four basic isomers may exist for every porphyrin compound; however, only type I and type III occur in nature. The difference between types I and III isomers is in the arrangement of side chains. Only type III isomers form heme; however, in some disorders, the functionless type I isomers may be present in excess in the tissue. Porphyrins are stable compounds, red-violet to red-brown in color, that fluoresce red when excited by light near 400 nm. Only three porphyrin compounds are clinically significant in humans: protoporphyrin (PROTO), uroporphyrin (URO), and coproporphyrin (COPRO). Their presence in excess in biologic fluids is a

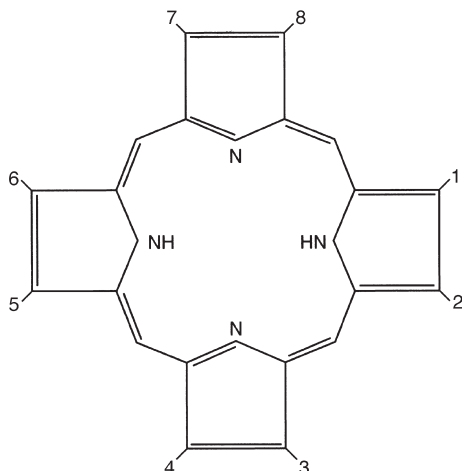

FIGURE 18-1. Basic structure of porphyrins.

clinical sign of abnormal heme synthesis. The three compounds have different solubility properties and different degrees of ionization determined by the addition of various carboxyl groups to the basic porphyrin structure. This allows for separate assays of each. URO is excreted primarily in urine, PROTO in the feces, and COPRO in either, depending on the rate of formation of the urine and its pH.

The reduced forms of porphyrins are termed **porphyrinogens**, the functional form of the compound that must be used in heme synthesis. Porphyrinogens are highly unstable and colorless and do not fluoresce, which makes them more difficult to analyze. With light, oxygen, or oxidizing agents, porphyrinogens are readily oxidized to the corresponding porphyrin form. Therefore, the porphyrin form is routinely analyzed in clinical laboratories as a result of the increased stability

and ease of detection by various common clinical laboratory systems.

Porphyrin Synthesis

All cells contain hemoproteins and can synthesize heme; however, the bone marrow and liver are the main sites. The series of irreversible reactions is outlined in Figure 18-2. Some steps occur in the mitochondria of the cell and some steps occur in the cytoplasm. The transport of substrates across the mitochondrion membrane is a complex process and a potential point for interruptions in heme synthesis.

Control of the rate of heme synthesis in the cells in the liver is achieved largely through regulation of the enzyme δ -aminolevulinic acid (ALA) synthase. The main mechanism is repression of synthesis of new enzyme. A negative feedback mechanism exists in which increases in the pool of hepatic heme diminish the production of ALA synthase. Conversely, ALA synthase production is increased with a depletion of heme. The size of the regulatory heme pool may be affected by the requirement for hemoproteins in the liver. Drugs and other compounds appear to induce ALA synthase production via several different mechanisms, but all result in a depletion of the regulatory heme pool. Therefore, the rate of heme synthesis is flexible and can change rapidly in response to a wide variety of external stimuli. In bone marrow erythrocytes, other enzymes in the pathway and the rate of cellular iron uptake seem to control the rate of heme synthesis.¹

Clinical Significance and Disease Correlation

The porphyrias are inherited or acquired enzyme deficiencies that result in overproduction of heme precursors in

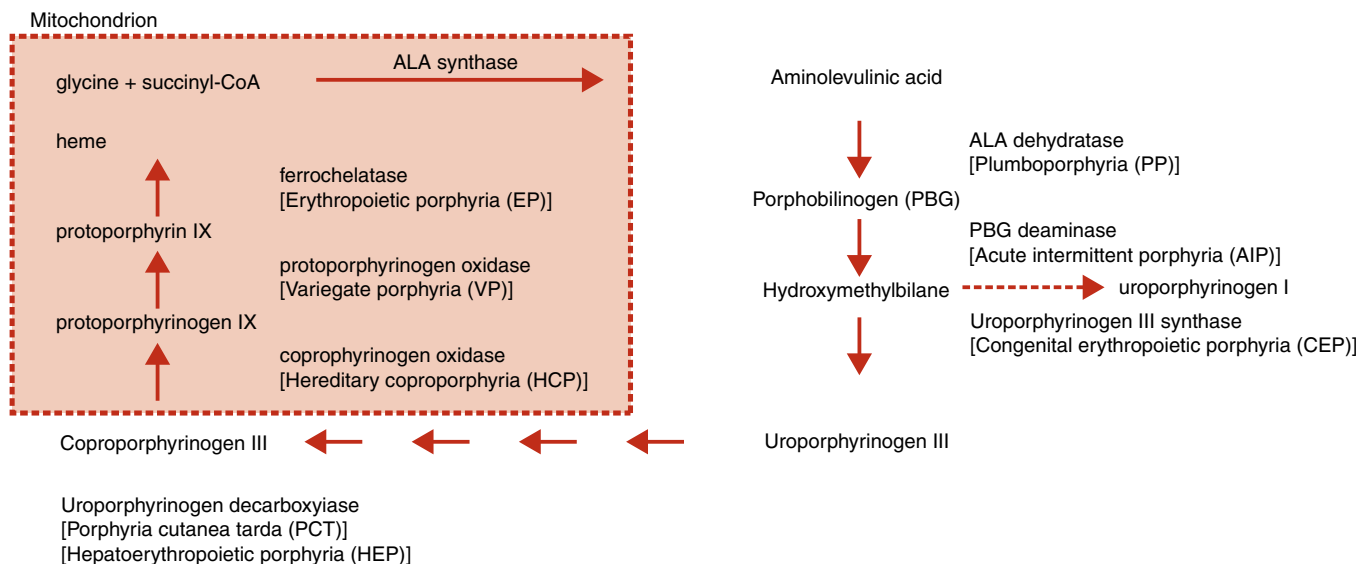

FIGURE 18-2. Synthesis of heme. Brackets indicate diseases associated with enzyme deficiencies.

the bone marrow (erythropoietic porphyrias) or the liver (hepatic porphyrias). Disease states corresponding to enzyme deficiencies have been identified in every step of heme synthesis except for ALA synthase. Some patients demonstrate an enzyme deficiency but do not show clinical or biochemical manifestations of porphyria, indicating that other factors, such as demand for increased heme biosynthesis, are also important in causing disease expression. An excess of the early precursors in the pathway of heme synthesis (ALA, porphobilinogen, or both) causes neuropsychiatric symptoms, including abdominal pain, vomiting, constipation, tachycardia, hypertension, psychiatric symptoms, fever, leukocytosis, and paresthesia. Porphyrias in this category include ALA dehydratase (ALAD) deficiency porphyria (ADP) or plumboporphyria (PP), and acute intermittent porphyria (AIP). Excesses of the later intermediates (UROs, COPROs, and PROTOs) may cause cutaneous symptoms, including photosensitivity, blisters, excess facial hair, and hyperpigmentation. Porphyria cutanea tarda (PCT), hepatoerythropoietic porphyria (HEP), erythropoietic porphyria (EP), and congenital erythropoietic porphyria (CEP) are associated with cutaneous symptoms. Porphyrin-induced photosensitivity manifests by increased fragility of light-exposed skin, as in PCT, or by burning of light-exposed skin, as in EP. The photosensitizing effects of the porphyrins are attributable to absorption of light. There may also be excesses of both early and late intermediates, causing neurocutaneous symptoms. Hereditary coproporphyria (HCP) and variegate porphyria (VP) fall into this category. All porphyrias are inherited as autosomal dominant traits producing about a 50% reduction in enzyme levels, except for ADP and CEP, which are autosomal recessive.²

The diagnosis of porphyrias is made by a combination of history and physical and laboratory findings. The cu-

taneous porphyrias are easier to diagnose because photosensitivity is usually the presenting symptom. Laboratory diagnosis, if necessary, is made by analysis of the appropriate sample for intermediates in heme synthesis (Table 18-1). The differentiation of neurologic porphyrias from other disorders is more difficult based on history and physical examination and must be verified by laboratory findings.

Inherited ADP, an autosomal recessive disorder, is extremely rare, with only seven cases reported.³ Urinary ALA is significantly elevated with normal porphobilinogen (PBG) excretion. Increased urinary coproporphyrin III may provide supporting evidence for the diagnosis, but this also occurs in lead poisoning, which is the most common cause of low ALAD activity and must be ruled out before making a diagnosis of ADP. ADP may be distinguished from lead poisoning by the *in vitro* addition of dithiothreitol or other sulfhydryl reagents. This results in restoration of erythrocyte ALAD activity to normal in patients with lead poisoning but no change in the reduced ALAD activity in ADP patients.⁴

AIP results from a deficiency of the enzyme PBG deaminase (PBGD). The estimated frequency of acute attacks of AIP in most developed countries is 1 to 2 per 100,000, with a higher prevalence in Scandinavian countries.⁴ PBGD is encoded on chromosome 11q23, with more than 100 mutations of this gene described.⁴ Although the inheritance is autosomal dominant, only about 10% of patients with the deficiency suffer attacks of the disease, so other etiologic factors are involved. Drugs are the most common precipitating cause of disease, especially barbiturates and sulfonamides; however, a wide variety of drugs are potentially hazardous. This disease is characterized by multiple neurologic symptoms with colicky stomach pain and, occasionally, fever

TABLE 18-1 METABOLITES FOUND IN EXCESS IN THE PORPHYRIAS

| PORPHYRIA | URINE | FECES | ERYTHROCYTES | SYMPTOMS |
|-----------|------------------------|----------------|--------------|------------------|
| ADP (PP) | ALA, COPRO III | Normal | ZPP | Neuropsychiatric |
| AIP | ALA, PBG, URO I | Normal | Normal | Neuropsychiatric |
| CEP | URO I, COPRO I | URO I, COPRO I | URO, ZPP | Cutaneous |
| PCT | URO I, ISOCOPRO | ISOCOPRO | Normal | Cutaneous |
| HEP | URO, COPRO | ISOCOPRO | ZPP | Cutaneous |
| HCP | *ALA, *PBG, *COPRO III | COPRO, HARDERO | Normal | Neurocutaneous |
| VP | *ALA, *PBG, *COPRO III | PROTO > COPRO | Normal | Neurocutaneous |
| EP | Normal | PROTO > COPRO | PROTO | Cutaneous |

*Indicates during acute attacks; PBG, porphobilinogen; HARDERO, harderoporphyrin.

and vomiting. The characteristic laboratory findings are a marked elevation of ALA and PBG in the urine, although these test results may be normal between attacks. A patient's urine with clinically manifest AIP may turn red or dark brown due to nonenzymatic conversion to uroporphyrin I, a process that may be delayed with refrigeration, protection from light, and alkaline adjustment to pH 8.0 to 9.0. Electrolyte abnormalities, including hyponatremia during acute attacks, may help suggest the diagnosis.⁴ Measurement of levels of erythrocyte or lymphoblast PBGD may be performed to confirm the diagnosis.⁵

CEP, a deficiency of uroporphyrinogen III cosynthase, is one of the rarest porphyrias (fewer than 200 cases reported) and usually appears shortly after birth, with the first signs often being red-brown urine staining of diapers and cutaneous photosensitivity.⁵ It is also known as *Günther's disease*. The teeth will fluoresce red under ultraviolet light and exhibit a red or brownish discoloration under normal light as a result of porphyrin deposits in the dentin. Urine and fecal porphyrins, URO I and COPRO I, are significantly elevated. The urine is often red because of the presence of URO and COPRO. Photosensitivity is a major clinical problem, resulting in lesions that may become infected and leave the patient scarred or with multiple occurrences that may lead to mutilation of the ears, nose, or digits. Abnormal hair growth is often seen in exposed areas. It is thought that the disfigurements of this disorder and the tendency to avoid daylight (hence, only coming outside at night) led to the legend of the werewolf.⁶ Patients may also develop a hemolytic anemia and splenomegaly with hemolysis serving as a stimulus for increased porphyrin production in the bone marrow. Allogenic bone marrow transplantation has proved curative in patients with CEP, and the use of stem cells for treatment of CEP patients is being investigated.⁴

Deficiency of uroporphyrinogen decarboxylase (UROD) occurs in PCT, the most common porphyria, and in the rarer HEP. PCT is subdivided into two types: sporadic type I, in which decreased UROD activity is restricted to the liver and there is no family history of the disease; and familial type II, characterized by UROD deficiency in all tissue and an autosomal dominant inheritance pattern. Genetic studies have shown that PCT is not a single monogenic disorder but rather a group of diseases characterized by different mutations to the gene (mapped on chromosome 1p34) coding for UROD and possibly to other genes outside the UROD locus.⁷ PCT usually presents in adulthood with cutaneous blistering and fragility in light-exposed areas, typically the hands, along with some abnormal hair growth. Liver biopsy specimens from these patients show fluorescence, hemosiderosis, fatty infiltration, and variable degrees of necrosis and fibrosis.

PCT is differentiated from all other porphyrias by three features: (1) association of skin lesions with severe deficiency of UROD, resulting in increased excretion of uroporphyrin, heptacarboxylic porphyrin, isocoporphyrin, and other porphyrins; (2) remission following low-dose chloroquine or iron depletion; and (3) some degree of liver cell damage in almost all patients.⁸ In genetically predisposed patients, PCT may be induced by multiple factors including alcohol, estrogen, halogenated aromatic hydrocarbons (hexachlorobenzene and 2,3,7,8-tetrachlorodibenzo-*p*-dioxin), infection by hepatitis C and human immunodeficiency virus (HIV), thalassemia, hepatic tumors, hemodialysis, and bone marrow transplantation.^{7,9} In laboratory tests, PCT is characterized by increased levels of urinary URO, COPRO, and 7-carboxyl porphyrin III, plasma URO, and fecal isocoporphyrins (ISOCOPROs)⁵. Other laboratory findings that may also be seen in this disease are elevated serum iron, ferritin, and liver enzymes.

HEP, a rare form of PCT, occurs in individuals who are homozygous or compound heterozygous for mutations that result in marked UROD deficiency.⁴ Clinical features are similar to those of CEP, including photosensitivity beginning in childhood. Patients are severely affected and develop excess facial hair and scarring of the hands and face. The severity of photosensitivity improves somewhat with age, but hepatic disease follows. Urine and fecal porphyrin levels are similar to those found in PCT. Erythrocyte zinc protoporphyrin (ZPP) levels are increased in HEP and normal in PCT.⁵

HCP, a deficiency of coproporphyrinogen oxidase, is a fairly mild condition with primarily neurologic manifestations and cutaneous photosensitivity in about 30% of patients.⁵ Attacks have been precipitated by exposure to certain drugs, hormones, and nutritional changes.⁴ The hallmark of HCP is significantly increased excretion of COPRO III in urine and feces and the presence of harderoporphyrin, a three-carboxyl porphyrin in feces. Increased plasma COPRO also occurs. During acute attacks, urinary excretion of COPRO III, ALA, and PBG is increased. VP is prevalent in South Africa and can be traced to a single couple that emigrated from the Netherlands in 1688. The cause is a deficiency of protoporphyrinogen oxidase activity. Clinical manifestations include acute attacks of neurologic dysfunction (such as those in AIP), photodermatitis (as in HCP and PCT), or both. Hallmark laboratory findings are increased levels of COPRO and PROTO in feces, with levels of PROTO exceeding those of COPRO and COPRO III levels higher than COPRO I levels. Porphyrin-protein complexes specific for VP (X-porphyrins) are present in plasma.⁵ During acute attacks, urinary ALA and PBG excretion is increased; however, in asymptomatic subjects, the excretion is often normal.

EPP, the second most common porphyria, results from a deficiency of ferrochelatase, the last enzyme in the heme pathway. The major clinical symptom is photosensitivity, which is usually present from infancy. Patients complain of burning, itching, or pain in the skin on exposure to sunlight. Some patients also have severe liver disease. The diagnosis of EPP is made by demonstrating increased levels of PROTO in erythrocytes, plasma, and stool, along with normal urinary porphyrins or increased COPRO I. High levels of free protoporphyrin (not bound to zinc) in erythrocytes and plasma occur in EPP. Clinical expression of the disease is highly variable. Some individuals have no clinical manifestations of the disease but have increased levels of erythrocyte PROTO. Coinheritance of a second weak mutation of the ferrochelatase gene (in addition to the primary mutations detected) may explain the significant individual differences in clinical expression.⁴

Treatment of the inherited porphyrias is aimed at modifying the biochemical abnormalities causing clinical symptoms. The cutaneous symptoms are treated by avoiding sunlight, using sun-blocking agents, and using oral beta-carotene, which acts as a singlet oxygen trap, preventing skin damage. Reduction of the heme load can be accomplished by phlebotomy or by giving desferrioxam-

ine to chelate iron. Intravenous hematin may be used to counteract acute attacks of neurologic dysfunction. Hematin, an enzyme inhibitor, limits synthesis of porphyrins in cells in the bone marrow. Cessation of precipitating factors, such as ingestion of alcohol or estrogens, should be the first line of PCT treatment.¹⁰ Gene therapy (adding the normal gene to a patient's bone marrow stem cells, such as addition of the normal ferrochelatase gene to an EPP patient's cells) appears to be a feasible future treatment of porphyrias.¹⁰

The term *secondary porphyrias*, or **porphyrinurias**, is given to acquired conditions in which a mild to moderate increase in excretion of urinary porphyrins is seen. In this case, the disorders are not the result of an inherited biochemical defect in heme synthesis but a result of another disorder, toxin, or drug interfering with heme synthesis. Symptoms may be similar to the inherited porphyrias in some cases. Various anemias, liver diseases, and toxins, such as lead and alcohol, fit into this category. Lead is known to inhibit both the activity of PBG synthase and the incorporation of iron into heme. Secondary porphyrias can be distinguished from true porphyrias by measuring levels of urinary ALA and PBG. In secondary porphyria, ALA levels are increased in the urine, whereas PBG excretion usually remains normal. Lead poisoning also classically exhibits increased COPRO in the urine and erythrocyte ZPP, as well as increased ALA. However, determination of blood lead is the most accurate method to detect lead poisoning.

CASE STUDY 18-1

A 58-year-old man with a history of alcoholism complained of increased skin fragility and skin lesion formation on his hands, forehead, neck, and ears on exposure to the sun. Also noted on physical examination was hyperpigmentation and hypertrichosis. Laboratory findings showed an increase in urinary uroporphyrin and a slight increase in coproporphyrin, with normal levels of ALA and porphobilinogen. Isocoproporphyrin was elevated in the feces. Serum ferritin and serum transaminase were increased. Erythrocyte ZPP and FEP levels were normal.

Questions

1. What is the most probable disorder?
2. What confirmatory test should be done?
3. What is the most probable precipitating factor?
4. What are other causes of acquired cases of this type of porphyria?
5. How is this case differentiated from the homozygous deficiency of this enzyme?
6. How is this type of porphyria differentiated from other porphyrias causing cutaneous symptoms?

Methods of Analyzing Porphyrins

There are individual enzyme assays available for each defective enzyme that causes porphyria. These procedures typically include addition of substrate under conditions close to physiologic pH and temperature, cessation of the reaction by addition of protein-precipitating agents, and separation (usually by high-performance liquid chromatography [HPLC]), followed by fluorometric identification and quantitation of porphyrin products.⁵ However, most are still limited to use in specialized laboratories and are not discussed here. Screening tests can be performed easily and may be beneficial in emergency situations, but care should be taken in interpretation because false-negatives and false-positives occur.^{11,12} Quantitative assays should follow all screening tests. Quantitative assays of the three porphyrins (URO, PROTO, and COPRO) and two porphyrin precursors (ALA and PBG) will serve to classify most porphyrias.

Tests for Urinary PBG and ALA

The two most common screening tests for urinary PBG are the Watson-Schwartz and the Hoesch tests.^{4,13} Ideally, these screening tests should be quantitative and not qualitative. Both tests are based on the principle of PBG form-

ing a red-orange color when mixed with Ehrlich's reagent (acidic *p*-dimethylaminobenzaldehyde). In the Watson-Schwartz test, an extraction with chloroform or butanol is performed to differentiate PBG from interfering substances such as urobilinogen or indole. If a cherry-red color remains in the aqueous phase after addition of chloroform or butanol, this indicates a positive test for PBG. The reagent in the Hoesch test does not react with urobilinogen; therefore, it is sometimes used to confirm the results of the Watson-Schwartz test. Porphobilinogen and ALA are determined quantitatively by successive separation on two ion-exchange columns.⁴ An aliquot of urine is loaded on an anion-exchange or alumina column that retains PBG while ALA passes through. Following washes to remove interfering substances, PBG is eluted with acetic acid and measured spectrophotometrically using Ehrlich's reagent. The eluate from the first column is loaded on a cation-exchange column to retain ALA and then eluted with sodium acetate. The eluted ALA is reacted with Ehrlich's reagent after first being condensed with acetylacetone to form a pyrrole and then measured spectrophotometrically.⁵

Tests for Porphyrins

Screening and quantitative tests for porphyrins in urine, blood (erythrocytes and plasma), and feces are based on the enhanced fluorescence of these compounds in acidic solution. Typically, an aliquot of specimen is extracted into an organic solvent and then back-extracted into an acidified aqueous layer. For screening procedures, samples containing porphyrins will exhibit a pink or red fluorescence in the aqueous layer when viewed under a Wood's (ultraviolet) lamp. Quantitative procedures include fluorometric measurements usually at an excitation wavelength of 400 to 405 nm and an emission wavelength of 594 to 598 nm. Standard solutions of coproporphyrin, uroporphyrin and, possibly, protoporphyrin are used to calculate the porphyrin concentrations in the samples. Each porphyrin exhibits different excitation and emission wavelengths (solvent dependent) and some procedures use average wavelengths, whereas other procedures include multiple measurements and calculation of levels of each porphyrin. To verify positive results and eliminate possible interferences, fluorescence scan with comparison to scans of standards is recommended. Fluorometric procedures are more sensitive than those measuring the absorbance of porphyrins.

Other tests for porphyrins use chromatographic separation and quantitation of the individual porphyrins with spectrophotometry or fluorometry. Reversed-phase HPLC separates porphyrins, including isomers. Capillary zone electrophoresis (CZE), which separates compounds based on charge/mass ratio (modified by pH adjustment), is another chromatographic technique used for quantitation of porphyrins. This technique is as sensitive as HPLC with

CASE STUDY 18-2

A few days after a laparotomy for "intestinal obstruction," a young nurse from South Africa became emotionally disturbed and appeared to be hysterical. For longer than 1 week before the operation, she had taken barbiturate capsules to help her sleep. When first seen, she complained of severe abdominal and muscle pain and general weakness, her tendon reflexes were absent, and she was vomiting and constipated. Her urine was dark in color on standing and gave a brilliant pink fluorescence when viewed in ultraviolet light. Within 24 hours, she was completely paralyzed, and within 2 days she died.

Questions

1. What possible condition did this young woman have, and why did it manifest at this time?
2. Would any members of her family have a similar disease?
3. What enzyme defect did she have?
4. What other confirmatory tests, if any, could be done?

fluorescence detection and has the advantages of simpler instrumentation, minimum use of organic solvent, and lower reagent consumption.⁵

Zinc protoporphyrin, a normal metabolite formed by the chelation of zinc instead of iron with protoporphyrin during heme biosynthesis, is another porphyrin that may be measured. Increased zinc protoporphyrin formation occurs during periods of iron insufficiency or impaired iron use. Clinically ZPP has been advocated as a valuable test for evaluating iron nutrition and metabolism in various settings, including pediatrics, obstetrics, and blood banking, as well as a screening test for iron deficiency anemia and lead exposure in adults.¹⁴ A rapid screening method for determination of ZPP includes measurement of the fluorescence of whole blood and washed erythrocytes using a hematofluorometer. It is recommended that ZPP concentrations be reported as a ratio to the heme concentration (per mole of heme).¹⁴

Molecular diagnostic techniques are becoming useful in the diagnosis of porphyrias.^{4,15} Most of the genes that encode the enzymes of heme synthesis have been identified and mutations, which cause various porphyrias, have been discovered. The use of these techniques to aid in the diagnosis of porphyrias has certain advantages over traditional biochemical assays. The interpretation of the traditional tests is complicated by the fact that analytes being measured may be normal except during an

acute attack and the amount of porphyrin excreted in the various disorders is highly variable, causing significant overlap between affected and normal patients. By testing for the disease-causing mutation, these problems of biologic variability and disease activity can be overcome. However, perhaps the most important application of molecular testing is its use in detecting asymptomatic gene carriers, which are not easily identified by standard laboratory testing.¹⁵

HEMOGLOBIN

Role in the Body

Hemoglobin has many important functions in the body. Its major role is oxygen transport to the tissue and CO₂ transport back to the lungs. The hemoglobin molecule is designed to take up oxygen in areas of high oxygen tension and release oxygen in areas of low oxygen tension. Hemoglobin is carried to all tissues of the body by erythrocytes. Hemoglobin is also one of the major buffering systems of the body.

Structure of Hemoglobin

Hemoglobin is a large, complex protein molecule with a molecular weight of approximately 64,000. It is roughly spherical in shape and comprises two major parts: heme, which makes up 3% of the molecule, and globin proteins, which make up the remaining 97%. The heme portion comprises a porphyrin ring with iron chelated in the center. The iron atom is the site of reversible oxygen attachment. The protein portion comprises two pairs of globin chains that are twisted together so that the heme groups are exposed on the exterior of the molecule (Fig. 18-3). The complete hemoglobin molecule contains four heme groups attached to each of four globin chains and may carry up to four molecules of oxygen. Each globin chain contains 141 or more amino acids.

The structure of each chain is fourfold. The primary structure consists of the individual amino acids and their sequences. Their sequences vary and are the basis of chain nomenclature: α , β , δ , and γ . The secondary structure is the three-dimensional arrangement of the amino acids making up the polypeptide chain. Regions of amino acids may form helixes or a pleated structure. The tertiary structure is a larger fold superimposed on the helical or pleated forms. It represents the position taken by each chain or subunit in three-dimensional space. The quaternary structure represents the relationship of the four subunits to one another, particularly at the points of contact. Mutations at particular points of contact result in altered specific functional properties of the molecule, such as its oxygen affinity.

The majority of hemoglobin in normal adults is designated as hemoglobin A, or A₁, which contains two α

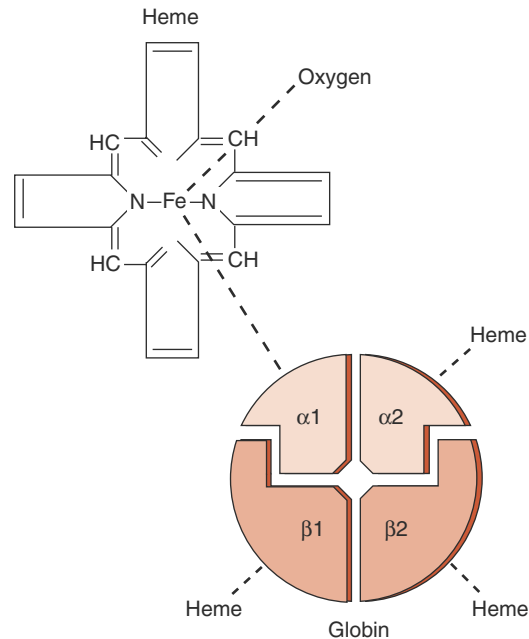

FIGURE 18-3. Hemoglobin A: structure of the hemoglobin molecule.

and two β chains (Fig. 18-3). Hemoglobin A₂, which comprises two α and two δ chains, makes up less than 3% of normal adult hemoglobin. The remainder is composed of hemoglobin F, which contains two α and two ϵ chains. Hemoglobin F is the main hemoglobin during fetal life and is about 60% of normal hemoglobin at birth. There is a gradual switch from production of γ chains to β chains, and, by about age 9 months, hemoglobin F usually constitutes less than 1% of total hemoglobin. Hemoglobin F has a greater affinity for oxygen than hemoglobin A; therefore, it is a more efficient oxygen carrier for the fetus. Hemoglobin F is more resistant to alkali than hemoglobin A, and this is the basis of one laboratory test to differentiate these two types of hemoglobin.

Two other hemoglobin chains, designated ζ and ϵ , are present only in embryonic life. Production of these chains stops by week 8 of gestation, and γ chain production takes over. The three embryonic hemoglobins are identified as Gower I, two ζ chains and two ϵ chains; Gower II, two α chains and two ϵ chains; and Portland I, two ζ chains and two γ chains.

Genetic control of hemoglobin synthesis occurs in two areas: control of structure and control of rate and quantity of production. Defects in structure produce a group of diseases called the *hemoglobinopathies*. Defects in rate and quantity of production lead to disorders called the *thalassemias*. Structurally, each globin chain has its own genetic locus; therefore, it is the individual chains, not the whole hemoglobin molecule, that are under genetic control. The genes for the globin chains can be divided into

two major groups: the α genes, located on chromosome 16, and the non- α genes, on chromosome 11. In most persons, the α gene locus is duplicated—there are two α chain genes per haploid set of chromosomes, designated α_1 and α_2 . The α gene and, hence, its polypeptide chains are identical in hemoglobins A, A₂, and F. The non- α genes for the β , δ , and γ chains are sufficiently close in genetic terms to be subjected to nonhomologous crossover, with the resulting production of fused or hybrid globin chains, such as hemoglobin Lepore ($\delta\beta$ -globin chain) and Kenya ($\gamma\beta$ -globin chain).

Based on the genetics of the globin chain production, the structural abnormalities, or *hemoglobinopathies*, can be divided into four groups:

1. Amino acid substitutions (e.g., hemoglobins S, C, D, E, O, and G)
2. Amino acid deletion—deletions of three or multiples of three nucleotides in deoxyribonucleic acid (DNA; e.g., hemoglobin Gun Hill)
3. Elongated globin chains resulting from chain termination, frame shift, or other mutations (e.g., hemoglobin Constant Spring)
4. Fused or hybrid chains resulting from nonhomologous crossover (e.g., hemoglobins Lepore and Kenya)

The amino acid substitutions are the most common abnormalities, with several hundred described so far. Approximately two thirds of the hemoglobinopathies have an affected β chain. They may be clinically silent or they may cause severe damage, as with hemoglobin S. Amino acid substitutions, for the majority of defects, result from a single-base nucleotide substitution in DNA.

Absent or diminished synthesis of one of the polypeptide chains of human hemoglobin characterizes the *thalassemias*, a heterogeneous group of inherited disorders. In α -thalassemia, α -globin chain synthesis is absent or reduced; in β -thalassemia, β -globin chain synthesis is absent (β^0 -thal) or partially reduced (β^+ -thal).

Synthesis and Degradation of Hemoglobin

Hemoglobin synthesis occurs in the immature red blood cells (RBCs) in the bone marrow: 65% in the nucleated cells and 35% in reticulocytes. Normal synthesis depends on adequate iron supply as well as normal synthesis of heme and protein synthesis to form the globin portion. Heme is synthesized in the mitochondria of the cells. Iron is transported to the developing RBCs by transferrin, a plasma protein. Iron traverses the cell membrane and the mitochondria, where it is inserted into the PROTO ring to form heme. Protein synthesis of the globin chains occurs in the cytoplasmic polyribosomes. Heme leaves the mitochondria and is joined to the globin chains in the cytoplasm in the final step.

Two possible pathways degrade hemoglobin. The normal pathway is called extravascular because it occurs outside of the circulatory system within the phagocytic cells of the spleen, liver, and bone marrow. Within the splenic phagocytic cells, or macrophages, hemoglobin loses its iron to transferrin, its α carbon is expired as CO, the globin chains return to the amino acid pool, and the rest of the molecule is converted to bilirubin, which undergoes further metabolism. Normally, 80%–90% of all hemoglobin is degraded in this manner (Fig. 18-4).

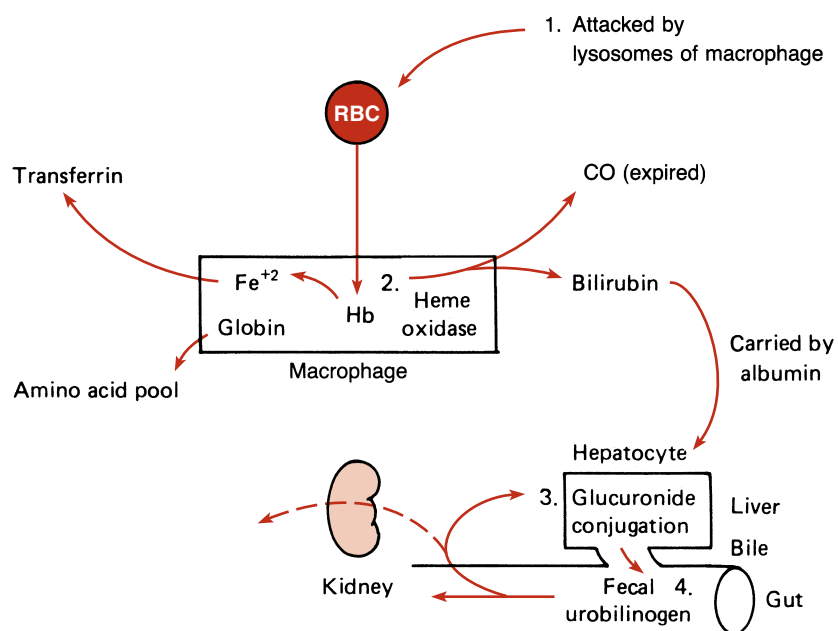

FIGURE 18-4. Extravascular degradation of hemoglobin.

Normally, 10%–20% of erythrocyte destruction occurs intravascularly. Hemoglobin is released directly into the blood stream and dissociated into α and β dimers. Greater amounts are released during hemolytic episodes. The dimers are bound to haptoglobin, which prevents renal excretion of plasma hemoglobin and stabilizes the heme–globin bond. This complex is then removed from the circulation by the liver and processed in a fashion similar to extravascular degradation. If the amount of circulating haptoglobin is decreased, as during a hemolytic episode, the unbound dimers go through the kidneys, are reabsorbed, and the iron is stored as hemosiderin. Some hemoglobin dimers may be excreted in the urine, resulting in hemoglobinuria. If the storage limit of the kidneys is exceeded, cells lining the renal tubules may be shed and free hemoglobin, methemoglobin, and/or hemosiderin will appear in the urine.¹⁶

Hemoglobin that is not entirely bound by haptoglobin or processed by the kidneys is oxidized to methemoglobin. Heme groups are released and taken up by the protein hemopexin. The heme–hemopexin complex is cleared by the liver and catabolized. Then, heme groups present in excess of the binding capacity of the hemopexin complex combine with albumin to form methemalbumin and are held by this protein until additional hemopexin becomes available for shuttle to the liver (Fig. 18-5). Laboratory measurement of any of these hemoglobin degradation products can help to determine increased RBC destruction, such as in a hemolytic anemia.

Clinical Significance and Disease Correlation

Hemoglobin Qualitative Defects: The Hemoglobinopathies

Hemoglobin S. The amino acid defect in hemoglobin S is at the sixth position on the β chain, where glutamic acid is substituted by valine, giving the hemoglobin a less negative charge than hemoglobin A. This is the most common hemoglobinopathy in the United States.

Individuals have either sickle cell trait (HbAS, the heterozygous state) or sickle cell disease (HbSS, the homozygous state). Black Africans and African Americans have the highest incidence: 1 of 500 infants have sickle cell anemia and 8% to 10% carry the HbAS trait. It is also found in Mediterranean countries, such as Greece, Italy, and Israel, as well as in Saudi Arabia and India.

Because of the high mortality and morbidity associated with homozygous expression of the gene, the frequency of the mutant gene would be expected to decline in the gene pool. However, a phenomenon known as balanced polymorphism exists, which indicates that the heterozygous state (HbAS) has a selective advantage over either of the homozygous states (HbAA or HbSS). It appears that the heterozygous condition offers protection from parasites, particularly *Plasmodium falciparum*, especially in children. When infected with *P. falciparum*, children with sickle cell trait have a lower parasite count, the infection is shorter in duration, and the incidence of death is low. It is thought that the infected RBCs are preferentially sickled and, therefore, efficiently destroyed by phagocytic cells.¹⁷

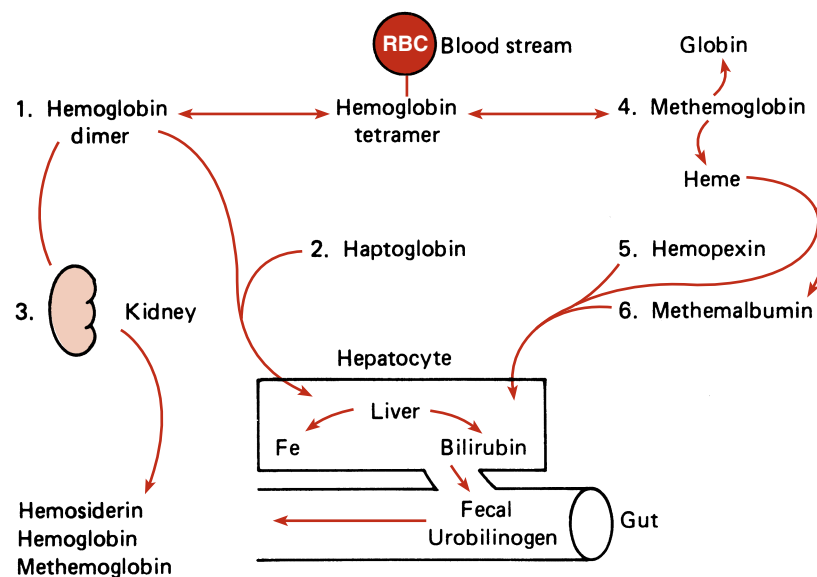

Intravascular Breakdown of Hemoglobin <10%

FIGURE 18-5. Intravascular breakdown of hemoglobin.

When hemoglobin S is deoxygenated in vitro under near-physiologic conditions, it becomes relatively insoluble as compared with hemoglobin A and aggregates into long, rigid polymers called *tactoids*. These cells appear as sickle- or crescent-shaped forms on stained blood films. Sickled cells may return to their original shape when oxygenated; however, after several sickling episodes, irreversible membrane damage occurs and cells are phagocytized by macrophages in the spleen, liver, or bone marrow, causing anemia. The severity of the hemolytic process is directly related to the number of damaged cells in circulation. The rigid sickled cells are unable to deform and circulate through small capillaries, resulting in blockage. Tissue hypoxia results, causing extreme pain and leading to tissue death. Infarctions in the spleen are common, causing excessive necrosis and scarring, leading to a non-functional spleen in most adults with sickle cell anemia. This is referred to as *autosplenectomy*. The amount of sickling is related to the amount of hemoglobin S in the cells. The reported inhibitory effect of hemoglobins A and F is due to a dilutional effect. There is also a lower tendency for hemoglobin F to copolymerize with hemoglobin S than with hemoglobin A. This is considered responsible for the observed protective effect of elevated hemoglobin F levels in individuals with sickle cell anemia.

Laboratory findings in the homozygous disease include a normocytic, normochromic anemia, increased reticulocyte count, and variation in size and shape of RBCs with target cells and sickle cells present. Polychromatophilia and nucleated RBCs are common. The heterozygous disease is clinically asymptomatic and usually has a normal blood film. The solubility test for hemoglobin S will be positive in both homozygous and heterozygous forms but should always be confirmed with hemoglobin electrophoresis. On cellulose acetate electrophoresis at an alkaline pH, hemoglobin S moves in a position between hemoglobin A and A₂. Of total hemoglobin, 85% to 100% will be hemoglobin S in the homozygous state and usually less than 50% in the heterozygous state. Hemoglobins D and G migrate in the same position as hemoglobin S, but both would be negative with the solubility test. Electrophoresis on citrate agar at an acid pH is necessary to separate these hemoglobins from hemoglobin S (see Fig. 18-7).

Hemoglobin C

The glutamic acid in the sixth position of the β chain is replaced by lysine, resulting in a net positive charge. Hemoglobin C is found in West Africa in the vicinity of North Ghana in 17%–28% of the population and in 2%–3% of African Americans.

The heterozygous form, hemoglobin AC, is asymptomatic. The homozygous form usually causes a mild, well-compensated anemia characterized by abdominal pain and splenomegaly. The most prominent laboratory fea-

CASE STUDY 18-3

A 32-year-old African American woman came to the obstetrics and gynecology clinic of her local hospital because she was feeling a little weak. A CBC showed hemoglobin of 9.9 g/dL (reference range 11.7–15.7 g/dL), with an MCV of 87 fL (reference range 80–100 fL). The physician ordered a hemoglobin electrophoresis as a follow-up. The cellulose-acetate pattern showed a peak of 58% at the hemoglobin A position, a peak of 35% at the hemoglobin S position, and a peak of 5% at the A₂ position. Further studies indicated a positive dithionite solubility test result and a hemoglobin F value of 1%.

Questions

1. What is the best possible diagnosis for this woman?
2. Does this condition require further follow-up and treatment?
3. What implications does this disease have for her unborn child?
4. Are the values for hemoglobins A₂ and F normal for this condition?

ture is the presence of target cells. There is a tendency to form large, oblong, hexagonal crystalloid structures within the red cell. These structures are most prominent in patients who have undergone splenectomy.

A differential diagnosis is obtained by cellulose acetate electrophoresis. Hemoglobin C moves with hemoglobin A₂ and is negative with the solubility test. In the heterozygous form, hemoglobin C falls in the range of 35%–48%. Hemoglobins E, O, and C_{Harlem} migrate with hemoglobin C. These hemoglobin variants can be readily distinguished from hemoglobin C by citrate agar electrophoresis at an acid pH.

Hemoglobin SC

Hemoglobin SC disease is the most common *mixed hemoglobinopathy*. One β gene codes for β -S chains and the other β gene codes for β -C chains, leaving no normal β chains to produce hemoglobin A. Clinically, this disease is less severe than homozygous sickle cell anemia but has similar clinical symptoms. The blood film characteristically shows many target cells and occasional abnormal shapes resembling the sickle cell, the hexagonal hemoglobin C crystal, and a combination of the two. The solubility test is positive, and electrophoresis on cellulose acetate shows about equal amounts of hemoglobin S and hemoglobin C.

Hemoglobin E

Hemoglobin E is an amino acid substitution of lysine for glutamic acid in the 26th position of the β chain, resulting in a net positive charge. Hemoglobin E is somewhat unstable when subjected to oxidizing agents.

Found in Asia, it is estimated to occur in about 20 million individuals, 80% of whom live in Southeast Asia. In the homozygous form, there is a mild anemia with microcytosis and target cells. In the heterozygous form, the patient is asymptomatic. The differential diagnosis is obtained by electrophoresis. On cellulose acetate, hemoglobin E moves with A₂, C, and O. It is present in the heterozygous form in amounts varying from 30%–45%, which is somewhat lower than the percentage for hemoglobin C. This is probably a result of the somewhat unstable nature of hemoglobin E. On citrate agar, hemoglobin E migrates with A. It is more common to find this defect in association with both α - and β -thalassemia. E- β -Thalassemia is a more severe disorder, with moderate anemia and splenomegaly.

Hemoglobin D

The letter *D* is given to any hemoglobin variant with an electrophoretic mobility on cellulose acetate similar to that of hemoglobin S but that has a negative solubility test. Hemoglobin D_{Los Angeles} and its identical variant, hemoglobin D_{Punjab}, are the most common, with glycine substituted for glutamic acid at the 121st position of the β chain. Hemoglobin D_{Punjab} is found in northwest India but occasionally can be seen in English, Portuguese, and French individuals because of the close historical connection of these countries with East India. Hemoglobin D_{Los Angeles} is found in 0.02% of African Americans.

The homozygous state is rare. There is a mild anemia and/or splenomegaly and only a slight anisocytosis. The oxygen affinity is higher than in normal blood. Heterozygous individuals are asymptomatic. Differential diagnosis is accomplished with electrophoresis. On cellulose acetate, hemoglobin D migrates with hemoglobin S in proportions of 35%–50%. On citrate agar, hemoglobin D migrates with A.

Hemoglobin Quantitative Defects:

The Thalassemias

The thalassemias are a group of diseases in which a defect causes reduced synthesis of one or more of the hemoglobin chains, but the chains are structurally normal. Interaction among a large number of different molecular defects is the cause for decreased or absent globin chain synthesis.¹⁸ The two most common types are α -thalassemia, resulting from defective production of α chains, and β -thalassemia, resulting from a defect in production in β chains. Defects in production of the δ and γ chains have been described, but these are not involved in production of hemoglobin A and, therefore,

not clinically significant. Rarely, combinations of gene deletions, such as δ and β , may lead to clinical disease. Any form of unbalanced production of globin chains causes the erythrocytes to be small, hypochromic, and sometimes deformed. Intracellular accumulation of unmatched chains in the developing erythrocytes causes precipitation of the proteins, which leads to cell destruction in the bone marrow. Although erythropoiesis is occurring, it is ineffective because mature cells do not reach the peripheral blood to carry oxygen.

Thalassemia is inherited as an autosomal dominant disorder with heterogeneous expression of the disease. One of the most common hereditary disorders, it is distributed worldwide. The prevalence of the thalassemia gene has been attributed to the protection it offers against falciparum malaria. The heterozygous state produces a disorder called *thalassemia minor*, which is clinically asymptomatic and resembles iron deficiency. The homozygous state, *thalassemia major*, is usually lethal before birth or in childhood. Early and continuous treatment of some forms of the disease allows survival to young adulthood, but complications are many.

α -Thalassemias

Two α genes are located on each chromosome 16, one inherited from the mother and one from the father yielding a total of four α genes. There are four principal clinical types of different severity known to occur in the population, and these four types can be explained, respectively, by deletions of four, three, two, or one of the α -globin gene loci (Fig. 18-6). α -Thalassemia occurs with high frequency in Asian populations but is also seen in the Black African, African American, Indian, and Middle Eastern populations. The type of α -thalassemia found in Black Africans and African Americans is also associated with deletion of the α -globin genes but in a different pattern than is found in the Asian population (Fig. 18-6). The four clinical types of α -thalassemia in order of most deletions to least deletions are the following:

1. Hydrops fetalis is the most clinically severe form of α -thalassemia because of the total absence of α chain synthesis. Hemoglobin Bart's, which is a tetramer of γ chains, is the main hemoglobin found in the red cells of affected infants. Hemoglobin Bart's has an extremely high O₂ affinity and allows almost no oxygen transport to the tissue. These infants are either stillborn or die of hypoxia shortly after birth.
2. Hemoglobin H disease has α chain synthesis at about one third the amount of β chain synthesis. As a result, β chains accumulate and form tetramers, which are called *hemoglobin H*. β Chain precipitates (hemoglobin H inclusions) alter the shape and ability of the cell to deform, significantly shortening the life span of the cells. These individuals have a moderate hemolytic anemia, with 5% to 30% hemoglobin H, 1% hemoglobin A₂, and

CASE STUDY 18-4

A 54-year-old African American woman was admitted to the hospital with the chief complaint of left hip pain and lethargy. She had a long history of multiple emergency department visits for hip pain requiring medication. She previously had been found to have a positive solubility test for hemoglobin S, but denied a history of sickle cell disease. There was family history of sickle cell trait. She had a mastectomy for breast cancer 10 years before. Admission laboratory values were as follows:

| | | REFERENCE RANGE |
|--------------------|--|----------------------------------|
| Hemoglobin | 5.3 g/dL | 11.7–15.7 g/dL |
| Hematocrit | 17% | 35–47% |
| MCV | 82 fL | 80–100 fL |
| MCHC | 31% | 32–36% |
| WBC | $12.0 \times 10^9/L$ | $3.5\text{--}11.0 \times 10^9/L$ |
| Platelet count | $53.0 \times 10^9/L$ | $150\text{--}440 \times 10^9/L$ |
| Differential | Normal | |
| Reticulocyte count | 6.4% (corrected, 2.4%) | 0.5–1.5% |
| RBC morphology | Target cells; spherocytes; schistocytes; basophilic stippling; and bizarre forms, including elongated, block-shaped, and more densely stained cells | |

A hemoglobin electrophoresis was ordered. Patterns from the cellulose acetate and citrate agar electrophoresis are shown in Case Study Figure 18-4.1. Chest x-ray showed a right lower lobe infiltrate with pulmonary vascular congestion and an enlarged spleen. Fluid aspirated from the nasogastric tube was positive for blood.

The patient was given medication for an aspiration pneumonia, gastrointestinal bleeding, and congestive heart failure. She was given packed RBCs; fresh, frozen plasma; and platelets, but her condition continued to worsen. Six hours later, laboratory tests confirmed disseminated intravascular coagulation (DIC). A bone marrow biopsy was performed and revealed extensive necrosis of marrow elements. Three hours later, the patient died of cardiac arrest.

Questions

1. What hemoglobinopathy is indicated by the hemoglobin electrophoresis patterns?
2. What clinical feature of this disease differs from the typical picture in sickle cell anemia?
3. What other hemoglobins interact with hemoglobin S, and how can these be differentiated from hemoglobin C?
4. Was this patient's death due to the hemoglobinopathy? Is it unusual for hemoglobin SC to be life shortening?

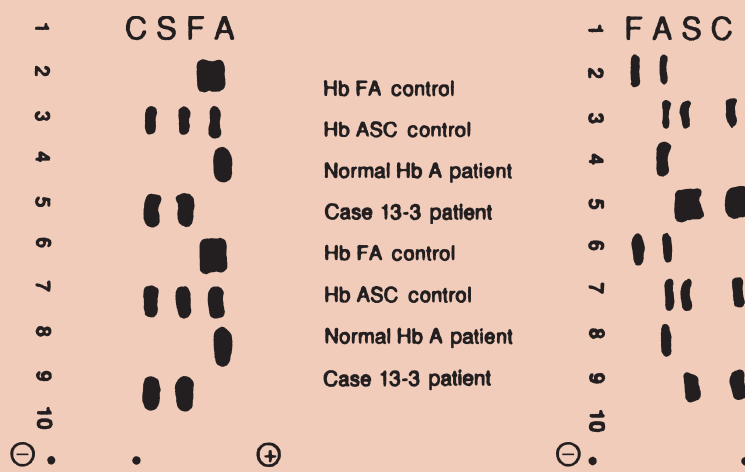

FIGURE 18-4.1. Hemoglobin electrophoretic patterns. (A) Cellulose acetate at pH 8.4. (B) Citrate agar at pH 6.2. (Case study data courtesy of Margaret Uthman, MD, University of Texas Medical School at Houston.)

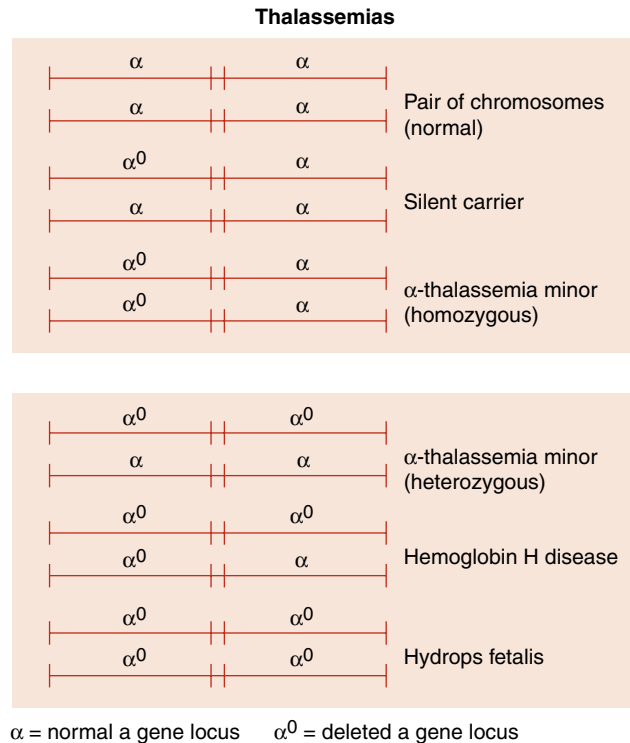

FIGURE 18-6. Deletions of α -globin gene loci on chromosome 16 in α -thalassemia.

the remainder hemoglobin A. Hemoglobin H inclusions can be seen in the red cells with a supravital stain. Cord blood contains 10%–20% hemoglobin Bart's.

3. α -Thalassemia trait results from two gene deletions, either on the same ($--/\alpha\alpha$) or on different chromosomes ($-\alpha/-\alpha$). The deletion on two separate chromosomes is more common in Black Africans and African Americans (Fig. 18-6). These individuals have a mild, microcytic, hypochromic anemia. Occasionally, excess β chains may form hemoglobin H inclusions. Cord blood contains 2%–10% hemoglobin Bart's; however, after age 3 months, electrophoresis is normal.
4. Silent carriers are missing only one α gene, and the remaining genes direct production of sufficient α chains for normal hemoglobin production. This state is often characterized by expression of 1%–2% of hemoglobin Bart's in a neonate. If hemoglobin Bart's is not detected or after age 3 months, it can only be detected by more specialized testing, such as gene mapping, α : β -globin messenger ribonucleic acid (mRNA) ratio, or other polymerase chain reaction (PCR)-based methods.^{18,19} It has been estimated that the frequency of this genetic disorder may be as high as 27% in the African American population.¹⁸

β -Thalassemias

In contrast to α -thalassemia, gene deletions usually do not cause β -thalassemia. More than 200 different mutations

have been described resulting in failure to produce normal amounts of β -globin chains. A large majority of the defects result from point mutations.¹⁸ The β -thalassemias are classically divided into homozygous disease, called thalassemia major or Cooley's anemia, and heterozygous disease, called thalassemia minor. However, the clinical expression of the disease is heterogeneous, depending on the type of genetic defect and involvement with other gene loci. The disease may be broadly divided into two major subtypes according to genetic expression: β^+ , in which β chains are produced in reduced amounts, and β^0 , which is complete absence of β chains.

β^+ -Thalassemia is the most common type. There is some synthesis of β -globin chains but in significantly reduced amounts (5%–30%) of normal. The biochemical defect shows a quantitative deficiency of β -globin mRNA. The hemoglobin electrophoresis pattern and hemoglobin F and A_2 quantitation show about 2%–8% hemoglobin A_2 , an elevated but varying amount of hemoglobin F, and the remainder hemoglobin A. The mean cell volume (MCV) is low, with severe anemia, reticulocytes, nucleated RBCs, basophilic stippling, target cells, extreme poikilocytosis, and anisocytosis.

β^0 -Thalassemia accounts for 10% of homozygous β -thalassemia, with a total absence of β chain synthesis but intact synthesis of γ chains. In the homozygous form, there is 1%–6% hemoglobin A_2 and 95% hemoglobin F. The hemoglobin concentration is low, with a

severe anemia. The heterozygous form appears clinically the same as homozygous β^+ -thalassemia.

Homozygous β -thalassemia— β -thalassemia major—either β^+ or β^0 , is a crippling disease of childhood. This is unlike α -thalassemia, in which the child either dies shortly after birth or leads a normal life. The hypochromic, microcytic anemia is a result of both the defect of functional hemoglobin tetramer synthesis and the premature destruction of RBCs, both intramedullary and extramedullary, due to increased α chains. The bone marrow compensates by enormously expanding in size, sometimes causing structural bone abnormalities. Treatment of severe forms of the disease include regular transfusion therapy, iron chelation drugs to remove excess iron, and folic acid supplements.²⁰ Bone marrow transplantation has been successful if an HLA-identical donor is available.¹⁸ Gene therapy is being studied as an alternative treatment of the future.^{21–23}

Heterozygous β -thalassemia—thalassemia minor—may be caused by inheritance of one thalassemia gene, either β^+ or β^0 . The other gene directing β chain production is normal and RBC survival is not shortened. About 1% of African Americans are affected and it also commonly occurs in individuals of Mediterranean and Arabic descent. Clinically, the condition is usually asymptomatic but may sometimes cause a mild microcytic anemia. The hematologic laboratory values resemble those of iron deficiency anemia, and it is important to distinguish the two because quite different treatments are required. The RBC count in thalassemia minor is usually higher than would be expected with the accompanying hemoglobin concentration and a few target cells or occasional basophilic stippling may be seen on a stained smear. The red cell distribution width (RDW) parameter on automated instruments, which is a quantitative measure of RBC variation in size, may be helpful to distinguish the two disorders. It is typically normal in thalassemia and increased in iron deficiency as a result of the heterogeneity of the RBCs. Hemoglobin electrophoresis of thalassemia minor characteristically shows an increase in hemoglobin A₂. Quantitation of hemoglobin A₂ by column chromatography usually reveals values between 3.5% and 7%.

δ - β -Thalassemia is a rare type characterized by total absence of both β chain synthesis of hemoglobin A and δ chain synthesis of hemoglobin A₂. Homozygous patients have 100% hemoglobin F. The heterozygous individuals have 93% hemoglobin A, 2% to 3% have hemoglobin A₂, and 3% to 10% have hemoglobin F.

Patients are anemic and show a thalassemic phenotype because the γ chain synthesis of hemoglobin F is not equal to α chain synthesis. There is approximately one third as much γ chain produced as α chain. Hemoglobin F is heterogeneously distributed among the erythrocytes, as revealed by the acid elution stain procedure.

Hereditary persistence of fetal hemoglobin (HPFH) is genetically and hematologically heterogeneous. In African Blacks and African Americans, there is a total absence of β as well as δ chain synthesis because of deletions in chromosome 11. γ Chain synthesis is present in the adult at a high level and, in contrast to synthesis of hemoglobin F in β -thalassemia or δ - β -thalassemia, is uniformly distributed. In heterozygotes, there is no imbalance of globin chain synthesis. There is 17%–33% hemoglobin F. The patients are clinically normal. In homozygotes, there is 100% hemoglobin F, with no synthesis of hemoglobin A or A₂. There are no significant hematologic abnormalities, other than erythrocytosis, and these patients are also asymptomatic.

Methodology

Most hemoglobinopathies and thalassemias can be diagnosed by use of the complete blood count (CBC), blood film evaluation, solubility test, and cellulose acetate electrophoresis. Citrate agar electrophoresis may be necessary for confirmation of some abnormal hemoglobins. Thalassemias may require quantitation of hemoglobin A₂ or F by more definitive methods. A serum ferritin may be helpful to distinguish thalassemia minor from iron deficiency anemia. Hemoglobinopathies may also be diagnosed rapidly and accurately using newer automated techniques such as HPLC and isoelectric focusing.²⁴ The more complicated cases may require more specialized procedures, such as α/β -globin chain analysis,^{24,25} cation exchange HPLC,^{25,26} or DNA technology testing.^{25–27}

Solubility Test (Screening Test for Sickling Hemoglobins)

The solubility test is based on the principle that sickling hemoglobin, in the deoxygenated state, is relatively insoluble and forms a precipitate when placed in a high-molarity phosphate buffer solution.^{27,28} The precipitate appears because the deoxygenated hemoglobin molecules form tactoids that refract and deflect light rays, producing a turbid solution. A small amount of packed RBCs is placed in a buffered solution of sodium dithionite with saponin to lyse the RBCs in a 12 × 75 mm glass tube. After mixing well and incubating at room temperature for 5 minutes, the tube containing the solution is placed approximately 1 inch in front of a heavy, black-lined index card. If there is no sickling hemoglobin present, the lines on the card will be easily seen. If sickling hemoglobin is present, the lines will be indistinct or impossible to read. The test is reported as positive or negative for sickling hemoglobin. A positive and a negative control should be run with each test batch.

Outdated reagents and reagents not at room temperature interfere with the test. False-negative tests may be due to anemia or recent transfusions or may occur

CASE STUDY 18-5

A 5-year-old white boy was seen by a physician for an upper respiratory tract infection and splenomegaly was noted. A CBC was ordered and, subsequently, a hemoglobin electrophoresis. The following were the results:

| | | REFERENCE RANGE |
|--|--|------------------------------------|
| Hemoglobin | 8.5 g/dL | 11.7–15.7 g/dL |
| Hematocrit | 27% | 35–47% |
| RBC | $4.3 \times 10^{12}/L$ | $3.8\text{--}5.2 \times 10^{12}/L$ |
| MCV | 62.3 fL | 80–100 fL |
| MCHC | 32.0% | 32–36% |
| RDW | 18.5% | 11.5–14.5% |
| Platelet | $538 \times 10^9/L$ | $150\text{--}440 \times 10^9/L$ |
| WBC | $10.7 \times 10^9/L$ | $3.5\text{--}11.0 \times 10^9/L$ |
| Reticulocyte count | 5.6% | 0.5–1.5% |
| WBC differential | Normal except for 1 nucleated RBC/100 WBCs | |
| RBC morphology | Moderate anisocytosis, moderate microcytosis, slight polychromasia, slight target cells, slight schistocytes | |
| Hemoglobin electrophoresis (cellulose acetate) | | |
| Hemoglobin C | 89% | |
| Hemoglobin F | 11% | |

A hemoglobin electrophoresis by citrate agar method confirmed hemoglobins C and F. Hemoglobin F was determined by the alkali denaturation method to be 7.5%. Hemoglobin A₂ could not be quantitated due to the presence of hemoglobin C. The patient's father had been previously told that he was slightly anemic due to a blood disorder called thalassemia. The patient's mother and four older siblings were healthy and unaware of any abnormal hemoglobin.

Questions

1. What combination of disorders did the patient most probably inherit?
2. Why were the mother and other siblings unaware of an abnormality?
3. Why was the patient unable to produce hemoglobin A?
4. What caused the discrepancy in values for hemoglobin F from electrophoresis and the alkali denaturation test?
5. Why was it unusual to find hemoglobin C in a white family?

in infants younger than age 6 months because of high concentrations of hemoglobin F. If whole blood is used instead of packed RBCs, false-positive results may occur due to erythrocytosis, hyperglobulinemia, extreme leukocytosis, or hyperlipidemia and false-negative results may occur in anemia. This test does not differentiate between the homozygous and heterozygous presence of hemoglobin S, and other rare sickling variants, such as hemoglobin C_{Harlem}, may give a positive test. Commonly used as a screening test for sickling hemoglobin in adults, this test may also be used as a confirmatory test for sickling hemoglobin after initial evaluation with cellulose acetate electrophoresis.

Cellulose Acetate Hemoglobin Electrophoresis

A fresh hemolysate made from a packed RBC sample is applied to a cellulose acetate plate using a buffer of alkaline

pH (8.4–8.6) and electrophoresis is performed.^{28–30} After electrophoresis, the membrane is stained and cleared. The patient's hemoglobin migration is compared with that of a control for test interpretation. A rough estimate of proportions of different hemoglobins may be made using a densitometer.

The order of electrophoretic mobility, from slowest to fastest, is hemoglobins C, S, F, and A (Fig. 18-7). (There are several mnemonic devices for remembering the migration pattern, such as Accelerated, Fast, Slow, and Crawl.) Hemoglobin that migrates beyond hemoglobin A is termed *fast hemoglobin*. Hemoglobin Bart's and hemoglobin H both migrate here. Any abnormal hemoglobin or any normal hemoglobin present in increased amounts, such as hemoglobin A₂ and F, should be confirmed. If there is abnormal hemoglobin, confirm with citrate agar electrophoresis and solubility test if hemoglobin S is

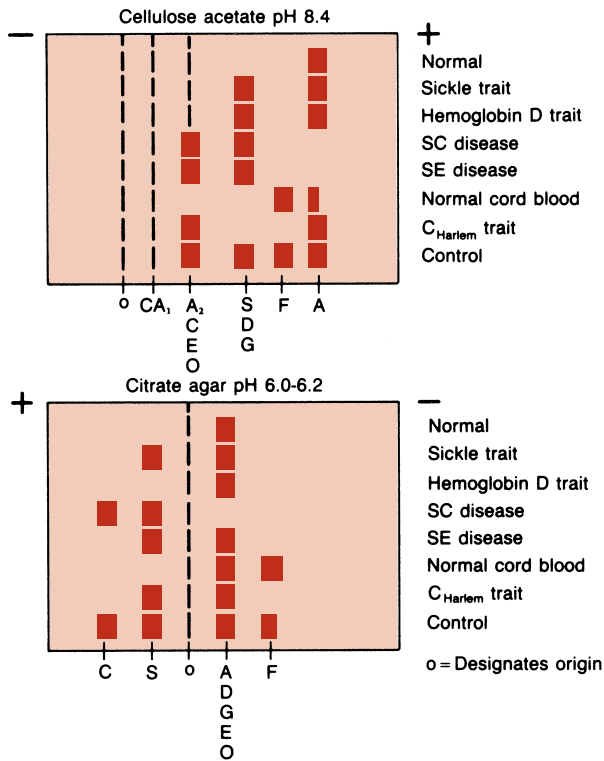

FIGURE 18-7. Comparison of various hemoglobin samples on cellulose acetate and citrate agar.

suspected. If an increased amount of A_2 or F occurs, then quantify the amount. Hemoglobin D and G comigrate with hemoglobin S in this method.

Citrate Agar Electrophoresis

Citrate agar electrophoresis is performed at an acid pH (6.0–6.2) after abnormal hemoglobin is detected on cellulose-acetate electrophoresis.^{28,31} In this method, an important factor in determining the mobility of hemoglobin is solubility. Hemoglobin F, with the fastest cathodal mobility, is also the most soluble, probably because it is most resistant to denaturation at pH 6.0. Adult hemoglobins with solubility similar to that of hemoglobin A, such as D, E, G, O, I and so forth, move with hemoglobin A. The relatively insoluble hemoglobin S moves behind hemoglobin A, and the even more insoluble hemoglobin C moves behind hemoglobin S (Fig. 18-7).

Hemoglobin A_2 Quantitation

The quantity of hemoglobin A_2 may be estimated by hemoglobin electrophoresis; however, this yields only a rough estimate. Quantitation is best accomplished by microcolumn chromatography^{24,28,32} or HPLC.^{25,26,28}

Acid Elution Stain for Hemoglobin F

Erythrocytes containing an increased amount of hemoglobin F can be distinguished from normal adult cells by the acid-elution technique.^{28,33} This method may be

helpful in the diagnosis of hereditary persistence of fetal hemoglobin or to detect fetal cells in maternal circulation during problem pregnancies. In the microscopic method, adult hemoglobin, hemoglobin A, is eluted from the erythrocytes by incubation in an acid buffer. Hemoglobin F remains behind and is stained with eosin. Adult cells are negative and have no staining because they contain no hemoglobin F. Fetal RBCs may also be detected by flow cytometric assay methods.³⁴

Hemoglobin F Quantitation

Fetal hemoglobin may be quantitated based on the principle that it is resistant to alkali denaturation in 1.25 mol/L NaOH for 2 minutes. Denatured hemoglobin A is precipitated out with ammonium sulfate and removed by filtration. The optical density of the clear supernatant solution is read at 540 nm, and the percentage of fetal hemoglobin is calculated against the optical density of the total hemoglobin solutions.²⁸ HPLC has been recommended as the method of choice for quantitation of fetal hemoglobin.²⁶

The average adult has less than 1.5% fetal hemoglobin. However, elevated levels may be found in several inherited and acquired diseases. The hereditary persistence of fetal hemoglobin should be suspected in individuals who possess 10% or more fetal hemoglobin with no other apparent clinical abnormalities.

DNA Technology

The definitive diagnosis of some hemoglobinopathies and thalassemias that involve combinations of genetic defects may require DNA analysis. With increased use and efficiency of the PCR technique, the DNA sequence of interest may be easily analyzed from whole blood or spots of dried blood on filter paper. With currently available automated sequencing methods, the time required to perform this type of analysis is not significantly greater than that for standard methodology. Disadvantages of these methods are higher cost and lack of availability in most routine laboratories. The advantages are that it provides definitive information on the genotype of individuals tested and, in some cases, direct detection of the molecular lesions is possible. Specific techniques are discussed elsewhere.^{25,27}

A special strength of the DNA technology is in the prenatal diagnosis of thalassemia major. Because the globin genes are represented in all tissue, including those in which they are not active, prenatal diagnosis of thalassemic states may be made by sampling tissue that is relatively easy to obtain, such as chorionic villi or amniotic fluid cells, rather than fetal blood, which is obtained with much greater difficulty and at a much greater risk to the fetus.²⁷

DNA technology also has been used in the prenatal diagnosis of sickle cell anemia. Fetal cells obtained by

CASE STUDY 18-6

A 22-year-old white woman of Italian heritage had been told that she was slightly anemic and had been treated with iron periodically throughout her life. She was a student in a clinical laboratory science program and had a CBC performed as a part of a hematology class.

Laboratory values were as follows:

| | | REFERENCE RANGE |
|------------|------------------------|------------------------------------|
| Hemoglobin | 11.0 g/dL | 11.7–15.7 g/dL |
| Hematocrit | 34% | 35–47% |
| RBC | $5.8 \times 10^{12}/L$ | $3.8\text{--}5.2 \times 10^{12}/L$ |
| MCV | 59.4 fL | 80–100 fL |
| MCHC | 31.9% | 32–36% |
| RDW | 14.2% | 11.5–14.5% |

From these values, the hematology instructor suspected an inherited disorder instead of iron deficiency and suggested that the student contact her physician for further testing. A hemoglobin electrophoresis revealed slightly increased amounts of hemoglobins F and A₂, which were subsequently quantitated to reveal hemoglobin F of 3.2% and hemoglobin A₂ of 4.2%. Iron studies were normal.

Questions

1. What is the most probable disorder?
2. What CBC values caused the instructor to suggest further testing?
3. Why is it important for this disorder to be correctly diagnosed?

amniocentesis or chorionic villus sampling may be analyzed using similar techniques as in the thalassemias. PCR is the method of choice for prenatal diagnosis, if available.²⁴ Hemoglobin electrophoresis on a hemolysate of fetal blood cells also can be used in cases in which DNA technology is unavailable or when rapid results are needed, owing to a patient's advanced gestational age.

MYOGLOBIN

Structure and Role in the Body

Myoglobin is a heme protein found in the skeletal and cardiac muscle. It can reversibly bind oxygen in a manner similar to the hemoglobin molecule; however, myoglobin is unable to release oxygen, except under low oxygen tension. Myoglobin is a simple heme protein containing one

polypeptide chain and one heme group per molecule. The polypeptide chain contains 153 amino acids, making it slightly larger than one chain in the hemoglobin molecule. Therefore, its size is slightly larger than one fourth that of a hemoglobin molecule, with a molecular weight of approximately 17,000. The iron atom in the center of the heme group is the site of reversible oxygen binding, identical to the hemoglobin molecule. In the body, myoglobin acts as an oxygen carrier in the cytoplasm of the muscle cell. Transport of oxygen from the muscle cell membrane to the mitochondria is its main role. Myoglobin serves as an extra reserve of oxygen to help exercising muscle maintain activity longer.

Clinical Significance

Damage to muscles often results in elevated levels of serum and urine myoglobin (Table 18-2). Renal clearance is rapid, and myoglobinemia following a single injury tends to be transient. High concentrations of myoglobin may cause acute renal failure (ARF). Measurement of myoglobin in serum and urine can be used to calculate a myoglobin clearance rate. The combination of a high serum myoglobin (≥ 400 ng/mL) and a low clearance rate (≤ 4 mL/min) indicates a high risk for ARF.³⁵ Myoglobin in urine will cross-react with the hemoglobin test on the dipstick and cause a positive reaction. Confirmation of myoglobinuria by a more specific assay, such as an immunoassay, allows differentiation from hemoglobinuria. Myoglobin measurement in urine or serum may be performed when rhabdomyolysis or any disease/injury resulting in muscle damage is suspected.

Currently the primary use of serum myoglobin testing is in the investigation of chest pain to diagnose or rule out acute myocardial infarction (AMI). The combined use of myoglobin and troponin or CKMB is useful for the early exclusion of AMI.³⁶ Damaged heart muscle cells release myoglobin within the first few hours of onset of myocardial infarction, and peak values are reached within 2–3 hours and as early as 30 minutes.

TABLE 18-2 CAUSES OF MYOGLOBIN ELEVATIONS

| | |
|--------------------|-----------------------------------|
| Acute myocardial | Angina without infarction |
| Rhabdomyolysis | Multiple fractures; muscle trauma |
| Renal failure | Myopathies |
| Vigorous exercise | Intramuscular injections |
| Open heart surgery | Tonic-clonic seizures |
| Electric shock | Arterial thrombosis |
| Certain toxins | Malignant hyperthermia |
| Muscular dystrophy | Systemic lupus erythematosus |

Myoglobin, therefore, is the first cardiac marker to rise, sooner than the MB isoenzyme of creatine kinase (CK-MB) or troponin (T or I). Although an increase of myoglobin in the circulation provides an early indicator of myocardial infarction, false-positive results may occur from any injury to skeletal muscle that also contains myoglobin. The use of myoglobin as an early marker should be followed by use of a definitive marker, such as troponin (T or I), that is more cardiac specific but does not appear in the blood as early. Despite the poor specificity of myoglobin for myocardium, skeletal muscle damage can be ruled out in many cases. Negative myoglobin results within the first few hours after chest pain can be used to rule out myocardial infarction. In cases in which thrombolytic therapy is used in the treatment of myocardial infarction, myoglobin levels combined with CK-MB and clinical indications may be used as monitors of reperfusion of the occluded artery.³⁷ Myoglobin also has been investigated to aid in the diagnosis and differentiation of the different types of

hereditary progressive muscular dystrophy.³⁸ Myoglobin is discussed in greater detail in Chapter 8.

Methodology

There are several immunoassay methods for measurement and identification of myoglobin. These procedures incorporate the binding of specific antibodies to myoglobin, with a resulting chemical or physical change (e.g., fluorescence, chemiluminescence, immunochromic) that can be measured and correlated to myoglobin concentration. These methods have been adapted to point-of-care devices for rapid assessment of chest pain, as well as conventional methods for multianalyte analyzer platforms.^{39,40} Although plasma is the specimen of choice for cardiac marker analysis, there is evidence that different anticoagulants have different effects on particular commercial assays for myoglobin.³⁹ It has also been shown that there are precision and reference range differences between the different myoglobin assays.³⁹

REFERENCES

- Schreiber WE. Iron, porphyrin, and bilirubin metabolism. In: Kaplan LA, Pesce AJ, eds. *Clinical chemistry—Theory, analysis, correlation*. 3rd ed. St. Louis, Mo.: CV Mosby, 1996:696.
- Deacon AC, Elder GH. Front line tests for the investigation of suspected porphyria. *J Clin Pathol* 2000;54:500.
- Maruno M, et al. Highly heterogeneous nature of δ -aminolevulinic acid dehydratase (ALAD) deficiencies in ALAD porphyria. *Blood* 2001;97:2972.
- Sassa S, Kappas A. Molecular aspects of the inherited porphyrias. *J Int Med* 2000;247:169.
- Zaider E, Bickers DR. Clinical laboratory methods for diagnosis of the porphyrias. *Clin Dermatol* 1998;16:277.
- Nuttall KL. Porphyrins and disorders of porphyrin metabolism. In: Burtis CA, Ashwood ER, eds. *Tietz fundamentals of clinical chemistry*. 4th ed. Philadelphia, Pa.: WB Saunders, 1996:731.
- Elder GH. Porphyria cutanea tarda. *Semin Liver Dis* 1998;18:67.
- Elder GH. Alcohol intake and porphyria cutanea tarda. *Clin Dermatol* 1999;17:431.
- Rich M. Porphyria cutanea tarda. *Postgrad Med* 1999;105:208.
- Mathews-Roth MM. Treatment of the cutaneous porphyrias. *Clin Dermatol* 1998;16:295.
- Nuttall KL. Porphyrins and disorders of porphyrin metabolism. In: Burtis CA, Ashwood ER, eds. *Tietz textbook of clinical chemistry*. 2nd ed. Philadelphia, Pa.: WB Saunders, 1994:2073.
- Buttery JE, Chamberlain BR, Beng CG. A sensitive method of screening for urinary porphobilinogen. *Clin Chem* 1989;35:2311.
- Watson CJ, Schwartz S. A simple test for urinary porphobilinogen. *Proc Soc Exp Biol Med* 1941;47:393.
- Labbe RF, Vreman HJ, Stevenson DK. Zinc protoporphyrin: A metabolite with a mission. *Clin Chem* 1999;45:2060.
- Elder GH. Genetic defects in the porphyrias: types and significance. *Clin Dermatol* 1998;16:225.
- Glader B. Destruction of erythrocytes. In: Greer JP, Foerster J, Lukens J, et al, eds. *Wintrobe's clinical hematology*. 11th ed. Baltimore, Md.: Lippincott Williams & Wilkins, 2004:255.
- Wang WC. Sickle cell anemia and other sickling syndromes. In: Greer JP, Foerster J, Lukens J, et al, eds. *Wintrobe's clinical hematology*. 11th ed. Baltimore, Md.: Lippincott Williams & Wilkins, 2004:1264.
- Borgna-Pignatti C, Galanello R. The thalassemias and related disorders: quantitative disorders of hemoglobin synthesis. In: Greer JP, Foerster J, Lukens J, et al, eds. *Wintrobe's clinical hematology*. 11th ed. Baltimore, Md.: Lippincott Williams & Wilkins, 2004:1319, 1321, 1329.
- Galanello R, Sollaine C, Paglietti E, et al. α -Thalassemia carrier identification by DNA analysis in the screening for thalassemia. *Am J Hematol* 1998;59:273.
- Harrison CR. Hemolytic anemias: intracorporeal defects, IV. Thalassemia. In: Harmening DM, ed. *Clinical hematology and fundamentals of hemostasis*. 4th ed. Philadelphia, Pa.: FA Davis, 2002:194.
- Herzog RW, Hagstrom JN. Gene therapy for hereditary hematological disorders. *Am J Pharmacogenomics* 2001;1:137.
- Tisdale J, Sadelain M. Toward gene therapy for disorders of globin synthesis. *Semin Hematol* 2001;38:382.
- Quek L, Thein SL. Molecular therapies in beta-thalassemia. *Br J Haematol*. 2007;136:353–365.
- Beutler E. Disorders of hemoglobin structure: sickle cell and related abnormalities. In: Lichtman MA, Beutler E, Kipps TJ, et al. *Williams hematology*. 7th ed. New York: McGraw-Hill, 2006:680.
- Tuzmen S, Schechter AN. Genetic diseases of hemoglobin: Diagnostic methods for elucidating β -thalassemia mutations. *Blood Rev* 2001;15:19.
- Clarke GM, Higgins TN. Laboratory investigation of hemoglobinopathies and thalassemias: Review and update. *Clin Chem* 2000;46:1284.
- Arcasoy MO, Gallagher PG. Molecular diagnosis of hemoglobinopathies and other red blood cell disorders. *Semin Hematol* 1999;36:328.

28. Elghetany MT, Davey FR. Erythrocytic disorders. In: Henry JB, ed. *Clinical diagnosis and management by laboratory methods*. 20th ed. Philadelphia, Pa.: WB Saunders, 2001:562–563.
29. Briere RO, Golias T, Gatsakis JG. Rapid qualitative and quantitative hemoglobin fractionation. *Am J Clin Pathol* 1965;44:695.
30. Graham JL, Grunbaum BW. A rapid method for microelectrophoresis and quantitation of hemoglobins on cellulose acetate. *Am J Clin Pathol* 1963;39:567.
31. Milner PF, Gooden H. Rapid citrate-agar electrophoresis in routine screening for hemoglobinopathies using a simple hemolysate. *Am J Clin Pathol* 1975;64:58.
32. Huisman THJ, Schroeder WA, Brodie AN, et al. Microchromatography of hemoglobins: II. A simplified procedure for the determination of hemoglobin A₂. *J Lab Clin Med* 1975;86:700.
33. Clayton E, Foster BE, Clayton EP. New stain for fetal erythrocytes in peripheral blood smears. *Obstet Gynecol* 1970;35:642.
34. Clinical and Laboratory Standards Institute (CLSI). *Fetal red cell detection: Approved guideline*. Wayne, Pa.: CLSI, 2001. (Document H52-A.)
35. Wu AH, et al. Immunoassays for serum and urine myoglobin: Myoglobin clearance assessed as a risk factor for acute renal failure. *Clin Chem* 1994;40:796.
36. Morrow DA, et al. National Academy of Clinical Biochemistry Standards of Laboratory Practice: Clinical characteristics and utilization of biochemical markers in acute coronary syndrome. *Clin Chem* 2007;53:556.
37. Christenson RH, Azzazy HME. Biochemical markers of the acute coronary syndromes. *Clin Chem* 1998;44:1855.
38. Poche H, et al. Hereditary progressive muscular dystrophies: serum myoglobin pattern in patients with different types of muscular dystrophies. *Clin Physiol Biochem* 1989;7:40.
39. Zaninotto M, et al. Multicenter evaluation of five assays for myoglobin determination. *Clin Chem* 2000;46:1631.
40. Apple FS, et al. Simultaneous rapid measurement of whole blood myoglobin, creatine kinase MB, and cardiac troponin I by the triage cardiac panel for detection of myocardial infarction. *Clin Chem* 1999;45:199.

PART

3

Assessment of Organ System Functions

Introduction to Hormones and Pituitary Function

Robert E. Jones

CHAPTER

19

CHAPTER OUTLINE

- **EMBRYOLOGY AND ANATOMY**
- **FUNCTIONAL ASPECTS OF THE HYPOTHALAMIC–HYPOPHYSIAL UNIT**
- **HYPOPHYSIOTROPIC OR HYPOTHALAMIC HORMONES**
- **ANTERIOR PITUITARY HORMONES**
- **PITUITARY TUMORS**
- **GROWTH HORMONE**
 - Actions of Growth Hormone
 - Testing
 - Acromegaly
 - Growth Hormone Deficiency
- **PROLACTIN**
 - Prolactinoma
 - Other Causes of Hyperprolactinemia
 - Clinical Evaluation of Hyperprolactinemia
 - Management of Prolactinoma
 - Idiopathic Galactorrhea
- **HYPOPITUITARISM**
 - Etiology of Hypopituitarism
 - Treatment of Panhypopituitarism
- **POSTERIOR PITUITARY HORMONES**
 - Oxytocin
 - Vasopressin
- **REFERENCES**

The term *pituitary* (derived from both Latin and Greek) literally means to “spit mucus,” reflecting the primitive notion of pituitary function. In one way, the ancient physiologists were correct—they believed that the brain was responsible for signaling the pituitary to secrete; however, instead of mucus, it was later discovered that the brain directs the pituitary to secrete hormones that regulate other endocrine glands. When this was recognized, the pituitary was designated the “master gland” because, without the pituitary, there was a cessation of growth, together with profound alterations in intermediary metabolism and failure of gonadal, thyroidal, and adrenal function. The pituitary is also referred to as the *hypophysis*, from Greek meaning “undergrowth,” attesting to its unique position under the hypothalamus.

Our concept of pituitary function and its role in regulating other endocrine glands has changed. Rather than viewed as the master gland, it is more appropriately recognized as a transponder that translates neural input into a hormonal or an endocrinologic product. Features that distinguish the function of the pituitary include **feedback loops**, **pulsatile secretions**, **diurnal rhythms**, and environmental or external modification of its performance. These characteristics of pituitary operation can vex the clinical evaluation of suspected endocrine disease or,

alternatively, lend incredible insight into subtle defects in endocrinologic function.

EMBRYOLOGY AND ANATOMY

The three distinct parts of the pituitary are the **anterior pituitary**, or **adenohypophysis**; the intermediate lobe, or pars intermedialis; and the **posterior pituitary**, or **neurohypophysis**. The intermediate lobe is poorly developed in humans and has little functional capacity other than to confuse radiologists by forming nonfunctional, benign, cystic enlargements of the pituitary. The posterior pituitary, which arises from the diencephalon, is responsible for the storage and release of **oxytocin** and **vasopressin** (also called *antidiuretic hormone* [ADH]). The anterior pituitary, the largest portion of the gland, originates from Rathke’s pouch, an evagination of buccal ectoderm that progressively extends upward and is eventually enveloped by the sphenoid bone. The creation of the **median eminence**, the inferior portion of the hypothalamus, and the **pituitary stalk** are the other critical events in the formation of the hypothalamic–hypophysial unit. Pituitary function can be detected between the seventh and ninth weeks of gestation. The ultimate determination of anterior pituitary cell types is dependent on the spatial

relationships of progenitor cell types and an integrated flow of transcription factors that ultimately form lactotrophs (prolactin-secreting cells), somatotrophs (growth hormone [GH]-secreting cells), thyrotrophs (thyroid-stimulating hormone [TSH]-secreting cells), corticotrophs (adrenocorticotropin hormone [ACTH]-secreting cells), and gonadotrophs (luteinizing hormone [LH]- and follicle-stimulating hormone [FSH]-secreting cells).¹

The pituitary resides in a pocket of the sphenoid (the **sella turcica**, meaning “Turkish saddle”) and is surrounded by dura mater. The reflection of dura that separates the superior portion of the pituitary from the hypothalamus, the diaphragma sellae, is penetrated by the **infundibulum**, or pituitary stalk, that connects the adenohypophysis to the *median eminence* and **hypothalamus**. The pituitary stalk contains both neural and vascular structures that terminate in the hypophysis. The posterior pituitary is connected to the supraoptic and paraventricular hypothalamic nuclei (where vasopressin and oxytocin are produced) by way of two, distinct neurosecretory tracts, the supraopticohypophyseal and tuberohypophyseal tracts, which pass through the stalk. The anterior pituitary receives 80% to 90% of its blood supply and many

hypothalamic factors via the **hypothalamic–hypophysial portal system**, also contained in the stalk. The primary plexus of this portal system is located in the median eminence and is composed of capillaries lacking a blood-brain barrier (fenestrated capillaries) where the hypothalamic nuclei that modulate pituitary function terminate their axons. In turn, the long portal vessels connect the primary plexus to the anterior pituitary and serve as a conduit for these hypothalamic–hypophysiotropic hormones. These anatomic relationships are illustrated in Figure 19-1.²

FUNCTIONAL ASPECTS OF THE HYPOTHALAMIC–HYPOPHYSIAL UNIT

Afferent pathways (inputs) to the hypothalamus are integrated in various specialized nuclei, processed, and then resolved into specific patterned responses. Because the hypothalamus has many efferent neural connections (outputs) to higher brain centers (the limbic system, the autonomic nervous system, and the pituitary), these responses appear to be rather diffuse but are actually stereotypical.³ The hypothalamic response patterns are similar for each specific pituitary hormone and character-

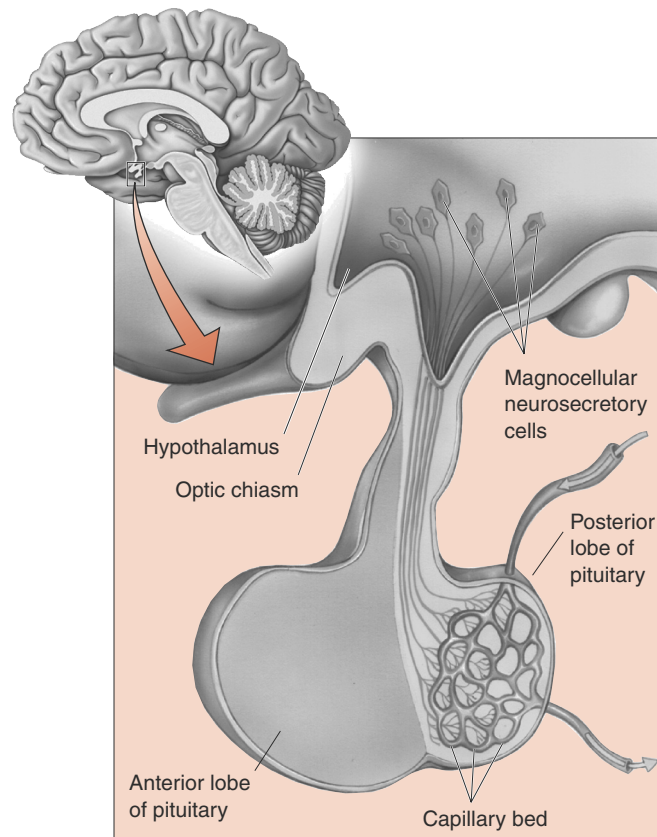

FIGURE 19-1. Relational anatomy of the pituitary and hypothalamus. (Reproduced with permission from Bear MF, Connors BW, Paradiso MA. *Neuroscience: Exploring the Brain*. 2nd ed. Baltimore, Md.: Lippincott Williams & Wilkins, 2001:501.)

ized by open-loop negative feedback mechanisms, pulsatility, and cyclicity. Negative feedback resembles a typical servomechanism and forms the basis of our understanding of hypothalamic–pituitary function. An example of negative feedback is the relationship between a thermostat and a home heating unit. The thermostat is set to a given temperature. As the temperature in the home falls below this set point, the thermostat sends an electrical impulse to the furnace and turns the furnace on. Heat is restored to the room and, when the temperature in the room exceeds the predetermined set point, the thermostat turns off the furnace. Because the thermostat set point can be adjusted for the comfort of the occupants, the furnace–thermostat functional relationship is termed an *open-loop negative feedback system*. Most endocrine feedback loops are of the open-loop variety, meaning that they are subject to external modulation and generally influenced or modified by higher neural input or other hormones.

A simple example of an endocrine feedback loop is the hypothalamic–pituitary–thyroidal axis. The hypothalamus produces the hypophysiotropic hormone, **thyrotropin-releasing hormone (TRH)**, and releases it into the portal system where it directs the thyrotrophs (or TSH-producing cells) in the anterior pituitary to secrete **thyroid-stimulating hormone (TSH)**. TSH circulates to the thyroid and stimulates several steps in the thyroid that are critical in the production and release of thyroid hormone (thyroxine). Thyroxine is released in the blood and circulates to the hypothalamus and pituitary to suppress further TRH and TSH production. This axis can be partially inhibited by adrenal steroids (glucocorticoids) and by cytokines; as a result, thyroid hormone production may decline during periods of severe physiologic stress.⁴ The feedback of thyroxine at the level of the pituitary is called a *short feedback loop*, and feedback at the level of the hypothalamus is called a *long feedback loop*. Feedback between the pituitary and hypothalamus (when present) is called an *ultrashort feedback loop*. Figure 19-2 illustrates this simple feedback loop.

All anterior pituitary hormones are secreted in a pulsatile fashion. The pulse frequency of secretion is generally regulated by neural modulation and is specific for each hypothalamic–pituitary–end organ unit. Perhaps the best example of pituitary pulsatility is the secretion of the hormones that regulate gonadal function (**luteinizing hormone [LH]** and **follicle-stimulating hormone [FSH]**). In normal male subjects, the median interpulse interval for LH is 55 minutes, and the average LH peak duration is 40 minutes.⁵ The pulse frequency of the regulatory hypothalamic hormone, **gonadotropin-releasing hormone (GnRH)**, has profound effects on LH secretion profiles—increasing the frequency of GnRH pulses reduces the gonadotrope secretory response and decreases

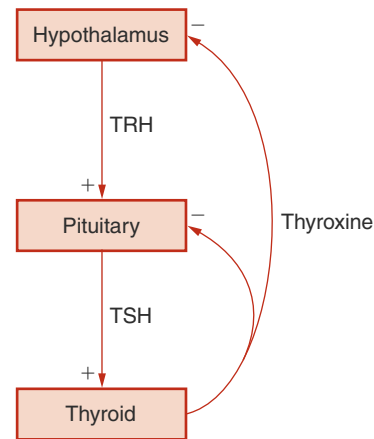

FIGURE 19-2. Simple feedback loop.

ing the GnRH pulse frequency increases the amplitude of the subsequent LH pulse.⁶

Another feature of the hypothalamic–pituitary unit is the cyclic nature of hormone secretion. The nervous system usually regulates this function through external signals, such as light–dark changes or the ratio of daylight to darkness. The term *zeitgeber* (“time giver”) refers to the process of entraining or synchronizing these external cues into the function of internal biologic clocks. As a result, many pituitary hormones are secreted in different amounts, depending on the time of day. These circadian, or diurnal, rhythms are typified by **adrenocorticotropic hormone (ACTH)**, or TSH secretion. With ACTH, the nadir of secretion is between 11:00 P.M. and 3:00 A.M., and the peak occurs on awakening or around 6:00 to 9:00 A.M.⁷ The circadian rhythm of ACTH is a result of variations in pulse amplitude and not alterations in pulse frequency.⁸ The nocturnal levels of TSH are approximately twice the daytime levels, and, in contrast to ACTH, the nocturnal rise in TSH is a result of increased pulse amplitude.⁹

HYPOPHYSIOTROPIC OR HYPOTHALAMIC HORMONES

The hypothalamus produces many different products; however, only those that have a direct effect on classic pituitary function will be discussed in this chapter. Most products are peptides; however, bioactive amines are also synthesized and transported from the hypothalamus. Hypothalamic hormones may have multiple actions. For example, TRH stimulates the secretion of both TSH and **prolactin**; GnRH stimulates both LH and FSH production; and **somatostatin (SS)** inhibits GH and TSH release from the pituitary. In addition to its effects on water metabolism, vasopressin (ADH) can also stimulate **adrenocorticotropic hormone (ACTH)** secretion. The main stimulus for ACTH secretion is **corticotropin-releasing hormone**. These hypophysiotropic hormones are found throughout the central

TABLE 19-1 HYPOPHYSIOTROPIC HORMONES

| HORMONE | STRUCTURE | ACTION |
|--|-----------------------|---|
| Thyrotropin-releasing hormone (TRH) | 3 amino acids | Releases TSH and prolactin |
| Gonadotropin-releasing hormone (GnRH) | 10 amino acids | Releases LH and FSH |
| Corticotropin-releasing hormone (CRH) | 41 amino acids | Releases ACTH |
| Growth hormone-releasing hormone (GHRH) | 44 amino acids | Releases GH |
| Somatostatin | 14 and 28 amino acids | Inhibits GH and TSH release (additional effects on gut and pancreatic function) |
| Dopamine (prolactin inhibitory factor) | 1 amino acid | Inhibits prolactin release |

nervous system and various other tissues, including the gut, pancreas, and other endocrine glands. Their function outside the hypothalamus and pituitary is poorly understood. The action of hypophysiotropic hormones on anterior pituitary function is summarized in Table 19-1.

ANTERIOR PITUITARY HORMONES

The hormones secreted from the anterior pituitary are larger and more complex than those synthesized in the hypothalamus. These pituitary hormones are either *tropic*, meaning their actions are specific for another endocrine gland, or they are **direct effectors**, because they act directly on peripheral tissue. TSH and its unique role in regulating thyroid function provide an example of tropic; an example of a direct effector is GH. GH has direct effects on substrate metabolism in numerous tissues and also stimulates the liver to produce growth factors that are critical in enhancing linear growth. The **tropic hormones** are LH, which directs testosterone production from Leydig cells in men and ovulation in women; FSH, which is responsible for ovarian recruitment and early folliculogenesis in women and spermatogenesis in men; TSH, which directs thyroid hormone production from the thyroid; and ACTH, which regulates

adrenal steroidogenesis. Both GH and prolactin are direct effectors. A general summary of relationships among anterior pituitary hormones and their target organs and feedback effectors are listed in Table 19-2.

The actions of the trophic hormones are discussed in other chapters devoted to the specific target gland.

PITUITARY TUMORS

According to autopsy studies, up to 20% of people harbor clinically silent pituitary adenomas, and findings consistent with pituitary tumors are observed in 10%–30% of normal individuals undergoing MRI examinations. In addition, pituitary tumors account for 91% of the lesions removed from carefully selected patients who have undergone transphenoidal surgery.¹⁰ Close medical follow-up is recommended if the incidentally discovered lesion is hormonally silent and is less than 1 cm in diameter. Prolactin-secreting pituitary tumors are the most common, followed by nonfunctioning or null cell tumors, and tumors that secrete GH, gonadotropins, ACTH, or TSH account for the remainder.

Physiologic enlargement of the pituitary can be seen during puberty and pregnancy. The enlargement seen

TABLE 19-2 ANTERIOR PITUITARY HORMONES

| PITUITARY HORMONE | TARGET GLAND | STRUCTURE | FEEDBACK HORMONE |
|------------------------------------|----------------------------|----------------------------------|--|
| Luteinizing hormone (LH) | Gonad (tropic) | Dimeric glycoprotein | Sex steroids (E ₂ /T) |
| Follicle-stimulating hormone (FSH) | Gonad (tropic) | Dimeric glycoprotein | Inhibin |
| Thyroid-stimulating hormone (TSH) | Thyroid (tropic) | Dimeric glycoprotein | Thyroid hormones (T ₄ /T ₃) |
| Adrenocorticotropin hormone (ACTH) | Adrenal (tropic) | Single peptide derived from POMC | Cortisol |
| Growth hormone | Multiple (direct effector) | Single peptide | Insulin-like growth factor (IGF-I) |
| Prolactin | Breast (direct effector) | Single peptide | Unknown |

T₄, thyroxine; T₃, triiodothyronine; E₂, estradiol; T, testosterone.

during pregnancy is due to lactotroph hyperplasia. Thyrotroph or gonadotroph hyperplasia can also be seen in longstanding primary thyroidal or gonadal failure.

GROWTH HORMONE

The pituitary is vital for normal growth. Growth ceases if the pituitary is removed and, if the hormonal products from other endocrine glands that are acted on by the pituitary are replaced (thyroxine, adrenal steroids, and gonadal steroids), growth is not restored until GH is administered. However, if GH is given in isolation without the other hormones, growth is not promoted. Therefore, it takes complete functioning of the pituitary to establish conditions ripe for growth of the individual. It also takes adequate nutrition, normal levels of insulin, and overall good health to achieve a person's genetic growth potential.

Growth hormone, also called *somatotropin*, is structurally related to prolactin and human placental lactogen. A single peptide with two intramolecular disulfide bridges, it belongs to the direct effector class of anterior pituitary hormones. The somatotrophs, pituitary cells that produce GH, comprise over one third of normal pituitary weight. Release of somatotropin from the pituitary is stimulated by the hypothalamic peptide **growth hormone-releasing hormone (GHRH)**; somatotropin's secretion is inhibited by somatostatin (SS).¹¹ GH is secreted in pulses, with an average interpulse interval of 2–3 hours, with the most reproducible peak occurring at the onset of sleep.¹² Between these pulses, the level of GH may fall below the detectable limit, resulting in the clinical evaluation of GH deficiency being based on a single, challenging measurement.

No other hypothalamic–hypophysial system more vividly illustrates the concept of an open-loop paradigm than that seen with GH. The on-and-off functions of GHRH/SS and the basic pattern of secretory pulses of GH are heavily modulated by other factors (Table 19-3).¹³

Actions of Growth Hormone

GH has many diverse effects on metabolism; it is considered an amphibolic hormone because it directly influences both anabolic and catabolic processes. One major effect of GH is that it allows an individual to effectively transition from a fed state to a fasting state without experiencing a shortage of substrates required for normal intracellular oxidation. GH directly antagonizes the effect of insulin on glucose metabolism, promotes hepatic gluconeogenesis, and stimulates lipolysis.¹¹ From a teleologic viewpoint, this makes perfect sense—enhanced lipolysis provides oxidative substrate for peripheral tissue, such as skeletal muscle, and yet conserves glucose for the central nervous system by stimulating the hepatic delivery of glucose and opposing insulin-mediated glucose disposal. Indeed, GH deficiency in children may be accompanied by hypoglycemia;¹⁴ in adults, hypoglycemia may occur if both GH and ACTH are deficient.

The anabolic effects of GH are reflected by enhanced protein synthesis in skeletal muscle and other tissues. This is translated into a positive nitrogen balance and phosphate retention.

Although GH has direct effects on many tissues, it also has indirect effects that are mediated by factors that were initially called *somatomedins*. In early experiments, it became apparent that GH supplementation in hypophysectomized animals induced the production of an additional factor that stimulated the incorporation of sulfate into cartilage. As this “protein” was purified, it was evident that there was more than one somatomedin, and, because of their structural homology to proinsulin, the nomenclature shifted to **insulin-like growth factor (IGF)**. For example, somatomedin C, the major growth factor induced by GH, is now IGF-I. IGFs also have cell surface receptors that are distinct from insulin; however, supra-physiologic levels of IGF-II can “bleed” over on the insulin receptor and cause hypoglycemia,¹⁵ and hyperin-

TABLE 19-3 OTHER MODIFIERS OF GROWTH HORMONE SECRETION

| STIMULATE GROWTH HORMONE SECRETION | INHIBIT GROWTH HORMONE SECRETION |
|------------------------------------|----------------------------------|
| Sleep | Glucose loading |
| Exercise | β-Agonists (e.g., epinephrine) |
| Physiologic stress | α-Blockers (e.g., phentolamine) |
| Amino acids (e.g., arginine) | Emotional/psychogenic stress |
| Hypoglycemia | Nutritional deficiencies |
| Sex steroids (e.g., estradiol) | Insulin deficiency |
| α-Agonists (e.g., norepinephrine) | Thyroxine deficiency |
| β-Blockers (e.g., propranolol) | |

sulinemia can partially activate IGF-I receptors.¹⁶ GH stimulates the production of IGF-I from the liver and, as a result, IGF-I becomes a biologic amplifier of GH levels. IGFs are complexed to specific serum binding proteins that have been shown to affect the actions of IGFs in multifaceted ways.¹⁷ IGF-binding protein III (IGFBP-III) is perhaps the best studied member of the IGFBP family. The levels of IGFBP III are positively correlated with IGF-I levels and, as a result, GH levels.¹⁸ Because of this relationship, IGF-I has been used in the clinical evaluation of both GH deficiency and excess.¹⁹

Testing

As noted above, a single, random measurement of GH is rarely diagnostic. The current testing paradigms for GH are soundly based on the dynamic physiology of the GH axis. For example, circulating levels of IGF-I and, perhaps, IGFBP-III reasonably integrate the peaks of GH secretion, and elevated levels of both are consistent with a sustained excess of GH.²⁰ Other conditions, however, notably hepatomas, can be associated with high levels of IGF-I, and levels of IGFBP-III may be inappropriately normal in some people with active acromegaly.²¹ Conversely, low IGF-I levels may reflect inadequate production of GH; however, low IGF levels are also seen in patients with poorly controlled diabetes, malnutrition, or other chronic illnesses.²²

Definitive testing for determining the autonomous production of GH relies upon the normal suppressibility of GH by oral glucose loading.²³ This test is performed after

an overnight fast, and the patient is given a 100-gram oral glucose load. GH is measured at time zero and at 60 and 120 minutes after glucose ingestion. Following oral glucose loading, GH levels are undetectable in normal individuals; however, in patients with acromegaly, GH levels fail to suppress and may even paradoxically rise.

Testing patients for suspected GH deficiency is more complicated. There are several strategies to stimulate GH, and new protocols are currently evolving.²⁴ Once considered the gold standard, insulin-induced hypoglycemia is being replaced by less uncomfortable testing schemes. Combination infusions of GHRH and the amino acid L-arginine or an infusion of L-arginine coupled with oral L-DOPA are the most widely used. If GH levels rise above 3–5 ng/mL, it is unlikely that the patient is GH deficient²⁴; however, a lower threshold may be adopted because of improved sensitivity of the newer two-site GH assays.²⁵ On the other hand, several studies have shown that provocative GH testing may not be necessary in patients with low IGF-I levels and otherwise documented panhypopituitarism.²⁶

Acromegaly

Acromegaly results from pathologic or autonomous GH excess and, in the vast majority of patients, is a result of a pituitary tumor. There have been isolated case reports of tumors causing acromegaly as a result of the ectopic production of GHRH,²⁷ and, although exceedingly interesting or instructive, the ectopic production of GHRH or GH (one case) remains rare.²⁸ If a GH-producing tumor occurs before epiphyseal closure, the patient develops gigantism and may grow to an impressive height; otherwise, the patient develops classical, but insidious, features of bony and soft tissue overgrowth.²⁹ These features include progressive enlargement of the hands and feet as well as growth of facial bones, including the mandible and bones of the skull. In advanced cases, the patient may develop significant gaps between their teeth. Diffuse (not longitudinal if the condition occurred following puberty) overgrowth of the ends of long bones or the spine can produce a debilitating form of arthritis. Because GH is an insulin antagonist, glucose intolerance or overt diabetes can occur. Hypertension; accelerated atherosclerosis; and proximal muscle weakness, resulting from acquired myopathy, may be seen late in the illness. Sleep apnea is common. Organomegaly, especially thyromegaly, is common, but hyperthyroidism is exceedingly rare unless the tumor cosecretes TSH. GH excess is also a hypermetabolic condition and, as a result, acromegalic patients may complain of excessive sweating or heat intolerance. The features of acromegaly slowly develop over time, and the patient (or their family) may be oblivious that changes in physiognomy have occurred. In these cases, the patient's complaints may center on the

CASE STUDY 19-1

A 48-year-old man seeks care for evaluation of muscle weakness, headaches, and excessive sweating. He has poorly controlled hypertension and, on questioning, admits to noticing a gradual increase in both glove and shoe size, as well as a reduction in libido. A review of older photographs of the man documents coarsening of facial features, progressive prognathism, and broadening of the nose. Acromegaly is suspected.

Questions

1. What screening tests are available?
2. What is the definitive test for autonomous growth hormone production?
3. Because the patient complains of reduced libido, hypogonadism is suspected. What evaluation is appropriate?

local effects of the tumor (headache or visual complaints) or symptoms related to the loss of other anterior pituitary hormones (hypopituitarism). A careful, retrospective review of older photographs may be crucial in differentiating coarse features due to inheritance from the classical consequences of acromegaly. If left untreated, acromegaly shortens life expectancy because of increased risk of heart disease, resulting from the combination of hypertension, coronary artery disease, and diabetes/insulin resistance. Because patients with acromegaly also have a greater lifetime risk of developing cancer, cancer surveillance programs (especially regular colonoscopy) are recommended.

Cosecretion of prolactin can be seen in up to 40% of patients with acromegaly.³⁰ Only a few TSH/GH-secreting tumors have also been reported.³¹

Confirming the diagnosis of acromegaly is relatively easy; however, some patients with acromegaly have normal random levels of GH. An elevated level of GH that does not suppress normally with glucose loading equates to an easy diagnosis. In those patients with normal, but inappropriately sustained, random levels of GH, elevated levels of IGF-I are helpful; however, nonsuppressibility of GH to glucose loading is the definitive test.²³

Treatment of acromegaly can be challenging. The goal of treatment is tumor ablation, with continued function of the remainder of the pituitary. Transphenoidal adenectomy is the procedure of choice.³² If normal GH levels and kinetics (normal suppressibility to glucose) are restored following surgery, the patient is likely cured. Unfortunately, GH-producing tumors may be too large or may invade into local structures that preclude complete surgical extirpation, and the patient is left with a smaller, but hormonally active, tumor. External beam or focused irradiation is frequently used at this point, but it may take several years before GH levels decline.³³ In the interim, efforts are made to suppress GH. Two different classes of agents, somatostatin analogs and dopaminergic agonists, may be employed for GH suppression, but it is important to note that dopaminergic agonists are only effective if the tumor cosecretes prolactin.³⁴ Pegvisomant, a GH receptor antagonist, has recently been approved as an adjuvant in the medical management of acromegaly.³⁵

Growth Hormone Deficiency

GH deficiency occurs in both children and adults. In children, it may be familial or it may be due to tumors, such as craniopharyngiomas. In adults, it is a result of structural or functional abnormalities of the pituitary (see *Hypopituitarism* in this chapter); however, a decline in GH production is an inevitable consequence of aging and the significance of this phenomenon is poorly understood.³⁶

Although GH deficiency in children is manifest by growth failure, not all patients with short stature have

GH deficiency (see above). There have been several genetic defects identified in the GH axis. The more common type is a recessive mutation in the GHRH gene that causes a failure of GH secretion. A rarer mutation, loss of the GH gene itself, has also been observed. Mutations that cause GH insensitivity have also been reported. These mutations may involve the GH receptor, IGF-I biosynthesis, IGF-I receptors, or defects in GH signal transduction. Patients with GH insensitivity do not respond normally to exogenously administered GH. Finally, structural lesions of the pituitary or hypothalamus may also cause GH deficiency and may be associated with other anterior pituitary hormone deficiencies.³⁷

An adult GH deficiency syndrome has been described in patients who have complete or even partial failure of the anterior pituitary. The symptoms of this syndrome are extremely vague and include social withdrawal, fatigue, loss of motivation, and a diminished feeling of well-being³⁸ but several studies have documented increased mortality in adults who are GH deficient although this relationship is less clear in adults.^{39,40} Osteoporosis and alterations in body composition (i.e., reduced lean body mass) are frequent concomitants of adult GH deficiency.⁴¹

GH replacement therapy has become relatively simple with the advent of recombinant human GH. Currently, the cost of GH is the major limiting factor for replacement.

PROLACTIN

Prolactin is structurally related to GH and human placental lactogen. Considered a stress hormone, it has vital functions in relationship to reproduction. Prolactin is classified as a direct effector hormone (as opposed to a tropic hormone) because it has diffuse target tissue and lacks a single endocrine end organ.

Prolactin is unique among the anterior pituitary hormones because its major mode of hypothalamic regulation is tonic inhibition rather than intermittent stimulation. **Prolactin inhibitory factor (PIF)** was once considered a polypeptide hormone capable of inhibiting prolactin secretion; **dopamine**, however, is the only neuroendocrine signal that inhibits prolactin and is now considered to be the elusive PIF. Any compound that affects dopaminergic activity in the median eminence of the hypothalamus will also alter prolactin secretion.⁴² Examples of medications that cause hyperprolactinemia include phenothiazines, butyrophenones, metoclopramide, reserpine, tricyclic antidepressants, α -methyldopa, and antipsychotics that antagonize the dopamine D2 receptor. Any disruption of the pituitary stalk (e.g., tumors, trauma, or inflammation) causes an elevation in prolactin as a result of interruption of the flow of dopamine from the hypothalamus to the lactotropes, the pituitary prolactin-secreting cells. TRH directly stimulates prolactin

secretion, and increases in TRH (as seen in primary hypothyroidism) elevate prolactin levels.⁴³ Estrogens also directly stimulate lactotropes to synthesize prolactin. Pathologic stimulation of the neural suckling reflex is the likely explanation of hyperprolactinemia associated with chest wall injuries. Hyperprolactinemia may also be seen in renal failure and polycystic ovary syndrome. Physiologic stressors, such as exercise and seizures, also elevate prolactin. The feedback effector for prolactin is unknown. Although the primary regulation of prolactin secretions is tonic inhibition (e.g., dopamine), it is also regulated by several hormones, including gonadotropin-releasing hormone, thyrotropin-releasing hormone and vasoactive intestinal polypeptide. Stimulation of breasts, as in nursing, causes the release of prolactin secreting hormones from the hypothalamus through a spinal reflex act.

As mentioned, the physiologic effect of prolactin is lactation. The usual consequence of prolactin excess is hypogonadism, either by suppression of gonadotropin secretion from the pituitary or by inhibition of gonadotropin action at the gonad.⁴⁴ The suppression of ovulation seen in lactating postpartum mothers is related to this phenomenon.

Prolactinoma

A prolactinoma is a pituitary tumor that directly secretes prolactin, and it represents the most common type of functional pituitary tumor. The clinical presentation of a patient with a prolactinoma depends on the age and gender of the patient and the size of the tumor. Premenopausal women most frequently complain of menstrual irregularity/amenorrhea, infertility, or galactorrhea; men or postmenopausal women generally present with symptoms of a pituitary mass, such as headaches or visual complaints. Occasionally, a man

may present with reduced libido or complaints of erectile dysfunction. The reason(s) for the varied presentations of a prolactinoma are somewhat obscure but likely relate to the dramatic, noticeable alteration in menses or the abrupt onset of a breast discharge in younger women. By contrast, the decline in reproductive function in older patients may be overlooked as an inexorable consequence of “aging.” One recently recognized complication of prolactin-induced hypogonadism is osteoporosis.⁴⁵

Other Causes of Hyperprolactinemia

There are many physiologic, pharmacologic, and pathologic causes of hyperprolactinemia, and a common error by clinicians is to ascribe any elevation in prolactin to a “prolactinoma.” Generally, substantial elevations in prolactin (>150 ng/mL) indicate prolactinoma, and the degree of elevation in prolactin is correlated with tumor size.⁴⁶ Modest elevations in prolactin (25–100 ng/mL) may be seen with pituitary stalk interruption, use of dopaminergic antagonist medications, or other medical conditions such as primary thyroidal failure, renal failure, or polycystic ovary syndrome. Breast or genital stimulation may also modestly elevate prolactin. Significant hyperprolactinemia is also encountered during pregnancy. Under most circumstances, the principal form of prolactin is a 23-kD peptide; however, a 150-kD form may also be secreted. This larger prolactin molecule has a markedly reduced biologic potency and does not share the reproductive consequences of the 23-kD variety. If the 150-kD form of prolactin predominates, this is called macroprolactinemia, and the clinical consequences are unclear but most patients are relatively asymptomatic.⁴⁷ The prevalence of macroprolactinemia has been estimated at 10%–22% of hyperprolactinemic samples⁴⁸ and can be excluded by precipitating serum samples with polyethylene glycol prior to measuring prolactin.

CASE STUDY 19-2

A 23-year-old woman has experienced recent onset of a spontaneous, bilateral breast discharge and gradual cessation of menses. She reports normal growth and development and has never been pregnant.

Questions

1. What conditions could be causing her symptoms?
2. What medical conditions (other than a prolactinoma) are associated with hyperprolactinemia?
3. Which medications raise prolactin?
4. How would your thinking change if she had galactorrhea but normal levels of prolactin?

Clinical Evaluation of Hyperprolactinemia

A careful history and physical examination are usually sufficient to exclude most common, nonendocrine causes of hyperprolactinemia. It is essential to obtain TSH and free T₄ (or total thyroxine and T₃ resin uptake) to eliminate primary hypothyroidism as a cause for the elevated prolactin. If a pituitary tumor is suspected, a careful assessment of other anterior pituitary function (basal cortisol, LH, FSH, and gender-specific gonadal steroid [either estradiol or testosterone]) and an evaluation of sellar anatomy with a high-resolution MRI should be obtained.

Management of Prolactinoma

The therapeutic goals are correction of symptoms that result from local invasion or extension of the tumor by

reducing tumor mass, restoration of normal gonadal function and fertility, prevention of osteoporosis, and preservation of normal anterior and posterior pituitary function. The different therapeutic options include simple observation, surgery, radiotherapy, or medical management with dopamine agonists.⁴² However, the management of prolactinoma also depends on the size of the tumor (macroadenomas [tumor size >10 mm] are less likely to be “cured” than are microadenomas [tumor size <10 mm])⁴⁹ and the preferences of the patient.

Dopamine agonists are the most commonly used therapy for microprolactinomas. Tumor shrinkage is noted in more than 90% of patients treated with bromocriptine mesylate (Parlodel) or the new dopamine agonist, cabergoline (Dostinex). Both drugs also shrink prolactin-secreting macroadenomas.⁵⁰ A resumption of menses and restoration of fertility is also frequently seen during medical therapy. The adverse effects of bromocriptine include orthostatic hypotension, dizziness, and nausea. The gastrointestinal adverse effects of bromocriptine can be ameliorated through intravaginal administration, and its efficacy is otherwise uncompromised.⁵¹ Cabergoline has fewer adverse effects and may be administered biweekly because of its longer duration of action. By virtue of its ability to interact with the 5-hydroxytryptamine (5-HT)_{2B} serotonergic receptor, cabergoline has been linked to the development of valvular heart disease,⁵² although the doses of cabergoline required to elicit the risk valvular damage are in vast excess to the doses used in the management of prolactinomas. Either agent should be discontinued during pregnancy unless tumor regrowth has been documented.

Neurosurgery is not a primary mode of prolactinoma management. The indications for neurosurgical intervention include pituitary tumor apoplexy (hemorrhage), acute visual loss due to macroadenoma, cystic prolactinoma, or intolerance to medical therapy. Surgical cure rates are inversely proportional to tumor size and the degree of prolactin elevation. External beam radiotherapy is generally reserved for high surgical risk patients with locally aggressive macroadenomas who are unable to tolerate dopamine agonists.

Idiopathic Galactorrhea

Lactation occurring in women with normal prolactin levels is defined as *idiopathic galactorrhea*. This condition is usually seen in women who have been pregnant several times and has no pathologic implication.

HYPOPITUITARISM

The failure of either the pituitary or hypothalamus results in the loss of anterior pituitary function. Complete loss of function is termed *panhypopituitarism*; however, there

CASE STUDY 19-3

A 60-year-old man presented with intractable headaches. MRI was requested to evaluate this complaint, and a 2.5-cm pituitary tumor was discovered. In retrospect, he noted an unexplained 20-kg weight loss, cold intolerance, fatigue, and loss of sexual desire.

Questions

1. How would you approach the evaluation of his anterior pituitary function?
2. What additional testing may be required to confirm a loss in anterior pituitary function?

may be a loss of only a single pituitary hormone, which is referred to as a *monotropic hormone deficiency*. The loss of a tropic hormone (ACTH, TSH, LH, and FSH) is reflected in function cessation of the affected endocrine gland. Loss of the direct effectors (GH and prolactin) may not be readily apparent. This section concentrates on the causes of hypopituitarism and certain subtleties involved in the therapy of panhypopituitarism; more detailed descriptions of various hormone deficiency states are covered in other chapters.

The laboratory diagnosis of hypopituitarism is relatively straightforward. In contrast to the primary failure of an endocrine gland that is accompanied by dramatic increases in circulating levels of the corresponding pituitary tropic hormone, secondary failure (hypopituitarism) is associated with low or normal levels of tropic hormone. In primary hypothyroidism, for example, the circulating levels of thyroxine are low and TSH levels may exceed 200 $\mu\text{U}/\text{mL}$ (normal, 0.4–5.0). As a result of pituitary failure in hypothyroidism, TSH levels are inappropriately low and typically less than 1.0 $\mu\text{U}/\text{mL}$.

There are several important issues in distinguishing between primary and secondary hormone deficiency states. To differentiate between primary and secondary deficiencies, both tropic and target hormone levels should be measured when there is any suspicion of pituitary failure or as part of the routine evaluation of gonadal or adrenal function. If one secondary deficiency is documented, it is essential to search for other deficiency states and the cause for pituitary failure. For example, failure to recognize secondary hypoadrenalism may have catastrophic consequences if the patient is treated with thyroxine. Similarly, initially overlooking a pituitary or hypothalamic lesion could preclude early diagnosis and treatment of a potentially aggressive tumor.

TABLE 19-4 CAUSES OF HYPOPITUITARISM

| |
|--------------------------------------|
| 1. Pituitary tumors |
| 2. Parapituitary/hypothalamic tumors |
| 3. Trauma |
| 4. Radiation therapy/surgery |
| 5. Infarction |
| 6. Infection |
| 7. Infiltrative disease |
| 8. Immunologic |
| 9. Familial |
| 10. Idiopathic |

Etiology of Hypopituitarism

The many causes of hypopituitarism are listed in Table 19-4. Direct effects of pituitary tumors, or the sequelae of treatment of tumors, are the most common causes of pituitary failure. Pituitary tumors may cause panhypopituitarism by compressing or replacing normal tissue or interrupting the flow of hypothalamic hormones by destroying the pituitary stalk. Large, nonsecretory pituitary tumors (chromophobe adenomas or null cell tumors) or macroprolactinomas are most commonly associated with this phenomenon. Parasellar tumors (meningiomas and gliomas), metastatic tumors (breast and lung), and hypothalamic tumors (craniopharyngiomas or dysgerminomas) can also cause hypopituitarism through similar mechanisms. Hemorrhage into a pituitary tumor (pituitary tumor apoplexy) is rare; however, when it occurs, it frequently causes complete pituitary failure.⁵³ Postpartum ischemic necrosis of the pituitary following a complicated delivery (Sheehan's syndrome) typically presents as profound, unresponsive shock or as failure to

lactate in the puerperium. Infiltrative diseases, such as hemochromatosis, sarcoidosis, or histiocytosis, can also affect pituitary function. Fungal infections, tuberculosis, and syphilis can involve the pituitary or hypothalamus and may cause impairment of function. Lymphocytic hypophysitis, an autoimmune disease of the pituitary, may only affect a single cell type in the pituitary, resulting in a monotropic hormone deficiency, or can involve all cell types, yielding total loss of function. Severe head trauma may shear the pituitary stalk or may interrupt the portal circulation. Similarly, surgery involving the pituitary may compromise the stalk and/or blood supply to the pituitary or may iatrogenically diminish the mass of functioning pituitary tissue. Panhypopituitarism can result from radiotherapy used to treat a primary pituitary tumor or a pituitary that was inadvertently included in the radiation port; loss of function, however, may be gradual and may occur over several years. There have been rare instances of familial panhypopituitarism or monotropic hormone deficiencies. In Kallmann's syndrome, for example, GnRH is deficient and the patient presents with secondary hypogonadism. Last, there may not be an apparent identified cause for the loss of pituitary function, and the patient is classified as having idiopathic hypopituitarism, although one recent case report emphasized the need to continue the search for a cause.⁵⁴

Treatment of Panhypopituitarism

In the average patient, replacement therapy for panhypopituitarism is the same as for primary target organ failure. Patients are treated with thyroxine, glucocorticoids, and gender-specific sex steroids. It is less clear about GH replacement in adults, and additional studies are needed to clarify this issue.^{55,56} Replacement becomes more complicated in panhypopituitary patients who desire fertility. Pulsatile GnRH infusions have induced puberty and restored fertility in patients with Kallmann's syndrome, and gonadotropin preparations have restored ovulation/spermatogenesis in people with gonadotropin deficiency.⁵⁷

POSTERIOR PITUITARY HORMONES

The posterior pituitary is an extension of the forebrain and represents the storage region for vasopressin (also called *antidiuretic hormone* [ADH]) and oxytocin. Both of these small peptide hormones are synthesized in the supraoptic and paraventricular nuclei of the hypothalamus and transported to the neurohypophysis via their axons in the hypothalamoneurohypophysial tract. This tract transits the median eminence of the hypothalamus and continues into the posterior pituitary through the pituitary stalk. The synthesis of each of these hormones is tightly linked to the production of neurophysin, a larger protein whose function is poorly understood. Both hor-

CASE STUDY 19-4

An 18-year-old woman was admitted to the neurologic intensive care unit following a severe closed head injury. Her course stabilized after 24 hours, but the nursing staff noticed a dramatic increase in the patient's urine output, which exceeded 1000 mL/h.

Questions

1. What caused her increased urine production?
2. How could you prove your suspicions?
3. Could she have other possible endocrinologic problems?

mones are synthesized outside of the hypothalamus in various tissue, and it is plausible they have an autocrine or a paracrine function.

Oxytocin

Oxytocin is a cyclic nonapeptide, with a disulfide bridge connecting amino acid residues 1 and 6. As a posttranslational modification, the C-terminus is amidated. Oxytocin has a critical role in lactation⁵⁸ and likely plays a major role in labor and parturition.⁵⁹ Synthetic oxytocin, Pitocin, is used in obstetrics to induce labor. In addition to its reproductive effects, oxytocin has been shown to have effects on pituitary, renal, cardiac, and immune function.

Vasopressin

Structurally similar to oxytocin, vasopressin is a cyclic nonapeptide with an identical disulfide bridge; it differs from oxytocin by only two amino acids. Vasopressin's major action is to regulate renal free water excretion and, therefore, has a central role in water balance. The vasopressin receptors in the kidney (V_2) are concentrated in the renal collecting tubules and the ascending limb of the loop of Henle. They are coupled to adenylate cyclase and, once activated, they induce insertion of aquaporin-2, a water channel protein, into the tubular luminal membrane.⁶⁰ Vasopressin is also a potent pressor agent and effects blood clotting⁶¹ by promoting factor VII release from hepatocytes and von Willebrand factor release from the endothelium. These vasopressin receptors (V_{1a} and V_{1b}) are coupled to phospholipase C.

Hypothalamic osmoreceptors and vascular baroreceptors regulate the release of vasopressin from the posterior pituitary. The osmoreceptors are extremely sensitive to even small changes in plasma osmolality, with an average osmotic threshold for vasopressin release in humans of 284 mOsm/kg. As plasma osmolality increases, vasopressin secretion increases. The consequence is a reduction in renal free water clearance, a lowering of plasma osmolality, and a return to homeostasis. The vascular baroreceptors (located in the left atrium, aortic arch, and carotid arteries) initiate vasopressin release in

response to a fall in blood volume or blood pressure. A 5% to 10% fall in arterial blood pressure in normal humans will trigger vasopressin release; however, in contrast to an osmotic stimulus, the vasopressin response to a baroreceptor-induced stimulus is exponential. In fact, baroreceptor-induced vasopressin secretion will override the normal osmotic suppression of vasopressin secretion.

Diabetes insipidus (DI), characterized by copious production of urine (polyuria) and intense thirst (polydipsia), is a consequence of vasopressin deficiency. However, total vasopressin deficiency is unusual, and the typical patient presents with a partial deficiency. The causes of hypothalamic DI include apparent autoimmunity to vasopressin-secreting neurons, trauma, diseases affecting pituitary stalk function, and various central nervous system or pituitary tumors. A sizable percentage of patients (up to 30%) will have idiopathic DI.⁶²

Depending on the degree of vasopressin deficiency, diagnosis of DI can be readily apparent or may require extensive investigation. Documenting an inappropriately low vasopressin level with an elevated plasma osmolality would yield a reasonably secure diagnosis of DI. In less obvious cases, the patient may require a water deprivation test in which fluids are withheld from the patient and serial determinations of serum and urine osmolality are performed in an attempt to document the patient's ability to conserve water. Under selected circumstances, a health care provider may simply offer a therapeutic trial of vasopressin or a synthetic analog, such as dDAVP, and assess the patient's response. In this circumstance, amelioration of both polyuria and polydipsia would be considered a positive response, and a presumptive diagnosis of DI is made. However, if the patient has primary polydipsia (also known as compulsive water drinking), a profound hypo-osmolar state (water intoxication) can ensue due to the continued ingestion of copious amounts of fluids and a reduced renal excretion of free water. This scenario illustrates the importance of carefully evaluating each patient prior to therapy.

Recently, conivaptan,⁶³ a vasopressin V_2 receptor antagonist, has been approved for the management of euvolemic hyponatremia due to vasopressin excess.

REFERENCES

1. Kelberman D, Dattani MT. Hypothalamic and pituitary development: Novel insights in the aetiology. *Eur J Endocrinol* 2007;157(Suppl 1):S3–S14.
2. Frohman LA. Diseases of the anterior pituitary. In Felig P, Baxter JD, Broadus AE, Frohman LA, eds. *Endocrinology and metabolism*. 2nd ed. New York: McGraw-Hill, 1981:247–337.
3. Asa SL, Horvath E, Kovacs KT. Functional pituitary anatomy and histology. In Melmed S, ed. *Endocrinology*. 4th ed. Philadelphia, Pa.: WB Saunders, 2001:167–182.
4. Monig H, Arendt A, Meyer M, et al. Activation of the hypothalamo-pituitary-adrenal axis in response to septic or non-septic diseases—implications for the euthyroid sick syndrome. *Intensive Care Med* 1999;25:1402–1496.

5. Urban RJ, Evans WS, Rogol, AD, et al. Contemporary aspects of discrete pulse detection algorithms. I. The paradigm of the LH pulse signal in men. *Endocr Rev* 1988;9:3–37.
6. Crowley WF Jr, Whitcomb RN, Jameson JL, et al. The neuroendocrine control of reproduction in the male. *Recent Prog Horm Res* 1991;47:27–62.
7. Follenius M, Brandenberger G. Plasma free cortisol during secretory episodes. *J Clin Endocrinol Metab* 1986;62:609–612.
8. Veldhuis JD, Iranmanesh A, Johnson ML, Lizarralde G. Amplitude, but not frequency, modulation of adrenocorticotropin secretory bursts gives rise to the nyctohemeral rhythm of the corticotropic axis in man. *J Clin Endocrinol Metab* 1990;71:452–463.
9. Samuels MH, Veldhuis JD, Henry P, Ridgeway EC. Pathophysiology of pulsatile and copulsatile release of thyroid stimulating hormone, luteinizing hormone, follicle stimulating hormone and alpha-subunit. *J Clin Endocrinol Metab* 1990;71:425–432.
10. Freda PU, Post KD. Differential diagnosis of sellar masses. *Endocrinol Metab Clin North Am* 1999;28:81–117.
11. Casanueva FF. Physiology of growth hormone secretion and action. *Endocrinol Metab Clin North Am* 1992;21:483–517.
12. Van Cauter E, Plat L, Copinschi G. Interrelations between sleep and the somatotopic axis. *Sleep* 1998;21:553–566.
13. Herman-Bonert VS, Prager D, Melmed S. Growth hormone. In Melmed S, ed. *The pituitary*. Cambridge, Mass.: Blackwell Science, 1995:98–135.
14. Pinto G, Adan L, Souberbielle JC, et al. Idiopathic growth hormone deficiency: Presentation, diagnosis and treatment. *Ann Endocrinol (Paris)* 1999;60:224–231.
15. Teale JD, Marks V. Inappropriately elevated plasma insulin-like growth factor II in relation to suppressed insulin-like growth factor I in the diagnosis of non-islet cell hypoglycemia. *Clin Endocrinol (Oxf)* 1990;33:87–98.
16. Blakesley VA, Scrimgeour A, Esposito D, LeRoith D. Signaling via the insulin-like growth factor I receptor. Does it differ from insulin receptor signaling. *Cytokine Growth Factor Rev* 1996;7:153–159.
17. Clemmons DR. Insulin-like growth factor-I and its binding proteins. In: Melmed S, ed. *Endocrinology*. 4th ed. Philadelphia: WB Saunders, 2001:439–460.
18. Binoux M, Roghani M, Hossenlopp P, et al. Molecular forms of IGF binding proteins: Physiological implications. *Acta Endocrinol (Copenh)* 1991;124:41–47.
19. Span JP, Pieters GF, Sweep CG, et al. Plasma IGF-I is a useful marker of growth hormone deficiency in adults. *J Endocrinol Invest* 1999;22:446–450.
20. van der Lely AJ, de Herder WW, Janssen JA, et al. Acromegaly: The significance of serum total and free IGF-I and IGF-binding protein-3 in diagnosis. *J Endocrinol* 1997;155:9–16.
21. de Herder WW, van der Lely AJ, Janssen JA, et al. IGFBP-3 is a poor parameter for assessment of clinical activity in acromegaly. *Clin Endocrinol (Oxf)* 1995;43:501–505.
22. Clemmons DR. Insulin-like growth factor binding proteins. *Trends Endocrinol Metab* 1990;1:412–417.
23. Ezzat S. Acromegaly. *Endocrinol Metab Clin North Am* 1997;26:703–723.
24. Biller BMK, Samuels MH, Zagar A, et al. Sensitivity and specificity of six tests for the diagnosis of adult GH deficiency. *J Clin Endocrinol Metab* 2002;87:2067–2079.
25. Molitch ME, Clemmons DR, Malozowski S, et al. Evaluation and treatment of adult growth hormone deficiency: An Endocrine Society clinical practice guideline. *J Clin Endocrinol Metab* 2006;91:1621–1634.
26. Hartman ML, Crowe BJ, Biller BM, et al. Which patients do not require a GH stimulation test for the diagnosis of adult growth hormone deficiency? *J Clin Endocrinol Metab* 2002;87:477–485.
27. Faglia G, Arosio M, Bazzoni N. Ectopic acromegaly. *Endocrinol Metab Clinics North Am* 1992;21:575–596.
28. Ezzat S, Ezrin C, Yamashita S, Melmed S. Recurrent acromegaly resulting from ectopic growth hormone gene expression by a metastatic pancreatic tumor. *Cancer* 1993;71:66–70.
29. Molitch ME. Clinical aspects of acromegaly. *Endocrinol Metab Clin North Am* 1992;597–614.
30. Lamberts SW, Klijn JGM, van Vroonhoven CCJ, et al. Different responses of growth hormone secretion to guanfacine, bromocriptine and thyrotropin-releasing hormone in acromegalic patients with pure growth hormone (GH)-containing and mixed GH/prolactin-containing pituitary adenomas. *J Clin Endocrinol Metab* 1985;60:1148–1153.
31. Beck-Peccoz P, Brucker-Davis F, Persani L, et al. Thyrotropin-secreting pituitary tumors. *Endocr Rev* 1996;17:610–638.
32. Fahlbusch R, Honegger J, Buchfelder M. Surgical management of acromegaly. *Endocrinol Metab Clin North Am* 1992;21:669–692.
33. Jackson IM, Norén G. Role of gamma knife therapy in the management of pituitary tumors. *Endocrinol Metab Clin North Am* 1999;28:133–142.
34. Newman C. Medical therapy for acromegaly. *Endocrinol Metab Clin North Am* 1999;28:171–190.
35. Katznelson L. Current thinking on the management of the acromegalic patient. *Curr Opin Endocrinol Diabetes Obes* 2007;14:311–116.
36. Rudman D, Kutner MH, Rogers CM, et al. Impaired growth hormone secretion in the adult population: relation to age and adiposity. *J Clin Invest* 1981;67:1361–1369.
37. Rosenfeld RG. Growth hormone deficiency in children. In Melmed S, ed. *Endocrinology*. 4th ed. Philadelphia, Pa.: WB Saunders, 2001:503–519.
38. Cuneo RC, Salomon F, McGauley GA, Sönksen PH. The growth hormone deficiency syndrome in adults. *Clin Endocrinol (Oxf)* 1992;37:387–397.
39. Rosén T, Bengtsson BA. Premature mortality due to cardiovascular disease in hypopituitarism. *Lancet* 1990;336:285–288.
40. Stockholm K, Christiansen J, Laursen T, Gravholt CH. Mortality and reduced growth hormone secretion. *Horm Res* 2007;68:173–176.
41. Hansen TB, Vahl N, Jørgensen JO, et al. Whole body and regional soft tissue changes in growth hormone deficient adults after one year of growth hormone treatment: A double-blind, randomized, placebo-controlled study. *Clin Endocrinol* 1995;43:689–696.
42. Molitch M. Medical management of prolactinomas. *Endocrinol Metab Clin North Am* 1999;28:143–169.
43. Honbo KS, Herle AVJ, Kellett KA. Serum prolactin levels in untreated hypothyroidism. *Am J Med* 1978;64:782–787.
44. Odell WD. Prolactin-producing tumors. In Odell WD, Nelson DH, eds. *Pituitary tumors*. Mt. Kisco, N.Y.: Futura Publishing, 1984:159–179.
45. Wardlaw SL, Bilezikian JP. Hyperprolactinemia and osteopenia. *J Clin Endocrinol Metab* 2002;75:690–691.
46. Faglia G. Prolactinomas and hyperprolactinemic syndrome. In: Melmed S, ed. *Endocrinology*, 4th ed. Philadelphia: WB Saunders, 2001:329–342.
47. Lambrinoudaki IV, Daskalaki OD, Thomopoulos SA, et al. Macroprolactinemia: Is treatment necessary? *Hormones* 2003;2:183–185.
48. Gibney J, Smith TP, McKenna TJ. The impact on clinical practice of routine screening for macroprolactin. *J Clin Endocrinol Metab* 2005;90:3927–3932.
49. Molitch ME. Prolactinomas. In Melmed S, ed. *The pituitary*. Cambridge, Mass.A: Blackwell Science, 1995:443–477.
50. Demura R, Kubo O, Demura H, et al. Changes in computed

- tomographic findings in microprolactinomas before and after bromocriptine. *Acta Endocrinol* 1985;110:308–312.
51. Vermesh M, Fossum GT, Kletzky OA. Vaginal bromocriptine: Pharmacology and effect on serum prolactin in normal women. *Obstet Gynecol* 1988;72:693–698.
 52. Rasumussen VG, Poulson SH, Dupont E, et al. Heart valve disease associated with treatment with ergot-derived dopamine agonists: A clinical and echocardiographic study of patients with Parkinson's disease. *J Intern Med* 2008;263:90–98.
 53. Nawar RN, Abdelmannan D, Selman WR, Arafah BM. Pituitary tumor apoplexy: A review. *J Intensive Care Med* 2008;23:75–90.
 54. Katz BJ, Jones RE, Digre KB, et al. Panhypopituitarism as an initial manifestation of primary central nervous system non-Hodgkin's lymphoma. *Endocr Pract* 2003;9:296–300.
 55. Isley WL. Growth hormone therapy for adults: Not ready for prime time? *Ann Intern Med* 2002;137:190–196.
 56. Cook DM. Shouldn't adults with growth hormone deficiency be offered growth hormone replacement therapy? *Ann Intern Med* 2002;137:197–201.
 57. Hayes FJ, Seminara SB, Crowley WF Jr. Hypogonadotropic hypogonadism. *Endocrinol Metab Clin North Am* 1998;27:739–763.
 58. Nishimori K, Young LJ, Guo Q, et al. Oxytocin is required for nursing but is not essential for parturition or reproductive behavior. *Proc Natl Acad Sci USA* 1996;93:11699–11704.
 59. Goodwin TM, Zograbyan A. Oxytocin receptor antagonists—update. *Clin Perinatol* 1998;25:859–871.
 60. Cheng A, van Hoek AN, Yeager M, et al. Three-dimensional organization of a human water channel. *Nature* 1997;387:627–630.
 61. Mannucci PM, Ruggeri ZM, Pareti FI, Capitanio A. DDAVP: A new pharmacological approach to the management of hemophilia and von Willebrand disease. *Lancet* 1977;1:869–872.
 62. Moses AM, Notman DD. Diabetes insipidus and syndrome of inappropriate antidiuretic hormone secretion (SIADH). *Adv Int Med* 1982;27:73–110.
 63. Lien YH, Shapiro JI. Hyponatremia: Clinical diagnosis and management. *Am J Med* 2007;120:653–658.

Adrenal Function

Ryan Hungerford, A. Wayne Meikle

CHAPTER

20

CHAPTER OUTLINE

- **THE ADRENAL GLAND: AN OVERVIEW**
- **EMBRYOLOGY AND ANATOMY**
- **THE ADRENAL CORTEX BY ZONE**
 - Cortex Steroidogenesis
 - Congenital Adrenal Hyperplasia
- **DIAGNOSIS OF PRIMARY ALDOSTERONISM**
 - Diagnosis Algorithm
- **ADRENAL CORTICAL PHYSIOLOGY**
- **ADRENAL INSUFFICIENCY (ADDISON'S DISEASE)**
 - Diagnosis of Adrenal Insufficiency
 - Treatment of Adrenal Insufficiency
- **HYPERCORTISOLISM**
- **CUSHING'S SYNDROME**
 - When Endogenous Cushing's Syndrome Is Confirmed
 - Pituitary versus Ectopic Adrenocorticotropic Hormone Secretion
 - Adrenocorticotropic Hormone Source in Dexamethasone Nonsuppression
 - Adrenocorticotropic Hormone Secretion
 - Inferior Petrosal Sinus Sampling
 - Diagnosis of Cushing's Syndrome
- **When Cushing's Syndrome Is Confirmed, Corticotropin-Releasing Hormone Stimulation Tests Help Determine Adrenocorticotropic Hormone Dependency (Typically Not Necessary)**
- **Localization Procedures**
- **Algorithm for Cushing's Syndrome Workup**
- **Treatment**
- **ANDROGEN EXCESS**
 - Diagnosis of Excess Androgen Production
 - Treatment for Adrenal Androgen Overproduction
- **THE ADRENAL MEDULLA**
 - Development
 - Biosynthesis and Storage of Catecholamines
 - Catecholamine Degradation
 - Urine and Plasma Catecholamine Measurements
 - Causes of Sympathetic Hyperactivity
 - Diagnosis of Pheochromocytoma
 - Treatment of Pheochromocytoma
 - Outcome and Prognosis
- **ADRENAL "INCIDENTALOMA"**
- **REFERENCES**

THE ADRENAL GLAND: AN OVERVIEW

The adrenal gland is a multifunctional organ that produces the steroid hormones and neuropeptides essential for life. Despite the complex effects of adrenal hormones, most pathologic conditions of the adrenal gland are linked by their impact on blood pressure and electrolyte balance.¹ As such, an adrenal etiology should be considered in the differential diagnosis of all patients with high blood pressure accompanied by electrolyte abnormalities, unexplained change in weight, inappropriate virilization, anxiety, weakness, orthostasis, palpitations, **headache**, chest pain, or abdominal pain.

In clinical practice, patients often present with states of diminished production or overproduction of one or more adrenal hormones. Hypofunction is generally treated with exogenous hormone replacement, and

hyperfunction is generally treated with pharmacologic suppression or surgery.

EMBRYOLOGY AND ANATOMY

The adrenal gland is composed of two embryologically distinct, but conjoined, glands—the outer adrenal cortex and inner adrenal medulla. The cortex is derived from mesenchymal cells located near the urogenital ridge that differentiate into three structurally and functionally distinct zones (Fig. 20-1). The medulla arises from neural crest cells that invade the cortex during the second month of fetal development. By adulthood, the medulla contributes 10% of total adrenal weight. To date, mechanisms involved in maintaining adrenal size and function are poorly understood.²

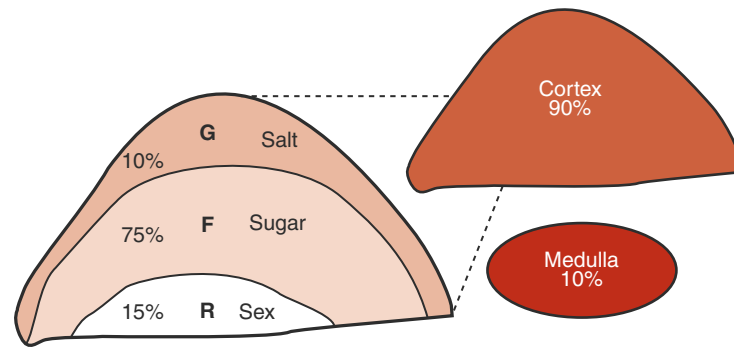

FIGURE 20-1. Adrenal gland by layer.

Adult adrenal glands are shaped like pyramids, located just above and medial to the kidneys in the retroperitoneal space (suprarenal glands). On gross sectioning, both regions remain distinct; the cortex appears yellow, the medulla is dark mahogany.

Adrenal arterial supply is symmetric. Small arterioles branch to form a dense subcapsular plexus that drains into the sinusoidal plexus of the cortex. There is no direct supply to middle and inner zones. In contrast, venous drainage from the central vein displays laterality. After crossing the medulla, the right adrenal vein empties into the inferior vena cava, and the left adrenal vein drains into the left renal vein. There is a separate capillary sinusoidal network from the medullary arterioles that also drains into the central vein and limits the exposure of cortical cells to medullary venous blood. Glucocorticoids from the cortex are carried directly to the adrenal medulla via the portal system, where they stimulate production of **epinephrine (EPI)** (see Fig. 20-17).

Sympathetic and parasympathetic axons reach the medulla through the cortex. En route, these axons release neurotransmitters (e.g., catecholamines, neuropeptide Y) that modulate cortex blood flow, cell growth, and function. Medullary projections into the cortex have been found to contain cells that also synthesize and release neuropeptides, such as **vasoactive inhibitory peptide (VIP)**, adrenomedullin, and **atrial natriuretic peptide (ANP)**, and potentially influence cortex function.

THE ADRENAL CORTEX BY ZONE

The major cortex hormones, aldosterone, cortisol, and *dehydroepiandrosterone sulfate (DHEAS)*, are uniquely synthesized from a common precursor by cells located in one of three functionally distinct zonal layers of the adrenal cortex. These zonal layers are **zona glomerulosa**, **zona fasciculata**, and **zona reticularis**, respectively (Fig. 20-1).

G-zone

Zona glomerulosa cells (outer 10%) synthesize mineralocorticoids (aldosterone) critical for sodium retention

(volume), potassium, and acid-base homeostasis. They have low cytoplasmic-to-nuclear ratios and small nuclei with dense chromatin with intermediate lipid inclusions.

F-zone

Zona fasciculata cells (middle 75%) synthesize glucocorticoids, such as cortisol, and corticosterone critical to blood glucose homeostasis and blood pressure. Fasciculata cells are cords of clear cells, with a high cytoplasmic-to-nuclear ratio and lipids laden with “foamy” cytoplasm. The fasciculata also generate androgen precursors such as **dehydroepiandrosterone (DHEA)**, which is sulfated in the innermost *zona reticularis (R-layer)*. Subcapsular adrenal cortex remnants can regenerate into fasciculate adrenals, metastasize, and survive in ectopic locations such as the liver, gallbladder wall, broad ligaments, celiac plexus, ovaries, scrotum, and cranium.

R-zone

Zona reticularis cells (inner 10%) sulfate DHEA to DHEAS, which is the main adrenal androgen. The zone is sharply demarcated with lipid-deficient cords of irregular, dense cells with lipofuscin deposits.

Adrenal cell types are presumed to arise from stem cells. A proposed tissue layer between the zona glomerulosa and fasciculata may serve as a site for progenitor cells to regenerate zonal cells.³

Cortex Steroidogenesis

Control of steroid hormone biosynthesis is complex, including **adrenocorticotropic hormone (ACTH)** and angiotensin (Ang) II. It occurs via substrate availability, enzyme activities, and inhibitory feedback loops that are layer specific. Defining adrenal cortex biosynthesis and actions in terms of three layers simplifies its complexity.

All adrenal steroids are derived by sequential enzymatic conversion of a common substrate, cholesterol. Adrenal parenchymal cells accumulate and store circulating low-density lipoproteins (LDL). The adrenal gland can also synthesize additional cholesterol using

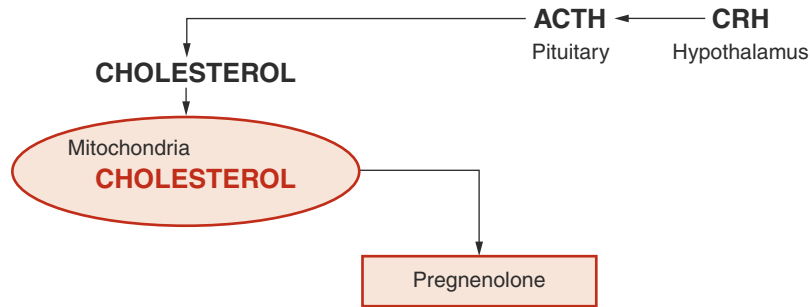

FIGURE 20-2. Conversion of cholesterol to pregnenolone.

acetyl-CoA, ensuring that adrenal steroidogenesis remains normal in patients with variable lipid disorders and in patients on lipid-lowering agents.

Only free cholesterol can enter steroidogenic pathways in response to ACTH. The availability of free intracellular cholesterol is metabolically regulated by LDL negatively and ACTH positively through multiple mechanisms. **Corticotropin-releasing hormone (CRH)** is secreted from the hypothalamus in response to circadian signals, serum cortisol, and stress, causing release of stored ACTH, which stimulates transport of free cholesterol into adrenal mitochondria, initiating steroid production.

Conversion of cholesterol to pregnenolone is a rate-limiting step in steroid biosynthesis: six carbons are removed from cholesterol by mitochondrial membrane cytochrome P450 (CYP450) enzyme (Fig. 20-2). Newly synthesized pregnenolone is then returned to the cytosol for subsequent zonal conversion by microsomal enzymes in each layer by F-layer enzymes and/or androgens by enzymes in the R-layer (Fig. 20-3). Because F-layer glucocorticoids powerfully suppress ACTH release, cortisol is the primary feedback regulator of ACTH-stimulated hormone production in the adrenal cortex. ACTH generally does not significantly impact G-layer **aldosterone**

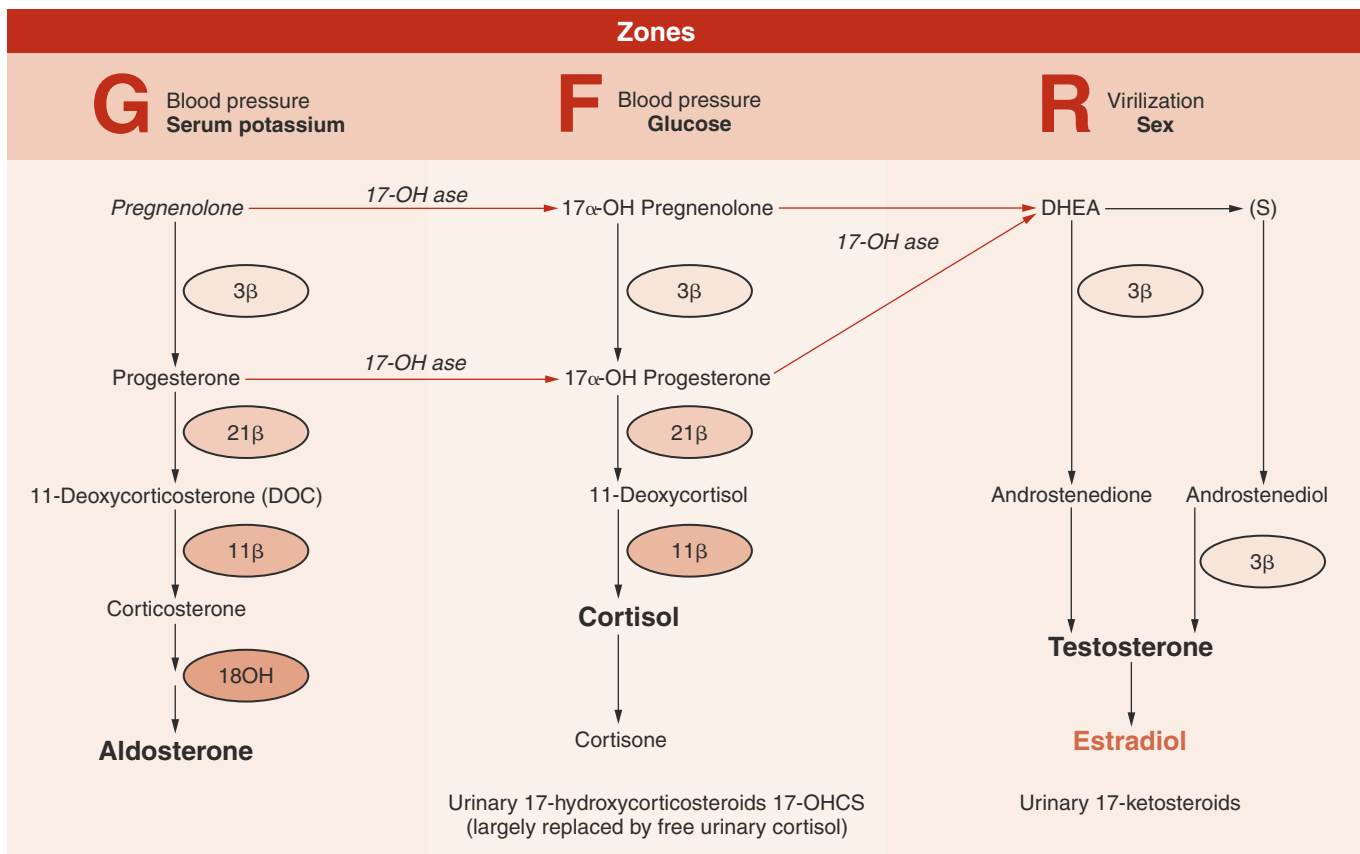

FIGURE 20-3. Conversion of cholesterol to pregnenolone and aldosterone.

| Enzyme Defect | New Classification | HTN | Virilization | High Lab Value |
|---|--------------------|-----|--------------|--------------------|
| 3 β -Hydroxysteroid dehydrogenase | 3 β -HSD II | N | Slight | DHEA |
| 17 α -Hydroxylase | CYP17 | Y | No | Aldosterone |
| 11 β -Hydroxylase | CYP11B1GF | Y | Marked | 11-DOC |
| 21 β -Hydroxylase | CYP21A2 | N | Marked | 17-OH-progesterone |

FIGURE 20-4. Congenital adrenal hyperplasia syndromes.

synthesis, although certain glucocorticoids have mineralocorticoid actions.

Decreased activity of any enzymes required for biosynthesis can occur as an acquired or inherited (autosomal recessive) trait. Defects that decrease production of cortisol cause increases in ACTH and CRH secretion in an attempt to stimulate cortisol levels and lead to adrenal hyperplasia or overproduction of androgens, depending on the affected enzyme.

Evaluation of adrenal function requires measuring relevant adrenal hormones, metabolites, and regulatory secretagogues. Diagnosis is based on the correlation of clinical and laboratory findings.⁴

Congenital Adrenal Hyperplasia

Congenital adrenal hyperplasia (CAH) is an inherited family of enzyme disorders causing decreased cortisol and aldosterone production. The clinical presentation depends on the affected enzyme as demonstrated in Figure 20-4. Laboratory findings reveal increased upstream substrates with overflow across open pathways and relatively decreased products downstream from the affected enzyme.⁵ Partial defects can present after puberty. Ninety-five percent are a result of a 21-hydroxylase deficiency causing 17-OH progesterone and androgen buildup while cortisol decreases. Treatment with oral glucocorticoids replaces deficient cortisol and suppresses ACTH-stimulated androgen excess.⁶

G-cells convert cholesterol to pregnenolone, the common steroid precursor, and then into aldosterone (15–20 mg/day) (Fig. 20-3). G-layer-specific aldosterone synthesis occurs for several reasons. Low G-cell 17 α -hydroxylase activity prevents substrate diversion into other pathways and low aldosterone synthase activity in other zones ensures the final oxidation of corticosterone to aldosterone is G-cell specific (Fig. 20-3).

Aldosterone secretion is regulated by the **renin-angiotensin system (RAS)**, which functions to maintain mainly sodium balance. Perceived volume depletion, low filtered salt, and sympathetic nerve stimulation is sensed as hypoperfusion by secreted and stimulates renin production. Renin is a proteolytic enzyme by renal cells in the juxtaglomerular apparatus. Renin initiates a sequence of cleavage steps of angiotensinogen made by the cortisol or renin substrate to form Ang I. **Angiotensin-converting enzyme (ACE)** influencing converts Ang I to Ang II. Ang II acts as a powerful vasoconstrictor to raise blood pressure and stimulate aldosterone release. Chronic Ang II stimulation or dietary salt restriction can cause aldosterone hypersecretion and isolated G-layer hypertrophy.⁷

Aldosterone acts on the kidney to increase blood pressure through volume expansion by increasing sodium reabsorption—hence, water retention. Aldosterone also stimulates hydrogen⁺ and potassium⁺ excretion, causing metabolic alkalosis with volume expansion, **hypertension (HTN)**, and hypokalemia. The phenomenon is enhanced with high sodium diets.

Ang II, ACTH, elevated serum potassium, progesterone, and dopamine stimulate aldosterone synthesis (Fig. 20-5). ANP, intracellular calcium, and certain drugs are aldosterone suppressors, including ketoconazole, ACE inhibitors, **nonsteroidal anti-inflammatory drugs (NSAIDs)**, and heparin.

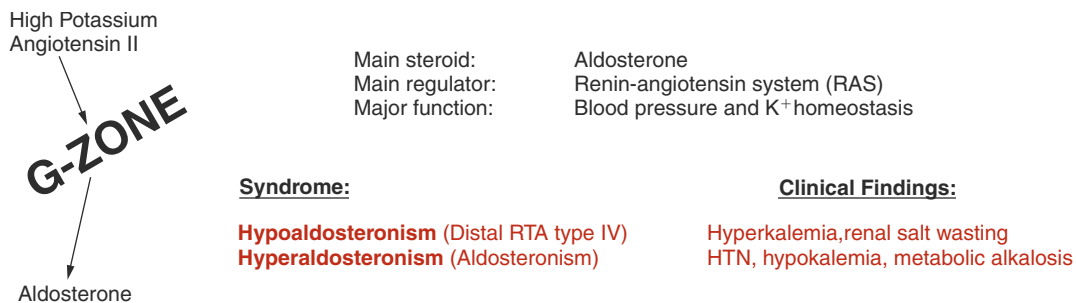

FIGURE 20-5. Cortex function and pathology by layer.

- Easy fatigability
- Muscle weakness (paralysis)
- Polyuria (loss of renal concentration ability and renal cysts)
- Palpitations (increased ventricular ectopy)
- Autonomic dysregulation (hypotension without reflex tachycardia)
- Impaired insulin secretion (decreased glucose tolerance)
- Aldosterone suppression

FIGURE 20-6. Signs and symptoms of hypokalemia.

Isolated Hypoaldosteronism

Insufficient aldosterone secretion is seen with adrenal gland destruction, chronic heparin therapy, following unilateral adrenalectomy (transient), and with G-layer enzyme deficiencies. Most hypoaldosteronism occurs in patients with mild renal insufficiency such as persons with diabetes who present with mild metabolic acidosis, high serum potassium⁺, low urinary potassium⁺ excretion (urine K⁺ < urine Na⁺), and low reninemia. Treatment is with dietary changes and Florinef (a synthetic mineralocorticoid), which enhances salt retention and the secretion of potassium⁺ and acid.

Hyperaldosteronism

Patients with excess aldosterone production may develop metabolic alkalosis, HTN, and hypokalemia. They may present with HTN and symptoms caused by low serum potassium⁺, as outlined in Figure 20-6.

Causes of HTN and unprovoked hypokalemia include:

- Primary aldosteronism (low renin)—autonomous oversecretion of aldosterone
- Secondary aldosteronism (elevated renin)—RAS-activated aldosterone secretion

- Pseudoaldosteronism (variable renin and aldosterone levels)—renal tubular diseases causing urinary potassium loss by aldosterone-independent mechanisms. In most cases, aldosterone is low; however, two syndromes are associated with high aldosterone levels: Bartter's syndrome (bumetanide-sensitive chloride channel mutation) and Gitelman's syndrome (thiazide-sensitive transporter mutation).

Documenting excess aldosterone excretion establishes the diagnosis of aldosteronism (urine measurements are superior to plasma measurements) but cannot discern between underlying etiologies. **Plasma renin activity (PRA)** measurements reflect the state of RAS activation and are helpful for that determination. Because PRA varies with volume status, upright position, and dietary sodium intake, an isolated PRA measurement has limited clinical value. PRA assessed relative to **plasma aldosterone (PA)** helps distinguish primary from other forms of aldosteronism.

Types of aldosteronism are diagrammed in Figure 20-7 according to their PA (y-axis) and PRA (x-axis) values in groups, according to those ratios.

DIAGNOSIS OF PRIMARY ALDOSTERONISM

Because 25% of HTN patients have low renin, the diagnosis of primary aldosteronism relies on these criteria⁸:

- PA/PRA greater than 25
- Low plasma renin that fails to increase with volume depletion

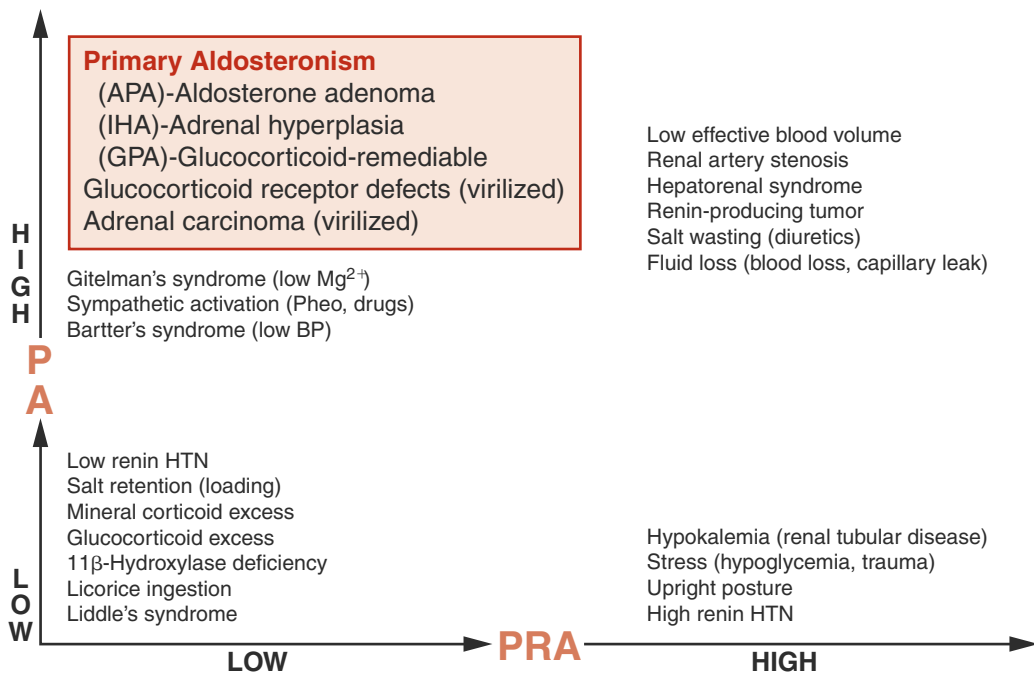

FIGURE 20-7. Types of aldosteronism according to PA:PRA ratio.

- High aldosterone that fails to decrease with saline or angiotensin inhibition

Diagnosis Algorithm

Urinary potassium excretion measured in patients with HTN and unprovoked hypokalemia is a cost-effective screening test for aldosteronism. Urine potassium⁺ greater than 30 mEq/day is inappropriate in hypokalemic patients and strongly suggests a hyperaldosteronemic state (spot urine K⁺ > Na⁺ is also suggestive). Urine potassium less than 30 mEq/day reflects renal potassium⁺ retention, as seen with prior diuretic use or gastrointestinal loss.

Upright PA/PRA ratio measured in a fluid-deprived patient (overnight dehydration increases PRA) is definitive in distinguishing primary from other causes of aldosteronism, particularly when repeated following volume expansion (2 liters of normal saline over 4 h), which normally suppresses aldosterone. A PA/PRA ratio greater than 25 suggests primary aldosteronism. Most clinicians then recommend abdominal imaging with computed tomography (CT) or magnetic resonance imaging (MRI) to evaluate for the presence of an adrenal mass.

Captopril suppression is often confirmatory. Within 3 hours of taking 50 mg of captopril (1 mg/kg), plasma aldosterone remains high in primary **abnormal aldosterone production (aldosteronism)** (PA:PRA ratio >25 ng/dL before and after test) but is suppressed in patients with other forms of HTN.

18-Hydroxycorticosterone levels have limited value in distinguishing the causes of autonomous (nonsuppressible) aldosterone production. Levels greater than 100 ng/dL suggest an *aldosterone-producing adenoma (APA)*, or idiopathic hyperaldosteronism. A correct diagnosis is critical for correct treatment. Surgery is curative for an autonomous functioning adenoma or unilateral hyperplasia; otherwise, drug therapy is used to antagonize (e.g., spironolactone or amiloride with thiazide for IHA) or inhibit aldosterone actions (e.g., cortisone for glucocorticoid-responsive hyperaldosteronism).

Adrenal imaging (CT or MRI) is used to visualize adrenal gland anatomy. Structural abnormalities should complement functional findings to establish a diagnosis. Pathology based on imaging studies alone can be

misleading. Adrenal adenomas (nonsecreting) are routinely found in 10% of healthy patients; adrenal nodules can be normal structural variants or result from abnormal gland stimulation. Occasionally, aldosterone-secreting adenomas are missed because they are too small to resolve or hide within hyperplastic glands. If imaging is negative, the scan can be repeated in 6 to 12 months.

Adrenal vein sampling is used to establish/exclude the presence of a unilateral adenoma and bilateral hyperplasia. It is superior to adrenal et. In one study, 50% of patients diagnosed with APA by venous sampling had hyperplasia by CT.⁸

Cortisol production is regulated by ACTH. ACTH is secreted in a pulsatile fashion by the pituitary gland. Diurnal variation causes ACTH and cortisol levels to be highest in the early morning (8:00 AM) and lowest at night (10:00 PM to 12:00 AM). ACTH pulse amplitude (not frequency) rises between 2:00 and 4:00 AM. Additional peaks of ACTH follow protein-rich meals, **antidiuretic hormone (ADH)** stimulation, as well as CRH. Hypoglycemia indirectly stimulates ACTH by increasing CRH and ADH release. In addition, acute stress (physical and psychological) directly stimulates ACTH secretion, causing cortisol levels to rise. Elevated glucocorticoids (endogenous and exogenous), in turn, suppress ACTH through feedback inhibition, decreasing pro-opiomelanocortin gene transcription in pituitary corticotroph cells and also by blocking the production, secretion, and stimulatory effects of CRH on ACTH synthesis and release in the pituitary.

ADRENAL CORTICAL PHYSIOLOGY

Cortisol synthesis (15–20 mg/day) is critical to hemodynamic and glucose homeostasis. F-zone disorders manifest with blood pressure and glucose abnormalities (Fig. 20-8). Glucocorticoids maintain blood glucose by inducing lipolysis and amino acid release from muscle breakdown for conversion into glucose (gluconeogenesis) and storage as liver glycogen.

ADRENAL INSUFFICIENCY (ADDISON'S DISEASE)

Adrenal insufficiency (low cortisol) results from a primary adrenal problem (destruction of 90% of the adrenal

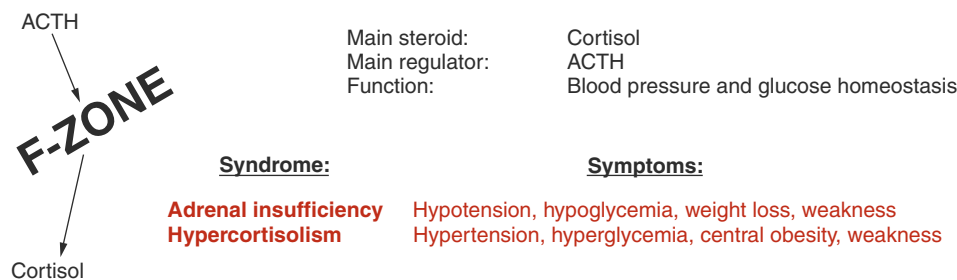

FIGURE 20-8. F-zone disorders.

| Frequency | Symptoms | Signs |
|-----------|---------------------------------|--|
| 100% | Weakness Fatigue Anorexia | Weight loss |
| 90% | | Hyperpigmentation (primary adrenal insufficiency) |
| 50% | Nausea Diarrhea | |
| 10% | Pain | Adrenal calcification |

FIGURE 20-9. Signs and symptoms of adrenal insufficiency.

cortex) or is secondary to ACTH deficiency (abnormality at the hypothalamic–pituitary level).⁹

Symptoms of deficiency can be vague and misleading (Fig. 20-9). As cortisol is critical to normal glucose homeostasis and maintenance of vascular tone, deficiency produces symptoms resembling failure to thrive, such as weakness, fatigue, anorexia, nausea, diarrhea, and abdominal pain accompanied by physical findings such as weight loss. Abnormal laboratory values depend on the underlying cause of low cortisol production and include hyponatremia, hyperkalemia, hypercalcemia, prerenal azotemia, and mild metabolic acidosis.

Autoimmune adrenalitis accounts for 70% of the cases of primary adrenal insufficiency; however, other conditions, including infectious diseases such as fungal (not candida), human immunodeficiency virus (HIV) infection, and tuberculosis; bilateral adrenal hemorrhage; adrenoleukodystrophy; infiltrative processes; and metastasis, can also destroy the adrenal gland. Glucocorticoid therapy is the most common cause of secondary adrenal insufficiency; however, tumors, hemorrhage, infiltrative processes, developmental abnormalities, and malignancies also interfere with ACTH production by the pituitary gland.

Diagnosis of Adrenal Insufficiency

Low baseline cortisol levels (8:00 AM, supine) and an elevated ACTH greater than 200 pg/mL are suggestive of

adrenal insufficiency. Random cortisol levels are only useful in excluding the diagnosis when elevated (>20 µg/dL). Cosyntropin is a synthetic stimulator of cortisol and aldosterone secretion, which tests the capacity of the adrenal gland to increase hormone production in response to stimulation. It is safe and offers reliable results regardless of food intake or time of day. Lower serum concentrations of ACTH and cortisol are consistent with secondary adrenal failure. Hypoglycemia is also a potent stimulator of cortisol secretion but potentially dangerous. A stimulated free cortisol level less than 18 µg/dL indicates impaired adrenal function.

Following a blood draw for baseline cortisol, ACTH, and aldosterone levels, cosyntropin (IV/IM) is given. Repeat samples are drawn at 30 and 60 minutes post stimulation. ACTH and aldosterone responses to cosyntropin aid in the differential diagnosis of low cortisol states as illustrated in Figure 20-10. Although good at identifying primary adrenal insufficiency, most causes of chronic secondary insufficiency (central) are associated with abnormal cortisol response to cosyntropin stimulation, but the test is not diagnostic of secondary adrenal insufficiency.

Metyrapone is used as an alternate diagnostic or confirmatory test for central causes of adrenal insufficiency. Metyrapone administered orally at midnight will, in normal individuals, block 11β-hydroxylase (Fig. 20-3), increasing **11-deoxycortisol (11-DOC)** (>7 µg/dL) while cortisol decreases (<5 µg/dL). Secondary adrenal insufficiency is suggested in patients with a near-normal response to a 250-µg cosyntropin test but with an abnormal response to metyrapone. Patients suspected of having central adrenal insufficiency should be screened with MRI of the brain to assess for pituitary disease unless they have a history of chronic exogenous glucocorticoid use.

The cause of primary adrenal gland destruction can often be distinguished by antibody titers and/or distinctive appearance with imaging. Autoimmune disease is suggested by findings such as small glands; infection, with large adrenal glands; and hemorrhage as shown by enlargement with characteristic intensity.

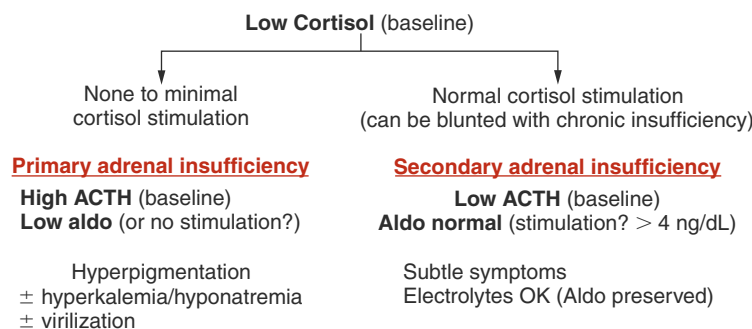

FIGURE 20-10. Differential diagnosis of low cortisol states.

Treatment of Adrenal Insufficiency

In primary adrenal insufficiency, synthetic steroids from the G and R zone are replaced—G-aldosterone (Florinef, 50–100 µg/day and F-cortisol (hydrocortisone, 20–25 mg/day or prednisone, 5 mg/day)—and in secondary insufficiency, steroidogenesis from the non-ACTH-regulated layers remains intact, so only cortisol is replaced. Most clinicians double the dose of glucocorticoids during mild stress and give hydrocortisone 300 mg/day in divided doses for significant stressors such as surgery.

HYPERCORTISOLISM

Overproduction of CRH or of ACTH, adrenal glucocorticoid secretion and exogenous intake cause hypercortisolism. Excess cortisol affects multiple systems, including immune (suppression, poor healing), dermatologic (thin, friable tissue, wide purple striae), vascular (vessel fragility, ecchymoses), adipose (increased fat with redistribution to upper back and central locations), muscle (wasting, proximal muscle weakness, heart failure), neurologic (peripheral neuropathy, autonomic dysregulation), bone (loss), renal (edema, HTN, calciuria), and metabolic (hyperglycemia and insulin resistance). Cortisol also has central nervous system actions, influencing pain perception and sense of well-being. Clinical presentation of hypercortisolism is variable, with no single feature common in all cases.

Multiple conditions are associated with high cortisol levels, with differing comorbidities and treatment options, as outlined in Figure 20-11. Determining the cause

of hypercortisolism can be difficult, as laboratory values and clinical findings often overlap between syndromes.

CUSHING’S SYNDROME

Cushing’s syndrome describes the array of signs and symptoms (Fig. 20-11) resulting from excess glucocorticoid production or prolonged exogenous steroid use. The most common causes of Cushing’s syndrome are ACTH-secreting pituitary adenoma (68%); autonomous cortisol production from an adrenal tumor (17%, ACTH is suppressed); and excess ectopic ACTH or CRH production (15%, usually malignant).^{10,11}

When Endogenous Cushing’s Syndrome Is Confirmed

Distinguishing ACTH-dependent versus ACTH-independent hypercortisolism is necessary as this directs the clinician to the most likely cause of the disease. This determination can be made with a reliable two-site IRMA assay for ACTH. One can presume that cortisol secretion is independent of ACTH if the serum cortisol is greater than 15 µg/dL with ACTH less than 5 pg/µL. If the ACTH is greater than 15 pg/µL, cortisol secretion is considered ACTH dependent. ACTH values between 5 and 15 pg/µL usually indicate cortisol secretion is also ACTH independent. Imaging for primary adrenal disease with CT or MRI of the adrenals is the next procedure in ACTH-independent Cushing’s syndrome. Adrenal adenomas are generally smaller than *carcinomas* and have lower unenhanced CT attenuation. MRI may provide even better differentiation between benign and malignant tumors.

Stress

Infection

Severe obesity (visceral)

Polycystic ovary syndrome (up to 40% have slightly elevated urine cortisol)

Chronic alcoholism (cortisol normalizes with abstinence)

Depression (up to 80% have abnormal cortisol levels, disappears with remission)

Iatrogenic Cushing’s (<1% inhaled, topical, oral glucocorticoid use)

Cushing’s Syndrome

Symptoms of Cushing’s Syndrome

| | |
|----------------------------|-----------------|
| HTN | (85–90%) |
| Central obesity | (90%) |
| Glucose intolerance | (80%) |
| Plethoric faces | (80%) |
| Purple striae | (65%) |
| Hirsutism | (65%) |
| Abnormal menses | (60%) |
| Muscle weakness | (60%) |

FIGURE 20-11. Conditions associated with hypercortisolism.

Pituitary versus Ectopic Adrenocorticotrophic Hormone Secretion

Most patients with ACTH-dependent Cushing's syndrome have pituitary adenomas or hyperplasia, but diagnosing ectopic sources of ACTH is virtually unimportant. ACTH and primary urine free cortisol is typically higher in ectopic ACTH syndrome than pituitary-dependent disease and hypokalemia and suggests an ectopic source. There is overlap between these causes. High-dose dexamethasone-suppression tests are relatively resistant to negative feedback regulation by glucocorticoids (dexamethasone), whereas most non-pituitary tumor-causing ectopic ACTH syndromes are completely resistant to feedback suppression, with the exception of some carcinoid tumors, frequently biochemical in origin. The high-dose test can be performed by an overnight test with 8–12 mg of dexamethasone administered at 11:00 PM followed by an 8:00 AM ACTH and cortisol measurement. The standard 2-day high-dose dexamethasone-suppression test uses 2 mg of dexamethasone every 6 hours for eight doses with measurement of urine free cortisol or *hydroxycorticosteroids*. In several studies, approximately 60% of patients with Cushing's disease exhibit greater than 90% suppression compared with none with ectopic disease. Thus, the sensitivity was greater than 60% and the specificity was 100% for Cushing's disease. Pituitary gland stimulation with CRH can also be performed.

Adrenocorticotrophic Hormone Source in Dexamethasone Nonsuppression Adrenocorticotrophic Hormone Secretion

From 60%–70% of patients with nonsuppressible ACTH secretion in response to high-dose dexamethasone will have Cushing's disease. *Scintigraphy* may be used for localization of neuroendocrine tumors.

Inferior Petrosal Sinus Sampling

The source of ACTH hypersecretion can be investigated by simultaneous sampling of blood from the inferior petrosal sinus and a peripheral vein both before and after stimulation of the pituitary gland with CRH. A petrosal sinus-to-peripheral blood ACTH ratio of greater than 2–3 is 97% sensitive and 100% specific for ACTH hypersecretion from the pituitary gland, or Cushing's disease.

Imaging with CT or MRI is used for localization of pituitary or ectopic ACTH-secreting tumors.

Patients with Cushing's share striking similarity with patients with type 1 diabetes (insulin resistant). They have a fourfold increase in mortality even after successful therapy, primarily a result of **cardiovascular disease (CVD)**. Because mineralocorticoid receptors are equally

responsive to glucocorticoids, excess cortisol can promote HTN in association with left ventricular hypertrophy. Electrocardiogram (ECG) abnormalities and loss of normal nocturnal fall in blood pressure are also seen. Untreated disease has a 5-year mortality rate of 50%.

Iatrogenic Cushing's syndrome is relatively common, but some sources may not be obvious. All glucocorticoids, including synthetic, inhaled, and topical, can inhibit ACTH secretion; therefore, plasma ACTH, serum cortisol, and cortisol excretion may all be low (unless cortisol or cortisone is used). In contrast, urine contamination with topical hydrocortisone (vulvovaginal or perineal use) can falsely elevate urine cortisol values. Relatively greater urinary than serum cortisol and cortisone values suggest that hydrocortisone is added to the urine. If suspected, synthetic glucocorticoids can be detected chromatographically.

Diagnosis of Cushing's Syndrome

Clinical symptoms are supported by laboratory findings of cortisol excess, loss of diurnal rhythm, and suppression resistance (once exogenous glucocorticoid administration is excluded because a universal diagnostic algorithm for Cushing's syndrome has not been established): (1) ACTH and cortisol are secreted in bursts and excess secretion may occur episodically; (2) each patient has unique metabolism, metabolites, and metabolic clearance rates; (3) stimulation and suppression thresholds often vary (nonsuppressible lesions can occasionally be suppressed, and normal patients can display suppression resistance); and (4) compliance and accuracy issues regarding sample collection and processing are common. Standard assessment tests for diagnosing Cushing's syndrome are listed next.¹²

Document Cortisol Excess

Urine free cortisol (and/or metabolites) (Fig. 20-3). Urine cortisol is a sensitive indicator of endogenous cortisolism. When serum cortisol exceeds the capacity of its carrier protein binding, free cortisol levels rise rapidly, increasing the free cortisol filtered into the urine. This value may be erroneous with high urine volume (>3 L) because patients who drink more than 5 L/day will have a 64% increase in urine cortisol. In contrast, urine **17-hydroxycorticosteroid (17-OHCS)** excretion occurs at a constant rate and is not affected by volume changes.

A 24-hour urine free cortisol measured by tandem mass spectroscopy (TMS) is the most sensitive (95%–100%) and specific (98%) screen for excess cortisol production. A revised method, collecting overnight (10:00 PM–8:00 AM) urine samples for cortisol factored by urinary creatinine, appears equally valid (specificity and sensitivity of 97%–100%). In one large study, 21%–47% of Cushing's syndrome patients had at least one normal

24-hour urine cortisol; therefore, patients with intermediate values should be reevaluated 2 to 3 months later.¹²

Random plasma cortisol levels are of little value for the diagnosis of Cushing's syndrome. Levels in normal people vary widely during the day and overlap with levels found in patients with Cushing's syndrome.

Baseline AM cortisol concentrations have no diagnostic value unless they are clearly above the normal range.

Determine if Diurnal Rhythm Is Lost (Late-Night Values Remain High)

Plasma cortisol is highest between 6:00 and 8:00 AM and 50% to 80% lower between 10:00 PM and 12:00 AM. Measuring late-night cortisol is justified by the fact that its normal evening nadir is lost in Cushing's syndrome and bilateral nodular hyperplasia but preserved in obese and depressed patients.

Ideally, a blood sample (for cortisol and ACTH) is drawn between 11:00 PM and 12:00 AM. Samples are stabilized, stored, and sent to the laboratory if the previously determined urine cortisol is elevated. Late-evening saliva, serum free or serum total cortisol values may be more reliable than urine cortisol for the diagnosis of Cushing's syndrome.

In two studies, a single midnight serum cortisol concentration (>7.5 $\mu\text{g/dL}$) was 90%–96% sensitive and 100% specific for Cushing's syndrome.¹²

In another study of Cushing's syndrome patients (30 normal and 18 obese subjects), a single 11:00 PM salivary cortisol level, when combined with the 8:00 AM salivary cortisol concentration after a 1-mg overnight dexamethasone-suppression test, had a sensitivity and specificity of 100%.¹²

Saliva cortisol is stable at room temperature for days and collection is noninvasive, can be performed at home, and has greater specificity (100%); however, it is less sensitive (92%) than serum or urine levels in detecting Cushing's syndrome. Midnight (12:00 AM) values less than 1.3 ng/mL determined by radioimmunoassay (RIA) or greater than 1.5 ng/mL by competitive protein-binding assay helps exclude the diagnosis. Saliva measurements are useful in patients with suspected intermittent Cushing's syndrome for whom numerous samples need to be collected over extended periods.

Determine Loss of Normal Cortisol Suppression by Dexamethasone

Dexamethasone acts as an exogenous cortisol substitute, suppressing ACTH if the pituitary gland is normal and cortisol secretion if the adrenal gland is normal.

An overnight dexamethasone-suppression test is commonly used to screen patients for autonomous overproduction of cortisol. Dexamethasone (1 mg) given at about 11:00 PM acts to suppress the early morning ACTH-stimulated rise in cortisol. Suppressed free cortisol less

than 3.6 $\mu\text{g/dL}$ measured between 8:00 and 9:00 AM is considered a negative test. Although it appears that repeated ingestion of dexamethasone minimizes individual differences in drug clearance, the low-dose (1 mg) suppression test was 95% accurate and equally reliable as the standard 2-day, low-dose dexamethasone suppression (0.5 mg every 6 hours to 2 days, with normal urine free cortisol <10 μg on day 2) per retrospective analysis of 426 Cushing's syndrome patients.

While the predictive value for a negative test nears 100%, false-positive results are common (up to 15%). Causes for this include testing errors, other cortisol suppression-resistant states (e.g., physical stress, anorexia nervosa, alcoholism, depression, acute illness, obesity, and renal insufficiency) and altered drug metabolism and drug interactions (e.g., dilantin, barbiturates, carbamazepine, and rifampin).

Except in rare cases, a normal (overnight or 2-day) dexamethasone-suppression test virtually excludes the possibility of Cushing's syndrome. Although not required for diagnosis, measured changes in saliva cortisol (normal, <2 ng/mL) and ACTH after dexamethasone suppression can be complementary for a diagnosis.¹³

As in adrenal insufficiency, ACTH levels, both baseline and following low (1 mg) or high (8 mg) dexamethasone suppression, can help determine an underlying etiology of cortisol excess states. One study demonstrated that high-dose dexamethasone was only 57% specific for differentiating an ectopic from pituitary source of ACTH hypersecretion (Fig. 20-12).¹²

When Cushing's Syndrome Is Confirmed, Corticotropin-Releasing Hormone Stimulation Tests Help Determine Adrenocorticotropic Hormone Dependency (Typically Not Necessary)

CRH stimulation is a newer and more helpful test for distinguishing types of Cushing's syndrome (central disease versus primary adrenal syndrome). An 8:00 AM serum cortisol and ACTH level is drawn following CRH injection. In ACTH-independent Cushing's syndrome, cortisol is high (>25 $\mu\text{g/dL}$) while ACTH is suppressed (<10 pg/mL), demonstrating ACTH production is not driving excess cortisol production. In this case, an adrenal cause for excess cortisol is sought. In ACTH-dependent Cushing's syndrome, both cortisol (>25 $\mu\text{g/dL}$) and ACTH (>10 pg/mL) are elevated. Autonomous ACTH is from a pituitary or ectopic source.

To determine if ACTH excess results from a pituitary or ectopic source, a CRH-stimulated bilateral, inferior, petrosal sampling (BIPSS) and peripheral vein sampling are performed. The results are expressed in a ratio. A petrosal sinus ACTH-to-peripheral vein ACTH ratio greater than 3 is diagnostic for pituitary disease. A ratio less than

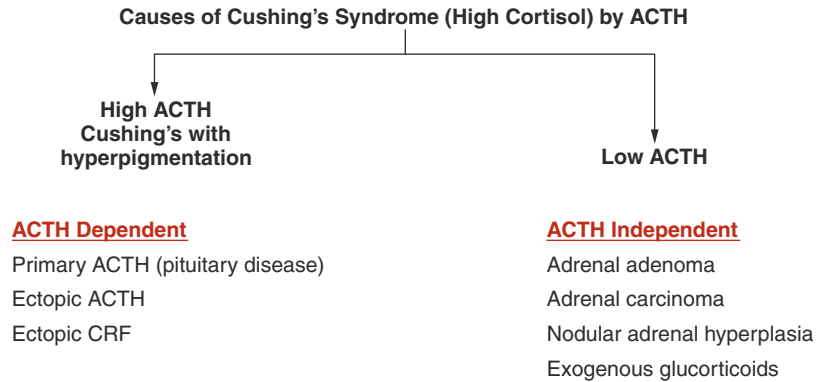

FIGURE 20-12. Differentiating source of ACTH secretion.

2.5 suggests an ectopic (nonpituitary) source of ACTH production. Remission rates for pituitary microadenoma approximate 85%; rates for invasive adenomas are less than 50% when resected. With additional treatment (pituitary x-irradiation), remission rates of invasive adenomas may slowly reach 85%.

For ectopic ACTH production, a neoplasm workup is performed; localization and surgical removal of autonomous ACTH producing lesions are attempted. Other treatment options include adrenalectomy and adrenal enzyme inhibitors.

Localization Procedures

- Adrenal Cushing's syndrome
 - Adrenal CT may discern tumor versus hyperplasia [R-layer DHEA(S) normal with F-layer adrenal adenomas].
 - Adrenal MRI T2-weighted image helps distinguish carcinoma. Cancer often involves other adrenal layers with the R-layer DHEA(S) being high in carcinoma; immunohistochemical markers, p53, and MIB-1 are also positive in carcinomas.

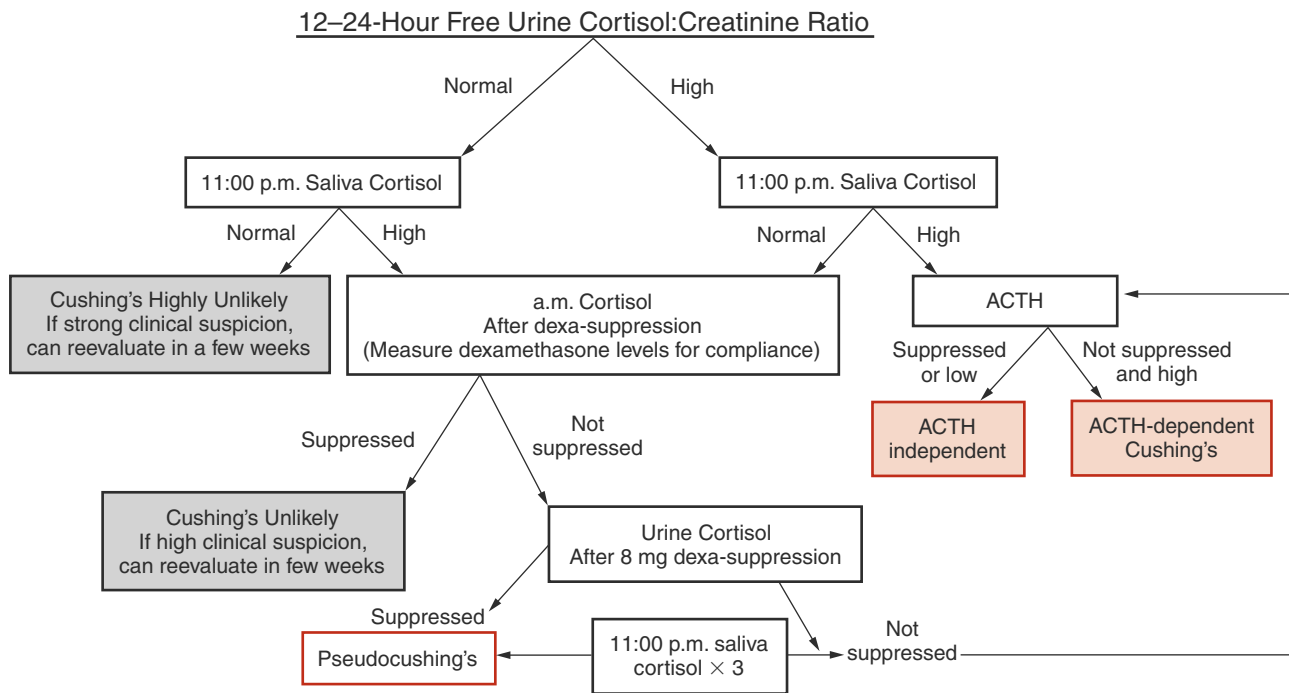

FIGURE 20-13. Cushing's syndrome workup. Note that dexamethasone serum levels (for standard test, 2 ng/mL; suppression test, 6.5 ng/mL) can be drawn at 8:00 AM (or 6 hours after the last dose) to help clarify or determine compliance. Normal dexamethasone saliva levels have not been determined.

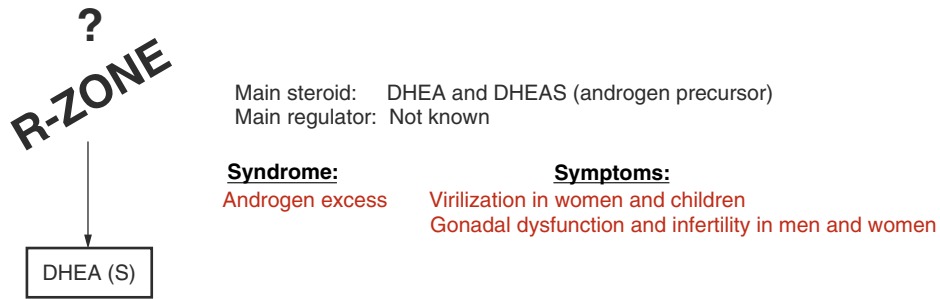

FIGURE 20-14. R-zone biosynthesis. Manifestations of adrenal hyperandrogenism vary with age, onset, and gender.

- Pituitary Cushing's syndrome
 - Pituitary MRI (detects 85% of microadenomas)
- Ectopic Cushing's syndrome
- Chest CT (e.g., ACTH bronchial adenoma, medullary thyroid carcinoma, and **squamous cell carcinoma [SCC]**)

Algorithm for Cushing's Syndrome Workup

DAY 1

8:00 AM: Completely empty bladder and start baseline urine collection.

11:00 PM: Collect saliva sample for cortisol level; ingest dexamethasone (1 mg); empty bladder; end baseline urine collection.

Optional extended workups: Begin overnight dexamethasone-suppressed urine collection.

DAY 2

8:00 AM: Empty bladder (postsuppression urine cortisol complete); venous blood or saliva for cortisol; ACTH; dexamethasone (compliance); hold samples until needed.

See flowcharting interpretation of Cushing's syndrome workup (Fig. 20-13).

Treatment

Options for primary (adrenal cortisol overproduction) and secondary (pituitary or ectopic ACTH overproduction) Cushing's syndrome are similar: surgery, radiation, and/or medications to suppress adrenal cortisol production or actions. Treatment strategies vary with clinical situations.

Lifelong replacement of glucocorticoids and mineralocorticoids (Florinef) is necessary in patients with bilateral adrenalectomy. Any patient undergoing bilateral adrenalectomy as a result of an ACTH-producing pituitary tumor should be routinely screened and closely followed for symptoms of increasing mass lesion of the pituitary gland (Nelson's syndrome). Finally, Cushing's syndrome can recur in adrenal rests; there-

fore, periodic, lifetime screening for adrenal overproduction is warranted in these patients.

Androgens are produced as byproducts of cortisol synthesis that are regulated by ACTH. Although prolactin, pro-opiomelanocortin peptides, and T-lymphocytes are known stimulators of androgens, regulatory mechanisms of R-zone biosynthesis remain uncertain (Fig. 20-14). R-cells primarily produce DHEA and multiple 19-carbon steroids (androgens and estrogens) from 17 α -hydroxylated pregnenolone and progesterone. DHEA is sulfated to DHEAS by sulfotransferase, an adrenal enzyme, and secreted daily (Fig. 20-1).

Both DHEA and DHEAS are precursors to more active androgens (e.g., androstenedione, testosterone, and **5-dehydrotestosterone [5-DHT]**) and estrogens (e.g., estradiol and estrone). Although DHEA and DHEAS have minimal androgenic activity, adverse effects are caused by conversion to active androgens in the adrenals and peripheral tissue, such as hair follicles, sebaceous glands, genitalia, adipose, and prostate tissue. Although men derive less than 5% of their testosterone from adrenal or peripheral sources, women rely on the adrenals for 40% to 65% of their daily testosterone production.¹⁴

Although observational data demonstrate adrenal androgen production increases in both genders in late childhood and correlates with the onset of pubic hair (adrenarche), it peaks in young adults and progressively declines with age.

ANDROGEN EXCESS

Androgen excess causes ambiguous genitalia in infant girls and precocious puberty in children of both sexes. Androgens stimulate organ development, linear growth, and epiphyseal fusion. Virilization in boys includes penile enlargement, androgen-dependent hair growth, and other secondary sexual characteristics. Girls develop hirsutism, acne, and clitorimegaly. Untimely overproduction can cause short stature by leading to early epiphyseal fusion.

In women, androgen overproduction can cause infertility, with masculinizing effects (e.g., hirsutism, acne, male pattern baldness, menstrual irregularities, and virility).

In men, excess adrenal androgens can also cause infertility with feminizing effects by inhibiting pituitary gonadotropins, which effectively lowers testicular testosterone production. Despite overall androgen excess, males can experience hypogonadal symptoms, such as loss of muscle mass, decreased hair growth, decreased testes size, testicular testosterone production, and spermatogenesis, similar to hypercortisolism.

Diagnosis of Excess Androgen Production

Less than 10% of DHEAS and DHEA are produced by the gonads, therefore, high DHEAS and DHEA production strongly suggests adrenal hyperandrogenism, whereas elevated testosterone values are seen with either adrenal or gonadal hyperandrogenism.

Plasma DHEAS, DHEA, or urine 17-ketosteroids can identify patients with adrenal causes of pathologic masculinization (females) and feminization (males).

Treatment for Adrenal Androgen Overproduction

Similar to the previously described disorders of overproduction, differentiation between ACTH-dependent and -independent secretion is assessed by dexamethasone-suppression tests; then imaging studies are performed (CT, MRI). Adenomas and carcinomas are surgically removed. Glucocorticoid-suppressible causes are treated accordingly. Exogenous contributors are discontinued and other nonadrenal conditions are treated. Drugs with antiandrogenic properties (e.g., minoxidil, spironolactone, birth control pills) are occasionally used.

Exogenous DHEA is a popular nutritional supplement with numerous purported properties (only a few studied), including vasodilatory, anti-inflammatory, antiaging, and antiatherosclerosis.

The clinical relevance of DHEA(S) interactions with nonandrogen/estrogen receptors remains unknown. DHEA (4 mg/day) and DHEAS (7–15 mg/day) are secreted as the major component of adrenal androgens.

There is no evidence that this molecule is required for health or that it contributes to disease. Steroid receptors for DHEA have not been clearly identified. DHEA actions are attributed to its downstream products, testosterone and estrogen.

In normal and compromised patients (e.g., adrenal insufficiency, glucocorticoid therapy, depression, older persons, and trained athletes), DHEA can increase the sense of well-being and raises or lowers a variety of serum markers (Fig. 20-15), although the changes are small. Supplementation (50–100 mg/day) in some androgen-deficient patients (e.g., those with adrenal insufficiency, ACTH deficiency, and glucocorticoid therapy) may help ameliorate deficiency adverse effects and may inhibit glucocorticoid induced bone loss. However, DHEA can cause adverse androgenic effects in women, and the long-term consequences of supplementation remain unknown.

THE ADRENAL MEDULLA

In response to stimulation, the medulla secretes catecholamines directly into the circulation in lieu of transmitting messages via efferent axons. It functions as an atypical sympathetic ganglion. Medullary catecholamine products serve as first responders to stress by acting within seconds (cortisol takes 20 minutes) to promote the fight-or-flight response, which increases cardiac output and blood pressure, diverts blood toward muscle and brain, and mobilizes fuel from storage.

Development

Sympathetic cells arise from primordial neural crest stem cells (sympathogonia), which migrate out of the central nervous system to a space behind the aorta where they differentiate into sympathoblasts (sympathetic ganglion cells) or pheochromoblasts (medulla chromaffin cells). Tumors that arise from either cell line share similar histologic and biochemical properties. Malignant neuroblastomas and benign ganglioneuromas arise from sympathoblasts, secrete **homovanillic acid**

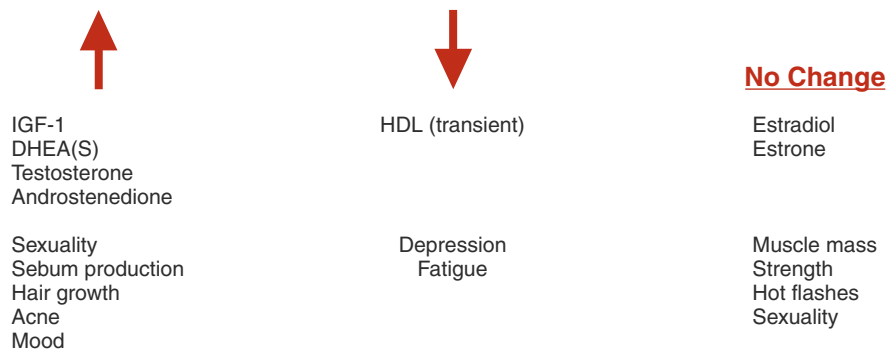

FIGURE 20-15. Effects of DHEA supplementation.

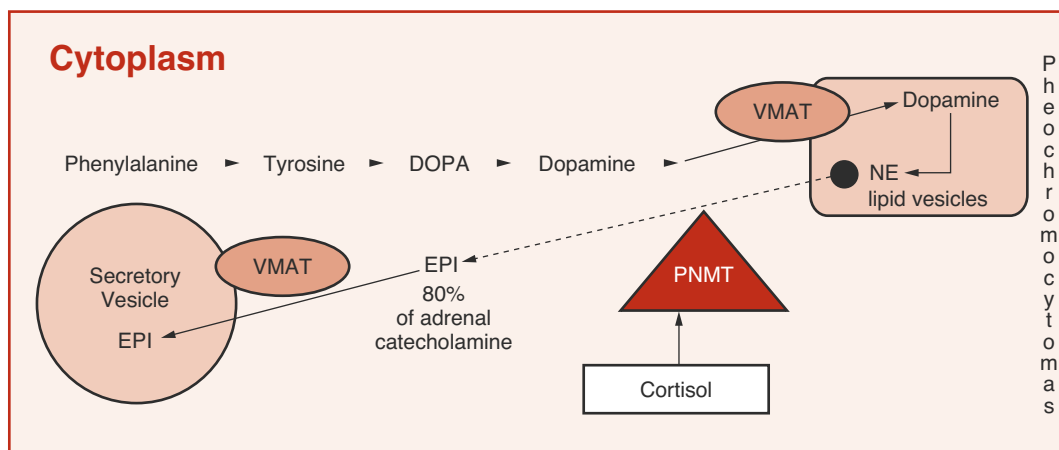

FIGURE 20-16. Biosynthesis and storage of catecholamines.

(HVA) and are rarely seen after adolescence. In contrast, tumors of chromaffin cells (**pheochromocytomas**) maintain the capacity to synthesize and store catecholamines (**norepinephrine [NE]** and EPI) throughout life.¹⁵

Biosynthesis and Storage of Catecholamines

NE and EPI biosynthesis begins with the sequential conversion of phenylalanine substrates in a tightly regulated, compartmentalized manner. All reactions take place in the cytoplasm, except for the production of NE, which occurs within lipid vesicles or outer mitochondrial membranes, as illustrated in Figure 20-16.

In sympathetic neurons, cytoplasmic dopamine is sequestered into vesicles, converted into NE, and stored until nerve stimulation causes its release.

In medulla chromaffin cells, NE can passively diffuse into the cytosol. In the cytosol, NE is converted into EPI by a cortisol-dependent enzyme called **phenylethanolamine N-methyltransferase (PNMT)**. Any form of stress that increases cortisol levels stimulates EPI production. Free cytosolic EPI (like dopamine) is actively transported into secretory vesicles by **vesicle monoamine transporters (VMAT)** in pheochromocytes. The ratio of NE to EPI in the serum is normally 9:1 (98% from postganglionic neurons, 2% from the medulla). In adrenal insufficiency (low cortisol), that ratio increases to 45:1 in females and 24:1 in males.

Catecholamine Degradation

All catecholamines are rapidly eliminated from target cells and the circulation by three mechanisms:

1. Reuptake into secretory vesicles
2. Uptake in nonneuronal cells (mostly liver)
3. Degradation

Degradation relies on two enzymes—**catechol methyltransferase (COMT)** (in nonneuronal tissues) and **monoamine oxidase (MAO)** (within neurons)—to produce metabolites (metanephrines and VMA) from free catecholamines. Metabolites and free catecholamines are eliminated by direct filtration into the urine and excreted as free NE (5%), conjugated NE (8%), metanephrines (20%), and VMA (30%). Urine EPI (50%) is converted from NE by renal, not adrenal, before excretion (Fig. 20-17).

Urine and Plasma Catecholamine Measurements

Catecholamines are hydrophilic, circulate in low levels (50% albumin bound), have short half-lives (seconds to 2 minutes), and produce wide, rapidly fluctuating plasma levels that render accurate determination and interpretation technically challenging.

Urine catecholamines (free NE and EPI) are assayed using liquid chromatography, fluorometry, and liquid chromatography (LC)-tandem mass spectrometry (MS/MS) (LC-MS/MS). Twenty-four-hour urine catecholamine and metabolite levels are more reliable and are not altered by age or gender.

Most antihypertensive drugs and many other medications interfere with accurate catecholamine measurement by fluorometric assays. Substances causing autofluorescence (e.g., tetracyclines, ephedrine, α -methyl dopa) can produce erroneous results when measured by fluorometric assays. Central α -antagonists (clonidine) and thiazides are preferred agents to control HTN during evaluation of conditions causing excessive sympathetic activation (high catecholamine states).

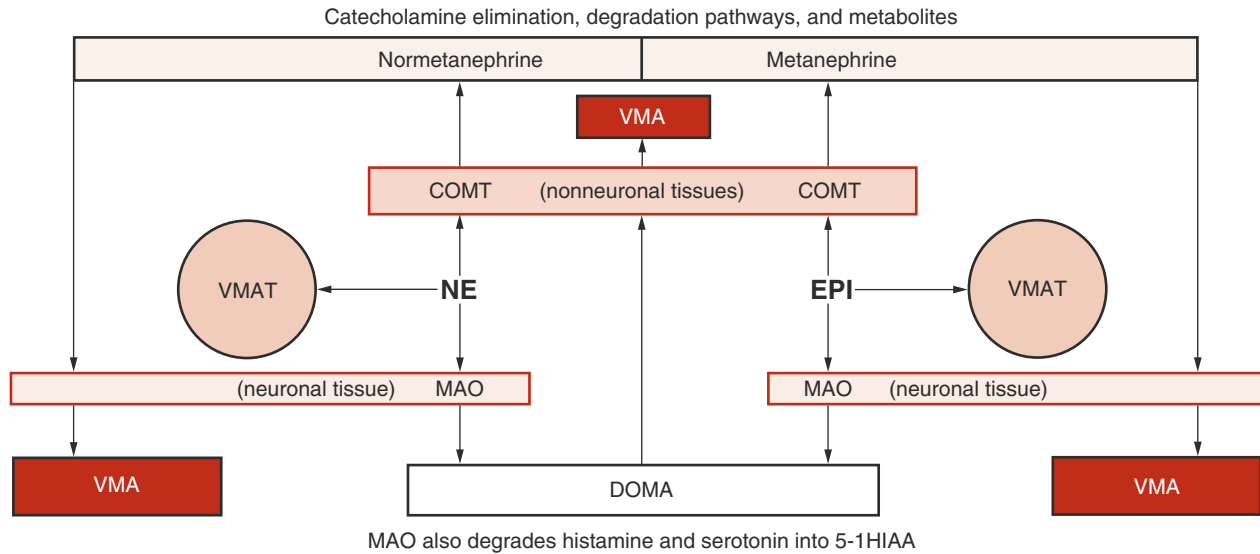

FIGURE 20-17. Catecholamine degradation. Free catecholamines (EPI and NE) are either sequestered into VMAT-containing vesicles or converted into metabolites, DOMA by neuronal MAOs and metanephrines by nonneuronal COMTs. These metabolites are ultimately degraded to VMA (DOMA by COMTs and metanephrines by MAOs) and excreted.

Causes of Sympathetic Hyperactivity

- Autonomic dysfunction
- Panic attack (emotions)
- Stress responses: hypoglycemia, injury, infarction, infection, psychosis, and seizures
- Drugs: decongestants, appetite suppressors, stimulants, bronchodilators, MAO inhibitors, thyroid hormone, cortisol, nicotine withdrawal, or short-acting sympathetic antagonists (clonidine or propranolol)
- Foods containing tyramine: imported beer, red wine, soy sauce, overripe/fermented foods, smoked or aged meats
- Pheochromocytoma (catecholamine-producing tumor).

Pheochromocytomas are rare (<0.1% of hypertensive patients), catecholamine producing tumors arising from chromaffin tissue, which causes HTN in association with nonspecific clinical symptoms that mimic anxiety. Symptoms include palpitations, diaphoresis, and headaches. In a retrospective study, 40% of patients evaluated for pheochromocytoma met the criteria for panic disorder, compared with 5% of control patients with HTN (Fig. 20-18).^{16,17}

Patient presentation is highly variable; most patients have episodes of HTN (diastolic/orthostatic), palpitations, and diaphoresis, with nonspecific periods of symptoms initiated by various stimuli, including physical exertion, torso twisting, Valsalva, micturition, or coitus. Others have sustained HTN (some refractory to treatment) and many have no symptoms. Rarely, patients with pheochromocytoma present with episodic hypotension (exclusive EPI or dopamine secreting). Additional signs may include pallor, increased erythrocyte sedimentation rate, dilated cardiomyopathy, and erythrocytosis as a result of overproduction of erythropoietin. Pheochromocytoma diagnosis is rarely confirmed.

Mechanisms of catecholamine secretion by persons with pheochromocytoma remain unclear (tumors are not innervated). Increased catecholamine synthesis, limited degradation capacity, and limited storage for excess NE and metabolites likely cause spillover into the blood, increasing circulating free NE and/or EPI along with other active peptides that cause symptoms. Because medullary catecholamines and adrenal cortical hormones serve similar functions that produce

| | |
|---|---|
| <p>10%</p> <p>Incidentally discovered (imaging, surgery, autopsy)</p> <p>Multiple</p> <p>Extra-adrenal (chest, neck abdomen, bladder)</p> <p>Malignant (invasion, distant metastases)</p> <p>Familial (Von Hippel-Lindau, MEN-II, parathyroid hyperplasia, medullary thyroid carcinoma, neurofibromatosis, paraganglioma)</p> | <p>90%</p> <p>Intra-adrenal</p> <p>Intra-abdominal (95%)</p> <p>Single</p> <p>Benign</p> |
|---|---|

FIGURE 20-18. Pheochromocytomas.

similar effects, a rare patient with clinical and biochemical evidence of catecholamine hypersecretion may have an adrenocortical adenoma or carcinoma rather than a medullary tumor causing the symptoms. Pheochromocytoma symptoms are related to the type of catecholamines secreted by the tumor and the receptors they activate.

Diagnosis of Pheochromocytoma

The best test for diagnosing pheochromocytoma is measurement of fractionated metanephrines and catecholamines in a 24-hour collection. This yields a sensitivity of 98% and a specificity of 98%. Fractionated plasma free metanephrines have a high sensitivity (96%–100%) but a poor specificity (85%–89%), which is even lower (77%) in patients older than 60 years. Although the majority of patients with pheochromocytoma have obvious diagnostic abnormalities on most tests, others can produce confounding results. When one test is equivocal, a different test should be performed if clinical suspicion remains high.^{18,19}

Measuring both total plasma catecholamines (NE and EPI) and urine metanephrines is the most sensitive screening profile. Plasma catecholamines greater than 2,000 pg/mL in a rested, supine patient with an indwelling cannula is nearly diagnostic of pheochromocytoma. Of 287 patients with pheochromocytoma, 88% had elevated plasma NE and EPI, which increased to 100% during hypertensive episodes despite no correlation between blood pressure and basal catecholamine levels.²⁰ With borderline values (1,000–2,000 pg/mL), a clonidine-suppression test can be helpful.

Plasma metanephrines, measured by high-performance liquid chromatography or RIA, are touted as the most specific and sensitive diagnostic test. Yet, investigators at the Mayo Clinic found that plasma metanephrines lack specificity (15% false-positive rate) and do not recommend it as a first-line test but reserve it for high-risk patients or patients who cannot collect an accurate 24-hour urine specimen. Urine metanephrines (normal, >1.2 mg/day) may be the most sensitive urine test; it is less likely to be altered by drugs or certain foods. An overnight urine collection (8–12 hours) appears as accurate as and more convenient than a 24-hour urine collection. Urine VMA by high-performance liquid chromatography or fluorometric assay has the highest false-negative rate (up to 41%) of the urine catecholamine tests.²¹

Chromogranin A is costored and secreted in quantum with catecholamines. Eighty percent of pheochromocytoma patients have increased plasma chromogranin levels. Serum chromogranin A is not routinely measured because it is less sensitive and specific for pheochromocytoma than are direct catecholamine and metabolite

measurements. In combination, serum chromogranin A and plasma catecholamines are specific (95%) but less sensitive (88%), likely because of high dependence on renal function. If the glomerular filtration rate is less than 80 mL/min, test sensitivity drops to 70%. Combined, resting plasma catecholamines greater than 200 pg/mL and chromogranin A greater than 20 pg/mL have a positive predictive value of 97% when glomerular filtration rate is normal.

If results of preceding tests are equivocal, pharmacologic tests are performed to separate patients with pheochromocytoma (low levels of biosynthetic activity) from those without pheochromocytoma who are experiencing similar symptoms secondary to increased sympathetic outflow (clonidine, an antihypertensive agent, suppresses sympathetic outflow).

Clonidine-suppression test (92% accurate) addresses the question, “Is excess catecholamine production suppressible?” Because sympathetic activation is not responsible for pheochromocytoma catecholamine release, suppressing sympathetic activation via clonidine activation of central α_2 -receptors will not lower NE levels in patients with pheochromocytoma despite improving the symptoms.

After stopping antihypertensive drugs for at least 12 hours, total plasma catecholamines are measured. Clonidine (0.3 mg) is administered and repeat levels are drawn 3 hours later. Patients without pheochromocytoma will have a fall in plasma total catecholamines to greater than 500 pg/mL (this is inaccurate in patients with normal catecholamine levels).²²

Biochemical confirmation of pheochromocytoma should be followed by radiologic localization. Although any site containing paraganglionic tissue may be involved, the most common extra-adrenal locations are the superior and inferior para-aortic areas (75%), bladder (10%), thorax (10%), and head, neck, and pelvis (5%).

For localization of pheochromocytoma, either CT (without dye) or MRI of the abdomen and adrenal glands is performed. On T2-weighted images, pheochromocytomas appear hyperintense, while other adrenal tumors look isointense compared with the liver. Either test detects most sporadic tumors (typically, ≥ 3 cm) with 98% to 100% sensitivity and 70% specificity. The lower specificity is due to relatively higher prevalence of adrenal *incidentalomas*. The ¹²³I-labeled MIBG (an NE analogue that concentrates in the adrenal and pheochromocytoma via VMAT) scintigraphy can be performed that is 100% specific for pheochromocytoma but not sensitive enough for routine screening. PET scanning with ¹⁸F-fluorodeoxyglucose, ¹¹C-hydroxyephedrine, or 6-[¹⁸F]fluorodopamine may be helpful in identifying sites of metastatic disease.²³

Treatment of Pheochromocytoma

Once pheochromocytoma is diagnosed, all patients are surgical candidates following appropriate medical preparation. Removal is a high-risk procedure. In the largest surgical series (147 pheochromocytoma patients) at one institution (1975–1997), overall perioperative mortality and morbidity rates were 2.4%.¹⁸ Patients with severe preoperative HTN, high-secretion tumors, or those undergoing repeat intervention were at highest risk for complications. Catecholamines fall to normal within 1 week of resection.

Although perioperative α -blockade is widely recommended, fewer perioperative complications were observed in those not given α -blockers (study of 113 pheochromocytoma patients undergoing resection). A second regimen proposed by the Cleveland Clinic resulted in successful use of a calcium channel blocker for blood pressure control.

Outcome and Prognosis

Surgical removal of a pheochromocytoma is the primary therapy; nevertheless, excision does not necessarily lead to long-term cure of pheochromocytoma or HTN (even in patients with benign tumors). Patients with familial pheochromocytomas are more likely to have recurrence. In one series of 114 patients,

pheochromocytoma recurred in 14% (48% of those were malignant). In patients without recurrence (86%), the HTN-free survival was only 74% at 5 years and 45% at 10 years (family history of HTN and increasing age were risk factors). In 90 patients, the 20-year overall cause-specific survival rate was 80% regardless of pheochromocytoma location.²⁰ Long-term monitoring is indicated in all patients, even those who are apparently cured.

ADRENAL “INCIDENTALOMA”

Given the very common use of CT, MRI, and ultrasound imaging of the abdomen for reasons unrelated to the adrenal glands, many adrenal masses, typically greater than 1 cm in diameter, are found incidentally and are thus termed “incidentalomas.” Autopsy studies report a frequency of adrenal adenomas at about 6%, and the prevalence increases with age.^{24,25} Although most of these lesions are nonfunctioning and benign, all should be assessed for malignancy or hypersecretion.²⁶ Surgery is considered if the adrenal mass is cancerous; is autonomously secreting cortisol, aldosterone, or catecholamines; is 4 cm or greater in diameter; or is growing.²⁷

Figure 20-19 illustrates a brief functional screen for adrenal masses, which assesses function of all adrenal layers and serves as a clinical summary.

| Incidentaloma Function Evaluation | | |
|-----------------------------------|---|--|
| | Clinical Features | Screening Tests Negative Results |
| Pheochromocytoma | HTN (paroxysmal) with spells (sweating, HA, or palpitations) | 24-hour urine metanephrines < 1 μ g or 5.5 μ mol/mg creatine |
| Cushing's syndrome | HTN , obesity (truncal) weakness | 1 mg bedtime dexamethasone 8 a.m. cortisol < 3.6 μ g/dL, or 24-hour urine free cortisol normal |
| Primary aldosteronism | HTN , hypokalemia, weakness | Serum potassium, <i>if low</i> urine K^+ excretion (<30 mEq) |
| Adrenocarcinoma | Virilization (+ above) | Plasma renin:aldosterone ratio < 30 Plasma DHEAS (< 9.2 μ mol/L) Urine 17-ketosteroid < 20 mg |

FIGURE 20-19. Brief functional screen for adrenal masses.

CASE STUDY

Hypertension is common and most often presents as an independent medical condition. Occasionally, hypertension is a result of an underlying illness and requires different treatment. Because adrenal function is critical for (1) blood pressure, (2) potassium, and (3) glucose homeostasis, an adrenal etiology should be considered in all patients with blood pressure problems accompanied by electrolyte abnormalities, unexplained change in weight, failure to thrive, inappropriate virilization, and anxiety periods.

Eight different clinical scenarios are presented below. Each presentation is associated with a different diagnosis and treatment. A discussion of adrenal causes, diagnoses, and treatments for each are found within the chapter. Each numbered case study completes the following opening statement: A 22-year-old woman (previously adopted, not currently taking medications, negative medical history) presents with . . .

CASE STUDY 20-1

. . . hypertension, with weakness and hypokalemia. The patient also has a high urine potassium excretion without diuretics.

Question

1. What is the diagnosis?

CASE STUDY 20-4

. . . hypertension, with periods of panic attacks and hot flashes. She also presents with headache, hyperglycemia, hyperthyroidism, and gastrointestinal complaints.

Question

1. What is the diagnosis?

CASE STUDY 20-2

. . . hypertension, with weakness and rapid onset of obesity. This patient also exhibits central fat pads, buffalo hump, plethora, thin skin, purple striae, easy bruising, osteoporosis, hyperglycemia/insulin resistance, and recurrent infections.

Question

1. What is the diagnosis?

CASE STUDY 20-5

. . . hypertension, with virilization. This young woman presents with irregular menses diagnosed with polycystic ovary syndrome. She has a borderline low cortisol and elevated 17-OH progesterone.

Question

1. What is the diagnosis?

CASE STUDY 20-3

. . . hypertension, with weakness, irregular menses, and hypokalemia. Her young age, borderline low cortisol, and low androgens also are significant.

Question

1. What is the diagnosis?

CASE STUDY 20-6

. . . hypertension and hyperkalemia. She has normal renal function (low urine potassium⁺) and metabolic acidosis.

Question

1. What is the diagnosis?

CASE STUDY 20-7

. . . hypotension, failure to thrive, weight loss, and weakness. Her laboratory results reveal hyperkalemia, fasting hypoglycemia, and metabolic acidosis.

Question

1. What is the diagnosis?

CASE STUDY 20-8

. . . new virilization and hirsutism. Laboratory results show increased IGF-I (insulin growth factor I), DHEA(S), and testosterone levels. She is a health food enthusiast who experiments with nutritional supplements.

Question

1. What is the diagnosis?

REFERENCES

1. Kacsoh D. The adrenal gland. In Dolan J, ed. *Endocrine physiology*. New York: McGraw-Hill, 2000:360–448.
2. Orth D. Anatomy and development of the adrenal cortex. Retrieved from www.UpToDate.com, online 12.1, 12/03.
3. Miller W. The adrenal cortex. In Felig P, ed. *Endocrinology and metabolism*. New York: McGraw-Hill, 2001:387–493.
4. Lacroix A. The adrenal cortex: basic concepts and diagnostic procedures. In: Pinchera A, et al, eds. *Endocrinology and metabolism*. London: McGraw-Hill, 2001:285–297.
5. Orth D. Adrenal steroid biosynthesis and congenital adrenal hyperplasia. www.UpToDate.com, online 12.1, 3/02.
6. Levine L. Congenital adrenal hyperplasia. In Lavin M, ed. *Manual of endocrinology and metabolism*. Philadelphia, Pa.: Lippincott Williams & Wilkins, 2002:147–163.
7. Stern N. The adrenal cortex and mineralocorticoid hypertension. In: Lavin M, ed. *Manual of endocrinology and metabolism*. Philadelphia, Pa.: Lippincott Williams & Wilkins, 2002:115–139.
8. Kaplan N. Primary aldosteronism. In: Pine J, ed. *Clinical hypertension*. Baltimore, Md.: Lippincott Williams & Wilkins, 1998:365–383.
9. Thomopoulos P. Adrenocortical insufficiency. In: Jeffers D, ed. *Endocrinology and Metabolism*. London: McGraw-Hill, 2001:297–305.
10. Bertagna X. Cushing's syndrome. In Pinchera A, et al, eds. *Endocrinology and metabolism*. London: McGraw-Hill, 2001:311–323.
11. Besser G. Cushing's syndrome. *J Clin Endocrinol Metabol* 1972;1:451.
12. Orth D. Establishing the diagnosis of Cushing's syndrome. www.UpToDate.com, online 12.1, 12/02.
13. Castro M, Quidute A, et al. Out-patient screening for Cushing's syndrome: Sensitivity of the combination of circadian rhythm and overnight dexamethasone suppression salivary cortisol tests. *J Clin Endocrinol Metabol* 1999;84:878.
14. Chrovos G. Dehydroepiandrosterone and its sulfate. www.UpToDate.com, online 12.1, 4/03.
15. Bravo E. The adrenal medulla: basic concepts. In: Pinchera A, et al, eds. *Endocrinology and metabolism*. London: McGraw-Hill, 2001:337–341.
16. Kaplan N. Pheochromocytoma. In: Pine J, ed. *Clinical hypertension*. Baltimore, Md.: Lippincott Williams & Wilkins, 1998:345–365.
17. Sowers K. Pheochromocytomas. In: Lavin M, ed. *Manual of endocrinology and metabolism*. Philadelphia, Pa.: Lippincott Williams & Wilkins, 2002:139–145.
18. Bravo E. Diagnosis and Management of Pheochromocytoma. In: Pinchera A, et al, eds. *Endocrinology and metabolism*. London: McGraw-Hill, 2001:341–349.
19. Fogarty J, Russo J, et al. Hypertension and pheochromocytoma testing: the association with anxiety disorders. *Arch Fam Med* 1994;3:55.
20. Young W, Kaplan N. Diagnosis and treatment of pheochromocytoma in adults. www.UpToDate.com, online 12.2, 1/04.
21. Sawka A. Fractionated plasma metanephrines are highly sensitive, but less specific than urinary total metanephrines and catecholamines in detection of pheochromocytoma. Program and Abstracts of The Endocrine Society's 83rd Annual Meeting, Denver, June 20–23, 2001, Abstract #P1-642. Denver, CO: The Endocrine Society, 2001:285.
22. Sjoberg R, Kidd G. The clonidine suppression test for pheochromocytoma: a review of its utility and pitfalls. *Arch Int Med* 1992;152:1193.
23. Pacak K, Eisenhofer G, Carrasquillo J, et al. 6-[¹⁸F]fluorodopamine positron emission tomographic (PET) scanning for diagnostic localization of pheochromocytoma. *Hypertension* 2001;38:6–8.
24. Young WF Jr. Management approaches to adrenal incidentalomas: A view from Rochester, Minnesota. *Endocrinol Metab Clin North Am* 2000;29:159–185.
25. Kloos RT, Gross MD, Francis IR, Korobkin M, Shapiro B. Incidentally discovered adrenal masses. *Endocr Rev* 1995;16:460–484.
26. Lutton J. The incidentally discovered adrenal mass. In: Pinchera A, et al, ed. *Endocrinology and metabolism*. London: McGraw-Hill, 2001:323–329.
27. Young WF Jr. The incidentally discovered adrenal mass. *N Engl J Med* 2007;356:601–610.

Gonadal Function

Marissa Grotzke

CHAPTER

21

CHAPTER OUTLINE

■ THE TESTES

Functional Anatomy of the Male Reproductive Tract
Physiology of the Testicles
Disorders of Sexual Development and Testicular Hypofunction
Diagnosis of Hypogonadism
Testosterone Replacement Therapy
Monitoring Testosterone Replacement Therapy

■ THE OVARIES

Functional Anatomy of the Ovaries
Hormonal Production by the Ovaries

The Menstrual Cycle
Hormonal Control of Ovulation
Pubertal Development in the Female
Menstrual Cycle Abnormalities
Hirsutism
Estrogen Replacement Therapy

■ SUGGESTED READINGS

■ REFERENCES

THE TESTES

The testes are paired, ovoid organs that serve the dual functions of (1) production of sperm and (2) production of reproductive steroid hormones.¹ In the embryonic stage, the dominant male sex hormone, testosterone (T), aids in development and differentiation of the primordial gonads. After puberty, throughout adulthood, and until late in old age, testosterone helps with sperm production and maintains secondary sexual characteristics.

Functional Anatomy of the Male Reproductive Tract

The testes are located outside the body, encased by a muscular sac. Blood flow is governed by an intricate plexus of arterial and venous blood flow that, together with contraction of the dartos muscle in the scrotal sac, regulates the temperature of the testicles to 2°C below core body temperature. This important function is vital to uninterrupted sperm production. Also encased in the muscular sheath is the spermatic cord, which has the ability to retract the testicles into the inguinal canal in instances of threatened injury. The testes themselves are comprised of two anatomical units: a network of tubules, known as the seminiferous tubules, and an interstitium. The tubules contain germ cells and Sertoli cells and are responsible for sperm production. The sperm move sequentially through

the tubuli recti; rete testes; ductuli efferentes testes; the head, body, and tail of the epididymis; and, finally, into the vas deferens. Various secretory products of the seminal vesicles and prostate mix with sperm to form the final product: semen. Seminal vesicle secretions are rich in vitamin C and fructose, important for the preservation of motility of the sperm.

Physiology of the Testicles

Spermatogenesis

Sperm are formed from stem cells called *spermatogonia*. The spermatogonia undergo mitosis and meiosis; finally, the haploid cells transform to form mature sperm.² The mature sperm has a head, body, and tail, which enables it to swim for the purpose of forming a zygote with the haploid ovum. Certain spermatogonia stagger division so that sperm production is uninterrupted and continuous. The Sertoli cells are polyfunctional cells that aid in the development and maturation of sperm.

Hormonogenesis

Testosterone, the predominant hormone secreted by the testes, is controlled primarily by two pituitary hormones: **follicle-stimulating hormone** (FSH) and **luteinizing hormone** (LH).^{3,4} Because these hormones were first described in women, they are named in reference to the menstrual cycle. Both hormones are produced by a single

group of cells in the pituitary called *gonadotrophs*. FSH acts primarily on germinal stem cells and LH acts primarily on the **Leydig cells**—located in the testicular interstitium—that synthesize testosterone.

Hormonal Control of Testicular Function

The hypothalamus, located in the brain, generates a hormone called gonadotropin-releasing hormone (GnRH) in a pulsatile fashion. GnRH is released into the portal hypophysial system that, in turn, determines the production of LH and FSH from the pituitary gland. Impaired pulse generation of GnRH leads to inadequate production of LH and FSH, resulting in **hypogonadism**.^{4,5} The first, and rate-limiting, step in the testicular steroidogenesis is the conversion of cholesterol to pregnenolone. This cholesterol is either trapped by endocytosis from the blood or synthesized within the Leydig cells. The LH binds to the glycoprotein receptor in the cell wall and induces intracellular cyclic AMP production that, in turn, activates protein kinase A, which catalyzes protein phosphorylation. This latter step induces testosterone synthesis. The testicular steroidogenesis pathway is similar to the pathway in the adrenal cortex and they share the same enzymatic systems. Testosterone is the principal **androgen** hormone in the blood. It is largely bound, with 2%–3% free. About 50% of testosterone is bound to albumin and about 45% is bound to sex hormone-binding globulin (SHBG). The concentration of binding protein determines the level of total testosterone but not the free testosterone levels during laboratory estimation. Testosterone and **inhibin** are the two hormones secreted by the testes that provide feedback control to the hypothalamus and pituitary.

Testosterone concentration fluctuates in a circadian fashion, reflecting the parallel rhythms of LH and FSH levels. This fact should be considered when interpreting serum levels of testosterone: the highest level is found at about 8 AM and correlates with most laboratory normal ranges, and the lowest level is found at about 8 PM.

Cellular Mechanism of Testosterone Action

Testosterone enters the cell and converts to dihydrotestosterone (DHT). DHT complexes with an intracellular receptor protein and this complex binds to the nuclear receptor, effecting protein synthesis and cell growth.

Physiologic Actions of Testosterone

Prenatal Development

Early in development, embryos have primordial components of the genital tracts of both sexes. The primitive gonads become distinguishable at about the seventh week of embryonic stage. Both chorionic gonadotropins and fetal LH stimulate production of testosterone by the fetal Leydig cells. Exposure of testosterone to the Wolffian duct leads to differentiation of the various components of the male genital tract. **Sertoli cells** produce müllerian regression factor, which aids in regression of the female primordial genital tract. The scrotal skin is

rich in 5 α -reductase, which converts testosterone to DHT. Fetal exposure to drugs that block this hormone leads to feminization of the male fetus.

Postnatal Development

Testicular function is reactivated during puberty after a period of quiescence to produce testosterone that results in development of secondary sex hair (face, chest, axilla, and pubis), enhanced linear skeletal growth, development of internal and external genitalia, increased upper body musculature, and development of larynx and vocal cords with deepening of the voice.^{6–8} Possible mood changes and aggression are undesired effects that may occur during puberty. The linear growth effects of testosterone are finite, with epiphysial closure when genetically determined height is achieved. Hypogonadism during puberty leads to imprecise closure of growth plates, leading to excessive height, long limbs, and disproportionate upper and lower body segments. Male secondary sexual characteristics can be staged by a system of development devised by Marshall and Tanner (Table 21-1).

Effect on Spermatogenesis

Stimulation of Leydig cells induces production of testosterone. Testosterone, acting with FSH, has paracrine effects on the seminiferous and Sertoli cells inducing spermatogenesis. Exogenous overuse or abuse of testosterone, such as occurs with some athletes, will reduce the high intratesticular concentration of testosterone, leading to reduction of sperm production.

Effect on Secondary Sexual Effects

Testosterone has growth-promoting effects on various target tissues. The secondary sex characteristics that develop

TABLE 21-1 TANNER STAGING OF GENITAL AND PUBIC HAIR DEVELOPMENT IN MALES

STAGES OF GENITAL DEVELOPMENT

- 1 Prepubertal
- 2 Enlargement of scrotum and testes
- 3 Increased length of penis, further enlargement of testes
- 4 Enlargement of testes, scrotum, and penis with growth of glans; darkening of scrotal skin
- 5 Mature genitalia

STAGES OF PUBIC HAIR DEVELOPMENT

- 1 Lanugo-type hair (prepubertal)
- 2 Dark terminal hair at base of penis
- 3 Darker terminal hair spreading over junction of pubes
- 4 Terminal hair covering pubic region, no spread to medial thighs
- 5 Mature stage with horizontal distribution of terminal hair to inner thighs

during puberty are maintained into late adulthood by testosterone.⁸ The prostate enlarges progressively during adulthood, while exposure of scalp hair results in regression of the hair follicles (temporal hairline recession). Loss of secondary sexual characteristics should prompt evaluation for hypogonadism because, among other effects, low testosterone levels lead to loss of bone mass and development of osteoporosis in males at any age.

Disorders of Sexual Development and Testicular Hypofunction

Pubertal development could be premature (precocious) or delayed, even if development is normal at birth.^{9,10} Detailed descriptions of the sequence of hormonal pubertal abnormalities of hair, genitals, and breasts are beyond the scope of this text. The differential diagnosis of hypogonadism includes a diverse group of disorders affecting the testicles and the hypothalamic-pituitary regulation of the testes outlined in Box 21-1. Certain important disorders are explained in the following section.

Hypergonadotropic Hypogonadism

Hypergonadotropic hypogonadism incorporates a group of disorders characterized by low testosterone, elevated FSH or LH, and impaired sperm production.

Klinefelter's Syndrome

Klinefelter's syndrome occurs in about 1 of 400 men and is caused by the presence of an extra chromosome. The most common karyotype is 47,XY.¹¹ Men with this disorder have small (<2.5 cm), firm testicles. **Gynecomastia** (enlargement of the male breast) can also be present at the time of diagnosis. Due to reduced production of testosterone, FSH and LH levels are elevated. These men also have azoospermia and resultant sterility. Men with mosaicism may produce some sperm and pregnancies have been reported with such men. Elevated levels of FSH and LH induced increased aromatase activity, resulting in elevated estrogen levels. Men with Klinefelter's syndrome may have reduced bone density and breast cancer.

Testicular Feminization Syndrome

Testicular feminization syndrome is the most severe form of androgen resistance syndrome, resulting in lack of testosterone action in the target tissue. As a result of the lack of testosterone effect, the physical development pursues the female phenotype, with fully developed breast and female distribution of fat and hair. Most men present for evaluation of primary amenorrhea, at which time the lack of female internal genitalia becomes apparent. The testicles are often undescended, and failure to promptly remove these organs results in malignant transformation. Biochemical evaluation reveals normal levels of testosterone with elevated FSH and LH levels. There is no utility or response to administration of exogenous testosterone.

BOX 21-1. CAUSES OF DELAYED PUBERTY

- Delayed puberty or hypogonadism, with increased gonadotropins (FSH and/or LH)
 - Klinefelter's syndrome
 - Bilateral gonadal failure
 - Primary testicular failure
 - Anorchia
 - Vanishing testicles
 - Chemotherapeutic agents
 - Irradiation
 - Trauma
 - Infection (mumps orchitis)
- Delayed puberty with normal or low FSH and/or LH
 - Constitutional delayed puberty^{51,52}
 - Hypothalamic dysfunction
 - Malnutrition
 - Chronic systemic illness
 - Severe obesity
 - Central nervous system tumors
 - Hypopituitarism
 - Panhypopituitarism
 - Kallmann's syndrome (anosmia, cleft palate, and reduced FSH and LH levels)
 - Isolated GH deficiency
 - Hyperprolactinemia (prolactinoma or drug induced)
 - Hypothyroidism
- Miscellaneous⁵²
 - Prader-Willi syndrome
 - Laurence-Moon syndrome
 - LEOPARD syndrome
 - Bloom syndrome
 - Germ cell neoplasia
 - Male pseudohermaphroditism
 - Ataxia-telangiectasia
 - Steroidogenic enzyme defects

5 α -Reductase Deficiency

The genotype in 5 α -reductase deficiency is XY. A reduction in levels of the enzyme 5 α -reductase results in decreased testosterone levels. Physical development is similar to the female phenotype until puberty when residual enzyme activity sufficiently converts testosterone to dihydrotestosterone, resulting in development of a male phenotype.

Myotonic Dystrophy

Myotonic dystrophy is inherited in an autosomal dominant fashion and presents with hypogonadism, muscle weakness, frontal balding, diabetes, and muscle dystonia. Testicular failure typically presents in the fourth decade of life.

Testicular Injury and Infection

Postpubertal mumps infection can result in mumps orchitis and permanent testicular injury. Testicular damage due to viral orchitis and HIV infection has also been reported. Radiation and chemotherapy for cancer can also result in long-term damage.

Sertoli Cell–Only Syndrome

Sertoli cell–only syndrome is characterized by a lack of germ cells. Men present with small testes, high FSH levels, azoospermia, and normal testosterone levels. Testicular biopsy is the only procedure to confirm this diagnosis.

Hypogonadotropic Hypogonadism

The hallmark of disorders of hypogonadotropic hypogonadism is the occurrence of low testosterone levels together with low or inappropriately normal FSH or LH levels.

Kallmann's Syndrome

Kallmann's syndrome is a result of an inherited, X-linked recessive trait that manifests as hypogonadism during puberty. The frequency of this syndrome is 1 of 10,000 males. The associated defects, such as anosmia (inability to smell) and midline defects (cleft palate and lip), should alert the clinician to suspect this disorder.^{12,13} Certain men also have red-green color blindness, congenital deafness, or cerebellar dysfunction.

Hyperprolactinemia

Prolactin elevation resulting from any cause (drug-induced or prolactin-producing tumors of the pituitary) can result in hypogonadotropic hypogonadism.^{14,15}

Age

There is a gradual reduction in testosterone after age 30, with an average decline of about 110 ng/dL every decade. The Baltimore Longitudinal Study of Aging revealed reduced total testosterone levels of 19% at age 60, 28% at age 70, and 49% at age 80,^{16,17} with free testosterone levels much lower in these men. Age is also associated with elevation of SHBG by about 1% per year. Total testosterone levels may be normal in aging men but the free (unbound) levels of testosterone are more reliable indicators of biochemical reduction. The associated features of reduced secondary sex hair growth, loss of muscle bulk and strength, and loss of bone density are corroborative evidence indicative of the lack of tissue effects of testosterone. Testosterone deficiency is a constellation of clinical features of hypogonadism combined with low serum testosterone levels. The combination of biochemical and clinical evidence of testosterone should prompt consideration of testosterone replacement in older men.

Pituitary Disease

Acquired hypogonadism can follow injury to the pituitary as a result of tumors, surgical trauma, vascular

injury, autoimmune hypophysitis, or granulomatous or metastatic disease. Hemochromatosis is a rare cause of pituitary dysfunction.

Diagnosis of Hypogonadism

Both clinical and biochemical features must be met (Fig. 21-1) to make the diagnosis of hypogonadism. Testosterone levels have a circadian rhythm and the time of sampling must be considered. Multiple estimation of free and bound testosterone levels should be done on different days before a diagnosis of hypogonadism is made.¹⁸ The distinction between primary (disease or destruction of the testes) versus secondary (disease or destruction of the pituitary) is relatively easy to make. FSH and/or LH¹⁹ levels are elevated in primary hypogonadism and are inappropriately normal or low with secondary etiologies. Pituitary MRI should be done in secondary hypogonadism in young individuals. Older individuals often have secondary or tertiary (hypothalamic) dysfunction as a result of reduced hypothalamic pulse generator frequency, resulting in low or inappropriately normal FSH and/or LH levels. Clinical signs and symptoms of hypogonadism (e.g., loss of secondary sexual characteristics, osteoporosis) should be corroborated with low testosterone levels, particularly when testosterone replacement therapy is considered.

Testosterone Replacement Therapy

The currently available modes of testosterone administration in the United States are as follows:

1. **Parenteral testosterone.** This is the most widely available and cost-effective mode of administration. The cypionate and enanthate esters of testosterone are available for intramuscular injection. The peak level is achieved in 72 hours and the effect lasts for a period of 1–2 weeks. Weekly administration provides for a lower peak and less fluctuation within the normal range of testosterone levels. Usual dosing is 50–100 mg weekly or 200–250 mg once every 2 weeks. Testosterone dose should be based on lean body mass, not on body weight, and is best reached by administering a standard dose of testosterone with minor dose escalations based on serum testosterone levels measured midpoint between two injections. The goal is to maintain this mid-dose level at midpoint of the normal ranges.
2. **Transdermal testosterone therapy.** This mode of administration provides more physiologic levels of testosterone. The patch is permeability enhanced to aid in the absorption of testosterone through normal skin. Local skin irritation can occur and limit patch use.
3. **Testosterone gel.** This hydroalcoholic gel preparation is applied to nongenital skin once daily. The absorption is gradual and provides blood levels of testosterone in

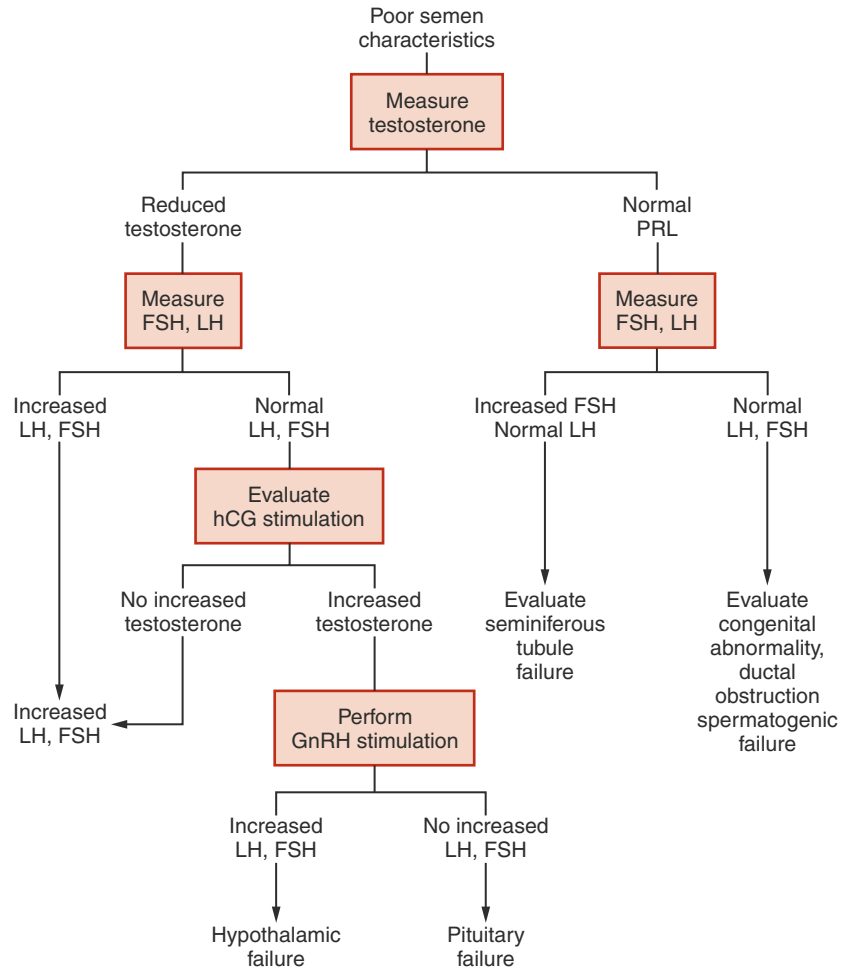

FIGURE 21-1. Clinical diagnostic evaluation of male hypogonadism.

the normal range for 24 hours. The main concern with this preparation is potential transmission to female partners or children on close skin contact.

- Buccal testosterone.** This plastic tablet is placed along the gum line twice daily. Local discomfort and the need for twice-daily dosing sometimes limit use.

Complications of testosterone replacement are polycythemia, prostate enlargement, possible growth-promoting effect on undiagnosed prostate cancer, worsening of obstructive sleep apnea, peripheral edema, and gynecomastia.

Monitoring Testosterone Replacement Therapy

Prostate-specific antigen (PSA), blood counts, and lipid levels should be checked 3–6 months after initiation of testosterone replacement and at least yearly thereafter. Routine clinical evaluation for leg edema, worsening of sleep apnea, and prostate enlargement is also recommended. Pharmacologic use of testosterone may also reduce sperm count by reducing the intratesticular

testosterone concentration that is manyfold higher than serum concentrations. If PSA elevation is noted after testosterone replacement, prostate evaluation with possible biopsy is recommended. Active prostate cancer is a contraindication to testosterone replacement.

THE OVARIES

The ovaries are paired organs that, like the male gonads, perform the dual functions of gamete (ovum) and steroid hormone production.^{20–22} Unlike in the male, the primordial reproductive cells in the female typically produce a solitary gamete. Ovarian and menstrual events are carefully synchronized by a complex interplay of hormones among the hypothalamus, pituitary, and ovaries to prepare the uterus for implantation of an embryo. In the absence of implantation, the uterine lining is shed, resulting in menses.^{23,24}

The length of the menstrual cycle is the time between any two consecutive cycles. The typical duration is 28 (± 3) days with average menstrual flow about 2–4 days.^{23,24}

Functional Anatomy of the Ovaries

The ovaries are oval organs that lie in the pelvic fossa, formed by the posterior and lateral pelvic wall, and attach to the posterior surface of the broad ligament by the peritoneal fold, otherwise known as the mesovarium. They are positioned near the fimbrial end of the fallopian tubes, which are connected to the uterine cavity. An adult ovary averages 2–5 cm in length, weighs an average of 14 grams, and typically contains 2–4 million primordial follicles.^{21,25} These primordial follicles are present at birth; however, maturation is blocked until puberty. Following the onset of puberty, each ovarian cycle is marked by recruitment of a few primordial follicles for maturation. Typically, all but one of these follicles will then atrophy, in a process termed the **follicular phase**.

The single remaining follicle—known as the **Graafian follicle**—is composed of an outer and inner layer (the theca externa and theca interna, respectively) encasing a central fluid-filled cavity and a layer of cells known as the granulosa layer.^{21,24–26} The maturing ovum attaches to the inside of the follicle via cells derived from granulosa cells, called **cumulus cells**. During the **luteal phase** of the ovarian cycle, the Graafian follicle releases its ovum in response to ovarian stimulation by LH. When the ovum is extruded, the Graafian follicle undergoes a morphologic change with hypertrophy of the theca and granulosa cells to become the **corpus luteum**. This process is called **luteinization**. The corpus luteum is rich in cholesterol and acts as a substrate for continued production of progesterone and estrogen, maintaining the endometrium for conception. If conception or implantation fails to occur, the endometrium is shed and the corpus luteum atrophies to an atretic follicle.

Hormonal Production by the Ovaries

As in the adrenal glands and the testes, the steroidogenic pathway and synthetic enzymes are present in the ovaries. Cholesterol is either synthesized from acetate or actively transported from the low-density lipoprotein (LDL) particle in blood and then used as a substrate for hormonal production.^{23,24,27,28}

Estrogen

Naturally synthesized estrogens are carbon-18 compounds. The principal estrogen produced in the ovary is estradiol. Estrone and estriol are primarily metabolites of intraovarian and extraglandular conversion. Estrogens promote breast, uterine, and vaginal development and also affect the skin, vascular smooth muscles, bone cells, and the central nervous system.^{23,24,27,29} The lack of estrogen that naturally occurs with the onset of menopause leads to atrophic changes in these organs. During the reproductive period, it is estrogen that is responsible for follicular phase changes in the uterus, with

deficiency resulting in irregular and incomplete development of the endometrium.^{21,29}

Progesterone

Progesterone is a carbon-21 compound within the steroid family and is produced by the corpus luteum. Progesterone induces the secretory activity of those endometrial glands that have been primed by estrogen, readying the endometrium for embryo implantation. Other effects include thickening of the cervical mucus, reduction of uterine contractions, and the thermogenic effect, in which basal body temperature rises after **ovulation**. This effect is of clinical use in marking the occurrence of ovulation. Progesterone is the dominant hormone responsible for the luteal phase, and deficiency results in failure of implantation of the embryo.^{21,23–25,27}

Androgens

Ovaries produce the androgens androstenedione, dehydroandrostenedione, testosterone, and dihydrotestosterone, all of which are carbon-19 compounds. Excess production of ovarian androgens in women leads to excess hair growth (**hirsutism**), loss of female characteristics, and—in severe cases—development of overt male secondary sexual features (masculinization or **virilization**).^{30–33} Unlike estrogen, which is not produced in the ovary after menopause, ovarian androgen synthesis continues well into advanced age.

Others

Inhibins A and B, which are produced by the ovaries, are hormones that inhibit FSH production.^{25,34} Activin is a hormone that enhances FSH secretion and induces steroidogenesis. Folliculostatin, relaxin, follicle regulatory protein, oocyte maturation factor, and meiosis-inducing substance are hormones that appear to have important, yet not clearly characterized, functions.

The Menstrual Cycle

By convention, the menstrual cycle is considered to start on the first day of menses (day 1). The menstrual cycle consists of two phases of parallel events occurring at the ovaries and endometrium. Within the ovaries, these events are known as the follicular and luteal phases, while the concurrent endometrial events are known as the proliferative and secretory phases.^{20,21,23–25,34,35}

The Follicular Phase

The follicular phase begins with the onset of menses and ends on the day of LH surge. Early in the follicular phase, the ovary secretes very little estrogen or progesterone. A rise in FSH, however, stimulates estrogen production. The estrogen secreted by the developing follicle within the ovary stimulates uterine epithelial cells, blood vessel growth, and endometrial gland develop-

ment to increase the thickness of the endometrium. The intense secretory capacity of the uterine glands provides a secretion that aids the implantation of the embryo.

The Luteal Phase

Estrogen levels peak 1 day before ovulation, at which point a positive feedback system results in an LH surge. The start of the luteal phase is marked by the extrusion of the ovum approximately 36 hours after this LH surge with subsequent luteinization of the Graafian follicle to form the corpus luteum. The corpus luteum secretes progesterone to aid in the implantation of the embryo. In the absence of fertilization, a gradual decline in the production of progesterone and estrogen by the corpus luteum there is a loss of endometrial blood supply; this results in shedding of the endometrium approximately 14 days after ovulation occurred. The typical duration of menstrual bleeding is 3–5 days, with blood loss averaging 50 mL. Onset of menses marks the end of the luteal phase.

Hormonal Control of Ovulation

The central control of FSH and LH secretion resides in the GnRH pulse generator of the arcuate nuclei and medial preoptic nuclei of the hypothalamus.^{20,21,23–25,34,35} Positive and negative feedback responses exist among estrogen, progesterone, LH, and FSH production. It is because of the lack of estrogen after menopause that both FSH and LH levels rise.^{20,34,35} During reproduc-

TABLE 21-2 TANNER STAGING OF BREAST AND PUBIC HAIR DEVELOPMENT IN FEMALES

STAGES OF BREAST DEVELOPMENT

| | |
|---|---|
| 1 | Prepubertal |
| 2 | Elevation of breast bud and papilla, areolar enlargement |
| 3 | Elevation of breast tissue and papilla |
| 4 | Elevation of areola and papilla in secondary mound above the level of the breast |
| 5 | Mature stage: recession of areola into the breast with projection of papilla only |

STAGES OF PUBIC HAIR DEVELOPMENT

| | |
|---|---|
| 1 | Lanugo-type hair (prepubertal) |
| 2 | Dark terminal hair on labia majora |
| 3 | Terminal hair covering labia majora and spreading to the mons pubis |
| 4 | Terminal hair fully covering the labia majora and mons pubis |
| 5 | Terminal hair covering the labia majora, mons pubis, and inner thighs |

CASE STUDY 21-1

A 39-year-old woman presented with hot flashes and irregular menstrual cycles for 6 months. Clinical examination did not reveal abnormality. Laboratory evaluation reveals the following: CBC, normal; blood glucose, 89 mg/dL; TSH, 1.5 IU; FSH, 128 IU; and LH, 30 IU.

This clinical situation is consistent with one of the following:

1. PCOS
2. Prolactinoma
3. Pituitary tumor
4. Menopause
5. Hypothalamic hormone deficiency

tive years, FSH levels are elevated early in the follicular phase. A midcycle surge in LH production stimulates a series of events that culminates in ovulation, with FSH levels falling after this event. Any injury to the hypothalamus or the presence of either psychosocial or physical stressors leads to changes in these hormonal cues and results in anovulation and amenorrhea.^{29,36,37}

Pubertal Development in the Female

As with males, puberty in females consists of a sequence of hormonally mediated events resulting in the development of secondary sexual characteristics and attainment of final adult height. Thelarche (development of breast tissue) is typically the earliest sign of sexual development, followed by development of pubic hair. Menarche, or initiation of menses, occurs an average of 2–3 years after the onset of puberty.

Tanner Staging

Devised by Marshall and Tanner as a way to determine pubertal staging, the Tanner staging system, outlined in Table 21-2, is used to monitor and assess the growth stages of breast and pubic hair.²⁸

Menstrual Cycle Abnormalities

The menstrual cycles ranges from 25 to 35 days, with an average 28-day duration. The average age of menopause in the United States is between 45 and 55 years of age with the median at age 53.^{20,21,23–25,34,35}

Amenorrhea is defined as the absence of menses. *Primary amenorrhea* describes when a woman has never menstruated, while *secondary amenorrhea* is used to describe a woman who has had at least one menstrual

TABLE 21-3 ETIOLOGIES OF AMENORRHEA

| | PRIMARY | SECONDARY |
|-----------------------------|---------|-----------|
| Hypothalamus | 27% | 38% |
| Pituitary | 2% | 15% |
| Polycystic ovarian syndrome | 7% | 30% |
| Ovary | 43% | 12% |
| Uterus/outflow | 19% | 7% |

cycle followed by absences of menses for a minimum of 3–6 months.^{26,29,36–39} Frequency of the different etiologies for amenorrhea, both primary and secondary, is listed in Table 21-3.

Oligomenorrhea refers to infrequent or irregular menstrual bleeding, with cycle lengths in excess of 35–40 days. Uterine bleeding in excess of 7 days is dysfunctional and is termed *menorrhagia*. In a patient with infertility, the diagnosis of inadequate luteal phase is made when the luteal phase is less than 10 days or when an endometrial biopsy indicates the progression of endometrial changes

is delayed or out of phase, resulting in implantation failure. The multiple causes of male and female infertility are shown in Table 21-4.

The principles underlying the evaluation of disorders of normal menstrual functions, as outlined by the World Health Organization, are the same for ovarian and pituitary dysfunction (Box 21-2). A diagnostic approach to secondary amenorrhea is outlined in Figure 21-2.

Hypogonadotropic Hypogonadism

Hypogonadotropic hypogonadism, or gonadotropin (FSH and LH) deficiency resulting in decreased sex steroid production, is a common cause of secondary amenorrhea. There are many physiologic and pathologic causes of hypogonadotropic hypogonadism, including weight loss as associated with anorexia nervosa or various disease processes, intense physical exercise (commonly termed *runner's amenorrhea*), and pituitary tumors that disrupt secretion of FSH or LH.^{18,36,37,39–41} Prolactin production by prolactinomas can have similar effects.^{29,36} Any secondary cause of chronic hypogonadism can induce pathologic bone loss, resulting in osteopenia or, if severe, osteoporosis.

TABLE 21-4 CAUSES OF INFERTILITY

| TARGET | RESULT | CAUSE |
|----------------------------|---|---|
| FEMALE | | |
| Hypothalamus | Decreased GnRH | Drugs Increased stress Diet |
| Pituitary | Decreased FSH, LH | Destructive tumor or vesicular lesion |
| Ovaries | Decreased estradiol or progesterone | Organ failure Organ dysgenesis Antiovarian antibodies Malnourishment, very low weight, metabolic disease |
| Fallopian tubes and uterus | Inadequate endometrium Tubal scarring and closure Decreased cervical mucus | Low progesterone output Pelvic inflammatory disease Cervical infections |
| Conception | Immobilization and destruction of sperm | Antisperm antibodies |
| MALE | | |
| Hypothalamus and pituitary | Oligospermia to azoospermia (no sperm) | Primary defects in hypothalamic or pituitary glands Exogenous androgens Testicular dysfunction |
| Testes | Oligospermia to azoospermia Delayed or deficient sexual maturity Decreased testosterone | Orchitis Testicular infections (mumps) Alcoholism/substance abuse Chromosomal defects |
| Prostate | Decreased seminal fluid | Infections of prostate or seminal vesicles |
| Urethrogenital tract | Retrograde or absent ejaculation | Physical abnormalities Chronic diabetes |

BOX 21-2. CLASSIFICATION OF AMENORRHEA BY WORLD HEALTH ORGANIZATION (WHO) GUIDELINES^{39,40}

- Type 1. Hypothalamic hypogonadism (low or normal FSH and/or LH)
 - Hypothalamic amenorrhea (anorexia nervosa, idiopathic, exercise induced).
 - Kallmann's syndrome
 - Isolated gonadotropin deficiency
- Type 2. Euestrogenic chronic anovulation (normal FSH and LH)
 - Polycystic ovarian syndrome (LH > FSH in some patients 2:1 or greater)
 - Hyperthecosis
- Type 3. Hyperthalamic hypogonadism (elevated FSH and/or LSH)
 - Premature ovarian failure
 - Turner's syndrome

CASE STUDY 21-2

A 49-year-old woman presented with increased hair growth for the past 6 months that started abruptly; she has male pattern hair loss, as well. On examination, she has temporal loss of hair and clitorimegaly. Laboratory evaluation reveals the following: testosterone, 360 ng/dL; FSH, 12 IU; LH, 9 IU; and a normal prolactin level.

The next step in the evaluation is one of the following:

1. DHEAS level
2. Repeat FSH and LH levels
3. Fasting blood sugar level
4. Fasting lipid level
5. Computed tomography of adrenal and ovaries

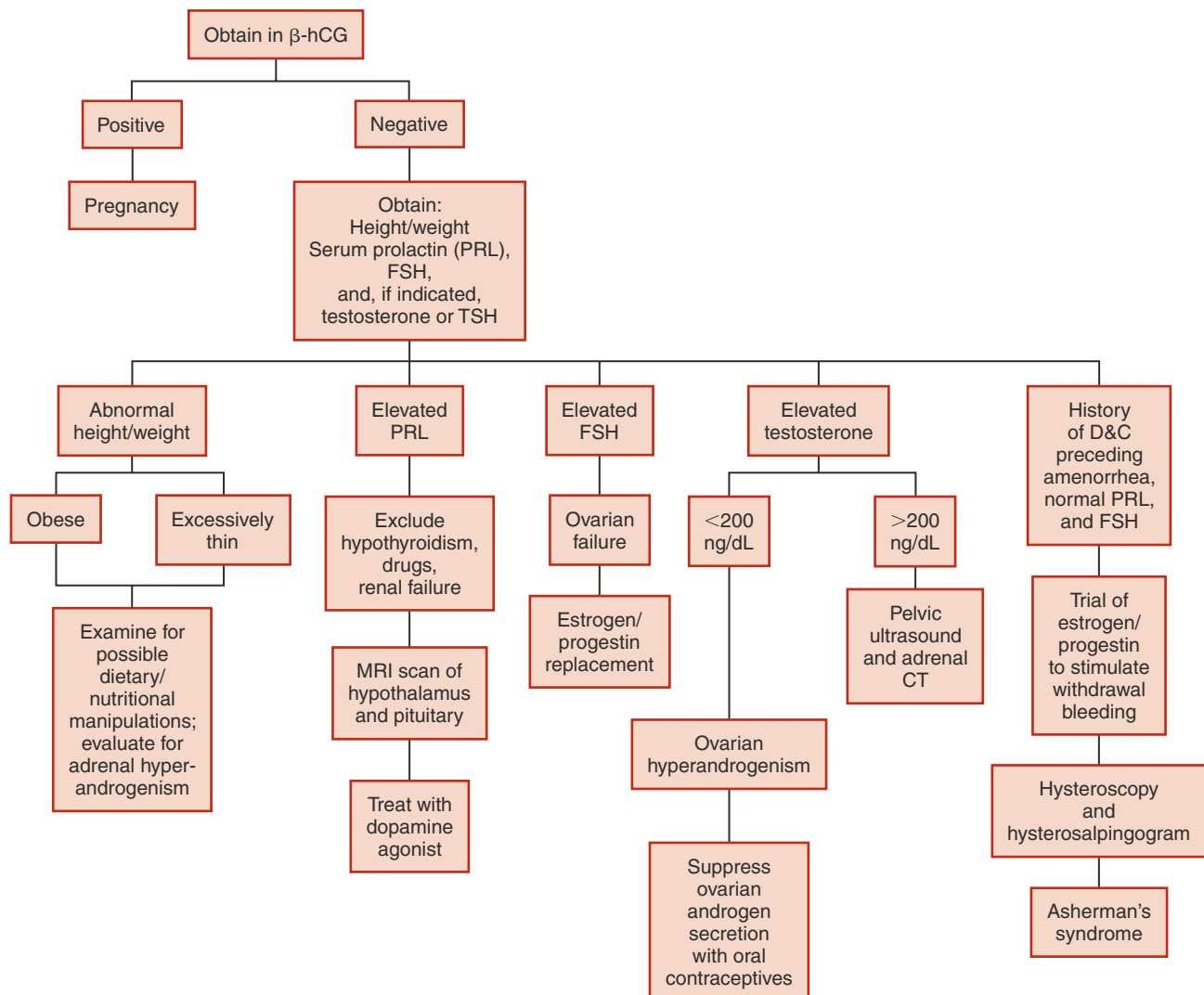

FIGURE 21-2. Diagnostic approach to secondary amenorrhea.

Hypergonadotropic Hypogonadism

Hypergonadotropic hypogonadism is characterized by ovarian failure resulting in elevation of FSH concentrations, with or without LH elevations. Ovarian failure occurs naturally between 45 and 55 years of age in American women. When the depletion of oocytes and follicles occurs at the expected time, it is termed *menopause*. Menopause is a natural, inevitable event that results in elevation of FSH and LH levels, with low levels of estrogen.^{20,25,35,42}

Premature ovarian failure is defined as primary hypogonadism in a woman before the age of 40 and can be

a result of congenital chromosomal abnormality (e.g., Turner's syndrome) or premature menopause.^{36,37,39,43} Patients with Turner's syndrome do not complain of the same hot flashes experienced by patients with secondary hypergonadotropic hypogonadism. Premature menopause can occur in isolation or in association with other endocrine gland failure such as hypoparathyroidism, hypothyroidism, or hypoadrenalism.^{25,36,37,39,41}

Polycystic Ovary Syndrome

This common disorder can present in many ways: infertility, hirsutism, chronic anovulation, glucose intolerance,

CASE STUDY 21-3

A 24-year-old man presented with a history of hay fever, which had been treated with antihistamines. He relates diminished smell. He continues to grow slowly and pubertal development has been slow. The man denies erections or nocturnal emissions.

Management

Testosterone replacement therapy

Sexual maturity

Later desired fertility

GnRH pulsatile therapy produced a normal sperm count in 4 months and the man's wife became pregnant.

| PE | EUNUCHOIDAL MAN, APPEARING YOUNGER THAN AGE |
|----------------|---|
| Height | 72 inches |
| Arm span | 75 inches |
| Weight | 180 lb |
| Blood pressure | 130/82 |
| Hair | Spare facial, axillary, and pubic |
| Genitalia | Penis, 3.1 cm (small) |
| Testes | Soft, 1 cm × 1.5 cm × 1.5 cm (normal, >4.5 × 3 cm × 3 cm) |

LABORATORY VALUES

| | |
|--------------|--|
| Testosterone | 157 ng/dL (normal, prepuberal <100; adult, 300–1000) |
| LH | <2 mU/mL (normal, prepubertal <5; adult, 3–18) |
| Prolactin | 6 ng/mL (normal, 5–25) |
| TSH | 1.2 mU/mL (normal, 0.3–5.0) |

Questions

1. What is the level of the defect?
2. What is the significance of the body measurements?
3. What are the diagnostic considerations?
4. What test(s) might be obtained to make the diagnosis?
5. What constitutes normal fertility?
6. How will you counsel this man when he asks if he can have children?

GnRH STIMULATION

| TIME (MINUTES) | LH | NORMAL |
|----------------|----------|---|
| 0, GnRH | <2 mU/mL | Pre-, <5 Adult, 3–18 |
| 15 | <2 | Post-, 2.5 times baseline at some point |
| 30 | 3 | |
| 45 | <2 | |
| 60 | 3 | |

AFTER GnRH PRIMING

| TIME (MINUTES) | LH | NORMAL |
|----------------|----------|--|
| 0 | <2 mU/mL | Pre-, <5 Adult, 3–18 |
| 15 | 10 | LH rise greater than 2.5 times baseline |
| 30 | 12 | |
| 45 | 16 | |
| 60 | 12 | |

BOX 21-3. CLASSIFICATION OF HIRSUTISM^{20,21,23,44}

Functional (normal androgen levels with excess hair growth) or true androgen excess (elevated androgens)
 Ovarian (LH mediated) or adrenal (ACTH mediated)
 Peripheral conversion of androgens (obesity)
 Tumoral hyperandrogenism (ovarian, adrenal)
 Chorionic gonadotropin mediated

hyperlipidemia or dyslipidemia, and hypertension.^{20,22,23} The onset is often perimenarchial, chronic, and notable for its slow progression. Investigations for this disorder involve estimation of free testosterone, SHBG, FSH, LH, fasting glucose, insulin, and lipid levels. Ovarian ultrasound reveals multiple cysts in many patients (about 30% of patients do not have ovarian cysts). Most patients with this disorder are overweight; however, patients with polycystic ovary syndrome (PCOS) of eastern Asian or South American descent are of normal weight. Most symptoms and laboratory abnormalities are reversed with weight loss and increased physical activity. The drug Glucophage (metformin), commonly used for the treatment of diabetes, is useful in this condition, even in the absence of diabetes. Although not U.S. Food and Drug Administration approved for this use, it reportedly normalizes menstrual cycles and improves conception rates.

Hirsutism

Hirsutism is abnormal, abundant, androgen-sensitive terminal hair growth in areas in which terminal hair follicles are sparsely distributed or not normally found in women. Most commonly, hirsutism is idiopathic in etiol-

TABLE 21-5 CAUSES OF HIRSUTISM**COMMON**

Idiopathic
 Polycystic ovary syndrome

UNCOMMON

Drugs: danazol, oral contraceptives with androgenic progestins
 Congenital adrenal hyperplasia
 Hyperprolactinemia
 Cushing's syndrome
 Adrenal tumors
 Ovarian tumors

ogy (60% of cases), with PCOS the next most common cause (35%) (Box 21-3). Typical causes of hirsutism are listed in Table 21-5.^{20,21,23,24}

Hirsutism should only be considered in the context of a woman's ethnic origin. Women of Italian, eastern European, eastern Indian, and Irish descent possess more androgen-sensitive terminal hair than do most northern European women, making a careful elicitation of ethnic background important prior to initiation of an extensive laboratory evaluation in a woman born in the United States. It is estimated that about 5%–10% of American women have hirsutism, which can be quantified using a measurement technique known as the Ferriman-Gallwey Scale that identifies nine areas (lip, chin, sideburn region, neck, chest, abdomen, upper and lower back, and thigh) for assessment and allots points on a scale of 1–4 based on hair thickness and pigmentation. A score of higher than 8 is consistent with a diagnosis of hirsutism.^{20,21,23,44} Hormonal abnormalities associated with hirsutism are summarized in Table 21-6.

TABLE 21-6 ANDROGEN LEVELS IN HIRSUTISM AND VIRILIZATION

| CONDITION | ANALYTE | | |
|--------------------------------|--------------------|-------------------|--|
| | TOTAL TESTOSTERONE | FREE TESTOSTERONE | DEHYDROEPIANDROSTERONE SULFATE (DHEAS) |
| Idiopathic hirsutism | ↑ | ↑↑↑ | ↑ |
| Polycystic ovary syndrome | ↑ | ↑↑ | ↑ |
| Congenital adrenal hyperplasia | ↑↑ | ↑↑ | ↑↑↑ |
| VIRILIZING TUMORS | | | |
| Ovarian | ↑↑↑ | ↑↑↑ | ↑ |
| Adrenal | ↑↑ | ↑↑ | ↑↑↑ |

Modified with permission from Demers LM. Hirsutism and virilization, news and views. Washington, D.C.: American Association for Clinical Chemistry, 1989.

CASE STUDY 21-4

A 17-year-old boy presented. A school physical examination showed less pubic and axillary hair than those of peers, penis and scrotum that are smaller, breast tissue since age 13, no erections or nocturnal emissions, and no adolescent growth spurt. Sleeve and pant lengths increase every 4–6 months.

Questions

1. At what level is the defect in this case?
2. What diagnostic possibilities would explain the endocrine data?
3. What treatment(s) would be available to:
 - a. Treat his androgen deficiency?
 - b. Allow him to father children if he wanted fertility?
4. His appearance shows the defect occurred:
 - a. Prior to birth (during fetal life)
 - b. After birth (postnatal)

PE:

| | |
|-----------|--|
| Height | 73 inches |
| Arm span | 74 inches |
| Weight | 148 lb |
| BP | 110/70 mm Hg |
| Pulse | 69 bpm |
| Hair | Scant axillary and pubic |
| Breasts | Moderate gynecomastia, 3 cm |
| Genitalia | Penis, 4.5 cm |
| Testes | 1.5 × 1 × 1 cm, bilaterally (normal, >4.5 × 2.5 × 2.5 cm) |

LABORATORY

| | |
|---------------------|--------------------------------|
| Testosterone, total | 115 ng/dL (normal, 300–1000) |
| LH | 42 mU/mL (normal, Adult, 3–18) |
| Karyotype | 47,XXY |

Estrogen Replacement Therapy

Estrogen replacement remains a contentious issue. The Women's Health Initiative study enrolled 16,608 postmenopausal women who were placed on conventional hormone replacement combinations. The study showed an increased incidence of invasive breast cancer (hazard

ratio, 1.26) and venous clot formation and no benefit in cognitive decline or coronary artery disease. Conversely, reductions in bone loss, colon polyp formation, and menopausal symptoms (hot flashes, vaginal dryness) were noted. Currently, estrogen replacement remains a treatment option in select women after careful risk counseling.^{45,50}

REFERENCES

1. Dewing P, Bernard P, Vilain E. Disorders of gonadal development. *Semin Reprod Med* 2002;20:189–198.
2. Sharpe RM, McKinnell C, Kivlin C, Fisher JS. Proliferation and functional maturation of Sertoli cells, and their relevance to disorders of testis function in adulthood. *Reproduction* 2003;125:769–784.
3. Goncharova ND, Lapin BA, Khavinson V. Age-associated endocrine dysfunctions and approaches to their correction. *Bull Exp Biol Med* 2002;134:417–421.
4. Grumbach MM. The neuroendocrinology of human puberty revisited. *Horm Res* 57 2002;(suppl 2):2–14.
5. Tong S, Wallace EM, Burger HG. Inhibins and activins: clinical advances in reproductive medicine. *Clin Endocrinol (Oxf)* 2003;58:115–127.
6. Labrie F. Extragonadal synthesis of sex steroids: intracrinology. *Ann Endocrinol (Paris)* 2003;64:95–107.
7. Hiort O, Holterhus PM. Androgen insensitivity and male infertility. *Int J Androl* 2003;26:16–20.
8. Lee DK, Chang C. Molecular communication between androgen receptor and general transcription machinery. *J Steroid Biochem Mol Biol* 2003;84:41–49.
9. Sultan C, Gobinet J, Terouanne B, et al. The androgen receptor: molecular pathology. *J Soc Biol* 2002;196:223–240.
10. Sultan C, Lumbroso S, Paris F, et al. Disorders of androgen action. *Semin Reprod Med* 2002;20:217–228.
11. Styne DM. Puberty and its disorders in boys. *Endocrinol Metab Clin North Am* 1991;20:43–69.
12. Seminara SB, Hayes FJ, Crowley WF Jr. Gonadotropin-releasing hormone deficiency in the human (idiopathic hypogonadotropic hypogonadism and Kallmann's syndrome): pathophysiological and genetic considerations. *Endocr Rev* 1998;19:521–539.
13. Labhart A. Male sex hormones and their derivatives. Pathophysiology and therapy. *Fortschr Med* 1978;96:2029–2034.
14. Heaton JP, Morales A. Endocrine causes of impotence (nondiabetes). *Urol Clin North Am* 2003;30:73–81.
15. Walsh JP, Pullan PT. Hyperprolactinaemia in males: a heterogeneous disorder. *Aust N Z J Med* 1997;27:385–390.
16. Harman SM, Metter EJ, Tobin JD, et al. Longitudinal effects of aging on serum total and free testosterone levels in healthy men. Baltimore Longitudinal Study of Aging. *J Clin Endocrinol Metab* 2001;86:724–731.
17. Morley JE. Androgens and aging. *Maturitas* 2001;38:61–71; discussion, 71–73.
18. Korenman SG, Morley JE, Mooradian AD, et al. Secondary hypogonadism in older men: its relation to impotence. *J Clin Endocrinol Metab* 1990;71:963–969.

19. Santoro N, Filicori M, Crowley WF Jr. Hypogonadotropic disorders in men and women: diagnosis and therapy with pulsatile gonadotropin-releasing hormone. *Endocr Rev* 1986;7:11–23.
20. Sherman BM, West JH, Korenman SG. The menopausal transition: analysis of LH, FSH, estradiol, and progesterone concentrations during menstrual cycles of older women. *J Clin Endocrinol Metab* 1976;42:629–636.
21. Gougeon A. Dynamics of follicular growth in the human: a model from preliminary results. *Hum Reprod* 1986;1:81–87.
22. Jost A, Vigier B, Prepin J, Perchellet JP. Studies on sex differentiation in mammals. *Recent Prog Horm Res* 1973;29:1–41.
23. Filicori M, Santoro N, Merriam GR, Crowley WF Jr. Characterization of the physiological pattern of episodic gonadotropin secretion throughout the human menstrual cycle. *J Clin Endocrinol Metab* 1986;62:1136–1144.
24. Taylor AE, Whitney H, Hall JE, et al. Midcycle levels of sex steroids are sufficient to recreate the follicle-stimulating hormone but not the luteinizing hormone midcycle surge: evidence for the contribution of other ovarian factors to the surge in normal women. *J Clin Endocrinol Metab* 1995;80:1541–1547.
25. Klein NA, Battaglia DE, Miller PB, et al. Ovarian follicular development and the follicular fluid hormones and growth factors in normal women of advanced reproductive age. *J Clin Endocrinol Metab* 1996;81:1946–1951.
26. Peters H, Byskov AG, Grinstead J. Follicular growth in fetal and prepubertal ovaries of humans and other primates. *Clin Endocrinol Metab* 1978;7:469–485.
27. Apter D, Cacciatore B, Alfthan H, Stenman UH. Serum luteinizing hormone concentrations increase 100-fold in females from 7 years to adulthood, as measured by time-resolved immunofluorometric assay. *J Clin Endocrinol Metab* 1989;68:53–57.
28. Marshall WA, Tanner JM. Variations in pattern of pubertal changes in girls. *Arch Dis Child* 1969;44:291–303.
29. Santoro N, Filicori M, Crowley WF Jr. Hypogonadotropic disorders in men and women: diagnosis and therapy with pulsatile gonadotropin-releasing hormone. *Endocr Rev* 1986;7:11–23.
30. Hatch R, Rosenfield RL, Kim MH, Tredway D. Hirsutism: implications, etiology, and management. *Am J Obstet Gynecol* 1981;140:815–830.
31. McKenna TJ. Screening for sinister causes of hirsutism. *N Engl J Med* 1994;331:1015–1016.
32. Nestler JE, Jakubowicz DJ. Decreases in ovarian cytochrome P450c17 alpha activity and serum free testosterone after reduction of insulin secretion in polycystic ovary syndrome. *N Engl J Med* 1996;335:617–623.
33. O'Driscoll JB, Mamtora H, Higginson J, et al. A prospective study of the prevalence of clear-cut endocrine disorders and polycystic ovaries in 350 patients presenting with hirsutism or androgenic alopecia. *Clin Endocrinol (Oxf)* 1994;41:231–236.
34. Welt CK, McNicholl DJ, Taylor AE, Hall JE. Female reproductive aging is marked by decreased secretion of dimeric inhibin. *J Clin Endocrinol Metab* 1999;84:105–111.
35. Stanford JL, Hartge P, Brinton LA, et al. Factors influencing the age at natural menopause. *J Chronic Dis* 1987;40:995–1002.
36. Groff TR, Shulkin BL, Utiger RD, Talbert LM. Amenorrhea-galactorrhea, hyperprolactinemia, and suprasellar pituitary enlargement as presenting features of primary hypothyroidism. *Obstet Gynecol* 1984;63:865–895.
37. Warren MP, Voussoughian F, Geer EB, et al. Functional hypothalamic amenorrhea: hypoleptinemia and disordered eating. *J Clin Endocrinol Metab* 1999;84:873–877.
38. Saenger P. Turner's syndrome. *N Engl J Med* 1996;335:1749–1754.
39. Timmreck LS, Reindollar RH. Contemporary issues in primary amenorrhea. *Obstet Gynecol Clin North Am* 2003;30:287–302.
40. Feichtinger W, Kemeter P, Salzer H, Friedrich F. Functional and hormonal differences between group I and group II amenorrhea (WHO classification) [author's translation]. *Wien Klin Wochenschr* 1981;93:186–193.
41. Reindollar RH, Novak M, Tho SP, McDonough PG. Adult-onset amenorrhea: a study of 262 patients. *Am J Obstet Gynecol* 1986;155:531–543.
42. Wise PM, Krajnak KM, Kashon ML. Menopause: the aging of multiple pacemakers. *Science* 1996;273:67–70.
43. Reindollar RH, Byrd JR, McDonough PG. Delayed sexual development: a study of 252 patients. *Am J Obstet Gynecol* 1981;140:371–380.
44. Meldrum DR, Abraham GE. Peripheral and ovarian venous concentrations of various steroid hormones in virilizing ovarian tumors. *Obstet Gynecol* 1979;53:36–43.
45. Chlebowski RT, Hendrix SL, Langer RD, et al. Influence of estrogen plus progestin on breast cancer and mammography in healthy postmenopausal women: the Women's Health Initiative Randomized Trial. *JAMA* 2003;289:3243–3253.
46. Stjernquist M. After the early termination of the Women's Health Initiative study. *New American recommendations for postmenopausal hormone therapy. Lakartidningen* 2003;100:1790–1797.
47. Wassertheil-Smoller S, Hendrix SL, Limacher M, et al. Effect of estrogen plus progestin on stroke in postmenopausal women: the Women's Health Initiative: a randomized trial. *JAMA* 2003;289:2673–2684.
48. Rapp SR, Espeland MA, Shumaker SA, et al. Effect of estrogen plus progestin on global cognitive function in postmenopausal women. The Women's Health Initiative Memory Study: a randomized controlled trial. *JAMA* 2003;289:2663–2672.
49. Shumaker SA, Legault C, Thal L, et al. Estrogen plus progestin and the incidence of dementia and mild cognitive impairment in postmenopausal women. The Women's Health Initiative Memory Study: a randomized controlled trial. *JAMA* 2003;289:2651–2662.
50. Pines A. Lessons from the Women's Health Initiative (WHI) using hormone replacement therapy with regard to heart disease—the dream that has been broken? *Harefuah* 2003;142:163–165, 240.
51. Kelly BP, Paterson WF, Donaldson MD. Final height outcome and value of height prediction in boys with constitutional delay in growth and adolescence treated with intramuscular testosterone 125 mg per month for 3 months. *Clin Endocrinol (Oxf)* 2003;58:267–272.
52. Zachmann M. Therapeutic indications for delayed puberty and hypogonadism in adolescent boys. *Horm Res* 1991;36:141–146.

The Thyroid Gland

Marissa Grotzke

CHAPTER

22

CHAPTER OUTLINE

■ THE THYROID

- Thyroid Anatomy and Development
- Thyroid Hormone Synthesis
- Protein Binding of Thyroid Hormone
- Control of Thyroid Function
- Actions of Thyroid Hormone

■ TESTS FOR THYROID EVALUATION

- Blood Tests

■ OTHER TOOLS FOR THYROID EVALUATION

- Nuclear Medicine Evaluation
- Thyroid Ultrasound
- Fine-Needle Aspiration

■ DISORDERS OF THE THYROID

- Hypothyroidism
- Thyrotoxicosis
- Graves' Disease
- Toxic Adenomas and Multinodular Goiter

■ DRUG-INDUCED THYROID DYSFUNCTION

- Amiodarone-Induced Thyroid Disease
- Subacute Thyroiditis

■ NONTHYROIDAL ILLNESS

■ THYROID NODULES

■ REFERENCES

THE THYROID

The thyroid gland is responsible for the production of two hormones: thyroid hormone and calcitonin. Calcitonin is secreted by parafollicular C cells and is involved in calcium homeostasis. Thyroid hormone is critical in regulating body metabolism, neurologic development, and numerous other body functions. Clinically, conditions affecting thyroid hormone levels are much more common than those affecting calcitonin and are the major focus of this chapter.

Thyroid Anatomy and Development

The thyroid gland is positioned in the lower anterior neck and is shaped like a butterfly. It is made up of two lobes that rest on each side of the trachea, with a band of thyroid tissue—called the isthmus—running anterior to the trachea and bridging the lobes. Posterior to the thyroid gland are the **parathyroid glands** that regulate serum calcium levels and the recurrent laryngeal nerves that innervate the vocal cords. These posterior structures become important during thyroid surgery, when care must be exercised to avoid injury that could lead to hypocalcemia or permanent hoarse voice.

The fetal thyroid develops from an outpouching of the foregut at the base of the tongue and migrates to its normal location over the thyroid cartilage in the first

4–8 weeks of gestation. By week 11 of gestation, the thyroid gland begins to produce measurable amounts of thyroid hormone.¹ Thyroid hormone is critical to neurologic development of the fetus. Iodine is an essential component of thyroid hormone. In parts of the world where severe iodine deficiency exists, neither the mother nor the fetus can produce thyroid hormone and both develop **hypothyroidism**. The impact is most severe on the fetus because hypothyroidism leads to mental retardation and cretinism. In areas where iodine deficiency is not an issue, other problems can occur with thyroid development. Congenital hypothyroidism occurs in 1 of 4,000 live births.² If the mother has normal thyroid function, the fetus will be protected during development by small amounts of maternal thyroid hormone crossing the placenta. Immediately postpartum, however, these newborns require initiation of appropriate doses of thyroid hormone or their neurologic development will be significantly impaired. In the developed world, screening tests are performed on all newborns to diagnose congenital hypothyroidism and prevent catastrophic complications by the timely institution of thyroid hormone therapy.

Thyroid Hormone Synthesis

Thyroid hormone is made primarily of the trace element iodine, making iodine metabolism a key determinant in thyroid function.¹ Iodine is found in seafood, dairy prod-

ucts, iodine-enriched breads, and vitamins. Significantly, iodine is used in high concentrations in the contrast medium used in computed tomography (CT) scans and to visualize arteries during heart catheterization. It is also present in amiodarone, a medication used to treat certain heart conditions. The recommended minimum daily intake of iodine is 150 μg , although most individuals in developed countries ingest far more than this amount. If iodine intake drops below 50 μg daily, the thyroid gland is unable to manufacture adequate amounts of thyroid hormone and thyroid hormone deficiency—hypothyroidism—results.³

Thyroid cells are organized into follicles. Follicles are spheres of thyroid cells surrounding a core of a viscous substance termed *colloid*. The major component of colloid is **thyroglobulin**, a glycoprotein manufactured exclusively by thyroid **follicular cells**. Thyroglobulin is rich in the amino acid tyrosine. Some of these tyrosyl residues can be iodinated, producing the building blocks of thyroid hormone. On the outer side of the follicle, iodine is actively transported into the thyroid cell by the Na^+/I^- symporter located on the basement membrane. Inside the thyroid cell, iodide diffuses across the cell to the apical side of the follicle, which abuts the core of colloid. Here, catalyzed by a membrane-bound enzyme called **thyroid peroxidase (TPO)**, concentrated iodide is oxidized and bound with tyrosyl residues on thyroglobulin. This results in production of monoiodothyronine (MIT) and diiodothyronine (DIT).

This same enzyme also aids in the coupling of two tyrosyl residues to form **triiodothyronine (T_3)** (one MIT residue + one DIT residue) or **thyroxine (T_4)** (two DIT residues). These are the two active forms of thyroid hormone. This thyroglobulin matrix, with branches now holding T_4 and T_3 , is stored in the core of the thyroid follicle. *Thyroid-stimulating hormone (TSH)* signals the follicular cell to ingest a microscopic droplet of colloid by endocytosis. Inside the follicular cell, these droplets are digested by intracellular lysosomes into T_4 , T_3 , and other products. T_4 and T_3 are then secreted by the thyroid cell into the circulation (Fig. 22-1).

Activity of thyroid hormone is dependent on the location and number of iodine atoms. Approximately 80% of T_4 is metabolized into either T_3 (35%) or reverse T_3 (rT_3) (45%). Outer ring deiodination T_4 of (5'-deiodination) leads to production of 3,5,3'-triiodothyronine (T_3). T_3 is 3–8 times more metabolically active than T_4 and often considered to be the active form of thyroid hormone, while T_4 is the “pre” hormone (with thyroglobulin being the “prohormone”). In addition to its “pre” hormone activity, however, inner ring deiodination T_4 of results in the production of metabolically inactive rT_3 (Fig. 22-2).

There are three forms of iodothyronine 5'-deiodinase. Type 1 iodothyronine 5'-deiodinase, the most abundant form, is found mostly in the liver and kidney and is responsible for the largest contribution to the circulating T_3 pool. Certain drugs (e.g., propyl-thiouracil, glucocor-

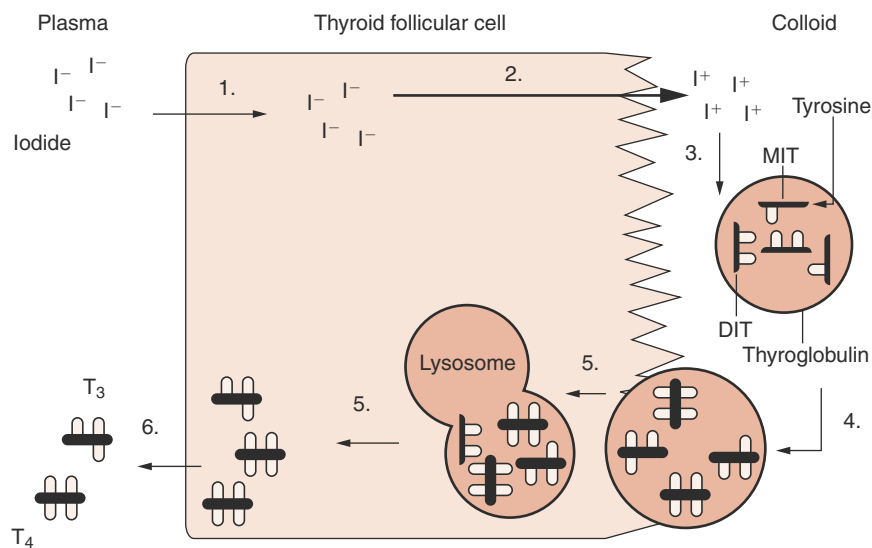

FIGURE 22-1. Biosynthesis of thyroid hormone. Thyroid hormone synthesis includes the following steps: (1) iodide (I^-) trapping by thyroid follicular cells; (2) diffusion of iodide to the apex of the cell and transport into the colloid; (3) oxidation of inorganic iodide to iodine and incorporation of iodine into tyrosine residues within thyroglobulin molecules in the colloid; (4) combination of two diiodotyrosine (DIT) molecules to form tetraiodothyronine (thyroxine, T_4) or of monoiodotyrosine (MIT) with DIT to form triiodothyronine (T_3); (5) uptake of thyroglobulin from the colloid into the follicular cell by endocytosis, fusion of the thyroglobulin with a lysosome, and proteolysis and release of T_4 and T_3 ; and (6) release of T_4 and T_3 into the circulation.

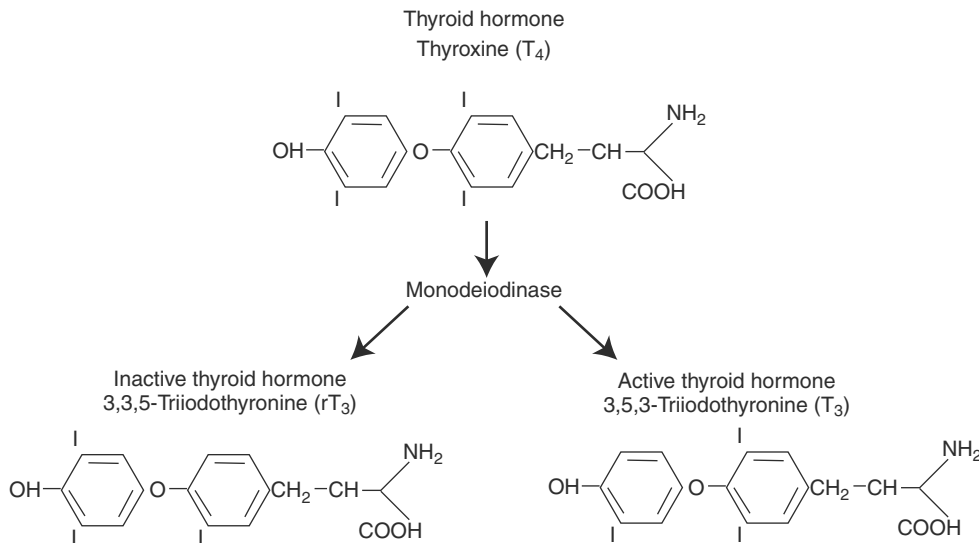

FIGURE 22-2. Metabolism of thyroxine.

ticoids, and propranolol) can slow the activity of this deiodinase and are used in the treatment of severe hyperthyroidism. Type 2 iodothyronine 5'-deiodinase is found in the brain and pituitary gland. Its function is to maintain constant levels of T₃ in the central nervous system. Its activity is decreased when levels of circulating T₄ are high and increased when levels are low. Activity of the deiodination enzymes gives another level of control on thyroid hormone activity beyond hypothalamic-pituitary control through **thyrotropin-releasing hormone (TRH)** and TSH¹ (Fig. 22-2).

Protein Binding of Thyroid Hormone

When released into the circulation, only 0.04% of T₄ and 0.4% of T₃ are unbound by proteins and available for hormonal activity. The three major binding proteins, in order of significance, are **thyroxine-binding globulin (TBG)**, **thyroxine-binding prealbumin (TBPA)**, and albumin. The quantity of T₄ and T₃ in the circulation can be significantly affected by the amount of binding protein available for carrying these hormones. For example, high estrogen levels during pregnancy lead to increased thyroxine-binding protein production by the liver. High TBG levels result in higher levels of bound thyroid hormones, leading to high levels of total T₃ and total T₄. In euthyroid individuals, levels of the active free thyroid hormone remain in the normal range. In some instances, however, measurement of **free T₄** and **free T₃** may be necessary to eliminate any confusion caused by abnormal binding protein levels.

Control of Thyroid Function

Understanding of the **hypothalamic-pituitary-thyroid axis** is essential for correctly interpreting thyroid function

testing. This axis is central in the regulation of thyroid hormone production. TRH is synthesized by neurons in the supraoptic and supraventricular nuclei of the hypothalamus and stored in the median eminence of the hypothalamus. When secreted, this hormone stimulates cells in the anterior pituitary gland to manufacture and release *thyrotropin (TSH)*. TSH, in turn, circulates to the thyroid gland and leads to increased production and release of thyroid hormone. When the hypothalamus and pituitary sense that there is an inadequate amount of thyroid hormone in circulation, TRH and TSH secretion increases and will lead to increased thyroid hormone production. If thyroid hormone levels are high, TRH and TSH release will be inhibited, leading to lower levels of thyroid hormone production and visa versa if thyroid hormone levels are low. This feedback loop requires a normally functioning hypothalamus, pituitary, and thyroid gland, as well as an absence of any interfering agents or agents that mimic TSH action (Fig. 22-3).

Actions of Thyroid Hormone

Once released from the thyroid gland, thyroid hormone circulates in the bloodstream where free T₄ and T₃ are available to travel across the cell membrane. In the cytoplasm, T₄ is deiodinated into T₃, the active form of thyroid hormone. T₃ combines with its nuclear receptor on thyroid hormone-responsive genes, leading to production of messenger RNA that, in turn, leads to production of proteins that influence metabolism and development. Effects of thyroid hormone include tissue growth, brain maturation, increased heat production, increased oxygen consumption, and an increased number of β-adrenergic receptors. Clinically, individuals who have excess thyroid hormone (**thyrotoxicosis**) will have symptoms of

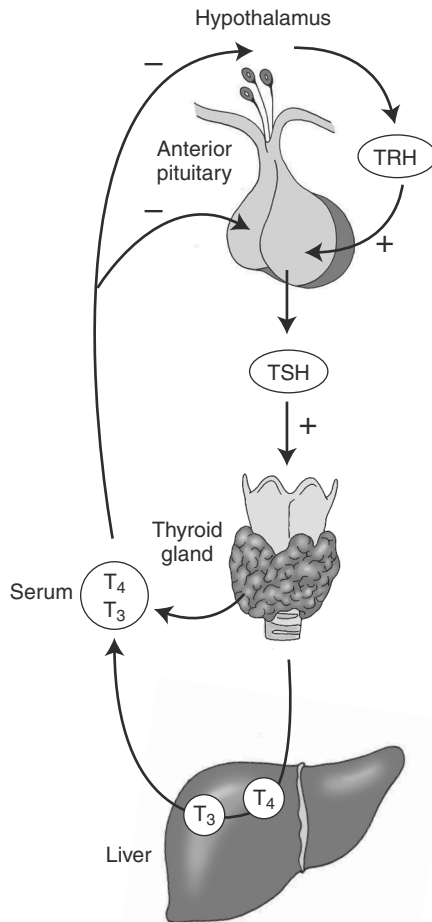

FIGURE 22-3. Hypothalamic-pituitary-thyroid axis. Thyrotropin-releasing hormone (TRH) stimulates the production and release of thyrotropin (TSH). TSH stimulates the thyroid gland to synthesize and secrete thyroid hormone. T_4 that is released by the thyroid gland is mostly converted to T_3 by the liver and kidney. T_3 and T_4 feedback inhibit TSH release directly through action at the pituitary and indirectly by decreasing TRH release from the hypothalamus. (Adapted with permission from Surks MI, Sievert R. Drugs and thyroid function. *N Engl J Med* 1995;333:1688.)

increased metabolism such as tachycardia and tremor, while individuals with hypothyroidism note symptoms of lowered metabolism like edema and constipation.

TESTS FOR THYROID EVALUATION

Blood Tests

TSH

The most useful test for assessing thyroid function is the TSH. Over the years, three generations of assays have been developed. All the assays are capable of diagnosing primary hypothyroidism (thyroid gland disease leading to low thyroid hormone production) with elevated levels of TSH. Second-generation TSH immunometric assays, with detection limits of 0.1 mU/L, can effectively screen for hyperthyroidism, but third-generation TSH chemiluminometric assays, with detection limits of 0.01 mU/L, are less likely to give false-negative results and can more accurately distinguish between euthyroidism and hyperthyroidism. Second- and third-generation TSH assays are routinely used to monitor and adjust thyroid hormone replacement therapy as well as screen for both hyperthyroidism and hypothyroidism.⁴

The sensitivity of the third-generation TSH assays has led to the ability to detect what is termed subclinical disease—or a mild degree of thyroid dysfunction—due to the large reciprocal change in TSH levels seen for even small changes in free T_4 .⁵ In **subclinical hypothyroidism**, the TSH is minimally increased while the free T_4 stays within the normal range. Likewise, in **subclinical hyperthyroidism**, the TSH is suppressed while the free T_4 is normal (Table 22-1). The clinical significance of subclinical disease and thresholds for treatment remain somewhat unclear and are a continued topic of investigation.

Serum T_4 and T_3

Serum total T_4 and T_3 levels are usually measured by radioimmunoassay (RIA), chemiluminometric assay, or similar immunometric technique. Because more than 99.9% of thyroid hormone is protein bound, alteration in thyroid hormone-binding proteins, unrelated to thyroid

TABLE 22-1 INTERPRETATION OF THYROID TESTS

| | LOW FREE T_4 | NORMAL FREE T_4 | HIGH FREE T_4 |
|------------|---|---|--|
| Low TSH | Secondary hypothyroidism Severe nonthyroidal illness | Subclinical hyperthyroidism Nonthyroidal illness | Hyperthyroidism |
| Normal TSH | Secondary hypothyroidism Severe nonthyroidal illness | Normal | Artifact Pituitary hyperthyroidism Laboratory draw within 6 hours of thyroxine dose |
| High TSH | Primary hypothyroidism | Subclinical hypothyroidism | Test artifact Pituitary hyperthyroidism Thyroid hormone resistance |

TABLE 22-2 PREVALENCE OF THYROID AUTOANTIBODIES

| ANTIBODY | GENERAL POPULATION | GRAVES' DISEASE | AUTOIMMUNE HYPOTHYROIDISM |
|--|--------------------|-----------------|---------------------------|
| Antithyroglobulin | 3% | 12%–30% | 35%–60% |
| Thyroid peroxidase (previously antimicrosomal) | 10%–15% | 45%–80% | 80%–99% |
| Anti-TSH receptor | 1%–2% | 70%–100% | 6%–60% |

disease, frequently lead to total T_4 and T_3 levels outside of the normal range. Because of this, assays have been developed to measure free T_4 and T_3 , the biologically active forms of thyroid hormone, and free T_4 kits have replaced total T_4 determinations at the clinical level, secondary to ease of interpretation and lower processing cost.⁶ Currently available assay kits for measuring free T_4 levels are not error proof, though, and can still be affected by some binding protein abnormalities.⁷ When this is suspected, measurement of free T_4 levels is performed by dialysis. Kits that estimate free T_3 levels also have theoretical advantages; however, actual clinical utility is yet to be clearly defined.

Thyroglobulin

Thyroglobulin is a protein synthesized and secreted exclusively by thyroid follicular cells. This prohormone in the circulation is proof of the presence of thyroid tissue, either benign or malignant. This fact makes thyroglobulin an ideal tumor marker for thyroid cancer patients. Patients with well-differentiated thyroid cancer who have been treated successfully with surgery and radioactive iodine ablation should have undetectable thyroglobulin levels.

Thyroglobulin is currently measured by double-antibody RIA, enzyme-linked immunoassay (ELISA), immunoradiometric assay (IRMA), and immunochemiluminometric assay (ICMA) methods. The accuracy of the thyroglobulin assay is primarily dependent on the specificity of the antibody used and the absence of antithyroglobulin autoantibodies. Even with modern assays, antithyroglobulin autoantibodies interfere with measurements and lead to unreliable thyroglobulin results. For this reason, it is critically important to screen for autoantibodies whenever thyroglobulin is being measured. If antibodies are present, the value of the thyroglobulin assay is marginal. Approximately 25% of patients with well-differentiated thyroid cancer will have antithyroglobulin autoantibodies. This is approximately twice as high as in the general population. If a patient with well-differentiated thyroid cancer and antithyroglobulin autoantibodies has been successfully treated with surgery and radioactive iodine ablation, autoantibodies should disappear over time.⁴

Thyroid Autoimmunity

Many diseases of the thyroid gland are related to autoimmune processes. In autoimmune thyroid disease,

antibodies are directed at thyroid tissue with variable responses. The most common cause of hyperthyroidism is an autoimmune disorder called **Graves' disease**. The antibody in this condition is directed at the TSH receptor and stimulates the receptor, leading to growth of the thyroid gland and production of excessive amounts of thyroid hormone. This condition can be diagnosed with tests that detect antibodies to the TSH receptor. Thyroid-stimulating antibodies (TSAb, TSI) use a bioassay to determine presence of autoimmune hyperthyroidism. Tests for **TSH receptor antibodies** (TRAb, TSHR-Ab) can detect antibodies directed against the TSH receptor whether they act to stimulate or block the TSH receptor. Both stimulating and blocking antibody assays will be positive in 70%–100% of patients with Graves' disease. **Chronic lymphocytic thyroiditis**—commonly known as **Hashimoto's thyroiditis**—is at the other end of the autoimmune continuum. This is the most common cause of hypothyroidism in the developed world. In this condition, antibodies lead to decreased thyroid hormone production by the thyroid gland. The best test for this condition is the thyroid peroxidase (TPO) antibody, which is present in 10%–15% of the general population and 80%–99% of patients with autoimmune hypothyroidism (Table 22-2).

OTHER TOOLS FOR THYROID EVALUATION

Nuclear Medicine Evaluation

Radioactive iodine is useful in assessing the metabolic activity of thyroid tissue and assisting in the evaluation and treatment of thyroid cancer. When radioactive iodine is given orally, a percentage of the dose is taken up by the thyroid gland. This percentage is called the radioactive iodine uptake (RAIU). High uptake suggests that the gland is metabolically active and producing significant amounts of thyroid hormone. Low uptake suggests that the gland is metabolically inactive. Because TSH stimulates iodine uptake by the thyroid gland, it is important to interpret the scan in conjunction with an assessment of TSH levels. An undetectably low TSH should turn off the thyroid gland's uptake of iodine. If the uptake is high despite an undetectable TSH, the thyroid must be either acting autonomously in regards to the usual hypothalamus-pituitary-thyroid feedback system or through a TSH surrogate. Such is the case with Graves' disease, where an

immunoglobulin activates the TSH receptor on the thyroid gland, leading to high rates of thyroid hormone production and a high RAIU. The high level of thyroid hormone in the circulation feeds back on the pituitary and hypothalamus, turning off TSH, but this has no effect on the levels of thyroid-stimulating immunoglobulin (the TSH surrogate). Conversely, if the radioactive iodine uptake is low in the presence of an undetectable TSH, the differential diagnosis includes excess exogenous thyroid hormone ingestion, high iodine intake, or a condition in which stored thyroid hormone is leaking from the thyroid gland (typically in a setting known as **subacute thyroiditis**).

Radioactive iodine can also be useful in the evaluation of thyroid nodules in the presence of a low or undetectable TSH. Thyroid nodules that take up significant amounts of radioactive iodine on thyroid scans—termed “hot” nodules—are unlikely to be thyroid cancer. The converse, however, does not hold true as nodules that show little or no radioiodine uptake—indeterminate or “cold” nodules, respectively—may be cancerous, but the majority of such nodules are benign.

Thyroid Ultrasound

The significance of thyroid ultrasound in the assessment of thyroid anatomy and characterization of palpable thyroid abnormalities has progressively increased in the last several years. Thyroid ultrasounds are capable of detecting even thyroid nodules of such a small size as to be of unclear or even no clinical significance; in up to 50% of clinically normal thyroid glands, small (<1 cm) thyroid nodules can be seen.⁸

Fine-Needle Aspiration

Thyroid fine-needle aspiration (FNA) biopsy is often the first step and most accurate tool in the evaluation of thyroid nodules. The routine use of FNA biopsy allows prompt identification and treatment of thyroid malignancies and avoids unnecessary surgery in most individuals with benign thyroid lesions. In this procedure, a small-gauge needle is inserted into the nodule and cells are aspirated for cytologic evaluation. The procedure can be performed using palpation if the nodule is palpable, or with the assistance of ultrasound imaging in cases of nonpalpable nodules. However, due to the small size, some nodules are read as indeterminate by FNA and must be surgically removed for a definitive diagnosis

DISORDERS OF THE THYROID

Hypothyroidism

Hypothyroidism—defined as a low free T₄ level with a normal or high TSH—is one of the most common disorders

CASE STUDY 22-1

A 24-year-old woman presents 2 months' postpartum with symptoms of hyperthyroidism. She does not have evidence of Graves' ophthalmopathy. Her TSH level is undetectable, and free T₄ is two times the upper limits of normal.

Questions

1. What are possible causes for her thyrotoxicosis?
2. What tests would be useful to sort out the cause of her thyrotoxicosis?

of the thyroid gland, occurring in 5%–15% of women over the age of 65. Symptoms of hypothyroidism vary, depending on the degree of hypothyroidism and the rapidity of its onset (Box 22-1). When thyroid hormone is significantly decreased, symptoms of cold intolerance, fatigue, dry skin, constipation, hoarseness, dyspnea on exertion, cognitive dysfunction, hair loss, and weight gain have been reported. On physical examination, those with severe hypothyroidism may have low body temperature, slowed movements, bradycardia, delay in the relaxation

BOX 22-1. SIGNS AND SYMPTOMS OF HYPOTHYROIDISM

Signs

Delayed relaxation phase of deep tendon reflex testing
 Bradycardia
 Diastolic hypertension
 Coarsened skin, yellowing of skin (carotenemia)
 Periorbital edema
 Thinning of eyebrows/loss of lateral aspect of brows
 Slowed movements/speech
 Pleural/pericardial effusion
 Ascites

Symptoms

Cold intolerance
 Depression
 Mental retardation (infants), slowed cognition
 Menorrhagia
 Growth failure (children)
 Pubertal delay
 Dry skin
 Edema
 Constipation
 Hoarseness
 Dyspnea on exertion

BOX 22-2. TYPES OF HYPOTHYROIDISM

Primary

Thyroid gland dysfunction

Secondary

Pituitary dysfunction

Tertiary

Hypothalamic dysfunction

phase of deep tendon reflexes, yellow discoloration of the skin (from hypercarotenemia), hair loss, diastolic hypertension, pleural and pericardial effusions, menstrual irregularities, and periorbital edema.

Because of the diffuse distribution of thyroid hormone receptors and the many metabolic effects of thyroid hormone, hypothyroidism can lead to a variety of other abnormalities. Hyponatremia can occur due to inappropriate levels of antidiuretic hormone and significant degrees of hypothyroidism can also lead to myopathy and elevated levels of creatine kinase (CK).^{9,10} Anemia can also be seen, either as a result of a decreased demand for oxygen carrying capacity or through an associated autoimmune pernicious anemia.¹¹ Hypothyroidism may also lead to hyperlipidemia, most notably when the TSH is greater than 10 mU/L.¹² One study documented more than half of those with hypothyroidism who were studied had hypercholesterolemia, while another study showed 4.2% of patients with hyperlipidemia had hypothyroidism.¹³ In the presence of these clinical abnormalities (hyponatremia, unexplained elevation of creatine phosphokinase [CPK], anemia, or hyperlipidemia), evaluation for hypothyroidism as a potential secondary cause should be considered.

Hypothyroidism can be divided into primary, secondary, or tertiary disease, dependent on the location of the defect (Box 22-2). The most common cause of hypothy-

roidism in developed countries is chronic lymphocytic thyroiditis, or Hashimoto's thyroiditis. This disorder is an autoimmune disease targeting the thyroid gland, often associated with an enlarged gland, or goiter. TPO antibody testing is positive in 80%–99% of patients with chronic lymphocytic thyroiditis. Other common causes of hypothyroidism include iodine deficiency, thyroid surgery, and radioactive iodine treatment (Table 22-3). Occasionally, individuals will experience transient hypothyroidism associated with inflammation of the thyroid gland. Examples of transient hypothyroidism include recovery from nonthyroidal illness and the hypothyroid phase of any of the forms of subacute thyroiditis (painful thyroiditis, postpartum thyroiditis, and painless thyroiditis).

American Thyroid Association Guidelines for Hypothyroidism Screening^{14,15}

Measurement of TSH

- At age 35
- Every 5 years after the age of 35
- More frequently with risk factors or symptoms: goiter, family history, lithium use, amiodarone use

Hypothyroidism is treated with thyroid hormone replacement therapy. Levothyroxine (T_4) is the treatment of choice. In primary hypothyroidism, the goal of therapy is to achieve a normal TSH level. If hypothyroidism is of secondary or tertiary in origin, TSH levels will not be useful in managing the condition and a midnormal free T_4 level becomes the target of therapy. Levothyroxine has a half-life of approximately 7 days. When doses of thyroid hormone are changed, it is important to wait at least five half-lives before rechecking thyroid function tests in order to achieve a new steady state.

Thyrotoxicosis

Thyrotoxicosis is a constellation of findings that result when peripheral tissues are presented with, and respond

TABLE 22-3 CAUSES OF HYPOTHYROIDISM

| | CONDITION | COMMENTS |
|-----------|---|---|
| Primary | Chronic lymphocytic thyroiditis (Hashimoto's thyroiditis) | TPOAb or TgAb positive in 80%–99% of cases |
| | Treatment for toxic goiter—subtotal thyroidectomy or radioactive iodine | History and physical exam (neck scar) are key to diagnosis |
| | Excessive iodine intake | History and urinary iodine measurement useful |
| | Subacute thyroiditis | Usually transient |
| Secondary | Hypopituitarism | Caused by adenoma, radiation therapy, or destruction of pituitary |
| Tertiary | Hypothalamic dysfunction | Rare |

TgAb, thyroglobulin antibodies; TPOAb, thyroid peroxidase antibodies.

BOX 22-3. SIGNS AND SYMPTOMS OF THYROTOXICOSIS

Signs

Tachycardia
Tremor
Warm, moist, flushed, smooth skin
Lid lag, widened palpebral fissures
Ophthalmopathy (Graves' disease)
Goiter
Brisk deep tendon reflexes
Muscle wasting and weakness
Dermopathy/pretibial myxedema (Graves' disease)
Osteopenia, osteoporosis

Symptoms

Nervousness, irritability, anxiety
Tremor
Palpitations
Fatigue, weakness, decreased exercise tolerance
Weight loss
Heat intolerance
Hyperdefecation
Menstrual changes (oligomenorrhea)
Prominence of eyes

to, an excess of thyroid hormone. Thyrotoxicosis can be the result of excessive thyroid hormone ingestion, leakage of stored thyroid hormone from storage in the thyroid follicles, or excessive thyroid gland production of thyroid hormone. The latter form of thyrotoxicosis is called **hyperthyroidism**. The manifestations of thyrotoxicosis vary, depending on the degree of thyroid hormone elevation and the status of the affected individual. Symptoms typically include anxiety, emotional lability, weakness, tremor, palpitations, heat intolerance, increased perspiration, and weight loss despite a normal or increased appetite (Box 22-3).

Graves' Disease

Graves' disease is the most common cause of thyrotoxicosis. It is an autoimmune disease in which antibodies are produced that activate the TSH receptor. Features of Graves' disease include thyrotoxicosis, goiter, ophthalmopathy (eye changes associated with inflammation and infiltration of periorbital tissue), and dermopathy (skin changes in the lower extremities that have an orange peel texture). There is a strong familial disposition to Graves' disease: 15% of patients will have a close relative with this condition. Women are five times more likely than men to develop this condition. Laboratory testing will usually document a high free T₄ and/or T₃ level with an undetectable TSH. Thyroid-stimulating immunoglobulins (TSIs) and TSH receptor antibodies are usually pos-

CASE STUDY 22-2

A 67-year-old woman is referred for treatment of hyperlipidemia. Her cholesterol and triglycerides are high, despite treatment with lipid-lowering medication. She is noted to have hair loss (wearing a wig) and hoarseness to her voice. She complains of cold intolerance and fatigue.

Questions

1. What testing would be helpful to screen for thyroid disease?
2. What treatment might she require?
3. What other laboratory abnormalities are commonly seen in hypothyroid patients other than hyperlipidemia and abnormal thyroid function tests?

itive in this condition. RAIU will be elevated, and the thyroid scan will show diffuse uptake (Table 22-4).

Graves' ophthalmopathy can be of particular concern.¹⁶ Approximately 20%–25% of patients with Graves' hyperthyroidism have clinically obvious Graves' ophthalmopathy. With more sensitive testing, such as orbital computed tomography (CT) scanning or magnetic resonance imaging (MRI), most patients with Graves' hyperthyroidism will be shown to have ophthalmopathy.¹⁷ The findings in Graves' ophthalmopathy can include orbital soft tissue swelling, injection of the conjunctivae, proptosis (forward protrusion of the eye, secondary to infiltration of retroorbital muscles and fat), double vision (secondary to orbital muscle involvement and fibrosis), and corneal disease (often related to difficulty closing the eyelids). Treatment of Graves' ophthalmopathy is controversial. Occasionally, patients require surgical decompression of the orbits to prevent optic nerve injury and blindness.

Thyroid disease associated with Graves' disease is treated with medication, radioactive iodine, or surgery. Initially, many thyrotoxic patients require β -blockers to control symptoms of adrenergic excess, such as tremor and tachycardia. Propylthiouracil (PTU) or methimazole (MMI) can be added to inhibit thyroid hormone biosynthesis and secretion.¹⁸ The antithyroidal medications, as they are known, carry a significant risk profile that includes rash, hepatotoxicity, agranulocytosis, and aplastic anemia. These medications may have immunomodulatory effects on the underlying autoimmune disease, helping promote remission of the condition after several months of therapy. Long-term remission rates vary but generally run between 20% and 50% in the United States. Women are more likely to achieve remission than men. Likewise, patients with small goiters and mild hyperthyroidism are

TABLE 22-4 DISORDERS ASSOCIATED WITH THYROTOXICOSIS

| | CONDITION | PATHOGENIC MECHANISM | TSH LEVEL | RAIU | OTHER TESTS |
|--------------------|---------------------------|--|-----------|------|-----------------------------------|
| Hyperthyroidism | Graves' disease | TSHRab | ↓ | ↑ | TRAb positive; TSI positive |
| | Toxic adenoma | Benign nodule | ↓ | ↑ | Seen on thyroid scan |
| | Toxic multinodular goiter | Foci of functional autonomy | ↓ | ↑ | Seen on thyroid scan |
| | TSH-secreting tumor | Benign pituitary tumor | Normal/↑ | ↑ | Pituitary MRI |
| Nonhyperthyroidism | Painful thyroiditis | Leakage of thyroid hormone | ↓ | ↓ | Tg inappropriately high |
| | Postpartum thyroiditis | Leakage of thyroid hormone | ↓ | ↓ | TPOAb often high |
| | Exogenous hormone | Medication | ↓ | ↓ | |
| | Ectopic thyroid tissue | Metastatic thyroid cancer; struma ovarii | ↓ | ↓ | Distant mets seen on thyroid scan |

RAIU, radioactive iodine uptake; Tg, thyroglobulin; TSHRab, TSH receptor antibodies; TSI, thyroid-stimulating immunoglobulins; TPOAb, thyroid peroxidase antibodies.

more likely to achieve remissions. Low dietary iodine increases the chance of staying in long-term remission. Patients experiencing such a remission do not require therapy with thyroid hormone replacement.

When radioactive iodine or surgery is used, the goal is to destroy or remove enough thyroid tissue so that the patient becomes hypothyroid. Subsequent lifelong treatment with thyroid hormone replacement therapy is usually required. Radioactive iodine therapy has been used for treatment of Graves' disease for more than 50 years and is both safe and effective. Surgery is associated with risk of recurrent laryngeal nerve injury, leading to permanent hoarseness, and injury to the parathyroid glands, causing hypoparathyroidism leading to hypocalcemia.

Because of their comparative risks for adverse events, radioactive iodine is generally the preferred treatment modality in the United States. Antithyroidal medications are typically used either because of patient preference or during pregnancy and breastfeeding. There are two situations in Graves' disease in which surgery is preferred to other forms of therapy. If there is concern that the patient may have thyroid cancer in addition to Graves' disease, surgery is the best way to ensure removal of the potential cancer. In patients with severe ophthalmopathy, some experts in Graves' disease management prefer surgery because of concern that radioactive iodine treatment may cause an acute flaring of associated eye problems.

Toxic Adenoma and Multinodular Goiter

Toxic adenomas and multinodular goiter are two relatively common causes of hyperthyroidism. These conditions are caused by autonomously functioning thyroid tissue. In these instances, neither TSH nor TSH receptor–stimulating immunoglobulin is required to stimulate thyroid hormone production. In some toxic nodules,

receptor mutations have been identified. These mutations have the same effect as chronic stimulation of the TSH receptor on thyroid hormone production. Clinically, toxic adenomas present in patients with hyperthyroidism and a palpable thyroid nodule. On a thyroid scan, the nodules are “hot”—that is, they avidly take up radioactive iodine. The radioactive iodine uptake is also inappropriately high for the suppressed level of TSH. In toxic multinodular goiter, there are multiple areas within the thyroid gland that are autonomously producing thyroid hormone (Table 22-4). Treatment for these two conditions involves surgery, radioactive iodine, or medication (PTU or MMI). Although the medications can block thyroid hormone production, they are not expected to lead to remission in these two conditions. Often, the toxic nodules produce so much thyroid hormone that the rest of the thyroid gland is suppressed and metabolically inactive. When radioactive iodine is given, it tends to destroy only the hyperactive (autonomous) portions of the thyroid gland, leaving normal (suppressed) thyroid tissue undamaged. Because the normal thyroid tissue is hypofunctioning and takes up little of the radioactive iodine, when treatment is given the patient may be left with normal thyroid function without the need for thyroid hormone replacement therapy.

DRUG-INDUCED THYROID DYSFUNCTION

Amiodarone-Induced Thyroid Disease

Several drugs other than PTU and methimazole can affect thyroid function. Amiodarone, a drug used to treat cardiac arrhythmias, is a fat-soluble drug with a long half-life (50 days) in the body that interferes with normal thyroid function.¹⁹ The fact that 37% of the molecular weight of amiodarone is iodine accounts for a significant part of the thyroid dysfunction seen. Iodine, when given

in large doses, acutely leads to inhibition of thyroid hormone production. This is called the Wolff-Chaikoff effect. Amiodarone also blocks T_4 -to- T_3 conversion. The combination of these two actions leads to hypothyroidism in 8%–20% of patients on chronic amiodarone therapy. Amiodarone can also lead to hyperthyroidism in 3% of patients treated chronically with this medication. Certain patients develop hyperthyroidism as they escape the Wolff-Chaikoff effect and use the excess iodine for thyroid hormone production. Others develop hyperthyroidism if the medication leads to inflammation of the thyroid gland (subacute thyroiditis) and subsequent leakage of stored thyroid hormone into the circulation.

Subacute Thyroiditis

Several conditions occur that lead to transient changes in thyroid hormone levels.²⁰ These conditions are associated with inflammation of the thyroid gland, leakage of stored thyroid hormone, and then repair of the gland. Although nomenclature varies between authors, grouping together postpartum thyroiditis, painless thyroiditis, and painful thyroiditis as forms of subacute thyroiditis is one of the simplest classification schemes. These conditions are often associated with a thyrotoxic phase when thyroid hormone is leaking into the circulation, a hypothyroid phase when the thyroid gland is repairing itself, and a euthyroid phase when the gland is repaired. These phases can last from weeks to months.

Postpartum thyroiditis is the most common form of subacute thyroiditis. It occurs in 3–16% of women in the postpartum period.²¹ It is strongly associated with the presence of TPO antibodies and chronic lymphocytic thyroiditis. Patients may experience a period of thyrotoxicosis followed by hypothyroidism or simply hypothyroidism or hyperthyroidism. Thyroid hormone levels usually return to normal after several months; however, by 4 years' postpartum, 25%–50% of patients have persistent hypothyroidism, goiter, or both.²² During the thyrotoxic phase, β -blockers can be used if treatment is necessary. During the hypothyroid phase, thyroid hormone replacement therapy can be given if symptoms require, usually for 3–6 months, unless permanent hypothyroidism

evolves. The thyrotoxic phase of this condition, as well as other forms of subacute thyroiditis, can be distinguished from Graves' disease by a low RAIU and an absence of TSI or TSH receptor antibodies (Table 22-4). Painless thyroiditis or subacute lymphocytic thyroiditis shares many characteristics of postpartum thyroiditis, except there is no associated pregnancy.

Painful thyroiditis, also called *subacute granulomatous, subacute nonsuppurative thyroiditis*, or *de Quervain's thyroiditis*, is characterized by neck pain, low-grade fever, myalgia, a tender diffuse goiter, and swings in thyroid function tests (as discussed earlier). Viral infections are felt to trigger this condition. TPO antibodies are usually absent; erythrocyte sedimentation rate and thyroglobulin levels are often elevated.

NONTHYROIDAL ILLNESS

Hospitalized patients, especially critically ill patients, often have abnormalities in their thyroid function tests. Typically, the laboratory pattern is one of low total T_4 , free T_4 , and (sometimes) TSH. Because illness decreases 5'-monodeiodinase activity, less T_4 is converted to active T_3 . This leads to decreased levels of T_3 and higher levels of reverse T_3 . There also seems to be an element of central hypothyroidism and thyroid hormone-binding changes associated with severe illness. It is believed that many of these changes are an appropriate adaptation to illness. Thyroid hormone replacement therapy is not indicated.

THYROID NODULES

Thyroid nodules are common. Clinically apparent thyroid nodules are present in 6.4% of adult women and 1.5% of adult men, according to Framingham data.²³ Thyroid ultrasound finds unsuspected thyroid nodules in 20%–45% of women and 17%–25% of men.²⁴ The major concern with thyroid nodules is that they may represent a thyroid cancer. Fortunately, only 5%–9% of thyroid nodules prove to be thyroid cancer. FNA of these nodules, with cytologic examination of the aspirate, has become a routine practice to help distinguish the nodules that require surgical removal from those that do not.²⁵

REFERENCES

- Greenspan FS. The thyroid gland. In Greenspan FS, Strewler GJ, eds. *Basic & clinical endocrinology*. 5th ed. New York: Appleton & Lange, 1997.
- Lavin L. *Manual of endocrinology*. 2nd ed. Boston, Mass.: Little, Brown & Co, 1994:395.
- Utiger TD. Thyroid hormone synthesis and physiology. www.UpToDate.com, online 11.1, 2002.
- Ross DS. Laboratory assessment of thyroid function. www.UpToDate.com, online 11.1, 2002.
- Spencer CA, LoPresiti JS, Patel A, et al. Applications of a new chemiluminometric thyrotropin assay to subnormal measurement. *J Clin Endocrinol Metab* 1990;70:453–460.
- Ekins R. The free hormone hypothesis and measurement of free hormones [editorial]. *Clin Chem* 1992;38:1289–1293.

7. Wong TK, Pekary AE, Hoo GS, et al. Comparison of methods for measuring free thyroxine in nonthyroidal illness. *Clin Chem* 1992;38:720–724.
8. Tan GH, Gharib H. Thyroid incidentalomas: management approaches to nonpalpable nodules discovered incidentally on thyroid imaging. *Ann Intern Med* 1997;126:226.
9. Skowsky WR, Kikuchi TA. The role of vasopressin in the impaired water excretion of myxedema. *Am J Med* 1987;64: 613–621.
10. Khaleeli AA, Gohil K, McPhail G, et al. Muscle morphology and metabolism in hypothyroid myopathy: Effects of treatment. *J Clin Pathol* 1983;36:519–526.
11. Green ST, Ng JP. Hypothyroidism and anaemia. *Biomed Pharmacother* 1986;40:326–331.
12. Diekman T, Lansberg PJ, Kastelein JJ, Wiersinga WM. Prevalence and correction of hypothyroidism in a large cohort of patients referred for dyslipidemia. *Arch Intern Med* 1995;155:1490–1495.
13. O'Brien T, Dinneen SF, O'Brien PC, Palumbo PJ. Hyperlipidemia in patients with primary and secondary hypothyroidism. *Mayo Clin Proc* 1993;68:860–866.
14. American College of Physicians. Clinical Guideline, Part 1. Screening for thyroid disease. *Ann Intern Med* 1998;129:141–143.
15. Ladenson PW, Singer PA, Ain KB, et al. American Thyroid Association guidelines for detection of thyroid dysfunction. *Arch Intern Med* 2000;160:1573–1575.
16. Burch HB, Wartofsky L. Graves' ophthalmopathy: Current concepts regarding pathogenesis and management. *Endocr Rev* 1993;14:747–793.
17. Villadolid MC, Yokoyama N, Izumi M, et al. Untreated Graves' disease patients without clinical ophthalmopathy demonstrate a high frequency of extraocular muscle (EOM) enlargement by magnetic resonance. *J Clin Endocrinol Metab* 1995;80:2830–2833.
18. Solomon BL, Evaul JE, Burman KD, Wartofsky L. Remission rates with antithyroid drug therapy: Continuing influence of iodine intake? *Ann Intern Med* 1987;107:510–512.
19. Nademanee K, Singh BN, Callahan B, et al. Amiodarone, thyroid hormone indexes, and altered thyroid function: long-term serial effects in patients with cardiac arrhythmias. *Am J Cardiol* 1986;58:981–986.
20. Burman KD. Overview of thyroiditis. www.UpToDate.com, online 11.1, 2002.
21. Gerstein HC. How common is postpartum thyroiditis? A methodologic overview of the literature. *Arch Intern Med* 1990;150: 1397–1400.
22. Othman S, Phillips DI, Parkes AB, et al. A long-term follow-up of postpartum thyroiditis. *Clin Endocrinol (Oxf)* 1990;32:559–564.
23. Vander JB, Gaston EA, Dawber TG. The significance of nontoxic thyroid nodules. *Ann Intern Med* 1968;69:537.
24. Brander A, Viikinkoski P, Nickels J, et al. Thyroid gland: US screening in a random adult population. *Radiology* 1991;181:683.
25. Ezzat S, Sarti DA, et al. Thyroid incidentalomas: Prevalence by palpation and ultrasonography. *Arch Intern Med* 1994;154:1838.
26. Gharif H. Changing concepts in the diagnosis and management of thyroid nodules. *Endocrinol Metab Clin North Am* 1997;26:777.

Calcium Homeostasis and Hormonal Regulation

Thomas P. Knecht, Ryan Hungerford

CHAPTER

23

CHAPTER OUTLINE

- **CALCIUM HOMEOSTASIS**
- **HORMONAL CONTROL OF CALCIUM METABOLISM**
 - Vitamin D
 - Parathyroid Hormone
- **ORGAN PHYSIOLOGY AND CALCIUM METABOLISM**
 - Gastrointestinal Physiology
 - Renal Physiology
 - Bone Physiology
- **HYPERCALCEMIA**
 - Signs and Symptoms of Hypercalcemia
 - Causes of Hypercalcemia
- **Endocrine Causes of Hypercalcemia**
- **Organ System Causes of Hypercalcemia**
- **Medications That Can Cause Hypercalcemia**
- **HYPOCALCEMIA**
 - Signs and Symptoms of Hypocalcemia
 - Causes of Hypocalcemia
 - Endocrine Causes of Hypocalcemia
 - Organ System Causes of Hypocalcemia
 - Medications That Affect Calcium Metabolism
- **METABOLIC BONE DISEASES**
 - Rickets and Osteomalacia
 - Osteoporosis
- **REFERENCES**

CALCIUM HOMEOSTASIS

Under normal circumstances, with intact endocrine and organ physiology, calcium metabolism in the human is very closely regulated. This chapter will review the endocrine and organ physiology responsible for control of blood calcium, and how disorders of these systems can cause disease.¹ Any understanding of calcium metabolism requires a review of organs involved in calcium homeostasis and the hormonal systems that affect the organ physiology (Fig. 23-1).

In understanding calcium homeostasis, it is essential to understand which parameter of “calcium” is the target of regulation. Blood calcium (serum calcium from an analyte standpoint) is teleologically what the endocrine system has evolved to maintain in a “normal” range.^{2,3} The cellular and tissue effects of calcium, involving contractile machinery, structural roles, roles in enzymatic reactions, and so on, all depend on blood calcium maintenance within a specific range.

The circulating (blood) pool of calcium is in constant flux. Calcium enters the blood pool, and calcium leaves the blood pool. Because blood calcium is the centric commodity in calcium homeostasis, it is useful to consider factors that put calcium into the bloodstream, and those that take calcium out of the bloodstream (Fig. 23-1). The principal organs involved in calcium

homeostasis are the small intestine, the skeleton (bone), and the kidneys. From birth, all calcium that enters the body comes from one’s diet. Thus, dietary calcium plays a very crucial role in calcium homeostasis. Bone is the chief reservoir of calcium in the body, and functions to either release calcium into the bloodstream or take it up from the bloodstream as needed to maintain a certain “set point.” Other than inconsequential losses from the body via the gastrointestinal (GI) tract, sweat, saliva, etc., the only significant loss of calcium from the body occurs via the kidneys into urine.

In reviewing calcium homeostasis, we first review the hormones involved in the control of blood calcium, and then the organs that play the principle roles in calcium homeostasis. We demonstrate how hormonal regulation of organ/tissue function maintains blood calcium. We then consider how various disease processes interfere with one or more steps in this regulatory network and, in so doing, disrupt calcium homeostasis.

HORMONAL CONTROL OF CALCIUM METABOLISM

Parathyroid hormone (PTH) and **vitamin D** are the two hormones that play the dominant role in the regulation of calcium homeostasis.

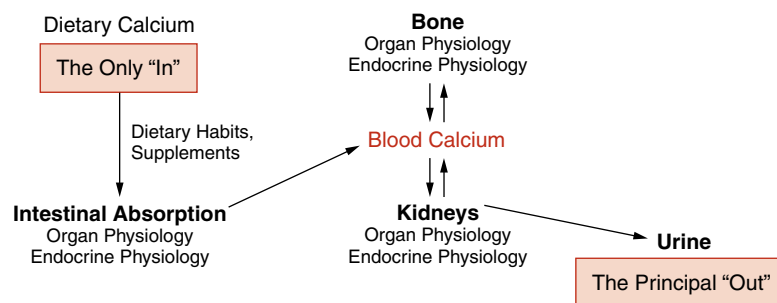

FIGURE 23-1. Calcium homeostasis. Tissue and organs involved in calcium homeostasis (gut, skeleton, and kidneys) and how they relate to blood calcium. Also shown is the means of getting calcium de novo into the system (GI absorption) and elimination of calcium from the system (renal excretion) under normal physiologic conditions.

Vitamin D

It should first be noted that vitamin D is in reality a hormone and, as is true of hormones in general, it is made at (a) site(s) different than the organs whose function it affects.⁴ It is referred to as a “vitamin” based on historical terms, and the terminology has remained. Vitamin D, therefore, shares striking similarities in origin with steroid hormones, that is, vitamin D is a metabolic product of the cholesterol synthetic pathway. The tissues that are involved in the synthesis of vitamin D are the skin, liver, and kidneys (Fig. 23-2), and the tissues it affects are the gut, bone, and parathyroids.⁴

De novo synthesis of vitamin D begins in the skin, where 7-dehydrocholesterol is transformed to vitamin D₃ by the action of ultraviolet light. Vitamin D₃ is biologically inert and must be further metabolized to the biologically active metabolite.

An enzyme in the liver, 25-hydroxylase, metabolizes vitamin D₃ to **25-hydroxy vitamin D**. Hepatic 25-hydroxylase is not regulated by any component of the calcium homeostatic system and functions constitutively to hydroxylate vitamin D₃ at the 25-position of the sterol ring

system. Serum 25-hydroxy vitamin D indicates the adequacy of vitamin D stores in the body. An enzyme in the kidneys, renal 1 α -hydroxylase, under regulation from PTH, completes the metabolism of vitamin D to the active metabolite, **1,25-dihydroxy vitamin D [1,25(OH)₂D]**.

Age and degree of exposure to sunlight influence adequacy of vitamin D stores. Older individuals, those with little or no sunlight exposure (e.g., those in more northern or southern latitudes) are more likely to develop vitamin D deficiency if not supplemented in the diet.

Vitamin D can also be obtained from dietary sources. Vitamin D would be relatively rare in common foods consumed by North Americans—were it not for fortification. For instance, milk is fortified by ultraviolet irradiation, in much the manner that ultraviolet light striking the skin mediates the formation of vitamin D₃. Multivitamins generally supply 400 units of vitamin D₃, about the same amount obtained from a quart of vitamin D–fortified milk. Other than these sources, you’re basically looking at cod liver oil as a source of vitamin D!

As mentioned, there are evolutionary similarities between vitamin D and steroid hormones. The cholesterol biosynthetic pathway provides the precursors for vitamin

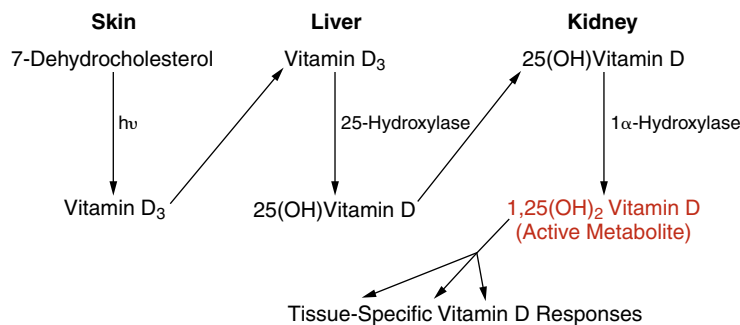

FIGURE 23-2. Vitamin D synthesis. Tissues involved in the synthesis of vitamin D and the steps that each tissue is responsible for. Also shown are enzymes responsible for the two enzymatically mediated steps (hepatic 25-hydroxylation and renal 1 α -hydroxylation). The product of this pathway, 1,25(OH)₂D, is responsible for the tissue-specific effects of vitamin D.

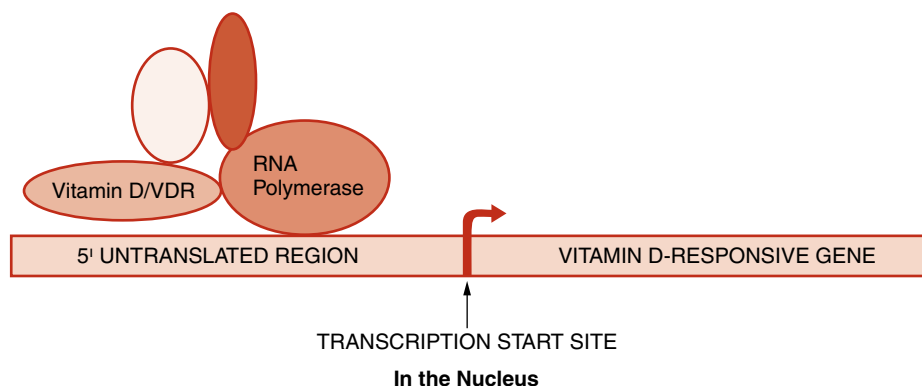

FIGURE 23-3. Vitamin D mechanism of action. DNA binding and interaction with other components of the transcriptional machinery of the vitamin D–vitamin D receptor complex are shown. Note the striking evolutionary similarity between this mechanism and that of other steroid and thyroid hormones. As prime examples, vitamin D inhibits transcription of the *PTH* gene in parathyroid tissue and stimulates transcription of the calcium transporter in the intestinal brush border epithelium.

D and for steroid hormones. There is further evolutionary relationship, in that the vitamin D receptor is in the same supergene family as the receptors for steroid hormones, thyroid hormone, retinoid receptors, and a number of “orphan” receptors (these orphan receptors have no known ligand; some appear to function via regulation of phosphorylation status). As with all receptors in this supergene family, the vitamin D receptor is a nuclear receptor, and carries out its physiologic regulation by directing transcription of specific vitamin D–responsive genes. $1,25(\text{OH})_2\text{D}$ is the natural ligand for the vitamin D receptor.

The $1,25(\text{OH})_2\text{D}$ –vitamin D receptor complex binds to the vitamin D response element upstream (5′) of the transcription start site of vitamin D–influenced genes and influences gene transcription by interacting with other transcriptional elements and RNA polymerase to regulate transcription of the gene in question (Fig. 23-3).

The physiologic influence of vitamin D is carried out by only a few organ systems/tissues. In small intestinal epithelial (primarily duodenal) cells, $1,25(\text{OH})_2\text{D}$ upregulates expression of a number of genes that stimulate transepithelial calcium transport from the intestinal lumen into the blood. The site of greatest absorption is the duodenum. $1,25(\text{OH})_2\text{D}$ also stimulates absorption of phosphate.

In bone, $1,25(\text{OH})_2\text{D}$ stimulates terminal differentiation of **osteoclast** precursors to osteoclasts. $1,25(\text{OH})_2\text{D}$ also stimulates **osteoblasts** to influence osteoclasts to mobilize bone calcium. $1,25(\text{OH})_2\text{D}$ does not directly affect *mature* osteoclast physiology. $1,25(\text{OH})_2\text{D}$ plays an important role in mineralization of bone, and abnormal bone results when vitamin D is deficient or its metabolism is defective.

As noted earlier, $1,25(\text{OH})_2\text{D}$ increases blood calcium by augmenting intestinal absorption of calcium. Blood calcium feeds back to parathyroid tissue and affects synthesis

and secretion of PTH (see Parathyroid Hormone). However, $1,25(\text{OH})_2\text{D}$ also has direct transcriptional control over the *PTH* gene in the parathyroids. The $1,25(\text{OH})_2\text{D}$ –vitamin D receptor complex binds to the vitamin D response element upstream of the *PTH* gene and downregulates *PTH* gene transcription. This is a classic case of endocrine regulation of tissue function (Fig. 23-4): PTH stimulates production of $1,25(\text{OH})_2\text{D}$, and $1,25(\text{OH})_2\text{D}$, in turn, feeds back to decrease PTH secretion, all to maintain blood calcium in the normal range.

Parathyroid Hormone

PTH is secreted from four parathyroid glands in the region of the thyroid gland, thus the name *parathyroid*. Sometimes one or more of the parathyroid glands are actually found *within* the thyroid gland. Parathyroid

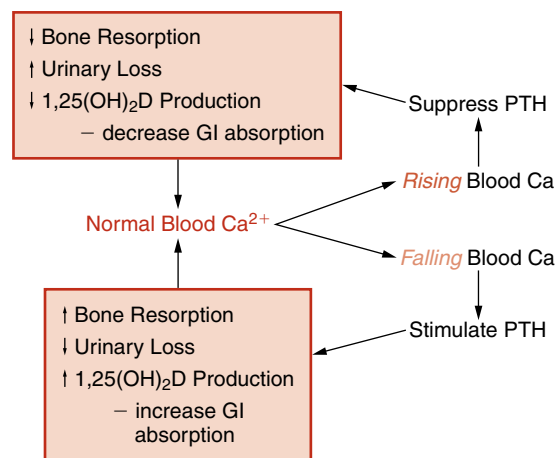

FIGURE 23-4. Calcium, PTH, and vitamin D feedforward and feedback loops. The endocrine response to shifts in blood calcium (rising or falling) is shown. A concerted hormone response, mediated at the organ level by the organs shown in Figure 23-1, helps restore blood calcium toward normal.

glands may also be found outside their normal anatomical site, residing anywhere between the hyoid bone in the neck and the mediastinum. To re-emphasize, the name “parathyroid” refers only to anatomical proximity to the thyroid gland; there is no metabolic relationship between the thyroid gland and the parathyroids.

The parathyroid glands possess specialized **calcium-sensing receptors** that respond to rising or falling ambient calcium by increasing or decreasing PTH secretion, respectively.⁵ PTH has numerous target organs including bone where it stimulates bone resorption and release of calcium into the blood. PTH acts on the kidney to both increase the fractional reabsorption of renal tubular calcium and to drive 1α -hydroxylation of 25-hydroxy vitamin D to produce the active metabolite of vitamin D, $1,25(\text{OH})_2\text{D}$. Last, PTH, via $1,25(\text{OH})_2\text{D}$, promotes intestinal absorption of calcium. All of these actions collectively function to raise blood calcium. In summary, low blood calcium is sensed by the parathyroid calcium-sensing receptor, which in turn releases PTH and sets into motion multiple activities that will increase blood calcium. Or, if blood calcium is elevated, the parathyroid calcium-sensing receptor will detect this and limit or even halt PTH release, the result being a fall in blood calcium. This entire process is a classic example of endocrine negative feedback physiology: as low blood falls, PTH secretion increases, but then as blood calcium rises again, this will *negatively* feed back to the parathyroid gland and PTH secretion will be reduced.

The multiple actions of PTH described above are mediated via a specific PTH receptor.⁶ This receptor activates adenylate cyclase and the “second messenger” pathway involving cyclic AMP (cAMP), with its effects on protein phosphorylation, etc. An interesting example of molecular medicine is the disease *pseudohypoparathyroidism*, which is mentioned in the section on **hypocalcemia**. Briefly, this is a disease where there is an inactivating mutation in the stimulatory G protein (Gs) that couples the PTH receptor to adenylate cyclase. Uncoupling the PTH receptor from adenylate cyclase makes the PTH target tissues unresponsive to PTH. Thus, PTH rises above normal but without its effects on target tissues (thus the name *pseudohypoparathyroidism*).⁷

ORGAN PHYSIOLOGY AND CALCIUM METABOLISM

As noted earlier, three organ systems dominate the organ system contribution to calcium metabolism: the GI tract, the kidneys, and bone.

Gastrointestinal Physiology

Normal intestinal function is required for calcium absorption.⁸ Interruptions in intestinal function, such as may be seen with short bowel syndromes, genetic or

physiologic defects, etc., may affect calcium absorption. Adequate dietary calcium intake is required. Then, normal vitamin D availability and metabolism are necessary for optimal calcium absorption. $1,25(\text{OH})_2\text{D}$ approximately doubles the absorption of duodenal calcium from about 30% to 60%–70% of ingested calcium. It should be noted as an aside that dietary phosphate can bind dietary calcium in the intestinal lumen, form the insoluble precipitate calcium phosphate, and prevent the absorption of both the calcium and the phosphate. The insolubility of calcium phosphate is reflected in its solubility product constant, K_{sp} , which equals 1.2×10^{-29} . This is the basis for the use of calcium carbonate as a “phosphate binder” in patients with renal failure. Likewise, a diet high in phosphate (such as a junk food diet or high consumption of dark-colored soda) will tend to inhibit calcium absorption for the same reason.

Renal Physiology

The kidneys play an essential role in calcium metabolism.⁹ However, the diseased kidney accounts for markedly disordered calcium metabolism. Impaired hydroxylation of 25-hydroxy vitamin D to form the active $1,25(\text{OH})_2\text{D}$ occurs with its attendant consequences such as poor calcium absorption from the gut, impaired phosphate excretion, and reduced bone quality.

In discussing renal physiology in relation to calcium homeostasis, it is important to differentiate between fractional reabsorption of calcium from the tubule and net excreted load of calcium in the urine. **Hypercalcemia**, whether as a result of autonomous overproduction of PTH, termed *primary hyperparathyroidism*, or from several other causes, greatly increases the filtered load of calcium. Even though PTH stimulates tubular reabsorption of calcium, this process becomes overwhelmed, and the *net* calcium excretion is increased compared to normal (nonhyperparathyroid) state. Hypercalciuria results as a standard component of primary hyperparathyroidism, although hypercalciuria from any cause poses an increased risk for calcium-containing kidney stones.

Bone Physiology

Bone turnover or “remodeling” is the coupled process of simultaneous bone formation and breakdown that occurs to varying degrees in all bone throughout life.¹⁰ This process is normally tightly coupled, so that one does not occur to a significantly greater extent than the other (the major exception to this is during the major skeletal development period of youth). Bone formation is mediated by osteoblasts, and bone breakdown, or resorption, is mediated by osteoclasts (a cell in the monocyte/macrophage lineage). Interestingly, although osteoclasts are required to mobilize calcium from bone, they do not express receptors for either $1,25(\text{OH})_2\text{D}$ or

for PTH, the principal hormones that stimulate bone resorption. Rather, these hormones act directly on osteoblasts, which in turn produce a complex array of cytokines, which then activate osteoclasts. When the net rates of osteoblast-mediated bone formation and osteoclast-mediated bone resorption are mismatched, or uncoupled, such that resorption exceeds formation, bone mass will ultimately decrease. Decreased bone mass translates clinically into an increased risk of fracture.

There are two main types of bone in the skeleton: **cortical bone** and **trabecular bone**.¹¹ Cortical bone is the primary bone type found in long bones, such as the femur. Cortical bone is very strong in the axial and cross-sectional dimensions and therefore is very well suited to the rigidity needed in long bones. Trabecular bone is the primary bone type found in the axial skeleton, such as the vertebrae. It consists of numerous cross-hair type connections called *trabeculae*. These interconnected trabeculae give this type of bone both strength and elasticity. Although the femur is primarily cortical bone and the vertebrae is primarily trabecular bone, other skeletal sites, such as the femoral neck, distal radius, and proximal humerus, are actually a mixture of both cortical and trabecular bone.

In summary, normal calcium metabolism is the end result of a balance between multiple different activities regulated directly or indirectly by PTH and include control of calcium influx and efflux from bone to the bloodstream, conversion of 25-hydroxy vitamin D to 1,25(OH)₂D in the kidney, renal tubular reabsorption of calcium, and absorption of dietary calcium from the gut. When this balance of activities is disturbed, a myriad of medical conditions can develop.

HYPERCALCEMIA

Hypercalcemia is the state of blood calcium levels above the expected normal range in a healthy population.¹² Ionized (free) calcium is the biologically active component of circulating calcium. Only about 50% of circulating calcium is present as ionized or “free” calcium. The remainder is complexed, or bound, with serum proteins, primarily albumin, or with cations such as phosphate and citrate. When calcium is measured in a serum chemistry panel, for example, the total calcium is being measured. These data are therefore less valuable unless interpreted in the context of these other substances with which calcium is complexed, the most important being albumin. Patients with low serum albumin would be expected to have low total calcium and normal ionized calcium; the opposite is true for patients with high serum albumin. Ionized calcium best correlates with the biological activity of calcium, as well as with symptoms of hypercalcemia or hypocalcemia, and thus the direct

measurement of ionized calcium may often be more valuable clinically. The binding of ionized calcium to proteins is a function of pH; more calcium binds at more alkaline pH, and less at more acidic pH. Arterial blood, which in health has a pH of about 7.4, usually has more protein-bound calcium than venous blood, which has a pH of about 7.2. Because of this arterial-venous difference in ionized calcium, it was historically measured only in arterial blood. It is now possible to measure ionized calcium in venous blood—the clinical laboratory can calculate the value of the equivalent ionized calcium at a pH of 7.4.

Signs and Symptoms of Hypercalcemia

The signs and symptoms of hypercalcemia are highly variable and depend on the degree of hypercalcemia. Clinically, the signs and symptoms also vary from patient to patient as to what levels of blood calcium they may occur at (comorbid conditions may also influence the development of symptoms).¹² The signs and symptoms are generally described by organ system:

Central nervous system: Patients may have altered central nervous system function, including lethargy, decreased alertness, depression, confusion, forgetfulness, obtundation, and, in the extreme, coma.

GI: Patients may experience anorexia, constipation, and nausea and vomiting.

Renal: Calcium acts as a diuretic and impairs the kidneys' ability to concentrate urine. This can lead to dehydration, which further worsens the hypercalcemia. The hypercalciuria seen in the setting of most causes of hypercalcemia increases the risk of calcium-containing kidney stones.

Skeletal: Patients with most causes of hypercalcemia have increased bone resorption and, thus, increased bone demineralization. This increases fracture risk.

Cardiovascular: Hypercalcemia may cause or exacerbate hypertension. The QT interval on the electrocardiogram may be shorted due to augmented calcium influx during myocardial depolarization.

Causes of Hypercalcemia

Causes of hypercalcemia relate to the various endocrine and organ physiology factors discussed earlier in Calcium Metabolism.

Endocrine Causes of Hypercalcemia

Disorders of parathyroid gland sensitivity to calcium and production and release of PTH, as well as impaired vitamin D function, are the major endocrine causes of hypercalcemia. Drugs that can cause hypercalcemia are discussed in this section, as well as in Drugs That Affect Calcium Metabolism.

Primary hyperparathyroidism¹³ is the most common cause of hypercalcemia in the outpatient setting. The term *primary* indicates that the physiologic defect lies with the parathyroid glands themselves and the autonomous nature of PTH production. This condition results from a single adenoma, multiple adenomas, or hyperplasia of the parathyroid glands. These adenomas are virtually always benign and result in hypersecretion of PTH, independent of the normal negative feedback regulation by ambient calcium. In essence, this is usually a “set point” problem⁵; there appears to be a new set point recognized by the parathyroid cells in the abnormal parathyroid tissue, such that the abnormal tissue senses normal ambient calcium as being low and oversecretes PTH to raise the calcium. In primary hyperparathyroidism (HPT), PTH is usually high but may actually be in the upper normal range. Because hypercalcemia should suppress normal parathyroid tissue (in an attempt to restore normal calcium levels—negative feedback), a PTH level in the upper normal range then becomes “inappropriately normal.” The hypercalcemia associated with primary HPT is generally not severe, unless compounded by additional factors, such as dehydration or renal insufficiency/failure. As the PTH increases the fractional tubular reabsorption of calcium, the filtered load of calcium is much greater than normal, so that there is a net increase in calcium excretion in spite of the increased fractional reabsorption. Thus, hypercalciuria is common in primary HPT. As PTH also increases renal excretion of phosphate, patients with primary HPT may also develop hypophosphatemia. In summary, an individual with primary HPT would be expected to have hypercalcemia (ideally measured as ionized calcium), elevated or inappropriately normal PTH, increased urinary calcium excretion, and often hypophosphatemia. Parathyroidectomy is the definitive treatment for this disorder.

Primary hyperparathyroidism most often occurs sporadically but may also be associated with several genetic syndromes:

Multiple endocrine neoplasia, type 1 (MEN-1): This may result in tumors of the parathyroids, pituitary, and pancreas. It results from loss of a tumor suppressor gene that maps to human chromosome 11.¹⁴

Multiple endocrine neoplasia, type 2a (MEN-2a): This may result in tumors of the parathyroids, medullary thyroid hyperplasia or cancer, and pheochromocytoma. This results from an activating mutation in the *ret* proto-oncogene, which resides on human chromosome 10. The *ret* proto-oncogene can be routinely measured in the clinical laboratory. Anytime this condition is suspected, *ret* should be measured so that other family members, where appropriate, can be alerted and tested.¹⁴

Familial hyperparathyroidism: This results in primary HPT, without other associated tumors. The gene is not known but has been mapped to human chromosome 1.¹⁴

Familial hypocalciuric hypercalcemia (FHH): This syndrome is the result of a mutation in the calcium-sensing receptor and thus an increased “set point” for calcium homeostasis. It is associated with mild hypercalcemia and hyperparathyroidism, yet *decreased* (or low normal) urinary calcium excretion.¹⁵ It is the decreased urinary calcium excretion that distinguishes FHH from primary HPT, making this test very valuable in distinguishing between the two. As the name implies, the condition is benign, and does not require treatment; it does not predispose to fractures, kidney stones, etc. Recognition is critical to prevent inappropriate referral for parathyroidectomy.

Hypervitaminosis D is a condition that may result from excessive intake of vitamin D, although this is very unusual if all organs are functioning normally. It may also result from aberrant production of 1,25(OH)₂D as a result of *extrarenal* 1 α -hydroxylation of 25-hydroxy vitamin D. This situation may occur in granulomatous diseases such as sarcoidosis or tuberculosis or in abnormal lymphoid tissue.¹⁶ The 1 α -hydroxylase activity in granulomas or lymphoid tissue is not the same as that seen in the kidney. The 1 α -hydroxylase enzyme in granulomas or lymphoid tissue is a different gene product and does not exhibit feedback regulation by calcium. This 1 α -hydroxylase activity functions constitutively to produce 1,25(OH)₂D, which in turn, can cause hypercalcemia by the mechanisms alluded to above under Endocrine Physiology and Organ Physiology. Hypercalcemia resulting from excess vitamin D is mediated in large part by stimulation of GI absorption of calcium and by recruitment of osteoclasts, resulting in bone resorption.¹⁶ Recall also that 1,25(OH)₂D suppresses PTH gene transcription. Therefore, the expected lab profile in a patient with hypervitaminosis D from *extrarenal* 1 α -hydroxylation of 25-hydroxy vitamin D is hypercalcemia, low PTH, and elevated 1,25(OH)₂D.

A variety of cancers may lead to hypercalcemia as the result of production and release of certain hormones or hormone-like substances. However, the substances produced by the cancer cells are not responsive to negative feedback by calcium.

Multiple myeloma is a cancer of antibody-producing B lymphocytes (i.e., plasma cells). Hypercalcemia results from secretion of cytokines that activate osteoclasts to resorb bone and disrupts the balance of bone formation and resorption.¹⁷ Lytic bone lesions are often seen on radiographs of affected bone. The parathyroid glands respond as expected by decreasing PTH secretion. The degree of hypercalcemia seen in multiple

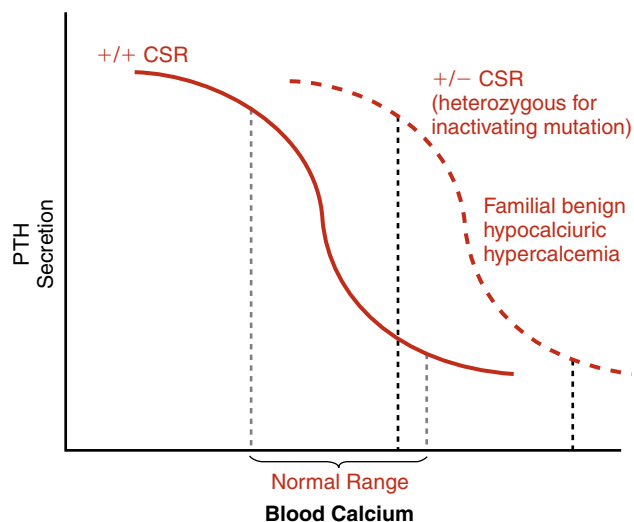

FIGURE 23-5. Calcium-sensing receptor: effect on PTH secretion. Shown is the response of parathyroid tissue (as demonstrated by PTH secretion) to blood calcium. The *set point* is determined by the parathyroid response mediated by the transmembrane calcium-sensing receptor. The *normal curve* is for heterozygosity for the “wild-type” calcium-sensing receptor (+/+). The *right-shifted curve* is shown for the case where there is heterozygosity for the receptor (familial benign hypocalciuric hypercalcemia): one wild-type copy of the gene and one inactivating mutation (+/-).

myeloma is often extreme. The immunoglobulin light chains associated with this disease may cause renal tubular necrosis and renal insufficiency, exacerbating the hypercalcemia.

Parathyroid hormone–related protein (PTHrP) is a substance very similar in structure to PTH and is produced by a variety of benign and malignant tumors including breast, lung, and kidney cancers and certain types of lymphoma.^{18–20} Because PTHrP shares the N-terminal sequence homology with PTH, it acts similarly and can cause hypercalcemia. Historically, this has been referred to as *humoral hypercalcemia of malignancy*. Both PTH and PTHrP bind to the same receptor in kidney and bone as well as a variety of other tissues. PTHrP is believed to function in the normal paracrine regulation of cartilage, skin, neurons in the CNS, and breast. However, the precise physiologic role of PTHrP in these and other tissues is unclear. As mentioned, PTHrP secretion is not regulated by blood calcium and may be secreted by cancer cells in very high amounts (Fig. 23-5). When humoral hypercalcemia of malignancy is suspected, PTHrP can be measured reliably in the blood using a particular immunoassay that does not cross-react with PTH. As one would expect, PTHrP-mediated hypercalcemia is associated with a suppressed PTH.

Organ System Causes of Hypercalcemia

The milk-alkali syndrome, also known as Burnett’s syndrome, a relatively uncommon cause of hypercalcemia in

the present era,²⁰ results from the ingestion of large amounts of calcium together with an absorbable alkali. It was originally described in the 1920s in patients being treated for peptic ulcers using carbonate or bicarbonate salts with milk or cream. In large amounts, this combination of substances can lead to hypercalcemia, metabolic alkalosis, and renal impairment. PTH would be expected to be low in this condition.

Renal failure, as already discussed, can produce a variety of abnormalities in calcium metabolism, depending on several factors.^{21,22} In this setting, renal excretion of both calcium and phosphate is severely, if not totally, abolished. Calcium phosphate is quite insoluble, and tends to precipitate in soft tissues. Hydroxylation of 25-hydroxy vitamin D is impaired, limiting production of the active form of vitamin D, stimulating PTH secretion. Elevated PTH, in combination with calcium phosphate precipitation and loss of urinary calcium excretion, may contribute to hypercalcemia.

CASE STUDY 23-1

A 40-year-old woman presents to her physician complaining of marked left flank pain that began the previous night. She reports the pain is worse than giving birth. She also reports blood in her urine earlier on the day she came to see her doctor. She has felt more fatigued, and as if her concentration has not been as good as normal for the last year or so, and she feels more forgetful. She has no significant past medical history. She is taking no medications. Family history contributes no pertinent information. On physical examination, she appears to be in extreme pain. There is marked tenderness on very gentle percussion over the left costovertebral angle. Labs are drawn and are notable for calcium 11.2 mg/dL (normal, 8.5–10.2 mg/dL), albumin 3.8 g/dL (normal, 3.5–4.8 g/dL), and intact PTH 162 pg/mL (normal, 11–54 pg/mL). Renal function is normal (BUN 25 and creatinine 0.9). Urine analysis is notable for blood and >50 RBCs per high-power field. This prompts a 24-hour urine collection, which reveals calcium elevated at 483 mg/24 hour (normal, 100–250 mg/24 hour).

Questions

1. Which laboratory results are abnormal?
2. What is the presumptive diagnosis for this patient? The differential diagnosis?
3. What treatment is indicated for this disease?

CASE STUDY 23-2

A 58-year-old man has been a smoker since childhood. He has been smoking three packs per day since he can remember but insists his cigarettes “don’t hurt me none, doc.” He has been feeling ill recently, however, with loss of appetite, malaise, and weight loss. His mental ability has been dulled recently, and he can’t remember from “one minute to the next” especially notable during his work as a cowboy. His cigarettes haven’t been as enjoyable for him as they used to be. His baseline cough has worsened, and he has noticed blood streaking his sputum when he clears sputum from his throat. He has no significant past medical history other than his tobacco abuse. He takes no medications. His family history is only notable for his father dying of lung cancer at age 63 and his mother dying of emphysema at age 68. On physical examination, he is a thin man who looks much older than his chronologic age and appears unwell. When he produces some sputum at the physician’s request, it does indeed have a pink tinge and is streaked with blood. Chest examination reveals some scattered wheezing, and some rales in the right upper lung region. He is diffusely weak on muscle strength testing. Labs are notable for calcium 16.8 mg/dL (normal, 8.5–10.2 mg/dL), albumin 3.4 (normal, 3.5–4.8 g/dL), BUN 27, and creatinine 1.3. Chest radiograph reveals a 3-cm proximal right hilar mass with distal streaking. Further testing is prompted and reveals a PTH of <1 pg/mL (normal, 11–54 pg/mL), and PTHrP elevated at 18.3 pmol/L (normal 0.0–1.5 pmol/L).

Questions

1. Do you think this patient’s smoking is related to his hypercalcemia?
2. What other laboratory results are abnormal?
3. What is this patient’s diagnosis? His prognosis?

Medications That Can Cause Hypercalcemia

There are a variety of medications that can cause hypercalcemia.²¹ These medications are mentioned here briefly and are discussed in greater detail in Medications That Affect Calcium Metabolism.

Thiazide diuretics, such as hydrochlorothiazide, have a long history in the treatment of hypertension. They cause retention of glomerularly filtered calcium and may cause or contribute to hypercalcemia. At doses routinely used to treat hypertension, hypercalcemia is uncommon. However, when thiazide diuretics are used in the

context of other conditions associated with hypercalcemia such as primary hyperparathyroidism, hypercalcemia can be worsened.

Lithium, at doses routinely used to treat bipolar affective disorder, may cause hypercalcemia. Lithium appears to shift the “set point” at the calcium-sensing receptor in a similar manner as does familial hypocalciuric hypercalcemia (FHH) mentioned earlier. It may also augment PTH signaling at PTH target tissues (particularly bone and kidney), increasing blood calcium.

High doses of vitamin A, or vitamin A analogs/metabolites in the retinoic acid family, may cause hypercalcemia. Vitamin A is believed to activate osteoclasts and enhance bone resorption, elevating blood calcium. In this condition, both PTH and 1,25(OH)₂D are suppressed.

HYPOCALCEMIA

Hypocalcemia is the state of blood calcium levels below the expected normal range in a healthy population.²³ As noted earlier, this is probably best measured by ionized calcium; a total calcium is not as valuable unless also accompanied by an albumin measurement.

Signs and Symptoms of Hypocalcemia

Signs and symptoms of hypocalcemia, like hypercalcemia, are numerous and varied.²³ The signs and symptoms of hypocalcemia are generally described by organ system:

Neuromuscular: Tetany (involuntary muscle contraction) affecting primarily the muscles in the hands, feet, legs, and back may be seen. Tapping on cranial nerve VII (facial nerve) just anterior to the ear may elicit twitching in the ipsilateral corner of the mouth (Chvostek’s sign). Numbness and tingling in the face, hands, and feet may be seen. Inflation of a blood pressure cuff to 20 mm Hg above the patient’s systolic blood pressure to induce a state of ischemia in the arm (metabolic acidosis), which may cause spasm in the muscles of the wrist and hand (Trousseau’s sign).

Central nervous system: Irritability, seizures, personality changes, and impaired intellectual functioning may be seen.

Cardiovascular: Calcium not only plays a crucial role in the slow inward calcium current of the QRS complex of ventricular depolarization but also plays a crucial role in electromechanical coupling. In hypocalcemia, QT prolongation may be seen on the electrocardiogram. In the extreme, electromechanical dissociation (EMD) may be seen. Cardiac contractile dysfunction is rare but in the extreme can result in congestive heart failure. Cardiac dysfunction from hypocalcemia should be treated with emergent intravenous calcium.

Causes of Hypocalcemia

The causes of hypocalcemia will be discussed in the setting of both endocrine and organ system dysfunction. However, one key concept should be emphasized when considering hypocalcemia: when functioning properly, the parathyroid glands will not only correct falling blood calcium but also *prevent* it, by increasing PTH secretion. The compensatory rise in PTH secretion, in response to factors that would lower blood calcium, is known as *secondary hyperparathyroidism*.²³ Thus, an individual may have an elevated PTH level—for example, in response to low 25-hydroxy vitamin D—and thus maintain normocalcemia. Secondary hyperparathyroidism is distinguished from primary hyperparathyroidism in several important ways (Fig. 23-6). Most notably, in primary hyperparathyroidism, PTH is elevated because of a disorder of parathyroid tissue (one or more parathyroid glands), whereas in secondary hyperparathyroidism, the parathyroids are functioning properly—the increased PTH secretion is an appropriate mechanism in response to the potential for hypocalcemia. In primary hyperparathyroidism, the hypercalcemia is cured by removal of the offending parathyroid(s). In secondary hyperparathyroidism, the hypocalcemia (or threat thereof) would worsen if the parathyroid glands were removed. Thus, treatment of secondary hyperparathyroidism is based upon identifying and correcting the process threatening hypocalcemia.

Endocrine Causes of Hypocalcemia

Because proper PTH secretion and action is necessary to maintain normocalcemia, any inadequacy of parathyroid gland function will cause, or at least increase the likelihood of, hypocalcemia.²⁴ The most common setting in which *hypoparathyroidism* can occur is neck surgery. Neck surgery, such as thyroidectomy, lymph node dissection, etc., may lead to removal or damage of the parathyroid glands. The most common setting in which this occurs is thyroid surgery, due to the anatomical

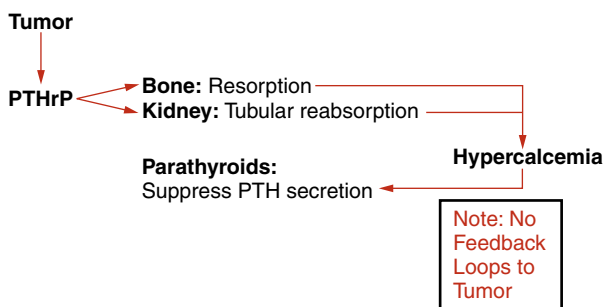

FIGURE 23-6. PTHrP endocrine pathophysiology. This demonstrates the effect of tumors that overproduce PTHrP. The pathophysiologic effect is via the same organ systems used by PTH to increase blood calcium. The difference between PTH and PTHrP is that PTH is subject to feedback regulation, whereas PTHrP is not subject to any feedback regulation by calcium (compare with Fig. 23-4).

proximity of the parathyroid glands. The hypoparathyroidism may be transient if it results from devascularization of the parathyroid glands during surgery, although it can also be permanent if multiple or all parathyroid glands are damaged or removed. Additional causes of hypoparathyroidism include autoimmune destruction of parathyroid tissue. This condition is often associated with other autoimmune diseases such as type 1 diabetes, Hashimoto's thyroiditis, and Addison's disease, among others. Hypoparathyroidism can result from mutations in the *PTH* gene, which leads to abnormal processing of PTH and impaired hormone function, although this familial condition is quite rare. Other uncommon causes include abnormal deposition of copper or aluminum in the parathyroid glands. Finally, magnesium deficiency can inhibit the secretion of PTH and also blunt its actions on target tissues. Depending on the cause, hypoparathyroidism can usually be treated with relatively high doses of vitamin D and calcium.²⁴ The vitamin D stimulates intestinal absorption of calcium, as discussed earlier. In the absence of PTH, however, the absorbed calcium may simply be excreted in the urine increasing the risk of the development of kidney stones. A more attractive treatment option for the most common causes of hypoparathyroidism is the use of recombinant human PTH. However, more research is needed to confirm the safety and efficacy of this potential treatment option. (See Medications Affecting Calcium Metabolism.)

Pseudohypoparathyroidism is a heritable disorder resulting in a lack of responsiveness to PTH in the target tissue. This results from uncoupling of the PTH receptor from adenylate cyclase, due to a mutant stimulatory G protein (G_s) (see Parathyroid Hormone Physiology).⁷ PTH binds its receptor but cannot activate the second messenger, cAMP, and thus there is no response. Hypocalcemia develops, although unlike other forms of hypoparathyroidism mentioned, those with pseudohypoparathyroidism have markedly elevated levels of PTH. Note that the elevated PTH is the expected physiologic response of healthy parathyroid glands to hypocalcemia—the defect is in signaling via the PTH receptor, not in the parathyroid glands. This is an example of a hormone resistance syndrome. Treatment is with calcium and vitamin D, as described earlier.

Hypovitaminosis D describes a collection of conditions including low vitamin D availability,²⁵ defective metabolism of vitamin D,²⁶ or mutations in the vitamin D receptor,²⁶ all of which predispose to hypocalcemia. This definition also includes insufficient vitamin D action [recall that the effects of vitamin D are mediated by $1,25(\text{OH})_2\text{D}$ binding to the vitamin D receptor]. This propensity to develop hypocalcemia generally results in the development of secondary hyperparathyroidism, which will prevent hypocalcemia or at least minimize its severity. As noted, this compensatory response by the parathyroid glands is

appropriate and treatment of the vitamin D disorder usually centers on vitamin D replacement with dietary sources (not parathyroidectomy!). When the disorder is caused by genetic defects in the metabolism of vitamin D, supplying the active metabolite, $1,25(\text{OH})_2\text{D}$, will bypass the metabolic defect. Unfortunately, genetic defects in the vitamin D receptor are more difficult to treat; generally, $1,25(\text{OH})_2\text{D}$ is given in pharmacologic doses, and the response is variable.

Tertiary hyperparathyroidism refers to the development of autonomous PTH secretion and hypercalcemia in the setting of renal failure or after renal transplantation. The mechanism by which this occurs is not clear, although some have suggested that prolonged secondary hyperparathyroidism seen in chronic renal disease, and thus prolonged stimulation of the parathyroid glands,

stimulates the development of parathyroid hyperplasia or adenoma similar to that seen in primary hyperparathyroidism.²⁷ PTH is often extremely elevated. This condition, although poorly understood, is usually treated with parathyroidectomy.

Organ System Causes of Hypocalcemia

Organ system causes of hypocalcemia result from abnormalities in those organs involved in normal calcium homeostasis.

A variety of intestinal disorders can result in inadequate calcium or vitamin D absorption and thus the potential for hypocalcemia. Examples include short bowel syndrome, dumping syndrome, celiac sprue, and many others. When present, these disorders will threaten hypocalcemia and will lead to increased PTH secretion and the development of secondary hyperparathyroidism. If the intestinal disorder is severe enough, large amounts of calcium may be moved from the bone reservoir to the bloodstream to maintain normocalcemia. Very large amounts of dietary or supplemental calcium and vitamin D are often needed to correct this situation.

Renal insufficiency/failure may cause hypocalcemia by hyperphosphatemia (recall the low solubility product constant, K_{sp} , for calcium phosphate; $K_{sp} = 1.2 \times 10^{-29}$) and by defective metabolism of vitamin D.²⁷ These patients also develop secondary hyperparathyroidism as an adaptive response. Dialysis (hemo- or peritoneal) will usually correct the serum calcium, but the hyperphosphatemia will often persist. Renal transplantation, however, will correct the defect. Treatment with $1,25(\text{OH})_2\text{D}$ (calcitriol) may also be helpful.

Genetic defects resulting in an impaired ability to recover filtered calcium from the tubular fluid can also lead to hypocalcemia. The filtered calcium simply moves through the tubules and is lost in the urine. This situation will, once again, lead to a compensatory response by the parathyroid glands to secrete more PTH: secondary hyperparathyroidism. The hyperparathyroidism ameliorates the tendency toward hypocalcemia by increasing calcium resorption in bone, augmenting calcium absorption from the gut, etc., but cannot increase tubular reabsorption of calcium because of the gene defect. As expected, these individuals have hypercalciuria and a tendency to develop kidney stones. Hydrochlorothiazide (HCTZ), a thiazide diuretic, is effective treatment for this condition in high doses.⁹ Treatment endpoints are normalization of urine calcium excretion and normalization of PTH.

Medications That Affect Calcium Metabolism

Multiple medications may directly or indirectly influence calcium homeostasis and can have significant clinical consequences.

CASE STUDY 23-3

A 26-year-old man presents to his physician 3 weeks after having his thyroid surgically removed for thyroid cancer. His doctor is certain that she “got it all.” However, since he went home from the hospital, he has noticed painful, involuntary muscle cramping. He also feels numbness and tingling around his mouth and in his hands and feet. His girlfriend says he has been irritable for the last couple of weeks. His past medical history is notable only for the recent diagnosis of thyroid cancer, and its resection 3 weeks prior to this visit. His only medication is levothyroxine. Family history contributes no relevant information. On physical examination, he has a well-healing thyroidectomy scar. Tapping on the face inferior to the ears causes twitching in the ipsilateral corner of the mouth (Chvostek’s sign). There are no palpable masses in the thyroid bed. A blood pressure cuff inflated above the systolic pressure induces involuntary muscle contracture in the ipsilateral hand after 60 seconds (Trousseau’s sign). Labs are notable for calcium 5.6 mg/dL (normal, 8.5–10.2 mg/dL), albumin 4.1 g/dL, BUN 20, and creatinine 1.0. PTH is undetectable at <1 pg/mL.

Questions

1. Which laboratory results are abnormal?
2. What condition is he experiencing since his thyroidectomy?
3. What is the cause of this symptomatic condition?
4. What is the treatment for this patient, in addition to thyroxine medication?

The class of medications known as “antiresorptive agents” function by inhibition of osteoclast-mediated bone resorption.²⁸ This class of medications, commonly prescribed for the prevention or treatment of **osteoporosis**, includes **bisphosphonates**, estrogen, selective estrogen receptor modulators (SERMs), and calcitonin. Individually, each of these medications has a unique structure and function. However, all will ultimately lead to inhibition of osteoclast-mediated bone resorption (thus the categorical name, antiresorptive). These drugs are used in a variety of clinical settings to help prevent bone turnover and loss of skeletal mass and thus help reduce fracture risk. The most notable indications for use are postmenopausal osteoporosis, glucocorticoid-induced osteoporosis, and idiopathic osteoporosis. In some settings, several of these drugs may be used to treat hypercalcemia. Specifically, several intravenously administered bisphosphonates are used to treat the hypercalcemia of malignancy, and one of these (zoledronate) is also approved for the once-yearly treatment of osteoporosis. Subcutaneous calcitonin may also be used to treat dangerously high blood calcium, although escalating doses are usually needed to maintain its effect (known as tachyphylaxis) and thus other means to lower calcium must also be implemented.

Several medications have the unfortunate effect of stimulating bone resorption and ultimately increasing one’s risk of fracture. The most notable of these are the glucocorticoids, such as prednisone and methylprednisolone. They are widely used to treat a variety of inflammatory conditions such as asthma, rheumatoid arthritis, and lupus, as well as to prevent rejection after organ transplantation. However, glucocorticoids dramatically influence calcium metabolism in a variety of ways. First, they limit bone formation by inhibiting the action of osteoblasts while also inducing osteoblast apoptosis, or cell death.²⁹ Further, they increase bone breakdown by stimulating the formation and action of osteoclasts. The result is a net loss of bone mass (and bone architecture). “Glucocorticoid-induced osteoporosis” is a major source of morbidity associated with pharmacologic doses of glucocorticoids. Two bisphosphonates, alendronate and risedronate, are approved by the Food and Drug Administration for the treatment of glucocorticoid-induced bone loss.³⁰ Other medications associated with accelerated bone resorption include, but are not limited to, anticonvulsants (particularly phenytoin) and cyclosporin A.

Lithium, a small monovalent cation, is used to treat bipolar affective disorder. At doses routinely used to treat this condition, lithium may lead to hypercalcemia. Lithium appears to shift the “set point” for calcium regulation of PTH secretion, favoring a higher level of blood calcium. It may also augment PTH signaling at PTH

CASE STUDY 23-4

An 82-year-old woman living in a nursing home feels unsteady on her feet and does not wander outside anymore. She has lactose intolerance and has never been able to drink milk. She does not take any dietary supplements. She says, “I feel my age, doc,” but otherwise has no specific complaints. On her annual laboratory assessment, her calcium level is found to be slightly low at 8.2 mg/dL (normal, 8.5–10.2 mg/dL) with albumin 3.5 mg/dL (normal, 3.5–4.8 g/dL), BUN 28, and creatinine 1.1. This prompts further evaluation, which reveals PTH elevated at 181 pg/mL and 25(OH)D low at 6 ng/mL (normal, 20–50 ng/mL).

Questions

1. What diagnostic possibility is suggested from the initial laboratory results of her annual assessment?
2. This patient’s differential diagnosis includes two diseases. What are they?
3. Is her renal function related to either of these two diseases?
4. How should this patient be treated?

target tissues (particularly bone and kidney), increasing blood calcium.

Thiazide diuretics have a long history in the treatment of hypertension and can cause retention of glomerularly filtered calcium, and cause or contribute to hypercalcemia. The commonly used agent in this class in the United States is HCTZ. At doses routinely used to treat hypertension, hypercalcemia is uncommon, although any other factors that could exacerbate the hypercalcemic effect of thiazides may increase the likelihood of thiazide-related hypercalcemia (e.g., renal disease, primary hyperparathyroidism, etc.).²¹ However, as noted, HCTZ is the treatment of choice for impaired calcium reabsorption from the renal tubules.

Finally, recombinant human parathyroid hormone, has been shown to be safe and effective for the treatment of osteoporosis. This hormone stimulates osteoblast-mediated bone *formation*.³¹ At first glance, this seems extremely paradoxical, that PTH, the hormone described earlier to resorb bone, can also be used to build bone! This apparent paradox can be explained by the pharmacokinetics of **teriparatide**. As noted, only osteoblasts, the bone-building cells, express PTH receptors. Teriparatide administered once daily has a short

serum half-life of only a couple of hours. Osteoblasts respond to teriparatide by building bone but, because of the short duration of the signal, do not send the cytokine signal to the osteoclasts (to which they would have responded by resorbing bone; see Bone Physiology). Teriparatide stimulates the formation of both cortical and trabecular bone without a coupled bone resorption response. Furthermore, it can be used in combination with an antiresorptive drug, which can further potentiate the effect of the drug on the skeleton. Because it is a peptide hormone, similar to insulin, it must be administered parenterally, or by injection. Currently, it is only approved for the treatment of severe osteoporosis, but other uses, such as the treatment of hypoparathyroidism, are being studied.

CASE STUDY 23-5

A 6-year-old girl is brought to a pediatrician by her parents who report that her height is not progressing as they think it should (or like it did for her 8-year-old sister) and her legs look bowed. The patient drinks milk, and other than her shorter stature and bowed legs, she has the normal characteristics of her 6-year-old friends. She takes no medications. Family history is notable for some cousins on the father's side with a similar problem back in the Appalachian hill country along Virginia/Tennessee border where the family hails from. The pediatrician obtains lab studies that are notable for a calcium level of 7.2 mg/dL (normal, 8.5–10.2 mg/dL) with albumin 4.1 g/dL (normal, 3.5–4.8 g/dL). Lower extremity radiographs show bowing of the long bones and generalized demineralization. This prompts the measurement of several other laboratory tests, which reveal intact PTH elevated at 866 pg/mL (normal, 11–54 pg/mL), 25-hydroxy vitamin D normal at 35 ng/mL (normal, 20–57 ng/mL), and 1,25-dihydroxy vitamin D undetectable at <1 pg/mL (normal, 20–75 pg/mL).

Questions

1. What condition do the preliminary lab tests indicate?
2. What is the significance of 25-hydroxy vitamin D and 1,25-dihydroxy vitamin D levels in the follow-up laboratory tests?
3. Describe the inborn error of metabolism with this patient.
4. What secondary condition will recur if vitamin D treatment is discontinued later in her life?

METABOLIC BONE DISEASES

A variety of disease states can affect skeletal architecture, strength, and integrity. Only **rickets**, **osteomalacia**, and osteoporosis are described here.

Rickets and Osteomalacia

Rickets and osteomalacia are diseases caused by abnormal mineralization of bone. They result from vitamin D deficiency.^{25,26} *Rickets* refers to the disease state in growing bone (in children). *Osteomalacia* refers to the abnormal mineralization of bone in adults, or after closure of the epiphyseal plates. Because of the onset in childhood of Rickets, and the onset in adulthood of osteomalacia, the skeletal manifestations differ. Rickets is associated with bony deformities because of bending of long bones under the influence of gravity. No such bony deformity is seen in adult bone. Both conditions are associated with the development of secondary hyperparathyroidism. Fractures may result in either case because of poor bone structure. Hypocalcemia may be seen when the response of secondary hyperparathyroidism is inadequate to counteract the threat of hypocalcemia posed by the vitamin D deficiency. Because of vitamin D fortification of milk—and public awareness—both conditions are in this era quite uncommon. However, those of any age who live in indoors, with minimal or no sun exposure, or who lack dietary vitamin D, are at risk for developing this condition. As mentioned under Vitamin D Physiology, adequacy of vitamin D in the body can be assessed by measuring the blood level of 25-hydroxy vitamin D. Because secondary hyperparathyroidism is also expected in the setting of rickets or osteomalacia, PTH and calcium should be obtained to further confirm the suspected diagnosis.

Rickets can, however, develop under conditions of adequate amounts of vitamin D. This unique situation may develop from genetic defects in vitamin D metabolism or in the vitamin D receptor.²⁶ Although 25-hydroxy vitamin D is often normal, 1,25(OH)₂D may be low, normal, or high depending on the genetic defect. Defects in vitamin D metabolism are best treated by supplying the metabolically active compound, 1,25(OH)₂D (calcitriol). A wide variety of vitamin D receptor defects have been described, including abnormal ligand binding, abnormal DNA binding, and abnormal transactivation of transcriptional machinery at the regulatory site of vitamin D-responsive genes. Depending on which defect is present determines how well the patient will respond to pharmacologic doses of calcitriol.

Osteoporosis

Osteoporosis is the most prevalent metabolic bone disease in adults. Osteoporosis was at one time generally

considered an inevitable consequence of aging. This condition is typically “silent,” or without symptoms or outward manifestations, until it leads to a fracture (at a degree of trauma that would not have caused a fracture in a non-osteoporotic skeleton, i.e., the so-called osteoporotic/fragility fracture). Osteoporosis is now recognized to be a specific disease with substantial morbidity, mortality, and public health consequences. The greater understanding of the pathophysiology of osteoporosis—and its recognition as a discrete disease entity—has resulted in significant advances in its diagnosis, prevention, and treatment.

Osteoporosis affects an estimated 20–25 million Americans with an estimated 4:1 female:male predominance. It is believed to cause approximately 1.5 million fractures annually in the United States.³² Most of these are vertebral compression fractures, followed in frequency by fracture of the hip, distal forearm, ribs, and humerus. The most devastating consequence of osteoporosis is a hip fracture. While as many as half of vertebral compressions may be asymptomatic, a hip fracture carries with it a significant morbidity as well as an increased mortality. All hip fractures require surgery at the very least. In fact, mortality from hip fracture is increased about 20% in the first year following the fracture, and it is estimated that deaths related to hip fracture are now on par with those from breast cancer.

Multiple additional conditions have been identified as significant risk factors for reduced bone mass and a consequent increased risk of fracture,³¹ although risk factor assessment alone is generally not sufficient to characterize or quantify bone mass and diagnose osteo-

porosis. The following are validated risk factors for the prediction of fracture, independent of formal bone density evaluation: decreased bone mass include previous fracture, advanced age, family history of osteoporosis or fracture, body weight less than 127 lb, long-term glucocorticoid therapy, cigarette smoking, or excess alcohol intake.³³ Other conditions known to also alter calcium metabolism and increase fracture risk include Cushing’s syndrome, hyperparathyroidism, disorders of vitamin D metabolism, hyperthyroidism, and certain malignancies. Many of these risk factors and medical conditions are treatable, thus underscoring the importance of evaluating for and treating “secondary” causes of bone loss before simply initiating treatment for osteoporosis (e.g., with a bisphosphonate).

Several laboratory tests are available and useful for the evaluation of osteoporosis and other bone disorders—and for the evaluation of other conditions known to be associated with poor bone health (Fig. 23-7). However, the formal diagnosis of osteoporosis is not based on a single laboratory test but rather on certain clinical characteristics and/or a particular imaging study known as a **dual energy x-ray absorptiometry (DXA)** scan.

Osteoporosis is diagnosed without any additional testing when a fracture occurs at an inappropriate degree of trauma (i.e., ground level fall) and is termed a *fragility* fracture. This definition then excludes fractures that occurred with a high degree of trauma (i.e., car accident). The occurrence of one fragility fracture predicts further fragility fractures. Currently, osteoporosis is also diagnosed based upon calculated bone density using DXA of the lumbar spine and the hip. This imaging technique,

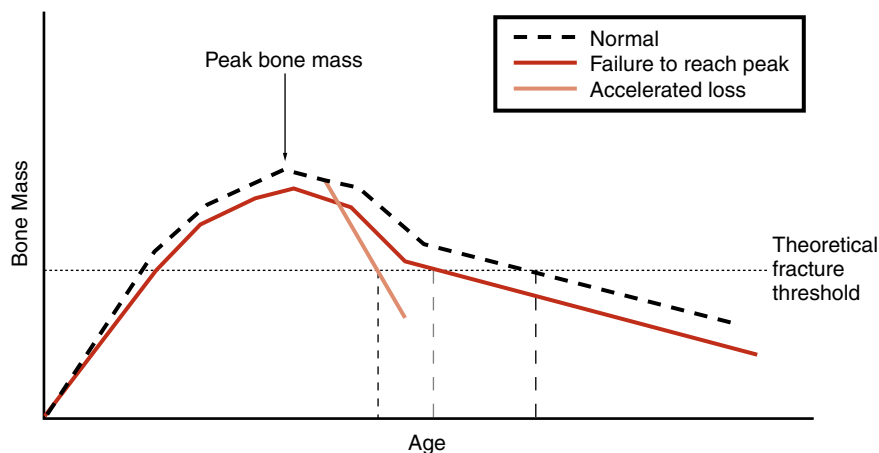

FIGURE 23-7. Bone mass as a function of age; perturbations that can affect bone mass. Shown is the accrual of bone mass with age to a peak that occurs in the mid-20s to early 30s (for both sexes) and the bone loss that occurs throughout life after the peak. Fracture risk increases as bone mass is lost. The “theoretical fracture threshold” is an artificial notion but may be useful in demonstrating that at a given degree of trauma (varying from the simple act of weightbearing to increasing levels of impact), factors that are associated with low bone mass increase fracture risk and that the age that fracture risk is reached is relatively younger the earlier that lower bone mass is reached.

CASE STUDY 23-6

A 74-year-old woman slipped while mopping the kitchen floor, fell, and sustained a hip fracture. The hip fracture was treated with open reduction and internal fixation (ORIF). After discharge from the hospital, she presents to her physician and asks if she has osteoporosis and, if so, what should be done. She only drinks milk on her cereal and takes no dietary supplements of calcium or vitamin D. She has asthma and has been treated with prednisone bursts and tapers about six times in her life (as best she can recall). She went through menopause at age 49 and never took hormone replacement. Other than her hip, she reports no other fractures in adulthood but does report that she thinks she has lost about 2.5 inches in height. She thinks her mom had osteoporosis, because she had a “dowager’s hump.” The physician orders bone densitometry, which shows posteroanterior spine T-score -3.8 and hip T-score -3.1 (done on the nonfractured hip!). Labs revealed normal calcium and albumin, renal function, thyroid function, albumin, and CBC. Alkaline phosphatase is slightly elevated, but she has a recent fracture.

Questions

1. What is this patient’s diagnosis?
2. Name four or five risk factors for this diagnosis.
3. In addition to adequate calcium and vitamin D supplements, this patient would be a candidate for which new therapeutic drug?

commonly referred to as bone mineral densitometry, measures grams of calcium per square centimeter of cross sectional area of bone (g/cm^2). Density is mass/volume, or g/cm^3 , so the term bone *density* is a misnomer. Peak bone mass usually occurs at about age 30 for both men and women and is associated with the lowest risk of fracture. The bone “density,” as calculated by DXA, is

then compared with that expected in a healthy 30-year-old individual of the same race and gender. This is reported as standard deviations above or below the mean peak bone mass using a “T-score.” A positive or “+” T-score equate to above the average peak bone mass, and negative or “-” for below the average peak bone mass. Normal bone density is defined as 1 SD from the mean, or a T-score between -1.0 and $+1.0$. Osteoporosis is defined as a T-score of -2.5 or below. An intermediate between normal and osteoporosis, termed *osteopenia*, is diagnosed as a T-score between -1.0 and -2.5 . In summary, osteoporosis is diagnosed by either the occurrence of a fragility fracture or a T-score of -2.5 or below by DXA imaging.

Treatment of osteoporosis is directed at the primary consequence of this disease: fracture. All treatment plans should include modification of preventable risk factors such as smoking and alcohol consumption. They should also include an evaluation of fall risk and consideration of walkers, hand rails, night lights, hip pads, etc. Further, all patients with osteoporosis—or those at high risk for developing osteoporosis—should have adequate dietary calcium (usually 1,200–1,500 mg daily) and vitamin D (usually 400–800 IU daily). Ideally, interventions should take place in those with high likelihood of developing osteoporosis, such as those with a strong family history of osteoporosis, even if there is no personal history of a fragility fracture and DXA indicates normal or osteopenic bone density. The treatment aims in this case is the same as that in established osteoporosis: minimize bone loss, increase bone density, and prevent fracture. The most commonly used medications for the prevention and treatment of osteoporosis are the antiresorptive agents (see Drugs Affecting Calcium Metabolism). Examples of commonly used bisphosphonates include alendronate, risedronate, ibandronate, and zoledronate. The most commonly used SERM modulator is raloxifene. Testosterone is commonly used in males with hypogonadism and estrogen \pm progestin in selected females (certain contraindications must be considered for this last treatment option). Teriparatide is not an antiresorptive agent but rather a bone formation (anabolic) agent. It is very effective for the treatment of those with osteoporosis and a particularly high risk of fracture.³⁰

REFERENCES

1. Broadus AE. Mineral balance and homeostasis. In Favus MJ, ed. Primer on the metabolic bone diseases and disorders of mineral metabolism. 4th ed. Philadelphia, Pa.: Lippincott Williams & Wilkins, 1999:74–80.
2. Portale AA. Blood calcium, phosphorus, and magnesium. In Favus MJ, ed. Primer on the metabolic bone diseases and disorders of mineral metabolism. 4th ed. Philadelphia, Pa.: Lippincott Williams & Wilkins, 1999:115–118.
3. Holick MF. Vitamin D: photobiology, metabolism, mechanism of action, and clinical applications. In Favus MJ, ed. Primer on the metabolic bone diseases and disorders of mineral metabolism. 4th ed. Philadelphia, Pa.: Lippincott Williams & Wilkins, 1999:92–98.

4. Juppner H, Brown EM, Kronenberg HM. Parathyroid hormone. In Favus MJ, ed. *Primer on the metabolic bone diseases and disorders of mineral metabolism*. 4th ed. Philadelphia, Pa.: Lippincott Williams & Wilkins, 1999:80–87.
5. Blind E, Gagel RF. Assay methods: parathyroid hormone, parathyroid hormone-related protein, and calcitonin. In Favus MJ, ed. *Primer on the metabolic bone diseases and disorders of mineral metabolism*. 4th ed. Philadelphia, Pa.: Lippincott Williams & Wilkins, 1999:119–124.
6. Levine MA. Parathyroid hormone resistance syndromes. In Favus MJ, ed. *Primer on the metabolic bone diseases and disorders of mineral metabolism*. 4th ed. Philadelphia, Pa.: Lippincott Williams & Wilkins, 1999:230–238.
7. Lemann J Jr, Favus MJ. The intestinal absorption of calcium, magnesium, and phosphate. In Favus MJ, ed. *Primer on the metabolic bone diseases and disorders of mineral metabolism*. 4th ed. Philadelphia, Pa.: Lippincott Williams & Wilkins, 1999:63–67.
8. Bushinsky DA. Calcium, magnesium, and phosphorus: renal handling and urinary excretion. In Favus MJ, ed. *Primer on the metabolic bone diseases and disorders of mineral metabolism*. 4th ed. Philadelphia, Pa.: Lippincott Williams & Wilkins, 1999:67–74.
9. Mundy GR. Bone remodeling. In Favus MJ, ed. *Primer on the metabolic bone diseases and disorders of mineral metabolism*. 4th ed. Philadelphia, Pa.: Lippincott Williams & Wilkins, 1999:30–38.
10. Baron R. Anatomy and ultrastructure of bone. In Favus MJ, ed. *Primer on the metabolic bone diseases and disorders of mineral metabolism*. 4th ed. Philadelphia, Pa.: Lippincott Williams & Wilkins, 1999:3–10.
11. Shane E. Hypercalcemia: pathogenesis, clinical manifestations, differential diagnosis, and management. In Favus MJ, ed. *Primer on the metabolic bone diseases and disorders of mineral metabolism*. 4th ed. Philadelphia, Pa.: Lippincott Williams & Wilkins, 1999:183–187.
12. Bilezikian JP. Primary hyperparathyroidism. In Favus MJ, ed. *Primer on the metabolic bone diseases and disorders of mineral metabolism*. 4th ed. Philadelphia, Pa.: Lippincott Williams & Wilkins, 1999:187–192.
13. Heath H III, Hobbs MR. Familial hyperparathyroid syndromes. In Favus MJ, ed. *Primer on the metabolic bone diseases and disorders of mineral metabolism*. 4th ed. Philadelphia, Pa.: Lippincott Williams & Wilkins, 1999:192–195.
14. Marx SJ. Familial hypocalciuric hypercalcemia. In Favus MJ, ed. *Primer on the metabolic bone diseases and disorders of mineral metabolism*. 4th ed. Philadelphia, Pa.: Lippincott Williams & Wilkins, 1999:195–198.
15. Adams JS. Hypercalcemia due to granuloma-forming disorders. In Favus MJ, ed. *Primer on the metabolic bone diseases and disorders of mineral metabolism*. 4th ed. Philadelphia, Pa.: Lippincott Williams & Wilkins, 1999:212–214.
16. Mundy GR, Yoneda T, Guise TA. Hypercalcemia in hematologic malignancies and solid tumors associated with extensive localized bone destruction. In Favus MJ, ed. *Primer on the metabolic bone diseases and disorders of mineral metabolism*. 4th ed. Philadelphia, Pa.: Lippincott Williams & Wilkins, 1999:208–212.
17. Strewler GJ, Nissenson RA. Parathyroid hormone-related protein. In Favus MJ, ed. *Primer on the metabolic bone diseases and disorders of mineral metabolism*. 4th ed. Philadelphia, Pa.: Lippincott Williams & Wilkins, 1999:88–91.
18. Roberts MM, Stewart AF. Humoral hypercalcemia of malignancy. In Favus MJ, ed. *Primer on the metabolic bone diseases and disorders of mineral metabolism*. 4th ed. Philadelphia, Pa.: Lippincott Williams & Wilkins, 1999:203–207.
19. Knecht TP, Behling CA, Burton DW, et al. The humoral hypercalcemia of benignancy: a newly appreciated syndrome. *Am J Clin Pathol*, 1996; 105:487–492.
20. Stewart AF. Miscellaneous causes of hypercalcemia. In Favus MJ, ed. *Primer on the metabolic bone diseases and disorders of mineral metabolism*. 4th ed. Philadelphia, Pa.: Lippincott Williams & Wilkins, 1999:215–219.
21. Goodman WG, Coburn JW, Slatopolsky E, Salusky IB. Renal osteodystrophy in adults and children. In Favus MJ, ed. *Primer on the metabolic bone diseases and disorders of mineral metabolism*. 4th ed. Philadelphia, Pa.: Lippincott Williams & Wilkins, 1999:347–363.
22. Shane E. Hypocalcemia: pathogenesis, differential diagnosis, and management. In Favus MJ, ed. *Primer on the metabolic bone diseases and disorders of mineral metabolism*. 4th ed. Philadelphia, Pa.: Lippincott Williams & Wilkins, 1999:223–226.
23. Goltzman D, Cole DEC. Hypoparathyroidism. In Favus MJ, ed. *Primer on the metabolic bone diseases and disorders of mineral metabolism*. 4th ed. Philadelphia, Pa.: Lippincott Williams & Wilkins, 1999:226–230.
24. Klein GL. Nutritional rickets and osteomalacia. In Favus MJ, ed. *Primer on the metabolic bone diseases and disorders of mineral metabolism*. 4th ed. Philadelphia, Pa.: Lippincott Williams & Wilkins, 1999:315–319.
25. Liberman UA, Marx SJ. Vitamin D-dependent rickets. In Favus MJ, ed. *Primer on the metabolic bone diseases and disorders of mineral metabolism*. 4th ed. Philadelphia, Pa.: Lippincott Williams & Wilkins, 1999:323–328.
26. Indridason OS, Quarles LD. Tertiary hyperparathyroidism and refractory secondary hyperparathyroidism. In Favus MJ, ed. *Primer on the metabolic bone diseases and disorders of mineral metabolism*. 4th ed. Philadelphia, Pa.: Lippincott Williams & Wilkins, 1999:198–202.
27. Watts NB. Pharmacology of agents to treat osteoporosis. In Favus MJ, ed. *Primer on the metabolic bone diseases and disorders of mineral metabolism*. 4th ed. Philadelphia, Pa.: Lippincott Williams & Wilkins, 1999:278–283.
28. Lukert BP. Glucocorticoid-induced osteoporosis. In Favus MJ, ed. *Primer on the metabolic bone diseases and disorders of mineral metabolism*. 4th ed. Philadelphia, Pa.: Lippincott Williams & Wilkins, 1999:292–296.
29. Johansson H, et al. Optimization of BMD measurements to identify high risk groups for treatment—a test analysis. *J Bone Miner Res* 2004 Jun;19(6):906–913.
30. Neer RM, Arnaud CD, Zanchetta JR, et al. Effect of parathyroid hormone (1–34) on fractures and bone mineral density in postmenopausal women with osteoporosis. *N Engl J Med*, 2001; 344: 1434–1441.
31. Wasnich RD. Epidemiology of osteoporosis. In Favus MJ, ed. *Primer on the metabolic bone diseases and disorders of mineral metabolism*. 4th ed. Philadelphia, Pa.: Lippincott Williams & Wilkins, 1999:257–259.
32. O'Brien CA, et al. Glucocorticoids act directly on osteoblasts and osteocytes to induce their apoptosis and reduce bone formation and strength. *Endocrinology* 2004;145:1835.

Liver Function

Janelle M. Chiasera, Xin Xu

CHAPTER

24

CHAPTER OUTLINE

■ ANATOMY

- Gross Anatomy
- Microscopic Anatomy

■ BIOCHEMICAL FUNCTIONS

- Excretory and Secretory
- Synthetic
- Detoxification and Drug Metabolism

■ LIVER FUNCTION ALTERATIONS DURING DISEASE

- Jaundice
- Cirrhosis
- Tumors

Reye Syndrome

Drug- and Alcohol-Related Disorders

■ ASSESSMENT OF LIVER FUNCTION/LIVER FUNCTION TESTS

Bilirubin

Urobilinogen in Urine and Feces

Serum Bile Acids

Enzymes

Tests Measuring Hepatic Synthetic Ability

Tests Measuring Nitrogen Metabolism

Hepatitis

■ REFERENCES

The liver is the largest internal organ of the human body. It is a functionally complex organ that plays a critical biochemical role in the metabolism, digestion, detoxification, and elimination of substances from the body. The liver is involved in a number of excretory, synthetic, and metabolic functions, all of which are essential to life. The liver is unique in the sense that it is a relatively resilient organ that can regenerate cells that have been destroyed by some short-term injury or disease. However, if the liver is damaged repeatedly over a long period of time, it may undergo irreversible changes that permanently interfere with its essential functions. This chapter focuses on the normal structure and function of the liver, the pathology associated with it, and the laboratory tests used to aid in the diagnosis of liver disorders.

ANATOMY

Gross Anatomy

The liver is a large and complex organ weighing approximately 1.2–1.5 kg in the healthy adult. It is located beneath and is attached to the diaphragm, is protected by the lower rib cage, and is held in place by ligamentous attachments. Despite the functional complexity of the liver, it is relatively simple in structure. It is divided unequally into two lobes by the falciform ligament, with the

right lobe being approximately six times larger than the left lobe. There is no known functional difference between the lobes, and communication flows freely between all areas of the liver (Fig. 24-1).

Unlike most organs, which have a single blood supply, the liver is an extremely vascular organ that receives its blood supply from two sources: the hepatic artery and the portal vein. The hepatic artery, a branch of the aorta, supplies oxygen-rich blood from the heart to the liver and is responsible for providing approximately 25% of the total blood supply to the liver. The portal vein supplies nutrient-rich blood (collected as food is digested) from the digestive tract, and it is responsible for providing approximately 75% of the total blood supply to the liver. The two blood supplies eventually merge and flow into the **sinusoids**, which course between individual hepatocytes. Approximately 1,500 mL of blood passes through the liver per minute. The liver is drained by a collecting system of veins that empties into the hepatic veins and ultimately into the inferior vena cava (Fig. 24-2).

The excretory system of the liver begins at the **bile** canaliculi. The bile canaliculi are small spaces between the hepatocytes that form intrahepatic ducts, where excretory products of the cell can drain. The intrahepatic ducts join to form the right and left hepatic ducts, which drain the secretions from the liver. The right and left

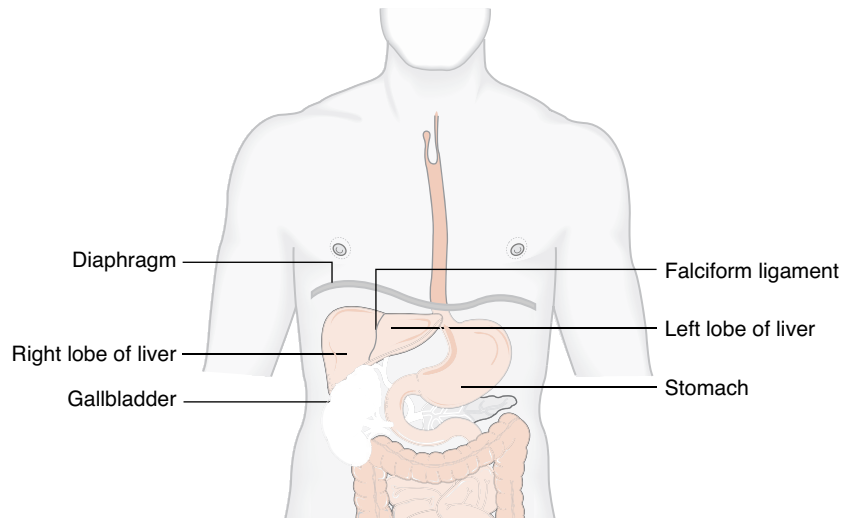

FIGURE 24-1. Gross anatomy of the liver.

hepatic ducts merge to form the common hepatic duct, which is eventually joined with the cystic duct of the gallbladder to form the common bile duct. Combined digestive secretions are then expelled into the duodenum (Fig. 24-3).

Microscopic Anatomy

The liver is divided into microscopic units called **lobules**. The lobules are the functional units of the liver; they are responsible for all metabolic and excretory functions performed by the liver. Each lobule is roughly a six-sided structure with a centrally located vein (called the *central*

vein) with portal triads at each of the corners. Each portal triad contains a hepatic artery, a portal vein, and a bile duct surrounded by connective tissue. The liver contains two major cell types: hepatocytes and **kupffer cells**. The hepatocytes, making up approximately 80% of the volume of the organ, are large cells that radiate outward from the central vein in plates to the periphery of the lobule. These cells perform the major functions associated with the liver and are responsible for the regenerative properties of the liver. Kupffer cells are macrophages that line the sinusoids of the liver and act as active phagocytes capable of engulfing bacteria, debris, toxins, and other substances flowing through the sinusoids (Fig. 24-4).

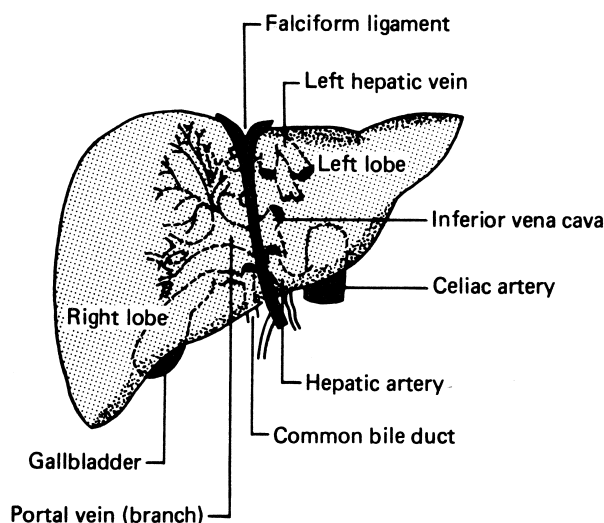

FIGURE 24-2. Blood supply to liver.

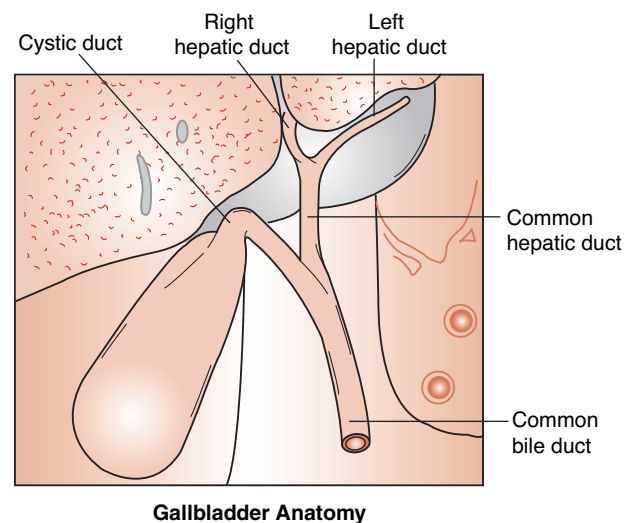

FIGURE 24-3. Excretory system of the liver.

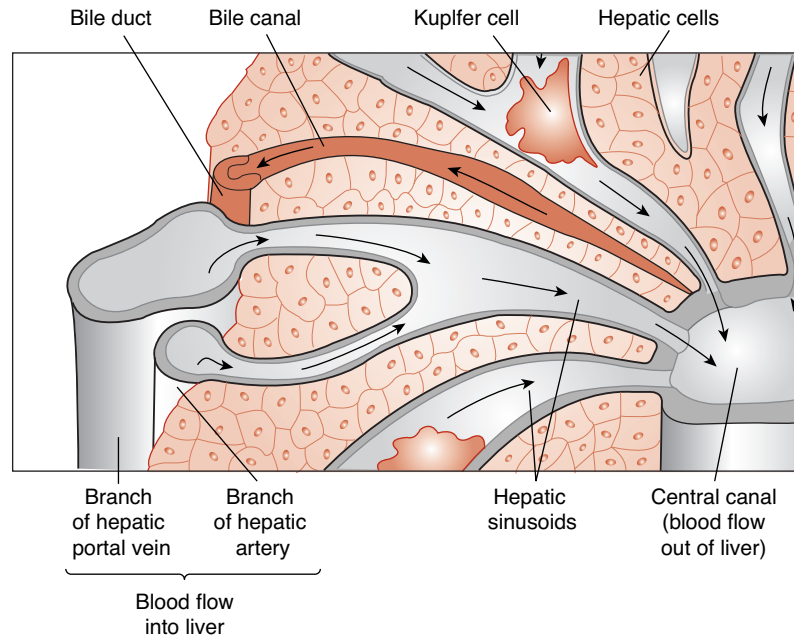

FIGURE 24-4. Microscopic anatomy of the liver.

BIOCHEMICAL FUNCTIONS

The liver performs four major functions: excretion/secretion, synthesis, detoxification, and storage. The liver is so important that if the liver becomes nonfunctional, death will occur with 24 hours due to hypoglycemia. Although the liver is responsible for a number of functions, this chapter focuses on the four major functions mentioned previously.

Excretory and Secretory

One of the most important functions of the liver is the processing and excretion of endogenous and exogenous substances into the bile or urine such as the major heme waste product, **bilirubin**. The liver is the only organ that has the capacity to rid the body of heme waste products. Bile is made up of bile acids or salts, bile pigments, cholesterol, and other substances extracted from the blood. The body produces approximately 3 L of bile per day and excretes 1 L of what is produced. Bilirubin is the principal pigment in bile, and it is derived from the breakdown of red blood cells. Approximately 126 days after the emergence from the reticuloendothelial tissue, red blood cells are phagocytized and hemoglobin is released. Hemoglobin is broken down into heme, globin, and iron. The iron is bound by transferrin and is returned to iron stores in the liver or bone marrow for reuse. The globin is degraded to its constituent amino acids, which are reused by the body. The heme portion of hemoglobin is converted to bilirubin in 2–3 hours. Bilirubin is bound by albumin and transported to the liver. This form of bilirubin is re-

ferred to as *unconjugated* or *indirect bilirubin*. This form of bilirubin is insoluble in water and cannot be removed from the body until it has been conjugated by the liver. Once at the liver cell, unconjugated bilirubin flows into the sinusoidal spaces and is released from albumin so it can be picked up by a carrier protein called *ligandin*. Ligandin, which is located in the hepatocyte, is responsible for transporting unconjugated bilirubin to the endoplasmic reticulum, where it may be rapidly conjugated. The conjugation (esterification) of bilirubin occurs in the presence of the enzyme uridyldiphosphate glucuronyl transferase (UDPGT), which transfers a glucuronic acid molecule to each of the two propionic acid side chains of bilirubin to form bilirubin diglucuronide, also known as **conjugated bilirubin**. This form of bilirubin, is water soluble and is able to be secreted from the hepatocyte into the bile canaliculi. Once in the hepatic duct, it combines with secretions from the gallbladder through the cystic duct and is expelled through the common bile duct into the intestines. Intestinal bacteria (especially the bacteria in the lower portion of the intestinal tract) work on conjugated bilirubin to produce mesobilirubin, which is reduced to form mesobilirubinogen and then **urobilinogen** (a colorless product). Most of the urobilinogen formed (roughly 80%) is oxidized to an orange-colored product called **urobilin** (stercobilin) and is excreted in the feces. The urobilin or stercobilin is what gives stool its brown color. There are two things that can happen to the remaining 20% of urobilinogen formed. The majority will be absorbed by extrahepatic circulation to be recycled through the liver and re-excreted. The

other very small quantity left will enter systemic circulation and will subsequently be filtered by the kidney and excreted in the urine¹ (Fig. 24-5).

Approximately 200–300 mg of bilirubin is produced per day, and it takes a normally functioning liver to process the bilirubin and eliminate it from the body. This, as stated earlier, requires that bilirubin be conjugated. Almost all the bilirubin formed is eliminated in the feces, and a small amount of the colorless product, urobilinogen, is excreted in the urine. The healthy adult has very low levels of total bilirubin (0.2–1.0 mg/dL) in the serum, and of this amount, the majority is in the unconjugated form.²

Synthetic

The liver has extensive synthetic capacity; it is responsible for synthesizing many biological compounds including carbohydrates, lipids, and proteins.

The metabolism of carbohydrates is one of the most important functions of the liver. When carbohydrates are ingested and absorbed, the liver can do three things: (1) use the glucose for its own cellular energy requirements, (2) circulate the glucose for use at the peripheral tissues, or (3) store glucose as glycogen (principal storage form of glucose) within the liver itself or within other tissues. The liver is the major player in maintaining stable glucose concentrations due to its ability to store glucose as glycogen through glycogenesis and degrade glycogen through glycogenolysis depending on the body's needs. Under conditions of stress or in a fasting state when there is an increased requirement for glucose, the liver will break down stored glycogen through glycogenolysis to liberate glucose. When the supply of glycogen becomes depleted, the liver will create glucose from nonsugar carbon substrates like pyruvate, lactate, and amino acids through a process referred to as *gluconeogenesis*.

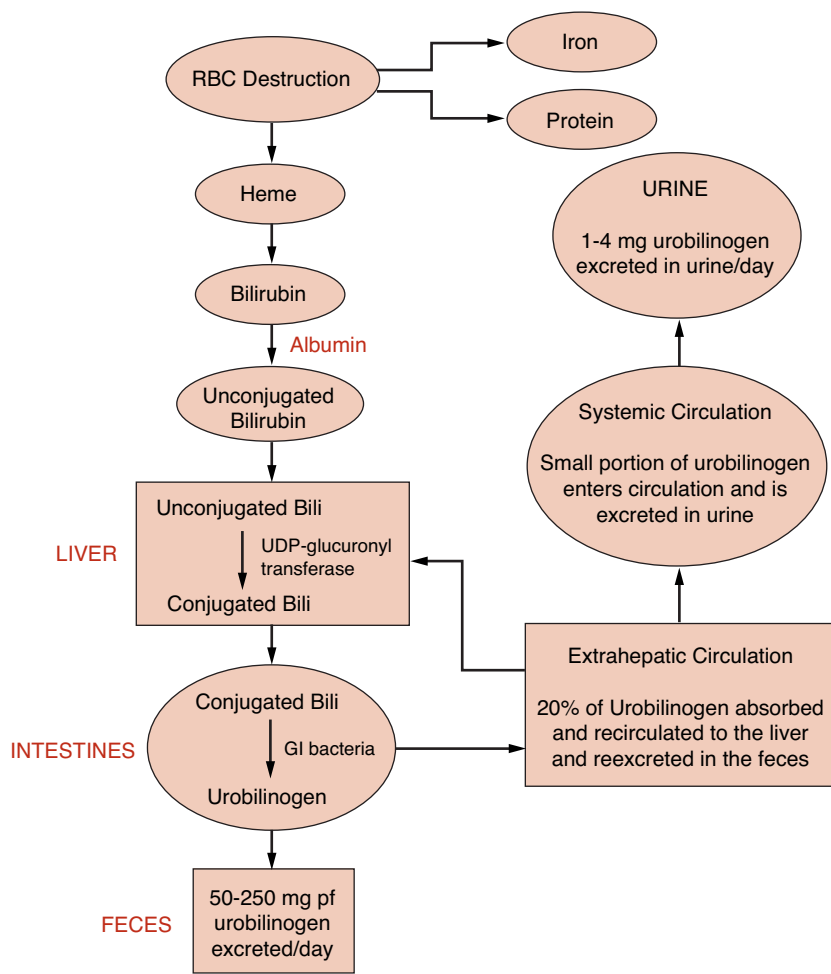

FIGURE 24-5. Metabolism of bilirubin. (Adapted with permission from Anderson SC, Cockayne S. *Clinical Chemistry: concepts and applications*. Bethesda, Md.: American Society of Clinical Laboratory Scientists, 2003:289, Figure 16-3.)

Lipids are synthesized in the liver under normal circumstances when nutrition is adequate and the demand for glucose is being met. The liver is responsible for gathering free fatty acids from the diet, and those produced by the liver itself, and breaking them down to produce acetyl-CoA. Acetyl-CoA can then enter several pathways to form triglycerides, phospholipids, or cholesterol. Despite popular belief, the greatest source of cholesterol in the body comes from what is produced by the liver, not from dietary sources. In fact, approximately 70% of the daily production of cholesterol (roughly 1.5–2.0 g) is produced by the liver.³ The liver is also involved in the metabolism of lipids and their removal from the body through the use of lipoproteins and apoproteins. A more thorough discussion of lipid metabolism may be found in Chapter 14.

Almost all proteins are synthesized by the liver except for the immunoglobulins and adult hemoglobin. The liver plays an essential role in the development of hemoglobin in infants. One of the most important proteins synthesized by the liver is albumin, which carries with it a wide range of important functions. The liver is also responsible for synthesizing the positive and negative acute-phase reactants and coagulation proteins, and it

also serves to store a pool of amino acids through protein degradation.

Although it would seem logical that any damage to the liver would result in a loss of synthetic and metabolic functions of the liver, that is not the case. The liver must be extensively impaired before it loses its ability to perform these essential functions.

Detoxification and Drug Metabolism

The liver serves as a gatekeeper between substances absorbed by the gastrointestinal tract and those released into systemic circulation. Every substance that is absorbed in the gastrointestinal tract must first pass through the liver; this is referred to as *first pass*. This is an important function of the liver because it can allow important substances to reach the systemic circulation and can serve as a barrier to prevent toxic or harmful substances from reaching the systemic circulation. The body has two mechanisms for detoxification of foreign materials (drugs and poisons) and metabolic products (bilirubin and ammonia). It may either bind the material reversibly so as to inactivate the compound, or it may chemically modify the compound so it can be excreted. The most important mechanism is the drug-metabolizing system of the liver. This system is responsible for the detoxification of many drugs through oxidation, reduction, hydrolysis, hydroxylation, carboxylation, and demethylation. Many of these take place in the liver microsomes via the cytochrome P-450 isoenzymes.

LIVER FUNCTION ALTERATIONS DURING DISEASE

Jaundice

The word *jaundice* comes from the French word *jaune*, which means “yellow,” and it is one of the oldest known pathologic conditions reported having been described by Hippocratic physicians.⁴ Jaundice, or **icterus**, is used to describe the yellow discoloration of the skin, eyes, and mucous membranes most often resulting from the retention of bilirubin; however, it may also occur due to the retention of other substances. Although the upper limit of normal for total bilirubin is 1.0–1.5 mg/dL, jaundice is usually not noticeable to the naked eye (known as *overt jaundice*) until bilirubin levels reach 3.0 mg/dL. Although the terms *jaundice* and *icterus* are used interchangeably, the term *icterus* is most commonly used in the clinical laboratory to refer to a serum or plasma sample with a yellow discoloration due to an elevated bilirubin level. Jaundice is most commonly classified based on the site of the disorder: **prehepatic**, hepatic, and **posthepatic** jaundice. This classification is important because knowing the

CASE STUDY 24-1

The following laboratory test results were obtained in a patient with severe jaundice, right upper quadrant abdominal pain, fever, and chills (Case Study Table 24-1.1).

Question

1. What is the most likely cause of jaundice in the patient?

CASE STUDY TABLE 24-1.1 LABORATORY RESULTS

| | |
|----------------------------|---|
| Serum alkaline phosphatase | 4 times normal |
| Serum cholesterol | Increased |
| AST (SGOT) | Normal or slightly increased |
| 5'-Nucleotidase | Increased |
| Total serum bilirubin | 25 mg/dL |
| Conjugated bilirubin | 19 mg/dL |
| Prothrombin time | Prolonged but improves with a vitamin K injection |

classification of jaundice will aid health care providers in formulating an appropriate treatment or management plan. *Prehepatic* and *posthepatic jaundice*, as the names imply, are caused by abnormalities outside of the liver, either before, as in “prehepatic,” or after, as in “posthepatic.” In these conditions, liver function is normal or it may be functioning at a maximum to compensate for abnormalities occurring elsewhere. This is not the case with hepatic jaundice, where the jaundice is due to a problem with the liver itself—an intrinsic liver defect or disease.

Prehepatic jaundice occurs when the problem causing the jaundice occurs prior to liver metabolism. It is most commonly caused by an increased amount of bilirubin being presented to the liver such as that seen in acute and chronic hemolytic anemias. Hemolytic anemia causes an increased amount of red blood cell destruction and the subsequent release of increased amounts of bilirubin presented to the liver for processing. The liver responds by functioning at maximum capacity; therefore, people with from prehepatic jaundice rarely have bilirubin levels that exceed 5 mg/dL because the liver is capable of handling the overload. This type of jaundice may also be referred to as *unconjugated hyperbilirubinemia* because the fraction of bilirubin increased in people with prehepatic jaundice is the unconjugated fraction. This fraction of bilirubin (unconjugated bilirubin) is not water soluble, is bound to albumin, and is not filtered by the kidneys and therefore will not be seen in the urine.

Hepatic jaundice occurs when the primary problem causing the jaundice resides in the liver (intrinsic liver defect or disease). This intrinsic liver defect or disease can be due to disorders of bilirubin metabolism and transport defects (Crigler-Najjar syndrome, Dubin-Johnson syndrome, Gilbert disease, and neonatal physiologic jaundice of the newborn) or due to diseases resulting in hepatocellular injury or destruction. Gilbert disease, Crigler-Najjar syndrome, and physiologic jaundice of the newborn are hepatic causes of jaundice that result in elevations in unconjugated bilirubin. Conditions such as Dubin-Johnson and Rotor syndrome are hepatic causes of jaundice that result in elevations in conjugated bilirubin.

Gilbert syndrome, first described in the early twentieth century, is a benign hereditary disorder that affects approximately 5% of the U.S. population.⁵ Of the many causes of jaundice, Gilbert syndrome is the most common cause and, interestingly, it carries no morbidity or mortality in the majority of those affected and carries generally no clinical consequences. It is characterized by intermittent unconjugated hyperbilirubinemia in the absence of hemolysis and underlying liver disease due to a defective conjugation system. The hyperbilirubinemia

usually manifests during adolescence or early adulthood. Total serum bilirubin usually fluctuates between 20–50 $\mu\text{mol/L}$, and it rarely exceeds 85 $\mu\text{mol/L}$. The molecular basis of Gilbert syndrome (in whites) is related to the UGT (uridine diphosphoglucose glucuronyltransferase) superfamily, which is responsible for encoding enzymes that catalyze the conjugation of bilirubin. The UGT1A1 (the hepatic 1A1 isoform of UGT) contributes substantially to the process of conjugating bilirubin. The UGT1A1 promoter contains the sequence $(\text{TA})_6\text{TAA}$. The insertion of an extra TA in the sequence, as seen in Gilbert syndrome, reduces the expression of the *UGT1A1* gene to 20%–30% of normal values. That is, the liver’s conjugation system in Gilbert syndrome is working at approximately 30% of normal.^{6,7}

Crigler-Najjar syndrome was first described by Crigler and Najjar in 1952 as a syndrome of chronic non-hemolytic unconjugated hyperbilirubinemia.⁸ Crigler-Najjar syndrome, like Gilbert syndrome, is an inherited disorder of bilirubin metabolism resulting from a molecular defect within the gene involved with bilirubin conjugation. Crigler-Najjar syndrome may be divided into two types: type I, where there is a complete absence of enzymatic bilirubin conjugation, and type II, where there is a mutation causing a severe deficiency of the enzyme responsible for bilirubin conjugation. Unlike Gilbert syndrome, Crigler-Najjar syndrome is rare and is a more serious disorder.⁹

While Gilbert disease and Crigler-Najjar syndrome are characterized as primarily unconjugated hyperbilirubinemias, Dubin-Johnson syndrome and Rotor syndrome are characterized as conjugated hyperbilirubinemias. Dubin-Johnson syndrome is a rare inherited disorder caused by a deficiency of the canalicular multidrug resistance/multispecific organic anionic transporter protein (MDR2/cMOAT). In other words, the liver’s ability to uptake and conjugate bilirubin is functional; however, the removal of conjugated bilirubin from the liver cell and the excretion into the bile are defective. This results in accumulation of conjugated and, to some extent, unconjugated bilirubin in the blood, leading to hyperbilirubinemia and bilirubinuria. Dubin-Johnson is a condition that is obstructive in nature, so much of the conjugated bilirubin circulates bound to albumin. This type of bilirubin (conjugated bilirubin bound to albumin) is referred to as *delta bilirubin*. An increase in delta bilirubin poses a problem in laboratory evaluation because the delta bilirubin fraction reacts as conjugated bilirubin in the laboratory method to measure conjugated or direct bilirubin. A distinguishing feature of Dubin-Johnson syndrome is the appearance of dark-stained granules (thought to be pigmented lysosomes) on a liver biopsy sample. Usually the total bilirubin concentration remains between 2–5 mg/dL with more than 50% due to the con-

jugated fraction. This syndrome is a relatively mild in nature with an excellent prognosis. People with Dubin-Johnson have a normal life expectancy, so no treatment is necessary.^{10,11}

Rotor syndrome is clinically similar to Dubin-Johnson syndrome but the defect causing Rotor syndrome is not known.¹² It is hypothesized to be due to a reduction in the concentration or activity of intracellular binding proteins such as ligandin. Unlike in Dubin-Johnson syndrome, a liver biopsy does not show dark pigmented granules. Rotor syndrome is seen less commonly than Dubin-Johnson syndrome; it is a relatively benign condition and carries an excellent prognosis, and therefore treatment is not warranted. However, an accurate diagnosis is required to aid in distinguishing it from more serious liver diseases that require treatment.

Physiologic jaundice of the newborn is a result of a deficiency in the enzyme glucuronyl transferase, one of the last liver functions to be activated in prenatal life since bilirubin processing is handled by the mother of the fetus. In premature births, infants may be born without glucuronyl transferase, the enzyme responsible for bilirubin conjugation. This deficiency results in the rapid buildup of unconjugated bilirubin, which can be life threatening. When this type of bilirubin builds up in the neonate, it cannot be processed and it is deposited in the nuclei of brain and nerve cells, causing kernicterus. Kernicterus often results in cell damage and death in the newborn, and this condition will continue until glucuronyl transferase is produced. Infants with this type of jaundice are usually treated with ultraviolet radiation to destroy the bilirubin as it passes through the capillaries of the skin. In extreme cases, some infants require an exchange transfusion. Because this condition is so serious, bilirubin levels are carefully and frequently monitored so the dangerously high levels of

unconjugated bilirubin (approximately 20 mg/dL) can be detected and treated.¹³

Posthepatic jaundice is results from biliary obstructive disease, usually from physical obstructions (gallstones or tumors), that prevent the flow of conjugated bilirubin into the bile canaliculi. Since the liver cell itself is functioning, bilirubin is effectively conjugated; however, it is unable to be properly excreted from the liver. Since bile is not being brought to the intestines, stool loses its source of normal pigmentation and becomes clay-colored. The laboratory findings for bilirubin and its metabolites in the above-mentioned types of jaundice are summarized in Table 24-1. Mechanisms of hyperbilirubinemia may be found in Figure 24-6.

Cirrhosis

Cirrhosis is a clinical condition in which scar tissue replaces normal, healthy liver tissue. As the scar tissue replaces the normal liver tissue, it blocks the flow of blood through the organ and prevents the liver from functioning properly. Cirrhosis rarely causes signs and symptoms in its early stages, but as liver function deteriorates, the signs and symptoms appear, including fatigue, nausea, unintended weight loss, jaundice, bleeding from the gastrointestinal tract, intense itching, and swelling in the legs and abdomen. Although some patients with cirrhosis may have prolonged survival, they generally have a poor prognosis. Cirrhosis was the twelfth leading cause of death by disease in 2004, killing just over 27,000 people.¹⁴ In the United States, the most common cause of cirrhosis is chronic alcoholism and chronic **hepatitis C** virus infection. Other causes of cirrhosis include chronic hepatitis B and D virus infection, autoimmune hepatitis, inherited disorders (e.g., α_1 -antitrypsin deficiency, Wilson disease, hemochromatosis, and galac-

TABLE 24-1 CHANGES IN CONCENTRATION OF BILIRUBIN IN THOSE WITH JAUNDICE

| TYPE OF JAUNDICE | SERUM | | |
|---------------------------|-----------------|----------------------|------------------------|
| | TOTAL BILIRUBIN | CONJUGATED BILIRUBIN | UNCONJUGATED BILIRUBIN |
| Prehepatic | ↑ | ↔ | ↑ |
| Hepatic | | | |
| • Gilbert disease | ↑ | ↔ | ↑ |
| • Crigler-Najjar syndrome | ↑ | ↓ | ↑ |
| • Dubin-Johnson | ↑ | ↑ | ↔ |
| • Rotor syndrome | ↑ | ↑ | ↔ |
| • Jaundice of newborn | ↑ | ↔ | ↑ |
| Posthepatic | ↑ | ↑ | ↑ |

Adapted with permission from Table 27-3 of Kaplan LA, Pesce AJ, Kazmierczak S. *Clinical chemistry: theory, analysis, correlation*. 4th ed. St. Louis, Mo.: Mosby, 2003.

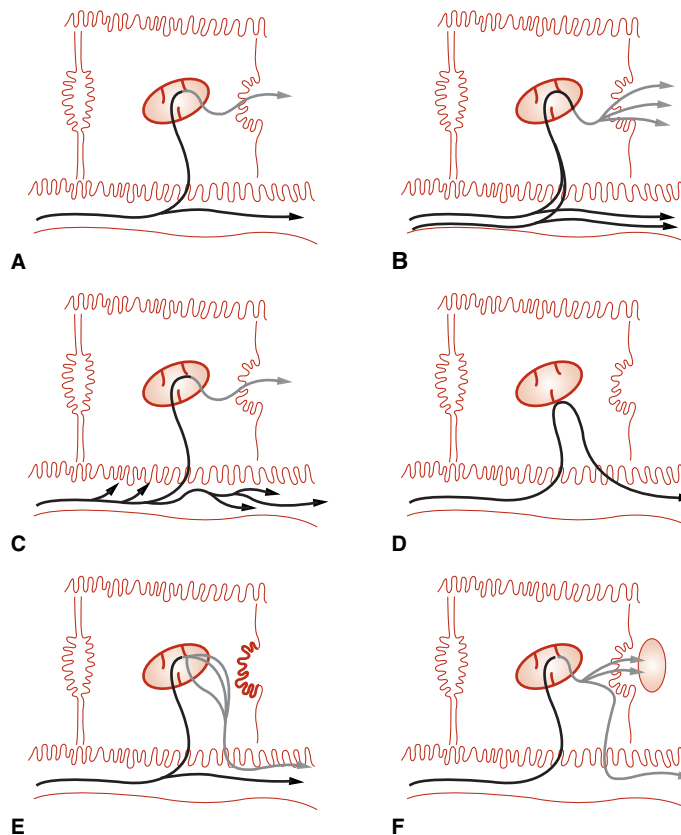

FIGURE 24-6. Mechanisms of hyperbilirubinemia. (Reprinted with permission from Kaplan LA, Pesce AJ, Kazmierczak S. *Clinical chemistry: theory, analysis, correlation*. 4th ed. St. Louis, Mo.: Mosby, 2003:449.)

tosemia), nonalcoholic steatohepatitis, blocked bile ducts, drugs, toxins, and infections.

Liver damage from cirrhosis cannot easily be reversed, but treatment can stop or delay further progression of the disorder. Treatment depends on the cause of cirrhosis and any complications a person is experiencing. For example, cirrhosis caused by alcohol abuse is treated by abstaining from alcohol. Treatment for hepatitis-related cirrhosis involves medications used to treat the different types of hepatitis, such as interferon for viral hepatitis and corticosteroids for autoimmune hepatitis.

Tumors

Cancers of the liver are classified as primary or metastatic. Primary liver cancer is cancer that begins in the liver cells. Metastatic cancer occurs when tumors from other parts of the body spread (metastasize) to the liver. Metastatic liver cancer is much more common than primary liver cancer; 90%–95% of all hepatic malignancies are classified as metastatic. Cancers that commonly spread to the liver include colon, lung, and breast cancer. Cancers of the liver may also be classified as benign or malignant. The com-

mon benign cancers of the liver include hepatocellular adenoma (rare condition occurring almost exclusively in females of child-bearing age) and hemangiomas (masses of atypical blood vessels usually mesenchymal in origin with no known etiology). Malignant tumors of the liver include hepatocellular carcinoma (HCC), hepatocarcinoma, and **hepatoma**. Of those, HCC is the most common malignant tumor of the liver.

HCC has become increasingly important in the U.S. Although 80% of the new cases of this liver cancer occur in developing countries, the incidence of HCC is increasing in economically developed countries such as Japan and the U.S.^{15,16} It is estimated that 18,000 new cases of HCC are projected to occur in the U.S. in 2005, and the trend is expected to continue. Commonly, but not exclusively, HCC develops in those with liver cell damage that eventually progresses to cirrhosis, which is a predisposing condition for the development of HCC.¹⁷

Approximately 80% of cases worldwide are attributable to the hepatitis B and C viruses; however, the mechanism by which the infection leads to HCC is not well established. Currently, liver transplantation is the only curative

treatment available for HCC with an estimated 1- and 5-year survival rate of 77% and 61%, respectively.¹⁸

Whether primary or metastatic, any malignant tumor in the liver is a serious finding and carries a poor prognosis, with survival times measured in months.

Reye Syndrome

Reye syndrome is a term used to describe a group of disorders caused by infectious, metabolic, toxic, or drug-induced disease found almost exclusively in children, although adult cases of Reye syndrome have been reported.¹⁹ Although the precise cause of Reye syndrome is unknown, it is often preceded by a viral syndrome such as varicella, gastroenteritis, or an upper respiratory tract infection such as influenza.^{20–22} Although not described as the precise cause of Reye syndrome, studies have demonstrated a strong epidemiologic association between the ingestion of aspirin during a viral syndrome and the subsequent development of Reye syndrome.^{23,24} As a result of these reports, the Centers for Disease Control and Prevention cautioned physicians and parents to avoid salicylate use in children with a viral syndrome, and the U.S. Surgeon General mandated that a warning label be added to all aspirin-containing medications, beginning in 1986.^{25,26} Reye syndrome is an acute illness characterized by noninflammatory encephalopathy and fatty degeneration of the liver with a clinical presentation of profuse vomiting accompanied with varying degrees of neurologic impairment such as fluctuating personality changes and deterioration in consciousness. The encephalopathy is characterized by a progression from mild confusion (stage 1) through progressive loss of neurologic function to loss of brainstem reflexes (stage 5). The degeneration of the liver is characterized by a mild hyperbilirubinemia and threefold increases in ammonia and the aminotransferases (AST and ALT). Without treatment, rapid clinical deterioration leading to death may occur.^{27,28}

Drug- and Alcohol-Related Disorders

Drug-induced liver disease is a major problem in the U.S., accounting for one third to one half of all reported cases of acute liver failure. The liver is a primary target organ for adverse drug reactions because it plays a central role in drug metabolism. Many drugs are known to cause liver damage, ranging from very mild transient forms to fulminant liver failure. Drugs can cause liver injury by a number of mechanisms, but the most common mechanism of toxicity is via an immune-mediated injury to the hepatocytes.²⁹ In this type of mechanism, the drug induces an adverse immune response directed against the liver itself and results in hepatic and/or cholestatic disease.³⁰

Of all the drugs associated with hepatic toxicity, the most important is ethanol. In very small amounts,

ethanol causes very mild, transient, and unnoticed injury to the liver; however, with heavier and prolonged consumption, it can lead to alcoholic cirrhosis. While the exact amount of alcohol needed to cause cirrhosis is unknown, a small minority of people with alcoholism develop this condition.³¹ Approximately 90% of the alcohol absorbed from the stomach and small intestines is transported to the liver for metabolism. Within the liver, the elimination of alcohol requires the enzymes alcohol dehydrogenase and acetaldehyde dehydrogenase to convert alcohol to acetaldehyde and subsequently to acetate. The acetate can then be oxidized to water and carbon dioxide, or it may enter the citric acid cycle.

Long-term excessive consumption of alcohol can result in a spectrum of liver abnormalities that may range from alcoholic fatty liver with inflammation (steatohepatitis) to scar tissue formation, as in hepatic fibrosis, to the destruction of normal liver structure seen in hepatic cirrhosis. This type of liver injury may be categorized into three stages: alcoholic fatty liver, alcoholic hepatitis, and alcoholic cirrhosis. Alcoholic fatty liver represents the mildest category where very few changes in liver function are measurable. This stage is characterized by slight elevations in AST, ALT, and GGT, and on biopsy, fatty infiltrates are noted in the vacuoles of the liver. This stage tends to affect young to middle-aged people with a history of moderate alcohol consumption. A complete recovery within 1 month is seen when the drug is removed. The second stage presents with far more evidence of liver damage such as moderately elevated AST, ALT, GGT, and ALP and elevations in total bilirubin up to 30 mg/dL. Serum proteins, especially albumin, are decreased and the prothrombin time is prolonged. Prognosis is dependent on the type and severity of damage to the liver. The last and most severe stage is alcoholic cirrhosis. The prognosis associated with alcoholic cirrhosis is dependent on the nature and severity of associated conditions such as a gastrointestinal bleeding or ascites; however, the 5-year survival rate is 60% in those who abstain from alcohol and 30% in those who continue to drink. This condition appears to be more common in males than in females, and the symptoms tend to be nonspecific and include weight loss, weakness, hepatomegaly, splenomegaly, jaundice, ascites, fever, malnutrition, and edema. Laboratory abnormalities include increased liver function tests (AST, ALT, GGT, ALP, total bilirubin), decreased albumin, and a prolonged prothrombin time. A liver biopsy is the only method by which a definitive diagnosis may be made.³²

Other drugs, including tranquilizers, some antibiotics, antineoplastic agents, lipid-lowering medication, and anti-inflammatory drugs, may cause liver injury ranging from mild damage to massive hepatic failure and cirrhosis. One of the most common drugs associated with serious hepatic injury is acetaminophen. When acetaminophen is taken in

massive doses, it is virtually certain to produce fatal hepatic necrosis unless rapid treatment is initiated.

ASSESSMENT OF LIVER FUNCTION/LIVER FUNCTION TESTS

Bilirubin

Analysis of Bilirubin: A Brief Review

The reaction of bilirubin with a diazotized sulfanilic acid solution to form a colored product was first described by Ehrlich in 1883 using urine samples. Since then, this type of reaction (bilirubin with a diazotized sulfanilic acid solution) has been referred to as the classic *diazo reaction*, a reaction on which all commonly used methods today are based. In 1913, van den Bergh found that the diazo reaction may be applied to serum samples but only in the presence of an accelerator (solubilizer). However, this methodology had errors associated with it. It was not until 1937 that Malloy and Evelyn developed the first clinically useful methodology for the quantitation of bilirubin in serum samples using the classic diazo reaction with a 50% methanol solution as an accelerator. In 1938, Jendrassik and Grof described a method using the diazo reaction with caffeine-benzoate-acetate as an accelerator. Today, all commonly used methods for measuring bilirubin and its fractions are modifications of the technique described by Malloy and Evelyn. Total bilirubin and conjugated bilirubin are measured and unconjugated bilirubin is determined by subtracting conjugated bilirubin from total bilirubin.

Bilirubin also been quantified by using bilirubinometry in the neonatal population. This methodology is only useful in the neonatal population because of the presence of carotenoid compounds in adult serum that causes strong positive interference in the adult population. Bilirubinometry involves the measurement of reflected light from the skin using two wavelengths that provide a numerical index based on spectral reflectance. Newer-generation bilirubinometers use microspectrophotometers that determine the optical densities of bilirubin, hemoglobin, and melanin in the subcutaneous layers of the infant's skin. Mathematical isolation of hemoglobin and melanin allows measurement of the optical density created by bilirubin.³³

When using the several methods described earlier, two of the three fractions of bilirubin were identified: conjugated (direct) and unconjugated (indirect) bilirubin. Unconjugated (indirect) bilirubin is a nonpolar and water-insoluble substance that is found in plasma bound to albumin. Because of these characteristics, unconjugated bilirubin will only react with the diazotized sulfanilic acid solution (diazo reagent) in the presence of an accelerator (solubilizer). Conjugated (direct) bilirubin is a polar and water-soluble compound that is found in

CASE STUDY 24-2

The following laboratory test results were found in a patient with mild weight loss and nausea and vomiting, who later developed jaundice and an enlarged liver (Case Study Table 24-2.1)

Question

1. What disease process is most likely in this patient?

CASE STUDY TABLE 24-2.1 LABORATORY RESULTS

| | |
|-----------------------|------------------------|
| Total serum bilirubin | 20 mg/dL |
| Conjugated bilirubin | 10 mg/dL |
| Alkaline phosphatase | Mildly elevated |
| AST (SGOT) | Significantly elevated |
| ALT (SGPT) | Moderately elevated |
| Albumin | Decreased |
| γ-Globulin | Increased |

plasma in the free state (not bound to any protein). This type of bilirubin will react with the diazotized sulfanilic acid solution directly (without an accelerator). Thus, conjugated and unconjugated bilirubin fractions have historically been differentiated by solubility of the fractions. Conjugated bilirubin reacts in the absence of an accelerator, whereas unconjugated bilirubin requires an accelerator. While for many years bilirubin results were reported as direct and indirect, this terminology is now outdated. Direct and indirect bilirubin results should be reported as conjugated and unconjugated, respectively.³⁴

The third fraction of bilirubin is referred to as “delta” bilirubin. Delta bilirubin is conjugated bilirubin that is covalently bound to albumin. This fraction of bilirubin is seen only when there is significant hepatic obstruction. Because the molecule is attached to albumin, it is too large to be filtered by the glomerulus and excreted in the urine. This fraction of bilirubin, when present, will react in most laboratory methods as conjugated bilirubin. Thus, total bilirubin is made up of three fractions: conjugated, unconjugated, and delta bilirubin. The three fractions together are known as *total bilirubin*.

Specimen Collection and Storage

Total bilirubin methods using a diazotized sulfanilic acid solution may be performed on either serum or plasma. Serum, however, is preferred for the Malloy-Evelyn procedure because the addition of the alcohol in the analysis can precipitate proteins and cause interference with

the method. A fasting sample is preferred as the presence of lipemia will increase measured bilirubin concentrations. Hemolyzed samples should be avoided as they may decrease the reaction of bilirubin with the diazo reagent. Bilirubin is very sensitive to and is destroyed by light; therefore, specimens should be protected from light. If left unprotected from light, bilirubin values may reduce by 30%–50% per hour. If serum or plasma is separated from the cells and stored in the dark, it is stable for 2 days at room temperature, 1 week at 4°C, and indefinitely at –20°C.³⁵

Methods

There is no preferred reference method or standardization of bilirubin analysis; however, the American Association for Clinical Chemistry and the National Bureau of Standards have published a candidate reference method for total bilirubin, a modified Jendrassik-Grof procedure using caffeine-benzoate as a solubilizer.³⁶ Because they both have acceptable precision and are adapted to many automated instruments, the Jendrassik-Grof or Malloy-Evelyn procedure is the most frequently used method to measure bilirubin. The Jendrassik-Grof method is slightly more complex, but it has the following advantages over the Malloy-Evelyn method:

- Not affected by pH changes
- Insensitive to a 50-fold variation in protein concentration of the sample
- Maintains optical sensitivity even at low bilirubin concentrations
- Has minimal turbidity and a relatively constant serum blank
- Is not affected by hemoglobin up to 750 mg/dL

Because this chapter does not allow for a detailed description of all previously mentioned bilirubin test methodologies, only the most widely used principles for measuring bilirubin in the adult and pediatric population are covered.^{37–39}

Malloy-Evelyn Procedure

Bilirubin pigments in serum or plasma are reacted with a diazo reagent. The diazotized sulfanilic acid reacts at the central methylene carbon of bilirubin to split the molecule forming two molecules of azobilirubin. This method is typically performed at pH 1.2 where the azobilirubin produced is red-purple in color with a maximal absorption of 560 nm. The most commonly used accelerator to solubilize unconjugated bilirubin is methanol, although other chemicals have been used.⁴⁰

Jendrassik-Grof Method for Total and Conjugated Bilirubin Determination

Principle

Bilirubin pigments in serum or plasma are reacted with a diazo reagent (sulfanilic acid in hydrochloric acid and

sodium nitrite), resulting in the production of the purple product azobilirubin. The product azobilirubin may be measured spectrophotometrically. The individual fractions of bilirubin are determined by taking two aliquots of sample and reacting one aliquot with the diazo reagent only and the other aliquot with the diazo reagent and an accelerator (caffeine-benzoate). The addition of the caffeine-benzoate will solubilize the water-insoluble fraction of bilirubin and will yield a total bilirubin value (all fractions). The reaction without the accelerator will yield conjugated bilirubin only. After a short period of time, the reaction of the aliquots with the diazo reagent is terminated by the addition of ascorbic acid. The ascorbic acid destroys the excess diazo reagent. The solution is then alkalinized using an alkaline tartrate solution, which shifts the absorbance spectrum of the azobilirubin to a more intense blue color that is less subject to interfering substances in the sample. The final blue product is measured at 600 nm with the intensity of color produced directly proportional to bilirubin concentration. Indirect (unconjugated) bilirubin may be calculated by subtracting the conjugated bilirubin concentration from the total bilirubin concentration.

Comments and Sources of Error

Instruments should be frequently standardized to maintain reliable bilirubin results, and careful preparation of bilirubin standards is critical as these are subject to deterioration from exposure to light. Hemolysis and lipemia should be avoided as they will alter bilirubin concentrations. Serious loss of bilirubin occurs after exposure to fluorescent and indirect and direct sunlight; therefore, it is imperative that exposure of samples and standards to light be kept to a minimum. Specimens and standards should be refrigerated in the dark until testing can be performed.

Reference Range

See Table 24-2.

Urobilinogen in Urine and Feces

Urobilinogen is a colorless end product of bilirubin metabolism that is oxidized by intestinal bacteria to the brown pigment urobilin. In the normal individual, part of the urobilinogen is excreted in feces, and the remainder is reabsorbed into the portal blood and returned to the liver. A small portion that is not taken up by the hepatocytes is excreted by the kidney as urobilinogen. Increased levels of urinary urobilinogen are found in hemolytic disease and in defective liver-cell function, such as that seen in hepatitis. Absence of urobilinogen from the urine and stool is most often seen with complete biliary obstruction. Fecal urobilinogen is also decreased in biliary obstruction, as well as in HCC.⁴¹

Most quantitative methods for urobilinogen are based on a reaction first described by Ehrlich in 1901: the

TABLE 24-2 REFERENCE RANGES FOR BILIRUBIN IN ADULTS AND INFANTS

| POPULATION | TYPE OF BILIRUBIN | REFERENCE RANGE |
|-------------------|-----------------------------|----------------------------------|
| Adults | Conjugated bilirubin | 0.0–0.2 mg/dL (0–3 μ mol/L) |
| | Unconjugated bilirubin | 0.2–0.8 mg/dL (3–14 μ mol/L) |
| | Total bilirubin | 0.2–1.0 mg/dL (3–17 μ mol/L) |
| Premature infants | Total bilirubin at 24 hours | 1–6 mg/dL |
| | Total bilirubin at 48 hours | 6–8 mg/dL |
| | Total bilirubin 3–5 days | 10–12 mg/dL |
| Full-term infants | Total bilirubin at 24 hours | 2–6 mg/dL |
| | Total bilirubin at 48 hours | 6–7 mg/dL |
| | Total bilirubin 3–5 days | 4–6 mg/dL |

reaction of urobilinogen with *p*-dimethyl aminobenzaldehyde (Ehrlich's reagent) to form a red color. Many modifications of this procedure have been made over the years to improve specificity. However, because the modifications did not completely recover urobilinogen from the urine, most laboratories use the less laborious, more rapid, semiquantitative method described next.

Determination of Urine Urobilinogen (Semiquantitative)

Principle

Urobilinogen reacts with *p*-dimethyl aminobenzaldehyde (Ehrlich's reagent) to form a red color, which is then measured spectrophotometrically. Ascorbic acid is added as a reducing agent to maintain urobilinogen in the reduced state. The use of saturated sodium acetate stops the reaction and minimizes the combination of other chromogens with the Ehrlich's reagent.⁴²

Specimen

A fresh 2-hour urine specimen is collected. This specimen should be kept cool and protected from light.

COMMENTS AND SOURCES OF ERROR

1. The results of this test are reported in Ehrlich units rather than in milligrams of urobilinogen because substances other than urobilinogen account for some of the final color development.
2. Compounds, other than urobilinogen, that may be present in the urine and react with Ehrlich's reagent include porphobilinogen, sulfonamides, procaine, and 5-hydroxyindoleacetic acid. Bilirubin will form a green color and, therefore, must be removed, as previously described.
3. Fresh urine is necessary, and the test must be performed without delay to prevent oxidation of urobilinogen to urobilin. Similarly, the spectrophotometric readings should be made within 5 minutes after color production because the urobilinogen-aldehyde color slowly decreases in intensity.

Reference Range

Urine urobilinogen, 0.1–1.0 Ehrlich units every 2 hours or 0.5–4.0 Ehrlich units per day (0.86.8 mmol/day); 1 Ehrlich unit is equivalent to approximately 1 mg of urobilinogen.

Fecal Urobilinogen

Visual inspection of the feces is usually sufficient to detect decreased urobilinogen. However, the semiquantitative determination of fecal urobilinogen is available and involves the same principle described earlier for the urine. It is carried out in an aqueous extract of fresh feces, and any urobilin present is reduced to urobilinogen by treatment with alkaline ferrous hydroxide before Ehrlich's reagent is added. A range of 75–275 Ehrlich units per 100 g of fresh feces or 75–400 Ehrlich units per 24-hour specimen is considered a normal reference range.⁴²

Serum Bile Acids

Serum bile acid analysis is rarely performed because the methods required are very complex. These involve extraction with organic solvents, partition chromatography, gas chromatography–mass spectroscopy, spectrophotometry, ultraviolet light absorption, fluorescence, radioimmunoassay, and enzyme immunoassay methods. Although serum bile acid levels are elevated in liver disease, the total concentration is extremely variable and adds no diagnostic value to other tests of liver function. The variability of the type of bile acids present in serum, together with their existence in different conjugated forms, suggests that more relevant information of liver dysfunction may be gained by examining patterns of individual bile acids and their state of conjugation. For example, it has been suggested that the ratio of the trihydroxy to dihydroxy bile acids in serum will differentiate patients with obstructive jaundice from those with hepatocellular injury and that the diagnosis of primary biliary cirrhosis and extrahepatic cholestasis can be made on the basis of the ratio of the cholic to chenodeoxycholic acids. However, the high cost of these tests,

the time required to do them, and the current controversy concerning their clinical usefulness render this approach unsatisfactory for routine use.^{43,44}

Enzymes

Liver enzymes play an important role in the assessment of liver function because injury to the liver resulting cytolysis or necrosis will cause the release of enzymes into circulation. Enzymes also play an important role in differentiating hepatocellular (functional) from obstructive (mechanical) liver disease, which is an important clinical distinction because failure to identify an obstruction will result in liver failure if the obstruction is not rapidly treated. Although many enzymes have been identified as useful in the assessment of liver function, the most clinically useful include the aminotransferases (alanine aminotransferase [ALT] and aspartate aminotransferase [AST]), the phosphatases (alkaline phosphatase [ALP] and 5'-nucleotidase), γ -glutamyltransferase (GGT), and lactate dehydrogenase.

The methods used to measure these enzymes, the normal reference ranges, and other general aspects of enzymology are discussed in Chapter 12. Discussion in this chapter focuses on the characteristic changes in serum enzyme levels seen in various hepatic disorders. It is important to note that the diagnosis of disease depends on a combination of patient history, physical examination, laboratory testing, and sometimes radiologic studies and biopsy and therefore abnormalities in liver enzymes alone are not diagnostic in and of themselves.^{45,46}

Aminotransferases

The two most common aminotransferases measured in the clinical laboratory are AST (formerly referred to as serum glutamic-oxaloacetic transaminase [SGOT]) and ALT (formerly referred to as serum glutamic-pyruvic transaminase [SGPT]). The aminotransferases are responsible for catalyzing the conversion of aspartate and alanine to oxaloacetate and pyruvate, respectively. In the absence of acute necrosis or ischemia of other organs, these enzymes are most useful in the detection of hepatocellular (functional) damage to the liver. ALT is found mainly in the liver (lesser amounts in skeletal muscle and kidney), whereas AST is widely distributed in equal amounts in the heart, skeletal muscle, and liver, making ALT a more "liver-specific" marker than AST. Regardless, the serum activity of both transaminases rises rapidly in almost all diseases of the liver and may remain elevated for up to 2–6 weeks. The highest levels of AST and ALT are found in acute conditions such as viral hepatitis, drug- and toxin-induced liver necrosis, and hepatic ischemia. The increase in ALT activity is usually greater than that for AST. Only moderate increases are found in less severe conditions. AST and ALT are found to be normal or only mildly elevated in cases

of obstructive liver damage. Because AST and ALT are present in other tissues besides the liver, elevations in these enzymes may be a result of other organ dysfunction or failure such as acute myocardial infarction, renal infarction, progressive muscular dystrophy, and those conditions that result in secondary liver disease such as infectious mononucleosis, diabetic ketoacidosis, and hyperthyroidism. It is often helpful to conduct serial determinations of aminotransferases when following the course of a patient with acute or chronic hepatitis, and caution should be used in interpreting abnormal levels because serum transaminases may actually decrease in some patients with severe acute hepatitis, owing to the exhaustive release of hepatocellular enzymes.^{45,46}

Phosphatases

Alkaline Phosphatase

The ALP family of enzymes are zinc metalloenzymes that are widely distributed in all tissues; however, highest activity is seen in the liver, bone, intestine, kidney, and placenta. The clinical utility of ALP lies in its ability to differentiate hepatobiliary disease from osteogenic bone disease. In the liver, the enzyme is localized to the microvilli of the bile canaliculi, and therefore it serves as a great marker of extrahepatic biliary obstruction, such as a stone in the common bile duct, or in intrahepatic cholestasis, such as drug cholestasis or primary biliary cirrhosis. ALP is found in very high concentrations in cases of extrahepatic obstruction with only slight to moderate increases seen in those with hepatocellular disorders such as hepatitis and cirrhosis. Because bone is also a source of ALP, it may be elevated in bone-related disorders such as Paget's disease, bony metastases, diseases associated with an increase in osteoblastic activity, and rapid bone growth during puberty. ALP is also found elevated in pregnancy due to its release from the placenta, where it may remain elevated up to several weeks post delivery. As a result, interpretation of ALP concentrations is difficult because enzyme activity of ALP can increase in the absence of liver damage.^{45,46}

5'-Nucleotidase

5'-Nucleotidase (5NT) is a phosphatase that is responsible for catalyzing the hydrolysis of nucleoside-5'-phosphate esters. Although 5NT is found in a wide variety of cells, serum levels become significantly elevated in hepatobiliary disease. There is no bone source of 5NT so it is useful in differentiating ALP elevations due to the liver from other conditions where ALP may be seen in increased concentrations (bone diseases, pregnancy, and childhood growth). Levels of both 5NT and ALP are elevated in liver disease, whereas in primary bone disease, ALP level is elevated, but the 5NT level is usually normal or only slightly elevated. This enzyme is much more sensitive to metastatic liver disease than is ALP because, unlike ALP, its level is not significantly elevated in other

conditions, such as pregnancy or childhood. In addition, some increase in enzyme activity may be noted after abdominal surgery.^{45–48}

γ-Glutamyltransferase

GGT is a membrane-localized enzyme found in high concentrations in the kidney, liver, pancreas, intestine, and prostate but not in bone. Similar to the clinical utility of 5NT (see earlier), GGT plays a role in differentiating the cause of elevated levels of ALP as the highest levels of GGT are seen in biliary obstruction. GGT is a hepatic microsomal enzyme; therefore, ingestion of alcohol or certain drugs (barbiturates, tricyclic antidepressants, and anticonvulsants) elevates GGT. It is a sensitive test for cholestasis caused by chronic alcohol or drug ingestion. Measurement of this enzyme is also useful if jaundice is absent for the confirmation of hepatic neoplasms.^{45–49}

Lactate Dehydrogenase

Lactate dehydrogenase (LDH) is an enzyme with a very wide distribution throughout the body. It is released into circulation when cells of the body are damaged or destroyed, serving as a general, nonspecific marker of cellular injury. Moderate elevations of total serum LDH levels are common in acute viral hepatitis and in cirrhosis, whereas biliary tract disease may produce only slight elevations. High serum levels may be found in metastatic carcinoma of the liver. As a result of its wide distribution, LDH measurements provide no additional clinical information above that which is provided by the previously mentioned enzymes. However, fractionation of LDH into its five tissue-specific isoenzymes may give useful information about the site of origin of the LDH elevation.

Tests Measuring Hepatic Synthetic Ability

A healthy functioning liver is required for the synthesis of serum proteins (except the immunoglobulins). The measurement of serum proteins, therefore, can be used to assess the synthetic ability of the liver. Although these tests are not sensitive to minimal liver damage, they may be useful in quantitating the severity of hepatic dysfunction.

A decreased serum albumin may be a result of decreased liver protein synthesis, and the albumin level correlates well with the severity of functional impairment and is found more often in chronic rather than in acute liver disease. The serum α -globulins also tend to decrease with chronic liver disease. However, a low or absent α -globulin suggests α -antitrypsin deficiency as the cause of the chronic liver disease. Serum γ -globulin levels are transiently increased in acute liver disease and remain elevated in chronic liver disease. The highest elevations are found in chronic active hepatitis and post-necrotic cirrhosis. In particular, IgG and IgM levels are more consistently elevated in chronic active hepatitis; IgM, in primary biliary cirrhosis; and IgA, in alcoholic cirrhosis.

Prothrombin time is commonly increased in liver disease because the liver is unable to manufacture adequate amounts of clotting factor or because the disruption of bile flow results in inadequate absorption of vitamin K from the intestine. However, a prothrombin time is not routinely used to aid in the diagnosis of liver disease. Rather, serial measurements of prothrombin times may be useful in following the progression of disease and the assessment of the risk of bleeding. A marked prolongation of the prothrombin time indicates severe diffuse liver disease and a poor prognosis.

Tests Measuring Nitrogen Metabolism

The liver plays a major role in removing ammonia from the bloodstream and converting it to urea so that it can be removed by the kidneys. A plasma ammonia level, therefore, is a reflection of the liver's ability to perform this conversion. In liver failure, ammonia and other toxins increase in the bloodstream and may ultimately cause hepatic coma. In this condition, the patient becomes increasingly disoriented and gradually lapses into unconsciousness. The cause of hepatic coma is not fully known, although ammonia is presumed to play a major role. However, the correlation between blood ammonia levels and the severity of the hepatic coma is poor. Therefore, ammonia levels are most useful when multiple measurements are made over time.

The most common laboratory determination of ammonia concentrations is based on the following reaction:

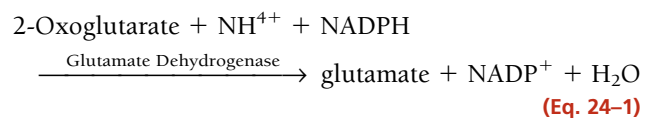

The NADP^+ formed is measured at 340 nm. The sample of choice is plasma collected in EDTA, heparin, or potassium oxalate, and the samples should be immediately placed on ice to prevent metabolism of other nitrogenous compounds to ammonia in the sample. If analysis cannot be performed immediately, the plasma should be removed and placed on ice or frozen. Frozen samples are stable for several days. Hemolyzed samples should be rejected for analysis as red blood cells have a concentration of ammonia 2–3 times higher than that of plasma.⁵⁰

Hepatitis

Hepatitis implies injury to the liver characterized by presence of inflammation in the liver tissue. Infectious causes for the inflammation of liver include viral, bacterial, and parasitic infections, as well as noninfectious causes, such as radiation, drugs, chemicals, and autoimmune diseases and toxins. Viral infections account for the majority of hepatitis cases observed in the clinical setting. Major hepatitis subtypes include A, B, C, D, and E. Infections with these viruses can lead to the onset of acute disease with

TABLE 24-3 THE HEPATITIS VIRUSES

| | NUCLEOTIDE | INCUBATION PERIOD | PRIMARY MODE OF TRANSMISSION | VACCINE | CHRONIC INFECTION | SEROLOGIC DIAGNOSIS AVAILABLE |
|-------------|------------|-------------------|------------------------------|---------|-------------------|-------------------------------|
| Hepatitis A | RNA | 2–6 weeks | Fecal-oral | Yes | No | Yes |
| Hepatitis B | DNA | 8–26 weeks | Parenteral, sexual | Yes | Yes | Yes |
| Hepatitis C | RNA | 2–15 weeks | Parenteral, sexual | No | Yes | Yes |
| Hepatitis D | RNA | — | Parenteral, sexual | Yes | Yes | Yes |
| Hepatitis E | RNA | 3–6 weeks | Fecal-oral | No | ? | Yes |

symptoms, including jaundice, dark urine, fatigue, nausea, vomiting, and abdominal pain. Some subtypes, such as hepatitis virus B and C, can lead to the prolonged elevation of serum transaminase level (longer than 6 months), a condition termed *chronic hepatitis*. Routes of transmission vary from one viral subtype to another. Hepatitis A and E are typically caused by ingestion of contaminated food or water. Hepatitis B, C, and D usually occur as a result of parenteral contact with infected body fluids (e.g., from blood transfusions or invasive medical procedures using contaminated equipment) and sexual contact. Refer to Table 24-3 for a list of the hepatitis viruses.

Hepatitis A

Hepatitis A (HAV), also known as infectious hepatitis or short-incubation hepatitis, is the most common form of viral hepatitis worldwide. It is caused by a nonenveloped RNA virus of the Picornavirus family. Tens of millions of HAV infections occur annually, with the most common reported source of infection in the household occurring via contaminated or improperly handled food.⁵¹ Because HAV is excreted in bile and shed in the feces, which can contain up to 10^9 infectious virions per gram, the fecal-oral route is the primary means of HAV transmission.^{52,53} Patients with HAV infection present with symptoms of fever, malaise, anorexia, nausea, abdominal discomfort, dark urine, and jaundice. Symptoms are generally self-limited and resolve within 3 weeks. However, in rare instances, patients develop fulminant liver failure. Chronic infection with HAV is not found and there is no evidence of a carrier state or long-term sequelae in humans.⁵¹

Clinical markers for the diagnosis and the progression of HAV infection are measured through the presence of serologic antibodies. Immunoglobulin M (IgM) antibodies to HAV (IgM anti-HAV) are detectable at or prior to the onset of clinical illness and decline in 3–6 months, when it becomes undetectable by commercially available diagnostic tests.⁵⁴ IgG antibodies to HAV (IgG anti-HAV) appear soon after IgM, persist for years after infection, and confer lifelong immunity.⁵⁵ IgM anti-HAV has been used as the primary marker of acute infection.⁵⁶

The presence of elevated titers of IgG anti-HAV in the absence of IgM indicates a past infection. Another reliable method to detect acute infection in patients is assaying for the presence of viral antigen, which is shed in the feces. However, the antigen is no longer present soon after liver enzymes have reached their peak levels. Another method for detecting HAV infection is amplification of viral RNA by reverse transcription–polymerase chain reaction (RT-PCR). Nucleic acid detection techniques are more sensitive than immunoassays for viral antigen to detect HAV in samples of different origins (e.g., clinical specimens, environmental samples, or food). Because of the high proportion of asymptomatic HAV infections, nucleic acid amplification techniques are useful to determine the extent to which unidentified infection occurs.⁵⁷

The availability of vaccines to provide long-term immunity against HAV infection has the potential to significantly reduce the incidence of disease and possibly eliminate the transmission of this virus worldwide.^{58–61} In 2006, following the approval of the HAV for children in the United States, the U.S. Food and Drug Administration/Centers for Disease Control and Prevention (FDA/CDC) recommended that all children receive the HAV vaccine as early as age 12–23 months.⁶² The use of this vaccine has significantly reduced the incidence of hepatitis A in the United States and has therefore changed the epidemiology of this infection.

Hepatitis B

Known as *serum hepatitis* or *long-incubation hepatitis*, hepatitis B virus (HBV) can cause both acute and chronic hepatitis and is the most ubiquitous of the hepatitis viruses. Two billion individuals are infected globally and between 350 and 400 million persons are carriers of the virus. In the United States, 1 million infected individuals are estimated to be chronic carriers of the virus.⁵¹ The highest incidence of acute hepatitis B was among adults aged 25–45 years.⁶³ HBV is comparatively stable in the environment and remains viable for longer than 7 days on environmental surfaces at room temperature.⁶⁴ It is detected in virtually all body fluids, including blood,

feces, urine, saliva, semen, tears, and breast milk; the three major routes of transmission are parenteral, perinatal, and sexual. Persons at high risk for infection in this country include persons who engage in the sharing of body fluids, such as high-risk sexual behaviors (e.g., prostitution, male homosexuality) and the sharing of drug-injection needles. Children born to mothers who are hepatitis B surface antigen–positive at the time of delivery, immigrants from endemic areas, and sexual partners and household contacts of patients who have hepatitis B are high-risk groups for HBV infection. Although transmission of hepatitis B by blood transfusion occurs, effective screening tests now make this transmission route rare. Health care workers, including laboratory personnel, may be at increased risk for developing hepatitis B, depending on their degree of exposure to blood and body fluids.⁶⁵

Serologic Markers of HBV Infection

HBV is a 42-nm DNA virus classified in the Hepadnaviridae family. The liver is the primary site of HBV replication. Following an HBV infection, the core of the antigen is synthesized in the nuclei of hepatocytes and then passed into the cytoplasm of the liver cell, where it is surrounded by the protein coat. An antigen present in the core of the virus (HBcAg) and a surface antigen present on the surface protein (HBsAg) have been identified by serologic studies. Another antigen, called the e antigen (HBeAg), also has been identified.⁶⁶

Hepatitis B Surface Antigen

Previously known as the Australia antigen and hepatitis-associated antigen (HAA), HBsAg is the antigen for which routine testing is performed on all donated units of blood. HBsAg is a useful serologic marker in patients before the onset of clinical symptoms because it is pres-

ent during the prodrome of acute hepatitis B. The HBsAg is not infectious; however, its presence in the serum may indicate the presence of the hepatitis virus. Therefore, persons who chronically carry HBsAg in their serum must be considered potentially infectious because the presence of the intact virus cannot be excluded. HBsAg is the only serologic marker detected during the first 3–5 weeks after infection in newly infected patients. The average time from exposure to detection of HBsAg is 30 days (range, 6–60 days).^{67–69} Highly sensitive single-sample nucleic acid tests can detect HBV DNA in the serum of an infected person 10–20 days before detection of HBsAg.⁶⁹ HBsAg positivity has been reported for up to 18 days after hepatitis B vaccination and is clinically insignificant.^{70,71} Patients who achieve complete viral clearance develop the antibody to the HBsAg, following the disappearance of the HBsAg (Fig. 24-7). The presence of anti-HBs antibody in patients is frequently observed in the general population, suggestive of past infection. Patients who have developed the antibody to the hepatitis B surface antigen are not susceptible to future reinfection with HBV.⁶⁵

Hepatitis B Core Antigen

HBcAg has not been demonstrated to be present in the plasma of hepatitis victims or blood donors. This antigen is present only in the nuclei of hepatocytes during an acute infection with HBV. The antibody to the core antigen, anti-HBc, usually develops earlier in the course of infection than the antibody to the surface antigen (Fig. 24-7). A test for the IgM antibody to HBcAg was recently developed as a serologic marker for clinical use. The presence of this IgM antibody is specific for acute hepatitis B infection. In patients who have chronic HBV infection, the IgM anti-HBc antibody titer can persist during chronic viral replication at low levels that typically are

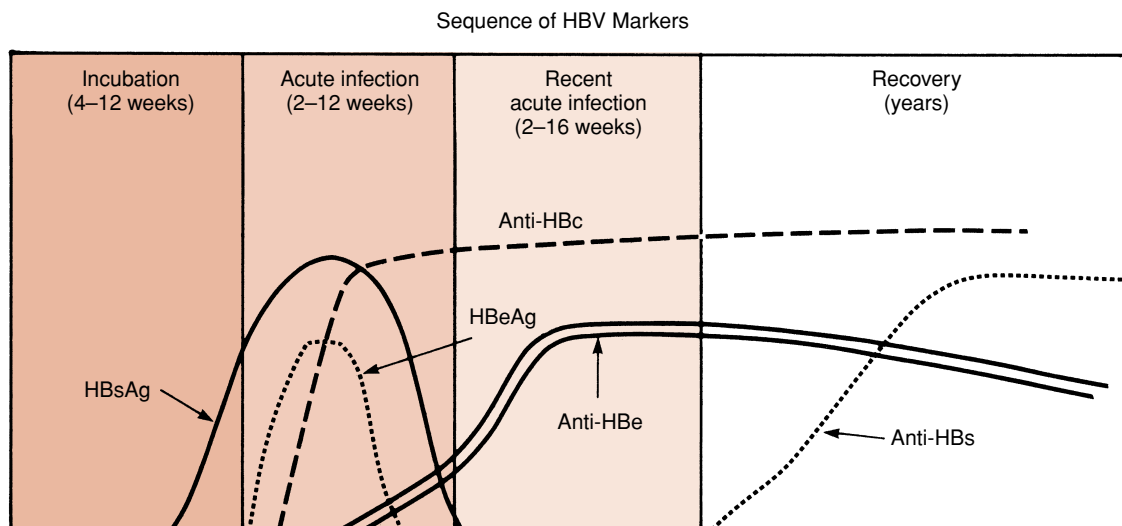

FIGURE 24-7. Serology of hepatitis B infection with recovery.

CASE STUDY 24-3

The following laboratory results are obtained from a 19-year-old college student who consulted the Student Health Service because of fatigue and lack of appetite. She adds that she recently noted that her sclera appears somewhat yellowish and that her urine has become dark (Case Study Table 24-3.1).

Questions

1. What is the most likely diagnosis?
2. What additional factors in the patient's history should be sought?
3. What is the prognosis?

CASE STUDY TABLE 24-3.1 LABORATORY RESULTS

| | |
|------------------------------|--------------------|
| ALT (SGPT) | Elevated |
| AST (SGOT) | Elevated |
| Alkaline phosphatase | Minimally elevated |
| LDH | Elevated |
| Serum bilirubin | 5 mg/dL |
| Urine bilirubin | Increased |
| Hepatitis A antibody (IgG) | Negative |
| Hepatitis A antibody (IgM) | Positive |
| Hepatitis B surface antigen | Negative |
| Hepatitis B surface antibody | Negative |
| Hepatitis C antibody | Negative |

not detectable by assays used in the United States. However, persons with exacerbation of chronic infection can test positive for IgM anti-HBc.⁷² Another marker for acute infection is a viral DN-dependent DNA polymerase that is closely associated with the presence of the core antigen. This viral enzyme is required for viral replication and is detectable in serum early in the course of viral hepatitis, during the phase of active viral replication.⁷³

Hepatitis B e Antigen

The e antigen, an antigen closely associated with the core of the viral particle, is detected in the serum of persons with acute or chronic HBV infection. The presence of the e antigen appears to correlate well with both the number of infectious virus particles and the degree of infectivity of HBsAg-positive sera. The presence of HBeAg in HBsAg carriers is an unfavorable prognostic sign and predicts a severe course and chronic liver disease. Conversely, the presence of anti-HBe antibody in carriers indicates a low infectivity of the serum (Fig. 24-8). The e antigen is detected in serum only when surface antigen is present (Fig. 24-9).

The serologic markers of HBV infection typically used to differentiate among acute, resolving, and chronic infections are HBsAg, anti-HBc, and anti-HBs (Table 24-4). Persons who recover from natural infection typically will be positive for both anti-HBs and anti-HBc, whereas persons who respond to hepatitis B vaccine have only anti-HBs. Persons who become chronically infected fail to develop antibody to the HBsAg, resulting in the persistent presence of HBsAg as well as the presence of anti-HBc in patient serum, typically for life.⁷⁴⁻⁷⁷ HBeAg and anti-HBe screenings typically are used for the management of patients with chronic infection. Serologic assays are available commercially for all markers except HBcAg because no free HBcAg circulates in blood.⁶³

Nucleic acid hybridization or PCR technique is used to detect HBV DNA in the blood and is another method

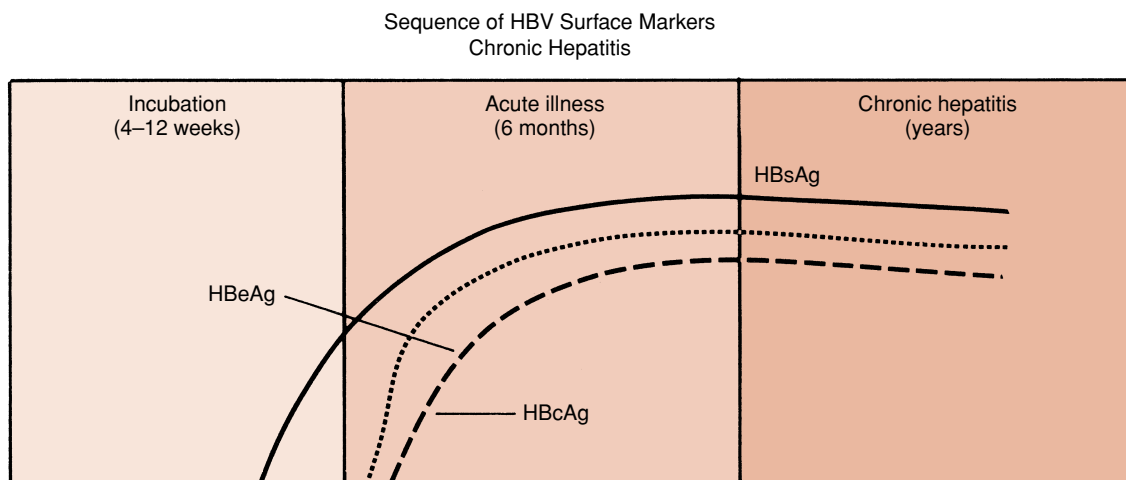

FIGURE 24-8. No antibody is formed against HBsAg. The persistence of HBeAg implies high infectivity and a generally poor prognosis. This patient would likely develop cirrhosis unless seroconversion occurs or treatment is given.

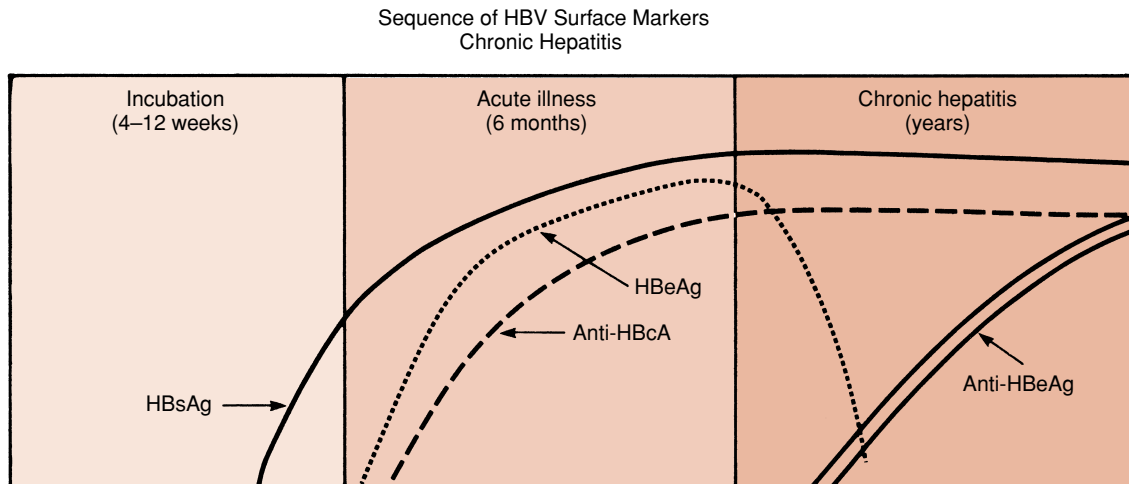

FIGURE 24-9. Serology of chronic hepatitis with formation of antibody to HBeAg. This is a favorable sign and suggests that the chronic hepatitis may resolve. Complete recovery would be heralded by the disappearance of HBsAg and formation of its corresponding antibody.

used to measure disease progression. This technique provides a more sensitive measurement of infectivity and disease progression than serology. It may be used to monitor the effectiveness of antiviral therapy in patients with chronic HBV infection, but it supplements rather than replaces current HBV serologic assays.^{78–80}

Chronic Infection With Hepatitis B Virus

Approximately 90% of patients infected with HBV recover within 6 months. Recovery is accompanied by the development of the antibody to the HBsAg. However, about 10% of patients progress to a chronic hepatitis infection. The likelihood of developing chronic HBV infec-

TABLE 24-4 TYPICAL INTERPRETATION OF SEROLOGIC TEST RESULTS FOR HBV INFECTION

| SEROLOGIC MARKER | | | | INTERPRETATION |
|-------------------|-----------------|---------------------------|-----------------------|--|
| HBSAG* | TOTAL ANTI-HBC† | IGM [‡] ANTI-HBC | ANTI-HBs [§] | |
| – [¶] | – | – | – | Never infected |
| + ^{**††} | – | – | – | Early acute infection; transient (up to 18 days) after vaccination |
| + | + | + | – | Acute infection |
| – | + | + | + or – | Acute resolving infection |
| – | + | – | + | Recovered from past infection and immune |
| + | + | – | – | Chronic infection |
| – | + | – | – | False-positive (i.e., susceptible); past infection, “low-level” chronic infection; ^{**} or passive transfer of anti-HBc to infant born to HBsAg-positive mother |
| – | – | – | + | Immune if concentration is ≥ 10 mIU/mL after vaccine series completion; passive transfer after hepatitis B immune globulin administration |

* Hepatitis B surface antigen.

† Antibody to hepatitis B core antigen.

‡ Immunoglobulin M.

§ Antibody to HBsAg.

¶ Negative test result.

** Positive test result.

†† To ensure that an HBsAg-positive test result is not a false-positive, samples with reactive HBsAg results should be tested with a licensed neutralizing confirmatory test if recommended in the manufacturer’s package insert.

** Persons positive only for anti-HBc are unlikely to be infectious except under unusual circumstances in which they are the source for direct percutaneous exposure of susceptible recipients to large quantities of virus (e.g., blood transfusion or organ transplant).

tion is higher in individuals infected perinatally (90%) and during childhood (20%–30%), when the immune system is thought to be less developed and unable to achieve efficient viral clearance, than in adult immunocompetent subjects (<1%).⁸¹ Approximately 25% of persons who were chronically infected since childhood and 15% of those who were chronically infected since adulthood die prematurely from cirrhosis or liver cancer. In the majority of cases, patients remain asymptomatic until the onset of cirrhosis.⁸²

Patients with chronic hepatitis B display the characteristic serologic profile as shown in Figure 24-9. The presence of HBsAg in chronically infected patients is an indication that they are infectious and at risk for developing complications, including cirrhosis and HCC. The natural course of chronic HBV infection is divided into four phases based on the virus–host interaction: immune tolerance, immune clearance (HBeAg-positive chronic hepatitis), low or non-replication (inactive HBsAg carrier), and reactivation (HBeAg-negative chronic hepatitis).^{83–85} Patients can be classified according to their serologic status as shown in Table 24-5.⁸¹

HBV Treatment and Prevention

Persons who have chronic HBV infection require medical evaluation and regular monitoring.^{86–88} The FDA has approved several drugs for treatment of chronic hepatitis B that can achieve sustained suppression of HBV replication and remission of liver disease in certain persons.⁸⁷

Hepatitis B vaccination is the most effective measure to prevent HBV infection and therefore obviate its consequences, including cirrhosis of the liver, liver cancer, liver failure, and death. HBsAg is the antigen used for hepatitis B vaccination.^{89,90} The vaccine is highly effective

in stimulating the production of hepatitis B surface antibody and thereby rendering the recipient immune. As a result of the national program of childhood immunization, by 2005, a 98% decline in HBV infection was reported among children aged 13 years or younger, as well as a 97% decline among adolescents aged 12–19 years.⁵¹ In 2006, the Advisory Committee on Immunization Practices (ACIP) recommended universal hepatitis B vaccination for all unvaccinated adults at risk for HBV infection and for all adults requesting protection from HBV infection. All health care workers who handle blood products and in close proximity to body fluids should have the hepatitis vaccine. The hepatitis B immune globulin (HBIG) provides passively acquired anti-HBs and temporary protection (i.e., 3–6 months) when administered in standard doses. HBIG typically is used as an adjunct to hepatitis B vaccine for postexposure immunoprophylaxis to prevent HBV infection. For nonresponders to hepatitis B vaccination, HBIG administered alone is the primary means of protection after an HBV exposure.⁶³

Hepatitis C

Hepatitis C (originally “non-A non-B hepatitis”) is caused by a virus with an RNA genome that is a member of the Flaviviridae family. The hepatitis C virus (HCV) is transmitted parenterally. Although the sexual and fecal-oral routes as modes of transmission have been documented, the virus is transmitted primarily by blood transfusion of inappropriately screened blood products.^{91–93} Approximately 3% of the world population is infected by the virus and most infections become chronic and may lead to cirrhosis, end-stage liver disease, HCC, and death. In the United States, HCV infection is present in about 1.6% of the noninstitutionalized population.⁹⁴ As many

TABLE 24-5 SEROLOGICAL PROFILES OF CHRONIC HEPATITIS B VIRUS INFECTION

| PHASE | SERUM ALT | HBeAg | ANTI-HBe | HBV-DNA | | |
|----------------------------------|--------------------------------|----------|----------|------------------------------------|--------------------|-----------------------|
| | | | | | COPIES/mL | IU/mL |
| Immune tolerance | Normal or minimally elevated | Positive | Negative | Very high levels | 10^8 – 10^{11} | 20 million–20 billion |
| HBeAg-positive chronic hepatitis | Persistently elevated | Positive | Negative | High levels | 10^6 – 10^{10} | 200,000–2 billion |
| HBeAg-negative chronic hepatitis | Elevated and often fluctuating | Negative | Positive | Moderate levels, often fluctuating | 10^4 – 10^8 | 2,000–20 million |
| Inactive carrier | Normal | Negative | Positive | Low or no detectable levels | $<10^4$ | $<2,000$ |

Reprinted with permission from Fattovich G, Bortolotti F, Donato F. Natural history of chronic hepatitis B: special emphasis on disease progression and prognostic factors. *J Hepatol* 2008;48: 335–352.

as 4 million Americans are chronically infected.⁵¹ Clinically, acute HCV infection presents only mild infection and patients may remain completely asymptomatic. However, HCV infection has a high rate of progression to chronic hepatitis, cirrhosis, and liver carcinoma, making HCV a major cause of chronic hepatitis in the United States.^{93,95} In addition, HCV infection is a leading cause of liver transplantation in this country.⁹⁶

Laboratory Tests for Hepatitis C

The hepatitis C antibody is usually not detected in the first few months of infection but will almost always be present in the later stages. The antibody is not protective against reinfection and sometimes disappears several years following resolution of the infection. Laboratory testing for the diagnosis of HCV infection in the clinical setting is relatively straightforward. Currently, two laboratory tests are commonly used to diagnose HCV infection in clinical practice: anti-HCV detection by enzyme immunoassay (EIA) and quantitative nucleic acid PCR assays for serum HCV RNA.^{97–102} In clinical practice, the most common approach is initially to test a patient's serum for the presence of anti-HCV by EIA. If this test gives a positive result, the next step is to test for serum HCV RNA by PCR.⁹⁹ The HCV antibody test is designed to detect antibodies generated in response to HCV infection.^{99,101} Although a positive HCV antibody test result generally indicates that the patient has been exposed to the HCV virus, this test cannot determine whether the patient is currently infected with HCV or has recovered from HCV infection.^{97,101} Some patients with a positive HCV antibody test result have spontaneously cleared HCV. These patients (anti-HCV positive but HCV RNA negative) are recommended to retake the test for HCV RNA on a second occasion, 3–6 months after the first HCV RNA test.¹⁰¹

Chronic Hepatitis C Infection

Most patients with HCV infection progress to chronic infection. Although patients with chronic HCV infection appear to be at high risk for liver cirrhosis, the role of HCV in the development of HCC is not clear. Most chronically infected patients are asymptomatic and manifest only mild elevations of liver function tests, especially transaminases. The degree of elevation in liver enzymes has little predictive value toward disease progression. About 80% of infected patients develop chronic hepatitis, although, in most cases, the disease does not progress. The percentage of patients progressing to liver cirrhosis varies widely in different studies but has been estimated to be as high as 40% after 40 years. Alcohol consumption concomitant with chronic HCV infection significantly increases the risk of cirrhosis. Liver biopsies are performed periodically in these patients, with the degree of inflammation and fibrosis correlating with the risk of cirrhosis.^{103–106}

Patients with chronic HCV infection are usually treated with pegylated interferon and ribavirin. Therapeutic efficacy is monitored by using PCR to determine the number of viral copies in serum.¹⁰⁷ A prototypic envelope peptide-based vaccine has been reported to induce antibodies in human subjects, but there is no evidence for the presence of a neutralizing antibody against HCV.¹⁰⁸ Likely, an effective and safe vaccine against HCV will not be available soon.

Hepatitis D

Hepatitis D is a unique subvirus satellite virus infection. It is a small, defective RNA-containing virus that cannot replicate independently but rather requires the HBsAg of HBV for replication. Therefore, it is incapable of causing any illness in patients who do not have HBV infection. Modes of transmission are generally similar to those of HBV. Approximately 5% of the global HBV carriers are coinfecting with HDV, leading to a total of 10–15 million HDV carriers worldwide.^{109,110} Each year, 7,500 new cases of HDV infections are estimated to occur in the United States.¹¹¹ Chronic HDV infection is estimated to be responsible for more than 1,000 deaths each year in the United States.¹¹²

HDV virions possess an outer envelope composed of HBsAg proteins and host membrane lipids and an inner nucleocapsid consisting of viral RNA and hepatitis delta antigen (HDAG). It is believed that HBsAg-mediated binding to a cellular receptor helps HDV penetrate the hepatocyte.¹¹³ Nuclear localization signal domain on the

CASE STUDY 24-4

The following results were obtained in the patient from Case Study 24-2 (Case Study Table 24-2.1).

Questions

1. What is the most likely diagnosis?
2. What is the prognosis?
3. What complications may develop?

CASE STUDY TABLE 24-4.1

| | |
|-------------------------------|----------|
| Hepatitis A antibody (IgG) | Positive |
| Hepatitis A antibody (IgM) | Negative |
| Hepatitis B surface antigen | Positive |
| Hepatitis B surface antibody | Negative |
| Hepatitis core antibody (IgM) | Positive |
| Hepatitis C antibody | Negative |

TABLE 24-6 CLINICAL FEATURES OF HEPATITIS D VIRUS (HDV) COINFECTION AND SUPERINFECTION IN HEPATITIS B VIRUS (HBV) CARRIERS

| | COINFECTION | SUPERINFECTION |
|---------------|---------------------------------|--|
| HBV infection | Acute | Chronic |
| Outcomes | Recovery with seroclearance | Usually persistent infection |
| Markers | | |
| HBsAg | Positive, early and transient | Positive and persistent |
| IgM anti-HBc | Positive | Negative |
| Anti-HBs | Positive in recovery phase | Negative |
| HDV infection | Acute | Acute or chronic |
| Outcomes | Recovery with seroclearance | Usually persistent infection |
| Markers | | |
| Serum HDAg* | Early and short-lived | Early and transient, undetectable later |
| Liver HDAg | Positive and transient | Positive, maybe negative in late stage |
| Serum HDV RNA | Positive, early and transient | Positive, early and persistent |
| Anti-HDV | Late acute phase, low titer | Rapidly increasing, high titers |
| IgM anti-HDV | Positive, transient, pentameric | Rapidly increasing, high titers, monomeric |

*Using immunoblot assay, detection rate of serum HDAg may be comparable to Northern blot detection of HDV RNA using cDNA probe. Reprinted with permission from Hsieh TH, Liu CJ, Chen DS, Chen PJ. Natural course and treatment of hepatitis D virus infection. *J Formos Med Assoc* 2006;105:869–881.

HDV facilitates transit of its genome into the nucleus, where viral replication takes place.¹¹⁴ HDV infection can occur concurrently with HBV infection (coinfection) or in a patient with established HBV infection (superinfection) (Table 24-6). The rate of chronicity following coinfection with HBV and HDV is equal to that of HBV infection alone.¹¹⁵ HDV superinfection is likely to become chronic simply because HBV infection is already chronic. In general, in the acute phase, HDV superinfected carriers may develop severe hepatitis, and around 70%–90% will progress to chronicity.¹¹⁶

The diagnosis of HDV relies on detection of antibodies against HDV and serum HDV RNA, as well as HBV markers.¹¹⁷ Clinical symptoms of HDV cannot be distinguished from those of other hepatic viruses. Accurate diagnosis is made by a negative test for IgM anti HBc and confirmed by the detection of HDV markers.¹¹⁸ Widespread use of the HBV vaccine has resulted in a decline in the incidence of hepatitis D.¹¹⁹ Interferon- α is currently the therapy used for treating chronic HDV infection. Compared with chronic hepatitis B or C, chronic hepatitis D treatment requires a higher dosage and a longer duration of treatment, and posttreatment relapses are common.¹¹⁸

Hepatitis E

The RNA-containing hepatitis E virus (HEV), a nonenveloped RNA virus that is only 27–34 nm in diameter, is the sole member of the genus *Hepevirus* in the family

Hepeviridae. After infection, the incubation period is short, generally between 21 and 42 days prior to the onset of symptoms. The virus may be detected in feces and bile by about 7 days after infection. HEV is transmitted primarily by the fecal-oral route, and waterborne epidemics are characteristic of hepatitis E in many developing countries. However, in industrialized countries, several nonhuman primates such as pigs, cows, and sheep are susceptible to infection with HEV, leading to the potential spread of the virus through zoonosis.¹²⁰ The clinical presentation of hepatitis E is comparable to that of hepatitis A. The severity of an HEV infection is generally greater than the severity of an HAV infection.¹²¹ In general, hepatitis E infection is mild, except in pregnant women, in whom it may be a devastating illness.¹²²

Because cases of hepatitis E are not clinically distinguishable from cases of other types of acute viral hepatitis, diagnosis is made by biochemical assessment of liver function. Acute hepatitis E is diagnosed when the presence of IgM anti-HEV is detected.^{121,123} The presence of a high or increasing anti-HEV IgG titer may support the diagnosis of acute HEV infection, and in such cases acute hepatitis E can be presumed even in the absence of IgM anti-HEV.¹²⁴ EIA and immunochromatography are most convenient for the detection of IgM and/or IgG anti-HEV. Additional testing by RT-PCR has a limited confirmatory role. Acute-phase HEV RNA can be detected in feces by PCR in approximately 50% of cases. In most instances, there is a very good positive correlation between

the results assayed by RT-PCR and EIA.¹²¹ Hepatitis E should be suspected in outbreaks of waterborne hepatitis occurring in developing countries, especially if the disease is more severe in pregnant women, or if hepatitis A has been excluded. If laboratory tests are not available, epidemiologic evidence can help in establishing a diagnosis.¹²⁵

At present, no commercially available vaccines exist for the prevention of hepatitis E. Experimental immune prophylaxis against HEV based on recombinant antigens appears to confer short-term protection and may be useful for pregnant women in endemic areas and travelers coming into these regions.

Other Forms of Hepatitis

Five forms of viral hepatitis (A, B, C, D, and E) are well recognized. The role of G viruses is currently unclear. Hepatitis F is an enteric agent that may be transmitted to primates. Again, more needs to be learned about this agent and its role, if any, in human disease. Other forms of viral hepatitis, such as TT virus and SEN virus, may exist. The GB group of flavo-like viruses, GBV-A, GBV-B, and GBV-C, are also associated with acute and chronic hepatitis. Little is known about these diseases, and no diagnostic tests for them are commercially available at this time.^{126–129} Cytomegalovirus, Epstein-Barr virus, and probably several other agents can also cause hepatitis.

CASE STUDY 24-5

A 36-year-old man consulted his family physician because of liver function abnormalities, which had been noted initially during a preinsurance physical examination 6 months earlier. The following laboratory results are obtained, which are identical to those obtained 6 months ago (Case Study Table 24-5.1)

Questions

1. What is the most likely diagnosis?
2. What is the prognosis?
3. What complications may develop?
4. What additional tests should be done?

CASE STUDY TABLE 24-5.1 LABORATORY RESULTS

| | |
|---------------------------------|----------|
| Hepatitis A antibody (IgG) | Positive |
| Hepatitis A antibody (IgM) | Negative |
| Hepatitis B surface antigen | Positive |
| Hepatitis B surface antibody | Negative |
| Hepatitis B core antibody (IgM) | Positive |
| Hepatitis C antibody | Negative |

REFERENCES

1. Wang X, Chowdhury JR, Chowdhury NR. Bilirubin metabolism: applied physiology. *Curr Paediatr* 2006;16:70–74.
2. Ahlfors CE. Measurement of plasma unbound unconjugated bilirubin. *Anal Biochem* 2000;279:130–135.
3. McNamara JR, Warnick GR, Wu LL. Lipids and lipoproteins. In: Bishop ML, Duben-Engellkirk JL, Fody EP, eds. *Clinical chemistry: principles, procedures, correlations*. Philadelphia, Pa.: Lippincott Williams & Wilkins, 2000:323.
4. Papavramidou N, Fee E, Christopoulou-Aletra H. Jaundice in the hippocratic corpus. *J Gastrointest Surg* 2007;11:1728–1731.
5. Pashankar D, Schreiber RA. Jaundice in older children and adolescents. *Pediatr Rev* 2001;22:219–226.
6. Black M, Billing BH. Hepatic bilirubin UDP-glucuronyl transferase activity in liver disease and Gilbert's syndrome. *N Engl J Med* 1969;280:1266–1271.
7. Kaplan M, Hammerman C. Bilirubin and the genome: the hereditary basis of unconjugated neonatal hyperbilirubinemia. *Curr Pharmacogenomics* 2005;3:21–42.
8. Crigler JF Jr, Najjar VA. Congenital familial nonhemolytic jaundice with kernicterus. *Pediatrics* 1952;10:169–180.
9. Berk PD, Noyer C. The familial unconjugated hyperbilirubinemias. *Semin Liver Dis* 1994;14:356–351.
10. Berk PD. Bilirubin metabolism and the hereditary hyperbilirubinemias. *Semin Liver Dis* 1994;14:321–322.
11. Berk PD, Noyer C. The familial conjugated hyperbilirubinemias. *Semin Liver Dis* 1994;14:386–394.
12. Zimniak P. Dubin-Johnson and Rotor syndromes: molecular basis and pathogenesis. *Semin Liver Dis* 1993;13:248–260.
13. Dennery PA, Seidman DS, Stevenson DK. Neonatal hyperbilirubinemia. *N Engl J Med* 2001;344:581–590.
14. Minino AM, Heron MP, Murphy SL, Kochanek KD. Deaths: final data for 2004. *Natl Vital Stat Rep* 2007;55:1–119.
15. Parkin DM, Pisani P, Ferlay J. Estimates of the worldwide incidence of 25 major cancers in 1990. *Int J Cancer* 1999;80:827–841.
16. Deuffic S, Poynard T, Buffat L, Valleron AJ. Trends in primary liver cancer. *Lancet* 1998;351:214–215.
17. Parkin DM, Bray FI, Devesa SS. Cancer burden in the year 2000. The global picture. *Eur J Cancer* 2001;37(Suppl 8):S4–S66.
18. Yoo HY, Patt CH, Geschwind JF, Thuluvath PJ. The outcome of liver transplantation in patients with hepatocellular carcinoma in the United States between 1988 and 2001: 5-year survival has improved significantly with time. *J Clin Oncol* 2003;21:4329–4335.
19. Peters LJ, Wiener GJ, Gilliam J, et al. Reye's syndrome in adults. A case report and review of the literature. *Arch Intern Med* 1986;146:2401–2403.
20. Preblud SR, Orenstein WA, Bart KJ. Varicella: clinical manifestations, epidemiology and health impact in children. *Pediatr Infect Dis* 1984;3:505–509.

21. Edwards KM, Bennett SR, Garner WL, et al. Reye's syndrome associated with adenovirus infections in infants. *Am J Dis Child* 1985;139:343–346.
22. Johnson GM, Scurletis TD, Carroll NB. A study of sixteen fatal cases of encephalitis. *N C Med J* 1963;24:464–473.
23. Starko KM, Ray CG, Dominguez LB, et al. Reye's syndrome and salicylate use. *Pediatrics* 1980;66:859–864.
24. Waldman RJ, Hall WN, McGee H, Van Amburg G. Aspirin as a risk factor in Reye's syndrome. *JAMA* 1982;247:3089–3094.
25. Surgeon General's advisory on the use of salicylates and Reye syndrome. *MMWR Morb Mortal Wkly Rep* 1982;31:289–290.
26. Davis DL, Buffler P. Reduction of deaths after drug labelling for risk of Reye's syndrome. *Lancet* 1992;340:1042.
27. Daugherty CC, Gartside PS, Heubi JE, et al. A morphometric study of Reye's syndrome. Correlation of reduced mitochondrial numbers and increased mitochondrial size with clinical manifestations. *Am J Pathol* 1987;129:313–326.
28. Belay ED, Bresee JS, Holman RC, et al. Reye's syndrome in the United States from 1981 through 1997. *N Engl J Med* 1999;340:1377–1382.
29. Liu ZX, Kaplowitz N. Immune-mediated drug-induced liver disease. *Clin Liver Dis* 2002;6:755–774.
30. Lieber CS. Alcohol and the liver: metabolism of alcohol and its role in hepatic and extrahepatic diseases. *Mt. Sinai J Med.* 2000;67:84–94.
31. Bissell DM, Gores GJ, Laskin DL, Hoofnagle JH. Drug-induced liver injury: mechanisms and test systems. *Hepatology* 2001;33:1009–1013.
32. Nagata K, Suzuki H, Sakaguchi S. Common pathogenic mechanism in development progression of liver injury caused by non-alcoholic or alcoholic steatohepatitis. *J Toxicol Sci* 2007;32:453–468.
33. Bertini G, Rubaltelli FF. Non-invasive bilirubinometry in neonatal jaundice. *Semin Neonatol* 2002;7:129–133.
34. Lott JA, Dumas BT. "Direct" and total bilirubin tests: contemporary problems. *Clin Chem* 1993;39:641–647.
35. Wilding P, Zilva JF, Wilde CE. Transport of specimens for clinical chemistry analysis. *Ann Clin Biochem* 1977;14:301–306.
36. Dumas BT, Kwok-Cheung PP, Perry BW, et al. Candidate reference method for determination of total bilirubin in serum: development and validation. *Clin Chem* 1985;31:1779–1789.
37. Dumas BT, Wu TW. The measurement of bilirubin fractions in serum. *Crit Rev Clin Lab Sci* 1991;28:415–445.
38. Ross JW, Miller WG, Myers GL, Praetstgaard J. The accuracy of laboratory measurements in clinical chemistry: a study of 11 routine chemistry analytes in the College of American Pathologists Chemistry Survey with fresh frozen serum, definitive methods, and reference methods. *Arch Pathol Lab Med* 1998;122:587–608.
39. Slaughter MR. Sensitivity of conventional methods for bilirubin measurements. *J Lab Clin Med* 1996;127:233.
40. Malloy HT, Evelyn KA. The determination of bilirubin with the photoelectric colorimeter. *J Biol Chem* 1937;119:481–490.
41. Hofmann AF. Bile acid secretion, bile flow and biliary lipid secretion in humans. *Hepatology* 1990;12(3 Pt 2):175–225.
42. Kotal P, Fevery J. Quantitation of urobilinogen in feces, urine, bile and serum by direct spectrophotometry of zinc complex. *Clin Chim Acta* 1991;202:1–9.
43. Azer SA, Klaassen CD, Stacey NH. Biochemical assay of serum bile acids: methods and applications. *Br J Biomed Sci* 1997;54:118–132.
44. Polkowska G, Polkowski W, Kudlicka A, et al. Range of serum bile acid concentrations in neonates, infants, older children, and in adults. *Med Sci Monit* 2001;7(Suppl 1):268–270.
45. Green RM, Flamm S. AGA technical review on the evaluation of liver chemistry tests. *Gastroenterology* 2002;123:1367–1384.
46. American Gastroenterological Association medical position statement: evaluation of liver chemistry tests. *Gastroenterology* 2002;123:1364–1366.
47. Pagani F, Panteghini M. 5'-Nucleotidase in the detection of increased activity of the liver form of alkaline phosphatase in serum. *Clin Chem* 2001;47:2046–2048.
48. Sunderman FW. The clinical biochemistry of 5'-nucleotidase. *Ann Clin Lab Sci* 1990;20:123–139.
49. Conigrave KM, Dengenhardt LJ, Whitfield JB. CDT, GGT and AST as markers of alcohol use: the WHO/ISBRA collaborative project. *Alcohol Clin Exp Res* 2002;25:332–339.
50. Jay DW. Nonprotein nitrogen. In: Bishop ML, Duben-Englekirk JL, Fody EP, eds. *Clinical chemistry: principles, procedures, correlations*. Philadelphia, Pa.: Lippincott Williams & Wilkins, 2000:260–274.
51. Koff RS. Review article: vaccination and viral hepatitis—current status and future prospects. *Aliment Pharmacol Therapeut* 2007;26:1285–1292.
52. Skinhoj P, Mathiesen LR, Kiryger P, Moller AM. Faecal excretion of hepatitis A virus in patients with symptomatic hepatitis A infection. *Scand J Gastroenterol* 1981;16:1057–1059.
53. Tassopoulos NC, Papaevangelou GJ, Ticehurst JR, Purcell RH. Fecal excretion of Greek strains of hepatitis A virus in patients with hepatitis A and in experimentally infected chimpanzees. *J Infect Dis* 1986;154:231–237.
54. Kao HW, Ashcavai M, Redeker AG. The persistence of hepatitis A IgM antibody after acute clinical hepatitis A. *Hepatology* 1984;4:933–936.
55. Skinhoj P, Mikkelsen F, Hollinger FB. Hepatitis A in Greenland: importance of specific antibody testing in epidemiologic surveillance. *Am J Epidemiol* 1977;105:140–147.
56. Cuthbert JA. Hepatitis A: old and new. *Clin Microbiol* 2001;14:38–58.
57. Nainan OV, Xia G, Vaughan G, Margolis HS. Diagnosis of hepatitis A virus infection: a molecular approach. *Clin Microbiol Rev* 2006;19:63–79.
58. Bell BP, Feinstone SM. Hepatitis A vaccine. In Plotkin SA, Orenstein WA, Offit PA, eds. *Vaccine*. 4th ed. Philadelphia, Pa.: WB Saunders, 2004:269–297.
59. Centers for Disease Control and Prevention (CDC). Prevention of hepatitis A through active or passive immunization: recommendations of the Advisory Committee on Immunization Practices (ACIP). *MMWR Morb Mortal Wkly Rep* 1999;48(RR-12):1–37.
60. Hollinger FB, Emerson SU. Hepatitis A virus. In Knipe SM, Howley PM, eds. *Fields virology*. 4th ed. New York: Lippincott Williams & Wilkins, 2001:799–840.
61. Margolis HS. Viral hepatitis. In Wallace RB, Doebbeling BN, eds. *Maxcy-Rosenau-Last public health and preventive medicine*. 14th ed. Stamford, Conn.: Appleton & Lange, 2000:174–188.
62. Centers for Disease Control and Prevention. Prevention of hepatitis A through active or passive immunization. Recommendations of the Advisory Committee on Immunization Practices (ACIP). *MMWR Morb Mortal Wkly Rep* 2006;55:RR-07.
63. Centers for Disease Control and Prevention. A comprehensive immunization strategy to eliminate transmission of hepatitis B virus infection in the United States. Recommendations of the Advisory Committee on Immunization Practices (ACIP) Part II: immunization of adults. *MMWR Morb Mortal Wkly Rep* 2006;55(RR-16):1–25.
64. Bond WW, Favero MS, Petersen NJ, et al. Survival of hepatitis B virus after drying and storage for one week. *Lancet* 1981;1:550–551.
65. Davis GL. Hepatitis B: diagnosis and treatment. *South Med J* 1997;90:866–870.
66. Neuschwander-Tetri BA. Common blood tests for liver disease. Which ones are most useful? *Postgrad Med* 1995;98:49–56, 59, 63.
67. Krugman S, Overby LR, Mushahwar IK, et al. Viral hepatitis, type B. Studies on natural history and prevention re-examined. *N Engl J Med* 1979;300:101–106.

68. Hoofnagle JH, DiBisceglie AM. Serologic diagnosis of acute and chronic viral hepatitis. *Semin Liver Dis* 1991;11:73–83.
69. Biswas R, Tabor E, Hsia CC, et al. Comparative sensitivity of HBV NATs and HBsAg assays for detection of acute HBV infection. *Transfusion* 2003;43:788–798.
70. Kloster B, Kramer R, Eastlund T, et al. Hepatitis B surface antigenemia in blood donors following vaccination. *Transfusion* 1995;35:475–477.
71. Lunn ER, Hoggarth BJ, Cook WJ. Prolonged hepatitis B surface antigenemia after vaccination. *Pediatrics* 2000;105:E81.
72. Kao JH, Chen PJ, Lai MY, Chen DS. Acute exacerbations of chronic hepatitis B are rarely associated with superinfection of hepatitis B virus. *Hepatology* 2001;34(4 Pt 1):817–823.
73. Kurstak C, Kurstak E, Hossain A. Progress in diagnosis of viral hepatitis A, B, C, D and E. *Acta Virol* 1996;40:107–115.
74. Alward WL, McMahon BJ, Hall DB, et al. The long-term serological course of asymptomatic hepatitis B virus carriers and the development of primary hepatocellular carcinoma. *J Infect Dis* 1985;151:604–609.
75. Liaw YF, Sheen IS, Chen TJ, et al. Incidence, determinants and significance of delayed clearance of serum HBsAg in chronic hepatitis B virus infection: a prospective study. *Hepatology* 1991;13:627–631.
76. Adachi H, Kaneko S, Matsushita E, et al. Clearance of HBsAg in seven patients with chronic hepatitis B. *Hepatology* 1992;16:1334–1337.
77. McMahon BJ, Holck P, Bulkow L, Snowball M. Serologic and clinical outcomes of 1536 Alaska Natives chronically infected with hepatitis B virus. *Ann Intern Med* 2001;135:759–768.
78. Jalava T, Ranki M, Bengtström M, et al. A rapid and quantitative solution hybridization method for detection of HBV DNA in serum. *J Virol Methods* 1992;36:171–180.
79. Malavé Lara C, Gorriño MT, Campelo C, et al. Detection of hepatitis B virus DNA in chronic carriers by the polymerase chain reaction. *Eur J Clin Microbiol Infect Dis* 1992;11:740–744.
80. Aspinall S, Steele AD, Peenze I, Mphahlele MJ. Detection and quantitation of hepatitis B virus DNA: comparison of two commercial hybridization assays with polymerase chain reaction. *J Viral Hepatol* 1995;2:107–111.
81. Fattovich G, Bortolotti F, Donato F. Natural history of chronic hepatitis B: special emphasis on disease progression and prognostic factors. *J Hepatol* 2008;48: 335–352.
82. Hadziyannis S, Papatheodoridis GV. Hepatitis B e antigen-negative chronic hepatitis: natural history and treatment. *Semin Liver Dis* 2006;26:130–141.
83. EASL International Consensus Conference on Hepatitis B. Consensus statement. *J Hepatol* 2003;38:533–540.
84. Perz JF, Armstrong GL, Farrington LA, et al. The contribution of hepatitis B virus and hepatitis C virus infections to cirrhosis and primary liver cancer worldwide. *J Hepatol* 2006;45:529–538.
85. Lok ASF, McMahon BJ. Chronic hepatitis B. *Hepatology* 2007;45:507–539.
86. Lok AS, McMahon BJ, Practice Guidelines Committee, American Association for the Study of Liver Disease (AASLD). Chronic hepatitis B. *Hepatology* 2001;34:1225–1241.
87. Lok AS, McMahon BJ, Practice Guidelines Committee, American Association for the Study of Liver Disease (AASLD). Chronic hepatitis B: update of recommendations. *Hepatology* 2004;39:857–861.
88. Bruix J, Sherman M, Practice Guidelines Committee, American Association for the Study of Liver Disease (AASLD). Management of hepatocellular carcinoma. *Hepatology* 2005;42:1208–1236.
89. Purcell RH, Gerin JL. Hepatitis B subunit vaccine: a preliminary report of safety and efficacy tests in chimpanzees. *Am J Med Sci* 1975;270:395–399.
90. Hilleman MR, McAleer WJ, Buynak EB, McLean AA. Quality and safety of human hepatitis B vaccine. *Dev Biol Stand* 1983;54:3–12.
91. Alter MJ, Margolis HS, Krawczynski K, et al. The natural history of community-acquired hepatitis C in the United States. *N Engl J Med* 1992;327:1899–1905.
92. Yen T, Keeffe EB, Ahmed A. The epidemiology of hepatitis C virus infections. *J Clin Gastroenterol* 2003;36:47–53.
93. Koerner K, Cardoso M, Dengler T, et al. Estimated risk of transmission of hepatitis C virus by blood transfusion. *Vox Sang* 1998;74:213–216.
94. Armstrong GL, Wasley A, Simard EP, et al. The prevalence of hepatitis C virus infection in the United States, 1999 through 2002. *Ann Intern Med* 2006;144:705–714.
95. Holland PV. Post-transfusion hepatitis: current risks and causes. *Vox Sang* 1998;74(suppl 2):135–141.
96. Rustgi VK. The epidemiology of hepatitis C infection in the United States. *J Gastroenterol* 2007;42:513–521.
97. Strader DB, Wright T, Thomas DL, Seeff LB. American Association for the Study of Liver Diseases practice guideline: diagnosis, management, and treatment of hepatitis C. *Hepatology* 2004;39:1147–1171.
98. Dal Molin G, Tiribelli C, Campello C. A rational use of laboratory tests in the diagnosis and management of hepatitis C virus infection. *Ann Hepatol* 2003;2:76–83.
99. Pawlotsky J-M. Diagnostic testing in hepatitis C virus infection: viral kinetics and genomics. *Semin Liver Dis* 2003;23(suppl 1):3–11.
100. Pawlotsky JM, Lonjon I, Hezode C, et al. What strategy should be used for diagnosis of hepatitis C virus infection in clinical laboratories? *Hepatology* 1998;27:1700–1702.
101. Alter MJ, Kuhnert WL, Finelli L. Guidelines for laboratory testing and result reporting of antibody to hepatitis C virus. *MMWR Recomm Rep* 2003;52(RR-03):1–16.
102. CDC. Recommendations for prevention and control of hepatitis C virus (HCV) infection and HCV-related chronic disease. *MMWR Recomm Rep* 1998;47(RR-19):1–39.
103. Corrao G, Arico S. Independent and combined action of hepatitis C virus infection and alcohol consumption on the risk of symptomatic liver cirrhosis. *Hepatology* 1994;20:1115–1120.
104. Seeff LB. The natural history of chronic hepatitis C virus infection. *Clin Liver Dis* 1997;1:587–602.
105. Poynard T, Ratzu V, Charlotte F, et al. Rates and risk factors of liver fibrosis progression in patients with chronic hepatitis C. *J Hepatol* 2001;34:730–739.
106. Forns X, Ampurdanès S, Sanchez-Tapias JM, et al. Long-term follow-up of chronic hepatitis C in patients diagnosed at a tertiary-care center. *J Hepatol* 2001;35:265–271.
107. Mast EE, Kuramoto IK, Favorov MO, et al. Prevalence of and risk factors for antibody to hepatitis E virus seroreactivity among blood donors in Northern California. *J Infect Dis* 1997;176:34–40.
108. Di Bisceglie AM, Frey S, Gorse GJ. A phase I safety and immunogenicity trial of a novel E1E2/MF59C.1 hepatitis C vaccine candidate in healthy HCV-negative adults [abstract]. *Hepatology* 2005;42(suppl 1):750A.
109. Hadziyannis SJ. Decreasing prevalence of hepatitis D virus infection. *J Gastroenterol Hepatol* 1997;12:745–746.
110. Farci P. Delta hepatitis: an update. *J Hepatol* 2003;39(suppl 1):S212–S219.
111. Centers for Disease Control and Prevention. Hepatitis surveillance report. *MMWR Morb Mortal Wkly Rep* 1990;53:23.
112. di Bisceglie AM. Interferon therapy for chronic viral hepatitis. *N Engl J Med* 1994;330:137–138.

113. Sureau C, Moriarty AM, Thornton GB, et al. Production of infectious hepatitis delta virus in vitro and neutralization with antibodies directed against hepatitis B virus pre-S antigens. *J Virol* 1992;66:1241–1245.
114. Taylor JM. The structure and replication of hepatitis delta virus. *Annu Rev Microbiol* 1992;46:253–276.
115. Caredda F, d'Arminio Monforte A, Rossi E, et al. Prospective study of epidemic delta infection in drug addicts. *Progr Clin Biol Res* 1983;143:245–250.
116. Wu JC, Chen TZ, Huang YS, et al. Natural history of hepatitis D viral superinfection: significance of viremia detected by polymerase chain reaction. *Gastroenterology* 1995;108:796–802.
117. Macagno S, Smedile A, Caredda F, et al. Monomeric (7S) immunoglobulin M antibodies to hepatitis delta virus in hepatitis type D. *Gastroenterology* 1990;98:1582–1586.
118. Hsieh TH, Liu CJ, Chen DS, Chen PJ. Natural course and treatment of hepatitis D virus infection. *J Formos Med Assoc* 2006;105:869–881.
119. Mele A, Mariano A, Tosti ME, et al. Acute hepatitis delta virus infection in Italy: incidence and risk factors after the introduction of the universal anti-hepatitis B vaccination campaign. *Clin Infect Dis* 2007;44: e17–24.
120. Okamoto H. Genetic variability and evolution of hepatitis E virus. *Virus Res* 2007;127:216–228.
121. Purcell RH. Hepatitis E virus. In: Fields BN, Knipe DM, Howley PM, eds. *Fields virology*. 3rd ed. Philadelphia, Pa.: Lippincott-Raven, 1996:2831–2843.
122. Khuroo MS, Teli MR, Skidmore S, et al. Incidence and severity of viral hepatitis in pregnancy. *Am J Med* 1981;70: 252–255.
123. Ticehurst JR. Hepatitis E virus. In Murray PR, Baron EJ, Pfaller MA, et al, eds. *Manual of clinical microbiology*. 7th ed. Washington, DC: American Society for Microbiology Press, 1999:1053–1069.
124. Panda SK, Thakral D, Rehman S. Hepatitis E virus. *Rev Med Virol* 2007;17:151–180.
125. Harrison TJ. Hepatitis E virus: an update. *Liver* 1999;19:171–176.
126. Frider B, Sookoian S, Castaño G, et al. Detection of hepatitis G virus RNA in patients with acute non-A-E hepatitis. *J Viral Hepat* 1998;5:161–164.
127. Loya F. Does the hepatitis G virus cause hepatitis? *Tex Med* 1996;92:68–73.
128. Doo EC, Lian TJ, Shiffs ER, et al. The hepatitis viruses. In Schiff ER, Sorrell MF, Maddrey WC, eds. *Schiff's diseases of the liver*. Philadelphia, Pa.: Lippincott Williams & Wilkins, 2003:917–940.
129. Alter HJ, Umemura T, Tanaka Y. Putative new hepatitis virus. In Schiff ER, Sorrell MF, Maddrey WC, eds. *Schiff's diseases of the liver*. Philadelphia, Pa.: Lippincott Williams & Wilkins, 2003:891–905.

Cardiac Function

Janelle M. Chiasera

CHAPTER

25

CHAPTER OUTLINE

■ ANATOMY AND FUNCTION OF THE HEART

- Anatomy
- Function

■ PATHOLOGIC CONDITIONS OF THE HEART

- Cardiovascular Disease
- Congenital Cardiovascular Defects
- Heart Failure
- Acute Coronary Syndromes
- Hypertensive Heart Disease
- Infective Heart Disease

■ DIAGNOSIS OF HEART DISEASE

- Laboratory Diagnosis of Myocardial Infarction
- Markers of Inflammation and Coagulation Disorders
- Markers of Congestive Heart Failure
- Patient-Focused Cardiac Tests
- Role of Laboratory in Monitoring Heart Disease

■ REFERENCES

ANATOMY AND FUNCTION OF THE HEART

Anatomy

The heart is a hollow muscular organ that is approximately the size of a fist. The average adult heart weighs 325 g in men and 275 g in females and is approximately 12 cm in length. It is located in the middle section of the chest cavity between the lower lobes of each lung and slightly to the left of the sternum. The heart is enclosed in a double-layered fibrous membrane (sac) called the *pericardium*. The inner layer of the pericardium (visceral pericardium) and the outer layer of the pericardium (parietal pericardium) are separated by a coating of fluid (pericardial fluid) that prevents friction between the two layers when the heart moves as it beats.

The heart is divided into two upper and two lower chambers. The upper chambers are termed the *right and left atria*, and the two lower chambers are termed the *right and left ventricles*. The right and left sides of the heart are separated by a septum. The portion of the septum that separates the two upper chambers of the heart is referred to as the *interatrial septum*, and the portion that separates the two lower chambers is the *interventricular septum*. Each atrium is attached to its ventricle by an atrioventricular valve. The atrioventricular valve connecting the upper and lower chamber on the left side of the heart is called the *mitral valve*. The atrioventricular valve

connecting the upper and lower chambers on the right side of the heart is called the *tricuspid valve*.

The wall of the heart is composed of three layers: the epicardium (outer layer), the myocardium (middle layer), and the endocardium (inner layer). The myocardium contains striated muscle fibers that alternate between contraction and relaxation, which allows the heart to do its work. These fibers are composed of cardiac-specific contractile proteins called *actin* and *myosin* and regulatory proteins called *troponins*. In addition, these fibers also contain a number of enzymes such as **myoglobin**, **creatine kinase (CK)**, and lactate dehydrogenase (LDH) that have been used as markers of cardiac injury (Fig. 25-1).

Function

The main function of the heart is to pump blood to the organs of the body, to deliver oxygen and nutrients where they are needed and to remove waste products from the tissues. It is easiest to think of the heart as two separate pumps that work in conjunction with one another—the right pump and the left pump. The right pump includes the right atrium, the tricuspid valve, the right ventricle, the pulmonary valve, and the pulmonary artery. The right atrium receives oxygen poor blood from circulation and stores the blood there until it contracts. When the right atrium contracts, the tricuspid valve opens and allows the

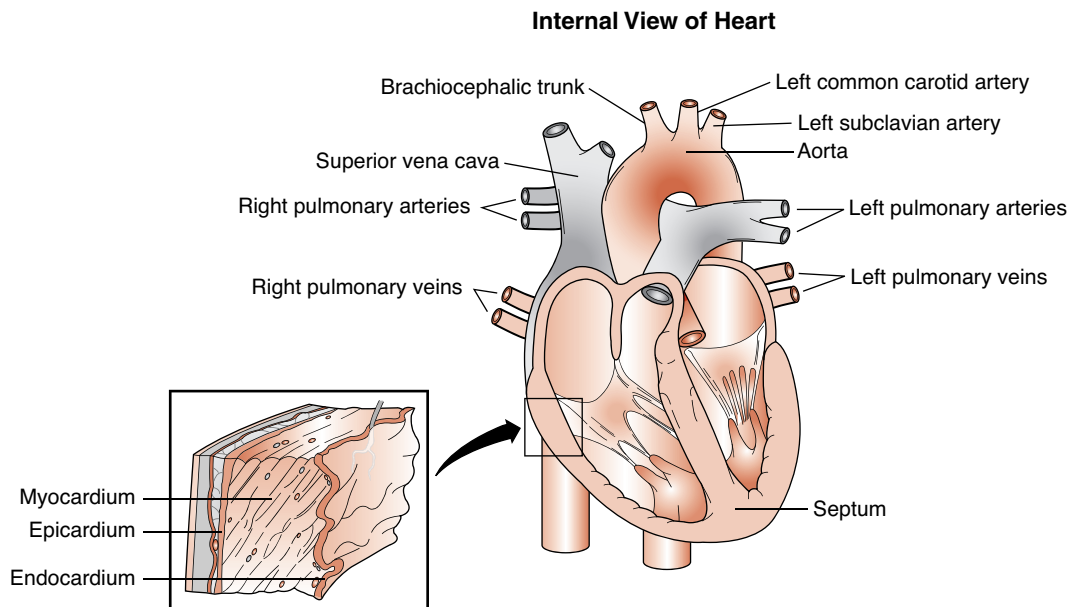

FIGURE 25-1. Anatomy of the heart.

blood to pump into the right ventricle where it serves to hold the blood until it contracts. When the right ventricle contracts, the pulmonary valve opens and allows blood into the pulmonary artery to be delivered to the lungs for reoxygenation. The left atrium receives oxygen-rich blood from the lungs and stores it until it contracts. When the left ventricle contracts, the mitral valve opens and allows blood to enter the left ventricle, where it is stored until the

ventricle contracts. When the left ventricle contracts, the aortic valve opens and allows blood to enter the aorta to be circulated throughout the body (Fig. 25-2).

Although the heart is an extremely durable and efficient pump, cardiac function may be diminished as a result of a variety of problems. This chapter reviews commonly occurring cardiac diseases, their associated laboratory tests, and routine treatments commonly used.

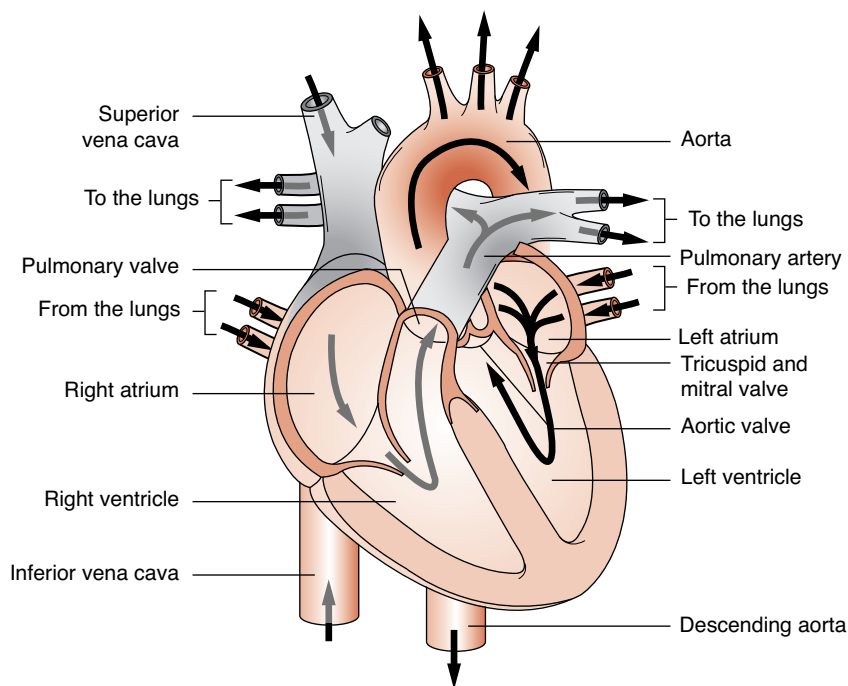

FIGURE 25-2. Blood flow in the heart.

PATHOLOGIC CONDITIONS OF THE HEART

Cardiovascular Disease

Cardiovascular disease (CVD) is a debilitating condition that affects an estimated 80 million adults in the United States, of whom 38 million are over the age of 60 years. CVD is responsible for the deaths of approximately 2,400 Americans daily and was identified as the underlying cause in one of every three reported deaths in 2004.¹ Timely and accurate diagnosis is essential, but even today, this is difficult due to the lack of tests available to provide information quickly enough to be beneficial to those presenting with chest pain. While there are many forms of cardiac disease, this chapter focuses on **congestive heart failure (CHF)** and **acute coronary syndromes**, such as acute **myocardial infarction (AMI)**. Others are discussed only briefly because of the relatively minor role of diagnostic tests in these disorders.

Symptoms of Heart Disease

There are seven classic symptoms of heart disease that, if recognized early, can aid in the accurate and early diagnosis of heart disease. It is important to note that not all individuals with heart disease will experience symptoms and not all people who experience symptoms will have heart disease. Observing the presence of any of the symptoms in conjunction with the person's age and family history may lead to an accurate and early diagnose. The seven symptoms include dyspnea, chest pain, palpitations, syncope, edema, cyanosis, and fatigue (Table 25-1)

Dyspnea is a medical term used to describe the earliest and most common symptom of heart disease, shortness of breath. While everyone experiences shortness of breath occasionally, it is important to attribute the shortness of breath to an activity that drives the shortness of breath to determine if it is appropriate for the activity. For example, it is appropriate for people to have dyspnea after heavy exertion (e.g., running, walking up a flight of stairs), while it is not appropriate to suffer dyspnea from low- or

no-exertion activity (e.g., routine walking, at rest). When dyspnea is experienced during a low- or no-exertion activity, it may be a symptom of heart disease. There are three basic types of dyspnea: cardiac, pulmonary, and psychological. Cardiac dyspnea occurs when the heart is weakened or something obstructs the flow of blood through the heart. Pulmonary dyspnea is shortness of breath as a result of lung disease. Psychological dyspnea occurs as a result of anxiety or panic attacks. It is important that the type of dyspnea be identified so an accurate diagnosis of heart disease can be made.

Chest pain is the second most common symptom of heart disease. As discussed with dyspnea, not all chest pain is due to heart disease as it may originate from other chest structures, a chest muscle, strained cartilage, or when organs below the chest have become irritated (blocked gallbladder, ulcerated stomach, inflamed pancreas, or acid reflux). **Angina pectoris**, also known as *angina*, is chest pain from the heart. It is described as gripping or crushing central chest pain felt around or deep within the chest. The pain may radiate to the neck or jaw, less commonly to the back or abdomen, and is associated with pain in one (usually the left) or both arms. Angina is most often caused by *ischemia* (restriction of blood supply to the heart) due most commonly to coronary artery disease. Angina is usually worsened by exercise and relieved by rest.

Palpitation is the term used to describe the awareness one has of their own heartbeat. Palpitations are not the pounding one feels as a result of heavy exertion; rather, it has been described as a fluttering beating or a thumping, flip-flopping, skipped heartbeat. The most common cause of palpitation is due to heightened awareness because of anxiety or tension. Palpitations are frustrating for the patient and physician because they often subside before they can be evaluated.

Syncope is the term used to indicate fainting or the sudden loss of consciousness. Syncope may be caused by a number of conditions that result in the deprivation of oxygen and blood to the brain. The most common type of syncope is vasovagal in nature (simple faints) and is not the result of serious disease. The most common cardiovascular cause of syncope is an irregular heartbeat (*arrhythmia*). Without warning, the patient falls to the ground with a slow or absent pulse and, after a few seconds, recovers.

Edema refers to the swelling of tissue around the ankles, legs, eyes, chest wall, or abdominal wall due to the retention of water or lymph fluid in the cells of the tissues. Edema is nearly always considered abnormal and a potential sign of disease. The edema associated with heart disease is often absent in the morning (as fluid is reabsorbed while lying down) and is progressively worse during the day.

TABLE 25-1 SEVEN CLASSIC SYMPTOMS OF HEART DISEASE AND THEIR MOST COMMON CAUSES

| SYMPTOM | MOST COMMON CAUSE OF SYMPTOM |
|--------------|------------------------------|
| Dyspnea | Diminished heart function |
| Chest pain | Coronary artery disease |
| Palpitations | Extra heartbeats |
| Syncope | Disturbance in heart rhythm |
| Edema | Diminished cardiac function |
| Cyanosis | Pulmonary insufficiency |
| Fatigue | Lack of sleep |

CASE STUDY 25-1

A 15-month-old girl with a heart murmur since birth was evaluated for repeated pulmonary infections, failure to grow, cyanosis, and mild clubbing of fingers and toes. She had been on digitalis therapy by the referring physician. The radiograph showed a moderately enlarged heart and an enlarged pulmonary artery. Pertinent laboratory data were obtained.

| | |
|---|------|
| Total protein (6.0–8.3 g/dL) | 5.4 |
| Albumin (3.5–5.2 g/dL) | 3.0 |
| Hemoglobin (14–18 g/dL) | 19.2 |
| Hematocrit (40%–54%) | 59 |
| Erythrocyte count ($4.3\text{--}5.7 \times 10^6/\text{mm}^3$) | 6.4 |

A cardiac catheterization was performed, and a large ventricular septal defect was found.

Questions

1. How does this congenital defect affect the body's circulation?
2. Why are the red cell measurements increased in this patient?
3. What treatment will be suggested for this patient?
4. What is this patient's prognosis?

Cyanosis is a term used to describe a bluish discoloration of the skin and is caused by an increased amount of nonoxygenated hemoglobin in the blood due to dyspnea. The discoloration is most apparent in the fingernail beds and around the lips. There are two types of cyanosis: central and peripheral. *Central* cyanosis is due to an inherited form of heart disease where venous and arterial blood mixes together because of a congenital opening between the left and right sides of the heart, or it is due to an anatomically defective heart where there is a common mixing chamber. *Peripheral* cyanosis is the type commonly caused by exposure to cold temperatures where the body attempts to conserve heat by restricting the capillaries of the skin and slowing blood flow. The two are easily distinguished by observable signs.

Fatigue is a term used to describe an overall feeling of weariness or a lack of energy. Fatigue is a common and nonspecific symptom of heart disease, other physical diseases, and depression. Generally, cardiac fatigue will be of recent onset and the person will report being fine at the beginning of the day and then exhausted by day's end.

Congenital Cardiovascular Defects

Congenital cardiovascular defects (CCVDs) are abnormalities arising from the abnormal formation of the heart or its major blood vessels. These defects can involve the interior walls of the heart, valves inside the heart, or the arteries and veins that carry blood to the heart or out to the body. Heart defects present at birth represent a major percentage of clinically significant birth defects and are the leading cause of death from congenital malformations.¹ It is estimated that 4 to 50 liveborn infants per 1000 are born with a congenital heart defect.¹ The signs and symptoms of many CCVDs include cyanosis, pulmonary **hypertension**, clubbing of the fingers, embolism, reduced growth, and syncope. Symptoms of congenital heart disease may be evident at birth or during early infancy, or they may not become evident until later in life. The etiology of CCVDs is unknown; however, most appear to have a multifactorial etiology based on an interaction between genetic predisposition and environmental influences. Factors closely associated with the development of CCVDs include maternal rubella infections, maternal alcohol abuse, drug treatment and radiation, and certain genetic and chromosomal abnormalities. Because the heart develops early in embryonic life and is completely formed and functioning by week 10 of gestation, all defects develop before week 10 of pregnancy.^{2,3}

CCVDs include **tetralogy of Fallot**, transposition of the great arteries, atrioventricular septal defects, **coarctation of the aorta**, hypoplastic left heart syndrome, and ventricular septal defects (VSDs). VSDs are the most common type of CCVD encountered. This type of defect is commonly referred to as a "hole" in the heart. In this condition, there is a defect, a large opening, between the ventricles of the heart. As a result of this structural defect, blood flows through the defect from the left to the right ventricle, resulting in oxygenated blood entering the pulmonary artery. This extra blood, in addition to the normal pulmonary flow from the vena cava, increases blood flow to the lungs and subsequently increases pulmonary venous return into the left atrium and ultimately into the left ventricle. This increased volume results in left ventricular dilatation and then hypertrophy. It increases the end-diastolic pressure and then pulmonary venous pressure. Finally, as blood is shunted through the VSD away from the aorta, cardiac output decreases, and compensatory mechanisms are stimulated to maintain adequate organ perfusion. These mechanisms include increased catecholamine secretion and salt and water retention by means of the renin-angiotensin system.

There are a number of genetic tests available that may assist in the diagnosis of CCVDs including fluorescence in situ hybridization (FISH) and DNA mutation analysis.

TABLE 25-2 NEW YORK HEART ASSOCIATION STAGING OF HEART FAILURE

| STAGING | SYMPTOMS | LIMITATIONS | OBJECTIVE EVIDENCE | COMMENTS |
|-----------|---------------------|----------------------------------|--|---|
| Class I | None | None | No evidence of cardiovascular disease | Ordinary PA does not cause symptoms |
| Class II | Mild | Some during exercise and walking | Objective evidence of minimal cardiovascular disease | Comfortable at rest; ordinary PA results in symptoms |
| Class III | Severe | Marked | Objective evidence of moderately severe cardiovascular disease | May be comfortable at rest; less than ordinary activity results in symptoms |
| Class IV | Severe even at rest | Severe | Objective evidence of severe cardiovascular disease | Unable to carry on activity without discomfort |

PA, physical activity.

Reprinted with permission from The Criteria Committee of the New York Heart Association. Nomenclature and criteria for diagnosis of diseases of the heart and great vessels. 9th ed. Boston: Little, Brown & Co., 1994.

The use and interpretation of such laboratory tests are described fully elsewhere and is beyond the scope of this chapter.²

Heart Failure

Heart failure (HF), formerly referred to as *CHF*, is a growing problem in the United States, affecting approximately 5 million people. Each year, HF results in 12–15 million physician office visits and 6.5 million hospital days. It is commonly known as a condition of the aging population, affecting 10 of every 1,000 persons over the age of 65 years. Of those hospitalized with a diagnosis of HF, 80% of them are over the age of 65. The indirect and direct costs of HF in the United States in 2007 were estimated at \$33 billion. In addition, an estimated \$2.9 billion is spent annually on medication used to treat HF.^{1,4–6}

HF is a clinical syndrome that results from any structural or functional cardiac disorder that impairs the ability of the ventricle to fill with or eject blood. When the left side of the heart is unable to pump, excess fluid accumulates in the lungs. As a result, this produces pulmonary edema and reduced output of blood to systemic circulation. The kidneys respond by retaining excess fluid, making the HF worse. When the right side of the heart is unable to pump, excess fluid accumulates in systemic circulation and generalized edema occurs.

The severity of HF symptoms has been well defined by the New York Heart Association (NYHA) classification system. This system classifies HF into four stages depending on the degree of effort needed to elicit symptoms. This type of staging classifies patients based on degree of symptomatic or functional limits⁷ (Table 25-2). A major criticism of the NYHA classification system is that it is too subjective in nature and it does not account for symptoms that tend to fluctuate in people with HF. In

2001, as a result of this shortcoming, the American College of Cardiology/American Heart Association (ACC/AHA) developed guidelines meant to complement the system developed by the NYHA. The ACC/AHA system was meant to emphasize prevention, evolution, and progression of HF. Four stages of HF (A–D) have been defined in the ACC/AHA system (Table 25-3). According to ACC/AHA, stage A identifies those who are asymptomatic with no structural abnormality of the heart but who are at high risk for the development of HF because of concomitant conditions. Stage B identifies the patient with structural heart abnormalities but who is still asymptomatic. Stage C identifies the patient with structural abnormalities of the heart and current or past symptoms of HF. Stage D identifies the patient with end-stage symptoms of HF despite treatment.⁸

TABLE 25-3 ACC/AHA CLASSIFICATION SYSTEM FOR HEART FAILURE

| STAGE | DESCRIPTION |
|-------|---|
| A | No identified structural/functional abnormalities; no signs or symptoms of HF; Patients at high risk for developing HF due to presence of conditions* associated with the development of HF |
| B | Structural heart diseases noted; no signs or symptoms of HF |
| C | Underlying structural heart disease; current or prior symptoms of HF |
| D | Advanced structural heart disease; marked symptoms of HF at rest despite medical therapy |

*Hypertension, diabetes mellitus, coronary artery disease, family history.

TABLE 25-4 CAUSES OF HEART FAILURE

| CAUSE | TYPES |
|---|---|
| Coronary artery disease | |
| Cardiomyopathies | Dilated cardiomyopathy Restrictive cardiomyopathy Hypertrophic cardiomyopathy |
| Inflammatory heart disease | Cardiac infections Immunologic injury to myocardium Valvular incompetence |
| Cardiac conduction dysfunctions/arrhythmias | |
| Congenital cardiovascular disease | |

HF may result from disorders of the walls of the heart (pericardium, myocardium, endocardium) or from disorders of the great vessels; however, most HF cases are due to left ventricular dysfunction. The most common causes of CHF are coronary artery disease, cardiomyopathies, inflammatory heart disease, valvular disease, and cardiac **arrhythmias**. It is important to note that HF is not equivalent to **cardiomyopathy** or to *left ventricular dysfunction*; these terms refer to possible functional and structural reasons for the development of HF (Table 25-4).

Acute Coronary Syndromes

The term *acute coronary syndrome* (ACS) is a general term used to describe the following continuum of events: angina, reversible tissue injury, unstable angina, myocardial infarction (MI), and extensive tissue necrosis. Symptoms of ACS include chest pain, referred pain (pain referred to the arm, jaw, neck, back, or abdomen), nausea, vomiting, dyspnea, diaphoresis, and lightheadedness. The clinical laboratory plays a critical role in the diagnosis, management, identification, and risk stratification of these events.^{9,10}

The major cause of ACS is **atherosclerosis**, the thickening and hardening of the artery walls caused by deposits of cholesterol-lipid-calcium plaque in the lining of the arteries. It is well established that atherosclerosis is an inflammatory disorder, not a cholesterol issue, as there are many mechanisms that lead to the cellular injury in atherosclerosis, such as bacterial infection, hyperlipidemia, glycosylated products seen in diabetes mellitus, and proinflammatory cytokines, among others.^{11,12} Atherosclerosis results in the narrowing of the arteries and a tendency for plaque disruption and thrombus formation.^{13,14} The narrowing of the arteries eventually leads to a reduced blood supply to the heart, referred to

as *ischemia*. The following nine factors predispose individuals to atherosclerosis: age, sex, family history, dyslipidemia, smoking, hypertension, sedentary lifestyle, and diabetes mellitus.

Premenopausal women appear to be less at risk for the development of atherosclerosis compared to men due to the higher levels of high-density lipoprotein (HDL) cholesterol found in this subset of women. However, when estrogen levels drop at menopause, the difference between men and women disappears. Atherosclerosis has been described to be present early in life, but age becomes a more significant risk factor as it increases. In fact, atherosclerosis is a more common finding in adults over the age of 40 years and is found almost universally in older persons in the Western world. Dyslipidemia, specifically elevations in triglycerides and LDL cholesterol and reductions in HDL cholesterol, have been shown to have a strong association with the development of atherosclerosis.^{15–17} Lowering serum LDL cholesterol values has been shown to reduce the incidence of coronary artery disease and the progression of atherosclerosis.¹⁸ Atherosclerosis is often found in members of the same family; however, it is difficult to distinguish genetic from lifestyle factors in predicting coronary artery disease.¹⁹ While research has shown that there is a relationship between number of cigarettes smoked and the risk of coronary artery disease in men, it is not as well defined in women.^{20,21} There is a strong relationship between diabetes and vascular disease, and therefore there is an increased risk for coronary artery disease, especially in those with poorly controlled diabetes.²² Finally, it has been established that both a sedentary lifestyle and a history of hypertension are risk factors for the development of atherosclerosis.²³

Atherosclerosis tends to lead to a narrowing of the arteries and subsequently a reduction in blood flow to the heart, referred to as *ischemia*. Three things may result from ischemia to the heart: CHF, angina pectoris, and MI (Fig. 25-3). Angina pectoris is a term used to describe chest pain due to coronary artery disease and it is often a symptom of ischemia. It occurs when the heart is not supplied with an adequate amount of blood due to a blockage in one or more arteries that supply blood to the heart. Angina pectoris manifests itself as uncomfortable pressure, squeezing in the center of the chest; however, it may also be manifested as referred pain in the neck, jaw, shoulder, back, or arm. It is important to keep in mind that not all chest pain is related to angina pectoris. For example, pain from heartburn can mimic pain caused by angina pectoris. There are two types of angina: stable (reversible) and unstable (progressive) angina. *Stable angina* presents as pain and discomfort in the chest only when engaged in moderate activity (running or walking). Once the activity is removed, the pain subsides. *Unstable angina* presents with pain and discomfort unpredictably

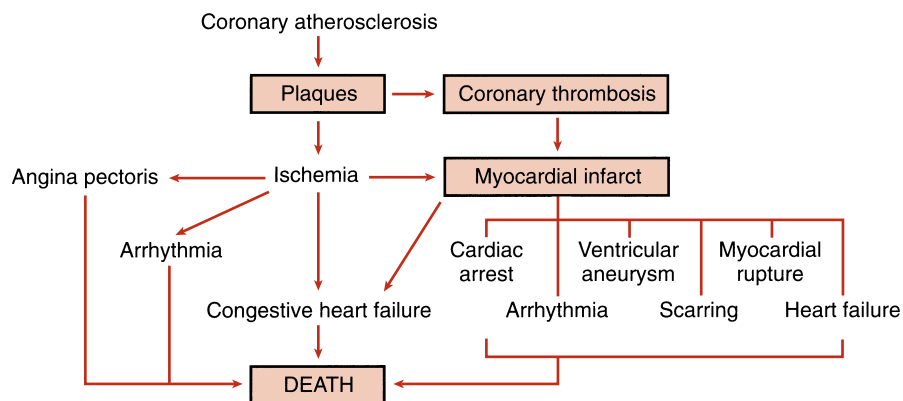

FIGURE 25-3. Presentation of coronary heart disease.

at rest. In addition to symptomatic differences between the types of angina, there is also a pathophysiologic difference. In stable angina, a formed plaque enclosed in a fibrous cap may be seen, whereas in unstable angina, the plaque ruptures, allowing blood clots to precipitate and further decrease the lumen of the coronary vessel. Stable angina goes away when heart demand is decreased (when one is at rest), while unstable angina may become worse and cause permanent damage to heart muscle tissue (independent of activity). Unstable angina is extremely painful, does not respond well to standard treatment, and progresses rapidly toward AMI. While it is not easy to differentiate angina from AMI with regard to symptoms, it can be differentiated using diagnostic tests. Angina presents symptomatically with chest pain; however, there are no electrocardiographic or enzyme changes seen in angina unless it is prolonged or very severe.

Hypertensive Heart Disease

Approximately one in every three U.S. adults has *hypertension*, also known as *high blood pressure*, and the prevalence increases with advancing age so that more than half of those in their 60s and three-fourths of those over 70 years old are affected by hypertension.^{24,25} *Hypertension* is defined as persistent systolic blood pressure (BP) of at least 140 mm Hg and/or diastolic pressure of at least 90 mm Hg, or BP that is controlled to guideline-recommended levels using antihypertensive medication.²⁶ It is becoming an increasingly common health problem worldwide due to an increasing life span and an increased prevalence of contributing factors such as obesity, physical inactivity, and unhealthy nutrition. In 2005, approximately 75 million people had high BP: 34 million males and 39 million females. Data have established that death from ischemic heart disease and stroke increases progressively and linearly so that for every 20 mm Hg systolic or 10 mm Hg diastolic increase in BP, there is a doubling of mortality from ischemic heart disease and stroke.

The Framingham Heart Study also reported that systolic BP values of 130–135 mm Hg and diastolic BP values of 85–80 mm Hg are associated with a more than twofold increase in risk for CVD.^{27,28}

Hypertensive heart disease is a general term used to describe heart diseases, such as left ventricular hypertrophy, coronary artery disease, cardiac arrhythmias, and CHF, caused by direct or indirect effects of elevated BP. Peripheral resistance is the most important factor that

CASE STUDY 25-2

A 59-year-old woman came to the emergency department of a local hospital complaining of pain and a feeling of heaviness in her abdomen for several days. She reported no weakness, chest pain, or left arm pain. She has no chronic health problems except for seasonal allergies and slightly elevated total cholesterol. Her ECG showed characteristic changes indicative of AMI.

| CARDIAC ENZYMES | 8:30 PM; APRIL 11 | 6:30 AM; APRIL 12 |
|-------------------------|----------------------|----------------------|
| Total CK (54–186 U/L) | 170 | 106 |
| CK-MB (0–5 ng/mL) | 6.3 | 3.8 |
| % CK-MB (<6%) | 3.7 | 3.6 |
| Myoglobin (<70 µg/L) | 52 | 41 |
| Troponin T (0–0.1 µg/L) | 0.8 | 2.3 |

Questions

1. Do the symptoms and personal history of this patient suggest AMI?
2. Based on the preceding laboratory data, would this diagnosis be AMI?
3. Why or why not?

determines BP, and the increased peripheral resistance is what results in heart disease. Peripheral resistance increases the workload of the left ventricle, eventually resulting in hypertrophy and dilatation. The problem with the left ventricle affects the mitral valve, which allows a regurgitation of blood to the left atrium. Over time, it results in increased pressure and dilatation in the left atrium. The relationship between BP and risk for CVD is independent of all other risk factors—the higher the BP, the greater the risk of heart attack, stroke, and kidney diseases. As a result of new data on hypertension and risk for CVD, The Seventh Report of the Joint National Committee on Prevention, Detection, Evaluation, and Treatment of High Blood Pressure²⁶ introduced a new hypertension classification intended to identify those in whom early intervention could reduce or ameliorate hypertension. This category, called *prehypertension*, applies to those with a systolic BP ranging from 120 to 139 mm Hg and/or a diastolic BP ranging from 80 to 89 mm Hg. The category of prehypertension is not a disease category; rather it is a designation used to identify those at an increased risk for the development of hypertension. Hypertension may be classified in adults as normal, prehypertension, stage 1 hypertension, or stage 2 hypertension (Table 25-5) There are often no symptoms of hypertension; however, dizziness, headaches, palpitations, restlessness, nervousness, and tinnitus may be present.

Infective Heart Disease

Infectious agents have been associated with a variety of heart diseases (Table 25-6) The most common heart diseases caused by infectious agents are **rheumatic heart disease**, **infective endocarditis**, and **pericarditis**.

Rheumatic heart disease is a serious complication of rheumatic fever. While the exact pathogenesis of

TABLE 25-5 CLASSIFICATION OF HYPERTENSION FOR ADULTS

| CLASSIFICATION | BLOOD PRESSURE (MM HG) |
|----------------------|--|
| Normal | <120 systolic <80 diastolic |
| Prehypertension | 120–139 systolic or 80–89 diastolic |
| Stage 1 hypertension | 140–159 systolic or 90–99 diastolic |
| Stage 2 hypertension | ≥160 systolic ≥100 diastolic |

Reprinted with permission from Chobanian AV, Bakris GL, Black HR, et al. Seventh report of the Joint National Committee on Prevention, Detection, Evaluation, and Treatment of High Blood Pressure. *Hypertension* 2003;42:1206–1252.

TABLE 25-6 INFECTIOUS AGENTS ASSOCIATED WITH HEART DISEASE

| | |
|-----------------------------------|---------------------------------|
| Pericarditis/myocarditis | |
| <i>Mycoplasma pneumoniae</i> | <i>Chlamydia trachomatis</i> |
| <i>Mycobacterium tuberculosis</i> | <i>Streptococcus pneumoniae</i> |
| <i>Staphylococcus aureus</i> | Enterobacteriaceae |
| Coxsackievirus A and B | Echovirus |
| Adenovirus | Influenza |
| <i>Coccidioides immitis</i> | <i>Aspergillus</i> species |
| <i>Candida</i> species | <i>Cryptococcus neoformans</i> |
| <i>Histoplasma capsulatum</i> | <i>Trypanosoma cruzi</i> |
| Infective endocarditis | |
| <i>Tococcus viridans</i> | <i>Streptococcus faecalis</i> |
| <i>Staphylococcus aureus</i> | <i>Histoplasma</i> species |
| <i>Staphylococcus epidermidis</i> | |
| <i>Candida</i> species | <i>Brucella</i> species |
| <i>Coxiella burnetii</i> | <i>Aspergillus</i> species |
| Rheumatic heart disease | |
| Group A β-hemolytic streptococcus | |
| Coronary heart disease | |
| <i>Chlamydia pneumoniae</i> | <i>Helicobacter pylori</i> |
| Cytomegalovirus | Herpes simplex virus type 2 |

rheumatic heart disease and rheumatic fever remains unclear, it is hypothesized to result from an autoimmune response. Rheumatic fever is a disease that primarily affects children and young adults as a result of complications from infection with group A β-hemolytic streptococci. Today, rheumatic fever is uncommon with a prevalence in the United States of less than 0.05 per 1,000 people; however, it remains a growing problem in developing countries, having affected anywhere from 5 to 20 million children and young adults.

Rheumatic fever develops in approximately 0.3% of the cases of group A β-hemolytic streptococcal infection in children. As many as 39% of the affected children may develop degrees of pancarditis (inflammation that affects all aspects of the heart) associated with valve insufficiency, HF, pericarditis, and even death.

The diagnosis of rheumatic heart disease was proposed by Dr. T. Duckett Jones in 1944 and has been modified four times with the updated diagnostic recommendation published in 1992.^{29,30} The diagnosis of rheumatic heart disease is divided into two levels of criteria,

TABLE 25-7 JONES CRITERIA FOR THE DIAGNOSIS OF RHEUMATIC HEART DISEASE

| CATEGORY | CRITERIA |
|----------|--|
| Major | <ol style="list-style-type: none"> 1. Carditis: All layers of cardiac tissue affected. 2. Polyarthriti s: Migrating arthritis that typically affects the knees, ankles, elbows and wrists. 3. Chorea: Abrupt, purposeless movements. This may be the only manifestation of ARF and its presence is diagnostic. 4. Erythema marginatum: A non-pruritic rash that commonly affects the trunk and proximal extremities. 5. Subcutaneous nodules: Painless, firm nodules located over bones or tendons. |
| Minor | <ol style="list-style-type: none"> 1. Fever 2. Arthralgia 3. Previous rheumatic fever or rheumatic heart disease 4. Acute phase reactants: leukocytosis, elevated erythrocyte sedimentation rate (ESR), and C-reactive protein (CRP) 5. Prolonged P-R interval on electrocardiogram (ECG) |
| Evidence | <p>Evidence of streptococcal infection (any of the following serve as a positive indication)</p> <ul style="list-style-type: none"> • Increased anti-streptolysin O or other streptococcal antibodies • Positive throat culture for group A β-hemolytic streptococci • Positive rapid direct group A streptococci carbohydrate antigen test • Recent scarlet fever |

Special Writing Group of the Committee on Rheumatic Fever, Endocarditis, and Kawasaki Disease of the Council on Cardiovascular Disease in the Young of the American Heart Association. Guidelines for the diagnosis of rheumatic fever. Jones Criteria, 1992 update. *JAMA* 1992;268:2069–2073; Ferrieri P. Proceedings of the Jones Criteria workshop. *Circulation* 2002;106:2521–2523.

major and minor, and one level of evidence. The diagnosis requires the presentation of two major or one major and two minor criteria in addition to evidence of a recent streptococcal infection (Table 25-7).

Infective endocarditis is an infection of the endocardial surface of the heart that is caused by several microorganisms and fungi. Streptococci and staphylococci are common bacterial causes in which the organism attaches to the endocardium, invades the valves, and forms vegetations that interfere with the function of the valves. The clinical presentation and course of infective endocarditis are either acute or subacute. Acute endocarditis occurs with a sudden onset of spiking fevers, chills, and drowsiness. Subacute endocarditis presents in a vague and insidious manner with low-grade fevers, fatigue, anorexia, and splenomegaly. If identified early, both types are treatable.

Pericarditis is a condition of inflammation of the *pericardium*, the membrane that surrounds the heart. It may be caused by infections (bacteria, viral or fungi),

autoimmune disorders, or other diseases. The space between the layers of the pericardium contains approximately 20 mL of pericardial fluid. Accumulation of this fluid is the hallmark sign of this condition, and the type of fluid that accumulates will differentiate the cause of pericarditis. Purulent exudates indicate bacterial infections, clear serous fluids are caused by viral infections, and a serofibrinous exudate is associated with severe damage as in rheumatic heart disease.

DIAGNOSIS OF HEART DISEASE

Laboratory Diagnosis of Myocardial Infarction

Myocardial infarction is defined as myocardial necrosis due to prolonged ischemia and it is usually categorized by the size of the infarct: microscopic (focal necrosis), small (<10% of the left ventricular myocardium), moderate (10%–30% of the left ventricular myocardium), and large (>30% of the left ventricular myocardium). It may

CASE STUDY 25-3

An 83-year-old man with known severe coronary artery disease, diffuse small vessel disease, and significant stenosis distal to a vein graft from previous CABG surgery was admitted when his physician referred him to the hospital after a routine office visit. His symptoms included 3+ pedal edema, jugular vein distention, and heart sound abnormalities. Significant laboratory data obtained on admission were as follows:

| | |
|------------------------------|-----|
| Urea nitrogen (6–24 mg/dL) | 53 |
| Creatinine (0.5–1.4 mg/dL) | 2.2 |
| Total protein (6.0–8.3 g/dL) | 5.8 |
| Albumin (3.5–5.3 g/dL) | 3.2 |
| Glucose (60–110 mg/dL) | 312 |
| Calcium (4.3–5.3 mEq/L) | 4.1 |
| Phosphorus (2.5–4.5 mg/dL) | 2.4 |
| Total CK (54–186 U/L) | 134 |
| CK-MB (0–5 ng/L) | 4 |
| % CK-MB (<6%) | 3 |
| Myoglobin (<70 µg/L) | 62 |
| Troponin T (0–0.1 µg/L) | 0.2 |

Questions

1. Do the symptoms of this patient suggest AMI?
2. Based on the preceding laboratory data, would this diagnosis be AMI? Why or why not?
3. Based on the preceding laboratory data, are there other organ system abnormalities present?
4. What are the indicators of these organ system abnormalities?
5. Is there a specific laboratory test that might indicate congestive heart failure in this patient?

be defined pathologically as acute, healing, or healed. Acute MI is characterized by the presence of polymorphonuclear leukocytes. Healing MI is characterized by the presence of mononuclear cells and fibroblasts in the absence of polymorphonuclear leukocytes. Healed MI is characterized by scar tissue without cellular infiltration, a process that usually takes 5–6 weeks. According to the Expert Consensus Document of the Joint European Society for Cardiology/AHA Science Advisory and Coordinating Committee/AHA/World Heart Federation Task Force for the Redefinition of Myocardial Infarction,³¹ the term *MI* should be used when there is

evidence of myocardial cell death in a clinical setting with myocardial ischemia. The current diagnosis of AMI is based on clinical symptoms, electrocardiographic (ECG) changes, and the rise and/or fall of highly sensitive biochemical markers. The European Society of Cardiology and the ACC (ESC/ACC) consensus report recommended samples be collected at presentation, at 6–9 hours, and again at 12–14 hours if the earlier samples were negative.³² Any one of the following criteria meets the diagnosis for MI:³¹

1. Rise and/or fall of cardiac biomarkers (preferably troponin) with at least one value above the 99th percentile of the upper reference limit, and evidence of myocardial ischemia, and at least one of the following:
 - Symptoms of ischemia
 - ECG changes (new ST-T changes or new left bundle-branch block [LBBB])
 - Development of pathologic Q waves in the ECG
 - Imaging evidence of new loss of viable myocardium or new regional wall motion abnormality
2. Sudden, unexpected cardiac death, involving cardiac arrest, often with symptoms suggestive of myocardial ischemia, and accompanied by presumably new ST elevation, or new LBBB, and/or evidence of fresh thrombus by coronary angiography and/or at autopsy, but death occurring before blood samples could be obtained, or at a time before the appearance of cardiac biomarkers in the blood.
3. For percutaneous coronary interventions (PCIs) in patients with normal baseline troponin values, elevations of cardiac biomarkers above the 99th percentile of upper reference limit are indicative of periprocedural myocardial necrosis. By convention, increases of biomarkers greater than three times the 99th percentile of the upper reference limit have been designated as defining PCI-related MI.
4. For coronary artery bypass grafting (CABG) in patients with normal baseline troponin values, elevations of cardiac biomarkers above the 99th percentile of the upper reference limit are indicative of periprocedural myocardial necrosis. By convention, increases of biomarkers greater than five times the 99th percentile of the upper reference limit plus either new pathologic Q waves or new LBBB, or angiographically documented new graft or native coronary artery occlusion, or imaging evidence of new loss of viable myocardium have been designated as defining CABG-related MI.
5. Pathologic findings of an AMI.

There has been significant progress made with regard to the identification and measurement of biomarkers released into circulation from damaged myocytes. Serum glutamine-oxaloacetic transaminase (SGOT) was replaced by lactate dehydrogenase (LDH) and its isoenzymes and

the classic diagnostic LDH flipped ratio, which was replaced by creatine kinase (CK) and the MB fraction of CK (CK-MB). Currently, the preferred biomarkers for the detection of myocardial necrosis are cardiac troponins I and T, which are more specific and sensitive for myocardial necrosis. Traditionally, a combination of **cardiac markers** has been recommended in the evaluation of many types of heart conditions because of the lack of an ideal single diagnostic test. An ideal cardiac marker would have the following features:

- High specificity for myocardial damage in the presence of skeletal muscle injury
- High sensitivity to detect very minor heart damage
- Capability to differentiate reversible from irreversible cardiac damage
- Ability to be used as a monitor of prognosis and therapy
- Availability of rapid, easy-to-perform, and cost-effective quantitative assays
- Absent or not detectable in patients without myocardial damage

Current guidelines from The National Academy of Clinical Biochemistry recommend the use of two biochemical markers to diagnose AMI: a marker increased early after the onset of symptoms (within 6 hours) and a definitive marker with a high sensitivity and specificity for myocardial damage that increases within 6–9 hours after symptoms and remains abnormal for several days.³³

Enzymes

Several enzymes have been used in the past to detect myocardial damage. A few of them not currently recommended for routine use in the detection of myocardial damage include aspartate aminotransferase (AST), LDH, and LDH isoenzyme determinations.

The enzymes currently in clinical use to detect myocardial infarction are CK and its isoenzyme **CK-MB**, although the measurement of total CK is not recommended because of the large skeletal muscle distribution and the lack of specificity of the enzyme.³¹ CK is a cytosolic enzyme involved with the transfer of energy in muscle metabolism. CK is a dimer composed of two subunits, B and M, resulting in three cytosolic isoenzymes, CK-MM (CK-3), CK-MB (CK-2), and CK-BB (CK-1). CK-BB is of brain origin and is only found in the blood when the blood brain barrier has been damaged. CK-MM is found primarily from skeletal muscle and heart, while CK-MB has been shown to be most specific for the myocardium. As a result, CK-MB is a valuable tool for the diagnosis of MI because of its relative high specificity for myocardial damage. CK-MB rises within 4–6 hours after the onset of chest pain, peaks at 12–24 hours, and returns to normal levels within 2–3 days (Fig. 25-4). CK-MB activity assays have been replaced by CK-MB mass assays to measure CK-MB. CK-MB mass assays can detect an increased amount of serum CK-MB about 1 hour earlier than activity-based assays. In addition, calculation of a relative index ($\text{CK-MB mass assay}/\text{total CK} \times 100$) may be used as an indicator of MI. The relative index allows the distinction between increased total CK due to myocardial damage and that due to skeletal or neural damage. A relative index exceeding 3 is indicative of AMI.

Cardiac Proteins

Several proteins may be monitored in cases of AMI, including myoglobin, cardiac troponins, and cardiac myosin light chains. Myoglobin is an oxygen-binding heme protein that is present in both cardiac and skeletal muscle. Although it lacks specificity, its clinical usefulness is in its early release from damaged cardiac or skeletal muscle. Myoglobin rises as early as 1–4 hours after the

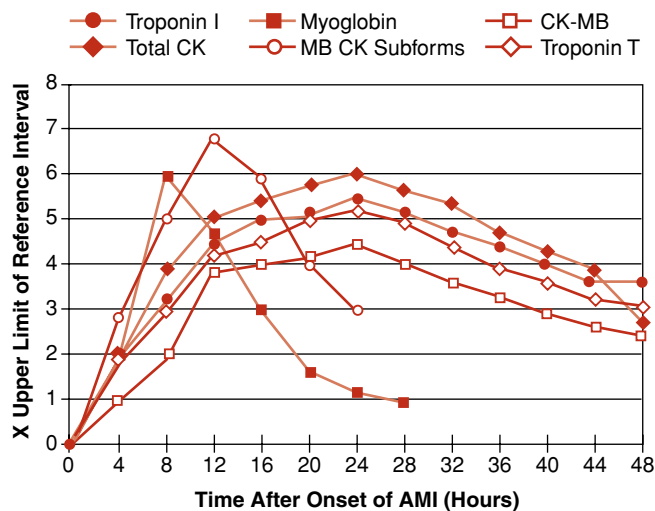

FIGURE 25-4. Time profiles of characteristic cardiac markers after AMI.

onset of symptoms, is found in *all* AMI patients between 6 and 9 hours, and rapidly returns to baseline within 18–24 hours³⁴ (Fig. 25-4). If myoglobin concentrations remain within the reference range 8 hours after the onset of chest pain, AMI can essentially be ruled out. Myoglobin is not cardiac specific, so care must be taken in its interpretation in patients with renal failure, trauma, or diseases involving skeletal muscle. However, because of its small size and rapid clearance by the kidneys, a persistently normal myoglobin concentration will rule out reinfarction in patients with recurrent chest pain after AMI.

The preferred biomarkers for assessment of myocardial necrosis are the cardiac troponins.³¹ Troponin is a complex of three proteins that bind to the thin filament (actin) of cardiac and skeletal muscle. The three proteins of the troponin complex are **troponin T (TnT)**, **troponin I (TnI)**, and troponin C (TnC). The major function of troponins is to bind calcium and regulate muscle contraction. Following injury to skeletal or heart muscle cells, the troponin complex and free troponin subunits are released into the bloodstream.³⁵ The troponins have been shown to have high sensitivity and specificity for myocardial damage. Data indicate that troponins rise 4–10 hours after the onset of symptoms, peak at 12–48 hours, and remain elevated for 4–10 days. It is the sustained elevation of the troponins that enables them to serve as definitive markers for AMI³⁶ (Fig. 25-4). Blood samples for troponins should be drawn as described for CK-MB at presentation, at 6–9 hours, and again at 12–24 hours if the earlier measurements were not elevated and the clinical suspicion of MI is high.³¹ Unlike CK-MB, the serum troponins are not found in the serum of healthy individuals.

TnT measurements are extremely useful in patients who do not seek medical attention in the 2- to 3-day window when CK-MB is elevated. Cardiac TnT begins to rise within a few hours after the onset of chest pain, peaks at 2 days, and can remain elevated for 7–10 days. Cardiac TnT increases and reaches its peak similarly to TnI, but TnT may show a biphasic release in some MI patients, with a peak occurring during the first 24 hours after the onset of symptoms and a second peak on approximately the fourth day after admission. Cardiac TnI is also helpful in monitoring patients after reperfusion treatment.

Cardiac TnI is cardiac specific due to the presence of an additional amino acid residue on the amino-terminal end. It is released in circulation is similar to cardiac TnT and CK-MB and its measurement offers advantages over CK-MB. Namely, TnI is not found in detectable amounts in the serum of patients with multiple injuries, in those engaged in strenuous exercise, in patients with renal failure, and in those with acute or chronic skeletal muscle disease. After an AMI, the TnI increases above the reference range between 4 and 6 hours after chest pain onset, peaks at 12–18 hours, and returns to

within reference limits in about 6 days, depending on AMI (Fig. 25-4).

Recently, an ultrasensitive TnI assay (TnI-Ultra) has been developed that offers a more sensitive assay for the detection of TnI and the detection of myocardial injury earlier than the current assays. Implementation of TnI-Ultra is likely to aid in the earlier identification of AMI and the earlier implementation of treatment for those with ACS.^{37,38}

Cardiac **myosin light chains (MLCs)** are also involved with muscle contractions. They were first thought to be unique myocardial proteins, but recent research has determined that MLCs are no more specific for cardiac injury than CK-MB determinations. Although rapid testing of MLCs is available, MLC determination does not offer any advantage over cardiac troponin assays. Therefore, MLC remains of limited clinical significance as a routine cardiac marker.

Markers of Inflammation and Coagulation Disorders

Inflammation plays a role in atherogenesis, atherosclerotic plaque formation, and acute coronary syndrome.¹¹ Because of their implication in these processes, inflammatory cells, cytokines, and other biomolecules have been considered as potential markers for the assessment of risk for the development of such events. As a result, several studies have identified a growing number of such biomarkers of inflammation over recent years including high-sensitivity C-reactive protein (**hsCRP**), pregnancy-associated plasma protein A (PAPP-A), and lipoprotein-associated phospholipase A₂ (Lp-PLA₂).

High-Sensitivity C-Reactive Protein

hsCRP is one of the most extensively studied proposed markers of inflammation, and despite some controversy regarding its clinical use, it appears to be the most promising to date. CRP is an acute-phase protein produced by the liver in response to injury, infection, and inflammation. Although considered to be a general nonspecific marker of inflammation, it is useful in its high predictive value for coronary artery disease in the healthy population.³⁹ Epidemiologic data document a positive association between hsCRP and the prevalence of coronary artery disease. Elevated baseline levels of hsCRP are correlated with higher risk of future cardiovascular morbidity and mortality among those with and without clinical evidence of vascular disease. In patients with established vascular disease, each standard deviation increase in baseline hsCRP is associated with a 45% increase in relative risk of nonfatal MI or sudden cardiac death over 2 years of follow-up.

hsCRP also demonstrates prognostic capacity in those who do not yet have a diagnosis of vascular disease. A mild elevation of baseline levels of hsCRP among appar-

ently healthy individuals is associated with higher long-term risk for future cardiovascular events. This predictive capacity offers patients the ability to receive treatment to reduce inflammation and, thus, their risk.⁴⁰

Pregnancy-Associated Plasma Protein A

PAPP-A is a zinc-binding protein found in high serum concentrations of women in advanced stages of pregnancy. PAPP-A was recently identified as a major contributor to the progression of atherosclerosis by Bayes-Genis et al.,⁴¹ who found high levels of PAPP-A in the cells and extracellular matrix of plaques from patients who died suddenly of cardiac causes. These researchers also found high concentrations of PAPP-A in unstable plaques compared with stable plaques. Since its association with plaque instability, several studies have substantiated the results discovered by Bayes-Genis et al. To date, evidence suggests that PAPP-A could play a role as a marker of unstable atherosclerotic plaques and may also have a prognostic value in patients with ACSs. However, more data are needed to substantiate these claims.

Lipoprotein-Associated Phospholipase A₂

LP-PLA₂, also known as platelet-activating factor acetylhydrolase, is an enzyme associated with the small, dense LDL cholesterol particles, which are pathogenic and readily undergo oxidative modification. It circulates mainly bound to LDL and HDL, and studies have shown that elevated LP-PLA₂ values are associated with an increased risk for heart disease and stroke. When analyzed with CRP, it was shown to have an additive effect of increasing risk for CVD.⁴² Research with LP-PLA₂ is currently focused on the role LP-PLA₂ has in the development of stroke.^{43,44}

Markers of Congestive Heart Failure

The natriuretic peptides (NPs) are a group of hormones that include atrial natriuretic peptide (ANP), B-type natriuretic peptide (BNP), C-type natriuretic peptide (CNP), and D-type natriuretic peptide (DNP). The NPs play an important role in the regulation of cardiovascular homeostasis.⁴⁵ BNP and the terminal fragment of its prohormone (NT-proBNP) are released on ventricular stretch or stress to the myocytes in the absence of necrosis. Therefore, BNP is increased in diseases characterized by an expanded fluid volume (e.g., renal failure, hepatic cirrhosis, primary aldosteronism, and CHF) characterized by reduced renal clearance of peptides or stimulation of peptide production. Both BNP and NT-proBNP work well in diagnosing HF and are of prognostic value in patients with ACSs.

BNP has a circulating half-life of 20 minutes, so it is indicative of a snapshot of myocardial function, while NT-proBNP circulates approximately 1.5 hours, giving a longer view of myocyte function.

CASE STUDY 25-4

A 68-year-old man presented to the emergency department with sudden onset of chest pain, left arm pain, dyspnea, and weakness while away from home on a business trip. His prior medical history is not available, but he admits to being a 2-pack per day smoker for longer than 20 years.

Cardiac markers were performed at admission and 8 hours postadmission with the following results:

| CARDIAC MARKERS | 7:30 AM; SEPTEMBER 26 | 4:00 PM; SEPTEMBER 26 |
|----------------------------|--------------------------|--------------------------|
| CK-MB (0–5 ng/L) | 5.3 | 9.2 |
| Myoglobin (<70 µg/L) | 76 | 124 |
| Troponin T (0–0.1 µg/L) | <0.1 | 1.3 |

Questions

1. Do these results indicate a specific diagnosis?
2. If so, what is the diagnosis?
3. What myoglobin, CK-MB, and troponin T results would be expected if assayed at 4 PM on September 27?
4. Can any assumptions be made about the patient's lifestyle/habits/health that would increase his risk for this condition?
5. Are there any assays that might indicate his risk for further events of this type?

Diagnosis of CHF is difficult because of its nonspecific symptoms, as well as the lack of a specific biochemical marker for CHF. Studies show that plasma concentrations of BNP are elevated in patients with HF, especially in those patients with severe symptoms.⁴⁶ Evidence suggests that patients with a BNP concentration below approximately 20 pmol/L are unlikely to have CHF and those with results above this concentration have a high probability of CHF.⁴⁷ BNP results should be able to differentiate those patients who should undergo further diagnostic assessments from those who are unlikely to have cardiac failure. BNP may also be clinically relevant in determining the prognosis of patients, especially those with a diagnosis of CHF or those who have experienced a recent AMI. The recent development of a reliable and rapid assay for BNP makes it likely that it will become a commonplace biochemical marker used in the diagnosis of CHF.

Patient-Focused Cardiac Tests

Less cardiac tissue damage, fewer complications, reduced hospital length of stay, and faster recovery will occur with the early diagnosis of patients with AMI. In addition, treatment options, to prevent further damage to the heart, must be administered in a timely fashion. Typically, 90% of patients admitted to the hospital re-

quire biochemical testing to confirm or exclude AMI.¹¹ The National Academy of Clinical Biochemistry Standards of Laboratory Practice recommends that cardiac marker results should be available within 1 hour of sampling.³³ Point-of-care (POC) testing for cardiac markers is a strategy to reduce turnaround time, and the recent development of devices for performing whole blood cardiac assays at the patient's bedside has made it feasible to meet these strict guidelines.

Several medical and technical issues must be addressed when POC cardiac testing is considered. There are both qualitative and quantitative test systems available and systems that produce a panel of cardiac marker results, as well as discrete, single-analyte results. Laboratorians and clinicians must collaborate to determine which cardiac markers are offered at their institution. Determining diagnostic cutoff values for AMI on POC results and correlating those results with those that may be performed in the clinical laboratory at a later time are also concerns.

Under the Clinical Laboratory Improvement Amendments Act (CLIA), POC cardiac marker testing is classified as moderately complex testing, not as waived testing. This classification requires more stringent regulatory guidelines and is more difficult to implement and maintain in POC settings. Issues such as maintaining ongoing proficiency testing, quality control, and operator competency will require greater oversight by the laboratory.⁴⁸

Role of Laboratory in Monitoring Heart Disease

The laboratory's role in monitoring heart function primarily involves measuring the effects of the heart on other organs, such as the lungs, liver, and kidney. Arterial blood gases measure the patient's acid-base and oxygen status and are used to determine the respiratory acidosis and elevated carbon dioxide levels that are often seen in patients with heart disease. The patient with edema will develop electrolyte and osmolality changes as a result of fluid retention and ionic redistribution. Decreased cardiac output results in sodium retention by the kidneys but also causes increased fluid retention; therefore, the serum sodium level generally remains within the reference ranges or may be slightly decreased. Serum electrolyte determinations, including sodium, potassium, chloride, and calcium, are important to monitor diuretic and drug therapy in patients with heart disease.

Elevations of AST, alanine aminotransferase (ALT), and alkaline phosphatase (ALP) are often seen in patients with chronic right ventricular failure, and the γ -glutamyltransferase (GGT) value may be twice the value of the upper limit of the normal range in CHF, suggesting liver congestion and damage.

CASE STUDY 25-5

A 48-year-old woman was seen by her primary physician for a routine physical examination. Her father and his brother died before the age of 55 with AMI and another uncle had CABG surgery at age 52. Because of this family history, she requested any testing that might indicate a predisposition or increased risk factors for early cardiac disease. She does not smoke, does not have hypertension, is approximately 20 lb overweight, and exercises moderately. The following test results were obtained.

| | |
|--------------------------------|----------------|
| Total cholesterol (<200 mg/dL) | 187 mg/dL |
| HDL cholesterol (30–75 mg/dL) | 52 mg/dL |
| LDL cholesterol (60–130 mg/dL) | 95 mg/dL |
| Lipoprotein(a) (<30 mg/dL) | 34 mg/dL |
| Triglycerides (60–160 mg/dL) | 203 mg/dL |
| Glucose (60–110 mg/dL) | 83 mg/dL |
| Total CK (15–130 IU/L) | 65 IU/L |
| CK-MB (<8 IU/L) | 1.9 IU/L |
| % CK-MB (0%–6%) | 3 |
| Homocysteine (<15 μ mol/L) | 18 μ mol/L |
| Fibrinogen (2–4.5 mg/dL) | 4.3 mg/dL |
| D-dimer (0–250 μ g/mL) | 160 μ g/mL |
| hsCRP (0.016–0.76 mg/dL) | 0.91 mg/dL |

Questions

1. Do any of the results obtained indicate a high risk for development of cardiac disease? If so, which results?
2. Does this patient have risk factors for early cardiac disease that can be modified by diet or lifestyle modifications? If so, what changes can be made?
3. Is there any specific treatment that can be instituted to reduce this patient's risk?
4. How should this patient be monitored?

Lipid evaluation will assess risk for coronary artery disease. Maintenance of near-normal HDL cholesterol, LDL cholesterol, and triglyceride levels is highly recommended for cardiac patients. Determination of a lipoprotein similar to LDL, called lipoprotein(a), may also be indicated as it is an independent risk factor associated with development of premature coronary artery and vascular disease.

The patient who has secondary HF due to thyroid dysfunction can be identified by a highly sensitive thyroid-stimulating hormone assay. The laboratory is also invaluable for monitoring therapeutic drugs following the diagnosis of heart disease.

The routine complete blood count is important for detecting anemia and infection. Hemolysis may indicate additional testing for hemoglobinuria and myoglobinuria, indicators of cardiovascular damage and myocardial

disease. An increase in white blood cells may indicate pericarditis, endocarditis, or valvular infections. If kidney dysfunction has occurred as a result of the heart disease, anemia due to decreased production of renal erythropoietin may develop.

An infection associated with pericarditis, endocarditis, and valvular problems would be identified by blood cultures. Cultures of specimens from the pericardium and endocardium might also be performed if a pericardial infection is suspected.

The laboratory's role during the treatment of heart disease may also extend to providing blood components when surgical intervention is needed. Bypass grafts, correcting valvular defects, and other surgical procedures to correct HF may involve the use of blood components during the surgery and the patient's recovery.

REFERENCES

- Rosamond W, Flegal K, Furie K, et al. Heart disease and stroke statistics—2008 update: a report from the American Heart Association Statistics Committee and Stroke Statistics Subcommittee. *Circulation* 2008;117:e25–e146.
- Pierpont ME, Basson CT, Benson DW Jr, et al. Genetic basis for congenital heart defects: current knowledge: a scientific statement from the American Heart Association Congenital Cardiac Defects Committee, Council on Cardiovascular Disease in the Young; endorsed by the American Academy of Pediatrics. *Circulation* 2007;115:3015–3038.
- Jenkins KJ, Correa A, Feinstein JA, et al. Noninherited risk factors and congenital cardiovascular defects: current knowledge: a scientific statement from the American Heart Association Council on Cardiovascular Disease in the Young; endorsed by the American Academy of Pediatrics. *Circulation* 2007;115:2995–3014.
- Kannel WB, Belanger AJ. Epidemiology of heart failure. *Am Heart J* 1991;121(3 Pt 1):951–957.
- Massie BM, Shah NB. Evolving trends in the epidemiologic factors of heart failure: rationale for preventive strategies and comprehensive disease management. *Am Heart J* 1997;133:703–712.
- Masoudi FA, Havranek EP, Krumholz HM. The burden of chronic congestive heart failure in older persons: magnitude and implications for policy and research. *Heart Fail Rev* 2002;7:9–16.
- The Criteria Committee of the New York Heart Association. Nomenclature and criteria for diagnosis of diseases of the heart and great vessels. 9th ed. Boston: Little, Brown & Co., 1994.
- Hunt SA, Abraham WT, Chin MH, et al. ACC/AHA 2005 Guideline Update for the Diagnosis and Management of Chronic Heart Failure in the Adult: a report of the American College of Cardiology/American Heart Association Task Force on Practice Guidelines (Writing Committee to Update the 2001 Guidelines for the Evaluation and Management of Heart Failure): developed in collaboration with the American College of Chest Physicians and the International Society for Heart and Lung Transplantation; endorsed by the Heart Rhythm Society. *Circulation* 2005;112:e154–e235.
- McCarthy BD, Wong JB, Selker HP. Detecting acute cardiac ischemia in the emergency department: a review of the literature. *J Gen Intern Med* 1990;5:365–373.
- Christenson RH, Duh SH. Evidence based approach to practice guides and decision thresholds for cardiac markers. *Scand J Clin Lab Invest Suppl* 1999;230:90–102.
- Libby P. Inflammation in atherosclerosis. *Nature* 2002;420:868–874.
- Libby P. Atherosclerosis: the new view. *Sci Am* 2002;286:46–55.
- Naghavi M, Libby P, Falk E, et al. From vulnerable plaque to vulnerable patient: a call for new definitions and risk assessment strategies: Part II. *Circulation* 2003;108:1772–1778.
- Naghavi M, Libby P, Falk E, et al. From vulnerable plaque to vulnerable patient: a call for new definitions and risk assessment strategies: Part I. *Circulation* 2003;108:1664–1672.
- Miller NE. Coronary atherosclerosis and plasma lipoproteins: epidemiology and pathophysiologic considerations. *J Cardiovasc Pharmacol* 1982;4(suppl 2):S190–S195.
- Miller NE. Associations of high-density lipoprotein subclasses and apolipoproteins with ischemic heart disease and coronary atherosclerosis. *Am Heart J* 1987;113(2 Pt 2):589–597.
- Sarwar N, Danesh J, Eiriksdottir G, et al. Triglycerides and the risk of coronary heart disease: 10,158 incident cases among 262,525 participants in 29 Western prospective studies. *Circulation* 2007;115:450–458.
- The Scandinavian Simvastatin Survival Study. Randomized trial of cholesterol lowering in 4444 patients with coronary heart disease. *Lancet* 1994;344:1383–1389.
- Shea S, Ottman R, Gabrieli C, et al. Family history as an independent risk factor for coronary artery disease. *J Am Coll Cardiol* 1984;4:793–801.
- McGill HC Jr, McMahan CA. Determinants of atherosclerosis in the young. Pathobiological Determinants of Atherosclerosis in Youth (PDAY) Research Group. *Am J Cardiol* 1998;82:30T–36T.
- Gazes P. Clinical cardiology: a cost-effective approach. New York: Chapman & Hall, 1997.
- Kannel WB, McGee DL. Diabetes and cardiovascular disease. The Framingham study. *JAMA* 1979;241:2035–2038.
- Schocken DD, Benjamin EJ, Fonarow GC, et al. Prevention of heart failure: a scientific statement from the American Heart Association Councils on Epidemiology and Prevention, Clinical Cardiology, Cardiovascular Nursing, and High Blood Pressure Research; Quality of Care and Outcomes Research Interdisciplinary Working Group; and Functional Genomics and Translational Biology Interdisciplinary Working Group. *Circulation* 2008;117:2544–2565.

24. Burt VL, Whelton P, Roccella EJ, et al. Prevalence of hypertension in the US adult population. Results from the Third National Health and Nutrition Examination Survey, 1988–1991. *Hypertension* 1995;25:305–313.
25. Fields LE, Burt VL, Cutler JA, et al. The burden of adult hypertension in the United States 1999 to 2000: a rising tide. *Hypertension* 2004;44:398–404.
26. Chobanian AV, Bakris GL, Black HR, et al. Seventh report of the Joint National Committee on Prevention, Detection, Evaluation, and Treatment of High Blood Pressure. *Hypertension* 2003;42:1206–1252.
27. Lewington S, Clarke R, Qizilbash N, et al. Age-specific relevance of usual blood pressure to vascular mortality: a meta-analysis of individual data for one million adults in 61 prospective studies. *Lancet* 2002;360:1903–1913.
28. Vasan RS, Larson MG, Leip EP, et al. Impact of high-normal blood pressure on the risk of cardiovascular disease. *N Engl J Med* 2001;345:1291–1297.
29. Special Writing Group of the Committee on Rheumatic Fever, Endocarditis, and Kawasaki Disease of the Council on Cardiovascular Disease in the Young of the American Heart Association. Guidelines for the diagnosis of rheumatic fever. Jones Criteria, 1992 update. *JAMA* 1992;268:2069–2073.
30. Ferrieri P. Proceedings of the Jones Criteria workshop. *Circulation* 2002;106:2521–2523.
31. Thygesen K, Alpert JS, White HD, et al. Universal definition of myocardial infarction. *Circulation* 2007;116:2634–2653.
32. Alpert JS, Thygesen K, Antman E, Bassand JP. Myocardial infarction redefined—a consensus document of The Joint European Society of Cardiology/American College of Cardiology Committee for the redefinition of myocardial infarction. *J Am Coll Cardiol* 2000;36:959–969.
33. Wu AH, Apple FS, Gibler WB, et al. National Academy of Clinical Biochemistry Standards of Laboratory Practice: recommendations for the use of cardiac markers in coronary artery diseases. *Clin Chem* 1999;45:1104–1121.
34. Karras DJ, Kane DL. Serum markers in the emergency department diagnosis of acute myocardial infarction. *Emerg Med Clin North Am* 2001;19:321–337.
35. Chapelle JP. Cardiac troponin I and troponin T: recent players in the field of myocardial markers. *Clin Chem Lab Med* 1999;37:11–20.
36. Jaffe AS, Landt Y, Parvin CA, et al. Comparative sensitivity of cardiac troponin I and lactate dehydrogenase isoenzymes for diagnosing acute myocardial infarction. *Clin Chem* 1996;42:1770–1776.
37. Casals G, Filella X, Bedini JL. Evaluation of a new ultrasensitive assay for cardiac troponin I. *Clin Biochem* 2007;40:1406–1413.
38. Melanson SE, Morrow DA, Jarolim P. Earlier detection of myocardial injury in a preliminary evaluation using a new troponin I assay with improved sensitivity. *Am J Clin Pathol* 2007;128:282–286.
39. Koenig W, Sund M, Frohlich M, et al. C-reactive protein, a sensitive marker of inflammation, predicts future risk of coronary heart disease in initially healthy middle-aged men: results from the MONICA (Monitoring Trends and Determinants in Cardiovascular Disease) Augsburg Cohort Study, 1984 to 1992. *Circulation* 1999;99:237–242.
40. Morrow DA, Ridker PM. C-reactive protein, inflammation, and coronary risk. *Med Clin North Am* 2000;84:149–161, ix.
41. Bayes-Genis A, Conover CA, Overgaard MT, et al. Pregnancy-associated plasma protein A as a marker of acute coronary syndromes. *N Engl J Med* 2001;345:1022–1029.
42. Ballantyne CM, Hoogeveen RC, Bang H, et al. Lipoprotein-associated phospholipase A2, high-sensitivity C-reactive protein, and risk for incident coronary heart disease in middle-aged men and women in the Atherosclerosis Risk in Communities (ARIC) study. *Circulation* 2004;109:837–842.
43. Caslake MJ, Packard CJ, Suckling KE, et al. Lipoprotein-associated phospholipase A(2), platelet-activating factor acetylhydrolase: a potential new risk factor for coronary artery disease. *Atherosclerosis* 2000;150:413–419.
44. Koenig W, Khuseynova N, Lowel H, et al. Lipoprotein-associated phospholipase A2 adds to risk prediction of incident coronary events by C-reactive protein in apparently healthy middle-aged men from the general population: results from the 14-year follow-up of a large cohort from southern Germany. *Circulation* 2004;110:1903–1908.
45. Rubattu S, Sciarretta S, Valenti V, et al. Natriuretic peptides: an update on bioactivity, potential therapeutic use, and implication in cardiovascular diseases. *Am J Hypertens* 2008.
46. Wei CM, Heublein DM, Perrella MA, et al. Natriuretic peptide system in human heart failure. *Circulation* 1993;88:1004–1009.
47. Cowie MR, Mendez GF. BNP and congestive heart failure. *Prog Cardiovasc Dis* 2002;44:293–321.
48. Lewandrowski K. Cardiac markers: the next opportunity of point-of care testing. *Clin Lab News* 2003;29:10–11.

Renal Function

Kara L. Lynch, Alan H. B. Wu

CHAPTER OUTLINE

■ RENAL ANATOMY

■ RENAL PHYSIOLOGY

Glomerular Filtration
Tubular Function
Elimination of Nonprotein Nitrogen Compounds
Water, Electrolyte, and Acid-Base Homeostasis
Endocrine Function
1,25-Dihydroxy Vitamin D₃

■ ANALYTIC PROCEDURES

Clearance Measurements
Urine Electrophoresis

β₂-Microglobulin
Myoglobin
Microalbumin
Urinalysis

■ PATHOPHYSIOLOGY

Glomerular Diseases
Tubular Diseases
Urinary Tract Infection/Obstruction
Renal Calculi
Renal Failure

■ REFERENCES

The kidneys are vital organs that perform a variety of important functions (Table 26-1). The most prominent functions are removal of unwanted substances from plasma (both waste and surplus), homeostasis (maintenance of equilibrium) of the body's water, electrolyte and acid-base status, and participation in hormonal regulation. In the clinical laboratory, kidney function tests are used in assessment of renal disease, water balance, and acid-base disorders and in situations of trauma, head injury, surgery, and infectious disease. This chapter focuses on renal anatomy and physiology and the analytic procedures available to diagnose, monitor, and treat kidney dysfunction.

RENAL ANATOMY

The kidneys are paired, bean-shaped organs located retroperitoneally on either side of the spinal column. Macroscopically, a fibrous capsule of connective tissue encloses each kidney. When dissected longitudinally, two regions can be clearly discerned—an outer region called the cortex and an inner region called the medulla (Fig. 26-1A). The pelvis can also be seen. It is a basin-like cavity at the upper end of the ureter into which newly formed urine passes. The bilateral ureters are thick-walled canals, connecting the kidneys to the urinary bladder. Urine is temporarily stored in the bladder until voided from the body by way of the urethra.

Figure 26-1B shows the arrangement of nephrons in the kidney, functional units of the kidney that can only be seen microscopically. Each kidney contains approximately 1 million nephrons. Each nephron is a complex apparatus comprised of five basic parts expressed diagrammatically in Figure 26-2.

- The **glomerulus**—a capillary tuft surrounded by the expanded end of a renal **tubule** known as Bowman's capsule. Each glomerulus is supplied by an afferent arteriole carrying the blood in and an efferent arteriole carrying the blood out. The efferent arteriole branches into peritubular capillaries that supply the tubule.
- The proximal convoluted tubule—located in the cortex.
- The long loop of Henle—composed of the thin descending limb, which spans the medulla, and the ascending limb, which is located in both the medulla and the cortex, composed of a region that is thin and then thick.
- The distal convoluted tubule—located in the cortex.
- The collecting duct—formed by two or more distal convoluted tubules as they pass back down through the cortex and the medulla to collect the urine that drains from each nephron. Collecting ducts eventually merge and empty their contents into the renal pelvis.

The following section describes how each part of the nephron normally functions.

TABLE 26-1 KIDNEY FUNCTIONS

| |
|---|
| Urine formation |
| Fluid and electrolyte balance |
| Regulation of acid-base balance |
| Excretion of the waste products of protein metabolism |
| Excretion of drugs and toxins |
| Secretion of hormones |
| Renin |
| Erythropoietin |
| 1,25-Dihydroxy vitamin D ₃ |
| Prostaglandins |

RENAL PHYSIOLOGY

There are three basic renal processes:

1. Glomerular filtration
2. Tubular reabsorption
3. Tubular secretion

Figure 26-3 illustrates how three different substances are variably processed by the nephron. Substance A is filtered and secreted, but not reabsorbed; substance B is filtered and a portion reabsorbed; and substance C is filtered and completely reabsorbed.¹ The following is a description of how specific substances are regulated in this manner to maintain homeostasis.

Glomerular Filtration

The glomerulus is the first part of the nephron and functions to filter incoming blood. Several factors facilitate filtration. One factor is the unusually high pressure in the glomerular capillaries, which is a result of their position between two arterioles. This sets up a steep pressure

difference across the walls. Another factor is the semipermeable glomerular basement membrane, which has a molecular size cutoff value of approximately 66,000 Da, about the molecular size of albumin. This means that water, electrolytes, and small dissolved solutes, such as glucose, amino acids, low-molecular-weight proteins, urea, and creatinine, pass freely through the basement membrane and enter the proximal convoluted tubule. Other blood constituents, such as albumin; many plasma proteins; cellular elements; and protein-bound substances, such as lipids and bilirubin, are too large to be filtered. In addition, because the basement membrane is negatively charged, negatively charged molecules, such as proteins, are repelled. Of the 1200–1500 mL of blood that the kidneys receive each minute (approximately one quarter of the total cardiac output), the glomerulus filters out 125–130 mL of an essentially protein-free, cell-free fluid, called *glomerular filtrate*. The volume of blood filtered per minute is the **glomerular filtration rate (GFR)**, and its determination is essential in evaluating renal function, as discussed in the section on Analytic Procedures.

Tubular Function

Proximal Convoluted Tubule

The proximal tubule is the next part of the nephron to receive the now cell-free and essentially protein-free blood. This filtrate contains waste products, which are toxic to the body above a certain concentration, and substances that are valuable to the body. One function of the proximal tubule is to return the bulk of each valuable substance back to the blood circulation. Thus, 75% of the water, sodium, and chloride; 100% of the glucose (up to the **renal threshold**); almost all of the amino acids, vitamins, and proteins; and varying amounts of urea, uric acid, and ions, such as magnesium, calcium, potassium,

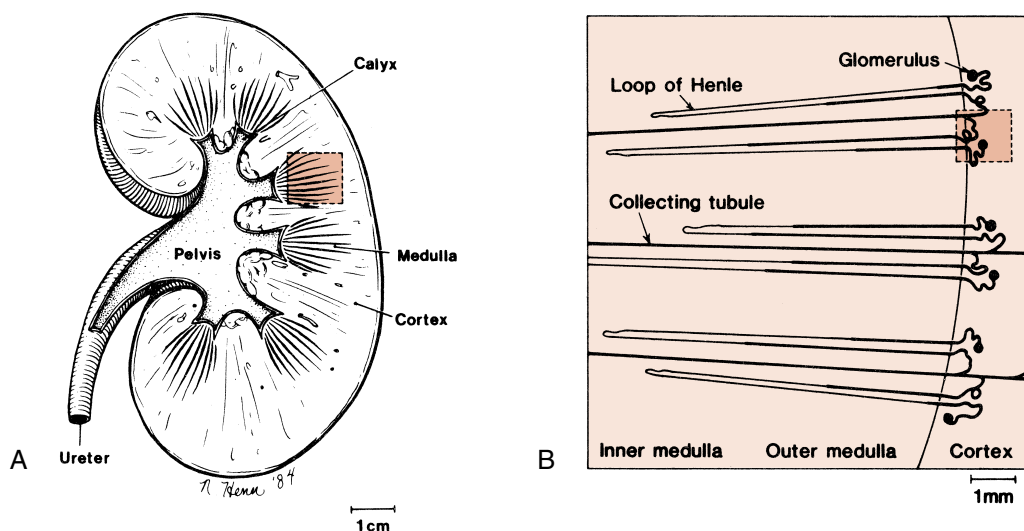

FIGURE 26-1. Anatomy of the kidney.

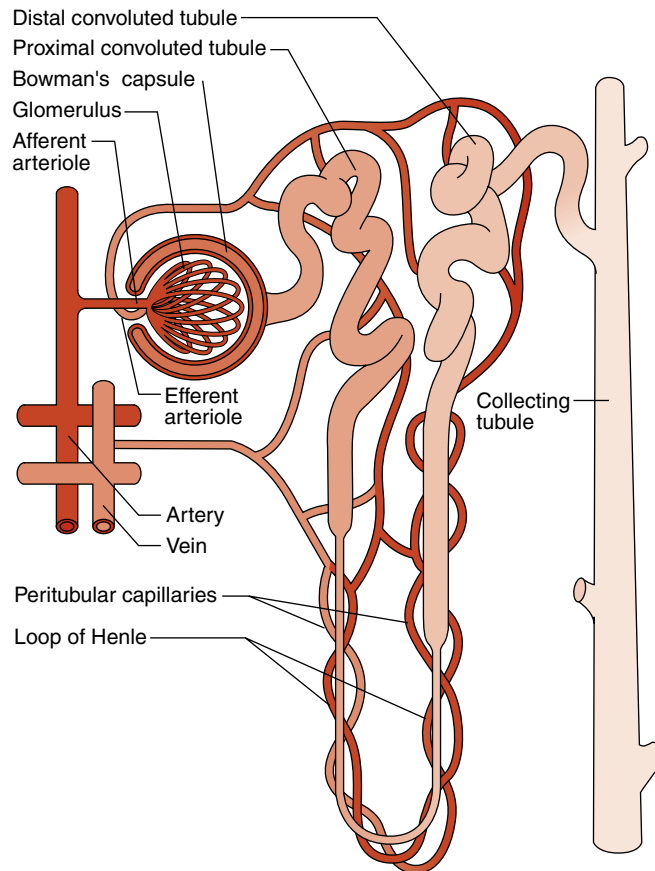

FIGURE 26-2. Representation of a nephron and its blood supply.

and bicarbonate, are reabsorbed. Almost all (98%–100%) of uric acid, a waste product, is actively reabsorbed, only to be secreted at the distal end of the proximal tubule.

When the substances move from the tubular lumen to the peritubular capillary plasma, the process is called **tubular reabsorption**. With the exception of water and chloride ions, the process is active; that is, the tubular epithelial cells use energy to bind and transport the substances across the plasma membrane to the blood. The transport processes that are involved normally have sufficient reserve for efficient reabsorption, but they are saturable. When the concentration of the filtered substance exceeds the capacity of the transport system, the

substance is then excreted in the urine. The plasma concentration above which the substance appears in urine is known as the renal threshold, and its determination is useful in assessing both tubular function and nonrenal disease states. A renal threshold does not exist for water because it is always transported passively through diffusion down a concentration gradient. Chloride ions in this instance diffuse in the wake of sodium.

A second function of the proximal tubule is to secrete products of kidney tubular cell metabolism, such as hydrogen ions, and drugs, such as penicillin. The term **tubular secretion** is used in two ways: (1) tubular secretion describes the movement of substances from

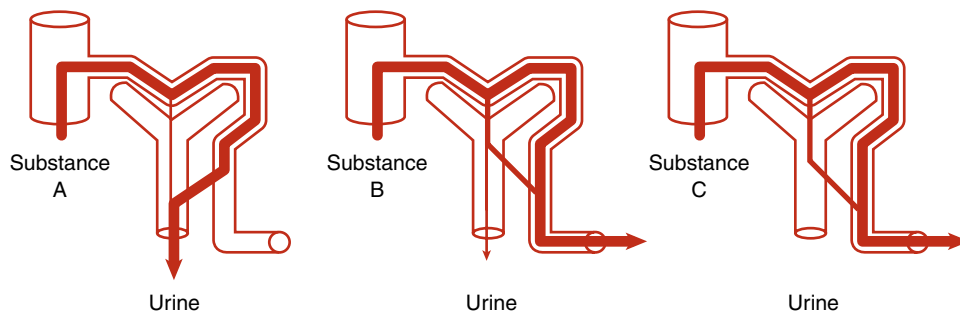

FIGURE 26-3. Renal processes of filtration, reabsorption, and secretion.

peritubular capillary plasma to the tubular lumen, and (2) tubular secretion also describes when tubule cells secrete products of their own cellular metabolism into the filtrate in the tubular lumen. Transport across the membrane of the cell is again either active or passive.

Loop of Henle

Countercurrent Multiplier System

The osmolality in the medulla in this portion of the nephron increases steadily from the corticomedullary junction inward and facilitates the reabsorption of water, sodium, and chloride. The hyperosmolality that develops in the medulla is continuously maintained by the loop of Henle, a hairpin-like loop between the proximal tubule and the distal convoluted tubule. The opposing flows in the loop, the downward flow in the descending limb, and the upward flow in the ascending limb, is termed a countercurrent flow. To understand how the hyperosmolality is maintained in the medulla, it is best to look first at what happens in the ascending limb. Sodium and chloride are actively and passively reabsorbed into the medulla interstitial fluid along the entire length of the ascending limb. Because the ascending limb is relatively impermeable to water, little water follows and the medulla interstitial fluid becomes hyperosmotic compared with the fluid in the ascending limb. The fluid in the ascending limb becomes hypotonic or dilute as sodium and chloride ions are reabsorbed with-

out the loss of water, so the ascending limb is often called the diluting segment. The descending limb, in contrast to the ascending limb, is highly permeable to water and does not reabsorb sodium and chloride. The high osmolality of the surrounding interstitial medulla fluid is the physical force that accelerates the reabsorption of water from the filtrate in the descending limb. Interstitial hyperosmolality is maintained because the ascending limb continues to pump sodium and chloride ions into it. This interaction of water leaving the descending loop and sodium and chloride leaving the ascending loop to maintain a high osmolality within the kidney medulla produces hypoosmolal urine as it leaves the loop. This process is called the countercurrent multiplier system.²

Distal Convoluted Tubule

The distal convoluted tubule is much shorter than the proximal tubule, with two or three coils that connect to a collecting duct. The filtrate entering this section of the nephron is close to its final composition. About 95% of the sodium and chloride ions and 90% of water have already been reabsorbed from the original glomerular filtrate. The function of the distal tubule is to effect small adjustments to achieve electrolyte and acid-base homeostasis. These adjustments occur under the hormonal control of both **antidiuretic hormone (ADH)** and **aldosterone**. Figure 26-4 describes the action of these hormones.

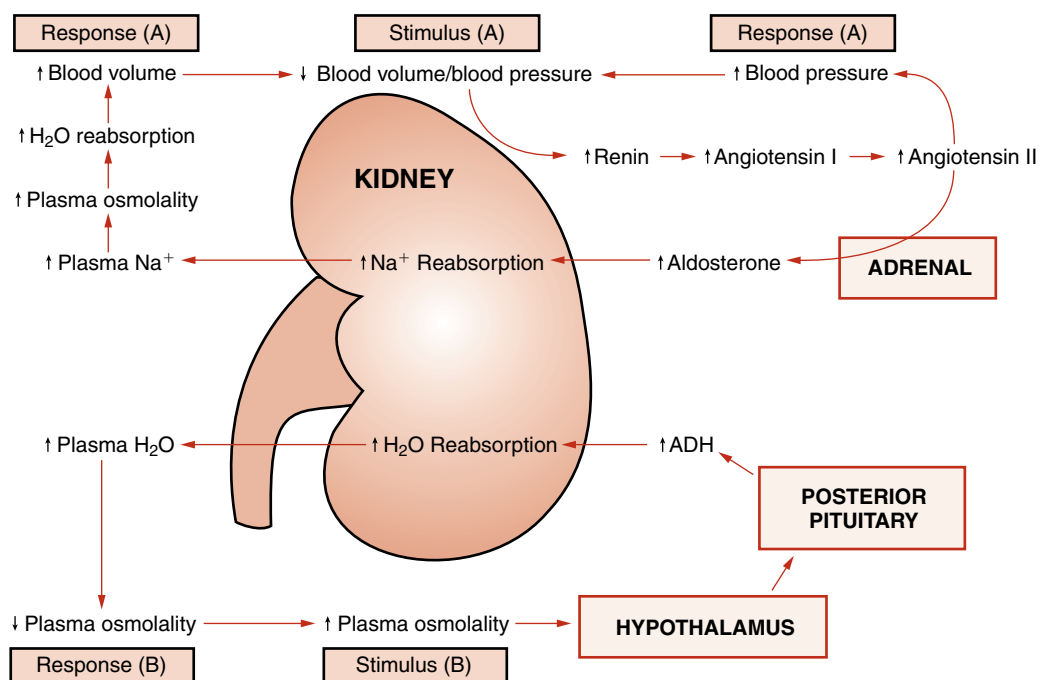

FIGURE 26-4. ADH and aldosterone control of the renal reabsorption of water and Na⁺. (Reprinted with permission from Kaplan A, et al. The kidney and tests of renal function. In: Kaplan A, Jack R, Orpheim KE, et al, eds. Clinical chemistry: interpretation and techniques. 4th ed. Baltimore, Md.: Williams & Wilkins, 1995:158, Figure 6.2.)

ADH

ADH is a peptide hormone secreted by the posterior pituitary, mainly in response to increased blood osmolality; ADH is also released when blood volume decreases by more than 5%–10%. Large decreases of blood volume will stimulate ADH secretion even when plasma osmolality is decreased.³ ADH stimulates water reabsorption. The walls of the distal collecting tubules are normally impermeable to water (like the ascending loop of Henle), but they become permeable to water in ADH. Water diffuses passively from the lumen of the tubules, resulting in more concentrated urine and decreased plasma osmolality.

Aldosterone

This hormone is produced by the adrenal cortex under the influence of the **renin–angiotensin** mechanism. Its secretion is triggered by decreased blood flow or blood pressure in the afferent renal arteriole and by decreased plasma sodium. Aldosterone stimulates sodium reabsorption in the distal tubules and potassium and hydrogen ion secretion. Hydrogen ion secretion is linked to bicarbonate regeneration and ammonia secretion, which also occur here. In addition to these ions, small amounts of chloride ions are reabsorbed.

Collecting Duct

The collecting ducts are the final site for either concentrating or diluting urine. The hormones ADH and aldosterone act on this segment of the nephron to control reabsorption of water and sodium. Chloride and urea are also reabsorbed here. Urea plays an important role in maintaining the hyperosmolality of the renal medulla. Because the collecting ducts in the medulla are highly permeable to urea, urea diffuses down its concentration gradient out of the tubule and into the medulla interstitium, increasing its osmolality.⁴

Elimination of Nonprotein Nitrogen Compounds

Nonprotein nitrogen compounds (NPNs) are waste products formed in the body as a result of the degradative metabolism of nucleic acids, amino acids, and proteins. Excretion of these compounds is an important function of the kidneys. The three principal compounds are urea, creatinine, and uric acid.^{5,6} For a more detailed treatment of their biochemistry and disease correlations, see Chapter 11.

Urea

Urea makes up the majority (more than 75%) of the NPN waste excreted daily as a result of the oxidative catabolism of protein. Urea synthesis occurs in the liver. Proteins are broken down to amino acids, which are then deaminated to form ammonia. Ammonia is readily converted to urea,

avoiding toxicity. The kidney is the only significant route of excretion for urea. It has a molecular weight of 60 Da and, therefore, is readily filtered by the glomerulus. In the collecting ducts, 40%–60% of urea is reabsorbed. The reabsorbed urea contributes to the high osmolality in the medulla, which is one of the processes of urinary concentration mentioned earlier (see Loop of Henle).

Creatinine

Muscle contains creatine phosphate, a high-energy compound for the rapid formation of adenosine triphosphate (ATP). This reaction is catalyzed by creatine kinase (CK) and is the first source of metabolic fuel used in muscle contraction. Creatinine is formed from creatine as shown below.

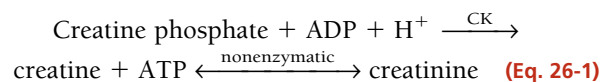

Every day, up to 20% of total muscle creatine (and its phosphate) spontaneously dehydrates and cycles to form the waste product creatinine. Therefore, creatinine levels are a function of muscle mass and remain approximately the same in an individual from day-to-day unless muscle mass or renal function changes. Creatinine has a molecular weight of 113 Da and is, therefore, readily filtered by the glomerulus. Unlike urea, creatinine is not reabsorbed by the tubules. However, a small amount of creatinine is secreted by the kidney tubules at high serum concentrations.

Uric Acid

Uric acid is the primary waste product of purine metabolism. The purines, adenine and guanine, are precursors of nucleic acids ATP and guanosine triphosphate (GTP), respectively. Uric acid has a molecular weight of 168 Da. Like creatinine, it is readily filtered by the glomerulus, but it then undergoes a complex cycle of reabsorption and secretion as it courses through the nephron. Only 6%–12% of the original filtered uric acid is finally excreted. Uric acid exists in its ionized and more soluble form, usually sodium urate, at urinary pH >5.75 (the first pK_a of uric acid). At pH <5.75, it is undissociated. This fact has clinical significance in the development of urolithiasis (formation of calculi) and gout.

Water, Electrolyte, and Acid-Base Homeostasis

Water Balance

The kidney's contribution to water balance in the body is through water loss or water conservation, which is regulated by the hormone ADH. ADH responds primarily to changes in osmolality and intravascular volume. Increased plasma osmolality or decreased intravascular volume stimulates secretion of ADH from the posterior

pituitary. ADH then increases the permeability of the distal convoluted tubules and collecting ducts to water, resulting in increased water reabsorption and excretion of more concentrated urine. In contrast, the major system regulating water intake is thirst, which appears to be triggered by the same stimuli that trigger ADH secretion.

In states of dehydration, the renal tubules reabsorb water at their maximal rate, resulting in production of a small amount of maximally concentrated urine (high urine osmolality, 1200 mOsm/L).⁷ In states of water excess, the tubules reabsorb water at only a minimal rate, resulting in excretion of a large volume of extremely dilute urine (low urine osmolality, down to 50 mOsm/L).⁸⁻¹⁰ The continuous fine-tuning possible between these two extreme states results in the precise control of fluid balance in the body (Fig. 26-5).

Electrolyte Balance

The following is a brief overview of the notable ions involved in maintenance of electrolyte balance within the body. For a more comprehensive treatment of this subject, refer to Chapter 15.

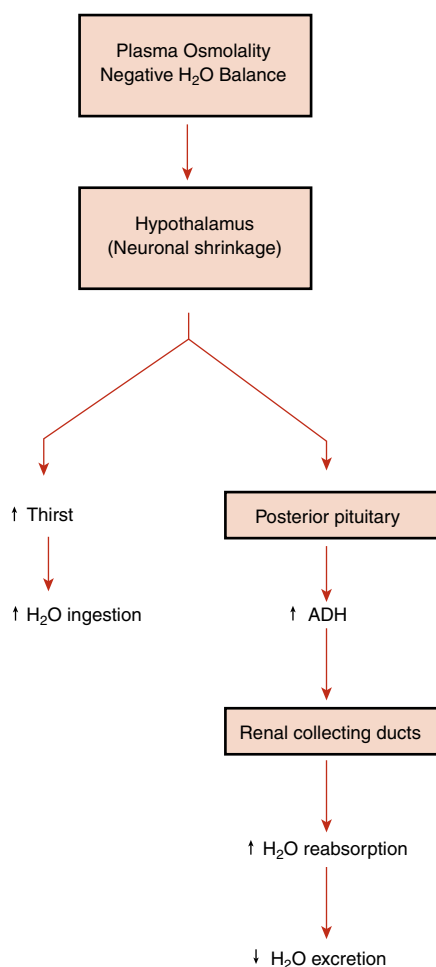

FIGURE 26-5. ADH control of thirst mechanism.

Sodium

Sodium is the primary extracellular cation in the human body and is excreted principally through the kidneys. Sodium balance in the body is controlled only through excretion. The renin-angiotensin-aldosterone hormonal system is the major mechanism for control of sodium balance.

Potassium

Potassium is the main intracellular cation in the body. The precise regulation of its concentration is of extreme importance to cellular metabolism and is controlled chiefly by renal means. Like sodium, it is freely filtered by the glomerulus and then actively reabsorbed throughout the entire nephron (except for the descending limb of the loop of Henle). Both the distal convoluted tubule and the collecting ducts can reabsorb and excrete potassium, and this excretion is controlled by aldosterone. Potassium ions can compete with hydrogen ions in their exchange with sodium (in the proximal convoluted tubule); this process is used by the body to conserve hydrogen ions and, thereby, compensate in states of metabolic alkalosis.

Chloride

Chloride is the principal extracellular anion and is involved in the maintenance of extracellular fluid balance. It is readily filtered by the glomerulus and is passively reabsorbed as a counter ion when sodium is reabsorbed in the proximal convoluted tubule. In the ascending limb of the loop of Henle, potassium is actively reabsorbed by a distinct chloride “pump,” which also reabsorbs sodium. This pump can be inhibited by loop diuretics, such as furosemide. As expected, the regulation of chloride is controlled by the same forces that regulate sodium.^{7,10}

Phosphate, Calcium, and Magnesium

The phosphate ion occurs in higher concentrations in the intracellular than in the extracellular fluid environments. It exists as either a protein-bound or a non-protein-bound form; homeostatic balance is chiefly determined by proximal tubular reabsorption under the control of parathyroid hormone (PTH). Calcium, the second-most predominant intracellular cation, is the most important inorganic messenger in the cell. It also exists in protein-bound and non-protein-bound states. Calcium in the non-protein-bound form is either ionized and physiologically active or nonionized and complexed to small, diffusible ions, such as phosphate and bicarbonate. The ionized form is freely filtered by the glomerulus and reabsorbed in the tubules under the control of PTH. However, renal control of calcium concentration is not the major means of regulation. PTH- and calcitonin-controlled regulation of calcium absorption from the gut and bone stores is more important than

renal secretion or reabsorption. Magnesium, a major intracellular cation, is important as an enzymatic cofactor. Like phosphate and calcium, it exists in both protein-bound and ionized states. The ionized fraction is easily filtered by the glomerulus and reabsorbed in the tubules under the influence of PTH. See Chapter 23 for more detailed information.

Acid-Base Balance

Many nonvolatile acidic waste products are formed by normal body metabolism each day. Carbonic acid, lactic acid, ketoacids, and others must be continually transported in the plasma and excreted from the body, causing only minor alterations in physiologic pH. The renal system constitutes one of three means by which constant control of overall body pH is accomplished. The other two strategies involved in this regulation are the respiratory system and the acid-base buffering system.¹¹

The kidneys manage their share of the responsibility for controlling body pH by dual means: conserving bicarbonate ions and removing metabolic acids. For a more in-depth examination of these processes, refer to Chapter 16.

Regeneration of Bicarbonate Ions

In a complicated process, bicarbonate ions are first filtered out of the plasma by the glomerulus. In the lumen of the renal tubules, this bicarbonate combines with hydrogen ions to form carbonic acid, which subsequently degrades to carbon dioxide (CO₂) and water. This CO₂ then diffuses into the brush border of the proximal tubular cells, where it is reconverted by carbonic anhydrase to carbonic acid and then degrades back to hydrogen ions and regenerated bicarbonate ions. This reaction is detailed as follows:

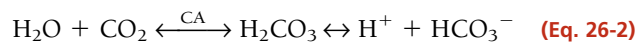

This regenerated bicarbonate is transported into the blood to replace what was depleted by metabolism; the accompanying hydrogen ions are secreted back into the tubular lumen and, from there, they enter the urine. Filtered bicarbonate is “reabsorbed” into the circulation, helping to return blood pH to its optimal level and effectively functioning as another buffering system.

Excretion of Metabolic Acids

Hydrogen ions are manufactured in the renal tubules as part of the regeneration mechanism for bicarbonate. These hydrogen ions, as well as others that are dissociated from nonvolatile organic acids, are disposed of by several different reactions with buffer bases.

Reaction With Ammonia (NH₃)

The glomerulus does not filter NH₃. However, this substance is formed in the renal tubules when the amino acid glutamine is deaminated by glutaminase. This NH₃ then reacts with secreted hydrogen ions to form ammo-

nium ions (NH₄⁺), which are unable to readily diffuse out of the tubular lumen and, therefore, are excreted into the urine.

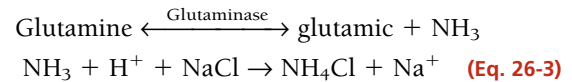

This mode of acid excretion is the primary means by which the kidneys compensate for states of metabolic acidosis.

Reaction With Monohydrogen Phosphate (HPO₄²⁻)

Phosphate ions filtered by the glomerulus can exist in the tubular fluid as disodium hydrogen phosphate (Na₂HPO₄) (dibasic). This compound can react with hydrogen ions to yield dihydrogen phosphate (monobasic), which is then excreted. The released sodium then combines with bicarbonate to yield sodium bicarbonate and is reabsorbed.

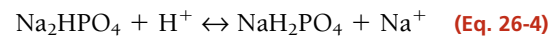

These mechanisms can excrete increasing amounts of metabolic acid until a maximum urine pH of approximately 4.4 is reached. After this, renal compensation is unable to adjust to any further decreases in blood pH and metabolic acidosis ensues. Few free hydrogen ions are excreted directly in the urine.

Endocrine Function

In addition to numerous excretory and regulatory functions, the kidney has endocrine functions as well. It is both a primary endocrine site, as the producer of its own hormones, and a secondary site, as the target locus for hormones manufactured by other endocrine organs. The kidneys synthesize renin, **erythropoietin**, 1,25-dihydroxy vitamin D₃, and the **prostaglandins**.

Renin

Renin is the initial component of the renin-angiotensin-aldosterone system. Renin is produced by the juxtaglomerular cells of the renal medulla when extracellular fluid volume or blood pressure decreases. It catalyzes the synthesis of angiotensin by cleavage of the circulating plasma precursor angiotensinogen. Angiotensin is converted to angiotensin II by angiotensin-converting enzyme (ACE). Angiotensin II is a powerful vasoconstrictor that increases blood pressure and stimulates release of aldosterone from the adrenal cortex. Aldosterone, in turn, promotes sodium reabsorption and water conservation.^{8,10} For a more detailed look at the complexities of this feedback loop, see Chapter 20.

Erythropoietin

Erythropoietin is a single-chain polypeptide produced by cells close to the proximal tubules, and its production is regulated by blood oxygen levels. Hypoxia produces

increased serum concentrations within 2 hours. Erythropoietin acts on the erythroid progenitor cells in the bone marrow, increasing the number of red blood cells (RBCs). In chronic renal insufficiency, erythropoietin production is significantly reduced. Recently, recombinant human erythropoietin has been developed and is in routine use in chronic renal failure patients. Before this therapy, anemia was a clinical reality in these patients.^{5,8} Erythropoietin concentrations in blood can be measured by immunoassays.

1,25-Dihydroxy Vitamin D₃

The kidneys are the sites of formation of the active form of **vitamin D**; 1,25 (OH)₂ vitamin D₃.^{3,5} This form of vitamin D is one of three major hormones that determine phosphate and calcium balance and bone calcification in the human body. Chronic renal insufficiency is, therefore, often associated with osteomalacia (inadequate bone calcification, the adult form of rickets), owing to the continual distortion of normal vitamin D metabolism.

Prostaglandins

The prostaglandins are a group of potent cyclic fatty acids formed from essential (dietary) fatty acids, primarily arachidonic acid. They are formed in almost all tissue and their actions are diverse. The prostaglandins produced by the kidneys increase renal blood flow, sodium and water excretion, and renin release. They act to oppose renal vasoconstriction due to angiotensin and norepinephrine.

ANALYTIC PROCEDURES

Several tests are available that assess the various aspects of nephron function, including glomerular filtration and proximal and distal tubular secretion and reabsorption.

Clearance Measurements

All laboratory methods used for evaluation of renal function rely on the measurement of waste products in blood, usually urea and creatinine, which accumulate when the kidneys begin to fail. Renal failure must be advanced, with only about 20%–30% of the nephrons still functioning, before the concentration of either substance begins to increase in the blood. The rate at which creatinine and urea are removed or cleared from the blood into the urine is termed clearance. Clearance is defined as that volume of plasma from which a measured amount of substance can be completely eliminated into the urine per unit of time expressed in milliliters per minute.⁵ Measurement of clearance is used to estimate the rate of glomerular filtration.

Creatinine

Creatinine is a nearly ideal substance for the measurement of clearance. It is an endogenous metabolic product

synthesized at a constant rate for a given individual and cleared essentially only by glomerular filtration. It is not reabsorbed and is only slightly secreted by the proximal tubule. Serum creatinine levels are higher in males than females due to the direct correlation with muscle mass. Analysis of creatinine is simple and inexpensive using colorimetric assays, however, different methods for assaying plasma creatinine, such as kinetic or enzymatic assays, have varying degrees of accuracy and imprecision (see Chapter 11).

Creatinine Clearance and Glomerular Filtration Rate

Calculation of **creatinine clearance** has become the standard laboratory method to determine GFR. This value is derived by mathematically relating the serum creatinine concentration to the urine creatinine concentration excreted during a period of time, usually 24 hours. Specimen collection, therefore, must include both a 24-hour urine specimen and a serum creatinine value, ideally collected at the midpoint of the 24-hour urine collection. The urine container (clean, dry, and free of contaminants or preservatives) must be kept refrigerated throughout the duration of both the collection procedure and the subsequent storage period until laboratory analysis can be performed. The concentration of creatinine in both serum and urine is measured by the applicable methods discussed in Chapter 11. The total volume of urine is carefully measured, and the creatinine clearance is calculated using the following formula:

$$\frac{U_{Cr} \text{ (mg/dL)} \times V_{Ur} \text{ (mL/24 hour)}}{P_{Cr} \text{ (mg/dL)} \times 1440 \text{ minutes/24 hours}} \times \frac{1.73}{A} \quad (\text{Eq. 26-5})$$

where C_{Cr} is creatinine clearance, U_{Cr} is urine creatinine clearance, V_{Ur} is urine volume excreted in 24 hours, P_{Cr} is serum creatinine concentration, and $1.73/A$ is normalization factor for body surface area (1.73 is the generally accepted average body surface in square meters and A is the actual body surface area of the individual determined from height and weight). If the patient's body surface area varies greatly from the average (e.g., obese or pediatric patients), this correction for body mass must be included in the formula. Nomograms for the more exact determination of body surface area from weight and height values can be found in Appendix E.

Reference Ranges for Creatinine Clearance

Males: 97 mL/min per 1.73 m² to 137 mL/min per 1.73 m²

Females: 88 mL/min per 1.73 m² to 128 mL/min per 1.73 m²

Creatinine clearance normally decreases with age, with a decrease of about 6.5 mL/min per 1.73 m² for each decade of life.

Estimated Glomerular Filtration Rate

The National Kidney Foundation recommends that estimated GFR (EGFR) be calculated each time a serum creatinine level is reported. (Additional information is available at the National Kidney Foundation Web site: <http://www.kidney.org/>.) The equation is used to predict GFR and is based on serum creatinine, age, body size, gender, and race, without the need of a urine creatinine. Because the calculation does not require a timed urine collection, it should be used more often than the traditional creatinine clearance and result in earlier detection of **chronic kidney disease**. See Chronic Kidney Disease later for interpretation of GFR (usually by EGFR).¹²

$$\text{GFR (mL/min)} = \frac{(140 - \text{Age}) \times \text{Weight(kg)}}{72 \times S_{\text{Cr}}(\text{mg/dL})} \times (0.85 \text{ if female})^* \quad (\text{Eq. 26-6})$$

Urea

Urea clearance was one of the first clearance tests performed. Urea is freely filtered at the glomerulus and approximately 40% reabsorbed by the tubules. For this reason, it does not provide a full clearance assessment and is no longer widely used. Older clearance tests used administration of inulin, sodium [¹²⁵I]iothalamate, or *p*-aminohippurate to assess glomerular filtration or tubular secretion. These tests are time consuming, expensive, and difficult to administer and, for the most part, have been discontinued.

Cystatin C

Cystatin C is a low-molecular-weight protein produced by nucleated cells. It is freely filtered by the glomerulus, reabsorbed, and catabolized by the proximal tubule. Produced at a constant rate, levels remain stable if kidney function is normal. Plasma concentrations appear to be unaffected by gender, race, age, and muscle mass. Studies have shown measurement of cystatin C to be at least as useful as serum creatinine and creatinine clearance in detecting early changes in kidney function. A rise in cystatin C is often detectable before there is a measurable decrease in GFR or increase in creatinine. Cystatin C can be measured by immunoassay methods.¹³

Biologic Variation

When the same test is performed on various individuals, we find that the mean of each person's results is not the same, showing that individual homeostatic setting points often vary. Biologic variation is defined as the random fluctuation around a homeostatic setting point.¹⁴ This includes the fluctuation around the homeostatic setting point for a single individual, termed within-subject biologic variation, and differences between the homeostatic setting points of multiple individuals, termed between-subject biologic variation. In the case of creatinine, levels for an individual differ slightly over time, and the mean

values of all individuals vary significantly from each other. Therefore, each individual's results span only a small portion of the population-based reference interval. This means that for creatinine, within-subject biologic variation is less than between-subject biological variation. When this is true of a given analyte, the analyte is said to have marked individuality. Interestingly, the between-subject biologic variation is much smaller for cystatin C compared with creatinine showing that population-based reference values are more useful for cystatin C compared with creatinine. However, the within-subject variation is greater for cystatin C compared with creatinine. As a result, creatinine is more helpful in monitoring renal function over time for a given individual whereas, cystatin C is potentially more useful for detecting minor renal impairment.

Urine Electrophoresis

Owing to the efficiency of renal glomerular filtration and tubular reabsorption, normal urinary protein excretion is only about 50–150 mg every 24 hours. Proteinuria may develop when there are defects in renal reabsorption or glomerular capillary permeability or when there is a significant increase in serum immunoglobulins. As a result, urine electrophoresis is used primarily to distinguish between acute glomerular nephropathy and tubular proteinuria. It is also used to screen for abnormal monoclonal or polyclonal globulins. Positive identification and subtyping of the urinary paraproteins can be performed by immunofixation electrophoresis.

β₂-Microglobulin

β₂-Microglobulin (β₂-M) is a small, nonglycosylated peptide (molecular weight, 11,800 Da) found on the surface of most nucleated cells. The plasma membrane sheds β₂-M as a relatively intact molecule into the surrounding extracellular fluid. Because this process is fairly constant in adults; levels of β₂-M remain stable in normal patients. Elevated levels in serum indicate increased cellular turnover as seen in myeloproliferative and lymphoproliferative disorders, inflammation, and renal failure. As a small, endogenous peptide, β₂-M is easily filtered by the glomerulus. About 99.9% is then reabsorbed by the proximal tubules and catabolized. Measurement of serum β₂-M is used clinically to assess renal tubular function in renal transplant patients, with elevated levels indicating organ rejection. β₂-M has been found in some studies to be a more efficient marker of renal transplant rejection than serum creatinine values because it does not depend on lean muscle mass or daily variation in excretion.^{15,16}

Myoglobin

Myoglobin is a low-molecular-weight protein (16,900 Da) associated with acute skeletal and cardiac muscle injury. Myoglobin functions to bind and transport oxygen

from the plasma membrane to the mitochondria in muscle cells. In **rhabdomyolysis**, myoglobin release from skeletal muscle is sufficient to overload the proximal tubules and cause **acute renal failure**. Early diagnosis and aggressive treatment of elevated myoglobin may prevent or lessen the severity of renal failure. Myoglobin clearance has been proposed as an effective early indicator of myoglobin-induced acute renal failure. A high clearance or a low clearance and low serum concentration indicates low risk and a low clearance and high serum concentration indicates high risk.¹⁷ Serum and urine myoglobin can be measured easily and rapidly by immunoassays. Urine myoglobin can also be measured by dipstick methods after removing hemoglobin, but this method has a lack of sensitivity and specificity.

Microalbumin

The term *microalbuminuria* describes small amounts of albumin in urine. Urine **microalbumin** measurement is important in the management of patients with **diabetes mellitus**, who are at serious risk of developing nephropathy over their lifetimes. Type 1 has a 30%–45% risk, and type 2 has a 30% risk. In the early stages of nephropathy, there is renal hypertrophy, hyperfunction, and increased thickness of the glomerular and tubular basement membranes. In this early stage, there are no overt signs of renal dysfunction. In the next 7–10 years, there is progression to glomerulosclerosis, with increased glomerular capillary permeability. This permeability allows small (micro) amounts of albumin to pass into the urine. If detected in this early phase, rigid glucose control, along with treatment to prevent hypertension, can be instituted and progression to end-stage renal disease (ESRD) prevented.¹⁸ The American Diabetes Association's criteria for the frequency of testing of all persons with diabetes for urinary albumin recommend testing at initial patient evaluation and yearly thereafter for all postpubertal patients who have had diabetes for at least 5 years.¹⁹

Quantitative albumin-specific immunoassays, usually using nephelometry or immunoturbidimetry, are widely used. Urinary albumin concentrations of 50–200 mg every 24 hours are predictive of diabetic nephropathy.²⁰ A 24-hour urine collection is preferred, but a random urine sample that uses a ratio of albumin to creatinine can be also be used. An albumin/creatinine ratio of 20–30 mg/g is indicative of microalbuminuria.²¹ Although many urine dipstick methods are not sensitive enough to detect these low levels of albumin, newer dipstick methods are now available for specific detection of albumin and the albumin/creatinine ratio.

Urinalysis

Urinalysis (UA) permits a detailed, in-depth assessment of renal status with an easily obtained specimen. UA also

serves as a quick indicator of an individual's glucose status and hepatic-biliary function. Routine UA includes assessment of physical characteristics, chemical analyses, and a microscopic examination of the sediment from a (random) urine specimen.

Physical Characteristics

Specimen Collection

The importance of a properly collected and stored specimen for UA cannot be overemphasized. Initial morning specimens are preferred, particularly for protein analyses, because they are more concentrated from overnight retention in the bladder. The specimen should be obtained by a clean midstream catch or catheterization. The urine should be freshly collected into a clean, dry container with a tight-fitting cover. It must be analyzed within 1 hour of collection if held at room temperature or else refrigerated at 2°–8°C for not more than 8 hours before analysis. If not assayed within these time limits, several changes will occur. Bacterial multiplication will cause false-positive nitrite tests, and urease-producing organisms will degrade urea to ammonia and alkalize the pH. Loss of CO₂ by diffusion into the air adds to this pH elevation, which, in turn, causes cast degeneration and red-cell lysis.

The urine container must be sterile if the urine is to be cultured. Specimens for routine UA are usually random, or spot, collections.

Visual Appearance

Color intensity of urine correlates with concentration: the darker the color, the more concentrated is the specimen. The various colors observed in urine are a result of different excreted pigments. Yellow and amber are generally due to urochromes (derivatives of urobilin, the end product of bilirubin degradation), whereas a yellowish-brown to green color is a result of bile pigment oxidation. Red and brown after standing are due to porphyrins, whereas reddish-brown in fresh specimens comes from hemoglobin or red cells. Brownish-black after standing is seen in alkaptonuria (a result of excreted homogentisic acid) and in malignant melanoma (in which the precursor melanogen oxidizes in the air to melanin). Drugs and some foods, such as beets, also may alter urine color.

Odor

Odor ordinarily has little diagnostic significance. The characteristic pungent odor of fresh urine is due to volatile aromatic acids, in contrast to the typical ammonia odor of urine that has been allowed to stand. Urinary tract infections impart a noxious, fecal smell to urine, whereas the urine of diabetics often smells fruity as a result of ketones. Certain inborn errors of metabolism, such as maple sugar urine disease, are associated with characteristic urine odors.

Turbidity

The cloudiness of a urine specimen depends on pH and dissolved solids composition. Turbidity generally may be due to gross bacteriuria, whereas a smoky appearance is seen in hematuria. Threadlike cloudiness is observed when the specimen is full of mucus. In alkaline urine, suspended precipitates of amorphous phosphates and carbonates may be responsible for turbidity, whereas in acidic urine, amorphous urates may be the cause.¹⁵

Volume

The volume of urine excreted indicates the balance between fluid ingestion and water lost from the lungs, sweat, and intestine. Most adults produce from 750 to 2,000 mL every 24 hours, averaging about 1.5 L per person. (For a routine UA, a 10–12-mL aliquot from a well-mixed sample is optimal for accurate analysis of sedimentary constituents.) Polyuria is observed in diabetes mellitus and insipidus (in insipidus, as a result of lack of ADH), as well as in chronic renal disease, acromegaly (overproduction of the growth hormone somatostatin), and myxedema (hypothyroid edema). Anuria or oliguria (<200 mL/day) is found in nephritis, ESRD, urinary tract obstruction, and acute renal failure.

Specific Gravity

The specific gravity (SG) of urine is the weight of 1 mL of urine in grams divided by the weight of 1 mL of water. SG gives an indication of the density of a fluid that depends on the concentration of dissolved total solids. SG varies with the solute load to be excreted (consisting primarily of NaCl and urea), as well as with the urine volume. It is used to assess the state of hydration/dehydration of an individual or as an indicator of the concentrating ability of the kidneys.

Laboratory Methods

The most commonly encountered analytic method consists of a refractometer, or total solids meter. This operates on the principle that the refractive index of a urine specimen will vary directly with the total amount of dissolved solids in the sample. This instrument measures the refractive index of the urine as compared with water on a scale that is calibrated directly into the ocular and viewed while held up to a light source. Correct calibration is vital for accuracy. Most recently, an indirect colorimetric reagent strip method for assaying SG has been added to most dipstick screens. Unlike the refractometer, dipsticks measure only ionic solutes and do not take into account glucose or protein.

Disease Correlation

The normal range for urinary SG is 1.005–1.030. Dilute specimens are classified in the range of 1.000–1.010, whereas concentrated samples fall between 1.025 and 1.030. SG can vary in pathologic states. Low SG can occur in diabetes insipidus, in which it may never exceed the

range of 1.001–1.003, and in pyelonephritis and **glomerulonephritis**, in which the renal concentrating ability has become dysfunctional. High SG can be seen in diabetes mellitus, congestive heart failure, dehydration, adrenal insufficiency, liver disease, and nephrosis. SG will increase about 0.004 unit for every 1% change in glucose concentration and about 0.003 units for every 1% change in protein. Fixed SG (isosthenuria) around 1.010 is observed in severe renal damage, in which the kidney excretes urine that is iso-osmotic with the plasma. This generally occurs after an initial period of anuria because the damaged tubules are unable to concentrate or dilute the glomerular filtrate.^{9,15}

pH

Determinations of urinary pH must be performed on fresh specimens because of the significant tendency of urine to alkalize on standing. Normal urine pH falls within the range of 4.5–8.0. Acidity in urine (pH <7.0) is primarily caused by phosphates, which are excreted as salts conjugated to Na⁺, K⁺, Ca²⁺, and NH₄⁺. Acidity also reflects the excretion of the nonvolatile metabolic acids pyruvate, lactate, and citrate. Owing to the Na⁺/H⁺ exchange pump mechanism of the renal tubules, pH (H⁺ concentration) increases as sodium is retained. Pathologic states, in which increased acidity is observed, include systemic acidosis, as seen in diabetes mellitus, and renal tubular acidosis. In renal tubular acidosis, the tubules are unable to excrete excess H⁺ even though the body is in metabolic acidosis, and urinary pH remains around 6.

Alkaline urine (pH >7.0) is observed postprandially as a normal reaction to the acidity of gastric HCl dumped into the duodenum and then into the circulation or following ingestion of alkaline food or medications. Urinary tract infections and bacterial contamination also will alkalize pH. Medications such as potassium citrate and sodium bicarbonate will reduce urine pH. Alkaline urine is also found in Fanconi's syndrome, a congenital generalized aminoaciduria resulting from defective proximal tubular function.

Chemical Analyses

Routine urine chemical analysis is rapid and easily performed with commercially available reagent strips or dipsticks. These strips are plastic coated with different reagent bands directed toward different analytes. When dipped into urine, a color change signals a deviation from normality. Colors on the dipstick bands are matched against a color chart provided with the reagents. Automated and semiautomated instruments that detect by reflectance photometry provide an alternative to the color chart and offer better precision and standardization. Abnormal results are followed up by specific quantitative or confirmatory urine assays. The analytes routinely tested are glucose, protein, ketones, nitrite, leukocyte esterase, bilirubin/urobilinogen, and hemoglobin/blood.

Glucose and Ketones

These constituents are normally absent in urine. The clinical significance of these analytes and their testing methods are discussed in Chapter 13.

Protein

Reagent strips for UA are used as a general qualitative screen for proteinuria. They are primarily specific for albumin, but they may give false-positive results in specimens that are alkaline and highly buffered. Positive dipstick results should be confirmed by more specific chemical assays, as described in Chapter 10, or more commonly by microscopic evaluation to detect casts.

Nitrite

This assay semiquantitates the amount of urinary reduction of nitrate (on the reagent strip pad) to nitrite by the enzymes of gram-negative bacteria. This scheme is shown in the following reaction:

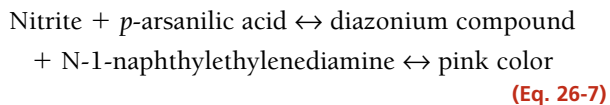

A negative result does not mean that no bacteriuria is present. A gram-positive pathogen, such as *Staphylococcus*, *Enterococcus*, or *Streptococcus*, may not produce nitrate-reducing enzymes; alternatively, a spot urine sample may not have been retained in the bladder long enough to pick up a sufficient number of organisms to register on the reagent strip.¹⁵

Leukocyte Esterase

White blood cells (WBCs), especially phagocytes, contain esterases. A positive dipstick for esterases indicates possible WBCs in urine.

Bilirubin/Urobilinogen

Hemoglobin degradation ultimately results in the formation of the waste product bilirubin, which is then converted to urobilinogen in the gut through bacterial action. Although most of this urobilinogen is excreted as urobilin in the feces, some is excreted in urine as a colorless waste product. This amount is normally too small to be detected as a positive dipstick reaction. In conditions of prehepatic, hepatic, and posthepatic jaundice, however, urine dipstick tests for urobilinogen and bilirubin may be positive or negative, depending on the nature of the patient's jaundice. A more in-depth view of bilirubin metabolism and assay methods is given in Chapter 24. Reagent strip tests for bilirubin involve diazotization and formation of a color change. Dipstick methods for urobilinogen differ, but most rely on a modification of the Ehrlich reaction with *p*-dimethylaminobenzaldehyde.¹⁵

Hemoglobin/Blood

Intact or lysed RBCs produce a positive dipstick result. The dipstick will be positive in cases of renal trauma/

injury, infection, or obstruction that result from calculi or neoplasms.

Sediment Examination

Centrifuged, decanted urine aliquot leaves behind a sediment of formed elements that is used for microscopic examination.

Cells

For cellular elements, evaluation is best accomplished by counting and then taking the average of at least 10 microscopic fields.

Red Blood Cells

Erythrocytes greater in number than 0–2/high-power field (HPF) are considered abnormal. Such hematuria may result simply from severe exercise or menstrual blood contamination. However, it also may be indicative of trauma, particularly vascular injury, renal/urinary calculi obstruction, pyelonephritis, or cystitis. Hematuria in conjunction with leukocytes is diagnostic of infection.

White Blood Cells

Leukocytes greater in number than 0–1/HPF are considered abnormal. These cells are usually polymorphonuclear phagocytes, commonly known as segmented neutrophils. They are observed when there is acute glomerulonephritis, urinary tract infection, or inflammation of any type. In hypotonic urine (low osmotic concentration), WBCs can become enlarged, exhibiting a sparkling effect in their cytoplasmic granules. These cells possess a noticeable brownian motion and are called glitter cells, but they have no pathologic significance.

Epithelial Cells

Several types of epithelial cells are frequently encountered in normal urine because they are continuously sloughed off the lining of the nephrons and urinary tract. Large, flat, squamous vaginal epithelia are often seen in urine specimens from female patients, and samples heavily contaminated with vaginal discharge may show clumps or sheets of these cells. Renal epithelial cells are round, uninucleate cells, and, if present in numbers greater than 2/HPF, indicate clinically significant active tubular injury or degeneration. Transitional bladder epithelial cells (urothelial cells) may be flat, cuboidal, or columnar and also can be observed in urine on occasion. Large numbers will be seen only in cases of urinary catheterization, bladder inflammation, or neoplasm.

Miscellaneous Elements

Spermatozoa are often seen in the urine of both males and females. They are usually not reported because they are of no pathologic significance. In males, however, their presence may indicate prostate abnormalities. Yeast cells are also frequently found in urine specimens. Because they are extremely refractile and of a similar size to RBCs, they

can easily be mistaken under low magnification. Higher power examination for budding or mycelial forms differentiates these fungal elements from erythrocytes. Parasites found in urine are generally contaminants from fecal or vaginal material. In fecal contaminant category, the most commonly encountered organism is *Enterobius vermicularis* (pinworm) infestation in children. In the vaginal contaminant category, the most common is the intensely motile flagellate, *Trichomonas vaginalis*. A true urinary parasite, sometimes seen in patients from endemic areas of the world, is the ova of the trematode *Schistosoma haematobium*. This condition will usually occur in conjunction with a significant hematuria.¹⁵

Bacteria

Normal urine is sterile and contains no bacteria. Small numbers of organisms seen in a fresh urine specimen usually represent skin or air contamination. In fresh specimens, however, large numbers of organisms, or small numbers accompanied by WBCs and the symptoms of urinary tract infection, are highly diagnostic for true infection. Clinically significant bacteriuria is considered more than 20 organisms/HPF or, alternatively, 10^5 or greater registered on a microbiologic colony count. Most pathogens seen in urine are gram-negative coliforms (microscopic “rods”) such as *Escherichia coli* and *Proteus* sp. Asymptomatic bacteriuria, in which there are significant numbers of bacteria without appreciable clinical symptoms, occurs somewhat commonly in young girls, pregnant women, and patients with diabetes. This condition must be taken seriously because, if left untreated, it may result in pyelonephritis and, subsequently, permanent renal damage.

Casts

Casts are precipitated, cylindrical impressions of the nephrons. They comprise Tamm-Horsfall mucoprotein (uromucoid) from the tubular epithelia in the ascending limb of the loop of Henle. Casts form whenever there is sufficient renal stasis, increased urine salt or protein concentration, and decreased urine pH. In patients with severe renal disease, truly accurate classification of casts may require use of “cytospin” centrifugation and Papanicolaou test for adequate differentiation. Unlike cells, casts should be examined under low power and are most often located around the edges of the coverslip.

Hyaline

The matrix of these casts is clear and gelatinous, without embedded cellular or particulate matter. They may be difficult to visualize unless a high-intensity lamp is used. Their presence indicates glomerular leakage of protein. This leakage may be temporary (as a result of fever, upright posture, dehydration, or emotional stress) or may be permanent. Their occasional presence is not considered pathologic.

Granular

These casts are descriptively classified as either coarse or finely granular. The type of embedded particulate matter is simply a matter of the amount of degeneration that the epithelial cell inclusions have undergone. Their occasional presence is not pathologic; however, large numbers may be found in chronic lead toxicity and pyelonephritis.

Cellular

Several different types of casts are included in this category. RBC or erythrocytic casts are always considered pathologic because they are diagnostic for glomerular inflammation that results in renal hematuria. They are seen in subacute bacterial endocarditis, kidney infarcts, collagen diseases, and acute glomerulonephritis. WBC or leukocytic casts are also always considered pathologic because they are diagnostic for inflammation of the nephrons. They are observed in pyelonephritis, **nephrotic syndrome**, and acute glomerulonephritis. In asymptomatic pyelonephritis, these casts may be the only clue to detection. Epithelial cell casts are sometimes formed by fusion of renal tubular epithelia after desquamation; occasional presence is normal. Many, however, are observed in severe desquamative processes and renal stases that occur in heavy metal poisoning, renal toxicity, eclampsia, nephrotic syndrome, and amyloidosis. Waxy casts are uniformly yellowish, refractile, and brittle appearing, with sharply defined, often broken edges. They are almost always pathologic because they indicate tubular inflammation or deterioration. They are formed by renal stasis in the collecting ducts and are, therefore, found in chronic renal diseases. Fatty casts are abnormal, coarse, granular casts with lipid inclusions that appear as refractile globules of different sizes. Broad (renal failure) casts may be up to 2–6 times wider than “regular” casts and may be cellular, waxy, or granular in composition. Like waxy casts, they are derived from the collecting ducts in severe renal stasis.

Crystals

Acid Environment

Crystals seen in urines with pH values of less than 7 include calcium oxalate, which are normal colorless octahedrons or “envelopes”; they may have an almost starlike appearance. Also seen are amorphous urates, normal yellow-red masses with a grain of sand appearance. Uric acid crystals found in this environment are normal yellow to red-brown crystals that appear in extremely irregular shapes, such as rosettes, prisms, or rhomboids. Cholesterol crystals in acid urine are clear, flat, rectangular plates with notched corners. They may be seen in nephrotic syndrome and in conditions producing chyluria and are always considered abnormal. Cystine crystals are also sometimes observed in acid urine; they are highly pathologic and appear as colorless, refractile, nearly flat hexagons, somewhat similar to uric acid. These are observed in homocystinuria (an aminoaciduria resulting in mental retardation) and

cystinuria (an inherited defect of cystine reabsorption resulting in renal calculi).

Alkaline Environment

Crystals seen in urines with pH values greater than 7 include amorphous phosphates, which are normal crystals that appear as fine, colorless masses, resembling sand. Also seen are calcium carbonate crystals, which are normal forms that appear as small, colorless dumbbells or spheres. Triple phosphate crystals are also observed in alkaline urines; they are colorless prisms of 3–6 sides, resembling “coffin lids.” Ammonium biurate crystals are normal forms occasionally found in this environment, appearing as spiny, yellow-brown spheres, or “thorn apples.”

Other

Sulfonamide crystals are abnormal precipitates shaped like yellow-brown sheaves, clusters, or needles, formed in patients undergoing antimicrobial therapy with sulfa drugs. These drugs are seldom used today. Tyrosine/leucine crystals are abnormal types shaped like clusters of smooth, yellow needles or spheres. These are sometimes seen in patients with severe liver disease.¹⁵

PATHOPHYSIOLOGY

Glomerular Diseases

Disorders or diseases that directly damage the renal glomeruli may, at least initially, exhibit normal tubular function. With time, however, disease progression involves the renal tubules, as well. The following syndromes have discrete symptoms that are recognizable by their patterns of clinical laboratory findings.^{5,8}

Acute Glomerulonephritis

Pathologic lesions in acute glomerulonephritis primarily involve the glomerulus. Histologic examination shows large, inflamed glomeruli with a decreased capillary

lumen. Abnormal laboratory findings usually include rapid onset of hematuria and proteinuria (usually albumin, and generally <3 g/day). The rapid development of a decreased GFR, anemia, elevated blood urea nitrogen (BUN) and serum creatinine, oliguria, sodium and water retention (with consequent hypertension and some localized edema), and, sometimes, congestive heart failure is typical. Numerous hyaline and granular casts are generally seen on UA. The actual RBC casts are regarded as highly suggestive of this syndrome. Acute glomerulonephritis is often related to recent infection by group A β -hemolytic streptococci. It is theorized that circulating immune complexes trigger a strong inflammatory response in the glomerular basement membrane, resulting in a direct injury to the glomerulus itself. Other possible causes include drug-related exposures, acute kidney infections due to other bacterial (and, possibly, viral) agents, and other systemic immune complex diseases, such as systemic lupus erythematosus (SLE) and bacterial endocarditis.

Chronic Glomerulonephritis

Lengthy glomerular inflammation may lead to glomerular scarring and the eventual loss of functioning nephrons. This process often goes undetected for lengthy periods because only minor decreases in renal function occur at first and only slight proteinuria and hematuria are observed. Gradual development of uremia (or azotemia, excess nitrogen compounds in the blood) may be the first sign of this process.

Nephrotic Syndrome

Nephrotic syndrome (Fig. 26-6) can be caused by several different diseases that result in injury and increased permeability of the glomerular basement membrane. This defect almost always yields several abnormal findings, such as massive proteinuria (>3.5 g/day) and

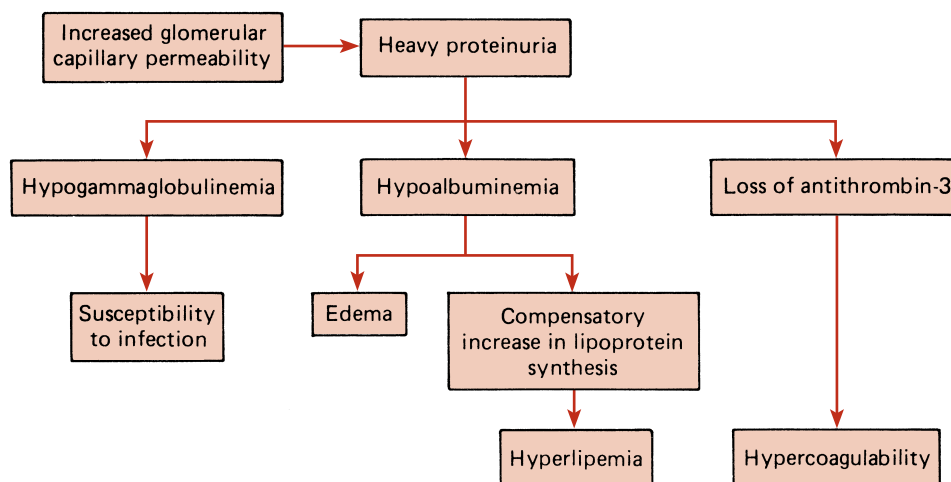

FIGURE 26-6. Pathophysiology of nephrotic syndrome.

resultant hypoalbuminemia. The subsequent decreased plasma oncotic pressure causes a generalized edema as a result of the movement of body fluids out of vascular and into interstitial spaces. Other hallmarks of this syndrome are hyperlipidemia and lipiduria. Lipiduria takes the form of oval fat bodies in the urine. These bodies are degenerated renal tubular cells containing reabsorbed lipoproteins. Primary causes are associated directly with glomerular disease states.

Tubular Diseases

Tubular defects occur to a certain extent in the progression of all renal diseases as the GFR falls. In some instances, however, this aspect of the overall dysfunction becomes predominant. The result is decreased excretion/reabsorption of certain substances or reduced urinary concentrating capability. Clinically, the most important defect is renal tubular acidosis (RTA), the primary tubular disorder affecting acid-base balance. This disease can be classified into two types, depending on the nature of the tubular defect:

- **Distal RTA**, in which the renal tubules are unable to keep up the vital pH gradient between the blood and tubular fluid
- **Proximal RTA**, in which there is decreased bicarbonate reabsorption, resulting in hyperchloremic acidosis. In general, reduced reabsorption in the proximal tubule is manifested by findings of abnormally low serum values for phosphorus and uric acid and by glucose and amino acids in the urine. In addition, there may be some proteinuria (usually <2 g/day).

Acute inflammation of the tubules and surrounding interstitium also may occur as a result of analgesic drug or radiation toxicity, methicillin hypersensitivity reactions, renal transplant rejection, and viral-fungal-bacterial infections. Characteristic clinical findings in these cases are decreases in GFR, urinary concentrating ability, and metabolic acid excretion; leukocyte casts in the urine; and inappropriate control of sodium balance.^{5,8}

Urinary Tract Infection/Obstruction

Infection

The site of infection may be either in the kidneys (pyelonephritis) or in the urinary bladder (cystitis). In general, a microbiologic colony count of more than 10^5 colonies/mL is considered diagnostic for infection in either locale. Bacteriuria (as evidenced by positive nitrite dipstick findings for some organisms), hematuria, and pyuria (leukocytes in the urine, as shown by positive leukocyte esterase dipstick) are all frequently encountered abnormal laboratory results in these cases. In particular, WBC (leukocyte) casts in the urine is considered diagnostic for pyelonephritis.^{5,8,15}

Obstruction

Renal obstructions can cause disease in one of two ways. They may either gradually raise the intratubular pressure until nephrons necrose and chronic renal failure ensues, or they may predispose the urinary tract to repeated infections.

Obstructions may be located in the upper or lower urinary tract. Blockages in the upper tract are characterized by a constricting lesion below a dilated collecting duct. Obstructions of the lower tract are evidenced by the residual urine in the bladder after cessation of micturition (urination); symptoms include slowness of voiding, both initially and throughout urination. Causes of obstructions can include neoplasms (e.g., prostate/bladder carcinoma or lymph node tumors constricting ureters), acquired diseases (e.g., urethral strictures or renal calculi), and congenital deformities of the lower urinary tract. The clinical symptoms of advancing obstructive disease include decreased urinary concentrating capability, diminished metabolic acid excretion, decreased GFR, and reduced renal blood flow. Laboratory tests useful in determining the nature of the blockage are urinalysis, urine culture, BUN, serum creatinine, and CBC. Final diagnosis is usually made by radiologic imaging techniques.^{3,6,10}

Renal Calculi

Renal calculi, or kidney stones, are formed by the combination of various crystallized substances, which are listed in Table 26-2. Of these, calcium oxalate stones are by far the most commonly encountered, particularly in the tropics and subtropics.

It is currently believed that recurrence of calculi in susceptible individuals is a result of several causes but mainly a reduced urine flow rate (related to a decreased fluid intake) and saturation of the urine with large amounts of essentially insoluble substances. Chemical analysis of

TABLE 26-2 TYPES OF KIDNEY STONES

| STONE COMPOSITION | CAUSE OF STONE FORMATION |
|------------------------------|--|
| Calcium oxalate | Hyperparathyroidism High urine calcium Vitamin D toxicity Sarcoidosis Osteoporosis |
| Magnesium ammonium phosphate | Infectious processes |
| Calcium phosphate | Excess alkali consumption Infection with urease producing organisms |
| Uric acid | Gout High levels of uric acid in blood and urine |
| Cystine | Inherited cystinuria |

stones is important in determining the cause of the condition. Specialized x-ray diffraction and infrared spectroscopy techniques are widely used for this purpose. Clinical symptoms are, of course, similar to those encountered in other obstructive processes: hematuria, urinary tract infections, and characteristic abdominal pain.^{5,8,15}

Renal Failure

Acute Renal Failure

Acute renal failure is a sudden, sharp decline in renal function as a result of an acute toxic or hypoxic insult to the kidneys, defined as occurring when the GFR is reduced to less than 10 mL/minute. This syndrome is subdivided into three types, depending on the location of the precipitating defect.

Prerenal failure: The defect lies in the blood supply before it reaches the kidney. Causes can include cardiovascular system failure and consequent hypovolemia.

Primary renal failure: The defect involves the kidney.

The most common cause is acute tubular necrosis; other causes include vascular obstructions/inflammations and glomerulonephritis.

Postrenal failure: The defect lies in the urinary tract after it exits the kidney. Generally, acute renal failure occurs as a consequence of lower urinary tract obstruction or rupture of the urinary bladder.

Toxic insults to the kidney that are severe enough to initiate acute renal failure include hemolytic transfusion reactions, myoglobinuria due to rhabdomyolysis, heavy metal/solvent poisonings, antifreeze ingestion, and analgesic and aminoglycoside toxicities. These conditions directly damage the renal tubules. Hypoxic insults include conditions that severely compromise renal blood flow, such as septic/hemorrhagic shock, burns, and cardiac failure. The most commonly observed symptoms of acute renal failure are oliguria and anuria (<400 mL/day). The diminished ability to excrete electrolytes

CASE STUDY 26-1

A 52-year-old man with a history of AIDS, hypertension, diabetes mellitus, and alcohol abuse was found unconscious in his home by his roommate. In the emergency department, he was hypotensive (103/60), febrile (temperature 101°C), and unresponsive. Computed tomography scan of the abdomen showed cholecystitis and gallstones. Laboratory data are listed. (Case developed by Cynthia Batangan Santos, MD, pathology resident, Hartford Hospital Department of Pathology and Laboratory Medicine, Hartford, CT, and was modified and printed with permission.)

The patient was diagnosed with acute renal failure. He was administered intravenous fluids; BUN fell to 68 mg/dL and creatinine fell to 2.2 mg/dL. The patient's blood culture report was positive for *Escherichia coli*. He was treated with tobramycin

and cefepime. The patient continued to deteriorate and died 5 days after admission. Cause of death was multiorgan failure secondary to AIDS, sepsis, and alcoholic cirrhosis.

Questions

1. What is the significance of the patient's elevated CK? Explain why the physician ordered a CK-MB and troponin level. What can you conclude about the patient's cardiac status?
2. What is the cause of his acute renal failure?
3. What is the significance of the patient's large urine hemoglobin?
4. How would you interpret this patient's liver function tests considering his clinical history?

| DRUGS OF ABUSE: | | URINALYSIS: | |
|-----------------------|---------------------|--------------------|--------------------------------|
| SERUM ETHANOL | NEGATIVE: 84 MG/DL | HEMOGLOBIN WBC RBC | LARGE: 4 HPF (0-4) 2 HPF (0-4) |
| CK | 3308 U/L (24-204) | BUN | 71 mg/dL (8-21) |
| CK-MB | 15 ng/mL (0-7.5) | Creatinine | 4.1 mg/dL (0.9-1.5) |
| CK-MB rel. index | 0.5 (0-4) | ALP | 443 U/L (45-122) |
| Troponin T | <0.01 ng/mL (0-0.4) | AST | 305 U/L (9-45) |
| pH | 7.50 | ALT | 78 U/L (8-63) |
| pCO ₂ | 27 mm Hg | GGT | 724 U/L (11-50) |
| Total CO ₂ | 15 mmol/L | Total bilirubin | 2.7 mg/dL (0.2-1.0) |
| | | Direct bilirubin | 2.4 mg/dL (0-0.2) |

and water results in a significant increase in extracellular fluid volume, leading to peripheral edema, hypertension, and congestive heart failure. Most prominent, however, is the onset of the uremic syndrome or ESRD, in which increased BUN and serum creatinine values are observed along with the preceding symptoms. The outcome of this disease is either recovery or, in the case of irreversible renal damage, progression to chronic renal failure.^{5,8}

Chronic Renal Failure (Chronic Kidney Disease)

Chronic kidney disease (CKD) is a clinical syndrome that occurs when there is a gradual decline in renal function over time (Fig. 26-7). According to the 2007 U.S. Renal Data System (USRDS) Annual Data Report, one in nine U.S. adults has CKD and 20 million more are at risk.²² Early detection and treatment are needed to prevent progression to ESRD and complications such as coronary vas-

cular disease. The National Kidney Foundation has formulated guidelines for earlier diagnosis, treatment, and prevention of further disease progression. See Table 26-3 for the five stages of CKD. GFR and evidence of kidney damage based on measurement of proteinuria or other markers form the basis of the classifications.²³

The conditions that can precipitate acute renal failure also may lead to chronic renal failure.^{5,16} Several other causes for this syndrome are listed in Table 26-4.

Increasing Incidence of Chronic Kidney Disease

There is an increasing incidence of CKD in the United States due to the increase in diabetes, the aging population, obesity, and metabolic syndrome. Diabetes mellitus can have profound effects on the renal system. Patients with type 1 diabetes have an insulin deficit. Approximately 45% of patients with type 1 diabetes will

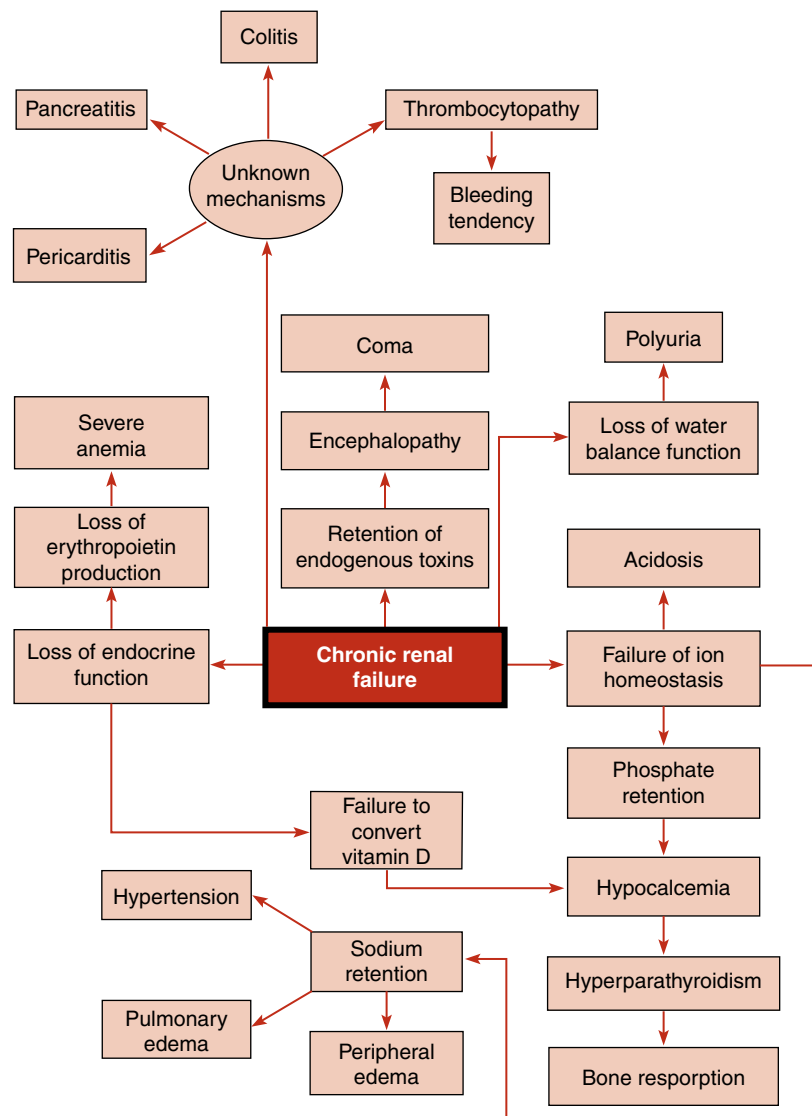

FIGURE 26-7. Pathophysiology of chronic kidney disease.

TABLE 26-3 SYSTEMATIC CLASSIFICATION OF CHRONIC KIDNEY DISEASE STAGES

| STAGE | DESCRIPTION | GFR (ML/MIN PER 1.73 m ²) |
|-------|------------------------------------|---------------------------------------|
| | At increased risk* | ≥90 (with risk factors) |
| 1 | Kidney damage with normal or ≠ GFR | >90 |
| 2 | Kidney damage with normal or ↓ GFR | 60–89 |
| 3 | Moderate ↓ GFR | 30–59 |
| 4 | Severe ↓ GFR | 15–29 |
| 5 | Kidney failure | <15 |

*At-risk patients should be screened. Stages 1–5 illustrate the progression of CKD. Source: National Kidney Foundation. K/DOQI clinical practice guidelines for chronic kidney disease: executive summary. New York: National Kidney Foundation, 2002:16.

develop progressive deterioration of kidney function (diabetic nephropathy) within 15–20 years after diagnosis. A smaller percentage of persons with type 2 diabetes will also develop this condition. The effects are primarily glomerular, but they may affect all kidney structures as well and are theorized to be caused by the abnormally hyperglycemic environment that constantly bathes the vascular system.^{5,8}

Typically, diabetes affects the kidneys by causing them to become glucosuric, polyuric, and nocturic. These states are caused by the heavy demands made on the kidneys to diurese hyperosmotic urine. In addition, a mild proteinuria (microalbuminuria) often develops between 10 and 15 years after the original diagnosis (see Microalbumin earlier). Hypertension often manifests next, further exacerbating the renal damage. Eventually, chronic renal insufficiency or nephrotic syndrome may evolve, and each may be identified by their characteristic symptoms and laboratory findings. Early treatment of diabetes that focuses on tight control of blood glucose and

prevention of high blood pressure may prolong the onset of chronic renal failure.

Aside from hypertension and diabetes, age is the key predictor of CDK. Due to the decline in fertility and increase in the average life span, the percentage of the population aged 65 years or older is projected to increase from 12.4% in 2000 to 19.6% in 2030, according to the U.S. Census Bureau. This continual rise, over the previous decade and those to come, contributes significantly to the increasing incidence of CKD.

Epidemiologic evidence links obesity to CKD and ESRD. However, diabetes mellitus and hypertension have potential confounding roles because obesity is a risk factor for diabetes and hypertension, the two most common causes of CKD and ESRD. Recent studies show that obesity itself increases the risk of kidney injury.²⁴ As an individual gains weight, the nephron number remains the same; however, the GFR increases to meet the higher metabolic demands, which results in damage to the kidney.

The metabolic syndrome, characterized by the presence of at least three of the following risk factors—abdominal obesity, hypertension, low high-density lipoprotein cholesterol level, hypertriglyceridemia, or hyperglycemia—is a prevalent disorder in the United States. In a population study of a representative sample of the U.S. general population, the risk of CKD and microalbuminuria increased progressively with a greater number of components of metabolic syndrome.²⁵ Individuals with metabolic syndrome had a 2.6-fold increased risk for developing CKD compared with individual without metabolic syndrome.²⁵ Interventions that target biochemical components of metabolic syndrome may reduce the risk of CDK.

Renal Hypertension

Renal disease–induced hypertension can be caused by either decreased perfusion to all or part of the kidney (ischemia). Lack of perfusion may be caused by traumatic injury or narrowing of an artery or intrarenal

TABLE 26-4 ETIOLOGY OF CHRONIC RENAL FAILURE

| ETIOLOGY | EXAMPLES |
|-------------------------------------|---|
| Renal circulatory diseases | Renal vein thrombosis, malignant hypertension |
| Primary glomerular diseases | SLE, chronic glomerulonephritis |
| Renal sequelae to metabolic disease | Gout, diabetes mellitus, amyloidosis |
| Inflammatory diseases | Tuberculosis, chronic pyelonephritis |
| Renal obstructions | Prostatic enlargement, calculi |
| Congenital renal deformity | Polycystic kidneys, renal hypoplasia |
| Miscellaneous conditions | Radiation nephritis |

CASE STUDY 26-2

A 45-year-old man presented to the hospital with alcohol withdrawal. After drinking a pint of brandy daily for the past 5–6 years, he decided to stop drinking 4 days ago. He experienced tremors and then visual and auditory hallucinations. On arrival at the hospital, he was diaphoretic and tachycardic, with a pulse rate of 102. His chemistry results are shown below.

| | | | |
|-----------------|------------|-----------------|-----------|
| Na ⁺ | 130 mmol/L | Total protein | 7.1 g/dL |
| K ⁺ | 3.7 mmol/L | Albumin | 3.7 g/dL |
| Cl ⁻ | 90 mmol/L | ALP | 63 U/L |
| CO ₂ | 20 mmol/L | AST | 42 U/L |
| BUN | 81 mg/dL | ALT | 16 U/L |
| Creatinine | 4.0 mg/dL | GGT | 131 U/L |
| Magnesium | 1.4 mg/dL | CK | 591 U/L |
| Alcohol | Negative | Total bilirubin | 0.5 mg/dL |

The patient's medical history included arthritis, hypertension, depression, and alcoholism. He had been taking an anti-inflammatory medication for arthritis and an antidepressant. Overnight, he

became agitated and required increasing doses of a benzodiazepine, together with physical restraints for behavior control. The next morning, he was transferred to the intensive care unit where he was evaluated for acute renal failure. The patient was rehydrated, and his arthritis and antidepressant medications were withheld. Laboratory test results are as follows:

| | | | |
|-----------------|------------|----------------|-----------|
| Na ⁺ | 139 mmol/L | Creatinine | 1.4 mg/dL |
| K ⁺ | 3.5 mmol/L | CK | 1626 U/L |
| Cl ⁻ | 107 mmol/L | CK-MB | 3.4 ng/mL |
| CO ₂ | 23 mmol/L | Relative index | 0.2 |
| BUN | 16 mg/dL | | |

Questions

1. Is the patient still in acute renal failure?
2. What was the cause of his acute renal failure?
3. Why has the patient's electrolyte status improved?
4. Why is his CK highly elevated?

arterioles. Chronic ischemia of any kind results in nephron dysfunction and eventual necrosis. The resulting changes in blood and body fluid volumes within the kidney trigger the activation of the renin-angiotensin-aldosterone system, setting off vasoconstriction that is manifested as persistent hypertension.

Renal hypertension can be evaluated by monitoring serum aldosterone, Na⁺, and renin levels. As a result of the effect of aldosterone, there will be increased serum Na⁺, decreased serum K⁺, and increased urine K⁺.

Therapy of Acute Renal Failure**Dialysis**

In patients with acute renal failure, uremic symptoms, uncontrolled hyperkalemia, and acidosis have traditionally been indications that the kidneys are unable to excrete the body's waste products and a substitute method in the form of dialysis was necessary. Dialysis is often instituted before this stage, however. Several forms of dialysis are available; however, they all use a semipermeable membrane surrounded by a dialysate bath.

In traditional **hemodialysis** (removal of waste from blood), the membrane is synthetic and outside the body. Arterial blood and dialysate are pumped at high rates (150–250 mL/min and 500 mL/min, respectively) in opposite directions. The blood is returned to the venous

circulation and the dialysate discarded. The diffusion of low-molecular-weight solutes (<500 Da) into the dialysate is favored by this process, but mid-molecular-weight solutes (500–2000 Da) are inadequately cleared. Creatinine clearance is about 150–160 mL/min.

In peritoneal dialysis, the peritoneal wall acts as the dialysate membrane and gravity is used to introduce and remove the dialysate. Two variations of this form are available, continuous ambulatory peritoneal dialysis (CAPD) and continuous cycling peritoneal dialysis; however, the process is continuous in both, being performed 24 hours a day, 7 days a week. This method is not as rigorous as the traditional method. Small solutes (e.g., potassium) have significantly lower clearance rates compared with the traditional method, but more large solutes are cleared and steady-state levels of blood analytes are maintained.

Continuous arteriovenous **hemofiltration** (ultrafiltration of blood), continuous venovenous hemofiltration, continuous arteriovenous hemodialysis, and continuous venovenous hemodialysis together make up the slow continuous renal replacement therapies developed to treat acute renal failure in critically ill patients in intensive care settings. In these methods, the semipermeable membrane is again outside the body. Solutes up to 5000 Da (the pore size of the membranes) and water are slowly (10 mL/min) and continuously filtered from the blood in

CASE STUDY 26-3

A 78-year-old woman with a history of hypertension, aortic thoracic graft, and esophageal reflux disease complained of fever (100°C) and weakness. She had been treated 3 weeks before at the hospital for a urinary tract infection. She was admitted to the hospital for a diagnostic workup and transfusion. Her laboratory results are as follows:

| | | | |
|-----------------|------------|-----|----------|
| Na ⁺ | 129 mmol/L | Hct | 25.6% |
| K ⁺ | 3.7 mmol/L | Hgb | 8.5 g/dL |
| Cl ⁻ | 97 mmol/L | WBC | 9,700 |
| CO ₂ | 19 mmol/L | | |
| BUN | 52 mg/dL | | |
| Creatinine | 3.2 mg/dL | | |

Urine culture was positive for *Citrobacter*. Urinalysis results are listed:

| | |
|------------------|---------------|
| Color | Hazy/yellow |
| Specific gravity | 1.015 |
| pH | 5 |
| Blood | Large |
| Protein | 2 |
| Glucose | Negative |
| Ketones | Negative |
| Nitrates | Negative |
| RBC | >25 |
| WBC | 1–4 |
| Casts | Granular, 1–4 |

The patient's renal function continued to decline, and she was put on hemodialysis. A renal biopsy was performed that showed end-stage crescent glomerulonephritis. Two days later, the patient sustained a perforated duodenal ulcer, which required surgery and blood transfusion. Subsequently, she developed coagulopathy and liver failure. Her condition continued to deteriorate in the next few days, and she died following removal of life support.

Questions

1. Looking at the urinalysis, what is the significance of the results of 2⁺ protein and >25 RBCs?
2. What is the most likely cause of glomerulonephritis?
3. Why was the patient put on hemodialysis?

the first two methods, causing minimal changes in plasma osmolality. Volume loss can be replaced in the form of parenteral nutrition and intravenous medications. The final two methods are similar to the filtration methods, but a continuous trickle of dialysis fluid is pumped past the dialysis membrane, resulting in continuous diffusion and a doubling of the urea clearance.

Therapy of End-Stage Renal Disease

For patients with irreversible renal failure, dialysis and transplantation are the only two therapeutic options. Initiation of either treatment occurs when the GFR falls to 5 mL/min (10–15 mL/min in patients with diabetic nephropathy).

Dialysis

Traditional hemodialysis or its more recent, high-efficiency form, as well as peritoneal dialysis are the available methods. The clinical laboratory used in conjunction with a hemodialysis facility must be able to adequately monitor procedural efficiency in a wide variety of areas. Renal dialysis has basic goals, and specific laboratory tests should be performed to evaluate the achievement of each goal.

Transplantation

The most efficient hemodialysis techniques provide only 10%–12% of the small solute removal of two normal kidneys and considerably less removal of larger solutes. Even patients who are well dialyzed have physical disabilities and decreased quality of life. Kidney transplantation offers the greatest chance for full return to a healthy, productive life. However, this option is limited by the significant shortage of donor organs. For ESRD patients, waiting for an organ donation can vary from several months to several years.

Renal transplantation is from a compatible donor to a recipient suffering from irreversible renal failure. The organ can be from a cadaver or a live individual (80% and 20%, respectively, of all kidney transplants in the United States). For this procedure to be successful, the body's immune response to the transplanted organ must be suppressed. Therefore, the donor and recipient are carefully screened for ABO blood group, human leukocyte antigen (HLA) compatibility, and preformed HLA antibodies. The HLA system is the major inhibitor to transplantation.

Although kidney transplants have the capacity to function for decades, the mean half-life of a cadaveric transplant is approximately 7 years. The mortality rate is not significantly different from hemodialysis. Three-year graft survival figures vary from 65% to 85%, with live grafts doing better. It has been reported that there is no difference in patient survival among hemodialysis, CAPD, and cadaveric kidney transplantation. Live related-donor transplantation is associated with a better patient survival than other ESRD therapeutic options.

REFERENCES

1. Vander A, et al. Human physiology: the mechanisms of body function. 7th ed. New York: McGraw-Hill, 1998:503, 508, 519.
2. Kaplan A, et al. Clinical chemistry: interpretation and techniques. 4th ed. Baltimore, Md.: Williams & Wilkins, 1995:156–157.
3. DuFour DR. Professional practice in clinical chemistry: a companion text, water and electrolyte balance. Washington, D.C.: AACC, 1999.
4. Davies A, Blakely A, Kidd C. Human physiology. London: Harcourt Publishers, 2001:747.
5. Rock RC, Walker WG, Jennings CD. Nitrogen metabolites and renal function. In: Tietz NW, ed. Fundamentals of clinical chemistry. 3rd ed. Philadelphia, Pa.: WB Saunders, 1987:669.
6. Russell PT, Sherwin JE, Obernolte R, et al. Nonprotein nitrogenous compounds. In: Kaplan LA, Pesce AJ, eds. Clinical chemistry: theory, analysis, and correlation. 2nd ed. St. Louis, Mo.: CV Mosby, 1989:1005.
7. Fraser D, Jones G, Kooh SW, et al. Calcium and phosphate metabolism. In: Tietz NW, ed. Fundamentals of clinical chemistry. 3rd ed. Philadelphia, Pa.: WB Saunders, 1987:705.
8. First MR. Renal function. In: Kaplan LA, Pesce AJ, eds. Clinical chemistry: theory, analysis, and correlation. 4th ed. St. Louis, Mo.: CV Mosby, 2003:477–491.
9. Kaplan LA. Measurement of colligative properties. In: Kaplan LA, Pesce AJ, eds. Clinical chemistry: theory, analysis, and correlation. 4th ed. St. Louis, Mo.: CV Mosby, 2003:265–271.
10. Kleinman LI, Lorenz JM. Physiology and pathophysiology of body water and electrolytes. In: Kaplan LA, Pesce AJ, eds. Clinical chemistry: theory, analysis, and correlation. 4th ed. St. Louis, Mo.: CV Mosby, 2003:441–461.
11. Sherwin JE, Bruegger BB. Acid-base control and acid-base disorders. In: Kaplan LA, Pesce AJ, eds. Clinical chemistry: theory, analysis, and correlation. 4th ed. St. Louis, Mo.: CV Mosby, 2003:462–476.
12. Lab Tests Online: GFR and eGFR at a glance. Retrieved from <http://www.labtestsonline.org>.
13. Lab Tests Online. Cystatin C at a glance. Retrieved from http://www.labtestsonline.org/understanding/analytes/cystatin_c/glance.html.
14. Fraser CG. Biological variation: from principles to practice. Washington, D.C.: AACC Press, 2001.
15. Kaplan LA, Pesce AJ. Examination of urine. In: Kaplan LA, Pesce AJ, eds. Clinical chemistry: theory, analysis, and correlation. 4th ed. St. Louis, Mo.: CV Mosby, 2003:1092–1109.
16. Fraunhoffer E, Demers LM. Beta2-microglobulin. Chicago, Ill.: ASCP Check Sample Continuing Education Program, Clinical Chemistry, 1986. [Publication no. CC 865 (CC173).]
17. Wu AHB, Laios I, Green S, et al. Immunoassays for serum and urine myoglobin: myoglobin clearance assessed as a risk factor for acute renal failure. Clin Chem 1994;40:796.
18. Skogen W. Urinary albumin and diabetic nephropathy. Clin Lab News 1995;21:6–7.
19. American Diabetes Association. Position statement: standards of medical care for patients with diabetes mellitus. Diabetes Care 2002;25:S33–S49.
20. Bennett PH, et al. Screening and management of microalbuminuria in patients with diabetes mellitus: recommendations to the Scientific Advisory Board of the National Kidney Foundation from an Ad Hoc Committee of the Council on Diabetes Mellitus of the National Kidney Foundation. Am J Kidney Dis 1995;25:107.
21. Emancipator K. Laboratory diagnosis and monitoring of diabetes mellitus. Am J Clin Pathol 1999;112:665.
22. U.S. Renal Data System. USRDS 2007 annual data report. Bethesda, Md.: National Institutes of Health, 2007.
23. Mitchum C. Implementing the new kidney disease testing guidelines. Clin Lab News 2002;September:14.
24. Kramer H, Luke A. Obesity and kidney disease: a big dilemma. Curr Opin Nephrol Hypertens 2007;16:237–241.
25. Chen J, Muntner P, Hamm LL, et al. The metabolic syndrome and chronic kidney disease in U.S. adults. Ann Intern Med 2004;140:167–174.

Pancreatic Function and Gastrointestinal Function

Edward P. Fody

CHAPTER

27

CHAPTER OUTLINE

- **PHYSIOLOGY OF PANCREATIC FUNCTION**
- **DISEASES OF THE PANCREAS**
- **TESTS OF PANCREATIC FUNCTION**
 - Secretin/Cholecystokinin Test
 - Fecal Fat Analysis
 - Sweat Electrolyte Determinations
 - Serum Enzymes
- **PHYSIOLOGY AND BIOCHEMISTRY OF GASTRIC SECRETION**
- **CLINICAL ASPECTS OF GASTRIC ANALYSIS**
- **TESTS OF GASTRIC FUNCTION**
 - Measuring Gastric Acid in Basal and Maximal Secretory Tests
 - Measuring Gastric Acid
 - Plasma Gastrin
- **INTESTINAL PHYSIOLOGY**
- **CLINICOPATHOLOGIC ASPECTS OF INTESTINAL FUNCTION**
- **TESTS OF INTESTINAL FUNCTION**
 - Lactose Tolerance Test
 - D-Xylose Absorption Test
 - Serum Carotenoids
 - Other Tests of Intestinal Malabsorption
- **SUGGESTED READINGS**
- **REFERENCES**

The gastrointestinal (GI) system is composed of the mouth, esophagus, stomach, small intestine, and large intestine. Digestion, which is primarily a function of the small intestine, is the process by which starches, proteins, lipids, nucleic acids, and other complex molecules are degraded to simple constituents (molecules) for absorption and use in the body. This chapter discusses the physiology and biochemistry of gastric secretion, intestinal physiology, pathologic aspects of intestinal function, and tests of gastric and intestinal function.

The pancreas is a large gland that is involved in the digestive process, but located outside of the GI system. It is composed of both endocrine and exocrine tissue. The liver is the other major external gland that is involved in the digestive process, and it is covered in Chapter 24. The endocrine functions of the pancreas include production of insulin and glucagon; both hormones are involved in carbohydrate metabolism. Exocrine function involves the production of many enzymes used in the digestive process. This chapter discusses the physiology of pancreatic function, diseases of the pancreas, and tests of pancreatic function.

PHYSIOLOGY OF PANCREATIC FUNCTION

As a digestive gland, the pancreas is only second in size to the liver, weighing about 70–105 g. It is located behind

the peritoneal cavity across the upper abdomen at about the level of the first and second lumbar vertebrae, about 1–2 inches above the umbilicus. It is located in the curve made by the duodenum (Fig. 27-1). The pancreas is composed of two morphologically and functionally different tissues: endocrine tissue and exocrine tissue. The *endocrine* (hormone-releasing) component is by far the smaller of the two and consists of the **islets of Langerhans**, which are well-delineated, spherical or ovoid clusters composed of at least four different cell types. The islet cells secrete at least four hormones into the blood: insulin, glucagon, gastrin, and somatostatin. The larger, *exocrine* pancreatic component (enzyme-secreting) secretes about 1.5–2 L/day of fluid, which is rich in digestive enzymes, into ducts that ultimately empty into the duodenum.

This digestive fluid is produced by pancreatic acinar cells (grapelike clusters), which line the pancreas and are connected by small ducts. These small ducts empty into progressively larger ducts, eventually forming one major pancreatic duct and a smaller accessory duct. The major pancreatic duct and the common bile duct open into the duodenum at the major duodenal papilla. Normal, protein-rich, pancreatic fluid is clear, colorless, and watery, with an alkaline pH that can reach up to 8.3. This alkalinity is caused by the high concentration of sodium

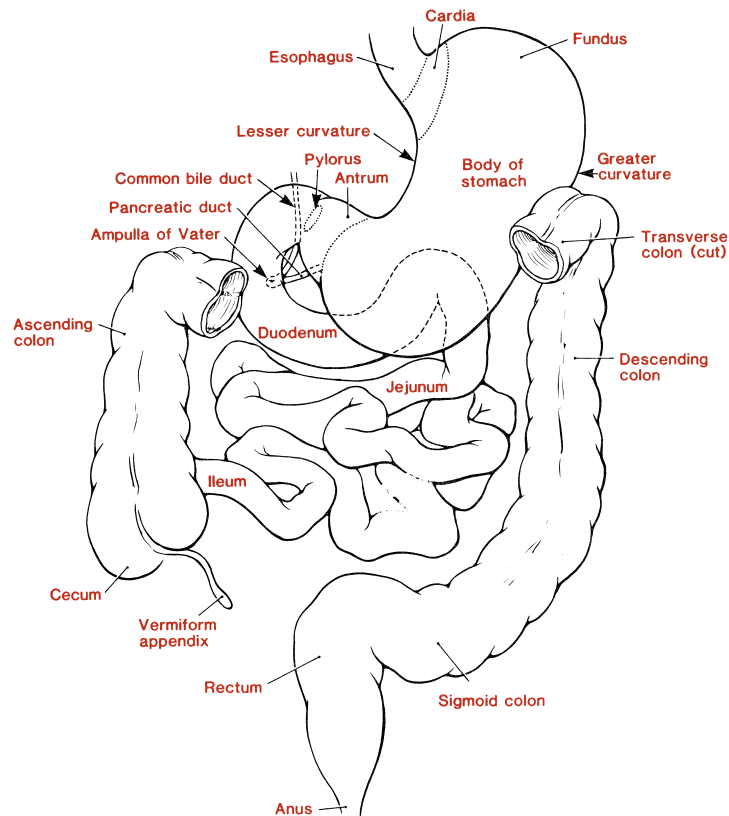

FIGURE 27-1. The abdominal structures of the alimentary tract.

bicarbonate present in pancreatic fluid, which is used eventually to neutralize the hydrochloric acid in gastric fluid from the stomach as it enters the duodenum. The bicarbonate and chloride concentrations vary reciprocally so that they total about 150 mmol/L.

Pancreatic fluid has about the same concentrations of potassium and sodium as serum. The digestive enzymes, or their proenzymes secreted by the pancreas, are capable of digesting the three major classes of food substances (proteins, carbohydrates, and fats) and include (1) the proteolytic enzymes trypsin, chymotrypsin, elastase, collagenase, leucine aminopeptidase, and some carboxypeptidases; (2) lipid-digesting enzymes, primarily lipase and lecithinase; (3) carbohydrate-splitting pancreatic amylase; and (4) several nucleases (ribonuclease), which separate the nitrogen-containing bases from their sugar-phosphate strands.

Pancreatic activity is under both nervous and endocrine control. Branches of the vagus nerve can cause a small amount of pancreatic fluid secretion when food is smelled or seen, and these secretions may increase as the bolus of food reaches the stomach. Most of the pancreatic action, however, is under the hormonal control of **secretin** and **cholecystokinin** (CCK; formerly called *pancreozymin*). Secretin is responsible for the production of bicarbonate-rich and, therefore, alkaline pancre-

atic fluid, which protects the lining of the intestine from damage. Secretin is synthesized in response to the acidic contents of the stomach reaching the duodenum. It can also affect gastrin activity in the stomach. This pancreatic fluid contains few digestive enzymes. CCK, in the presence of fats or amino acids in the duodenum, is produced by the cells of the intestinal mucosa and is responsible for release of enzymes from the acinar cells by the pancreas into the pancreatic fluid.

DISEASES OF THE PANCREAS

Other than trauma, only three diseases cause more than 95% of the medical attention devoted to the pancreas. If they affect the endocrine function of the pancreas, these diseases can result in altered digestion and nutrient metabolism. The role of the pancreas in diabetes mellitus is discussed in Chapter 13.

Cystic fibrosis (known by various other terms, such as *fibrocystic disease of the pancreas* and *mucoviscidosis*) is an inherited autosomal recessive disorder characterized by dysfunction of mucous and exocrine glands throughout the body. The disease is relatively common and occurs in about 1 of 1,600 live births. It has various manifestations and can initially present in such widely varying ways as intestinal obstruction of the newborn, excessive pulmonary infections in childhood, or, uncommonly, as pancreatoge-

nous malabsorption in adults. The disease causes the small and large ducts and the acini to dilate and convert into small cysts filled with mucus, eventually resulting in the prevention of pancreatic secretions reaching the duodenum or, depending on the age of the patient, a plug that blocks the lumen of the bowel, leading to obstruction. As the disease progresses, there is increased destruction and fibrous scarring of the pancreas and a corresponding decrease in function. Cystic fibrosis is transmitted as an autosomal recessive disorder with a high degree of penetrance. It occurs primarily in persons of northern European descent. The cystic fibrosis gene known as *CFTR* occurs on chromosome 7, and more than 900 mutations causing this disorder have been identified; however, some occur more commonly than others. In areas of high frequency, such as Brittany in western France, more than 10% of the population may carry a cystic fibrosis mutation, and 1 in 3,000 infants may be affected, making it the most common genetic disorder in these populations. Genetic screening is now widely carried out.¹⁻³

Pancreatic carcinoma is the fourth most frequent form of fatal cancer and causes about 27,000 deaths each year in the United States, which represents about 5% of all deaths from malignant neoplasms. The disease is slightly more common in males than females and in African Americans than whites. The 5-year survival rate is less than 5% and more than 90% of patients die within 1 year of diagnosis. Most pancreatic tumors arise as adenocarcinomas of the ductal epithelium. Because the pancreas has a rich supply of nerves, pain is a prominent feature of the disease. If the tumor arises in the body or tail of the pancreas, detection does not often occur until an advanced stage of the disease because of its central location and the associated vague symptoms. Cancer of the head of the pancreas is usually detected earlier because of its proximity to the common bile duct. Signs of these tumors are jaundice, weight loss, anorexia, and nausea. Jaundice is associated with signs of posthepatic hyperbilirubinemia (intrahepatic cholestasis) and low levels of fecal bilirubin, resulting in clay-colored stools. However, findings are not specific for pancreatic tumors, and other causes of obstruction must be ruled out.

Islet cell tumors of the pancreas affect the endocrine capability of the pancreas. If the tumor occurs in beta cells, hyperinsulinism is often seen, resulting in low blood glucose levels, sometimes followed by hypoglycemic shock. Pancreatic cell tumors, which overproduce gastrin, are called *gastrinomas*; they cause **Zöllinger-Ellison syndrome** and can be duodenal in origin. These tumors are associated with watery diarrhea, recurring peptic ulcer, and significant gastric hypersecretion and hyperacidity. Pancreatic cell glucagon-secreting tumors are rare; the hypersecretion of glucagon is associated with diabetes mellitus.

Pancreatitis, or inflammation of the pancreas, is ultimately caused by autodigestion of the pancreas as a result of reflux of bile or duodenal contents into the pancreatic duct. Pathologic changes can include acute edema, with large amounts of fluid accumulating in the retroperitoneal space and an associated decrease in effective circulating blood volume; cellular infiltration, leading to necrosis of the acinar cells, with hemorrhage as a possible result of necrotic blood vessels; and intrahepatic and extrahepatic pancreatic fat necrosis. Pancreatitis is generally classified as acute (no permanent damage to the pancreas), chronic (irreversible injury), or relapsing/recurrent, which can also be acute or chronic. It commonly occurs in midlife. Painful episodes can occur intermittently, usually reaching a maximum within minutes or hours, lasting for several days or weeks, and frequently accompanied by nausea and vomiting. Pancreatitis is often associated with alcohol abuse or biliary tract diseases such as gallstones, but patients with hyperlipoproteinemia and those with hyperparathyroidism are also at a significantly increased risk for this disease.

Other etiologic factors associated with acute pancreatitis include mumps, obstruction caused by biliary tract disease, gallstones, pancreatic tumors, tissue injury, atherosclerotic disease, shock, pregnancy, hypercalcemia, hereditary pancreatitis, immunologic factors associated with postrenal transplantation, and hypersensitivity. Symptoms of acute pancreatitis include severe abdominal pain that is generalized or in the upper quadrants and often radiates toward the back or down the right or left flank. The etiology of chronic pancreatitis is similar to that of acute pancreatitis, but chronic excessive alcohol consumption appears to be the most common predisposing factor.

Laboratory findings include increased amylase, lipase, triglycerides, and hypercalcemia, which is often associated with underlying hyperparathyroidism. Hypocalcemia may be found and has been attributed to the sudden removal of large amounts of calcium from the extracellular fluid because of impaired mobilization or as a result of calcium fixation by fatty acids liberated by increased lipase action on triglycerides. Hypoproteinemia is attributable mainly to the notable loss of plasma into the retroperitoneal space. A shift of arterial blood flow from the inflamed pancreatic cells to less affected or normal cells causes oxygen deprivation and tissue hypoxia in the area of damage, including the surrounding organs and tissue.

All three conditions can result in severely diminished pancreatic exocrine function, which can significantly compromise digestion and absorption of ingested nutrients. This is the essence of the general malabsorption syndrome, which embodies abdominal bloating and discomfort; the frequent passage of bulky, malodorous feces; and weight loss. Failure to digest or absorb fats, known as **steatorrhea**, renders a greasy appearance to feces (more

than 5 g of fecal fat per 24 hours). The malabsorption syndrome typically involves abnormal digestion or absorption of proteins, polysaccharides, carbohydrates, and other complex molecules, as well as lipids. Severely deranged absorption and metabolism of electrolytes, water, vitamins (particularly fat-soluble vitamins A, D, E, and K), and minerals can also occur. Malabsorption can involve a single substance, such as vitamin B₁₂, which results in a megaloblastic anemia (pernicious anemia), or lactose caused by a lactase deficiency. In addition to pancreatic exocrine deficiency, the malabsorption syndrome can be caused by biliary obstruction, which deprives the small intestine of the emulsifying effect of bile, and various diseases of the small intestine, which inhibit absorption of digested products.

TESTS OF PANCREATIC FUNCTION

Depending on etiology and clinical picture, pancreatic function may be suspect when there is evidence of increased amylase and lipase.^{4–7} The reader is referred to Chapter 10 for an in-depth discussion of these enzymes. Other laboratory tests of pancreatic function include those used for detection of malabsorption (e.g., examination of stool for excess fat, D-xylose test, and fecal fat analysis), tests measuring other exocrine function (e.g., secretin, CCK, fecal fat, trypsin, and chymotrypsin), tests assessing changes associated with extrahepatic obstruction (e.g., bilirubin), and endocrine-related tests (e.g., gastrin, insulin, and glucose) that reflect changes in the endocrine cells of the pancreas.

Direct evaluation of pancreatic fluid may include measurement of the total volume of pancreatic fluid and the amount or concentration of bicarbonate and enzymes, which requires pancreatic stimulation. Stimulation may be accomplished using a predescribed meal or administration of secretin, which allows for volume and bicarbonate evaluation, or secretin stimulation followed by CCK stimulation, which adds enzymes to the pancreatic fluid evaluation. The advantage of these tests, both of which require intubation of the patient, is that the chemical and cytologic examinations are performed on actual pancreatic secretions. Cytologic examination of the fluid can often establish the presence, or at least the suspicion, of malignant neoplasms, although the precise localization of the primary organ of involvement (i.e., pancreas, biliary system, ampulla of Vater, or duodenum) is not possible by duodenal aspiration.

Because of advances in imaging techniques, these stimulation tests are used less often; none have proved especially useful in diagnosis of mild or acute pancreatic disease in which the acute phase has subsided. Most of the tests have found clinical utility in excluding the pancreas from diagnosis. The sweat test, used for screening cystic fibrosis, is not specific for assessing pancreatic in-

CASE STUDY 27-1

A 38-year-old man entered the emergency department with the complaint of severe, mid abdominal pain of 6 hours' duration. A friend, who had driven him to the hospital, stated that the patient fainted three times as he was being helped into the automobile. The patient had a 15-year history of alcoholism and drank 1–2 pints of whiskey every day. He had last been hospitalized for acute alcoholism 3 months ago, at which time he had relatively minor abnormalities of liver function. On this admission, his blood pressure was 80/40 mm Hg; pulse, 110 beats/minute and thready; and respirations, 24 breaths per minute and shallow. Clinical laboratory test results are shown in Case Study Table 27-1.1.

Questions

1. What is the probable disease?
2. What is the cause for the low serum calcium?
3. What is the cause for the increased blood urea nitrogen?

CASE STUDY TABLE 27-1.1 LABORATORY RESULTS

| | |
|------------------------|---------------------------|
| Serum amylase | 640 units (3.5–260 units) |
| Serum sodium | 133 mEq/L (135–145 mEq/L) |
| Potassium | 3.4 mEq/L (3.8–5.5 mEq/L) |
| Calcium | 4.0 mEq/L (4.5–5.5 mEq/L) |
| Blood urea nitrogen | 32 mg/dL (8–25 mg/dL) |
| White blood cell count | 16,500 |
| Hemoglobin | 12 g/dL |

volvement but, when used along with the clinical picture at the time of testing, can provide important diagnostic information. The following pancreatic function tests are reviewed briefly: secretin/CCK test, fecal fat analysis, sweat chloride determinations, and amylase and lipase interpretation.

Secretin/Cholecystokinin Test

The secretin/CCK test is a direct determination of the exocrine secretory capacity of the pancreas. The test involves intubation of the duodenum without contamination by gastric fluid, which would neutralize any bicarbonate. The test is performed after a 6-hour or overnight fast. Pancreatic secretion is stimulated by intravenously administered secretin in a dose varying from 2–3 U/kg of

CASE STUDY 27-2

A 56-year-old man who is an alcoholic presents with a 2-week history of mid abdominal pain. He also describes clay-colored stools, mild icterus, nausea, vomiting, and a 10-lb weight loss. Laboratory findings are shown in Case Study Table 27-2.1.

Questions

1. What organ system is primarily involved?
2. What are the major diagnostic considerations?
3. What do the laboratory results mean? What additional laboratory tests would be useful in establishing a diagnosis?
4. What other studies or procedures might be required?

CASE STUDY TABLE 27-2.1
LABORATORY RESULTS

| TEST | RESULT | REFERENCE RANGE |
|--------------------------------|-----------|-----------------|
| Serum bilirubin | 4.2 mg/dL | 0.3–1.0 mg/dL |
| Serum lactate dehydrogenase | 625 IU/L | 0–200 IU/L |
| Serum alanine aminotransferase | 76 IU/L | 0–46 IU/L |
| Serum alkaline phosphatase | 462 IU/L | 0–80 IU/L |
| Serum amylase | 80 IU/L | 0–85 IU/L |
| Urine bilirubin | 3+ | Negative |

body weight, followed by CCK administration. If a simple secretin test is desired, the higher dose of secretin is given alone.

No one protocol has been uniformly established for the test. Pancreatic secretions are collected variously for 30, 60, or 80 minutes after administration of the stimulants, either as 10-minute specimens or as a single, pooled collection. The pH, secretory rate, enzyme activities (e.g., trypsin, amylase, or lipase), and amount of bicarbonate are determined. The average amount of bicarbonate excreted per hour is about 15 mmol/L for men and 12 mmol/L for women, with an average flow of 2 mL/kg. Assessment of enzymes must be taken in view of total volume output. Decreased pancreatic flow is associated with pancreatic obstruction and increase in enzyme concentrations. Low concentrations of bicarbonate and enzymes are associated with cystic fibrosis, chronic pancreatitis, pancreatic cysts, calcification, and edema of the pancreas.

Fecal Fat Analysis

Fecal lipids are derived from four sources: unabsorbed ingested lipids, lipids excreted into the intestine (predominantly in the bile), cells shed into the intestine, and metabolism of intestinal bacteria. Patients on a lipid-free diet still excrete 1–4 g of lipid in the feces in a 24-hour period. Even with a lipid-rich diet, the fecal fat does not normally exceed about 7 g in a 24-hour period. Normal fecal lipid is composed of about 60% fatty acids; 30% sterols, higher alcohols, and carotenoids; 10% triglycerides; and small amounts of cholesterol and phospholipids. Although significantly increased fecal fat can be caused by biliary obstruction, severe steatorrhea is usually associated with exocrine pancreatic insufficiency or disease of the small intestine.

Qualitative Screening Test for Fecal Fat

Various screening tests have been devised for detecting steatorrhea. These tests commonly use fat-soluble stains (e.g., Sudan III, Sudan IV, Oil Red O, or Nile blue sulfate), which dissolve in and color lipid droplets. Of greater importance than the particular technical procedure is the level of experience and dependability of the clinical laboratorian performing the test.

Sudan Staining for Fecal Fat

Neutral fats (triglycerides) and many other lipids stain yellow-orange to red with Sudan III because the dye is much more soluble in lipid than in water or ethanol.^{8,9} Free fatty acids do not stain appreciably unless the specimen is heated in the presence of the stain with 36% acetic acid. The slide may be examined warm or cool and the number of fat droplets assessed. As the slide cools, the fatty acids crystallize out in long, colorless, needle-like sheaves. Detection of meat fiber is accomplished by a third aliquot of fecal sample mixed on the slide with 10% alcohol and a solution of eosin stained for 3 minutes. The meat fiber should stain as rectangular cross-striated fibers. Splitting the sample and detecting neutral fats, fatty acids, and undigested meat fibers can provide diagnostic information. Increases in fats and undigested meat fibers are indicative of patients with steatorrhea of pancreatic origin. A representative fecal specimen is used for analysis.

Normal feces can have up to 40 or 50 small (1–5 mm), neutral lipid droplets per high-power microscope field. Steatorrhea is characterized by an increase in the number and size of stainable droplets, often with some fat globules in the 50- to 100- μ m range. Fatty acid assessment greater than 100 stained small droplets, along with the presence of meat fiber, is expected in patients with steatorrhea.

Quantitative Fecal Fat Analysis

The definitive test for steatorrhea is the quantitative fecal fat determination, usually on a 72-hour stool collection, although the collection period may be increased to up to

5 days. Traditional methods for fecal fat determination are the gravimetric and titrimetric methods. Newer methods involve the use of infrared and nuclear magnetic resonance spectroscopy.^{10,11} In the gravimetric method, fatty acid soaps (predominantly calcium and magnesium salts of fatty acids) are converted to free fatty acids, followed by extraction of most of the lipids into an organic solvent, which is then evaporated so that the lipid residue can be weighed. In titrimetric methods, lipids are saponified with hydroxide, and the fatty acid salts are converted to free fatty acids using acid. The free fatty acids, along with various unsaponified lipids, are then extracted with an organic solvent, and the fatty acids are titrated with hydroxide after evaporation of the solvent and redissolving of the residue in ethanol. The titration methods obviously measure only saponifiable fatty acids and, consequently, render results about 20% lower than those from gravimetric methods. A further objection is that titrimetric methods use an assumed average molecular weight for fatty acids to convert moles of fatty acids to grams of lipid.

At one time, it was common to measure the amount of free fatty acids as a percentage of total lipids on the presumption that a high percentage of free fatty acids indicates adequate pancreatic lipase activity. This method is no longer considered reliable because of spurious results, particularly caused by lipase produced by intestinal bacteria.

It is essential that patients be placed on a lipid-rich diet for at least 2 days before instituting the fecal collection. The diet must contain at least 50 g, and preferably 100 g, of lipids each day. Fecal collections should extend for 3 or more successive days.

There are various ways to express fecal lipid excretion. Expressing lipid excretion as a percentage of wet or dry fecal weight is open to serious challenge because of wide variations in both fecal water content and dry residue as a result of dietary intake. The most widely accepted approach is to report the grams of fecal fat excreted in a 24-hour period.

Gravimetric Method for Fecal Fat Determination

The entire fecal specimen is emulsified with water. An aliquot is acidified to convert all fatty acid soaps to free fatty acids, which are then extracted with other soluble lipids into petroleum ether and ethanol. After evaporation of the organic solvents, the lipid residue is weighed. All feces for a 3-day period are collected in tared containers. The containers *must not* have a wax coating. The specimen must be kept refrigerated.

Total lipid does not change significantly during 5 days' storage of the specimen at refrigerator temperatures. Patients must not ingest castor oil, mineral oil, or other oily laxatives and must not use rectal suppositories containing oil or lipid for 2 days before the test and during the test.

The reference range for fecal lipids in adults is 1–7 g per 24 hours.

Sweat Electrolyte Determinations

Measurement of the sodium and chloride concentration in sweat is the most useful test for the diagnosis of cystic fibrosis.^{12–14} Significantly elevated concentrations of both ions occur in more than 99% of affected patients. The twofold to fivefold increases in sweat sodium and chloride are diagnostic of cystic fibrosis in children. Even in adults, no other condition causes increases in sweat chloride and sodium above 80 mmol/L. Sweat potassium is also increased, but less significantly so, and is not generally relied on for diagnosis. Contrary to some assertions, sweat electrolyte determinations do not distinguish heterozygote carriers of cystic fibrosis from normal homozygotes.

Older methods for acquiring sweat specimens required skilled technologists who frequently performed the test. Induction of sweat included applying plastic bags or wrapping the patient in blankets, which was fraught with serious risks of dehydration, electrolyte disturbances, and hyperpyrexia. In 1959, pilocarpine administration by iontophoresis was reported as an efficient method for sweat collection and stimulation. Iontophoresis uses an electric current that causes pilocarpine to migrate into a limited skin area, usually the inside of the forearm, toward the negative electrode from a moistened pad on the positive electrode. A collection vessel is then applied to the skin. The sweat is then analyzed for chloride. For confirmation, the test should be repeated. Commercially available surface electrodes that analyze the sweat chloride are readily available. For details, the reader is referred to Chapter 28.

It is widely accepted that sweat chloride concentrations greater than 60 mmol/L are diagnostic of cystic fibrosis in children. Sweat sodium and chloride concentrations in female patients undergo fluctuation with the menstrual cycle and reach a peak 5–10 days before the onset of menstruation but do not overlap with the ranges associated with cystic fibrosis.

Serum Enzymes

Amylase is the serum enzyme most commonly relied on for detecting pancreatic disease.^{15,16} It is not, however, a function test. Amylase is particularly useful in the diagnosis of acute pancreatitis, in which significant increases in serum concentrations occur in about 75% of patients. Typically, amylase in serum increases within a few hours of the onset of the disease, reaches a peak in about 24 hours, and because of its clearance by the kidneys, returns to normal within 3–5 days, often making urine amylase a more sensitive indicator of acute pancreatitis. The magnitude of the enzyme elevation cannot be correlated with the severity of the disease.

CASE STUDY 27-3

Parents brought their 7-year-old son to the pediatrician with the complaint of frequent fevers and failure to grow. The child had three bouts of pneumonia during the past 2 years and was bothered by chronic bronchitis, which caused him to cough up copious amounts of thick, yellow, mucoid sputum. Despite a big appetite, he had gained only 1–2 lb in the past 2 years and was of short, frail stature. He especially liked salty foods. He usually had three or four bulky, foul-smelling bowel movements daily. A 9-year-old sister was in excellent health.

Questions

1. What is the most likely disease?
2. What clinical laboratory test would be most informative, and what results would be expected?
3. What other clinical laboratory tests would likely be abnormal?

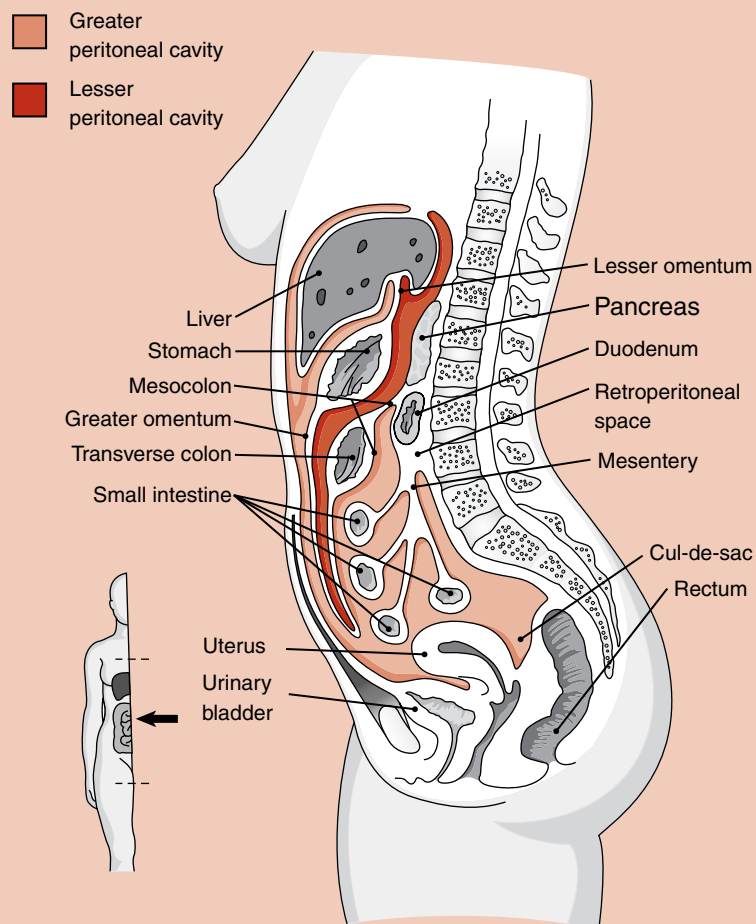

FIGURE 27-3.1. Peritoneum and mesenteries. The parietal peritoneum lines the abdominal cavity, and the visceral peritoneum covers abdominal organs. Retroperitoneal organs are covered by the parietal peritoneum. The mesenteries are membranes that connect abdominal organs to each other and to the body wall. (Reprinted with permission from Thompson JS, Akesson EJ, eds. Thompson's core textbook of anatomy. 2nd ed. Philadelphia, Pa.: JB Lippincott, 1990:115.)

CASE STUDY 27-3 (continued)

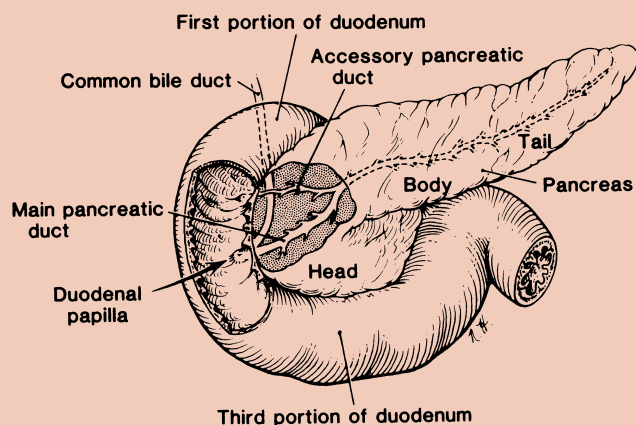

FIGURE 27-3.2. Diagram of the pancreas and its relationship to the duodenum.

TABLE 27-3 D-XYLOSE RESULTS FOR PEDIATRIC PATIENTS^{2,4}

| AGE | REFERENCE RANGE |
|-----------------------|-----------------|
| Younger than 6 months | 11%–33% |
| 6–12 months | 20%–32% |
| 1–3 years | 20%–42% |
| 3–10 years | 25%–45% |
| Older than 10 years | 25%–50% |

Determination of the renal clearance of amylase is useful in detecting minor or intermittent increases in the serum concentration of this enzyme. To correct for diminished glomerular function, the most useful expression is the ratio of amylase clearance to creatinine clearance, as follows:

$$\frac{\% \text{ Amylase clearance}}{\text{Creatinine}} = 100 \times \frac{US}{SA} \times \frac{SC}{UC} \quad (\text{Eq. 27-1})$$

where UA is urine amylase, SA is serum amylase, SC is serum creatinine, and UC is urine creatinine.

Normal values are less than 3.1%. Significantly increased values, averaging about 8% or 9%, occur in acute pancreatitis but also may occur in other conditions, such as burns, sepsis, and diabetic ketoacidosis.

The use of serum lipase in the clinical detection of pancreatic disease has been compromised in the past by technical problems inherent in the various analytic methods. Improved analytic methods appear to indicate that lipase increases in serum about as soon as amylase in acute pancreatitis and that increased levels persist somewhat longer than those of amylase. Consequently, some physicians consider lipase more sensitive than amylase as an indicator of acute pancreatitis or other causes of pancreatic necrosis.

Both amylase and lipase may be significantly increased in serum in many other conditions (e.g., opiate administration, pancreatic carcinoma, intestinal infarction, obstruction or perforation, and pancreatic trauma). Amylase levels are also frequently increased in mumps, cholecystitis, hepatitis, cirrhosis, ruptured ectopic pregnancy, and macroamylasemia, which is a benign condition in which amylase binds to an immunoglobulin molecule, causing chronic elevation of serum amylase values but normal urine amylase levels. Lipase levels are often significantly

increased in bone fractures and in association with fat embolism.

PHYSIOLOGY AND BIOCHEMISTRY OF GASTRIC SECRETION

Gastric secretion occurs in response to various stimuli¹⁷:

- Neurogenic impulses from the brain transmitted by means of the vagal nerves (e.g., responses to the sight, smell, or anticipation of food)
- Distention of the stomach with food or fluid
- Contact of protein breakdown products, termed **secretagogues**, with the gastric mucosa
- The hormone **gastrin** is the most potent stimulus to gastric secretion; it is secreted by specialized G cells in the gastric mucosa and the duodenum in response to vagal stimulation and contact with secretagogues.

Inhibitory influences include high gastric acidity, which decreases the release of gastrin by the gastric G cells. Gastric inhibitory polypeptide is secreted by K cells in the middle and distal duodenum and proximal jejunum in response to food products such as fats, glucose, and amino acids. Vasoactive intestinal polypeptide, produced by H cells in the intestinal mucosa, directly inhibits gastric secretion, gastrin release, and gastric motility.

Gastric fluid has a high content of hydrochloric acid, pepsin, and mucus. Hydrochloric acid is secreted against a hydrogen ion gradient as great as 1 million times the concentration in plasma (i.e., gastric fluid can reach a pH of 1.2–1.3 under conditions of augmented or maximal stimulation). **Pepsin** refers to a group of relatively weak proteolytic enzymes, with pH optima from about 1.6 to 3.6, that catalyze all native proteins except mucus. The

most important component of gastric secretion in terms of body physiology is **intrinsic factor**, which greatly facilitates the absorption of vitamin B₁₂ in the ileum.

CLINICAL ASPECTS OF GASTRIC ANALYSIS

Gastric analysis is used in clinical medicine mainly for the following purposes^{18,19}:

- Gastric analysis was once widely used in clinical medicine but has now been largely replaced by fiberoptic endoscopy and improved radiologic procedures.
- Gastric analysis is used clinically mainly to detect hypersecretion characteristic of the *Zöllinger-Ellison syndrome*. This syndrome involves a gastrin-secreting neoplasm, usually located in the pancreatic islets, and exceptionally high plasma gastrin concentrations. Basal 1-hour secretion usually exceeds 10 mEq, and the ratio of basal 1-hour to maximal secretion usually exceeds 60% (i.e., the stomach is not really in the basal state but rather is pathologically stimulated by the high plasma gastrin level).

Gastric analysis is also used occasionally to evaluate pernicious anemia in adults. Gastric atrophy is present in this condition, and the stomach fails to secrete intrinsic factor, which binds to vitamin B₁₂ to prevent its degradation by gastric acid. The pH of gastric fluid in this condition typically does not fall below 6, even with maximum stimulation. Rarely, gastric analysis may aid in determining the type of surgical procedure required for ulcer treatment.

Previously, various substances were used to stimulate gastric secretion (e.g., caffeine, alcohol, and test meals), but these are submaximal stimuli and obsolete. From 1953 until the late 1970s, histamine acid phosphate was used as a maximal stimulus to gastric secretion. Because of adverse effects, some of them severe, histamine has now been replaced by pentagastrin, which is a synthetic pentapeptide composed of the four C-terminal amino acids of gastrin linked to a substituted alanine derivative.

Normal gastric fluid is translucent, pale gray, and slightly viscous and often has a faintly acrid odor. Residual volume should not exceed 75 mL. Residual specimens occasionally contain flecks of blood or are green, brown, or yellow from reflux of bile during the intubation procedure. The presence of food particles is abnormal and indicates obstruction.

TESTS OF GASTRIC FUNCTION

Measuring Gastric Acid in Basal and Maximal Secretory Tests

After an overnight fast, gastric analysis is usually performed as a 1-hour basal test, followed by a 1-hour stimulated test subsequent to pentagastrin administration

(6 µg/kg subcutaneously).^{20,21} Test results reveal wide overlap among healthy subjects and diseased patients, except for an acidity (e.g., in pernicious anemia) and the extreme hypersecretion found in *Zöllinger-Ellison syndrome*. Gastric peptic ulcer is usually associated with normal secretory volume and acid output. Duodenal peptic ulcer is usually associated with increased secretory volume in both the basal and maximal secretory tests; considerable overlap occurs, nevertheless, with the normal range.

Measuring Gastric Acid

In stimulated-secretion specimens, the ability of the stomach to secrete against a hydrogen ion gradient is determined by measuring the pH. The total acid output in a timed interval is determined from the titratable acidities and volumes of the component specimens. After intubation, the residual secretion is aspirated and retained. Secretion for the subsequent 10–30 minutes is discarded to allow for adjustment of the patient to the intubation procedure. Specimens are ordinarily obtained as 15-minute collections for a period of 1 hour.

The gastrin response to intravenous secretin stimulation may be used to investigate patients with mildly elevated serum gastrin levels. In this test, pure porcine secretin is injected intravenously, and gastrin levels are collected at 5-minute intervals for the next 30 minutes. In patients with *Zöllinger-Ellison syndrome*, the gastrin level increases at least 100 pg/mL over the basal level. Patients with ordinary peptic ulceration, achlorhydria, or other conditions show a slight decrease in gastrin concentration.

The volume, pH, and titratable acidity and the calculated acid output of each specimen are reported, as are the total volume and acid output for each test period (sum of the component specimens). There is considerable variation in gastric acid output among healthy subjects in both the basal and maximal secretory tests. Nevertheless, in the basal test, most healthy subjects secrete 0–6 mEq of acid in a total volume of 10–100 mL. In the maximal 1-hour test, using histamine or pentagastrin as the stimulus, most men secrete 1–40 mEq of acid in a total volume of 40–350 mL. Women and older persons usually secrete somewhat less acid than do young men.

Plasma Gastrin

Measurement of plasma gastrin levels is invaluable in diagnosing *Zöllinger-Ellison syndrome*, in which fasting levels typically exceed 1000 pg/mL and can reach 400,000 pg/mL, compared with the normal range of 50–150 pg/mL.^{24,25} Gastrin is usually not increased in simple peptic ulcer disease. Increased plasma gastrin levels do occur in most pernicious anemia patients but decrease toward normal when hydrochloric acid is artificially instilled into the stomach.

INTESTINAL PHYSIOLOGY

Digestion, predominantly a function of the small intestine, is the process in which starches, proteins, lipids, nucleic acids, and other complex molecules are degraded to monosaccharides, amino acids and oligopeptides, fatty acids, purines, pyrimidines, and other simple constituents. For most large molecules, digestion is necessary for absorption to occur. Each day, the duodenum receives about 7–10 L of ingested water and food and secretion from the salivary glands, stomach, pancreas, and biliary tract. The materials then enter the jejunum and ileum, where another 1–1.5 L of secretion is added. Ultimately, however, only about 1.5 L of fluid material reaches the *cecum*, which is the first portion of the colon or large intestines. This considerable absorptive capability is possible because the small intestine (about 20 feet long) has numerous mucosal folds, minute projections from the luminal surface called *villi*, and microscopic projections on the mucosal cells called *microvilli*, all of which greatly increase the secretory and absorptive surface to an estimated 200 m². Absorption takes place by passive diffusion for some substances and by active transport for others. In addition, the small intestine actively secretes electrolytes and other metabolic products. The large intestine (about 5 feet long) has two major functions: water resorption, in which the 1.5 L of fluid received by the cecum is reduced to about 100–300 mL of feces, and storage of feces before defecation. The abdominal structures that constitute the alimentary tract are shown diagrammatically in Figure 27-1.

CLINICOPATHOLOGIC ASPECTS OF INTESTINAL FUNCTION

Clinical chemistry testing of intestinal function focuses almost entirely on the evaluation of absorption and its derangements in various disease states. As discussed in the Pancreatic Function section of this chapter, diseases of the exocrine pancreas and biliary tract may also cause malabsorption. Intestinal diseases that may cause the malabsorption syndrome are highly varied in their etiology, pathogenesis, and severity. These intestinal diseases and disorders include tropical and nontropical or celiac sprue, Whipple's disease, Crohn's disease, primary intestinal lymphoma, small intestinal resection, intestinal lymphangiectasia, ischemia, amyloidosis, and giardiasis. In addition to the malabsorption syndrome, which ordinarily causes impaired absorption of fats, proteins, carbohydrates, and other substances, specific malabsorption states also occur (e.g., acquired deficiency of lactase, which prevents normal absorption of lactose, and Hartnup syndrome, a genetic disorder that involves deficient intestinal transport of phenylalanine and leucine).

CASE STUDY 27-4

A 34-year-old man was admitted for diagnostic evaluation with the complaint of epigastric pain of 2 years' duration, which was variously described as gnawing or burning. He had been diagnosed with a duodenal peptic ulcer 18 months ago; at that time, therapy of antacids and dietary revision provided considerable alleviation of symptoms. More recently, the pain had become more persistent and awakened the patient 4–6 times each night. Radiologic studies revealed a 2.5-cm ulcer crater in the first portion of the duodenum and a 0.5-cm ulcer in the antrum of the stomach. Serum electrolytes were normal. Hemoglobin was 8.3 g/dL with normal red blood cell indices. White blood count was 13,100. Gastric analysis revealed 640 mL of secretion in the basal hour, with an acid output of 38 mEq, and 780 mL of secretion in the 1-hour pentagastrin stimulation test, with an acid output of 48 mEq.

Questions

1. What is the probable disease?
2. In view of existing data, what other test would be virtually diagnostic for this disease?
3. What is the explanation for decreased hemoglobin and increased white blood cell count?

TESTS OF INTESTINAL FUNCTION

Lactose Tolerance Test

The disaccharidases, lactase (which cleaves lactose into glucose and galactose) and sucrase (which cleaves sucrose into glucose and fructose), are produced by the mucosal cells of the small intestine.^{24,25} Congenital deficiencies of these enzymes are rare, but acquired deficiencies of lactase are commonly found in adults. Affected patients experience abdominal discomfort, cramps, and diarrhea after ingesting milk or milk products. About 10%–20% of white Americans and 75% of African Americans are affected.

Lactose tolerance testing was used to establish this diagnosis, but the test is subject to many false-positive and false-negative results. This test has largely been replaced by hydrogen breath testing.

D-Xylose Absorption Test

D-Xylose is a pentose sugar that is ordinarily not present in the blood in any significant amount.^{26,27} As with other monosaccharides, pentose sugars are absorbed unaltered in the proximal small intestine and do not require the intervention of pancreatic lytic enzymes. Therefore, the

ability to absorb D-xylose is of value in differentiating malabsorption of intestinal etiology from that of exocrine pancreatic insufficiency. Because only about one half of orally administered D-xylose is metabolized or lost by action of intestinal bacteria, significant amounts are excreted unchanged in the urine. Some protocols have used the measurement of only the D-xylose excreted in the urine during the 5 hours following ingestion of a 25-g dose by a fasting adult (0.5 g/kg in a child). Even with normal renal function, false-positive and false-negative results frequently occur. Blood levels measured one or more times after ingestion of D-xylose (e.g., at 30 minutes, 1 hour, or 2 hours) significantly improve the diagnostic reliability of the test. Some protocols use smaller doses of D-xylose to avoid abdominal cramps, intestinal hypermotility, and osmotic diarrhea that frequently accompany the 25-g dose.

D-Xylose Test

After ingestion of a specified solution of D-xylose, blood specimens are obtained and urine is collected for a 5-hour period to determine the extent of D-xylose absorption. The concentration of D-xylose is determined by heating protein-free supernates of urine and plasma to convert xylose to furfural, which is then reacted with *p*-bromoaniline to form a pink product, the absorbance of which is measured at 520 nm. Thiourea is added as an antioxidant to prevent the formation of interfering chromogens. After an overnight fast, the patient voids and drinks a D-xylose solution: 25 g of D-xylose in 250 mL of water for adults and 0.5 g/kg for children, or other dose as established. The patient drinks an equivalent amount of water during the next hour. No additional food or fluids are to be taken until the test is completed. Urine is collected for 5 hours after the D-xylose ingestion. A blood specimen is collected in potassium oxalate at 2 hours (commonly, 1 hour is chosen for children).

Normal blood concentrations of D-xylose in association with decreased urine excretion suggest impairment of renal function or incomplete urine collection. Aspirin therapy diminishes renal excretion of D-xylose, whereas indomethacin decreases intestinal absorption. After ingestion of a 25-g dose of D-xylose, healthy adults should excrete at least 4 g in the 5-hour period. For infants and children, the excretion following a dose of 0.5 g/kg for various ages expressed as percentages of ingested dose are shown in Table 26-1. Blood levels for healthy adults vary widely, but a blood concentration of less than 25 mg/dL at 2 hours should be considered abnormal after the 25-g dose. With the 0.5 g/kg dose, infants younger than 6 months should have a blood concentration of at least 15 mg/dL at 1 hour, infants older than 6 months and children should achieve levels of at least 30 mg/dL.

Serum Carotenoids

Carotenoids are various yellow to orange or purple pigments that are widely distributed in animal tissue;

they are synthesized by many plants and impart a yellow color to some vegetables and fruits. The major carotenoids in human serum are lycopene, xanthophyll, and beta carotene, the chief precursor of vitamin A in humans. Being fat soluble, carotenoids are absorbed in the small intestine in association with lipids. Malabsorption of lipids typically results in a serum concentration of carotenoids lower than the reference range of 50–250 mg/dL. Starvation, dietary idiosyncrasies, and fever also cause diminished serum concentrations. The test does not distinguish among the various etiologies of malabsorption.

Other Tests of Intestinal Malabsorption

Deficiencies of numerous analytes can occur in association with intestinal malabsorption. Measurement of these analytes is usually of value, not so much in confirming the diagnosis of malabsorption as in determining the extent of nutritional deficiency and, thus, the need for replacement therapy. Diminished appetite and dietary intake are usually more severe in patients who have malabsorption with an intestinal etiology. Body wasting or cachexia may be severe. Frequently, because loss of albumin into the intestinal lumen and diminished dietary intake of protein accompany the diminished absorption of oligopeptides and amino acids, a negative nitrogen balance occurs together with decreased serum total proteins and albumin. A serum albumin of less than 2.5 g/dL is much more characteristic of intestinal disease than of pancreatic disease. In association with severe disease of the small intestine, deficiencies of fat-soluble vitamins A, D, E, and K occur. Vitamin K deficiency, in turn, causes deficiencies of vitamin K-dependent coagulation factors II (prothrombin), VII (proconvertin), IX (plasma thromboplastin component), and X (Stuart-Prower factor), which are reflected in abnormal prothrombin time and partial thromboplastin time tests.

In severe small intestinal disease, such as tropical or celiac sprue, malabsorption of folate and vitamin B₁₂ can occur, and megaloblastic anemia is rather common and is of some benefit in distinguishing intestinal from pancreatic disease. Absorption of iron is usually diminished, and the tendency toward low serum iron levels may be aggravated by intestinal blood loss. Intestinal absorption of calcium is often diminished as a result of calcium binding by unabsorbed fatty acids and accompanying vitamin D deficiency and decreased serum magnesium. Because sodium, potassium, water absorption, and metabolism may also be seriously deranged, serum sodium and potassium levels are decreased and dehydration occurs. Impaired absorption of carbohydrates in intestinal diseases, such as sprue, results in decreased to flat blood concentration curves in glucose, lactose, and sucrose tolerance tests.

CASE STUDY 27-5

A 26-year-old woman appeared in the outpatient clinic with the complaint of abdominal discomfort; diarrhea; and an 18-lb, unintentional weight loss during the past 2–3 years. She related a similar period of 5 or 6 years of abdominal distress and diarrhea in childhood, but this essentially disappeared when she was about 12–13 years old. She was now having three to five bowel movements daily, which were described as bulky, malodorous, and floating. She weighed 106 lb and was 67 inches tall. She never had surgical procedures. Physical examination revealed poor skin turgor, general pallor, and a protuberant abdomen. Abnormal clinical laboratory values included those in Case Study Table 27-5.1.

Fecal examination revealed no ova or parasites, and bacteriologic culture revealed no pathogens.

Questions

1. What is the disease process?
2. What is the probable etiology in this case?
3. What is the cause of the abnormal coagulation tests?
4. What is the probable major cause for the anemia, and what are other possible contributing causes?

CASE STUDY TABLE 27-5.1 LABORATORY RESULTS

| ANALYTE | RESULT |
|---------------------------------------|---|
| Hemoglobin | 8.1 g/dL |
| Hematocrit | 30% |
| RBC count | $4.1 \times 10^6/\mu\text{L}$ |
| Serum sodium | 134 mEq/L |
| Potassium | 3.4 mEq/L |
| Serum carotenoids | 14 $\mu\text{g/dL}$ |
| Fecal fat | 22 g/24 hr |
| D-Xylose absorption test (25-g dose) | 5-hour excretion of 1.3 g and blood level at 2 hours of 8 mg/dL |
| Prothrombin time | 15.8 seconds (12–14 seconds) |
| Activated partial thromboplastin time | 56 seconds (30–45 seconds) |

SUGGESTED READINGS

- Berger HG, Buchler M, Kozarek R, et al. An integrated textbook of basic science, medicine and surgery. Indianapolis, Ind.: Wiley-Blackwell, 2008.
- Feldman M, Friedman LS, Brandt LJ. Sleisenger and Fordtran's gastrointestinal and liver disease: pathophysiology, diagnosis, management. St. Louis, Mo.: WB Saunders, 2006.

REFERENCES

1. Scotet V, Gillet D, Dugueperoux I, et al. Spatial and temporal distribution of cystic fibrosis and of its mutations in Brittany, France: a retrospective study from 1960. *Hum Genet* 2002;111:247–254.
2. Corbetta C, Seia M, Bassotti A, et al. Screening for cystic fibrosis in newborn infants: results of a pilot programme based on a two tier protocol (IRT/DNA/IRT) in the Italian population. *J Med Screen* 2002;9:60–63.
3. Gregg AR, Simpson JL. Genetic screening for cystic fibrosis. *Obstet Gynecol Clin North Am* 2002;29:329–340.
4. Walsh MK. Diagnosis, prognosis, and treatment of acute pancreatitis. *Am Fam Physician* 2008;77:594.
5. Lankish PG. Chronic pancreatitis. *Curr Opin Gastroenterol* 2007;23:502–507.
6. Schibli S, Corey M, Gaskin KJ, et al. Towards the ideal quantitative pancreatic function test: analysis of test variables that influence validity. *Clin Gastroenterol Hepatol* 2006;4:90–97.
7. Leus J, Van Biervliet S, Robberecht E. Detection and follow up of exocrine pancreatic insufficiency in cystic fibrosis: a review. *Eur J Pediatr* 2000;159:563–568.
8. Simko V. Sudan stain and quantitative fecal fat. *Gastroenterology* 1990;98:1725–1723.
9. Huang G, Khouri MR, Shiao YF. Sudan stain of fecal fat: new insight into an old test. *Gastroenterology* 1989;96(2 Pt 1):421–427.
10. Kunz P, Künnecke B, Kunz I, et al. Natural abundance ^{13}C -NMR spectroscopy for the quantitative determination of fecal fat. *Clin Biochem* 2003;36:505–510.
11. Voortman G, Gerrits J, Altavilla M, et al. Quantitative determination of fecal fatty acids and triglycerides by Fourier transform infrared analysis with a sodium chloride transmission flow cell. *Clin Chem Lab Med* 2002;40:795–798.
12. Baumer JH. Evidence based guidelines for the performance of the sweat test for the investigation of cystic fibrosis in the UK. *Arch Dis Child* 2003;88:1126–1127.

13. Wang L, Freedman SD. Laboratory tests for the diagnosis of cystic fibrosis. *Am J Clin Pathol* 2002;117(suppl):S109–S115.
14. De Boeck K, Wilschanski M, Castellani C, et al; Diagnostic Working Group. Cystic fibrosis: terminology and diagnostic algorithms. *Thorax* 2006;61:627–635.
15. Matull WR, Pereira SP, O'Donohue JW. Biochemical markers of acute pancreatitis. *J Clin Pathol* 2006;59:340–344.
16. Kylänpää-Bäck ML, Repo H, Kemppainen E. New laboratory tests in acute pancreatitis. *Addict Biol* 2002;7:181–190.
17. Schubert ML. Gastric secretion. *Curr Opin Gastroenterol* 2007;23:595–601.
18. Hung PD, Schubert ML, Mihas AA. Zollinger-Ellison syndrome. *Curr Treat Options Gastroenterol* 2003;6:163–170.
19. Metz DC, Starr JA. A retrospective study of the usefulness of acid secretory testing. *Aliment Pharmacol Ther* 2000;14:103–111.
20. Hirschowitz BI, Simmons J, Mohnen J. Long-term lansoprazole control of gastric acid and pepsin secretion in ZE and non-ZE hypersecretors: a prospective 10-year study. *Aliment Pharmacol Ther* 2001;15:1795–1806.
21. Berger AC, Gibril F, Venzon DJ, et al. Prognostic value of initial fasting serum gastrin levels in patients with Zollinger-Ellison syndrome. *J Clin Oncol* 2001;19:3051–3057.
22. Hung PD, Schubert ML, Mihas AA. Zollinger-Ellison syndrome. *Curr Treat Options Gastroenterol* 2003;6:163–170.
23. Metz DC, Buchanan M, Purich E, Fein S. A randomized controlled crossover study comparing synthetic porcine and human secretins with biologically derived porcine secretin to diagnose Zollinger-Ellison syndrome. *Aliment Pharmacol Ther* 2001;15:669–676.
24. Korpela R, Peuhkuri K, Poussa T. Comparison of a portable breath hydrogen analyser (Micro H2) with a Quintron MicroLyzer in measuring lactose maldigestion, and the evaluation of a Micro H2 for diagnosing hypolactasia. *Scand J Clin Lab Invest* 1998;58:217–224.
25. Matthews SB, Waud JP, Roberts AG, Campbell AK. Systemic lactose intolerance: a new perspective on an old problem. *Postgrad Med J* 2005;81:167–173.
26. Farrell RJ, Kelly CP. Diagnosis of celiac sprue. *Am J Gastroenterol* 2001;96:3237–3246.
27. Uil JJ, van Elburg RM, van Overbeek FM, et al. Clinical implications of the sugar absorption test: intestinal permeability test to assess mucosal barrier function. *Scand J Gastroenterol Suppl* 1997;223:70–78.

Body Fluid Analysis

Susan Strasinger

CHAPTER

28

CHAPTER OUTLINE

■ AMNIOTIC FLUID

Neural Tube Defects
Hemolytic Disease of the Newborn
Fetal Lung Maturity

■ PHOSPHADITYL GLYCEROL

■ FLUORESCENCE POLARIZATION

Lamellar Body Counts

■ CEREBROSPINAL FLUID

■ SWEAT

■ SYNOVIAL FLUID

■ SEROUS FLUIDS

Pleural Fluid
Pericardial Fluid
Peritoneal Fluid

■ REFERENCES

This chapter is designed to acquaint the reader with several fluids that are often analyzed in the clinical chemistry laboratory. In general, the source, physiologic purpose, and clinical utility of laboratory measurements for each of these body fluids are emphasized.

AMNIOTIC FLUID

The amniotic sac provides an enclosed environment for fetal development. This sac is bilayered as the result of a fusion of the amnionic (inner) and chorionic (outer) membranes at an early stage of fetal development. The fetus is suspended in **amniotic fluid** (AF) within the sac. The AF provides a cushioning medium for the fetus, regulates the temperature of the fetal environment, allows fetal movement, and serves as a matrix for influx and efflux of constituents.

Obviously, the mother must be the ultimate physiologic source for AF. Depending on the interval of the gestational period, the fluid may be derived from different sources. At initiation of pregnancy, some maternal secretion across the amnion contributes to the volume. Shortly after formation of the placenta, embryo, and fusion of membranes, AF is largely derived by transudation across the fetal skin. In the last half of pregnancy, the skin becomes substantially less permeable, and fetal micturition, or urination, becomes the major volume source. The fate of the fluid also varies with period of gestation. A bidirectional exchange is presumed to occur across the membranes and at the placenta. Similarly, during early

pregnancy, the fetal skin is involved. In the last half of pregnancy, the mechanism of fetal swallowing is the major fate of AF. There is a dynamic balance established between production and clearance; fetal urination, and swallowing maintain this balance. The continual swallowing maintains intimate contact of the AF with the fetal gastrointestinal tract, buccal cavity, and bronchotracheal tree. This contact is evidenced by the sloughed material from the fetus that provides us with the “window” to fetal developmental and functional stages.

Cells found in the fluid originate with the fetus, and the chemical content reflects the continual swallowing and clearance of fluid. A sample of fluid is obtained by transabdominal **amniocentesis** (amniotic sac puncture), which is performed under aseptic conditions. Before an attempt is made to obtain fluid, the positions of the placenta, fetus, and fluid pockets are visualized using ultrasonography. Aspiration of anything except fluid could lead to erroneous conclusions, as well as possible harm to the fetus.

Amniocentesis and subsequent AF analysis are performed to test for (1) congenital diseases, (2) neural tube defects, (3) hemolytic disease, and (4) fetal pulmonary development. The first, diagnosis of genetic abnormality, can be accomplished by cell culture. Fluid obtained between 14 and 20 weeks of pregnancy is harvested for cells of fetal origin. The cells are cultured, collected for chromosomal analysis, and are lysed so that enzyme contents may be determined to evaluate for metabolic defects. This procedure has been largely supplanted by the use of chorionic villus

sampling (CVS) and fluorescence in situ hybridization (FISH) genetic analysis. CVS may pose a risk to the fetus, and first-trimester amniocentesis may provide a sample with less interfering substances.

Neural Tube Defects

Screening for neural tube defects (NTDs) is initially performed using maternal serum. The presence of elevated levels of α -fetoprotein (AFP) is primarily associated with NTDs such as spina bifida and anencephaly. Elevated maternal serum AFP can also be closely correlated with abdominal hernias into the umbilical cord, cystic hygroma, and poor pregnancy outcome. Low maternal serum AFP is associated with an increased incidence of Down's syndrome and other aneuploidies. The protocol for AFP testing is generally considered to include (1) maternal serum AFP, usually with the assay of hCG, unconjugated estriol, and inhibin A; (2) repeat, if positive; (3) diagnostic ultrasound; and (4) amniocentesis for confirmation. Interpretation of maternal serum AFP testing is complex, being a function of age, race, weight, gestational age, and level of nutrition. Testing of amniotic fluid AFP (AFAFP) is the confirmatory procedure. AFP is a product of, first, the fetal yolk sac and, then, the fetal liver. It is released into the fetal circulation and presumably enters the AF by transudation. Entry into the maternal circulation could be by placenta crossover or from the AF. If there was an open neural tube defect (e.g., spina bifida) that caused an increase in AFAFP, there would be a concomitant increase in maternal serum AFP. Under normal conditions, AFAFP would be cleared by fetal swallowing and metabolism. An increased presence overloads this mechanism, causing AFAFP elevation. Both serum and AF are routinely analyzed using immunologic methods. Results are reported as multiples of the median (MoM). Because of the variety of demographics involved in determining normal values, each laboratory should establish its own median values for gestational weeks (usually weeks 15–21). Results can then be calculated using the formula:

$$\text{MoM} = \frac{\text{Specimen AFP concentration}}{\text{Median AFP concentration for gestational week}} \quad (\text{Eq. 28-1})$$

Concern over the difficulty in interpreting AFP tests generated the need for a second test to affirm NTDs and abdominal wall defects. The method used is the assay for a central nervous system (CNS)-specific acetylcholinesterase (AChE). The NTD allows direct or, at least less difficult, passage of AChE into the AF. Analysis for CNS-specific AChE in the AF then offers a degree of confirmation for AFAFP. The methods used for CNS AChE include enzymatic, immunologic, and electrophoretic with

inhibition. The latter includes the use of acetylthiocholine as substrate and BW284C51, a specific CNS inhibitor, to differentiate the serum pseudocholinesterase from the CNS-specific AChE.

Hemolytic Disease of the Newborn

Analysis of AF to screen for hemolytic disease of the newborn (erythroblastosis fetalis) was the first recognized laboratory procedure performed on AF. Hemolytic disease of the newborn is a syndrome of the fetus resulting from ABO incompatibility of the maternal and fetal blood. Maternal antibodies to fetal erythrocytes cause a hemolytic reaction that can vary in severity. The resultant hemoglobin breakdown products, predominantly bilirubin, appear in the AF and provide a measure of the severity of the incompatibility reaction.

The most commonly used method is a direct spectrophotometric scan of undiluted AF and subsequent calculation of the relative bilirubin amount. Classically, absorbance due to bilirubin is reported instead of a concentration of bilirubin. The method consisted of scanning AF from 550 nm to 350 nm against a water blank. The resultant absorbances can be used differently to derive the necessary information. The common method, the method of Liley,¹ requires the plotting of the observations at 5-nm intervals against wavelength, using semilogarithmic paper. A baseline is constructed from 550 nm to 350 nm; the change at 450 nm is a result of bilirubin.

Care must be used in the interpretation of the spectra. A decision for treatment can be made based on the degree of hemolysis and gestational age. The rather limited treatment options are immediate delivery, intrauterine transfusion, or observation. The transfusion can be accomplished by means of the umbilical artery and titrated to desired hematocrit. Several algorithms have been proposed to aid in decision making (Fig. 28-1). An example of an uncomplicated bilirubin scan is shown in Figure 28-2. To avoid interference in the spectrophotometric scan, specimens should be immediately centrifuged and the fluid separated from the sediment. This will prevent not only particulate interference but also the possibility of increased lysis of red blood cells in the specimen producing hemoglobin in the AF. As with all specimens for bilirubin analysis, AF specimens for bilirubin scans must be protected from light. Specimens are routinely collected in amber-colored tubes. Exposure to light results in the photo-oxidation of bilirubin to biliverdin that will not be detected at 450 nm, resulting in underestimation of the hemolytic disease severity.

Examples of interferences, compared with a normal specimen, are given in Figure 28-3. Each laboratory should compile its own catalog of real examples for spectrophotometric analysis. The presence of hemoglobin is

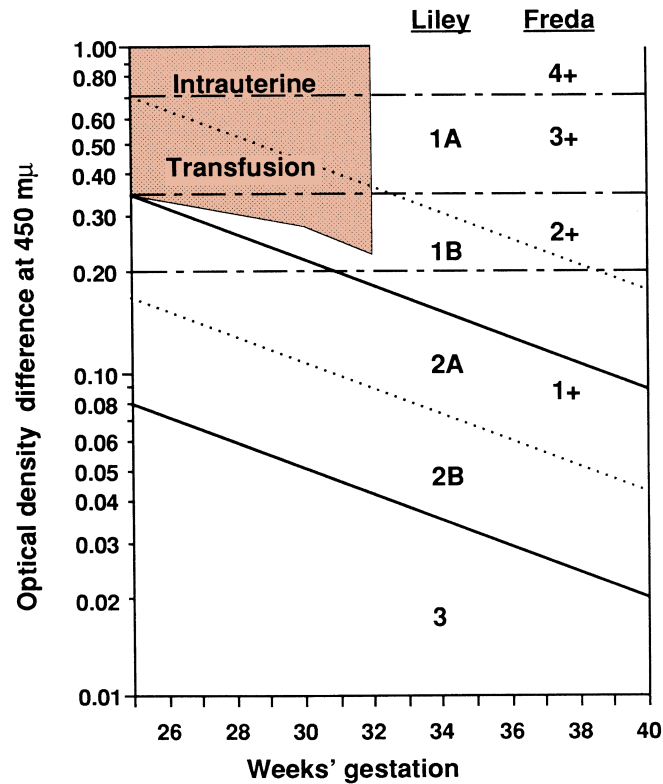

FIGURE 28-1. Assessment of fetal prognosis. Liley method: 1A, above broken line, condition desperate, immediate delivery or transfusion; 1B, between broken and continuous lines, hemoglobin >8 g/100 mL, delivery or transfusion (stippled area) urgent; 2A, between continuous and broken lines, hemoglobin 8–10 g/100 mL, delivery 36–37 weeks; 2B, between broken and continuous lines, hemoglobin 11–13.9 g/100 mL, delivery 37–39 weeks; 3, below continuous line, not anemic, delivery at term.

Freda method: 4+, above upper horizontal line, fetal death imminent, immediate delivery or transfusion; 3+, between upper and middle horizontal lines, fetus in jeopardy, death within 3 weeks, delivery or transfusion as soon as possible; 2+, between middle and lower horizontal lines, fetal survival for at least 7–10 days, repeat test, possible indication for transfusion; 1+, below lower horizontal line, fetus in no immediate danger of death. (Adapted with permission from Robertson JG. Evaluation of the reported methods of interpreting spectrophotometric tracings of amniotic fluid in rhesus isoimmunization. *Am J Obstet Gynecol* 1966;95:120.)

identified by its peak absorbance at 410–415 nm; the presence of urine is identified by the broad curve and confirmed by creatinine and urea analyses; and the presence of meconium is identified by the distinctly greenish color of the AF and flat absorbance curve.

Fetal Lung Maturity

The primary reason for AF testing is the need to assess fetal pulmonary maturity. All the organ systems are at jeopardy from prematurity, but the state of the fetal lungs is a priority from the clinical perspective. The availability of laboratory tests that give an indication of maturity has

also fostered this emphasis. Consequently, the laboratory is asked whether sufficient specific phospholipids are reflected in the AF to prevent atelectasis (alveolar collapse) if the fetus were to be delivered. This question is important when preterm delivery is contemplated because of other risk factors in pregnancy, such as preeclampsia or premature rupture of membranes. Risk factors to fetus or mother can be weighed against interventions, such as delay of delivery with steroid administration to the mother to enhance fetal **surfactant** production, or against at-risk postdelivery therapies, such as exogenous surfactant therapy, high-frequency ventilation, or extracorporeal membrane oxygenation.

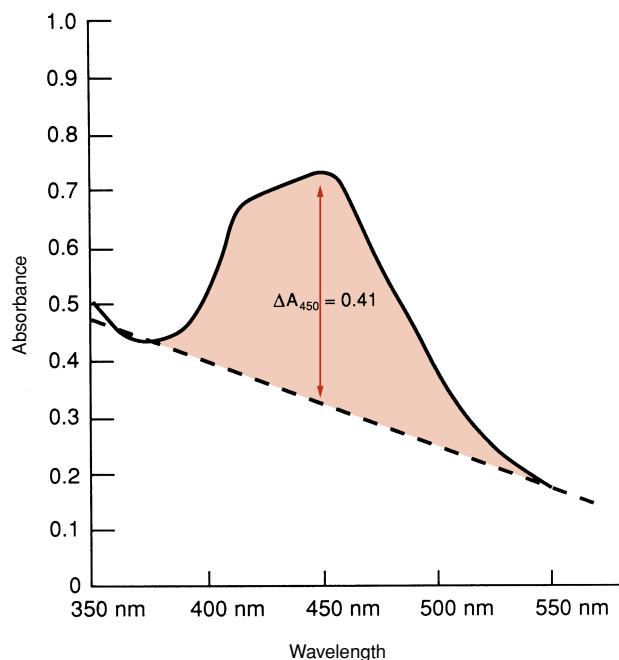

FIGURE 28-2. Change in $A_{450\text{nm}}$ from AF bilirubin scan.

Alveolar collapse in the neonatal lung may occur during the changeover from placental oxygen to air as an oxygen source at birth if the proper quantity and type of phospholipid (surfactant) is not present. The ensuing condition, which may vary in degree of severity, is called

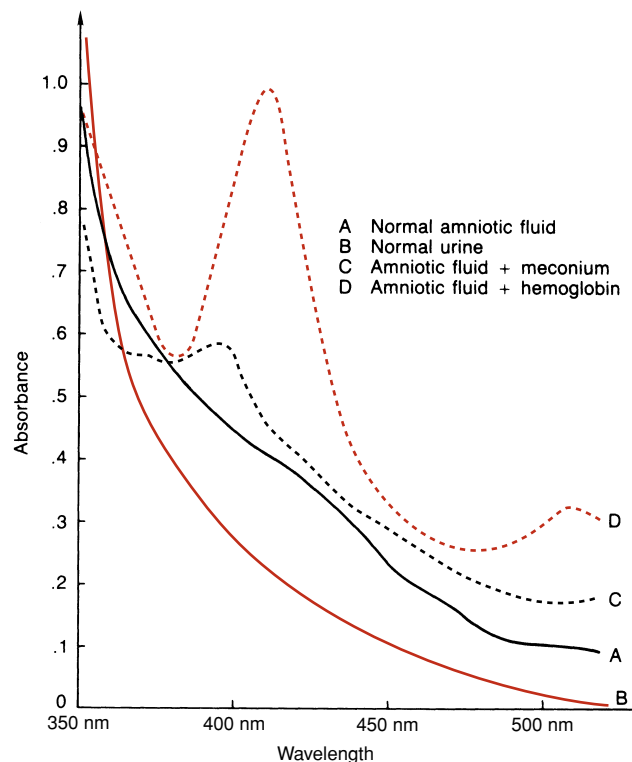

FIGURE 28-3. Amniotic fluid absorbance scans.

respiratory distress syndrome (RDS). It also has been referred to as *hyaline membrane disease* because of the hyaline membrane found in affected lungs. Lung maturation is a function of differentiation, beginning near the 24th week of pregnancy, of alveolar epithelial cells (pneumocytes) into type I and type II cells. The type I cells form the alveolar-capillary membrane for exchange of gases. The type II cells produce and store the surfactants needed for alveolar stability in the form of lamellar bodies. As the lungs mature, increases occur in phospholipid concentration, particularly the compounds phosphatidylglycerol and lecithin² (Fig. 28-4). These two compounds, present in 10% and 70%, respectively, of total phospholipid concentration, are most important as surfactants. Their presence in high enough levels acts in concert to allow contraction and reexpansion of the neonatal alveoli. To conceptualize their importance, remember the difficulty in blowing up a new toy balloon relative to a balloon that has been partially inflated. For the newborn, the normal amount of proper surfactant allows contraction of the alveoli without collapse. The next inspiration is the difference between a partially inflated versus a flattened new balloon. Insufficient surfactant allows alveoli to collapse, requiring a great deal of energy to re-expand the alveoli upon inspiration. This not only creates an extreme energy demand on a newborn but probably also causes physical damage to the alveoli with each collapse. The damage may lead to “hyaline” deposition, or the newborn may not have the strength to continue inspiration at the energy cost. The end result of either can be fatal.

Tests for assessing FLM include functional assays and quantitative assays. Functional assays provide a direct physical measure of AF in an attempt to assess surfactant ability to decrease surface tension. These include the “bubble or shake” test and the foam stability index (FSI). Quantitative tests include the lecithin-sphingomyelin ratio (**L/S ratio**), phosphatidylglycerol, fluorescence polarization, and lamellar body counts.

Excessive force (anything greater than that needed to remove debris) can change the lipid profile by causing the lipids present to fractionate as a result of centrifugal force. The difference in ratios observed at 1000 versus 3000 g can radically alter clinical interpretation. Before adoption of any method for AF analysis, a protocol for centrifugal separation to include relative force (*not* revolutions per minute) and duration of centrifugation must be adopted and rigorously followed. Separation method requirements for all test procedures should be considered before centrifuging of the specimen. For example, the package insert for the TDxFLM II fluorescent polarization assay (Abbott Laboratories, Abbott Park, IL) specifically states that filtration rather than centrifugation should be used prior to testing.

The FSI,³ a variant of Clements’ original “bubble test”⁴ that was performed at the bedside, appears

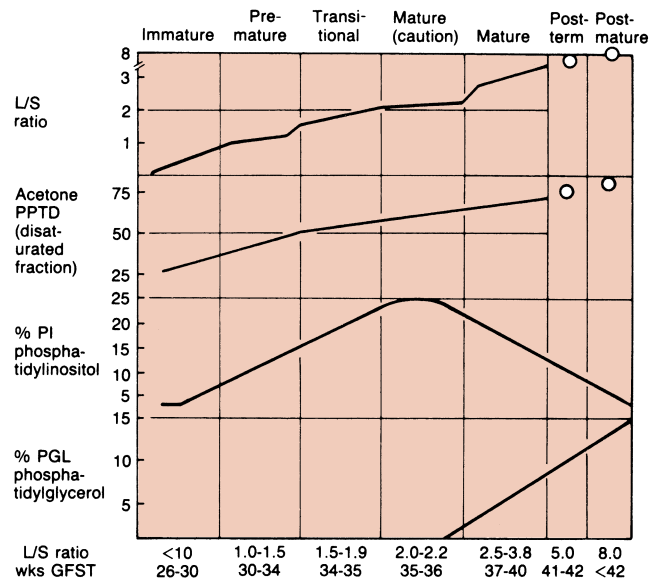

FIGURE 28-4. The form used to report the lung profile. The four determinations are plotted on the *ordinate*, and the weeks of gestation are plotted on the *abscissa* (as well as the *L/S ratio* as an "internal standard"). When plotted, these fall with a high frequency into a given grid that then identifies the stage of development of the lung as shown in the upper part of the form. The designation "mature (caution)" refers to patients other than those with diabetes who can be delivered *if necessary* at this time; if the patient has diabetes, she can be delivered with safety when the values fall in the "mature" grid. (Reprinted with permission from Kulovich MV, Hallman MB, Gluck L. The lung profile. I. Normal pregnancy. *Am J Obstet Gynecol* 1979;135:57. Copyright 1977 by the Regents of the University of California.)

acceptable as a rapid, inexpensive, informative assay. This qualitative, technique-dependent test requires only common equipment. The assay is based on the ability of surfactant to generate a surface tension lower than that of a 0.47-mole fraction ethanol-water solution. If sufficient surfactant is present, a stable ring of foam bubbles remains at the air-liquid interface. As surfactant increases (fetal lung maturity probability increases), a larger mole fraction of ethanol is required to overcome the surfactant-controlled surface tension. The highest mole fraction used while still maintaining a stable ring of bubbles at the air-liquid interface is reported as the FSI (Table 28-1). The test is dependent on technique and can also be skewed by contamination of any kind in the AF (e.g., blood or meconium contamination). Interpretation of the FSI bubble patterns is dif-

ficult and technique dependent. Results can vary among clinical laboratorians. Most laboratories have found an FSI of 0.47 has been found to correlate well with an L/S ratio of 2.0.

The quantitative tests were given emphasis primarily by the work of Gluck.⁵ The phospholipids of importance are phosphatidylglycerol (PG), lecithin, and sphingomyelin (SP). Relative amounts of PG and lecithin increase dramatically with pulmonary maturity, whereas SP concentration is relatively constant and provides a baseline for the L/S ratio. Increases in PG and lecithin correspond to larger amounts of surfactant being produced by the type II pneumocytes as fetal lungs mature.

The classic technique for separation and evaluation of the lipids involves thin-layer chromatography (TLC) of an extract of the AF. The extraction procedure removes most interfering substances and results in a concentrated lipid solution. Current practices use either one- or two-dimensional TLC for identification. Laboratory needs determine if a one-dimensional or a two-dimensional method is performed. An example of the phospholipids separation by one-dimensional TLC is shown in Figure 28-5.⁶

The classic breakpoint for judgment of maturity has been an L/S ratio of 2.

TABLE 28-1 FSI DETERMINATION

| | TUBE 1 | TUBE 2 | TUBE 3 |
|--------------|--------|--------|--------|
| Vol AF | 0.50 | 0.50 | 0.50 |
| Vol 95% EtOH | 0.51 | 0.53 | 0.55 |
| FSI | 0.47 | 0.48 | 0.49 |

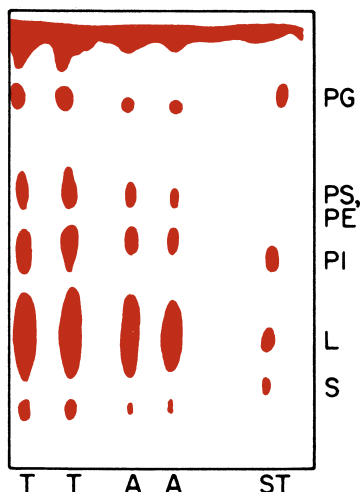

FIGURE 28-5. Thin-layer chromatogram of amniotic fluid phospholipids. Standard phospholipids (ST), total extract (T), and acetone-precipitable compounds (A) in amniotic fluid are shown. The phospholipid standards contained, per liter, 2 g each of lecithin and P1, 1 g each of PG and sphingomyelin, and 0.3 g each of PS and PE; 10 mL of the standard was spotted. (Reprinted with permission from Tsai MY, Marshall JG. Phosphatidylglycerol in 261 samples of amniotic fluid. *Clin Chem* 25[5]:683. Copyright 1979 American Association for Clinical Chemistry.)

As a result of the time-consuming requirements of performing the L/S ratio, several additional tests have been developed to allow faster determination of FLM. The L/S ratio, however, remains the “gold standard” by which all methods are compared.

PHOSPHATIDYLGLYCEROL

As mentioned previously, an additional phospholipid essential for FLM is PG that increases in proportion to lecithin. In the case of diabetic mothers, however, development of PG is delayed. Therefore, using an L/S ratio of 2.0 as an indicator of FLM cannot be relied upon to ensure that RDS will not occur unless PG is also included in

interpretation of the L/S ratio. With the current trend toward less labor-intensive techniques, an immunologic assay using antibody specific for PG can be used to determine FLM.

The Aminostat-FLM (Irving Scientific, Santa Ana, CA) immunologic test is designed to measure the adequate presence of PG in AF. Because lecithin production is not affected in diabetic mothers and the levels of PG and lecithin rise at the same rate in unaffected pregnancies, the Aminostat-FLM can be used to determine whether adequate FLM is present. Good correlation has been shown compared with the L/S ratio. The antibody-specific immunologic assay offers the additional advantage, not present in other assays, of being unaffected by specimen debris such as meconium and blood.

FLUORESCENCE POLARIZATION

The TDx/FLM II Assay system (Abbott Laboratories) consists of a commercial reagent system that can be run on the versatile TDx automated polarizing instrument. The system compares the polarization of a fluorescent dye that combines with albumin and surfactant in the AF specimen. The concentration of albumin remains consistent throughout later gestation and serves as an internal standard similar to sphingomyelin in the L/S ratio.

Dye molecules combined with albumin have restricted movement producing a high level of polarization and a reduced life span. In contrast, dye molecules combined with surfactant produce a lower level of polarization and have a longer life span. The polarizer separates the differences in polarization and determines the ratio of surfactant to albumin. The ratio of surfactant is expressed in milligrams of surfactant to grams of albumin and is achieved by instrumental comparison to a standard curve. A set of FLM II calibrators is run through the polarizer to develop the standard curve producing a range of 0 mg/g–160 mg/g. The standard curve is stored in the polarizer.

Values of 55 mg surfactant per gram of albumin and higher are considered to indicate FLM. A value of 39 mg/g is considered immature, and values between 55 mg/g–39 mg/g are considered borderline.

A protocol for interpretation based on gestational age has been reported.⁷ The FLM II test correlates with an L/S ratio of 2.0.⁸

AF specimens must be filtered, not centrifuged, to avoid falsely decreased values for FLM. Filters and holders are provided with the assay system. Test interference can be caused by the presence of bilirubin, meconium, and blood.⁹

Lamellar Body Counts

The phospholipids are produced and secreted by the type II alveolar cells in the form of lamellar bodies. As

CASE STUDY 28-1

A 26-year-old woman pregnant for the second time has a Liley graph reading of 0.6. She is at approximately 34 weeks' gestation. The physician is considering inducing labor. Further testing of the amniotic fluid shows an FLM II reading of 55 mg/g.

Questions

1. Why is the physician considering inducing labor?
2. Based on the FLM II results, is it safe for the physician to induce labor?

FLM increases, these lamellated packets of surfactant also exhibit an increased presence in the AF. The fact that lamellar bodies are approximately the same size as platelets provides a convenient method to determine their concentration using the platelet channel on automated hematology analyzers.¹⁰ Based on the model of analyzer used, the number of lamellar bodies needed to ensure FLM can vary. This variation occurs as a result of different instrumental methods used to detect the bodies. Acceptable counts must be correlated with the specific instrumentation.¹¹ A standardized protocol has been developed in an effort to make the assay transferable between laboratories.¹²

CEREBROSPINAL FLUID

Cerebrospinal fluid (CSF) is the liquid that surrounds the brain and spinal cord. The brain and spinal cord are covered by the meninges that consist of three layers: the dura mater, arachnoid, and pia mater. CSF flows between the arachnoid and the pia mater in an area referred to as the subarachnoid space. The three functions of the CSF are (1) physical support and protection, (2) provision of a controlled chemical environment to supply nutrients to the tissues and removal of wastes, and (3) intracerebral and extracerebral transport (Fig. 28-6).

The major and most obvious function of CSF is as a buoyant cushion for the brain. The denser brain floats in the less dense fluid, allowing movement within the skull. The significance is demonstrated by the result of a blow to the head. The initial shock is transferred to the entire brain, instead of inflicting damage to one area. It may be bruised at the side opposite the blow, depending on the force imparted.

The second major function of CSF is the maintenance of a constant gross chemical matrix for the CNS. Serum components may vary greatly, but constituent levels of CSF are maintained within narrow limits.

The transport function is described as a neuroendocrine role. The CSF is involved in the distribution of hypophyseal hormones within the brain and the clearance of hormones from the brain to the blood.

The total CSF volume is about 150 mL, or about 8% of the total CNS cavity volume. The fluid is formed predominantly at the choroid plexus deep within the brain and by the ependymal cells lining the ventricles. The endothelial cells of the choroid plexuses have very tight-fitting junctions to control the passage of substances across their membranes. This is termed the **blood-brain barrier**. Damage to the blood-brain barrier is frequently the reason for abnormal chemistry results in CSF analysis.

CSF is formed at an average rate of about 0.4 mL/min, or 500 mL/day. Formation is a result of selective ultrafiltration of plasma and active secretion by the epithelial membranes. Absorption of CSF occurs at outpouchings in the dura called **arachnoid villi / granulations** that pro-

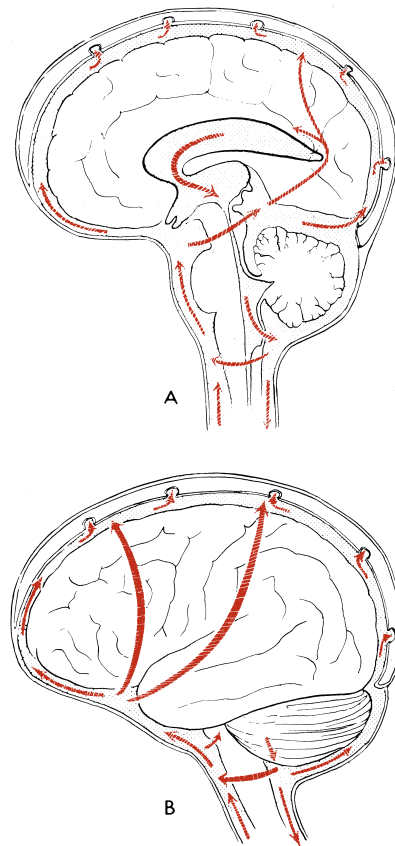

FIGURE 28-6. Major pathways of CSF. (A) Sagittal view. (B) Lateral view. (Reprinted with permission from Milhorat TH. Hydrocephalus and the cerebrospinal fluid. Baltimore, Md.: Williams & Wilkins, 1972:25.)

trude through the dura to the venous sinuses of the brain and into the bloodstream. The granulations act as one-way valves to maintain an excretion volume equal to the production volume.

Specimens of CSF are obtained by lumbar puncture, usually at the interspace of vertebrae L3-4 or lower, using aseptic technique. The fluid obtained is usually separated into three numbered aliquots: (1) for chemistry and serology, (2) for microbiology, and (3) for hematology. It is paramount to remember that this matrix is of limited volume and should be analyzed immediately. Any remaining sample should be preserved because of its limited availability. The order of the tubes reflects the presumed order for minimalization of interference from less than optimal collection technique, with tube 3 presumably least contaminated by cells of intervening tissue.

Laboratory investigation of CSF is indicated for cases of suspected CNS infection, demyelinating disease, malignancy, and hemorrhage in the CNS. As with all patient samples entering the laboratory, visual examination of the specimen is the first and often the most important observation made. The CSF, if normal, is clear, colorless, free of clots, and free of blood. Differences from these standards indicate a probable pathology and merit

further examination. Cloudy fluids usually require microscopic examination, whereas a yellow to brown or red color may indicate blood.

The two most common reasons for blood and hemoglobin pigments to be found in CSF are traumatic tap and subarachnoid hemorrhage. Traumatic tap is the artifactual presence of blood or derivatives due to interdiction of blood vessels during the lumbar puncture. Hemorrhage results from a breakdown of the barrier of the CNS and circulatory system from trauma, for example. Obviously, the latter is serious. The two can be differentiated by observation and, possibly, testing. Bright red color and erythrocytes in decreasing number as the fluid is sampled indicate a traumatic tap. Xanthochromia or hemoglobin breakdown pigments indicate that erythrocyte lysis and metabolism have previously occurred, at least 2 hours earlier. Excluding a prior traumatic tap or hyperbilirubinemia (>20 mg/dL), xanthochromia would indicate hemorrhage.

Biochemical (chemical) analysis of CSF has led to compilations of the scope of possible constituents. In clinical practice, however, the number of useful indicators becomes small. The tests of interest are glucose, protein (total and specific), lactate, and, glutamine. Most often used are glucose and proteins. Before any analysis, the fluid should be centrifuged to avoid contamination by cellular elements. The level of glutamine should reflect the level of CNS ammonia removed by glutamine formation from glutamate. This would be elevated in hepatic encephalopathy, as would occur in liver failure. The test has largely been supplanted by the relative ease and simplicity of reliable plasma ammonia determinations. The tests that have been most reliable diagnostically and accessible analytically are those for CSF glucose, total protein, and specific proteins. Glucose enters the spinal fluid predominantly via a facilitative transport compared with a passive (diffusional) or an active (energy-dependent) transport. It is carried across the epithelial membrane by a stereospecific carrier species. The carrier mechanism is responsible for transport of lipid-insoluble materials across the membrane into the CSF. Generally, this is a “downhill” process consistent with a concentration gradient. The CSF glucose concentration is about two thirds that of plasma.

Because an isolated CSF glucose concentration may be misleading, it is recommended that a plasma sample be obtained 2–4 hours prior to the tap so that plasma and CSF glucose levels can equilibrate. Normal CSF glucose is considered to be 60%–70% that of the blood glucose. Increased glucose levels are not clinically informative, usually providing only confirmation of hyperglycemia. With increasing blood glucose levels, the CSF glucose increases, but not proportionally. This is significant because it implies that the plasma/CSF glucose ratio decreases as gross hyperglycemia occurs.

The decreasing CSF/plasma glucose ratio as plasma glucose increases is consistent with a saturable carrier process. It would not be unusual for the ratio to be 0.4:0.6 with massive plasma glucose levels (more than 600 mg/dL), but a CSF glucose level of 80 mg/dL, with plasma level of 300 mg/dL, is clinically significant and would merit concern.

Decreased CSF glucose levels (**hypoglycorrachia**) can be the result of (1) disorder in carrier-mediated transport of glucose into CSF, (2) active metabolism of glucose by cells or organisms, or (3) increased metabolism by the CNS. The mechanism of transport decrease remains under intense discussion, but it is speculated to be the cause in tuberculous meningitis and sarcoidosis. Acute purulent, amebic, fungal, and trichinotic meningitis are examples of consumption by organisms, whereas diffuse meningeal neoplasia and brain tumor are examples of consumption by CNS tissue. Consumption of glucose is usually accompanied by an increased lactate level because of anaerobic glycolysis by organisms or cerebral tissue.

An increased lactate level with a normal to decreased glucose level has been suggested as a readily accessible indicator for bacterial versus viral meningitis.¹³ Analysis of glucose and lactate in CSF is easily accomplished by techniques used for plasma and serum. It is important that provision for analysis of glucose or lactate in CSF be immediate or that the specimen be preserved with an antiglycolytic, such as fluoride ion.

Protein levels in CSF reflect the selective ultrafiltration of the CSF blood-brain barrier. All protein usually found in plasma is found in CSF, except at much decreased levels. Total protein is about 0.5%, or $1/100$, that of plasma. The specific protein concentrations in CSF are not proportional to the plasma levels because of the specificity of the ultrafiltration process. Correlation is best accomplished using hydrodynamic ratios of the protein species rather than molecular weight. Because of the relationship of CSF proteins to serum, serum analysis should accompany specific CSF protein analysis. A decreased level of CSF total protein can arise from (1) decreased dialysis from plasma, (2) increased protein loss (e.g., removal of excessive volumes of CSF), or (3) leakage of CSF from a tear in the dura, otorrhea, or rhinorrhea. The last reason is most common. A dural tear can occur as a result of a previous lumbar puncture or from severe trauma. **Otorrhea** and **rhinorrhea** refer to leakage of CSF from the ear or into the nose, respectively. Identification of CSF leakage is best done by an analysis for β -transferrin, a protein unique to the CSF.

An increased level of CSF total protein is a useful nonspecific indicator of pathologic states. Increases may be caused by (1) lysis of contaminant blood from traumatic tap, (2) increased permeability of the epithelial membrane, (3) increased production by CNS tissue, or (4) obstruction. Contamination from blood is signifi-

cant because of the 200:1 concentration ratio. The presence of any amount of blood can elevate CSF protein levels. The blood-brain barrier becomes more permeable from bacterial or fungal infection or cerebral hemorrhage, whereas an increase in CNS production occurs in subacute sclerosing panencephalitis (SSPE) or multiple sclerosis (MS). There may also be combinations of permeability and production, with the collagen-vascular diseases. An obstructive process, such as tumor or abscess, would also cause increased protein. Diagnostically more sensitive information can be obtained by analysis of the protein fractions present. A comparison to the serum pattern is necessary for accurate conclusions. Under normal conditions, prealbumin is present in CSF in higher concentration than in serum. Although the respective proteins can be determined in both serum and CSF, the proteins of greatest interest are albumin and immunoglobulin G (IgG). Because albumin is produced solely in the liver, its presence in CSF must occur by means of blood-brain barrier passage. IgG, however, can arise by local synthesis from plasma cells within the CSF. The measurement of albumin in both serum and CSF is then used to normalize the IgG values from each matrix to determine the source of the IgG.

To determine the integrity of the blood-brain barrier, a CSF/serum albumin index is calculated as follows:

$$\frac{\text{CSF albumin (mg/dL)}}{\text{Serum albumin (g/dL)}} = \frac{\text{CSF serum}}{\text{albumin index}} \quad (\text{Eq. 28-2})$$

An index value less than 9 indicates an intact blood-brain barrier.

This index can then be used to calculate the IgG index to determine CNS synthesis of IgG to aid the diagnosis of demyelinating diseases, such as MS and SSPE. MS is the most common inflammatory demyelinating disease of the CNS.

$$\frac{\text{CSF IgG/serum IgG}}{\text{CSF albumin/serum albumin}} = \frac{\text{CSF IgG}}{\text{index}} \quad (\text{Eq. 28-3})$$

The normal value = < 0.7

Increases in serum albumin cause increases in the CSF levels because of membrane permeability. However, increased CSF IgG, without concomitant CSF albumin increase, suggests local production (MS or SSPE). Increases in permeability and production are found with bacterial meningitis. Methods to analyze IgG and albumin CSF levels are the same as for serum but are optimized for the lower levels found.

Increased CSF protein levels or clinical suspicion usually indicates the need for electrophoretic separation of the respective proteins. At times, this separation demonstrates multiple banding of the IgG band. This observation is referred to as **oligoclonal bands** (a small number of clones of IgG from the same cell type with nearly iden-

tical electrophoretic properties). This occurrence is usually associated with inflammatory diseases and MS or SSPE. These types of disorders would stimulate the immunocompetent cells. The recognition of an oligoclonal pattern supersedes the report of normal protein levels and is cause for concern if the corresponding serum separation does not demonstrate identical banding.

Another protein thought to be specific for MS is myelin basic protein (MBP). Initial reports suggested high specificity, but MBP also has been found in nondemyelinating disorders and does not always occur in demyelinating disorders. MBP levels are used to monitor therapy of MS. Current international guidelines for the diagnosis of MS recognize both an elevated IgG Index and the presence of CSF oligoclonal bands that are not found in the serum as supporting evidence. Immunoassay procedures are available for analyzing MBP.¹⁴

SWEAT

The common eccrine sweat glands function in the regulation of body temperature. They are innervated by cholinergic nerve fibers and are a type of exocrine gland.

CASE STUDY 28-2

A 32-year-old man was in good health until about 1 year ago, when he entered an accelerated computer programming training program. Within the last year, he began to notice episodic blurring of vision, mild vertigo, and headache. He attributed his complaints of sensory loss in his hands and a feeling of weakness after physical exertion to being “out of shape.” He decided to see his physician after an attack of blurred vision accompanied by a feeling of paralysis, which was followed by a sensation of “pins and needles” in his left leg. An optic examination was negative. Neurologic examination led to a spinal tap being performed for laboratory findings and myelography. The latter was negative. The laboratory results were as follows:

| | |
|---------------|---|
| CSF | Clear, colorless fluid, apparently free of debris; culture yields no growth |
| WBC | Normal |
| Glucose | 60 mg/dL (plasma = 80 mg/dL) |
| Albumin index | 1.7 |
| IgG index | 0.4 |

Questions

1. What is the significance of the albumin index?
2. What pathology is consistent with these results?

Sweat has been analyzed for its multiple inorganic and organic contents but, with one notable exception, has not proved a clinically useful model. That exception is the analysis of sweat for chloride levels in the diagnosis of cystic fibrosis (CF). The sweat test is the single most accepted common diagnostic tool for the clinical identification of this disease. Normally, the coiled lower part of the sweat gland secretes a “presweat” upon cholinergic stimulation. As the presweat traverses the ductal part of the gland going through the dermis, various constituents are resorbed. In CF, the electrolytes, most notably chloride and sodium ions, are improperly resorbed owing to a mutation in the cystic fibrosis transmembrane conductance regulator (*CFTR*) gene, which controls a cyclic AMP-regulated chloride channel.

CF (mucoviscidosis) is an autosomal recessive inherited disease that affects the exocrine glands and causes electrolyte and mucous secretion abnormalities. This exocrinopathy is present only in the homozygous state. The frequency of the carrier (heterozygous) state is estimated at 1 of 20 in the United States. The disease predominantly affects whites. The observed rate of expression ranks CF as the most common lethal hereditary disease in the United States, with death usually occurring by the third decade. The primary cause of death is pneumonia, secondary to the heavy, abnormally viscous secretion in the lungs. These heavy secretions cause obstruction of the micro-airways, predisposing the CF patient to repeated episodes of pneumonia. The third part of the diagnostic triad is pancreatic insufficiency. Again, abnormally viscous secretions obstruct pancreatic ducts. This obstruction ostensibly causes pooling and autoactivation of the pancreatic enzymes. The enzymes then cause destruction of the exocrine pancreatic tissue.

Diagnostic algorithms for CF continue to rely on abnormal sweat electrolytes, pancreatic or bronchial abnormalities, and family history. The use of blood immunoreactive trypsin, a pancreatic product, is now used in newborn screening programs. The rapidly developing area of molecular genetics provides the definitive methodology. The gene defect causing CF has been localized on chromosome 7, and the most common mutations causing CF have been DNA “fingerprinted.” As many as 1,550 mutations of the *CFTR* gene have been cataloged with the majority of patients found to be homozygous or heterozygous for the most common mutation. The sweat glands, although affected in their secretion, remain structurally unaffected by CF. Analysis of sweat for both sodium and chloride is valid but, historically, chloride was and is the major element, leading to use of the sweat chloride test. Because of its importance, a standard method has been suggested by the Cystic Fibrosis Foundation. It is based on the pilocarpine nitrate iontophoresis method of Gibson and Cooke.¹⁵ Pilocarpine is a cholinergic-like drug used to stimulate the sweat glands. The sweat is absorbed on a

gauze pad during the procedure. After collecting sweat by iontophoresis, chloride analysis is performed. Many methods have been suggested, and all are dependent on laboratory requirements. Generally, the sweat is leached into a known volume of distilled water and analyzed for chloride (chloridometer). In general, values greater than 60 mmol/L are considered positive.

Other tests including osmolarity, conductivity, and chloride electrodes or patches placed on the skin are available but are considered screening tests with abnormal results followed by the Gibson-Cooke reference method. A variety of instrumentation is available for these screening tests.

Although a value of 60 mmol/L is generally recognized for the quantitative pilocarpine iontophoretic test, it is important to consider several factors in interpretation. Not only will there be analytic variation around the cutoff, an epidemiologic borderline area will also occur. Considering this, the range of 45–65 mmol/L for chloride would be more appropriate in determining the need for repetition. Some patients with *CFTR* mutations have been found to have values below 60 mmol/L. Other variables must be considered. Age generally increases the limit—so much so that it is increasingly difficult to classify adults. Obviously, the patient’s state of hydration also affects sweat levels. Because the complete procedure is technically demanding, expertise should be developed before the test is clinically available. A complete description of sweat collection and analysis, including procedural justifications, is available for review.¹⁶

SYNOVIAL FLUID

Joints are classified movable or immovable. The movable joint contains a cavity that is enclosed by a capsule; the inner lining of the capsule is synovial membrane. This cavity contains **synovial fluid**, which is formed by ultrafiltration of plasma across the synovial membrane. The membrane also secretes a mucoprotein rich in hyaluronic acid into the dialysate, which causes the synovial fluid to be viscous. The membrane is composed of three different cell types: type A cells are rich in vacuoles and lysosomes and function as phagocytes; type B cells are rich in rough endoplasmic reticulum and presumed to be secretory in function; and type C cells appear to be hybrids of types A and B in appearance and function. Synovial fluid functions as a lubricant for the joints and as a transport medium for delivery of nutrients and removal of cell wastes. The volume of fluid found in a large joint, such as the knee, rarely exceeds 3 mL. Normal fluid is clear, colorless to pale yellow, viscous, and nonclotting. Variations are indicative of pathologic conditions.

Collection of a sample is accomplished by arthrocentesis of the joint under aseptic conditions. The sample should be collected in a heparin tube for culture, a he-

parin or liquid ethylenediaminetetraacetic acid (EDTA) for microscopic analysis, and a fluoride tube for glucose analysis. Microscopic examination is the most rewarding in diagnostic significance. Although many analytes have been chemically determined, the ratio of synovial fluid to plasma glucose (normally 0.9:1) remains the most useful. Decreased ratios are found in inflammatory (e.g., gout, rheumatoid arthritis, or systemic lupus erythematosus) and septic (e.g., bacterial, viral arthritis) conditions. Standard methods for glucose analysis are applicable. Fluid and blood specimens for glucose should be collected concurrently following an 8-hour fast.

SEROUS FLUIDS

The lungs, heart, and abdominal cavities are surrounded by two serous membranes: the parietal membrane lining the cavity wall and the visceral membrane lining the organs. Serous fluids, an ultrafiltrate of plasma, are located between the membranes. When *serum* dialyzes across these membranes, the fluid formed is called **serous fluid**—specifically, pleural (lung), pericardial (heart), and peritoneal (abdominal) fluid.

The formation of serous fluid is a continuous process driven by the hydrostatic pressure of the systemic circulation and maintenance of oncotic pressure due to protein. The potential space is usually filled; that is, no gases are present. The fluid reduces or eliminates friction caused by expansion and contraction of the encased organs. A disturbance of the dynamic equilibrium that causes an increase in fluid is an abnormal state. An increase in fluid volume is called **effusion**.

Pleural Fluid

The outer layer of the pleural sac, the parietal layer, is served by the systemic circulation; the inner layer, the visceral layer, by the bronchial circulation. Pleural fluid is essentially interstitial fluid of the systemic circulation. With normal conditions, there is 3–20 mL of pleural fluid in the pleural space. The fluid exits by drainage into the lymphatics of the visceral pleura and the visceral circulation. Any alteration in the rate of formation or removal of the pleural fluid affects the volume, causing an effusion. It is then necessary to classify the nature of the effusion by analysis of the pleural fluid. The fluid is removed from the pleural space by needle and syringe after visualization by radiology. This procedure is called **thoracentesis**; the fluid is called **thoracentesis fluid**, or **pleural fluid**. Specifically preserved aliquots of the fluid are used for future testing as follows: (1) heparinized for culture, (2) EDTA for microscopy, (3) sodium fluorescein (NaF) for glucose and lactate, and (4) nonanticoagulated for further biochemical testing.

The classification of the fluid as transudate or exudate is crucial for all serous fluids. **Transudates** are secondary

to remote (nonpleural) pathology and indicate that treatment should begin elsewhere. An **exudate** indicates primary involvement of the pleura and lung, such as infection, and demands immediate attention. For example, any mechanical disturbance in the formation of fluid (e.g., hypoproteinemia causing decreased oncotic pressure) would increase pleural fluid volume. This would be a transudative process. An exudative process involves damage to the membranes, allowing increased fluid entry such as would occur with infection or malignancy (Table 28-2). Further testing, including chemical, microscopy, and culture, is then required to identify the etiology.

The assignment of fluid to either the transudate or exudate category had previously been based on the protein concentration of the fluid. This criterion has been replaced by the use of a series of fluid/plasma (F/P) ratios known as Light's criteria. Specifically, if the F/P for total protein is greater than 0.5, if the ratio for lactate dehydrogenase (LDH) is greater than 0.6, or if the pleural fluid LDH/upper limit serum LDH ratio reference interval is greater than 0.67, the fluid is an exudate. For pleural fluid, an additional characterization can be made by determining the pleural fluid cholesterol, the fluid-to-serum cholesterol ratio, and the fluid-to-serum bilirubin ratio. Exudates are indicated by fluid cholesterol greater than 60 mg/dL, fluid-to-serum cholesterol ratio of greater than 0.3 and fluid-to-bilirubin ratio of 0.6 or higher.

Further characterization of the exudate by the chemistry laboratory may involve analysis for glucose, lactate, amylase, triglyceride, or pH. A decrease in glucose (increase in lactate) would suggest infection or inflammation. An increase in amylase compared with that of serum suggests pancreatitis. Grossly elevated triglyceride levels (2–10 × serum) could indicate thoracic duct leakage. The use of pH measurements, performed as one would a blood-gas level determination, has

TABLE 28-2 CAUSES OF PLEURAL EFFUSIONS

| TRANSUDATIVE | EXUDATIVE |
|---------------------------|------------------------------------|
| Congestive heart failure* | Bacterial pneumonia* |
| Nephrotic syndrome | Tuberculosis |
| Hypoproteinemia | Pulmonary abscess |
| Hepatic cirrhosis | Malignancy (lymphatic obstruction) |
| Chronic renal failure | Viral/fungal infection |
| | Pulmonary infarction |
| | Pleurisy |
| | Pulmonary malignancy |
| | Lymphoma |
| | Pleural mesothelioma |

*Most common cause.

gained favor. Succinctly, pH less than 7.2 suggests infection, and pH close to 6.0 indicates esophageal rupture. The methodologies for these analyses are the same as those employed for the serum and blood constituents and, therefore, are feasible in the clinical laboratory.

Pericardial Fluid

The relationship of the pericardium, **pericardial fluid**, and the heart is similar to that with the lungs. Mechanisms of formation and drainage are the same; however, pericardial sampling and laboratory analysis are rare. Adenosine deaminase testing may be requested in suspected cases of tubercular effusions.

Peritoneal Fluid

Excess fluid (>50 mL) in the peritoneal cavity indicates disease. The presence of excess fluid is called **ascites**, and the fluid is called *ascitic fluid*. The process of obtaining samples of this fluid by needle aspiration is *paracentesis*. Usually, the fluid is visualized by ultrasound to confirm its presence and volume before paracentesis is attempted.

Theoretically, the same mechanisms that cause serous effusions in other potential spaces are operative for the peritoneal cavity. Specifically, a disturbance in the rate of dialysis secondary to a primary, remote pathology is a transudate, compared with a primary pathology of the peritoneal membrane (an exudate). The multiple factors that apply to this large space, including renal function, tend to cloud the distinction. The most common cause of ascites with a normal peritoneum is portal hypertension. Obstructions to hepatic flow, such as cirrhosis, congestive heart failure, and hypoalbuminemia for any reason, demonstrate the highest incidence.

The exudative causes of ascites are predominantly metastatic ovarian, prostate, and colon cancer and infective peritonitis. The recommended method for determining transudates and exudates is the serum-ascites albumin gradient (SAAG). The SAAG is calculated by subtracting the fluid albumin level from the serum albumin level. A gradient of 1.1 g/dL or more used to indicate portal hypertension is the most accepted measurement. A neutrophil count greater than 250 cells/ μm^3 indicates peritonitis. Measurement of the tumor markers CEA and CA125 is indicated in suspected cases of malignancy.

REFERENCES

- Liley AW. Liquor amni analysis in the management of the pregnancy complicated by rhesus sensitization. *Am J Obstet Gynecol* 1961;82:1359.
- Kulovich MV, Hallman MB, Gluck L. The lung profile. I. Normal pregnancy. *Am J Obstet Gynecol* 1979;135:57.
- Statland BE, Freer DE. Evaluation of two assays of functional surfactant in amniotic fluid: surface-tension lowering ability and the foam stability index test. *Clin Chem* 1979;25:1770.
- Clements JA, Plataker ACG, Tierney DF, et al. Assessment of the risk of the respiratory distress syndrome by a rapid test for surfactant in amniotic fluid. *N Engl J Med* 1972;286:1077.
- Gluck L, Kulovich MV, Borer RC Jr, et al. Diagnosis of the respiratory distress syndrome by amniocentesis. *Am J Obstet Gynecol* 1971;109:440.
- Tsai MY, Marshall JG. Phosphatidylglycerol in 261 samples of amniotic fluid from normal and diabetic pregnancies, as measured by one-dimensional thin layer chromatography. *Clin Chem* 1979;25:682.
- Kaplan LA, Chapman JT, et al. Prediction of respiratory distress syndrome using the Abbot FLM II amniotic fluid assay. *Clin Chem Acta* 2002;326:61–68.
- Winn-McMillan T, Karon B. Comparison of the TDx-FLM II and lecithin to sphingomyelin ratio assays in predicting fetal lung maturity. *Am J Obstet Gynecol* 2005;193:778–762.
- TDxFLx fetal Lung Maturity II (FLM II) package insert, reference 7A76. Abbott Park, Ill.: Abbott Laboratories, Diagnostic Division, 2003.
- Khazardoost H, Yakazadeh S, Borna F, et al. Amniotic fluid lamellar body count and its sensitivity and specificity evaluating fetal lung maturity. *J Obstet Gynecol* 2005;25:257–259.
- Szallasi A, Gronowski AM, Eby CS. Lamellar body count in amniotic fluid: a comparison of four different hematology analyzers. *Clin Chem* 2003;49:994–997.
- Neerhof ME, Dohnal JC, Ashwood ER, et al. Lamellar body counts: a consensus on protocol. *Obstet Gynecol* 2001;97:318–320.
- Bailey EM, Domenico P, Cunha BA. Bacterial or viral meningitis. *Postgrad Med* 1990;88:217.
- Okta M, Okta K, et al. Clinical and analytical evaluation of an enzyme immunoassay for myelin basic protein in cerebrospinal fluid. *Clin Chem* 2000;46:1336–1330.
- Gibson LE, Cooke RE. A test for concentration of electrolytes in cystic fibrosis of the pancreas utilizing pilocarpine by iontophoresis. *Pediatrics* 1959;23:545.
- Clinical Laboratory Standards Institute. Sweat testing: sample collection and quantitative analysis approved guidelines. Villanova, Pa.: Clinical Laboratory Standards Institute, reaffirmed 2005. (CLSI document C34-A2.)

PART

4

Specialty Areas of Clinical Chemistry

Therapeutic Drug Monitoring

David P. Thorne, Michelle E. Russell

CHAPTER

29

CHAPTER OUTLINE

■ ROUTES OF ADMINISTRATION

■ ABSORPTION

■ FREE VERSUS BOUND DRUGS

■ DRUG DISTRIBUTION

■ DRUG ELIMINATION

Metabolic Clearance

Renal Clearance

■ PHARMACOKINETICS

■ SAMPLE COLLECTION

■ PHARMACOGENOMICS

■ CARDIOACTIVE DRUGS

Digoxin

Quinidine

Procainamide

Disopyramide

■ ANTIBIOTICS

Aminoglycosides

Vancomycin

■ ANTIPILEPTIC DRUGS

First-Generation Antiepileptic Drugs

Second-Generation Antiepileptic Drugs

■ PSYCHOACTIVE DRUGS

Lithium

Tricyclic Antidepressants

Clozapine

Olanzapine

■ IMMUNOSUPPRESSIVE DRUGS

Cyclosporine

Tacrolimus

Sirolimus

Mycophenolic Acid

■ ANTINEOPLASTICS

Methotrexate

■ SUGGESTED READINGS

■ REFERENCES

Therapeutic drug monitoring (TDM) involves the analysis, assessment, and evaluation of circulating concentrations of drugs in serum, plasma, or whole blood. The purpose of these actions is to ensure that a given drug dosage produces maximal therapeutic benefit and minimal toxic adverse effects. For most drug therapies, dosage regimens have been established that are safe and effective in most of the population and therefore TDM is unneeded. With certain drugs, however, the correlation between dosage and therapeutic effects or toxic outcomes is weak and it is difficult to predict what dose should be used. In these situations, trial and error, in conjunction with direct observation, may work. For example, if a standard drug dose does not display therapeutic benefit and increasing the dose does provide benefit without toxic effects, an appropriate dosage adjustment has been made. Unfortunately, this system may not be appropriate in all situations. If overdosing or underdosing results in severe consequences to the patient, trial and error is not justified. If this is the case, TDM based on strong correlations between circulating concentrations of drug and

therapeutic benefit or toxic effects assists in the determination of an appropriate dosage regimen.

The standard dosage is statistically derived from observations in a healthy population. Disease states may produce altered physiologic conditions in which the standard dose does not produce the predicted concentration in circulation. In these cases, individualizing a dosage regimen is warranted. Again, TDM provides a basis for establishing a rational dosage regimen to fit individual situations.

The following are the common indications for TDM:

- The consequences of overdosing and underdosing are serious.
- There is a small difference between a therapeutic and a toxic dose.
- There is a poor relationship between the dose of drug and circulating concentrations but a good correlation between circulating concentrations and therapeutic or toxic effects.
- There is a change in the patient's physiologic state that may unpredictably affect circulating drug concentrations.

- A drug interaction is or may be occurring.
- TDM helps in monitoring patient compliance.

A common feature of all aspects of TDM is the quantitative evaluation of circulating concentrations of drugs. When taken together with clinical context, this provides a basis for rational problem solving and optimizing patient outcomes. This process requires that several key factors be taken into consideration, such as the route of administration, rate of absorption, distribution of drug within the body, and rate of elimination (Fig. 29-1). This chapter begins by focusing on these factors and how they influence the circulating concentration of a drug. The remainder of the chapter surveys selected drugs commonly subject to TDM.

ROUTES OF ADMINISTRATION

For a drug to express a therapeutic benefit, it must be at the appropriate concentration at its site of action. Measuring drug concentration at the site of action would be ideal. Unfortunately, for most drugs, this cannot be done. The circulatory system offers a convenient route that can effectively deliver most drugs to its site of action. The unchanged fraction of the administered dose as it enters systemic circulation defines its **bioavailability**. The goal of most therapeutic regimens is to acquire a blood, plasma, or serum concentration that has been correlated with an effective concentration at the site of action. Drugs can be administered by several routes. Each presents with different characteristics that influence circulating concentrations. Drugs can be injected directly into the circulation (intravenous [IV]), into muscles (intramuscular [IM]), or just under the skin (subcutaneous [SC]). They can also be inhaled or absorbed through the skin (transcutaneous). Rectal delivery (suppository) is commonly used in infants and in situations in which oral delivery is unavailable. Oral administration is the most common route of delivery. The focus of the current discussion is on oral and IV administration.

ABSORPTION

For orally administered drugs, the efficiency of absorption from the gastrointestinal tract is dependent on many factors. The formulation of the drug is a key issue. Tablets and capsules require dissolution before being absorbed. Liquid solutions have a tendency to be more rapidly absorbed. Some drugs are subject to uptake by transport mechanisms intended for dietary constituents; however, most are absorbed by passive diffusion. This process requires that the drug be in a hydrophobic (nonionized) state. Because of gastric acidity, weak acids are efficiently absorbed in the stomach. Weak bases are preferentially absorbed in the intestine, where the pH is more neutral. For most drugs, absorption from the gastrointestinal tract occurs in a predictable manner in healthy people. However, changes in intestinal motility, pH, inflammation, as well as food or other drugs may dramatically change absorption characteristics. In these cases, the use of TDM may assist in establishing an effective dosage regimen.

All substances, including drugs, absorbed from the intestine (except the rectum) enter the hepatic portal system. In this system, all the blood from the gastrointestinal tract is routed through the liver before it enters into general circulation. Certain drugs are subject to significant hepatic uptake and metabolism during this passage through the liver. This process is known as *first-pass metabolism*.

For certain drugs, there may be a wide degree of variance in these processes, even within a normal population. In addition, many of the absorptive characteristics of a drug may change with age, pregnancy, or pathologic conditions. In these instances, predicting the final circulating concentration from a standard oral dose can be difficult. With the use of TDM, however, effective oral dosage regimens can be determined.

FREE VERSUS BOUND DRUGS

Most drugs in circulation are subject to binding with serum constituents. Although many potential species may be formed, most are drug-protein complexes.

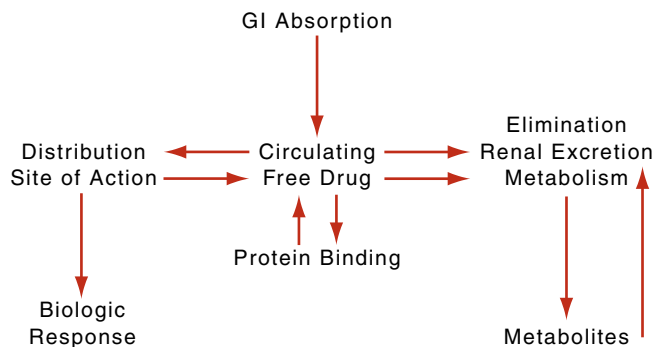

FIGURE 29-1. Overview of factors that influence the circulating concentration of an orally administered drug. GI, gastrointestinal.

An important aspect needed to understand drug dynamics is that only the free fraction can interact with its site of action and result in a biologic response. It is the free fraction that best correlates with both the therapeutic and toxic effects of a drug. For many drugs, the percentage free is dependent on physiologic and biochemical parameters. At a standard dose, total plasma content may be within the **therapeutic range**, but the patient experiences toxic adverse effects (high free fraction) or does not realize a therapeutic benefit (low free fraction). This may occur secondary to changes in serum protein content. Changes in serum-binding proteins may occur during inflammation, malignancies, pregnancy, hepatic disease, nephrotic syndrome, malnutrition, and acid-base disturbances. The percentage free may also be influenced by the concentration of substances that compete for binding sites, which may be other drugs or endogenous substances, such as urea, bilirubin, or hormones. Free drug measurements should be considered for drugs that are highly protein bound and for which clinical signs are inconsistent with total drug concentrations.

DRUG DISTRIBUTION

The free fraction of circulating drugs is subject to diffusion out of the vasculature into interstitial and intracellular spaces. The ability to leave circulation is largely dependent on the lipid solubility of the drug. Drugs that are highly hydrophobic can easily traverse cellular membranes and partition into lipid compartments, such as adipose and nerve cells. Drugs that are polar but not ionized also cross cell membranes but do not sequester into lipid compartments. Ionized species diffuse out of the vasculature but at a slow rate. The volume of distribution (V_d) index is used to describe the distribution characteristics of a drug. It is expressed mathematically as follows:

$$V_d = D/C_t \quad (\text{Eq. 29-1})$$

where V_d is volume of distribution (in liters), D is an intravenous injected dose (milligrams [mg] or grams [g]), and C is concentration in plasma (mg/L or g/L).

Drugs that are hydrophobic can have a large V_d due to partitioning into hydrophilic compartments. Substances that are ionized or are primarily bound in plasma have small V_d values due to sequestration in the vasculature.

DRUG ELIMINATION

Drugs can be cleared from the body by various mechanisms. Independent of the clearance mechanism, decreases in the serum concentration of drugs most often occur as a first-order process (exponential rate of loss). This implies that the rate of change of drug concentration over time varies continuously in relation to the

concentration of the drug. First-order elimination follows the following general equation:

$$\Delta C/\Delta T = -kC \quad (\text{Eq. 29-2})$$

This equation defines how the change in concentration per unit time ($\Delta C/\Delta T$) is directly related to the concentration of drug (C) and the constant (k). The k value is a simple proportionality factor that describes the percentage change (negative because it is decreasing) per unit time; it is commonly referred to as the elimination constant or the rate of elimination. The graphic solution to this equation is an exponential function that declines in the predicted curvilinear manner, asymptotically approaching zero (Fig. 29-2). The graph shown in Figure 29-2 illustrates a large of change at high drug concentrations and a small of change at low drug concentrations. However, the rate (percent lost) remains the same. Plotting it in semilogarithmic dimensions (Fig. 29-3) can linearize this function.

Hepatic metabolism or renal filtration, or a combination of the two, eliminates most drugs. For certain drugs, elimination by these routes is highly variable. In addition, functional changes in these organs may result in changes in the rate of elimination. In these situations, information regarding elimination rate and estimating the circulating concentration of a drug after a given time period are important factors in establishing an effective and safe dosage regimen. Equation 29-2 and Figures 29-2 and 29-3 are useful in determining the rate of elimination and the concentration of a drug after the time period. The following equation illustrates how the equation is used. Integration of Equation 29-2 yields the following:

$$C_T = C_0 e^{-kT} \quad (\text{Eq. 29-3})$$

where C_0 is the initial concentration of drug, C_T is the concentration of drug after the time period (T), k is the elimination constant, and T is the time period evaluated.

This is the most useful form of the elimination equation, from it, we can calculate the elimination constant or, if k is known, we can determine the amount of drug that will be present after a certain time period.

Example:

The concentration of gentamicin is 10 $\mu\text{g}/\text{mL}$ at 1200. At 1600, the gentamicin concentration is 6 $\mu\text{g}/\text{mL}$. What is the elimination constant (k) for gentamicin in this patient?

Using Equation 29-3:

$$C_T = C_0 e^{-kT}$$

$$C_0 = 10, C_T = 6, T = 4 \text{ hours}$$

Substituting these values into the equation produces:

$$6 = 10e^{-k(4 \text{ hours})}$$

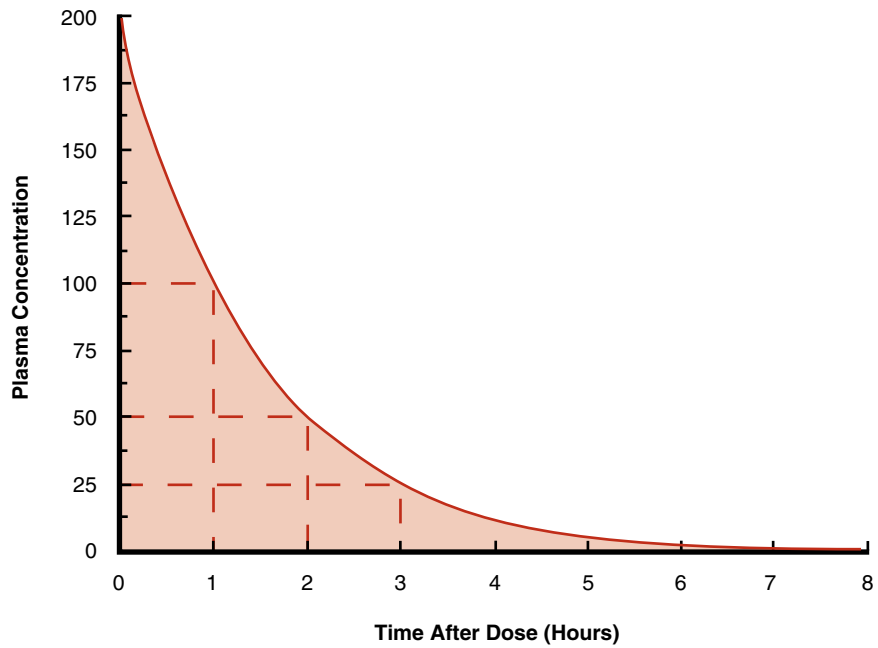

FIGURE 29-2. First-order drug elimination. This graph demonstrates exponential rate of loss on a linear scale. *Hash-marked lines* are representative of half-life.

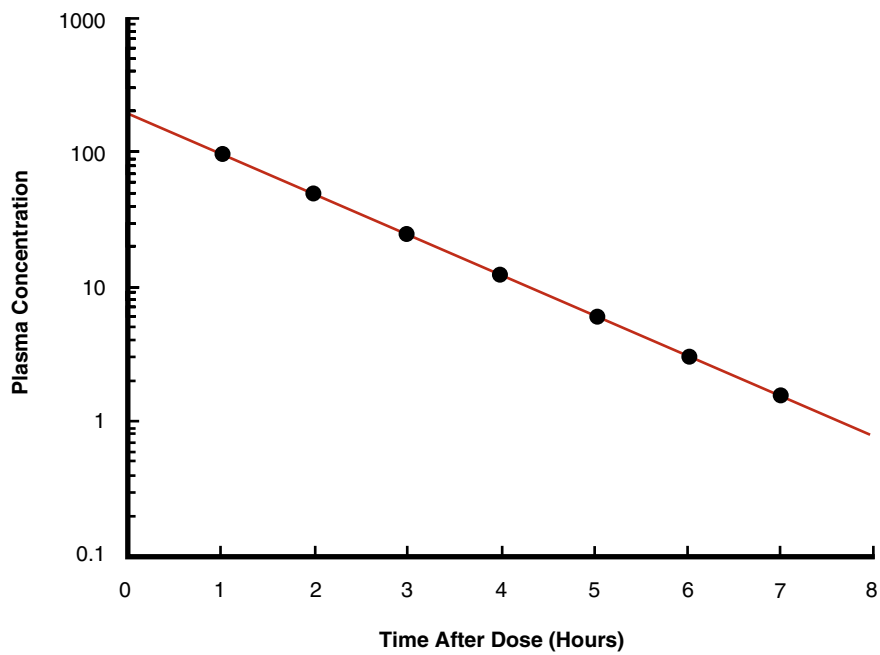

FIGURE 29-3. Semilogarithmic plot of exponential rate of drug elimination. The slope of this plot is equal to the rate of elimination (k).

Dividing both sides by 10 produces:

$$0.6 = e^{-k (4 \text{ hours})}$$

To eliminate the exponential sign, we would take the natural logarithm of both sides:

$$\ln 0.6 = \ln(e^{-k (4 \text{ hours})})$$

Solving the natural log:

$$-0.51 = -k (4 \text{ hours})$$

Multiplying through by -1 :

$$0.51 = k (4 \text{ hours})$$

Dividing both sides by 4 hours:

$$0.13/\text{h} = k$$

This calculated value for k indicates the patient is eliminating 13% of serum gentamicin per hour.

In this same patient on the same day, what would be the predicted serum concentration of gentamicin at midnight (2400)?

For C_0 , we can use either the 1200 or 1600 value as long as the correct corresponding time value is used. In this example, we will use the 1600 value of 6 $\mu\text{g/mL}$.

$$C_0 = 6 \mu\text{g/mL}, T = 8 \text{ hours}, k = 0.13/\text{h}$$

Substituting into Equation 29-3:

$$C_T = 6e^{-0.13/\text{h} (8 \text{ hours})}$$

Solving for the exponent:

$$C_T = 6e^{-1.04}$$

Note that the time unit (hours) has canceled. Solving for the exponent:

$$C_T = 6 (0.35)$$

$$C_T = 2.1 \mu\text{g/mL}$$

Note that the concentration units have carried through.

Although the elimination constant (k) is a useful value, it is not common nomenclature in the clinical setting. Instead, the term *half-life* is used. This represents the time needed for the serum concentration to decrease by one half. It can be determined graphically (Fig. 29-2) or by conversion of the elimination constant (k) to half-life ($T_{1/2}$) using the formula given in Equation 29-4. Of these two methods, the calculation provides an easy and accurate way to determine half-life. Thus, from the just-cited example, the half-life of gentamicin in this patient would be calculated as follows.

$$T_{1/2} = 0.693/k$$

$$T_{1/2} = (0.693)/(0.13/\text{h})$$

$$T_{1/2} = 5.331 \text{ hours}$$

(Eq. 29-4)

Metabolic Clearance

Xenobiotics are substances not normally found within human systems, yet they are capable of entering biochemical pathways intended for endogenous substances. Most drugs are *xenobiotics*. There are many potential biochemical pathways in which drugs can be acted on. The biochemical pathway responsible for a large portion of drug metabolism is the hepatic mixed function oxidase (MFO) system. The basic function of this system involves taking hydrophobic substances and, through a series of enzymatic reactions, converting them into water-soluble substances. These products are then either transported into the bile or released into the general circulation, where they are eliminated by renal filtration.

There are many enzymes involved in the MFO system. They are commonly divided into two functional groups or phases. Phase I reactions produce reactive intermediates. Phase II reactions conjugate functional groups to these reactive sites, the products of which are water soluble. The reactive intermediates can be conjugated with various functional groups; glutathione, glycine, phosphate, and sulfate are common. The MFO system is a nonspecific system that allows many different endogenous and exogenous substances to go through this series of reactions. Although there are many potential substrates for this pathway, the products formed from an individual substance are specific. For example, acetaminophen is a substrate for MFO and always forms a glutathione conjugate. In addition, if the conjugating group for a given drug becomes depleted, the phase I products continue to be produced. In this situation, accumulation of phase I products may result in toxic effects.

It is also noteworthy that the MFO system is inducible. This is seen as an increase in the synthesis and activity of the rate-limiting enzymes within this pathway. The most common inducers are xenobiotics that are substrates for this pathway. Thus, certain drugs may stimulate their own rate of elimination. Due to biologic variability in the degree of induction, TDM could again assist in establishing an appropriate dosage regimen.

Because many potential substrates can enter the MFO system, many drug-drug interactions occur within this pathway. Competitive and noncompetitive interactions may occur. This results in altered rates of elimination of the involved drugs. In most instances, the degree of alteration is unpredictable. Again, the value of TDM is apparent.

Implied in this discussion are that changes in hepatic status can result in changes in the concentration of circulating drugs eliminated by this pathway. Induction of the MFO system typically results in accelerated clearance and a corresponding shorter half-life. In the opposite manner, hepatic disease states characterized by a loss of functional tissue may result in slow rates of clearance

and corresponding longer half-lives. In these situations, TDM aids in dosage adjustment.

For some drugs, there is considerable variance in the rate of hepatic and nonhepatic drug metabolism within a normal population. This results in a highly variable rate of clearance, even in the absence of disease. Establishing dosage regimens for these drugs is, in many instances, aided by the use of TDM. With the use of molecular genetics, it is now possible to identify common genetic variants of some drug-metabolizing pathways. Identification of these individuals may assist in establishing an individualized dosage regimen.

Renal Clearance

The plasma free fraction of a parent drug or its metabolites is subject to glomerular filtration, renal secretion, or both. For those drugs not secreted or subject to reabsorption, the elimination rate of free drug directly relates to the glomerular filtration rate. Decreases in glomerular filtration rate directly results in increased serum half-life and concentration. The aminoglycoside antibiotics and cyclosporine are examples of drugs with this behavior.

PHARMACOKINETICS

Pharmacokinetics is the mathematic modeling of drug concentration in circulation. This process assists in establishing or modifying a dosage regimen. It takes into consideration all factors that determine the concentration of a serum drug and its rate of change. Many factors

previously discussed in this chapter would be included in this field of study. Figure 29-3 is an idealized plot of elimination after an IV bolus. It assumes there is no distribution of this drug. A drug that does distribute outside of vascular space would produce an elimination graph such as in Figure 29-4. The rapid rate of change seen immediately after the initial IV bolus is a result of distribution and elimination. The rate of elimination (k) can be determined only after distribution is complete. Figure 29-5 is a plot of serum concentration as it would appear after oral administration of a drug. As absorbed drug enters the circulation, it is subject to simultaneous distribution and elimination. Serum concentrations rise when the rate of absorption exceeds distribution and elimination. The concentration declines as the rate of elimination and distribution exceeds absorption. The rate of elimination can only be determined after absorption and distribution are complete.

Most drugs are not administered as a single bolus but are delivered on a scheduled basis (e.g., once every 8 hours). With this type of administration, serum concentration of a drug oscillates between a maximum (**peak drug level**) and a minimum (**trough drug level**). The goal of a multiple dosage regimen is to achieve a trough that is in the therapeutic range and a peak that is not in the toxic range. Evaluation of this oscillating function cannot be done immediately after initiation of a scheduled dosage regimen. About seven doses are required before a steady state oscillation is acquired. The basis of this number (seven doses) is demonstrated in Figure 29-6.

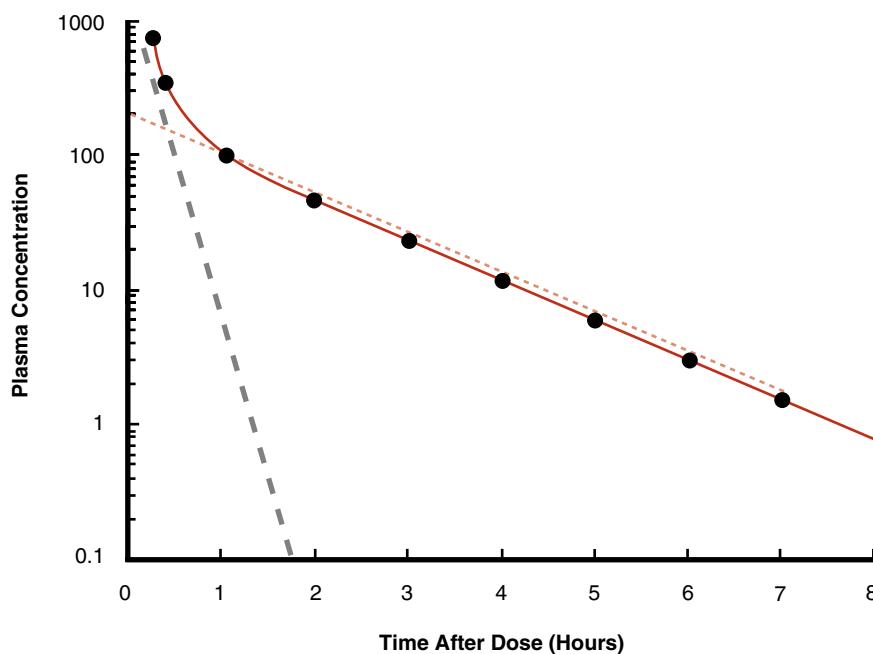

FIGURE 29-4. Semilogarithmic elimination plot of a drug subject to distribution. Initial rate of elimination is influenced by distribution (*dashed line*) and terminal elimination rate (*dotted line*). After distribution is complete (1.5 hours), elimination is first order.

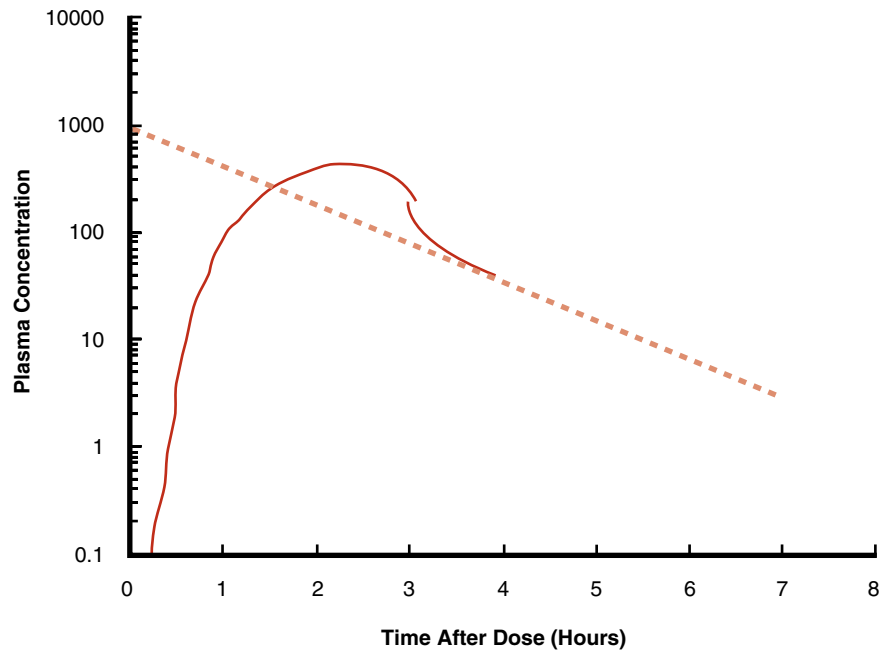

FIGURE 29-5. Plasma concentration of a drug after oral administration. After oral administration at time 0, serum concentration increases (*solid line*) after a brief lag period. Plasma concentrations peak when rate of elimination and distribution exceed rate of absorption. First-order elimination (*dotted line*) occurs when absorption and distribution are complete.

After the first oral dose, absorption and distribution occur, followed only by elimination. Before the concentration of drug drops significantly, the second dose is given. The peak of the second dose is additive to what remained from the first dose. Because elimination is first order, the higher concentration results in a larger amount eliminated. The third through seventh

scheduled doses all have the same effect, increasing serum concentration and the amount eliminated. By the end of the seventh dose, the amount of drug administered in a single dose is equal to the amount eliminated during the dosage period. At this point, steady state is established and peak and trough concentrations can be evaluated.

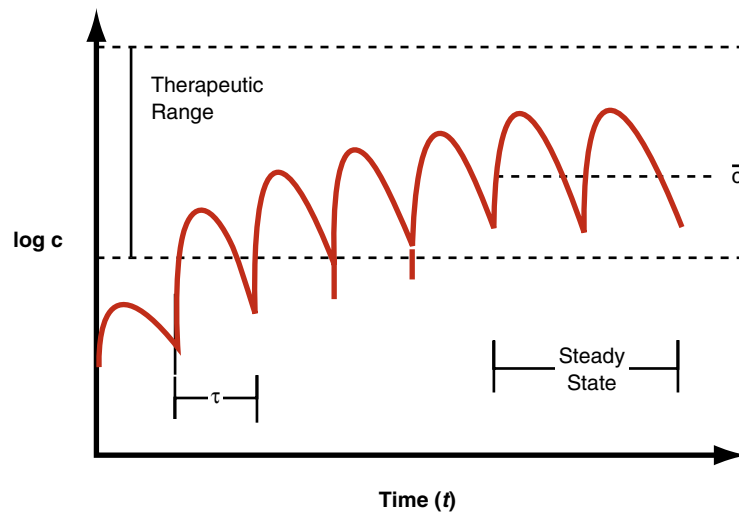

FIGURE 29-6. Steady-state kinetics in a multiple-dosage regimen. The character τ indicates the dosage interval. Equal doses at this interval reach steady state after 6 or 7 dosage intervals. \bar{c} , mean drug concentration.

SAMPLE COLLECTION

Timing of specimen collection is the single most important factor in TDM. In general, trough concentrations for most drugs are drawn right before the next dose; peak concentrations are drawn 1 hour after an orally administered dose. This rule of thumb must always be used within the clinical context of the situation. A commonly used drug that is an exception to this rule is digoxin. In this situation, drugs that are absorbed slowly may require several hours before peak drug levels can be evaluated. In all situations, determination of serum concentrations should be done only after steady state has been achieved.

Serum or plasma is the specimen of choice for the determination of circulating concentrations of most drugs. Care must be taken that the appropriate container is used when collecting these specimens. Certain drugs have a tendency to be absorbed into the gel of certain serum separator collection tubes; it is necessary to follow vendor recommendations when this effect is possible. Failure to do so may result in falsely low values. Heparinized plasma is suitable for most drug analysis. The calcium-binding anticoagulants add a variety of anions and cations that may interfere with analysis or cause a drug to distribute differently between cells and plasma. As a result, EDTA and citrated and oxalated plasma are not usually acceptable specimens.

PHARMACOGENOMICS

The effectiveness of a drug over the population that uses it can be divided into categories of patients defined as responders and nonresponders. *Responders* are the patients benefiting from the therapeutic and desired effects of the drug, while *nonresponders* do not demonstrate a beneficial and desired therapeutic effect from the initiation of a given drug regimen. The therapeutic effectiveness of drugs in responders and nonresponders has recently been attributed to the interindividual variation in the genetic polymorphisms of the patients' drug metabolism pathways.

One of the most prominent gene families that affect drug metabolism is the cytochrome P450 (CYP450) family. It is an enzyme within the mixed function oxidase system previously described. It encodes a family of liver enzymes that metabolizes many drugs. The variations in the enzymes (as a result of genetic polymorphism) are attributed to the differences in rates of drug metabolism over a population. The three most often linked to differences in degrees of drug metabolism are CYP2D6, CYP2C9, and CYP3A4. This information can then be used to personalize drug doses to the degree that is appropriate for the CYP450 profile of the patient. For example, if the patient's CYP450 profile indicates he or she has genes known to metabolize more slowly, they would be given lower doses

of the drug to avoid toxic serum concentrations. In the opposite manner, if a patient's CYP450 profile indicates he or she has genes predisposing the patient to an increased rate of metabolism, he or she would need an increased dose to maintain therapeutic serum drug concentrations. Pharmacogenetic profiling can be used to predict drug-drug interactions or as an indicator if drug will provide any therapeutic benefit at all.¹

CARDIOACTIVE DRUGS

Many cardiac conditions are treated with drugs. Of these drugs, only a few require TDM. The cardiac glycosides and the antiarrhythmics are two classes of drugs for which assessment of serum concentration aids in decisions regarding their dosage regimen.

Digoxin

Digoxin is a cardiac glycoside used in the treatment of congestive heart failure. It functions by inhibiting membrane Na^+ , K^+ -ATPase. This causes a decrease in intracellular potassium, resulting in increased intracellular calcium in cardiac myocytes. The increased calcium improves cardiac contractility (inotropic effect). This effect is seen in the serum concentration range of 0.8–2 ng/mL.² Higher serum concentrations (3 ng/mL) decrease the rate of ventricular depolarization. Although this level can be used to control ventricular tachycardia, it is infrequently used because of toxic adverse effects that become apparent at serum concentrations of greater than 2 ng/mL; these include nausea, vomiting, and visual disturbances. Cardiac effects, such as premature ventricular contractions (PVCs) and atrioventricular node blockage, are also common.

Absorption of orally administered digoxin is variable, and it is influenced by dietary factors, gastrointestinal motility, and formulation of the drug. In circulation, about 25% is protein bound. The nonbound (free) form of serum digoxin is sequestered into muscle cells. At equilibrium, the tissue concentration is 15–30 times greater than plasma. Elimination of digoxin occurs primarily by renal filtration of the plasma free form. The remainder is metabolized to several products by the liver. The half-life of plasma digoxin is 38 hours in an average adult. The major contributing factor to the half-life is the slow release of tissue digoxin back into circulation.

Because of variable gastrointestinal absorption of digoxin, establishing a dosage regimen usually requires assessment of serum concentrations after initial dosing to ensure that effective and nontoxic serum concentrations are achieved. In addition, changes in glomerular filtration rate can have a dramatic effect on serum concentration; frequent dosage adjustments, in conjunction with serum levels, need to be done in patients with renal

disease. The therapeutic actions and toxicities of digoxin can be influenced by the concentration of serum electrolytes. Low serum potassium and magnesium potentiate digoxin actions.² In these conditions, adjustment of serum concentrations below the therapeutic range may be necessary to avoid toxicity. Thyroid status may also influence the actions of digoxin. Hyperthyroid patients display a resistance to digoxin actions; hypothyroid patients are more sensitive.³

The timing for evaluation of peak digoxin levels is crucial. In an average adult, serum levels peak between 2 and 3 hours after an oral dose. However, uptake into tissue is a relatively slow process. As a result, peak serum concentrations do not correlate with tissue concentrations. It has been established that the serum concentration 8–10 hours after an orally administered dose correlates with tissue concentration. Peak levels are usually evaluated at this time. Peak levels collected before this time are misleading and not valid.

Immunoassay is used to measure total digoxin concentration in serum.² With most commercial assays, cross-reactivity with hepatic metabolites is minimal; however, newborns, pregnant women, and patients with uremia or late-stage liver disease produce an endogenous substance that cross-reacts with the antibodies used to measure serum digoxin. In patients with these digoxin-like immunoreactive substances, falsely elevated concentrations are common and should be considered along with the clinical context.

Quinidine

Quinidine is a naturally occurring drug that can be used to treat various cardiac arrhythmic situations. The two most common formulations are quinidine sulfate and quinidine gluconate. Oral administration is the most common route of delivery. Gastrointestinal absorption is complete and rapid for the sulfate. Peak serum concentrations are reached about 2 hours after an oral dose of the sulfate. The gluconate is a slow-release formulation.² Peak serum concentration is reached 4–5 hours after an oral dose. The most predominant toxic adverse effects of quinidine are nausea, vomiting, and abdominal discomfort. Cardiovascular toxicity, such as PVCs, may be seen at twice the upper limit of the therapeutic range. In most instances, monitoring of quinidine involves only determination of the trough level to ensure it is within the therapeutic range. Peak assessment is performed only when symptoms of toxicity are present. Because of its slow rate of absorption, trough levels of the gluconate are usually drawn 1 hour after the last dose.

Absorbed quinidine is about 70%–80% bound to serum proteins.² Most is eliminated by hepatic metabolism. Induction of this system, such as by barbiturates, increases the clearance rate. Impairment of this system,

CASE STUDY 29-1

A patient with congestive heart failure has been successfully treated with digoxin for several years. Laboratory records indicate semiannual peak digoxin levels have all been in the therapeutic range. This patient recently developed renal failure, and admission testing was performed. Selected serum or blood laboratory results from this specimen are shown in Case Study Table 29-1.1. Although digoxin is high, the physician indicates the patient is not exhibiting signs or symptoms of toxicity.

Questions

1. If these results were derived from a random specimen, how may the time since the last dose affect the interpretation of the digoxin results?
2. Other than time, what additional factors should be taken into consideration when interpreting the digoxin results?
3. What additional laboratory test would aid in the interpretation of this case?

CASE STUDY TABLE 29-1.1 LABORATORY RESULTS

| TEST | RESULT | REFERENCE RANGE |
|------------------|--------|-----------------|
| Sodium | 129 | 135–145 mEq/L |
| Potassium | 5.5 | 3.5–5 mEq/L |
| Chloride | 113 | 97–107 mEq/L |
| Blood pH | 7.25 | 7.35–7.45 |
| TCO ₂ | 16 | 21–31 mmol/L |
| Urea nitrogen | 180 | 5–20 mg/dL |
| Creatinine | 4.5 | 0.6–1 mg/dL |
| Osmolality | 275 | 282–300 mOsm/kg |
| Digoxin | 2.5 | 0.9–2 ng/mL |

as seen in late-stage liver disease, may extend the half-life of this drug. Plasma quinidine concentration can be determined by chromatography or immunoassay. The production of quinidine may contain active contaminants such as dihydroquinidine. Early immunoassay detected quinidine only. Most current immunoassays cross react with these bioactive contaminants. This provides for assessment of total quinidine potential.

Procainamide

Like quinidine, procainamide is used to treat cardiac arrhythmia. Oral administration is the most common.

CASE STUDY 29-2

A patient is receiving procainamide for treatment of cardiac arrhythmia. An IV loading dose resulted in a serum concentration of 6.0 $\mu\text{g/mL}$. The therapeutic range for procainamide is 4–8 $\mu\text{g/mL}$, and its half-life is 4 hours. Four hours after the initial loading dose, another equivalent dose was given as an IV bolus. This resulted in a serum concentration of 7.5 $\mu\text{g/mL}$.

Questions

1. Does the serum concentration after the second dose seem appropriate? If not, what would be the predicted serum concentration at this time?
2. What factors would influence the rate of elimination of this drug?

Gastrointestinal absorption is rapid and complete. Peak plasma concentrations occur at about 1 hour.² Absorbed procainamide is about 20% bound to plasma proteins. It is eliminated by a combination of renal filtration and hepatic metabolism. *N*-Acetyl procainamide (NAPA) is an hepatic metabolite of the parent drug, with antiarrhythmic activity similar to procainamide. The total antiarrhythmic potential of this drug must take into consideration the parent drug and this metabolite. Alteration in either renal or hepatic function may lead to increased serum concentration of the parent drug and its metabolites. Increased concentration results in myocardial depression and arrhythmia. Both procainamide and its active metabolite can be measured by immunoassay.

Disopyramide

Disopyramide (Norpace) is another drug used to treat cardiac arrhythmias. It is commonly used as a quinidine substitute when quinidine adverse effects are excessive. It is most commonly administered as an oral preparation. Gastrointestinal absorption is complete and rapid, with serum concentrations peaking at about 1–2 hours.² It binds to several plasma proteins. Binding is highly variable between individuals and is concentration dependent: as serum concentration increases, so does the percentage free. As a result, it is difficult to correlate total serum concentration with therapeutic benefit and toxicity. In most patients, total serum concentrations in the range of 3–7.5 $\mu\text{g/mL}$ have been determined to be effective and nontoxic; however, interpretation of disopyramide results should take the clinical perspective into consideration. The primary toxicities of disopyramide are dose dependent.² Anticholinergic effects, such as dry

mouth and constipation, may be seen at serum concentrations greater than 4.5 $\mu\text{g/mL}$. Cardiac effects, such as bradycardia and atrioventricular node blockage, are usually seen at serum concentrations greater than 10 $\mu\text{g/mL}$. Disopyramide is primarily eliminated by renal filtration and, to a lesser extent, by hepatic metabolism. In conditions with low glomerular filtration rate, the half-life is prolonged and serum concentrations rise. Plasma disopyramide concentration can be determined by chromatography or immunoassay.

ANTIBIOTICS**Aminoglycosides**

Aminoglycosides are a group of chemically related antibiotics used for the treatment of infections with gram-negative bacteria that are resistant to less toxic antibiotics. There are many individual agents within this classification. The most commonly encountered in a clinical setting are gentamicin, tobramycin, amikacin, and kanamycin. All share a common mechanism of action but vary in effectiveness against different strains of bacteria. All share a common nephrotoxicity and ototoxicity. The ototoxic effect involves disruption of inner ear cochlear and vestibular membranes, which results in hearing and balance impairment. These effects are irreversible. Cumulative effects may be seen with repeated high-level exposure. Nephrotoxicity is also of major concern. Aminoglycosides impair the function of proximal tubules of the kidney, which may result in electrolyte imbalance and possibly proteinuria. These effects are usually reversible; however, extended high-level exposure may result in necrosis of these cells and subsequent renal failure.⁴ Toxic concentrations are usually considered any concentration above the therapeutic range.

Because aminoglycosides are not well absorbed from the gastrointestinal tract, administration is limited to the IV or IM route; therefore, these drugs are not used in an outpatient setting. Aminoglycosides are eliminated by renal filtration. In patients with compromised renal function, appropriate adjustments must be made based on serum concentrations. Chromatography and immunoassay are the primary methods used for aminoglycoside determinations.

Vancomycin

Vancomycin is a glycopeptide antibiotic that is effective against gram-positive cocci and bacilli. Because of poor oral absorption, vancomycin is administered by IV infusion. Unlike other drugs, a clear relationship between serum concentration and toxic adverse effects has not been firmly established. Indeed, many of the toxic effects occur in the therapeutic range (5–10 $\mu\text{g/mL}$).⁴ The major toxicities of vancomycin are red-man syndrome,

nephrotoxicity, and ototoxicity. Red-man syndrome is characterized by an erythemic flushing of the extremities. The renal and hearing effects are similar to those of the aminoglycosides. It appears that the nephrotoxic effects occur more frequently at trough concentrations that are greater than 10 $\mu\text{g/mL}$. The ototoxic effect occurs more frequently when peak serum concentrations exceed 40 $\mu\text{g/mL}$. Because vancomycin has a long distribution phase, in most instances, only trough levels are monitored to ensure the serum drug concentration is within the therapeutic range. Vancomycin is primarily eliminated by renal filtration and secretion. It is assayed by immunoassay and chromatographic methods.

ANTIEPILEPTIC DRUGS

Epilepsy, convulsions, and seizures are prevalent neurologic disorders. Because these drugs are used as prophylactics, therapeutic ranges are considered guidelines and should be interpreted in accordance with the presenting clinical context.⁵ Effective concentrations are determined as the concentration that works, with no or acceptable adverse effects. In recent years, a second generation of antiepileptic drugs (AEDs) have been introduced in clinical practice as supplemental therapy to the more traditional drugs (i.e., phenobarbital, phenytoin, etc.). Unlike first-generation AEDs, optimal concentration ranges have not been firmly established. For these drugs, though, TDM may be indicated in initially establishing individual baseline concentrations at which the patient is responding well.⁵ It is important to take these individual reference ranges into account, especially as physiologic conditions may be altered (age related, pregnancy, kidney or liver disease, etc.), and in reassessing these concentrations as other AEDs are added to an established regimen.⁵ Most AEDs are analyzed by immunoassay or chromatography and measure the free or bound drug in a serum or plasma sample. In a normal physiologic state, the total drug concentration may be sufficient. A free drug measurement may only be necessary when there is cause for alteration in patient plasma protein, such as in the later stages of pregnancy, in late-stage renal or hepatic disease, malnutrition, or when a known drug-drug interaction may occur.⁶ As with all TDM, sampling time must be consistent and the most preferred specimen is the trough serum concentration, collected at the end of the dosing interval.⁶

First-Generation Antiepileptic Drugs

Phenobarbital

Phenobarbital is a slow-acting barbiturate that effectively controls several types of seizures. Absorption of oral phenobarbital is slow but complete. For most patients, peak serum concentration is reached about 10 hours after an

CASE STUDY 29-3

A child, who has been successfully treated for seizure disorders with oral phenytoin for several years, has had severe diarrhea for the past 2 weeks. Subsequent to this, the patient had a seizure. Evaluation of serum phenytoin at the time of the seizure revealed a low value. The dose was increased until serum concentrations were within the therapeutic range. The diarrhea was resolved. Several days after this, the patient had another seizure.

Questions

1. What is the most probable cause of the initial low serum phenytoin?
2. Would determination of free serum phenytoin aid in resolving the cause of the initial seizure?
3. What assays other than the determination of serum phenytoin would aid in this situation?
4. What is the most probable cause of the seizure after the diarrhea has been resolved?

oral dose. Circulating phenobarbital is 50% protein bound. It is eliminated primarily by hepatic metabolism. However, renal filtration is also significant. With compromised renal or hepatic function, the rate of elimination is decreased. The half-life of serum phenobarbital is 70–100 hours. Because of the slow absorption and long half-life, serum concentrations do not change dramatically within a dosing interval. Therefore, only trough levels are usually evaluated unless toxicity is suspected. Toxic adverse effects of phenobarbital include drowsiness, fatigue, depression, and reduced mental capacity.

Phenobarbital clearance occurs by the hepatic MFO system. It is noteworthy that it is also a potent inducer of this system. After initiation of therapy, dose adjustment is usually required after the induction period is complete. For most individuals, this is 10–15 days after the first dose.

Primidone is an inactive proform of phenobarbital. After absorption of an oral dose, this drug is rapidly converted to its active form, phenobarbital. Primidone is used in preference of phenobarbital when steady-state kinetics need to be established quickly. Primidone is rapidly absorbed and converted to the active drug. Both primidone and phenobarbital need to be measured to assess the total potential amount of phenobarbital in circulation.

Phenytoin

Phenytoin (Dilantin) is a commonly used treatment for seizure disorders. It is also used as a short-term prophylactic agent in brain injury to prevent loss of functional

tissue. Phenytoin is primarily administered as an oral preparation. Gastrointestinal absorption is variable and sometimes incomplete. Circulating phenytoin has a high but variable degree of protein binding (87%–97%) and can be easily displaced by other highly protein-bound drugs.⁷ Like most drugs, the unbound (free) fraction is the biologically active portion of total serum concentration. Reduced protein binding may occur with anemia, with hypoalbuminemia, and in the coadministration of other drugs with similar binding properties. Thus, toxicity may be observed when the total serum drug concentration is within the therapeutic range. The major toxicity of phenytoin is initiation of seizures. Thus, seizures in a patient being treated with phenytoin may be a result of subtherapeutic or toxic concentrations. Additional adverse effects of phenytoin include hirsutism, gingival hyperplasia, vitamin D deficiency, and folate deficiency. Phenytoin is eliminated by hepatic metabolism. At therapeutic concentrations, this elimination pathway may become saturated (zero-order kinetics). Therefore, relatively small changes in dosage or elimination may have dramatic effects on plasma concentration.

For most patients, total serum concentrations of 10–20 g/mL are effective. In many situations; however, the effective range of total serum concentration must be individualized to suit the clinical situation. It is also an inducer of the hepatic MFO pathway, which reduces the half-life of concurrently administered drugs that are eliminated by this pathway.⁵ The therapeutic range for free serum phenytoin is 1–2 µg/mL. This has been well correlated with the pharmacologic actions of this drug. In patients with altered serum protein binding, determination of the free fraction aids in dosage adjustment.

Fosphenytoin is an injectable proform of phenytoin that is rapidly metabolized in serum, releasing the parent drug. It takes about 75 minutes for this conversion to take place. Most immunoassays for phenytoin do not detect this proform. Thus, peak levels should be evaluated only after the conversion to the active drug is complete.

Valproic Acid

Valproic acid is used as a monotherapy for the treatment of petit mal and absence seizures.⁷ It is administered as an oral preparation. Gastrointestinal absorption is rapid and complete. Circulating valproic acid is highly protein bound (93%). The percentage bound decreases in renal failure, in late liver disease, and with coadministration of other drugs that may compete for its binding site. It is eliminated by hepatic metabolism, which may be induced by numerous coadministered AEDs but is inhibited by coadministration of felbamate (another AED).⁷ The therapeutic range for valproic acid is relatively wide (50–120 µg/mL). Determination of serum concentration is primarily done to ensure that toxic levels (greater than 120 µg/mL) are not present. Nausea, lethargy, and weight

gain are the most common adverse effects. Pancreatitis, hyperammonemia, and hallucinations have been associated with high serum levels (>200 µg/mL). Hepatic dysfunction occasionally occurs in some patients even at therapeutic serum concentrations, therefore, hepatic indicators should be checked frequently for the first 6 months after initiation of therapy. Many factors may influence the nonbound (free) fraction of total serum valproic acid. Therefore, determination of the free fraction provides a more reliable index of therapeutic and toxic concentrations.

Carbamazepine

Carbamazepine (Tegretol) is an effective treatment in various seizure disorders. Because of its serious toxic adverse effects, it is less frequently used, except when patients do not respond to other drugs. Orally administered carbamazepine is absorbed with a high degree of variability. Circulating carbamazepine is 70%–80% protein bound. It is eliminated primarily by hepatic metabolism. Many forms of liver dysfunction may result in serum accumulation. Carbamazepine is an inducer of its own metabolism. Thus, frequent plasma levels must be analyzed on initiation of therapy until the induction period has come to completion.

Carbamazepine toxicity is diverse and variable. Certain effects occur in a dose-dependent manner; others do not. There are several idiosyncratic effects of carbamazepine, which affect a portion of the population at therapeutic concentrations, including rashes, leukopenia, nausea, vertigo, and febrile reactions. Of these, leukopenia is the most serious. Leukocyte counts are commonly done during the first 2 weeks of therapy to detect this possible toxic effect. Liver function testing is also done during this period. Mild, transient liver dysfunction is commonly seen during this period. Large and persistent increases in liver indices or a significant leukopenia commonly result in discontinuation of the drug. The therapeutic range for carbamazepine is 4–12 µg/mL. Plasma concentrations greater than 15 µg/mL are associated with hematologic dyscrasias and possible aplastic anemia.

Ethosuximide

Ethosuximide (zerontonin) is used for control of petit mal seizure. It is administered as an oral preparation. The therapeutic range is 40–100 µg/mL. The toxicities associated with high plasma concentrations are rare, tolerable, and self-limiting. TDM of ethosuximide is done to ensure that serum concentrations are in the therapeutic range.

Second-Generation Antiepileptic Drugs

Felbamate

Felbamate is an orally administered drug that is nearly completely absorbed by the gastrointestinal tract, and peak serum concentrations are reached within 1–4 hours.⁸

In circulation, it is 30% bound to serum proteins and is eliminated by renal and hepatic metabolism. Felbamate is known for its toxicity and is primarily indicated in severe epilepsies such as children with the mixed seizure disorder Lennox-Gastaut syndrome (refractory to all other AEDs) and in adults with refractory epilepsy.⁵⁻⁷ When administered as a monotherapy, the half-life of the drug is 14–22 hours in adults. In comparison, clearance has been reported higher in children and reduced in the elderly. Renal impairment will increase the half-life to 27–34 hours. Felbamate therapy is contradicted in patients with hepatic dysfunction.⁸ Metabolism of the drug is enhanced by enzyme inducers including phenobarbital, primidone, phenytoin, and carbamazepine, resulting in a decreased half-life.

TDM may be indicated due to the narrow therapeutic range and can be considered after steady state has been reached. In patients receiving therapeutic doses, the serum concentrations have been measured in the range of 30–60 $\mu\text{g/mL}$.⁸ Adverse side effects have been documented and include fatal aplastic anemia and hepatic failure.^{5,7}

Gabapentin

Gabapentin is administered orally with a maximum bioavailability of 60% and is reduced when antacids are administered concurrently. This drug may be indicated as monotherapy or in conjunction with other AEDs in patients suffering from complex partial seizures with or without generalized seizures.^{5,7} It does not bind to serum proteins and is not metabolized hepatically. Gabapentin is eliminated unchanged by the kidneys and has a half-life of approximately 5–9 hours in patients with normal renal function.⁸ Children require a 30% larger than normal dose to maintain a comparable half-life, as they eliminate the drug more quickly than does the normal adult. Due to the exclusive renal clearance of this drug, impaired kidney function increases half-life of the circulating drug in a linear manner.⁸ Therapeutic concentration has been documented at 12–20 $\mu\text{g/mL}$, although a wide range of serum concentrations have been reported in association with seizure control. Multiple daily doses may be the preferred regimen as excessively high blood concentrations may lead to adverse drug effects, while low-level trough concentrations may lead to breakthrough seizures.⁵ Gabapentin may be the most likely treatment consideration in patients with liver disease and in treating partial-onset seizures in patients with acute intermittent porphyria.⁵

Lamotrigine

Lamotrigine is orally administered and is rapidly and completely absorbed from the gastrointestinal tract. Its use is indicated in patients with partial and generalized seizures.⁵ Once in circulation, it is approximately 55% protein bound.⁸ Hepatic metabolism accounts for the majority of

elimination.^{7,8} In patients undergoing monotherapy, the half-life of lamotrigine is 15–30 hours. Its rate of elimination is highly dependent on patient age and physiologic condition. Younger infants tend to metabolize more slowly than do older infants. Children tend to metabolize on the order of twice as quickly as normal adults. There have been marked increases in clearance as pregnancy progresses, peaking at the 32nd week.⁵

Lamotrigine clearance is also influenced by the recognized enzyme-inducing AEDs such as phenobarbital, primidone, phenytoin, and carbamazepine. In a very opposite manner, valproic acid is an inhibitor of lamotrigine metabolism and may increase its half-life to 60 hours. The above drug-drug interactions justify a need for TDM during therapy. Individual therapeutic ranges do vary, but a concentration range of 2.5–15 $\mu\text{g/mL}$ has been noted as efficacious and increasing concentration seems to correlate with increasing risk of toxicity.⁸ Tailoring dose and serum concentration is advisable because therapeutic results have been observed in concentrations greater than previously noted therapeutic range (in lieu of toxic side effects).⁸

Levetiracetam

Levetiracetam is an orally administered AED that is nearly entirely bioavailable.^{5,7,8} Its use is indicated in partial and generalized seizures. It does not bind to serum proteins. Its half-life is 6–8 hours, although the rate of elimination is increased in children and pregnant women and decreased in the elderly. Levetiracetam's rate of clearance correlates well with glomerular filtration rate, which may be of use in monitoring patients with renal impairment. The need for TDM of levetiracetam is not as pronounced as in other AEDs (due to its lack of pharmacokinetic variability) but may be useful in monitoring compliance and fluctuating levels during pregnancy.⁵ Therapeutic concentrations have been reported at 8–26 $\mu\text{g/mL}$.

Oxcarbazepine

Oxcarbazepine is a prodrug that is almost immediately metabolized to licarbazepine.^{7,8} It is indicated for the monotherapy of partial seizures and in secondarily generalized tonic-clonic seizures. Its protein binding is approximately 40%. Its peak concentration is at about 8 hours. It is metabolized by the liver into two pharmacologically active, equipotent enantiomers via keto reduction followed by glucuronide conjugation of the active licarbazepine derivative.^{7,8} Its half-life is 8–10 hours in normal adults. In children, there is a higher clearance rate; therefore, a need exists for a higher dosing regimen to obtain the optimal serum concentration per kilogram of body weight compared with adults. The opposite scenario is seen in the elderly as their drug clearance is reduced by 30%.⁸ The clearance of the drug and its

metabolite are reduced in patients with marked renal dysfunction. The metabolism of licarbazepine is sensitive to enzyme inducers such as phenytoin and phenobarbital, which decreases the blood concentration by 20%–40%.⁸ TDM may be indicated until established steady state has been reached, at therapeutic failure, when there may be drug-drug interactions, and during pregnancy. Although not well defined, therapeutic effects of licarbazepine have been reported at serum concentrations of 12–35 µg/mL.

Tiagabine

Tiagabine absorption is rapid and nearly complete as circulating concentration peaks at 0.5–2 hours. It is approximately 96% protein bound, and its half-life is variable in the range of 4–13 hours. It is highly metabolized by the hepatic mixed-function oxidase pathway.^{5,8} It is indicated in treating partial seizures.⁷ Due to its significant protein binding, the ratio of free to bound drug is affected by other protein-binding drugs such as valproic acid, naproxen, and salicylates and by pregnancy.⁸ Hepatic dysfunction also prolongs the half-life of the drug. TDM may be indicated due to intraindividual and interindividual variations. Therapeutic benefits of the drug have been observed at concentrations of 20–100 ng/mL.⁸ Dose titration may be the most effective method in balancing therapeutic effects with adverse CNS side effects of the drug. These side effects include symptoms of confusion, difficulty speaking clearly (stuttering), mild sedation, and a tingling sensation in the body's extremities (paresthesia), especially in the hands and fingers.^{5,9}

Topiramate

Topiramate is nearly completely bioavailable after oral administration, and peak concentration is reached within 1–4 hours.^{7,8} It is 15% protein bound. The serum half-life is 20–30 hours. The majority of topiramate is eliminated by renal filtration; the remainder is eliminated by hepatic metabolism. Topiramate is indicated in partial and generalized seizures.⁵ The dose-to-serum concentration ratio in children is less than that of adults per kilogram of body mass such that they require a higher dose to maintain serum topiramate concentrations comparable to adults.⁸ Serum concentrations are increased secondary to renal insufficiency but may be decreased when used with other enzyme-inducing AEDs (listed in previous sections). Dose titration may also be the most effective method in balancing therapeutic effects with adverse CNS side effects; these include change of taste with particular foods (e.g., diet soda and beer) and a sensation of “pins and needles” in the extremities.^{5,9} TDM may be indicated at steady state to provide the clinician with an effective individual baseline concentration, at therapeutic failure, and to monitor drug-drug interactions.⁸

Zonisamide

Zonisamide is orally administered and absorbed from the gastrointestinal tract on the order of 65% or higher. Peak serum concentrations are reached at 4–7 hours, and the drug is approximately 60% protein bound and accumulates extensively in erythrocytes.⁸ The majority is metabolized by the liver via glucuronide conjugation, acetylation, and oxidation and then renal excretion. Its use is implicated in the therapy of partial and generalized seizures. The half-life of zonisamide is 50–70 hours in patients receiving monotherapy and may be reduced to 25–35 hours when other enzyme-inducing AEDs are being administered concurrently.⁸ Children require higher doses to achieve effective serum concentrations comparable to that of an adult.⁸ Clinicians treating patients with liver or kidney disease and using this drug should exercise caution as serum concentrations may increase proportionally with the level and type of organ impairment. There is documented overlap in zonisamide blood concentrations between those experiencing therapeutic effectiveness and those experiencing toxic side effects.⁸ TDM may be indicated to establish a baseline level after steady state has been achieved, to detect drug-drug interactions, and at therapeutic failure. Therapeutic doses have been reported in patients with serum concentrations of 10–38 µg/mL.

PSYCHOACTIVE DRUGS

Lithium

Lithium is an orally administered drug used to treat manic depression (bipolar disorder). Absorption is complete and rapid. Lithium is a cationic metal that does not bind to proteins. Distribution is uniform throughout total body water. It is eliminated predominantly by renal filtration and is subject to reabsorption. Compromises in renal function usually result in accumulation. Correlations between serum concentration and therapeutic response have not been well established. However, serum concentrations in the range of 0.5–1.2 mmol/L are effective in a large portion of the patient population.¹⁰ The purpose of TDM for lithium is to avoid serum concentrations associated with toxic effects. Serum concentrations in the range of 1.5–2 mmol/L may cause apathy, lethargy, speech difficulties, and muscle weakness.¹⁰ Serum concentrations greater than 2 mmol/L are associated with muscle rigidity, seizures, and possible coma. Determination of serum lithium is commonly done by ion-selective electrode. Flame emission photometry and atomic absorption are also viable methods. It is relatively inexpensive to monitor serum lithium in avoiding toxic side effects. Thus, it is prudent to do so for patients on such a regimen.¹⁰

Tricyclic Antidepressants

Tricyclic antidepressants (TCAs) are a class of drugs used to treat depression, insomnia, extreme apathy, and loss of libido. From a clinical laboratory perspective, imipramine, amitriptyline, and doxepin are the most relevant.¹⁰ Desipramine and nortriptyline are active metabolic products of imipramine and amitriptyline, respectively, and must also be included. The TCAs are orally administered drugs with a varying degree of absorption. In many patients, they slow gastric emptying and intestinal motility, which significantly slows the rate of absorption. As a result, peak serum concentrations are reached in the range of 2–12 hours. The TCAs are highly protein bound (85%–95%). For most TCAs, the therapeutic effects are not seen for the first 2–4 weeks after initiation of therapy. The correlations between serum concentration and therapeutic effects of most TCAs are moderate to weak. They are eliminated by hepatic metabolism. Many of the metabolic products formed have therapeutic actions. The rate of metabolism of these agents is variable and influenced by a wide variety of factors. As a result, the half-life of TCAs varies considerably among patients. The rate of elimination can also be influenced by the coadministration of other drugs that are eliminated by hepatic metabolism. The toxicity of TCAs is dose dependent. At serum concentrations about twice the upper limit of the therapeutic range, drowsiness, constipation, blurred vision, and memory loss are common adverse effects. Higher levels may cause seizure, cardiac arrhythmia, and unconsciousness.

Because of the high variability in half-life and absorption, plasma concentrations of the TCAs should not be evaluated until a steady state has been achieved. At this point, therapeutic efficacy is determined from clinical evaluation of the patient, and potential toxicity is determined by serum concentration. Many of the immunoassays for TCAs use polyclonal antibodies, which cross-react among the different TCAs and their metabolites and are used for TCA screening rather than blood concentration monitoring and TDM.¹⁰ In this analytic system, the results are reported out as “total tricyclics.” Other immunoassays use an extraction step to separate parent drugs from the metabolites. Interpretation of these results after extraction requires an in-depth understanding of the assay. Chromatographic methods provide simultaneous evaluation of both the parent drugs and metabolites, which provides a basis for unambiguous interpretation of results.¹⁰

Clozapine

Clozapine is an atypical antipsychotic used to treat otherwise treatment-refractory schizophrenia, including its negative symptoms, suicidal tendencies, and various

types of cognitive deficiencies associated with the disease. Research has found that although there is not a well-established clinical serum concentration, beneficial effects of the drug have been demonstrated at 350–420 ng/mL. TDM may be indicated to check for compliance and in patients with altered pharmacokinetics. TDM may also be used in avoiding symptoms of toxicity and overdosing, which may present with seizures.¹¹

Olanzapine

Olanzapine is a thienobenzodiazapine derivative that effectively treats schizophrenia, acute manic episodes, and the recurrence of bipolar disorders.¹¹ It can be administered as a fast-acting intramuscular injection at a dose of 2.5–10 mg per injection. Olanzapine is more likely administered orally and is 85% absorbed, although is approximately 40% inactivated by first-pass metabolism. Women and nonsmokers tend to have lower clearance and thus a higher serum concentration of olanzapine compared with men and smokers.¹¹ There is indication that plasma concentration correlates well with clinical outcomes. TDM may help to optimize clinical response while balancing it with adverse effects with a therapeutic range of 20–50 ng/mL.¹¹

IMMUNOSUPPRESSIVE DRUGS

Transplantation medicine is a rapidly emerging discipline within clinical medicine. The clinical laboratory plays many important roles that determine the success of any transplantation program. Among these responsibilities, monitoring of the immunosuppressive drugs used to prevent rejection is of key concern. Most of these drugs require establishment of individual dosage regimens to optimize therapeutic outcomes and minimize toxicity.

Cyclosporine

Cyclosporine is a cyclic polypeptide that has potent immunosuppressive activity. Its primary clinical use is suppression of host-versus-graft rejection of heterotopic transplanted organs. It is administered as an oral preparation. Absorption of cyclosporine is in the range of 5%–50%. Because of this high variability, the relationship between oral dose and blood concentration is poor; therefore, TDM is an important part of establishing an initial dosage regimen. Circulating cyclosporine sequesters in cells, including erythrocytes.¹² Erythrocyte content is highly temperature dependent; therefore, evaluation of plasma concentration requires rigorous control of specimen temperature. To avoid this preanalytic variable, whole blood is the specimen of choice. Correlations have been established between whole blood concentration and therapeutic and toxic effects. Cyclosporine is eliminated by hepatic metabolism to inactive products.

Immunosuppression requirements differ depending on the organ transplanted. Cardiac, liver, and pancreas transplants have the highest requirement (300 ng/mL). Whole blood concentrations in the range of 350–400 ng/mL have been associated with toxic effects. The toxic effects of cyclosporine are primarily renal tubular and glomerular dysfunction, which may result in hypertension.¹³ Several immunoassays are available for determination of whole blood cyclosporine concentration. Many cross-react with inactive metabolites. Chromatographic methods are available; they provide separation and quantitation of the parent drug from metabolites.¹⁴

Tacrolimus

Tacrolimus (FK-506) is an orally administered immunosuppressive drug that is 100 times more potent than cyclosporine; therefore, the dosage is far less than that of cyclosporine.¹⁵ Early use of tacrolimus suggested a low degree of toxicity compared with cyclosporine at therapeutic concentrations. However, after extensive use in clinical practice, it has been demonstrated that both have comparable degrees of nephrotoxicity at therapeutic concentrations. At concentrations above therapeutic, tacrolimus has been associated with thrombus formation.

Many aspects of tacrolimus pharmacokinetics are similar to those of cyclosporine. Gastrointestinal uptake is highly variable. Whole blood concentrations correlate well with therapeutic and toxic effects. Tacrolimus is eliminated almost exclusively by hepatic metabolism. Metabolic products are primarily secreted into the bile. Increases in immunoreactive tacrolimus may be seen in cholestasis as a result of cross-reactivity with several of these products. Because of the high potency of tacrolimus, circulating therapeutic concentrations are low. This limits the methodologies capable of measuring whole blood concentrations. The most common method is high-performance liquid chromatography–mass spectrophotometry (HPLC/MS); however, several immunoassays are also available.

Sirolimus

Sirolimus (Rapamycin) is an antifungal agent with immunosuppressive activity. It is U.S. Food and Drug Administration approved for patients receiving kidney transplants. Sirolimus is extremely potent and requires TDM due to its inherent toxicity. Adverse events include thrombocytopenia, anemia, leukopenia, infections, and hyperlipidemia.^{16,17} It is commonly used in conjunction with cyclosporine or tacrolimus.^{14,16} Sirolimus is rapidly absorbed after once-daily oral administration, with peak blood levels at about 1 hour. The oral bioavailability is 15% when taken in conjunction with cyclosporine.¹⁷

Serum concentration is affected extensively by intestinal and hepatic first-pass metabolism. It has a long half-life of 62 hours. Intraindividual and interindividual variability demonstrates the need for TDM as serum concentration is affected by individual differences in absorption, distribution, metabolism, and excretion. It binds more highly to lipoproteins than to serum protein; therefore, whole blood is the ideal specimen for analysis.¹⁷ TDM commences using a trough level specimen obtained 5–7 days after initiation of therapy. Trough specimens are then drawn on a weekly basis for the first month following a biweekly sampling pattern in the second month and can be analyzed to establish a safe and effective therapeutic range. The therapeutic range is 4–12 µg/L when it is used in conjunction with cyclosporine and 12–20 µg/L if cyclosporine therapy is discontinued.¹⁷ It is assayed using chromatography.^{14,16}

Mycophenolic Acid

Mycophenolate mofetil (MMF) is the prodrug, which is rapidly converted in the liver to its active form of mycophenolic acid (MPA).¹³ It is a lymphocyte proliferation inhibitor.¹⁸ It is used most commonly as supplemental therapy with cyclosporine and tacrolimus in renal transplant patients. As with the other antirejection drugs, low trough levels increase the risk of acute rejection, while high levels imply toxicity. It is an orally administered drug that is absorbed under neutral pH conditions in the intestine.¹⁸ Interindividual variation of gastrointestinal tract physiology influences the degree of absorption of MPA. Once in circulation, it is 95% protein bound. The degree to which MPA is protein bound varies both intra individually and interindividually and is dependent on circulating albumin concentration, renal function, and the concentration of other drugs that may be competitively binding to serum albumin.¹⁸ Therapeutic serum concentrations have been documented at 1.0–3.5 µg/mL. MPA and its metabolites can be assayed using plasma specimen as the most likely sample of choice when using chromatography. Immunoassay is a less specific, yet common, method in assaying plasma MPA.¹⁸ As with most immunoassay methods, cross-reactivity between MPA and its active metabolite (AcMPAG) should be taken into account and interpreted flexibly in the clinical picture as the each demonstrates varying pharmacokinetics.

ANTINEOPLASTICS

Assessment of the therapeutic benefit and toxicity of most antineoplastic drugs is not aided by TDM, because correlations between plasma concentration and therapeutic benefit are hard to establish. Many of these agents are rapidly metabolized or incorporated into cellular macromolecular structures within seconds to minutes of

their administration. In addition, the therapeutic range for many of these drugs includes concentrations associated with toxic effects. Considering that most antineoplastic agents are administered intravenously as a single bolus, the actual delivered dose is more important than circulating concentrations.

Methotrexate

Methotrexate is one of the few antineoplastic drugs in which TDM offers benefits to a therapeutic regimen. High-dose methotrexate followed by leucovorin rescue has been shown to be an effective therapy for various neoplastic conditions.¹⁹ The basis of this therapy involves the relative rate of mitosis of normal versus neoplastic cells. In general, neoplastic cells divide more rapidly than do normal cells. Methotrexate inhibits DNA synthesis in all cells. Neoplastic cells, as a result of their rapid rate of division,

have a higher requirement for DNA and are susceptible to deprivation of this essential constituent before normal cells. The efficacy of methotrexate therapy is dependent on a controlled period of inhibition, one that is selectively detrimental to neoplastic cells. This is accomplished by administration of leucovorin, which reverses the actions of methotrexate at a specific time after methotrexate infusion. This is referred to as *leucovorin rescue*. Failure to stop methotrexate actions results in cytotoxic effects to most cells. Evaluation of serum methotrexate concentration, after the inhibitory time period has passed, is used to determine how much leucovorin is needed to counteract many of the toxic effects of methotrexate.¹⁹

The basic principles of TDM, which address absorption, distribution, and elimination, can also be applied to nontherapeutic substances that have entered the body. Indeed, the use of these concepts is central to the study of poisons.

SUGGESTED READINGS

- Birkett DJ. Pharmacokinetics made easy. New York: McGraw-Hill, 2003.
- Broussard L, Tuckler V. The value of TDM, Toxicology. *Adv Admin Clin Lab* 2004;13:32.
- Graham, K. Lab Limelight: TDM: Applications for pharmacogenetics. *Adv Admin Clin Lab* 2007;16:81.
- Hardman JG, Limbird LE, Gillman AG, eds. Goodman & Gilman's The pharmacological basis of therapeutics, 10th ed. New York: Pergamon Press, 2002.

REFERENCES

1. Abbot A. With your genes? Take one of these, three times a day. *Nature* 2003;425:760–762.
2. Campbell TJ, Williams MK. Therapeutic drug monitoring: antiarrhythmic drugs. *Br J Clin Pharmacol* 2001;52:21S–34S.
3. Jurgens G, Graudal NA, Kampmann J.P. Therapeutic drug monitoring of antiarrhythmic drugs. *Clin Pharmacokinet* 2003;42:647–663.
4. Winston L, Benowitz N. Once-daily dosing of aminoglycosides: how much monitoring is truly required? *Am J Med* 2003;114:239–240.
5. Perucca, E. An introduction to antiepileptic drugs. *Epilepsia* 2005;46:31–37.
6. Eadie MJ. Therapeutic drug monitoring—antiepileptic drugs. *Br J Clin Pharmacol* 2001;52:11S–19S.
7. Israni RK, Kasbekar N, Haynes K, Berns JS. Use of antiepileptic drugs in patients with kidney disease. *Semin Dialysis* 2006;19:408–416.
8. Johannessen SI, Tomson T. pharmacokinetic variability of newer antiepileptic drugs. *Clin Pharmacokinet* 2006;45:1061–1075.
9. Wikipedia Online. Searched Tiagabine. Accessed 2/17/2008. <http://en.wikipedia.org/wiki/Tiagabine>
10. Mitchell PB. Therapeutic drug monitoring of psychotropic medications. *Br J Clin Pharmacol* 2001;52:45S–54S.
11. Mauri MC, Volonteri LS, Colasanti A, Fiorentini A, De Gaspari IF, Bareggi SR. Clinical pharmacokinetics of atypical antipsychotics. *Clin Pharmacokinet* 2007;46:359–388.
12. Masuda S, Inui K. An update review on individualized dosage of calcineurin inhibitors in organ transplant recipients. *Pharmacol Therap* 2006;112:184–198.
13. Taylor AL, Watson CJE, Bradley JA. Immunosuppressive agents in solid organ transplantation: mechanisms of action and therapeutic efficacy. *Crit Rev Oncol Hematol* 2005;56:23–46.
14. Johnston A, Holt DW. Immunosuppressant drugs—the role of therapeutic drug monitoring. *Br J Clin Pharmacol* 2001;52:61S–73S.
15. Baraldo M, Furlanut M. Chronopharmacokinetics of cyclosporine and tacrolimus. *Clin Pharmacokinet* 2006;45:775–788.
16. Wong SHY. Therapeutic drug monitoring for immunosuppressants. *Clin Chim Acta* 2001;313:241–253.
17. Stenton SB, Partovi N, Ensom MHH. Sirolimus: the evidence for clinical pharmacokinetic monitoring. *Clin Pharmacokinet* 2005;44:769–786.
18. Elbarbry FA, Shoker AS. Therapeutic drug measurement of mycophenolic acid derivatives in transplant patients. *Clin Biochem* 2007;40:752–764.
19. Lennard L. Therapeutic drug monitoring of cytotoxic drugs. *Br J Pharmacol* 2001;52:75S–87S.

Toxicology

David P. Thorne, Michelle E. Russell

CHAPTER

30

CHAPTER OUTLINE

■ EXPOSURE TO TOXINS

■ ROUTES OF EXPOSURE

■ DOSE-RESPONSE RELATIONSHIP

Acute and Chronic Toxicity

■ ANALYSIS OF TOXIC AGENTS

■ TOXICOLOGY OF SPECIFIC AGENTS

Alcohol

Carbon Monoxide

Caustic Agents

Cyanide

Metals and Metalloids

Pesticides

■ TOXICOLOGY OF THERAPEUTIC DRUGS

Salicylates

Acetaminophen

■ TOXICOLOGY OF DRUGS OF ABUSE

Amphetamines

Anabolic Steroids

Cannabinoids

Cocaine

Opiates

Phencyclidine

Sedatives-Hypnotics

■ REFERENCES

Toxicology is the study of **poisons**. The scope of this field is very broad. There are four major disciplines within toxicology: mechanistic, descriptive, forensic, and clinical toxicology. *Mechanistic toxicology* elucidates the cellular and biochemical effects of toxins. These studies provide a basis for rational therapy design and the development of tests to assess the degree of exposure of poisoned individuals. *Descriptive toxicology* uses the results from animal experiments to predict what level of exposure will cause harm in humans. This process is known as *risk assessment*. Regulatory toxicologists are responsible for interpreting the data from mechanistic and descriptive studies to establish standards that define the level of exposure that will not pose a risk to public health or safety. Typically, these toxicologists work for, or in conjunction with, government agencies. *Forensic toxicology* is primarily concerned with the medicolegal consequences of toxin exposure. A major focus of this area is establishing and validating the analytic performance of the methods used to generate evidence in legal situations, including the cause of death. *Clinical toxicology* is the study of interrelationships between toxin exposure and disease states. This area emphasizes not only diagnostic testing but also therapeutic intervention.

Within the organizational scheme of a typical medical laboratory, toxicology is usually considered part of chemistry, mainly because the methods used to evaluate toxins

qualitatively and quantitatively are best suited to this area. However, appropriate diagnosis and management of poisoning victims, in many instances, require an integrated approach from all sections of the clinical laboratory.

EXPOSURE TO TOXINS

Exposure to toxic agents can occur for various reasons. From a clinical standpoint, about 50% of poisoning cases are intentional suicide attempts. Accidental exposure accounts for about 30% of cases. The remaining cases are a result of homicide or occupational exposure. Of these, suicide has the highest mortality rate. Accidental exposure occurs most frequently in children; however, an accidental drug overdose of either therapeutic or illicit drugs is relatively common in adults. Occupational exposure primarily occurs in industrial and agricultural settings.

ROUTES OF EXPOSURE

Toxins can enter the body via several routes; ingestion, inhalation, and transdermal absorption are the most common. Of these, ingestion is the most often seen in a clinical setting. For most toxins to exert a systemic effect, they must be absorbed into circulation. Absorption of toxins from the gastrointestinal tract occurs via several mechanisms. Some are taken up by processes intended for dietary nutrients. However, most are absorbed by passive

diffusion. This process requires that the substance cross cellular barriers. Hydrophobic substances have the ability to diffuse across cell membranes and, therefore, can be absorbed anywhere along the gastrointestinal tract. Ionized substances cannot passively diffuse across membranes. Weak acids can become protonated in gastric acid. The result is a nonionized species, which can be absorbed in the stomach. In a similar manner, weak bases favor absorption in the intestine, where the pH is largely neutral or slightly alkaline. Other factors can influence absorbance of toxins from the gastrointestinal tract, including rate of dissolution, gastrointestinal motility, resistance to degradation in the gastrointestinal tract, and interaction with other substances. Toxins that are not absorbed from the gastrointestinal tract do not produce systemic effects but may produce local effects, such as diarrhea, bleeding, or malabsorption of nutrients, which may cause systemic effects secondary to toxin exposure.

DOSE-RESPONSE RELATIONSHIP

A *poison* can be defined as any substance that causes a harmful effect on exposure. Although this basic definition is useful, other factors must be taken into consideration. Among these, dose is a key issue. The concept that any substance has the potential to cause harm if given at the correct dosage (even water) is a central theme in toxicology. There is a need to establish an index of the relative toxicity of substances to allow assessment of their potential to cause pathologic effects. Several systems are available. Most correlate the dose of a toxin that will result in a harmful response. One such system correlates a single acute oral dose range with the probability of a lethal outcome in an average 70-kg man (Table 30-1). This is a useful system to compare the relative toxicities of substances. The predicted response in this system is death, which is valid. However, most toxins can express pathologic effects other than death at lower degrees of exposure; therefore, other indices have been developed.

TABLE 30-1 TOXICITY RATING SYSTEM

| TOXICITY RATING | LETHAL ORAL DOSE IN AVERAGE ADULT |
|----------------------|--------------------------------------|
| Super toxic | <5 mg/kg |
| Extremely toxic | 5–50 mg/kg |
| Very toxic | 50–500 mg/kg |
| Moderately toxic | 0.5–5 g/kg |
| Slightly toxic | 5–15 g/kg |
| Practically nontoxic | >15 g/kg |

Adapted with permission from Klaassen CD. Principles of toxicology. In Klaassen CD, Amdur MO, Doull J, eds. Toxicology: the basic science of poisons. 3rd ed. New York: Macmillan, 1986:13.

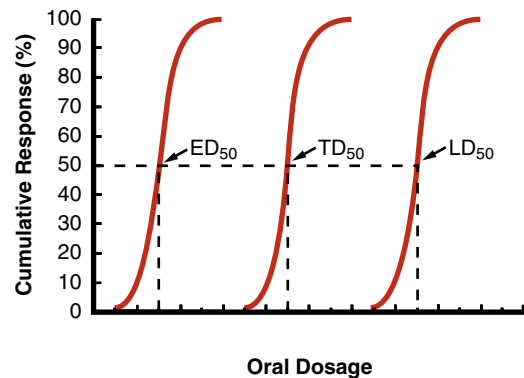

FIGURE 30-1. Dose-response relationship. Comparison of responses of a therapeutic drug over a range of doses. The ED_{50} is the dose of drug in which 50% of treated individuals will experience benefit. The TD_{50} is the dose of drug in which 50% of individuals will experience toxic adverse effects. The LD_{50} is the dose of drug in which 50% of individuals will result in morbidity.

A more in-depth characterization can be acquired by evaluating data from a cumulative frequency histogram of toxic responses over a range of doses. This experimental approach is typically used to evaluate several responses over a wide range of concentrations. One response monitored is the toxic response. This is the response that has been associated with an early pathologic effect at lower than lethal doses. This response has been determined to be an indicator of the toxic effects specific for that toxin. For a substance that exerts early toxic effects by damaging liver cells, the response monitored may be increases in serum alanine aminotransferase (ALT) or γ -glutamyltransferase (GGT) activity. The **dose-response relationship** implies that there will be an increase in the toxic response as the dose is increased. It should be noted that not all individuals display a toxic response at the same dose. The population variance can be seen in a cumulative frequency histogram of the percentage of people producing a toxic response over a range of concentrations (Fig. 30-1). The TD_{50} is the dose that would be predicted to produce a toxic response in 50% of the population. If the monitored response is death, the LD_{50} is the dose that would predict death in 50% of the population. Similar experiments can be used to evaluate the doses of therapeutic drugs. The ED_{50} is the dose that would be predicted to be effective or have a therapeutic benefit in 50% of the population. The therapeutic index is the ratio of the TD_{50} to the ED_{50} . Drugs with a large therapeutic index have few toxic adverse effects when the dose of drug is in the therapeutic range.

Acute and Chronic Toxicity

Acute toxicity and *chronic toxicity* are terms used to relate the duration and frequency of exposure to observed toxic effects. Acute toxicity is usually associated with a

single, short-term exposure to a substance, the dose of which is sufficient to cause immediate toxic effects. Chronic toxicity is usually associated with repeated frequent exposure for extended periods, at doses that are insufficient to cause an immediate acute response. In many instances, chronic exposure is related to an accumulation of the toxicant or the toxic effects. Chronic toxicity may affect different systems than those associated with acute toxicity. Dose-response relationships have been established for many toxic substances in both acute and chronic situations.

ANALYSIS OF TOXIC AGENTS

In most instances, analysis of toxic agents in a clinical setting is a two-step procedure. The first step is a screening test, which is a rapid, simple, qualitative procedure intended to detect specific substances or classes of toxicants. In general, these procedures have good analytic sensitivity but lack specificity. A negative result can rule out a drug or toxicant; however, a positive result should be considered a presumptive positive until confirmed by a second, more specific method. A variety of analytic methods can be used for screening and confirmatory testing. Immunoassays are commonly used to screen for drugs. In some instances, these assays are specific for a single drug (e.g., tetrahydrocannabinol [THC]). In most cases, however, drugs within general classes are detected (e.g., barbiturates, opiates). Thin-layer chromatography is a relatively simple, inexpensive method of detecting various drugs and other organic compounds. Gas chromatography (GC) is a widely used, well-established technique for the qualitative and quantitative determination of many volatile substances. The reference method for the qualitative identification of most organic compounds is GC, using a mass spectrometer as the detector.

TOXICOLOGY OF SPECIFIC AGENTS

Many chemical agents encountered on a regular basis have potential adverse effects. The focus of this section is to survey the commonly encountered nondrug toxins seen in a clinical setting, as well as those that present as medical emergencies with acute exposure.¹

Alcohol

The toxic effects of alcohol are both general and specific. Exposure to alcohol, like exposure to most volatile organic solvents, initially causes disorientation, confusion, and euphoria, which can progress to unconsciousness, paralysis, and, with high-level exposure, even death. Most alcohols display these effects at about equivalent molar concentrations. This similarity suggests a common depressant effect on the central nervous system (CNS) that appears to be mediated by changes in membrane

properties. In most cases, recovery from CNS effects is rapid and complete after cessation of exposure.

Distinct from the general CNS effects are the specific toxicities of each type of alcohol, which are usually mediated by biotransformation of alcohols to toxic products. There are several pathways by which short-chain aliphatic alcohols can be metabolized. Of these, hepatic conversion to an aldehyde, by alcohol dehydrogenase (ADH), and further conversion to an acid, by hepatic aldehyde dehydrogenase (ALDH), is the most significant.

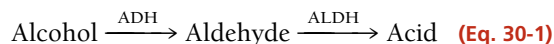

Ethanol exposure is common.² Excessive ethanol consumption, with its associated consequences, is a leading cause of economic, social, and medical problems throughout the world. The economic impact is estimated to exceed \$100 billion per year in terms of lost wages and productivity. Many social and family problems are associated with excessive ethanol consumption. The burden to the health care system is significant. Ethanol-related disorders are consistently one of the top 10 causes of hospital admissions. About 20% of all hospital admissions have some degree of alcohol-related problems. It is estimated that 80,000 Americans die each year, either directly or indirectly, as a result of abusive alcohol consumption. This correlates to about a fivefold increase in premature mortality. In addition, consumption of ethanol during pregnancy may lead to fetal alcohol syndrome or fetal alcohol effects, both of which are associated with delayed motor and mental development in children.

Correlations have been made between blood alcohol concentration and the clinical signs and symptoms of acute intoxication. A blood alcohol level in the range of 80 mg/dL has been established as the statutory limit for operation of a motor vehicle in most states. This is associated with a diminution of judgment and motor performance. The determination of blood ethanol concentration by the laboratory in cases of drunk driving requires an appropriate chain of custody, documentation of quality control, and proficiency testing records. About one half of the 40,000–50,000 annual automobile-related fatalities in the United States involve alcohol as a factor.

Besides the short-term effects of ethanol, most pathophysiologic consequences of ethanol abuse are associated with chronic consumption over a long period. In an average adult, this correlates to the consumption of about 50 g of ethanol per day for about 10 years. Consumption to this degree has been associated with compromised function in various organ, tissue, and cell types. However, the liver is the most sensitive organ. The pathologic sequence starts with the accumulation of lipids in hepatocytes. With continued consumption, this may progress to alcoholic hepatitis. About 20% of individuals with long-term, high-level intake develop this form of toxic hepatitis. Of those who

TABLE 30-2 COMMON INDICATORS OF ETHANOL ABUSE

| TEST | COMMENTS |
|---------------|--|
| GGT | Increases can be seen before the onset of pathologic consequences. Increases in serum activity can occur in many non-ethanol-related conditions. |
| AST | Increases in serum activity can occur in many non-ethanol-related conditions. |
| AST/ALT ratio | A ratio of greater than 2.0 is highly specific for ethanol-related liver disease. |
| HDL | High serum HDL is specific for ethanol consumption. |
| MCV | Increased erythrocyte MCV is commonly seen with excessive ethanol consumption. Increases are not related to folate or vitamin B ₁₂ deficiency. |

do, progression to cirrhosis is common. Cirrhosis can be characterized as fibrosis leading to a loss of functional hepatic mass. Progress through this sequence is associated with changes in many laboratory tests related to hepatic function. Several laboratory indicators of excessive ethanol consumption have sufficient diagnostic sensitivity and specificity to identify excessive ethanol consumption as the cause of a disease state. Most are related to the progression of ethanol-induced liver disease. Table 30-2 lists common laboratory indicators of prolonged hazardous consumption.

Several mechanisms have been proposed to mediate the pathologic effects of long-term ethanol consumption. Of these, adduct formation with acetaldehyde appears to play a key role. Hepatic metabolism of ethanol is a two-step enzymatic reaction. The final product is acetic acid. Acetaldehyde is a reactive intermediate in this pathway. Most ethanol is converted to acetic acid in this pathway; however, a significant portion of the intermediate is released in the free state.

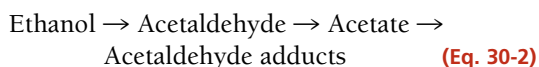

Extracellular acetaldehyde is a transient species as a result of rapid adduct formation with amine groups of proteins. Formation of acetaldehyde adducts has been shown to change the structure and function of various proteins. Many of the pathologic effects of ethanol have been correlated with the formation of these adducts.

Methanol is a common solvent. It may be ingested accidentally as a component of many commercial products or as a contaminant of homemade liquors. Methanol is initially metabolized by hepatic ADH to the intermediate formaldehyde. Formaldehyde is rapidly converted to formic acid by hepatic ALDH. The formation of formic acid causes severe acidosis, which may lead to death. Formic acid is also responsible for an optic neuropathy that may lead to blindness.

Isopropanol, also known as rubbing alcohol, is commonly available. It is metabolized by hepatic ADH to acetone, which is its primary metabolic end product. Both

isopropanol and acetone have CNS depressant effects similar to ethanol. However, acetone has a long half-life. Intoxication with isopropanol, therefore, may result in severe acute-phase ethanol-like symptoms that may persist for an extended period.

Ethylene glycol (1,2-ethanediol) is a common component of hydraulic fluid and antifreeze. Ingestion by children is relatively common because of its sweet taste. The immediate effects of ethylene glycol ingestion are similar to those of ethanol. However, metabolism by hepatic ADH and ALDH results in the formation of several toxic species, including oxalic acid and glycolic acid, which

CASE STUDY 30-1

A patient with a provisional diagnosis of depression was sent to the laboratory for a routine workup. The complete blood cell count was unremarkable except for an elevated erythrocyte mean cell volume (MCV). Results of urinalysis were unremarkable. The serum chemistry testing revealed slightly increased aspartate aminotransferase (AST), total bilirubin, and high-density lipoprotein (HDL) levels. All other chemistry results, including glucose, urea, creatinine, cholesterol, pH, pCO₂, ALT, sodium, and potassium, were within the normal reference range. The physician suspects ethanol abuse; however, the patient claims to be a nonconsumer. Subsequent testing revealed a serum GGT three times the upper limit of normal. No ethanol was detected in serum. Screening tests for infectious forms of hepatitis were negative.

Questions

1. Are these results consistent with a patient who is consuming hazardous quantities of ethanol?
2. Is further testing needed to rule ethanol abuse in or out? If so, what tests would you recommend?

results in severe metabolic acidosis. This is complicated by the rapid formation and deposition of calcium oxalate crystals in renal tubules. With high levels of consumption, calcium oxalate crystal formation may result in renal tubular damage.

Determination of Alcohols

From a medicolegal perspective, determination of blood ethanol concentration must be accurate and precise. Serum, plasma, and whole blood are acceptable specimens. Correlations have been established between ethanol concentration in these specimens and impairment of psychomotor function. Because ethanol uniformly distributes in total body water, serum, which has a greater water content than whole blood, has a higher concentration per unit volume. Most states have standardized the acceptable specimen types admissible as evidence. Some jurisdictions mandate a certain method (often GC) for legal ethanol determination.

When acquiring a specimen for ethanol determination, the venipuncture site should be cleaned with an alcohol-free disinfectant. Because of the volatile nature of short-chain aliphatic alcohols, specimens must be capped at all times to avoid evaporation. Sealed specimens can be refrigerated or stored at room temperature for up to 14 days without loss of ethanol. Nonsterile specimens or those intended to be stored for long periods of time should be preserved with sodium fluoride to avoid increases in ethanol content that result from contaminating bacterial fermentation.

Several analytic methods can be used for the determination of ethanol in serum. Among these, the enzymatic, GC, and osmometry methods are the most commonly used. When osmolality is measured by freezing point

depression, increases in serum osmolality correlate well with increases in serum ethanol concentration. The degree of increase in osmolality due to ethanol is expressed as the difference between the measured and the calculated osmolality; the difference is called the *osmolar gap*. Serum osmolality increases by about 10 mOsm/kg for each 60-mg/dL increase in serum ethanol.

$$\text{Osmolar gap} = \text{measured osmolality} - \text{calculated osmolality} \quad (\text{Eq. 30-3})$$

This relationship is not specific for ethanol. Increases in the osmolar gap can also occur with certain metabolic imbalances; therefore, use of the osmolar gap for the determination of serum or blood ethanol concentration lacks analytic specificity. However, it is a useful screening test.

GC is the reference method for ethanol determination. This method can simultaneously quantitate other alcohols, such as methanol and isopropanol. This analysis starts with dilution of the serum or blood sample with a saturated solution of sodium chloride in a closed container. Volatiles within the liquid specimen partition into the air space (head space) of the closed container. Sampling of this head space provides clean specimens with little or no matrix effect. Quantitation of peaks can be done by constructing a standard curve or by ratio to an internal standard (*n*-propanol) as shown in Figure 30-2.

Enzymatic methods for the determination of ethanol are common. The enzyme used in this assay is a nonhuman form of ADH. This enzyme oxidizes ethanol to acetaldehyde with reduction of NAD^+ to NADH.

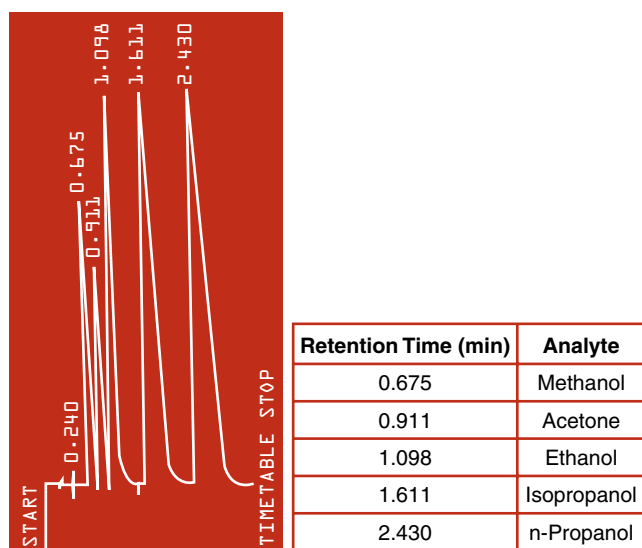
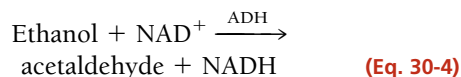

FIGURE 30-2. Headspace gas chromatography of alcohol. The concentration of each alcohol can be determined by comparison to the response from the internal standard *n*-propanol.

The NADH produced can be monitored directly by absorbance at 340 nm or can be coupled to an indicator reaction. This form of ADH is relatively specific for ethanol (Table 30-1). Intoxication with methanol or isopropanol produces a negative or low result; therefore, a negative result by this method does not rule out ingestion of other alcohols. There is good agreement between the enzymatic reactions of ethanol and GC. The enzymatic reactions can be fully automated and do not require specialized instrumentation.

Carbon Monoxide

Carbon monoxide is produced by incomplete combustion of carbon-containing substances. The primary environmental sources of carbon monoxide include gasoline engines, improperly ventilated furnaces, and wood or plastic fires. Carbon monoxide is a colorless, odorless, and tasteless gas that is rapidly absorbed into blood from inspired air.

When carbon monoxide binds to hemoglobin, it is called *carboxyhemoglobin* (COHb). The affinity of carbon monoxide for hemoglobin is 200–225 times greater than for oxygen.^{3,4} Air is about 20% oxygen by volume. If inspired air contained 0.1% carbon monoxide by volume, this would result in a 50% carboxyhemoglobinemias at equilibrium. For this reason, carbon monoxide is considered a very toxic substance. Because both carbon monoxide and oxygen compete for the same binding site, exposure to carbon monoxide results in a decrease in the concentration of oxyhemoglobin.

Carbon monoxide expresses its toxic effects by causing a leftward shift in the oxygen-hemoglobin dissociation curve, resulting in decreasing in oxygen delivery to tissue.³ The net effect of carbon monoxide exposure is a decrease in the amount of oxygen delivered to tissue, producing hypoxia. The major toxic effects of carbon monoxide exposure are seen in organs with high oxygen demand, such as the brain and heart. The concentration of COHb (expressed as the percentage of COHb present to the capacity of the specimen to form COHb) and corresponding symptoms are detailed in Table 30-3. The only treatment for carbon monoxide poisoning is 100% oxygen therapy. In severe cases, hyperbaric oxygen may be used. In a patient breathing 100% oxygen who has a normal respiratory function, the half-life of COHb is about 60–90 minutes.

Several methods are available for the evaluation carbon monoxide poisoning. COHb has a cherry-red appearance. This is the basis of a spot test for excessive carbon monoxide exposure; 5 mL of 40% NaOH is added to 5 mL of a $\frac{1}{20}$ aqueous dilution of whole blood. Persistence of a pink solution is consistent with a COHb level of 20% or greater. There are two primary quantitative assays for COHb: differential spectrophotometry and GC.

TABLE 30-3 SYMPTOMS OF CARBOXYHEMOGLOBINEMIA

| COHB (%) | SYMPTOMS AND COMMENTS |
|----------|--|
| 0.5 | Typical in nonsmokers |
| 5–15 | Range of values seen in smokers |
| 10 | Shortness of breath with vigorous exercise |
| 20 | Shortness of breath with moderate exercise |
| 30 | Severe headaches, fatigue, impairment of judgment |
| 40–50 | Confusion, fainting on exertion |
| 60–70 | Unconsciousness, respiratory failure, death with continuous exposure |
| 80 | Immediately fatal |

GC is accurate and precise and the reference method for the determination of COHb. Carbon monoxide is released from hemoglobin after treatment with potassium ferricyanide. After analytic separation, carbon monoxide is detected by changes in thermal conductivity. Spectrophotometric methods work on the principle that different forms of hemoglobin present with different spectral absorbency curves. By measuring absorbance at four to six different wavelengths, the concentration of the different species of hemoglobin (including COHb) can be determined by calculation. This is the most common method used and is the basis for several automated systems.

Caustic Agents

Caustic agents are found in many household products and occupational settings. Even though any exposure to a strong acid or alkaline substance is associated with injury, aspiration and ingestion present the greatest hazard. Aspiration is usually associated with pulmonary edema and shock, which can rapidly progress to death. Ingestion produces lesions in the esophagus and gastrointestinal tract, which may produce perforations. This results in hematemesis, abdominal pain, and possibly shock. Onset of metabolic acidosis or alkalosis occurs rapidly after ingestion. Corrective therapy for ingestion is usually by dilution.

Cyanide

Cyanide is classified as a supertoxic substance that can exist as a gas or solid or in solution. Exposure can occur by inhalation, ingestion, or transdermal absorption. Cyanide is used in many industrial processes. It is also a component of some insecticides and rodenticides. Cyanide is also produced as a pyrolysis product from the burning of some plastics, including urea foams used as

insulation in homes. Thus, carbon monoxide and cyanide exposure may account for a significant portion of the toxicities associated with smoke inhalation. Ingestion of cyanide is a common suicide agent.

Cyanide expresses toxicity by binding to heme iron. Binding to mitochondrial cytochrome oxidase causes an uncoupling of oxidative phosphorylation. This results in rapid depletion of cellular adenosine triphosphate as a result of the inability of oxygen to accept electrons. Increases in cellular oxygen tension and venous PO_2 occur as a result of lack of oxygen utilization. At low levels of exposure, patients experience headaches, dizziness, and respiratory depression, which can rapidly progress to seizure, coma, and death at slightly greater doses. Cyanide clearance is primarily mediated by rapid enzymatic conversion to thiocyanate, a nontoxic product rapidly cleared by renal filtration. Cyanide toxicity is associated with acute exposure at concentrations sufficient to exceed the rate of clearance by this enzymatic process.

Evaluation of cyanide exposure requires a rapid turnaround time. There are several methods available. Ion-specific electrode methods and photometric analysis following two-well microdiffusion separation are the most common. Chronic low-level exposure can be evaluated by determination of urinary thiocyanate concentration.

Metals and Metalloids

Arsenic

Arsenic is a metalloid that may exist bound to or as a primary constituent of many different organic and inorganic compounds. It exists in both naturally occurring and manmade substances; therefore, exposure to arsenic may occur in various settings. Environmental exposure through air and water is prevalent in many industrialized areas. Occupational exposure occurs in agriculture and the smelting industries. It is also a common homicide and suicide agent.

Absorption of arsenic depends on the form of the compound. Organic arsenic-containing compounds are rapidly absorbed by passive diffusion. Other forms are absorbed at a slower rate. Clearance of arsenic is primarily by renal filtration of the free, ionized state. Arsenic expresses toxic effects by high-affinity binding to the thiol groups in proteins; therefore, the portion available for filtration in serum is low. This results in a long half-life in the body; the whole body content of arsenic may be cumulative with chronic exposure.

Arsenic binding to proteins often results in a change in structure and function.⁵ Because many proteins are capable of binding arsenic, the toxic symptoms of arsenic poisoning are nonspecific. Many cellular and organ systems are affected. Fever, anorexia, and gastrointestinal distress are seen with chronic or acute ingestion at low levels. Peripheral and central damage to

the nervous system, renal effects, hemopoietic effects, and vascular disease leading to death are associated with high levels of exposure.

Analysis of arsenic is most commonly done by atomic absorption spectrophotometry. Blood and urine are acceptable specimens to evaluate short-term exposure. Hair and fingernail content have been found useful in the assessment of long-term exposure.

Cadmium

Cadmium is a metal found in many industrial processes, with its main use in electroplating and galvanizing. It is commonly encountered during the mining and processing of many metals. Cadmium is a pigment found in paints and plastics and is the cathodal material of nickel-cadmium batteries. It is a significant environmental pollutant. Excessive exposure occurs most frequently by inhalation of cadmium particulates in industry and by ingestion of contaminated food. Cadmium expresses its toxicity primarily by binding to proteins; however, it can also bind to other cellular constituents. Cadmium distributes throughout the body but has a tendency to accumulate in the kidney, where most of its toxic effects are expressed. An early finding of cadmium toxicity is manifested by renal tubular dysfunction. Tubular proteinuria, glucosuria, and aminoaciduria are typically seen. Evaluation of excessive cadmium is most commonly accomplished by determination of whole blood or urinary content using atomic absorption spectrophotometry.

Lead

Lead is a common environmental contaminant. It was a common constituent of household paints before 1972 and is still found in commercial and art paints. Gasoline contained tetraethyl lead until 1978. Residuals from automobile exhaust can still be found in high concentrations on highways. Plumbing constructed of lead pipes or joined with leaded connectors can significantly contribute to the lead concentration of water. Lead is a by-product or component of many industrial processes. The lead content of foods is highly variable. In the United States, the average daily intake for an adult is between 75 and 120 $\mu\text{g}/\text{day}$. This level of intake is not associated with overt toxicity. Because lead is present in all biologic systems and because no physiologic or biochemical function has been found, the key issue is what dose causes a toxic effect. Susceptibility to lead toxicity is dependent primarily on age. Adults are largely tolerant to the effects of lead compared with children.

Exposure to lead can occur by any route; however, ingestion of contaminated dietary constituents accounts for most.⁵ Gastrointestinal absorption of lead is influenced by various factors. Adults absorb 5%–15% of ingested lead. Children have a greater degree of absorption. Infants absorb 30%–40%. Factors controlling rate of

absorption are unclear. Absorbed lead binds with high affinity to many macromolecular structures. It distributes throughout the body. Lead distributes into two theoretical compartments. One is the skeleton, which is the largest pool. Lead combines with the matrix of bone and can persist in this compartment for a long period. The half-life of lead in bone is longer than 20 years. The other theoretical compartment is soft tissue. The half-life of lead in this compartment is somewhat variable; the average half-life in soft tissue is 120 days.

Elimination of lead occurs primarily by renal filtration. Because only a small fraction of total body lead presents in circulation, the elimination rate is slow. Considering the relatively constant rate of exposure and the slow elimination rate, total body lead accumulates over a lifetime. The largest accumulation occurs in bone. Significant accumulation also occurs in kidney, bone marrow, circulating erythrocytes, and peripheral and central nerves.

Lead toxicity is multifaceted and occurs in a dose-dependent manner (Fig. 30-3). Most toxic effects are a

result of binding to proteins, which results in a change in structure and function. The neurologic effects of lead are of particular importance. Lead exposure causes encephalopathy characterized by a cerebral edema and ischemia. Severe lead poisoning can result in stupor, convulsions, and coma. Lower levels of exposure may not present with these symptoms. However, low-level exposure may result in subclinical effects typified by behavioral changes, hyperactivity, attention deficit disorder, and a decrease in intelligence quotient scores. Children appear particularly sensitive to these effects and are now evaluated for lead poisoning before entry into school. Higher levels of exposure have been associated with demyelination of peripheral nerves, which results in a decrease in nerve conduction velocity.

Lead is a potent inhibitor of many enzymes; this inhibition mediates many toxic effects. Noteworthy are the effects on vitamin D metabolism and the heme synthetic pathway. This results in changes in bone and calcium metabolism and in anemia. Decreased serum concentrations of both 25-hydroxy and 1,25-dihydroxy vitamin D

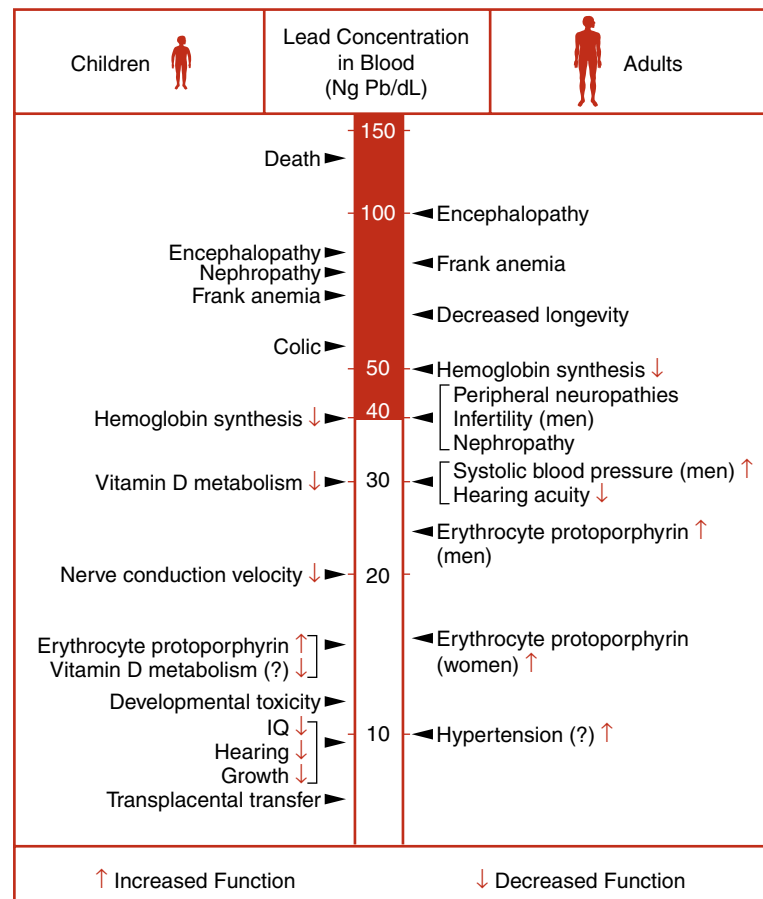

FIGURE 30-3. Comparison of effects of lead on children and adults.

(Reprinted from Royce SE, Needleman HL, eds. Case studies in environmental medicine: lead toxicity. Washington, DC: U.S. Public Health Service, ATSDR, 1990.)

are seen in excessive lead exposure. The anemia is primarily caused by an inhibition of the heme synthetic pathway, which results in increases in the concentration of several intermediates in this pathway, including aminolevulinic acid and protoporphyrin. Increases in protoporphyrin result in high concentrations of zinc protoporphyrin in circulating erythrocytes. Zinc protoporphyrin is a highly fluorescent compound. Measurement of this fluorescence has been used to screen for lead toxicity. Increased urinary aminolevulinic acid is a highly sensitive and specific indicator of lead toxicity that correlates well with blood levels. Another hematologic finding is the presence of basophilic stippling in erythrocytes as a result of inhibition of erythrocytic pyrimidine nucleotidase. This enzyme is responsible for removal of residual DNA after extrusion of the nucleus. Basophilic stippling is a sensitive indicator of lead exposure.

Excessive lead exposure has also been associated with hypertension, carcinogenesis, birth defects, and compromised immunity. Lead causes several toxic renal effects. Early stages are associated with tubular dysfunction, resulting in glycosuria, aminoaciduria, and hyperphosphaturia. Late stages are associated with tubular atrophy and glomerular fibrosis. The fibrosis may result in a decreased glomerular filtration rate.

Treatment of lead poisoning involves removal from exposure and treatment with therapeutic chelaters, such as ethylenediaminetetraacetic acid (EDTA) and dimercaptosuccinic acid (DMSA). These substances are capable of removing lead from soft tissue and bone by forming low-molecular-weight, high-affinity complexes that can be cleared by renal filtration. The efficacy of this therapy is determined by monitoring the urinary concentration of lead.

The assessment of total body burden of lead poisoning is best evaluated by the quantitative determination of lead concentration in whole blood. The use of urine is also valid but correlates closer to the level of recent exposure. Care must be taken during specimen collection to ensure that the specimen does not become contaminated from exogenous sources. Lead-free containers are recommended for this purpose.

Several methods can be used to measure lead concentration. Chromogenic reactions and anodic stripping voltametry methods have been used, but they lack clinical utility because they lack analytic sensitivity. At present, graphite furnace atomic absorption spectrophotometry (AAS) is the most common method used.

Mercury

Mercury is a metal that exists in three forms: elemental (liquid at room temperature), inorganic salts, or a component of organic compounds. Exposure occurs primarily by inhalation and ingestion. Consumption of

contaminated foods is the major source of exposure in the general population. Inhalation and accidental ingestion of inorganic and organic forms in industrial settings is the most common reason for toxic levels. Each form of mercury has different toxicologic characteristics. Elemental mercury (Hg^0) can be ingested without significant effects. Inhalation of elemental mercury is insignificant because of its low vapor pressure. Cationic mercury (Hg^{2+}) is moderately toxic. Organic mercury, such as methyl mercury (CH_3Hg^+), is very toxic. Considering that the most common route of exposure to mercury is via ingestion, the primary factor that determines toxicity is gastrointestinal absorbance.

Elemental mercury is largely not absorbed because of its viscous liquid nature. Inorganic mercury is only partially absorbed. Although not significantly absorbed, inorganic mercury still has significant local toxicity in the gastrointestinal tract. The portion that is absorbed distributes uniformly throughout the body. The organic forms of mercury are rapidly and efficiently absorbed by passive diffusion. Systemic organic mercury partitions into hydrophobic compartments. This results in high concentrations in brain and peripheral nerves.⁵ In these lipophilic compartments, organic mercury is biotransformed to the divalent state, allowing it to bind to neuronal proteins. Elimination of systemic mercury occurs primarily via renal filtration of bound low-molecular-weight species or the free (ionized) state. Considering that most mercury is bound to protein, the elimination rate is slow. Therefore, chronic exposure exerts a cumulative effect.

Mercury toxicity is a result of protein binding, which results in a change of structure and function. The most significant result of this interaction is the inhibition of many enzymes. Binding to intestinal proteins after ingestion of inorganic mercury results in acute gastrointestinal disturbances. Ingestion of moderate amounts may result in severe bloody diarrhea because of ulceration and necrosis of the gastrointestinal tract. In severe cases, this may lead to shock and death. The absorbed portion of ingested inorganic mercury affects many organs. Clinical findings include tachycardia, tremors, thyroiditis, and, most significant, a disruption of renal function. The renal effect is associated with glomerular proteinuria and loss of tubular function. Organic mercury may also have a renal effect at high levels of exposure. However, neurologic symptoms are the primary toxic effects of this hydrophobic form. Low levels of exposure cause tremors, behavioral changes, mumbling speech, and loss of balance. Higher levels of exposure result in hyporeflexia, hypotension, bradycardia, renal dysfunction, and death. Analysis of mercury is by atomic absorption, using whole blood or an aliquot of a 24-hour urine specimen or anodic stripping voltametry. Analysis of mercury by atomic

absorption requires special techniques as a result of the volatility of elemental mercury.

Pesticides

Pesticides are substances that have been intentionally added to the environment to kill or harm an undesirable life form. Pesticides can be classified into several categories, such as insecticides and herbicides. These agents have been applied to the control of vector-borne disease and urban pests and to improve agricultural productivity. Pesticides can be found in occupational settings and in the home; therefore, there are frequent opportunities for exposure. Contamination of food is the major route of exposure for the general population. Inhalation, transdermal absorption, and ingestion as a result of hand-to-mouth contact are common occupational and accidental routes of exposure.

Ideally, the actions of pesticides would be target specific. Unfortunately, most are nonselective and result in toxic effects to many nontarget species, including humans. Pesticides come in many different forms with a wide range of potential toxic effects. The health effects of short-term, low-level exposure to most of these agents have yet to be well elucidated. Extended low-level exposure to low levels may result in chronic disease states. Of primary concern is high-level exposure, which may result in acute disease states or death. The most common victims of acute poisoning are people who are applying pesticides and do not take appropriate precautions to avoid exposure. Ingestion by children at home is also common. Pesticide ingestion is also a common suicide vehicle.

There is a wide variation in the chemical configuration of pesticides, ranging from simple salts of heavy metals to complex high-molecular-weight organic compounds. Insecticides are the most prevalent of pesticides. Based on chemical configuration, the organophosphates, carbamates, and halogenated hydrocarbons are the most common insecticides. Organophosphates are the most abundant pesticides and are responsible for about one third of all pesticide poisonings.

Organophosphates and carbamates function by inhibition of acetylcholinesterase, an enzyme present in both insects and mammals. In mammals, acetylcholine is a neurotransmitter found in both central and peripheral nerves. It is also responsible for stimulation of muscle cells and several endocrine/exocrine glands. The actions of acetylcholine are terminated by the actions of membrane-bound, postsynaptic acetylcholinesterase. Inhibition of this enzyme by this agent results in the prolonged presence of acetylcholine on its receptor, which produces a wide range of systemic effects. Low levels of exposure are associated with salivation, lacrimation, and involuntary urination and defecation. Higher levels of exposure

result in bradycardia, muscular twitching, cramps, apathy, slurred speech, and behavioral changes. Death due to respiratory failure may also occur.

Absorbed organophosphates bind with high affinity to several proteins, including acetylcholinesterase. Protein binding prevents direct analysis of organophosphates. Thus, exposure is evaluated indirectly by measurement of acetylcholinesterase inhibition. Inhibition of this enzyme has been found to be a sensitive and specific indicator of organophosphate exposure. Because acetylcholinesterase is a membrane-bound enzyme, serum activity is low. To increase the analytic sensitivity of this assay, erythrocytes that have high surface activity are commonly used. Evaluation of erythrocytic acetylcholinesterase activity for detection of organophosphate exposure, however, is not commonly performed in reference laboratories because of low demand and the lack of an automated method.

An alternative test that has become commonly available is measurement of serum pseudocholinesterase (SChE) activity. This enzyme is inhibited by organophosphates in a similar manner to the erythrocytic enzyme. Unlike the erythrocytic enzyme, however, changes in the serum activity of SChE lack sensitivity and specificity for organophosphate exposure. Pseudocholinesterase is found in liver, pancreas, brain, and serum. The biologic function of this enzyme is not well defined. Decreased levels of SChE can occur in acute infection, pulmonary embolism, hepatitis, and cirrhosis. There are also several variants of this enzyme that demonstrate diminished activity. Thus, decreases in SChE are not specific for organophosphate poisoning. The normal reference range for SChE is between 4,000 and 12,000 U/L. The intraindividual variation (the degree of variance within an average individual) is about 700 U/L. Symptoms associated with organophosphate toxicity occur at about a 40% reduction in activity. An individual whose normal SChE is on the high side of the normal reference range and who has been exposed to toxic levels of organophosphates may still have SChE activity in the normal reference range. Because of these factors, determination of SChE activity lacks sensitivity in the diagnosis of organophosphate poisoning. Therefore, SChE is considered a screening test, and clinical context must be taken into consideration when interpreting the results. Immediate antidotal therapy can be initiated in cases of suspected organophosphate poisoning with decreased activity of SChE. However, continuation of therapy and documentation of such poisoning should be confirmed by testing of the erythrocytic enzyme.

TOXICOLOGY OF THERAPEUTIC DRUGS

Many overdose situations are the result of accidental or intentional excessive dosage of pharmaceutical drugs. All drugs are capable of toxic effects at the right dosage. This

discussion focuses on the therapeutic drugs most commonly seen in clinical overdose situations.

Salicylates

Aspirin (acetylsalicylic acid) is a commonly used analgesic, antipyretic, and anti-inflammatory drug. It functions by decreasing thromboxane and prostaglandin formation through inhibition of cyclooxygenase. At recommended doses, there are several noteworthy adverse effects, including interference with platelet aggregation and gastrointestinal function. There is also an epidemiologic relationship between aspirin, childhood viral infections (e.g., varicella and influenza), and the onset of Reye's syndrome.

Acute ingestion of high doses of aspirin is associated with various toxic effects through several different mechanisms.¹ Because it is an acid, excessive salicylate ingestion is associated with a metabolic acidosis. Salicylate is also a direct stimulator of the respiratory center. The hyperventilation produces a respiratory alkalosis. In many instances, the net result is immediate mixed acid-base disturbance. Salicylates also inhibit the Krebs cycle, resulting in excess conversion of pyruvate to lactate. In addition, at high levels of exposure, salicylates stimulate mobilization and use of free fatty acid, resulting in excess ketone body formation. All these factors contribute to a metabolic acidosis that may lead to death. Treatment for overdose involves neutralizing and eliminating the excess acid and maintaining electrolyte balance.

Correlations have been established between serum concentrations of salicylates and toxic outcomes. Several methods are available for the quantitative determination of salicylate in serum. GC or liquid chromatography methods provide the highest analytic sensitivity and

specificity but have not found clinical use because of equipment expense and technical difficulty. Several immunoassay methods are available; the most common is a chromogenic assay known as the Trinder reaction, which reacts salicylate with ferric nitrate to form a colored complex that is then evaluated spectrophotometrically.

Acetaminophen

Acetaminophen, either solely or in combination with other compounds, is a commonly used analgesic drug. In healthy subjects, therapeutic dosages have few adverse effects. Overdose of acetaminophen, however, is associated with a severe hepatotoxicity (Fig. 30-4).

Absorbed acetaminophen is bound with high affinity to various proteins, resulting in a low free fraction. Thus, renal filtration of the parent drug is minimal. Most is eliminated by hepatic uptake, biotransformation, conjugation, and excretion. Acetaminophen can follow several different pathways through this process, each forming a different product. The pathway of major concern is the hepatic mixed-function oxidase system. In this system, acetaminophen is first transformed to reactive intermediates, which are then conjugated with reduced glutathione. In overdose situations, glutathione can become depleted, yet reactive intermediates continue to be produced. This results in an accumulation of reactive intermediates inside the cell. Because some intermediates are free radicals, this results in a toxic effect to the cell that leads to necrosis of the liver, the organ in which these reactions are occurring.

The time frame for the onset of hepatocyte damage is relatively long. In an average adult, serum indicators of hepatic damage do not become abnormal until 3–5 days after ingestion of a toxic dose. The initial symptoms of acetaminophen toxicity are vague, nonspecific, and not

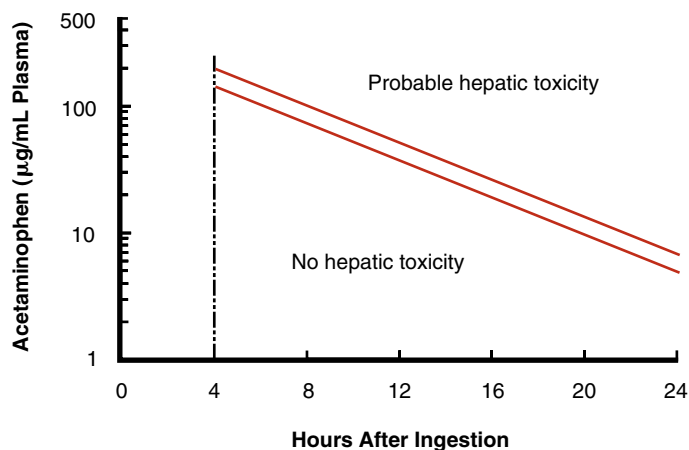

FIGURE 30-4. Rumack-Matthew nomogram. Prediction of acetaminophen-induced hepatic damage based on serum concentration. (Reprinted with permission from Rumack BH, Matthew H. Acetaminophen poisoning and toxicity. *Pediatrics* 1975;55:871.)

predictive of hepatic necrosis.⁶ The serum concentration of acetaminophen that results in depletion of glutathione has been determined for an average adult. Unfortunately, acetaminophen is rapidly cleared from serum and determination of serum acetaminophen is often made many hours after ingestion. In these situations, it is unknown whether toxic concentrations of acetaminophen were present at some previous time. To aide in this situation, nomograms are available that predict hepatotoxicity based on serum concentrations of acetaminophen at a known time after ingestion. It is also noteworthy that chronic, heavy consumers of ethanol metabolize acetaminophen at a more rapid rate than average, resulting in a more rapid formation of reactive intermediates and an increased possibility of depleting glutathione at a lower dose than normal. Therefore, alcoholic patients are more susceptible to acetaminophen toxicity, and using the nomogram for interpretation in these patients is inappropriate.

The reference method for the quantitation of acetaminophen in serum is high-performance liquid chromatography. This method, however, is not widely used in clinical settings because of expense and technical difficulty. Immunoassay is currently the most common analytic method used for serum acetaminophen determination. Competitive enzyme or fluorescence polarization immunoassay systems are most frequently used.

TOXICOLOGY OF DRUGS OF ABUSE

Assessment of drug abuse is of medical interest for many reasons. In drug overdose, it is essential to identify the responsible agent to ensure appropriate treatment. In a similar manner, identification of drug abuse in nonoverdose situations provides a rationale for treatment for addiction. For these reasons, testing for **drugs of abuse** is commonly done. This typically involves screening of a single urine specimen for many substances by qualitative screening procedures. In most instances, this procedure only detects recent drug use; therefore, with abstinence of relatively short duration, many abusing patients may not be identified. In addition, a positive drug screen cannot discriminate between a single casual use and chronic abuse. Identification of chronic abuse usually involves several positive test results in conjunction with clinical evaluation. In a similar manner, a positive drug screen does not determine the time frame or dose of the drug taken. Drug abuse or overdose can occur with prescription, over-the-counter, or illicit drugs. The focus of this discussion is on substances with addictive potential.

The use of drugs for recreational or performance enhancement purposes is relatively common. The National Institute on Drug Abuse reports that about 30% of the population older than high school age have used an illicit drug. Testing for drug abuse has become commonplace in

professional, industrial, and athletic settings. The potential punitive measures associated with this testing may involve or result in civil or criminal litigation. Therefore, the laboratory must ensure that data are legally admissible and defensible. This requires the use of analytic methods that have been validated as accurate and precise. It also requires documentation of specimen security. Protocols and procedures must be established that prevent and detect specimen adulteration and that may prevent drug detection. Measurement of urinary temperature, pH, specific gravity, and creatinine is commonly done to ensure that these specimens have not been diluted or treated with substances that may interfere with testing. Specimen collection should be monitored and a chain-of-custody established to guard against specimen exchange.

Testing for drugs of abuse can be done by several methods. A two-tiered approach of screening and confirmation is usually used. Screening procedures should be simple, rapid, inexpensive, and capable of being automated. They are often referred to as *spot tests*. In general, screening procedures have good analytic sensitivity with marginal specificity; a negative result can rule out an analyte with a reasonable degree of certainty. These methods usually detect classes of drugs based on similarities in chemical configuration. This allows detection of parent compounds and congeners, which have similar effects. Considering that many designer drugs are modified forms of established drugs of abuse, these methods increase the scope of the screening process. A drawback to this type of analysis is that it may also detect chemically related substances that have no or low abuse potential; therefore, interpretation of positive test results requires integration of clinical context and further testing. Confirmation testing uses methods that have high sensitivity and specificity; many of these tests provide quantitative as well as qualitative information. Confirmatory testing requires the use of a method different from that used in the screening procedure. GC–mass spectrophotometry (GC/MS) is the reference method for confirmation for most analytes.

There are several general analytic procedures commonly used for analysis of drugs of abuse. Chromogenic reactions, the generation of a colored product usually by a chemical reaction, are occasionally used as screening procedures. Immunoassay-based procedures are widely used both as screening and confirmatory assays. In general, immunoassays offer a high degree of sensitivity and are easily automated. A wide variety of chromatography techniques are used for the qualitative identification and quantitation of drugs. Thin-layer chromatography is an inexpensive method for the screening of many drugs and has the advantage that no instrumentation is required. GC and liquid allow complex mixtures of drugs to be separated and quantitated. These methods are generally labor intensive and not well suited to screening.

Many drugs have the potential for abuse. Trends in drug abuse vary geographically and between different socioeconomic groups. For a clinical laboratory to provide an effective **toxicology** service requires knowledge of the drug or drug groups likely to be found within the patient population it serves. Fortunately, the process of selecting which drugs to test for has been aided by national studies that have identified the drugs of abuse most commonly seen in the population (Table 30-4). This provides the basis for test selection in most situations. The following discussion focuses on select drugs with a high potential for abuse.

Amphetamines

Amphetamine and methamphetamine are therapeutic drugs used for narcolepsy and attention-deficit disorder. These drugs are stimulants with a high abuse potential. They produce an initial sense of increased mental and physical capacity along with a perception of well-being. These initial effects are followed by restlessness, irritability, and possibly psychosis. Abatement of these late effects is often countered with repeated use. Tolerance and psychological dependence develop with chronic use. Overdose, although rare in experienced users, results in hypertension, cardiac arrhythmias, convulsions, and possibly death. Various compounds chemically related to amphetamines are components of over-the-counter medications, including ephedrine, pseudoephedrine, and phenylpropanolamine. These amphetamine-like compounds are common in allergy and cold medications.

Identification of amphetamine abuse involves analysis of urine for the parent drugs. Immunoassay systems are

TABLE 30-4 PREVALENCE OF COMMON DRUGS OF ABUSE

| SUBSTANCE | PREVALENCE (%) |
|---------------------------|----------------|
| Alcohol | 58 |
| Marijuana | 16 |
| Cocaine | 2–3 |
| Benzodiazepines | ? |
| Barbiturates | ? |
| Opiates (heroin only) | 0.2 |
| Phencyclidine | 0 |
| MDMA | 1 |
| Amphetamines | 0.1–1 |
| Other stimulants | 1.3 |
| Other sedatives-hypnotics | 0.2 |

This table provides approximate frequencies of relevant drugs of abuse as surveyed from national data. The percentage values estimate the prevalence of use in individuals aged 18–25, the most common users, who by survey claim to have used drugs within the past 30 days. (Adapted from Department of Health and Human Services, Substance Abuse and Mental Health Administration, and Office of Applied Studies. Results from the 2006 National Survey on Drug Use and Health: national findings. Retrieved February 8, 2008, from <http://www.drugabusestatistics.samhsa.gov/nsduh/2k6nsduh/2k6Results.pdf>.)

commonly used as the screening procedure. Because of variable cross-reactivity with over-the-counter medications that contain amphetamine-like compounds, a positive result by immunoassay is considered presumptive. Confirmation of immunoassay-positive tests is most commonly made with liquid or gas chromatography.

Methylenedioxymethylamphetamine

Methylenedioxymethylamphetamine (MDMA) is an illicit amphetamine derivative that is commonly referred to as “Ecstasy”.^{7,8} Although it had been associated with club culture in the 1990s, its use has continued to grow. It has a high potential for abuse. There are also as many as 200 “designer” analogues that have been developed to produce effects comparable to those of MDMA. MDMA and its analogues are primarily administered orally in tablets of 50–150 mg. Other, less-frequent routes of administration are inhalation, injection, or smoking. Its circulating half-life is 8–9 hours. The majority of the drug is eliminated by hepatic metabolism, although 20% is eliminated unchanged in the urine.

The onset of effect is 30–60 minutes and duration is about 3.5 hours. The desired effects include hallucinations, euphoria, empathic and emotional responses, and increased visual and tactile sensitivity. Its adverse effects include headaches, nausea, vomiting, anxiety agitation, impaired memory, violent behavior, tachycardia, hypertension, respiratory depression, seizures, hyperthermia, cardiac toxicity, liver toxicity, and renal failure. The

CASE STUDY 30-2

An emergency department patient with a provisional diagnosis of overdose with an over-the-counter cold medicine undergoes a drug screen. Test results from immunoassay screening were negative for opiates, barbiturates, benzodiazepines, THC, and cocaine but positive for amphetamines. The salicylate level was 15 times the upper limit of the therapeutic range. Results for acetaminophen and ethanol were negative.

Questions

1. What would be the expected results of arterial blood gas analysis?
2. What would be the expected results of a routine urinalysis?
3. What are some of the possible reasons the amphetamine screen is positive?

presenting symptoms along with patient behavior and history must be taken into account as routine drug screening by immunoassay of a urine specimen will usually not test positive. Further analysis and confirmation of MDMA use are completed with GC/MS.

Anabolic Steroids

Anabolic steroids are a group of compounds related chemically to the male sex hormone testosterone. These artificial substances were developed in the 1930s as therapy for male hypogonadism. It was soon discovered that use of these compounds in healthy subjects increases muscle mass. In many instances, this results in an improvement in athletic performance. Recent studies have reported that 6.5% of adolescent boys and 1.9% of girls reported the use of steroids without a prescription.

Most illicit steroids are obtained through the black market from underground laboratories and foreign sources. The quality and purity of these drugs are highly variable. In most instances, the acute toxic effects of these drugs are related to inconsistent formulation, which may result in high dosages and impurities. A variety of both physical and psychological effects have been associated with steroid abuse. Chronic use of steroids has been associated with a toxic hepatitis. Chronic use has also been associated with accelerated atherosclerosis and abnormal aggregation of platelets, both of which predispose to stroke and myocardial infarction. In addition, steroid abuse causes an enlargement of the heart. In this condition, heart muscle cells develop faster than the associated vasculature. This may lead to ischemia of heart muscle cells, which predisposes cardiac arrhythmias and possible sudden death. In males, chronic steroid use is associated with testicular atrophy, sterility, and impotence. In females, it causes development of masculine traits, breast reduction, and sterility.

Evaluation of anabolic steroid use can be challenging. Until recently, the primary forms abused were animal derived or synthetic forms. There are several, well-established methods for the detection of the parent drug and its metabolite for the majority of these. The newer forms are very difficult or may be difficult to detect. To address this and related issues, the ratio of testosterone to epitestosterone (T/E) is commonly used as a screening test. High ratios are associated with exogenous testosterone administration.⁹

Cannabinoids

Cannabinoids are a group of psychoactive compounds found in marijuana. Of these, THC is the most potent and abundant. Marijuana, or its processed product, hashish, can be smoked or ingested. A sense of well-being and euphoria is the subjective effect of exposure. It is also associated with impairment of short-term memory

and intellectual function. Effects of chronic use have not been well established. Overdose has not been associated with specific physiologic toxic outcomes. Tolerance and a mild dependence may develop with chronic use. THC is a lipophilic substance, which is rapidly removed from circulation by passive distribution into hydrophobic compartments, such as brain and fat. This results in slow elimination as a result of redistribution back into circulation and subsequent hepatic metabolism.

The half-life of THC in circulation is 1 day after a single use and 3–5 days in chronic, heavy consumers. Hepatic metabolism of THC produces several products that are primarily eliminated in urine. The major urinary metabolite is 11-nor- Δ -tetrahydrocannabinol-9-carboxylic acid (THC-COOH). This metabolite can be detected in urine for 3–5 days after a single use or for up to 4 weeks in a chronic, heavy consumer after abstinence. Immunoassay for THC-COOH is the basis of the screening test for marijuana consumption. GC/MS is used for confirmation. Both methods are sensitive and specific. Because of the low limit of detection of these methods, it is possible to find THC-COOH in urine as a result of passive inhalation. Urinary concentration standards have been established that can discriminate between passive and direct inhalation.

Cocaine

Cocaine is an effective local anesthetic with few adverse effects at therapeutic concentrations. At higher circulating concentrations, it is a potent CNS stimulator that elicits a sense of excitement and euphoria. Cocaine is an alkaloid salt that can be administered directly (e.g., by insufflation or intravenous injection) or inhaled as a vapor when smoked in the free-base form (crack). It has high abuse potential. The half-life of the circulating cocaine is brief: 0.5–1 hour. Acute cocaine toxicity is associated with hypertension, arrhythmia, seizure, and myocardial infarction. Both subjective and toxic effects are expressed when circulating concentrations are rising. Because of its short half-life, maintaining the subjective effects over a single extended period requires repeated dosages of increasing quantity, therefore, correlations between serum concentration and the subjective or toxic effects cannot be established. Because rate of change is more important than serum concentration, a primary factor that determines the toxicity of cocaine is the dose and route of administration. Intravenous administration presents with the greatest hazard, closely followed by smoking.

Cocaine's short half-life is a result of rapid hepatic hydrolysis to inactive metabolites. This is the major route of elimination. Only a small portion of the parent drug can be found in urine after an administered dose. The primary product of hepatic metabolism is benzoylecgonine, which is primarily eliminated in urine. The half-life of benzoylecgonine is 4–7 hours. The presence of this

metabolite in urine is a sensitive and specific indicator of cocaine use. It can be detected in urine for up to 3 days after a single use. In chronic heavy abusers, it can be detected in urine for up to 20 days after the last dose. The primary screening procedure for identification of cocaine use is detection of benzoylecgonine in urine by immunoassay. Confirmation testing is done by GC/MS.

Opiates

Opiates are a class of substances capable of analgesia, sedation, and anesthesia. All are derived from or chemically related to substances derived from the opium poppy. The naturally occurring substances include opium, morphine, and codeine. Heroin, hydromorphone (Dilaudid), and oxycodone (Percodan) are chemically modified forms of the naturally occurring opiates. Meperidine (Demerol), methadone (Dolophine), propoxyphene (Darvon), pentazocine (Talwin), and fentanyl (Sublimaze) are the common synthetic opiates. Opiates have a high abuse potential. Chronic use leads to tolerance with physical and psychological dependence. Acute overdose presents with respiratory acidosis due to depression of respiratory centers, myoglobinuria, and possibly an increase in serum indicators of cardiac damage (e.g., CKMB and troponin). High-level opiate overdose may lead to death caused by cardiopulmonary failure. Treatment of overdose includes the use of the opiate antagonist naloxone.

Laboratory testing for opiates usually involves initial detection (screening) by immunoassay. Most immunoassays are primarily designed to detect morphine and codeine. However, cross-reactivity as a result of similarities in chemical structure allows detection of many of the opiates: naturally occurring, chemically modified, and synthetic. GC/MS is the confirmatory method of choice.

Phencyclidine

Phencyclidine (PCP) is an illicit drug with stimulant, depressant, anesthetic, and hallucinogenic properties. It has high abuse potential. Adverse effects are commonly noted at doses that produce the desired subjective effects, such

as agitation, hostility, and paranoia. Overdose is associated with stupor and coma. PCP can be ingested or inhaled by smoking PCP-laced tobacco or marijuana. It is a lipophilic drug that rapidly distributes into fat and brain. Elimination is slow as a result of redistribution into circulation and hepatic metabolism. About 10%–15% of an administered dose is eliminated unchanged in urine. Hepatic metabolism forms various products. Identification of PCP abuse is by detection of the parent drug in urine. In chronic heavy users, PCP can be detected 7–30 days after abstinence. Immunoassay is used as the screening procedure. GC/MS is the confirmatory method.

Sedatives-Hypnotics

Many therapeutic drugs can be classified as sedatives-hypnotics or tranquilizers. All members of this class are CNS depressants. They have a wide range of therapeutic roles and are commonly used. Most of these drugs have abuse potential, ranging from high to low. These drugs become available for illegal use through diversion from approved sources. Barbiturates and benzodiazepines are the most common type of sedative hypnotics abused. Although barbiturates have a higher abuse potential, benzodiazepines are more commonly found in abuse and overdose situations. This appears to be a result of availability. There are many individual drugs within the barbiturate and benzodiazepine classification. Secobarbital, pentobarbital, and phenobarbital are the more commonly abused barbiturates. Diazepam (Valium), chlordiazepoxide (Librium), and lorazepam (Ativan) are commonly abused benzodiazepines. Overdose with sedatives-hypnotics initially presents with lethargy and slurred speech, which can rapidly progress to coma. Respiratory depression is the most serious toxic effect of most of these agents. Hypotension can occur with barbiturates. The toxicity of many of these agents is potentiated by ethanol.

Immunoassay is the most common screening procedure for both barbiturates and benzodiazepines. Broad cross-reactivity within members of each group allows for detection of many individual drugs. GC or liquid chromatography can be used for confirmatory testing.

REFERENCES

1. Eldridge DL, Holstege CP. Utilizing the laboratory in the poisoned patient. *Clin Lab Med* 2006;26:13–30.
2. Thorne D, Kaplan KJ. Laboratory indicators of ethanol consumption. *Clin Lab Sci* 1999;120:343.
3. Kao LW, Nanagas KA. Toxicity associated with carbon monoxide. *Clin Lab Med* 2006;26:99–125.
4. Widdop B. Analysis of carbon monoxide. *Ann Clin Biochem* 2002;39:378–391.
5. Ibrahim D, Froberg B, Wolf A, Rusyniak DE. Heavy metal poisoning: clinical presentations and pathophysiology. *Clin Lab Med* 2006;26:67–97.
6. Rowden AK, Norvell J, Eldridge DL, Kirk MA. Acetaminophen poisoning. *Clin Lab Med* 2006;26:49–65.
7. Haroz R, Greenberg MI. New drugs of abuse in North America. *Clin Lab Med* 2006;147–164.
8. Nyberg Karlsen S, Spigset O, Slordal L. The dark side of ecstasy: neuropsychiatric symptoms after exposure to 3,4-methylenedioxymethamphetamine. *Basic Clin Pharmacol Toxicol* 2007;102:15–24.
9. Green G. Doping control for the team physician: a review of drug testing procedures in sport. *Am J Sports Med* 2006;34:1690–1698.

Circulating Tumor Markers: Basic Concepts and Clinical Applications

Christopher R. McCudden, Monte S. Willis

CHAPTER

31

CHAPTER OUTLINE

■ TYPES OF TUMOR MARKERS

■ APPLICATIONS OF TUMOR MARKER DETECTION

Screening
Prognosis
Monitoring Effectiveness of Therapy and Disease
Recurrence

■ RECOMMENDATIONS FOR TEST ORDERING

■ METHODS

Immunoassays
High-Performance Liquid Chromatography
Immunohistochemistry
Enzyme Assays

■ FREQUENTLY ORDERED TUMOR MARKERS

α -Fetoprotein
Cancer Antigen 125
Carcinoembryonic Antigen
Human Chorionic Gonadotropin
Prostate Specific Antigen

■ SUGGESTED READINGS

■ REFERENCES

Cancer is the second leading cause of death in North America, accounting for more than 500,000 deaths annually. It is estimated that 45% of males and 38% of females will develop invasive cancer in their lifetime.¹ Although it is often specified as a single disorder, *cancer* is a broad term used to describe more than 200 different diseases that affect more than 50 tissues. Despite considerable efforts to curtail cancer incidence, the most common types of these will account for an estimated 1.5 million new cases of cancer in the United States annually (Table 31-1).

Biologically, *cancer* refers to the uncontrolled growth of cells that can develop into a solid mass or tumor and spread to other areas of the body. The formation (*tumorigenesis*) and spreading (*metastasis*) of tumors are caused by a complex combination of inherited and acquired genetic mutations (for comprehensive reviews, consult Abeloff² and Hanahan and Weinberg³). During tumorigenesis, these mutations include activation of growth factors (e.g., epidermal growth factor [EGF]) and **oncogenes** (e.g., K-ras), in combination with inhibition of apoptosis, tumor suppressor, and cell cycle regulation genes (e.g., *BRCA1*, *p53*, cyclins). As cancer progresses toward metastasis, additional genetic changes are required such as loss of cell adhesion proteins (e.g., β -catenin and E-cadherin) and activation of angiogenesis genes (e.g., VEGF) (Fig. 31-1). An understanding of

these genetic mechanisms is the basis for many current and future cancer treatments.

Cancer severity is generally classified by a combination of several factors. Depending on the type of cancer, these factors include tumor size, histology, regional lymph node involvement, and presence of metastasis. For most solid tumors (e.g., breast, lung, kidney), cancer is broadly classified (using roman numerals I–IV) into four stages (Fig. 31-2). These stages correlate with disease severity, where higher stages are indicative of significant spreading and severe systemic disease. As disease progresses, both proliferation and metastasis occur at the expense of normal organ processes, which usually is the ultimate cause of cancer-associated morbidity and mortality.

TYPES OF TUMOR MARKERS

Cancer can be detected and monitored using biologic **tumor markers**. Tumor markers are produced either directly by the tumor or as an effect of the tumor on healthy tissue (*host*). Tumor markers encompass an array of diverse molecules such as serum proteins, **oncofetal antigens**, hormones, metabolites, receptors, and enzymes. A variety of enzymes are elevated nonspecifically in tumors (Table 31-2). These elevated enzymes are largely a result of the high metabolic demand of these proliferative cells. Accordingly, enzyme levels tend to correlate with

COMMON CANCER TERMS

Angiogenesis: development of new blood vessels to supply oxygen and nutrients to cells

Apoptosis: programmed cell death

Cell cycle: phases of cell activity divided into G, S, and M (growth, DNA synthesis, and mitosis, respectively)

Oncogene: encodes a protein that, when mutated, promotes uncontrolled cell growth

Tumor suppressor gene: encodes a protein involved in protecting cells from unregulated growth

tumor burden, making them clinically useful for monitoring the success of therapy. Serum proteins, such as β_2 -microglobulin and immunoglobulins, are also used to monitor cancer therapy (Table 31-3). β_2 -Microglobulin is found on the surface of all nucleated cells and can therefore be used as a nonspecific marker of the high cell turnover that is often observed in tumors. Immunoglobulins provide a more specific measure of plasma cell production of monoclonal proteins observed in hematologic malignancies such as multiple myeloma. Hormones and hormone metabolites are widely used as specific markers of secreting tumors (Table 31-4). These hormones are particularly valuable in diagnosing neuroblastomas, as well as pituitary and adrenal adenomas.

One of the first tumor markers discovered was the oncofetal antigens. Oncofetal antigens such as carcinoembryonic antigen (CEA) and α -fetoprotein (AFP) are expressed transiently during normal development and are then turned on again in the formation of tumors (Table 31-5 for use of oncofetal antigens). Other tumor markers include monoclonal defined antigens, which were directly identified from human tumor extracts or cell lines. These are directed toward specific **carbohydrate or cancer antigens** and are best used for monitoring treatment of tumor that secretes these epitopes (Table 31-6). Finally, receptors are used to classify tumors for therapy (Table 31-7). These are the only “nonserologic” markers described in the chapter but are an important example of the diversity of tumor markers. Prototypic examples of such a marker are estrogen and progesterone receptors. When solid tumor biopsies are positive for these markers, tamoxifen chemotherapy is more likely to be effective.

Tumor markers are an invaluable set of tools that health care providers can use for a variety of clinical modalities. Depending on the marker and the type of malignancy, tumor markers may be used for screening, diagnosis, prognosis, therapy monitoring, and detecting recurrence (Fig. 31-3).

APPLICATIONS OF TUMOR MARKER DETECTION

Ideally, a tumor marker would be tumor specific, absent in healthy individuals, and readily detectable in body

TABLE 31-1 ESTIMATED NEW CASES OF CANCER AND DEATHS FROM CANCER IN THE UNITED STATES

| TISSUE | MALE | | TISSUE | FEMALE | |
|-----------------------|-----------|------------------|-----------------------|-----------|------------------|
| | INCIDENCE | DEATH | | INCIDENCE | DEATH |
| Prostate | 29% | 9% | Breast | 26% | 15% |
| Lung | 15% | 31% | Lung | 15% | 26% |
| Colorectal | 10% | 9% | Colorectal | 11% | 10% |
| Bladder | 7% | 3% | Uterine | 6% | 3% |
| Lymphoma ^a | 4% | ... ^b | Lymphoma ^a | 4% | 3% |
| Melanoma | 4% | ... | Melanoma | 4% | ... ^b |
| Renal | 4% | 3% | Thyroid | 4% | ... |
| Leukemia | 3% | 4% | Ovarian | 3% | 6% |
| Oral cavity | 3% | ... | Renal | 3% | ... |
| Pancreatic | 2% | ... | Leukemia | 3% | ... |
| Hepatic | <2% | 4% | Hepatic | <2% | 2% |
| Total cases | 766,860 | 289,550 | | 678,060 | 270,100 |

^aNon-Hodgkin's lymphoma.

^bLess than 2% of total.

Based on 2007 data from the National Cancer Institute (<http://www.cancer.gov/statistics/>); excludes basal cell and squamous cell skin cancers.

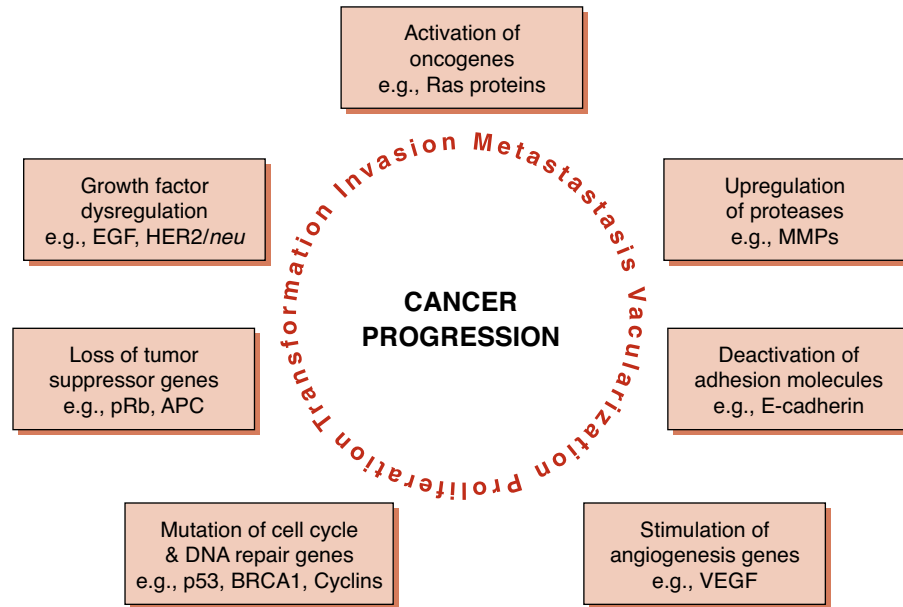

FIGURE 31-1. Genetic changes associated with cancer. A combination of acquired and/or hereditary defects underlie tumor formation and metastasis. This process begins with unregulated proliferation and transformation and is followed by invasion and loss of cellular adhesion. A vascular supply of oxygen nutrients is necessary to facilitate growth of a tumor larger than 100–200 μm . (APC, familial adenomatous polyposis coli, mutated in colorectal cancers; *BRCA1*, breast cancer susceptibility gene; E-cadherin, adhesion molecule; EGF, epithelial growth factor; MMP, matrix metalloproteinase; p53, cell cycle regulator, mutated in 50% of cancers; pRb, retinoblastoma protein, mutated in many cancers; Ras, small G protein, mutated in many cancers; TIMP, tissue inhibitor of metalloproteinase; VEGF, vascular endothelial growth factor, drug target for inhibition of angiogenesis.)

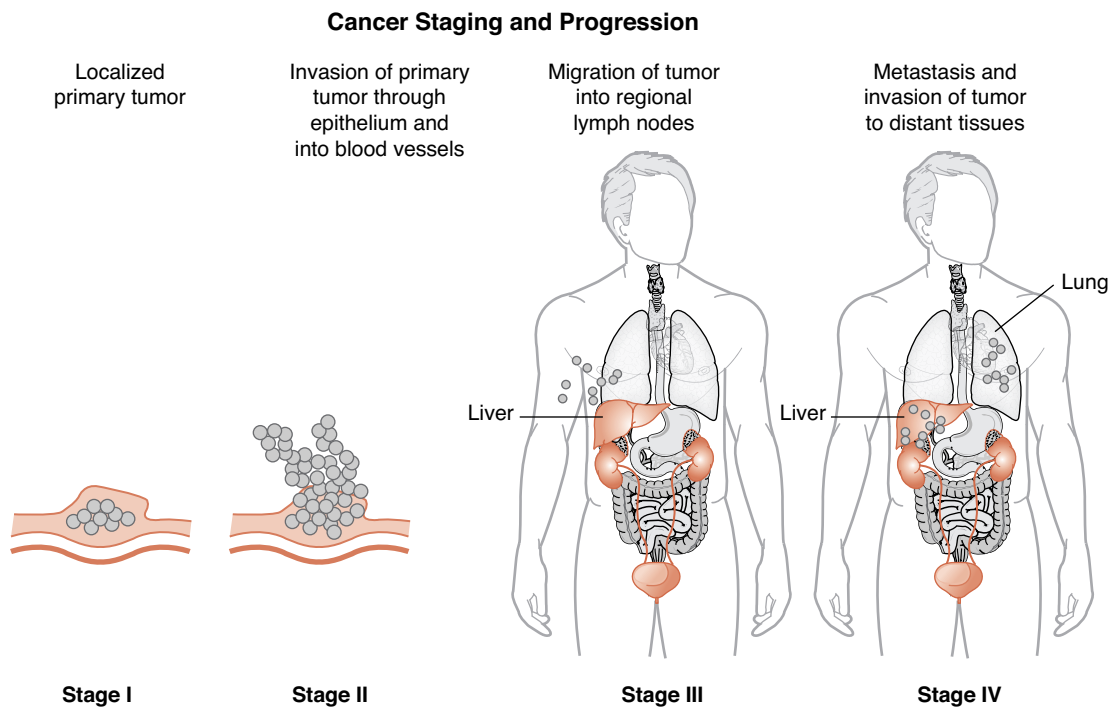

FIGURE 31-2. Cancer staging and progression. Numerous factors are used in combination to define cancer stage; these include tumor size, lymph node involvement, metastasis, and histologic assessments. In this simplified diagram, stage is presented as a function of invasion and spreading regionally and to other tissues.

TABLE 31-2 ENZYME TUMOR MARKERS

| TUMOR MARKER | TUMOR TYPE | METHOD | SPECIMEN | CLINICAL UTILITY |
|---------------------------|--|----------|----------|---|
| Prostate-specific antigen | Prostate cancer | IA | Serum | Prostate cancer screening, therapy monitoring, and recurrence |
| Lactate dehydrogenase | Hematologic malignancies | EA | Serum | Prognostic indicator; elevated nonspecifically in numerous cancers |
| Alkaline phosphatase | Metastatic carcinoma of bone, hepatocellular carcinoma, osteosarcoma, lymphoma, leukemia | EA | Serum | Determination of liver and bone involvement; nonspecific elevation in many bone-related and liver cancers |
| Neuron-specific enolase | Neuroendocrine tumors | RIA, IHC | Serum | Prognostic indicator and monitoring disease progression for neuroendocrine tumors |

EA, enzyme assay; IA, immunoassay; IHC, immunohistochemistry; RIA, radioimmunoassay.

fluids. Unfortunately, all of the presently available tumor markers do not fit this ideal model. However, a host of tumor markers have been identified that have a high enough specificity and sensitivity to be used in screening populations at risk and can be used in the diagnosis, prognosis, and detection of recurrence and monitoring response to treatment (Fig. 31-3).

Screening

With the possible exception of PSA, no tumor marker identified to date can be used to adequately screen asymptomatic populations because most of the clinically used tumor markers are found in normal cells and benign conditions in addition to cancer cells. Screening asymptomatic populations would therefore result in detection of false-positives (patients without disease with detectable tumor marker), leading to undue alarm and

cost to patients. Presently, only a few tumor markers are used in populations with high incidence or other carefully defined populations (Fig. 31-3).

Susceptibility to cancer can be determined using molecular diagnostics in patients with breast, ovarian, or colon cancer by identifying germline mutations in patients with a family history of these diseases. Screening for susceptibility to breast and ovarian cancers is done by identifying germline *BRCA1* and *BRCA2* mutations. Similarly, familial colon cancers can be identified by the presence of the adenomatous polyposis coli gene (*APC*).

Prognosis

Tumor marker concentration generally increases with tumor progression, reaching their highest levels when tumors metastasize. Therefore, serum tumor marker levels at diagnosis can reflect the aggressiveness of a tumor

TABLE 31-3 SERUM PROTEIN TUMOR MARKERS

| TUMOR MARKER | TUMOR TYPE | METHOD | SPECIMEN | CLINICAL UTILITY |
|--------------------------|--------------------------|---------|----------|---|
| Serum M-protein | Plasma cell dyscrasias | SPE/IFE | Serum | Diagnosis, therapeutic monitoring of plasma cell malignancies |
| Serum free light chains | Plasma cell dyscrasias | IA | Serum | Diagnosis, therapeutic monitoring of plasma cell malignancies |
| β_2 -Microglobulin | Hematologic malignancies | IA | Serum | Prognostic marker for lymphoproliferative disorders |

IA, immunoassay; IFE, immunofixation electrophoresis; SPE, serum protein electrophoresis.

TABLE 31-4 ENDOCRINE TUMOR MARKERS

| TUMOR MARKER | TUMOR TYPE | METHOD | SPECIMEN | CLINICAL UTILITY |
|--|--|----------------|-----------------------|--|
| Homovanillic acid (HVA) | Neuroblastoma, pheochromocytoma, paraganglionoma | HPLC | 24-hr urine | Diagnosis of neuroblastoma ^a |
| Vanillylmandelic acid (VMA) | Pheochromocytoma, paraganglionoma, neuroblastoma | HPLC | 24-hr urine | Diagnosis of neuroblastoma ^a |
| Metanephrines (fractionated) ^b | Pheochromocytoma, paraganglionoma, neuroblastoma | HPLC | 24-hr urine or plasma | Screening and diagnosis of pheochromocytoma ^c |
| Catecholamines (fractionated) ^d | Pheochromocytoma, paraganglionoma, neuroblastoma | HPLC, LC-MS/MS | 24-hr urine | Screening and diagnosis of pheochromocytoma, paraganglionoma, neuroblastoma ^c |
| Hydroxyindoleacetic acid (5-HIAA) | Carcinoid tumors | HPLC | 24-hr urine | Diagnosis of carcinoid tumors ^e |
| Serotonin | Carcinoid tumors | HPLC | Serum | Diagnosis of carcinoid tumors ^e |
| Calcitonin | MTC and neuroendocrine tumors | IA | Serum | Screening, ^f response to therapy, and monitoring recurrence of MTC |
| Parathyroid hormone (PTH) | Pituitary adenoma | IA | Serum | Diagnosis and postsurgical monitoring of 1' hyperparathyroidism |
| Growth hormone (GH) | Pituitary adenoma, ectopic GH-secreting tumorsurgical | IA | Serum | Diagnosis and post monitoring of acromegaly |
| Prolactin (PRL) | Pituitary adenoma | IA | Serum | Diagnosis and postsurgical monitoring of prolactinoma |
| Adrenocorticotrophic hormone (ACTH) | Pituitary adenoma, ectopic ACTH-producing tumor | IA | Serum | Diagnosis of ectopic ACTH-producing tumor |
| Cortisol | Adrenal tumors | IA | Serum or urine | Diagnosis of Cushing's syndrome, adrenal adenoma |
| Antidiuretic hormone (ADH) | Posterior pituitary tumors | IA | Serum | Diagnosis of SIADH |
| Chromogranin A | Pheochromocytoma, neuroblastoma, carcinoid tumors, small cell lung cancers | ELISA, RIA | Serum | Aid in diagnosis of carcinoid tumors, pheochromocytomas, and neuroblastomas |
| C-peptide | Insulin-secreting tumors | ELISA, IA | Serum | Diagnosis of insulinoma |

^aHVA and VMA are used in combination for diagnosis of neuroblastomas.

^bMetanephrine, normetanephrine.

^cDopamine, epinephrine, norepinephrine.

^dPreferred screening method for pheochromocytoma is plasma metanephrines.

^e5-HIAA is the preferred method for carcinoid tumor detection.

^fScreening family members for MTC.

ELISA, enzyme-linked immunosorbent assay; HPLC, high-performance liquid chromatography; IA, immunoassay; LC-MS/MS, liquid chromatography–tandem mass spectrometry; MTC, medullary thyroid carcinoma; RIA, radioimmunoassay; SIADH, syndrome of inappropriate antidiuretic hormone secretion.

TABLE 31-5 USE OF SERUM AFP AND HCG FOR TESTICULAR CANCER CLASSIFICATION

| | GERM CELL TUMOR | AFP | HCG |
|------------------------|---|-----------------------------|-----------|
| Nonseminomatous tumors | Yolk sac tumor (endodermal sinus tumor) | Increased | No |
| | Choriocarcinoma | No | Increased |
| | Embryonal carcinoma | Increased | ± |
| | Teratoma | No | No |
| Seminoma | | Not elevated in pure tumors | ± |

and help predict the outcome for patients. High serum tumor markers at diagnosis might indicate the presence of malignancy and possible metastasis associated with a poorer prognosis. In other instances, the mere presence or absence of a particular marker may be valuable. Such is the case with some of the receptors used to base chemotherapeutic treatment in breast cancer.

Monitoring Effectiveness of Therapy and Disease Recurrence

One of the most useful applications of tumor markers is monitoring therapy efficacy and detecting disease recurrence. After surgical resection, radiation, or drug therapy of cancer (chemotherapy), tumor markers are routinely followed serially. In patients with elevated tumor markers at diagnosis, effective therapy results in a dramatic decrease or disappearance of the tumor marker. If the initial treatment is effective, the appearance of circulating tumor markers can then be used as a highly sensitive marker of recurrence; many markers have a significant lead time of several months before

disease would be detected by other modalities, allowing treatment of an earlier-stage cancer.

RECOMMENDATIONS FOR TEST ORDERING

The magnitude and range of tumor marker concentrations levels can be considerably larger than those of most other analytes measured in clinical chemistry, and therefore the strategies for ordering tests differ. It is important that multiple tests are performed, using the same commercial kits, and follow-up testing is based on the half-life of the marker. It is important to serially evaluate tumor markers because they increase with time, while high normal values will not. Using different commercial kits can be particularly troublesome because values may vary widely between laboratories, potentially leading to unnecessary intervention. When monitoring therapeutic response to treatment or detection of recurrence, it is essential that the half-life of the tumor marker is known. For example, if a particular marker has a half-life of weeks, there is little diagnostic value in measuring daily. This ensures that the pre-existing marker has time to clear from circulation and that subsequent measurements accurately reflect tumor burden.

METHODS

There are several methodologic issues that arise when dealing with the measurement of tumor markers. In this section, we discuss the methods most commonly used to detect tumor markers and the key issues with them. The most commonly used method to detect tumor markers is the quantitative immunoassay. However, chromatography, immunohistochemistry, and enzyme assays have unique roles to play in the diagnosis, prognosis, and therapeutic monitoring of cancer.

In contrast to other commonly used assays in the clinical laboratory, the standardization found for other common clinical assays generally does not exist. This makes comparisons of a single patient using different

TABLE 31-6 CARBOHYDRATE AND CANCER ANTIGEN TUMOR MARKERS

| TUMOR MARKER | TUMOR TYPE | METHOD | SPECIMEN | CLINICAL UTILITY |
|--------------|--|-------------|----------|--|
| CA 19-9 | Gastrointestinal cancer and adenocarcinoma | Immunoassay | Serum | Monitoring pancreatic cancer |
| CA 15-3 | Metastatic breast cancer | Immunoassay | Serum | Response to therapy and detecting recurrence |
| CA 27-29 | Metastatic breast carcinoma | Immunoassay | Serum | Response to therapy and detecting recurrence |
| CA-125 | Ovarian cancer | Immunoassay | Serum | Monitoring therapy |

TABLE 31-7 RECEPTOR TUMOR MARKERS

| TUMOR MARKER | TUMOR TYPE | METHOD | SPECIMEN | CLINICAL UTILITY |
|----------------------------------|--|------------------|----------|---|
| Estrogen receptor | Breast cancer | IHC | Biopsy | Hormonal therapy indicator |
| Progesterone receptor | Breast cancer | IHC | Biopsy | Hormonal therapy indicator |
| Her-2/ <i>neu</i> | Breast, ovarian, gastrointestinal tumors | IHC, FISH, ELISA | Biopsy | Prognostic and hormonal therapy indicator |
| Epidermal growth factor receptor | Head, neck, ovarian, cervical cancers | IHC | Biopsy | Prognostic indicator |

ELISA, enzyme linked immunosorbent assay; FISH, fluorescence in situ hybridization; IHC, immunohistochemistry.

assays treacherous. There are multiple reasons why these assays are not comparable, including differences in antibody specificity, analyte heterogeneity, assay design, lack of standard reference material, calibration, kinetics, and variation in reference ranges. To most accurately follow tumor marker concentrations in a patient, it is important to use the same methodology (or kit) and to perform diligent quality control during lot changes.

Immunoassays

Immunoassay is the most commonly used method to measure tumor markers. There are many advantages to this assay, such as the ability to automate testing. Several

factors in interpreting tumor marker immunoassays are important to recognize, particularly when there is a very high (or very low) clinical suspicion of disease. These factors include understanding the linearity of the assay, understanding the hook effect, and recognizing the potential for human antimouse antibodies (HAMAs).

Linearity

A key challenge to measuring tumor markers is that the concentration of these markers potentially extends over a wide range of values. Therefore, it is important to determine the linearity of the assay (as described in Chapter 7). The *linear range* is the range of analyte concentrations in which a linear relationship exists between the analyte and signal. Linearity is determined

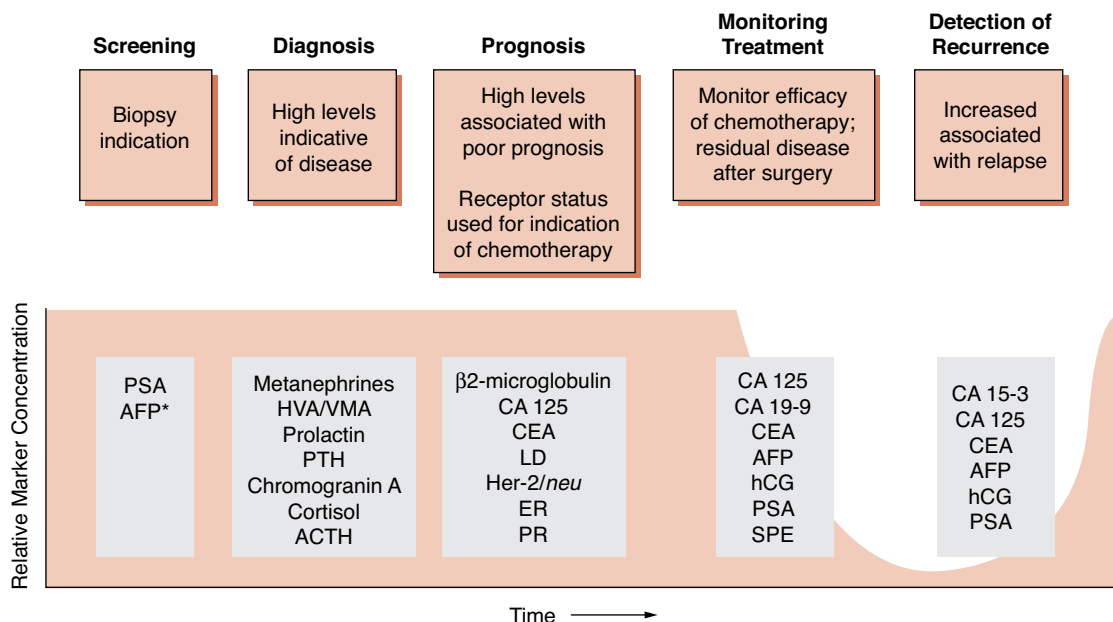

FIGURE 31-3. Timeline of tumor marker use. Tumor markers are used for screening, prognosis, treatment monitoring, and detecting recurrence of several types of cancer. Whereas few markers are used for screening, many are used to monitor therapy. Endocrine and hormone metabolite markers are often used to aid in diagnosis of secreting tumors. *Asterisk indicates use in high prevalence areas such as China, Alaska, and the Middle East.

by analyzing (in replicates) specimens spanning the reportable range. Guidelines for this determination are outlined in the Clinical Laboratory Improvement Amendments (CLIA) guidelines for linearity.⁴ Samples exceeding the linear range, which is much more likely to occur in the detection of tumor markers, need to be systemically diluted to determine values within the reportable linear range. Excessively high tumor marker concentrations can result in falsely low measurements, a phenomenon known as *antigen excess* or *hook effect*.

Hook Effect

When analyte concentrations exceed the analytical range excessively, both the capture and label antibodies can be saturated, resulting in a lack of “sandwich” formation, which results in a significant decrease in signal. If clinical suspicion is high for an elevated tumor marker, it can be discovered by dilution followed by repeated testing. Samples displaying hook effect will yield higher values on dilution.

Heterophile Antibodies

Significant interference can be seen in immunoassays if an individual has circulating antibodies against animal immunoglobulins. Heterophilic antibodies are also known as human antianimal antibodies (HAAAs) or HAMAs. HAMAs are most commonly encountered in patients who have been given mouse monoclonal antibodies for therapeutic reasons or have been exposed to mice,⁵ but they may be idiopathic. In patients, these antibodies lead to false-positive or, less commonly, false-negative results by cross linking the capture/label antibody (see Chapter 7). To confirm that heterophilic antibodies are present, samples are diluted and the linearity of the dilutions is analyzed. Samples with heterophilic antibodies do not give linear results upon dilution. The presence of anti-animal immunoglobulins (such as antimouse) can also be detected directly. Nonimmune animal serum is often added to immunoassays to minimize the effects of heterophilic antibodies, and there are commercial blocking reagents that can be used to remove HAMAs. Many monoclonal therapeutic agents are now derived to include only fragments of an antibody to avoid the development of heterophilic antibodies.

Common Concerns Applied to Tumor Marker

Immunoassays

Immunoassays for tumor markers can be affected by interference resulting from icterus, lipemia, hemolysis, and antibody cross-reactivity in the same manner as immunoassay. As with all automated tests, the potential for carryover with high levels of tumor marker analytes can also be a concern, leading to falsely elevated levels in patients if adequate washing steps are not included between patient samples.

High-Performance Liquid Chromatography

High-performance liquid chromatography (HPLC) is the most widely used methodology to detect catecholamines and their metabolites in plasma and urine. Generally, there is an extraction process, by which the analytes of interest are separated from either plasma or urine. Subsequently, these analytes are run over a column and separated by their physical characteristics. Neuroblastoma, the most common malignant tumor in children, can be diagnosed by the detection of high levels of plasma catecholamines (epinephrine, norepinephrine, and dopamine). Pheochromocytoma, a rare tumor associated with hypertension, is diagnosed by detecting elevated plasma metanephrines (along with urine VMA and free catecholamines). Carcinoid tumors are serotonin-secreting tumors that arise from the small intestine, appendix, or rectum leading to a host of symptoms (carcinoid syndrome), including pronounced flushing, bronchial constriction, cardiac valve lesions, and diarrhea. The diagnosis of carcinoid tumors involve the detection of 5-hydroxyindoleacetic acid (5-HIAA), which is a serotonin metabolite. In all of these cases, HPLC is used to detect these tumors and follow their therapy and recurrence.

Immunohistochemistry

There are a few tumor markers that are detected directly within solid tissue. They are present in the cancer cells themselves in a different manner than the surrounding tissue. These assays are performed by thinly cutting and placing the tissue in question on glass slides. Specific antibodies (and the proper control antibodies) in solution are then incubated with tissue sections to detect the presence (or absence) of antigens using colorimetric secondary antibodies. In many ways, this is similar to detection by immunoassay, but the added value is the ability to determine whether the antigen in question is in a particular cell type (such as a tumor), in the specific subcellular location. A good example of the use of a tumor marker that is detected by immunohistochemistry (IHC) is the identification of estrogen and progesterone receptors in breast cancer. When breast tumors are positive for estrogen and progesterone receptors at the cell surface, they tend to respond to hormonal therapy, while tumors lacking these receptors are treated with other chemotherapeutic modalities. There has also been a recent guideline update on the use of hormone receptors as prognostic indicators.⁶

Enzyme Assays

The detection of elevated circulating enzymes generally cannot be used to identify a specific tumor or site of tumor. One key exception to this is the prostate specific

antigen (PSA), which is a serine protease of the kallikrein family, found exclusively in both diseased and benign prostate glands. Before the widespread use of immunoassays and the discovery of oncofetal antigens, enzyme detection use was widespread. Because enzymes are found in much higher concentrations intracellularly, release into the system resulted when cells necrosed or underwent changes in permeability. Examples of enzymes that have been used as tumor markers include alkaline phosphatase (bone, liver, leukemia, sarcoma), creatine kinase-BB (prostate, small cell lung, breast, colon, ovarian), lactate dehydrogenase (liver, lymphomas, leukemia, others), and PSA (prostate). Enzyme activity assays (see also Chapter 12) are used to quantify all of these enzymes, with the exception of PSA, which is measured by immunoassay.

FREQUENTLY ORDERED TUMOR MARKERS

α -Fetoprotein

Introduction and Description

α -Fetoprotein (AFP) is an abundant serum protein normally synthesized by the fetal liver that is reexpressed in certain types of tumors. This re-expression during malignancy classifies AFP as a carcinoembryonic protein. AFP is often elevated in patients with hepatocellular carcinoma (HCC) and germ cell tumors.

Regulation and Physiology

Structurally, AFP is a 70-kD glycoprotein related to albumin that normally functions as a transport protein and is involved in regulating oncotic pressure in the fetus. During development, AFP peaks at approximately one tenth the concentration of albumin at 30 weeks' gestation (see Chapter 28). The upper normal limit for serum AFP is approximately 15 ng/mL in healthy adults. Infants initially have high serum AFP values that decline to adult levels at an age of 7–10 months.⁷

Clinical Application and Interpretation

AFP is used for the diagnosis, **staging**, prognosis, and treatment monitoring of HCC. Also known as hepatoma, HCC is a tumor that originates in the liver, often due to chronic disease such as hepatitis and cirrhosis. Patients with HCC frequently have elevated serum AFP; however, as with most tumor markers, AFP is not completely specific. For example, AFP can also be increased in benign conditions such as pregnancy and liver disease, as well as other types of malignancy such as testicular cancer.

Although it is not widely used for screening in Europe and North America, AFP has been used to detect HCC in populations with high disease prevalence such as in China. When used for screening high-risk populations, AFP has a sensitivity ranging from 40%–65%

and specificity of 80%–95% (at cutoffs ranging from 20–30 ng/mL).⁸ Very high levels of AFP (>500 ng/mL) in high-risk individuals are considered diagnostic of HCC.⁹ Several expert groups, including the National Comprehensive Cancer Network, National Academy of Clinical Biochemistry, and the British Society of Gastroenterology, now recommend that AFP be used in conjunction with ultrasound imaging every 6 months in patients at high risk of developing HCC. This includes patients with hepatitis B virus- and/or hepatitis C virus-induced liver cirrhosis.¹⁰

High levels of AFP in HCC are associated with poor prognosis and are exemplified in individuals who do not respond to therapy or have residual disease following surgery.

Correspondingly, a decrease in circulating AFP levels after treatment is associated with prolonged survival rates. It is therefore recommended that serial measurements of AFP be used to monitor treatment and post-surgery in patients with HCC.

The other major use for AFP as a tumor marker is for classification and monitoring therapy for testicular cancer. Testicular cancer includes several subtypes broadly classified into seminomatous and nonseminomatous tumors. Seminomatous tumors form directly from malignant germ cells, whereas nonseminomatous tumors involve differentiation into embryonal carcinoma, teratoma, choriocarcinoma, and yolk sac tumors (endodermal sinus tumor).¹¹ AFP is used in combination with β -human chorionic gonadotropin (β -hCG) to classify nonseminomatous tumors (Table 31-5). Serum AFP is also useful for tumor staging, where it is increased in 10%–20% of stage I tumors, 50%–80% of stage II tumors, and 90%–100% of stage III nonseminomatous testicular cancer. As with HCC, AFP can be used serially to monitor therapy efficacy and disease progression.

Methodology

AFP is measured using any of a variety of commercially available automated immunoassays. Many automated platforms that measure AFP in serum and amniotic fluid are available, including the Beckman Access, Roche Cobas series, Advia Centaur, Tosoh AIA series, Clinical Diagnostics Vitros Eci, Diagnostic Products Corp Immulite Analyzers, and the Abbott ARCHITECT. These assays are typically sandwich immunoassays relying on monoclonal or polyclonal antibodies directed toward different regions of AFP. Serial monitoring of AFP should be done using the same laboratory and assay. As with other glycoproteins, AFP displays some heterogeneity where certain isoforms are preferentially produced by malignant cells. Antibodies against these isoforms produced by malignant cells may in the future be used to improve the specificity of AFP immunoassays.

Application and Pathophysiology

The primary applications of AFP as a tumor marker are for HCC and nonseminomatous testicular cancer. AFP is typically used as a marker to monitor therapy, detect residual tumor, or detect relapse.

Cancer Antigen 125

Introduction and Description

Cancer antigen 125 (CA-125) was first defined by a murine monoclonal antibody raised against a serous ovarian carcinoma cell line.¹⁰ CA-125 may be useful for detecting ovarian tumors at an early stage and for monitoring treatments without surgical restaging.

Regulation and Physiology

CA-125 is expressed in the ovary, in other tissues of müllerian duct origin, and in human ovarian carcinoma cells. The CA-125 gene encodes a high-molecular-weight (200,000–1,000,000 kD) mucin protein containing a putative transmembrane region and a tyrosine phosphorylation site.¹² Although it is not usually found in serum, CA-125 may be elevated in patients with endometriosis, during the first trimester of pregnancy, or during menstruation.

Clinical Application and Interpretation

CA-125 is the only clinically accepted serologic marker of ovarian cancer. Ovarian cancer accounts for approximately 3% of the newly diagnosed malignancies in women and is among the top five causes of cancer-related death (Table 31-1). Ovarian cancer includes a broad range of categories, including sex cord tumors, stromal tumors, germ cell tumors, and, most commonly, epithelial cell tumors. As with most other tumor

markers, CA-125 should not be used to screen for ovarian cancer in asymptomatic individuals. However, CA-125 is elevated in a high percentage of ovarian tumors and is recommended as an annual test for women with a family or prior history of ovarian cancer. CA-125 levels also correlate with ovarian cancer stage. CA-125 is elevated in 50% of patients with stage I disease, 90% of patients with stage II, and more than 90% of patients with stage III or IV.

Methodology

CA-125 can be detected by immunoassays that use OC 125 and M11 antibodies. These monoclonal antibodies recognize distinct nonoverlapping regions of the CA-125 epitope. CA-125 is available on many automated platforms. However, results from different platforms are not interchangeable due to differences between reagent detection methods. The upper normal limit for serum CA-125 is 35 U/mL.

Application and Pathophysiology

CA-125 is predominantly used to monitor therapy and to distinguish benign masses from ovarian cancer.¹³ For example, in postmenopausal women with a palpable abdominal mass, a high level (>95 U/mL) of CA-125 has a 90% positive predictive value for ovarian cancer. For therapy monitoring, CA-125 is useful both for predicting the success of surgery (debulking procedures) and for determining efficacy of chemotherapy. Therefore, patients with elevated CA-125 following either treatment modality have a poor prognosis. Prognosis is also associated with CA-125 half-life; a CA-125 half-life of less than 20 days is associated with longer survival; the average half-life of CA-125 is 4.5 days.^{14,15}

Carcinoembryonic Antigen

Introduction and Description

Carcinoembryonic antigen (CEA) was discovered in the 1960s and is prototypical example of an oncofetal antigen; it is expressed during development and then re-expressed in tumors. CEA is the most widely used tumor marker for colorectal cancer and is also frequently elevated in lung, breast, and gastrointestinal tumors. CEA can be used to aid in the diagnosis, prognosis, and therapy monitoring of colorectal cancer. Although high levels of CEA (>10 ng/mL) are frequently associated with malignancy, high levels of CEA are not specific for colorectal cancer and therefore CEA is not used for screening.

Regulation and Physiology

CEA is a large heterogeneous glycoprotein with a molecular weight of approximately 200 kD. It is part of the immunoglobulin superfamily and is involved in apoptosis, immunity, and cell adhesion. Because of its role in cell adhesion, CEA has been postulated to be involved in

CASE STUDY 31-1

A 33-year-old man with a history of chronic liver disease presents with edema, abdominal pain, and recent weight loss. Laboratory examination reveals a low platelet count, hypoalbuminemia, and prolonged prothrombin time and partial thromboplastin time.

Questions

1. What tumor marker may aid in diagnosing this patient?
2. What additional laboratory tests would be useful in diagnosing this patient?
3. The patient is treated with surgery; how should tumor markers be used to determine the success of surgery?

metastasis. Akin to other serologic tumor markers, CEA may be elevated nonspecifically because of impaired clearance or through increased production. Increased CEA concentrations have been observed in heavy smokers and in some patients following radiation treatment and chemotherapy. CEA may also be elevated in patients with liver damage due to prolonged clearance. The upper normal range for serum CEA is 2.5–5 ng/mL depending on the assay.

Clinical Application and Interpretation

The main clinical use of CEA is as a tumor marker for colorectal cancer. In colon cancer, CEA is used for prognosis, in postsurgery surveillance, and to monitor response to chemotherapy. For prognosis, CEA can be used in combination with histology and the TMN staging system to establish the need for adjuvant therapy. Adjuvant therapy is indicated in patients with stage II disease (i.e., tumor has spread beyond immediate colon but not to lymph nodes) who have high levels of CEA.¹⁶

Methodology

Although CEA assays historically used polyclonal antibodies, these have largely been replaced by the use of monoclonal anti-CEA antibodies. CEA is available on numerous commercial automated platforms. Due to the high heterogeneity of CEA, it is essential that the same assay be used for serial monitoring.

Application and Pathophysiology

Before surgical resection, baseline CEA values are typically obtained to confirm successful removal of the tumor burden. After surgery and during chemotherapy, it is recommended that CEA levels be serially monitored every 2–3 months to detect recurrence and determine therapy efficacy; the half-life of CEA is approximately 2–8 days depending on the assay and the individual. CEA is not recommended for screening asymptomatic individuals for colorectal cancer. While there are no specific guidelines recommending the use of CEA in other types of cancer, it may be valuable for detecting recurrence of antigen positive breast and gastrointestinal cancers and to aid in the diagnosis of non-small-cell lung cancer.

Human Chorionic Gonadotropin

Introduction and Description

hCG is a dimeric hormone normally secreted by trophoblasts in the placenta to maintain the corpus luteum during pregnancy. hCG is elevated in trophoblastic tumors, choriocarcinoma, and germ cell tumors of the ovary and testis.

Regulation and Physiology

hCG is a 45-kD glycoprotein consisting of α and β subunits. A unique aspect of hCG is that it is degraded into multiple fragments. In serum, this results in the presence

CASE STUDY 31-2

A 65-year-old man presents to the emergency department after he had abnormally tarry-colored stool on multiple occasions. He has had gastrointestinal discomfort and has felt increasingly tired during the past 2 months. Physical examination reveals a guaiac-positive stool. A subsequently colonoscopy identified a circumferential mass in the sigmoid colon. A biopsy was performed, which identified the mass as an adenocarcinoma. CEA level was obtained as part of the presurgery workup.

Questions

1. Is the CEA test useful as a screening test for colon carcinoma?
2. What other conditions can result in elevated CEA levels?
3. How is CEA used to monitor patients after surgery for colon cancer?

of the intact molecule, nicked hCG, the free β subunit (β -hCG), and a hyperglycosylated intact form. Either intact hCG or the free β subunit may be elevated in malignancies, and most assays detect multiple fragments of hCG.

Clinical Application and Interpretation

hCG has several clinical applications as a tumor marker. It is a prognostic indicator for ovarian cancer, a diagnostic marker for classification of testicular cancer, and the most useful marker for detection of gestational trophoblastic diseases (GTDs).² GTDs include four distinct types of tumor (hydatidiform mole, persistent/invasive gestational trophoblastic neoplasia, choriocarcinoma, and placental site trophoblastic tumors) that are classified by clinical history, ultrasound, histology, and hCG levels. hCG is invariably elevated in women with GTDs¹⁷ and is often found at higher levels than are observed in normal pregnancy (i.e., >100,000). It is particularly helpful marker for monitoring GTD therapy, as levels of hCG correlate with tumor mass and prognosis.

Methodology

hCG can be measured by using any of a variety of widely available automated immunoassays. Typical assays use monoclonal capture and tracer antibodies targeted toward epitopes in the β subunit and intact hCG. Total β -hCG assays are the most useful because they detect both intact hormone and free β -hCG. Due to the variability in hCG

assays,¹⁸ it is imperative that patients be monitored with the same technique.

Application and Pathophysiology

In testicular cancer, the free β -hCG subunit is elevated in 60%–70% of patients with nonseminomas. hCG can be used in combination with AFP and biopsies to diagnose subtypes of testicular cancer (Table 31-5). Ectopic β -hCG is also occasionally elevated in ovarian cancer and some lung cancers. It is generally accepted that free β -hCG is sensitive and specific for aggressive neoplasms; the free β -hCG is not detectable in the serum of healthy subjects.

Prostate Specific Antigen

Introduction and Description

PSA is a 28-kD glycoprotein produced only in the epithelial cells of the acini and ducts of the prostatic ducts

in the prostate. It is a serine protease of the kallikrein gene family and functionally regulates seminal fluid viscosity and instrumental in dissolving the cervical mucus cap, allowing sperm to enter.

Regulation and Physiology

In healthy men, low circulating levels of PSA can be detected in the serum. There are two major forms of PSA that are found circulating in the blood: (1) free and (2) complexed. Most of the circulating PSA is complexed to α_1 -antichymotrypsin or α_2 -macroglobulin. Assays to detect total and free PSA have been developed. While the detection of total PSA has been used in screening for and in monitoring of prostate cancer, evidence for the usefulness in detecting free PSA as a fraction of total has been identified. Patients with malignancy have a lower percentage of free PSA.

CASE STUDY 31-3

A 25-year-old man with a history of testicular cancer is followed postsurgery over the course of 10 months, with β -hCG and AFP monitored. The patient is treated with radiation at 2 months, followed by chemotherapy (taxol, ifosfamide, and cisplatin) from months 6 through 9 (see Case Study Fig. 31-3.1).

Questions

1. What type of germ cell tumor might this patient have based on the serum AFP and β -hCG levels?
2. Explain the pattern of AFP and hCG observed in the graph.
3. Can a final diagnosis be made based only on the tumor marker findings? If not, why not?

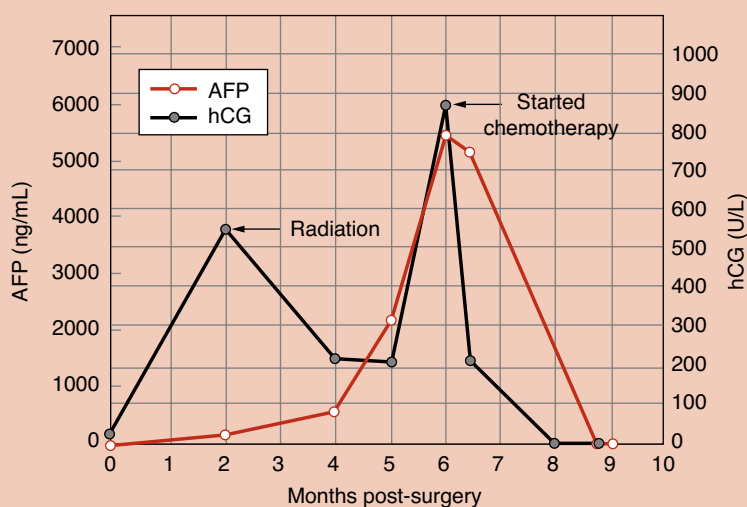

CASE STUDY FIGURE 31-3.1. Time course of hCG and AFP in patient with testicular cancer. The patient was treated with radiation at 2 months, and then again with chemotherapy (taxol, ifosfamide, and cisplatin) from months 6 through 9. Reference range for AFP is less than 10 μ g/L, and that for hCG is less than 5 U/L.

Clinical Application and Interpretation

Annual PSA testing has been approved by the U.S. Food and Drug Administration and recommended by the American Cancer Society for screening of prostate cancer in men over 50 years old since 1992.¹⁹ Current guidelines recommend that PSA testing and digital rectal examination (DRE) be performed on men over 50 years of age annually (with a 10-year life expectancy) and on younger men at high risk, such as those with a family history of prostate cancer. In addition to the use of standard cutoff values of total PSA (<4 ng/mL is generally considered normal), other measurements of PSA have been used to test for prostate malignancy; age-adjusted cutoff values of PSA, PSA velocity (rate of rise over time), and free PSA/total PSA ratios have been used to increase the accuracy of PSA testing.²⁰ Patients with a total PSA greater than 4 ng/mL and/or a clinical suspicion of cancer by DRE undergo biopsy to confirm the presence of prostate cancer and are followed closely over time.

Prostate infection, irritation, and benign prostatic hyperplasia (enlargement) can result in increased PSA. Moreover, recent ejaculation or DRE can also lead to increases in circulating PSA.^{21–25} It has also been recognized that cancer can be present at all concentrations of PSA.^{26,27} Taken together, these studies urge the interpretation of PSA in the context of the clinical picture (including DRE and family history, etc.).

While the value of PSA in screening for prostate cancer is presently unproved in randomized controlled studies, there are currently two studies addressing this issue and results are expected in the next couple of years.^{28,29} However, there is much indirect evidence from observational and case-control studies that indicate that the observed decrease in prostate cancer mortality in the United States is in part due to the widespread use of screening.²⁰

Methodology

PSA is measured by immunoassay, which detects both free PSA and PSA complexed with α_1 -antichymotrypsin but not α_2 -macroglobulin. Most immunoassays commercially available use enzyme, fluorescence, or chemiluminescence on an automated immunoassay platform. Because antibodies recognizing different epitopes may recognize the multiple forms of PSA variably, there can be some discrepant PSA results between manufacturers. Known interferences that have been reported for PSA include both the Hook effect³⁰ and HAMAs.^{31,32}

Application and Pathophysiology

The best clinical use and first clinical application of PSA testing was to monitor for the progression of prostate cancer after therapy. After radical prostatectomy, serum PSA should become undetectable if the cancer is localized. In

a series of men treated by radical prostatectomy from 1982 through 1997, biochemical recurrence was found to proceed any evidence of metastatic disease by nearly 8 years.³³ This use of PSA to monitor cancer progression has also been found useful after radiation or endocrine therapy.³⁴

CASE STUDY 31-4

A 52-year-old man presented for an annual physical in January 2007, where a screening PSA and DRE were performed. A serum PSA of 7.0 was detected, and on DRE, asymmetric nodules were detected (see Case Study Fig. 31-4.1). A transrectal biopsy, the gold standard for prostate cancer diagnosis, revealed the presence of carcinoma. A radical prostatectomy was performed in February, where the preoperative PSA level was 7.1.

Questions

1. Was a prostatectomy performed on this patient because of an elevated PSA?
2. Is there any evidence for residual disease or recurrence in this patient?
3. Why was PSA testing delayed for 1 month after the prostatectomy?

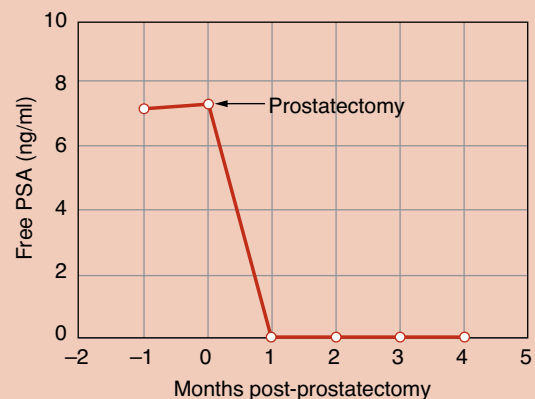

CASE STUDY FIGURE 31-4.1. Time course of serum PSA after radical prostatectomy. Because PSA is produced exclusively in the prostate gland, radical prostatectomy in this patient resulted in PSA levels below the level of detection of the assay. The half-life of PSA is 2–3 days, which generally requires approximately 1 month for this drop to occur. At 3 months after prostatectomy, this patient's PSA levels were undetectable (generally <0.1–0.3 ng/mL), indicating that residual disease was not present. After the first year of surgery, PSA levels should be taken every 3 months (as shown). During the second year, it will be taken every 4 months, and after that, every 6 months. Any increase in PSA strongly indicates the recurrence of disease, with a delay in clinical symptoms 1–5 years.

SUGGESTED READINGS

- Diamandis EP, Fritsche HA, Lilja H, et al. Tumor markers: physiology, pathobiology, technology, and clinical applications. Washington, DC: AACC Press, 2002.
- Wu JT. circulating tumor markers of the new millennium: target therapy, early detection, and prognosis. Washington, DC: AACC Press, 2002.

REFERENCES

- National Cancer Institute, Statistical Research and Applications Branch. DevCan: probability of developing or dying of cancer software version 6.1.0. Retrieved October 20, 2008, from <http://srab.cancer.gov/devcan/>.
- Abeloff MD. Clinical oncology. 2nd ed. New York: Churchill Livingstone, 2000.
- Hanahan D, Weinberg RA. The hallmarks of cancer. *Cell* 2000;100:57–70.
- Clinical and Laboratory Standards Institute. Standards and guidelines for clinical laboratories. Retrieved October 20, 2008, from www.clsi.org.
- Klee GG. Human anti-mouse antibodies. *Arch Pathol Lab Med* 2000;124:921–923.
- Harris L, Fritsche H, Mennel R, et al. American Society of Clinical Oncology 2007 update of recommendations for the use of tumor markers in breast cancer. *J Clin Oncol* 2007;25:5287–5312.
- Bader D, Riskin A, Vafsi O, et al. Alpha-fetoprotein in the early neonatal period—a large study and review of the literature. *Clin Chim Acta* 2004;349:15–23.
- Gupta S, Bent S, Kohlwes J. Test characteristics of alpha-fetoprotein for detecting hepatocellular carcinoma in patients with hepatitis C. A systematic review and critical analysis. *Ann Intern Med* 2003;139:46–50.
- Wu JT. Serum alpha-fetoprotein and its lectin reactivity in liver diseases: a review. *Ann Clin Lab Sci* 1990;20:98–105.
- Diamandis EP, Hoffman BR, Sturgeon CM. National Academy of Clinical Biochemistry Laboratory Medicine Practical Guidelines for the Use of Tumor Markers. *Clin Chem* 2008;54:1935–1939.
- Raghavan D. Germ cell tumors. BC Decker: London, Ontario, 2003.
- Yin BW, Lloyd KO. Molecular cloning of the CA125 ovarian cancer antigen: identification as a new mucin, MUC16. *J Biol Chem* 2001;276:27371–27375.
- Duffy MJ, Bonfrer JM, Kulpa J, et al. CA125 in ovarian cancer: European Group on Tumor Markers guidelines for clinical use. *Int J Gynecol Cancer* 2005;15:679–691.
- Bast RC Jr, Xu FJ, Yu YH, et al. CA 125: the past and the future. *Int J Biol Markers* 1998;13:179–187.
- Verheijen RH, von Mensdorff-Pouilly S, van Kamp GJ, Kenemans P. CA 125: fundamental and clinical aspects. *Semin Cancer Biol* 1999;9:117–124.
- Duffy MJ, van Dalen A, Haglund C, et al. Clinical utility of biochemical markers in colorectal cancer: European Group on Tumour Markers (EGTM) guidelines. *Eur J Cancer* 2003;39:718–727.
- Bower M, Rustin G. Serum tumor markers and their role in monitoring germ cell cancers of the testis. In Vogelzang N, Scardino P, Shipley W, Coffey D, eds. *Comprehensive textbook of genitourinary oncology*. 2nd ed. Philadelphia: Lippincott Williams & Wilkins, 2000:931.
- Cole LA, Sutton JM, Higgins TN, Cembrowski GS. Between-method variation in human chorionic gonadotropin test results. *Clin Chem* 2004;50:874–882.
- Smith RA, Cokkinides V, Eyre HJ. American Cancer Society guidelines for the early detection of cancer, 2006. *CA Cancer J Clin* 2006;56:11–25; quiz 49–50.
- Loeb S, Catalona WJ. Prostate-specific antigen in clinical practice. *Cancer Lett* 2007;249:30–39.
- Herschman JD, Smith DS, Catalona WJ. Effect of ejaculation on serum total and free prostate-specific antigen concentrations. *Urology* 1997;50:239–243.
- Crawford ED, Schutz MJ, Clejan S, et al. The effect of digital rectal examination on prostate-specific antigen levels. *JAMA* 1992;267:2227–2228.
- Chybowski FM, Bergstralh EJ, Oesterling JE. The effect of digital rectal examination on the serum prostate specific antigen concentration: results of a randomized study. *J Urol* 1992;148:83–86.
- Collins GN, Martin PJ, Wynn-Davies A, et al. The effect of digital rectal examination, flexible cystoscopy and prostatic biopsy on free and total prostate specific antigen, and the free-to-total prostate specific antigen ratio in clinical practice. *J Urol* 1997;157:1744–1747.
- Tarhan F, Orcun A, Kucukercan I, et al. Effect of prostatic massage on serum complexed prostate-specific antigen levels. *Urology* 2005;66:1234–1238.
- Thompson IM, Goodman PJ, Tangen CM, et al. The influence of finasteride on the development of prostate cancer. *N Engl J Med* 2003;349:215–224.
- Thompson IM, Pauler DK, Goodman PJ, et al. Prevalence of prostate cancer among men with a prostate-specific antigen level < or =4.0 ng per milliliter. *N Engl J Med* 2004;350:2239–2246.
- Roobol MJ, Kirkels WJ, Schroder FH. Features and preliminary results of the Dutch centre of the ERSPC (Rotterdam, the Netherlands). *BJU Int* 2003;92(suppl 2):48–54.
- Hayes RB, Reding D, Kopp W, et al. Etiologic and early marker studies in the Prostate, Lung, Colorectal and Ovarian (PLCO) cancer screening trial. *Control Clin Trials* 2000;21(6 suppl): 349S–355S.
- Akamatsu S, Tsukazaki H, Inoue K, Nishio Y. Advanced prostate cancer with extremely low prostate-specific antigen value at diagnosis: an example of high dose hook effect. *Int J Urol* 2006;13: 1025–1027.
- Park S, Wians FH Jr, Cadeddu JA. Spurious prostate-specific antigen (PSA) recurrence after radical prostatectomy: interference by human antimouse heterophile antibodies. *Int J Urol* 2007;14: 251–253.
- Descotes JL, Legeais D, Gauchez AS, et al. PSA measurement following prostatectomy: an unexpected error. *Anticancer Res* 2007; 27:1149–1150.
- Pound CR, Partin AW, Eisenberger MA, et al. Natural history of progression after PSA elevation following radical prostatectomy. *JAMA* 1999;281:1591–1597.
- Roach M 3rd, Hanks G, Thames H Jr, et al. Defining biochemical failure following radiotherapy with or without hormonal therapy in men with clinically localized prostate cancer: recommendations of the RTOG-ASTRO Phoenix Consensus Conference. *Int J Radiat Oncol Biol Phys* 2006;65:965–974.

Nutritional Assessment

Linda S. Gorman, Maria G. Boosalis

CHAPTER

32

CHAPTER OUTLINE

■ NUTRITION CARE PROCESS: OVERVIEW

■ NUTRITION ASSESSMENT

■ BIOCHEMICAL MARKERS

Macronutrients

■ CARBOHYDRATES

Urine Testing

Tests to Monitor Electrolyte Disturbances

■ MICRONUTRIENTS

Vitamins

Fat-Soluble Vitamins

Water-Soluble Vitamins

■ MINERAL METABOLISM—CALCIUM/PHOSPHORUS

Mineral Tests to Monitor

■ TRACE MINERALS

Trace Elements to Monitor

■ REFERENCES

NUTRITION CARE PROCESS: OVERVIEW

The *nutrition care process (NCP)* is defined as “a systemic problem-solving method that dietetic professionals use to critically think and make decisions to address nutrition-related problems and provide safe and effective quality nutrition care.”¹ In other words, this process is the systematic approach used by the registered dietitian (RD) to identify, diagnose, and treat any nutrition-related problems or disorders.

There are four components to the NCP: nutrition assessment; nutrition diagnosis; nutrition intervention, and nutrition monitoring and evaluation.¹

The focus of this chapter is the first component of the NCP, specifically nutrition assessment. *Nutrition assessment* is defined as a “systematic process of obtaining, verifying, and interpreting data in order to make decisions about the nature and cause of nutrition-related problems.”¹ Nutrition assessment includes the “A–Es of assessment.”²

A—anthropometric or body composition measurements

B—biochemical analyses, the prime focus of this chapter

C—clinical examination usually performed by the physician or other health care provider

D—dietary analysis and assessment to determine usual food intake generally performed by the RD

E—environmental assessment, which includes a consideration of all the other aspects of the individual’s

environment that may affect his/her ability to purchase, prepare, and consume food.

NUTRITION ASSESSMENT

A. Anthropometric measurements include, at minimum, the measurement of height and weight and from those two measurements, the calculation of the **body mass index [BMI]**. The BMI “describes relative weight for height, is significantly correlated with total body fat content” and should be “used to assess overweight and obesity and to monitor changes in body weight.”³

Other measurements in this category that are helpful, especially when assessing an individual, include a weight history (amount or percentage of gain versus loss; intentional versus unintentional) and possibly a waist circumference measurement (to help identify additional comorbidity risk and the presence of metabolic syndrome).

Other anthropometric or body composition measurements that belong in this category include skinfold thickness, hydrostatic weighing, air-displacement plethysmography, dual energy x-ray absorptiometry (DEXA), and bioelectrical impedance analysis (BIA), all of which are beyond the scope of this chapter. All of these different types of measurements are used to determine the percentage of fat, lean body muscle, water, and/or bone mineral density in the human body.

Until this epidemic of overweight/obesity lessens, approximately two of every three individuals measured may be either overweight (BMI 25–29.9 kg/m²) or obese (BMI ≥30 kg/m²) by National Heart, Lung, and Blood Institute (NHLBI) standards. On the other side of the spectrum is the individual who may be malnourished/undernourished and possibly also underweight (BMI <18.5 kg/m²).

B. Biochemical assessment/markers are divided into macronutrients and micronutrients. The macronutrients include markers of carbohydrate, protein, and fat metabolism and utilization. How these markers change during inflammation and disease can be important to know if treatment is to be effective. Health care providers appreciate the clinical laboratory assessment of these markers and expect to receive the results in a timely manner. Micronutrients measurements are often the more difficult to obtain and yet may hold the key to why a patient straddles the fence between health and illness. Insufficient or excessive vitamins and/or excess or deficient minerals can have a serious impact on the enzymes and biochemistry of the human body. In particular, trace elements or minerals are especially important to many biologically significant metabolic reactions.

There is a close interrelationship between the function of certain organs in the body and **nutrient** balance/imbalance, both positive and negative. Liver function will be affected if there is insufficient protein and excess fats. Liver function within normal limits is critical to the adequate processing of ingested protein and fats and the packaging/storage of certain vitamins and minerals. An excessive intake of protein may also be harmful to kidney function due to the excess of nonprotein nitrogen compounds formed that must then be removed. On the other hand, normal renal function is critical to amount of protein, sodium, and fluids that can be consumed. Other nutrient imbalances can affect the heart (fats, water imbalances, vitamin deficiencies or excesses, selenium, etc.), pancreas, and/or other glands. The thyroid in particular requires adequate tyrosine levels for hormone synthesis but also requires adequate iron levels as enzyme cofactors for the formation and degradation of T₄ and T₃.⁴

In addition, during hospitalization, biomarkers enable the health care team to monitor and detect acute stress and other systemic inflammatory conditions. The acute-phase reactant proteins and other circulating vitamins and/or minerals that are monitored can help pinpoint patients at risk and in need of nutritional intervention and aid in the identification of the systemic inflammatory response syndrome (SIRS).^{5–12} In addition, signs of a chronic inflammatory state can be ascertained with the aid of clinical laboratory tests.¹³

Assessing the biomarkers in nutritional assessment is the responsibility of the clinical laboratory professional. These are discussed individually in a later section of this chapter.

C. The clinical component of the nutrition assessment consists of the history of present illness, the past medical history, and an inquiry into the family history. It also includes the physical examination and a careful review of systems looking for signs of disease/illness. It includes a measurement of blood pressure as well as presence of any physical limitations/restrictions regarding physical movement/activity.

For example, the *review of systems (ROS)* is a head-to-toe examination looking for signs of **malnutrition** and/or disease. For instance, ease of pluckability of hair (>8–10 hairs at one time) may indicate a protein deficiency that requires biochemical verification via measurement of circulating proteins such as albumin, transthyretin, etc. Changes in vision such as night blindness or Bitot's spots may indicate a deficiency of vitamin A.

Metabolic syndrome is defined by utilizing information derived from the first three components (A–C) of a nutrition assessment. Specifically, the presence of three or more of any of the following parameters defines the presence of the metabolic syndrome in an individual according to the American Heart Association and the NHLBI.¹⁴ These parameters include:

1. An elevated waist circumference. In women, ≥35 inches (88 cm); in men, ≥40 inches (102 cm)
2. Elevated triglyceride levels, i.e., ≥150 mg/dL
3. Elevated fasting glucose, i.e., ≥100 mg/dL
4. Reduced HDL cholesterol. In women, <50 mg/dL; in men, <40 mg/dL
5. Elevated blood pressure, i.e., ≥130/85 mm Hg

D. The dietary component of the nutritional assessment strives to determine the adequacy of the usual day's intake with respect to nutritional recommendations that are specific for an individual's age, gender, level of physical activity, and particular health conditions. In addition, if there are any specific dietary needs that must be met, a determination if these needs are met must also be included. There are several ways to assess adequacy of intake—by general food groupings and respective servings using the USDA Food Guidance System MyPyramid eating plans¹⁵ or via specific nutrients compared with the Dietary Reference Intake recommendations (**Recommended Dietary Allowance [RDA]**, adequate intake [AI], and or tolerable upper limits [UL]).¹⁶ Examples of tools used by the RD to determine dietary adequacy include the 24-hour recall, the 3-day food record or diary, and/or the food frequency questionnaire. Again, specific details of each methodology are beyond the scope of this chapter.

E. The environmental assessment takes into consideration all aspects of an individual's environment or living conditions that may affect his or her ability to purchase, prepare, and/or consume food.

For example, it includes financial status to determine if money is a limiting factor to obtaining one's nutritional needs/adequate nutrition.

An individual's physical living conditions (e.g., adequate cooking skills, preparation supplies, running water, etc.), social support system, and religious beliefs (especially if it prevents the individual from consuming certain food groups) are other types of information included.

This assessment also evaluates the highest level of education attained to tailor educational materials and message. In essence, any aspect of the environment that may affect the ability to purchase, prepare, and/or consume food is included in this evaluation.

The information obtained from all A–E aspects of a complete nutrition assessment are then summarized and reviewed by the RD or other health care professional to determine a nutrition diagnosis, the next step in the NCP. Once the nutrition diagnosis is made, a plan for the nutrition intervention is designed and implemented followed by monitoring and evaluation as the last component of the NCP.

BIOCHEMICAL MARKERS

Macronutrients

Proteins

Protein Markers in Nutritional Assessment

The primary objective of nutritional assessment is to identify the patient who is malnourished and then, through nutritional therapy, to preserve or replenish the protein component of the body. Laboratory nutritional assessment is best accomplished by monitoring selected serum proteins. The ideal proteins have a short biologic half-life and reflect changes in protein status by measuring concentration changes in the serum. The concentration of protein markers of malnutrition are affected by protein malnutrition associated with end-stage liver and renal disease and severe infection and, most significantly, by stress injury. Because the effect of the inflammatory response is closely associated with the decline of essential transport proteins, a separation of the inflammatory state from protein malnutrition can be problematic, except by using an acute-phase

reactant (APR), such as C-reactive protein. The prognostic inflammatory nutritional index (PINI), using the ratio of the CRP-orosomuroid (α_1 -acid glycoprotein) product to the albumin–transthyretin product, is intended to resolve this issue.¹⁷ Table 32-1 offers detailed information about these protein markers.

Albumin

Albumin has long been used in the assessment of hospitalized patients. The albumin concentration in the body is influenced by albumin synthesis, degradation, and distribution. Low levels of serum albumin may reflect low hepatic production or loss from transfer of albumin between the extravascular and the vascular compartment. The long biologic half-life of albumin (approximately 20 days) allows changes in the serum concentration only after long periods of malnutrition. Low albumin levels have been identified as a predictor of mortality in patients in long-term-care facilities. Hospitalized patients with low serum albumin levels experience a fourfold increase in morbidity and a sixfold increase in mortality.^{18,19}

Serum albumin is not a good indicator of short-term protein and energy deprivation; however, albumin levels are good indicators of chronic deficiency. Traditionally, albumin has been used to help determine two important nutritional states. First, it helps identify chronic protein deficiency under conditions of adequate non–protein-calorie intake, which leads to marked hypoalbuminemia. This may result from the net loss of albumin from both the intravascular and extravascular pools, causing **kwashiorkor**. Second, albumin concentrations may help define **marasmus**. Because this is caused by caloric insufficiency without protein insufficiency, the serum albumin level remains normal but there is considerable loss of body weight.

Studies have classified various levels of malnutrition by using albumin levels. Serum albumin levels of ≥ 35 g/L are considered normal. Albumin levels of 28–30 to 35 g/L indicate mild malnutrition, levels of 23–25 to 28–30 g/L indicate moderate malnutrition, and levels less than 23–25 g/L indicate severely depleted levels of albumin. Serum albumin is an accurate marker of the catabolic stress of infection. A level of ≤ 32 g/L indicates that if a

TABLE 32-1 CHARACTERISTICS OF PLASMA PROTEINS OF NUTRITIONAL INTEREST

| PROTEIN | MOLECULAR WEIGHT (kD) | HALF-LIFE | REFERENCE RANGE |
|----------------------------|-----------------------|-----------|-----------------|
| Albumin | 65,000 | 20 days | 33–48 g/L |
| Fibronectin | 250,000 | 15 hours | 220–400 mg/L |
| Prealbumin (transthyretin) | 54,980 | 48 hours | 160–350 mg/L |
| Retinol-binding protein | 21,000 | 12 hours | 30–60 mg/L |
| Insulin growth factor-1 | 7,650 | 2 hours | 0.10–0.40 mg/L |
| Transferrin | 76,000 | 9 days | 1.6–3.6 g/L |

patient is in the hospital for up to 10 days, there is a 75% chance of developing decubitus ulcers. Serum albumin levels of less than 25 g/L can be used as an accurate measure of predicting survival prognosis in 90% of critically ill patients.

Transferrin

Transferrin is a glycoprotein with a biologic half-life of approximately 9 days (shorter than albumin). It is synthesized in the liver and binds and transports ferric iron. Transferrin synthesis is regulated by iron stores. When hepatocyte iron is absent or low, transferrin levels rise in proportion to the deficiency. It is an early indicator of iron deficiency, and the elevated transferrin is the last analyte to return to normal when iron deficiency is corrected.

The half-life of transferrin is approximately one half that of albumin, and the body pool is smaller than that of albumin; therefore, transferrin is more likely to indicate protein depletion before serum albumin concentration changes. The usefulness of transferrin in diagnosis of subclinical, marginal, or moderate malnutrition is questionable, however, because a wide range of values have been reported in various studies. Transferrin levels can be lowered by factors other than protein or energy deficiency, such as nephrotic syndrome, liver disorders, anemia, and neoplastic disease.

In hospital and nursing home settings, transferrin levels have been used as indices of morbidity and mortality.²⁰ Information shows, however, that serum transferrin concentrations are not sufficiently sensitive to detect a change in nutritional status that occurs after 2 weeks of total parenteral nutrition.²¹ In addition to being responsive to serum iron concentrations, transferrin is uniquely sensitive to some antibiotics and fungicides.

Transthyretin

Transthyretin is sometimes called thyroxine-binding prealbumin or prealbumin because it migrates ahead of albumin in the customary electrophoresis of serum or plasma proteins. In normal situations, each transthyretin subunit contains one binding site for retinol-binding protein (RBP). Transthyretin and RBP are considered the major transport proteins for thyroxine and vitamin A, respectively.

Because of its short half-life and small body pool, transthyretin is a better indicator of visceral protein status and positive nitrogen balance than albumin and transferrin.²¹ Transthyretin is a superior indicator for monitoring short-term effects of nutritional therapy. The concentration of transthyretin and RBP complex, greatly decreased in protein-energy malnutrition,²² returns toward normal values after nutritional replenishment. Transthyretin has a low pool concentration in the serum, a half-life of 2 days, and a rapid response to low energy intake, even when protein intake is inadequate

for as few as 4 days.²³ Serum transthyretin concentrations are decreased postoperatively by 50–90 mg/L in the first week, with the ability to double in 1 week or at least increase 40–50 mg/L in response to adequate nutritional support. If the transthyretin response increases less than 20 mg/L in 1 week as an outcome measure, this indicates either inadequate nutritional support or inadequate response.^{21,24}

When transthyretin decreases to levels of less than 80 mg/L, severe protein-calorie malnutrition develops; however, nutritional support can cause a daily increase in transthyretin of up to 10 mg/L.²¹ These concentrations do not appear to be significantly influenced by fluctuations in the hydration state. Although end-stage liver disease appears to affect all protein levels in the body, liver disease does not affect transthyretin as early or to the same extent as it affects other serum protein markers, particularly RBP. Although transthyretin levels may be elevated in patients with renal disease, if a trend in the direction of change is noted, the changes are likely to reflect alteration in nutritional status and nitrogen balance. Steroids can cause a slight elevation in transthyretin, but the nutritional trend can still be followed because transthyretin responds to both overfeeding and underfeeding.

Transthyretin is also used as an indicator of the adequacy of a nutritional feeding plan²¹ because changes in plasma protein are correlated with nitrogen balance. Transthyretin concentrations increase in patients with positive nitrogen balance and decrease in patients with negative nitrogen balance. When the transthyretin level is at ≥ 180 mg/L, this correlates with a positive nitrogen balance and indicates a return to adequate nutritional status. It has been shown in both the pediatric and neonate population to be a highly accurate and relatively inexpensive marker for nutritional status^{25,26} and has been found to be the most sensitive and helpful indicator when looking at the nutritional status of very ill patients.²⁷

In summary, transthyretin effectively demonstrates an anabolic response to feeding and is a good marker for visceral protein synthesis in patients receiving metabolic or nutritional support.^{27–29}

Retinol-Binding Protein

RBP has been used in monitoring short-term changes in nutritional status.^{30–32} Its usefulness as a metabolic marker is based on its biologic half-life of 12 hours and its small body pool size. As a single polypeptide chain, RBP interacts strongly with plasma transthyretin and circulates in the plasma as a 1:1 mol/L transthyretin–RBP complex.³³ A potential problem exists in using RBP as a nutritional marker, however. Although RBP has a shorter half-life than transthyretin (12 hours, compared with 2 days), it is excreted in urine, and its concentration increases more significantly than transthyretin in patients with renal failure. In contrast to RBP, transthyretin concentration

is only moderately elevated in advanced chronic renal insufficiency.

Insulin Growth Factor I

Insulin growth factor-1 (IGF-1) (formerly termed somatomedin C) is important for stimulation of growth. The molecular size and structure of IGF-1 is similar to proinsulin.³⁴ IGF-1 serum concentrations are regulated by growth hormone and nutritional intake. Growth hormone stimulates the liver to produce IGF-1, which circulates bound to IGF-BP3. IGF-BP3 modulates the biologic effect of IGF-1 in the stress response, causing both decreases and increases in biologic activity. IGF-1 has been used as a nutritional marker in adults and children.^{35–37}

Fibronectin

Fibronectin is an opsonic glycoprotein with a half-life in humans of about 15 hours. This protein has repeating blocks of a homogeneous sequence of amino acids and is an α_2 -glycoprotein that serves important roles in cell-to-cell adherence and tissue differentiation, wound healing, microvascular integrity, and opsonization of particulate matter. It is considered the major protein regulating phagocytosis. Synthesis sites include endothelial cells, peritoneal macrophages, fibroblasts, and the liver. Fibronectin concentrations may decrease after physiologic damage caused by severe shock, burns, or infection. Levels return to normal on recovery. Fibronectin is of interest because it is not exclusively synthesized in the liver,³⁸ and it is an indicator of sepsis in burn patients. Fibronectin levels have been shown to decrease during infection or severe stress, partly due to its opsonic property. The infection or trauma, however, does not significantly decrease fibronectin concentration.³⁹ Fibronectin only increases in severe infection, in which it remains flat and does not increase as soon as IGF-1. It is not routinely used as a nutritional marker.

Nitrogen Balance

Another nutritional evaluation tool, **nitrogen balance**, is the difference between nitrogen intake and nitrogen excretion. It is one of the most widely used indicators of protein change and/or adequacy of feeding in a controlled setting. In the healthy adult population, anabolic and catabolic rates are in equilibrium, and the nitrogen balance approaches zero. During stress, trauma, or burns, the nutritional intake decreases, and due to an increase in **catabolism**, nitrogen losses increase and may exceed intake, leading to a negative nitrogen balance. During recovery from illness, the nitrogen balance should become positive with either enteral or parenteral nutrition support. In humans, 90%–95% of the daily nitrogen loss is accounted for by elimination through the kidneys. About 90% of this loss is in the form of urea. Therefore, the determination of 24-hour urinary urea nitrogen (UUN) is a method for estimating the amount of

nitrogen excretion. The nitrogen balance is calculated as follows⁴⁰:

$$\text{Nitrogen balance} = \frac{24\text{-hour protein intake (g)}}{6.25} - \frac{24\text{-hour UUN} + 4}{\text{Total volume (L)}} \quad (\text{Eq. 32-1})$$

Protein intake includes grams of protein that are provided by intravenous amino acids or by **enteral feeding**. Protein intake (in grams) is converted into grams of nitrogen by dividing by 6.25. The factor of 4 in the equation represents an estimation of nonurinary losses of nitrogen (e.g., from skin, feces, hair, and nails).⁴⁰ Nitrogen balance, as calculated by this equation, is not valid in patients with severe stress or sepsis, as can be seen in critical care areas or in patients with renal disease. Determining the validity of this equation in other clinical conditions involving normally high nitrogen losses may be difficult or even incorrect.

C-Reactive Protein

C-reactive protein is an acute-phase protein that increases dramatically under conditions of sepsis, inflammation, and infection. C-reactive protein can increase dramatically up to 1,000 times after tissue injury, which are more than two or three orders of magnitude greater than any other acute-phase reactant. C-reactive protein rises in concentration 4–6 hours before other acute-phase reactants begin to rise.^{5,11,13,41,42}

The flow phase of marked catabolism presents clinically with tachycardia, fever, increased respiratory rate, and increased cardiac output. During this time, synthesis rates of C-reactive protein and other acute-phase proteins increase and albumin and prealbumin decrease.⁵ Even with this increase in acute-phase proteins, a significant negative nitrogen balance usually occurs secondary to the greater protein catabolism.⁴⁴ Whether this catabolic state produces a clinically defined malnutrition or a separate entity is unknown, but it certainly produces weight loss with decreased albumin and prealbumin levels.

Interleukins

Nutrition research has focused on the interleukins, a complex group of proteins and glycoproteins that can exert pleiotropic effects on several different target cells. Most interleukins are produced by macrophages and T-lymphocytes, in response to antigenic or mitogenic stimulation, and affect primary T-lymphocyte function. Most nutritional investigations have been performed on interleukin-1 (IL-1), IL-6, and tumor necrosis factor- α (TNF- α). Interleukins in general are involved in many reactions and body systems, both of which are beyond the scope and purpose of this chapter.

Total Parenteral Nutrition

Total parenteral nutrition (TPN) is a widely used means of intense nutritional support for patients who

are malnourished, or in danger of becoming malnourished, because they are unable to consume required nutrients or to take nutrients enterally (i.e., by mouth). Parenteral nutrition therapy involves administering appropriate amounts of carbohydrate, amino acid, and lipid solutions, as well as electrolytes, vitamins, minerals, and trace elements, to meet the caloric, protein, and nutrient requirements while maintaining water and electrolyte balance.⁴⁵ Parenteral nutritional preparations are usually administered through a subclavian catheter. Preferably, an individual will eat by mouth or a feeding tube that is placed either in the stomach or ideally, the upper duodenum. These aforementioned tube feedings deliver nutrients. Patients may also have gastrointestinal surgery to have a feeding gastrostomy or jejunostomy catheter put in place during the surgical procedure. Because TPN administration bypasses normal absorption and circulation routes, careful laboratory monitoring of these patients is critical. The goal is to provide optimal nutritional status by whatever routes nutrients are administered. An unintended weight loss of more than 10%–12% leads to suspicion of either disease or malnutrition. The patient's height, age, and activity level are also considered.⁴⁶

It is important to monitor the TPN patient to avoid possible complications. Such laboratory monitoring provides necessary information needed to properly administer TPN therapy.

CARBOHYDRATES

Urine Testing

In small premature infants, glycosuria during the early phase of TPN is a signal that glucose infusion is too rapid. If glucose appears in the urine of small infants after glucose tolerance has been established, however, the clinician should question the presence of respiratory disease, sepsis, or cardiovascular changes.

Tests to Monitor Electrolyte Disturbances

Sodium regulation is a problem in children during TPN. Daily sodium requirements may vary depending on renal maturity and the ability of the child's body to regulate sodium. Factors that increase the amount of sodium necessary to maintain normal serum sodium concentrations in both children and adults are glycosuria, diuretic use, diarrhea or other excessive gastrointestinal losses, and increased postoperative fluid losses.

Hyperkalemia is a common problem in children when blood is obtained by heel stick. The squeezing of the heel may cause red cell hemolysis, resulting in falsely high serum potassium levels. Although adequate nutrition may be supplied to promote **anabolism**, hypokalemia may develop as the extracellular supply is used for cell synthesis.

The primary function of chloride is osmotic regulation. Hyperchloremia metabolic acidosis is a problem when crystal amino acid solutions are used, but such acidosis can be prevented or treated by altering the amount of chloride salt in the parenteral nutrition solution. Supplying some of the sodium and potassium requirements as acetate or phosphate salts can reduce the required amount of chloride. The reformulation of synthetic amino acid solutions by commercial manufacturers has helped to avoid this serious complication. If hyperchloremia metabolic acidosis does occur, treatment with sodium and potassium acetate solutions is used because acetate is metabolized rapidly to bicarbonate. Acetate salts are compatible with all other common parenteral nutrition components and are ideal to use when acidosis is present. Sodium bicarbonate cannot be used in parenteral nutrition solutions containing calcium because calcium carbonate readily precipitates. The use of acetate not only increases serum bicarbonate but also decreases the amount of chloride delivered to the patient.

MICRONUTRIENTS

Vitamins

Vitamins have a wide range of functions in biologic tissue, serving as cofactors in many enzymatic reactions, so that these enzymes have low catalytic activity in cellular reactions if vitamins are not present. These compounds and their biologically inactive precursors must be partially obtained from food sources and, in some instances, from bacterial synthesis. When vitamin cellular and activity levels from diet or intestinal absorption are inadequate, it is termed vitamin deficiency. The term *vitamin* has an historical basis in deficiency states that were relieved by specific food intake. The most notable examples are **scurvy** (vitamin C, sailors and lime consumption, limeys); **rickets** (vitamin D in the early industrial age); **beriberi** (alcoholics and thiamine); **pellagra** (niacin and **night blindness**, vitamin A); **megaloblastic anemia**, (folic acid); **spina bifida**; and **pernicious anemia** (with neuropathy, vitamin B₁₂). Abnormal increases of metabolism requiring high supplies of one of these cofactors may be termed *vitamin insufficiency* or *vitamin dependency*, depending on the level of supply demanded for physiologic function.^{47,48}

Variabilities in clinical expression of vitamin abnormalities result from differences in specific cause, degree, and duration of vitamin inadequacy; the simultaneous presence of nutritional insufficiencies; and increased metabolic demands imposed by conditions such as pregnancy, infection, and cancer. The clinical symptoms of vitamin deficiencies are usually nonspecific in early stages and in mild, chronic deficiency states. A combination of dietary history, physical examination, and laboratory measurements is often required to diagnose vitamin deficiency. Vitamin

metabolism is complex and vitamin supplementation of foods is common. It is not unusual to find vitamin toxicities from inappropriate use of vitamin supplementation.

For simplicity, vitamins of diverse chemical structure are classified as either water soluble or fat soluble. Fat-soluble vitamins include A, D, E, and K. Those vitamins soluble in water include the B complex of vitamins—thiamine, riboflavin, niacin, vitamins B₆ and B₁₂, biotin, folate, and vitamin C. Water-soluble vitamins are readily excreted in the urine and are less likely than fat-soluble vitamins to accumulate to toxic levels in the body. Vitamins, classified as fat or water soluble, and the symptoms usually seen in deficiency states are shown in Table 32-2.⁴⁹

Investigating the dietary deficiency of vitamins (**hypovitaminosis**) is sustained primarily from knowledge of dietary sources and dietary practices that produce inadequate intake or absorption. In the early 1990s, the Food and Nutrition Board of the Institute of Medicine began the process of reviewing the previous nutritional recommendations known as RDAs to also include the prevention of chronic diseases. In addition, besides the RDA, there are additional categories such as estimated average requirement (EAR), AI, and tolerable upper intake level (UL).^{50–52}

Chemical determination of human vitamin states has been approached in the following ways:

- Measurement of active cofactors or precursors in biologic fluids or blood cells
- Measurement of urinary metabolites of the vitamin
- Measurement of a biochemical function requiring the vitamin (e.g., enzymatic activity), with and without in vitro addition of the cofactor form
- Measurement of urinary excretion of vitamin or metabolites after a test load of the vitamin
- Measurement of urinary metabolites of a substance, the metabolism of which requires the vitamin after administration of a test load of the substance

Reduced serum concentrations of a vitamin do not always indicate a deficiency that interrupts cellular function. Conversely, values within the reference interval do not always reflect adequate function. Interpretation of laboratory values must be done with knowledge of the biochemistry and physiology of vitamins.^{53–55}

Fat-Soluble Vitamins

Vitamin A

Retinol and retinoic acid are derived directly from dietary sources, primarily as retinyl esters, or from metabolism of dietary carotenoids (provitamin A), primarily beta carotene. Major dietary sources of these compounds include animal products and pigmented fruits and vegetables (carotenoids). Vitamin A is stored in the liver and

TABLE 32-2 VITAMIN AND DEFICIENCY STATES

| VITAMIN NAME | CLINICAL DEFICIENCY |
|-------------------------------|--|
| FAT-SOLUBLE VITAMINS | |
| Vitamin A ₁ | Night blindness, growth retardation, abnormal taste response, dermatitis, recurrent infections |
| Vitamin E | Mild hemolytic anemia (newborn), red blood cell fragility, ataxia |
| Vitamin D | Rickets (young), osteomalacia (adult) |
| Vitamin K | Hemorrhage (ranging from easy bruising to massive bruising), especially post-traumatic bleeding |
| WATER-SOLUBLE VITAMINS | |
| Vitamin B ₁ | Infants: dyspnea, cyanosis, diarrhea, vomiting Adults: beriberi (fatigue, peripheral neuritis), Wernicke-Korsakoff syndrome (apathy, ataxia, visual problems) |
| Vitamin B ₂ | Angular stomatitis (mouth lesions), dermatitis, photophobia, neurologic changes |
| Vitamin B ₆ | Infants: irritability, seizures, anemia, vomiting, weakness Adults: facial seborrhea |
| Niacin/niacinamide | Pellagra (dermatitis, mucous membrane inflammation, weight loss, disorientation) |
| Folic acid | Megaloblastic anemia |
| Vitamin B ₁₂ | Megaloblastic anemia, neurologic abnormalities |
| Vitamin C | First, vague aches and pains; if long term, scurvy (hemorrhages into skin, alimentary and urinary tract, anemia, wound healing delayed) |

transported in the circulation complexed to RBP and transthyretin. Vitamin A and related retinoic acids are a group of compounds essential for vision, cellular differentiation, growth, reproduction, and immune system function. A clearly defined physiologic role for retinol is in vision. Retinol is oxidized in the rods of the eye to retinal, which, when complexed with opsin, forms rhodopsin, allowing dim-light vision. This vitamin and vitamin D act

through specific nuclear receptors in the regulation of cell proliferation. Vitamin A deficiency leads to night blindness (nyctalopia) and, when prolonged, may cause total blindness. In vitamin A deficiency states, epithelial cells (cells in the outer skin layers and cells in the lining of the gastrointestinal, respiratory, and urogenital tracts) become dry and keratinized. Fruits and vegetables contain carotene, which is a precursor of retinol. Carotenes provide more than one-half of the retinol requirements in the American diet. Vitamin A deficiency is most common among children living in nonindustrialized countries and is usually a result of insufficient dietary intake. Deficiency may also occur because of chronic fat malabsorption or impaired liver function or may be associated with severe stress and protein malnutrition. Premature infants are born with lower serum retinol and RBP levels, as well as lower hepatic stores of retinol; therefore, these newborns are treated with vitamin A as a preventive measure.^{55,58}

When ingested in high doses, either chronically or acutely, vitamin A causes many toxic manifestations and may ultimately lead to liver damage due to **hypervitaminosis**. High doses of vitamin A may be obtained from excessive ingestion of vitamin supplements or large amounts of liver or fish oils, which are rich in vitamin A. Carotenoids, however, are not known to be toxic because of a reduced efficiency of carotene absorption at high doses and limited conversion to vitamin A. The RDA of vitamin A is 900 μg per day for adult males and 700 μg per day for adult females.⁵⁷ Measurement of retinol is the most common means of assessing vitamin A status in the clinical setting. Retinol is most commonly measured by high-performance liquid chromatography (HPLC). Toxicity is usually assessed by measuring retinyl ester levels in serum rather than retinol, which is accomplished by HPLC.⁵⁸

Vitamin E

Vitamin E is a powerful antioxidant and the primary defense against potentially harmful oxidations that cause disease and aging, protecting unsaturated lipids from peroxidation (cleavage of fatty acids at unsaturated sites by oxygen addition across the double bond and formation of free radicals). The role of vitamin E in protecting the erythrocyte membrane from oxidant stress is presently the major documented role of vitamin E in human physiology. It has been shown to strengthen cell membranes and augment such functions as drug metabolism, heme biosynthesis, and neuromuscular function. The generic name for vitamin E is tocopherol, which includes several biologically active isomers.⁵⁹ Alpha-tocopherol is the predominant isomer in plasma and the most potent isomer by current biologic assays. About 40% of ingested tocopherol is absorbed, affected mainly by the amount and degree of unsaturated dietary fat, largely determining the physiologic requirement. Absorbed vitamin E is associated with

circulating chylomicrons, very-low-density lipoprotein, and chylomicron remnants. Dietary sources of tocopherols include vegetable oil, fresh leafy vegetables, egg yolk, legumes, peanuts, and margarine. Diets suspect for vitamin E deficiency are those low in vegetable oils, fresh green vegetables, or unsaturated fats.

The major symptom of vitamin E deficiency is hemolytic anemia. Although the use is still controversial, premature newborns are commonly supplemented with vitamin E to stabilize red blood cells and prevent hemolytic anemia. There is evidence for preventive roles of vitamin E in retrolental fibroplasia, intraventricular hemorrhage, and mortality of small, premature infants. Premature infants receiving vitamin E in amounts that sustain serum levels above 30 mg/L have an increased incidence of sepsis and necrotizing enterocolitis.⁵⁹

Patients with conditions that result in fat malabsorption, especially cystic fibrosis and abetalipoproteinemia, are also susceptible to vitamin E deficiency.⁵⁶ A relationship exists between vitamin E deficiency and progressive loss of neurologic function in infants and children with chronic cholestasis.⁵⁶ Absorption of dietary vitamin E is most efficient in the jejunum, where it combines with lipoproteins and is transported through the lymphatics. Vitamin E is stored in the liver and other tissues with high lipid content and excreted principally in the feces. Assessment of vitamin E status is, therefore, primarily indicated in newborns, patients with fat-malabsorption states, and patients receiving synthetic diets. Synergistic with two other **essential nutrients**, selenium and ascorbic acid, vitamin E is also necessary for the maintenance of normal vitamin A levels.⁵⁶ This vitamin deficiency commonly occurs in two groups: premature, very-low-birth-weight infants and patients who do not absorb fat normally. Although megadoses of vitamin E do not produce toxic effects, high doses have no proven health benefit; the RDA is 15 mg/day for adult males and/or females.⁵⁷ The most widely distributed and most biologically active form of vitamin E is alpha-tocopherol, which is the form commonly measured in the laboratory using HPLC methods.⁵⁹

Vitamin D

Vitamin D refers to a group of related metabolites used for proper skeleton formation and mineral homeostasis. Exposure of the skin to sunlight (ultraviolet light) catalyzes the formation of cholecalciferol from 7-dehydrocholesterol. The other major form of vitamin D is ergocalciferol (vitamin D₂). Vitamin D occurs in foods as cholecalciferol or ergocalciferol. The most active metabolite of vitamin D is 1,25(OH)₂D₃. It stimulates intestinal absorption of calcium and phosphate for bone growth and metabolism and, together with parathyroid hormone, stimulates bone to increase the mobilization of calcium and phosphate. 1,25(OH)₂D₃ has an important

CASE STUDY 32-1

A 4-year-old boy is brought to an Alaskan children's clinic by the Social Services System of Alaska. The child was living in a foster home. Infrequently outdoors, his diet consisted of few green vegetables, dairy products, or meats. He began walking at 14 months; his legs showed some bowing. There is tetany or convulsions. He is small for his age: 27 pounds; 90.6 cm tall; third percentile. His laboratory test results are shown in Case Study Table 32-1.1.

Questions

- This disorder is probably related to:
 - Wilson's disease.
 - maple syrup urine disease.
 - galactosemia and galactosuria.
 - some form of vitamin or mineral metabolism disorder, probably related to some vitamin D deficiency.
- The causative agent in this disease is:
 - inadequate intake of lipids and fatty acids.
 - a viral disease related to rhinovirus.
 - an abnormality related to vitamin D or inadequate intake or vitamin D resistance.
 - inadequate intake of sugar.
- The therapy that might help in this situation is:
 - vitamin D, 10,000 IU/day.
 - 5% glucose and water.
 - normal Ringer's lactate solution.
 - a diet with a high level of unsaturated fatty acids.

CASE STUDY TABLE 32-1.1
LABORATORY RESULTS

| TEST | RESULT | REFERENCE RANGE |
|----------------------|--|-----------------|
| Hgb | 14.1 g/dL | 12.0–18.0 g/dL |
| Hct | 46% | 34.0%–52.0% |
| WBC | 8.4 × 10 ³ /μL Normal differential | 4.0–11.0 μL |
| URINALYSIS | | |
| Specific gravity | 1.010 | 1.003–1.030 |
| pH | 6.8 | 5.0–9.0 |
| Glucose | Negative | Negative |
| Protein | Negative | Negative |
| Microscopic | Negative | Negative |
| Amino acid screen | Negative | Negative |
| SERUM | | |
| Na | 140 mEq/L | 132–143 mEq/L |
| K | 4.0 mEq/L | 3.2–5.7 mEq/L |
| Cl | 101 mEq/L | 98–116 mEq/L |
| CO ₂ | 14.3 mg/dL | 13–29 mg/dL |
| Ca | 7.0 mg/dL | 8.9–10.3 mg/dL |
| Phosphate | 1.1 mg/dL | 3.4–5.9 mg/dL |
| Alkaline phosphatase | 23 units | 15–20 units |
| Total protein | 6.6 g/dL | 5.6–7.7 g/dL |
| Albumin | 3.4 g/dL | 3.1–4.8 g/dL |

proapoptotic effect, acting through a vitamin D hormonal system, that depends on binding of the active ligand to a vitamin D receptor. This led to important drug discovery developments in which calcium and phosphate release is minimized and proliferative and anti-inflammatory effects of D-analogues are modulated.⁵⁶

In northern climates, it is difficult to receive enough ultraviolet exposure to fully meet minimum requirements (2 hours per day). Major dietary sources of vitamin D include irradiated foods and commercially prepared milk. Small amounts are found in butter, egg yolks, liver, sardines, herring, tuna, and salmon. The RDA of vitamin D for adults is 5 to 15 μg per day, depending on age.⁵⁷ Absorbed in the small intestine, vitamin D requires bile salts for absorption. It is stored in the liver and excreted in the bile. Severe deficiency in children causes a failure to calcify cartilage at the growth plate in metaphysical

bone formation, leading to the development of rickets. In adults, the deficiency leads to undermineralization of bone matrix in remodeling, resulting in **osteomalacia**. Low levels of vitamin D are reported with the use of anticonvulsant drugs and in small bowel disease, chronic renal failure, hepatobiliary disease, pancreatic insufficiency, and hypoparathyroidism. Vitamin D can be toxic, especially in children. Elevated levels of vitamin D are present in hyperparathyroidism and hypophosphatemia and during pregnancy. Excess vitamin D produces hypercalcemia and hypercalciuria, which can lead to calcium deposits in soft tissue and irreversible renal and cardiac damage.⁵⁶

It is important to measure the metabolic form of vitamin D [1,25(OH)₂D₃], parathyroid hormone, and calcium levels when diagnosing primary hyperparathyroidism and different types of rickets, when monitoring

patients with chronic renal failure, and when assessing patients on $1,25(\text{OH})_2\text{D}_3$ therapy. Two forms are most commonly measured in the clinical laboratory: $25(\text{OH})\text{D}_3$ and $1,25(\text{OH})_2\text{D}_3$. $25(\text{OH})\text{D}_3$ is the major circulating form of vitamin D; its measurement is a good indicator of vitamin D nutritional status, as well as vitamin D intoxication. The reference range is 22–42 ng/mL for $25(\text{OH})\text{D}_3$ and 30–53 pg/mL for $1,25(\text{OH})_2\text{D}_3$. Quantitation of the metabolites of vitamin D should be performed using radioimmunoassay (RIA) or HPLC in conjunction with competitive protein binding.^{13,60}

Vitamin K

Vitamin K (from the German word “koagulation”) is the group of substances essential for the formation of prothrombin and at least five other coagulation proteins, including factors VII, IX, and X and proteins C and S. The quinone-containing compounds are a generic description for menadione and derivatives exhibiting this activity. Vitamin K helps convert precursor forms of these coagulation proteins to functional forms; this transformation occurs in the liver. Dietary vitamin K is absorbed primarily in the terminal ileum and, possibly, the colon. Vitamin K is synthesized by intestinal bacteria; this synthesis provides 50% of the vitamin K requirement. Major dietary sources are cabbage, cauliflower, spinach and other leafy vegetables, pork, liver, soybeans, and vegetable oils. Uncomplicated dietary vitamin K deficiency is considered rare in healthy children and adults.

Vitamin K deficiency may be caused by antibiotic therapy, which results from decreased synthesis of the vitamin by intestinal bacteria. When vitamin K antagonists, such as warfarin sodium (Coumadin), are used for anticoagulant therapy, anticoagulant factors II, VII, IX, and X are synthesized but nonfunctional. An apparent vitamin K deficiency may lead to a hemorrhagic episode or may result when anticoagulants, such as warfarin sodium, are used.^{61,62}

Prothrombin time (velocity of clotting after addition of thromboplastin and calcium to citrated plasma) determination is an excellent index of prothrombin adequacy. Prothrombin time is prolonged in vitamin K deficiency and in liver diseases characterized by decreased synthesis of prothrombin. Vitamin K deficiency also results in prolongation of the partial thromboplastin time, but the thrombin time is within the reference interval.

Toxicity from vitamin K is not commonly seen in adults. Large doses in infants may result in hyperbilirubinemia. The adult AI for vitamin K is 120 $\mu\text{g}/\text{day}$ for males and 90 $\mu\text{g}/\text{day}$ for females.⁵⁷ In most laboratories, vitamin K is not assayed; however, prothrombin time is used as a functional indicator of vitamin K status.⁶³ The normal prothrombin time is 11–15 seconds, which varies with method. With a vitamin K deficiency, the prothrombin time is prolonged. Several herbal supplements

(e.g., garlic, ginkgo, and ginseng) may enhance the effects of Coumadin or interact with platelets, increasing the risk of bleeding.

Water-Soluble Vitamins

Thiamine

Thiamine (vitamin B₁) acts as a coenzyme in decarboxylation reactions in major carbohydrate pathways and in branched-chain amino acid metabolism. It is rapidly absorbed from food in the small intestine and excreted in the urine. The clinical condition associated with chronic thiamine deficiency is beriberi. Although usually occurring in underdeveloped countries of the world, beriberi may be found in the United States among persons with chronic alcoholism. Decreased intake, impaired absorption, and increased requirements all appear to play a role in the development of thiamine deficiency in persons with alcoholism. The RDA of thiamine is 1.2 mg/day for adult males and 1.1 mg/day for adult females.⁵⁷ Thiamine functional activity is best measured by erythrocyte transketolase (ETK) activity, before and after the addition of thiamine pyrophosphate (TPP). Thiamine deficiency is present if the increase in activity after the addition of TPP is greater than 25%.⁶⁴

Riboflavin

Riboflavin (vitamin B₂) functions primarily as a component of two coenzymes, flavin mononucleotide and flavin adenine dinucleotide (FAD). These two coenzymes catalyze various oxidation-reduction reactions. Dietary riboflavin is absorbed in the small intestine. The body stores of a well-nourished person are adequate to prevent riboflavin deficiency for 5 months. Excess riboflavin is excreted in the urine and has no known toxicity. Foods high in riboflavin include milk, liver, eggs, meat, and leafy vegetables. Riboflavin deficiency occurs with other nutritional deficiencies, alcoholism, and chronic diarrhea and malabsorption. Certain drugs antagonize the action or metabolism of riboflavin, including phenothiazine, oral contraceptives, and tricyclic antidepressants.⁶⁵ The RDA of riboflavin is 1.3 mg/day for adult males and 1.1 mg/day for adult females.⁵⁷ Reduced glutathione reductase activity greater than 40% is an indication of deficiency.

Pyridoxine

Pyridoxine (vitamin B₆) is ubiquitous. Vitamin B₆ is three related compounds: pyridoxine, occurring mainly in plants; and pyridoxal and pyridoxamine, which are present in animal products. The major dietary sources of vitamin B₆ are meat, poultry, fish, potatoes, and vegetables; dairy products and grains contribute lesser amounts. Readily absorbed from the intestinal tract, vitamin B₆ is excreted in the urine in the form of metabolites.⁶⁶ Vitamin B₆ deficiency rarely occurs alone; it is

more commonly seen in patients deficient in several B vitamins. Those particularly at risk for deficiency are patients with uremia, liver disease, absorption syndromes, malignancies, or chronic alcoholism. High intake of proteins increases the requirements for vitamin B₆. Deficiency is associated with hyperhomocystinemia. Vitamin B₆ has low toxicity because of its water-soluble nature; however, extremely high doses may cause peripheral neuropathy. The RDA of vitamin B₆ is 1.3–1.7 mg/day for adult males and 1.3–1.5 mg/day for adult females, depending on age.⁵⁷

Niacin

The requirement for niacin in humans is met, to some extent, by the conversion of dietary tryptophan to niacin. Niacin is the generic term for both nicotinic acid and nicotinamide. Niacin functions as a component of the two coenzymes (NAD) and (NADP), which are necessary for many metabolic processes, including tissue respiration, lipid metabolism, fatty acid metabolism, and glycolysis. Reduction of the coenzyme yields dihydronicotinamide (NADH or NADPH), which has a strong absorption at 340 nm, a feature widely used in assays of pyridine nucleotide-dependent enzymes.

Niacin is absorbed in the small intestine, and excess is excreted in the form of metabolites in the urine.⁶⁷ Pellagra, the clinical syndrome resulting from niacin deficiency, is associated with diarrhea, dementia, dermatitis, and death. Niacin deficiency may result from alcoholism. To decrease lipid levels, pharmacologic doses of nicotinic acid are given therapeutically. The toxicity of niacin is low. When large doses are ingested, however, as often occurs during lipid-lowering therapies, flushing of the skin and vasodilation may occur. The RDA of niacin is 16 mg/day for adult males and 14 mg/day for an adult female.⁵⁷ Blood or urinary niacin levels are of value in assessing niacin nutritional status.

Folate

Folate is the generic term for components nutritionally and chemically similar to folic acid. Folate functions metabolically as coenzymes involved in various one-carbon transfer reactions. Folate and vitamin B₁₂ are closely related metabolically. The hematologic changes that result from deficiency of either vitamin are indistinguishable. Folate in the diet is absorbed in the jejunum, and the excess is excreted in the urine and feces. Large quantities of folate are also synthesized by bacteria in the colon. Structural relatives of pteroylglutamic acid (folic acid) are metabolically active compounds usually referred to as folates. Food folates are primarily found in green and leafy vegetables, fruits, organ meats, and yeast. Boiling food and using large quantities of water result in folate destruction. The average American diet may be inadequate in folate for adolescents and for pregnant or lactating women.⁶⁸

The major clinical symptom of folate deficiency is megaloblastic anemia. Chemical indices of deficiency are, in order of occurrence, low serum folate, hypersegmentation of neutrophils, high urinary formiminoglutamic acid (FIGLU) (a histidine metabolite accumulating in the absence of folate), low erythrocyte folate, macro-ovalocytosis, megaloblastic marrow, and anemia. Serum folate levels, although an early index of deficiency, can frequently be low despite normal tissue stores. Because most folate storage occurs after the vitamin B₁₂-dependent step, erythrocyte folate can also be reduced in deficiency of either vitamin B₁₂ or folate. Despite this overlap, erythrocyte folate concentration is accepted as the best laboratory index of folate deficiency.⁶⁹ Most physicians order both serum and erythrocyte folate levels because serum levels indicate circulating folate and erythrocyte levels better approximate stores. Homocysteine elevation in serum and urine occurs in folate deficiency.⁷⁰ Total homocysteine is generally measured, which is the sum of all homocysteine species, both free and protein-bound forms.⁷⁰

Folate requirement is increased during pregnancy and especially during lactation. The increase during lactation results, in part, from the presence of high-affinity folate binders in milk. Dietary supplementation of folate in pregnant women reduces the incidence of fetal neural tube defects. Other instances of increased folate requirement include hemolytic anemia, iron deficiency, prematurity, and multiple myeloma. Patients receiving dialysis treatment rapidly lose folate. Clinical conditions^{68,71,72} associated with folate deficiency include megaloblastic anemia, alcoholism, malabsorption syndrome, carcinoma, liver disease, chronic hemodialysis, and hemolytic and sideroblastic anemia. Certain anticonvulsants and other drugs that interfere with folate metabolism include sulfasalazine, isoniazid, and cycloserine. Folate deficiency of dietary origin commonly occurs in older persons. Phenytoin (Dilantin) therapy accelerates folate excretion and interferes with folate absorption and metabolism. Alcohol interferes with folate's enterohepatic circulation, and methotrexate, a chemotherapeutic agent, inhibits the enzyme dihydrofolate reductase (Table 32-3). Low levels of serum folate can occur with use of oral contraceptives.

There are no known cases of folate toxicity; the RDA is 400 µg/day for adult males and females.⁵⁷ In women of childbearing age, 400 µg of folate per day is recommended to prevent or reduce the incidence of neural tube defects.⁵⁷

Reference ranges are as follows:

Serum: 3–16 ng/mL

Erythrocyte: 130–630 ng/mL

Deficient stores: <140 ng/mL

Folate levels may be measured in serum using a microbiologic assay with *Lactobacillus casei* or a competitive protein-binding assay for levels in serum and erythrocytes.

TABLE 32-3 ACTIONS OF DRUGS AND ORAL CONTRACEPTIVES ON VITAMINS

| DRUG OR NUTRIENT |
|--|
| Pyridoxine—antagonized by isoniazid, steroids, penicillamine |
| Riboflavin—antagonized by phenothiazines, some antibiotics |
| Folate—antagonized by phenytoin, alcohol, methotrexate, trimethoprim |
| Ascorbate—antagonized by (increased excretion) aspirin, barbiturates, hydantoins |
| Ascorbate excess—interferes with actions of aminosalicylic acid, tricyclic antidepressants, anticoagulants; may cause “rebound scurvy” on withdrawal |
| ORAL CONTRACEPTIVE AGENTS CAUSE |
| Increased serum vitamin A, RBP |
| Decreased requirement for vitamins K and C |
| Decreased vitamin B ₆ status indices |
| Decreased riboflavin use |
| Increased niacin pathway of tryptophan |
| Decreased induction of thiamin deficiency |
| Decreased serum folate (cycle-day dependent) |
| Decreased induction of cervical folate deficiency |

When folate deficiency develops, serum levels fall first, followed by a decrease in erythrocyte folate levels and ultimately hematologic manifestation.^{71,72} Measuring both serum and erythrocyte levels is helpful because serum levels indicate circulating folate and erythrocyte levels better approximate stores.⁶⁹

Serum contains endogenous binding proteins that can bind folate and result in falsely low serum folate concentration measurements. Although measurement of red blood cell folate concentration has advantages over the serum assay for the diagnosis of megaloblastic anemia, analytic problems may result from the various forms of folate in erythrocytes. Folate in the serum is almost exclusively present in the monoglutamate form; however, in red blood cells, it is in the polyglutamate form and as high-molecular-weight complexes.^{71,72}

Vitamin B₁₂

Vitamin B₁₂ (cobalamin) refers to a large group of cobalt-containing compounds. Intestinal absorption of vitamin B₁₂ takes place in the ileum and is mediated by a unique binding protein called intrinsic factor, which is secreted by the stomach. Vitamin B₁₂ participates as a coenzyme in enzymatic reactions necessary for hematopoiesis and fatty acid metabolism. Excess vitamin B₁₂ is excreted in the urine. Vitamin B₁₂ bears a corrin ring (containing pyrroles similar to porphyrin) linked to a central cobalt atom. Different corrinoid compounds, or cobalamins, are distinguished by the substituent linked to the cobalt. The active cofactor forms of vitamin B₁₂ are methylcobalamin and deoxyadenosylcobalamin. The primary dietary sources for

vitamin B₁₂ are from animal products (e.g., meat, eggs, and milk). Therefore, total vegetarian diets are likely to be deficient or low in vitamin B₁₂. Animals derive vitamin B₁₂ from intestinal microbial synthesis. The average daily diet contains 3–30 μg of vitamin B₁₂, of which 1–5 μg is absorbed. The frequency of dietary deficiency increases with age, occurring in more than 0.5% of people older than age 60,⁷¹ although the symptoms resulting from dietary deficiency are rare.

Most vitamin B₁₂ absorption occurs through a complex with intrinsic factor, a protein secreted by gastric parietal cells. This intrinsic factor–B₁₂ complex binds with specific ileal receptors. “Blocking” intrinsic factor antibodies prevent binding of vitamin B₁₂ to intrinsic factor, and “binding” antibodies can combine with either free intrinsic factor or the intrinsic factor–B₁₂ complex, preventing attachment of the complex to ileal receptors and intestinal uptake of the vitamin. Parietal cell antibodies have also been identified as a cause of pernicious anemia. After release from the intrinsic factor complex within the mucosal cell, vitamin B₁₂ circulates in plasma bound to specific transport proteins and is deposited in liver, bone marrow, and other tissue. There is a significant enterohepatic circulation of vitamin B₁₂. Plasma contains both types of transport proteins, transcobalamins, and the three forms of vitamin B₁₂ (hydroxycobalamin, methylcobalamin, and deoxyadenosylcobalamin).

In the Schilling test, the patient receives a small, oral dose of radiolabeled vitamin B₁₂. Parenteral B₁₂ is given simultaneously to saturate binding sites. Serum and urine are collected at intervals, and labeled B₁₂ is measured in

CASE STUDY 32-2

A 65-year-old woman was admitted to the hospital in mild congestive heart failure. She had been seen in the family practice clinic with complaints of numbness, tingling in the calves and feet, and weight loss. The physical examination revealed a slightly confused, depressed, pale woman. Her blood pressure was 110/70 mm Hg. Faint scleral icterus was present. There was 1+ pitting and ankle edema. The neurologic examination revealed loss of vibratory sensation in both legs with exaggerated ankle and knee reflexes. Initial laboratory results are shown in Case Study Table 32-2.1.

Questions

- What is a biologically active form of cobalamin in plasma?
 - Cyanocobalamin
 - Hydrocobalamin
 - Deoxyadenosylcobalamin
 - Aquocobalamin
 - Transcobalamin
- Where is intrinsic factor made in the body?
 - Stomach
 - Esophagus
 - Small intestine
 - Large intestine
- What is the binding protein for vitamin B₁₂?
 - Retinol-binding protein
 - Extrinsic factor
 - Corticotropin
 - Transcobalamin II
- List food substances that contain vitamin B₁₂.
- List food substances that contain folate.

CASE STUDY TABLE 32-2.1
LABORATORY RESULTS

| TEST | RESULT | REFERENCE RANGE |
|-----------------------|-----------|-----------------|
| Hgb | 9.3 g/dL | 12–16 g/dL |
| Hct | 28% | 38%–47% |
| MCH | 35 pg | 27–31 pg |
| MCV | 108 fL | 80–96 fL |
| MCHC | 32.4 g/dL | 32–36 g/dL |
| Na | 141 mEq/L | 136–145 mEq/L |
| K | 4.2 mEq/L | 3.5–5.3 mEq/L |
| Cl | 102 mEq/L | 96–106 mEq/L |
| CO ₂ | 26 mg/dL | 22–33 mg/dL |
| Ca | 9.7 mg/dL | 8.4–10.3 mg/dL |
| Glucose | 100 mg/dL | 70–110 mg/dL |
| BUN | 14 mg/dL | 10–20 mg/dL |
| Creatine | 1.0 mg/dL | 0.4–1.4 mg/dL |
| Serum B ₁₂ | 130 pg/mL | 180–900 pg/mL |
| Serum folate | 6 ng/mL | 5–12 ng/mL |
| RBC folate | 105 ng/mL | 200–700 ng/mL |

the specimens. Patients who cannot absorb vitamin B₁₂ (usually a deficiency of intrinsic factor, as in pernicious anemia)⁷² cannot absorb the labeled B₁₂ and, therefore, have low levels in the blood and urine.

The term *pernicious anemia* is now most commonly applied to vitamin B₁₂ deficiency resulting from lack of intrinsic factor. Antibodies to intrinsic factor and parietal cells are common in patients with pernicious anemia, their healthy relatives, and patients with other autoimmune disorders. Deficiency of B₁₂ can occasionally occur in strict vegetarians because of dietary deficiency. A loss of B₁₂ also occurs in individuals infected with fish tapeworm or because of malabsorption diseases, such as sprue or celiac disease. Low vitamin B₁₂ levels occur with folate deficiency, and a vitamin B₁₂ deficiency can be masked by large doses of folate. Toxicity of vitamin B₁₂ has not been reported. The RDA of vitamin B₁₂ for adults

is 2.4 µg/day.⁵⁷ Assay methods for B₁₂ are either microbiologic assay using *Lactobacillus leichmanii* competitive protein-binding RIA or an enzyme immunoassay.

Deficiency of vitamin B₁₂ causes two major disorders—megaloblastic anemia (pernicious anemia) and a neurologic disorder called combined systems disorder.⁷¹ The neurologic manifestations are variable and may be subtle. For this reason, vitamin B₁₂ deficiency should be considered a cause of any unexplained macrocytic anemia or neurologic disorder, especially in an older person. Serum vitamin B₁₂ may be used in the initial assessment.⁷¹ Methylmalonic acid levels may be more definitive because the lower reference limit is unclear. Patients with pernicious anemia usually have atrophic gastritis and have an increased incidence of gastric carcinoma. The reference range for vitamin B₁₂ is 110–800 pg/mL.^{71,72} The most common methods for determination of vitamin B₁₂

are the competitive protein-binding RIAs, which are based on the principle that vitamin B₁₂ released from endogenous binding proteins can be measured by its competition with colabeled B₁₂ for a limited amount of specific binding protein. The binding proteins typically used are animal intrinsic factors. Special measures must be taken to eliminate interference caused by other, non-specific protein binders of vitamin B₁₂. Several nonradioisotopic assays for vitamin B₁₂ have been developed for routine laboratory use.

Biotin

Biotin is a coenzyme for several enzymes that transport carboxyl units in tissue and plays an integral role in gluconeogenesis, lipogenesis, and fatty acid synthesis.⁷³ Dietary biotin is absorbed in the small intestine, but it is also synthesized in the gut by bacteria. Numerous foods contain biotin, although no food is especially rich (up to 20 µg/100 g). The dietary intake of biotin, while low in the neonatal period, increases as newborns switch from colostrum to mature breast milk. Biotin deficiency can be produced by ingestion of large amounts of avidin, found in raw egg whites that bind to biotin. Biotin deficiency has been noted in patients receiving long-term parenteral nutrition and in infants with genetic defects of carboxylase and biotinidase enzymes. The RDA for biotin is 30 µg/day.⁵⁷

Reference ranges of 200–500 pg/mL have been established in whole blood and serum.^{73,74} Assays had been performed using microbiology functional assay and the *Lactobacillus* organism. Newer methods of isotopic dilution, chemiluminescent, and photometric assays are now available but rarely used in hospital laboratories. Specimens are usually sent to a reference laboratory for analysis.⁷⁴

Pantothenic Acid

A growth factor occurring in all types of animal and plant tissue was first designated vitamin B₃ and later named *pantothenic acid* (from Greek for “everywhere”). Dietary sources include liver and other organ meats, milk, eggs, peanuts, legumes, mushrooms, salmon, and whole grains. Approximately 50% of pantothenate in food is available for absorption. Pantothenate is metabolically converted to 4'-phosphopantetheine, which becomes covalently bound to either serum acyl carrier protein or coenzyme A. Coenzyme A is a highly important acyl-group transfer coenzyme involved in many reactions of many reaction types. The RDA for pantothenic acid in adults is 5 mg/day.⁵⁷ Whole blood pantothenate of less than 100 µg/dL and urinary excretion of less than 1 mg/day are regarded as indicative of deficiency.⁷⁵ Reference range for urine is 1–15 mg/day or 5–68 µmol/day. Assays using a load test look for excretion of the acetylated *p*-aminobenzoic acid that is formed.⁷⁵

Ascorbic Acid

The most commonly discussed vitamin, ascorbic acid (vitamin C), is a strong reducing compound that has to be acquired via dietary ingestion. Major dietary sources include fruits (especially citrus) and vegetables (e.g., tomatoes, green peppers, cabbage, leafy greens, and potatoes). Ascorbic acid is important in formation and stabilization of collagen by hydroxylation of proline and lysine for cross-linking and conversion of tyrosine to catecholamines (by dopamine β-hydroxylase). It increases the absorption of certain minerals, such as iron, and is absorbed in the upper small intestine and distributed throughout the water-soluble compartments of the body.⁷⁶ The deficiency state, known as scurvy, is characterized by hemorrhagic disorders, including swollen, bleeding gums and impaired wound healing and anemia.^{76,77}

Although urine is the primary route of excretion, measurement of urinary ascorbate is not recommended for status assessment. Drugs known to increase urinary excretion of ascorbate include aspirin, aminopyrine, barbiturates, hydantoin, and paraldehyde. Ascorbic acid requirements are more increased with acute stress injury and chronic inflammatory states, but are also increased with pregnancy and oral contraceptive use. Excessive intake may interfere with vitamin B₁₂ metabolism and drug actions (e.g., aminosalicic acid, tricyclic antidepressants, and anticoagulants).^{76,77}

The most widely used assay for ascorbic acid is the 2,4-dinitrophenylhydrazine method. In this procedure, ascorbic acid is first oxidized to dehydroascorbic acid and 2,3-diketogulonic acid with the formation of a colored product that absorbs at 520 nm. This method measures the total vitamin C content of the sample because ascorbic acid, dehydroascorbic acid, and diketogulonic acid are also measured, and it is subject to interference from amino acids and thiosulfates. HPLC has been developed to give increased sensitivity and specificity. The reference range for ascorbic acid is 0.4–0.6 mg/dL.⁷⁷ The RDA for vitamin C is 90 mg/day for adult males and 75 mg/day for adult females.⁵⁷

Carnitine

Carnitine, which includes L-carnitine and its fatty acid esters (acylcarnitine), is described as a conditionally essential nutrient.⁷⁸ Meat, poultry, fish, and dairy products are the major dietary sources. Foods of plant origin generally contain little carnitine, except for peanut butter and asparagus.⁷⁸ Normal diets provide more than half the human requirement, but strict vegetarian diets provide only 10% of the total carnitine needed by humans.⁷⁸ Synthesis occurs in liver, brain, and kidney. L-Carnitine facilitates entry of long-chain fatty acids into mitochondria for oxidation and energy production.⁷⁸ The major signs of carnitine deficiency are muscle weakness and

CASE STUDY 32-3

A 27-year-old man was diagnosed with a carcinoid tumor in the lower portion of the small intestine. The tumor was debulked, with removal of a portion of the lower section of the small intestine. His recovery course was somewhat complicated by weight loss. Seven months after surgery, he underwent a laparotomy, which showed that the carcinoid tumor had not been entirely removed; more of the small bowel was removed because of the obstructing adhesions. He recovered from the second surgery, and tube feeding was discontinued. He came back to the clinic 18 months after the initial surgery slightly pale and stating that he was having trouble maintaining weight. His laboratory evaluation showed slight hypochromic, macrocytic anemia, normal renal function, and normal liver function. A stool specimen was negative for ova, parasites, and enteric pathogens. He was readmitted for intravenous fluid and electrolyte replacement.

Questions

1. What biochemical evidence exists for fat malabsorption?
2. What nutritional parameters would be affected by fat malabsorption?
3. Identify the fat-soluble vitamins.
4. What condition results from vitamin B₁₂ deficiency?

CASE STUDY TABLE 32-3.1
LABORATORY RESULTS

| TEST | RESULT | REFERENCE RANGE |
|-------------------------|------------|-----------------|
| Albumin | 3.4 g/dL | 3.5–5 g/dL |
| Prealbumin | 15 mg/dL | 18–40 mg/dL |
| Na | 139 mmol/L | 136–145 mmol/L |
| K | 3.7 mmol/L | 3.5–5 mmol/L |
| Cl | 101 mmol/L | 99–109 mmol/L |
| Bicarbonate | 23 mmol/L | 22–28 mmol/L |
| Ca | 8.6 mg/dL | 8.5–10.5 mg/dL |
| Mg | 1.7 mg/dL | 1.5–2.5 mg/dL |
| Phosphate | 3 mg/dL | 2.8–4 mg/dL |
| Prothrombin time | 17 seconds | 10–14 seconds |
| Ferritin | 22 ng/mL | 20–250 ng/mL |
| Vitamin A | 207 µg/L | 300–800 mg/L |
| Vitamin D | 6 ng/mL | 30–53 ng/mL |
| Vitamin E | 2 mg/L | 5–18 mg/L |
| Vitamin C | 0.4 mg/dL | 0.4–0.6 mg/dL |
| Vitamin B ₁₂ | 100 pg/mL | 110–800 pg/mL |
| Fecal fat (72 hours) | 30 g/day | <6 g/day |

fatigue. Total carnitine is measured after hydrolysis of ester forms to free carnitine. Human deficiency can be either hereditary or acquired—by inadequate intake, increased requirement (pregnancy and breastfeeding), or increased urinary loss (valproic acid therapy). Infants and patients following a course of long-term parenteral nutrition and those on hemodialysis are most vulnerable to deficiency.⁷⁸

MINERAL METABOLISM—CALCIUM/PHOSPHORUS

Mineral Tests to Monitor

One of the most important aspects of TPN monitoring is determining deficiencies and excesses of calcium, phosphorus, and magnesium. When regulated inadequately, these minerals not only affect bone mass but also can precipitate life-threatening situations. Calcium and phosphorus are related closely in the important role of bone mineralization. Calcium is present in serum in two

forms—protein bound, or nondiffusible, and ionized diffusible calcium. Ionized calcium is the physiologically active form and constitutes only 25% of total serum calcium. Regardless of total serum calcium, a decrease in ionized calcium may result in tetany. Decreased ionized calcium often is caused by an increase in blood pH (alkalosis). It is important to monitor ionized serum calcium and blood pH, especially in a patient on TPN who is receiving calcium supplementation along with ingredients in the TPN solution that may alter blood pH. Although calcium imbalance is frequent in newborns undergoing TPN, it is much less common in adolescents and adults. Hypercalciuria with nephrolithiasis has been reported, however, as a complication in patients on long-term TPN.

A reciprocal relationship exists between calcium and phosphorus. Intracellular phosphate is necessary to promote protein synthesis and other cellular functions. Calcium and phosphorus must be monitored carefully to maintain the correct balance between these two minerals. Severe hypophosphatemia has been reported in patients

TABLE 32-4 ELECTROLYTE AND MINERAL ABNORMALITIES ASSOCIATED WITH TPN

| ABNORMALITY | MANIFESTATIONS | USUAL CAUSES |
|------------------|--|--|
| Hypernatremia | Edema, hypertension, thirst, intracranial hemorrhage | Inappropriate sodium intake |
| Hyponatremia | Weakness, hypotension, oliguria, tachycardia | Inadequate sodium intake relative to water intake |
| Hyperkalemia | Weakness, paresthesia, cardiac arrhythmias | Acidosis, renal failure, excessive potassium intake |
| Hypokalemia | Weakness, alkalosis, cardiac abnormalities | Insufficient potassium intake associated with protein anabolism |
| Hyperchloremia | Metabolic acidosis | Excessive chloride intake, amino acid solutions with high chloride content |
| Hypocalcemia | Tetany, seizures, rickets, bone demineralization | Inadequate calcium, phosphorus, and/or vitamin D intake |
| Hypophosphatemia | Weakness, bone pain, bone demineralization | Insufficient phosphorus intake |
| Hypomagnesemia | Seizure, neuritis | Inadequate intake of magnesium |

undergoing prolonged TPN.^{79,80} Magnesium, as a TPN solution additive, is closely related to calcium and phosphorus. A reciprocal relationship exists between magnesium and calcium and, in certain situations, between magnesium and phosphorus. Low levels of magnesium can cause tetany, whereas high levels can increase cardiac atrioventricular conduction time. Certain electrolyte and mineral abnormalities associated with parenteral nutrition are shown in Table 32-4.

TRACE MINERALS

Trace Elements to Monitor

Nutritional monitoring has led to an increase in trace element monitoring by the clinical (trivalent), cobalt, copper, selenium, and zinc. Each of these has a role in biochemical reactions of metabolism, some are more inclined to be deficient and then of critical importance to maintenance of nutritional health.

Copper

This metal is essential for a number of biochemical reactions as it is an essential element to enzymes critical to these reactions. The enzyme cytochrome oxidase has a copper component and is involved in reactions in the electron transport system where ATP energy is generated. Copper is part of the enzyme dopamine monooxygenase, which is necessary for neuron activity and transmission of impulse. A lack of copper at this crucial juncture can lead to neurologic problems. The enzyme superoxide dismutase is involved in reaction to reduce the free radical superoxide. Copper is an essential part of this enzyme, so its function as a free radical scavenger is related to the superoxide dismutase activity. A deficiency of copper sizable enough

to affect the superoxide dismutase activity leaves the patient's cells open to free radical damage and cellular destruction. Ceruloplasmin is the fourth enzyme listed here that requires copper for activity. Eight copper atoms, four covalently bound and four loosely bound are needed for ceruloplasmin to convert iron from the 3 plus state to the absorbed 2 plus state. Ceruloplasmin is viewed as an acute-phase reactant protein,⁸¹ but it has a biochemical action as an enzyme that converts iron atoms to an ingestible state.

Because copper has such a large impact on many biochemical reactions, it is understandable that the liver contains high levels of copper. The turnover of copper from the liver is closely regulated with excesses excreted through the bile leaving the liver. Deficiencies of copper are rare due to the liver's close regulation of copper levels. However, preterm babies, Menkes disease, and deficiency due to high dietary intake of zinc, iron, or vitamin C can be potential causes of copper deficiencies. TPN can also lead to deficiency of copper. The diets of most patients on TPN must be supplemented to maintain optimal levels of several trace elements; these elements also must be monitored to prevent deficiency or toxicity. Copper and zinc are the most common trace elements added to TPN solutions. Pallor, decreased pigmentation, vein enlargement, and rashes resembling seborrheic dermatitis are the major clinical signs of copper deficiency, which at times go unnoticed. Some other abnormalities include recurrent leukopenia (white blood cell count, less than $5 \times 10^9/L$) and neutropenia (neutrophils, less than $1.5 \times 10^9/L$).

The diagnosis of copper deficiency is confirmed when both serum copper and ceruloplasmin (the copper-binding glycoprotein) are low. It is difficult to make this

diagnosis in premature infants, however, because their serum copper levels remain depressed until about 9 weeks of age. Low copper levels have also been reported in malabsorption syndrome, protein-wasting intestinal diseases, nephrotic syndrome, severe trauma, and burns. The anemia seen in copper deficiencies is related to the low ceruloplasmin activity and thus lack of iron absorption into the patient.

Menkes disease is an X-linked recessive disease in which copper transport is adversely affected. Lack of copper absorption leads to low liver and serum levels of copper. The symptoms for Menkes disease include kinky hair, mental retardation, seizures, arterial aneurysms, and bone demineralization.⁸¹

The opposite of copper deficiency is copper toxicity. RDs may be asked to help a patient with Wilson's disease reduce their intake of copper. Although Wilson's disease is a deficiency of ceruloplasmin protein, the copper that should be attached is in the serum and liver leading to a toxic copper state. Patients with Wilson's disease have blockages of copper excretion from the liver to bile or serum. This accumulation of copper in the liver can go into hepatitis, then a fibrosis, and then a cirrhosis if not treated with chelation and diet restricted in copper content. Copper toxicity to brain leads to tremors, dysphasia, chorea and drooling. Patients with Wilson's disease need lifelong monitoring and chelation treatment.

Methods for copper measurement include atomic absorption for serum and urinary copper measurements. Indirect copper measurements are attained by measuring the ceruloplasmin levels. Serum copper reference range is 70–155 µg/dL. Ceruloplasmin serum levels are 123–230 mg/L.⁸² The RDA for copper in adults is 900 µg/day.⁵⁷

Zinc

Zinc is an essential metal for over 200 enzymes in humans. Metalloenzymes using zinc include carbonic anhydrase, alkaline phosphatase (ALP), thymidine kinase, alcohol dehydrogenase, and RNA and DNA polymerases. The range of biochemical functions of zinc-containing metalloenzymes includes protein synthesis, gene expression, transport processes, immunologic reactions, and wound healing, to name a few. Carbonic anhydrase needs zinc to foster the reaction it catalyzes in the forward reaction between carbon dioxide and water or the reverse reaction. When zinc is deficient, carbonic anhydrase activity is lower in the blood, stomach, and intestines of affected patients. Patients with sickle cell anemia are especially at risk for adverse effects due to the lack of zinc for the carbonic anhydrase reaction as well as insufficient zinc for their red cells.

The role of zinc in wound healing and immune function is the primary reason that this trace metal needs to be monitored when assessing nutritional adequacy in hospitalized patients. The biosynthesis of connective

tissues and ability to fight off infections after surgery can be positively affected if the patient's nutritional status is monitored and zinc levels are kept within the therapeutic range.

Patients on TPN may develop acute zinc deficiency.^{83,84} They initially suffer from a massive urinary loss of zinc during phases of catabolism. When weight gain begins, the zinc-deficient patient may experience diarrhea, perioral dermatitis, and alopecia. Premature newborns are particularly predisposed to zinc deficiency because zinc normally is acquired at the rate of about 500 mg/day during the final month of gestation. To compensate for this deficiency, zinc supplements for the premature newborn should be 50% higher than those for the full-term newborn. This concentration is then gradually decreased until it is the same as for a full-term infant.

Zinc should be monitored even more frequently in patients with ongoing gastrointestinal losses, even if they are receiving zinc supplements in their parenteral solutions.⁸⁵

Normal zinc absorption is only 30%–40% of dietary intake. This means that while the duodenum and proximal jejunum are sites of active transport of zinc absorption, this absorption area limits zinc intake. Given the competition between zinc and copper absorption, interference of other metals for the metalloprotein needed to transport zinc can further limit the level of zinc intake and absorption. Deficiency of zinc can thus be a problem in normal people let alone one who has a compromised immune system and surgical trauma.

Zinc transport in serum uses albumin primarily and α_2 -macroglobulin. Some zinc may be transported by transferrin and amino acids, but this is not significant in most patients. Excretion of zinc is via the feces with 25% of the excreted zinc leaving with pancreatic secretions. Urinary loss of zinc is about 5% of dietary intake of zinc. Sweat and semen can also be routes of zinc loss from humans.

Zinc is required for vision, taste, and smell functions. It promotes tissue repair, connective tissue synthesis, bone growth, and insulin synthesis. Zinc is involved in carbohydrate, protein, and phosphorus metabolism. Its role in antibody production and white blood cell well-being fosters the finding that zinc is needed for immune functions.

Malnutrition, infertility, inflammation, and hair loss are often treated with zinc supplementation because it has such a wide array of body functions.

Deficiencies of zinc are usually due to lack of absorption. Whether dietary fiber prevents zinc absorption or a conflicting metal prevents zinc uptake, a deficiency of zinc can be seen in the array of its known functions. Wound healing is reduced or lacking, appetite is lost, skin lesions develop secondary infections, fertility declines, and RNA and DNA synthesis is hampered.

CASE STUDY 32-4

A 66-year-old postmenopausal woman complained of severe weakness and dyspnea during the past 6 months on exertion. She noted that her appetite had decreased, with resultant weight loss. Her past medical history revealed ulcers. On admission to the hospital, she had normal blood pressure and pulse. Skin, conjunctiva, and mucous membranes were pale. Lungs were clear at auscultation. A grade 3/6 systolic murmur was present, heard best at the lower left sternal border and radiating to the carotids and axilla. Stool guaiac examination was 2+. Nail beds were pale, with no pedal edema. Laboratory data on admission are shown in Case Study Table 32-4.1.

Questions

- This patient's anemia is probably best explained by:
 - dietary habits.
 - chronic blood loss.
 - chronic intravascular hemolysis.
 - chronic inflammatory disease.
- Clinical manifestations of her anemia may include all of the following *except*:
 - glossitis.
 - pica.
 - spoon nail (koilonychia).
 - peripheral neuropathy.
- The bone marrow iron stores are:
 - reduced.
 - normal.
 - absent.
 - increased but present only in reticuloendothelial cells.
- If the correct treatment for this anemia is with oral ferrous sulfate, the treatment should:
 - be stopped as soon as the hematocrit returns to normal.
 - be continued indefinitely, even if the cause of the deficiency has been corrected.
 - be continued for 3–6 months after the hematocrit returns to normal to replace body iron stores.
 - be continued only until there is a brisk response in the reticulocyte index and hematocrit.

CASE STUDY TABLE 32-4.1
LABORATORY RESULTS

| TEST | RESULT | REFERENCE RANGE |
|-----------------------------------|------------------------------|---|
| CBC | | |
| Hct | 15% | 36%–48% |
| Hb | 3.8 g/dL | 12–16 g/dL |
| RBC | $2.79 \times 10^6/\text{mL}$ | $3.6\text{--}5.0 \times 10^6/\text{mL}$ |
| MCV | 53.8 FL | 82–98 FL |
| MCHC | 25.3 g/dL | 31–37 g/dL |
| WBC | $8.2 \times 10^3/\text{mL}$ | $4.0\text{--}11.0 \times 10^3/\text{mL}$ |
| Neutrophil | 80% | 40%–80% |
| Lymph | 20% | 15%–40% |
| Reticulocyte count | 5.5% | 0.5%–1.5% |
| Reticulocyte index | 0.8% | >3% |
| CHEMISTRY | | |
| BUN | 15 mg/dL | 7–18 mg/dL |
| Glucose | 150 mg/dL | Fasting 70–100 mg/dL Nonfasting 70–150 mg/dL |
| Electrolytes | Normal | |
| Bilirubin | 1.0 mg/dL | 0.2–1 mg/dL |
| Direct | 0.4 mg/dL | 0–0.2 mg/dL |
| T ₃ and T ₄ | Normal | |
| Serum Fe | 15 $\mu\text{g}/\text{dL}$ | 30–150 $\mu\text{g}/\text{dL}$ |
| TIBC | 439 $\mu\text{g}/\text{dL}$ | 241–421 $\mu\text{g}/\text{dL}$ |

Methods for zinc analysis include atomic absorption spectroscopy, inductively coupled atomic plasma (ICP) emission spectroscopy, HPLC, and ICP-MS. Indirect methods look at the effects of zinc on proteins and metalloenzymes. These have not been as fruitful for assessing zinc status. Specimen collection without contamination has been hard to achieve, making zinc measurements higher than actual values. Red cells contain zinc, so hemolysis elevates zinc plasma values. Serum levels of zinc are in the 60–120 $\mu\text{g}/\text{dL}$,⁸⁶ while red cells have shown a

70–102 $\mu\text{mol}/\text{L}$ range. The RDA for zinc is 11 mg/day for adult males and 8 mg/day for adult females.⁵⁷

Iron

Iron plays a crucial role in respiration and transfer of oxygen to body tissues. The importance of iron in the nutritional sense has to do with its importance to several enzymes, as well as the fact that excess iron has been associated with increasing the amount of free radicals and infection in patients. Enzymes requiring iron cofactor

include aconitase, succinate dehydrogenase, and isocitrate dehydrogenase from the TCA cycle. Catalase for the breakdown of hydrogen peroxide and myeloperoxidase found in neutrophils both require iron as cofactor. The ribonucleotide reductase and xanthine oxidase involved in RNA and DNA metabolism both require iron as cofactor. Besides enzymes part of the cytochrome P-450 mechanism, iron is also needed by tryptophan hydroxylase (production of serotonin), phenylalanine hydroxylase, homogentisic oxidase, and tyrosine hydroxylase (formation of L-DOPA catecholamine precursor).^{87,88} There are many other enzymes that require iron, and without sufficient quantities, these enzymes are prevented from performing as they should in energy metabolism, growth and proliferation, biotransformations of drugs, myelinogenesis, cell differentiation, and nutrient absorption. Deficiencies of iron are associated with anemia but also akathisia, or “restless leg syndrome.” Increasing the iron supplies to these patients has led to improvement and a reduction in symptoms.^{88,89}

Iron absorption by the gastrointestinal system will be affected by the level of iron present in the body and in ferritin storage form. Low levels of serum or body iron enhance absorption from the intestinal cells as the ferritin levels are low and the apotransferrin levels are high. Other absorption enhancers of iron include vitamin C, copper, cobalt, and manganese when present in the intestine. Inhibitors of absorption besides excess ferritin in mucosal cells include phytic acid, polyphenols of tea and wine, and calcium.^{87,89}

Measurements of iron, transferrin, and ferritin have already been discussed elsewhere in this book. The nutritional assessment of iron uses these same methods and reference ranges.

The RDA for iron is 8 mg/day for adult males and adult females over 51 years of age and 18 mg/day for adult females 19–50 years of age.⁵⁷

Selenium

Selenium (Se) as a trace mineral is reported to have an influence on cancer, cardiovascular diseases, diabetes, and arthritis. Trace amounts of selenium in humans necessitate a daily RDA for selenium in adults of 55 µg/day,⁵⁷ but most texts indicate a daily intake of over 100 mg. Selenium functions as an essential cofactor to the antioxidant enzyme glutathione peroxidase, which is involved in neutralizing hydrogen peroxide formed during lipid oxidation in cells. Free radicals like hydrogen peroxide need to be removed if cell membranes and DNA are to remain intact.^{90,91} Selenium incorporation into proteins and enzymes occurs through the selenocysteine dietary form, but a secondary selenomethionine also comes from dietary sources. Selenomethionine is not advantageous as it may interfere with normal methionine incorporation into proteins. The selenocysteine form is

CASE STUDY 32-5

A young woman 33 years old complains to her family physician that she is always tired and cannot get her weight to a normal level. Her father has type 2 diabetes and her grandmother is being treated post myocardial infarction for CVD. Her mother and brother are on medication for high blood pressure. Her physician performs a physical examination and determines that her waist circumference is 90 cm. Her blood pressure is 135/90 mm Hg. Blood is drawn and the results are listed below:

CASE STUDY TABLE 32-5.1
LABORATORY RESULTS

| TEST | RESULT | REFERENCE RANGE |
|------------------------|------------|-------------------|
| Albumin | 3.4 g/dL | 3.5–5 g/dL |
| Total protein | 7.1 g/dL | 6.0–8.0 g/dL |
| Na | 141 mmol/L | 136–145 mmol/L |
| K | 3.7 mmol/L | 3.5–5 mmol/L |
| Cl | 103 mmol/L | 99–109 mmol/L |
| Bicarbonate | 23 mmol/L | 22–28 mmol/L |
| Glucose | 120 mg/dL | 80–100 mg/dL |
| BUN | 19 mg/dL | 7–18 mg/dL |
| Creatinine | 1.1 mg/dL | 0.5–1.1 mg/dL |
| Total cholesterol | 196 mg/dL | <200 mg/dL |
| LDL cholesterol (calc) | 127 mg/dL | <100 mg/dL |
| HDL cholesterol | 35 mg/dL | >50 mg/dL (women) |
| Triglycerides | 167 mg/dL | <150 mg/dL |
| AST | 40 U/L | 5–30 U/L |
| ALT | 45 U/L | 6–37 U/L |
| ALP | 41 U/L | 30–90 U/L |

Questions

- Given the information in this case study, the suspected disease is:
 - Diabetes type 2
 - Metabolic syndrome
 - Cirrhosis
 - Atherosclerosis leading to CVD
- Of the indicators seen in this case, which ones indicate to you that your choice in question 1 is correct. Why?
- What treatment modality is required for this patient? How will the laboratory contribute to that treatment plan?

desirable and its positive effects are seen in the enzyme glutathione peroxidase as well as other selenium-containing enzymes.

Functions of selenium in humans include antiatherogenic effect, anticancer effect, antioxidant, improved fertility, and increasing the immune response.⁹² Deficiency of selenium, obviously, will lead to decreased capabilities in these areas. Cardiovascular disease (CVD) seems to rise in populations lacking adequate selenium. Cancer increases as well as cell damage and the susceptibility to infections when selenium is deficient. Fertility issues affected include low sperm motility and an increase in female miscarriages. Adequate levels of selenium promote white blood cell production, improved thyroid metabolism, and healthy eye lens, skin, and hair. Besides the heart, thyroid, and skin, selenium helps maintain normal liver function and aids in slowing down the aging process.⁹³

Selenium deficiency decreases function of selenium-dependent enzymes like glutathione peroxidase. This compromises vitamin E actions in cell membranes and can lead to increased levels of free radicals like hydrogen peroxide. The damage that the free radicals cause to heart, liver, and other organ tissue can leave them susceptible to cancer, viral and bacterial infections and even cell death and organ failure. The cardiovascular damage due to selenium deficiency has resulted in juvenile cardiomyopathy (Keshan's disease) and chondrodystrophy (Kashin-Beck disease).⁹³ Other effects of selenium deficiency associated with heart disease and stroke include cataracts, anemia, increased cancer risk, diabetes, arthritis, early aging, infertility, and decreased immune function.

Excessive selenium can occur with excessive supplementation. Effects include fatigue, irritability, loss of

hair and nails, vomiting, nerve damage, skin rashes, and brittle bones.^{92,93} Most believe that selenium toxicity is very rare and the better condition to treat is selenium deficiency.

The cardiomyopathy effects of selenium deficiency are seen in home parenteral nutrition or HPN. A case report describes a 46-year-old man who developed an enlarged heart and a myopathy.⁹⁴ The findings reported include that selenium-derived deficiency adversely affected the red blood cell selenium levels and the glutathione peroxidase levels. Red cells were then susceptible to the oxidative stress without a way to neutralize those compounds. Recognition of the problem resulted in the patient being started on selenium. In a month, he improved, once selenium was added to his HPN solutions. A second earlier study on selenium deficiency looked at patients with significant dilated cardiomyopathy.⁹⁰ The results indicated no significant difference in the patient group with the disease versus the age- and gender-matched control group without disease. While both groups had lower than normal selenium levels, the question as to why some developed disease while others did not remained an unresolved scientific question.

Selenium reference ranges depend on the method of analysis and the specimen type. One reference laboratory publishes a serum range of 23–190 µg/L using ICP-MS. The urine range is 0–200 µg/L using the same method.⁹⁵ Other methods for determining selenium have been flameless atomic absorption spectroscopy or spectrofluorometry.⁹⁶ Most facilities need to collect the specimen in a trace mineral free tube such as those offered by reference laboratories. Elevated values need to be confirmed with a second specimen collection and analysis.⁹⁵

REFERENCES

- Lacey K, Pritchett E. Nutrition Care Process and Model: ADA adopts road map to quality care and outcomes management. *J Am Dietetic Assoc* 2003;103:1061–1072.
- Sebastian JG, Boosalis MG. Nutritional aspects of home health care. In Martinson IM, Widmer AG, Portillo CJ, eds. *Home health care nursing*, 2nd ed. Philadelphia, Pa.: WB Saunders, 2002:140–179.
- NHLBI. Obesity Education Initiative electronic textbook: treatment guidelines. Retrieved from http://www.nhlbi.nih.gov/guidelines/obesity/e_txtbk/txd/411.htm.
- Dillman E, Gala C, Green W, et al. Hypothermia in iron deficiency due to altered triiodo-thyroxine metabolism. *Am J Physiol* 1980;239:377–381.
- Boosalis MG, Ott L, Levine AS, et al. The relationship of visceral proteins to nutritional status in chronic and acute stress. *Crit Care Med* 1989;17:741–747.
- Boosalis MG, McCall JT, Solem LD, et al. Serum copper and ceruloplasmin and urinary copper levels in thermal injury. *Am J Clin Nutr* 1986;44:899–906.
- Boosalis MG, Solem LD, Ahrenholz DH. Serum and urinary selenium levels in thermal injury. *Burns Incl Therm Inj* 1986;12:236–240.
- Boosalis MG, McCall JT, Solem LD, et al. Serum copper and ceruloplasmin and urinary copper levels in thermal injury. *Am J Clin Nutr* 1986;44:899–906.
- Boosalis MG, McCall JT, Solem LD, et al. Serum and urinary silver levels in thermal injury. *Surgery* 1987;101:40–43.
- Boosalis MG, McCall JT, Solem LD, et al. Serum zinc response in thermal injury. *J Am Coll Nutr* 1988;7:69–76.
- Boosalis M.G, Gray D, Walker S, et al. The acute phase response in autologous bone marrow transplantation. *J Med* 1992;23:175–193.
- Boosalis, M.G. & Stiles NJ. Nutritional assessment in elders: biochemical analyses. *Clin Lab Sci* 1995;8:31–33.
- Boosalis MG, Snowdon DA, Tully CL, et al. The acute phase response and plasma carotenoid concentrations in older women: findings from the Nun Study. *Nutrition* 1996;12:475–478.
- American Heart Association. Retrieved from <http://www.americanheart.org/presenter.jhtml?identifier=4756>.

15. USDA. MyPyramid. Retrieved from www.mypyramid.gov.
16. USDA National Agricultural Library. DRI tables. Dietary guidance. Food and nutrition information center. Retrieved from http://fnic.nal.usda.gov/nal_display/index.php?info_center=4&tax_level=3&tax_subject=256&topic_id=1342&level3_id=5140.
17. Royle GT, Kettlewell MGW. Liver function tests in surgical infection and malnutrition. *Ann Surg* 1980;192:459.
18. Apelgren KN, Rombeau JL, Twomey PL, et al. Comparison of nutritional indices and outcome in critically ill patients. *Crit Care Med* 1982;10:305.
19. Ingenbleek Y, Van Den Schrieck H-G, De Nayer P, et al. Albumin, transferrin and thyroxine-binding prealbumin/retinol-binding protein (TBPA-RBP) complex in assessment of malnutrition. *Clin Chem Acta* 1975;63:61.
20. Georgieff MK, Amarnath UM, Murphy EL, et al. Serum transferrin levels in the longitudinal assessment of protein-energy status in preterm infants. *J Pediatr Gastroenterol Nutr* 1989;8:234.
21. Ingenbleek Y, De Visscher M, De Nayer P. Measurement of prealbumin as an index of protein-calorie malnutrition. *Lancet* 1972;2:106.
22. Smith FR, Goodman DS, Zaklama MS, et al. Serum vitamin A, retinol-binding protein, and prealbumin concentrations in protein calorie malnutrition. I. Functional defect in hepatic retinol release. *Am J Clin Nutr* 1973;26:973.
23. Bernstein LH, Leukhardt-Fairfield CJ, Pleban W, et al. Usefulness of data on albumin and prealbumin concentrations in determining effectiveness of nutritional support. *Clin Chem* 1989;35:271.
24. Large S, Neal G, Glover J, et al. The early changes in retinol-binding protein and prealbumin concentrations in plasma of protein-energy malnourished children after treatment with retinol and an improved diet. *Br J Nutr* 1980;43:393.
25. Georgieff MK, Sasanow SR, Pereira GR. Serum transthyretin levels and protein intake as predictors of weight gain velocity in premature infants. *J Pediatr Gastroenterol Nutr* 1987;6:775.
26. Giacoia GP, Watson S, West K. Rapid turnover transport proteins, plasma albumin, and growth in low birth weight infants. *J Parenter Enteral Nutr* 1984;8:367.
27. Moskowitz SR, Pereira G, Spitzer A, et al. Prealbumin as a biochemical marker of nutritional adequacy in premature infants. *J Pediatr* 1983;102:749.
28. Church JM, Hill GL. Assessing the efficacy of intravenous nutrition in general surgical patients: dynamic nutritional assessment with plasma proteins. *J Parenter Enteral Nutr* 1987;11:135.
29. Tuten MB, Wogt S, Dasse F, et al. Utilization of prealbumin as a nutritional parameter. *J Parenter Enteral Nutr* 1985;9:709.
30. Cavarocchi NC, Au FC, Dalal FR, et al. Rapid turnover proteins as nutritional indicators. *World J Surg* 1986;10:468.
31. Carlson DE, Cioffi WG Jr, Mason AD Jr, et al. Evaluation of serum visceral protein levels as indicators of nitrogen balance in thermally injured patients. *J Parenter Enteral Nutr* 1991;15:440.
32. Ingenbleek Y, Van Den Schrieck HG, De Nayer P, et al. The role of retinol-binding protein in protein-calorie malnutrition. *Metabolism* 1975;24:633.
33. Smith FR, Suskind R, Thanangkul O, et al. Plasma vitamin A, retinol-binding protein and prealbumin concentrations in protein-calorie malnutrition. III. Response to varying dietary treatments. *Am J Clin Nutr* 1975;28:732.
34. Baxter RC. The somatomedins: insulin-like growth factors. *Adv Clin Chem* 1986;25:49.
35. Isley WL, Lyman B, Pemberton B. Somatomedin-C as a nutritional marker in traumatized patients. *Crit Care Med* 1990;18:795.
36. Clemmons DR, Underwood LE, Dickerson RN, et al. Use of plasma somatomedin-C/insulin-like growth factor I measurements to monitor the response to nutritional repletion in malnourished patients. *Am J Clin Nutr* 1985;41:191.
37. Unterman TG, Vazquez RM, Slas AJ, et al. Nutrition and somatomedin. XIII. Usefulness of somatomedin-C in nutritional assessment. *Am J Med* 1985;78:228.
38. Moshier DF. Physiology of fibronectin. *Annu Rev Med* 1984;35:561.
39. Saba TM, Blumenstock FA, Shah DM, et al. Reversal of opsonic deficiency in surgical, trauma, and burn patients by infusion of purified human plasma fibronectin. *Am J Med* 1986;80:229.
40. Spiekerman AM. Laboratory tests for monitoring total parenteral nutrition (TPN). *Clin Chem* 1987;27:1.
41. Deodhar SD. C-reactive protein: the best laboratory indicator available for monitoring disease activity. *Cleve Clin J Med* 1989;56:126.
42. Hokama Y, Nakamura RM. C-reactive protein: current status and future perspectives. *J Clin Lab Anal* 1987;1:15.
44. Wilmore DW, Black PR, Muhlbacher F. Injured man: trauma and sepsis. In Winters RW, Greene M, eds. *Nutritional support of the seriously ill patient*. New York: Academic Press, 1983:33–52.
45. Cerra FB. Hypermetabolism, organ failure, and metabolic support. *Surgery* 1987;101:1.
46. Dudrick SJ. A clinical review of nutritional support of the patient. *J Parenter Enteral Nutr* 1979;3:444.
47. Howard L, Meguid MM. Nutritional assessment in total parenteral nutrition. *Clin Lab Med* 1981;1:611.
48. Briggs MH, ed. *Vitamins in human biology and medicine*. Boca Raton, Fla.: CRC Press, 1981.
49. Food and Nutrition Board. *Recommended dietary allowances*. 10th ed. Washington, DC: National Academy of Science, 1989.
50. IFIC. *Dietary reference intakes: an update: August 2002*. Retrieved from <http://ific.org/publications/other/driupdateom.cfm?renderfor-print=1>.
51. Boosalis MG. Vitamins. In Matarese LE, Gottschlich MM, eds. *Contemporary nutrition support practice: a clinical guideline*. Philadelphia, Pa.: WB Saunders, 1998:145–162.
52. Boosalis MG. Micronutrients. In Boosalis MG. *The science and practice of nutrition support: a case-based core curriculum*. Dubuque, Iowa, Kendall/Hunt Publishing Co. Publications, 2001:85–106.
53. Calabrese EJ. The vitamins. In Calabrese EJ. *Nutrition and environmental health*, Vol. 1. New York: John Wiley & Sons, 1980.
54. Ensminger AH, Ensminger ME, Konlande JE, et al. *Foods and nutrition encyclopedia*, 2nd ed. Boca Raton, Fla.: CRC Press, 1994:2257–2260.
55. Garry PJ. Vitamin A. In Labbe RF, ed. *Clinics in laboratory medicine*, Vol 1. Laboratory assessment of nutritional status. Philadelphia: WB Saunders, 1981.
56. Book LS. Fat soluble vitamins and essential fatty acids in total parenteral nutrition. In Leenthal E, ed. *Total parenteral nutrition: indications, utilization, complications*. New York: Raven Press, 1986:59–81.
57. Food and Nutrition Board, Institute of Medicine, National Academies. *Dietary reference intakes (DRIs): recommended intakes for individuals, vitamins*. Retrieved from <http://www.iom.edu/Object.File/Master/21/372/0.pdf>.
58. Underwood BA. Methods for assessment of vitamin A status. *J Nutr* 1990;120(suppl 11):1459–1463.
59. Bieri JG, Everts RP, Thorp S. Factors affecting the exchange of tocopherol between red cells and plasma. *Am J Clin Nutr* 1977;30:686.
60. Holick MF. The use and interpretation of assays for vitamin D and its metabolites. *J Nutr* 1990;120(suppl 11):1464–1469.
61. Suttie JW. Role of vitamin K in the synthesis of clotting factors. In Draper HH, ed. *Advances in nutritional research*, Vol 1. New York: Plenum, 1977.
62. Hazell K, Baloch KH. Vitamin K deficiency in the elderly. *Gerontol Clin* 1970;12:10–17.

63. Sitren H. Vitamin K. In Baumgartner TG, ed. Clinical guide to parenteral micronutrition. New York: Fujizawa USA, 1991:411–430.
64. Sitren HS, Bailey LB, Cerda JJ, Anderson CR. Thiamin (vitamin B₁). In Baumgartner TG, ed. Clinical guide to parenteral micronutrition. New York: Fujizawa USA, 1991:431–449.
65. Sitren HS, Bailey LB, Cerda JJ, Anderson CR. Riboflavin (vitamin B₂). In Baumgartner TG, ed. Clinical guide to parenteral micronutrition. New York: Fujizawa USA, 1991:451–468.
66. Bailey LB. Pyridoxine (vitamin B₆). In Baumgartner TG, ed. Clinical guide to parenteral micronutrition. New York: Fujizawa USA 1991:521–539.
67. Sitren HS, Bailey LB, Cerda JJ, Anderson CR. Niacin (vitamin B₃). In Baumgartner TG, ed. Clinical guide to parenteral micronutrition. New York: Fujizawa USA, 1991:469–486.
68. Bailey LB. Folic Acid. In Baumgartner TG, ed. Clinical guide to parenteral micronutrition. New York: Fujizawa USA, 1991:573–590.
69. Bailey LB. Folate status assessment. *J Nutr* 1990;120(suppl 11):1508–1511.
70. Ueland PM, Refsum H, Stabler SP, et al. Total homocysteine in plasma or serum: methods and clinical applications. *Clin Chem* 1993;39:1764–1779.
71. Steinkamp RC. Vitamin B₁₂ and folic acid: clinical and pathophysiological considerations. In Brewster MA, Naito IIK, eds. Nutritional elements and clinical biochemistry. New York: Plenum, 1980.
72. Bailey LB. Cobalamine (vitamin B₁₂). In Baumgartner TG, ed. Clinical guide to parenteral micronutrition. New York: Fujizawa USA, 1991:541–572.
73. Roth KS. Biotin in clinical medicine: a review. *Am J Clin Nutr* 1981;34:1967.
74. Zempleni J, Mock DM: Advanced analysis of biotin metabolites in body fluids allows a more accurate measurement of biotin bioavailability and metabolism in humans. *J Nutr* 1999;129:494S–497S.
75. McCormick DB, Greene HL. Vitamins. In Burtis CA, Ashwood ER, eds. Tietz textbook of clinical chemistry. 3rd ed. Philadelphia, Pa.: WB Saunders, 1999:999–1029.
76. Englard S, Seifter S. The biochemical functions of ascorbic acid. *Annu Rev Nutr* 1986;6:265–304.
77. Jacob RA. Assessment of human vitamin C status. *J Nutr* 1990;120(suppl 11):1480–1485.
78. Tanphaichitr V, Leelahagul P. Carnitine metabolism and human carnitine deficiency. *Nutrition* 1993;9:246–254.
79. Takala J, Neuvonen P, Klossner J. Hypophosphatemia in hypercatabolic patients. *Acta Anaesthesiol Scand* 1985;29:65.
80. Tovey SJ, Benton KGF, Lee HA. Hypophosphatemia and phosphorus requirements during intravenous nutrition. *Postgrad Med* 1977;53:289.
81. O'Dell BL. Copper. In Ziegler EF, Filer EF Jr, eds. Present knowledge in nutrition. 7th ed. Washington, DC, ILSI Press, 1996:261–267.
82. Lockitch G, Godolphin W, Pendray MR, et al. Serum zinc, copper, retinol-binding protein, prealbumin and ceruloplasmin concentrations in infants receiving intravenous zinc and copper supplement. *J Pediatr* 1983;102:304.
83. Bogden JD, Klevay LM. Clinical nutrition of essential trace elements and minerals. Totowa, N.J.: Humana Press, 2000.
84. Gordon EF, Gordon RC, Passal DB. Zinc metabolism: basic clinical and behavioral aspects. *J Pediatr* 1981;99:341.
85. Jeejeebhoy KN. Zinc and chromium in parenteral nutrition. *Bull N Y Acad Med* 1984;60:118.
86. ARUP Lab. Zinc, serum. Retrieved from <http://www.aruplab.com/guides/ug/tests/0020097.jsp>.
87. Ghosh K. Non-haematological effects of iron deficiency: a perspective. *Indian J Med Sci* 2006;60:30–37.
88. Willis WT, Gohil K, Brooks GA, Dallman PR, iron deficiency: improved exercise performance within 15 hours of iron treatment in rats. *J Nutri* 1990;120:909–916.
89. Nuttall KL, Klee GG. Iron. In Burtis CA, Ashwood ER, eds. Tietz fundamentals of clinical chemistry. 5th ed, Philadelphia, Pa.: WB Saunders, 2001:596–601.
90. Fawzy ME, Yazigi AE, Stefadouros MA, et al. The role of selenium deficiency in dilated cardiomyopathy in Saudi Arabia. *Ann Saudi Med* 1999;19:20–22.
91. Hussein O, Rosenblat M, Refael G, et al. Dietary selenium increases cellular glutathione peroxidase activity and reduces the enhanced susceptibility to lipid peroxidation of plasma and low density lipoprotein in kidney transplant recipients. *Transplantation* 1997;63:679–685.
92. Girodon F, et al. Impact of trace elements and vitamin supplementation on immunity and infections in institutionalised elderly patients. *Arch Intern Med* 1999;159:748–754.
93. Fleet JC, Mayer J. Dietary selenium repletion may reduce cancer incidence in people at high risk who live in areas with low soil selenium. *Nutr Rev* 1997;55:277–279.
94. Wamique. YS. Cardiomyopathy in association with selenium deficiency: a case report. *J Parenter Enteral Nutr* 26:63–66, 2002.
95. ARUP Lab. Selenium. Retrieved from <http://www.aruplab.com/guides/ug/tests/>.
96. Tully RT, Lehmann HP. Flameless atomic absorption spectrophotometry of selenium in whole blood. *Clin Chem* 1982;28:1448.

Clinical Chemistry and the Geriatric Patient

Betty White

CHAPTER

33

CHAPTER OUTLINE

■ THE IMPACT OF GERIATRIC PATIENTS ON THE CLINICAL LABORATORY

■ THEORIES OF AGING

■ BIOCHEMICAL AND PHYSIOLOGIC CHANGES OF AGING

Endocrine Function Changes
Diabetes Mellitus and Insulin Resistance
Renal Function Changes
Hepatic Function Changes
Pulmonary Function and Electrolyte Changes

Cardiovascular and Lipid Changes

Enzyme Changes

■ CLINICAL CHEMISTRY RESULTS AND AGING

Establishing Reference Intervals for the Elderly
Preanalytic Variables, the Elderly,
and Chemistry Results

Therapeutic Drug Monitoring in the Elderly

Effects of Exercise and Nutrition on the Elderly
and Chemistry Results

■ REFERENCES

Aging, simply put, means to grow older. Several physiological changes occur as people age, causing gradual deterioration resulting from time-dependent, irreversible changes in that individual. These changes will be reflected in clinical laboratory test results. Because there is variability in the age of onset, rate, and course of structural and functional changes, the establishment of laboratory reference values is complicated.

THE IMPACT OF GERIATRIC PATIENTS ON THE CLINICAL LABORATORY

The U.S. population is aging and is in the midst of a longevity revolution. Life expectancy increased dramatically during the last century from 47 years for a person born in 1900 to 77 years for those born in 2001.^{1,2} This gain was, in large measure, due to improved sanitation, better medical care, and increased use of preventive health services.

Starting in 2012, nearly 10,000 Americans will turn 65 every day. By 2030, when the last “baby boomers” have reached 65 years old, 20% of all Americans will be age 65 or older. People who are older than 65 are called elderly, seniors, and geriatric patients. The number of older Americans is expected to reach 71 million by this time. From 2030 to 2050, the growth rate is projected to increase another 14%, bringing the population to 86.7 million. Because of the increase in the percentage and number of elderly people, the need for geriatric medical care

will increase. **Geriatrics**, according to *Taber’s Medical Dictionary*, is “the branch of health care concerned with the care of the aged, including physiological, pathological, psychological, economic, and sociological problems.” **Gerontology** is the study of the aging process.

The demand on the health care system by geriatric patients is different from that of the rest of the population. Health care will need to shift its emphasis to meet the needs of the chronically ill. As the population ages, increases in chronic diseases such as cancer, arthritis, hypertension, and diabetes, as well as other diseases, are expected. This will present a major challenge to the nation’s health care and social systems, as well as to the clinical laboratory. This will mean more physician office visits, hospital stays, and laboratory tests. Laboratory test volumes will increase because of this aging of our population and the rapid development of new tests.

The establishment of Medicare benefits at age 65 years was based on an estimate that 1% of the population would be age 65 when the benefits were needed, having no effect on the economy. That view has changed. Medicare accounts for 17% of health care dollars. This percentage is projected to rise over the next several years creating deficits in the Medicare program. However, only about 3% of the total Medicare expenditure is related to laboratory services. Reduced reimbursements, increased costs, and the laboratory personnel shortage threaten the quality of laboratory services and reduced access to testing.

Clinical laboratory professionals must familiarize themselves with problems unique to or especially common in the geriatric population. Geriatric patients may be subject to loss of eyesight, hearing, mobility, and loss of independence, all of which may affect their emotional states. During interaction with the geriatric patient, the clinical laboratory professional must explain the process clearly and treat the patient with dignity and respect. They must become aware of special considerations regarding the collection of blood samples, development of reference intervals, effect of medications on chemistry results, and diagnosis of diseases in the elderly. Most important, however, they must thoroughly understand the effects of aging on laboratory values.

THEORIES OF AGING

Theories of aging have described both intrinsic (genetic) and extrinsic (environmental) factors that are associated with change in structure and cell damage, a combination of which can be attributed to the aging process. Table 33-1 includes (a) random genetic damage, (b) glycation, (c) developmental processes involving the immune and neuroendocrine systems, (d) genetic programming, and (e) free radical damage.^{3,4}

The theory involving damaged DNA is not random, involving damage or alteration of genetic materials by mutagens, such as background radiation (ultraviolet), and causing chromosome or DNA damage.³ This damage is cumulative, but the failure associated with aging is a diminished capacity for repair of damaged DNA.^{3,5} The “error catastrophe” theory requires posttranslational modification of proteins that lead to genetic abnormalities and ultimate death of the cell.³ The loss of a nonessential amino acid in a protein, as with isoforms of CK-MM, is a nonfunctional change. The glycation theory contends that the nonenzymatic interaction of glucose with numerous

proteins forms glycated end products and cross-linked protein molecules. These modified proteins may eventually accumulate and interfere with both cell structure and function. This process may then result in various problems characteristic of the elderly (e.g., stiffening or loss of flexibility).^{3,6}

The developmental theories of aging involve the immune and neuroendocrine systems, neither of which provides a plausible explanation for aging. Immune system capability declines with age.³ Thymic atrophy occurs early in the aging process. Reduction of the T-cell population with an associated loss of B cells leads to a decreased response to new antigens. However, the exposure to neoantigens is highest at an early age. In addition, misfolding abnormalities, which occur in various forms of amyloidosis, are not merely associated with chronic infection and autoimmune disorders. Familial amyloid polynuropathy associated with polymerization of the transthyretin molecule (55 mutants) is an example of this disorder limited to communities in Portugal, Brazil, Japan, and Sweden. This and the endocrine model are not sufficient to explain various infectious diseases and disorders (e.g., autoimmune disorders, lymphocytic leukemia, and cancer) in the elderly.^{3,6,7} The aging theory involving the neuroendocrine system focuses on the hypothalamic–pituitary system and its target glands. The most notable changes involving decline in endocrine function occur in postmenopausal women and include a loss of estrogen and bone calcium. In men, plasma testosterone levels decrease with age.¹

The genetically programmed theory of aging suggests that genes play a role in the aging process and that everyone is “programmed” by their genes to live a certain number of years.³ Support for this theory is based on general observations of life span in families and various aging syndromes, such as progeria, Werner’s syndrome, and Down syndrome.³ There is more compelling work in basic science that has opened a large scope of study of cell signaling and cell death. Genes carry instructions not only for growth and development but also for cell destruction, causing decline of the body and ultimate death. Preprogrammed cell death is called **apoptosis**, from the Greek term for “dropping out.” Apoptosis was first described in 1972 as a process in cellular development and aging distinct from necrosis.⁸ While necrotic cells swell, apoptotic cells typically shrink and detach from surrounding parenchymal cells. Concurrently, cell volume decreases and chromatin condenses at the edge of the nucleus. Apoptotic cells die by design, whereas necrotic cells die by accident and lethal injury.⁸ The investigation of apoptosis was driven by its observation in the nematode *Caenorhabditis elegans*, followed by the identification of death gene homologs in other organisms.⁹ Aberrant regulation of apoptosis contributes to

TABLE 33-1 SOME CURRENT THEORIES OF AGING

RANDOM GENETIC DAMAGE

Mutagen or background radiation damage

Errors in chromosomal translation or transcription

Glycation of proteins

DEVELOPMENTAL

Immune system decline

Neuroendocrine

GENETICALLY PROGRAMMED

Preprogrammed cell death (apoptosis)

Free radical (e.g., OH·, O₂^{·-}) damage

Adapted with permission from Knight JA. *Laboratory medicine and the aging process*. Chicago: American Society of Clinical Pathologists, 1996.

well-known pathologies, such as autoimmune diseases, cancer, and viral infections.¹⁰ During apoptosis, the cell is killed by a class of proteases called *caspases*. Certain caspases (i.e., caspases 8 and 10) are involved in the initiation of apoptosis, and others (caspases 3, 6, and 7) execute the death order by destroying essential proteins in the cell. The apoptotic process can be summarized as follows:

Activation of initiating caspases by specific signals
 Activation of executing caspases by the initiating caspases, which can cleave inactive caspases at specific sites
 Degradation of essential cellular proteins by the protease activity of executing caspases
 Mitochondria have a central role in the mechanism of apoptosis.

Changes also occur from the action of reactive oxygen species generated and scavenged incompletely throughout the cell cycle that affect between cell interactions via alterations in the intercellular matrix, the intercellular exchange of trophic factors, the release of inflammatory cytokine mediators, and other effects. The basis of the free radical theory is that oxygen free radicals cause progressive, random damage to cellular components. A **free radical** is an atom or molecule with one or more unpaired electrons; therefore, free radicals have an odd number of electrons, resulting in an open bond, or a half bond, making them highly reactive. A free radical may be represented by a superscript dot which signifies the unpaired electron, for example, $\text{H}_2\text{O} = \text{OH}^\cdot + \text{H}^\cdot$. The hydroxyl ion (OH^\cdot) is a highly reactive free radical and perhaps one of the most damaging to cells. Free radicals are also electrophilic and attack sites of increased electron density (e.g., DNA, RNA, proteins, membranes). Eventually, free radical damage to cellular components causes death of the cell.^{3,5,11}

Superoxide (O_2^\cdot) is another free radical generated in the body by several reactions, including oxidative phosphorylation and cytoplasmic reactions. Fortunately, the body has a way of handling most of these free radicals. For example, superoxide dismutase, an enzyme present in all body cells, converts superoxide to hydrogen peroxide. Other enzymes (e.g., glutathione peroxidase and catalase) then inactivate the hydrogen peroxide. Hydroxyl radicals are neutralized by nonenzymatic compounds, such as vitamins C and E and the provitamin A and beta-carotene (the antioxidants).^{3,6,11} Recently, there has been much support for and research into this particular theory of aging.¹¹

Although many theories of aging have been proposed, no one mechanism has been fully borne out by research. In fact, in studies of multiple species, the only intervention known to delay aging is caloric restriction. In rodents, for example, caloric restriction increased average life expectancy and maximum life span and delayed the onset of

some typical age-associated diseases, as well as the deterioration of physiologic processes (e.g., immune system responsiveness and glucose metabolism).⁴ The reasons for these effects appear to be related solely to caloric restriction and *not* to the reduction of any one dietary factor, such as fat intake, or dietary supplement, such as vitamins or antioxidants. Unfortunately, the impact of caloric restriction on aging in humans is still not known.⁴

BIOCHEMICAL AND PHYSIOLOGIC CHANGES OF AGING

The theories of aging have points of intersection and are not mutually exclusive. Aging is a complex phenomenon involving biochemical and physiologic adjustments. In general, aging is associated with a decreasing efficiency in adaptation to stress. Aging systems continue to function adequately as long as they are not subjected to excessive physiologic stress. The ability of the body to successfully cope with stress decreases with advancing age and varies among individuals. The extent and rate at which the ability to adapt declines depend on many factors, including heredity, lifestyle, and nutrition; therefore, it becomes difficult to generalize about the complex process of aging. There is an aging-associated decrease in total body water, muscle mass, increased bone density with remodeling (and decreased mass with osteoporosis); an increase in lipids (e.g., cholesterol, high-density lipoprotein [HDL] cholesterol, and triglycerides); and a gradual decline in respiratory, cardiovascular, kidney, liver, gastrointestinal, immune, neurologic, and endocrine system functions.^{1,4,6,12,13}

Differentiating between age-associated decline and pathologic conditions may be difficult in the elderly patient because disease presentation may be atypical with nonspecific complaints and no classic signs. When this occurs, diagnosis and treatment may be delayed.

Aging is also typically associated with the development of several diseases and disorders.^{4,14} Table 33-2 shows some common diseases and disorders associated with the

TABLE 33-2 DISEASES AND DISORDERS COMMONLY ASSOCIATED WITH AGING^{3,11}

| |
|---|
| Atherosclerosis (e.g., myocardial infarct, renal disease, stroke) |
| Cancer |
| Diabetes mellitus |
| Hyperparathyroidism |
| Hyperthyroidism |
| Hypothyroidism |
| Monoclonal gammopathies (e.g., multiple myeloma) |
| Osteoporosis |

TABLE 33-3 THE TOP TEN LEADING CAUSES OF DEATH (AGE 65 AND OLDER)

| |
|---|
| 1. Heart disease |
| 2. Cancer |
| 3. Stroke |
| 4. Chronic lower respiratory disease |
| 5. Accidental death due to unintentional injury |
| 6. Diabetes |
| 7. Alzheimer's disease |
| 8. Influenza or pneumonia |
| 9. Nephritis, nephrotic syndrome, or nephrosis |
| 10. Septicemia |

From CDC, National Center for Health Statistics, National Vital Statistics Report 2004.

aging process. The leading causes of death in people 65 years of age and older are shown in Table 33-3.

The specific biochemical and physiologic changes of the aging process, as they relate to clinical chemistry tests, are discussed in the following sections. Table 33-4 summarizes changes in chemistry analytes associated with the aging process. Changes in analytes are those generally cited in the literature.^{4,13} Whenever possible,

laboratorians should examine the possibility of establishing age-adjusted reference intervals based on analyte values determined for healthy, older adults. Many clinicians accept that the greatest benefit derived from laboratory data comes from monitoring a specific individual's test values over time.

Endocrine Function Changes

It has long been known that endocrine-related abnormalities are common in the elderly and tend to increase in frequency during the aging process. Not only are there obvious changes in the production of hormones by the sex organs, there are also changes in thyroid, pituitary, and adrenal function. The most notable changes relate to the gonadal and thyroid hormones.

A variety of significant and complex hormonal changes relating to gonadal function occur in both men and women, including a decrease in the gonadal production of estrogen in women (menopause) and of testosterone in men (andropause); the adrenal production of dehydroepiandrosterone (DHEA) and DHEA sulfate (DHEAS) (adrenopause); and a decrease in the activity of growth hormone (GH)–insulin-like growth factor (IGF) axis (somatopause).^{15,16} As a result, hormone replacement regimens are being developed as a strategy to delay or prevent some of the consequences of aging. Between

TABLE 33-4 CHANGES IN SELECTED CLINICAL CHEMISTRY ANALYTES WITH AGE^{1,3,4,6,18–20,25,28}

| INCREASE | DECREASE | UNCHANGED |
|-----------------------------|----------------------|---------------------------------------|
| GGT | Albumin | Chloride |
| Alkaline phosphatase, women | Aldosterone | Cortisol |
| α_1 -Antitrypsin | Bilirubin | Free T ₄ |
| Amylase | Creatinine clearance | Haptoglobin |
| AST | DHEA | Insulin, fasting |
| BUN | Growth hormone | pCO ₂ , or slight increase |
| Creatine kinase, slight | pO ₂ | pH, or slight decrease |
| γ -Globulin, slight | T ₃ | Sodium |
| Glucose, fasting | Total protein | T ₄ , or slight decrease |
| HDL | Transferrin | Thyroid-binding globulin (TBG) |
| Inorganic phosphate | | |
| Lactate dehydrogenase (LDH) | | |
| pCO ₂ | | |
| Potassium, slight | | |
| Total cholesterol | | |
| Triglycerides | | |
| TSH, slight | | |
| Uric acid | | |

Changes in analytes are those generally cited in the literature. Some variability in the results of studies on aging and laboratory results may exist (i.e., one author may report no significant change for an analyte; another may report a slight decrease or increase for the same analyte).

60 and 80 years of age, the ratio of testosterone to estradiol falls from 12:1 to 2:1.^{1,4} The decrease in testosterone is linked primarily to diminished testicular function.^{1,17} In women, endocrine system changes are primarily related to menopause, when there is a cessation of ovarian estrogen production. **Menopause** is the permanent cessation of menstruation caused by a decline in ovarian follicular activity; it generally occurs between 35 and 58 years of age. The process of apoptosis, nontraumatic and noninflammatory cell death, balances cell proliferation and maintains **homeostasis**. Aging disrupts the orderly neuroendocrine feedback regulation of the secretion of GH, luteinizing hormone (LH), follicle-stimulating hormone (FSH), and adrenocorticotropin hormone (ACTH).¹⁷ Specific gene products either promote (Bax) or oppose (Bcl-2) regulated cell death via mitochondrial effects. Dysregulation of apoptosis has been implicated in the development of diseases that are more prevalent in older individuals, such as cancer and neurodegenerative disorders (e.g., Alzheimer's and Parkinson's disease). The major consequences of estrogen deficiency are osteoporosis and coronary heart disease (CHD).^{18,19}

Osteoporosis is a problem in both older men and women but particularly in women after menopause (at about 50 years of age). It is estimated that about 30% of elderly women and 20% of elderly men have osteoporosis.^{18,19} Osteoporosis involves a gradual loss of bone mass; the skeleton becomes weak and less dense as a result of increased bone resorption unbalanced by bone remodeling. The osteoblast cell maintains bone homeostasis. Bone resorption and bone formation are carried out in orderly sequence throughout life by osteoclasts and osteoblasts. The osteoclasts remove bone matrix at a rate of 150 μm per day; refill is carried out by osteoblasts at a rate of 1 μm per day. The refill of bone increases the strength of the bone by the structure of the osteon. Partly driven by muscle tension, refill is affected by estrogen. The uncompensated loss of skeletal mass may lead to microfractures and pain. Common clinical chemistry values in osteoporosis are generally normal, including serum calcium, phosphorus, magnesium, alkaline phosphatase, and the parathyroid and thyroid hormones,^{18,19} because bone loss is not associated with massive, rapid removal of mineral, as for hyperparathyroidism (parathyroid hypercalcemia) or Paget's disease (uncontrolled bone turnover). After a diagnosis of osteoporosis has been made, laboratory tests to assess bone metabolism (turnover) are helpful in following its progress in response to therapy. Major risk factors include diet, inactive lifestyle, genetic predisposition, smoking, endocrine disturbances, and medications.²⁰ The greatest problem secondary to osteoporosis is hip fracture, which is disabling and associated with nonhealing in the older population. Osteoporosis, therefore, is a significant problem among the elderly, resulting in increased morbidity and health care costs. A significant association also exists

between hypovitaminosis D and secondary hyperparathyroidism (elevated alkaline phosphatase and osteoporotic changes) in the elderly.^{21,22} This would presumably be related to dietary intake, lack of exposure to sunlight, and to reduced conversion of 25-hydroxy vitamin D₃ to the 1,25-form by the kidney.

The thyroid gland is central to the regulation of metabolic processes (i.e., regulation of metabolic rate). Reports conflict on age-related changes in structure and function of the thyroid gland. Increased fibrosis and nodularity of the gland are generally agreed on. Although there is little evidence of changes in thyroid function in the elderly, the incidence of both hypothyroidism and hyperthyroidism increases.^{1,3,4} It has been reported that the prevalence of hypothyroidism in the elderly is between 0.5% and 4.4%, whereas the prevalence of hyperthyroidism is between 0.5% and 3%.²³ Hypothyroidism, although more common in the elderly, is often more difficult to diagnose.²⁴ Typically, the signs and symptoms of hypothyroidism (e.g., dry skin, sparse hair, constipation, forgetfulness) may be easily misinterpreted as just "old age."³ In subclinical hypothyroidism, for example, patients have few or no clinical symptoms, but have a normal thyroxine (T₄) level with an elevated thyroid-stimulating hormone (TSH) level.²⁴ Whether these patients should be treated with thyroid hormone or followed with periodic thyroid tests is controversial. Inappropriate thyroid treatment is hazardous in the elderly since it may worsen manifestations of coronary heart disease. Interpretation of thyroid function in hospitalized and very ill patients is also difficult because of the effect of non-thyroid-related illness on common thyroid function tests.²⁴ Illness can depress the serum concentrations of both triiodothyronine (T₃) and T₄, whereas TSH remains normal or is even decreased. Alterations in protein binding, thyroid hormone metabolism, and suppression of the pituitary release of TSH may account for these findings in non-thyroid-related illness. Generally, these patients are considered to be euthyroid (i.e., have normal thyroid function) and no hormone supplementation is prescribed.²³ Many early studies attributed changes in thyroid function to the natural aging process. More recent studies, however, indicate that abnormal thyroid function is probably secondary to some underlying or associated disorder and not just old age.³ Because thyroid disorders may present subtly and are often difficult to diagnose, laboratory evaluation becomes important. In healthy elderly people, there is essentially no change in T₄, free T₄, thyroid-binding globulin, and reverse T₃ levels.^{6,23,24} However, some studies have shown a significant decrease in T₃ levels after 50 years of age, with a slight increase in TSH levels, perhaps as a normal response to the low T₃ level. It is still unclear whether these changes are age related or the result of underlying disease.^{6,23}

There are few morphologic changes of the pancreas in the elderly, other than some degree of atrophy and an

CASE STUDY 33-1

A 65-year-old woman hospitalized for pneumonia and uncontrolled diabetes had the thyroid test results shown in Case Study Table 33-1.1.

Questions

1. Based on the patient's status and the laboratory test results, how might the thyroid data be explained?
2. Should any additional testing be done?

CASE STUDY TABLE 33-1.1 LABORATORY RESULTS

| TEST | RESULT | REFERENCE RANGE |
|-------------|----------------------|-------------------------|
| Serum TSH | 1.5 $\mu\text{U/mL}$ | 0.5–5 $\mu\text{U/mL}$ |
| Total T_4 | 3.8 $\mu\text{g/dL}$ | 4.5–12 $\mu\text{g/dL}$ |
| Total T_3 | 55 ng/dL | 60–220 ng/dL |

increased incidence of tumors.²⁵ Although other aspects of endocrine function, such as the hypothalamus–anterior pituitary system and adrenal glands, exhibit no change in cortisol production, both aldosterone and DHEA decline with age.^{26,27} The prevalence of hypertension also increases with age, with about 60% of people older than 60 years having the condition.²⁷ Causes include increased peripheral resistance due to atherosclerosis, chronic renal and endocrine disorders, and multiple medications. In general, there is also a decline in the efficiency of homeostatic regulation.^{4,27}

Diabetes Mellitus and Insulin Resistance

Glucose tolerance declines with age, with elderly people having a slightly higher fasting serum glucose level than younger adults. Fasting glucose increases about 1–2 mg/dL (0.11 mmol/L) per decade throughout life.^{6,28} The renal threshold (the point at which glucose spills in the urine) also increases with age; there is also an altered insulin response to glucose.^{1,3} Diabetes mellitus is a common problem in the elderly, with a prevalence of about 18.4% in persons 65 years of age and older. The above observations about expected values for healthy elderly can be misleading. The definition of diabetes and prediabetes has been revised to glucose values above 126 mg/dL and to 100–126 mg/dL, respectively. Hyperglycemia, even if it is mild, is not a benign condition and appears to accelerate the aging process. There has been an alarming increase in obesity with increased type 2 diabetes and associated increase in hypertension and cardiovascular

risk. This syndrome is characterized by varying degrees of glucose intolerance, abnormal cholesterol and/or triglyceride levels, high blood pressure, and upper body obesity, all independent risk factors for cardiac disease. The PROCAM (Prospective Cardiovascular Munster) study, which examined the relationship between various cardiac risk factors and the incidence of heart attack in 2,754 men aged 40–65 years over a 4-year period, showed that the presence of diabetes or high blood pressure alone increased heart attack risk by 2.5 times. When diabetes and high blood pressure were both present, risk increased 8 times. An abnormal lipid profile increased the risk 16 times; when abnormal lipid levels were present with high blood pressure and/or diabetes, the risk was 20 times higher. These abnormalities constitute the insulin resistance syndrome. The insulin resistance syndrome was first described in 1988, when it was suggested that the defect was related to insulin.²⁹ This syndrome is estimated to affect 70–80 million Americans.³⁰ Because resistance usually develops long before these diseases appear, identifying and treating insulin-resistant patients has potentially great preventive value. The condition is common among persons with obesity (defined as a body mass index [BMI] of $\geq 30 \text{ kg/m}^2$). The pattern of obesity is also extremely important. There is a strong relationship between abdominal obesity and degree of insulin resistance, independent of total body weight.³¹ The degree of abdominal obesity can be estimated by use of waist circumference or the waist–hip ratio. The waist is usually measured at its narrowest point and the hips at the fullest point around the buttocks. A waist–hip ratio of greater than 1.0 in men or 0.8 in women is strongly correlated with abdominal obesity and insulin resistance and confers an increased risk of associated diseases. Advanced glycation end products (AGEs) are assumed to play a key role in diabetic nephropathy (DN) and other diabetic complications. These exert marked effects on endothelial cells, monocytes, macrophages, and bind to AGE receptors (RAGEs). AGEs are formed by the binding of aldoses on free NH_2 groups on proteins. The binding of AGEs to RAGEs activates endothelial cells, monocytes, and macrophages, which, when activated, produce cytokines and express adhesion molecules and tissue factors. These have a role in increased oxidative stress and the microvascular lesions in diabetes.³² There is also a complex relationship between fat mass, tumor necrosis factor α (TNF- α) and insulin resistance; however, the mechanism(s) by which TNF- α induces insulin resistance is not understood. TNF- α -induced genes include transcription factors implicated in preadipocyte gene expression or nuclear factor- κB activation, cytokines and cytokine-induced proteins, growth factors, enzymes, and signaling molecules.³³ Based on this, type 2 diabetes is more suspect as a chronic inflammatory disease than as a disease of pancreatic endocrine dysfunction.

Renal Function Changes

All aspects of renal function are affected by the aging process; it is age of onset, specific changes, and consequences that vary in elderly people.³⁴ Renal function begins to decline after the age of 30 years and, by age 60, is further reduced to one half.³⁴ This decline is attributed to the gradual loss of nephrons, decreased enzymatic and metabolic activity of tubular cells, and increased incidence of pathologic processes (e.g., atherosclerosis).³⁴

Renal function may be assessed at any age by a number of clinical tests, including urine volume, analysis of constituents and concentration, blood urea nitrogen (BUN), uric acid, and several clearance tests.³⁴ Creatinine clearance, glomerular filtration rate (GFR), and renal plasma flow all decrease with age.^{6,34} Reduction in GFR is the single most important physiologic change observed in the aging kidney. The analytes, BUN, uric acid, and inorganic phosphate that reflect GFR are found to increase.⁶

In general, elderly people have a decreased capacity to conserve water through the kidneys and a significantly lower sensation of thirst.³⁵ This, of course, can lead to dehydration, a common and underappreciated problem in the elderly. Not only is dehydration a common finding in the elderly, it also can be serious, leading to increased mortality rates.³ Clinical laboratory tests indicative of dehydration include hypernatremia, increased BUN/creatinine ratio, increased serum osmolality, and increased urine specific gravity.³

In addition to the previously mentioned renal changes of aging, there is an increased incidence of renal disease and a reduced ability to handle the excretion of drugs. Problems affecting renal function are related to damage from infections or drugs (medications), hypertension, or disorders such as diabetes mellitus, tuberculosis, and nephritis.³⁴

Hepatic Function Changes

In general, atrophy and decreased liver weight, as well as a decline in liver function, are common in the elderly.^{3,36} Although the liver performs many functions (see Chapter 24), three important functions—synthetic, excretory and secretory, and detoxification and drug metabolism—are addressed in this section in relation to the aging process.

The synthetic function of the liver can be monitored by means of concentrations of plasma proteins. Tietz et al.²⁸ reported a slight decrease of total protein in “fit” aging people. Albumin and transferrin show a decline as well. This observation has to be taken with some reservation. The homogeneity of the fit aging population sample must be taken with reservation. The declines in albumin and transferrin are probably attributable to a significant degree of malnutrition and liver disease in the population studied. The existence of malnutrition, alcoholic liver disease, depression, and poor nutrient

CASE STUDY 33-2

An otherwise healthy 70-year-old man entered the hospital for abdominal surgery. Preoperative chemistry test results are shown in Case Study Table 33-2.1.

Questions

1. What is the BUN/creatinine ratio for this patient?
2. What do these data suggest?
3. Which test results support this conclusion?
4. How common is this condition in the elderly?

CASE STUDY TABLE 33-2.1 LABORATORY RESULTS

| TEST | RESULT | REFERENCE RANGE |
|------------------|-------------|-----------------|
| Albumin | 53 g/L | 35–50 g/L |
| BUN | 40 mg/dL | 8–26 mg/dL |
| Creatinine | 1.6 mg/dL | 0.9–1.5 mg/dL |
| Serum osmolality | 330 mOsm/kg | 275–295 mOsm/kg |
| Sodium | 150 mmol/L | 135–145mmol/L |

intake in the ambulatory elderly population cannot be discounted. In the nursing home population, protein energy malnutrition rates are as high as 40%–50%. If the malnutrition rate was 10% and the ambulatory aged people had an albumin of 2.8 g/dL, the serum albumin concentration for a sample of 10,000 people at a level of 3.5 g/dL would decrease to 3.4 g/dL. In addition, type 2 diabetes can be associated with nonalcoholic steatosis and steatohepatitis (fatty liver), which would lead to decreased albumin and transferrin and increased alkaline phosphatase. γ -Globulin and α_1 -antitrypsin, however, increase slightly with age, whereas haptoglobin remains essentially the same as in young adults.²⁸ Likewise, immunoglobulins are decreased in a part of the population.

Certain enzymes also change. Alkaline phosphatase (ALP) and lactate dehydrogenase (LDH), for example, increase in both men and women, but it is unlikely that these are age-related changes. Urea synthesis, a process that occurs in the hepatocytes, and bilirubin metabolism both decline with age.^{3,36} The liver's detoxification or drug metabolism function is important when considering the increased numbers of medications that are usually prescribed to elderly patients. Although people 65 years of age and older compose about 12% of the U.S. population, they receive about one third of all prescribed medications.³ In addition to possible drug interactions,

drug toxicity is a potential problem. As mentioned previously, there is some atrophy of the liver as well as reduced hepatic blood flow with the aging process. This, in turn, may lead to the accumulation of some drugs (e.g., lidocaine and morphine) and the possibility of toxicity.³ Medications and the elderly are discussed in more detail later.

Pulmonary Function and Electrolyte Changes

Several known anatomic and physiologic changes occur in cardiopulmonary function during the aging process. Pulmonary function actually begins to decline after the age of 25 as a result of changes in the lung, thoracic cage, respiratory muscles, and respiratory centers in the central nervous system.³⁷ Of course, pulmonary function is, perhaps, more affected by personal habits, such as smoking, and by environmental pollution.³⁷

The more frequently described changes relating to pulmonary function in the elderly include the pO_2 and pCO_2 values. These changes reflect the decreased vital (lung) capacity found in most elderly people.³⁷ Arterial pO_2 , for example, decreases during the aging process, whereas pCO_2 is reported to increase slightly or remain the same.^{4,37} An increase in bicarbonate would compensate for the increase in pCO_2 and maintain the blood pH value, which is reported to remain fairly constant or to decrease only slightly.^{6,37}

The electrolytes sodium, potassium, and chloride all show little change in healthy elderly people from values seen in younger adults.²⁷ Sodium remains fairly constant from young adulthood to older age. Chloride values are also fairly constant but have been found to be slightly higher in people older than 90 years. Potassium, however, increases slightly from age 60 to 90.²⁷

Respiratory-related diseases are prevalent in elderly people and account for 25% of all deaths in those older than 85.³⁷ Respiratory diseases of the elderly include chronic bronchitis, chronic obstructive pulmonary disease (COPD), neoplasia, and lung infections, particularly tuberculosis and pneumonia.³⁷

Cardiovascular and Lipid Changes

Cardiovascular disease continues to be an important cause of death in old age in both men and women. Atherosclerosis, a type of arteriosclerosis, is the major cause of death from cardiovascular disease in the United States.³ **Atherosclerosis**, a progressive disease process that begins early in life, involves vascular alterations characterized by fatty accumulations in the vascular walls.³ Atherosclerosis develops slowly over the years. Results of atherosclerosis include hypertension, hemorrhage, thrombosis, stroke, and coronary heart disease (CHD). CHD, also called *ischemic heart disease*, continues to be a major cause of disability and death in the United

States, and its prevalence increases with advancing age.³⁸ Risk factors for CHD include age, gender, genetic predisposition, obesity, hypertension, poor fitness, diabetes mellitus, cigarette smoking, and hyperlipidemia.³

Lipids shown to play a major role in the atherosclerotic process and risk for CHD are HDL and low-density lipoprotein (LDL) cholesterol, total cholesterol, and triglycerides. In a study by Tietz et al.²⁸ of fit elderly, total cholesterol, HDL cholesterol, and triglycerides were found to increase as a part of the aging process.²⁸ HDL cholesterol, or “good” cholesterol, however, is considered as an important *inverse* risk factor for CHD, with values less than about 35 mg/dL indicating a high risk and values more than 35 mg/dL indicating a low risk.³

Enzyme Changes

Changes in enzyme levels during the aging process have been studied extensively; they are varied and complex. Enzyme concentration and synthesis are under genetic control and are affected by hormones, substrates, and other factors. Enzymes do not appear to follow any particular age-related pattern; they may increase, decrease, or remain the same during the aging process. However, the ability to initiate adaptive changes in the activity of enzymes has been found to be impaired with increasing age.³

Enzymes reported to change in healthy, elderly people include aspartate aminotransferase (AST), alanine aminotransferase (ALT), ALP, γ -glutamyltransferase (GGT), creatine kinase (CK), LDH, and amylase.²⁸ AST, GGT, LD, and amylase show increases in both men and women. ALT levels show only a marginal increase in men, whereas values in women show no change. ALP, however, shows a significant increase in women, whereas men show no increase until age 90. CK values in men increase slightly between 60 and 69 years of age; however, between 70 and 90 years of age, the values decrease. In women, CK values also increase slightly from 60 to 70 years of age but decrease in those older than age 70. Lipase increases only slightly, if at all, in those aged 60–90 but definitely increases in those older than age 90.²⁸

CLINICAL CHEMISTRY RESULTS AND AGING

In addition to knowledge of basic biochemical and physiologic changes of aging, clinical laboratorians must understand other factors that may affect clinical chemistry results in the elderly. For example: does the aging process affect laboratory test results sufficiently to warrant separate reference intervals for the elderly? What preanalytic variables (e.g., diet, posture, medications) relating to the elderly affect clinical chemistry results? How does the aging process affect interpretation of drug levels in the elderly? What are the effects of exercise and nutrition on the elderly and chemistry results?

TABLE 33-5 FACTORS TO CONSIDER IN THE INTERPRETATION OF CLINICAL LABORATORY RESULTS FOR THE ELDERLY^{3,22,33}

| |
|--|
| EXERCISE |
| Duration |
| Type |
| MEDICATIONS |
| Polypharmacy |
| MOBILITY |
| Immobility |
| Posture |
| NUTRITIONAL STATUS |
| PERSONAL HABITS |
| Alcohol use |
| Smoking |
| PRESENCE OF MULTIPLE CHRONIC OR SUBCLINICAL DISORDERS |
| REFERENCE INTERVAL VALIDITY |
| SPECIMEN COLLECTION VARIABLES |
| Site |
| Trauma |
| Volume |

Table 33-5 shows some factors laboratorians should consider when interpreting laboratory values for the elderly.

Establishing Reference Intervals for the Elderly

Interpretation of test results and reference intervals for the elderly can be confusing and complex. The uniqueness of geriatric clinical laboratory results has been missed in the past due to shorter life spans resulting in fewer geriatric specimens for testing. As people live longer, age-related criteria for the analysis and interpretation of geriatric laboratory tests become more important. However, there appears to be some confusion on the topic of reference intervals for the elderly among experts in the field of clinical chemistry and aging.

As previously discussed, many reference intervals for analytes vary from the reference intervals of younger adults. Certain analytes, such as the levels of male and female hormones, are the undisputed result of aging organs. With other analytes, however, the case may not be so clear.³ Some variance in analyte levels may be a result of various secondary conditions (e.g., subclinical diseases, drugs, inactivity, nutrition) and not the aging process alone;—for example, the relationship between non-insulin-dependent diabetes mellitus and a rise in serum glucose levels.

Frequently, abnormal test results in the elderly are interpreted as “normal” for the individual’s age and not a sign of a disorder or disease.¹¹ Research is now showing, however, that in many instances, abnormal laboratory results in so-called healthy individuals, may, in fact, be associated with unrecognized subclinical disorders or with other secondary conditions.^{3,11} The fact that reference intervals are not easily determined, even for younger healthy adult populations, adds to the problem. Frequently, reference intervals are poorly defined and not always determined by a uniform process.³⁹ The establishment of reference intervals involves a well-defined protocol, including careful selection of reference individuals, control of preanalytic factors, a comprehensive list of analytic interferences, careful and consistent collection of specimens for a given analyte, analysis of specimens under well-defined conditions, and identification of data errors.³⁹ It is apparent that determination of reference intervals for the elderly can be problematic because a large percentage of elderly have some subclinical or obvious pathologic abnormality. The National Committee for Clinical Laboratory Standards (NCCLS) published an important guideline (C28-A) regarding the determination of valid reference intervals for quantitative clinical laboratory tests⁴⁰; however, the guideline is inadequate for validating or determining reference intervals because of inadequate power, sample bias, and failure to control for confounding conditions in the sample population.

Although the aging process does affect certain selected analytes, the relationship between aging and changes in other analytes is less understood. Generally, clinicians and laboratorians agree that separate reference intervals for the elderly are needed to prevent false abnormal results. Knight³ recommends that until we have a better understanding of the relationships among true aging, age-associated disorders, and various laboratory results, clinicians and laboratorians should maintain the normal reference intervals established for healthy, younger adults. It is also useful to compare a person’s current values with values obtained throughout his or her adult life. In any case, clinicians and clinical laboratory scientists should keep in mind all factors affecting the interpretation of laboratory test results for the elderly.

Preanalytic Variables, the Elderly, and Chemistry Results

Many preanalytic variables may affect the interpretation of chemistry results; however, preanalytic variables may have a much greater effect on the elderly. Preanalytic variables relating to the patient include diet, gender, posture (e.g., sitting or lying), personal habits (e.g., smoking and alcohol consumption), body composition, physical activity, and prescribed medications.⁴¹ Any of these may

affect the concentration of various analytes; for example, body composition changes with age. In healthy people, body fat increases and lean muscle mass decreases with age. In view of the increase in type 2 diabetes, body fat, and inherent health risks, a reference to “healthy” people may be unwarranted. Body mass and height also decrease after about age 60.⁴¹ These changes, in turn, may affect the levels of various analytes (e.g., creatinine).

Other preanalytic variables affecting laboratory results for the elderly involve the collection of specimens for analysis.⁴² Several physical and physiologic changes of aging can affect the collection and quality of a specimen and make phlebotomy a challenge to the phlebotomist. Because elderly patients may have diseases such as arthritis, malnutrition, or dehydration, in addition to the aging process itself, there may be a decrease in muscle tone and skin elasticity (i.e., flabby skin). Veins may be difficult to find or inappropriate to use, making phlebotomy difficult and causing hemolysis and an increased likelihood of elevated plasma hemoglobin and LDH level.⁴² The veins of elderly patients may also provide poor blood flow, resulting in a less-than-adequate sample for some laboratory tests.⁴²

CASE STUDY 33-3

A 72-year-old man was admitted to the emergency department with irregular heart rhythm. Although he was confused, he cooperated and answered the physician’s questions. During the interview, it became apparent that the patient could not remember if or when he had taken his digoxin. The decision was made to perform a random digoxin level to determine the amount present.

Questions

1. Based on these results, what are two possibilities that may explain the results?
2. Further testing ruled out kidney, liver, or circulatory problems. What is the most likely cause of this increased digoxin level?
3. What could interfere with the test for digoxin?

CASE STUDY TABLE 33-3.1 LABORATORY RESULTS

| TEST | RESULT | REFERENCE RANGE |
|---------|-----------|--------------------------------|
| Digoxin | 2.6 ng/mL | 0.5–1.5 ng/mL (therapeutic) |
| | | > 2.0 ng/mL (toxic) |

Therapeutic Drug Monitoring in the Elderly

Elderly people, comprising 13% of the U.S. population, use 34% of prescription and 30% of all nonprescription medications and often are on multiple medications.⁴³ Unfortunately, overdosing and adverse drug reactions (from multiple medications) are problematic in the elderly. With the normal aging process, there are many changes in how the body handles drugs.⁴³ Absorption, distribution, metabolism, and excretion of a drug are all affected by the aging process. (See Chapter 29 for more information on the pharmacokinetics of drugs.) For example, gastric emptying time may be prolonged in the elderly, causing a delay in drug absorption.^{44,45} Absorption by intramuscular injections may also be impaired because of decreased blood flow.⁴⁴ Metabolism or biotransformation of drugs, which is handled primarily by the liver, may be impaired as a result of an age-related decrease in hepatic mass and blood flow.⁴⁴

The most significant pharmacokinetic change in the elderly is related to the elimination of drugs through the kidneys. Renal mass and blood flow both decrease with advancing age.⁴⁴ Serum albumin may also be decreased because of protein energy malnutrition, which affects drugs that are transported bound to albumin. GFR (as measured by creatinine clearance) also declines linearly with age.⁴⁴ For drugs principally excreted in the urine, caution should be exercised in treatment to prevent any overdosing or toxic effects.⁴⁴

Drug dosing is adjusted for creatinine clearance using the Cockcroft-Gault formula⁴³:

$$Cl_{cr} = \frac{(140 - \text{age})(\text{wt in kg})}{(72)(\text{serum creatinine in mg/dL})} \quad (\text{Eq. 33-1})$$

Multiply by 0.85 for women. Ideal weight, rather than usual weight, corrects for weight in obese individuals. Because serum creatinine below 0.9 gives a spuriously high clearance creatinine, creatinine must be rounded.

Psychosocial factors common among the elderly, such as depression, dementia, poverty, and loneliness, are also factors contributing to medication problems. Elderly patients, for example, may be less compliant (e.g., because of poverty) or incapable of following medication instructions, adding to the problem.⁴⁴ Because the effects of drugs are more likely to be exaggerated in the elderly, laboratorians should be knowledgeable of the principles of therapeutic drug monitoring and the affects of aging on therapeutic drug monitoring. To provide the best quality care to the elderly, frequent drug monitoring and the development of therapeutic ranges for the elderly may be necessary.⁴⁵

Effects of Exercise and Nutrition on the Elderly and Chemistry Results

Many studies indicate that exercise is an excellent way for the elderly to maintain health and increase longevity.

Rowe and Kahn,³⁵ in a study of more than 40,000 postmenopausal women during a 7-year period, reported that those who exercised regularly were 20% less likely to die than those who were sedentary. Shephard⁴⁶ concludes that exercise may benefit the sedentary elderly population (75–80 years of age) by improving overall health, increasing social contacts, and improving cerebral function. Obesity, as a result of metabolic changes, reduced activity, and age-related alterations in muscle, is a common problem in elderly people that is also helped by exercise.^{47,48} Other studies indicated that (a) the more frequent the exercise, the greater is the benefit, (b) moderate exercise (e.g., walking) is nearly as beneficial as vigorous exercise, and (c) exercise can negate the adverse effects of other risk factors, such as high blood pressure and hyperglycemia.²⁷ The health benefits from exercise include reduced cardiovascular risk, weight control, increased functional capacity, improved nutrient intake, and better sleep.^{3,47,48}

As increasing numbers of elderly people are encouraged to participate in exercise programs, laboratorians will need a better understanding of how exercise affects the test results of these individuals; for example, exercise affects lipids by lowering triglycerides and increasing HDL cholesterol, insulin is lowered, and GH is increased.⁴⁷

Consideration should also be given to type of exercise, timing of specimen collection, and prescribed medications. Glucose and insulin, for example, do not respond in the same manner to different types of exercise. Both essentially remain stable during isometric exercise with large muscle groups, whereas insulin decreases during dynamic exercise of moderate to high intensity.⁴⁷ Timing of specimen collection is important because glucagon secretion is stimulated after intense

exercise in patients with type 2 diabetes, which results in a transient elevation of glucose levels for about 1 hour after exercise.⁴⁷

Nutritional problems are common in elderly patients. There is a growing body of information on the nutritional needs of the elderly population. Elderly people are at increased risk for poor nutritional status (e.g., protein-calorie malnutrition) compared with younger adults, as a result of both physiologic and psychological factors, including age-related changes in taste and smell; malabsorption caused by medications or changes in stomach acidity; and mobility, disability, depression, and poverty.^{46,49,50} The incidence of malnutrition among elderly residents in long-term-health care facilities is reported to range from 50%–85%; in acute care hospitals, the percentage may range from 17%–65%.⁵¹

The relationships among nutrition, general health, aging, and disease are important and need to be investigated further. A protein-calorie deficit can lead to decreased resistance to infection and lymphopenia. Excessive calories result in obesity and the probability of type 2 diabetes. Deficiencies in vitamins A, C, and E (the antioxidants) may lead to atherosclerosis and an increased risk for cancer.⁸ Low-fiber diets may lead to diverticulitis and colon cancer.³

Through nutritional assessment, it may be possible to prevent and identify nutritional deficiencies in elderly people, preventing many chronic diseases of aging and promoting better health.^{38,52,53} In the clinical laboratory, nutritional assessment includes the measurement of various proteins (e.g., albumin, prealbumin, transferrin, and retinol-binding protein) and vitamin levels. A detailed discussion of nutritional assessment and vitamins can be found in Chapter 32.

REFERENCES

- Liew CC. Biochemical aspects of aging. In Gornall AG, ed. *Applied biochemistry of clinical disorders*. 2nd ed. Philadelphia, Pa.: Lippincott-Raven, 1986:558–565.
- National Center for Health Statistics. *Health, United States, 2003*. Hyattsville, Md.: U.S. Department of Health and Human Services, Centers for Disease Control and Prevention, 2003.
- Knight JA. *Laboratory medicine and the aging process*. Chicago, Ill.: American Society of Clinical Pathologists, 1996.
- Resnick NM. Part 1: Introduction to clinical medicine. Chapter 9. Geriatric medicine. Harrison's on-line available at: www.harrisonsonline.com. New York: McGraw-Hill, 1998.
- Strehler BL. A critique of theories of biological aging. In Dietz AA, ed. *Aging: its chemistry*. Washington, D.C.: American Association of Clinical Chemistry, 1980:25–45.
- Gorman LS. Aging: laboratory testing and theories. *Clin Lab Sci* 1995;8:24–30.
- Cearlock DM, Laude-Flaws M. Stress, immune function and the older adult. *Med Lab Obs* 1997;29:36–46.
- Kerr JFR, Wyllie AH, Currie AR. Apoptosis: a basic biological phenomenon with wide-ranging implications in tissue kinetics. *Br J Cancer* 1972;26:239–257.
- Sulston JE, Horvitz HR. Post-embryonic cell lineages of the nematode, *Caenorhabditis elegans*. *Dev Biol* 1977;56:110–156.
- Carson DA, Ribeiro JM. Apoptosis and disease. *Lancet* 1993;341:1251–1254.
- Miller SM. Antioxidants and aging. *Med Lab Obs* 1997;29:42–51.
- Etnyre-Zacher P, Isabel JM. The impact of an aging population on the clinical laboratory. *Med Lab Obs* 1997;29:48–54.
- Young DS. *Effects of preanalytical variables on clinical laboratory tests*. Washington, D.C.: AACC Press, 1993.
- Knight JA. Laboratory issues regarding geriatric patients. *Lab Med* 1997;28:458–461.
- Merry BJ, Holehan AM. Aging of the male reproductive system. In Timiras PS, ed. *Physiological basis of aging and geriatrics*. 2nd ed. Boca Raton, Fla.: CRC Press, 1994:171–178.

16. Merry BJ, Holehan AM. Aging of the female reproductive system: the menopause. In Timiras PS, ed. *Physiological basis of aging and geriatrics*. 2nd ed. Boca Raton, Fla.: CRC Press, 1994:147–170.
17. Pincus S, Mulligan T, Iranmanesh A, et al. Older males secrete luteinizing hormone and testosterone more irregularly, and jointly more asynchronously, than younger males. *Proc Natl Acad Sci USA* 1996;93:14100–14105.
18. Kane RL, Ouslander JG, Abrass IB. *Essentials of clinical geriatrics*. 3rd ed. New York: McGraw-Hill, 1994.
19. Meier DE. Osteoporosis and other disorders of skeletal aging. In Cassel CK, et al, eds. *Geriatric medicine*. 3rd ed. New York: Springer-Verlag, 1997:411–432.
20. Davies MD, Blizotes M. Osteoporosis: risk factors, diagnosis and therapy. *Lab Med* 1998;29:418–421.
21. Komar L, Nieves J, Cosman F, et al. Calcium homeostasis of an elderly population upon admission to a nursing home. *J Am Geriatr Soc* 1993;41:1057–1064.
22. Perry HM III, Miller DK, Morley JE, et al. A preliminary report of vitamin D and calcium metabolism in older African Americans. *J Am Geriatr Soc* 1993;41:612–616.
23. Timiras PS. Aging of the thyroid gland and basal metabolism. In Timiras PS, ed. *Physiological basis of aging and geriatrics*. 2nd ed. Boca Raton, Fla.: CRC Press, 1994:179–189.
24. Simons RJ, Demers LM. Thyroid disorders in the elderly. In Faulkner WR, Meites S, eds. *Geriatric clinical chemistry: reference values*. Washington, D.C.: AACC Press, 1994:103–116.
25. Timiras PS. The endocrine, pancreas and carbohydrate metabolism. In Timiras PS, eds. *Physiological basis of aging and geriatrics*. 2nd ed. Boca Raton, Fla.: CRC Press, 1994:191–197.
26. Timiras PS. Aging of the adrenals and pituitary. In Timiras PS, ed. *Physiological basis of aging and geriatrics*. 2nd ed. Boca Raton, Fla.: CRC Press, 1994:133–146.
27. Timiras PS. Cardiovascular alterations with age: atherosclerosis, coronary heart disease, hypertension. In Timiras PS, ed. *Physiological basis of aging and geriatrics*. 2nd ed. Boca Raton, Fla.: CRC Press, 1994:199–214.
28. Tietz NW, Shuey DF, Wekstein DR. Laboratory values in fit aging individuals: sexagenarians through centenarians. In Faulkner WR, Meites S, eds. *Geriatric clinical chemistry: reference values*. Washington, D.C.: AACC Press, 1994:145–184.
29. Reaven GM. Role of insulin resistance in human disease. *Banting Lecture* 1988. *Diabetes* 1988;37:1595–1607.
30. American Diabetes Association. Consensus Development Conference on Insulin Resistance, November 5–6, 1997. *Diabetes Care* 1998;21:310–314.
31. Karter AJ, Mayer-Davis EJ, Selby JV, et al. Insulin sensitivity and abdominal obesity in African-American, Hispanic, and non-Hispanic white men and women. The Insulin Resistance and Atherosclerosis Study. *Diabetes* 1996;45:1547–1555.
32. Wautier JL, Guillausseau PJ. Advanced glycation end products, their receptors and diabetic angiopathy. *Diabetes Metab (Paris)* 2001;27:535–542.
33. Ruan H, Hacoheh N, Golub TR, et al. Tumor necrosis factor-alpha suppresses adipocyte-specific genes and activates expression of preadipocyte genes in 3T3-L1 adipocytes: nuclear factor-kappa B activation by TNF-alpha is obligatory. *Diabetes* 2002;51:1319–1336.
34. Timiras ML. The kidney, the lower urinary tract, the prostate, and body fluids. In Timiras PS, ed. *Physiological basis of aging and geriatrics*. 2nd ed. Boca Raton, Fla.: CRC Press, 1994:235–246.
35. Rowe JW, Kahn RL. *Successful aging*. New York: Pantheon Books, 1998.
36. Timiras PS. Aging of the gastrointestinal tract and liver. In Timiras PS, ed. *Physiological basis of aging and geriatrics*. 2nd ed. Boca Raton, Fla.: CRC Press, 1994:247–257.
37. Timiras PS. Aging of respiration, erythrocytes, and the hematopoietic system. In Timiras PS, ed. *Physiological basis of aging and geriatrics*. 2nd ed. Boca Raton, Fla.: CRC Press, 1994:225–233.
38. Institute for Health and Aging Report, University of California, San Francisco. *Chronic care in America: a 21st century challenge*. Princeton, N.J.: Robert Wood Johnson Foundation, 1996.
39. Sasse EA. The determination of reference intervals. In Faulkner WR, Meites S, eds. *Geriatric clinical chemistry: reference values*. Washington, D.C.: AACC Press 1994:6–17.
40. National Committee for Clinical Laboratory Standards. NCCLS approved guideline. How to define and determine reference intervals in the clinical laboratory. Villanova, Pa.: National Committee for Clinical Laboratory Standards, 1995.
41. Young DS. Pre-analytical variability in the elderly. In Faulkner WR, Meites S, eds. *Geriatric clinical chemistry: reference values*. Washington, D.C.: AACC Press, 1994:19–39.
42. Klosinski DD. Collecting specimens from the elderly patient. *Lab Med* 1997;28(8):518–522.
43. Bloom HG, Shlom EA. *Drug prescribing for the elderly*. New York: Raven Press, 1993.
44. Beizer JL, Timiras ML. Pharmacology and drug management in the elderly. In Timiras PS, ed. *Physiological basis of aging and geriatrics*. 2nd ed. Boca Raton, Fla.: CRC Press, 1994:279–284.
45. Warner A. Therapeutic drug monitoring in the elderly. In Faulkner WR, Meites S, eds. *Geriatric clinical chemistry: reference values*. Washington, D.C.: AACC Press, 1994:134–144.
46. Shephard RJ. The scientific basis of exercise prescribing for the very old. *J Am Geriatr Soc* 1990;38:62–70.
47. Cearlock DM, Nuzzo NA. Evaluating the benefits and hazards of exercise in the older adult. *Med Lab Obs* 1997;29:40–49.
48. Holloszy JO. Health benefits of exercise in middle-aged and older people. In Kotsonis FN, Mackey MA, eds. *Nutrition in the '90s: current controversies and analysis*. New York: Marcel Dekker, 1994:81–97.
49. Blair SN. Physical activity, fitness, and health. In Kotsonis FN, Mackey MA, eds. *Nutrition in the '90s: current controversies and analysis*. New York: Marcel Dekker, 1994:61–79.
50. Ham RJ. The signs and symptoms of poor nutritional status. In Ham JR, ed. *Primary care: nutrition in old age*. Philadelphia, Pa.: WB Saunders, 1994:33–54.
51. Garry PJ. Nutrition and aging. In Faulkner WR, Meites S, eds. *Geriatric clinical chemistry: reference values*. Washington, D.C.: AACC Press, 1994:48–72.
52. Miller SM. Nutrition, the elderly, and the laboratory. *Med Lab Obs* 1997;29:23–30.
53. Gallagher-Allred CR, Emley S. Specific dietary interventions: diabetes, osteoporosis, renal disease. In Ham JR, ed. *Primary care: nutrition in old age*. Philadelphia, Pa.: WB Saunders, 1994:175–189.

Clinical Chemistry and the Pediatric Patient

Dean C. Carlow, Michael J. Bennett

CHAPTER

34

CHAPTER OUTLINE

■ DEVELOPMENTAL CHANGES FROM NEONATE TO ADULT

Respiration and Circulation
Growth
Organ Development
Problems of Prematurity and Immaturity

■ PHLEBOTOMY AND CHOICE OF INSTRUMENTATION FOR PEDIATRIC SAMPLES

Phlebotomy
Preanalytic Concerns
Choice of Analyzer

■ POINT-OF-CARE ANALYSIS IN PEDIATRICS

■ REGULATION OF BLOOD GASES AND pH IN NEONATES AND INFANTS

Blood Gas and Acid-Base Measurement

■ REGULATION OF ELECTROLYTES AND WATER: RENAL FUNCTION

Disorders Affecting Electrolytes and Water Balance

■ DEVELOPMENT OF LIVER FUNCTION

Physiologic Jaundice
Energy Metabolism
Diabetes
Nitrogen Metabolism

Nitrogenous End Products as Markers of Renal Function
Liver Function Tests

■ CALCIUM AND BONE METABOLISM IN PEDIATRICS

Hypocalcemia and Hypercalcemia

■ ENDOCRINE FUNCTION IN PEDIATRICS

Hormone Secretion
Hypothalamic–Pituitary–Thyroid System
Hypothalamic–Pituitary–Adrenal Cortex System
Growth Factors
Endocrine Control of Sexual Maturation

■ DEVELOPMENT OF THE IMMUNE SYSTEM

Basic Concepts of Immunity
Components of the Immune System
Neonatal and Infant Antibody Production
Immunity Disorders

■ GENETIC DISEASES

Cystic Fibrosis
Newborn Screening for Whole Populations
Diagnosis of Metabolic Disease in the Clinical Setting

■ DRUG METABOLISM AND PHARMACOKINETICS

Therapeutic Drug Monitoring
Toxicologic Issues in Pediatric Clinical Chemistry

■ REFERENCES

DEVELOPMENTAL CHANGES FROM NEONATE TO ADULT

Pediatric laboratory medicine provides many unique opportunities to study how the homeostatic and physiologic mechanisms that control normal human development evolve. With these opportunities to study development comes a completely new set of challenges, many based on failure of some component of the normal development process and resulting disease. With this scenario in mind, it becomes clear that the environment for the specialist pediatric laboratorian is different from the environment encountered in adult practice, in which **physiologic development** is not a major issue. The diseases encountered in pediatric practice, therefore, differ considerably

from those in adult situations. Moreover, the nature of body size and, hence, available blood volume create additional problems for the analyst with regard to choice of instrumentation and testing menu.

The greatest pediatric challenge relates to the birth of an infant. There is a requirement at this time for rapid adaptation from intrauterine life, in which homeostasis is maintained by maternal and placental means, to the self-maintenance needed to adapt to extrauterine life. Issues related to this adaptation are further complicated by prematurity or intrauterine growth retardation (IGR), when many organ systems have not reached sufficient maturity to enable the newborn to adapt to the necessary changes at the time of delivery.¹

Respiration and Circulation

At birth, the normal infant rapidly adapts by initiating active respiration. The stimuli for this process include clamping of the umbilicus, cutting off maternal delivery of oxygen, and the baby's first breath. Initiation of breathing requires the normal expression of surfactant in the lungs. Surfactant is necessary for the normal expansion and contraction of alveoli and allows gaseous exchange to take place.

Initiation of respiration and expansion of lung volume causes increased pulmonary blood flow and reduced blood pressure. This, in turn, results in closure of the ductus arteriosus and a shift in blood flow through the heart that allows newly oxygenated blood from the lungs to be directed through the left side of the heart to the body. Blood flow now goes from the right side of the heart to the lungs for oxygenation. Closure of the ductus arteriosus is essential for this process to take place.

Growth

A normal baby delivered at term weighs about 3.2 kg. A baby weighing less than 2.5 kg at term is regarded as small for gestational age (SGA), which is usually a result of IGR. Babies of low birth weight born before term are regarded as premature. In the first days of life, weight loss is a result of insensible water loss through the skin. This is generally offset by weight gain of 6 g/kg per day as feeding is initiated. An infant's body weight will double in 4–6 months. Premature babies tend to grow at a slower rate and often still weigh less than a term baby at the equivalent of term.

Organ Development

Most organs are not fully developed at birth. Glomerular filtration rate of the kidney and renal tubular function mature during the first year of life at which point laboratory markers of renal function approximate adult values. Liver function can take 2–3 months to fully mature. Motor function and visual acuity develop during the first year of life. This development is accompanied by changes in the electroencephalogram until the normal "adult" picture is seen. There are dramatic changes in hematopoiesis as the switch from fetal hemoglobin to adult hemoglobin takes place. This coincides with significant hyperbilirubinemia as fetal hemoglobin is broken down, coincident with immature hepatic pathways of bilirubin metabolism. Bone growth in the rapid growth phases in the first few years of life and at puberty results in cyclical changes in bone growth markers. **Sexual maturation** results in significant endocrine changes, particularly of the hypothalamic–pituitary–gonadal hormone pathway, which eventually lead to the

constitutive development of adult secondary sexual characteristics and eventually to the adult.

Problems of Prematurity and Immaturity

Intrauterine development is programmed for a normal 38- to 40-week gestation.¹ Many organs are not fully ready to deal with extrauterine life before this time. This organ immaturity results in many of the clinical problems that we see associated with prematurity, which include respiratory distress (lung immaturity), electrolyte and water imbalance (kidney immaturity), and excessive jaundice (liver immaturity). Infants born before their due date constitute a major burden on the laboratory. They not only have abnormal biochemical parameters that require frequent blood drawing, they also have small blood volumes from which to draw on.

PHLEBOTOMY AND CHOICE OF INSTRUMENTATION FOR PEDIATRIC SAMPLES

Phlebotomy

Blood collection from infants and young children is complicated by the patient's size and frequently by the ability of the patient to communicate with the phlebotomist. The small blood volume of small patients dictates both the number of tests that can safely be performed on the patient and the number of times that blood can safely be drawn for repeat analysis.² Table 34-1 shows the percentage of total body blood that is drawn from an individual with a 10-mL blood draw. This volume is standard in adult laboratory medicine but the table clearly shows that this amount of blood represents about 5% of total blood volume in a premature neonate. Clearly, frequent blood draws of this nature will quickly lead to anemia and the need for blood transfusion. Table 34-2 shows the

TABLE 34-1 IMPLICATIONS OF A 10-mL BLOOD DRAW IN AN INFANT POPULATION

| AGE | WEIGHT (kg) | TOTAL BLOOD VOLUME (%) |
|---------------------|-------------|------------------------|
| 26 weeks' gestation | 0.9 | 9.0 |
| 32 weeks' gestation | 1.6 | 5.5 |
| 34 weeks' gestation | 2.1 | 4.0 |
| Term | 3.4 | 2.5 |
| 3 months | 5.7 | 2.0 |
| 6 months | 7.6 | 1.6 |
| 12 months | 10.1 | 1.4 |
| 24 months | 12.6 | 1.0 |

TABLE 34-2 RECOMMENDED BLOOD DRAW VOLUMES FOR PEDIATRIC PATIENTS

| WEIGHT (kg) | MAXIMUM VOLUME FOR A SINGLE BLOOD DRAW (mL) | WEIGHT (kg) | MAXIMUM VOLUME FOR A SINGLE BLOOD DRAW (mL) |
|-------------|---|-------------|---|
| 2 | 4 | 30 | 60 |
| 4 | 8 | 32.5 | 65 |
| 6 | 12 | 35 | 70 |
| 8 | 16 | 37.5 | 75 |
| 10 | 20 | 40 | 80 |
| 12.5 | 25 | 42.5 | 85 |
| 15 | 30 | 45 | 90 |
| 17.5 | 35 | 47.5 | 95 |
| 20 | 40 | 50 | 100 |
| 22.5 | 45 | 52.5 | 105 |
| 25 | 50 | 55 | 110 |
| 27.5 | 55 | | |

Courtesy of Dr. David Friedman, Children's Hospital of Philadelphia, Philadelphia, Pennsylvania.

guidelines for blood volume collection developed at Children's Hospital of Philadelphia. It is necessary on occasion to advise the physician that a particular set of orders may result in excessive blood depletion and transfusion requirement.

Infants and children have smaller veins than adults; to ensure that small veins do not collapse, narrow-gauge needles are generally used for venipuncture. Smaller needles increase the risk of hemolysis and hyperkalemia.

Frequently, good access to veins is impossible in a pediatric patient with intravenous and central lines in place. Capillary samples are often collected when suitable veins are not available. However, capillary blood obtained by skin puncture is usually contaminated, at least to some extent, by interstitial fluid and tissue debris. The concentration of protein (and protein-bound constituents) is approximately three times lower in interstitial fluid than in plasma. Table 34-3 highlights the major differences in analyte composition between venous serum and capillary serum. The lower concentrations of protein, bilirubin, and calcium in capillary specimens likely reflect mixing (and dilution) with interstitial fluid. Capillary samples, by either heel or thumb stick, should be collected by phlebotomists with pediatric expertise. The heel should be warmed and well perfused to "arterialize" the capillaries. This can be achieved by gently rubbing the area or by immersion in warm water. The lancet puncture should be in an area of the heel away from

bone. Stabbing into bone may result in osteomyelitis. Excessive squeezing or milking of the lancet site can result in both hemolysis and factitious hyperkalemia from tissue fluid leakage.

Preanalytic Concerns

There is a growing trend toward complete front-end automation in clinical chemistry laboratories. The clear advantage with automation of sample handling is that traditional bottlenecks at sites of data entry and centrifugation are removed and turnaround times are reduced. Several issues have retarded the introduction of full-scale automation in pediatrics. A typical pediatric chemistry laboratory receives samples in tubes of many different sizes, varying from standard adult tubes to small "peditubes." While several of the large chemistry analyzers can directly sample from small pediatric tubes, as of this time, no manufacturer of laboratory equipment has developed a fully automated system that can handle this range of tubes.

However, there have been reports in the literature from individual laboratories that have modified existing robotic instrumentation to allow complete automation of the testing process using pediatric tubes.^{4,5}

A second important issue relates to evaporation of sample from open tubes. Most automated sample handling systems require open-topped tubes for processing. With large sample volumes, the effect of evaporation is minimal. With small volumes that have relatively large surface areas to total volume, evaporation can be significant and may effect results by as much as 10%.

Choice of Analyzer

Careful inspection and choice of analytic systems remain crucial for handling pediatric samples. Until recently, only a few analyzers were capable of performing multiple

TABLE 34-3 DIFFERENCES IN COMPOSITION OF CAPILLARY AND VENOUS SERUM

| CAPILLARY VALUE GREATER THAN VENOUS VALUE (%) | NO DIFFERENCE BETWEEN CAPILLARY AND VENOUS VALUES | CAPILLARY VALUE LESS THAN VENOUS VALUE (%) | | |
|---|---|--|---------------|-----|
| Glucose | 1.4 | Phosphorous | Bilirubin | 5.0 |
| Potassium | 0.9 | Urea | Calcium | 4.6 |
| | | | Chloride | 1.8 |
| | | | Sodium | 2.3 |
| | | | Total Protein | 3.3 |

From Burtis CA, Ashwood ER, eds. Tietz fundamentals of clinical chemistry. 5th ed. Philadelphia, Pa.: WB Saunders, 2001.

analytic procedures on small sample volumes (5–50 μL). Today, most analyzers can perform this function. Choice of analyzer becomes dependent on issues such as the following:

1. How much dead volume is there in the system? The smaller the dead volume, the greater is the number of tests that can be run.
2. Does clot or bubble detection allow for salvage of sample? All analyzers can detect a clot, but not all will allow retrieval of sample.
3. Is the system truly random access? This allows selectivity of menu for a given sample.

Typically, sample throughput time is less of an issue, as pediatric facilities tend to run fewer samples than busy adult services.

POINT-OF-CARE ANALYSIS IN PEDIATRICS³

Point-of-care testing (POCT), or near-patient testing, plays an important and expanding role in pediatric practice.³ Testing devices that are portable and easy to use, require small specimen volume, do not require sample preparation, and provide rapid results at the bedside are providing the momentum for increased POCT. To provide cost-effective and appropriate quality assurance for POCT, several factors need to be addressed.

1. Does the analyte really require immediate turnaround for optimal patient management? Analyzers are becoming available that measure increasing numbers of different analytes at the patient's bedside. Typically, the cost of POCT measurement is higher than the traditional laboratory measurement. The idea of instant results is so seductive that nonlaboratorian users often discount economic factors. In the author's institution, the clinical laboratory has played a leading role in determining which POCT assays will be available and in which clinical settings they have real value (Table 34-4).
2. Who chooses the POCT device? As the field of POCT expands, the number of devices on the market is also increasing. The clinical laboratory should be the setting in which POCT devices for institutional use should be first evaluated. The laboratory should make choices for instrumentation. Important features of a good POCT device should include the following:
 - The ability to lock out untrained users. Only individuals accredited to use the device should be allowed access via a personal code.
 - The device should not be allowed to proceed to patient sample analysis without running and validating appropriate quality assurance procedures.
 - The data should be downloadable to the hospital laboratory information system (LIS) for evaluation by

the hospital quality assurance officer. Downloading the data also allows for billing and data entry into patient charts, features readily lost when analyzers are used that cannot be linked to the LIS.

The data generated by POCT devices have limitations. Typical analytic performance is not as good as that with the main laboratory analyzer. POCT data are less precise and not suited to monitoring therapy in instances where small changes are important. The linear range for most POCT devices is not as broad as that of the main chemistry analyzer, and users need to be aware of these limitations. A prime example in the authors' institution is the use of POCT glucose analyzers. The instrument used for acute diabetic management loses linearity above 400 mg/dL, particularly in patients who are hemoconcentrated. We recommend that any POCT glucose level above 400 mg/dL be immediately checked in the main laboratory. Hypoglycemia is also particularly common in pediatrics and characteristically difficult to accurately quantitate using POCT devices. Low glucose levels should also be checked using a more sensitive main laboratory analyzer.

REGULATION OF BLOOD GASES AND pH IN NEONATES AND INFANTS

Primary maintenance of blood gas and pH homeostasis following birth requires that the lungs and kidneys are sufficiently mature to regulate acid and base metabolism.

TABLE 34-4 IMPORTANT PEDIATRIC POINT-OF-CARE TESTS AND TESTING SITES

| TEST |
|---|
| Blood gas |
| Electrolyte |
| Glucose |
| Activated clotting time |
| Hemoglobin |
| Glycated hemoglobin |
| Pregnancy |
| Urinalysis |
| Prothrombin time |
| Rapid <i>Streptococcus</i> |
| TESTING SITES |
| Coronary care unit/intensive care unit |
| Trauma unit/emergency department |
| Diabetes clinic |
| Transport |
| Surgery |
| Extracorporeal membrane oxygenation sites |

At about 24 weeks of gestation, the lung expresses two distinct types of cells: type 1 and type 2 pneumocytes. Type 2 pneumocytes are responsible for the secretion of surfactant, which contains the phospholipids lecithin and sphingomyelin. Surfactant is required for the lungs to expand and the transfer of blood gases following delivery. Oxygen crosses into the circulation, and carbon dioxide is removed and expired. Immaturity of the surfactant system as a result of prematurity or IGR results in respiratory distress syndrome (RDS). In RDS, there is failure to excrete carbon dioxide and, as a result, carbon dioxide levels rise, causing respiratory acidosis; oxygen levels are low and result in additional oxygen requirements for the baby.

The relative amounts of lecithin and sphingomyelin are critical for normal surfactant function. The measurement of amniotic fluid lecithin/sphingomyelin (L/S ratio) has been used for many years to predict fetal lung maturity. A ratio of less than 1.5 is considered indicative of surfactant deficiency.

The fetal fibronectin (fFN) test is a promising new test designed to determine the likelihood of premature delivery and risk for fetal maturity.^{6,7} fFN is a protein secreted uniquely by the fetus; toward term, it is found in maternal cervical fluid. A POCT device is available that has been designed for use in the obstetrician's office. It has a high predictive value for impending early delivery of the baby and can be used to alert the pediatrician to the potential for RDS.

The trauma and relative anoxia during delivery can also induce acidosis in the newborn. This is typically a metabolic acidosis associated with increased lactic acid production. Serum bicarbonate levels are reduced in this situation compared with the respiratory acidosis in RDS. Persistent metabolic acidosis in the newborn that is difficult to correct with bicarbonate replacement is an indication for further intensive evaluation for possible inborn error of metabolism or other etiologies that require differentiation (Table 34-5).

Alkalosis is an unusual finding in pediatric medicine. One important cause of alkalosis is hyperammonemia, which may be secondary to a number of etiologies, including liver disease and inborn errors of metabolism (Table 34-5).

Blood Gas and Acid-Base Measurement

Oxygen status can readily be measured using noninvasive transcutaneous monitoring. Good correlation has been demonstrated between the arterial pressure of oxygen and transcutaneous measurement. Transcutaneous carbon dioxide monitors are also in widespread use. The measurement of acid-base status requires blood sampling. Most blood gas/acid-base analyzers can be adapted to take the small capillary samples routinely collected in

pediatric settings. It is important for the person drawing the capillary blood to do so anaerobically, which requires thorough warming of the capillary site and collection of a freely flowing blood sample from a lancet stick. The sample needs to be sealed to ensure minimal gas exchange. Analysis should be performed immediately to not compromise the sample integrity. The author's laboratory maintains a goal of a 10-minute turnaround time from the sample receipt.

Most blood gas analyzers measure pO₂, pCO₂, and pH by ion-specific electrodes and calculate bicarbonate concentration by the Henderson-Hasselbalch equation. The Henderson-Hasselbalch equation is less valid when pH is far outside the normal physiologic range (extreme acidosis or alkalosis). On these occasions, it may become important to measure the bicarbonate concentration using a direct measurement.

Many blood gas analyzers have been upgraded in recent years to measure additional analytes, including blood sodium, potassium, and chloride, using ion-specific electrodes and lactate and urea. The major advantage of this type of analyzer in pediatrics is that whole blood can be used. The volumes are typically smaller than those required for the main chemistry analyzer, and the lack of need for centrifugation shortens the turnaround time. One disadvantage of using whole blood is that the analyst cannot detect whether a sample is hemolyzed.

REGULATION OF ELECTROLYTES AND WATER: RENAL FUNCTION

From the 35th week of gestation, the fetal kidneys develop rapidly in preparation for extrauterine life.¹ The kidneys, critical organs for the maintenance of electrolyte

TABLE 34-5 CAUSES OF ACIDOSIS AND ALKALOSIS IN NEONATES AND INFANTS

| RESPIRATORY ACIDOSIS | HYPOVENTILATION/CO ₂ RETENTION |
|-----------------------|---|
| Metabolic acidosis | Renal tubular bicarbonate wasting |
| | Anoxia |
| | Poor tissue perfusion |
| | Metabolic disease |
| Respiratory alkalosis | Hyperventilation |
| | High blood ammonia/metabolic disease |
| Metabolic alkalosis | Pyloric stenosis/loss of gastric acid |
| | Excessive bicarbonate administration |
| | Low blood potassium |

TABLE 34-6 DEVELOPMENT OF GLOMERULAR FILTRATION IN THE NEWBORN

| GLOMERULAR FILTRATION RATE | | |
|----------------------------|--|---------|
| AGE | (mL/MINUTE PER 1.73 m ² MEAN) | RANGE |
| 1 day | 24 | 3–38 |
| 2–8 days | 38 | 17–60 |
| 10–22 days | 50 | 32–68 |
| 37–95 days | 58 | 30–86 |
| 1–2 years | 115 | 95–135* |

*Adult values.

and water homeostasis, control the rate of salt and water loss and retention. At term, neither the glomeruli nor the renal tubules function at the normal rate. The glomerular filtration rate is about 25% of the rate seen in older children and does not reach full potential until age 2 years (Table 34-6). Tubular function also develops at a similar rate. The maximal concentrating power of the kidney is only about 78% of that of the adult kidney at this time, although the tubular response to antidiuretic hormone appears to be normal. This gradual process of renal development in the newborn results in diminished filtration and impaired reabsorption of salt and water; therefore, in the newborn period and early infancy, large shifts in serum electrolyte levels can be observed. These problems are exacerbated in the preterm infant with renal function that is even less mature.

The kidneys also primarily maintain water loss and retention. However, in the newborn period, insensible water loss through the skin is also an important cause of water and electrolyte imbalance. Water loss and consequent hemoconcentration frequently result from the use of radiant heaters that are used to maintain body temperature. Increased water loss also occurs via respiration in children with RDS. Up to one third of insensible water loss may occur through this route. The total body water content of a newborn is about 80%; 55% is intracellular fluid and 45% is extracellular fluid. The extracellular water is 20% plasma water and 80% interstitial. During the first month of extrauterine life, the total body water content decreases to about 60%, mostly a result of loss of the interstitial component.¹

Disorders Affecting Electrolytes and Water Balance

The causes of hypernatremia (sodium, >145 mEq/L) and hyponatremia (sodium, <130 mEq/L) are listed in Table 34-7. Both disturbances can have dire outcomes, with a high risk of seizures. This is a result of the shift of water out of or into brain cells, with concurrent shrinkage or expansion of these cells. Hypernatremia results from hypotonic fluid loss, and hyponatremia results

from hypertonic fluid loss. Hyponatremia may also be a result of excessive body water content and needs to be distinguished from hypertonic loss. Clinical evaluation and measurement of other components, including hematocrit, serum albumin, creatinine, and blood urea nitrogen, can be used to differentiate these etiologies. All of these compounds will be elevated with hemoconcentration. Clinically, it is usually possible to distinguish dehydration from excessive hydration.

Treatment of electrolyte and water loss is directed at replacing the loss to regain normal physiologic levels. Care must be taken to avoid too rapid a replacement, particularly with hypertonic dehydration. If water replacement is done too quickly, a rapid expansion of neuronal cell volume can occur, which results in seizures.

The causes of hyperkalemia and hypokalemia are listed in Table 34-8. The symptoms of hyperkalemia (serum potassium, >6.5 mEq/L) include muscle weakness and cardiac conduction defects that may lead to heart failure. In pediatrics, it is particularly important to recognize factitious hyperkalemia as a result of hemolysis and bad capillary blood collection, without hemolysis but with high potassium tissue leakage.

Because the situation regarding electrolyte and water homeostasis can change rapidly in small infants, it is important to monitor therapeutic intervention on a frequent basis.^{1,2} The availability of POCT devices that use small volumes of whole blood helps with management of these imbalances, with the only caution being that it is impossible to detect hemolysis and factitious hyperkalemia on a whole blood sample.

TABLE 34-7 CAUSES OF HYPERNATREMIA AND HYPONATREMIA

| HYPERNATREMIA |
|--|
| Excessive loss of water through overhead heater |
| Gastrointestinal fluid loss |
| Fluid deprivation |
| Renal loss of water/nephrogenic diabetes insipidus |
| Administration of hypertonic fluids containing sodium |
| HYPONATREMIA |
| Inappropriate ADH secretion due to trauma or infection |
| Administration of hypotonic fluids |
| Renal tubular acidosis |
| Salt-losing congenital adrenal hyperplasia (21-hydroxylase deficiency) |
| Cystic fibrosis |
| Diuretics |
| Renal failure |

TABLE 34-8 CAUSES OF HYPERKALEMIA AND HYPOKALEMIA

| HYPERKALEMIA |
|--|
| Fluid deprivation/dehydration causing tissue leakage |
| Intravascular hemorrhage causing release from red cells |
| Trauma/tissue damage |
| Acute renal failure |
| Salt-losing adrenal hyperplasia (see <i>hyponatremia</i>) |
| Exchange transfusion using stored blood |
| HYPOKALEMIA |
| Inappropriate ADH secretion |
| Diuretics, particularly frusemide |
| Alkalosis |
| Pyloric stenosis |
| Renal tubular acidosis secondary to bicarbonate loss |

DEVELOPMENT OF LIVER FUNCTION

Physiologic Jaundice

The liver is an essential organ for many metabolic processes. The processing of many normal metabolic pathways and the metabolism of exogenous compounds, in particular, pharmacologic agents, proceed slower in neonates. The most striking effect of an immature liver, even in a normal-term baby, is the failure to adequately metabolize bilirubin. Bilirubin is an intermediate of the breakdown of the heme molecules, which accumulate as fetal hemoglobin is rapidly destroyed and replaced by adult hemoglobin. Normally, the liver conjugates bilirubin to glucuronic acid using the enzyme bilirubin UDP-glucuronoyltransferase. Conjugated bilirubin can be readily excreted in the bile or through the kidneys. At birth, this enzyme is too immature to complete the process and increased levels of unconjugated bilirubin and “physiologic” jaundice result. At this time, a normal baby may have a serum bilirubin level of up to 15 mg/dL, most of which is unconjugated. This level, which would be alarming in adult practice, should fall back to baseline by about 10 days of age. Because excessive jaundice can lead to kernicterus and result in severe brain damage, the measurement of blood conjugated and unconjugated bilirubin has an important role in pediatrics. An alternative means of reducing high unconjugated circulating bilirubin levels is phototherapy with ultraviolet light, which causes bilirubin to be converted to a potentially less toxic and more readily excreted metabolite. Severe cases may require an exchange transfusion. Complete absence of the bilirubin-conjugating enzyme results in severe persistent jaundice and Crigler-Najjar disease, a rare **genetic disease**. It is important to differentiate

Crigler-Najjar from physiologic immaturity because treatment options vary considerably.

Energy Metabolism

The liver plays an essential role in energy metabolism for the whole body (Table 34-9). Carbohydrates derived from the diet as disaccharides or polysaccharides form the bulk of our energy sources. They are broken down into simpler monosaccharides, which reach the liver via the portal blood system. The primary sugars in newborns and infants come from the breakdown of disaccharide lactose in milk. Lactose is broken down to glucose and galactose. When it reaches the hepatocytes, galactose is converted to glucose by a series of enzymic reactions that have unique pediatric significance. Genetic deficiency of any of the reactions results in failure to convert galactose to glucose and essentially reduce the energy content of milk by 50%. The most common cause of failure to convert galactose to glucose results in galactosemia or deficiency of galactose-1-phosphate uridylyltransferase, a serious genetic disease of the newborn. In this disease, galactose-1-phosphate accumulates inside liver cells and causes hepatocellular damage and rapid liver failure. Other organs are also involved with this disease, including the renal tubules and the eyes. Galactose-1-phosphate accumulation causes acute renal tubular failure and tubular loss of glucose, phosphate, and amino acids. The loss of glucose in cooperation with the liver damage results in severe hypoglycemia. Accumulation of galactose in the eye results in cataract formation. A simple test that directs us to the diagnosis of galactosemia is the urine reducing substance test. This detects the presence of non-glucose-reducing sugars (galactose) in urine when a child is symptomatic. The clinical

TABLE 34-9 IMPORTANT BIOCHEMICAL PATHWAYS IN THE LIVER

| CATABOLIC |
|---|
| Transamination |
| Amino acid oxidation to make ketones and acetyl-CoA |
| Fatty acid oxidation to make ketones |
| Urea cycle to remove ammonia |
| Bilirubin metabolism (hemoglobin breakdown) |
| Drug and exogenous xenobiotic compounds metabolized |
| ANABOLIC |
| Albumin synthesis |
| Clotting factor synthesis |
| Lipoprotein synthesis, very-low-density lipoprotein |
| Gluconeogenesis (synthesis of glucose) |
| Bile acid synthesis |

CASE STUDY 34-1

A newborn infant was born with a bilirubin level of 7 mg/dL (mostly unconjugated) that rose to 10 mg/dL by the third day of life. The infant was breastfed normally and the bilirubin levels returned to normal values within 2 weeks without treatment.

Questions

1. What is the most likely diagnosis? Are there likely to be any long-term adverse health effects?
2. What is the most likely biochemical cause of the elevated bilirubin level?
3. What other disorders can cause unconjugated hyperbilirubinemia in neonates?

significance of establishing a diagnosis is clear; galactosemia is often fatal if undiscovered but completely treatable by dietary lactose restriction when diagnosis is made.

Another critical pathway of carbohydrate energy metabolism in the newborn involves the pathway of gluconeogenesis. At birth, a term baby has sufficient liver glycogen stores to provide glucose as an energy source and maintain euglycemia. If the delivery is particularly stressful, these reserves of energy may become depleted prematurely. At this time, the normal physiologic role of gluconeogenesis, which essentially converts the amino acid alanine into glucose, becomes critical in maintaining glucose homeostasis. This pathway is not always mature at birth and suboptimal operation results in what is termed *physiologic hypoglycemia*. Newborns can survive blood glucose levels below 30 mg/dL, although adults would fall into rapid hypoglycemic coma and risk sudden death at these levels. Physiologic hypoglycemia usually corrects quickly as the enzyme systems mature or by simple intravenous glucose infusion. Persistent and severe hypoglycemia should alert the physician to a possible inborn error of metabolism, such as galactosemia, gluconeogenesis, or disorders of fatty acid oxidative metabolism.

Diabetes

Blood glucose homeostasis and hepatic metabolism of glucose are maintained by the concerted actions of several hormones.⁸ Following a meal, the level of glucose in the circulation rises, which triggers increased synthesis and release of insulin by the pancreatic β cells of the islets of Langerhans. Increased levels of insulin in the circulation cause glucose to be taken up by certain cells, such as hepatocytes and muscle cells, and to be converted into glycogen as a future source of energy. As a result of the insulin

action, blood glucose levels begin to fall to the preprandial level. Glucagon, a hormone secreted by the α cells of the islets of Langerhans, has an opposing effect to that of insulin. It is generally believed that the insulin/glucagon ratio, rather than absolute amounts of either, is the primary endocrine modulator of circulating glucose levels. Other hormones, including cortisol, epinephrine, and insulin-like growth factor, can also affect glucose levels. These hormones are secreted in response to stress and can affect glucose measurement when samples are collected under stressful situations.

Diabetes mellitus, a condition in which the endocrine control of glucose metabolism is abnormal, is usually related to failure of the insulin regulatory pathway. Type 1 diabetes (insulin-dependent) is the most common in pediatrics. This may be caused by failure of the pancreas to secrete insulin or by the presence of circulating insulin antibodies that reduce the ability for endocrine action. A patient typically presents with diabetic ketoacidosis, with profound hyperglycemia and metabolic acidosis that result from the liver increasing fatty acid metabolism and producing excess ketone bodies.

Type 2 diabetes (non-insulin-dependent) has a much lower incidence in the pediatric population and is normally associated with increased resistance to normally secreted insulin in obese individuals. Unfortunately, type 2 diabetes is being recognized more frequently in children as the number of obese children increases in the population. It may soon become more prominent in children than type 1.

It is important to recognize diabetes as a cause of hyperglycemia in children and to distinguish it from other medical causes of high blood sugar, including acute pancreatic disease or hypersecretion of counterregulatory hormones such as growth hormone, cortisol, or catecholamines. Chronic hyperglycemia can be readily distinguished from acute causes by simply measuring the blood concentration of glycated hemoglobin or hemoglobin A_{1c}, a well-established marker for long-term hyperglycemia. This assay also has great value in monitoring diabetic compliance in patients on treatment.

Nitrogen Metabolism

The liver plays a central role in nitrogen metabolism. It is involved with the metabolic interconversions of amino acids and the synthesis of nonessential amino acids. The liver synthesizes many body proteins, including most proteins found in the circulation, such as albumin, transferrin, and the complement clotting factors. The liver does not synthesize immunoglobulins. The liver is also responsible for complete metabolism of the breakdown products of nitrogen turnover, such as ammonia and urea through the urea cycle and creatinine and uric acid from energy stores and nucleic acids, respectively. Blood

ammonia levels are higher in the newborn period than in later life, presumably due to immaturity of urea cycle enzymes and the portal circulation. A blood ammonia level of 100 $\mu\text{mol/L}$ in a newborn would be regarded as less significant than the same level in a 1-year-old. Persistently elevated ammonia levels should alert the investigator to possible liver damage and secondary failure of the urea cycle. High ammonia levels suggest a possible primary defect in the urea cycle, and patients should be evaluated for such a defect.

Nitrogenous End Products as Markers of Renal Function

In contrast to the high neonatal ammonia levels, creatinine and uric acid levels are lower in newborns. Both metabolites rise eventually to normal adult ranges. Creatinine concentrations in blood increase with muscle mass and are independent of diet. It is filtered at the glomerulus and not extensively reabsorbed by the renal tubules. Its measurement as a clearance ratio in blood and in a 24-hour urine sample has been used as a marker for glomerular filtration for many years. Serum cystatin C, a new and possibly more sensitive marker, has recently appeared on the market as a potential replacement for creatinine.⁹ This marker awaits further evaluation in pediatric populations, but it could potentially replace the creatinine clearance assay and remove the need for difficult 24-hour urine collections from children. Incomplete collections form the basis of most errors in this assay.

Liver Function Tests

As discussed, the liver is responsible for performing a large number of synthetic and catabolic processes, and normal liver function is central to maintaining body homeostasis. Several laboratory tests have emerged that are generally classified as liver function tests.

The measurements of serum albumin and total and conjugated bilirubin are true tests of liver function because they measure the synthetic and metabolic pathways for these compounds. In protein-calorie malnutrition, the reduced availability of amino acids for synthesis of new proteins results in diminished functional synthetic rate and low levels of newly synthesized proteins, such as albumin. Very low levels of albumin indicate a long exposure to protein restriction, and its measurement in blood is often used as a guide to nutritional status and chronic liver disease of other causes. Impaired hepatocellular function also results in reduced ability to conjugate bilirubin, with subsequent increase in the unconjugated form, which is normally barely detectable.

Other tests, such as measurement of liver enzymes, more truly reflect tests of liver cell integrity and are not strictly functional assays. Large elevations in serum AST and ALT indicate hepatocellular damage and subsequent

leakage of cellular contents into the serum, and elevated ALP suggests hepatic biliary damage but gives little functional information.

CALCIUM AND BONE METABOLISM IN PEDIATRICS

Normal bone **growth**, which parallels body growth, requires integration of calcium, phosphate, and magnesium metabolism with endocrine regulation from vitamin D, parathyroid hormone (PTH), and calcitonin.⁸ The active metabolite of vitamin D is 1,25-dihydroxy vitamin D. Hydroxylation of vitamin D from the diet takes place in the liver and in the kidneys and requires normal functioning of these organs. Absorption of vitamin D from the gastrointestinal tract, conversion to its active form in the kidney, and incorporation of calcium and phosphate into growing bone require normally active PTH. Secretion of PTH is, in turn, modulated by serum calcium and magnesium levels. Low levels of both divalent cations inhibit PTH secretion. Calcitonin has an antagonistic effect on PTH action.

The rapid bone growth that occurs during infancy, and later during puberty, requires optimal coordination of mineral absorption, transport, and endocrine-controlled incorporation of the minerals into growing bone. Approximately 98% of total body calcium content is present in bone and less than 1% is measurable in the blood. Serum calcium is present as the unbound ionized fraction (about 50% of total in blood), with the rest bound to protein (40%) or chelated to anions in the circulation, such as phosphate and citrate. Serum ionized and bound calcium levels are highly regulated and maintained within strict homeostatic limits. Abnormalities in any of the regulatory components have profound clinical effects on children.

Hypocalcemia and Hypercalcemia

Hypocalcemia is defined as total serum calcium below 7.0 mg/dL or ionized calcium below 3.0 mg/dL. In the newborn and particularly the immature newborn, these levels may be commonly encountered with few symptoms. However, hypocalcemia can result in irritability, twitching, and seizures. Serum calcium is usually measured in infants with seizures of unknown etiology. Prolonged hypocalcemia can result in reduced bone growth and rickets. The causes of hypocalcemia are listed in Table 34-10. Hypomagnesemia frequently occurs with hypocalcemia. Because low levels of serum magnesium also inhibit PTH secretion, it is important to consider the possibility of concurrent hypomagnesemia in a child with hypocalcemic seizures and to correct any abnormalities that may be identified in the magnesium status as calcium is also corrected.

Hypercalcemia is defined as total serum calcium of greater than 11.0 mg/dL. This is an unusual finding in

TABLE 34-10 CAUSES OF HYPOCALCEMIA

| |
|---|
| Prematurity |
| Metabolic acidosis |
| Vitamin D deficiency |
| Liver disease (failure to activate vitamin D) |
| Renal disease (failure to activate vitamin D) |
| Hypoparathyroidism |
| Low calcium intake |
| High phosphorus intake |
| Diuretic use |
| Hypomagnesemia |
| Exchange transfusion (anticoagulants in transfused blood) |

pediatrics (Table 34-11) but has potentially severe clinical implications. Patients with hypercalcemia have poor muscle tone, constipation, and failure to thrive and may develop kidney stones leading to renal failure.

ENDOCRINE FUNCTION IN PEDIATRICS

The field of endocrinology provides numerous examples of the “differences” that occur in clinical chemistry between children and adults.² The process of maturation into a sexually fertile adult, for example, requires a complex, endocrine-mediated, developmental process switching on during childhood. As addressed in the previous section, the bone growth that accompanies systemic growth also requires a complex process, which is under endocrine control.

Hormone Secretion

The endocrine system relates to a group of hormones that are typically produced and secreted by one cell type into the circulation, where their effect is exerted in other target cells. Some of these hormones are polypeptides; others are amino acid derivatives or steroids.

Four major **endocrine systems** have been described, all of which play critical roles in normal human development. These systems all involve the hypothalamus as a major higher brain control center, the pituitary gland as a major secretor of hormones, and then various end

TABLE 34-11 CAUSES OF HYPERCALCEMIA

| |
|-------------------------------------|
| Hyperparathyroidism |
| Acute renal failure |
| Excessive intake of vitamin D |
| Idiopathic hypercalcemia of infancy |

Hypercalcemia is less common than hypocalcemia in infants.

organs, which have responsive elements for the pituitary hormone and affect many metabolic and developmental functions. These end organs include the thyroid gland, adrenal cortex, liver, and gonads. Each system involves regulated secretion of a trophic hormone by the hypothalamus, which, in turn, controls endocrine secretion by the pituitary and, occasionally, secondary hormonal secretion by the end organ, which then produces the appropriate endocrine effect. There is feedback on the hypothalamus by the final product of the pathway (long-loop feedback) and also by the endocrine product of the pituitary (short-loop feedback). The feedback regulates hypothalamic control of the pathway. Clearly, there are many areas that can go wrong in each of these pathways, all of which result in disease. Certain disease conditions are uniquely pediatric and they are discussed further.

Hypothalamic–Pituitary–Thyroid System

The hypothalamus secretes thyrotropin-releasing hormone (TRH), a 3-amino acid peptide.⁸ TRH causes specialized cells in the anterior pituitary to secrete thyroid-stimulating hormone (TSH), a polypeptide made up of two chains (α and β). TSH is released into the circulation and targets its end organ, the thyroid gland. Unique TSH receptors on the thyroid gland, when occupied by a TSH molecule, cause the thyroid gland to synthesize and release thyroid hormones into the circulation. The synthesis of thyroid hormone involves several complex steps in which iodine is trapped within the thyroid tissue and used to convert the amino acid tyrosine into triiodothyronine (T_3) and tetraiodothyronine (T_4). Thyroid hormones are greater than 99% bound to specific transporter proteins in the blood called *thyroid-binding globulins*. Free thyroid hormone, in particular free T_3 , is active and reacts with many peripheral tissues to cause increased metabolism and stimulates normal growth and development. T_4 , T_3 (long loop), and TSH (short loop) levels feed back on the hypothalamus to regulate TRH production.

Two major areas of dysfunction in this endocrine pathway need consideration in pediatrics: primary hypothyroidism and secondary hypothyroidism. Primary hypothyroidism results from any defect that causes failure of the thyroid gland to synthesize and secrete thyroid hormone. This results in a common disease known as *congenital hypothyroidism*, which is present in 1 of 4,000 births. Untreated patients with this disease have severe mental retardation with unusual facial appearances. Treatment by thyroid replacement therapy is usually successful when diagnosis is established. The best diagnostic test is to measure serum TSH levels, which are high as a result of failure of the long feedback loop. Thyroid hormone levels in untreated patients are very low.

Secondary hypothyroidism is a result of the pituitary gland failing to secrete TSH, which results in lack of

thyroid gland stimulation and subsequent production of thyroid hormone. The differential diagnosis is established by measuring low circulating TSH levels. Because the pituitary is involved with all major endocrine systems, it is important to study the other pathways below to determine if the hypothyroidism is the result of an isolated TSH defect or to panhypopituitarism involving all other pathways. Panhypopituitarism is a clinically complex situation, which may include hypoglycemia, salt loss, poor somatic and bone growth, failure to thrive, and failure to develop secondary sexual characteristics.

Hypothalamic–Pituitary–Adrenal Cortex System

This system is essential for regulating mineral and carbohydrate metabolism.⁵ The hypothalamus secretes corticotrophin-releasing hormone (CRH), a 41-amino acid polypeptide, which reacts with the anterior pituitary, resulting in the release of corticotrophin or adrenocorticotrophic hormone (ACTH). ACTH is released into the circulation and reaches its end organ, the adrenal cortex, which is then stimulated to secrete the steroid hormones, cortisol and aldosterone. This pathway is also stimulated by stress at the higher cerebral center. ACTH acts as a short-loop feedback control; the steroid hormones secreted by the adrenal cortex are long-loop regulators. Aldosterone functions in the kidneys and regulates salt and water balance. Cortisol acts in many peripheral tissues and has many reactions, including regulation of carbohydrate, protein, and lipid metabolism. It also functions by providing resistance to infection and inflammation, a poorly understood mechanism that accounts for the therapeutic use of steroids in these clinical situations. As with all endocrine systems, diseases occur that result from hyperfunction or hypofunction of that pathway. Diseases may be primary, resulting from end organ dysfunction, or secondary, resulting from pituitary or hypothalamic disease. Pediatric diseases associated with primary disorders of the adrenal cortex are shown in Table 34-12. Many disorders listed are rare, genetic diseases; however, one particular disease, the steroid 21-hydroxylase deficiency, is sufficiently common (about 1 of 5,000 births) to merit whole population screening by state screening laboratories. This disorder results in failure to adequately synthesize both aldosterone and cortisol. Aldosterone deficiency results in salt-losing crises, and patients in the newborn period can be profoundly hyponatremic and hyperkalemic. Failure to synthesize cortisol results in stress-induced hypoglycemia. Furthermore, intermediates of steroid metabolism, which build up as a result of the metabolic block, cause androgenization. Girls born with this disorder frequently have ambiguous genitalia and may be first classed as boys. Boys may not have such pronounced abnormalities at birth, but may still develop electrolyte

TABLE 34-12 CONGENITAL DISEASES OF THE ADRENAL CORTEX

| | METABOLIC PROFILE |
|--------------------------|--------------------------------------|
| 21-Hydroxylase* | ↑ 17-Hydroxyprogesterone, ↓ cortisol |
| 3β-Hydroxy dehydrogenase | ↑ Dehydroepiandrosterone (DHEA) |
| 11β-Hydroxylase | ↑ 11-Doxycortisol, ↓ cortisol |
| 17α-Hydroxylase | ↑ 17-Ketosteroids, ↓ testosterone |
| 18-Hydroxylase | ↓ Aldosterone, ↑ renin |

*Common disorder screened for in all newborns.

crises. This disorder is usually detected by measuring 17-hydroxyprogesterone levels in neonatal blood samples.

Growth Factors

The hypothalamus secretes two regulatory hormones that effect growth. Growth hormone-releasing hormone is a 40-amino acid polypeptide that stimulates release of growth hormone (GH) from the anterior pituitary. GH-inhibiting factor, also known as *somatostatin*, inhibits GH secretion. Additional factors from higher cerebral centers, including catecholamines, serotonin, and endorphins, have a positive effect on GH secretion. Inhibition of GH secretion also occurs when infants are socially deprived. The mechanism for this reversible inhibition is not known, but neglect and potential child abuse are major differentials in infants with retarded growth.

GH is a 191-amino acid polypeptide, with the liver as its primary site of action. GH receptors on the liver that are occupied by a GH molecule cause the liver to secrete a group of related polypeptide hormones, called *insulin-like growth factors (IGF)*, and their binding proteins, called *IGF-binding proteins*. IGF-1 and IGF-BP3 are the most significant products of GH activity on the liver. IGF-1 has a molecular structure similar to insulin; however, it is a much more potent stimulator of linear growth and increased metabolism in infants.

This growth pathway probably represents the most important endocrine pathway responsible for normal growth; deficiencies of any component of the pathway are known to result in poor growth, resulting in short statured adults.

Because it is difficult to measure GH in serum as a result of diurnal variation and various stress-related effectors (e.g., catecholamines), a single, low level of GH may not be sufficient to confirm GH deficiency. It is important to determine true organic deficiency, caused by hypothalamic or pituitary disease, from emotional deficiency because only organic deficiency responds to expensive GH replacement therapy, while nonorganic

CASE STUDY 34-2

A 5-year-old boy is taken to his pediatrician because of growth delay. He was below the third percentile in height and weight. There was no history of trauma and any other pertinent family history or clinical findings. A randomly obtained growth hormone level was well below the normal value for this patient's age.

Questions

1. What conditions may be associated with growth delay?
2. Does the single growth hormone result confirm a diagnosis of growth hormone deficiency? If not, what additional testing should be performed to confirm a diagnosis?
3. If further testing reveals a deficiency in growth hormone, is the patient likely to respond to therapy?

GH deficiency will respond to emotional lifestyle changes. Trauma to the head may also cause failure of GH secretion by the pituitary through direct anoxic damage to GH secreting cells. This type of growth failure will respond to GH therapy. Several stimulation tests have been devised to test the capacity of the pituitary to secrete GH, including inducement of hypoglycemia with insulin or direct stimulation with glucagon. These tests require that up to five blood samples be collected in the 2 hours post stimulation and the peak level of GH secretion determined. If this is less than 10 ng/mL, the patient has organic GH deficiency and is likely to respond to GH therapy.

Recently, tests for IGF-1 and IGF-BP3 have become available that show great promise in the identification of GH deficiency because these compounds are not released by the liver in GH deficiency states and their basal levels do not seem to have the large variation that occurs for GH. In addition, defects of both IGF and IGF-BP synthesis and secretion have been recognized as a cause of growth failure in certain infants. Individuals with these defects are unlikely to respond to GH replacement.

Endocrine Control of Sexual Maturation

The hypothalamus secretes a 10-amino acid peptide called *gonadotropin-releasing hormone (GnRH)*. This hormone causes the release of two larger polypeptide hormones, called *follicle-stimulating hormone (FSH)* and *luteinizing hormone (LH)*, in both males and females. FSH and LH are structurally similar to TSH and also to human chorionic gonadotropin (hCG), which is not discussed further in this chapter.

Baseline levels of FSH and LH are low in infants as a result of GnRH suppression and require sensitive immunoassays based on chemiluminescence for accurate detection.

FSH and LH have different effects in males and females, both before and during puberty. In males, the hormonal activity is directed to the testis, which causes the release of androgens, primarily testosterone and androstenedione. In females, the primary site of action is the ovary, which results in the excretion of a different family of steroid hormones—estrogens, primarily estradiol. Prior to puberty, the circulating levels of androgens and estrogens are low, although the pediatric clinical laboratory is often requested to measure these hormones when a child appears to be going into premature puberty. Testosterone is particularly difficult to measure in prepubertal children as most commercial assays detect an interfering compound, which results in false elevation of the hormone level.

At puberty, the GnRH suppression is removed and there is a gradual increase in FSH and LH secretion, with concomitant increase in androgens in males and estrogens and progesterone in females. This results in the development of secondary sexual characteristics and onset of menarche in females. This period is also associated with a major surge in linear and bone growth until adult proportions are achieved.

Disorders of this endocrine pathway are associated with either premature or precocious puberty or delayed onset of puberty. The measurement of FSH, LH, testosterone, and estradiol is useful in evaluating disordered puberty. Often, disorders of other endocrine systems effect puberty. Congenital adrenal hyperplasia, the disorder described under adrenal cortex diseases, results in excess secretion of androgen-like steroids that can effect puberty. Disorders of the hypothalamus and pituitary can effect secretion of FSH and LH and cause delayed puberty.

DEVELOPMENT OF THE IMMUNE SYSTEM

In pediatric clinical facilities, the vast majority of hospital visits and admissions are related to complications arising from infectious diseases. At the same time, although the parents or caregivers may be exposed to the same infectious etiologies, they do not become so ill as to require medical attention. This is because the child does not have the same degree of **immunity** to disease at birth or during infancy.¹

Basic Concepts of Immunity

The immune system is divided into two functional divisions; the innate immune system and the adaptive immune system. The innate immune system is the first line

of defense, particularly in the newborn and infant not exposed to infection. The adaptive immune system generates a specific reaction following exposure to an infectious agent and provides greater immunity with subsequent exposure to that agent. Initially, however, the first response to exposure may be suboptimal and result in illness related to that exposure.

Components of the Immune System

Skin

The skin is normally an effective barrier to most microorganisms, although in premature babies this barrier is less well developed and can easily become a source of infection.⁸ Most infectious agents enter the body by the nasopharynx, gastrointestinal tract, lungs, and genitourinary tract. Surgical incisions and intravenous or central lines are also potential sites of entry. Normally, various physical and biochemical defenses protect the nonsurgical sites of entry. Lysozyme, an enzyme widely distributed in different secretions, for example, is capable of partially digesting a chemical bond in the membrane of many bacterial cell walls.

Phagocytes

Phagocytes are present in many cell types. When a foreign organism penetrates an epithelial surface, it encounters phagocytic cells, which are derived from bone marrow and recruited into tissue in response to the organism. These cells engulf and digest particles. Phagocytic cells include polymorphonuclear cells, which are short-lived in the circulation, and monocytes that, when exposed to a foreign particle, develop into macrophages that subsequently recognize the organism when the individual is re-exposed.

B Cells

B cells are lymphocytes that are characterized by the presence of surface immunoglobulins. These cells can differentiate into plasma cells that are able to respond to foreign antigens in the circulation by producing neutralizing antibodies. Activation, proliferation, and differentiation of B cells are assisted by cytokine secretion from T-cell lymphocytes, which do not produce antibodies. On binding antigen, antibodies can activate a cascade involving complement, which ultimately produces lysis and cellular death of foreign organisms.

Natural Killer Cells

Natural killer (NK) cells are leukocytes capable of recognizing cell-surface changes on host cells infected by virus particles. The NK cells bind to these target cells and can kill them and the virus. The NK cells respond to interferons, which are cytokine molecules produced by the host cells when infected by virus. Interferons are also part of the innate immune system capable of providing resistance to infection in host cells not virally infected.

Acute-Phase Proteins

Acute-phase proteins are defense proteins produced by the liver in response to infection, particularly bacterial infection. Certain proteins can increase in the serum by twofold to 100-fold. The most significant acute-phase protein is called *C-reactive protein (CRP)* because of its ability to bind to the C-protein of *pneumococci*. CRP bound to bacteria promotes the binding of complement that, in turn, aids phagocytosis. Serum CRP levels are routinely measured to determine degree of infection in pediatric patients. The required sensitivity of the CRP assay for this clinical purpose is less than that used for the high-sensitivity CRP assay used clinically as an independent risk factor for cardiac disease. In the pediatric application of this assay, rapid turnaround of results is most important. The complement system consists of at least 20 proteins, most of which are acute-phase proteins. They interact sequentially with each other, with antigen-antibody complexes, and with cell membranes in a coordinate manner to ultimately destroy bacteria and viruses. Clinically, the complement proteins that are measured most often are C3 and C4. Low levels of either of these proteins indicate poor ability to destroy foreign particles.

Antibody Production

Immunoglobulins are classified into five major groups, based on structure and function: IgG, IgM, IgA, IgD, and IgE. Secreted by plasma cells derived from B-lymphocytes, their properties are listed in Table 34-13. IgG is the major immunoglobulin subclass providing antibody response in adults and represents 70%–75% of total immunoglobulin content. IgG is further broken down into four additional subclasses: IgG₁₋₄. Each immunoglobulin is built from similar structural units, based on two heavy polypeptide

TABLE 34-13 PROPERTIES OF IMMUNOGLOBULIN (Ig) CLASSES

| | IgG* | IgA | IgM | IgD | IgE |
|----------------------|-------|-------|------|---------|---------|
| Mass (kD) | 160 | 160 | 970 | 184 | 188 |
| Percent of total Ig | 70–75 | 10–15 | 5–10 | <1 | Trace |
| Crosses placenta | Yes | No | No | No | No |
| In breast milk | Yes | Yes | No | Unknown | Unknown |
| Activates complement | Yes | Yes | Yes | No | No |
| In secretions | No | Yes | No | No | No |
| Binds to mast cells | No | No | No | No | Yes |

*Present as four subclasses (IgG1–4).

chains (A, G, M, D, and E) and two light chains (κ and λ). The ability to recognize large numbers of foreign antigens is a result of the infinite ability of the genes for the so-called variable region of the immunoglobulin molecule to rearrange. This area recognizes foreign antigens, and a gene rearrangement and production of a unique antibody cover each new antigen exposed to the body. Because of the large number of different immunoglobulin species, electrophoretic separation of these serum proteins on an isoelectric-focusing gel during serum protein electrophoresis (SPEP) analysis is diffuse, unlike albumin or transferrin separation, which generates distinct bands.

Neonatal and Infant Antibody Production

The human fetus is able to synthesize a small amount of IgM and, to a lesser degree, IgA. IgG has a lower molecular weight than IgM and is readily able to cross the placenta. IgG is also transferred from mother to baby in breast milk. Transplacental and breast milk–derived IgG offer the baby a passive immunologic protection until endogenous IgG production takes place. The half-life of IgG is about 30 days and, with prolonged breastfeeding, the infant can derive additional protection. The process of antibody production in infants takes several years to complete when based on total serum levels of the immunoglobulin subclasses, which take up to 4 years to be attained. Premature babies have an even greater immunoglobulin deficit because of diminished transplacental delivery of antibodies.

Immunity Disorders

Given the complexity of the immune system, there are many stages at which acquired or genetically inherited defects can result in inappropriate infectious disease in the pediatric population.⁸ Transient hypogammaglobulinemia of infancy may occur in prematurity or, in certain infants, may be a result of delayed onset of immunoglobulin production of unknown etiology. These infants eventually develop a normal immune system but will be prone to repeated bouts of severe infection. At the opposite end of the spectrum, complete absence of γ -globulins occurs in boys in an X-linked disorder known as *agammaglobulinemia*, or Bruton's disease. This disorder presents early in life with recurrent febrile infections. Patients do not have B cells and have low levels of all endogenous immunoglobulin subclasses. The disease process probably begins the moment that any maternally derived immunoglobulins have been lost. The most common infections are of the upper and lower respiratory tracts, causing otitis, pneumonia, sinusitis, meningitis, sepsis, and osteomyelitis. Without early γ -globulin therapy, these children die from respiratory complications. Other immune pathways are normal in these children.

Severe Combined Immune Deficiency

One of the most graphic examples of unique pediatric disease comes from infants who lack both humoral and cellular pathways for killing bacteria and viruses. These children are at risk of severe infection each time they are exposed to an infectious agent. The vivid image is of the “boy in the bubble,” existing in a completely sterile environment to avoid contact with any bacteria or virus particles. Severe combined immune deficiency (SCID) may be inherited as an X-linked disorder only seen in boys, or it may be autosomal recessive and girls may also inherit the disease. There are several causes of SCID, including genetic diseases of purine metabolism and disorders of lymphocyte development and maturation, in which both T cells and B cells, if present, are nonfunctional. The most common purine disorder, adenosine deaminase deficiency, is responsible for 15% of SCID cases. It is diagnosed by measuring elevated levels of adenosine in body fluids. Establishing this diagnosis is important because enzyme replacement therapy using recombinant enzyme has been successfully used to treat the disorder.

GENETIC DISEASES

Analytic methods for the identification of genetic disease play an important part in the pediatric clinical chemistry laboratory.^{1,10} Most genetic diseases are unique to the pediatric population and require specialized knowledge and training. Most diseases that present with clinical signs in the pediatric population are inherited in an autosomal recessive mode, which means that the patient has two disease-causing mutations in the gene for that disorder, one inherited maternally and one inherited paternally. Several examples of diseases with this inheritance pattern have already been introduced in this chapter, including galactosemia and congenital adrenal hyperplasia as a result of steroid 21-hydroxylase deficiency. Certain other diseases are recessive but are inherited on the X chromosome. Typically, boys inherit a mutated X-chromosome from their mothers; because they do not inherit a paternal X chromosome, they show signs of disease with only one mutation. For both inheritance patterns, the parent with one normal gene will be, for the most part, asymptomatic. Dominantly inherited diseases, which can be inherited as a single mutation through either parental line, tend not to present in childhood and do not impact fertility. Examples include familial hypercholesterolemia, Huntington disease, and factor V Leiden thrombophilia, all of which are diseases of the adult population. Recently, a new mode of genetic inheritance was identified. All of the diseases described above are diseases of DNA that replicates in the cell nucleus. Mitochondria, the organelles responsible for generating cellular energy and other important metabolic pathways, contain a small molecule of DNA (mtDNA) that encodes proteins involved in energy generation. mtDNA

has a high rate of spontaneous mutation and results in a large number of energy-wasting diseases. Mitochondria are only inherited from the mother, so that mutations that are not spontaneous can only come from the maternal lineage.

Cystic Fibrosis

Cystic fibrosis (CF) is one of the most commonly inherited genetic diseases encountered by pediatric clinical chemistry laboratories. The rate of this debilitating disease is one of 2,400 live births, which results from recessively inherited mutations in the cystic fibrosis transmembrane regulator (*CFTR*) gene. Patients may present in the newborn period with severe pancreatic insufficiency caused by accumulated thick mucous secretions in the pancreatic ducts, which inhibit the secretion of pancreatic digestive enzymes. These babies have steatorrhea and fail to thrive. Patients with CF do not always develop pancreatic symptoms; however, in most patients, the thick mucus that accumulates in the lungs causes respiratory disease and makes them particularly susceptible to rare infectious diseases, such as *Pseudomonas*. Although palliative therapies have improved over the past few generations because of the availability of better antibiotics, CF is still regarded as untreatable.

The gold standard diagnostic test for CF has been available for many years. It involves measurement of chloride content in sweat collected after pilocarpine iontophoresis. This type of testing is time consuming and requires specialist experience from the operator. The genetic basis for CF has been established. Although there are some mutations that are frequently encountered in the population, such as the $\Delta F508$, there are hundreds of other mutations. Recently, the American College of Medical Genetics and the American College of Obstetrics and Gynecology recommended heterozygote screening in selected couples.⁹ This recommendation poses an analytic challenge because of the large number of mutations, and it will probably require the development of a clinically acceptable microchip technology before they can be fully implemented (see Chapter 28).

Newborn Screening for Whole Populations

Certain inherited diseases are sufficiently common in the population to be considered candidates for whole population screening.¹⁰⁻¹² Phenylketonuria was the first genetic metabolic disorder to be screened in every baby born in the Western world. Other diseases that are readily treatable were added to the list in following years, including steroid 21-hydroxylase deficiency, sickle cell disease, and congenital hypothyroidism and, in some states, galactosemia. These genetic diseases respond well to simple therapy, often dietary. In most states, this process takes place in the state-screening laboratory, a facility that has the ability to easily follow up abnormal test results. The

nature of the testing procedure requires a sensitive screening test that has few false-negative results. There should then be confirmation using a test that is more specific to rule out false-positive results.

A relatively new technology, **tandem mass spectrometry**, allows many different biochemical genetic diseases to be screened on a single sample at the same time (Table 34-14). This technique allows whole groups of similar compounds to be analyzed on small sample volumes

TABLE 34-14 METABOLIC DISEASES DETECTABLE BY EXPANDED NEWBORN SCREENING

| |
|---|
| AMINO ACIDS |
| Phenylketonuria (PKU) |
| Maple syrup urine disease (MSUD) |
| Tyrosinemia, types 1 and 2 |
| Homocystinuria |
| Hypermethioninemia |
| UREA CYCLE |
| Argininemia |
| Citrullinemia |
| Argininosuccinic aciduria (ASA) |
| ORGANIC ACIDS |
| Propionic acidemia (PA) |
| Methylmalonic acidemia (MMA) |
| Isovaleric acidemia (IVA) |
| Glutaric acidemia, types 1 and 2 (GA1, GA2) |
| β -Ketothiolase deficiency |
| 3-Hydroxy-3-methylglutaryl-CoA lyase deficiency (HMG-CoA lyase) |
| 3-Methylcrotonyl-CoA carboxylase deficiency (MCC) |
| Malonyl-CoA decarboxylase deficiency |
| 2-Methyl-3-hydroxybutyryl-CoA dehydrogenase |
| FATTY ACIDS |
| Medium-chain acyl-CoA dehydrogenase deficiency (MCAD) |
| Short-chain acyl-CoA dehydrogenase deficiency (SCAD) |
| Very-long-chain acyl-CoA dehydrogenase deficiency (VLCAD) |
| Carnitine palmitoyltransferase, types 1A and 2 (CPT1A, CPT2) |
| Carnitine acylcarnitine translocase deficiency (CAT) |
| Long-chain 3-hydroxyacyl-CoA dehydrogenase deficiency (LCHAD) |
| Mitochondrial trifunctional protein deficiency (MTP) |

without complex sample preparation. The analytic time is about 2 minutes per sample, which means that it is possible to readily perform analysis for an entire state. The birth rate in the United States is approximately 3.5–4 million births per year. Tandem mass spectrometry has been shown to be capable of handling this workload.

The present status of expanded newborn screening for metabolic diseases comprises a panel of 29 recommended conditions, referred to as the uniform panel, of which 20 can presently be diagnosed using tandem mass spectrometry. At the time of this writing, approximately 98% of all babies born in the United States are provided with expanded newborn screening by tandem mass spectrometry. Many additional metabolic diseases can be diagnosed by tandem mass spectrometry; however, the current evidence to support a substantial benefit at the population level by uniform screening is less strong. Methods to diagnose additional diseases by tandem mass spectrometry are constantly being developed and it is likely that routine population-based screening will be expanded in the near future.

Diagnosis of Metabolic Disease in the Clinical Setting

At the present time, the clinical laboratory is needed to confirm the diagnosis in most of the diseases listed in Table 34-14 and also for the rest of the 500 single gene defects that result in biochemical genetic disease not detectable by tandem mass spectrometry. These inborn errors of metabolism can be broken down generally into two main types.

Large-Molecule Diseases

Large-molecule diseases have an accumulating intermediate of metabolism composed of large complex molecules; examples are listed in Table 34-15. Many of these diseases involve intracellular accumulation of the abnormal chemical with relatively small excretion in body fluids. In glycogen storage diseases, the glycogen accumulates in liver and muscle but cannot be seen in blood or urine samples. The histopathologist, using microscopic examination of tissue, often makes these diagnoses. A few, mostly urine, tests are available for gathering clues to large-molecule diseases, including glycosaminoglycan analysis using high-voltage electrophoresis to identify unusual metabolites associated with the mucopolysaccharide storage diseases. These tests are relatively insensitive and confirmation of the diagnosis requires measurement of deficient enzyme activity on a body tissue. Fortunately, many enzymes that result in large-molecule storage diseases can be found in white blood cells, enabling confirmation to be made on a blood sample. Enzymic confirmation can be difficult to establish in small babies because large blood samples are frequently required for diagnostic testing.

TABLE 34-15 EXAMPLES OF LARGE-MOLECULE STORAGE DISORDERS

| |
|--|
| MUCOPOLYSACCHARIDE (MPS) OR GLYCOSAMINOGLYCAN STORAGE DISEASES |
| Hurler disease (MPS, type I) |
| Hunter disease (type II) |
| Morquio disease (type IV) |
| COMPLEX LIPID STORAGE |
| Gaucher disease |
| Tay-Sachs disease |
| Niemann-Pick disease (types A, B, C) |
| GLYCOGEN STORAGE DISEASES |
| Von Gierke (type 1) |
| Pompe (type 2) |
| McArdle (type 5) |
| PEPTIDE STORAGE |
| Neuronal Ceroid Lipofuscinoses, Types 1–8 (Batten Disease) |

Small-Molecule Diseases

Small-molecule diseases result from defects in metabolic pathways of intermediary metabolism. Usually, the abnormal compounds that are present in these diseases are low-molecular-weight compounds that are readily excreted in body fluids; the types of pathways involved are listed in Table 34-16. Initially, the clinical chemistry laboratory had few diagnostic tools capable of identifying the large number of metabolic intermediates that may accumulate in these diseases, and a number of simple, colorimetric urine tests, such as the dinitrophenylhydrazine

TABLE 34-16 PATHWAYS INVOLVED WITH SMALL-MOLECULE METABOLIC DISEASE

| |
|------------------------------------|
| Amino acids |
| Fatty acids |
| Organic acids |
| Urea cycle |
| Oxidative phosphorylation |
| Vitamin metabolism |
| Steroid biosynthesis and breakdown |
| Cholesterol synthesis |
| Purine and pyrimidine metabolism |
| Neurotransmitter metabolism |
| Plasmalogen synthesis |
| Glutathione metabolism |
| Oxalate metabolism |

(DNPH) test for ketoacids, were developed to establish diagnosis. These methods lack both sensitivity and specificity and have no role to play in the modern clinical chemistry laboratory. They have been superseded by assays with greater sensitivity and specificity, often based on mass spectrometry.

Small-molecule diseases have a variable clinical presentation and could present to almost any medical subspecialty with any organ system involved. (Table 34-16 lists certain diseases and which specialist may be consulted.) Biochemical testing for these diseases is usually described in two phases. First, it is important to recognize the degree of tissue compromise at presentation. This requires routine chemistry evaluation for blood gas status, if acidotic; anion gap measurement; liver function testing; analysis of muscle markers, such as CK; lactic acid; and ammonia measurement. All of these analyses should be available stat and used to monitor management. The second phase of analysis should be to look for metabolic markers that pinpoint the site of a defect. These tests involve a form of separation technology, such as ion-exchange chromatography for amino acids. The preferred material for amino acid analysis is serum because the renal tubules have efficient transport systems for reabsorbing filtered amino acids. It is possible to miss an amino acid abnormality if urine is analyzed. Urine amino acid analysis is only of value if a tubular defect such as cystinuria is suspected. The most useful test for detecting abnormal metabolic intermediates is organic acid analysis. This test is performed on urine and should only be performed using the technique of gas chromatography mass spectrometry. It is a method that is capable of identifying metabolic markers for up to 200 genetic diseases. As mentioned earlier, tandem mass spectrometry is another technique seeing rapid growth in the metabolic disease diagnosis field. This technique is being applied to newborn screening and is playing an increasing role in analysis of multiple different metabolites. Currently, this technology is mainly found in research and large cutting-edge clinical chemistry laboratories, but it will find a place in all chemistry laboratories in the near future.

DRUG METABOLISM AND PHARMACOKINETICS

There are several important differences in the way that infants and children handle pharmacologic agents compared with adults.¹ This area of pediatric laboratory medicine provides many good examples of why children should not be regarded as “small adults.” It is not clinically appropriate to prorate the amount of drug prescribed to a child based on relative body weight compared with an adult dose.

Drug metabolism depends on the following factors: absorption, circulation and distribution, and metabolism

CASE STUDY 34-3

An infant presented to the pediatrician with failure to thrive, steatorrhea (foul-smelling, fatty stool), and persistent respiratory infections. An older sibling with the same clinical presentation has a confirmed genetic disease.

Questions

1. What is the likely diagnosis?
2. How is the disease inherited?
3. What is the molecular mechanism of this disease?
4. What is the gold standard diagnostic test?

and clearance. Often, the medium in which a drug is provided to a child differs from that in which an adult may take the same drug. Syrups, for instance, provide a more rapid release of a drug and greater availability for gastrointestinal absorption than tablets, which have the drug trapped in a solid matrix that requires digestion. Children are more likely to be given medication in a palatable form, such as syrup, and to require lower doses. The pH of gastric secretions differs in infants. At birth, the gastric pH is nearly neutral, not reaching the adult level of acidity for several years. This pH difference can affect the absorption of certain drugs, including some frequently prescribed penicillins. The distribution of drugs often differs between adults and children. Lipid-soluble drugs are taken up into lipid reserves and only slowly released into the circulation. Because infants have relatively little adipose tissue, these drugs are not stored as efficiently. The overall effect is that lipid-soluble drugs reach a higher level more quickly than in individuals with sizable fat stores; however, the drug is also cleared more rapidly. It becomes appropriate for drugs to be provided in smaller, more frequent doses to optimize the effect. Hepatic metabolism of many drugs is immature in young infants. This may delay the metabolic conversion to an active drug or increase the time in which an active drug is circulating. Good hepatic function is important for clearing those drugs metabolized by the liver, as good renal function is important for clearing drugs that have water-soluble end products.

Therapeutic Drug Monitoring

The principles of therapeutic drug monitoring remain the same in adult and pediatric clinical chemistry. It is important to measure the blood levels of various drugs if that information can provide important guidance to

TABLE 34-17 DRUGS WITH WELL-DEFINED THERAPEUTIC INDICES

| DRUG | THERAPEUTIC RANGE | TOXICITY |
|---------------------------|-------------------------------|------------------------------------|
| Phenytoin | 10–20 mg/L | >40 causes seizures, ataxia |
| Phenobarbital | 10–40 mg/L | >40 causes drowsiness; >60 coma |
| Carbamazepine | 4–10 mg/L | >10 causes drowsiness |
| Theophylline ^a | 5–15 mg/L | >20 can cause cardiac arrhythmia |
| Caffeine ^a | 5–15 mg/L | Less toxic than theophylline |
| Methotrexate 61 | Depends on therapy | High levels cause myelosuppression |
| Gentamycin | 5–10 mg/L (peak) ^b | >12 ototoxic; renal toxicity |

^aTheophylline is metabolized to caffeine in neonates but not in adults. Used to treat apnea.

^bPeak level should be drawn 30 minutes after last dose for aminoglycoside drugs. Children are particularly prone to hearing loss at toxic levels.

the physician with regard to optimal dosing. This is most important if a drug has a well-defined therapeutic index. This means that the drug is known to be ineffective if the blood level is below a certain value, that there is a well-defined therapeutic range over which the drug is effective, and that there is a higher level at which the drug becomes toxic. It is important to monitor levels of drugs with these characteristics. Table 34-17 lists drugs for which the importance of therapeutic monitoring is established.

Toxicologic Issues in Pediatric Clinical Chemistry

Issues related to the provision of a toxicologic service can be divided into two distinct groups in pediatrics. The first group involves infants and young children who unknowingly consume pharmacologic and other chemical agents. This usually involves the child finding access to medication belonging to another individual in the household and consuming the medication as if it were candy.

It is relatively easy for the investigator to ascertain the nature of the medication by identifying what is available in the household. Toxicologic investigation can usually be restricted to a few specific tests.

A rare, but potentially dangerous condition, is that of Munchausen syndrome by proxy. In this condition, mental illness in a caregiver causes them to give unnecessary and illness-causing drugs to an otherwise well child. This can go unrecognized and result in multiple hospitalizations and even death of the child. Clinical suspicion of this form of child abuse should involve performing a comprehensive drug screen to identify causative agents. Because of the intermittent nature of clinical presentation of Munchausen syndrome by proxy, it can often be confused with metabolic disease. Metabolic studies, in addition to comprehensive toxicologic studies, may be necessary.

Because the likelihood of self-ingestion of street drugs of abuse is present in older children, pediatric clinical chemistry laboratories should make assays available for street drugs similar to those in adult practice.

REFERENCES

- Green A, Morgan I, Gray J. Neonatology and laboratory medicine. London: ACB Venture Publications, 2003.
- Soldin SJ, Rifai N, Hicks JMB, eds. Biochemical basis of pediatric disease. Washington, D.C.: American Association for Clinical Chemistry, 1992.
- Gill FN, Bennett MJ. The pediatrics unit. In Price CP, Hicks JM, eds. Point of care testing. Washington, D.C.: American Association for Clinical Chemistry, 1999.
- Rautenberg MW, van Solinge WW, Heunks JJ, et al. Pediatric tube direct sampling by the Abbott Architect Integrated ci8200 Chemistry/Immunochemistry Analyzer. Clin Chem 2006;52:768–770.
- Demir AY, van Solinge WW, Kemperman, H. Handling of and direct sampling from primary barcode-labeled pediatric tubes on Vitros Clinical Chemistry Analyzers integrated into an enGen Work Cell. Clin Chem 2005;51:920–921.
- Honest H, Bachmann LM, Gupta JK, Kleijnen J, Khan KS. Accuracy of cervicovaginal fetal fibronectin test in predicting risk of spontaneous preterm birth: systematic review. BMJ 2002;325:301–311.
- Goldenberg RL, Mercer BM, Iams JD. The preterm prediction study: patterns of cervicovaginal fetal fibronectin as predictors of spontaneous preterm delivery. Am J Obstet Gynecol 1997;177:8–12.

8. Burtis CA, Ashwood ER, eds. Tietz fundamentals of clinical chemistry. 5th ed. Philadelphia, Pa.: WB Saunders, 2001.
9. Newman DJ. Cystatin C. *Ann Clin Biochem* 2002;39:89–104.
10. Scriver CR, Beaudet AL, Valle D, Sly WS, eds. The metabolic and molecular bases of inherited disease. 8th ed. New York: McGraw-Hill, 2001.
11. Hommes FA, ed. Techniques in diagnostic human biochemical genetics. New York: Wiley-Liss, 1991.
12. Bennett MJ, Rinaldo P, Whitley RJ, et al. National Academy of Clinical Biochemistry, Laboratory Medicine Practice Guidelines: Testing for metabolic diseases identified by expanded newborn screening using tandem mass spectrometry. American Association of Clinical Chemistry. September 2007. Retrieved from http://www.aacc.org/members/nacb/LMPG/OnlineGuide/DraftGuidelines/EN_Metabolic_Disease/Pages/default.aspx.

Appendices

- A Basic SI Units
- B Prefixes to Be Used with SI Units
- C Basic Clinical Laboratory Conversions
- D Conversion of Traditional Units to SI Units for Common Chemistry Analytes
- E Nomogram for the Determination of Body Surface Area
- F Relative Centrifugal Force Nomogram
- G Characteristics of Types of Glass
- H Characteristics of Types of Plastic
- I Chemical Resistance of Types of Plastic
- J Cleaning Labware
- K Summary Table of Pharmacokinetic Parameters
- L Selected Information on Commonly Abused Drugs

APPENDIX A. BASIC SI UNITS

| MEASUREMENT | NAME | SYMBOL |
|---------------------------|----------|--------|
| Length | Meter | m |
| Mass | Kilogram | kg |
| Quantity of substance | Mole | mol |
| Time | Second | s |
| Electric current | Ampere | A |
| Thermodynamic temperature | Kelvin | K |
| Luminous intensity | Candela | cd |

Note: SI (Système Internationale d'Unités) units are those having a definition recognized by international agreement. Note that some SI units have capitalized symbols. This is to avoid confusion with SI prefixes using the same letter symbol.

For additional information, refer to the latest edition of one of the following excellent references: Bold AM, Wilding P. Clinical Chemistry Companion. Oxford, UK: Blackwell Scientific Publications. West RC. CRC Handbook of Clinical Chemistry. Boca Raton, FL: CRC Press. Werner M. CRC Handbook of Clinical Chemistry. Boca Raton, FL: CRC Press.

APPENDIX B. PREFIXES TO BE USED WITH SI UNITS

| FACTOR | PREFIX | SYMBOL |
|------------|--------|--------|
| 10^{-18} | atto | a |
| 10^{-15} | femto | f |
| 10^{-12} | pico | p |
| 10^{-9} | nano | n |
| 10^{-6} | micro | μ |
| 10^{-3} | milli | m |
| 10^{-2} | centi | c |
| 10^{-1} | deci | d |
| 10^1 | deka | da |
| 10^2 | hecto | h |
| 10^3 | kilo | k |
| 10^6 | mega | M |
| 10^9 | giga | G |
| 10^{15} | peta | P |
| 10^{18} | exa | E |

Note: Prefixes are used to indicate a subunit or multiple of a basic SI unit.

APPENDIX C. BASIC CLINICAL LABORATORY CONVERSIONS

| LENGTH, VOLUME, WEIGHT CONVERSIONS | | | TEMPERATURE CONVERSIONS | | |
|------------------------------------|---------------------|-------------|-----------------------------------|-----------------------------------|--|
| TO CONVERT | INTO | MULTIPLY BY | TO CONVERT | INTO | USE |
| Inches | Centimeters | 2.54 | Centigrade ($^{\circ}\text{C}$) | Kelvin ($^{\circ}\text{K}$) | $^{\circ}\text{K} = ^{\circ}\text{C} + 273$ |
| Centimeters | Inches | 0.39 | Centigrade ($^{\circ}\text{C}$) | Fahrenheit ($^{\circ}\text{F}$) | $^{\circ}\text{F} = (^{\circ}\text{C} \times 1.8) + 32$ |
| Yards | Meters | 0.91 | Fahrenheit ($^{\circ}\text{F}$) | Centigrade ($^{\circ}\text{C}$) | $^{\circ}\text{C} = (^{\circ}\text{F} - 32) \times 0.556$ |
| Meters | Yards | 1.09 | CONCENTRATION CONVERSIONS | | |
| Gallons (U.S.) | Liters | 3.78 | TO CONVERT | INTO | USE |
| Liters | Gallons (U.S.) | 0.26 | % w/v | Molarity (M) | $M = \frac{\% \text{ w/v} \times 10}{\text{GMW}}$ |
| Fluid ounces (U.S.) | Milliliters | 29.6 | % w/v | Normality (N) | $N = \frac{\% \text{ w/v} \times 10}{\text{eq wt}}$ |
| Milliliters | Fluid ounces (U.S.) | 0.034 | mg/dL | mEq/L | $\text{mEq/L} = \frac{\text{mg/dL} \times 10}{\text{eq wt}}$ |
| Ounces | Grams | 28.4 | Molarity | Normality | $N = M \times \text{valence}$ |
| Grams | Ounces | 0.035 | | | |
| Pounds | Kilograms | 0.45 | | | |
| Kilograms | Pounds | 2.2 | | | |

APPENDIX D. CONVERSION OF TRADITIONAL UNITS TO SI UNITS FOR COMMON CHEMISTRY ANALYTES^a

| | CONVENTIONAL/CURRENT | SI UNIT | CONVERSION FACTOR |
|----------------------------------|----------------------|---------|-------------------|
| Albumin | g/100 mL | g/L | 10 |
| Ammonia | μg/dL | μmol/L | 0.587 |
| Aspartate aminotransferase (AST) | U/L (mU/mL) | μkat/L | 0.0167 |
| Bicarbonate (HCO ₃) | mEq/L | mmol/L | 1.0 |
| Bilirubin | mg/dL | μmol/L | 17.1 |
| Blood urea nitrogen (BUN) | mg/dL | mmol/L | 0.357 |
| Calcium | mg/dL | mmol/L | 0.25 |
| Chloride | mEq/L | mmol/L | 1.0 |
| Cholesterol | mg/dL | mmol/L | 0.026 |
| Cortisol | μg/dL | μmol/L | 0.0276 |
| Creatinine | mg/dL | μmol/L | 88.4 |
| Creatinine clearance | mL/min | mL/s | 0.0167 |
| Folic acid | ng/mL | nmol/L | 2.27 |
| Glucose | mg/dL | mmol/L | 0.0555 |
| Hemoglobin | g/dL | g/L | 10 |
| Iron | mg/dL | μmol/L | 0.179 |
| Lithium | mEq/L | μmol/L | 1.0 |
| Magnesium | mEq/L | mmol/L | 0.5 |
| Osmolality | mOsm/kg | mmol/kg | 1.0 |
| Phosphorus | mg/dL | mmol/L | 0.323 |
| Potassium | mEq/L | mmol/L | 1.0 |
| Sodium | mEq/L | mmol/L | 1.0 |
| Thyroxine (T ₄) | μg/dL | nmol/L | 12.9 |
| Total protein | g/dL | g/L | 10 |
| Triglyceride | mg/dL | mmol/L | 0.0113 |
| Uric acid | mg/dL | mmol/L | 0.0595 |
| Vitamin B ₁₂ | ng/mL | pmol/L | 0.0738 |
| PCO ₂ | mm/Hg | kPa | 0.133 |
| PO ₂ | mm/Hg | kPa | 0.133 |

^aTo obtain SI unit, multiply current unit by conversion factor. To obtain the conventional or current unit, divide the SI unit by the conversion factor.

APPENDIX E. NOMOGRAM FOR THE DETERMINATION OF BODY SURFACE AREA

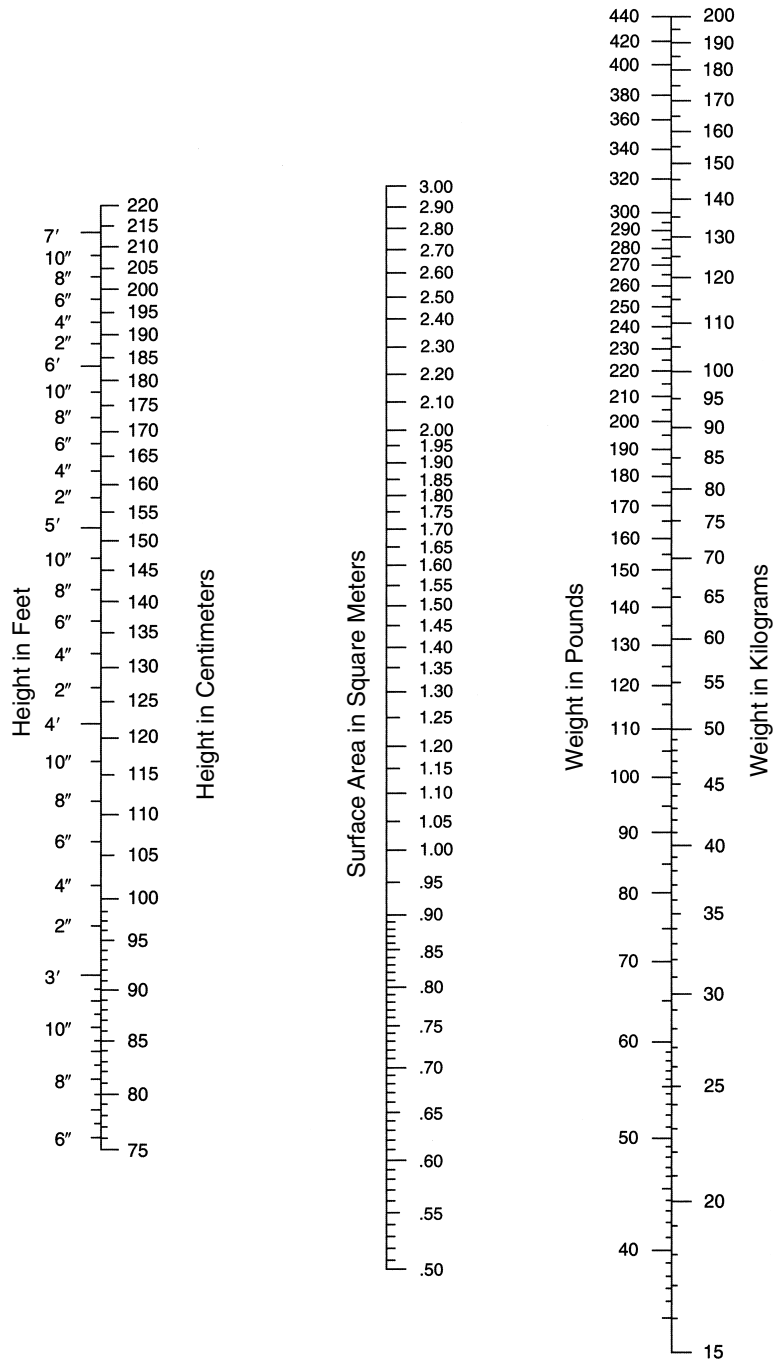

APPENDIX F. RELATIVE CENTRIFUGAL FORCE NOMOGRAM

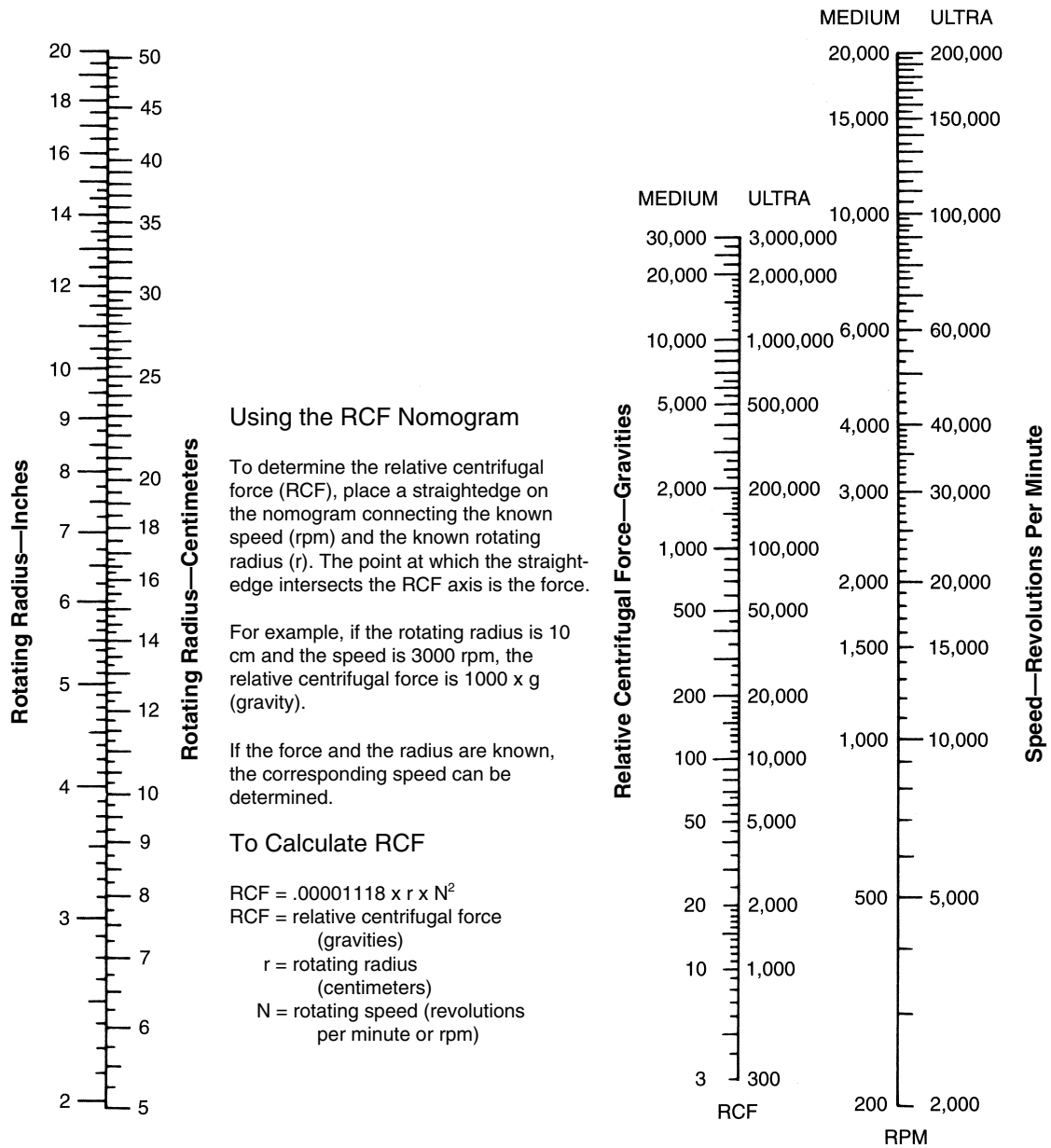

Using the RCF Nomogram

To determine the relative centrifugal force (RCF), place a straightedge on the nomogram connecting the known speed (rpm) and the known rotating radius (r). The point at which the straightedge intersects the RCF axis is the force.

For example, if the rotating radius is 10 cm and the speed is 3000 rpm, the relative centrifugal force is 1000 x g (gravity).

If the force and the radius are known, the corresponding speed can be determined.

To Calculate RCF

$$RCF = .00001118 \times r \times N^2$$

RCF = relative centrifugal force (gravities)
 r = rotating radius (centimeters)
 N = rotating speed (revolutions per minute or rpm)

Rotating Tip Radius

The distance measured from the rotor axis to the tip of the liquid inside the tubes at the greatest horizontal distance from the rotor axis is the rotating tip radius.

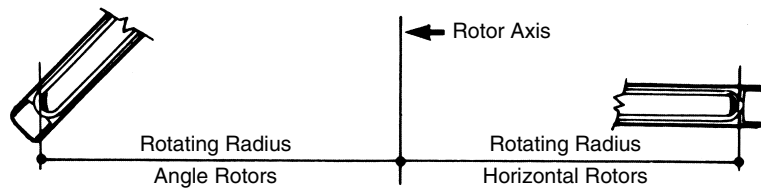

APPENDIX G. CHARACTERISTICS OF TYPES OF GLASS

| CATEGORY | TYPE OF MATERIAL | COMMON OR BRAND NAMES | ROUTINE USES | LIMITATIONS |
|---------------------------|--|-----------------------|---|---|
| High thermal resistance | Borosilicate with low alkaline content | Pyrex Kimax | All purpose, all types of beakers, flasks, etc. Can tolerate heating and sterilization for lengthy periods of time to 510°C | Should not be cooled too quickly after heating May cloud after use with a strong alkali Subject to scratching |
| | | Corex | Centrifuge tubes and thermometers Extremely strong and hard Temperature stability to 672°C; short-term use to 850°C | Resists scratching Subject to some acid or alkali attack at temperature of 100°C |
| | | Vycor | Ashing and ignition techniques. Can withstand very high temperature (900°C–1200°C), as well as drastic changes in temperature. Most are alkali resistant in this category. | |
| High silica | 96% silica | | Cuvets and thermometers Can be used at high temperatures (900°C–1200°C) and withstand a sharp change in temperature Can be considered optically pure (cuvets, thermometers) | |
| High resistance to alkali | Aluminosilicate | | Can be used with strong alkali and suffer minimal attack (0.09 mg/cm ² vs. 1.4 mg/cm ² for borosilicate or 0.35 mg/cm ² for regular aluminosilicate) | Must be heated and cooled with care Highest temperature for safe use is 578°C |

APPENDIX H. CHARACTERISTICS OF TYPES OF PLASTIC

| PLASTIC | TEMPERATURE LIMIT (°C) | TRANSPARENCY | AUTOCLAVABLE | FLEXIBILITY | USAGE EXAMPLES |
|---------------------------------------|------------------------|----------------------|--------------|-------------|---|
| Polystyrene (PS) | 70 | Clear | No | Rigid | Disposables |
| Polyethylene Conventional (CPE) | 80 | Translucent | No | Excellent | All-purpose Reagent bottles Test-tube rack Carboys Droppers |
| Linear (LPE) | 120 | Opaque | With caution | Rigid | Specimen transport containers Reagent bottles |
| Polypropylene (PP) | 135 | Translucent | Yes | Rigid | Screw-cap closures Bottles |
| Tygon | 95 | Translucent | Yes | Excellent | Tubing |
| Teflon FEP | 205 | Clear Translucent | Yes | Excellent | Stopcocks Wash bottles Beakers |
| Polycarbonate (PC) | 135 | Very clear | Yes | Rigid | All-purpose Large reagent containers Carboys Test-tube rack |
| Polyvinyl chloride ^a (PVC) | 70 | Clear | No | Rigid | Bottles/tubing |

^aPVC tubing can be heated to 120°C, can be autoclaved, and is very flexible.

APPENDIX I. CHEMICAL RESISTANCE OF TYPES OF PLASTIC

| PLASTIC | CHEMICAL RESISTANCE ^a |
|---------------|---|
| Polystyrene | Useful with water and aqueous salt solutions. It is not recommended for use with acids, aldehydes, ketones, ethers, hydrocarbons, or essential oils. Alcohols and bases can be used, but storage beyond 24 h is discouraged. |
| Polyethylene | Both classifications of polyethylene (<i>i.e.</i> , conventional and linear) have similar chemical resistances. They have excellent chemical resistance to most substances, with the exception of aldehydes, amines, ethers, hydrocarbons, and essential oils. For conventional polyethylene, the exceptions should also include lubricating oil and silicones. The usage of any of the above-named chemical groups should be limited to 24 hours at room temperature. |
| Polypropylene | Has the same chemical resistance as linear polyethylene. |
| Teflon | This resin possesses excellent chemical resistance to almost all chemicals used in the clinical laboratory. |
| Polycarbonate | Very susceptible to damage by most chemicals. It is resistant to water, aqueous salts, food, and inorganic acids for a long period of time. |

^aIt should be noted that this information is based on room temperature (22°C) and normal atmospheric pressure. Resistance to chemicals decreases as the temperature of the resin nears its maximum. Chemical resistance will also vary as the concentration of the chemical increases.

APPENDIX J. CLEANING LABWARE

| GLASSWARE "PROBLEM" | CLEANING TECHNIQUE |
|---|--|
| General usage (procedure 1 is recommended for routine washing needs) | <ol style="list-style-type: none"> 1. <i>Dirty</i> glassware should be immediately placed in a soapy or dilute bleach solution and allowed to soak. Wash using any detergent designed for labware. Rinse with tap water 3 times, followed by 1 rinse with distilled water. Dry in an oven at temperature less than 140°C. 2. <i>Acid dichromate</i>. Dissolve 50 g technical-grade sodium dichromate in 50 mL of distilled water. Add this mixture to 500 mL of technical-grade concentrated sulfuric acid. This solution is useful until a green color develops. Store in a covered glass jar. Soak glassware overnight and then rinse with dilute ammonia. Rewash glassware according to procedure 1. 3. <i>Nitric acid (20%)</i>. Soak for 12–24 hours. Wash according to procedure 1. |
| Blood clots | <ol style="list-style-type: none"> 4. <i>Sodium hydroxide (10%)</i>. Soak for 12–24 hours; then follow routine procedure. Dry micropipets using an acetone rinse. |
| New pipets (S1 alkaline) | <ol style="list-style-type: none"> 5. <i>Rinse</i> with 5% hydrochloric acid or 5% nitric acid. Wash following routine procedure. |
| Metal ion determinations | <ol style="list-style-type: none"> 6. <i>Acid soak (20% nitric acid)</i>, for 12–24 hours. Rinse with distilled water 3–4 times. Water should be fresh for each rinsing step. Dry. |
| Grease | <ol style="list-style-type: none"> 7. <i>Soak</i> in any organic solvent. 8. <i>Dissolve</i> 100 g potassium hydroxide in 100 mL of distilled water. Allow to cool. Add 900 mL commercial-grade 10% ethanol. Not to be used for delicate glassware. 9. <i>Contrad 70</i> (manufactured by Decon Labs). |
| Permanganate stains | <ol style="list-style-type: none"> 10. <i>50% Hydrochloric acid</i>. Rinse with tap water. Wash. 11. <i>Dissolve</i> 1% ferrous sulfate in 25% sulfuric acid. |

APPENDIX K. SUMMARY TABLE OF PHARMACOKINETIC PARAMETERS

| | THERAPEUTIC RANGE PER mL PLASMA | TOXIC CONC. PER mL PLASMA | TIME TO PEAK CONC. (HOURS) | HALF-LIFE (HOURS) | % PROTEIN BOUND | VOLUME OF DISTRIBUTION (L/kg) | % ORAL BIOAVAILABILITY | % EXCRETED IN URINE UNCHANGED |
|----------------------------|---------------------------------|---------------------------|----------------------------|--|-----------------|-------------------------------|--|-------------------------------|
| Cardioactive drugs | | | | | | | | |
| Amiodarone | 1.0–3 µg | | 2–6 | 15–100 days | 95–98 | 70–150 | 22–88 | 0 |
| Digitoxin | 15–30 ng | >35 | | 2.4–16.4 days | 90 | 0.6 | 95 | 30–50 |
| Digoxin | 0.8–2 ng | >2.4 | 1–5 | 36–51 | 20–40 | 5–10 | Tablets, 60–75 Elixir, 80 Capsules, 95 IM, 80 | 60–80 |
| Disopyramide | 2–5 µg | >7 | 0.5–3.0 | 5–6 | 10–80 | 0.8–2 | 80 | |
| Lidocaine | 1.5–5 µg 0.5–1.5 free | >5 | 15–30 ^a | 1–2 | 70 | 1.3 | 25–50 ^b | 5–10 |
| Procainamide | 4–10 µg | >12 | 1–2 | 2.5–4.7 | 15 | 1.7–2.2 | 70–95 | 50 |
| NAPA | 15–25 µg | | | 4.3–15 | | | | |
| Total | 5–30 µg | | | | | | | |
| Propranolol | 50–100 ng | Variable | 1–2 | 2–6 | 90–95 | 4–6 | 20–40 ^b | 1–4 |
| Quinidine | 2–6 µg | >6 | 1–2 4–8 ^c | 6–8 | 70–90 | 2–3 | 70–80 ^b | 10–30 |
| Antiepileptic drugs | | | | | | | | |
| Carbamazepine | 6–12 µg | >15 | 6–12 | 18–54 ^d 10–25 ^e | 72–75 | 0.8–1.4 | 75–85 | 2 |
| Ethosuximide | 40–100 µg | >150 | 1–4 | 40–60 | <10 | 0.6–0.9 | 100 | 10–20 |
| Phenobarbital | 15–40 µg | >40 | 6–18 | 50–120 | 49–58 | 0.6 | 80–100 | 10–30 |
| Phenytoin | 10–20 µg | >20 | 4–8 | 7–42 | 87–93 | 0.5–0.8 | 85–95 | 5 |
| Primidone | 5–12 µg | >15 | 2–4 | 3.3–19 | 0–20 | 0.6–1 | 80–90 | 45–50 |
| Valproic Acid | 50–100 µg | >100 | 1–2 | 8–20 | 85–95 | 0.1–0.5 | 85–100 | 3 |
| Bronchodilator | | | | | | | | |
| Theophylline | 10–20 µg | >20 | 2–3 | 6–12 | 55–65 | 0.3–0.7 | 95–100 | 9–11 |
| Antibiotics | | | | | | | | |
| Aminoglycosides | | | 0.5–IM ^a | | | | | |
| Amikacin | 5–12 µg | | | | | | | |
| Peak | 50–100 µg | >32 | | | | | | |
| Trough | 10–20 µg | >5 | | | | | | |
| Gentamicin | | | | | | | | |
| Peak | 20–25 µg | >12 | | | | | | |
| Trough | 1–4 µg | >2 | | | | | | |
| Kanamycin | | | | | | | | |
| Peak | 5–10 µg | >30 | | | | | | |
| Trough | 0.5–1.5 µg | >10 | | | | | | |
| Netilmicin | | | | | | | | |
| Peak | 5–12 µg | >12 | | | | | | |
| Trough | 0.5–1.5 µg | >2 | | | | | | |

APPENDIX K. SUMMARY TABLE OF PHARMACOKINETIC PARAMETERS (continued)

| | THERAPEUTIC RANGE PER mL PLASMA | TOXIC CONC. PER mL PLASMA | TIME TO PEAK CONC. (HOURS) | HALF-LIFE (HOURS) | % PROTEIN BOUND | VOLUME OF DISTRIBUTION (L/kg) | % ORAL BIOAVAILABILITY | % EXCRETED IN URINE UNCHANGED |
|--------------------------------|------------------------------------|---------------------------|----------------------------|-------------------|-----------------|-------------------------------|------------------------|-------------------------------|
| Antibiotics (continued) | | | | | | | | |
| Streptomycin | | | | | | | | |
| Peak | 20–25 µg | >30 | | | | | | |
| Trough | 1–3 µg | >10 | | | | | | |
| Tobramycin | | | | | | | | |
| Peak | 5–12 µg | >12 | | | | | | |
| Trough | 0.5–1.5 µg | >2 | | | | | | |
| Vancomycin | | | | | | | | |
| Peak | 30–40 µg | >80 | | 3–9 | 50 | 0.5–0.8 | <2 | 80–90 |
| Trough | 5–10 µg | >20 | | | | | | |
| Chloramphenicol | 10–20 µg | >25 | 2 | 1.5–3 | 50 | 0.5–1 | 90 | 10 |
| Psychoactive drugs | | | | | | | | |
| Amitriptyline | 125–250 ng | >500 | 1–5 | 17–40 | 82–96 | 6.4–36 | 56–70 | |
| Nortriptyline | 50–150 ng | >500 | 3–12 | 16–88 | 87–95 | 14–38 | 46–70 | 2–5 |
| Imipramine | 150–250 ng | >500 ^f | 1.5–3 | 6–34 | 63–96 | 9–23 | 29–77 | 1–4 |
| Desipramine | 150–300 ng | >500 | 3–6 | 11–46 | 73–92 | 15–60 | 31–51 | 1–4 |
| Doxepin | 110–250 ng | | 1–4 | 8–36 | 68–82 | 9–52 | 13–45 | |
| Protriptyline | 70–260 ng | | 6–12 | 54–198 | 90–94 | 15–31 | 75–90 | |
| Lithium | 0.8–1.4 µEq | >2 | 1–3 | 8–35 ^g | 0 | 0.5–1.0 | 85–95 | 100 |
| Immunosuppressants | | | | | | | | |
| Cyclosporine (HPLC) | 100–300 ng | >400 | 1–8 | 4–60 | 98 | 3.5–4.5 | 4–90 | <6 |
| Antineoplastics | | | | | | | | |
| Methotrexate | After 24 hours >10 ⁻⁵ M | | 1–2 | Variable | 50–70 | 0.75–0.8 | 30 | 90 |
| | After 48 hours >10 ⁻⁶ M | | | | | | | |
| | After 72 hours >10 ⁻⁷ M | | | | | | | |

^aVaries dependent on dosage regimen, immediately after IV infusion.

^bMuch of the drug metabolized on first pass through the liver.

^cSlow-release preparation.

^dAfter single dose.

^eAfter multiple doses.

^fImipramine + desipramine.

^gVariable with renal function.

APPENDIX L. SELECTED INFORMATION ON COMMONLY ABUSED DRUGS

| DRUG | STREET NAME (TRADE NAME) | ROUTE OF INGESTION | DURATION OF EFFECT (HOURS) | HALF-LIFE (HOURS) | EXCRETED UNCHANGED IN URINE | PRINCIPAL URINARY METABOLITES | SYMPTOMATOLOGY |
|-------------------|--|----------------------------|----------------------------------|----------------------|-----------------------------------|---|---|
| Stimulants | | | | | | | |
| Cocaine | Coke, crack, snow flake | Nasal, oral, IV, smoked | 1–2 | 2–5 | <10% | Benzoyllecgonine; ecgonine; ecgonine methyl ester | Anesthesia, euphoria, confusion, depression, convulsions, cardiotoxicity |
| Amphetamine | Bennies, dexies, uppers | Oral, IV | 2–4 | 4–24 | ~30% | Benzoic acid; <i>p</i> - hydroxyamphetamine; <i>p</i> -hydroxynorephedrine; phenylacetone | Insomnia, anorexia, euphoria, tolerance and dependence, paranoid psychosis |
| Methamphetamine | Meth, speed, crystal | Oral, IV | 2–4 | 9–24 | 10%–20% | 4-Hydroxymethamphetamine; amphetamine; 4-tyroxy- amphetamine; norephedrine | Euphoria, agitation, psychosis, depression, exhaustion |
| Narcotics | | | | | | | |
| Heroin | Horse, smack, white lady, scag | IV, nasal, smoked | 3–6 | 1–1.5 | <1% | 6-Acetylmorphine; morphine; morphine glucuronide | Euphoria, drowsiness, respiratory depression, convulsions, coma |
| Codeine | C; Co-Dine; lean and dean; school boy; syrup | Oral, IV, IM | 3–6 | 2–4 | 5%–20% | Morphine; norcodeine; conjugates | Sedation, convulsions, respiratory failure |
| Morphine | Junk, white stuff, morpho, M | IV, IM, oral, smoked | 3–6 | 2–4 | <10% | Morphine-3-glucuronide; morphine-6-glucuronide; morphine sulfate; normorphine; codeine | Analgesia, euphoria, nausea, respiratory coma |
| Methadone | Methadose | Oral, IV, IM | 12–24 | 15–60 | 5%–50% | 2-Ethylidene-1, 5-dimethyl- 3,3-diphenylpyrrolidine; 2-ethyl- 5methyl-3,3-diphenyl- pyrrolidine methadol; normethadol; conjugates | Analgesia, sedation, respiratory depression, coma |
| Meperidine | (Demerol) | IV, oral | 3–6 | 2–5 | 5% | Normeperidine; meperidinic acid; normeperidinic acid | Analgesia, stupor, respiratory depression, hypotension, coma |
| Propoxyphene | Yellow footballs (Darvon) | Oral | 1–6 | 8–24 | <1% | Norpropoxyphene; dinorpropoxyphene | Analgesia, stupor, respiratory depression, coma |

APPENDIX L. SELECTED INFORMATION ON COMMONLY ABUSED DRUGS (continued)

| DRUG | STREET NAME (TRADE NAME) | ROUTE OF INGESTION | DURATION OF EFFECT (HOURS) | HALF-LIFE (HOURS) | EXCRETED | | PRINCIPAL URINARY METABOLITES | SYMPTOMATOLOGY |
|-------------------------------|--|-------------------------------|---|----------------------|-----------------------|--|--|---|
| | | | | | UNCHANGED IN URINE | | | |
| Hallucinogens | | | | | | | | |
| Phencyclidine (PCP) | PCP, angel dust, hog, killer weed | IV, oral, nasal, smoked | 2-4; psychooses may last weeks | 7-16 | 30-50% | | 4-Phenyl-4- piperidinocyclohexanol; 1-(1-phenylcyclohexyl)-4- hydroxy-piperidine; glucuronide conjugates | Dissociative anesthesia, depression, psychosis, stupor, coma, seizures |
| LSD | Acid, LSD-25, white lightning, microdots | Oral | 8-12 | 3-4 | 1% | | <i>N</i> -Desmethoxylysergide; 13-hydroxylysergide | Hallucinations, flashbacks, psychosis, vomiting, paralysis, respiratory depression |
| Marijuana, hashish | Pot, THC, mary jane, grass, hash | Oral, smoked, IV | 2-4 | 14-38 | <1% | | 11-Nor-9-carboxy- Δ^9 -THC; 11- hydroxytetrahydrocannabinol | Altered perception, memory loss, disorientation, psychosis |
| Benzodiazepines | | | | | | | | |
| Chlordiazepoxide (Librium) | (Librium) | Oral, IM | 4-8 | 6-27 | <1% | | Norchlordiazepoxide; demoxepam; nordiazepam; oxazepam; glucuronide conjugates | Drowsiness, muscle relaxation, coma |
| Diazepam (Valium) | (Valium) | Oral, IV, IM | 4-8 | 20-50 | <1% | | Nordiazepam; oxazepam; 3-hydroxydiazepam; glucuronide conjugates | Drowsiness, dizziness, muscle relaxation |
| Sedatives/Depressants | | | | | | | | |
| Pentobarbital | Yellow, nembies, yellow jackets | Oral, IV, IM | 3-6 | 15-48 | 1% | | 3-Hydroxypentobarbital; <i>N</i> -hydroxypentobarbital; 3-carboxypentobarbital | Sedation, respiratory collapse |
| Amobarbital | Rainbows, blues, bluebirds | Oral, IV, IM | 3-24 | 12-60 | <1% | | 3-Hydroxyamobarbital; <i>N</i> -glucosyl amobarbital; | Exhilaration, sedation, disorientation, respiratory depression, coma |
| Secobarbital | Reds, seccies, red devils, M&M's | Oral, IV, IM | 3-6 | 15-40 | 5% | | 3-Hydroxysocobarbital secodiol; 5-(1-methylbutyl) barbituric acid | Sedation, lethargy, coma, respiratory collapse |
| Ethanol | | Oral | 2-6 | 2-14 | 2%-10% | | Acetaldehyde; acetic acid glucuronide | Slurred speech, loss of equilibrium, drowsiness, coma, respiratory collapse |

APPENDIX L. SELECTED INFORMATION ON COMMONLY ABUSED DRUGS (continued)

| DRUG | STREET NAME (TRADE NAME) | ROUTE OF INGESTION | DURATION OF EFFECT (HOURS) | HALF-LIFE (HOURS) | EXCRETED UNCHANGED IN URINE | PRINCIPAL URINARY METABOLITES | SYMPTOMATOLOGY |
|--|-----------------------------|-----------------------|----------------------------------|----------------------|-----------------------------------|---|--|
| <i>Sedatives/Depressants (continued)</i> | | | | | | | |
| Methaqualone | Ludes, soapers | Oral | 4-8 | 20-60 | <1% | 3', 4', and 6-Hydroxymethaqualone; respective glucuronide | Sedation, dizziness, paresthesias, convulsions, respiratory and circulatory depression |
| Chloral hydrate | Joy juice | Oral, rectal | 5-8 | <1 | <1% | Trichloroethanol; trichloroacetic acid; conjugates | Sedation, GI distress, hypotension, respiratory depression |

Glossary

A

- Accessioning:** identification and logging of specimens in a laboratory.
- Accuracy:** without error; closeness to the true value.
- Acid:** a substance that can yield a hydrogen ion or hydronium ion when dissolved in water.
- Acidemia:** a pH of blood less than the reference range.
- Acidosis:** a pH below the reference range.
- Acromegaly:** chronic disease of middle-aged individuals typified by elongation and enlargement of the extremities and certain head bones.
- ACTH:** see Adrenocorticotrophic hormone.
- Activation energy:** energy required to raise all molecules in 1 mole of a compound at a certain temperature to the transition state at the peak of the energy barrier.
- Activator:** a substance that converts an inactive substance to an active one; induces activity.
- Active transport:** a mechanism that requires energy in order to move ions across cellular membranes.
- Activity coefficient (AC):** relating to the study of vitamins, an expression indicating the enhancement of enzyme activity upon saturation with a vitamin. The greater the AC, the more likely it is that the patient is deficient in the vitamin.
- Acute coronary syndromes:** a progression of pathologic conditions involved in ischemic heart disease, including erosion and rupture of coronary artery plaques, activation of platelets, and thrombi. This progression is as termed the acute coronary syndromes and ranges from unstable angina to extensive tissue necrosis in acute myocardial infarction.
- Acute renal failure:** a sudden, sharp decline in renal operation as a result of an acute toxic or hypoxic insult to the kidneys. This has been defined as occurring when the glomerular filtration rate (GFR) is reduced to <10 mL per minute.
- Adaptive immune system:** one of two functional parts of the immune system; it produces a specific reaction to each infectious agent, then normally eradicates that agent and remembers that particular infectious agent, preventing it from causing disease later. For example, measles and diphtheria produce a lifelong immunity following an infection.
- Addison's disease:** disease stemming from a deficiency in the secretion of adrenocortical hormones.
- Additive:** A substance not naturally a part of a material (e.g., food) but deliberately added to fulfill some specific purpose (e.g., preservation).
- Adenohypophysis:** see Anterior pituitary.
- ADH:** see Antidiuretic hormone.
- Adrenal glands:** paired organs located at the upper pole of each kidney. Each gland consists of an outer cortex and an inner medulla, which have different embryologic origins, different mechanisms of control, and different products.
- Adrenocorticotrophic hormone (ACTH):** a peptide hormone secreted by the anterior pituitary. It stimulates the cortex of the adrenal glands to produce adrenal cortical hormones.
- Affinity:** attraction or force causing two substances to unite.
- Aging:** maturing; a progressive loss of adaptation leading to decreased viability and life expectancy and increased vulnerability.
- Airborne pathogen:** any infectious agent transmissible by air, e.g., tuberculosis.
- Albumin:** the main protein in plasma.
- Aldosterone:** the principal mineralocorticoid (electrolyte-regulating hormone) produced by the zona glomerulosa of the adrenal cortex; its major action is to facilitate potassium exchange for sodium in the distal renal tubule, causing sodium reabsorption and potassium and hydrogen loss.
- Aliquot:** a sample, of which the mass of volume is a known fraction of that of the whole.
- Alkalemia:** a blood pH greater than the reference range (<7.35–7.45).
- Alkalosis:** a pH above the reference range.
- Allantoin:** produced by the oxidation of uric acid by the enzyme uricase. It is the end product of purine metabolism.
- Allograft:** transplant tissue from the same species (e.g., kidney).
- Amenorrhea:** cessation of menstruation.
- Amine:** any one of a group of nitrogen-containing organic compounds. The amine hormones include epinephrine, norepinephrine, thyroxine, and triiodothyronine.
- Amino acid:** small biomolecules with a tetrahedral carbon covalently bound to an amino group, a carboxyl group, a variable (R) group, and a hydrogen atom.
- Aminoacidopathies:** inherited disorders of amino acid metabolism.
- Ammonia:** NH₃; formed in vivo from breakdown of amino acids.
- Amniocentesis:** puncture of the amniotic sac to obtain fluid for analysis.
- Amniotic fluid:** a fluid in which the fetus is suspended; it provides a cushioning medium for the fetus and serves as a matrix for influx and efflux of constituents.
- Amphoteric:** having two or more ionizable sites that can result in either a net positive or a net negative charge depending on the pH of the environment.
- Amplicon:** amplified target DNA sequences.
- Anabolism:** the building up in the body of complex chemical compounds from smaller simpler compounds (e.g., proteins from amino acids), usually with the use of energy.
- Analgesic:** a drug that relieves pain.
- Analyte:** a biologic solute or constituent (e.g., calcium, glucose, sodium).
- Analytical error:** error due to the instrument's, procedure's, or laboratory scientist's handling of a specimen during testing.
- Analytical variations:** nonidentical measurements that have diverse causes, including instrument, reagent, and operator variations.
- Anchored vein:** vein that is held in place by surrounding tissues and does not roll easily, therefore resulting in successful venipuncture.

Androgen: any substance (hormone) stimulating the development of male characteristics (e.g., testosterone).

Angina pectoris: pain and a feeling of constriction around the heart; may radiate down the arm and into the jaw and is caused by deficiency of oxygen to heart muscle.

Angiotensin: a polypeptide produced when renin is released from the kidney; a vasopressor substance.

Angiotensin-converting enzyme (ACE): a hydrolase responsible for the conversion of angiotensin I to the vasoactive angiotensin II by removal of a dipeptide (histidylleucine) from angiotensin I. Drugs that inhibit ACE are used to treat hypertension and congestive heart failure.

Anhydrous: without water.

Anion: a negatively charged ion; anions move toward the anode (positive pole) because of its positive charge.

Anion gap: the difference between unmeasured anions and unmeasured cations.

Anneal: the action of pairing complementary sequences to form a double-stranded molecule, usually DNA or RNA molecules.

Antecubital fossa: area of forearm at the bend of the elbow; most commonly used for venipuncture.

Anterior pituitary: adenohypophysis. The pituitary is located in a small cavity in the sphenoid bone of the skull called the sella turcica. The tropic hormones of the anterior pituitary are mediated by negative feedback, which involves interaction of the effector hormones with the hypothalamus, as well as with cells of the anterior pituitary.

Anthropometric methods: used to assess the general nutritional status of a patient. Includes skinfold test and arm circumference and height and weight measurements.

Antibody: glycoproteins (immunoglobulins) secreted by plasma cells, which in turn are under the control of many lymphocytes and their cytokines. Antibodies are produced in response to antigens.

Anticoagulant: inhibits the blood's clotting action; yields specimens containing intact clotting factors.

Antidiuretic hormone (ADH): a nonapeptide neurohypophysial hormone related to oxytocin and vasotocin; synthetically prepared or obtained from the posterior lobe of the pituitary of healthy domestic animals. In pharmacologic doses, vasopressin causes contraction of smooth muscle, notably that of all blood vessels; large doses may produce cerebral or coronary arterial spasm.

Antigen: agents that are recognized as foreign by the immune system. The immune system produces antibodies in response.

Antigenic determinant: a part of an antigen's structure that is recognized as foreign by the immune system. This structural domain is also referred to as an epitope.

Antiglycolytic agent: a substance that inhibits the metabolism of glucose by cells in a specimen of blood. The most common antiglycolytic agents are sodium fluoride and lithium iodoacetate.

Antioxidant: substance (e.g., vitamin) that inhibits or prevents oxidation.

Antiplatelet therapy: therapy to destroy platelets.

Apoenzyme: protein portion of an enzyme.

Apoptosis: programmed death of cells; disintegration of body cells into membrane-bound particles that can then be phagocytized by other cells.

Arachnoid villi/granulations: tufted prolongations of pia-arachnoid that protrude through the meningeal layer of the dura mater and have a thin limiting membrane; collections of arachnoid villus form arachnoid granulations that lie in venous lacunae at the margin of the superior sagittal sinus.

Arrhythmia: irregular heartbeat or action.

Arterial blood: blood from arteries.

Arterial septal defect: heart abnormality that causes left-to-right shunting of blood between the atria.

Arteriosclerosis: includes a number of pathologic conditions in which there is a thickening or hardening of the walls of the arteries.

Ascites: excess fluid in the peritoneal cavity; the fluid is called ascitic fluid.

Atherosclerosis: a disease in which there is an accumulation of lipid material in the veins and arteries.

Atomic absorption: analytic technique that measures concentration of analyte by detecting absorption of electromagnetic radiation by atoms rather than by molecules. Instrument is atomic absorption spectrophotometer.

Atrial septal defect (ASD): a congenital defect in the interatrial septum between the atria of the heart, due to failure of the foramen primum or foramen secundum to close normally; causes left-to-right shunting of blood between the atria.

Autocrine system: cell secretions that act to influence only their own development.

Autoimmune disorder: disease or disorder in which the body produces antibodies (immunologic response) against itself.

Automation: mechanization of the steps in a procedure. Manufacturers of clinical chemistry analyzers design their instruments to mimic the manual techniques in an analytic procedure.

Avidity: strength of bond of antigen-antibody complex; attraction.

Azotemia: elevated level of urea in blood.

B

Bar code: a set of vertical bars of varying width used to encode information. Used most frequently in the clinical laboratory for patient and specimen information.

Basal state: early morning before the patient has eaten or become physically active. This is a good time to draw blood specimens because the body is at rest and food has not been ingested during the night.

Base: a substance that can yield hydroxyl ions (OH^-).

Base excess (BE): the theoretical amount of titratable acid or base required to return the plasma pH to 7.40 at a PCO_2 of 40 mm Hg at 37°C .

Basilic vein: arises from the ulnar side of the dorsal venous network of the hand; it curves around the medial side of the forearm, communicates with the cephalic vein through the median cubital vein, and passes up the medial side of the arm to join the axillary vein.

Beer's law: mathematically establishes the relationship between concentration and absorbance in photometric determinations; expressed as: $A = abc$.

Beriberi: chronic deficiency of the vitamin thiamine produces the disease beriberi.

Bevel: the angled point of an injection needle.

Bias: systematic discrepancy between a measurement and the true value; may be constant or proportionate and may adversely affect test results.

Bicarbonate: the HCO_3^- anion.

Bile: a fluid produced by the liver and composed of bile acids or salts, bile pigments (primarily bilirubin esters), cholesterol, and other substances extracted from the blood. Total bile production averages about 3 L/day, although only 1 L is excreted.

Bilirubin: the principal pigment in bile; derived from the breakdown of hemoglobin when aged red blood cells are phagocytized by the reticuloendothelial system, primarily in the spleen, liver, and bone marrow.

Bioavailability: the physiologic availability of a given amount of a drug, as distinct from its chemical potency; proportion of the administered dose that is absorbed into the bloodstream.

Biohazard: anything harmful or potentially harmful to man, other organisms, or the environment. Examples include blood or blood products and contaminated laboratory waste.

β -Blocking drug: drug that reduces heart rate and/or the force of contractions, reducing the oxygen demand of the heart by blocking the β receptors in the sinus node and the myocardium (e.g., propranolol).

Bisphosphonates: class of medications to treat osteoporosis.

Bloodborne pathogen: any infectious agent or pathogen transmissible by means of blood or blood products.

Blood-brain barrier: a selective mechanism opposing the passage of most ions and large-molecular-weight compounds from the blood to brain tissue.

Body mass index (BMI): an anthropometric measure of body mass, defined as weight in kilograms divided by height in meters squared; a method of determining caloric nutritional status.

Bone mineral densitometry (DXA): x-ray procedure that measures bone mineral density, measure grams of calcium per square centimeter of cross-sectional area of bone (g/cm^2).

Bone turnover: coupled process that takes place throughout life in bone with bone formation and bone resorption.

Branched chain signal amplification (bdNA): signal amplification system originally developed by Chiron Corporation and now sold through Siemens Healthcare Diagnostics (Tarrytown, NJ).

Buffer: a substance that minimizes any change in hydrogen ion concentration; a weak acid or base and its conjugate salt.

BUN/creatinine ratio: ratio of plasma or serum urea nitrogen (mg/dL) to plasma or serum creatinine (mg/dL).

Buret: a wide, long, graduated pipet with a stopcock at one end.

Butterfly needle: an intravenous needle with a hub equipped with winglike flexible tabs that serve as a handle during insertion and for skin attachment afterward.

C

CAH: see Congenital adrenal hyperplasia.

Calcaneus: the largest of the tarsal bones; it forms the heel and articulates with the cuboid anteriorly and the talus above.

Calcitonin: hormone produced by the thyroid gland; important in bone and calcium metabolism.

Calibration: standardization or the determination of the accuracy of an instrument.

Cancer: general term for malignant neoplasms; carcinoma or sarcoma; the uncontrolled growth of cells from normal tissue. Cancer cells can grow and spread, killing the host.

Capillary blood: blood from minute blood vessels.

Carbohydrate: polyhydroxy aldehydes or polyhydroxy ketones, or multimeric units of such compounds. The general formula of a carbohydrate is $(\text{CH}_2\text{O})_n$.

Carbonic acid: H_2CO_3 .

Carcinogen: cancer-causing agent.

Carcinoid syndrome: syndrome produced by metastatic carcinoid tumors that secrete excessive amounts of serotonin.

Cardiac catheterization: invasive technique where a catheter is placed into a peripheral vessel and advanced into the heart.

Cardiac glycosides: drugs used to increase the contractility of the heart and slow the conduction impulses (e.g., digoxin).

Cardiac markers: diagnostic test or analyte used to assess cardiac function.

Cardiac radiology: use of x-rays to assess heart size and position, etc.

Cardiomyopathy: disease of the myocardium.

Cardiovascular nuclear imaging: technique using radionuclides to assess cardiovascular performance and perfusion of the myocardium and viability of the cardiac muscle.

Catabolism: the breaking down in the body of complex chemical compounds into simpler ones (e.g., glycogen to CO_2 and H_2O), often accompanied by the liberation of energy.

Cation: a positively charged ion; cations migrate in the direction of the cathode because of their positive charge.

CCK: see Cholecystokinin.

Centrifugal analysis: analytic technique that uses the force generated by centrifugation to transfer and then contain liquids in separate cuvettes for measurement at the perimeter of a spinning rotor.

Centrifugation: a process whereby centrifugal force is used to separate solid matter from a liquid suspension.

Cephalic vein: arises at the radial border of the dorsal venous rate of the hand, passes upward in front of the elbow and along the lateral side of the arm; it empties into the upper part of the axillary vein.

Cerebrospinal fluid (CSF): a selective ultrafiltrate of the plasma that surrounds the brain and spinal cord.

Ceruloplasmin: an α_2 -glycoprotein to which copper is attached; more than 90%–95% of the circulating copper in the plasma is bound to ceruloplasmin.

Chain-of-custody: records each step and each person who handled a sample (for toxicologic analysis) from time of collection to time of analysis.

Channel: on an automated analyzer, a path or passage for reagents, specimens, or electrical impulses. Automated analyzers may be single or multiple channel analyzers.

Character: the number to the left of the decimal point in a logarithmic expression.

Chelator: causing the joining of an ion (e.g., metal) and a ring structured chemical.

- Chemical hygiene:** procedures and work practices for regulating exposure of laboratory personnel to hazardous chemicals.
- Chemical toxin:** a substance that is a poison.
- Chemiluminescence:** light produced as a result of a chemical reaction. Most important chemiluminescence reactions are oxidation reactions of luminol, acridinium esters, and dioxetanes and are characterized by a rapid increase in intensity of emitted light followed by a gradual decay.
- Cholecystokinin:** CCK, formerly called pancreozymin; a hormone produced by the pancreas. CCK, in the presence of fats and/or amino acids in the duodenum, is produced by the cells of the intestinal mucosa and responsible for the release of enzymes from the acinar cells by the pancreas into the pancreatic juice.
- Cholesterol:** an unsaturated steroid alcohol of high molecular weight, consisting of a perhydrocyclopentanoline ring and a side chain of eight carbon atoms. In its esterified form, it contains one fatty acid molecule.
- Chronic kidney disease:** clinical syndrome that occurs when there is a gradual decline in renal function over time; classified into 5 stages.
- Chronic renal failure:** a clinical syndrome that occurs when there is a gradual decline in renal operation over time.
- Chronic thyroiditis:** thyroiditis with round cell (usually lymphocytes) infiltration, destruction of thyroid cells, epithelial giant cell proliferation, and evidence of regeneration; thought by some to be a reflection of a systemic infection and not an example of true chronic thyroiditis.
- Chylomicrons:** large triglyceride-rich particles.
- Cirrhosis:** derived from the Greek word that means “yellow.” However, in current use, cirrhosis refers to the irreversible scarring process by which normal liver architecture is transformed into abnormal nodular architecture.
- CK isoforms:** produced as a part of the normal clearance mechanism for CK isoenzymes and are present in all sera.
- CK-MB:** isoenzyme used to detect myocardial infarction because of its relatively high specificity for myocardial damage. CK-MB rises within 4–6 hours after the onset of chest pain, peaks at 12–24 hours, and returns to normal levels within 2–3 days.
- Clearance:** volume of plasma filtered by glomeruli per unit time.
- Clinical Laboratory Improvement Amendments (CLIA):** regulations signed into federal law in 1988; mandate standards in clinical laboratory operations and testing.
- Closed collection system:** a type of collection system in which blood is taken directly from a patient’s vein into a stoppered tube; the sample is completely contained, thereby reducing the risk of outside contaminants to the sample and reducing the hazard of the collector’s exposure to the blood; also known as the evacuated-tube system.
- Closed tube sampling:** an instrument’s ability to remove the patient’s sample for analysis from the primary collection tube by piercing through the stopper.
- Clot activators:** coagulation factors such as thrombin and substances such as glass (silica) particles and inert clays like diatomite (Celite) that enhance clotting by providing more surface for platelet activation.
- CLSI:** Clinical Laboratory Standards Institute (formerly NCCLS).
- Coarctation of aorta:** narrowing of the aorta at the insertion of the ductus arteriosus.
- Coenzyme:** an enzyme activator (e.g., coenzyme A).
- Cofactor:** a nonprotein molecule that may be necessary for enzyme activity.
- Colligative property:** the properties of osmotic pressure, freezing point, boiling point, and vapor pressure.
- Common variable agammaglobulinemia:** also known as acquired agammaglobulinemia. This disorder represents a group of disorders characterized by hypogammaglobulinemia.
- Compensation:** the body’s attempt to return the pH toward normal whenever an imbalance occurs.
- Competitive immunoassay:** see Competitive protein binding.
- Competitive protein binding:** (also competitive immunoassay.) Labeled and unlabeled antigens compete for limited antibody sites. Labeled antigen bound to antibody will be inversely proportional to the concentration of antigen.
- Conductivity:** relates to the ease in which electricity passes through a solution.
- Congenital adrenal hyperplasia (CAH):** results from the lack of an enzyme necessary for the production of cortisol.
- Congenital agammaglobulinemia:** X-linked agammaglobulinemia, also called Bruton disease. This disorder presents with early onset of recurrent pyogenic infections. These patients have no circulating B cells, low concentrations of all circulating immunoglobulin classes, and absence of plasma cells in all lymphoid tissue. T cells are not involved.
- Congestive heart disease:** (also congestive heart failure) results from an inability of the heart to pump blood effectively.
- Congestive heart failure (CHF):** clinical syndrome that results from any structural or functional cardiac disorder that impairs the ability of the ventricle to fill with or eject blood.
- Conjugated bilirubin:** bilirubin diglucuronide; it is water soluble and is secreted from the hepatic cell into the bile canaliculi and then passes along with the rest of the bile into larger bile ducts and eventually into the intestines.
- Conjugated protein:** composed of a protein (amino acids) and a nonprotein moiety.
- Conn’s syndrome:** aldosterone-secreting adrenal adenoma.
- Constant error:** type of systemic error in the sample direction and magnitude; the magnitude of change is constant and not dependent on amount of analyte.
- Continuous flow:** an approach to automated analysis in which liquids (reagents, diluents, and samples) are pumped through a system of continuous tubing. Samples are introduced in a sequential manner, following each other through the same network. A series of air bubbles at regular intervals serve as separating and cleaning media.
- Control:** a substance or material of determined value, used to monitor the accuracy and precision of a test. Controls are run with the patient’s specimens.
- Control rule:** criterion for judging whether an analytic process is out of control; error detection criteria.
- Corpus albicans:** fibrous tissue that replaces a degenerating corpus luteum.
- Corpus luteum:** small body that develops within a ruptured ovarian follicle; secretes progesterone.

Corrosive chemical: chemicals injurious to the skin or eyes by direct contact or to the tissues of the respiratory and gastrointestinal tracts if inhaled or ingested. Examples include acids (acetic, sulfuric, nitric, and hydrochloric) and bases (ammonium hydroxide, potassium hydroxide, and sodium hydroxide).

Cortical bone: type of bone that is very strong in the axial and cross-sectional dimensions, very well suited to the needs of the long bones.

Corticotropin-releasing hormone (CRH): a hormone released from the hypothalamus that acts on the anterior pituitary to increase ACTH secretion.

Cortisol: a steroid hormone produced by the adrenal glands.

Countercurrent multiplier system: process occurring in the loop of Henle whereby a high osmolality is maintained within the kidney and a hypo-osmolal urine is produced.

Counterimmunoelectrophoresis (CIE): immunoelectrophoresis in which antigen is placed in wells cut in the sheet of agar gel toward the cathode, and antiserum is placed in wells toward the anode; antigen and antibody, moving in opposite directions, form precipitates in the area between the cells where they meet in concentrations of optimal proportions.

Coupled enzymatic method: use of several sequential enzymatic reactions that produce a product that can be detected spectrophotometrically and whose concentration will be related to the analyte in question.

Creatine: compound found in muscle synthesized from several amino acids. It combines with high-energy phosphate to form creatine phosphate, which functions as an energy compound in muscle.

Creatine kinase (CK): an enzyme catalyzing the reversible transfer of phosphate from phosphocreatine to ADP, forming creatine and ATP; of importance in muscle contraction. Certain isozymes are elevated in plasma following myocardial infarctions.

Creatinine: compound formed when creatine or creatine phosphate spontaneously loses water or phosphoric acid. It is excreted into the plasma at a relatively constant rate in a given individual and excreted in the urine.

Creatinine clearance: rate of removal of creatinine from plasma. Calculated as urine creatinine concentration times 24-hour urine volume divided by serum creatinine concentration or UV/P, expressed in mL/minute. Usually corrected to normal body surface area.

CRH: see Corticotropin-releasing hormone.

Cross-reactivity: capability of an antibody to react with an antigen that is structurally similar to the homologous antigen.

Cryogenic material: material brought to low temperatures, such as liquefied gases.

CSF: see Cerebrospinal fluid.

Cushing's syndrome: syndrome resulting from excessive production of glucocorticoids by adrenal cortex.

Cyclosporine: a cyclic polypeptide of fungal origin. It consists of 11 amino acids and has a molecular weight of 1203. It inhibits the immune response selectively by inhibiting the interleukin-2-dependent proliferation of activated T cells that destroy the allograft. The immune response is frozen and unresponsive.

Cystatin C: a low-molecular-weight protein produced by nucleated cells. It is freely filtered by the glomerulus, reabsorbed, and catabolized by the proximal tubule. Produced at a constant rate, levels remain stable if kidney function is normal.

Cytochrome: a pigment that plays a role in respiration, such as hemoglobin or myoglobin.

Cytokines: extracellular factors produced by a variety of cells including monocytes, lymphocytes and other nonlymphoid cells. They are important in controlling local and systemic inflammatory responses.

D

D-dimer: a covalently cross-linked degradation product released from the cross-linked fibrin polymer during plasmin-mediated fibrinolysis. Laboratory measurements of this product are made using latex bead assay, or enzyme-linked immunosorbent assay can be used to identify the presence of fibrinolysis; helpful in diagnosis of deep vein thrombosis.

Dehydroepiandrosterone (DHEA): an androgen primarily derived from the adrenal gland.

Deionized water: water purified by ion exchange.

Deliquescent substances: compounds that absorb enough water from the atmosphere to cause dissolution.

Delta absorbance: difference in absorbance, known as delta absorbance or ΔA .

Delta check: an algorithm in which the most recent result of a patient is compared with the previously determined value.

Denaturation: alteration of a substance (e.g., proteins) to alter physical and chemical properties.

Density: weight of a substance compared with a standard; expressed in terms of mass per unit volume.

Deoxyribonucleic acid (DNA): the type of nucleic acid containing deoxyribose as the sugar component and found principally in the nuclei (chromatin, chromosomes) and mitochondria of animal and plant cells, usually loosely bound to protein (hence the term deoxyribonucleoprotein); considered to be the autoreproducing component of chromosomes and of many viruses, and the repository of hereditary characteristics. Its linear macromolecular chain consists of deoxyribose molecules esterified with phosphate groups between the 3'- and 5'-hydroxyl groups; linked to this structure are the purines adenine (A) and guanine (G) and the pyrimidines cytosine (C) and thymine (T). DNA may be open ended or circular, single or double stranded, and many forms are known, the most commonly described of which is double stranded, wherein the pyrimidines and purines cross-link through hydrogen bonding in the schema A-T and C-G, bringing two antiparallel strands into a double helix. Chromosomes are composed of double-stranded DNA; mitochondrial DNA is circular.

Descriptive statistics: statistics or values (e.g., mean, median, mode) used to summarize the important features of a group of data.

Desiccant: causing dryness; materials that can remove moisture from the air as well as from other materials.

Desiccator: a closed chamber for drying substances.

Development: the act or process of natural progression in physical and psychological maturation from a previous, lower, or embryonic stage to a later, more complex, or adult stage.

DHEA: see Dehydroepiandrosterone.

Diabetes mellitus: a diverse group of hyperglycemic disorders with different etiologies and clinical pictures.

Dialysis: a method for separating macromolecules from a solvent; method of artificial kidney function.

Diffusion: the random movement of molecules or ions or small particles in solution or suspension toward a uniform distribution throughout the available volume; as in gel diffusion precipitation.

Dilution: a dilution represents the ratio of concentrated or stock material to the total final volume of a solution and consists of the volume or weight of the concentrate plus the volume of the diluent (the concentration units remaining the same).

Dilution factor: ratio of concentrated or stock solution to the total solution volume.

Direct effector: hormone that acts directly on peripheral tissues.

Direct immunofluorescence: detection of antigens with fluorescent-labeled antibody.

Disaccharide: separate carbohydrates, or monosaccharides joined together.

Discrete analysis: an approach to automated analysis in which each sample and accompanying reagents is in a separate container. Discrete analyzers have the capability of running multiple tests one sample at a time or multiple samples one test at a time.

Dispersion: the spread of data; most simply estimated by the range, the difference between the largest and smallest observations. The most commonly used statistic for describing the dispersion of groups of single observations is the standard deviation, which is usually represented by the symbol s .

Distal tubule: portion of renal tubule extending from ascending limb of loop of Henle to the collecting duct.

Distilled water: water solely purified by distillation results.

Diuretics: agents that increase the secretion of urine.

DMAIC (define, measure, analyze, improve, and control): improvement methodology. DMAIC's five phases ensure sound problem solving and root cause analysis. Each DMAIC phase has one or two key objectives and corresponding tasks to be completed (also known as deliverables), as well as clearly identified steps to be taken using specific tools and techniques.

DNA index (DI): ploidy status of malignancies; the amount of measured DNA in cancer cells relative to that in normal cells.

DNA probe: a known fragment of DNA molecule used to join with or locate an unknown or comparable DNA strand. Human papilloma virus DNA has been detected using DNA probes.

Done nomogram: a chart that approximates drug toxicity, given the time of ingestion and blood drug level.

Dopamine: the only neuroendocrine signal that inhibits prolactin.

Dose-response relationship: comparison of the dose of a substance (i.e., drug or chemical) with its potential pathologic effects. Dose-response relationship implies that there will be an increase in toxic response with an increased dose.

Drug absorption: uptake of a drug in the gastrointestinal tract into the body.

Drug disposition: the way in which the body handles a foreign compound, the drug. The mechanisms used by the body to handle a drug can be explained in terms of four general processes: absorption, distribution, metabolism, and excretion.

Drug distribution: the circulation and diffusion of a drug into the interstitial and intracellular spaces.

Drug elimination: clearance of a drug from the body by a variety of mechanisms.

Drug metabolism: process of breakdown of a drug that is dependent on the following factors: absorption, circulation and distribution, and metabolism and clearance.

Drugs of abuse: drugs used illegally or inappropriately; many drugs have the potential for abuse.

Dry chemistry slide: a multilayered film technology (dry chemicals) used by the Vitros series of automated analyzers. All reagents necessary for a particular test are contained on the "slide."

Dual-energy x-ray absorptiometry (DEXA): x-ray procedure that measures bone mineral density by measuring grams of calcium per square centimeter of cross-sectional area of bone (g/cm^2).

Duplex: a hybrid formed from complementary strands of nucleic acid from unrelated sources bound together.

Dyslipidemias: diseases associated with abnormal lipid concentrations.

E

ECG: see Electrocardiography.

Echocardiography: noninvasive diagnostic technique that uses high-frequency sound waves to show the heart structure on a CRT screen.

Ectopic: in an abnormal position or location.

Ectopic hormone production: hormones produced by cells in sites other than the gland from which they are usually derived.

Edema: an accumulation of an excessive amount of watery fluid in cells, tissues, or serous cavities.

EDTA: ethylenediaminetetraacetic acid; anticoagulant used in lavender and royal blue stopper blood collection tubes. Commonly used for whole blood hematology studies.

Effusion: abnormal accumulations of pleural or pericardial fluid.

Electrocardiography (ECG): test used to evaluate the electrical stimulation of the heart.

Electrochemistry: the use of galvanic and electrolytic cells (electrochemical cells) for chemical analysis. Examples include potentiometry, amperometry, coulometry, and polarography.

Electrodes: electronic sensing devices to measure PO_2 , PCO_2 , and pH.

Electrolyte: ions capable of carrying an electric charge.

Electrophoresis: migration of charged solutes or particles in an electrical field.

Emden-Myerhof pathway: series of steps involving the anaerobic metabolism of glucose, glycogen or starch to lactic acid; principal means of producing energy in man.

Encephalopathy: disorder or dysfunction of brain.

Endocrine gland: a ductless gland that produces a secretion (hormone) into the blood or lymph to be carried by the circulation to other parts of the body.

- Endocrine systems:** four major systems that have critical roles in normal human development. These systems all involve the hypothalamus as a major higher brain control center, the pituitary gland as a major secretor of hormones, and then various end organs, which have responsive elements for the pituitary hormone and affect many metabolic and developmental functions. These end organs include the thyroid gland, adrenal cortex, liver, and gonads.
- Endogenous:** triglycerides synthesized in liver and other tissues.
- Enteral feeding:** taking nutrients via the digestive tract; by mouth.
- Enzyme:** specific biologically synthesized proteins that catalyze biochemical reactions without altering the equilibrium point of the reaction or being consumed or undergoing changes in composition.
- Enzyme-substrate complex:** a physical binding of a substrate to the active site of an enzyme.
- Epinephrine:** an amine hormone. The adrenal medulla primarily produces epinephrine.
- Epitope:** component of an antigen that functions as an antigenic determinant, allowing the attachment of certain antibodies.
- Equivalent weight:** equal to the molecular weight of a substance divided by its valence.
- Erectile dysfunction:** inability to have or maintain an erection.
- Erlenmeyer flask:** a glass container with a flat base and a funnel-shaped body, the top of which forms the pour spout, usually with a wide opening.
- Erythropoietin:** a hormone that stimulates red blood cell production.
- Essential element:** an element that is absolutely necessary for life. Deficiency or absence of the element will cause a severe alteration of function and/or eventually lead to death.
- Essential hypertension:** hypertension with no known cause.
- Essential nutrients:** nutritional substances required for optimal health. These must be in the diet, because they are not formed metabolically within the body.
- Estimated glomerular filtration rate (EGFR):** equation used to predict the glomerular filtration rate and is based on serum creatinine, age, body size, gender and race, without the need of a urine creatinine.
- Estriol:** an estrogenic hormone; estriol is not produced in significant quantities in the mother and is solely a reflection of fetoplacental function. Thus estriol measurement provides valuable information about fetal well-being.
- Estrogen:** any of the group of substances (hormones) that induces estrogenic activity; specifically the estrogenic hormones, estradiol and estrone, produced by the ovary.
- Estrone:** an estrogenic hormone found in the urine of pregnant women.
- Evacuated tube:** sample collection tube with a vacuum.
- Exocrine gland:** any gland that excretes externally through a duct. Secretions of exocrine glands do not directly enter the circulation.
- Exogenous:** triglycerides obtained from dietary sources.
- Extracellular fluid:** water (fluid) outside the cell; can be subdivided into the intravascular extracellular fluid (plasma) and the interstitial cell fluid (ISCF) that surrounds the cells in the tissues.
- Extrauterine:** outside the uterus or womb.
- Exudate:** accumulation of fluid in a cavity; also the production of pus or serum. In comparison with a transudate, an exudate contains more cells and protein. Exudates demand immediate attention.
- F**
- Fasting specimens:** a blood specimen taken after the patient has not eaten for at least 12 hours.
- Fatty acids:** major constituents of triglycerides and phospholipids. There are short-chain (4–6 carbon atoms), medium-chain (8–12 carbon atoms), and long-chain fatty acids (>12 carbon atoms).
- Feedback loops:** a control system of a physiologic function that allows for feedback and correction based on conditions or circulating levels of a hormone or substance.
- Ferritin:** a spherical protein shell composed of 24 subunits with a molecular mass of 500 kD. The protein can bind up to 4,000 iron molecules, making it a large potential source of iron.
- Fibrinogen:** a globulin of the blood plasma that is converted into fibrin by the action of thrombin in the presence of ionized calcium to produce coagulation of the blood; the only coagulable protein in the blood plasma of vertebrates; absent in afibrinogenemia and defective in dysfibrinogenemia.
- Filtrate:** liquid that passes through filter paper is called the filtrate.
- Filtration:** separation of solids from liquids.
- FI_O₂:** the fraction of inspired oxygen; can be as much as 100% when oxygen is being supplied.
- Fire tetrahedron:** a three-dimensional pyramid representing the element of fire; previously the fire triangle.
- First-order kinetics:** point in enzyme reaction in which the rate of the reaction is dependent on enzyme concentration only.
- Fisher projection:** diagrammatic model that can be used to represent carbohydrates. The Fisher projection of a carbohydrate has the aldehyde or ketone at the top of the drawing. The carbons are numbered starting at the aldehyde or ketone end, and the compound can be represented either as a straight chain or in a cyclic, hemiacetal form.
- Flag:** on automated analyzers, a computerized printed warning of an error or instrument problem.
- Flame photometry:** analytic technique that measures the wavelength and intensity of light emitted from a burning solution (patient specimen).
- Flow cytometry:** the use of immunofluorescent labels to identify specific antigens on live cells in suspension. Stained cell suspensions are transported under pressure past a laser beam, and emitted fluorescence (at 90 degrees relative to the beam) is measured and computer analyzed with this technique. Using multiple labels, cells can be identified and sorted either electronically or physically. The technique has been used to analyze a subpopulation of lymphocyte cells in various clinical diagnoses.
- Fluorescence polarization immunoassay (FPIA):** a technique in which a fluorescein-labeled antigen rotates rapidly in solution and, when excited, does not emit polarized light. After binding to antibody the label rotates much slower and emits polarized light. When polarized light is used as a source of excitation, emitted fluorescence is measured in two planes. The difference in fluorescence polarization

(calculated) before and after the addition of labeled analyte is inversely proportional to the concentration of unknown analyte. This methodology is most useful for small antigens (drugs, hormones, etc.).

Fluorescence resonance energy transfer (FRET): the nonradioactive transfer of energy from a donor molecule to an acceptor molecule.

Fluorometry: analytic technique used to measure fluorescence (light emitted as a result of energy absorbed).

Follicle-stimulating hormone (FSH): a protein hormone secreted by the anterior pituitary.

Follicular cells: (or cuboidal) one of two types of cells of the thyroid; they are secretory cells and produce thyroxine (T_4) and triiodothyronine (T_3).

Follicular phase: the first half of the menstrual cycle, when estrogen effect is unopposed by progesterone, also called the proliferative phase.

Forensic: pertaining to the law or legal matters (e.g., toxicology and the law).

Forensic medicine: medical knowledge or results that apply to questions of law affecting life or property. A specimen result might be used as evidence in a court of law to prove cause of death, an accused individual's innocence or guilt, or possibly alcohol or drug abuse.

FPIA: see fluorescence polarization immunoassay.

Fractional oxyhemoglobin (FO_2Hb): is the ratio of the concentration of oxyhemoglobin to the concentration of total hemoglobin (ctHb).

Free radical: a highly reactive molecule containing an open bond or half a bond; free radicals are harmful to the body (e.g., OH).

Free thyroxine index (FT_4I): an indirect measure of free hormone concentration and is based on the equilibrium relationship of bound T_4 and FT_4 . The FT_4I is calculated by the following formula: $FT_4I = T_4 \cdot T_3U$ ratio.

Friedewald calculation: calculation used to estimate LDL cholesterol in routine clinical practice.

Fructosamine: any glycated serum protein.

FSH: see Follicle-stimulating hormone.

F-test: statistical test used to compare the features of two or more groups of data.

G

Gas chromatography: analytic technique used to separate mixtures of compounds that are volatile or can be made volatile. Gas chromatography may be gas-solid chromatography (GSC), with a solid stationary phase, or gas-liquid chromatography (GLC), with a nonvolatile liquid stationary phase.

Gastrin: a gastrointestinal hormone. It is a peptide secreted by the G cells of the antrum (lower third) of the stomach. It is released in response to contact of food.

Genetic disease: illness caused by abnormalities in genes or chromosomes.

Geriatrics: branch of general medicine dealing with remedial and preventable clinical problems in the elderly, as well as the social consequences of such illness.

Gerontology: study of the aging process in the human body.

GFR: see Glomerular filtration rate.

GH: see Growth hormone.

Globulins: heterogeneous group of proteins that can be separated by electrophoresis into α_1 , α_2 , and γ fractions.

Glomerular filtrate: plasma filtrate containing water and small molecules but lacking cells and large molecules such as most proteins.

Glomerular filtration rate (GFR): rate at which plasma is filtered by glomerulus, expressed in mL/minute.

Glomerulonephritis: inflammation of the glomeruli of the kidney. May be acute, subacute, or chronic.

Glomerulus: small blood vessels in the nephron that project into the capsular end of the proximal tubule and serve as a filtering mechanism.

Glucagon: a protein hormone that is involved in the regulation of carbohydrate, fat, and protein metabolism. It is synthesized by the α cells of the pancreatic islet and is composed of 29 amino acids.

Glucocorticoid: a general classification of hormones synthesized in the zona fasciculata of the adrenal cortex. Cortisol is the principal glucocorticoid hormone.

Gluconeogenesis: the conversion of amino acids by the liver and other specialized tissues, such as the kidney, to substrates that can be converted to glucose. Gluconeogenesis also encompasses the conversion of glycerol, lactate, and pyruvate to glucose.

Glycogen: a polysaccharide similar to starch; form in which carbohydrates are stored.

Glycogenolysis: process by which glycogen is converted back to glucose 6-phosphate for entry into the glycolytic pathway.

Glycolysis: hydrolysis of glucose by an enzyme into pyruvate or lactate; the process is anaerobic.

Glycolytic inhibitor: a substance that prevents the hydrolysis of sugar. Sodium fluoride is a glycolytic inhibitor.

Glycosylated hemoglobin: a hemoglobin compound formed when glucose reacts with the amino group of hemoglobin (HbA_{1c}).

Gonadotropin-releasing hormone (GnRH): a hypothalamic substance causing the release of gonadotropin.

Gout: arthritis associated with increased levels of uric acid in the blood, which then become deposited in the joints or tissues causing painful swelling. It is more common in men than in women.

Graafian follicle: a follicle in which the oocyte attains its full size and is surrounded by an extracellular glycoprotein layer (zona pellucida) that separates it from a peripheral layer of follicular cells permeated by one or more fluid-filled antra; the theca of the follicle develops into internal and external layers.

Graduated cylinder: long, cylindrical tubes usually held upright by an octagonal or circular base. The cylinder has calibration marks along its length and is used to measure volumes of liquids. Graduated cylinders do not have the accuracy of volumetric glassware.

Graft: tissue that is transplanted.

Graves' disease: diffuse toxic goiter. Graves' disease occurs six times more commonly in women than in men. It occurs frequently at puberty, during pregnancy, at menopause, or following severe stress.

Griffin beakers: beaker designed to hold different volumes rather than one exact amount; has a flat bottom, straight sides, and an opening as wide as the flat base, with a small spout in the lip.

Growth hormone (GH): a peptide composed of 191 amino acids. In contrast to most of the other protein hormones, GH does not act through cAMP. Binding of GH to its membrane receptor leads to glucose uptake, amino acid transport, and lipolysis. Secreted by the anterior pituitary.

Growth hormone-releasing hormone (GHRH): a decapeptide released by the hypothalamus, which induces the release of human growth hormone (somatotropin).

Gynecomastia: abnormally large mammary gland development in the male.

H

Half-life: time needed for 50% of a radionuclide to decay and become more stable.

Hapten: a substance that can bind with an antibody but cannot initiate an immune response unless bound to a carrier.

Hashimoto's disease: chronic autoimmune thyroiditis; it is the most common cause of primary hypothyroidism.

Haworth projection: represents glucose in a cyclic form that is more representative of the actual structure. When glucose is drawn in a Haworth projection, the form of D-glucopyranose is represented by the hydroxy group of carbon-1 oriented downward or below the plane of the paper.

Hazard communication: based on the fact that all employees must be informed of any health risks involving the use of chemicals; from the Hazardous Communication Standard of 1987 (Right to Know Law).

Hazardous material: a material that may potentially cause personal injury or damage if handled.

Hazardous waste: any potentially dangerous waste material.

HbA_{1c}: see Hemoglobin A_{1c}.

hCG: see Human chorionic gonadotropin.

HDL: see High-density lipoproteins.

Headache (HA): pain in various parts of the head, not confined to the area of distribution of any nerve.

Heart fatty acid-binding protein: a fatty acid-binding protein that participates in the intracellular movement of fatty acids in the heart.

Hematoma: a localized mass of extravasated blood that is relatively or completely confined within an organ or tissue, a space, or a potential space; the blood is usually clotted, and, depending on how long it has been there, may manifest various degrees of organization and decolorization.

Hemoconcentration: decrease in the volume of plasma in relation to the number of red blood cells; increase in the concentration of red blood cells in the circulating blood.

Hemodialysis: a technique or procedure that provides the function of the kidneys when one or both are damaged. The patient's blood is circulated through membranes to remove wastes.

Hemofiltration: an ultrafiltration procedure or technique (similar to hemodialysis) used to remove an excess accumulation of normal metabolic products from the blood.

Hemoglobin A_{1c} (HbA_{1c}): largest subfraction of normal HbA in both diabetic and nondiabetic subjects. It is formed by the reaction of the β chain of HbA with glucose. It reflects the concentration of glucose present in the body over a prolonged time period related to the 60-day half-life of erythrocytes.

Hemoglobinopathy: a disorder associated with the presence of an abnormal hemoglobin.

Hemoglobin-oxygen (binding) capacity: the maximum amount of oxygen that can be carried by hemoglobin in a given quantity of blood.

Hemoglobin-oxygen dissociation curve: a graphic representation ("S"-shaped) of oxygen content as percent oxygen saturation against PO₂; based on the principle that oxygen dissociates from adult hemoglobin in a characteristic fashion.

Hemolysis: damage to erythrocyte membranes, causing release of cellular constituents (e.g., hemoglobin) into the blood plasma or serum.

Henderson-Hasselbalch equation: equation that mathematically describes the dissociation characteristics of weak acids and bases and the effect on pH; $\text{pH} = \text{pK}_a (6.1) + \log$ of the ratio of bicarbonate to carbon dioxide ($\text{HCO}_3/\text{H}_2\text{CO}_3$).

HEPA filter: high-efficiency particulate air filter; a respirator.

Heparin: an anticoagulant used in blood collection.

Hepatitis: "inflammation of the liver"; may be caused by a virus, bacteria, parasites, radiation, drugs, chemicals, or toxins. Among the viruses causing hepatitis are hepatitis types A, B, C, D (or delta), and E, cytomegalovirus, Epstein-Barr virus, and probably several others.

Hepatoma: primary malignant tumors of the liver; also known as hepatocellular carcinoma or hepatocarcinoma.

Heterogeneous assay: a technique (e.g., radioimmunoassay) where it is necessary to physically separate labeled antigen or hapten bound to antibody from a labeled antigen or hapten that remains free in solution.

Heterogeneous immunoassays: immunoassays that require an extra step to remove unbound antibody or antigen from the site, usually using a solid phase reagent. Heterogeneous immunoassays can be competitive or non-competitive.

High-density lipoproteins (HDL): a "clean-up crew" that gathers up extra cholesterol for transport back to the liver.

Highly complex testing: methods that are either modified from the manufacturer's instructions or developed within the individual laboratory or may require significant operator skill and decision making.

Hirsutism: presence of excessive bodily and facial hair, in a male pattern, especially in women; may be present in normal adults as an expression of an ethnic characteristic or may develop in children or adults as the result of androgen excess due to tumors or drugs.

Histogram: graphic representation of data where the number or frequency of each result is placed on the y axis and the value of the result is plotted on the x axis.

Holoenzyme: enzyme consisting of a protein portion and a non-amino acid portion or prosthetic group.

Homeostasis: state of equilibrium in the body maintained by dynamic processes.

Homogeneous assay: a technique (e.g., EMIT) that does not require the physical separation of the bound and free labeled antigen.

Hormone: a chemical substance that is produced and secreted into the blood by an organ or tissue and has a specific effect on a target tissue.

HPL: see Human placental lactogen.

HPTA: see Hypothalamic-pituitary-thyroid axis.

- hsCRP (high-sensitivity C-reactive protein):** acute-phase protein produced by the liver in response to injury, infection, inflammation; highly predictive value for coronary artery disease.
- Human chorionic gonadotropin (hCG):** a protein hormone produced by the placenta and consisting of α and β subunits.
- Human placental lactogen (HPL):** a protein hormone that is structurally, immunologically, and functionally very similar to growth hormone and prolactin. Like hCG, it is produced by the placenta and can be measured in maternal urine and serum as well as amniotic fluid.
- Hybridization:** the production of hybrids.
- Hydrate:** compound and its associated water.
- Hydrolase:** an enzyme that catalyzes hydrolysis of ether, ester, acid–anhydride, glycosyl, C–C, C–halide, or P–N bonds.
- Hygroscopic:** substances that take up water on exposure to atmospheric conditions.
- Hyperaldosteronism:** excessive production of aldosterone by the adrenal gland. It may be primary (due to an adrenal lesion) or secondary to abnormalities in the renin-angiotensin system.
- Hyperandrogenemia:** excessive production of androgens in women.
- Hypercalcemia:** elevated levels of calcium in the blood.
- Hypercarbia:** abnormally increased arterial carbon dioxide tension.
- Hyperchloremia:** elevated levels of chloride in the blood.
- Hypercoagulability:** increased ability (i.e., of blood) to coagulate.
- Hypercortisolism:** increased levels of cortisol.
- Hyperglucagonemia:** excessive production of glucagon. Hyperglucagonemia due to tumors must be differentiated from other causes of increased glucagon, which include diabetes, pancreatitis, and trauma.
- Hyperglycemic:** increased level of blood sugar.
- Hyperinsulinemia:** excessive and/or inappropriate release of insulin.
- Hyperkalemia:** elevated levels of potassium in the blood.
- Hypermagnesemia:** elevated levels of magnesium in the blood.
- Hypernatremia:** elevated levels of sodium in the blood.
- Hyperoxemia:** increased oxygen in the blood.
- Hyperparathyroidism:** condition resulting from the increased activity of the parathyroid glands.
- Hyperphosphatemia:** elevated levels of phosphorus in the blood.
- Hyperprolactinemia:** excess secretion of prolactin due to hypothalamic-pituitary dysfunction. Generally due to a pituitary neoplasm.
- Hyperproteinemia:** total protein level in the blood that is higher than the reference interval.
- Hypertension:** abnormally elevated blood pressure.
- Hyperthyroidism:** excessive secretion of the thyroid glands.
- Hyperuricemia:** plasma levels of uric acid greater than 7.0 mg/dL in males and 6.0 mg/dL in females.
- Hypervitaminosis:** a condition that results from excessive intake of a vitamin(s).
- Hypoaldosteronism:** decreased level of aldosterone.
- Hypocalcemia:** decreased levels of calcium.
- Hypocarbia:** abnormally decreased arterial carbon dioxide tension.
- Hypochloremia:** an abnormally low level of chloride ions in the circulating blood.
- Hypocortisolism:** low or decreased levels of cortisol.
- Hypoglycemic:** decreased blood glucose levels.
- Hypoglycorrhachia:** depressed concentration of glucose in the cerebrospinal fluid; a characteristic of bacterial, fungal, and tuberculous meningitis.
- Hypogonadism:** aberrant internal secretion of the gonads.
- Hypoinsulinemia:** decreased level of insulin.
- Hypokalemia:** decreased levels of potassium.
- Hypomagnesemia:** decreased levels of magnesium in the blood.
- Hyponatremia:** decreased levels of sodium in the blood.
- Hypoparathyroidism:** most often due to destruction of the adrenal glands and, as such, is associated with glucocorticoid deficiency.
- Hypophosphatemia:** decreased levels of phosphorus in the blood.
- Hypoproteinemia:** total protein level in the blood that is below the reference interval.
- Hypothalamic-pituitary–thyroid axis (HPTA):** the neuroendocrine system that regulates the production and secretion of thyroid hormones.
- Hypothalamus:** the portion of the brain located in the walls and floor of the third ventricle. It is directly above the pituitary gland and is connected to the posterior pituitary by the pituitary stalk.
- Hypothyroidism:** decreased thyroid secretion.
- Hypouricemia:** plasma levels of uric acid less than 2.0 mg/dL.
- Hypovitaminosis:** a condition that results from a lack or deficiency of vitamins in the diet.
- Hypovolemia:** decreased blood volume.
- Hypoxemia:** insufficient or decreased oxygenation of the blood.
- Hypoxia:** physiologic condition caused by a deficiency of the amount of oxygen reaching the tissues.
- I**
- Iatrogenic:** denoting response to medical or surgical treatment, as induced by the treatment itself; usually used for unfavorable responses.
- ICF:** see Intracellular fluid.
- Icterus:** yellow pigmentation in the skin or sclera (including tissues, membranes, and secretions); also known as jaundice. A result of excess bilirubin concentration in the blood.
- Icterus index:** a test that involves diluting serum with saline until it visually matches the color of a 0.01% potassium dichromate solution. The number of times the serum must be diluted is called the icterus index.
- Immune system:** a complex series of events in the body that protect the individual from external, harmful agents. Individual survival depends on a properly functioning system.
- Immunity:** resistance to infection by a pathologic agent.
- Immunoassay:** a technique that measures the rate of immune complex formation. Immunoassays can be labeled or nonlabeled.
- Immunoblot:** a technique for analysis and identification of antigens; Western blot.
- Immunocytochemistry:** use of antibodies to detect antigens in cells.
- Immuno-electrophoresis:** a technique combining electrophoresis of proteins and immunodiffusion.
- Immunofixation:** or immunofixation electrophoresis (IFE); a technique in which an immune precipitate is trapped (fixed) on the electrophoretic support medium. This method has superseded immuno-electrophoresis because of ease and speed.

Immunohistochemistry: use of antibodies to detect antigens in tissue.

Immunophenotyping: use of flow cytometer to detect intracellular and cell surface antigens.

Immunsorbent assays: heterogeneous biochemical technique used to detect the presence of an antibody or an antigen in a sample; has an enzyme label and uses a solid phase as the separation technique.

In situ hybridization: a technique performed on cells, tissue, or chromosomes that are fixed on a microscope slide. After the DNA is heat denatured, a labeled probe is added and will hybridize the target sequence after the slide is cooled. Colorimetric or fluorescent products are generally used.

Indirect immunofluorescence: technique in which serum antibody reacts with antigen fixed on a slide and the antibody in turn reacts with conjugated antihuman globulins. If the patient serum contains antibody of interest, this will be observed under a fluorescent microscope.

Infancy: infant; period in life where child is unable to walk or feed himself or herself.

Infectious endocarditis: inflammation of the inner lining of the heart chambers and valves; caused by a number of microorganisms.

Inferential statistics: values or statistics used to compare the features of two or more groups of data.

Infertility: inability or diminished ability to produce offspring.

Infundibulum: the expanding portion of a calyx as it opens into the pelvis of the kidney.

Inhibin: a testicular hormone that inhibits luteinizing hormone.

Innate immune system: one of two functional divisions of the immune system; it is the first line of defense.

Insulin: a peptide hormone that is synthesized in the B cells of the islets of Langerhans in the pancreas.

International unit: IU, the amount of enzyme that will catalyze the reaction of 1 μ mole of substrate per minute under specified conditions of temperature, pH, substrates, and activators.

Intracellular fluid (ICF): fluid inside the cells.

Intrinsic factor: a substance normally present in gastric juice that allows absorption of vitamin B₁₂.

Inulin: an exogenous plant polysaccharide derived from artichokes and dahlias. It is completely filtered by the glomeruli and neither secreted nor reabsorbed by the tubules. It is the most accurate of all GFR assays.

Ion selective electrodes: the half-cell or electrode (indicator) that responds to a specific ion in a solution.

Ionic strength: concentration or activity of ions in a solution or buffer.

Islets of Langerhans: clusters of cells (α , β , and δ) in the pancreas; insulin is a peptide hormone that is synthesized by the β -cells of the pancreatic islets.

Isoelectric point (pI): the pH at which the molecule has no net change.

Isoenzyme: different forms of an enzyme that may originate from genetic or nongenetic causes and may be differentiated from each other based on certain physical properties, such as electrophoretic mobility, solubility, or resistance to inactivation.

Isoform: results when an enzyme is subject to posttranslational modifications. Isoenzymes and isoforms contribute to heterogeneity in properties and function of enzymes.

K

Ketone: a compound containing a carbonyl group (C=O) attached to two carbon atoms.

Kinetic assay: a type of test or procedure in which there is a reaction proceeding at a particular rate.

Kinetic Jaffe method: assay method for creatine with increase the specificity. Serum is mixed with alkaline picrate and the rate of change in absorbance is measured.

Kinetic method of measurement: quantitation by determining the rate at which a reaction occurs or a product is formed.

K_m: see Michaelis-Menten constant.

Kupffer cells: phagocytic macrophages capable of ingesting bacteria or other foreign material from the blood that flows through the sinusoids.

Kwashiorkor: acute protein calories malnutrition.

L

L/S ratio: see Lecithins/sphingomyelins ratio.

Laboratory standard: a rule or criterion related to the laboratory.

Lactate dehydrogenase flipped pattern: situation in which serum levels of LDH1 increase to a point where they are present in greater concentration than LDH2.

Lactescence: resembling milk; milky appearance.

Lactose tolerance test: an assay to determine the lactase content in the intestinal mucosa. The enzyme lactase is essential to the absorption of lactose from the intestinal tract.

Lancet: a surgical device used to puncture the skin for blood collection.

Lateral: to the side.

LDH flipped pattern: a condition involving cardiac necrosis (AMI) and intravascular hemolysis, where the serum levels of LDH-1 will increase to a point at which they are present in greater concentration than LDH-2. This flipped pattern is suggestive of AMI.

LDL: see Low-density lipoproteins.

Lecithins/sphingomyelins ratio (L/S ratio): a classic test that assesses the ratio of lecithins to sphingomyelins to determine fetal lung maturity.

Leuteinizing hormone (LH): a glycoprotein hormone secreted by the anterior pituitary.

Levey-Jennings control chart: a chart illustrating the allowable limits of error in laboratory test performance, the limits are a defined deviation from the mean of a control serum, most commonly ± 2 standard deviations.

Leydig cells: cells of the testicles that produce testosterone.

LH: see Leuteinizing hormone.

Ligase chain reaction: probe amplification technique that uses two pairs of labeled probes that are complementary for two short target DNA sequences in close proximity.

Limit of detection: Lowest amount of analyte accurately detected by a method.

Linear regression: provides objective measures of the location and dispersion for the line. Three factors are generated in a linear regression—the slope, the y-intercept, and the correlation coefficient (r).

Lipemia: the presence of an abnormally high concentration of lipids in the circulating blood.

Lipoprotein: protein bound with lipid components, i.e., cholesterol, phospholipid, and triglyceride. May be classified as very low density (VLDL), low density (LDL), and high density (HDL).

Lipoprotein(a) [Lp(a)]: LDL-like lipoprotein particles.

Liquid chromatography: separation technique in which the mobile phase is a liquid.

Lithium: an element of the alkali metal group, atomic no. 3, atomic weight 6.941. Many salts have clinical applications.

Lobule: forms the structural unit of the liver, which measures 1–2 mm in diameter, it is composed of cords of liver cells (hepatocytes) radiating from a central vein.

Loop of Henle: descending and ascending loops of the renal tubule.

Low-density lipoproteins (LDL): “empty tankers” rich in cholesterol that remain after the triglycerides have been deposited.

Lp(a): see Lipoprotein(a).

Lumen: the space in the interior of a tubular structure, such as an artery or the intestine.

Luteal phase: phase in menstrual cycle; progesterone is synthesized by the corpus luteum during this phase. Also secretory phase.

Luteinizing hormone (LH): a glycoprotein hormone that stimulates the final ripening of an ovarian follicle, its secretion of progesterone, its rupture to release the egg, and the conversion of the ruptured follicle into the corpus luteum.

M

Malnutrition: a state of decreased intake of calories or micronutrients (vitamins and trace elements) resulting in a risk of impaired physiologic function; associated with increased morbidity and mortality.

Mantissa: that portion of the logarithm to the right of the decimal point, derived from the number itself.

Marasmus: a condition caused by caloric insufficiency without protein insufficiency so that, the serum albumin level remains normal; there is considerable loss of body weight.

Mass spectrometry: analytic technique in which a sample is first volatilized and then ionized to form charged molecular ions and fragments that are separated according to their mass-to-charge (m/z) ratio; the sample is then measured by a detector, which gives the intensity of the ion current for each species.

Material safety data sheets (MSDS): a major source of safety information for employees who may use hazardous materials in their occupations.

Mechanical hazard: any potential danger from equipment such as centrifuges, autoclaves, and homogenizers.

Medial: in the middle.

Median cubital vein: passes across the anterior aspect of the elbow from the cephalic vein to the basilic vein; commonly this vein is replaced by intermediate basilic and intermediate cephalic veins. The median cubital vein is often used for venipuncture.

Medical waste: material that is infectious or physically dangerous; includes discarded blood, tissues, fluids, body parts, sharps, etc.

Megavitamin: intake of a vitamin or vitamins in extreme excess of daily requirements.

MEN: see Multiple endocrine neoplasia.

Menopause: the permanent cessation of menstrual activity.

Messenger RNA (mRNA): the RNA reflecting the exact nucleoside sequence of the genetically active DNA and carrying the “message” of the latter, coded in its sequence, to the cytoplasmic areas where protein is made in amino acid sequences specified by the mRNA, and hence primarily by the DNA; viral RNA is considered to be natural messenger RNA.

Metabolic (nonrespiratory) acidosis and alkalosis: a disorder due to a change in the bicarbonate level (a renal or metabolic function).

Metabolite: any product of metabolism as in the derivative of a drug.

Metalloenzyme: trace element associated with an enzyme as an essential component or cofactor.

Metalloprotein: trace element associated with a protein as an essential component or cofactor.

Metanephrine: a metabolic product of epinephrine and norepinephrine.

Michaelis-Menten constant (K_m): Constant for a specific enzyme and substrate under defined reaction conditions and is an expression of the relationship between the velocity of an enzymatic reaction and substrate concentration.

Microalbuminuria: small quantities of albumin in the urine; microalbumin concentrations are between 20 and 300 mg/day.

Microchemistry: clinical chemistry analyses involving only several microliters of sample.

Microtubes: special small plastic tubes; often referred to as “bullets.” Most have color-coded stoppers that correspond to color-coding of ETS tubes and markings for minimum and maximum fill levels typically measured in microliters (μL).

β_2 -Microglobulin: a small, nonglycosylated peptide; used as an indicator of GFR.

Mineralocorticoid: a group of substances produced by the adrenal cortex. Aldosterone is the principal mineralocorticoid (electrolyte-regulating hormone) produced by the zona glomerulosa.

Moderately complex testing: includes about 75% of approximately 12,000 test methods. Tests are not modified from the manufacturer’s instructions, reagents are readily available, and few operator decision-making steps are required.

Modular analyzers: flexible laboratory instruments that can be expanded and modified by adding or removing components in order to meet the laboratory’s changing testing requirements.

Molality: represents the amount of solute per kilogram of solvent.

Molarity: number of moles per liter of solution.

Monoamine oxidase inhibitor (MAOI): any of several antidepressants that inhibit enzymatic breakdown of monoamine neurotransmitters of the sympathetic/adrenergic system; not used as first-line therapy because of the risk of hypertensive crisis after consumption of foods or beverages containing pressor amines, including cheese, chocolate, beer, and wine.

Monoclonal: arising from one line of cells.

Monoclonal immunoglobulin: homogeneous immunoglobulin; a protein from a single clone of plasma cells, of which all molecules are the same. A densitometric scan shows a sharp peak if the increase in immunoglobulins is a result of monoclonal increase.

Monosaccharide: a simple carbohydrate; it cannot be decomposed by hydrolysis. Examples include glucose, galactose, and fructose.

MSDS: see Material safety data sheets.

Multiple endocrine neoplasia (MEN): the occurrence of several tumors or hyperplasias involving diverse endocrine organs.

Multisample needle: a blood drawing needle used with an evacuated tube system to allow the user to collect more than one tube of blood without contaminating the tube or holder.

Myocardial infarction: also heart attack; occurs when blood flow to an area of the cardiac muscle is suddenly blocked, leading to ischemia and death of myocardial tissue.

Myocarditis: inflammation of the myocardium.

Myoglobin: myoglobin is a heme protein found only in skeletal and cardiac muscle in humans. It can reversibly bind oxygen in a manner similar to the hemoglobin molecule, but myoglobin is unable to release oxygen, except under very low oxygen tension.

Myosin heavy/light chains: myocardial proteins.

Myosin light chains (MLCs): myocardial protein used as a cardiac marker.

Myxedema: condition resulting from hypofunction of the thyroid. The term is used to describe the peculiar nonpitting swelling of the skin.

N

Nanofiltration: filtration technique for removing particulate matter, microorganisms and any pyrogens or endotoxins.

Narcotic: any group of substances (drug) that produces the opioid group of substances; encompass not only heroin, morphine, and codeine, but also several synthetic compounds such as meperidine, methadone, propoxyphene, pentazocine, and others. All have some potential for addiction.

National Fire Protection Association (NFPA) Symbol: the National Fire Protection Agency (NFPA) label displays warnings for firefighters of the location of hazardous materials in the event of a fire. It includes a diamond-shaped symbol with four quadrants that indicate the relative danger level in four different areas: health (blue), fire (red), chemical stability (yellow), and other specific hazard types.

NCCLS: National Committee for Clinical Laboratory Standards; an agency that establishes laboratory standards. (See Clinical Laboratory Improvement Amendments.)

Negligence: failure to perform duties or activities with due diligence and attention or to meet the standards of regular care.

Neonate: a newborn up to 6 weeks of age.

Neoplasm: an abnormal tissue that grows by cellular proliferation more rapidly than normal and continues to grow after the stimuli that initiated the new growth cease. Neoplasms show partial or complete lack of structural organization and functional coordination with the normal tissue, and usually form a distinct mass of tissue which may be either benign (benign tumor) or malignant (cancer).

Nephelometry: analytic technique that measures the amount of light scattered by particles (immune complexes) in a solution. Measurements are made at 5 to 90 degrees incident to the beam.

Nephrotic syndrome: glomerular injury; an abnormally increased permeability of the glomerular basement membrane. Can be a result of many different etiologies.

Neuroblastoma: malignant tumors of the adrenal medulla that occur in children. They produce catecholamines and may occasionally be associated with hypertension.

Neurohypophysis: posterior portion of the pituitary gland.

NFPA: National Fire Protection Association.

Nitrogen balance: equilibrium between protein anabolism and catabolism.

Noncompetitive immunoassay: use of labeled reagent antibody to detect an antigen; also immunometric immunoassay.

Nonprotein nitrogen (NPN): nitrogen-containing compounds remaining in a blood sample after the removal of protein constituents.

Nonsteroidal anti-inflammatory drug (NSAID): any one of a group of pharmacotherapeutic agents exerting anti-inflammatory (and also usually analgesic and antipyretic) actions (e.g., aspirin, diclofenac, ibuprofen, and naproxen). A contrast is made with steroidal compounds (e.g., hydrocortisone or prednisone) exerting anti-inflammatory activity.

Norepinephrine (NE): a catecholamine hormone, acting on α - and β -receptors; it is stored in chromaffin granules in the medulla of suprenal gland in much smaller amounts than epinephrine and secreted in response to hypotension and physical stress; used pharmacologically as a vasopressor.

Normal bone growth: parallels body growth; requires integration of calcium, phosphate, and magnesium metabolism with endocrine regulation from Vitamin D, parathyroid hormone (PTH), and calcitonin.

Normality: number of gram equivalent weights per liter of solution.

Normetanephrine: a metabolite of epinephrine.

Northern blot: technique for detection of RNA molecules or species with defined sequences.

NPN: see Nonprotein nitrogen.

Nucleic acid probes: use of nucleic acids to investigate cellular changes; nucleic acids store all genetic information and direct the synthesis of specific proteins.

Nucleic acid sequence-based amplification (NASBA): isothermal reactions that do not require the use of a thermal cycler.

Nutrient: a constituent of food necessary for normal physiological function.

Nutritional assessment: evaluation of a patient's metabolic and dietary (nutritional) needs.

Nyctalopia: poor vision in dim light due to vitamin A deficiency. This condition is also known as night blindness.

O

Oligoclonal bands: small discrete bands in the gamma globulin region of the spinal fluid electrophoresis, indicating local central nervous system production of IgG; bands are frequently seen in patients with multiple sclerosis but can also be found in other diseases of the central nervous system including syphilis, sarcoidosis, and chronic infection or inflammation.

Oncofetal antigen: a protein produced in large amounts during fetal life and released into the fetal circulation. After birth, the production of oncofetal antigens is repressed, and only minute quantities are present in the circulation of adults.

Oncogenes: viral DNA segments that can transform normal cells into malignant cells.

One point calibration (or calculation): a term that refers to the calculation of the comparison of a known standard/calibrator concentration and its corresponding absorbance to the absorbance of an unknown value.

Oposonization: action of opsonins to facilitate phagocytosis.

Order of draw: recommended sequence in which blood specimens should be drawn so as to minimize interference in testing caused by carryover of additives in tubes.

OSHA: Occupational Safety and Health Act; enacted by Congress in 1970. The goal of this federal regulation was to provide all employees (clinical laboratory personnel included) with a safe work environment.

Osmolal gap: difference between the measured osmolality and the calculated osmolality. The osmolal gap indirectly indicates the presence of osmotically active substances other than sodium, urea, or glucose, such as ethanol, methanol, ethylene glycol, lactate, or β -hydroxybutyrate.

Osmolality: physical property of a solution, based on the concentration of solutes (expressed as millimoles) per kilogram of solvent.

Osmolarity: concentration of osmotically active particles in solution reported in milliosmoles per liter; not routinely used.

Osmometer: laboratory instrument used to measure osmolality, or concentration of solute per kilogram of solvent.

Osmotic pressure: pressure that allows solvent flow between a semipermeable membrane to establish an equilibrium between compartments of different osmolality.

Osteoblast: cells that build bone when triggered by the appropriate hormonal signals.

Osteoclast: cells that causes reabsorption of bone when triggered by the appropriate hormonal signals.

Osteomalacia: condition resulting from a deficiency of vitamin D. Deficiency of vitamin D causes bones to be soft and brittle. It is the adult form of rickets.

Osteoporosis: a disease involving the gradual loss of bone mass resulting in a less dense and weak skeleton.

Otorrhea: discharge from the ear; also leakage of cerebrospinal fluid from the ear.

Ovulation: the periodic discharge of an ovum from the ovary.

Oxidized: loss of electrons; combined with oxygen.

Oxidizing agent: substance that accepts electrons.

Oxidoreductase: an enzyme that catalyzes an oxidation-reduction reaction between two substrates.

Oxygen content: sum of the oxygen bound to hemoglobin as O_2Hb and the amount dissolved in the blood.

Oxygen saturation: (SO_2) represents the ratio of oxygen that is bound to the carrier protein—hemoglobin—compared with the total amount that the hemoglobin could bind.

Oxytocin: a hormone produced in the hypothalamus. It stimulates contraction of the gravid uterus at term and also results in contraction of myoepithelial cells in the breast, causing ejection of milk.

P

P₅₀: represents the partial pressure of oxygen at which the hemoglobin oxygen saturation (SO_2) is 50%. The P₅₀ is a mea-

sure of the O_2Hb binding characteristics and identifies the position of the oxygen-hemoglobin dissociation curve at half saturation.

Palpate: to examine by feeling and pressing with the palms of the hands and the fingers.

Pancreatitis: inflammation of the pancreas ultimately caused by autodigestion of the pancreas as a result of reflux of bile or duodenal contents into the pancreatic duct.

Panhypopituitarism: a condition resulting from pituitary hormone deficiencies; it usually involves more than one and eventually all the anterior pituitary hormones. These hormones are lost in a characteristic order, with growth hormone and gonadotropins disappearing first, followed by TSH, ACTH, and prolactin.

Paracentesis: aspiration of fluid through the skin; as in removal or aspiration of pericardial, pleural, and peritoneal fluids.

Paracrine: secretion of a hormone from other than an endocrine gland.

Parathyroid glands: four glands adjacent to the thyroid gland. Two of these glands are found in the upper portion and two are found near the lower portion of the thyroid gland. The parathyroid glands produce parathyroid hormone, which controls calcium and phosphate metabolism.

Parathyroid hormone (PTH): hormone synthesized as a prohormone containing 115 amino acids. The active form of the hormone contains 84 amino acids and is secreted by the chief cells of the parathyroid glands.

Parathyroid hormone-related protein (PTHrP): a hormone that can be produced by tumors, especially of the squamous cell type; massive overproduction can lead to hypercalcemia and other manifestations of hyperparathyroidism. PTHrP exerts a biologic action similar to that of parathyroid hormone (PTH), acting through the same receptor, which is expressed in many tissues but most abundantly in kidney, bone, and growth plate cartilage. It apparently has significant actions during development, but it is uncertain whether PTHrP circulates at all or has any function in normal human adults. The structure of the gene for human PTHrP is more complex than that of PTH, and varying molecular forms exist, including proteins of 141, 139, and 173 amino acids, which share a significant homology with parathyroid hormone.

Parenteral nutrition: intense nutritional support for patients who are malnourished, or in danger of becoming malnourished, because they are unable to consume required nutrients or to take nutrients entirely. Parenteral nutrition therapy involves administering appropriate amounts of carbohydrate, amino acid, and lipid solutions as well as electrolytes, vitamins, minerals, and trace elements to meet the caloric, protein, and nutrient requirements while maintaining water and electrolyte balance.

Partial pressure: the pressure exerted by an individual gas in the atmosphere; equal to blood pressure at a particular altitude times the appropriate percentage for each gas.

Patency: the state of being freely open or exposed.

PCO₂: partial pressure of carbon dioxide.

PCR: see Polymerase chain reaction.

Peak drug level: the time after administration until a drug reaches peak concentration in the body. A rule of thumb suggests that, for peak drug levels, the specimen should be collected 1 hour after the dose is administered.

- Pediatric:** regarding the treatment of children.
- Pellagra:** a condition resulting from a deficiency of niacin. Initial signs of pellagra include anorexia, headaches, weakness, irritability, indigestion, and sleeplessness. This progresses to the classic four Ds of advanced pellagra: dermatitis, diarrhea, dementia, and death.
- Pepsin:** a group of relatively weak proteolytic enzymes, with pH optima from about 1.6 to 3.6, that catalyze all native proteins except mucus.
- Peptide bond:** linkage combining the carboxyl group of one amino acid to the amino group of another amino acid.
- Peptides:** compounds formed by the cleavage of peptones, which contain two or more amino acids. The peptide hormones include insulin, glucagon, parathyroid hormone, growth hormone, and prolactin.
- Percent solution:** the amount of solute per 100 total units of solution.
- Performance improvement:** process that should be in place to ensure quality in laboratory testing.
- Pericardial fluid:** fluid surrounding and protecting the heart. The frequency of pericardial sampling and laboratory analysis is rare.
- Pericarditis:** inflammation of the pericardium.
- Perifollicular cells:** one of two types of cells forming the thyroid gland. Also C cells; they are situated in clusters along the interfollicular or interstitial spaces. The C cells produce the polypeptide calcitonin, which is involved in calcium regulation.
- Peritoneal fluid:** a clear to straw-colored fluid secreted by the cells of the peritoneum (abdominal cavity). It serves to moisten the surfaces of the viscera.
- Petechiae:** minute hemorrhagic spots, of pinpoint to pinhead size, in the skin, which are not blanched by diascopy.
- PG:** see Prostaglandins.
- pH:** represents the negative or inverse log of the hydrogen ion concentration; $-\log [H^+]$.
- Phalanx:** any of the bones of the fingers or toes.
- Pharmacokinetics:** characterization, mathematically of the disposition of a drug over time in order to better understand and interpret blood levels and to effectively adjust dosage amount and interval for best therapeutic results with minimal toxic effects.
- Phenylketonuria (PKU):** phenylpyruvic acid in the urine; a recessive hereditary disease.
- Pheochromocytoma:** tumors of the adrenal medulla or sympathetic ganglia that produce and release large quantities of catecholamines.
- Phlebotomist:** an individual who obtains or draws blood samples.
- Phlebotomy:** procedure for withdrawing blood from the body.
- Phospholipids:** formed by the conjugation of two fatty acids and a phosphorylated glycerol. Phospholipids are amphipathic, which means they contain polar hydrophilic (water-loving) head groups and nonpolar hydrophobic (water-hating) fatty acid side chains.
- Physiologic:** something apparent from its functional effects rather than from its anatomical structure; or a dose or the effects of such a dose (of a chemical agent that either is or mimics a hormone, neurotransmitter, or other naturally occurring agent) that is within the range of concentrations or potencies that would occur naturally.
- Pipet:** utensils made of glass or plastic that are used to transfer liquids; they may be reusable or disposable.
- Pituitary stalk:** a process comprising the tubular part investing the infundibular stem that attaches the hypophysis to the tuber cinereum at the base of the brain.
- pK:** the negative log of the ionization constant.
- PKU:** see Phenylketonuria.
- Placenta:** a structure in the uterus through which the fetus derives nourishment. The placenta synthesizes and secretes a variety of protein hormones, as well as the steroids estrogen and progesterone. Evaluation of maternal serum and urine concentration of these hormones may be of value not only in diagnosing pregnancy but also in monitoring placental development and fetal well-being.
- Plantar:** relating to the sole of the foot.
- Plasma:** liquid portion of blood that contains clotting factors.
- Plasma renal flow:** renal secretory capability.
- Plasma renin activity (PRA):** estimation of renin in plasma by measurement of the rate of formation of angiotensin I or II.
- Pleural fluid:** essentially interstitial fluid of the systemic circulation; it is contained in a membrane that surrounds the lungs.
- PO₂:** the partial pressure of oxygen.
- Point-of-care testing (POCT):** analytic testing of patient specimens performed outside the physical laboratory and at the site of patient care.
- Poison:** any substance that causes a harmful effect upon exposure.
- Poisons:** Any substance, either taken internally or applied externally, that is injurious to health or dangerous to life.
- Polyclonal:** arising from different cell lines.
- Polydipsia:** excess H₂O intake due to chronic thirst.
- Polymerase chain reaction (PCR):** an in vitro process used to replicate unlimited specific short regions of DNA.
- Polysaccharide:** complex carbohydrates; polysaccharides are the most abundant organic molecules in nature.
- Porphyria:** disorders that result from disturbances in heme synthesis.
- Porphyrin:** chemical intermediates in the synthesis of hemoglobin, myoglobin, and other respiratory pigments called cytochromes.
- Porphyrinogens:** the reduced form of porphyrins.
- Porphyria:** increased amount of porphyrins in the urine.
- Posterior pituitary:** a portion of the pituitary; also the neurohypophysis.
- Posthepatic:** extrahepatic disturbance in the excretion of bilirubin. Posthepatic jaundice results from the impaired excretion of bilirubin caused by mechanical obstruction of the flow of bile into the intestines. This may be due to gallstones or a tumor.
- Postrenal:** obstruction in the flow of urine from kidney to bladder and its excretion.
- Postzone:** in immunoprecipitation reactions, antigen concentration is in excess and cross-linking is decreased.
- Potassium oxalate:** an anticoagulant used to maintain glucose in whole blood and for some special chemistry tests.

Preanalytic error: mistakes introduced during the collection and transport of samples prior to analysis.

Precision: the closeness of repeated results; quantitatively expressed as standard deviation or coefficient of variation.

Precocious puberty: onset of puberty (normal sexual development) earlier than the expected time (generally 10–14 years old).

Predictive value theory: referring to diagnostic sensitivity, specificity and predictive value. The predictive value of a test can be expressed as a function of sensitivity, specificity, and disease prevalence.

Prehepatic: before the liver. Prehepatic jaundice results when an excessive amount of bilirubin is presented to the liver for metabolism, such as in hemolytic anemia. This type of jaundice is characterized by unconjugated hyperbilirubinemia.

Prerenal: prior to plasma reaching the kidney.

Primary standard: a highly purified chemical that can be measured directly to produce a substance of exact known concentration.

Probe: on an automated analyzer, a mechanized device that automatically dips into a sample cup and aspirates a portion of the liquid.

Proficiency testing: confirmation of the quality of laboratory testing by means of “unknown” samples.

Progesterone: a steroid hormone produced by the corpus luteum and placenta. Progesterone serves to prepare the uterus for pregnancy and the lobules of the breast for lactation.

Prohormone: a precursor to the active hormone.

Proinsulin: precursor to insulin; it is packaged into secretory granules, where it is broken down into equimolar amounts of insulin and an inactive C-peptide.

Prolactin: a protein hormone whose amino acid composition is similar to that of GH. It is produced by the pituitary gland. In humans, it appears to function solely in the initiation and maintenance of lactation.

Proportional error: subcategory of systematic error in which the differences between the test method and the comparative method values are proportional to the analyte concentration; present when the slope is $\neq 1$.

Prostaglandins (PG): a group of biologically active unsaturated fatty acids; metabolites of arachidonic acid.

Protein-free filtrate: clear filtrate of whole blood or plasma prepared by adding acid or other ions to remove proteins.

Proteinuria: protein in the urine.

Proto-oncogenes: normal cellular genes that play essential roles in cell differentiation and proliferation and potentially can become oncogenic are known as proto-oncogenes. Transformation of proto-oncogenes into oncogenes can occur by single-point mutations, translocation, and amplification.

Proximal tubule: portion of renal tubule beginning at Bowman’s capsule and extending to loop of Henle.

Prozone: in immunoprecipitation reactions, antibody concentration is in excess and cross-linking is decreased.

PTH: see Parathyroid hormone.

Pyrrole: a heterocyclic compound found in many biologically important substances, such as hemoglobin.

Q

Quality assurance: system or process that encompasses (in the laboratory) preanalytic, analytic, and postanalytic factors. Quality control is part of a quality-assurance system.

Quality control: system for recognizing and minimizing (analytic) errors. The purpose of the quality-control system is to monitor analytic processes, detect analytic errors during analysis, and prevent the reporting of incorrect patient values. Quality control is one component of the quality-assurance system.

Quality improvement: activities and systems designed to evaluate and improve patient care.

Quaternary structure: the arrangement of two or more polypeptide chains to form a functional protein molecule.

R

Radial immunodiffusion (RID): immune precipitation technique used to quantitate a protein (the antigen).

Radioactive material: any material capable of emitting radiant energy (rays or particles).

Random access: the capability of an automated analyzer to process samples independently of other samples on the analyzer. Random access analyzers may be programmed to run individual tests or a panel of tests without operator intervention.

Random error: a type of analytic error; random error affects precision and is the basis for disagreement between repeated measurements. Increases in random error may be caused by factors such as technique and temperature fluctuations.

Random urine specimen: a urine specimen in which collection time and volume are not important. The first morning void is often requested because it is the most concentrated; generally used for routine urinalysis (pH, glucose, protein, specific gravity, and osmolality).

Ratio: an expression of the relation of one quantity to another (e.g., of a proportion or rate).

RDA: see Recommended Dietary Allowance.

Reabsorption: process of absorbing again.

Reactive chemical: substances that, under certain conditions, can spontaneously explode or ignite or that evolve heat and/or flammable or explosive gases.

Reagent grade water: water that is classified into one of six categories based on the specifications needed for its use rather than the method of purification or preparation. These categories include clinical laboratory reagent water (CLRW), special reagent water (SRW), instrument feed water, water supplied by method manufacturer, autoclave and wash water, and commercially bottled purified water.

Receptor: site of hormone action on a cell; receptors provide for target-organ specificity, since not all cells have receptors for all hormones.

Recommended Dietary Allowance (RDA): The amount of a vitamin that should be ingested by a healthy individual to meet routine metabolic needs and allow for biologic variation, maintain normal serum concentrations, prevent depletion of body stores, and thus preserve normal function and health.

Redox potential: a measure of a solution's ability to accept or donate electrons.

Reduced: substance that has gained electrons.

Reference interval: the usual values for a healthy population; also normal range.

Reference method: an analytic method used for comparison. It is a method with negligible inaccuracy in comparison with its imprecision.

Reflux: a backward flow, as of blood through an incompetent valve of the heart.

Renal threshold: plasma concentration above which a substance appears in the urine.

Renal tubular secretion: process that transports substances from plasma into tubular filtrate for excretion into urine.

Renin: enzyme produced by the kidney that acts on angiotensin to form angiotensin I.

Renin-angiotensin system (RAS): hormones, renin, angiotensin, and aldosterone work together to regulate blood pressure. A sustained fall in blood pressure causes the kidney to release renin. This is converted to angiotensin in the circulation. Angiotensin then raises blood pressure directly by arteriolar constriction and stimulates the suprarenal glands to produce aldosterone that promotes sodium and water retention by kidney, such that blood volume and blood pressure increase.

Respiratory acidosis and alkalosis: a disorder due to ventilatory dysfunction (a change in the PCO_2 , the respiratory component).

Respiratory distress syndrome: a condition that may occur upon the changeover to air as an oxygen source at birth if the proper quantity and type of phospholipid (surfactant) is not present. Also referred to as hyaline membrane disease because of the hyaline membrane found in affected lungs.

Restriction fragment length polymorphisms (RFLP): a technique to evaluate differences in genomic DNA sequences.

Retinoids: derivatives of vitamin A.

Reverse transcriptase-polymerase chain reaction: conversion of RNA to DNA by reverse transcriptase; the complementary DNA (cDNA) can then be analyzed by PCR.

Rhabdomyolysis: destruction of skeletal muscle cells.

Rheumatic heart disease: affects all layers of the heart. Inflammation of the inner surface of the heart (endocarditis), especially the valves of the left heart, leads to ulceration and growth of vegetations on the heart lining and eventually to irreversible valve damage.

Rhinorrhea: discharge from the nose; also leakage of cerebrospinal fluid into the nose.

Ribonucleic acid (RNA): A macromolecule consisting of ribonucleoside residues connected by phosphate from the 3'-hydroxyl of one to the 5'-hydroxyl of the next nucleoside. RNA is found in all cells, in both nuclei and cytoplasm and in particulate and nonparticulate form, and also in many viruses; polynucleotides made in vitro are generally called such. Various RNA fractions are identified by location, form, or function.

Rickets: the classic vitamin D deficiency disease of children. It may be nutritional or metabolic in origin.

RID: see Radial immunodiffusion.

Robotics: front end automation to "handle" a specimen through the processing steps and load the specimen onto the analyzer.

Rocket technique: immune precipitation method in gel. In this quantitative technique, reagent antibody is mixed with agarose; antigen is placed in the well and electrophoresed. As the antigen moves through the agarose, it reacts with the reagent antibody and forms a "rocket," with stronger precipitation along the edges. The height of the rocket is proportional to the concentration of antigen present; the concentration is determined based on a calibration curve. The narrow range of linearity may require dilution or concentration of the unknown sample. Also referred to Laurell technique, or electroimmunoassay.

Rotor: a round device on some automated analyzers that holds sample cups and is capable of spinning.

S

Sclerosed: hardened. Veins are occluded so they feel hard and cord-like, lack resiliency. They are difficult to puncture, have impaired blood flow that leads to erroneous test results, and should be avoided.

Scurvy: disease marked by inanition, debility, anemia, and edema of the dependent parts; a spongy condition sometimes with ulceration of the gums and loss of teeth, hemorrhages into the skin from the mucous membranes and internal organs, and poor wound healing; due to a diet lacking vitamin C.

Secondary hypertension: hypertension with an identified source.

Secondary standard: a substance of lower purity whose concentration is determined by comparison with a primary standard.

Secretagogue: an agent that stimulates or causes secretion.

Secretin: secretin is synthesized by cells in the small intestine in response to the acidic contents of the stomach reaching the duodenum. It can control gastrin activity in the stomach and cause the production of alkaline bicarbonate rich pancreatic juice, thereby protecting the lining of the intestine from damage.

Secretion: process whereby glandular organ cells produce substances from blood.

Self-sustained sequence replication: target amplification method that detects target RNA and involves continuous isothermic cycles of reverse transcription.

Sella turcica: a small cavity in the sphenoid bone of the skull; the pituitary is located in this cavity.

Sensitivity: the proportion of patients with a given disease or condition in which a test intended to identify that disease or condition yields positive results. Sensitivity (%) = number of diseased people with a positive test result \times 100 total number of diseased people tested.

Serial dilution: multiple progressive dilutions ranging from more concentrated solutions to less concentrated solutions.

Serotonin (5-OH tryptamine): an amine derived from hydroxylation and decarboxylation of tryptophan. It is synthesized by enterochromaffin cells, which are located primarily in the gastrointestinal tract and, to a lesser degree, in the bronchial mucosa, biliary tract, and gonads.

Serous fluid: liquid of the body similar to blood serum; in part secreted by serous membranes.

- Sertoli cell:** cell of seminiferous tubules that nourish spermatids.
- Serum:** liquid portion of the blood without clotting factors.
- Sexual maturation:** stage when an organism can reproduce; results in significant endocrine changes particularly of the hypothalamic–pituitary–gonadal hormone pathway, which eventually lead to the constitutive development of adult secondary sexual characteristics and eventually to the adult.
- Sheehan’s syndrome:** hypopituitarism arising from an infarct (necrosis) of the pituitary.
- Shift:** a sudden change in data and the mean.
- SI:** see *Système Internationale d’Unités*.
- SIADH:** syndrome of inappropriate ADH; it results when ADH is released despite low serum osmolality in association with a normal or increased blood volume.
- Significant figures:** the minimum number of digits needed to express a particular value in scientific notation without loss of accuracy.
- Silica:** the chief constituent of sand, hence of glass.
- Simple protein:** composed only of amino acids.
- Sinusoids:** spaces between the cords of liver cells; they are lined by endothelial cells and Kupffer cells.
- Six Sigma:** a culture, infrastructure, methodology, and metric for quality improvement; begins with a belief in the relentless pursuit of continuous improvement toward excellence in products or services, processes, and people; the metric—represents a universal standard for both benchmarking and pursuing excellence.
- Skin puncture:** an open collection system. Blood is brought to the surface of the skin by applying pressure to the site. The sample is dripped into a capillary blood collector (instead of vacuum pressure pulling the sample into the tube). Specimen contains both venous and arterial blood.
- Sodium citrate:** an anticoagulant; used for collection of citrated plasma for coagulation studies.
- Sodium fluoride:** a substance that inhibits the metabolism of glucose by cells in a specimen of blood.
- Solid phase:** in radioimmunoassay, solid particles or tubes onto which antibody is adsorbed.
- Solute:** a substance that is dissolved in a liquid or solvent.
- Solution:** a liquid containing a dissolved substance; the combination of solute and solvent.
- Solvent:** liquid in which the solute is dissolved.
- Somatostatin (SS):** a tetradecapeptide capable of inhibiting release of somatotropin, insulin, and gastrin.
- Southern blot:** a technique for detecting specific DNA sequences using a mixture of DNA molecules.
- Specific gravity:** term used to express density.
- Specificity:** in regard to quality control, the ability of an analytic method to quantitate one analyte in the presence of others in a mixture such as serum.
- Spectrophotometry:** analytic technique to measure the light absorbed by a solution. A spectrophotometer is used to measure the light transmitted by a solution in order to determine the concentration of the light-absorbing substance in the solution.
- SPS:** an anticoagulant added to blood specimens.
- Squamous cell carcinoma (SSC):** a malignant neoplasm derived from stratified squamous epithelium, which may also occur in sites where only glandular or columnar epithelium is normally present.
- SRM:** see Standard reference materials.
- SST:** abbreviation for serum separator tube, a blood collection tube containing a clot activator and a mass of gel with a density between those of serum and cells. During centrifugation, the gel comes to lie between serum and cells. Prevents contact between serum and cells.
- Staging:** determination of the period in the course of a disease. The major clinical value of tumor markers is in tumor staging, monitoring therapeutic responses, predicting patient outcomes, and detecting cancer recurrence.
- Standard precautions:** guidelines that consider blood and other body fluids from all patients as infective; include hand washing, gloves, eye protection, etc.
- Standard reference materials (SRM):** established by authority; used for comparison of measurement.
- Standard:** a substance or solution in which the concentration is determined. Standards are used in the calibration of an instrument or method.
- Standardization:** a set of techniques used to minimize the effects of differences in age or other confounding variables when comparing two or more population.
- Steatorrhea:** failure to digest and/or absorb fats.
- Steroids:** classification of hormones; they are all synthesized from cholesterol, using the same initial biochemical pathways. The end result depends on the enzymatic machinery that is predominant in a particular organ.
- Strand displacement amplification (SDA):** one set of primers incorporates a specific restriction enzyme site that is later attacked by an endonuclease. The resulting “nick” created in only one strand by the restriction enzyme allows for displacement of the amplified strands that then, in turn, serve as targets for further amplification and nick digestion.
- Subacute thyroiditis:** one of the simplest classification schemes of thyroiditis. Conditions are often associated with a thyrotoxic phase when thyroid hormone is leaking into the circulation, a hypothyroid phase when the thyroid gland is repairing itself and a euthyroid phase once the gland is repaired. These phases can last weeks to months.
- Surfactant:** those surface-active agents forming a monomolecular layer over pulmonary alveolar surfaces; lipoproteins that include lecithins and sphingomyelins that stabilize alveolar volume by reducing surface tension and altering the relationship between surface tension and surface area.
- Synovial fluid:** fluid formed by ultrafiltration of plasma across the synovial membrane of a joint. The membrane also secretes into the dialysate a mucoprotein rich in hyaluronic acid, which causes the synovial fluid to be viscous.
- Systematic error:** a type of analytic error that arises from factors that contribute a constant difference, either positive or negative, and directly affects the estimate of the mean. Increases in systematic error can be caused by poorly made standards or reagents, failing instrumentation, poorly written procedures, etc.
- Système International d’Unités (SI):** internationally adopted system of measurement. Established in 1960 and is the only system used in many countries. The units of the system are referred to as SI units.

T

- T₃ uptake:** assay used to measure the number of available binding sites of the thyroxine-binding proteins, most notably TBG. It should not be confused with the T₃ assay.
- Tandem mass spectrometry:** analytic technique that allows whole groups of similar compounds to be analyzed on very small sample volumes without complex sample preparation.
- TBA:** see Thyroxine-binding albumin.
- TBG:** see Thyroxine-binding globulin.
- TBPA:** see Thyroxine-binding prealbumin.
- TD₅₀:** dose of a drug that would be predicted to produce a toxic response in 50% of the population.
- TDM:** see Therapeutic drug monitoring.
- Teratogen:** a drug or other agent that can produce congenital anomalies or birth defects or increase the incidence of an anomaly in the population.
- Testosterone:** a steroid hormone synthesized from cholesterol. It causes growth and development of the male reproductive system, prostate, and external genitalia.
- Tetany:** irregular muscle spasms.
- Tetralogy of Fallot:** a congenital condition of the heart that includes septal defects, stenosis of the pulmonary artery, dextroposition of the aorta, and hypertrophy of the right ventricle.
- Thalassemia:** disorder involving a defect in rate and quantity of production of hemoglobin.
- THBR:** see Thyroid hormone-binding ratio.
- Therapeutic drug monitoring (TDM):** the determination of serum drug levels in order to produce a desirable effect.
- Therapeutic range:** concentration range of a drug that is beneficial to the patient without being toxic.
- Thermistor:** electronic thermometer.
- Thixotropic gel:** inert substances contained in or near the bottom of certain tubes; during centrifugation, the gel lodges between the cells and the fluid, forming a physical barrier that prevents the cells from metabolizing substances in the serum or plasma.
- Thoracentesis:** removal of fluid from the pleural space by needle and syringe after visualization by radiology.
- Thrombolytic agents:** substances that break up a thrombus (blood clot) (e.g., streptokinase).
- Thrombosed:** clotted.
- Thyroglobulin:** an iodine-containing protein secreted by the thyroid gland.
- Thyroid:** a gland consisting of two lobes located in the lower part of the neck. The lobes are connected by a narrow band called an isthmus and are typically asymmetrical, with the right lobe being larger than the left.
- Thyroid hormone-binding ratio (THBR):** test used to measure available binding sites of the thyroxine-binding proteins; also T₃-uptake test.
- Thyroiditis:** inflammation of the thyroid gland.
- Thyroperoxidase (TPO) antibodies:** thyroid antibodies; formerly known as thyroid antimicrosomal antibodies.
- Thyrotoxicosis:** a group of syndromes caused by high levels of free thyroid hormones in the circulation. Thyrotoxicosis means only that the patient is suffering the metabolic consequences of excessive quantities of thyroid hormones.
- Thyrotropin (TSH):** thyrotropin, or thyroid-stimulating hormone (TSH), is a glycoprotein consisting of two subunits, α and β , linked noncovalently. It is released by the anterior pituitary.
- Thyrotropin receptor (TSHR) antibodies:** thyroid antibodies associated with hyperthyroid or hypothyroid states.
- Thyrotropin-releasing hormone (TRH):** a tripeptide released by the hypothalamus. It travels along the hypothalamic stalk to the β -cells of the anterior pituitary, where it stimulates the synthesis and release of thyrotropin or thyroid-stimulating hormone (TSH).
- Thyroxine (T₄):** hormone produced by the thyroid gland.
- Thyroxine-binding albumin (TBA):** a protein that binds thyroxine.
- Thyroxine-binding globulin (TBG):** a protein that binds thyroid hormones. The TBG assay is used to confirm results of FT₃ or FT₄ or abnormalities in the relationship of the TT₄ and T₃U test; or as a postoperative marker of thyroid cancer.
- Thyroxine-binding prealbumin (TBPA):** transport protein of thyroxine; also transthyretin (TTR).
- TIBC:** see Total iron-binding capacity.
- Timed urine specimen:** specimens collected at specific intervals, such as before and after meals, or specimens to be collected over specific periods of time. For example, discrete samples collected over a period of time are used for tolerance tests (e.g., glucose).
- Titer:** the highest dilution of serum that shows a positive reaction in the presence of antigen (e.g., precipitation of antigen-antibody complex).
- Total iron-binding capacity (TIBC):** an estimate of serum transferrin levels; obtained by measuring the total iron binding capability of a patient's serum. Since transferrin represents most of the iron-binding capacity of serum, TIBC is generally a good estimate of serum transferrin levels.
- Total laboratory automation:** automated devices and robots integrated with existing analyzers to perform all phases of laboratory testing.
- Total parenteral nutrition (TPN):** a widely used means of intense nutritional support for patients who are malnourished, or in danger of becoming malnourished, because they are unable to consume required nutrients.
- Toxicology:** the study of poisons, their actions, their detection, and the treatment of the conditions produced by them.
- Trabecular bone:** bone in which the spicules or trabeculae form a three-dimensional latticework (cancellus), with the interstices filled with embryonal connective tissue or bone marrow.
- Trace element:** an element that occurs in biological systems at concentrations of mg/kg amounts or less (parts per million). Typically the daily requirement of such an element is a few milligrams per day.
- Tracer:** radioactive isotope used to tag or mark a molecule; also called label.
- Transcription mediated amplification (TMA):** an amplification assay that is similar to nucleic acid sequence-based amplification.
- Transferase:** an enzyme that catalyzes the transfer of a group other than hydrogen from one substrate to another.

Transferrin saturation: percent of transferrin molecules that have iron bound. A ratio of serum iron (actual iron in the serum) and serum transferrin or TIBC (potential quantity of iron that can be bound). Also percent saturation.

Transudate: fluid that passes through a membrane; in comparison to an exudate it has fewer cells and is of lower specific gravity. Transudates are secondary to remote (nonpleural) pathology and indicate that treatment should begin elsewhere.

Trend: a gradual change in data and the mean.

TRH: see Thyrotropin-releasing hormone.

Triglyceride: consists of one molecule of glycerol with three fatty acid molecules attached (usually three different fatty acids including both saturated and unsaturated molecules).

Triiodothyronine (T₃): a hormone produced by the thyroid gland.

Triose: a monosaccharide having three carbons.

Troponin I: globular protein; specific marker for cardiac disease.

Troponin T: asymmetrical globular protein; cardiac marker that allows for both early and late diagnosis of acute myocardial infarction.

Trough drug level: the lowest concentration of drug obtained in the blood. Trough levels should be drawn immediately before the next dose.

TSH: see Thyrotropin.

t-Test: used to determine whether there is a statistically significant difference between the means of two groups of data.

Tubular reabsorption: process in which movement of a substance (e.g., calcium) is from the tubular lumen to the peritubular capillary plasma.

Tubular secretion: movement of substances from peritubular capillary plasma to tubular lumen; also secretion of some products of cellular metabolism into the filtrate in the tubular lumen.

Tubules: tubes or canals that make up a part of the kidney; as in convoluted tubules.

Tumor marker: biological substances synthesized and released by cancer cells or substances produced by the host in response to cancerous tissue. Tumor markers can be present in the circulation, body cavity fluids, cell membranes, or the cytoplasm/nucleus of the cell.

Tumor-associated antigen: an antigen associated with a tumor; it is derived from the same or closely related tissue. Oncofetal proteins are an example of tumor-associated antigens. They are present in both embryonic/fetal tissue and cancer cells.

Tumor-specific antigen: a tumor antigen; thought to be a direct product of oncogenesis induced by viral oncogenes, radiation, chemical carcinogens, or unknown risk factors.

Turbidimetry: an analytic technique that measures the decreased amount of light transmitted through a solution as a result of light scatter by particles. Measurements are made at 180 degrees to the incident beam (unscattered light).

U

Ultrafiltration: filtration technique for removing particulate matter, microorganisms and any pyrogens or endotoxins

Ultratrace element: present in tissues at concentrations of mg/kg amounts or less (parts per billion) and has extremely low daily requirements (usually <1 mg).

Urea: compound synthesized in the liver from ammonia and carbon dioxide and excreted in the urine.

Urea nitrogen/creatinine ratio: calculation aids differentiation of the cause of abnormal urea concentration; usually 10:1 to 20:1. A high urea N/creatinine ratio with an elevated creatinine is usually seen in postrenal conditions. A low urea N/creatinine ratio is observed in conditions associated with decreased urea production, such as low protein intake, acute tubular necrosis, and severe liver disease.

Uremia or uremic syndrome: very high levels of urea in blood accompanied by renal failure.

Uric acid: end product of the breakdown of purines from nucleic acids in humans.

Urinalysis: a group of screening tests generally performed as part of a patient's admission workup or physical examination. It includes assessment of physical characteristics, chemical analyses, and a microscopic examination of the sediment from a (random) urine specimen.

Urobilinogen: colorless product or derivative of bilirubin formed by the action of bacteria.

V

Valence: mass of material that can combine with or replace 1 mole of hydrogen ions.

Vanillylmandelic acid (VMA): epinephrine and norepinephrine are metabolized by the enzymes monoamine oxidase and catechol-O-methyltransferase to form metanephrines and vanillylmandelic acid.

Vascular access device (VAD): temporary, semi-permanent, or permanent device inserted into a blood vessel to draw blood and deliver drugs and nutrition into a patient's bloodstream; types of VADs included an arterial line, an arteriovenous shunt or fistula, a heparin or saline lock, an intravenous line, or a central vascular access device.

Vasodilator drugs: drugs that dilate the peripheral arteries and veins, decreasing the amount of effort that the heart expends to pump blood.

Vasopressin: a hormone secreted by the hypothalamus. Involved in blood pressure regulation.

Venipuncture: puncture of a vein. For example, to obtain blood for analysis.

Venous blood: blood obtained from a vein.

Ventricular septal defect: defect in the septum between the left and right ventricles of the heart.

Very-low-density lipoproteins (VLDL): a group of lipoproteins that carry triglycerides assembled in the liver out to cells for energy needs or storage as fat.

Virilization: development of masculine sex characteristics in the female.

Vitamer: related compounds that interconvert to or substitute for the functional form of the vitamin.

Vitamin: organic molecules required by the body in amounts ranging from micrograms to milligrams per day for maintenance of structural integrity and normal metabolism. They perform a variety of functions in the body.

VLDL: see Very-low-density lipoproteins.

VMA: see Vanillylmandelic acid.

W

Waived tests: the simplest complexity listing in CLIA. It involves primarily test systems approved by the Food and Drug Administration for home use. The requirements are that there is no reasonable risk of harm to the patient if the test is performed incorrectly. The likelihood of erroneous results is negligible; the test method is simple and uncomplicated; and it is available for home use.

Western blot: transfer technique used for analyzing protein antigens. Antigens are separated by electrophoresis and transferred to a new medium by absorption or covalent bonding and then detected by a wide range of antibody probes. The probe could be labeled with a radioactive tag, an enzyme that can produce a visual product or a fluorescent or chemiluminescent label. Detection would be accomplished with specialized instrumentation, spectrophotometer, fluorometer and luminometer, respectively. Used to detect the presence of human immunodeficiency virus (HIV).

Whole blood: complete blood, containing the liquid portion (plasma) and the cellular elements.

X

D-Xylose absorption test: an analytic technique that assesses the ability to absorb D-xylose; it is of value in differentiating malabsorption of intestinal etiology from that of exocrine pancreatic insufficiency.

Z

Zero-order kinetics: point in enzyme reaction when product is formed and the resultant free enzyme immediately combines with excess free substrate; the reaction rate is dependent on enzyme concentration only.

Zöllinger-Ellison syndrome: a gastrin-secreting neoplasm, usually located in the pancreatic islets, associated with exceptionally high plasma gastrin concentrations. The fasting plasma gastrin levels typically exceed 1,000 pg/mL and can reach 400,000 pg/mL, compared with the normal range of 50–150 pg/mL.

Zona fasciculata: the adrenal cortex.

Zona glomerulosa: outer portion of the adrenal cortex.

Zona reticularis: inner layer of the cortex of the adrenal gland.

Zymogens: inactivated forms of enzymes; must be converted into active forms for biological function.

Index

A

- A. *See* Absorbance
AAS. *See* Atomic absorption spectrophotometry
AAT. *See* α_1 Antitrypsin
Ab. *See* Antibody
ABCA1 transporter, 335–336
Absolute specificity, of enzymes, 284
Absorbance (A)
of amniotic fluid, 593, 594
in automated analysis measurement, 176
and Beer's law, 26, 26–28, 131–132, 132, 405
of bilirubin, 592–593
delta, 27
Absorption
of arsenic, 409
in atomic absorption spectrophotometry, 405
of cadmium, 410–411
of chromium, 414
of copper, 415
deficiency of, 580–581, 587–588, 658
of drugs, 606, 610–611, 682, 701
of energy, 131, 131, 136, 136–138, 138
evaluation of, 587–588
of hemoglobin, 394, 394
of iron, 416, 588, 669
of lead, 411, 628–629
of lipids, 333–334, 334
of manganese, 419
of mercury, 412–413
of molybdenum, 419
of selenium, 420
of toxins by gastrointestinal system, 622–623, 628–629
of vitamin B₁₂, 662–663
of zinc, 421, 667
Absorptivity, molar, 27, 132–133
Abuse
of alcohol, 624–625, 625t
of drugs, toxicology of, 633–636, 634t
ACC/AHA. *See* American College of Cardiology/American Heart Association
Acceptable performance criteria, 111, 111–112, 112b, 120
Accession, of blood samples, 71
Accession test request, 48
Accidents, documentation and investigation of, 74, 85–86
Accreditation, 75
Accuracy, 88, 117, 136, 350
ACD. *See* Acid citrate dextrose
ACE. *See* Angiotensin-converting enzyme
ACE inhibitors, 461
Acetaldehyde, 625
Acetaminophen, 306t, 524–525, 609, 632, 632–633, 634b
Acetone, 326, 326
Acetylcholinesterase, 631
Acetylsalicylic acid. *See* Aspirin
Acid citrate dextrose (ACD), 43t, 45, 46t
Acid elution stain, for hemoglobin F, 439
 α_1 Acid glycoprotein, 239t, 242
Acid phosphatase (ACP), 299–300
Acid-base balance, 385–390, 386–387, 563
Acid-base homeostasis, 388–390, 388t
Acid-base measurement, in pediatric patients, 689
Acidemia, 389
Acidic urine, 270, 567, 569–570
Acidosis, 368, 378, 381, 385, 389–390, 398, 571, 689, 689t
Acids, 385, 586
concentration of, 22–23
pH of, 8–9
renal excretion of, 563
ACP. *See* Acid phosphatase
Acridinium ester, 192
Acrodermatitis enteropathica, 421
Acromegaly, 450–451
Acrylamide gel, 147
ACS. *See* Acute coronary syndrome
ACT. *See* Activated clotting time
ACTH. *See* Adrenocorticotropic hormone
Actin, 541
Activated clotting time (ACT), 219
Activation, 283
Activation energy, 283, 283–284
Activators, 285
Active site, 271, 284
Active transport, 356
Activity
of acid phosphatase, 300
of alanine aminotransferase, 297
of alkaline phosphatase, 299
of amylase, 302–303, 302t
of aspartate aminotransferase, 296
of creatine kinase, 293
of enzymes, 27–28, 286–288
of glucose-6-phosphate dehydrogenase, 304
of γ -glutamyltransferase, 301
of ions, 397
of lactate dehydrogenase, 295
of lipase, 303–304
Activity units, 287
Actual percent oxyhemoglobin, 394
Acute coronary syndrome (ACS), 248, 543, 546–547, 547
Acute glomerulonephritis, 570
Acute intermittent porphyria (AIP), 426–427
Acute myocardial infarction (AMI), 543, 547, 554
aspartate aminotransferase in, 296, 550, 554
creatinine kinase in diagnosis of, 289–292, 292, 551
diagnosis of, 550–552, 551
lactate dehydrogenase in diagnosis of, 294, 550–551
myoglobin in diagnosis of, 247, 440–441, 551–552
Acute pancreatitis, 302–303
Acute renal failure (ARF), 440, 566, 572–573, 575–576
Acute toxicity, 623–624
Acute-phase proteins, 697
Acute-phase reactants, 242, 257, 258
Addison's disease, 463–465, 464
Additives
carry-over of, 46–47, 46b, 46t–47t
for evacuated tubes, 43–46, 43t, 46t
Adenine, 202–203, 203
Adenohypophysis. *See* Anterior pituitary
Adenoma, 463, 465, 498, 498t
Adenosine triphosphate (ATP), 312–313
Adenylate kinase (AK), 293
ADH. *See* Alcohol dehydrogenase; Vasopressin
Adiponectin, 249
Administration, for point-of-care testing, 211–215, 212b, 212t–214t
CLIA license and regulation, 211–213, 212t–214t
support staff, 213–214
Administration routes, of drugs, 606
ADP. *See* ALA dehydratase deficiency porphyria
Adrenal adenoma, 465
Adrenal cortex, 458–459, 459–462
congenital adrenal hyperplasia, 461–462, 461–462
in pediatric patients, 695, 695t
physiology of, 463, 463
steroidogenesis of, 459–461, 460
zones of, 459–462, 459–462
Adrenal Cushing's syndrome, 468
Adrenal gland, 458–476
adrenal cortex by zone, 459–462, 459–462
adrenal cortex physiology, 463, 463
adrenal insufficiency, 463–465, 464
adrenal medulla, 470–474, 471–472
androgen excess, 469–470, 470
Cushing's syndrome, 465, 465–469, 468–469
embryology and anatomy of, 458–459, 459
hypercortisolism, 465, 465
incidentaloma of, 473–474, 474
overview, 458
primary aldosteronism diagnosis, 462–463
Adrenal hyperplasia, congenital, 461–462, 461–462
Adrenal insufficiency, 463–465, 464
Adrenal medulla, 458–459, 459, 470–474, 471–472
Adrenocorticotropic hormone (ACTH), 314, 447–448, 641t, 695
in Addison's disease, 464
in adrenal gland, 459–461
aging effects on, 677
in Cushing's syndrome, 465–469
in dexamethasone nonsuppression adrenocorticotropic hormone secretion, 466
in hypercortisolism, 465, 465
in primary aldosteronism, 463
Adsorption, as separation technique for labeled immunoassays, 195
Adsorption chromatography, 148
Adsorptive stripping voltammetry, 409
Adult, developmental changes leading to, 685–686
Advanced glycation end products (AGEs), 678
Advia analyzers, 167, 169t, 175, 181
AEDs. *See* Antiepileptic drugs
Aerobic glycolysis, 312, 378, 379
Aerosol analyzers, 167, 169t, 175
AES. *See* Atomic emission spectrometry
AF. *See* Amniotic fluid
Affinity
of antibodies, 185–186
of hemoglobin for oxygen, 393–394
AFP. *See* α_1 Fetoprotein; α -Fetoprotein
AG. *See* Anion gap
Ag. *See* Antigen
Ag capture assay. *See* Sandwich assay
A/G ratio. *See* Albumin/globulin ratio
Ag/AgCl electrode, 142–144, 396
Agammaglobulinemia, 698
Agar gel, 147
Agarose gel, 146–147, 204, 256, 256, 263, 346
Age, gestational, 97t
AGEs. *See* Advanced glycation end products
Aging, 673
biochemical and physiological changes of, 675–680, 675t–676t
clinical chemistry results and, 680–683, 681t
testosterone reduction with, 480, 674, 676–677
theories of, 674–675, 674t
of U.S. population, 673–674
 α -HBD. *See* α -Hydroxybutyrate dehydrogenase activity
AIP. *See* Acute intermittent porphyria
Airborne pathogens, 79
Airborne precautions, 37b
Air-displacement pipets, 14, 14–15
Airway, blockage of, 391
AK. *See* Adenylate kinase
Akathisia, 669
ALA. *See* δ -Aminolevulinic acid
ALA dehydratase deficiency porphyria (ADP), 426
Alanine, 225t, 226
Alanine aminotransferase (ALT), 296–297, 528, 554, 623
Albumin, 238–240, 239t, 250t, 256, 257, 258, 262
aging effects on, 679
as biochemical marker, 653–654

- Albumin (*continued*)
 calcium bound to, 505
 in cerebrospinal fluid, 599
 fractionation, identification, and quantitation of, 253–254, 254t
 in intestinal disease, 588
 surfactant ratio to, 596
 thyroid hormone binding by, 492
 urinary, 262, 326–327, 566
- Albumin/globulin (A/G) ratio, 253
- Alcohol
 acetaminophen consumption with, 633
 for capillary specimen collection, 64
 determination of, 626, 626–627
 liver disorders from, 524–525, 624–625
 osteoporosis with consumption of, 513–514
 toxicology of, 624–627, 625t, 626
- Alcohol dehydrogenase (ADH), 295, 624–627
- Alcoholism
 cirrhosis with, 522–524
 effect on analytes, 30
 γ -glutamyltransferase in, 301
- Aldehydes, 309, 310, 311
- Aldose form, of carbohydrates, 309, 310
- Aldosterone, 459, 678, 695
 in Addison's disease, 464
 adrenal mass secretion of, 474
 adrenal steroidogenesis of, 460–461, 461
 in congenital adrenal hyperplasia, 461–462, 461–462
 in potassium balance, 562
 in renal reabsorption of water and sodium, 560, 560–561
- Aldosterone-producing adenoma (APA), 463
- Aldosteronism, 462, 462–463
- Alendronate, 511, 514
- Alimentary hypoglycemia, 321
- Aliquot preparation, 72
- Alkalemia, 389
- Alkaline phosphatase (ALP), 30, 192, 297–299, 528, 554, 640t, 679
- Alkaline urine, 567, 570
- Alkalosis, 368, 385, 389–390, 398, 689, 689t
- Alkaptonuria, 230
- Allantoin, 270, 270
- Allergies, 48, 63
- Allopurinol, 272
- Allosteric site, 281
- Allowable analytic error (EA), 115–116, 116t
- ALP. *See* Alkaline phosphatase
- ALT. *See* Alanine aminotransferase
- Alveolar collapse. *See* Atelectasis
- Alveoli, 391
- Alzheimer disease, 250
- Amenorrhea, 483–484, 484t, 485, 485b
- American College of Cardiology/American Heart Association (ACC/AHA), heart failure classification system of, 545, 545t
- American Thyroid Association, hypothyroidism screening guidelines of, 496
- AMI. *See* Acute myocardial infarction
- Amikacin, 614
- Amiloride, 463
- Amino acids, 223–233, 224–225t, 228
 aminoacidopathies, 227–233, 228
 analysis of, 233
 basic structure, 223–224, 224, 225t
 essential, 224–226
 metabolism of, 224
 new, 227
 nonessential, 226–227
 overview, 223
- Aminoacidopathies, 227–233, 228
 alkaptonuria, 230
 argininosuccinic aciduria, 231–232
 citrullinemia, 231
 cystinuria, 232–233
 homocystinuria, 231
 isovaleric acidemia, 230–231
 maple syrup urine disease, 230
 phenylketonuria, 227–229, 228
 tyrosinemia, 229–230
- Aminoglycosides, 572, 610, 614
- δ -Aminolevulinic acid (ALA), 425–426, 428–429
- Aminopyrine, 664
- Aminosalicic acid, 662t, 664
- Aminotransferases, measurement of, 528
- Amiodarone, 306t, 491
- Amiodarone-induced thyroid disease, 498–499
- Amitriptyline, 306t, 619
- Ammonia, 266–267, 267t, 277, 277–279, 278t–279t
 buildup of, 231–232
 clinical application of measurement of, 277–278
 error sources in measurement of, 279
 liver removal of, 529
 methods for measurement of, 278, 278t
 pathophysiology of, 279
 in pediatric patients, 692–693
 physiology of, 277, 277
 reference interval for, 279, 279t
 renal reaction with, 563
 specimen requirements and interfering substances, 278–279
 from urease reactions, 267
- Ammonium chloride, 389
- Amniocentesis, 591–592
- Amniotic fluid (AF)
 absorbance of, 593, 594
 analysis of, 591–596, 593–596, 595t
 samples of, 29
- Amperometric-coulometric titration, for chloride determination, 367–368
- Amphetamines, 306t, 634–635, 634b
- Amphipathic helix, 331
- Amphipathic lipid, 330, 335
- Ampholyte, 146
- Amplicon, 207
- Amplification
 for nucleic acid amplification techniques, 203, 206, 206–208, 208
 of probe, 208
 of signal, 208–209, 209
 of target, 206, 206–208, 208
- AMR. *See* Analytic measurement range
- AMS. *See* Amylase
- Amylase (AMS), 301–303, 302t, 311, 581, 583–585
- Amyloid, 249–250
- Amyloidosis, 249
- Anabolic steroids, toxicology of, 635
- Anabolism, 656
- Anaerobic glycolysis, 312, 312–313, 378, 379
- Analgesic drugs, 571–572
- Analysis
 of amino acids, 233
 of body fluids, 591–602, 593–597, 595t, 601t
 of data to establish reference intervals, 99, 100
 of data to verify reference intervals, 99–101, 100–102, 102t
 of gastric function, 586
 of lipids and lipoproteins, 344–349, 345
 of reference values, 99
 statistical, of comparison-of-method studies, 114–115, 114–115
 of toxins, 624
- Analytes, 7
 aging effects on, 676t, 681
 concentration of, 4
 drug effects on, 30
 protection of, 71
 waived, 212t–213t
- Analytic considerations, for reference interval studies, 98, 98t
- Analytic errors, 117
- Analytic measurement range (AMR), 109b, 643
- Analytic methods
 for ammonia measurement, 278, 278t
 for bilirubin analysis, 526
 for blood gases, 401–402
 for calcium determination, 376, 377
 for cancer antigen, 125, 646
 for carcinoembryonic antigen, 647
 for chloride determination, 367–368
 for creatine measurement, 275
 for creatinine measurement, 274–275, 276t
 for α -fetoprotein, 645
 for hemoglobin, 437–439, 439
 for human chorionic gonadotropin, 647–648
 for inorganic phosphorus determination, 378
 for lactate determination, 380
 for magnesium determination, 372
 for myoglobin, 441
 for point-of-care testing, selection, and validation of, 216
 for porphyrins, 428–430
 for potassium determination, 366
 for prostate-specific antigen, 649
 for proteins, 252–259, 252t, 254t, 255–257, 259–261
 for renal function, 564–570
 for sodium determination, 362–363, 363
 for trace elements, 404–409, 404t, 405–407
 for tumor markers, 642–645
 of urea measurement, 267
- Analytic performance, 119b, 238t, 351
- Analytic phase, of total laboratory automation, 181–182, 182
- Analytic reagent (AR), 5
- Analytic sensitivity, 102, 109b
- Analytic specificity, 104, 109b
- Analytic techniques, 130–165
 chromatography, 147–155, 149–150, 152–153, 157–159, 229, 231, 233, 293, 325, 409, 595, 596, 626, 626–627, 644
 electrochemistry, 141–144, 141–145, 142t, 167, 278, 278t, 362–363, 363, 376, 377, 395–398
 electrophoresis, 145–147, 145–148, 156, 159, 183, 188–189, 188–189, 198, 199, 204–205, 233, 254–259, 255–257, 259–260, 263, 263, 290, 291, 292–293, 295, 298–299, 302, 305, 346, 438–439, 439, 565, 599
 mass spectrometry, 154–158, 154–160, 160–162, 183, 229–231, 233, 404, 404t, 406–409, 407, 409
 osmometry, 160–163, 163
 for point-of-care testing, 163–164, 163–164
 proteomics, 156, 159–160, 160–162
 spectrophotometry and photometry, 130–141, 131–136, 138–140, 176–178, 176–178, 257, 257–258, 278, 278t, 323, 394, 394–398, 404–408, 404t, 405–406
- Analytic testing, errors in, 123–125, 124t
- Analytic variability, 89b
- Analytical balances, 17, 17–18
- Analyze phase, of DMAIC, 122–123, 122b
- Analyzers, automated. *See* Automation
- Anatomy
 of adrenal gland, 458–459, 459
 of heart, 541, 542
 of liver, 516–517, 517–518
 of male reproductive tract, 477
 of ovary, 482
 of pituitary, 445–446, 446
 renal, 557, 558–559
 of thyroid gland, 490
 of vascular system, 39–41, 40
- Anchoring, of veins, 49–50, 54, 56
- Androgens
 in Cushing syndrome, 469
 excess of, 469–470, 470
 in hirsutism and virilization, 487t
 ovarian production of, 482
 in pediatric patients, 696
 of testes, 478
- Anemia, 669
 gastric analysis for, 586
 glucose-6-phosphate dehydrogenase in, 304
 haptoglobin testing for, 243
 with hemoglobinopathies, 434
 hemolytic, 243, 304, 521, 658
 jaundice with, 521
 megaloblastic, 661–663
 pernicious, 663

- from phlebotomy, 63
with thalassemias, 434–437
transferrin testing for, 243–244
- Angina pectoris, 543, 546–547
- Angiogenesis, 638*b*
- Angiotensin-converting enzyme (ACE), 461
- Anhydrous compounds, 16
- Anion gap (AG), 380–381, 381
- Anion-exchange resin, 149, 149
- Anions, 356, 380–381, 381
- Annealing, of probes, 204
- Anode, 395
- Anodic stripping voltammetry (ASV), 145, 409
- ANP. *See* Atrial natriuretic peptide
- Antacid, 371, 378, 587*b*, 617
- Antecubital veins, 39–41, 40
- Anterior pituitary, 445–446
failure of, 451, 453–454, 454*t*
hormones of, 448, 448*t*
- Anthropometric measurements, 651–652
- Antiarrhythmics, 612–613
- Antibiotics, 229, 275, 279, 654, 660, 662*t*
clearance of, 610
liver disorders from, 524
therapeutic drug monitoring of, 614–615
- Antibody (Ab), 185. *See also* Immunoglobulins
Ag binding by, 185–186
anti-enzyme, 305
against creatine kinase, 293
heterotrophic, 644
in labeled immunoassays, 190–200, 190*t*, 192, 193*t*, 194–196, 195*t*, 199
assay design, 192, 192–194, 193*t*, 194–195
examples of, 196, 196–197
immunoblots, 198, 199
immunocytochemistry and immunohistochemistry, 198–199
immunophenotyping, 199–200
labels, 190–192, 190*t*
rapid immunoassay, 197–198
separation techniques for, 194–196, 195*t*
production of, 697–698, 697*t*
against thyroid, 494, 494*t*
in unlabeled immunoassays, 186–190, 187–189, 187*t*
fluid-phase antigen-antibody complexes, 189–190
precipitation reactions, 186–189, 187–189, 187*t*
- α_1 Antichymotrypsin, 239*t*, 242
- Anticoagulants
for blood samples, 28, 29, 41, 44–46, 59, 71, 278, 321–322, 351, 362, 372, 376, 378, 394, 399, 417
as interferent, 113
- Anticoagulation therapy, 63, 72, 660, 662*t*, 664
- Anticonvulsants, 324, 511, 661
- Antidepressants, 575*b*
- Antidiuretic hormone. *See* Vasopressin
- Anti-enzyme antibodies, 305
- Antiepileptic drugs (AEDs), 615–618
- Antifungal agents, 620
- Antigen (Ag), 185
Ab binding by, 185–186
hepatitis B core antigen, 531, 531–532, 533, 533*t*
hepatitis B e antigen, 531–533, 532–534, 533*t*
hepatitis B surface antigens, 531, 531–532, 533, 533*t*, 534
hepatitis delta antigen, 535–536
in labeled immunoassays, 190–200, 190*t*, 192, 193*t*, 194–196, 195*t*, 199
assay design, 192, 192–194, 193*t*, 194–195
examples of, 196, 196–197
general considerations, 190
immunoblots, 198, 199
immunocytochemistry and immunohistochemistry, 198–199
immunophenotyping, 199–200
labels, 190–192, 190*t*
rapid immunoassay, 197–198
separation techniques for, 194–196, 195*t*
in unlabeled immunoassays, 186–190, 187–189, 187*t*
fluid-phase antigen-antibody complexes, 189–190
precipitation reactions, 186–189, 187–189, 187*t*
- Antigen excess. *See* Hook effect
- Antigen-antibody complexes, fluid-phase, 189–190
- Antiglycolytic agents, for blood samples, 45–46, 46*b*
- Anti-HBc, 532, 533*t*
- Anti-HBs, 532, 533*t*
- Antihistamines, 486*b*
- Antihypertensive drugs, 471, 473, 547
- Anti-inflammatory drugs, 524, 575*b*
- Antilogarithm, 20
- Antimalarial drugs, 304
- Antineoplastic agents, 524, 620–621
- Antipsychotics, 451
- Antiresorptive therapy, 249, 511–512, 514
- Antiseptic
for hand cleaning, 39
mercury in, 412
for sample collection, 29, 49, 54, 63
- α_1 Antitrypsin (AAT), 239*t*, 240–241, 257, 258
- APA. *See* Aldosterone-producing adenoma
- APCI. *See* Atmospheric pressure chemical ionization
- Apo. *See* Apolipoproteins
- Apoenzyme, 283
- Apolipoproteins (Apo), 331–336, 332*t*, 342–343
in lipid and lipoprotein analyses, 346–347
measurement of, 349
- Apoptosis, 638*b*, 674–675, 677
- Appearance
of cerebrospinal fluid, 597–598
of phlebotomist, 34
of urine, 566
- AR. *See* Analytic reagent
- Arachnoid villi/granulations, 597
- ARF. *See* Acute renal failure
- Arginine, 224, 225*t*, 236, 382
- Arginine supplementation, 231–232
- Arginine vasopressin hormone (AVP), 357, 360–362
- Argininosuccinic aciduria (ASA), 231–232
- Arrhythmia, 543, 546
- Arsenic, 408–410, 628
- Arsenobetaine, 408, 409
- Arsenocholine, 409
- Arterial blood, 28, 41, 399–400
- Arterial blood gas, reference range for, 388*t*
- Arterial puncture, inadvertent, from phlebotomy, 63
- Arteries, 39, 39
- ASA. *See* Argininosuccinic aciduria
- Ascites, 602
- Ascitic fluid, 602
- Ascorbic acid, 417, 664
- Asparagine, 225*t*, 226
- Aspartate aminotransferase (AST), 296, 528, 550, 554
- Aspartic acid, 225*t*, 226, 236
- Aspirin, 240, 277, 524, 588, 632, 662*t*, 664
- Assault, 35
- Assay. *See also* Analysis; Analytic methods
reported ranges of, 26
- Assay design, for labeled immunoassays, 192, 192–194, 193*t*, 194–195
- Assay values, 22
- Assayed materials, 117
- Assessment. *See also* Nutritional assessment
of acid-base homeostasis, 388–390, 388*t*
of liver function, 525–537, 527*t*, 530*t*, 531–533, 533*t*–534*t*, 536*t*
bilirubin analysis, 525–526, 527*t*
hepatitis tests, 529–537, 530*t*, 531–533, 533*t*–534*t*, 536*t*
liver enzymes, 528–529
serum bile acids, 527–528
tests for hepatic synthetic ability, 529
tests for nitrogen metabolism, 529
urobilinogen in urine and feces, 526–527
of patient's oxygen status, 392–393
of renal function, 266–267, 272–273, 276–277
- AST. *See* Aspartate aminotransferase
- ASV. *See* Anodic stripping voltammetry
- Atelectasis, of neonatal lung, 593–594
- Atherosclerosis, 245, 546, 553, 680
diagnosis and treatment of, 339–341
lipids and lipoproteins in, 329, 333–335, 546
- Atmospheric pressure chemical ionization (APCI), 155
- Atmospheric pressure ionization, 155, 156
- Atomic absorption spectrophotometry (AAS), 136, 136–138, 404–408, 404*t*, 405–406
- Atomic emission spectrometry (AES), 404–405, 404*t*, 405, 408
- Atorvastatin, 341
- ATP. *See* Adenosine triphosphate
- Atransferrinemia, 244
- Atria, 541
- Atrial natriuretic peptide (ANP), 459, 553
- Autism, 412
- Autoantibody
islet, testing for, 327
thyroid, 494, 494*t*
- Autoimmune thyroid disease, 494, 494*t*
- Automatic pipets, 13–15, 14
- Automation, 166–184
analyzers in
basic types of, 168, 169*t*
history of, 166–167
for pediatric samples, 687–688
selection of, 179–180
approaches to, 168, 169*t*
forces toward more, 167–168, 168
future trends in, 183
for pediatric samples, 687
steps in analysis, 168–179, 170*t*, 171–178
chemical reaction phase, 170*t*, 174–176, 175
measurement phase, 170*t*, 176–178, 176–178
reagent systems and delivery, 170*t*, 174, 174
signal processing and data handling, 170*t*, 178–179
specimen measurement and delivery, 170–173, 170*t*, 171–173
specimen preparation and identification, 170, 170*t*
total laboratory, 180, 180–183, 182
- Autoradiography, 203–204
- Autosplenectomy, 433
- Auxiliary enzyme, 287
- Average. *See* Mean
- Avidity, 186
- AVP. *See* Arginine vasopressin hormone
- AVP receptor antagonists, 361
- Awareness, for laboratory safety, 76
- Azathioprine, 272, 306*t*, 307
- Azotemia, 268

B

- B cells, 697
- Back-end automation, 180, 182
- Bacteria, in urinalysis, 569
- Balance
acid-base, 385–390, 386–387, 563
electrolyte, renal role in, 562–563
nitrogen, 225, 235, 250, 252, 654–655
nutrient, 652
of water, 360, 455, 561–562, 562, 690, 690*t*–691*t*
- Balances, 17, 17–18
- Bar code labels, 170–171, 171, 179
- Barbiturates, 279, 306*t*, 426, 429*b*, 467, 615, 624, 634*b*, 636, 662*t*, 664
- Barrier-layer cell, 134
- Basal testing, of gastric secretion, 586
- Base excess, 395, 398
- Bases, 8–9, 385
- Basic units, 3, 4*t*
- Basilic vein, 40, 49

- Basophilic stippling, 630
 Batch analysis, 168
 Battery, 35
 bDNA. *See* Branched chain signal amplification
 Beakers, Griffin, 11, 15
 Bedside manner, of phlebotomist, 34
 Beer's law, 26, 26–28, 131–132, 131–133, 405
 Bell curve. *See* Gaussian distribution
 Benedict's modification. *See* Clinitest
 Benzo[a]pyrene, 306t
 Benzodiazepine, 575b, 634b, 636
 Benzoylcegonine, 635–636
 Beriberi, 660
 β cells, 314, 316, 320–321, 327
 Beta-quantification, of low-density lipoproteins, 348
 BH₄. *See* Tetrahydrobiopterin
 Bias, 94, 99b
 Bicarbonate (HCO₃⁻), 368, 382, 386, 396, 398.
 See also Bicarbonate-carbonic acid buffer system
 carbon dioxide determination, 368
 clinical applications for, 368
 kidney reabsorption of, 386–387, 387
 reference range for, 368
 regulation of, 368
 renal regeneration of, 563
 Bicarbonate-carbonic acid buffer system, 384–386, 386, 388–390, 388t
 Bile, 516, 518
 Bile acid, 329, 331, 335, 527–528
 Bile-acid sequestrants, 341
 Biliary obstructive disease, 522
 Bilirubin, 691
 absorbance of, 592–593
 analysis of, 525–526, 527t
 collection of, 70–71, 525–526
 as interferent, 113
 liver excretion of, 518–519
 metabolism of, 518–519, 519
 retention of, 520–522, 522t, 523
 urinalysis measurement of, 568
 Bilirubinometry, 525
 Bimodal distribution, 93
 Binding
 Ab to Ag, 185–186
 of albumin, 240
 of enzymes, 284
 of thyroid hormone by protein, 492
 Binding capacity, of hemoglobin, 393
 Bioavailability, 606
 Biochemical assessment, 652
 Biochemical changes, of aging, 675–680, 675t–676t
 cardiovascular and lipid changes, 680
 diabetes mellitus and insulin resistance, 678
 endocrine function changes, 676–678
 enzyme changes, 680
 hepatic function changes, 679–680
 pulmonary function and electrolyte changes, 680
 renal function changes, 679
 Biochemical markers, 652–656, 653t
 Biochemistry
 of gastric secretion, 585–586
 of lactate, 378, 379
 of liver, 518–520, 519
 Biochips, 206
 Biohazardous materials, spills of, 78–79
 Biohazardous waste, 85
 Biologic safety, 78–79
 Biologic variation, in renal clearance, 565
 Biological fluids, 6–7
 Biomarkers, 159
 Biosafety cabinets, 76–77, 78t
 Biosensors, 164, 164, 183
 Biotin, 203–204, 664
 2,3-Bisphosphoglycerate (2,3-BPG), 376
 Bisphosphonates, 376, 511, 514
 Biuret method, 252t, 253, 261, 262t
 Bland-Altman plot. *See* Difference plot
 Blanking, in triglyceride measurements, 345–346
 α -Blockers, 474
 β -Blockers, 497, 499
 Blood
 arterial, 28, 41, 399–400
 calcium in, 501, 502–503, 503–505
 capillary, 41, 64–65, 64–65
 in cerebrospinal fluid, 598
 collection of (*See* Phlebotomy)
 exposure to, 75, 78–79
 source and composition of, 41
 types of specimens of, 41
 in urine, 568
 venous, 41, 399
 whole, 28, 41, 44, 72, 170, 321–322, 325
 Blood alcohol level, 624
 Blood gas analyzers, 395, 398–399
 Blood gases, 384–402
 acid, base, and buffer defined, 384–385
 acid-base balance, 385–388, 386–387
 acid-base homeostasis assessment, 388–390, 388t
 measurement of, 394, 394–398, 689
 monitoring of heart disease with, 554
 in neonates and infants, 688–689, 689t
 oxygen and gas exchange, 390–394, 391, 393
 point-of-care testing of, 218–219
 quality assurance, 398–402, 400
 reference range for, 388t
 specimen for, 28, 394–396, 399–400
 Blood glucose monitoring, 163, 164, 323
 Blood pressure. *See* Hypertension
 Blood supply
 of heart, 541–542, 542
 inadequacy of, 392
 of liver, 516, 517
 Blood tests, for evaluating thyroid gland, 493–494, 493t–494t
 Blood urea nitrogen (BUN), 266
 Blood volume, regulation of, 357–358, 358
 Bloodborne pathogens, OSHA standard for, 49, 75, 79
 Blood-brain barrier, 597, 599
 Blow-out pipets, 13
 BMI. *See* Body mass index
 BNP. *See* Brain natriuretic peptide
 Body composition, 651–652
 Body fluids
 analysis of, 591–602
 amniotic fluid, 591–596, 593–596, 595t
 cerebrospinal fluid, 597, 597–599
 fluorescence polarization for, 596–597
 phosphatidylglycerol, 596
 serous fluids, 601–602, 601t
 sweat, 599–600
 synovial fluid, 600–601
 biologic safety for, 78–79
 proteins in, 259–264, 262t, 263
 cerebrospinal fluid proteins, 29, 262–264, 263
 urinary protein, 260–262, 262t
 Body mass index (BMI), 651–652
 Boiling point, 8
 Bond specificity, of enzymes, 284
 Bone
 calcium in, 501, 503
 calcium metabolism and, 504–505
 metabolic disease of, 512–514, 513
 metabolism of, in pediatric clinical chemistry, 693–694, 694t
 resorption of, 373, 511–512
 turnover of, 504
 Bone density, 512–514, 513
 Bone disorders, 297–298, 300
 Bone isoenzyme, of alkaline phosphatase, 298
 Bound drugs, free drugs v., 606–607
 2,3-BPG. *See* 2,3-Bisphosphoglycerate
 Brain natriuretic peptide (BNP), 248, 553
 Branched chain signal amplification (bDNA), 208, 209
 Branched-chain amino acids, 225–226, 230
 Breach of confidentiality, 35
 Breast cancer, 640, 644, 646
 Breast, Tanner staging of development of, 483, 483t
 Bromocriptine mesylate, 453
 Bronchodilators, 397b, 472
 Bruton's disease, 698
 BTP. *See* β -Trace protein
 Bubble test, 594
 Buccal testosterone, 481
 Buffers, 8, 384–402
 acid, base, and buffer defined, 384–385
 acid-base balance, 385–388, 386–387
 acid-base homeostasis assessment, 388–390, 388t
 for electrophoresis, 146
 measurement of, 394, 394–398
 oxygen and gas exchange, 390–394, 391, 393
 point-of-care testing of, 218–219
 quality assurance, 398–402, 400
 reference range for, 388t
 regulation of H⁺ by, 385, 386
 in solutions, 8–9
 Bulbs, pipet, 13, 13
 BUN. *See* Blood urea nitrogen
 Bupropion, 306t
 Burets, 11t, 15, 15
 Burner, for atomic absorption spectrophotometer, 137
 Burnett's syndrome. *See* Milk-alkali syndrome
 Burns, as phlebotomy problem site, 62
 Butterfly system, 41, 44, 45, 53–55, 54–55, 61
 Butyrophenones, 451
C
 CA-125. *See* Cancer antigen 125
 Cabergoline, 453
 Cabinets, biosafety, 76–77, 78t
 CAD. *See* Coronary artery disease
 Cadmium, 410–411, 628
 Caffeine, 306t, 702t
 CAH. *See* Congenital adrenal hyperplasia
 Calcitonin, 373, 490, 511, 641t
 Calcitriol, 512
 Calcium, 373–376, 374, 374t, 377, 377t, 382, 588
 clinical applications of, 374, 374–376, 374t
 determination of, 376, 377
 distribution of, 373–374
 homeostasis of, 501–515, 502
 hormonal regulation of calcium metabolism, 501–504, 502–503
 hypercalcemia, 374, 374t, 375–376, 504, 505–508, 507
 hypocalcemia, 374, 374–375, 374t, 504, 508–512, 509
 metabolic bone disease, 512–514, 513
 organ physiology and calcium metabolism, 504–505
 metabolism of, 665–666, 666t
 drugs affecting, 510–512
 hormonal regulation of, 501–504, 502–503
 organ physiology and, 504–505
 monitoring of, 665–666, 666t
 in pediatric clinical chemistry, 693–694, 694t
 physiology of, 373
 recovery study of, 112, 113
 reference range for, 376, 377t
 regulation of, 373
 renal role in balance of, 562–563
 Six Sigma chart for testing of, 125, 126
 Calcium chloride, 389
 Calcium ion-selective electrode, 144
 Calcium therapy, 375, 508–510, 514
 Calcium-sensing receptors, 504
 Calculated parameters, of blood gas measurement, 398
 Calculations, 19–28, 24–26
 concentration, 20–23
 dilution, 23–26, 24–25
 enzyme activity, 27–28, 287–288
 logarithms, 20
 one point, 27
 significant figures, 19
 water of hydration, 26
 Calculi, renal, 571–572, 571t

- Calibration
 of automated analyzers, 178–179
 of balances, 18
 of blood gas measurements, 398
 one point, 27
 of pH meter, 143, 143
 of pipets, 15–16
 of thermometers, 10
- Calibration curves, for spectrophotometry, 133
- Calomel electrode, 142–143, 396
- Cancer, 637. *See also* Tumor markers; Tumors; *specific cancers, e.g.,* Breast cancer
 acid phosphatase in, 299–300
 alkaline phosphatase association with, 298–299
 cases and deaths of, 638t
 flow cytometry indication of, 200
 hypercalcemia with, 506–507
 monitoring of recurrence of, 542
 prognosis of, 640–642
 screening for, 640
 staging of, 637, 639, 645
- Cancer antigen 125 (CA-125), 646
- Cancer therapy, monitoring of effectiveness of, 542
- Cannabinoids, toxicology of, 635
- CAP. *See* College of American Pathologists
- Capacity, of hemoglobin, 393
- Capillaries, 39, 39
- Capillary blood, 41, 64–65, 64–65
- Capillary electrophoresis (CE), 147, 147–148, 183, 205, 233, 258–259
- Capillary puncture, 34, 64–67, 64–70, 69, 687, 687t
- Captopril, 365, 463
- Carbamates, 631
- Carbamazepine, 243, 306t, 467, 616–617, 702t
- Carbohydrates, 309–327
 as biochemical markers, 656
 general description of, 309–314, 310–312, 313t–314t
 chemical properties, 311, 311
 classification, 309–310, 310
 glucose fate, 311–313, 312, 313t
 glucose metabolism, 309, 310, 311
 monosaccharides, disaccharides, and polysaccharides, 310–311, 311
 regulation of carbohydrate metabolism, 313–314, 314t
 stereoisomers, 310, 311
 genetic defects in metabolism of, 231
 hyperglycemia, 314–320, 315t–316t, 318t–319t
 hypoglycemia, 320–321, 320t
 laboratory role in differential diagnosis and management of patients with glucose metabolic alterations, 321–327, 322t, 324t–326t, 326
 liver synthesis of, 519
 metabolism of, in pediatric patient, 691–692, 691t
 as tumor markers, 642t
- Carbon dioxide, 385–386, 388, 398
 bicarbonate and, 368
 determination of, 368
 oxygen and, 390–392, 391
 partial pressure of, 391, 395, 680
 reference range for, 368
- Carbon monoxide, toxicology of, 627, 627t
- Carbonic acid, 396, 398. *See also* Bicarbonate-carbonic acid buffer system
- Carboxyhemoglobin (COHb), 392–394, 627, 627t
- Δ^9 -Carboxytetrahydrocannabinol, 154
- Carcinoembryonic antigen (CEA), 638, 646–647
- Carcinogenic chemicals, 81
- Carcinoplacental alkaline phosphatases, 298–299
- Cardiac function, 541–556
 anatomy of heart, 541, 542
 diagnosis of heart disease, 549–555, 551
 function of heart, 541–542, 542
 pathologic conditions of heart, 543–549, 543t, 545t–546t, 547, 548t–549t
- Cardiac glycosides, 612
- Cardiac markers, 550–551, 551
 brain natriuretic peptide, 248, 553
 of congestive heart failure, 553
 creatine kinase, 289–293, 290t, 291–292, 551
 lactate dehydrogenase, 294, 550–551
 myoglobin, 247, 440–441, 551–552
 point-of-care testing for, 554
 troponin, 248, 441, 541, 550–552
- Cardiac tests, patient-focused, 554
- Cardiac troponin. *See* Troponin
- Cardioactive drugs, 612–614
- Cardiomyopathy, 546, 670
- Cardiovascular defects, congenital, 544–545
- Cardiovascular disease (CVD), 543–544, 543t, 548
 with aging, 680
 CRP and hsCRP in, 245–246
 with Cushing syndrome, 466
 diagnosis of, 549–555, 551
 lactate dehydrogenase in, 294–295, 550–551
 lipids and lipoproteins in, 337, 339–341
 selenium deficiency in, 670
 symptoms of, 543–544, 543t
- Cardiovascular function, aging effects on, 680
- Carnitine, 230, 664–665
- Carotenoids, serum, 588
- Carry-over
 of additives, 46–47, 46b, 46t–47t
 in automated analyzers, 168, 172–173
- Carvedilol, 306t
- Caspase, 675
- Castor oil, 583
- Casts, in urinalysis, 569
- Catabolism, 235, 655
- Catalytic mechanism, of enzymes, 283, 283–284
- Catechol methyltransferase (COMT), 471, 472
- Catecholamines, 470–474, 471–472, 474, 641t
- Cathode, 395
- Cation-exchange resin, 149, 149
- Cations, 356, 380–381, 381
- Caustic agents, toxicology of, 627
- CCK. *See* Cholecystokinin
- CCVDs. *See* Congenital cardiovascular defects
- CDC Cholesterol Reference Method Laboratory Network, 351
- CE. *See* Capillary electrophoresis
- CEA. *See* Carcinoembryonic antigen
- Cecum, 587
- CEDIA. *See* Cloned enzyme donor immunoassay
- Cefepime, 572b
- Celecoxib, 306t
- Cell cycle, 638b
- Cells
 galvanic and electrolytic, 141, 141
 for spectrophotometer, 134, 137
 in urinalysis, 568
- Cellular acetate, 146–147, 256, 256, 263
- Cellular breakdown, potassium release by, 364
- Cellular casts, in urinalysis, 569
- Cellular mechanism, of testosterone action, 478
- Cellulose acetate hemoglobin electrophoresis, 438–439, 439
- Center, of data, 89–90, 89–91, 91t
- Centers for Medicare and Medicaid Services (CMS), 108
 point-of-care testing requirements of, 211, 213, 214t
- Central cyanosis, 544
- Central nervous system-specific acetylcholinesterase (CNS-specific AChE), 592
- Centrifugal analyzers, 166, 168, 175, 177–179
- Centrifugation, 18–19, 18–19
 hazards of, 84
 of samples, 28–30, 72, 78
- CEP. *See* Congenital erythropoietic porphyria
- Cephalic vein, 40
- Cephalosporins, 275
- Cerebrospinal fluid (CSF)
 analysis of, 597, 597–599
 electrophoresis of, 146, 263, 263, 599
 glucose in, 29, 322
 proteins in, 29, 262–264, 263
 samples of, 29
- Cerebrovascular disease (CVD), 339, 343
- Certified reference material (CRM/SRM), 6
- Ceruloplasmin, 239t, 243, 415
- CETP inhibitors, 340
- CF. *See* Cystic fibrosis
- Chain of custody, 31, 71
- Channels of analyzers, 166
- Characteristic, of logarithm, 20
- Charcoal, as separation technique for labeled immunoassays, 195
- Charge, of proteins, 236, 236
- Charts, Six Sigma, 125, 126
- CHD. *See* Coronary heart disease
- Chelation therapy, 413b, 415, 416–417, 437, 630
- Chemical analysis, for urinalysis, 567–568
- Chemical fume hoods, 76
- Chemical hygiene officer, 75
- Chemical hygiene plan, 75, 80
- Chemical properties, of carbohydrates, 311, 311
- Chemical reactions
 in analyzers in total automated systems, 181–182, 182
 in automated analyzers, 174–177, 175
- Chemical waste, 85
- Chemically pure reagent, 5
- Chemicals
 carcinogenic, 81
 corrosive, 81, 81t
 disposal of, 84–85
 flammable/combustible, 81, 81t
 grades of purity of, 5–6
 hazardous, 75, 79–81, 81, 81t
 labeling of, 76, 77
 reactive, 81, 81t
 safety with, 79–81, 81, 81t
 spills of, 81, 81
 storage of, 77, 80–81, 81t
- Chemiluminescence, 140, 140, 177, 252
- Chemiluminescent assay, 190t
- Chemistry. *See also* Clinical chemistry
 of fire, 82, 82
 of gastric secretion, 585–586
 of lipids, 329, 329–331
 of nucleic acids, 202–203, 203
 point-of-care testing of, 218–219
 of porphyrins, 424–425, 425
- Chemotherapy, 65, 272, 277b, 307, 638, 646–647, 648b, 661
 monitoring of, 542
 testicular damage with, 480
- Cherry-Crandall method, 303–304
- Chest pain, 543, 546–547
- CHF. *See* Congestive heart failure
- Children
 capillary puncture for, 65, 687, 687t
 lead poisoning in, 628–629, 629
 type 2 diabetes testing in, 318
 venipuncture of, 60–61, 61
- Chip technology, 183, 206
- Chloramphenicol, 306t
- Chlordiazepoxide, 636
- Chloride, 366–368, 367, 368t, 382
 clinical applications for, 367
 determination of, 367–368
 disturbances of, 656
 in kidney medulla, 560
 reference ranges for, 368t
 renal role in balance of, 562
 in sweat, 583, 600
- Chloride ion-selective electrodes, 145
- Chloride shift, 367, 367, 386
- Chloridometers, Coulometric, 145
- Chloripramine, 306t
- Chlorpheniramine, 306t
- Chlorpromazine, 306t
- Chlorzoxzone, 306t
- Cholecystokinin (CCK), 579, 581–582
- Cholesterol, 328–329
 in adrenal steroidogenesis, 459–460, 460
 in arteriosclerosis, 340–341
 chemistry of, 329, 330–331
 in combined hyperlipoproteinemia, 343
 dietary, 338–339
 in hypercholesterolemia, 341–342

- Cholesterol (*continued*)
 in hyperlipoproteinemia, 341
 in lipoprotein physiology and metabolism, 334, 334–336
 in lipoproteins, 331, 333
 measurement of, 344–345, 345
 NCEP goals for, 238t
 in ovarian steroidogenesis, 482
 population distributions of, 336–337, 336t
 standardization of measurement of, 350–351
 in testicular steroidogenesis, 478
 in vitamin D synthesis, 502, 502
- Cholesteryl ester, 330, 331, 333–335
- Cholestyramine resin, 341b
- Chromatogram, 151, 152, 153
- Chromatography, 147–154, 149–150, 152–153
 adsorption, 148
 for amino acid analysis, 233
 gas, 151–155, 153, 229, 626, 626–627
 gas-liquid, 152
 gas-solid, 152
 GC/MS, 154–155, 157–159, 409
 gel permeation, 149
 for hemoglobin A_{1c} measurement, 325
 high-performance liquid, 150, 150–152, 152, 229, 231, 233, 644
 ion, 409
 ion-exchange, 149, 149, 233, 293
 LC/MS, 154–155, 157–159
 LC-MS/MS, 231
 liquid-liquid, 148
 liquid-solid, 148–149, 149
 modes of separation, 148–149, 149
 partition, 148
 procedures, 149–154, 150, 152–153
 steric exclusion, 148–149, 149
 thin-layer, 149–150, 150, 233, 595, 596
- Chromium, 413–414
- Chromogenic method, for amylase activity assay, 302–303, 302t
- Chromogranin A, 473, 641t
- Chronic glomerulonephritis, 570
- Chronic hepatitis, 530, 533–535, 534t
- Chronic kidney disease (CKD), 565, 573, 573–574, 574t
- Chronic lymphocytic thyroiditis, 494, 496
- Chronic renal failure, 573, 573–574, 574t
- Chronic toxicity, 623–624
- Chylomicrons, 331–333, 332t, 342–343
 in lipid and lipoprotein analyses, 347–349
 in lipoprotein physiology and metabolism, 334–335
- CID. *See* Collision-induced dissociation
- Cimetidine, 306t
- Ciprofloxacin, 306t
- Circulating tumor markers. *See* Tumor markers
- Circulation, development of, 686
- Cirrhosis, 522–524, 535, 625
- Cisplatin, 370, 648b
- Citrate, 372, 378, 417, 612
- Citrate agar hemoglobin electrophoresis, 439, 439
- Citrin, 231
- Citrullinemia, 231, 232
- Civil actions, 35
- CK. *See* Creatine kinase
- CK-BB, 290–293, 290t, 291
- CKD. *See* Chronic kidney disease
- CK-MB, 98t, 290–293, 290t, 291–292, 551–552
- CK-Mi. *See* Mitochondrial-CK
- CK-MM, 290–293, 290t, 291
- Clarke electrodes, 395
- Class A tolerances, 10–11, 11t
- Class switching, of immunoglobulins, 246
- Classification
 of amenorrhea, 485b
 of carbohydrates, 309–310, 310
 of chronic kidney disease, 574t
 of diabetes mellitus, 314–316, 315t
 of enzymes, 282t, 283
 of fire, 82
 of heart failure, 545, 545t
 of hypertension, 548, 548t
 of hyponatremia by osmolality, 360–361, 360t
 of proteins, 237–238, 237t
- Cleaning
 of automated analyzer probes, 172–173, 175
 of biologic sample spills, 78–79
 of capillary puncture site, 66, 69
 of chemical spills, 81, 81
 of glassware and plasticware, 10–11
 of venipuncture site, 49, 54
- Clearance. *See also* Creatinine clearance
 of amylase, 585
 of drugs, 607–610, 608, 682, 701
 measurements of, 564–565
- CLIA. *See* Clinical Laboratory Improvement Amendments
- CLIA 88. *See* Clinical Laboratory Improvement Amendments Act of 1988
- Client interaction, in phlebotomy, 34–35, 35b
- Clinical analysis
 of gastric function, 586
 in nutritional assessment, 652
- Clinical and Laboratory Standards Institute (CLSI), 6–7, 33, 46b, 75, 399–400
 recommendations for establishing reference interval, 97, 97b
- Clinical application
 of ammonia measurement, 277–278
 of bicarbonate, 368
 of calcium, 374, 374–376, 374t
 of cancer antigen 125, 646
 of carcinoembryonic antigen, 647
 of chloride, 367
 of creatinine and creatine measurements, 273–274
 of α -fetoprotein, 645
 of human chorionic gonadotropin, 647
 of lactate, 378
 of magnesium, 369–372, 370t–372t
 of phosphate, 377–378
 of prostate-specific antigen, 649
 of sodium, 359–362, 360t–362t
 of tumor marker detection, 638–642, 643
 of urea measurement, 267
 of uric acid measurement, 270
- Clinical chemistry
 aging effects on, 680–683, 681t
 basic principles and practice of, 3–32
 clinical laboratory supplies, 9–18, 11t–12t, 12–15, 17
 laboratory mathematics and calculations, 19–28, 24–26
 reagents, 5–9
 separation techniques, 18–19, 18–19
 specimen considerations, 28–31, 29, 31t
 units of measure, 3–5, 4t
 for geriatric patient, 673–684
 aging effects on chemistry results, 680–683, 681t
 biochemical and physiological changes of aging, 675–680, 675t–676t
 geriatric patient impact on clinical laboratory, 673–674
 theories of aging, 674–675, 674t
- pediatric, 685–703
 calcium and bone metabolism in pediatric, 693–694, 694t
 development of liver function, 691–693, 691t
 developmental changes from neonate to adult, 685–686
 drug metabolism and pharmacokinetics, 701–702, 702t
 endocrine function in pediatrics, 694–696, 695t
 genetic diseases, 698–701, 699t–700t
 immune system development, 696–698, 697t
 phlebotomy and choice instrumentation for, 686–688, 686t–687t
 point-of-care analysis in, 688, 688t
 regulation of blood gases and pH in neonates and infants, 688–689, 689t
 regulation of electrolytes and water in pediatric patients, 689–690, 690t–691t
 renal function in pediatric patients, 689–690, 690t–691t
- Clinical chemistry analytes. *See* Analytes
- Clinical evaluation, of hyperprolactinemia, 452
- Clinical lab personnel, safety awareness and responsibilities of, 76, 77
- Clinical laboratory
 geriatric patient impact on, 673–674
 mass spectrometry applications in, 158–159
- Clinical laboratory automation. *See* Automation
- Clinical Laboratory Improvement Amendments (CLIA), 554, 644
 licensing and regulation by, for point-of-care testing, 211–213, 212t–214t
 method validation regulations of, 108, 109t
- Clinical Laboratory Improvement Amendments Act of 1988 (CLIA 88), 28, 115, 288
 in automated testing, 167
 in point-of-care testing, 211–213, 212t–214t, 216–217
- Clinical laboratory supplies. *See* Laboratory supplies
- Clinical reportable range (CRR), 109b
- Clinical sensitivity, 102
- Clinical setting, metabolic disease diagnosis in, 700–701, 700t
- Clinical significance
 enzymes of, 288–307, 289t–290t, 291–292, 294t–295t, 302t, 306t
 acid phosphatase, 299–300
 alanine aminotransferase, 296–297, 528, 554, 623
 alkaline phosphatase, 30, 192, 297–299, 528, 554, 640t, 679
 amylase, 301–303, 302t, 311, 581, 583–585
 aspartate aminotransferase, 296, 528, 550, 554
 creatine kinase, 288–293, 289t–290t, 291–292, 541, 551
 drug-metabolizing enzymes, 305–307, 306t
 glucose-6-phosphate dehydrogenase, 304
 γ -glutamyltransferase, 300–301, 529, 554, 623
 lactate dehydrogenase, 30, 293–295, 294t–295t, 529, 541, 550–551, 640t, 679
 lipase, 303–304, 581, 585
 macroenzymes, 304–305
 of hemoglobin, 432–437, 436
 of myoglobin, 440–441, 440t
 of osmolality, 357
 of porphyrins, 425–428, 426t
- Clinical specificity, 104
- Clinical toxicology, 622
- Clintest, 322t, 323
- Clofibrate, 341
- Cloned enzyme donor immunoassay (CEDIA), 197
- Clonidine, 471–473
- Closed tube sampling, 171, 172
- Clot, 28, 29
- Clot activator, 43t, 46, 46t, 71
- Clotting, 245
- Clozapine, 619
- CLSI. *See* Clinical and Laboratory Standards Institute
- CMS. *See* Centers for Medicare and Medicaid Services
- CNS-specific AChE. *See* Central nervous system-specific acetyl-cholinesterase
- Coagulation disorders, markers of, 552–553
- Coagulation, point-of-care testing of, 219
- Cobalamin, 662–664
- Cocaine, 306t, 634b, 635–636
- Codeine, 306t, 636
- Coefficient
 correlation, 93, 93
 osmotic, 160
 partition, 148
- Coefficient of variation (CV), 90, 90–91, 91t, 111
- Coenzyme, 283, 285, 287

- Cofactor, 281–283, 285–287, 404
COHb. *See* Carboxyhemoglobin
Coinfection, of HBV and HDV, 535–536, 536t
Cold medicine, 634, 634b
Cold vapor atomic absorption spectrophotometry (CVAAS), 406
Collapsed vein, 59, 60
Collecting duct, of kidney, 557, 561
Collection, 28–29, 29
of bilirubin specimen, 70–71, 525–526
of blood (*See* Phlebotomy)
data, by chemistry analyzers, 170t
of samples, 28–29, 29, 682–683
for determining blood gases, 394–396, 399–400
from elderly patients, 682–683
for potassium determination, 366
for therapeutic drug monitoring, 612
for trace element analysis, 404
of urine, 29, 564, 566, 588
Collection tubes. *See* Tubes
College of American Pathologists (CAP), 75, 96b, 108, 119, 168, 211, 213
Colligative properties, of solutions, 8, 160
Collision-induced dissociation (CID), 157
Colon cancer, tumor markers for, 640, 647
Color, of urine, 566
Colorectal cancer, 646–647
Columns, chromatography, 151, 153
COM studies. *See* Comparison-of-method studies
Coma, hepatic, 529
Combination pH electrode, 142–144, 144
Combined hyperlipoproteinemia, 343
Combustible chemicals, 81, 81t
Commercial grade, 5
Commission on Laboratory Accreditation, 75
Communication
on hazards, OSHA standard for, 75, 79
of phlebotomist with patient, 34
in point-of-care testing, 215–218, 215b
for proficiency testing, 218
Compact analyzers, for lipids and lipoproteins, 349
Comparison-of-method (COM) studies, 92, 113–115, 114–115, 114b
Compensation, for acid-base imbalance, 389–390
Competitive immunoassays, 192, 192–193, 193t, 194
Competitive inhibitors, 286, 286
Complement, 239t, 244–245
Complications, of phlebotomy, 63–64
Composition
of blood specimens, 41
body, 651–652
Compressed gases, 77, 84
Computers
in automated analysis, 179
in total laboratory automation, 182–183
COMT. *See* Catechol methyltransferase
Concentrated solutions, 8, 139, 139
Concentration
absorbance relationship to, 26, 26–28, 131–132, 131–133
calculation of, 20–23
of drugs in body, 605–610, 606
antibiotics, 614–615
antiepileptic drugs, 615–618
antineoplastics, 620–621
cardioactive drugs, 612–614
immunosuppressive drugs, 619–620
modeling of, 610–611, 610–611
psychoactive drugs, 618–619
of enzyme substrates, 284–285, 284–285
of enzymes, 287–288
of solutions, 7–8, 20–23, 160–163, 163
converting units in, 23
molality, 8
molarity, 7–8, 21–22
normality, 8, 22
percent solutions, 7, 20–21
saturation in, 8
of trace metals, 137
units of, 4
Conductivity, of solutions, 8
Confidence interval, 99b
Confidence-interval criteria, 116
Confidentiality, patient, 35
Conformation, of proteins, 235
Congenital adrenal hyperplasia (CAH), 461–462, 461–462, 696
Congenital cardiovascular defects (CCVDs), 544–545
Congenital diseases, of adrenal cortex, 695t
Congenital erythropoietic porphyria (CEP), 426–427
Congenital hypothyroidism, 490, 694
Congestive heart failure (CHF), 248, 543, 546, 553, 612
Conivaptan, 361, 455
Conjugated bilirubin, 518, 525–526, 691
Conjugated hyperbilirubinemia, 521–522
Conjugated proteins, 238
Connectivity, in point-of-care testing, 219
Consent, of patient, for blood sampling, 34–35, 35b
Constant systemic error, 94–95, 94b, 99b, 110b, 114–115, 115
Contact precautions, 38b
Containers, for specimens, 170–171
Contamination, additive, 46–47, 46b, 46t–47t
Continuous flow analyzers, 166, 168, 171–172, 174–176, 178
Continuous monitoring technique, for amylase activity assay, 302t, 303
Continuous-monitoring assays, for measuring enzyme activity, 287
Contraceptives, oral, 243, 245, 324, 470, 485, 487t
effect on analytes, 30
effect on nutrition, 660–661, 662t
Contract negotiation, in point-of-care testing, 216
Control charts, 116b, 117, 117
Control limits, 116–118, 116b, 118
Control material, 116–117, 116b
Control phase, of DMAIC, 122–123, 122b
Control plan
for exposure to blood, 75, 79
for exposure to tuberculosis, 79
Control rules, 118–119, 118t, 125–126
Conversions, of units, 23
Cooley's anemia. *See* Thalassemia major
Coximeter, 394, 394–398
Copper, 243, 408, 414–415, 415t, 421, 666–667
COPRO. *See* Coproporphyrin
Coproporphyrin (COPRO), 424–430
Coronary artery disease (CAD), 339, 342
Coronary heart disease (CHD)
with aging, 680
lipids and lipoproteins in, 328–329, 333, 339–344
NCEP risk factors for, 337, 337t
Corpus luteum, 482–483
Correlation coefficient (r), 93, 99, 114–115
Corrosive chemicals, 81, 81t
Cortex. *See* Adrenal cortex
Cortical bone, 505
Corticosteroid therapy, 268, 324, 523
Corticotropin-releasing hormone (CRH), 459–461, 463, 465, 465, 695
Corticotropin-releasing hormone stimulation test, for Cushing's syndrome, 467–468
Cortisol, 306t, 314, 641t, 678, 695
in Addison's disease, 463–465, 464
in adrenal gland, 459, 461
adrenal mass secretion of, 474
in congenital adrenal hyperplasia, 461–462, 461–462
in Cushing's syndrome, 465–467
in hypercortisolism, 465, 465
in primary aldosteronism, 463
Cortisol therapy, 472
Cosyntropin, 464
Coulometric chloridometers, 145
Coumarin, 306t
Countercurrent multiplier system, 560
Counterimmunoelectrophoresis, 188
Coupled-enzyme assay, 270, 271t, 275, 287
C-peptide, 641t
CrCl. *See* Creatinine clearance
C-reactive protein (CRP), 240t, 245, 552–553, 655, 697
Creatinase assay, 275
Creatine, 266, 267t, 273, 273–277, 276t
Creatine kinase (CK), 288–293, 289t–290t, 291–292, 541, 551
Creatinine, 29, 266, 267t, 269, 273, 273–277, 276t, 561
Creatinine clearance (CrCl), 29, 273–274, 564–565, 682
CRH. *See* Corticotropin-releasing hormone
Crigler-Najjar syndrome, 521, 691
CRM/SRM. *See* Certified reference material
Cross-linked C-telopeptides (CTX), 249
Cross-reactivity, 186
CRP. *See* C-reactive protein
CRR. *See* Clinical reportable range
Cryogenic materials, 84
Crystals, in urinalysis, 569–570
CSF. *See* Cerebrospinal fluid
cCO₂. *See* Total carbon dioxide content
cTn. *See* Troponin
CTX. *See* Cross-linked C-telopeptides
Cumulus cells, 482
Curve, standard, 26, 26–28
Cushing's syndrome, 465, 465–469, 468–469
Cut-off, for diagnostic tests, 105, 106, 108
Cuvets, 134, 137, 171, 172, 175, 177
CV. *See* Coefficient of variation
CVAAS. *See* Cold vapor atomic absorption spectrophotometry
CVD. *See* Cardiovascular disease; Cerebrovascular disease
Cyanide, toxicology of, 627–628
Cyanosis, 544
Cycle time, Lean Six Sigma reduction of, 123, 123–124
Cyclophosphamide, 306t
Cycloserine, 661
Cyclosporin A, 511
Cyclosporine, 306t, 365, 370, 610, 619–620
CYP 450 enzymes. *See* Cytochrome P450 enzymes
Cystatin C, 249, 565
Cysteine, 225t, 226, 236
Cysteine supplementation, 231
Cystic fibrosis (CF), 579–580, 583, 600, 699
Cystinuria, 232–233
Cytochrome P450 (CYP 450) enzymes, 305–307, 520, 612
Cytochromes, 424
Cytosine, 202–203, 203
Cytosine arabinoside, 277b
D
D genes. *See* Diversity genes
Danazol, 487t
Data analysis
by chemistry analyzers, 170t
to establish reference intervals, 99, 100
to verify reference intervals, 99–101, 100–102, 102t
Data collection, by chemistry analyzers, 170t
Data management
in automated analysis, 170t, 178–179
in point-of-care testing, 219
in total laboratory automation, 182–183
Data management systems, standardization of, 5
Databases, of protein structures, 237–238
Daughter ion, 157
dDAVP, 455
de Quervain's thyroiditis. *See* Painful thyroiditis
Dead space air, 391
Death, leading causes of, 676t
Decongestants, 472
Defects per million opportunities (DPMC), reduction of, 123–125

- Deferoxamine, 416
- Deficiency
of absorption, 580–581, 587–588, 658
of chromium, 414
of copper, 415, 666–667
of growth hormone, 451
of iron, 243, 416, 654, 669
of manganese, 419
of molybdenum, 419
5 α -reductase, 479
of selenium, 420
of trace minerals, 666–670
of vitamin D, 512, 588, 656, 659, 677
of vitamins
fat-soluble, 588, 657–660, 657t
water-soluble, 657t, 660–665, 662t
of zinc, 421
- Deficit, water, 357
- Define, Measure, Analyze, Improve, Control (DMAIC), 121–123, 122, 122b
- Define phase, of DMAIC, 122–123, 122b
- Degradation
of catecholamines, 471
of hemoglobin, 431–432, 431–432
- Dehydration, 250–251, 679
- Dehydroepiandrosterone (DHEA), 459, 469–470, 470, 676, 678
- Dehydroepiandrosterone sulfate (DHEAS), 459, 470
- 5-Dehydrotestosterone (5-DHT), 469
- Deionized water, 6–7
- DELFA. *See* Dissociation-enhanced lanthanide fluoroimmunoassay
- Deliquescent substances, 16
- Delivery
of reagents in automated analysis, 170t, 174, 174
of specimens in automated analysis, 170–173, 170t, 171–173
- Delivery time limits, of blood samples, 71
- Delta absorbance, 27
- Delta bilirubin, 521, 525
- Deming regression analysis, 114, 114b
- Denaturation, 235, 285
- Densitometer, 147, 147, 257, 257–258
- Density
of bone, 512–514, 513
of solutions, 22
- 11-Deoxycortisol (11-DOC), 464
- Deoxyhemoglobin (HHb), 392–394
- Deoxyribonucleic acid (DNA)
amplification of, 206, 206–208, 208
chemistry of, 202–203, 203
flow cytometry analysis of, 200
protein synthesis from, 233–234, 234
- Derived units, 3, 4t
- Dermal puncture. *See* Capillary puncture
- Descriptive statistics, 89–92, 89–93, 89b, 91t
of groups of paired observations, 92–95, 93–94, 94b
- Descriptive toxicology, 622
- Desferrioxamine, 428
- Desiccants, 16–17, 17
- Desiccators, 16–17, 17
- Designated contacts, for point-of-care testing, 214
- Designated trainers, for point-of-care testing, 214
- Desipramine, 619
- Detection
in electrophoresis, 147, 147
for labeled immunoassays, 190t
limit of, 102, 109b
- Detectors
for chromatography, 151, 153–154
for mass spectrometry, 158, 158
of spectrophotometer, 134–135, 134–137
- Detoxification, by liver, 520
- Development
of adrenal medulla, 470–471
of immune system, 696–698, 697t
of liver function, 691–693, 691t
postnatal, testosterone actions in, 478, 478t
prenatal, testosterone actions in, 478
sexual, 479–480, 479b, 483, 483t
of thyroid gland, 490
- Developmental changes, from neonate to adult, 685–686
- Developmental theories of aging, 674
- Devices, for point-of-care testing, selection of, 216
- Dexamethasone, 306t, 466–467, 468
- Dexamethasone nonsuppression adrenocorticotrophic hormone secretion, adrenocorticotrophic hormone source in, 466
- Dexamethasone suppression test, 467, 468, 470
- Dextran, as separation technique for labeled immunoassays, 195
- Dextromethorphan, 306t
- DFA. *See* Direct fluorescence assays
- D-glucose, 310
- DHEA. *See* Dehydroepiandrosterone; Dehydroepiandrosterone sulfate
- DHT. *See* Dihydrotestosterone
- 5-DHT. *See* 5-Dehydrotestosterone
- DI. *See* Diabetes insipidus; DNA index
- Diabetes insipidus (DI), 361, 455, 567
- Diabetes mellitus, 314–320, 315t–316t, 318t–319t, 678
chronic kidney disease with, 573–574
classification of, 314–316, 315t
criteria for diagnosis of, 318–319, 318t–319t
criteria for testing for, 317–318
gestational diabetes mellitus, 315t, 316, 319–320
microalbuminuria with, 326–327, 566
pathophysiology of, 316–317
in pediatric patients, 692
urinalysis results and, 567
- Diagnosis, 96, 96t
of adrenal insufficiency, 464, 464
of androgen excess, 470
of cardiovascular disease, 549–555, 551
of Cushing's syndrome, 466–467
of diabetes mellitus, 318–319, 318t–319t
of heart disease, 549–555, 551
of hypogonadism, 480, 481
of infection, 200, 209
of lipid disorders, 339–344
of metabolic diseases in clinical setting, 700–701, 700t
of myocardial infarction, 549–552, 551
of patients with glucose metabolic alterations, 321–327, 322t, 324t–326t, 326
of pheochromocytoma, 473
prenatal, nucleic acid probes for, 209
of primary aldosteronism, 462–463
- Diagnostic efficiency, 101–108, 102b, 103–107, 105t
- Diagnostic sensitivity. *See* Sensitivity
- Diagnostic significance
of acid phosphatase, 299–300
of alanine aminotransferase, 297
of alkaline phosphatase, 297–299
of amylase, 302
of aspartate aminotransferase, 296
of creatine kinase, 289–293, 290t, 291–292
of glucose-6-phosphate dehydrogenase, 304
of γ -glutamyltransferase, 300–301
of lactate dehydrogenase, 294–295, 294t–295t
of lipase, 303
- Diagnostic specificity. *See* Specificity
- Diagnostic specimens, 79
- Diagnostic tests, cut-off for, 105, 106, 108
- Dialysis, 19, 175, 575–576
- Diatomite, for blood samples, 46
- Diazepam, 306t, 636
- Diazo reaction, 525–526
- Diazotized sulfanilic acid, 525–526
- Diclofenac, 306t
- Dideoxy chain termination reaction, 205, 205
- Diet
assessment of, 652
for heart disease, 337–339, 339t
- Diet restrictions, for blood testing, 48
- Diethylthiocarbamate, 306t
- DIF. *See* Direct immunofluorescence
- Difference plot, 94, 94
- Differential diagnosis, of patients with glucose metabolic alterations, 321–327, 322t, 324t–326t, 326
- Diffraction grating, for spectrophotometer, 134, 176, 176
- Diffusion, 356, 392
- Digestion, 587
- Digital thermometer, 9–10
- Digitalis, 369–370, 370t, 376, 397b, 544b
- Digoxin, 97t, 365, 370, 371b, 612–613, 613b, 682b
- Dihydrotestosterone (DHT), 478
- 1,25-Dihydroxy vitamin D (1,25(OH)₂D), 502, 502–506, 510, 512, 563–564, 629–630, 658–660, 677
- Dilantin, 467
- Dilute solutions, 8
- Dilution factor, 23–26
- Dilutions, 23–26, 24–25
- Dilutor/dispensers, 14, 14
- Dimension RxL analyzer, 167, 169t, 171, 172, 181
- Dimercaptosuccinic acid (DMSA), for lead poisoning, 630
- Dimethyl mercury, 412–413
- Diphenhydramine, 279
- Dipsticks, for urinalysis, 567–568
- Direct effectors, 448
- Direct fluorescence assays (DFA), 199
- Direct immunofluorescence (DIF), 199
- Director, for point-of-care testing, 213–214
- Disaccharides, 310–311, 311
- Discrete analyzers, 166, 168, 170–171, 174–177
- Disease
aging and, 675t
correlations
with hemoglobin, 432–437, 436
with porphyrins, 425–428, 426t
with urinalysis results, 567
iron status in, 418t
- Disinfectants, mercury in, 412
- Disopyramide, 614
- Dispensers, 14, 14
- Dispersion, of data, 89
- Disposal
of capillary puncture materials, 66–70
of hazardous materials, 84–85
of needle, 51, 58
of used venipuncture materials, 53, 55, 59
- Dissociation constant (K_a), 9
- Dissociation, of hemoglobin and oxygen, 393, 393–394
- Dissociation-enhanced lanthanide fluoroimmunoassay (DELFA), 197
- Distal convoluted tubule, 557, 560, 560–561
- Distal renal tubular acidosis, 571
- Distilled water, 6–7
- Distribution
of calcium, 373–374
of data, 90, 90, 93, 95
of drugs, 607, 610, 610–611, 701
of error, 118, 118
Gaussian, 91–92, 91–93, 99, 100, 118, 118
of phosphate, 377
- Disulfiram, 306t
- Diuretics, 30, 275b, 279, 324, 366, 369–370, 372, 374t, 376, 388, 390, 397b, 412, 475b, 508, 510–511, 562
- Diurnal rhythms, 445, 447, 467
- Diversity (D) genes, 246
- DMAIC. *See* Define, Measure, Analyze, Improve, Control
- DMSA. *See* Dimercaptosuccinic acid
- DNA. *See* Deoxyribonucleic acid
- DNA chip technology, 206
- DNA index (DI), 200
- DNA probe, 203–206, 204t, 208
- DNA sequencing, 205, 205–206
- DNA technology, for hemoglobin, 439–440
- DNA-based assays, 202
- 11-DOC. *See* 11-Deoxycortisol
- Documentation, of accidents, 85–86
- Dopamine, 275, 451
- Dopamine agonists, 485

- Dopaminergic agonists, 451, 453
 Dopaminergic antagonists, 452
 Dose response curve, 192–193, 194
 Dose-response relationship, in toxicology, 623, 623–624, 623t
 Dosing. *See* Therapeutic drug monitoring
 Dot-blot, 204
 Double diffusion, in immune precipitation in gel, 187
 Double-Ab method, 196
 Double-beam spectrophotometer, 135–136, 136
 Doxepin, 619
 DPMC. *See* Defects per million opportunities
 Draw
 order of, 46–47, 46b, 46t–47t, 65
 troubleshooting failure of, 47, 59, 60
 Drift error, 398
 Droplet precautions, 37b
 Drug monitoring. *See* Therapeutic drug monitoring
 Drug-drug interactions, 609, 617–618
 Drug-induced thyroid dysfunction, 498–499
 Drug-metabolizing enzymes, 305–307, 306t
 Drug-protein complexes, 606–607
 Drug-related disorders, of liver, 524–525
 Drugs. *See also* Therapeutic drug monitoring
 absorption of, 606, 610–611, 682, 701
 of abuse, toxicology of, 633–636, 634t
 calcium metabolism response to, 510–512
 clearance of, 607–610, 608, 682, 701
 distribution of, 607, 610, 610–611, 701
 effect on analytes, 30
 effect on nutrition, 662t
 elimination of, 607–611, 608, 610, 682, 701
 hypercalcemia from, 508
 mass spectrometry of, 159
 metabolism of, 520
 pediatric patient metabolism of, 701–702, 702t
 therapeutic, toxicology of, 631–633, 632
 Dry chemistry slides, 166–167, 174, 174–176, 177–179, 178
 Dry reagents, 174
 Dual energy x-ray absorptiometry (DXA), 513–514
 Dual-wavelength reflectance photometry, 163, 164
 Dubin-Johnson syndrome, 521–522
 Duodenum, 585b
 Duplex, 203
 Duplicate assays, 401
 DXA. *See* Dual energy x-ray absorptiometry
 D-xylose absorption test, 587–588
 D-xylose, reference range of, 585b
 Dye binding, 252t, 253–254, 261–262, 262t
 Dynamic range. *See* Analytic measurement range
 Dynodes, 135, 135, 158
 Dyshemoglobins, 392–394
 Dyslipidemia, 329, 339–344, 546
 Dyspnea, 543
- E**
- EA. *See* Allowable analytic error
 ECF. *See* Extracellular fluid
 Ecstasy. *See* Methylenedioxymethylamphetamine
 Ectopic Cushing's syndrome, 466–469
 ED₅₀, 623, 623
 Edema, 62, 543
 EDTA. *See* Ethylenediaminetetraacetic acid
 Efficiency, diagnostic, 101–108, 102b, 103–107, 105t
 Effusion, 601–602, 601t
 Ehrlich's reagent, 527
 Elderly. *See also* Geriatric patient
 effects of exercise and nutrition on chemistry results of, 682–683
 establishing reference intervals for, 681
 preanalytic considerations for, 681–682
 therapeutic drug monitoring in, 682
 Electrical hazards, 83–84
 Electrochemical cell, 141, 141, 395
 Electrochemical sensors, types of, 397
 Electrochemiluminescence, in automated analysis, 177
 Electrochemistry, 141–144, 141–145, 142t
 Coulometric chloridometers and anodic stripping voltammetry, 145
 enzyme electrodes, 145
 galvanic and electrolytic cells, 141, 141, 395
 gas-sensing electrodes, 144, 144–145
 half-cells, 141–142, 142t
 ion-selective electrodes, 142, 144, 144, 167, 278, 278t, 362–363, 363, 376, 377
 pH electrodes, 142–144, 142–144, 396–398
 Electrodeless discharge lamp, 137
 Electrodes, 141–142
 of blood gas analyzers, 395
 enzyme, 145
 gas-sensing, 144, 144–145
 ion-selective, 142, 144, 144, 167, 278, 278t, 362–363, 363, 376, 377
 microion-selective, 164
 for pCO₂, 144, 144–145, 396–397
 pH, 142–144, 142–144, 396–398
 for pO₂, 395–396
 Severinghaus, 394–397
 Electroendosmosis, 147
 Electrolytes, 345–383
 aging effects on, 680
 anion gap, 380–381, 381
 balance of, renal role in, 562–563
 bicarbonate, 368, 382, 386–387, 387, 396, 398, 563
 calcium, 112, 113, 125, 126, 373–376, 374, 374t, 377, 377t, 382, 501–515, 502–503, 507, 509, 513, 562–563, 588, 665–666, 666t, 693–694, 694t
 chloride, 366–368, 367, 368t, 382, 560, 562, 583, 600, 656
 disturbances of, 656
 lactate, 378–380, 379, 380t, 381, 598
 magnesium, 369–372, 370t–372t, 382, 562–563, 665–666
 monitoring of heart disease with, 554
 pediatric patient regulation of, 689–690, 690t–691t
 phosphate, 376–378, 378t, 382, 504, 507, 562–563, 665–666, 666t
 potassium, 363–366, 364t–366t, 382, 463, 562, 656, 690, 691t
 renal function and, 381, 381–382
 sodium, 142, 357–363, 360t–362t, 363, 364t, 382, 554, 560, 560–562, 583, 656, 690, 690t
 in sweat, 583
 water, 356–361, 358, 359t, 560
 Electrolytic cells, 141, 141
 Electromagnetic radiation, 130–131, 131, 136, 136–138
 Electromotive force, 143
 Electron ionization, 154, 155
 Electron multiplier, 158, 158
 Electronic balances, 17, 17–18
 Electronic documentation, for point-of-care testing, 219
 Electronic reporting, of laboratory results, 5
 Electronic thermometers, 9–10
 Electro-osmotic flow (EOF), 147, 148, 259
 Electrophoresis, 145–147, 145–148, 188
 of alkaline phosphatase, 298–299
 for amino acid analysis, 233
 of amylase, 302
 capillary, 147, 147–148, 183, 205, 233, 258–259
 of cerebrospinal fluid, 146, 263, 263, 599
 of creatine kinase isoenzymes, 290, 291, 292–293
 detection and quantitation, 147, 147
 for DNA sequencing, 205
 electroendosmosis, 147
 for hemoglobin, 438–439, 439
 for immunoblots, 198, 199
 immunoelectrophoresis, 188, 188–189
 immunofixation electrophoresis, 188–189, 189, 259, 260
 isoelectric focusing, 147, 147
 of lactate dehydrogenase, 295
 of lipoproteins, 346
 of macroenzymes, 305
 procedure, 145–146
 for proteins, 254–256, 255, 258–259, 259
 serum protein electrophoresis, 256–257, 256–258
 for solid support hybridization, 204
 support materials, 146
 treatment and application of sample, 146–147
 two-dimensional, 156, 159
 of urine, 146, 565
 Electrophoretic mobility, of proteins, 255, 259
 Electrophoretogram, 145
 Electro spray ionization (ESI), 155, 156
 Electrothermal atomic absorption spectrophotometry. *See* Graphite furnace atomic absorption spectrometry
 Electrothermal technique, 137
 Elemental speciation, in trace element analysis, 408
 Elevated anion gap, 381
 Elimination
 of drugs, 607–611, 608, 610, 682, 701
 of nonprotein nitrogen compounds, 561
 ELISA. *See* Enzyme-linked immunosorbent assays
 Elution, 151–152, 152
 Embden-Myerhof pathway, 312, 312–313
 Embryology
 of adrenal gland, 458–459, 459
 of pituitary, 445–446, 446
 Emission
 of energy, 131, 131
 of molecules, 138, 138
 EMIT. *See* Enzyme multiplied immunoassay technique
 Employees, safety responsibilities of, 76
 Employers, safety responsibilities of, 76
 Endocarditis, infective, 548–549
 Endocrine control, of sexual maturation, 696
 Endocrine function
 aging effects on, 676–678
 of pancreas, 578
 in pediatrics, 694–696, 695t
 renal, 563–564
 Endocrine system, 694
 hypercalcemia arising from, 505–507, 507
 hypocalcemia arising from, 509–510
 Endocrine tumor markers, 641t
 Endogenous Cushing's syndrome, 465
 Endogenous pathway, of lipid metabolism, 333, 334, 335
 Endosmosis. *See* Electroendosmosis
 Endpoint method, 188, 190
 End-stage renal disease (ESRD), 573–574, 576
 Energy metabolism, in pediatric patient, 691–692, 691t
 Enteral feeding, 655
 Environmental assessment, 652–653
 Environmental protection, against radiation, 81–82
 Enzymatic assay
 of alcohols, 626–627
 for ammonia measurement, 278, 278t
 for carbon dioxide determination, 368
 for cholesterol measurement, 344–345, 345
 for creatinine measurement, 275, 276t
 for ketone analysis, 326, 326t
 for lactate determination, 380
 for triglyceride measurement, 345, 345
 for tumor markers, 644–645
 for urea, 267, 267
 for uric acid measurement, 270, 271t
 Enzymatic reactions, factors influencing, 284–286, 284–286
 Enzyme electrodes, 145
 Enzyme immunoassay, 190t
 Enzyme immunoassay, 198
 Enzyme labels, for labeled immunoassays, 191
 Enzyme multiplied immunoassay technique (EMIT), 196, 196–197
 Enzyme-linked immunosorbent assays (ELISA), 196
 Enzymes, 237, 281–308
 activity of, calculation of, 27–28
 aging effects on, 680

- Enzymes (*continued*)
 classification and nomenclature of, 282t, 283
 of clinical significance, 288–307, 289t–290t,
 291–292, 294t–295t, 302t, 306t
 acid phosphatase, 299–300
 alanine aminotransferase, 296–297, 528,
 554, 623
 alkaline phosphatase, 30, 192, 297–299,
 528, 554, 640t, 679
 amylase, 301–303, 302t, 311, 581, 583–585
 aspartate aminotransferase, 296, 528,
 550, 554
 creatine kinase, 288–293, 289t–290t,
 291–292, 541, 551
 drug-metabolizing enzymes, 305–307, 306t
 glucose-6-phosphate dehydrogenase, 304
 γ -glutamyltransferase, 300–301, 529,
 554, 623
 lactate dehydrogenase, 30, 293–295, 294t–
 295t, 529, 541, 550–551, 640t, 679
 lipase, 303–304, 581, 585
 macroenzymes, 304–305
 concentration of, 285
 general properties and definitions, 281–283
 kinetics of, 283–286, 283–288
 calculation of enzyme activity, 27–28,
 287–288
 catalytic mechanism of enzymes, 283,
 283–284
 enzymes as reagents, 288
 factors influencing enzymatic reactions,
 284–286, 284–286
 measurement of enzyme activity, 286–287
 measurement of enzyme mass, 288
 of liver, 528–529
 in myocardial infarction diagnosis, 551, 551
 as reagents, 288
 as tumor markers, 637–638, 640t
 Enzyme-substrate (ES) complex, 284, 286
 EOF. *See* Electro-osmotic flow
 EP. *See* Erythropoietic porphyria
 Ephedrine, 471, 634
 Epilepsy, 615–618
 Epinephrine, 314, 320, 364, 459, 471–473, 472
 Epithelial cells, in urinalysis, 568
 Epitope, 185
 Equipment. *See also* Personal protective equipment
 safety, 76–78, 78t
 for venipuncture, 41–46, 42–45, 43t, 46t, 61
 Equivalent weight, 8
 Ergocalciferol, 658
 Ergonomic hazards, 84
 Erlenmeyer flasks, 11, 15
 Error, 94, 117
 in acid phosphatase measurement, 300
 in alanine aminotransferase measurements, 297
 in alkaline phosphatase measurements, 299
 allowable analytic, 115–116, 116t
 in ammonia measurement, 279
 in amylase measurements, 303
 analytic, 117
 in aspartate aminotransferase measurement, 296
 in bilirubin analysis, 526
 in creatine kinase assays, 293
 distribution of, 118, 118
 drift, 398
 in γ -glutamyltransferase measurements, 301
 imprecision, 117, 125, 125
 in lactate dehydrogenase measurement, 295
 Lean Six Sigma reduction of, 123, 123–124, 124t
 in lipase measurements, 304
 in lipid and lipoprotein assays, 351
 maximum allowable, 110
 in phlebotomy, 62
 preanalytic, 28, 30, 31t, 398–401
 random, 93, 94, 94b, 110–111, 110b, 111, 114,
 114–117
 standard of estimate, 93
 systemic, 93, 94–95, 94b, 99b, 110, 110b,
 113–117, 115, 125, 125
 total, 110b, 125, 125
 in urobilinogen determination, 527
 Error rate, 123–125, 124t
 Erythroblastosis fetalis. *See* Hemolytic disease of
 newborn
 Erythromycin, 306t
 Erythropoietic porphyria (EP), 426, 428
 Erythropoietin, renal production of, 563–564
 ES complex. *See* Enzyme-substrate complex
 ESI. *See* Electrospray ionization
 ESRD. *See* End-stage renal disease
 Essential amino acids, 224–226, 225t, 236
 Essential nutrients, 658
 Essential trace elements, 404
 Establishment, of reference interval, 95–97, 95b,
 97b, 99, 100
 Estradiol, 306t, 677
 Estrogen, 482–483, 486
 aging effects on, 674, 676–677
 in pediatric patients, 696
 Estrogen receptors, as tumor markers, 638,
 643t, 644
 Estrogen replacement therapy, 243, 344, 347b,
 376, 485, 488, 511, 514
 Ethanol, 306t, 524–525, 624–627, 625t, 626
 Ethosuximide, 616
 Ethylene glycol, toxicology of, 625–626
 Ethylenediaminetetraacetic acid (EDTA)
 for blood samples, 43t, 45–46, 46b, 46t–47t,
 65, 271, 278, 323, 325, 351, 372, 376,
 378, 394, 417, 529, 612
 for lead poisoning, 630
 for synovial fluid samples, 601
 Etiofibrate, 341
 Etiology, of hypopituitarism, 454, 454t
 ETS. *See* Evacuated tube system
 Evacuated tube system (ETS), 41–43, 42–43, 43t,
 48–53, 48–53
 Evacuated tubes, 28, 43, 43, 43t
 additives for, 43–46, 43t, 46t
 filling of, 50, 54, 58–59
 labeling of, 52
 microtubes, 61
 mixing of, 71
 order of collection of, 46–47, 46b, 46t–47t
 positioning of, 47
 trace element-free, 46
 Evaluation. *See also* Method evaluation
 of thyroid gland, 493–495, 493t–494t
 Evaporation, sample, 171
 Exchange. *See* Gas exchange
 Excitation, of molecules, 138, 138
 Exclusion criteria, for reference interval studies,
 97–98, 98t
 Excretion. *See also* Secretion
 of arsenic, 409
 of cadmium, 410–411
 of chromium, 414
 of copper, 415
 of iron, 416
 of lead, 411
 of liver, 518–519, 519
 of manganese, 419
 of mercury, 412–413
 of metabolic acids, 563
 of molybdenum, 419
 of potassium in urine, 463
 of selenium, 420
 of zinc, 421
 Excretory system, of liver, 516, 517
 Exercise
 for elderly, 682–683
 potassium release during, 364
 Exocrine function, of pancreas, 578
 Exogenous pathway, of lipid metabolism, 333–335,
 334
 Exposure
 to blood, 75, 78–79
 to hazardous substances, 75, 80
 to toxins, 622–623
 to tuberculosis, 78–79
 Exposure control plan, 75, 79
 Expressed consent, 35b
 Extracellular fluid (ECF), 356, 359, 364, 366, 368
 Extravascular degradation, of hemoglobin, 431, 431
 Exudative pleural effusion, 601–602, 601t
 Eye drops, mercury in, 412
 Eye protective equipment, 77
 Ezetimibe, 341
- F**
- FAAS. *See* Flame atomic absorption spectrometry
 Failure. *See also* specific types, e.g., Heart failure
 of venipuncture, 47, 59, 60
 Fainting, 63, 543
 False negatives, 102, 103–104, 104
 False positives, 103–104, 104–105
 False rejections, 118
 Familial combined hyperlipoproteinemia (FCH),
 343
 Familial hypercholesterolemia (FH), 341–342
 Familial hyperparathyroidism, 506
 Familial hypertriglyceridemia, 342
 Familial hypocalciuric hypercalcemia (FHH), 506
 Families of Structurally Similar Proteins (FSSP),
 237–238
 Fast hemoglobin, 438
 Fasting blood glucose (FBG), 322
 Fasting plasma glucose, 318–319, 318t–319t
 Fasting specimens, 30
 Fatigue, 544
 Fats. *See also* Lipids
 dietary, 338–339
 Fat-soluble vitamins, 588, 657–660, 657t
 Fatty acids, 329, 329–330, 333–335, 349, 582–583
 Fatty liver, alcoholic, 524
 FBG. *See* Fasting blood glucose
 FCH. *See* Familial combined hyperlipoproteinemia
 F-cortisol, 465
 Fecal fat analysis, 582–583
 Feces, urobilinogen in, 526–527
 Feedback loops
 in calcium homeostasis, 503, 504
 of pituitary, 445, 447, 447
 of thyroid gland, 492, 493
 Felbamate, 616–617
 Feminization, 469–470, 479
 Fenofibrate, 341
 Fentanyl, 306t, 636
 Ferritin, 416–418, 417t–418t
 Fetal fibronectin (fFN), 248–249, 689
 Fetal lung maturity, assessment of, 593–596
 FETI. *See* Fluorescence excitation transfer
 immunoassay
 α_1 Fetoprotein (AFP), 239t, 241–242
 α -Fetoprotein (AFP), 592, 638, 642t, 645–646
 fFN. *See* Fetal fibronectin
 FH. *See* Familial hypercholesterolemia
 FHH. *See* Familial hypocalciuric hypercalcemia
 Fiber optics, in automated analyzers, 177
 Fibrinogen, 239t, 245
 Fibrocystic disease of pancreas. *See* Cystic fibrosis
 Fibronectin, 248–249, 655
 Fibrous proteins, 238
 Filling
 of evacuated tubes, 50, 54, 58–59
 of microcollection and microhematocrit tubes,
 67, 70
 of syringe, 57
 Filter fluorometers, 138, 139
 Filters
 high-efficiency particulate air, 78, 78t
 for separation, 19, 19
 for spectrophotometer, 133, 133–134, 176
 for water, 6–7
 Filtrate, 19
 Filtration
 in automated analysis, 175
 glomerular, 558, 559, 690, 690t
 for separation, 19, 19
 of water, 6–7
 Fine-needle aspiration (FNA), of thyroid gland,
 495
 Finger stick, 28, 64–67, 64–68, 68t

- FiO₂. *See* Fraction of inspired oxygen
 Fire extinguishers, 83, 83
 Fire safety, 82–83, 82–83
 Fire tetrahedron, 82, 82
 First pass, 520, 606
 First-generation antiepileptic drugs, 615–616
 First-order elimination, of drugs, 607–609, 608
 First-order kinetics, of enzymatic reactions, 284
 Fisher projection, 310, 310
 Fixed time method, for measuring enzyme activity, 287
 Fixed-volume pipet, 13, 14
 Flags in automated analysis, 178
 Flame atomic absorption spectrometry (FAAS), 404–406, 404t, 405
 Flame ionization detectors, 153, 153–154
 Flame photometry, 138
 Flame-emission photometer, 138
 Flameless atomic absorption. *See* Graphite furnace atomic absorption spectrometry
 Flammable chemicals, 81, 81t
 Flammable materials, storage of, 77
 Flasks, 11, 11t, 15
 Florinef, 462, 469
 Flow cytometry, 200
 Fluconazole, 306t
 Fluid-phase antigen-antibody complexes, 189–190
 Fluids. *See also* Body fluids
 collection and processing of, 28–30, 29
 Fluorescence
 in DNA chip technology, 206
 in fluorometry, 138–139, 138–140
 for maple syrup urine disease detection, 230
 of molecules, 138, 138
 for phenylketonuria testing, 229
 polarization, 139–140, 197, 596–597
 of porphyrins, 429–430
 in target amplification, 207
 Fluorescence excitation transfer immunoassay (FETI), 197
 Fluorescence polarization immunoassay (FPIA), 197
 Fluorescence resonance energy transfer (FRET), 207
 Fluorescent immunoassay, 190t
 Fluorescent labels, for labeled immunoassays, 191, 198–199
 Fluoride additives, 380, 598, 601
 Fluorimeters, 138–140, 139
 Fluorometry, 138–139, 138–140
 Fluoroquinolones, 306t
 Fluoxetine, 306t
 Fluvastatin, 341
 FNA. *See* Fine-needle aspiration
 F₀O₂Hb. *See* Fractional oxyhemoglobin
 Foam stability index (FSI), 594–595, 595t
 Folate, 588, 661–662, 662t
 Fold classification based on Structure-Structure alignment of Proteins. *See* Families of Structurally Similar Proteins
 Folding
 of filter paper, 19, 19
 of proteins, 235
 Folic acid, 231, 437, 661
 Folin-Lowry method, 261, 262t
 Follicle-stimulating hormone (FSH), 447–448, 482, 677, 696
 in hypergonadotropic hypogonadism, 479–480, 479b, 486
 in menstrual cycle abnormalities, 484, 485b, 486
 in ovulation, 483
 testicle production of, 477–478
 Follicular cells, of thyroid, 491, 491
 Follicular phase, of menstrual cycle, 482–483
 Forensic specimens, 31, 71, 300
 Forensic toxicology, 622
 Forms, for point-of-care testing, 217–218
 Fosphenytoin, 616
 FPIA. *See* Fluorescence polarization immunoassay
 Fraction of inspired oxygen (FiO₂), 391–392
 Fractional oxyhemoglobin (F₀O₂Hb), 392
 Fractionation, of specific proteins, 253–256, 254t, 255
 Fracture, with osteoporosis, 513, 513–514
 Fragility fracture, 513
 Free drugs, bound drugs v., 606–607
 Free radical theory of aging, 675
 Free radicals, 675
 Free T₃, 492, 497
 Free T₄, 492, 495, 497
 Freezing point, 8
 Freezing-point osmometer, 160–163, 163
 FRET. *See* Fluorescence resonance energy transfer
 Friedewald calculation, 348
 Front-end automation, 170, 180–181
 Fructose, 310–311
 FSH. *See* Follicle-stimulating hormone
 FSI. *See* Foam stability index
 FSSP. *See* Families of Structurally Similar Proteins
 Fume hoods, 76
 Functions, of proteins, classification by, 237, 237t
 Fungicides, 654
 Furosemide, 370, 562
 F-zone, of adrenal cortex, 459, 463, 463
- G**
 G-6-PD. *See* Glucose-6-phosphate dehydrogenase
 Gabapentin, 617
 Galactorrhea, idiopathic, 453
 Galactose, 310–311, 691
 Galactosemia, 321
 G-aldosterone, 465
 Galvanic cells, 141, 141
 Gas chromatography (GC), 151–154, 153
 of alcohols, 626, 626
 of carbon monoxide, 627
 columns for, 153
 detectors for, 153–154
 gas-liquid, 152
 gas-solid, 152
 GC/MS, 154–155, 157–159, 409
 for phenylketonuria testing, 229
 Gas exchange, 390–394, 391, 393
 hemoglobin-oxygen dissociation, 393, 393–394
 oxygen and carbon dioxide, 390–392, 391
 oxygen transport, 392
 quantities associated with assessment of patient's oxygen status, 392–393
 Gas-discharge lamps, 138
 Gases. *See also* Blood gases
 compressed, 77, 84
 partial pressure of, 391
 Gas-liquid chromatography (GLC), 152
 Gas-sensing electrodes, 144, 144–145
 Gas-solid chromatography (GSC), 152
 Gastric acid, measurement of, 586
 Gastric fluid, 585–586
 Gastric secretion, physiology and biochemistry of, 585–586
 Gastrin, 578, 585–586
 Gastrinomas, 580
 Gastrointestinal cancer, 646
 Gastrointestinal (GI) system, 578
 calcium metabolism and, 504
 clinical aspects of gastric analysis, 586
 clinicopathologic aspects of intestinal function, 587
 intestinal physiology, 587
 physiology and biochemistry of gastric secretion, 585–586
 testing of intestinal function, 587–588
 tests of gastric function, 586
 toxin absorption by, 622–623, 628–629
 Gauge, of needles, 41–42, 44
 Gaussian distribution, 91–92, 91–93, 99, 100, 118, 118
 GC. *See* Gas chromatography
 Gc-globulin, 239t, 242
 GC/MS, 154–155, 157–159, 409
 GDM. *See* Gestational diabetes mellitus
 Gel
 in electrophoresis, 146–147
 immune precipitation in, 186–189, 187–189, 187t
 filtration, 148
 permeation chromatography, 149
 separator, 43t, 46
 Gemfibrozil, 341, 343
 Gene rearrangements, nucleic acid probe detection of, 209
 Gene-Chips, 206
 Genes, for immunoglobulins, 246
 Genetic changes, of cancer, 639
 Genetic defects, 231, 591–592
 Genetic disease, 691, 698–701, 699–700t
 Genetically programmed theory of aging, 674–675
 Genetics
 of globin chain production, 430–431, 434, 436
 of thalassemias, 434, 436, 436
 Genitals, male, Tanner staging of development of, 478t
 Genomics, 159
 Gentamicin, 370, 607–609, 614, 702t
 Geriatric patient, clinical chemistry for, 673–684
 aging effects on chemistry results, 680–683, 681t
 biochemical and physiological changes of aging, 675–680, 675t–676t
 geriatric patient impact on clinical laboratory, 673–674
 theories of aging, 674–675, 674t
 Geriatric patient, venipuncture for, 61
 Geriatrics, 673
 Gerontology, 673
 Gestational age, 97t
 Gestational diabetes mellitus (GDM), 315t, 316, 319–320
 Gestational trophoblastic disease (GTD), 647
 GFAAS. *See* Graphite furnace atomic absorption spectrometry
 GFR. *See* Glomerular filtration rate
 GGT. *See* γ -Glutamyltransferase
 GH. *See* Growth hormone
 GHRH. *See* Growth hormone-releasing hormone
 GI system. *See* Gastrointestinal system
 Gilbert syndrome, 521
 Glassware, 10–16, 11t–12t, 12–15
 burets, 11t, 15, 15
 categories of, 10
 Class A tolerances, 10–11, 11t
 cleaning of, 10–11
 hazards of, 84
 laboratory vessels, 11, 11t, 12, 15
 pipets, 11–15, 11t–12t, 12–14
 syringes, 16
 GLC. *See* Gas-liquid chromatography
 Globin chains, 430–431, 434, 436
 Globular proteins, 238
 γ -Globulin therapy, 698
 Globulins, 238–247, 239t–240t, 250t, 256, 257, 258
 α_1 acid glycoprotein, 239t, 242
 α_1 antichymotrypsin, 239t, 242
 α_1 antitrypsin, 239t, 240–241, 257, 258
 β_2 -microglobulin, 239t, 244
 ceruloplasmin, 239t, 243
 complement, 239t, 244–245
 C-reactive protein, 240t, 245, 552–553, 655, 697
 α_{11} fetoprotein, 239t, 241–242
 fibrinogen, 239t, 245
 fractionation, identification, and quantitation of, 254
 Gc-globulin, 239t, 242
 haptoglobin, 239t, 242–243
 hemopexin, 239t, 244
 high-sensitivity C-reactive protein, 245–246, 552–553
 immunoglobulins, 237, 240t, 246–247
 lipoproteins, 239t, 244
 transferrin, 239t, 243–244
 Glomerular diseases, 570, 570–571
 Glomerular filtration, 558, 559, 690, 690t
 Glomerular filtration rate (GFR), 273–274, 276, 564–565, 610, 679, 690
 Glomerulonephritis, 567, 570
 Glomerulus, 381–382, 557
 Gloves, 77–78

- Glucagon, 313–314, 314t, 320, 578, 692
 Glucocorticoid therapy, 314, 447, 454, 461, 464–466, 469–470, 491–492
 osteoporosis from, 511, 513
 Glucocorticoids
 of adrenal gland, 460–461, 463, 465, 465
 in Cushing's syndrome, 465, 465–469, 468–469
 Gluconeogenesis, 313, 313t, 378, 519, 692
 Glucose, 310–311
 in cerebrospinal fluid, 29, 598
 determination of, 145
 fate of, 311–313, 312, 313t
 liver synthesis of, 519
 measurement of, 318–319, 318t–319t, 321–323, 322t
 metabolic alterations of, laboratory role in differential diagnosis and management of patients with, 321–327, 322t, 324t–326t, 326
 metabolism of, 309, 310, 311
 in pediatric patients, 691
 plasma, hemoglobin A_{1c} relationship to, 324, 324t
 point-of-care testing of, 163, 164, 218, 688
 projections of, 310, 310
 reference interval for, 98
 self-monitoring of, 323
 stereoisomers of, 310, 311
 urinalysis measurement of, 568
 Glucose oxidase, 322–323, 322t
 Glucose tolerance, 323–324, 678
 Glucose-6-phosphatase deficiency type 1, 321
 Glucose-6-phosphate, 312–313, 323
 Glucose-6-phosphate dehydrogenase (G-6-PD), 304
 Glutamate dehydrogenase, for ammonia measurement, 278, 278t
 Glutamic acid, 225t, 226, 236
 Glutamic-pyruvic transaminase. *See* Alanine aminotransferase
 Glutamine, 225t, 226–227
 γ-Glutamyltransferase (GGT), 300–301, 529, 554, 623
 Glycation theory of aging, 674
 Glycerol, 329, 335, 345–346
 Glycine, 225t, 227, 230
 Glycogen, 301, 311–313
 Glycogen storage disease, 321
 Glycogenesis, 313, 313t
 Glycogenolysis, 313, 313t
 Glycolysis, 71, 312, 312–313, 313t, 378, 379
 Glycoproteins, 238
 Glycoside bonds, 311
 Glycosuria, 656
 Glycosylated hemoglobin, 324–326, 324t–325t
 Glyoxylic acid, 254
 GnRH. *See* Gonadotropin-releasing hormone
 Goiter, 496–498, 498t
 Gonadal function, 477–489
 ovary, 481–488, 483t–484t, 485, 485b, 487b, 487t
 testes, 477–481, 478t, 479b, 481
 Gonadotrophs, 478
 Gonadotropin-releasing hormone (GnRH), 447, 478, 483, 696
 Gonadotropin-releasing hormone therapy, 486b
 GOT. *See* Aspartate aminotransferase
 Gout, 270, 272
 GPT. *See* Alanine aminotransferase
 Graafian follicle, 482
 Grades, of chemicals, 5–6
 Gradient elution, 152, 152
 Graduated cylinders, 11, 15
 Graduated pipets, 13
 Granular casts, in urinalysis, 569
 Graphing, Beer's law and, 26, 26–28
 Graphite furnace atomic absorption spectrometry (GFAAS), 137, 404, 404t, 406
 Graves' disease, 494, 497–498, 498t
 Gravimetric methods, for fecal fat determination, 583
 Gravimetric pipet calibration, 15–16
 Griffin beakers, 11, 15
 Group specificity, of enzymes, 284
 Group-specific component. *See* Gc-globulin
 Growth, 686, 693
 Growth factors, in pediatric patients, 695–696
 Growth hormone (GH), 314, 377, 448, 449–451, 449t, 641t
 acromegaly and, 450–451
 actions of, 449–450
 aging effects on, 676–677
 deficiency of, 451
 in pediatric patients, 695–696
 secretion of, 449, 449t
 testing of, 450
 Growth hormone replacement therapy, 451, 454, 695–696
 Growth hormone-releasing hormone (GHRH), 449–451
 GSC. *See* Gas-solid chromatography
 GTD. *See* Gestational trophoblastic disease
 Guanine, 202–203, 203
 Günther's disease. *See* Congenital erythropoietic porphyria
 Guthrie test
 for homocystinuria, 231
 for maple syrup urine disease, 230
 for phenylketonuria, 229
 Gynecomastia, 479
 G-zone, of adrenal cortex, 459, 461, 461–462
- H**
- H⁺
 maintenance of, 385
 regulation of, 385, 386
 H pattern veins, 40, 40
 HAAAs. *See* Human anti-animal antibodies
 HABA. *See* 2,4'-Hydroxy-azobenzene-benzoic acid
 Hair
 abnormal growth of, 482, 487, 487b, 487t
 pubic, 478t, 483, 483t
 Half-cells, 141–142, 142t
 Half-life, of drugs, 608, 609
 Halogenated hydrocarbons, 631
 Haloperidol, 306t
 Halothane, 306t
 HAMAs. *See* Human anti-mouse antibodies
 Hand hygiene, 39, 48, 53, 66, 68
 Hand, venipuncture of, 53–55, 54–55
 Handling
 of blood samples, 52, 71
 of capillary specimen, 68, 70
 of chemicals, 80–81, 81t
 of specimens, 71
 Hapten (Hp), 185
 Haptoglobin (Hp), 239t, 242–243, 432
 Hashimoto's thyroiditis. *See* Chronic lymphocytic thyroiditis
 Hashish, 635
 HAV. *See* Hepatitis A virus
 Haworth projection, 310, 310–311
 Hazard communication, OSHA standard for, 75, 79
 Hazardous materials, 79
 Hazardous substances, 75
 Hazards
 biohazards, 78–79
 chemical, 75, 79–81, 81, 81t
 compressed gases, 77, 84
 cryogenic materials, 84
 disposal of materials, 84–85
 electrical, 83–84
 ergonomic, 84
 fire, 82–83, 82–83
 mechanical, 84
 radiation, 81–82, 82t
 regulations for, 74–75
 signage and labeling for, 76, 77
 HBA_{1c}. *See* Hemoglobin A_{1c}
 HBcAg. *See* Hepatitis B core antigen
 HBIG. *See* Hepatitis B immune globulin
 HBsAg. *See* Hepatitis B surface antigens
 HBV. *See* Hepatitis B virus
 HCC. *See* Hepatocellular carcinoma
 hCG. *See* Human chorionic gonadotropin
 βhCG. *See* β-Human chorionic gonadotropin
 HCO₃⁻. *See* Bicarbonate
 HCP. *See* Hereditary coproporphyrin
 HCTZ. *See* Hydrochlorothiazide
 HCV. *See* Hepatitis C virus
 HDAg. *See* Hepatitis delta antigen
 HDL. *See* High-density lipoproteins
 HDV. *See* Hepatitis D virus
 Headache, 458
 Health effects
 of arsenic, 409
 of cadmium, 410
 of chromium, 413–414
 of copper, 415
 of iron, 416
 of lead, 411
 of manganese, 419
 of mercury, 412
 of molybdenum, 419
 of selenium, 420
 of zinc, 421
 Health Insurance Portability and Accountability Act (HIPAA), 35
 Heart
 aging effects on, 680
 anatomy of, 541, 542
 function of, 541–542, 542
 pathologic conditions of, 543–549, 543t–546t, 547, 548t–549t
 Heart attack. *See* Myocardial infarction
 Heart defects. *See* Cardiovascular defects
 Heart disease. *See* Cardiovascular disease;
 Coronary heart disease
 Heart failure (HF), 544t–546t, 545–546. *See also*
 Congestive heart failure
 Heart injury. *See* Myocardial injury
 Heating bath, 176
 Heel stick, 28, 64–65, 64–65, 68–70, 69, 687
 Hematin, 428
 Hematology, point-of-care testing of, 219
 Hematoma
 as phlebotomy problem site, 62
 from venipuncture, 60, 62–63, 63b
 Heme, 424, 432
 cyanide binding to, 628
 in hemoglobin, 430
 in myoglobin, 440
 scavenging of, 244
 synthesis of, 425, 425–426, 431, 629–630
 waste products of, 518–519
 Hemiacetal ring, 310
 Hemiketal ring, 310
 Hemochromatosis, 416–417
 Hemoconcentration, of blood, 49, 53, 57
 Hemodialysis, 575–576
 Hemofiltration, 575–576
 Hemoglobin, 430–432, 430–440, 436, 439, 520
 absorption by, 394, 394
 buffer characteristics of, 385–386, 386
 in cerebrospinal fluid, 598
 clinical significance and disease correlation of, 432–437, 436
 DNA technology for, 439–440
 electrophoresis for, 438–439, 439
 glycosylated, 324–326, 324t–325t
 haptoglobin binding of, 242–243
 as interferent, 113
 iron in, 416
 methodology for, 437–439, 439
 oxygen dissociation from, 393, 393–394
 oxygen transport by, 392
 role in body, 430
 structure of, 430, 430–431
 synthesis and degradation of, 431–432, 431–432
 urinalysis measurement of, 568
 waste products of, 518
 Hemoglobin A, 430–434, 436–439
 Hemoglobin A_{1c} (HBA_{1c}), 324–326, 324t–325t
 Hemoglobin A₂, 430–431, 436–439
 Hemoglobin Bart's, 434–436, 438

- Hemoglobin C, 438
Hemoglobin D, 434, 439
Hemoglobin E, 434
Hemoglobin F, 430–431, 433, 436–439
Hemoglobin G, 439
Hemoglobin H disease, 434–436, 438
Hemoglobin hemolysate, electrophoresis of, 146
Hemoglobin oxygen capacity, 393
Hemoglobin S, 432–433, 438
Hemoglobin SC, 433
Hemoglobinopathies, 424, 430–434
Hemoglobinuria, 432
Hemolysis
 as interferent, 112–113, 113, 233, 252, 293, 295–296, 299, 304, 366–367, 372, 378
 in reference interval studies, 98
 in sample processing, 28, 30, 44–45, 67, 70–72
Hemolytic anemia, 243, 304, 521, 658
Hemolytic disease of newborn, 592–593, 593–594
Hemopexin, 239t, 244, 432
Hemosiderin, 416
Hemosiderosis, 416
Henderson-Hasselbalch equation, 9, 236, 385, 388–390, 388t, 689
HEP. See Hepatoerythropoietic porphyria
HEPA filters. See High-efficiency particulate air filters
Heparin
 for blood samples, 41, 43t, 45–46, 46b, 46t–47t, 65, 72, 170, 233, 271, 278, 323, 362, 366–367, 376, 399, 417, 529
 for synovial fluid samples, 600–601
Heparin therapy, 219, 366, 461–462
Hepatic clearance, of drugs, 609–610
Hepatic coma, 529
Hepatic disorders, alanine aminotransferase in, 297
Hepatic ducts, 516–517
Hepatic function, aging effects on, 679–680
Hepatic jaundice, 520–521
Hepatitis, 529–537, 530t, 531–533, 533t–534t, 536t
 alcoholic, 524, 624–625
 cirrhosis with, 522–523
 other forms of, 537
Hepatitis A virus (HAV), 530, 530t
Hepatitis B core antigen (HBcAg), 531, 531–532, 533, 533t
Hepatitis B e antigen (HBeAg), 531–533, 532–534, 533t
Hepatitis B immune globulin (HBIG), 534
Hepatitis B surface antigens (HBsAg), 531, 531–532, 533, 533t, 534
Hepatitis B virus (HBV), 75, 522–523, 530–534, 530t, 531–533, 533t–534t
 chronic infection with, 533–534, 534t
 HDV coinfection and superinfection with, 535–536, 536t
 serologic markers of, 531–533, 531–533, 533t–534t
 treatment and prevention of, 534
Hepatitis C virus (HCV), 523, 530t, 534–535
Hepatitis D virus (HDV), 530t, 535–536, 536t
Hepatitis delta antigen (HDAg), 535–536
Hepatitis E virus (HEV), 530t, 536–537
Hepatobiliary disorders, 297–298, 300–301, 528–529
Hepatocellular carcinoma (HCC), 242, 523–524, 645–646
Hepatocellular disorders, aspartate aminotransferase in, 296
Hepatocytes, 517
Hepatoerythropoietic porphyria (HEP), 426–427
Hepatoma. See Hepatocellular carcinoma
Hepatotoxicity, of acetaminophen, 632, 632–633
Herbicides, toxicology of, 631
Hereditary coproporphyrin (HCP), 426–427
Hereditary hemochromatosis (HH), 416–417
Hereditary persistence of fetal hemoglobin (HPFH), 437
Heroin, 636
Heterogenous assays, 194
Heterotrophic antibodies, 644
HEV. See Hepatitis E virus
Hexokinase, 312, 322–323, 322t
Hexose monophosphate pathway, 312
Hexose monophosphate (HMP) shunt, 313
HF. See Heart failure
HGA. See Homogentisic acid
HGAAS. See Hydride generation atomic absorption spectrophotometry
HH. See Hereditary hemochromatosis
HHb. See Deoxyhemoglobin
High-density lipoproteins (HDL), 328, 332–333, 332t
 in arteriosclerosis, 340–341, 546
 in hypertriglyceridemia, 342
 in hypoalphalipoproteinemia, 344
 in lipid and lipoprotein analyses, 344, 346–349
 measurement of, 347–348
 NCEP goals for, 238t
 physiology and metabolism of, 334–336
 population distributions of, 336–337, 336t–337t
High-efficiency particulate air (HEPA) filters, 78, 78t
Highly complex tests, 212, 214t
High-performance liquid chromatography (HPLC), 150, 150–152, 152
 for amino acid analysis, 233
 columns in, 151
 detectors in, 151
 for homocystinuria detection, 231
 for phenylketonuria testing, 229
 pumps in, 151
 recorders in, 151–152, 152
 sample injectors in, 150, 151
 for tumor markers, 644
High-performance thin-layer chromatography (HPTLC), 150
High-resolution mass spectrometers, 407
High-resolution protein electrophoresis (HRE), 258, 259
High-sensitivity C-reactive protein (hsCRP), 245–246, 552–553
Hip fracture, with osteoporosis, 513
HIPAA. See Health Insurance Portability and Accountability Act
Hirsutism, 482, 487, 487b, 487t
HIS. See Hospital information systems
Histamine, 224
Histamine acid phosphate, 586
Histidine, 224, 225t, 236
Histograms, 92
Hitachi analyzers, 167, 171, 171, 173, 173, 175–176, 176
HIV. See Human immunodeficiency virus
HIV antivirals, 306t
HIV consent, 35b
HMG-CoA reductase drug inhibitors. See Statins
HMP shunt. See Hexose monophosphate shunt
Hoesch test, 428–429
Holders, for evacuated tubes, 42, 42–43
Hollow-cathode lamp, 137
Holoenzyme, 283
Home parenteral nutrition (HPN), 670
Homeostasis
 acid-base, 388–390, 388t
 in aging, 677
 calcium, 501–515, 502
 hormonal regulation of calcium metabolism, 501–504, 502–503
 hypercalcemia, 374, 374t, 375–376, 504–508, 507
 hypocalcemia, 374, 374–375, 374t, 504, 508–512, 509
 metabolic bone disease, 512–514, 513
 organ physiology and calcium metabolism, 504–505
 water, electrolyte, and acid-base, renal role in, 561–563, 562
Homocystinuria, 231
Homogenous assays, 192, 347–349
Homogentisic acid (HGA), 230
Homovanillic acid (HVA), 470–471, 641t
Hoods, fume, 76
Hook effect, 644
Hormonal regulation
 of calcium homeostasis, 501–515, 502
 hormonal regulation of calcium metabolism, 501–504, 502–503
 hypercalcemia, 374, 374t, 375–376, 504–508, 507
 hypocalcemia, 374, 374–375, 374t, 504, 508–512, 509
 metabolic bone disease, 512–514, 513
 organ physiology and calcium metabolism, 504–505
 of calcium metabolism, 501–504, 502–503
 of ovulation, 483
 of testicular function, 478
Hormone replacement therapy, 514b, 676–677
Hormones, 237
 aging effects on, 676–678
 anterior pituitary, 448, 448t
 carbohydrate metabolism regulation by, 313–314, 314t
 growth hormone, 314, 377, 448–451, 449t
 hypophysiotropic or hypothalamic, 447–448, 448t
 of ovaries, 482
 in pediatric patients, 694–696, 695t
 pituitary secretion of, 446–447, 447
 posterior pituitary, 454–455
 prolactin, 447–448, 451–453
 as tumor markers, 638, 641t
Hormonogenesis, of testicles, 477–478
Hospital information systems (HIS), 219
2-Hour postprandial tests, glucose tolerance and, 323–324
Hp. See Hapten; Haptoglobin
HPA. See Hybridization protection assay
HPFH. See Hereditary persistence of fetal hemoglobin
HPLC. See High-performance liquid chromatography
HPN. See Home parenteral nutrition
HPT. See Hyperparathyroidism
HPTLC. See High-performance thin-layer chromatography
HPV. See Human papilloma virus
HRE. See High-resolution protein electrophoresis
hsCRP. See High-sensitivity C-reactive protein
HTN. See Hypertension
Human anti-animal antibodies (HAAAs), 644
Human anti-mouse antibodies (HAMAs), 643–644
 β -Human chorionic gonadotropin (β hCG)
 diagnostic efficiency for, 102–105, 103–107
 method comparison of, 114, 114
 POCT for, 150
 proficiency testing for, 120, 120b
 reference interval studies of, 97, 97t, 99, 100
Human chorionic gonadotropin (hCG), as tumor marker, 642t, 645, 647–648
Human immunodeficiency virus (HIV), 75, 199, 206, 209
Human papilloma virus (HPV), 205
Humoral hypercalcemia of malignancy, 507
HVA. See Homovanillic acid
Hyaline casts, in urinalysis, 569
Hyaline membrane disease. See Respiratory distress syndrome
Hybridization protection assay (HPA), 205
Hybridization techniques, 203–205, 204t
Hybridoma, 186
Hydantoin, 662t, 664
Hydrates, 16
Hydride generation atomic absorption spectrophotometry (HGAAS), 406
Hydrochlorothiazide (HCTZ), 508, 510–511
Hydrocortisone, 465–466
Hydrolases, 282t, 283, 299
Hydrolysis, 310
Hydromorphone, 636
Hydrops fetalis, 434
25-Hydroxy vitamin D, 502, 504, 506–507, 509, 512, 629–630, 660, 677
2,4'-Hydroxy-azobenzene-benzoic acid (HABA), 254
 α -Hydroxybutyrate dehydrogenase activity (α -HBD), 295
3- β -Hydroxybutyric acid, 326, 326
17-Hydroxycorticosteroid (17-OHCS), 466
Hydroxycorticosteroids, 466

- 18-Hydroxycorticosterone, 463
 Hydroxyproline, 227
 Hygiene, hand, 39, 48, 53, 66, 68
 Hygiene officer, chemical, 75
 Hygiene plan, chemical, 75, 80
 Hygroscopic compounds, 16
 Hyperaldosteronism, 462, 462–463
 Hyperalimentation therapy, 278
 Hyperammonemia, 279
 Hyperamylasemia, 302
 Hyperbilirubinemia, 520–522, 522t, 523, 691
 Hypercalcemia, 374, 374t, 375–376, 504–508, 507
 in pediatric patient, 693–694, 694t
 Hypercarbia, 386
 Hyperchloremia, 367, 656
 Hypercholesterolemia, 335, 341–342
 Hypercortisolism, 465, 465
 Hyperglycemia, 314–320, 315t–316t, 318t–319t, 678
 criteria for diagnosing diabetes mellitus, 318–319, 318t–319t
 criteria for testing and diagnosing gestational diabetes mellitus, 319–320
 criteria for testing for prediabetes and diabetes, 317–318
 in diabetes mellitus, 314–320, 315t–316t, 318t–319t
 laboratory findings in, 316t
 pathophysiology of diabetes mellitus, 316–317
 in pediatric patients, 692
 Hyperglycemic agents, 314
 Hypergonadotropic hypogonadism, 479–480, 486
 Hyperkalemia, 363, 365–366, 365t, 656, 690, 691t
 Hyperlipoproteinemia, 341, 343
 Hypermagnesemia, 371–372, 371t–372t
 Hypernatremia, 357, 361–362, 361t–362t, 690, 690t
 Hyperosmolality, 364, 560–561
 Hyperparathyroidism (HPT), 375–376, 504, 506, 509–510, 512
 Hyperphenylalaninemia, 228
 Hyperphosphatemia, 378
 Hyperprolactinemia, 451–452, 480
 Hyperproteinemia, 250–251
 Hypertension (HTN), 547–548, 548t
 with congenital adrenal hyperplasia, 461–462
 with Cushing's syndrome, 466
 with pheochromocytomas, 472, 474
 pulmonary, 544
 renal, 574–576
 Hypertensive heart disease, 547–548, 548t
 Hyperthyroid disease, 96t
 Hyperthyroidism, 493–494, 497–499
 Hypertriglyceridemia, 342
 Hyperuricemia, 272
 Hyperventilation, 389
 Hypervitaminosis, 506, 658
 Hypervitaminosis D, 506
 Hyphenated analysis, of trace elements, 408
 Hypoaldosteronism, isolated, 462
 Hypoalphalipoproteinemia, 344
 Hypocalcemia, 374, 374–375, 374t, 504, 508–512, 509
 in pediatric patient, 693–694, 694t
 Hypochloremia, 367
 Hypofunction, of testicles, 479–480, 479b
 Hypogammaglobulinemia of infancy, 698
 Hypoglycemia, 320–321, 320t, 692
 Hypoglycemic agents, 314
 Hypoglycorrhachia, 598
 Hypogonadism, 478–480, 479b, 481, 484
 Hypogonadotropic hypogonadism, 480, 484
 Hypokalemia, 363–365, 364t, 462, 462–463, 690, 691t
 Hypolipoproteinemia, 344
 Hypomagnesemia, 369–371, 370t, 374–375
 Hyponatremia, 357, 359–361, 360t, 690, 690t
 Hypoosmolality, 357
 Hypoparathyroidism, primary, 374
 Hypophosphatemia, 377–378
 Hypophysiotropic hormones, 447–448, 448t
 Hypopituitarism, 453–454, 454t
 Hypoproteinemia, 250
 Hypothalamic hormones, 447–448, 448t
 Hypothalamic-hypophysial portal system, 446
 Hypothalamic-hypophysial unit, functional aspects of, 446–447, 447
 Hypothalamic-pituitary-adrenal cortex system, 695, 695t
 Hypothalamic-pituitary-thyroid axis, 492, 694–695
 Hypothalamus, 446, 446, 454, 478, 483
 failure of, 453–454, 454t
 in pediatric patients, 694–696, 695t
 Hypothalamus-pituitary-thyroid system, 694–695
 Hypothyroid disease, 96t
 Hypothyroidism, 490–491, 494–496, 495b–496b, 496t, 677, 694–695
 American Thyroid Association screening guidelines for, 496
 amiodarone-induced, 499
 blood tests for, 493
 subclinical, 493
 Hypouricemia, 272
 Hypoventilation, 389
 Hypovitaminosis, 509–510, 588, 656–657, 657t, 677
 Hypovitaminosis D, 509–510, 677
 Hypoxemia, 390, 392
 Hypoxia, 378–380, 379, 627
- I**
- Iatrogenic anemia, from phlebotomy, 63
 Ibandronate, 514
 Ibuprofen, 306t
 IC. See Ion chromatography
 ICF. See Intracellular fluid
 ICON. See Immunoconcentration Assay
 ICP. See Inductively coupled plasma
 ICP-AES. See Inductively coupled plasma atomic emission spectrometry
 ICP-MS. See Inductively coupled plasma mass spectrometry
 Icterus. See Jaundice
 Identification
 of patients, 29, 48
 of specific proteins, 253–256, 254t, 255
 of specimens in automated analyzers, 170, 170t, 179
 Identity, pattern of, in immune precipitation in gel, 187, 187
 Idiopathic galactorrhea, 453
 Idiopathic hypoglycemia, 321
 Idiopathic type 1 diabetes, 316
 IEF. See Isoelectric focusing
 IEP. See Immunoelectrophoresis
 IFA. See Indirect immunofluorescence assays
 IFE. See Immunofixation electrophoresis
 Ifosamide, 648b
 IgA, 204t, 246–247, 698
 IgD, 204t, 246–247
 IgE, 204t, 246–247
 IGF. See Insulin-like growth factor
 IGF-1. See Insulin growth factor I
 IgG, 204t, 246–247, 263–264, 599, 698
 IgG anti-HAV. See Immunoglobulin G antibodies to HAV
 IgM, 204t, 246–247, 698
 IgM anti-HAV. See Immunoglobulin M antibodies to HAV
 IGR. See Intrauterine growth retardation
 Igs. See Immunoglobulins
 IIF. See Indirect immunofluorescence
 Imaging, adrenal, 463
 Imipramine, 619
 Immaturity, 686
 Immobilization, of child, for venipuncture, 60–61, 61
 Immobilized enzymes, 288
 Immune precipitation, 196
 Immune precipitation in gel, 186–189, 187–189, 187t
 Immune system, 696–698, 697t
 Immunity, 696–698
 Immunoassays, 185–201, 187–189, 187t, 190t, 192, 193t, 194–196, 195t, 199
 in automated analysis, 177
 for cancer antigen, 125, 646
 of creatine kinase isoenzymes, 293
 for digoxin, 613
 for α -fetoprotein, 645
 for human chorionic gonadotropin, 647–648
 labeled, 190–200, 190t, 192, 193t, 194–196, 195t, 199
 for lipoproteins, 346–347
 for measurement of enzyme mass, 288
 for prostrate-specific antigen, 649
 for quinidine, 613
 for tumor markers, 643–644
 unlabeled, 186–190, 187–189, 187t
 urinary protein detection by, 262
 Immunoblots, 198, 199
 Immunochemical methods, for protein analysis, 259, 260
 Immunoconcentration Assay (ICON), 198
 Immunocytochemistry, 198–199
 Immunoelectrophoresis (IEP), 188, 188–189
 Immunofixation electrophoresis (IFE), 188–189, 189, 259, 260
 Immunogen, 185
 Immunoglobulin G antibodies to HAV (IgG anti-HAV), 530
 Immunoglobulin M antibodies to HAV (IgM anti-HAV), 530
 Immunoglobulins (Igs), 237, 240t, 246–247, 697–698, 697t
 enzymes bound to, 304–305
 as tumor markers, 638
 Immunohistochemistry, 198–199, 644
 Immunometric assays. See Noncompetitive immunoassays
 Immunophenotyping, 199–200
 Immunosuppressive drugs, 619–620
 Impaired fasting glucose, 316, 319
 Impaired glucose tolerance, 319
 Implementation, in point-of-care testing, 216–218
 Implied consent, 35b
 Imprecision
 determination of, 110, 110, 110b
 errors in, 117, 125, 125
 measurement of, 110–112, 111, 112b
 Imprecision study, 111, 111–112, 112b
 Improve phase, of DMAIC, 122–123, 122b
 In situ hybridization, 204
 In vitro diagnostics (IVDs), 108
 Inaccuracy
 determination of, 110, 110, 110b
 measurement of, 112–115, 113–115, 114b
 Incidence, of chronic kidney disease, 573–574
 Incidentaloma, 473–474, 474
 Inclusion criteria, for reference interval studies, 97–98, 98t
 Incubation, in automated analysis, 176
 Indications, for capillary puncture, 65
 Indicator electrodes, 142–144
 Indicator enzyme, 287
 Indinavir, 306t
 Indirect bilirubin. See Unconjugated bilirubin
 Indirect immunofluorescence (IIF), 199
 Indirect immunofluorescence assays (IFA), 199
 Indomethacin, 306t, 588
 Inducers, of drug-metabolizing enzymes, 307
 Inductively coupled plasma (ICP), 137–138
 Inductively coupled plasma atomic emission spectrometry (ICP-AES), 404–405, 404t
 Inductively coupled plasma mass spectrometry (ICP-MS), 404, 404t, 406–409, 407
 Indwelling blood gas systems, 397–398
 Indwelling line, phlebotomy in patients with, 62
 Inert-metal electrodes, 144
 Infants
 acidosis and alkalosis in, 689, 689t
 antibody production in, 697t, 698
 capillary puncture for, 65, 687, 687t
 regulation of blood gases and pH in, 688–689, 689t
 Infection
 complement protection against, 244–245
 diagnosis of, 200, 209

- hepatitis, 529–537, 530*t*, 531–533, 533*t*–534*t*, 536*t*
 from phlebotomy, 63
 of testicles, 480
 of urinary tract, 571
- Infection control, in phlebotomy, 35–39, 36*b*–38*b*
- Infectious hepatitis. *See* Hepatitis A virus
- Infectious substances, 79
- Infectious waste, 85
- Infective endocarditis, 548–549
- Infective heart disease, 548–549, 548*t*–549*t*
- Inferential statistics, 95
- Inferior petrosal sinus sampling, for Cushing's syndrome, 466
- Infertility, causes of, 484, 484*t*
- Inflammation, 257, 258
 C-reactive protein in, 245, 552–553
 globulins in, 242–245
 haptoglobin in, 242–243
 markers of, 552–553
- Information requirements, for new or additional point-of-care testing, 215–216, 215*b*
- Informed consent, 35*b*
- Infundibulum. *See* Pituitary stalk
- Ingestion, of toxins, 622–623
- Inhibin, 478, 482
- Inhibitors
 of drug-metabolizing enzymes, 307
 of enzymatic reactions, 286, 286–287
- Injectors, in high-performance liquid chromatography, 150, 151
- Injury
 documentation and investigation of, 85–86
 of testicles, 480
- Inorganic phosphorus, determination of, 378
- Insecticides, toxicology of, 631
- Insertion, of needle, 49–50, 54, 56, 59
- Inspection
 laboratory, CAP checklist regarding reference intervals for, 96*b*
 of needle, 49, 54, 56
- Instrumentation
 for chemiluminescence, 140, 140
 for chromatography, 147–154, 149–150, 152–153
 for electrochemistry, 141–144, 141–145, 142*t*
 for electrophoresis, 145–147, 145–148
 for fluorometry, 138–140, 139
 for mass spectrometry, 154–158, 154–159
 for osmometry, 160–163, 163
 for pediatric clinical chemistry samples, 686–688, 686*t*–687*t*
 for point-of-care testing, 163–164, 163–164
 for proteomics, 159–160, 160–162
 for spectrophotometry and photometry, 130–141, 131–136, 138–140
 for trace elements, 404–409, 404*t*, 405–407
- Insufficiency, adrenal, 463–465, 464
- Insulin, 306*t*, 313–314, 314*t*, 449
 in hyperglycemia, 314–320, 315*t*–316*t*, 318*t*–319*t*
 in hypoglycemia, 320–321
 pancreatic production of, 578
 in pediatric patients, 692
 testing for, 327
- Insulin growth factor I (IGF-1), as biochemical marker, 655
- Insulin resistance, 316–317, 678
- Insulin therapy, 315*b*, 316, 365, 382*b*
- Insulin-dependent diabetes mellitus. *See* Type 1 diabetes
- Insulin-like growth factor (IGF), 449–451, 676, 695
- Insulinoma, 320–321
- Intensive care, for hypocalcemia, 375
- Interatrial septum, 541
- Inter- α -trypsin inhibitor (ITI), 239*t*, 242
- Interference, 98, 112*b*, 523
 in ammonia measurement, 278–279
 in automated analysis, 175–176
 in creatinine and creatine measurements, 275
 in LC/MS, 159
 in pH measurement, 142
 in trace element analysis, 407–408
 in triglyceride measurement, 345–346
 in urea measurements, 268
 in uric acid measurements, 271
- Interference filters, 133–134
- Interference studies, 112–113, 113
- Interferents, 112–113, 112*b*
- Interferon, 535
- Interferon- α , 536
- Interleukins, as biochemical marker, 655
- International Organization for Standards (ISO), 4–5
- International units (IU), 27, 287
- Interpretation, of chemistry results in elderly, 680–683, 681*t*
- Interstitial cell fluid, 356
- Interventricular septum, 541
- Intestinal isoenzyme, of alkaline phosphatase, 298
- Intestines, 587–588
- Intracellular fluid (ICF), 356
- Intrauterine growth retardation (IGR), 685–686, 689
- Intravascular degradation, of hemoglobin, 432, 432
- Intravascular extracellular fluid, 356
- Intrinsic factor, 586, 662–663
- Invasion of privacy, 35
- Investigation, of accidents, 85–86
- Iodine, 490–491, 491, 498–499. *See also* Radioactive iodine
 Iodoacetate, 380
- Ion chromatography (IC), for trace elements, 409
- Ion trap, 156–157
- Ion-exchange chromatography, 149, 149, 233, 293
- Ionic strength, 9
- Ionization, in mass spectrometry, 154–155, 155–156
- Ionized gas, 406
- Ion-selective electrodes (ISEs), 142, 144, 144
 for ammonia measurement, 278, 278*t*
 in automated analyzers, 167
 for calcium, 376, 377
 for sodium, 362–363, 363
- Iontophoresis, 145
- Iron, 243–244, 416–418, 417*t*–418*t*, 588, 668–669
 deficiency of, 243, 416, 654, 669
 transferrin binding of, 243
- Iron chelation drugs, 437
- Irreversible inhibitors, 286
- Ischemia, of heart, 543, 546, 549–550
- Ischemic heart disease, with aging, 680
- ISEs. *See* Ion-selective electrodes
- Islet autoantibody, testing for, 327
- Islet cells, tumors of, 580
- Islets of Langerhans, 578
- ISO. *See* International Organization for Standards
- Isocratic elution, 151, 152
- Isoelectric focusing (IEF), 147, 147, 259
- Isoelectric points (pIs), 159, 236, 236
- Isoenzymes, 281
 of alkaline phosphatase, 298–299
 of amylase, 302
 of creatine kinase, 290, 290*t*, 291, 292–293
 of lactate dehydrogenase, 294–295, 294*t*–295*t*
- Isoforms, 241–242, 281
- Isolated hypoaldosteronism, 462
- Isolation, 39
- Isoleucine, 225, 225*t*, 230
- Isomerases, 282*t*, 283
- Isoniazid, 306*t*, 307, 661, 662*t*
- Isopotential, 143
- Isopropanol, 66, 69, 625–627
- Isopropyl alcohol, 49, 54, 64
- Isovaleric acidemia, 230–231
- ITI. *See* Inter- α -trypsin inhibitor
- IU. *See* International units
- IVDs. *See* In vitro diagnostics
- J**
- J genes. *See* Joining genes
- Jaffe reaction, 274–275, 276*t*
- Jaundice, 30, 72, 520–522, 522*t*, 523, 691
- Jendrassik-Grof method, for bilirubin analysis, 526
- Joining (J) genes, 246
- Joint Commission. *See* The Joint Commission
- Joints, synovial fluid in, 600–601
- Junction, liquid, 143
- K**
- K_a. *See* Dissociation constant
- Kallmann's syndrome, 454, 480
- Kanamycin, 614
- Kashin-Beck disease, 420
- Katal, 27, 288
- Keshan disease, 420
- Ketoacidosis, 317
- Ketoconazole, 306*t*, 461
- Ketonemia, 326
- Ketones, 309, 310, 311, 326, 326, 326*t*
- Ketoneuria, 326
- Ketose form, of carbohydrates, 309, 310
- Kidney. *See also* Renal function
 aging effects on, 679
 anatomy of, 557, 558–559
 calcium metabolism and, 504
 compensation by, 389–390
 magnesium regulation by, 369
 potassium regulation by, 364
- Kidney failure. *See* Renal failure
- Kidney stones, 571–572, 571*t*
- Kinetic assays, of enzyme activity, 287
- Kinetic method, 188, 190
- Kinetics, of enzymes, 283–286, 283–288
 calculation of enzyme activity, 27–28, 287–288
 catalytic mechanism of enzymes, 283, 283–284
 enzymes as reagents, 288
 factors influencing enzymatic reactions, 284–286, 284–286
 measurement of enzyme activity, 286–287
 measurement of enzyme mass, 288
- Kjeldahl method, for total protein analysis, 252, 252*t*
- Klinefelter's syndrome, 479
- K_m. *See* Michaelis-Menten constant
- Kodak Ektachem Analyzer, 167
- Kupffer cells, 517
- Kwashiorkor, 653
- L**
- Lab coats, 78
- Lab personnel, safety awareness and responsibilities of, 76, 77
- Labeled immunoassays, 190–200, 190*t*, 192, 193*t*, 194–196, 195*t*, 199
 assay design, 192, 192–194, 193*t*, 194–195
 examples of, 196, 196–197
 immunoblots, 198, 199
 immunocytochemistry and immunohistochemistry, 198–199
 immunophenotyping, 199–200
 labels, 190–192, 190*t*
 rapid immunoassay, 197–198
 separation techniques for, 194–196, 195*t*
- Labeling
 bar code, 170–171, 171, 179
 of capillary specimen, 68, 70
 of evacuated tubes, 52
 for hazards, 76, 77
 on reagents, 5–6
- Labels, for labeled immunoassays, 190–192, 190*t*, 198–199
- Laboratory
 cardiovascular disease monitoring by, 554–555
 Lean Six Sigma and patient safety and, 124–125, 124*t*, 125
 Laboratory automation. *See* Automation
- Laboratory diagnosis, of myocardial infarction, 549–552, 551
- Laboratory errors, rate of, 123–125, 124*t*

- Laboratory evaluation
of arsenic status, 410
of cadmium status, 411
of chromium status, 414
of copper status, 415, 415t
of iron, 417
of lead status, 412
of manganese status, 419
of mercury status, 413
of molybdenum status, 419–420
of selenium status, 421
of zinc status, 421–422
- Laboratory findings, in hyperglycemia, 316t
- Laboratory information systems (LIS), 182–183, 219, 688
- Laboratory inspection, CAP checklist regarding reference intervals for, 96b
- Laboratory methods, for urinalysis, 567
- Laboratory regulations. *See* Regulations
- Laboratory safety. *See* Safety
- Laboratory standard. *See* OSHA Laboratory Standard
- Laboratory supplies, 9–18, 11t–12t, 12–15, 17
balances, 17, 17–18
desiccators and desiccants, 16–17, 17
glassware and plasticware, 10–16, 11t–12t, 12–15
thermometers, 9–10
- Laboratory tests, for hepatitis C virus, 535
- Laboratory vessels, 11, 11t, 12, 15
- Lactate, 378–380, 379, 380t, 381, 598
- Lactate dehydrogenase (LDH), 30, 293–295, 294t–295t, 529, 541, 550–551, 640t, 679
- Lactic acid, 293–295
- Lactose, 310–311
- Lactose tolerance test, 587
- Lactulose, 279
- Lamellar body counts, 596–597
- Lamotrigine, 617
- Lamps, for spectrophotometer, 133, 137–138
- Lancets, for capillary specimen collection, 64, 64, 66
- Large-molecule diseases, 700, 700t
- Laser ablation ICP-MS, 409
- Lasers, in spectrophotometry, 141
- Latex sensitivity, 48
- Laxative, 412, 583
- LC/MS, 154–155, 157–159
- LC-MS/MS. *See* Liquid chromatography electro-spray-tandem mass spectrometry
- LCR. *See* Ligase chain reaction
- LD₅₀, 623, 623
- LDH. *See* Lactate dehydrogenase
- LDH flipped pattern, 294, 551
- LDL. *See* Low-density lipoproteins
- Lead, 408, 411–412, 428, 628–630, 629
- Lean Six Sigma, 121, 121, 123, 123–126, 124t, 125–126
- Lecithin, 595–596, 596, 689
- Lecithin-sphingomyelin ratio (L/S ratio), 594–596, 596, 689
- Left ventricular dysfunction, 546
- Legal issues, in phlebotomy, 35
- Lesch-Nyhan syndrome, 272
- Leucine, 225, 225t, 230–231
- Leucovorin rescue, 621
- Leukemia, 200
- Leukocyte esterase, urinalysis measurement of, 568
- Levetiracetam, 617
- Levey-Jennings control chart, 116b, 117, 117
- Levodopa, 279
- Levothyroxine, 496, 510b
- Leydig cells, 478
- L-glucose, 310
- LH. *See* Luteinizing hormone
- Licarbazepine, 617
- Licensing, for point-of-care testing, 211–213, 212t–214t
- Lidocaine, 275, 680
- Ligandin, 518
- Ligase chain reaction (LCR), 208
- Ligases, 282t, 283
- Light
bilirubin destruction by, 526
lasers, 141
measuring in automated analysis, 176–178, 176–178
polarized, 139–140, 197, 596–597
scatter of, 140, 140–141, 189–190, 200
stray, 136
- Light source, of spectrophotometer, 133, 137–138, 141
- Limit of detection, 102, 109b
- Limits, control, 116–118, 116b, 118
- Linear range. *See* Analytic measurement range
- Linear regression, 92–93, 93, 99, 114–115, 114b, 115
- Linearity, 136
of immunoassays for tumor markers, 643–644
- Lineweaver-Burk plot, 285, 285–286
- Lipase (LPS), 303–304, 581, 585
- Lipemia, 30, 72, 98, 113
- Lipids, 328–355
absorption of, 333–334, 334
aging effects on, 680
analysis of, 344–349, 345
chemistry of, 329, 329–331
cholesterol, 329, 330–331
diagnosis and treatment of disorders of, 339–344
fatty acids, 329, 329–330
fecal, 582–583
general lipoprotein structure, 331, 331–333, 332t
liver synthesis of, 520
measurement of, 344
monitoring of heart disease with, 555
phospholipid, 329, 330
physiology and metabolism of lipoproteins, 333–336, 334
population distributions of, 336–339, 336t–339t
standardization of assays of, 349–351
triglyceride, 329, 330
- Lipolysis, 313, 313t
- Lipoprotein(a) (Lp(a)), 333, 343–344, 349
- Lipoprotein lipase (LPL), 334–335, 342
- Lipoprotein-associated phospholipase A₂ (LP-PLA₂), 553
- Lipoproteins, 238, 239t, 244, 328–355, 346–347, 349–351
analysis of, 344–349, 345
chylomicrons, 331–333, 332t
diagnosis and treatment of lipid disorders, 339–344
general structure of, 331, 331–333, 332t
high-density lipoproteins, 328, 332–334, 332t
lipid chemistry, 329, 329–331
low-density lipoproteins, 328, 331–333, 332t
physiology and metabolism of, 333–336, 334
population distributions of, 336–339, 336t–339t
very-low-density lipoproteins, 328, 331–333, 332t
- Liquid chromatography. *See* High-performance liquid chromatography
- Liquid chromatography electrospray-tandem mass spectrometry (LC-MS/MS), for homocystinuria detection, 231
- Liquid junction, 143
- Liquid reagents, 174
- Liquid-in-glass thermometers, 9–10
- Liquid-liquid chromatography, 148
- Liquid-membrane electrode, 144
- Liquid-solid chromatography, 148–149, 149
- LIS. *See* Laboratory information systems
- Lithium, 508, 511, 618
- Lithium oxalate, 362
- Liver, 516–540
acetaminophen damage to, 632, 632–633
aging effects on, 679–680
anatomy of, 516–517, 517–518
assessment of functioning of, 525–537, 527t, 530t, 531–533, 533t–534t, 536t
bilirubin analysis, 525–526, 527t
hepatitis tests, 529–537, 530t, 531–533, 533t–534t, 536t
liver enzymes, 528–529
serum bile acids, 527–528
tests for hepatic synthetic ability, 529
tests for nitrogen metabolism, 529
urobilinogen in urine and feces, 526–527
- biochemical functions of, 518–520, 519
development of, 691–693, 691t
disease alterations of function of, 30, 72, 520–525, 522t, 523
diseases of, 257, 258, 277, 279
drug clearance by, 609–610
enzymes of, 528–529
function tests of, 693
- Liver cancer, 523–524, 528–529
- Liver isoenzyme, of alkaline phosphatase, 298–299
- Load, water, 357
- Lobules, 517
- Localization procedures, for Cushing's syndrome, 468–469
- Locura manganica, 419
- Logarithms, 20
- Logs, for point-of-care testing, 217–218
- Long feedback loop, of pituitary, 447
- Long-incubation hepatitis. *See* Hepatitis B virus
- Loop diuretics, 370, 397b, 562
- Loop injectors, in high-performance liquid chromatography, 151
- Loop of Henle, 382, 557, 560
- Lorazepam, 636
- Losartan, 306t
- Lovastatin, 306t, 341, 341b
- Low anion gap, 381
- Low-density lipoproteins (LDL), 328, 331–333, 332t
in arteriosclerosis, 339–341, 546
in combined hyperlipoproteinemia, 343
in hypercholesterolemia, 342
in lipid and lipoprotein analyses, 344–349
in lipoprotein(a) elevation, 343–344
measurement of, 348–349
NCEP goals for, 238t
physiology and metabolism of, 335
population distributions of, 336–337, 336t–337t
- Lp(a). *See* Lipoprotein(a)
- LPL. *See* Lipoprotein lipase
- LP-PLA₂. *See* Lipoprotein-associated phospholipase A₂
- LPS. *See* Lipase
- L/S ratio. *See* Lecithin-sphingomyelin ratio
- Lumbar puncture, 597–598
- Lumen, 47
- Luminescent labels, for labeled immunoassays, 191–192
- Luminol, 191
- Luminometers, 177–178
- Lung cancer, 646, 648
- Lung maturity, assessment of, 593–596
- Lungs
acid-base balance regulation by, 385–388, 387
aging effects on, 680
compensation by, 389
gas content of, 391, 391
phospholipids in, 593–596, 596, 689
- Luteal phase, of menstrual cycle, 482–483
- Luteinization, 482
- Luteinizing hormone (LH), 447–448, 677, 696
in hypergonadotropic hypogonadism, 479, 479b, 486
in hypogonadotropic hypogonadism, 480
in menstrual cycle, 483
in menstrual cycle abnormalities, 484, 485b, 486
in ovulation, 483
testicle production of, 477–478
- Lyases, 282t, 283
- Lymphoma, 200
- Lysine, 225, 225t, 236

M

- M. *See* Molarity
- β₂-M. *See* β₂-Microglobulin
- M pattern veins, 40, 40–41

- Macroamylasemia, 302
 Macro-CK, 292
 Macroelectrode sensors, 397
 Macroelectrodes, 304–305
 Macronutrients, 653–656, 653t
 Macronutrition, 652
 Macroprolactinemia, 452
 Magnesium, 369–372, 370t–372t, 382, 562–563, 665–666
 Magnesium therapy, 371–372, 375
 Malabsorption, 580–581, 587–588, 658
 Malabsorption syndrome, 580–581, 587–588
 MALDI-TOF. *See* Matrix-assisted laser desorption ionization time-of-flight mass spectrometry
 Male reproductive tract, anatomy of, 477
 Malignancy, humoral hypercalcemia of, 507
 Malloy-Evelyn procedure, for bilirubin analysis, 526
 Malnutrition, 652–656, 679
 Malpractice, 35
 Maltose, 310–311
 Management. *See also* Data management; Quality management
 of patients with glucose metabolic alterations, 321–327, 322t, 324t–326t, 326
 of prolactinoma, 452–453
 Manganese, 418–419
 Mantissa, 20
 MAO. *See* Monoamine oxidase
 MAO inhibitors, 472
 Maple syrup urine disease (MSUD), 230
 Marasmus, 653
 Marijuana, 635–636
 Markers. *See also* Biochemical markers; Cardiac markers; Tumor markers
 of inflammation and coagulation disorders, 552–553
 of renal function, nitrogenous end products as, 693
 Masculinization, 469–470, 482
 Mass
 of enzymes, measurement of, 288
 standard prefixes for, 4
 Mass analyzer, 156–158, 157–158
 Mass spectrometry (MS), 154–158, 154–159. *See also* Tandem mass spectrometry
 for amino acid analysis, 233
 in automated testing, 183
 in clinical laboratory, 158–159
 detector for, 158, 158
 GC/MS, 154–155, 157–159, 409
 for homocystinuria detection, 231
 inductively-coupled plasma, 404, 404t, 406–409, 407
 for isovaleric acidemia detection, 230
 LC/MS, 154–155, 157–159
 LC-MS/MS, 231
 for maple syrup urine disease detection, 230
 mass analyzer, 156–158, 157–158
 for phenylketonuria testing, 229
 of proteins, 155, 156, 159–160, 160–162
 sample introduction and ionization, 154–155, 155–156
 for tyrosinemia detection, 229
 Mass-to-charge ratio (*m/z*), 154–158, 156–158, 406–408
 Mastectomy, phlebotomy in patients with, 62
 Material Safety Data Sheets (MSDS), 6, 75, 79–80
 Materials collection, in point-of-care testing, 216
 Mathematics. *See* Calculations
 Matrix, 112b
 Matrix interactions, of lipid and lipoprotein assays, 350–351
 Matrix interference, in trace element analysis, 407–408
 Matrix-assisted laser desorption ionization time-of-flight mass spectrometry (MALDI-TOF), 159–160, 160–162
 Maturation, sexual, 686, 696
 Maturity-onset diabetes of youth (MODY), 316
 Maximal secretory tests, of gastric secretion, 586
 Maximum allowable error, 110
 MDMA. *See* Methylenedioxymethylamphetamine
 MDRD equation. *See* Modification of Diet in Renal Disease equation
 Mean, 89, 90
 Measure phase, of DMAIC, 122–123, 122b
 Measurement
 in automated analysis, 170t, 176–178, 176–178
 of blood gases, 394, 394–398
 of blood gases and acid-base in pediatric patients, 689
 of glucose, 321–323, 322t
 of specimens in automated analyzers, 170–173, 170t, 171–173
 units of, 3–5, 4t, 23
 Measuring pipets, 13
 Mechanical hazards, 84
 Mechanistic toxicology, 622
 Median, 89, 90
 Median basilic vein, 41
 Median cephalic vein, 41
 Median cubital vein, 40
 Median eminence, 445–446
 Median vein, 40
 Medical decision level, 96b, 105
 Medical waste, 85
 Medicare, 673
 Medications. *See* Drugs
 Medulla. *See* Adrenal medulla
 Megaloblastic anemia, 661–663
 MEIA. *See* Microparticle capture enzyme immunoassay
 Membrane electrodes, 144
 MEN. *See* Multiple endocrine neoplasm
 Menkes disease, 415, 667
 Menopause, 486, 677
 Menorrhagia, 484
 Menstrual cycle, 481–483
 abnormalities of, 483–487, 484t, 485, 485b
 Meperidine, 30, 636
 6-Mercaptopurine, 272, 306t, 307
 Mercurochrome, 412
 Mercury, 80, 406, 412–413, 630–631
 Mercury (I) chloride, 412
 Mercury/mercurous chloride electrode, 142–143
 Mercury-vapor lamps, 138
 Mesenteries, 584b
 Messenger RNA (mRNA), 203, 234
 Metabolic acids, renal excretion of, 563
 Metabolic bone disease, 512–514, 513
 Metabolic clearance, of drugs, 609–610
 Metabolic diseases, 699t, 700–701, 700t
 Metabolic syndrome, 574, 652
 Metabolism
 of amino acids, 224
 of bilirubin, 518–519, 519
 bone, in pediatric clinical chemistry, 693–694, 694t
 of calcium, 501–505, 502–503, 510–512, 665–666, 666t
 of carbohydrates, 231, 313–314, 314t
 of drugs, 520, 701–702, 702t
 energy, in pediatric patient, 691–692, 691t
 of glucose, 309, 310, 311, 321–327, 322t, 324t–326t, 326
 of lipoproteins, 333–336, 334
 mineral, 665–666, 666t
 of nitrogen, 529, 692–693
 of thyroxine, 492
 Metal electrodes, 144
 Metalloenzymes, 404, 415, 419
 Metalloids, toxicology of, 628–631, 629
 Metalloproteins, 238, 404
 Metals, toxicology of, 628–631, 629
 Metanephrine, 473, 641t
 Metastasis, 637, 639
 Methadone, 636
 Methamphetamine, toxicology of, 634–635
 Methanol, toxicology of, 625–627
 MetHb. *See* Methemoglobin
 Methemoglobin (MetHb), 392–394
 Methicillin, 571
 Methimazole (MMI), 497–498
 Methionine, 225, 225t, 231
 Method. *See* Analytic methods
 Method evaluation, 88, 108–116, 108b–110b, 109t, 110–111, 112b, 112t, 113–115, 114b, 116t
 allowable analytic error, 115–116, 116t
 determination of imprecision and inaccuracy, 110, 110, 110b
 imprecision measurement, 110–112, 111, 112b
 inaccuracy measurement, 112–115, 113–115, 114b
 method selection, 109, 109b, 110
 regulation aspects of, 108, 108b, 109t
 Methotrexate, 277b, 621, 661, 662t, 702t
 Methyl mercury, 412–413, 630
 Methyl orange, 254
 Methylated arsenic compounds, 409
 α -Methyldopa, 451, 471
 Methylenedioxymethylamphetamine (MDMA), 634–635
 Methylprednisolone, 511
 Metoclopramide, 451
 Metrics, Lean and Six Sigma, 123, 123–126, 124t, 126
 Metyrapone, 644
 MFO system. *See* Mixed function oxidase system
 MI. *See* Myocardial infarction
 Michaelis-Menten constant (K_m), 284, 284–286, 286
 Microalbumin, for renal function assessment, 566
 Microalbuminuria, 262, 326–327, 566
 Microammeter, 395
 Microarrays, 206
 Microcollection tubes, 64–65, 65, 67, 70, 171
 Microelectrodes, 397
 Microfluorometric assay, 229–230
 β_2 -Microglobulin (β_2 -M), 239t, 244, 565, 638, 640t
 Microhematocrit tubes, 65, 65, 67, 70
 Microion-selective electrodes, 164
 Micronutrients, 656–665, 657t, 662t
 Micronutrition, 652
 Microparticle capture enzyme immunoassay (MEIA), 197
 Micropipets, 13, 14
 Microprolactinoma, 453
 Microtubes, 61
 Microvilli, 587
 Migration rate, in electrophoresis, 145–146
 Milk-alkali syndrome, 507
 Mineral metabolism, calcium/phosphorus, 665–666, 666t
 Mineral oil, 583
 Mineralocorticoid therapy, 469
 Minors, consent for, 35b
 Minoxidil, 470
 Mitochondrial-CK (CK-Mi), 292
 Mitral valve, 541
 Mixed function oxidase (MFO) system, 609
 Mixed hemoglobinopathy, 433
 Mixing
 in automated analysis, 175, 175
 of tubes, 71
 MLCs. *See* Myosin light chains
 MMF. *See* Mycophenolic mofetil
 MMI. *See* Methimazole
 Mode, 89–90, 90
 Moderately complex tests, 211–213, 214t, 216–217, 554
 Modification of Diet in Renal Disease (MDRD) equation, 274
 Modular analyzers, 167, 169t, 182, 182
 MODY. *See* Maturity-onset diabetes of youth
 Mohr pipets, 13
 Molality, 8
 Molar absorptivity, 27, 132–133
 Molarity (M), 7–8, 21–22
 Molecular arrays, 202
 Molecular size, of proteins, 233
 Molecular techniques, 202–210
 nucleic acid-based techniques, 202–209, 203, 204t, 205–206, 208–209
 for porphyrin testing, 429–430

- Molybdenum, 419–420
 MoM. *See* Multiples of the median
 Monitoring. *See also* Therapeutic drug monitoring
 of calcium, 665–666, 666t
 of cancer therapy effectiveness, 542
 of cardiovascular disease, 554–555
 of phosphorus, 665–666, 666t
 of physiologic condition, 96, 97t
 of reference intervals, 101, 102t
 of testosterone replacement therapy, 481
 of trace minerals, 666–670
 Monitors, for radiation, 82
 Monoamine oxidase (MAO), 471, 472
 Monochromators, 133, 133–134, 137–138, 176, 176, 405
 Monoclonal Ab, 186, 194, 200
 Monoclonal immunoglobulin disease, 257, 258
 Monoclonal proteins, characterization of, 188–189, 188–189
 Monohydrogen phosphate, renal reaction with, 563
 Monosaccharides, 310–311, 311
 Monosodium urate, 270
 Monotropic hormone deficiency, 453–454, 454t
 Morphine, 30, 303, 636, 680
 Moving boundary electrophoresis, 256
 mRNA. *See* Messenger RNA
 MS. *See* Mass spectrometry
 MSDS. *See* Material Safety Data Sheets
 MS/MS, 157–158, 157–158
 MSUD. *See* Maple syrup urine disease
 Mucoproteins, 238
 Mucoviscidosis. *See* Cystic fibrosis
 Multinodular goiter, 498, 498t
 Multiple dosing regimen, 610–611, 611
 Multiple endocrine neoplasm (MEN), 506
 Multiple myeloma, 251, 506–507
 Multiple sclerosis, 263–264, 599
 Multiple venipuncture attempts, 60
 Multiple wavelength monitoring, 183
 Multiples of the median (MoM), 241, 592
 Multi-rule procedure, 116b, 118–119, 118t, 119
 Multisample needle, 41, 42
 Muscular dystrophy, creatine kinase in diagnosis of, 289–290
 Mycophenolic acid, 620
 Mycophenolic mofetil (MMF), 620
 Myelin basic proteins, 264, 599
 Myocardial infarction (MI), 543, 546–547, 554
 with aging, 678
 aspartate aminotransferase in, 296, 550, 554
 creatinine kinase in diagnosis of, 289–292, 292, 551
 laboratory diagnosis of, 549–552, 551
 lactate dehydrogenase in diagnosis of, 294, 550–551
 myoglobin in diagnosis of, 247, 440–441, 551–552
 Myocardial injury, 248, 291–292
 Myoglobin, 247, 248t, 424, 440–441, 440t, 541, 551–552
 clinical significance of, 440–441, 440t
 iron in, 416
 methodology for, 441
 for renal function assessment, 565–566
 structure and role in body, 440
 Myosin, 541
 Myosin light chains (MLCs), 551–552
 Myotonic dystrophy, 479
m/z. *See* Mass-to-charge ratio
- N**
 N. *See* Normality
 NAA. *See* Neutron activation analysis
 N-acetyl procainamide (NAPA), 614
 N-acetyltransferase (NAT), 307
 NAD. *See* Nicotinamide adenine dinucleotide
 NADP. *See* Nicotinamide adenine dinucleotide phosphate
 NaF. *See* Sodium fluorescein
- Nagao isoenzyme, of alkaline phosphatase, 298–299
 Naloxone, 636
 Nanofiltration, 7
 NAPA. *See* N-acetyl procainamide
 Naproxen, 618
 Narcotic analgesics, 279
 Nasal sprays, mercury in, 412
 NASBA. *See* Nucleic acid sequence-based amplification
 NAT. *See* N-acetyltransferase
 National Cholesterol Education Program (NCEP), 329, 337, 347–348, 350–351
 abnormal lipoprotein treatment guidelines of, 238t
 analytic performance goals of, 238t, 351
 on coronary heart disease risk factors, 337, 337t
 therapeutic lifestyle changes diet recommendations of, 339t
 National Formulary (NF) reagent, 5
 National Institute of Standards and Technology (NIST), 6, 10
 Natriuretic peptides, 248, 553
 Natural killer (NK) cells, 697
 NCEP. *See* National Cholesterol Education Program
 NCP. *See* Nutrition care process
 Neck surgery, hypocalcemia arising from, 509–510
 Needle
 butterfly, 44
 disposal of, 51
 insertion of, 49–50, 54, 56, 59
 inspection of, 49, 54, 56
 multisample, 41, 42
 positioning of, 47, 59, 60
 for syringe system, 44
 for venipuncture, 41–42, 56–58, 56–59
 withdrawal of, 51, 55, 57–58
 Negative bias, 99b
 Negative feedback, 447
 Negative logarithm, 20
 Negative predictive value (NPV), 102b, 104, 104
 Negligence, 35
 Neonate
 acidosis and alkalosis in, 689, 689t
 antibody production in, 697t, 698
 bilirubin collection in, 70
 developmental changes in, 685–686
 regulation of blood gases and pH in, 688–689, 689t
 screening of, 70–71, 375
 Neoplasm, 298–299, 506, 648
 Nephelometry, 140, 140–141, 189–190
 Nephron, 557, 559
 Nephropathy, microalbuminuria with, 326–327, 566
 Nephrosis, 243
 Nephrotic syndrome, 257, 258, 569, 570, 570–571, 574
 Nernst equation, 143, 396
 Nerve injury, from phlebotomy, 63
 Neural tube defects (NTDs), 592
 Neurohypophysis. *See* Posterior pituitary
 Neuron-specific enolase, 640t
 Neutron activation analysis (NAA), 408–409
 New York Heart Association (NYHA), heart failure classification system of, 545, 545t
 Newborn
 hemolytic disease of, 592–593, 593–594
 homocystinuria in, 231
 isovaleric acidemia in, 230
 maple syrup urine disease in, 230
 phenylketonuria in, 228–229
 physiologic jaundice of, 522
 screening for whole populations, 699–700, 699t
 NF reagent. *See* National Formulary reagent
 NH₃ gas electrode, 144
 Niacin, 341, 341b, 343–344, 661
 Nicotinamide adenine dinucleotide (NAD), 287–288, 312, 378
- Nicotinamide adenine dinucleotide phosphate (NADP), 312–313, 323
 Nicotine, 30, 472
 Nifedipine, 306t
 Night blindness, 658
 NIST. *See* National Institute of Standards and Technology
 Nitisinone (NTBC), 230
 Nitrite, urinalysis measurement of, 568
 Nitrogen, 236, 252, 529, 692–693
 Nitrogen balance, 225, 235, 250, 252, 654–655
 Nitrogenous end products, as markers of renal function, 693
 Nitroprusside, for ketone analysis, 326, 326t
 NK cells. *See* Natural killer cells
 Nodules, thyroid, 495, 498–499
 Nomenclature, of enzymes, 282t, 283
 Noncompetitive immunoassays, 193–194, 194–195
 Noncompetitive inhibitors, 286, 286
 Noncontinuous-flow discrete analyzer, 168
 Nonessential amino acids, 225t, 226–230, 228, 236
 Nonessential trace elements, 404
 Non-insulin-dependent diabetes mellitus. *See* Type 2 diabetes
 Nonionizing radiation, 82, 82t
 Nonketotic hyperosmolar state, 317
 Nonparametric method, 95, 99, 99b, 100
 Nonprotein nitrogen (NPN) compounds, 266–279, 267t
 ammonia, 231–232, 266–267, 267t, 277, 277–279, 278t–279t, 529, 563, 692–693
 creatinine, 266, 267t, 273, 273–277, 276t
 creatinine, 266, 267t, 269, 273, 273–277, 276t, 561, 564–565
 renal elimination of, 561
 urea, 266–269, 267, 267t–269t, 561, 565
 uric acid, 266, 267t, 270, 270–272, 271t–272t, 561
 Nonrespiratory acidosis, 389, 398
 Nonrespiratory alkalosis, 390, 398
 Nonresponders, 612
 Non-SI units, 3, 4t
 Nonsteroidal anti-inflammatory drugs (NSAIDs), 365, 461
 Nonsurrogate quality control, 401
 Nonthyroidal illness, 499
 Norepinephrine, 471–473, 472
 Normal distribution. *See* Gaussian distribution
 Normal phase, 148
 Normal range, 95, 96b
 Normality (N), 8, 22
 Northern blot, 204
 Nortriptyline, 305, 619
 NPN compounds. *See* Nonprotein nitrogen compounds
 NPV. *See* Negative predictive value
 NSAIDs. *See* Nonsteroidal anti-inflammatory drugs
 5NT. *See* 5'-Nucleotidase
 NTBC. *See* Nitisinone
 NTDs. *See* Neural tube defects
 N-terminal-brain natriuretic peptide (NT-proBNP), 248, 553
 NT-proBNP. *See* N-terminal-brain natriuretic peptide
 Nuclear medicine evaluation, of thyroid gland, 494–495
 Nucleic acid probe, 203–206, 204t, 208–209
 Nucleic acid sequence-based amplification (NASBA), 206–207, 208
 Nucleic acid-based techniques, 202–209, 203, 204t, 205–206, 208–209
 Nucleic acids, chemistry of, 202–203, 203
 Nucleoproteins, 238
 5'-Nucleotidase (5NT), 528–529
 Nutrient balance, 652
 Nutrition care process (NCP), overview of, 651
 Nutrition, for elderly, 682–683
 Nutritional assessment, 651–672
 anthropometric measurements, 651–652
 biochemical markers, 652–656, 653t
 carbohydrates, as biochemical markers, 656

- clinical component, 652
 dietary component, 652
 environmental assessment, 652–653
 macronutrients, 653–656, 653*t*
 micronutrients, 656–665, 657*t*, 662*t*
 mineral metabolism–calcium/phosphorus, 665–666, 666*t*
 nutrition care process, 651
 proteins, 653–656, 653*t*
 trace minerals, 666–670
 NYHA. *See* New York Heart Association
- O**
- O₂Hb. *See* Oxyhemoglobin
 Observations, paired, descriptive statistics of groups of, 92–95, 93–94, 94*b*
 Obstruction, of urinary tract, 571
 Occupational exposure to hazardous chemicals in laboratories, 75, 80
 Occupational injuries, documentation and investigation of, 85–86
 Occupational Safety and Health Act (OSHA), 6, 49, 51, 55–56, 72, 74–75, 79–80, 86
 Odor, of urine, 566
 OGTT. *See* Oral glucose tolerance test
 1,25(OH)₂D. *See* 1,25-Dihydroxy vitamin D
 17-OHCS. *See* 17-Hydroxycorticosteroid
 OIA. *See* Optical immunoassay
 Ointments, mercury in, 412
 Olanzapine, 619
 Oligoclonal bands, 599
 Oligomenorrhea, 484
 Oligosaccharides, 310–311
 Omeprazole, 306*t*
 Oncofetal antigens, 637–638, 646
 Oncogenes, 637, 638*b*
 One point calibration, 27
 Open-loop negative feedback system, 447
 Operation, of quality control system, 117–118, 118
 Operation process specification (OPSpect) chart, 125, 126
 Ophthalmopathy, with Graves' disease, 497–498
 Opiates, 30, 303, 585, 624, 634*b*, 636
 Opium, 636
 Opsonization, 245
 OPSpect chart. *See* Operation process specification chart
 Optical immunoassay (OLA), 198
 Optical sensors, 397–398
 Oral contraceptives, 243, 245, 324, 470, 485, 487*t*
 effect on analytes, 30
 effect on nutrition, 660–661, 662*t*
 Oral glucose tolerance test (OGTT), 318–319, 318*t*–319*t*, 324
 Order of draw
 additive carry-over and, 46–47, 46*b*, 46*t*–47*t*
 capillary, 65
 Ordering, of tests for tumor markers, 642
 Organ physiology, calcium metabolism and, 504–505
 Organ systems
 hypercalcemia arising from, 507
 hypocalcemia arising from, 510
 Organic mercury, 412–413, 630
 Organic reagents, 5–6
 Organophosphates, 631
 Organs, development of, 686
 Orosomucoid. *See* α₁Acid glycoprotein
 OSHA. *See* Occupational Safety and Health Act
 OSHA Laboratory Standard, 75, 80
 Osmolal gap, 358–359
 Osmolality, 160
 classification of hyponatremia by, 360–361, 360*t*
 clinical significance of, 357
 determination of, 358–359, 359*t*
 hypernatremia related to, 362*t*
 of plasma, 357–359, 358, 359*t*, 455
 reference ranges for, 359*t*
 regulation of blood volume, 357–358, 358
 of renal medulla, 560–561
 Osmolar gap, 626
 Osmolarity, 357, 626
 Osmometers, 358
 Osmometry, 160–163, 163
 Osmotic coefficient, 160
 Osmotic force, from proteins, 237
 Osmotic pressure, 8
 Osteoblasts, 503, 677
 Osteoclasts, 503, 677
 Osteomalacia, 512
 Osteopenia, 514
 Osteoporosis, 511–514, 513, 677
 Ostwald-Folin pipets, 13
 OTC medications. *See* Over-the-counter medications
 Otorrhea, 598
 Ovarian cancer, tumor markers for, 640, 646–648
 Ovary, 481–488, 483*t*–484*t*, 485, 485*b*, 487*b*, 487*t*
 estrogen replacement therapy and, 488
 functional anatomy of, 482
 hirsutism, 482, 487, 487*b*, 487*t*
 hormonal control of ovulation, 483
 hormonal production by, 482
 menstrual cycle, 481–483
 menstrual cycle abnormalities, 483–487, 484*t*, 485, 485*b*
 pubertal development in female, 483, 483*t*
 Overdose, of therapeutic drugs, 631–633, 632
 Oversight structure, for point-of-care testing, 215
 Over-the-counter (OTC) medications, 421, 634, 634*b*
 Ovulation, 482, 483
 Oxalate, 372, 376, 378, 417, 612
 Oxcarbazepine, 617–618
 Oxidation, 395
 Oxidation-reduction potential, 8
 Oxidizing agents, 8
 Oxidoreductases, 282*t*, 283, 304
 Oxycodone, 636
 Oxygen, 390–394, 391, 393
 carbon dioxide and, 390–392, 391
 hemoglobin-oxygen dissociation, 393, 393–394
 myoglobin binding of, 247
 partial pressure of, 391–393, 395–396, 680
 quantities associated with assessment of patient's oxygen status, 392–393
 transport of, 392, 430, 440
 Oxygen capacity, of hemoglobin, 393
 Oxygen content, 393
 Oxygen saturation (SO₂), 392, 394, 394–398
 Oxygen-dissociation curve, 393, 393–394
 Oxyhemoglobin (O₂Hb), 392–394, 393
 Oxytocin, 445, 454–455
- P**
- PA. *See* Plasma aldosterone
 Painful thyroiditis, 499
 Paired observations, descriptive statistics of groups of, 92–95, 93–94, 94*b*
 Palpitation, 40, 543
 Pancreas, 578–585, 579, 585*b*
 Pancreatic cancer, 580
 Pancreatic fluid, 578–579, 581–582
 Pancreatitis, 302–303, 580
 Pancreozymin. *See* Cholecystokinin
 Panhypopituitarism, 453–454, 454*t*, 695
 Pantothenic acid, 664
 Paper forms, for point-of-care testing, 217–218
 PAPP-A. *See* Pregnancy-associated plasma protein A
 Paracentesis fluids, 29, 602
 Paraldehyde, 664
 Parameters, of blood gas measurement, 398
 Parametric method, 95, 99, 99*b*, 100
 Paraproteins, 251
 Parasites, in urinalysis, 569
 Parathyroid glands, 490, 503–504, 506, 509–510
 Parathyroid hormone (PTH), 373–375, 377, 641*t*
 in calcium homeostasis, 501, 503, 503–505, 511
 in electrolyte balance, 562–563
 in hypercalcemia, 505–508, 507
 in hypocalcemia, 509, 509–510
 in metabolic bone disease, 512
 Parathyroid hormone-related protein (PTHrP), 507, 509
 Parent ion, 157
 Parenteral testosterone, 480
 Partial pressure of carbon dioxide (pCO₂), 391, 395–398, 680
 Partial pressure, of gases, 391–393, 395
 Partial pressure of oxygen (pO₂), 391–393, 395–396, 398, 680
 Participants, for reference interval studies, 97, 98*t*
 Particle concentration fluorescence immunoassay (PCFIA), 197
 Particle enhanced turbidimetric inhibition immunoassay (PETINIA), 196
 Partition chromatography, 148
 Partition coefficient, 148
 Partitioning, of individuals in reference interval studies, 98, 98*t*
 Pasteur pipets, 13
 Patency, of vein, 63
 Pathogens
 airborne, 79
 bloodborne, OSHA standard for, 49, 75, 79
 Pathologic conditions, of heart, 543–549, 543*t*, 545*t*–546*t*, 547, 548*t*–549*t*
 acute coronary syndrome, 248, 543, 546–547, 547
 congenital cardiovascular defects, 544–545
 heart failure, 544–546*t*, 545–546
 hypertensive heart disease, 547–548, 548*t*
 infective heart disease, 548–549, 548*t*–549*t*
 Pathology, of intestinal function, 587
 Pathophysiology
 of ammonia, 279
 cancer antigen 125 application to, 646
 carcinoembryonic antigen application to, 647
 of creatine, 277
 of creatinine, 276
 of diabetes mellitus, 316–317
 α-fetoprotein application to, 646
 human chorionic gonadotropin application to, 648
 prostrate-specific antigen application to, 649
 of renal function, 510, 570, 570–576, 571*t*, 573, 574*t*
 of urea, 268–269, 269*t*
 of uric acid, 272, 272*t*
- Patient
 communication with, 34
 conditions of, 63–64
 confidentiality of, 35
 consent of, 34–35, 35*b*
 identification of, 29, 48
 oxygen status of, quantities associated with assessment of, 392–393
 positioning of, 48–49, 66, 68
 safety of, 124–125, 124*t*, 125
 Patient samples. *See* Specimens
 Patient-focused cardiac tests, 554
 Pattern of identity, in immune precipitation in gel, 187, 187
 PBG. *See* Porphobilinogen
 PCFIA. *See* Particle concentration fluorescence immunoassay
 pCO₂. *See* Partial pressure of carbon dioxide
 pCO₂ electrode, 144, 144–145, 396–397
 PCOS. *See* Polycystic ovary syndrome
 PCP. *See* Phencyclidine
 PCR. *See* Polymerase chain reaction
 PCT. *See* Porphyria cutanea tarda
 PDA detectors. *See* Photodiode array detectors
 PDB. *See* Protein Data Bank
 Peak drug level, 610, 612
 Pediatric clinical chemistry, 685–703
 calcium and bone metabolism in pediatrics, 693–694, 694*t*

- Pediatric clinical chemistry (*continued*)
 developmental changes from neonate to adult, 685–686
 drug metabolism and pharmacokinetics, 701–702, 702t
 endocrine function in pediatrics, 694–696, 695t
 genetic diseases, 698–701, 699t–700t
 immune system development, 696–698, 697t
 liver function development, 691–693, 691t
 phlebotomy and choice of instrumentation for, 686–688, 686t–687t
 point-of-care analysis in, 688, 688t
 regulation of blood gases and pH in neonates and infants, 688–689, 689t
 regulation of electrolytes and water in pediatric patients, 689–690, 690t–691t
 renal function in pediatric patients, 689–690, 690t–691t
- Pediatric venipuncture, 60–61, 61
- Pegvisomant, 451
- Pellagra, 656, 661
- Penicillamine, 233, 662t
- Penicillin, 254, 559, 701
- Pentagastrin, 586, 587b
- Pentazocine, 636
- Pentobarbital, 636
- Pepsin, 585
- Peptide bond, 223–224, 224
- Percent oxyhemoglobin. *See* Fractional oxyhemoglobin
- Percent purity values, 22
- Percent saturation, of iron, 417, 417t–418t
- Percent solutions, 7, 20–21
- Percent transmittance (%T), 131–132, 131–132
- Performance, analytic, 119b, 238t, 351
- Performance improvement (PI), 218
- Pericardial fluid, analysis of, 602
- Pericarditis, 548–549
- Pericardium, 541, 548–549
- Peripheral cells, fatty acid transport to, 333–335, 334
- Peripheral cyanosis, 544
- Peripheral vascular disease (PVD), 339
- Peritoneal dialysis, 575–576
- Peritoneal fluid, analysis of, 602
- Peritoneum, 584b
- Pernicious anemia, 663
- Personal protective equipment (PPE), 35–39, 75, 77–78, 82
- Personnel
 for blood collection, 33–34
 safety awareness and responsibilities of, 76, 77
- Pesticides, toxicology of, 631
- Petechiae, from phlebotomy, 63
- PETINIA. *See* Particle enhanced turbidimetric inhibition immunoassay
- Petrosal sinus sampling, for Cushing's syndrome, 466
- PG. *See* Phosphatidylglycerol
- pH, 20, 384–402
 acid, base, and buffer defined, 384–385
 acid-base balance, 385–388, 386–387
 acid-base homeostasis assessment, 388–390, 388t
 of blood, 384–402, 385
 blood gas analyzers for, 395
 of buffered solutions, 8–9
 of enzymatic reactions, 285
 measurement of, 394, 394–398
 in neonates and infants, 688–689, 689t
 oxygen and gas exchange, 390–394, 391, 393
 point-of-care testing of, 218–219
 quality assurance, 398–402, 400
 reference range for, 388t
 sample collection for, 399
 temperature correction for, 398
 of urine, 567
- pH electrode, 142–144, 142–144, 396–398
- pH meter, 142–143, 142–144, 396
- Phagocytes, 697
- Pharmacogenomics, 612
- Pharmacokinetics, 610–611, 610–611, 701–702, 702t
- Phencyclidine (PCP), 636
- Phenobarbital, 243, 301, 306t, 615, 617–618, 636, 702t
- Phenothiazine, 451, 660, 662t
- Phenylalanine, 225–226, 225t, 230
- Phenylethanolamine N-methyltransferase (PNMT), 471
- Phenylketonuria (PKU), 227–229, 228
- Phenylpropanolamine, 634
- Phenytoin, 301, 306t, 511, 615–618, 615b, 661, 662t, 702t
- Pheochromocytomas, 471–474, 472
- Phlebotomy, 28–29, 33–73
 blood collection personnel, 33–34
 blood samples for amino acid analysis, 233
 capillary puncture procedures, 65–70, 66–67, 69
 capillary specimen collection, 64–65, 64–65
 for elderly patients, 682
 geriatric venipuncture, 61
 infection control, 35–39, 36b–38b
 legal issues, 35
 order of draw and additive carry-over, 46–47, 46b, 46t–47t
 for pediatric clinical chemistry, 686–688, 686t–687t
 pediatric venipuncture, 60–61, 61
 phlebotomy-related vascular anatomy, 39–41, 40
 preanalytic considerations for, 62–64, 63b
 public relations and client interaction, 34–35, 35b
 quality assurance in, 61–62
 source and composition of blood specimens, 41
 specimen handling, 71
 specimen processing, 71–72
 types of blood specimens, 41
 vascular system, 39, 39
 venipuncture equipment, 41–46, 42–45
 venipuncture procedures, 47–60, 48–59
 for butterfly system and ETS holder, 53–55, 54–55
 for evacuated tube system, 48–53, 48–53
 syringe system, 56–58, 56–59
- Phosphatases, measurement of, 528–529
- Phosphate, 376–378, 378t, 382, 504, 507, 562–563, 665–666, 666t
- Phosphate buffer system, 385
- Phosphatidylglycerol (PG), 595–596, 596
- Phospholipid, 329, 330–331, 333–334, 349, 593–596, 596, 689
- Phosphorus, 378, 665–666, 666t
- Photocell, 134
- Photodetectors, of spectrophotometer, 134–135, 134–137
- Photodiode array (PDA) detectors, 135, 135
- Photometer, in automated analyzers, 176, 176
- Photometry, 130–141, 131–136, 138–140
 atomic absorption, 136, 136–138, 404, 404t
 in automated analysis, 176–178, 176–178
 Beer's law in, 131–132, 131–133
 chemiluminescence, 140, 140
 dual-wavelength reflectance, 163, 164
 flame, 138
 fluorometry, 138–139, 138–140
 laser applications in, 141
 quality assurance in, 136
 spectrophotometer components, 133–135, 133–136
 spectrophotometer instruments, 133, 133
 turbidity and nephelometry, 140, 140–141
- Photomultiplier (PM) tube, 135, 135, 137
- Photosensitivity, porphyrin-induced, 426–428
- Phototube, 134, 134–135
- Physical characteristics, of urine, 566–567
- Physiologic changes, of aging, 675–680, 675t–676t
 cardiovascular and lipid changes, 680
 diabetes mellitus and insulin resistance, 678
 endocrine function changes, 676–678
 enzyme changes, 680
 hepatic function changes, 679–680
 pulmonary function and electrolyte changes, 680
 renal function changes, 679
- Physiologic condition, monitoring of, 96, 97t
- Physiologic development, 685
- Physiologic hypoglycemia, 692
- Physiologic jaundice, 522, 691
- Physiology
 of adrenal cortex, 463, 463
 of ammonia, 277, 277
 of calcium, 373
 of cancer antigen 125, 646
 of carcinoembryonic antigen, 646–647
 of creatinine and creatine, 273, 273
 of α -fetoprotein, 645
 of human chorionic gonadotropin, 647
 intestinal, 587
 of lactate, 378, 379
 of lipoproteins, 333–336, 334
 of magnesium, 369
 of organs, calcium metabolism and, 504–505
 of pancreatic function, 578–579, 579
 of phosphate, 376–377
 of prostate-specific antigen, 648
 renal, 558–564, 559–560, 562
 of testicles, 477–479, 478t
 of testosterone actions, 478–479, 478t
 of urea, 267
 of uric acid, 270
- PI. *See* Performance improvement
- PIF. *See* Prolactin inhibitory factor
- Pilocarpine, 306t, 583, 600, 699
- Pipets, 11–15, 11t–12t, 12–14, 76, 172–173
 pls. *See* Isoelectric points
- Pituitary, 445–457
 anterior pituitary hormones, 448, 448t
 embryology and anatomy of, 445–446, 446
 failure of, 453–454, 454t
 functional aspects of hypothalamic-hypophysial unit, 446–447, 447
 growth hormone, 449–451, 449t
 hypogonadism with disease of, 480
 hypophysiotropic or hypothalamic hormones, 447–448, 448t
 hypopituitarism, 453–454, 454t
 in pediatric patients, 694–695, 695t
 posterior pituitary hormones, 454–455
 prolactin, 447–448, 451–453
 tumors of, 448–454
- Pituitary Cushing's syndrome, 466–469
- Pituitary stalk, 445–446, 451–452, 454
 pK, 384–385
 pK_a, 9, 20
- PKU. *See* Phenylketonuria
- Plaque, in arteriosclerosis, 339–340
- Plasma, 6, 28, 29, 30, 41, 72
 ammonia in, 277–279
 for carbon dioxide determination, 368
 catecholamines in, 471
 cortisol in, 467
 creatine in, 277
 creatinine in, 273–274, 276
 gastrin in, 586
 glucose in, 321–322, 324, 324t
 for lipid and lipoprotein assays, 351
 osmolality of, 357–359, 358, 359t, 455
 partial pressure of oxygen dissolved in, 392–393
 potassium in, 364–365
 total nitrogen analysis in, 252
 total protein analysis in, 252
 urea in, 267–269, 269t
 uric acid in, 270, 272, 272t
- Plasma aldosterone (PA), 462, 462
- Plasma proteins, 238–247, 239t–240t
 albumin, 238–240, 239t, 250t, 253–254, 254t, 256, 257, 258, 262, 326–327, 492, 505, 566, 588, 596, 599, 653–654, 679
 globulins, 238–247, 239t–240t, 250t, 254, 256, 257, 258
 prealbumin, 238, 239t, 599, 654
- Plasma renin activity (PRA), 462, 462
- Plasticware, 10–16, 11t–12t, 12–15
 burets, 11t, 15
 Class A tolerances, 10–11, 11t
 cleaning of, 10–11

- laboratory vessels, 11, 11*t*, 12, 15
 pipets, 11–15, 11*t*–12*t*, 12–14
 syringes, 16
- Platelet-activating factor acetylhydrolase. *See*
 Lipoprotein-associated phospholipase A₂
- Pleural effusion, 601–602, 601*t*
- Pleural fluid, analysis of, 601–602, 601*t*
- PM tube. *See* Photomultiplier tube
- PNMT. *See* Phenylethanolamine
 N-methyltransferase
- pO₂. *See* Partial pressure of oxygen
- POCC. *See* Point-of-care coordinator
- POCT. *See* Point-of-care testing
- Point-of-care blood gases, 218–219
- Point-of-care chemistries, 218–219
- Point-of-care coagulation, 219
- Point-of-care connectivity, 219
- Point-of-care coordinator (POCC), 214
- Point-of-care glucose, 163, 164, 218, 688
- Point-of-care hematology, 219
- Point-of-care testing (POCT), 130, 211–220
 administration and structure, 211–215, 212*b*,
 212*t*–214*t*
 analytical techniques for, 163–164, 163–164
 applications, 163, 164, 218–219, 688
 automated analyzers for, 167
 for β-human chorionic gonadotropin, 150
 blood samples for, 41, 65
 for cardiac markers, 554
 communication in, 215–218, 215*b*
 in pediatric clinical chemistry, 688, 688*t*
 proficiency testing in, 218
 program components of, 212*b*
- Poisons, 622–623
- Polarization, fluorescence, 139–140, 197, 596–597
- Polarographic glucose analysis, 323
- Policy, in point-of-care testing, 216–217
- Polyacrylamide gel, 146, 346
- Polyclonal Ab, 186
- Polycystic ovary syndrome (PCOS), 486–487
- Polydipsia, 358, 455
- Polymerase chain reaction (PCR), 204–207,
 206, 209
- Polypeptide, 224
- Polysaccharides, 310–311, 311
- Polyuria, 455
- Population distributions, of lipids and lipoproteins,
 336–339, 336*t*–339*t*
- Porphobilinogen (PBG), 426, 428–429
- Porphyria cutanea tarda (PCT), 426–427
- Porphyrias, 424–428, 426*t*
- Porphyrinogens, 425
- Porphyryns, 424–430, 425, 426*t*
- Porphyrinurias, 428
- Positioning
 of evacuated tubes, 47
 of needle for venipuncture, 47, 59, 60
 of patient, 48–49, 53, 66, 68
- Positive bias, 99*b*
- Positive predictive value (PPV), 102*b*, 104, 104
- Positive-displacement pipets, 14, 14
- Postanalytic error, 125
- Posterior pituitary, 445, 454–455
- Posthepatic jaundice, 520–522
- Postnatal development, testosterone actions in,
 478, 478*t*
- Postrenal azotemia, 268, 269*t*
- Postrenal failure, 572
- Postzone, 186
- Potassium, 363–366, 364*t*–366*t*, 382, 463, 562,
 656, 690, 691*t*
- Potassium oxalate, 43*t*, 45–46, 46*t*, 323, 529
- Potassium-selective liquid membranes, 144
- Potentials, reduction, 142, 142*t*
- Power supply, for electrophoresis, 146
- PPE. *See* Personal protective equipment
- PPM. *See* Provider-performed microscopy
- PPV. *See* Positive predictive value
- PRA. *See* Plasma renin activity
- Pravastatin, 341
- Prealbumin, 238, 239*t*, 599, 654
- Preanalytic considerations
 for blood gas measurements, 398–401, 400
 for elderly, 681–682
 for pediatric patients, 687
 for phlebotomy, 62–64, 63*b*
 for reference interval studies, 98, 98*t*
- Preanalytic error, 28, 30, 31*t*, 125, 398–401
- Preanalytic phase, of total laboratory automation,
 180–181
- Precautions
 in phlebotomy, 35–39, 36*b*–38*b*
 universal, 75
- Precipitation
 of Ab and Ag, 186–189, 187–189, 187*t*
 of high-density lipoproteins, 347–348
 of proteins, 253
 as separation technique for labeled immunoas-
 says, 194–196
- Precision, of lipid and lipoprotein assays, 349–350
- Precision study, 110–111, 111
- Precursor ion, 157
- Prediabetes, 317–318
- Predictive values, 102, 102*b*, 104, 104–105,
 105*t*, 106
- Prednisone, 277*b*, 465, 511, 514*b*
- Prefiltration, 6
- Prefixes, SI, 4, 4*t*
- Pregnancy, folate requirements in, 661
- Pregnancy-associated plasma protein A (PAPP-A),
 553
- Pregnenolone, 460, 460, 478
- Prehepatic jaundice, 520–521
- Prehypertension, 548
- Prematurity, 685–686, 689
- Prenatal development, testosterone actions in, 478
- Prenatal diagnosis, nucleic acid probes for, 209
- Preparation, of specimens for automated analyzers,
 170, 170*t*
- Prequalification, of instruments, 401
- Prerenal azotemia, 268, 269*t*
- Prerenal failure, 572
- Preservatives, as interferent, 113
- Prevention, of hepatitis B virus, 534
- Primaquine, 304
- Primary aldosteronism, diagnosis of, 462–463
- Primary amenorrhea, 483–484, 484*t*
- Primary collection tubes, in automated
 analyzers, 171
- Primary hyperparathyroidism, 504, 506, 509
- Primary hypoparathyroidism, 374
- Primary hypothyroidism, 694
- Primary renal failure, 572
- Primary respiratory acidosis, 389
- Primary respiratory alkalosis, 389
- Primary standards, 6
- Primary structure, 235, 281, 430
- Primidone, 615, 617
- Privacy, invasion of, 35
- Probenecid, 306*t*
- Probes
 in automated analyzers, 171–173, 173
 nucleic acid, 203–206, 204*t*, 208–209
- Problem sites, for phlebotomy, 62
- Proboscis, 173
- Procainamide, 613–614, 614*b*
- Procaine, 527
- Procedural error risks, in phlebotomy, 62
- Procedure
 for capillary puncture, 65–70, 66–67, 69
 in point-of-care testing, 216–217
 venipuncture, 47–60, 48–59
 for butterfly system and ETS holder,
 53–55, 54–55
 for evacuated tube system, 48–53, 48–53
 syringe system, venipuncture procedure
 for, 56–58, 56–59
- Process sigma, 123–124, 124*t*
- Processing
 of samples, for trace element analysis, 404
 of specimens, 30, 71–72, 180–181
- Product ion, 157, 158
- Production, of antibodies, 697–698, 697*t*
- Proenzyme, 283
- Professionalism, of phlebotomist, 34
- Proficiency samples, 119–120, 119*b*
- Proficiency testing (PT), 115
 for blood gas analytic assessments, 401–402
 for point-of-care testing, 218
 in quality control, 119–120, 119*b*–120*b*
- Progesterone, 482–483, 696
- Progesterone receptors, as tumor markers, 638,
 643*t*, 644
- Progesterin replacement therapy, 485, 514
- Prognosis
 of cancer, 640–642
 of pheochromocytoma, 474
- Program components, of point-of-care testing, 212*b*
- Prolactin, 447–448, 451–453, 480, 484, 641*t*
- Prolactin inhibitory factor (PIF), 451
- Prolactinoma, 452–453
- Proline, 225*t*, 227
- Prooxidant, 417
- Proportional systemic error, 94*b*, 95, 110*b*,
 114–115, 115
- Propoxyphene, 636
- Propranolol, 364, 472, 492
- Propylthiouracil (PTU), 491, 497–498
- Prospective control, 401
- Prostaglandins, renal production of, 563–564
- Prosthetic group, 283, 285
- Prostrate cancer, 299–300, 648–649
- Prostrate-specific antigen (PSA), 299–300, 640*t*,
 644–645, 648–649
- Protection
 of analytes, 71
 against radiation, 81–82
- Protein Data Bank (PDB), 238
- Protein-free filtrate, 266
- Proteins, 224, 233–238, 234–236, 237*t*
 adiponectin, 249
 amyloid, 249–250
 analysis methods for, 252–259, 252*t*, 254*t*,
 255–257, 259–261
 as biochemical markers, 653–656, 653*t*
 brain natriuretic peptide and N-terminal-brain
 natriuretic peptide, 248, 553
 β-trace protein, 249
 catabolism and nitrogen balance, 235
 in cerebrospinal fluid, 29, 598–599
 charge and isoelectric point of, 236, 236
 classification of, 237–238, 237*t*
 cross-linked C-telopeptides, 249
 Cystatin C, 249
 drug complexes with, 606–607
 fibronectin, 248–249, 655
 importance of, 233
 liver synthesis of, 520
 mass spectrometry of, 155, 156, 159–160,
 160–162
 molecular size of, 233
 monoclonal, characterization of, 188–189,
 188–189
 in myocardial infarction diagnosis, 551, 551–552
 myoglobin, 247, 248*t*, 416, 424, 440–441,
 440*t*, 541, 551–552
 nitrogen content of, 236
 in nutritional assessment, 653
 in other body fluids, 29, 259–264, 262*t*, 263
 plasma, 238–247, 239*t*–240*t*
 albumin, 238–240, 239*t*, 250*t*, 253–254,
 254*t*, 256, 257, 258, 262, 326–327,
 492, 505, 566, 588, 596, 599,
 653–654, 679
 globulins, 238–247, 239*t*–240*t*, 250*t*, 254,
 256, 257, 258
 prealbumin, 238, 239*t*, 599, 654
 polyclonal, characterization of, 189
 solubility of, 236
 structure of, 235, 235
 synthesis of, 233–235, 234
 thyroid hormone binding by, 492
 total protein abnormalities, 250–251, 250*t*
 troponin, 248, 441, 541, 550–552
 as tumor markers, 638, 640*t*
 urinalysis measurement of, 568

Proteinuria, 237, 260–262, 262t, 565, 568
 Proteoglycans. *See* Mucoproteins
 Proteomics, 156, 159–160, 160–162
 Prothrombin time, 660
 PROTO. *See* Protoporphyrin
 Protoporphyrin (PROTO), 424–430
 Provider-performed microscopy (PPM), testing requirements for, 213
 Proximal convoluted tubule, 557–560
 Proximal renal tubular acidosis, 571
 Prozone, 186
 PSA. *See* Prostate-specific antigen
 Pseudoaldosteronism, 462
 Pseudocholinesterase, 631
 Pseudoephedrine, 634
 Pseudohyponatremia, 360–361
 Pseudohypoparathyroidism, 375, 504, 509
 Psychoactive drugs, 618–619
 PT. *See* Proficiency testing
 PTH. *See* Parathyroid hormone
 PTH gene, 503, 503, 509
 PTHrP. *See* Parathyroid hormone-related protein
 PTU. *See* Propylthiouracil
 Puberty, 478–480, 478t, 479b, 483, 483t, 696
 Pubic hair, development of, 478t, 483, 483t
 Public relations, in phlebotomy, 34–35, 35b
 Pulmonary circulation, gas content of, 391, 391
 Pulmonary edema, 391
 Pulmonary function, aging effects on, 680
 Pulmonary hypertension, 544
 Pulsatile secretion, of pituitary, 445, 447
 Pulse oximetry (SpO₂), 393
 Pumps, in high-performance liquid chromatography, 151
 Puncture. *See* Capillary puncture; Venipuncture
 Purines, uric acid from, 270, 272
 Purity, of chemicals, 5–6
 PVD. *See* Peripheral vascular disease
 Pyridoxine, 660–661
 Pyrrole rings, 424
 Pyrrolysine, 227
 Pyruvic acid, 293–295

Q

QC. *See* Quality control
 QC materials, 116–117
 QM. *See* Quality management
 Quadrupole, 156
 Quadrupole mass spectrometers, 407
 Qualitative defects, of hemoglobin, 432–434
 Qualitative screening, for fecal fat, 582
 Quality, 88
 Quality assurance, 120b
 for blood gas measurements, 398–402, 400
 in phlebotomy, 61–62
 in spectrophotometry, 136
 Quality control (QC), 88, 116–120, 116b, 117–119, 118t, 119b–121b
 for blood gas analytic assessments, 401–402
 control charts, 116b, 117, 117
 of lipid and lipoprotein assays, 351
 multi-rule procedure, 116b, 118–119, 118t, 119
 operation of system of, 117–118, 118
 for point-of-care testing, 218
 proficiency testing in, 119–120, 119b–120b
 Quality design, 121b
 Quality improvement, 121b
 Lean Six Sigma, 121, 121
 Quality management (QM), 88–129, 120b–121b, 121–123, 124t, 125–126
 basic concepts of, 89–94, 89–95, 89b, 91t, 94b
 diagnostic efficiency, 101–108, 102b, 103–107, 105t
 method evaluation, 88, 108–116, 108b–110b, 109t, 110–111, 112b, 112t, 113–115, 114b, 116t
 metrics, 123, 123–124, 124t
 patient safety, Lean Six Sigma, and laboratory, 124–125, 124t, 125
 practical application of Six Sigma metrics, 125–126, 126

quality control, 88, 116–120, 116b, 117–119, 118t, 119b–121b
 quality improvement, 121, 121, 121b
 reference interval studies, 95–101, 95b–99b, 96t–98t, 100–102, 102t
 Quantitation
 in electrophoresis, 147, 147
 of hemoglobin A₂, 439
 of hemoglobin F, 439
 of specific proteins, 253–256, 254t, 255
 Quantitative analysis, for fecal fat, 582–583
 Quantitative defects, of hemoglobin, 434–437, 436
 Quaternary structure, 235, 281, 430
 Quenching, 140
 Quinidine, 306t, 613

R

r. *See* Correlation coefficient
 Radial immunodiffusion (RID), 188, 188
 Radiation
 disposal of waste, 85
 electromagnetic, 130–131, 131, 136, 136–138
 nonionizing, 82, 82t
 safety policies for, 81–82, 82t
 Radioactive iodine, 494–498
 Radioactive labels, for labeled immunoassays, 191
 Radioimmunoassay, 190t, 192, 192–193, 193t, 94, 197
 Raloxifene, 514
 Random access, 166
 Random error, 93, 94, 94b, 110–111, 110b, 111, 116
 in comparison-of-methods studies, 114, 114–115
 in control data, 117
 Random genetic damage theory of aging, 674
 Random plasma glucose, 318, 318t
 Range, 90
 analytic measurement, 109b
 clinical reportable range, 109b
 normal, 95, 96b
 therapeutic, 96b
 Rape investigation, acid phosphatase in, 300
 Rapid immunoassay, 197–198
 RAS. *See* Renin-angiotensin system
 Rate
 of enzymatic reactions, 284–286, 284–286
 of laboratory errors, 123–125, 124t
 of reaction, automated analysis of, 176–177
 RBCs. *See* Red blood cells
 RBP. *See* Retinol-binding protein
 RDA. *See* Recommended Dietary Allowance
 RDS. *See* Respiratory distress syndrome
 Reabsorption, 386
 of bicarbonate by kidney, 386–387, 387
 tubular, 558–561, 559–560
 of uric acid, 270
 Reaction containers, in automated analyzers, 170t, 174–176, 175
 Reaction time, in automated analyzers, 176
 Reaction velocity. *See* Velocity
 Reactive chemicals, 81, 81t
 Readout meter, 143
 Reagent grade, 5–6
 Reagent grade water, 6–7
 Reagent strips, for urinalysis, 567–568
 Reagents, 5–9
 in automated analysis, 170t, 174, 174
 enzymes as, 288
 Receiver operator characteristic (ROC), 105–108, 107
 Receptors
 calcium-sensing, 504
 as tumor markers, 638, 643t, 644
 Recertification checklist, for point-of-care testing, 217
 Reclamation. *See* Reabsorption
 Recombinant human parathyroid hormone, 511–512
 Recommended Dietary Allowance (RDA), 652
 of fat-soluble vitamins, 657–660
 of trace minerals, 666–670
 of water-soluble vitamins, 657t, 660–665, 662t
 Record keeping, of laboratory accidents, 85–86
 Recorders, in high-performance liquid chromatography, 151–152, 152

Recording, for point-of-care testing, 218
 Recovery studies, 112, 112b, 113
 Recurrence, of cancer, monitoring of, 542
 Red blood cells (RBCs), 431–433, 437, 568
 Redox potential, 8
 Reducing agents, 8
 5 α -Reductase deficiency, 479
 Reduction, 311, 322, 395
 Reduction potentials, 142, 142t
 Reference electrodes, 142–144, 396
 Reference interval studies, 95–101, 95b–99b, 96t–98t, 100–102, 102t
 analysis of reference values, 99
 data analysis to establish reference intervals, 99, 100
 data analysis to verify reference intervals, 99–101, 100–102, 102t
 establishment of reference interval, 95–97, 95b, 97b, 99, 100
 preanalytic and analytic considerations for, 98, 98t
 selection of individuals for, 97–98, 98t
 verification of reference interval, 95–96, 95b, 99–101, 100–102, 102t
 Reference intervals, 95b
 for ammonia, 279, 279t
 for arsenic, 410
 for cadmium, 411
 CAP checklist for laboratory inspection, 96b
 for chromium, 414
 for CK-MB, 98t
 for copper, 415
 for creatinine, 275, 276t
 for elderly, 681
 establishment of, 95–97, 95b, 97b, 99, 100
 for fasting glucose, 98
 for iron, 417t
 of lead status, 412
 for manganese, 419
 for mercury, 413
 for molybdenum, 420
 monitoring of, 101, 102t
 for selenium, 421
 for urea measurements, 268, 268t
 for uric acid, 271, 271t
 verification of, 95–96, 95b, 99–101, 100–102, 102t
 for zinc, 422
 Reference materials, 6
 Reference method, 92, 113
 Reference ranges, 4–5, 26
 for acid phosphatase, 300
 for alanine aminotransferase, 297
 for alkaline phosphatase, 299
 for amylase, 303
 for arterial blood gas, 388t
 for aspartate aminotransferase, 296
 for bilirubin, 527t
 for blood pH, 385
 for calcium, 376, 377t
 for carbon dioxide, 368
 for chloride, 368t
 for creatine kinase, 293
 for creatinine clearance, 564
 for D-xylose, 585b
 for folate, 661
 for glucose-6-phosphate dehydrogenase, 304
 for γ -glutamyltransferase, 301
 for lactate, 380, 380t
 for lactate dehydrogenase, 295
 for lipase, 304
 for lipids, 336t
 for magnesium, 372t
 for osmolality, 359t
 for phosphate, 378, 378t
 for potassium, 366t
 for selenium, 670
 for sodium, 364t
 for urobilinogen, 527
 Reference values, analysis of, 99
 Reflectance spectrophotometry, 177, 178, 257, 257–258
 Reflux, from phlebotomy, 63

- Refractive index, of serum, 252–253
- Refractometry
for total protein analysis, 252–253, 252t
of urine, 567
- Refusal of consent, 35b
- Regan isoenzyme, of alkaline phosphatase, 298–299
- Regression analysis
Deming, 114, 114b
linear, 92–93, 93, 99, 114–115, 114b, 115
- Regulation
of acid-base balance by kidney and lungs, 385–388, 387
of bicarbonate, 368
of blood gases and pH in neonates and infants, 688–689, 689t
of blood volume, 357–358, 358
of calcium, 373
of calcium homeostasis, 501–515, 502
hormonal regulation of calcium metabolism, 501–504, 502–503
hypercalcemia, 374, 374t, 375–376, 504–508, 507
hypocalcemia, 374, 374–375, 374t, 504, 508–512, 509
metabolic bone disease, 512–514, 513
organ physiology and calcium metabolism, 504–505
of calcium metabolism, 501–504, 502–503
of cancer antigen 125, 646
of carbohydrate metabolism, 313–314, 314t
of carcinoembryonic antigen, 646–647
of electrolytes and water in pediatric patients, 689–690, 690t–691t
of α -fetoprotein, 645
by governing bodies
for laboratory safety, 74–75
for method evaluation, 108, 108b, 109t
for point-of-care testing, 211–213, 212t–214t
of H^+ , 385, 386
of human chorionic gonadotropin, 647
of lactate, 378
of magnesium, 369
of ovulation, 483
of phosphate, 377
of potassium, 364
of prostate-specific antigen, 648
of sodium, 359
of testicular function, 478
- Removal, of tube stoppers, 72
- Renal azotemia, 268, 269t
- Renal calculi, 571–572, 571t
- Renal clearance, of drugs, 610
- Renal failure, 440, 507, 510, 556, 572–576, 573, 574t
- Renal function, 557–577
acid-base balance regulation, 385–388, 387
aging effects on, 679
analytic procedures for, 564–570
clearance measurements, 564–565
microalbumin, 566
myoglobin, 565–566
urinalysis, 566–570
urine electrophoresis, 565
assessment of, 266–267, 272–273, 276–277
electrolytes and, 381, 381–382
nitrogenous end products as markers of, 693
pathophysiology of, 510, 570, 570–576, 571t, 573, 574t
in pediatric patients, 689–690, 690t–691t
physiology of, 504, 558–564, 559–560, 562
renal anatomy, 557, 558–559
renal physiology, 558–564, 559–560, 562
- Renal hypertension, 574–576
- Renal nephropathy, microalbuminuria with, 326–327, 566
- Renal threshold, 558–559
- Renal tubular acidosis (RTA), 571
- Renal tubules, 381, 382, 557, 628, 690
- Renin, 461–462, 563
- Renin-angiotensin system (RAS), 461, 561
- Renin-angiotensin-aldosterone system, 357–358, 358
- Reported ranges, of assay, 26
- Reporting
electronic, 5
for point-of-care testing, 218
- Requests, for new or additional point-of-care testing, 215–216, 215b
- Reserpine, 451
- Resin, ion exchange, 149, 149
- Resistance
to insulin, 316–317, 678
of water, 7
- Resistivity, 8
- Resorption, of bone, 373, 511–512
- Respirators, 78
- Respiratory acidosis, 389–390
- Respiratory alkalosis, 389–390
- Respiratory distress syndrome (RDS), 594, 689–690
- Respiratory system, development of, 686
- Responders, 612
- Response, to toxins, 623, 623–624, 623t
- Responsibility, for laboratory safety, 76
- Restless leg syndrome, 669
- Restriction fragment length polymorphism (RFLP), 204
- Results, interpretation of, 402
- Results reporting, for point-of-care testing, 218
- Retention factor (R_t), 149–150
- Retention, of water, 360
- Retinoic acid, 657
- Retinol, 657
- Retinol-binding protein (RBP), 654–655
- Reverse cholesterol transport pathway, 333–336, 334
- Reverse osmosis (RO) water, 6–7
- Reverse phase, 148
- Reverse transcriptase-polymerase chain reaction (RT-PCR), 207
- Reverse-phase HPLC, 151
- Review of systems (ROS), 652
- Ry syndrome, 277–278, 524
- R_t . See Retention factor
- RFLP. See Restriction fragment length polymorphism
- Rhabdomyolysis, 566
- Rheumatic heart disease, 548–549
- Rhinorrhea, 598
- Ribavirin, 535
- Riboflavin, 660
- Ribonucleic acid (RNA), 203, 207, 234, 234
- Ricketts, 512, 656
- RID. See Radial immunodiffusion
- Rifampin, 306t, 467
- Right to Know Law, 79
- Risedronate, 511, 514
- Risk assessment, 622
- Risk factors, for coronary heart disease, 337t
- Risks, for procedural errors in phlebotomy, 62
- RNA. See Ribonucleic acid
- RNA probe, 203–206, 204t
- RO water. See Reverse osmosis water
- Robotics, 170, 181
- ROC. See Receiver operator characteristic
- Rocket technique, 189
- ROS. See Review of systems
- Rosuvastatin, 341
- Rotor syndrome, 521–522
- Routes of administration, of drugs, 606
- Routes of exposure, to toxins, 622–623
- Routine handling, of blood samples, 71
- RTA. See Renal tubular acidosis
- RT-PCR. See Reverse transcriptase-polymerase chain reaction
- Rubbing alcohol. See Isopropanol
- Rules, control, 118–119, 118t, 125–126
- R-zone, of adrenal cortex, 459
- S**
- SAAG. See Serum-ascites albumin gradients
- Saccharogenic method, for amylase activity assay, 302, 302t
- Safety
for laboratory, 74–87
accident documentation and investigation, 85–86
- awareness of, 76, 77
biologic safety, 78–79
chemical safety, 79–81, 81, 81t
compressed gases, 77, 84
for cryogenic materials, 84
disposal of hazardous materials, 84–85
electrical, 83–84
ergonomic hazards, 84
fire safety, 82–83, 82–83
mechanical hazards, 84
radiation, 81–82, 82t
regulations for, 74–75
responsibilities for, 76
safety equipment, 76–78, 78t
signage and labeling, 76, 77
of patient, 124–125, 124t, 125
for sample processing, 72
- Safety device, on needle, 55, 57–58
- Salicylates, 254, 271, 324, 378, 381, 390, 524, 618, 632, 634b
- Salicylic acid, 240
- Salt fractionation, of proteins, 253
- Sample cell, for spectrophotometer, 134, 137
- Sample injectors, 150, 151
- Sample introduction, in mass spectrometry, 154–155, 155–156
- Sample ionization, in mass spectrometry, 154–155, 155–156
- Samples. See Specimens
- Sandwich assay, 193–194, 194–195
- Sandwich hybridization assays, 204
- Sanger dideoxy DNA sequencing, 205, 205
- Sapropterin dihydrochloride, 228–229
- Saturated fatty acids, 329, 330
- Saturated solutions, 8
- Saturation
of iron, 417, 417t–418t
of oxygen, 392, 394, 394–398
- Scatterling, of light, 140, 140–141, 189–190, 200
- SCC. See Squamous cell carcinoma
- SCID. See Severe combined immune deficiency
- Scientific notation, 20
- Sclerosed veins, 62
- SCOP database. See Structural Classification of Proteins database
- Screening
for adrenal masses, 474
for cancer, 640
for drugs of abuse, 633
for fecal fat, 582
for α_1 -fetoprotein, 241
for hemolytic disease of newborn, 592–593, 593–594
for homocystinuria, 231
for hypocalcemia, 375
for hypothyroidism, 496
for isovaleric acidemia, 230
for maple syrup urine disease, 230
neonatal, 70–71
for neural tube defects, 592
of newborns, 699–700, 699t
for phenylketonuria, 228–229
for sickling hemoglobin, 437–438
- Scurvy, 656, 664
- SD. See Standard deviation
- SDA. See Strand displacement amplification
- SDI. See Standard deviation index
- SDS-PAGE. See Sodium dodecyl sulfate-polyacrylamide gel electrophoresis
- Sealants, for capillary specimen collection, 65
- Secobarbital, 306t, 390, 636
- Second-Ab method, 196
- Secondary aldosteronism, 462
- Secondary amenorrhea, 483–484, 484t, 485
- Secondary hyperparathyroidism, 509–510, 512
- Secondary hypothyroidism, 694–695
- Secondary porphyrias, 428
- Secondary sexual effects, testosterone actions on, 478–479
- Secondary standards, 6
- Secondary structure, 235, 235, 281, 430
- Second-generation antiepileptic drugs, 616–618
- Secretagogues, 585

- Secretin, 579, 581–582, 586
 Secretion, 386
 of bicarbonate by kidney, 386, 387
 gastric, 585–586
 of growth hormone, 449, 449t
 of hormones in pediatric patients, 694–696, 695t
 of liver, 518–519, 519
 of pituitary, 445, 447
 renal, impairment of, 272
 tubular, 559, 559–560
 Secretory tests, of gastric secretion, 586
 Sedatives-hypnotics, toxicology of, 636
 Sediment examination, in urinalysis, 568–569
 Seizure, 63, 615–618
 SELDI-TOF. *See* Surface-enhanced laser desorption
 ionization time-of-flight mass spectrometry
 Selected ion monitoring (SIM), 156, 158
 Selected reaction monitoring (SRM), 158, 158
 Selection
 of automated analyzers, 179–180
 of devices/methods for point-of-care testing, 216
 of method, 109, 109b, 110
 Selective estrogen receptor modulators (SERMS),
 511, 514
 Selenium, 408, 420–421, 669–670
 Selenocysteine, 227
 Self-draining pipets, 13
 Self-monitoring, of blood glucose, 323
 Self-sustained sequence replication (3SR), 207
 Sella turcica, 446
 Sensitivity, 102–104, 102b, 103, 106, 140
 Separation modes, in chromatography, 148–149, 149
 Separation techniques, 18–19, 18–19
 in automated analysis, 175–176
 centrifugation, 18–19, 18–19
 dialysis, 19
 filtration, 19, 19
 for labeled immunoassays, 194–196, 195t
 Sequencing. *See* DNA sequencing
 Serial dilutions, 25, 25–26
 Serine, 225t, 227
 SERMS. *See* Selective estrogen receptor modulators
 Serologic markers, of hepatitis B virus, 531–533,
 531–533, 533t–534t
 Serologic pipets, 13
 Serous fluids, analysis of, 601–602, 601t
 Sertoli cell-only syndrome, 480
 Sertoli cells, 478
 Sertraline, 306t
 Serum, 6, 28, 29, 30, 41, 44, 72
 bile acids in, 527–528
 for carbon dioxide determination, 368
 cholesterol in, 337
 creatinine in, 274
 drug concentration in, 610–611, 610–611
 electrophoresis of, 146
 glucose measurement in, 321–322
 iron in, 417, 417t–418t
 for ketone analysis, 326, 326t
 for lipid and lipoprotein assays, 351
 for osmolality determination, 358
 total protein analysis in, 252–253
 Serum carotenoids, 588
 Serum glutamic-oxaloacetic transaminase. *See*
 Aspartate aminotransferase
 Serum hepatitis. *See* Hepatitis B virus
 Serum protein electrophoresis (SPE), 256–257,
 256–258
 Serum-ascites albumin gradients (SAAG), 602
 Severe combined immune deficiency (SCID), 698
 Severinghaus electrode, 394–397
 Sexual development, 479–480, 479b, 483, 483t
 Sexual maturation, 686, 696
 SGOT. *See* Aspartate aminotransferase
 SGPT. *See* Alanine aminotransferase
 Shake test, 594
 Shape, of data, 89, 89, 91–92, 91–93
 Sharps, 51, 55, 58–59, 67, 69, 84–85
 Shifts trends, 101
 Shipping, of biohazardous materials, 79
 Short feedback loop, of pituitary, 447
 Short-incubation hepatitis. *See* Hepatitis A virus
 SI. *See* Système International d'Unités
 SI units, 3–4, 4t, 27, 267, 288
 Sickle cell disease, 432–433, 439–440
 Sickle cell trait, 432–433
 Sickling hemoglobin, screening for, 437–438
 Siderophilin. *See* Transferrin
 Sigma, process, 123–124, 124t
 Signage, for hazards, 76, 77
 Signal amplification, 208–209, 209
 Signal processing, in automated analysis, 170t,
 178–179
 Significant figures, 19
 Silent carriers, of α -thalassemias, 434–436, 436
 Silica, for blood samples, 46, 46t
 SIM. *See* Selected ion monitoring
 Simple dilutions, 24, 24–25
 Simple proteins, 238
 Simvastatin, 341
 Single diffusion, in immune precipitation in gel,
 188, 188
 Single nucleotide polymorphisms (SNPs), 206
 Single-beam atomic absorption spectrophotometer,
 136
 Single-beam spectrophotometer, 133, 135–136
 Single-channel analyzers, 166
 Single-value criteria, 116, 116t
 Sinusoids, 516
 Sirolimus, 620
 SIRS. *See* Systemic inflammatory response
 syndrome
 Six Sigma. *See* Lean Six Sigma
 Six Sigma charts, 125, 126
 Skeletal muscle
 aspartate aminotransferase in disorders of, 296
 creatinine kinase as marker of disorders of,
 289–293, 290t, 291–292
 Skewed distribution, 93, 99
 Skin, 697
 Skin puncture. *See* Capillary puncture
 SLFIA. *See* Substrate-level fluorescence immunoassay
 Slides. *See* Dry chemistry slides
 Small-molecule diseases, diagnosis of, in clinical
 setting, 700–701, 700t
 Smoking, 30, 410, 513–514
 SNPs. *See* Single nucleotide polymorphisms
 SO₂. *See* Oxygen saturation
 Sodium, 357–363, 360t–362t, 363, 364t, 382
 clinical applications for, 359–362, 360t–362t
 determination of, 362–363, 363
 disturbances of, 656
 as interference in pH measurement, 142
 in kidney medulla, 560
 monitoring of heart disease with, 554
 in pediatric patient, 690, 690t
 reference range for, 364t
 regulation of, 359
 renal reabsorption of, 560, 560–561
 renal role in balance of, 562
 in sweat, 583
 Sodium acetate, 390
 Sodium benzoate, 231–232
 Sodium citrate, 43t, 45, 46t, 323, 390
 Sodium dodecyl sulfate-polyacrylamide gel elec-
 trophoresis (SDS-PAGE), 159, 198, 199
 Sodium fluorescein (NaF), 601
 Sodium fluoride, 43t, 45–46, 46t, 71, 271, 321–323
 Sodium lactate, 390
 Sodium phenylacetate, 231–232
 Sodium polyanethol sulfonate (SPS), 43t
 Sodium polystyrene sulfonate, 366
 Solid phase, as separation technique for labeled im-
 munoassays, 196
 Solid support hybridization, 204
 Solid-phase fluorescence immunoassay (SPFIA), 197
 Solubility, of proteins, 236
 Solubility test, for hemoglobin, 437–438
 Solutes, 7
 Solution hybridization, 204–205
 Solutions, 7–9
 colligative properties of, 8, 160
 concentration of, 7–8, 20–23, 160–163, 163
 converting units of, 23
 density of, 22
 dilutions, 23–26, 24–25
 molality of, 8
 molarity of, 7–8, 21–22
 normality of, 8, 22
 percent, 7, 20–21
 specific gravity of, 22–23
 supercooled, 163
 Solvents, 7
 Somatomedin, 449–450
 Somatomedin C. *See* Insulin growth factor I
 Somatostatin, 314, 447, 449, 578, 695
 Somatostatin analogs, 451
 Somatotropin. *See* Growth hormone
 Source
 of blood specimens, 41
 light, of spectrophotometer, 133, 137–138, 141
 Southern blot, 204, 209
 SP. *See* Sphingomyelin
 SPE. *See* Serum protein electrophoresis
 Special handling, of blood samples, 71
 Speciation, in trace element analysis, 408
 Specific gravity, 22–23
 of urine, 567
 Specifications, for reagent water, 6–7
 Specificity, 102–104, 102b, 103, 106, 109b
 of enzymes, 284
 of fluorometry, 140
 Specimens, 28–31, 29, 31t
 for alcohol determination, 626
 for ammonia measurement, 278–279
 automated identification and preparation of,
 170, 170t, 179
 automated measurement and delivery of,
 170–173, 170t, 171–173
 for bilirubin analysis, 525–526
 blood, 28–29, 33–73
 blood collection personnel, 33–34
 capillary puncture procedures, 65–70,
 66–67, 69
 capillary specimen collection, 64–65, 64–65
 geriatric venipuncture, 61
 infection control, 35–39, 36b–38b
 legal issues, 35
 order of draw and additive carry-over,
 46–47, 46b, 46t–47t
 pediatric venipuncture, 60–61, 61
 phlebotomy-related vascular anatomy,
 39–41, 40
 preanalytic considerations for, 62–64, 63b
 public relations and client interaction,
 34–35, 35b
 quality assurance in, 61–62
 source and composition of, 41
 specimen handling, 71
 specimen processing, 71–72
 types of specimens of, 41
 vascular system, 39, 39
 venipuncture equipment, 41–46, 42–45
 venipuncture procedures, 47–60, 48–59
 for blood gas determination, 28, 394–396,
 399–400
 for calcium determination, 376
 for carbon dioxide determination, 368
 of cerebrospinal fluid, 597
 chain of custody for, 31, 71
 for chloride determination, 367
 collection of, 28–29, 29, 682–683
 for determining blood gases, 394–396,
 399–400
 from elderly patients, 682–683
 for potassium determination, 366
 for therapeutic drug monitoring, 612
 for trace element analysis, 404
 for creatinine and creatinine measurements, 275
 for creatinine clearance, 564
 of cyclosporine, 619–620
 diagnostic, 79
 for D-xylose tests, 588
 for electrophoresis, 146–147
 evaporation of, 171
 handling of, 71

- for hemoglobin A_{1c} measurement, 325
 - for inorganic phosphorus determination, 378
 - for ketone analysis, 326, 326t
 - for lactate determination, 378–380
 - for lead analysis, 630
 - for lipid and lipoprotein assays, 351
 - for magnesium determination, 372
 - for osmolality determination, 358
 - for pediatric clinical chemistry, 686–688, 686t–687t
 - processing of, 30, 71–72, 180–181
 - size of, 173
 - for sodium determination, 362
 - storage of, 30
 - of synovial fluid, 600–601
 - for trace element analysis, 404
 - types of, 28–29, 29
 - for urea measurements, 268
 - for uric acid measurement, 271
 - for urinalysis, 566
 - for urobilinogen determination, 527
 - variables of, 30, 31t
 - Spectra, 131, 131t
 - Spectral-mapping, 183
 - Spectrophotometer, 130–141, 131–136, 138–140
 - components of, 133–136, 133–138, 141, 405
 - double-beam, 135–136, 136
 - single-beam, 133, 135–136
 - Spectrophotometry, 130–141, 131–136, 138–140
 - for ammonia measurement, 278, 278t
 - atomic absorption, 136, 136–138, 404–408, 404t, 405–406
 - atomic emission, 404–405, 404t, 405, 408
 - in automated analysis, 176–178, 176–178
 - Beer's law in, 131–132, 131–133
 - chemiluminescence, 140, 140
 - for determination of oxygen saturation, 394, 394–398
 - flame photometry, 138
 - fluorometry, 138–139, 138–140
 - for glucose analysis, 323
 - laser applications in, 141
 - quality assurance in, 136
 - reflectance, 177, 178, 257, 257–258
 - spectrophotometer components, 133–135, 133–136
 - spectrophotometer instruments, 133, 133
 - turbidity and nephelometry, 140, 140–141
 - Spectroscopic interference, in trace element analysis, 407–408
 - Spermatogenesis, 477–478
 - Spermatogonia, 477
 - Spermatozoa, in urinalysis, 568
 - SPFIA. *See* Solid-phase fluorescence immunoassay
 - Sphingomyelin (SP), 595–596, 596, 689
 - Spills
 - of biohazardous materials, 78–79
 - chemical, 81
 - mercury, 80
 - Spirolactone, 365, 463, 470
 - SpO₂. *See* Pulse oximetry
 - Spot tests, for drugs of abuse, 633
 - Spread, of data, 89–90, 89–90
 - SPS. *See* Sodium polyanethol sulfonate
 - Spun hematocrit, 219
 - Squamous cell carcinoma (SCC), 469
 - 3SR. *See* Self-sustained sequence replication
 - SRM. *See* Selected ion monitoring
 - SRMs. *See* Standard reference materials
 - SSPE. *See* Subacute sclerosing panencephalitis
 - St. John's wort, 306t
 - Stable angina, 546–547
 - Staffing, for point-of-care testing, 213–214
 - Staging, of cancer, 637, 639, 645
 - Standard curve, 26, 26–28
 - Standard deviation (SD), 90, 90–91, 91t, 92, 111
 - Standard deviation index (SDI), 109b, 111
 - Standard error of estimate (Sy/x), 93, 94, 114–115
 - Standard hydrogen electrode, 141–142, 144
 - Standard of care, 35
 - Standard precautions, in phlebotomy, 35–39, 36b–38b
 - Standard precautions policy, 79
 - Standard prefixes, SI, 4, 4t
 - Standard reduction potentials, 142, 142t
 - Standard reference materials (SRMs), 6
 - Standardization
 - of glycosylated hemoglobin, 325–326
 - of lipid and lipoprotein assays, 349–351
 - for point-of-care testing, 215
 - Standards, 109
 - for calibration of automated analyzers, 178
 - primary, 6
 - secondary, 6
 - Starch, 301, 311
 - Starch gel, 146
 - Statins, 245, 335, 341–343
 - Statistical analysis, of comparison-of-method studies, 114–115, 114–115
 - Statistical quality control, establishment of, 117–118, 118
 - Statistics
 - descriptive, 89–92, 89–93, 89b, 91t
 - of groups of paired observations, 92–95, 93–94, 94b
 - inferential, 95
 - Steatorrhea, 580–583
 - Stereoisomeric specificity, of enzymes, 284
 - Stereoisomers, of carbohydrates, 310, 311
 - Steric exclusion chromatography, 148–149, 149
 - Sterilization of water, 6–7
 - Steroid therapy, 465, 593, 654, 662t
 - Cushing's syndrome from, 465, 465–469, 468–469
 - Steroidogenesis
 - of adrenal cortex, 459–461, 460
 - testicular, 477–478
 - Steroids, 238, 397b, 447
 - of adrenal gland, 458–461, 460
 - toxicology of, 635
 - Stimulants, 472
 - Stirring paddles, in automated analysis, 175, 175
 - Stokes shift, 138
 - Stoppers, for evacuated tubes, 43, 43t, 47t, 72
 - Storage
 - of bilirubin specimen, 525–526
 - of catecholamines, 471, 471–472
 - of chemicals, 77, 80–81, 81t
 - equipment for, 77
 - of specimens, 30
 - Storage proteins, 237
 - Strand displacement amplification (SDA), 206–208
 - Stroke, 333
 - Structural Classification of Proteins (SCOP)
 - database, 237
 - Structural proteins, 237
 - Structure
 - of amino acids, 223–224, 224, 225t
 - of enzymes, 281
 - of hemoglobin, 430, 430–431
 - of lipoproteins, 331, 331–333, 332t
 - of myoglobin, 440
 - for point-of-care testing, 211–215, 212b, 212t–214t
 - of proteins, 235, 235, 237–238
 - Subacute sclerosing panencephalitis (SSPE), 599
 - Subacute thyroiditis, 495, 498t, 499
 - Subclinical hyperthyroidism, 493
 - Subclinical hypothyroidism, 493
 - Subgroups, of reference interval studies, 98, 98t
 - Substitution balances, 17
 - Substrate-level fluorescence immunoassay (SLFIA), 197
 - Substrates
 - of acid phosphatase, 300
 - of drug-metabolizing enzymes, 306t
 - of enzymes, 281, 283–287, 284–285
 - of γ -glutamyltransferase, 301
 - of lactate dehydrogenase, 295
 - Sucrose, 310–311, 311
 - Sudan staining, for fecal fat, 582
 - Suitability, of blood sample, 72
 - Sulf drugs, 570
 - Sulfamethoxazole, 306t
 - Sulfasalazine, 661
 - Sulfonamides, 426, 527
 - Supercooled solutions, 163
 - Supersaturated solutions, 8
 - Support materials, for electrophoresis, 146
 - Support staff, for point-of-care testing, 213–214
 - Suppression
 - of captopril, 463
 - by dexamethasone, 467, 468, 470
 - Surface antigens, of hepatitis B virus, 531, 531–532, 533, 533t, 534
 - Surface-enhanced laser desorption/ionization time-of-flight (SELDI-TOF) mass spectrometry, 159–160, 160–162
 - Surfactant, 593–596, 689
 - Surrogate liquid control materials, 401
 - Sweat, analysis of, 583, 599–600
 - Sympathetic hyperactivity, causes of, 472, 472–473
 - Symptoms
 - of adrenal insufficiency, 464, 464
 - of cardiovascular disease, 543–544, 543t
 - of hypercalcemia, 376, 505
 - of hyperkalemia, 366
 - of hypermagnesemia, 372, 372t
 - of hypernatremia, 362
 - of hypocalcemia, 375, 508
 - of hypokalemia, 365, 462
 - of hypomagnesemia, 370–371, 370t
 - of hyponatremia, 361
 - of hypothyroidism, 495b
 - of thyrotoxicosis, 497b
 - Syncope. *See* Fainting
 - Synovial fluid, analysis of, 600–601
 - Synthesis
 - of catecholamines, 471, 471–472
 - of heme, 425, 425–426, 431, 629–630
 - of hemoglobin, 431–432, 431–432
 - in liver, 519–520, 529
 - of porphyrins, 425, 425
 - of proteins, 233–235, 234
 - of thyroid hormone, 490–492, 491–492
 - of vitamin D, 502, 502
 - Syringe, 16
 - in automated analyzers, 173
 - for blood gas measurements, 399–400
 - filling of, 57
 - Syringe system, 41, 44, 44–45, 56–58, 56–59
 - Système International d'Unités (SI), 3–4, 4t, 267, 288
 - Systemic circulation, gas content of, 391, 391
 - Systemic error, 93, 94–95, 94b, 110, 110b, 116, 125, 125
 - in comparison-of-methods studies, 114–115, 115
 - constant, 94–95, 94b, 99b, 110b, 114–115, 115
 - in control data, 117
 - estimation of, 113
 - proportional, 94b, 95, 110b, 114–115, 115
 - Systemic inflammatory response syndrome (SIRS), 652
 - Sy/x. *See* Standard error of estimate
- T**
- %T. *See* Percent transmittance
 - T₃. *See* Triiodothyronine
 - T₄. *See* Thyroxine
 - Tablets, reagent, 174
 - Tacrolimus, 620
 - Tactoids, 433
 - Tamoxifen, 305, 306t, 638
 - Tandem mass spectrometry, 157–158, 157–158, 229–231, 233
 - for newborn screening for whole populations, 699–700, 699t
 - Tangier disease, 344
 - Tanner staging, 478t, 483, 483t
 - Target amplification, 206, 206–208, 208
 - Tau protein, 249–250
 - Taxol, 648b
 - TB. *See* Tuberculosis

- TBG. *See* Thyroxine-binding globulin
 TBPA. *See* Thyroxine-binding prealbumin
 TC detectors. *See* Thermal conductivity detectors
 TC electrodes. *See* Transcutaneous electrodes
 TC laboratory supplies. *See* To contain laboratory supplies
 TCA cycle. *See* Tricarboxylic acid cycle
 TD laboratory supplies. *See* To deliver laboratory supplies
 TD₅₀. 623, 623
 TDM. *See* Therapeutic drug monitoring
 Technical grade, 5
 Temperature
 blood gas measurement correction for, 398
 of enzymatic reactions, 285
 measurement of, 9–10
 TER. *See* Transcapillary escape rate
 Teratogens, 80
 Teriparatide, 511–512, 514
 Tertiary hyperparathyroidism, 510
 Tertiary structure, 235, 281, 430
 Test ordering, for tumor markers, 642
 Testes, 477–481, 478t, 479b, 481
 disorders of sexual development and testicular hypofunction, 479–480, 479b
 functional anatomy of male reproductive tract, 477
 hypogonadism diagnosis, 480, 481
 monitoring of testosterone replacement therapy, 481
 physiology of testicles, 477–479, 478t
 testosterone replacement therapy, 306t, 479–481, 486b, 514
 Testicles
 hypofunction of, 479–480, 479b
 injury and infection of, 480
 physiology of, 477–479, 478t
 Testicular cancer, 542t, 645–648
 Testicular feminization syndrome, 479
 Testing
 of gastric function, 586
 of intestinal function, 587–588
 of pancreatic function, 581–585
 for phenylketonuria, 229
 of thyroid gland, 493–494, 493t–494t
 Testing requirements, for provider-performed microscopy, 213
 Testosterone, 470, 477–480, 478t, 674, 676–677, 696
 Testosterone gel, 480–481
 Testosterone replacement therapy, 306t, 479–481, 486b, 514
 Tetany, 373
 Tetracyclines, 471
 Tetrahydrobiopterin (BH₄), 228
 Tetrahydrocannabinol (THC), toxicology of, 624, 634b, 635
 Tetraiodothyronine. *See* Thyroxine
 Tetralogy of Fallot, 544
 Thalassemia, 424, 430–431, 434–437, 436, 439
 δ - β -Thalassemia, 437
 Thalassemia major, 434, 436, 439
 Thalassemia minor, 434, 436–437
 α -Thalassemias, 434–436, 436
 β -Thalassemias, 436–437
 THC. *See* Tetrahydrocannabinol
 The Joint Commission (TJC), 75, 108, 167–168, 213
 Theophylline, 306t, 702t
 Theories, of aging, 674–675, 674t
 Therapeutic drug monitoring (TDM), 605–621
 of antibiotics, 614–615
 of antiepileptic drugs, 615–618
 antineoplastics, 620–621
 of cardioactive drugs, 612–614
 drug absorption, 606, 610–611, 682
 drug distribution, 607, 610, 610–611
 drug elimination, 607–611, 608, 610, 682
 in elderly, 682
 free v. bound drugs, 606–607
 of immunosuppressive drugs, 619–620
 in pediatric patient, 701–702, 702t
 pharmacogenomics, 612
 pharmacokinetics, 610–611, 610–611
 of psychoactive drugs, 618–619
 routes of administration, 606
 sample collection, 612
 Therapeutic drugs, toxicology of, 631–633, 632
 Therapeutic lifestyle changes diet, 339t
 Therapeutic management, 96, 97t
 Therapeutic range, 96b, 607
 Thermal conductivity (TC) detectors, 153, 153
 Thermistor probes, 9–10, 163
 Thermometers, 9–10
 Thiamine, 660
 Thiazide diuretics, 30, 271, 370, 374t, 376, 463, 471, 508, 510–511
 Thick and thin film technology, 166–167, 397
 Thin-layer chromatography (TLC), 149–150, 150, 233, 595, 596
 Thiomersal-mercury compound, 412
 Thiopurine drugs, 307
 Thiopurine methyltransferase (TPMT), 307
 Thirst, 357, 562, 679
 Thixotropic gel separators, 46
 Thoracentesis, 601
 Threonine, 225t, 226
 Thrombin, 43t, 46
 Thrombolytic therapy, 247, 441
 Thrombosed veins, 62
 Thymine, 202–203, 203
 Thymolphthalein monophosphate, 299–300
 Thyroglobulin, 491, 491, 494
 Thyroid autoimmunity, 494, 494t
 Thyroid cancer, 494–495, 499
 Thyroid gland, 447, 490–500, 491–493
 actions of thyroid hormone, 492–493
 aging effects on, 677
 anatomy and development of, 490
 control of function of, 492, 493
 disorders of, 495–498, 495b–497b, 496t–498t
 drug-induced dysfunction of, 498–499
 evaluation of, 494–495
 fine-needle aspiration of, 495
 nodules of, 495, 498–499
 nonthyroidal illness, 499
 in pediatric patients, 694–695
 protein binding of thyroid hormone, 492
 tests for evaluation of, 493–494, 493t–494t
 thyroid hormone synthesis, 490–492, 491–492
 ultrasound of, 495
 Thyroid hormone, 490, 492
 actions of, 492–493
 excess of, 497
 in pediatric patients, 694–695
 protein binding of, 492
 in subacute thyroiditis, 499
 synthesis of, 490–492, 491–492
 in toxic adenoma, 498
 Thyroid hormone replacement therapy, 472, 490, 498–499, 694
 Thyroid peroxidase (TPO), 491, 494, 499
 Thyroid surgery, hypocalcemia arising from, 509–510
 Thyroid-binding globulin, 694
 Thyroiditis, subacute, 495, 498t, 499
 Thyroid-stimulating hormone (TSH), 96t, 447–448, 453, 494–495, 677
 blood tests for, 493, 493t
 in Graves' disease, 497
 in hypothyroidism, 495–496
 measurement of, 496
 monitoring of heart disease with, 555
 in pediatric patients, 694–695
 synthesis of, 491–492
 in toxic adenoma, 498
 Thyrotoxicosis, 492–494, 496–498, 497b, 498t
 Thyrotropin (TSH), 492, 493
 Thyrotropin-releasing hormone (TRH), 447, 492, 493, 694
 Thyroxine (T₄), 100–101, 101, 314, 447, 453–454, 491–493, 491–494, 493t, 677, 694
 Thyroxine-binding globulin (TBG), 492
 Thyroxine-binding prealbumin (TBPA), 492
 Tiagabine, 618
 TIBC. *See* Total iron binding capacity
 Ticlopidine, 306t
 Time limits, of blood samples, 71
 Timing, of specimen collection, 29
 Tips, for pipets, 15, 172–173
 Tissue source
 of acid phosphatase, 299
 of alanine aminotransferase, 296
 of alkaline phosphatase, 297
 of amylase, 301
 of aspartate aminotransferase, 296
 of creatine kinase, 289
 of glucose-6-phosphate dehydrogenase, 304
 of γ -glutamyltransferase, 300
 of lactate dehydrogenase, 294
 of lipase, 303
 Titration, 367–368, 583
 TJC. *See* The Joint Commission
 TLA. *See* Total laboratory automation
 TLC. *See* Thin-layer chromatography
 TnT. *See* Troponin-T
 To contain (TC) laboratory supplies, 10, 12
 To deliver (TD) laboratory supplies, 10, 12
 Tobacco, 306t, 410
 Tobramycin, 572b, 614
 Tocopherol, 658
 Tolbutamide, 306t
 Tolerance, of glucose, 323–324, 678
 Tonometry, 401
 Tophi, 272
 Topiramate, 618
 Tort actions, 35
 Total bilirubin, analysis of, 525–526
 Total carbon dioxide content (tCO_2), 398
 Total error, 110b, 125, 125
 Total iron binding capacity (TIBC), 244, 417, 417t
 Total laboratory automation (TLA), 180, 180–183, 182
 Total nitrogen, analysis of, 252
 Total parenteral nutrition (TPN), 655–656, 665–670, 666t
 Total protein, 250–253, 250t, 252t
 Tourniquet, 41, 42, 48–51, 53–57
 Toxic adenoma, 498, 498t
 Toxicity
 acute and chronic, 623–624
 of antibiotics, 614–615
 of arsenic, 409–410
 of cadmium, 411
 of carbamazepine, 616
 of chromium, 414
 of copper, 415, 667
 of disopyramide, 614
 from hazardous substances, 80
 of iron, 416–417
 of lead, 411–412
 of manganese, 419
 of mercury, 413
 of methotrexate, 621
 of molybdenum, 419
 of phenytoin, 616
 of quinidine, 613
 rating system of, 623, 623t
 of selenium, 420–421, 670
 of sirolimus, 620
 of trace elements, 408
 of tricyclic antidepressants, 619
 of valproic acid, 616
 of zinc, 421
 Toxicology, 622–636
 analysis of toxins, 624
 dose-response relationship, 623, 623–624, 623t
 of drugs of abuse, 633–636, 634t
 exposure to toxins, 622–623
 in pediatric clinical chemistry, 702
 routes of exposure, 622–623
 of specific agents, 624–631, 625t, 626, 627t, 629
 of therapeutic drugs, 631–633, 632
 Toxins, 624–631, 625t, 626, 627t, 629
 analysis of, 624
 exposure to, 622
 response to, 623, 623–624, 623t
 TPMT. *See* Thiopurine methyltransferase

- TPN. *See* Total parenteral nutrition
- TPO. *See* Thyroid peroxidase
- TRAb. *See* TSH receptor antibodies
- Trabecular bone, 505
- Trace element-free tubes, 46
- Trace elements, 403–423
 - arsenic, 409–410, 628
 - cadmium, 410–411, 628
 - chromium, 413–414
 - copper, 243, 408, 414–415, 415*t*, 421, 666–667
 - instrumentation and methods, 404–409, 404*t*, 405–407
 - iron, 243–244, 416–418, 417*t*–418*t*, 588, 654, 668–669
 - lead, 408, 411–412, 428, 628–630, 629
 - manganese, 418–419
 - mercury, 80, 406, 412–413, 630–631
 - molybdenum, 419–420
 - selenium, 408, 420–421, 669–670
 - zinc, 408, 421–422, 667–668
- Trace metals, concentration of, 137
- β -Trace protein (BTP), 249
- Traceable electrodes, 398
- Tracers, in immunoassays, 191–193, 192, 193*t*, 194
- Training checklist, for point-of-care testing, 217
- Tranquilizers, 524, 636
- Trans fatty acids, 330
- Transaminases, 235, 296
- Transaminations, 235
- Transcription, 234
- Transcription-based amplification, 207–208, 208
- Transcutaneous (TC) electrodes, 396
- Transcutaneous monitoring, 183
- Transdermal testosterone therapy, 480
- Transfer devices, for syringe system, 44, 58–59
- Transfer pipets, 13
- Transferases, 282*t*, 283, 296
- Transference. *See* Verification
- Transferrin, 239*t*, 243–244, 414, 416–418, 417*t*–418*t*, 654, 679
- Translation, 234
- Transmission-based precautions, 35–39, 36*b*–38*b*
- Transmittance, percent, 131–132, 131–132
- Transplantation, renal, 576
- Transport
 - of arsenic, 409
 - of blood samples, 71
 - of cadmium, 410–411
 - of chromium, 414
 - of copper, 415
 - of iron, 416
 - of lead, 411
 - of manganese, 419
 - of mercury, 412–413
 - of molybdenum, 419
 - of oxygen, 392, 430, 440
 - of selenium, 420
 - of zinc, 421
- Transport proteins, 237
- Transthyretin. *See* Prealbumin
- Transudates, 601
- Transudative pleural effusion, 601–602, 601*t*
- Treatment
 - of abnormal lipoprotein, 238*t*
 - of acute renal failure, 575–576
 - of adrenal insufficiency, 465
 - of androgen excess, 470
 - of Cushing's syndrome, 469
 - of electrophoresis sample, 146–147
 - of end-stage renal disease, 576
 - of hepatitis B virus, 534
 - of hypercalcemia, 376
 - of hyperkalemia, 366
 - of hypermagnesemia, 372
 - of hypernatremia, 362
 - of hypocalcemia, 375
 - of hypokalemia, 365
 - of hypomagnesemia, 371
 - of hyponatremia, 361
 - of lipid disorders, 339–344
 - of pheochromocytoma, 474
- TRH. *See* Thyrotropin-releasing hormone
- Tricarboxylic acid (TCA) cycle, 312
- Tricuspid valve, 541
- Tricyclic antidepressants, 28, 305, 451, 619, 660, 662*t*, 664
- Triglyceride
 - in arteriosclerosis, 340–341, 546
 - chemistry of, 329, 330
 - in combined hyperlipoproteinemia, 343
 - in hyperlipoproteinemia, 341
 - in hypertriglyceridemia, 342
 - as interferent, 113
 - in lipid and lipoprotein analyses, 344, 347–348
 - in lipoprotein physiology and metabolism, 333–335
 - in lipoproteins, 331, 333
 - measurement of, 345, 345–346
 - NCEP goals for, 238*t*
 - population distributions of, 336–337, 336*t*
 - standardization of measurement of, 350–351
- Triiodothyronine (T₃), 491, 492–494, 493, 493*t*, 677, 694
- Trimethoprim, 662*t*
- Trioses, 309
- Triple quadrupole mass spectrometer, 157, 157–158
- Troglitazone, 306*t*
- Tropic hormones, 448, 453
- Troponin (cTn), 248, 441, 541, 550–552
- Troponin-T (TnT), 113, 552
- True negatives, 103–104, 104
- True positives, 102, 103–104, 104–105
- Tryptophan, 225*t*, 226
- TSH. *See* Thyroid-stimulating hormone; Thyrotropin
- TSH receptor antibodies (TRAb, TSHR-Ab), 494, 497, 499
- TSHR-Ab. *See* TSH receptor antibodies
- t*-test, in comparison-of-methods studies, 114–115
- Tube additives, 43–46, 43*t*, 46*t*
- Tube holder, 42, 42–43
- Tuberculosis (TB), safety for dealing with, 78–79
- Tuberculosis exposure control plan, 79
- Tubes. *See also* Evacuated tubes
 - collection, in automated analyzers, 171, 171
 - microcollection, 64–65, 65, 67, 70
 - microhematocrit, 65, 65, 67, 70
 - mixing of, 71
 - for pediatric samples, 687
 - photomultiplier, 135, 135
- Tubular diseases, 571
- Tubular reabsorption, 558–561, 559–560
- Tubular secretion, 559, 559–560
- Tumor markers, 637–650
 - applications of detection of, 638–642, 643
 - frequently ordered markers, 645–649
 - cancer antigen 125, 646
 - carcinoembryonic antigen, 638, 646–647
 - α -fetoprotein, 592, 638, 642*t*, 645–646
 - human chorionic gonadotropin, 642*t*, 645, 647–648
 - prostate-specific antigen, 640*t*, 644–645, 648–649
 - methods for, 642–645
 - recommendations for test ordering, 642
 - types of, 637–638, 639, 640*t*–643*t*, 643
- Tumor suppressor gene, 638*b*
- Tumorigenesis, 637, 639
- Tumors
 - of adrenal medulla, 470–471
 - aldosterone-producing, 463
 - catecholamine producing, 472, 472–474, 474
 - gastrin-secreting, 580, 586
 - hypercalcemia with, 506–507
 - of liver, 523–524
 - of pancreas, 580
 - of pancreatic β cells, 320–321
 - of parathyroid glands, 506
 - pituitary, 448–454
 - of thyroid, 494–495, 498
- Turbidimetry, 189–190, 260–261, 262*t*, 263, 304
- Turbidity, 140, 140–141
- of specimens, 30, 72, 98, 112
- of urine, 567
- Turnover, of bone, 504
- Two-dimensional electrophoresis, 156, 159
- Type 1 diabetes, 314–317, 315*t*, 323, 326–327, 573–574, 692
- Type 2 diabetes, 314–318, 315*t*, 323, 574, 678–679, 692
- Type I citrullinemia, 231
- Type I tyrosinemia, 229
- Type II citrullinemia, 231
- Type II tyrosinemia, 229
- Type III hyperlipoproteinemia, 343
- Type III tyrosinemia, 229–230
- Tyrosine, 225*t*, 227–230, 228, 236
- Tyrosinemia, 229–230
- U**
- UA. *See* Urinalysis
- Ulcer, gastric, 586
- Ultracentrifugation, 346, 348
- Ultrafiltration, of water, 6–7
- Ultrapur reagent, 5
- Ultraslow feedback loop, of pituitary, 447
- Ultrasound, of thyroid gland, 495
- Ultraviolet oxidation, 7
- Uncompetitive inhibitors, 286, 286
- Unconjugated bilirubin, 518–519, 522, 525, 691
- Unconjugated hyperbilirubinemia, 521
- United States Pharmacopeia (USP) reagent, 5
- Units of measure, 3–5, 4*t*, 23
- Universal precautions, 75
- Unlabeled immunoassays, 186–190, 187–189, 187*t*
- Unsaturated fatty acids, 329, 330
- Unstable angina, 546–547
- Upright PA/PRA ratio, 463
- Uracil, 203
- Urea, 224, 266–269, 267, 267*t*–269*t*, 561, 565
- Urea cycle disorders, 231–232, 278–279
- Urea nitrogen, 266, 268*t*, 655
- Urea nitrogen/creatinine ratio, 269
- Urease, 267
- Uremia, 268
- Uremic syndrome, 268, 573–574, 576
- Uric acid, 266, 267*t*, 270, 270–272, 271*t*–272*t*, 561
- Uricase, 270
- Urinalysis (UA), 566–570
 - for alkaptinuria, 230
 - for amino acid analysis, 233
 - chemical analyses, 567–568
 - crystals, 569–570
 - for cystinuria, 233
 - physical characteristics, 566–567
 - sediment examination, 568–569
- Urinary creatinine, 277
- Urinary protein, 260–262, 262*t*
- Urinary tract infection, 571
- Urinary tract obstruction, 571
- Urinary urea nitrogen (UUN), 655
- Urine, 6
 - acidic, 270, 567, 569–570
 - albumin in, 262, 326–327, 566
 - alkaline, 567, 570
 - carbohydrates in, 656
 - catecholamines in, 471
 - collection of, 29, 564, 566, 588
 - cortisol in, 466–467
 - electrophoresis of, 146, 565
 - glucose measurement in, 322
 - for ketone analysis, 326, 326*t*
 - for osmolality determination, 358
 - osmolality of, hypernatremia related to, 362*t*
 - PBG in, 428–429
 - physical characteristics of, 566–567
 - potassium in, 463
 - urobilinogen in, 526–527
- Urine microalbumin testing, 262
- URO. *See* Uroporphyrin
- Urobilin, 518
- Urobilinogen, 518, 526–527, 568

Uroporphyrin (URO), 424–427, 429–430
 USP reagent. *See* United States Pharmacopeia reagent
 UUN. *See* Urinary urea nitrogen

V

V genes. *See* Variable genes
 Vaccination
 for hepatitis A virus, 530
 for hepatitis B virus, 75, 534, 536
 mercury in, 412
 Vacuum, of evacuated tubes, 47
 VAD. *See* Vascular access devices
 Valence, 8
 Validation, of point-of-care testing methods, 216
 Valine, 225t, 226, 230
 Valinomycin, 144
 Valproic acid, 243, 616–618, 665
 Vancomycin, 614–615
 Vapor pressure, 8
 Vapors, toxic, 80
 Variability, 89b, 610
 Variable (V) genes, 246
 Variable volume pipet, 13
 Variables, of samples, 30, 31t
 Variance, of data, 90–91
 Variation
 Lean Six Sigma reduction of, 121
 in renal clearance, 565
 Vascular access devices (VAD), 62
 Vascular system, 39–40, 39–41
 Vasoactive inhibitory peptide (VIP), 459
 Vasopressin, 445, 447, 454–455, 463, 560, 560–562, 562, 641t
 V_d . *See* Volume of distribution
 Veins, 39, 39
 anchoring of, 49–50, 54, 56
 antecubital, 39–41, 40
 collapse of, 59, 60
 damaged, 62–63
 of elderly patients, 61
 H pattern, 40, 40
 M pattern, 40, 40–41
 of pediatric patients, 687, 687t
 sampling of, adrenal, 463
 selection of, 48–49, 53
 Velocity, of enzymatic reactions, 284, 284–286, 286
 Venipuncture, 28–29, 34
 equipment for, 41–46, 42–45, 43t, 46t
 geriatric, 61
 hematoma from, 60, 62–63, 63b
 multiple attempts at, 60
 pediatric, 60–61, 61
 procedures, 47–60, 48–59
 for butterfly system and ETS holder, 53–55, 54–55
 for evacuated tube system, 48–53, 48–53
 syringe system, venipuncture procedure for, 56–58, 56–59
 troubleshooting failure of, 47, 59, 60
 Venous blood, 41, 399
 Ventricles, 541
 Ventricular septal defects (VSDs), 544

Verification, of reference interval, 95–96, 95b, 99–101, 100–102, 102t

Very-low-density lipoproteins (VLDL), 328, 331–333, 332t, 335, 341–344, 346–349

Vesicle monoamine transporters (VMAT), 471, 472

Vessels, laboratory, 11, 11t, 12, 15

Villi, 587

Vincristine, 277b

VIP. *See* Vasoactive inhibitory peptide

Virilization, 482, 487t

Viruses, hepatitis, 75, 522–523, 529–537, 530t, 531–533, 533t–534t, 536t

Vitamin A, 508, 657–658

Vitamin B₁, 660

Vitamin B₂, 660

Vitamin B₆, 231, 660–661

Vitamin B₁₂, 111, 111, 231, 586, 588, 662–664

Vitamin C, 230, 656, 664

Vitamin D, 375, 377–378

 assessment of, 658–660

 in calcium homeostasis, 501–504, 502–503

 deficiency of, 512, 569, 588, 656, 677

 in hypercalcemia, 505–507

 in hypocalcemia, 509–510

 lead effects on, 629–630

 in osteoporosis, 513–514

Vitamin D₃, 373–375, 502, 563–564

Vitamin D-binding protein. *See* Gc-globulin

Vitamin dependency, 656

Vitamin E, 658

Vitamin insufficiency, 656

Vitamin K, 588, 660

Vitamins

 assessment of, 656–657, 657t

 deficiency of, 588, 656–657, 657t

 fat-soluble, 588, 657–660, 657t

 water-soluble, 657t, 660–665, 662t

Vitros analyzers, 167, 169t, 170–171, 171, 174, 174–179, 178, 181, 363, 363

V(D)J recombination, 246

VLDL. *See* Very-low-density lipoproteins

VMAT. *See* Vesicle monoamine transporters

Voltammetry, anodic stripping, 145, 409

Volume

 of blood, 357–358, 358

 of pipets, 13, 13

 of urine, 29, 567

Volume of distribution (V_d), 607

Volumetric flasks, 11, 11t, 15

Volumetric pipets, 13

von Gierke disease. *See* Glucose-6-phosphatase

 deficiency type 1

VSDs. *See* Ventricular septal defects

W

Waived tests, 108, 211, 212t–214t, 216

Warfarin, 301, 306t, 660

Warming devices, for capillary specimen

 collection, 64

Warming, of capillary puncture site, 66, 69

Washing, of automated analyzer probes,

 172–173, 175

Waste

 disposal of, 84–85

 Lean Six Sigma elimination of, 121

Water, 356–361, 358, 359t, 560

 deionized, 6–7

 distilled, 6–7

 osmolality, 160, 357–359, 358, 359t

 pediatric patient regulation of, 689–690,

 690t–691t

 renal reabsorption of, 560, 560–561

 retention of, 360

 reverse osmosis, 6–7

 specifications for reagents, 6–7

 types I, II, III, 6–7

Water balance, 360, 455, 561–562, 562, 690,

 690t–691t

Water deficit, 357

Water load, 357

Water of hydration, 26

Water-soluble vitamins, 657t, 660–665, 662t

Watson-Schwartz test, 428–429

Wavelength

 accuracy of, 136

 energy and, 131, 131

Weight/volume (w/v), 21

Weight/weight (w/w), 20–21

Western blot, 198, 199

White blood cells, in urinalysis, 568

Whole blood, 28, 41, 44, 72, 170, 321–322, 325

Whole populations, newborn screening for,

 699–700, 699t

Wilson's disease, 243, 415, 421, 667

Winged infusion set. *See* Butterfly system

w/v. *See* Weight/volume

w/w. *See* Weight/weight

X

Xanthomas, 342

Xenobiotics, 305, 609

Xenon lamps, 138

Y

Yeast cells, in urinalysis, 568–569

Z

Zeeman effect, 137

Zero-order kinetics, of enzymatic reactions, 284, 287

Zidovudine, 306t

Zinc, 408, 421–422, 667–668

Zinc acetate, 415

Zinc protoporphyrin (ZPP), 429, 630

Zoledronate, 511, 514

Zöllinger-Ellison syndrome, 580, 586

Zona fasciculata, 459

Zona glomerulosa, 459

Zona reticularis, 459

Zone electrophoresis, 145, 256

Zones, of adrenal cortex, 459–462, 459–462

Zonisamide, 618

ZPP. *See* Zinc protoporphyrin

Zymogen, 283