



N  
O  
V  
A  
  
B  
i  
o  
m  
e  
d  
i  
c  
a  
l



# Handbook of Vitamin C Research

*Daily Requirements, Dietary Sources  
and Adverse Effects*

Hubert Kucharski  
Julek Zajac  
Editors

**Nutrition and Diet Research Progress Series**

NOVA



**NUTRITION AND DIET RESEARCH PROGRESS SERIES**

**HANDBOOK OF VITAMIN C RESEARCH:  
DAILY REQUIREMENTS, DIETARY  
SOURCES AND ADVERSE EFFECTS**

No part of this digital document may be reproduced, stored in a retrieval system or transmitted in any form or by any means. The publisher has taken reasonable care in the preparation of this digital document, but makes no expressed or implied warranty of any kind and assumes no responsibility for any errors or omissions. No liability is assumed for incidental or consequential damages in connection with or arising out of information contained herein. This digital document is sold with the clear understanding that the publisher is not engaged in rendering legal, medical or any other professional services.

# NUTRITION AND DIET RESEARCH PROGRESS SERIES

## **Diet Quality of Americans**

*Nancy Cole and Mary Kay Fox*

2009. ISBN: 978-1-60692-777-9 (Hardcover Book)

## **Diet Quality of Americans**

*Nancy Cole and Mary Kay Fox*

2009. ISBN: 978-1-60876-499-0 (Online Book)

## **School Nutrition and Children**

*Thomas J. Baxter*

2009. ISBN: 978-1-60692-891-2

## **Appetite and Nutritional Assessment**

*Shane J. Ellsworth and Reece C. Schuster (Editors)*

2009. ISBN: 978-1-60741-085-0

## **Flavonoids: Biosynthesis, Biological Effects and Dietary Sources**

*Raymond B. Keller (Editor)*

2009. ISBN: 978-1-60741-622-7

## **Beta Carotene: Dietary Sources, Cancer and Cognition**

*Leiv Haugen and Terje Bjornson (Editors)*

2009. ISBN: 978-1-60741-611-1

## **Handbook of Vitamin C Research: Daily Requirements, Dietary Sources and Adverse Effects**

*Hubert Kucharski and Julek Zajac (Editors)*

2009. ISBN: 978-1-60741-874-0

**NUTRITION AND DIET RESEARCH PROGRESS SERIES**

**HANDBOOK OF VITAMIN C RESEARCH:  
DAILY REQUIREMENTS, DIETARY  
SOURCES AND ADVERSE EFFECTS**

**HUBERT KUCHARSKI  
AND  
JULEK ZAJAC  
EDITORS**

**Nova Biomedical Books**  
*New York*

Copyright © 2009 by Nova Science Publishers, Inc.

**All rights reserved.** No part of this book may be reproduced, stored in a retrieval system or transmitted in any form or by any means: electronic, electrostatic, magnetic, tape, mechanical photocopying, recording or otherwise without the written permission of the Publisher.

For permission to use material from this book please contact us:

Telephone 631-231-7269; Fax 631-231-8175

Web Site: <http://www.novapublishers.com>

### **NOTICE TO THE READER**

The Publisher has taken reasonable care in the preparation of this book, but makes no expressed or implied warranty of any kind and assumes no responsibility for any errors or omissions. No liability is assumed for incidental or consequential damages in connection with or arising out of information contained in this book. The Publisher shall not be liable for any special, consequential, or exemplary damages resulting, in whole or in part, from the readers' use of, or reliance upon, this material. Any parts of this book based on government reports are so indicated and copyright is claimed for those parts to the extent applicable to compilations of such works.

Independent verification should be sought for any data, advice or recommendations contained in this book. In addition, no responsibility is assumed by the publisher for any injury and/or damage to persons or property arising from any methods, products, instructions, ideas or otherwise contained in this publication.

This publication is designed to provide accurate and authoritative information with regard to the subject matter covered herein. It is sold with the clear understanding that the Publisher is not engaged in rendering legal or any other professional services. If legal or any other expert assistance is required, the services of a competent person should be sought. FROM A DECLARATION OF PARTICIPANTS JOINTLY ADOPTED BY A COMMITTEE OF THE AMERICAN BAR ASSOCIATION AND A COMMITTEE OF PUBLISHERS.

### **Library of Congress Cataloging-in-Publication Data**

Handbook of vitamin C research : daily requirements, dietary sources, and adverse effects / editors, Hubert Kucharski and Julek Zajac.

p. ; cm.

Includes bibliographical references and index.

ISBN 978-1-61324-970-3 (eBook)

1. Vitamin C--Handbooks, manuals, etc. I. Kucharski, Hubert. II. Zajac, Julek.

[DNLM: 1. Ascorbic Acid--therapeutic use. 2. Ascorbic Acid--adverse effects. 3. Ascorbic Acid--metabolism. 4. Oxidative Stress--physiology. QU 210 H236 2009]

QP772.A8H36 2009

612.3'99--dc22

2009026856

*Published by Nova Science Publishers, Inc., ✚ New York*

---

# Contents

---

<b>Preface</b>		<b>vii</b>
<b>Chapter I</b>	Impact of Vitamin C on Exercise-Induced Oxidative Stress and Tissue Injury <i>Kelsey H. Fisher-Wellman and Richard J. Bloomer</i>	<b>1</b>
<b>Chapter II</b>	Human Specific Vitamin C Metabolism and Xenobiotic Polymorphism: The Optimal Nutrition <i>Yasuo Kagawa, Shizu Higasa, Masaru Tsujimura, Fumio Komatsu, Yoshiko Yanagisawa and Sadahiko Iwamoto</i>	<b>45</b>
<b>Chapter III</b>	Vitamin C Protects from Oxidative DNA Damage and Apoptosis Caused by Food N-Nitrosamines <i>Ana I. Haza, Almudena García and Paloma Morales</i>	<b>87</b>
<b>Chapter IV</b>	Vitamin C: Dietary Requirements, Dietary Sources and Adverse Effects <i>Chin-San Liu</i>	<b>127</b>
<b>Chapter V</b>	Pro-Oxidant vs. Antioxidant Effects of Vitamin C <i>Borut Poljsak and John G. Ionescu</i>	<b>153</b>
<b>Chapter VI</b>	Encapsulation Devices for Vitamin C <i>Magdalena Stevanović and Dragan Uskoković</i>	<b>185</b>
<b>Chapter VII</b>	Molecular Bases of the Cellular Handling of Vitamin C <i>J.J.G. Marin, M.A. Serrano, M.J. Perez and R.I.R. Macias</i>	<b>213</b>
<b>Chapter VIII</b>	Vitamin C: Daily Requirements, Dietary Sources and Adverse Effects <i>Jun Yang, Jiaren Liu and John Parry</i>	<b>237</b>

<b>Chapter IX</b>	Vitamin C Intake: Types of Foods Consumed and Meal Pattern Differences in Children with High or Low Exposure to Environmental Tobacco Smoke	<b>261</b>
	<i>Alan M. Preston, Luis Vázquez Quiñones, Cynthia M. Pérez, Ernesto Pérez Torres and Cindy Rodríguez</i>	
<b>Chapter X</b>	The Role of Vitamin C in Human Reproduction	<b>281</b>
	<i>E. Tzagaraki, C. Sofocleous, G. Tounta, A. Mavrou and A. Kolialexi</i>	
<b>Chapter XI</b>	Effects of Vitamin C on Oxidative Stress-Induced Molecular Pathways in Epilepsy	<b>299</b>
	<i>Mustafa Nazıroğlu</i>	
<b>Chapter XII</b>	Vitamin C as a Stress Bioindicator of Norway Spruce: A Case Study in Slovenia	<b>313</b>
	<i>Samar Al Sayegh Petkovšek and Boštjan Pokornj</i>	
<b>Chapter XIII</b>	Protective Effect of Vitamin C on Vascular Damage and Arterial Hypertension Induced by Low-Level Mercury and Lead Exposure	<b>329</b>
	<i>Antonio J. López-Farré, José J. Zamorano-León, Daniel Sacristán, Maria Marques, Carlos Macaya and Alberto Barrientos</i>	
<b>Chapter XIV</b>	Vitamin C in the Treatment of Endothelial Dysfunction	<b>343</b>
	<i>Alin Stirban</i>	
<b>Chapter XV</b>	Vitamin C Intake by Japanese Patients with Chronic Obstructive Pulmonary Disease	<b>355</b>
	<i>Fumi Hirayama and Andy H. Lee</i>	
<b>Chapter XVI</b>	Reciprocal Effects of Ascorbate on Cancer Cell Growth and the Expression of Matrix Metalloproteinases and Transforming Growth Factor-Beta: Modulation by Gene Silencing or <i>P. Leucotomos</i>	<b>367</b>
	<i>Neena Philips</i>	
<b>Chapter XVII</b>	Shortage of Vitamin C Accelerates Aging	<b>377</b>
	<i>Akihito Ishigami</i>	
<b>Expert Commentary</b>		<b>385</b>
	The Importance of Food Processing on Vitamin C: Present and Future Trends	<b>385</b>
	<i>Rui M. S. Cruz, Margarida C. Vieira and Cristina L. M. Silva</i>	
<b>Index</b>		<b>389</b>



---

## Preface

---

The 6-carbon lactone known as ascorbic acid (vitamin C) is an important water-soluble vitamin. It is essential for preserving optimal health and it is used by the body for many purposes, including collagen biosynthesis, melanin reduction and enhanced immunity. This book addresses some important issues related to various methods which are employed to encapsulate ascorbic acid. A comparison of the characteristics of ascorbic acid nano and microparticles prepared by different methods is also given. Furthermore, the biomedical significance of human vitamin C metabolism is examined, in the light of polymorphisms in xenobiotic enzymes deduced from genetic, biochemical and epidemiological results to estimate optimal nutrition. Additionally, Vitamin C exerts a protective role against some types of cancer. For that reason, this book investigates the protective effect of vitamin C. Possible pro- and antioxidant effects of vitamin C are also presented and their extrapolation on human health is discussed. Other chapters in this book include a review of the role of vitamin C in the physiology of several diseases, good dietary sources of vitamin C, a study of the effects of environmental tobacco smoke (ETS) on vitamin C status in exposed populations and the role of vitamin C in human reproduction and its effect on people who suffer from epileptic seizures.

Chapter I - The 6-carbon lactone known as ascorbic acid (vitamin C) is a principal water soluble micronutrient within biological systems, where it serves as an electron donor for a variety of physiological processes. Vitamin C is perhaps best known for its role as the primary small molecule antioxidant within aqueous environments. Here it assists other enzymatic and nonenzymatic components of the antioxidant defense system in providing protection against free radical-mediated attack, in an effort to minimize oxidative stress. Simply stated, oxidative stress is a condition in which the production of free radicals exceeds antioxidant defenses, potentially leading to oxidative damage to small and large molecules. Oxidative stress is associated with human disease, as well as the aging process. Although multiple stimuli exist, the performance of acute exercise is one such condition in which the production of free radicals is exacerbated. This exercise-induced oxidative stress has commonly been viewed as a detriment to physical performance, as it is believed to interfere with force production capabilities during exercise, as well as accelerate muscle damage and delay recovery in the days following exercise. For this reason, coupled with the aforementioned association of oxidative stress with disease, numerous investigators have

attempted to elucidate methods aimed at attenuating such a stress. One such method that has received considerable attention during the past several years is the use of supplemental vitamin C (either alone or in combination with other antioxidant nutrients). Although some investigators have reported a reduction in oxidative stress following vitamin C intake, results are mixed, and controversy exists as to whether such attenuation is really desirable. That is, the consumption of additional vitamin C or other exogenous antioxidants, within otherwise healthy populations, may actually blunt the adaptive improvement in antioxidant defenses commonly observed with regular exercise training. This phenomenon is based on the principle of hormesis and suggests that exercise-induced free radical production may serve as the necessary “signal” for the induction/regulation of a wide variety of favorable adaptations.

At the present time, it would appear that vitamin C supplementation likely possesses no additional benefits related to improved performance in otherwise healthy individuals engaged in regular exercise training who consume a quality diet containing adequate amount of fruits, vegetables, whole grains, and antioxidant-rich oils (fish, flax, olive). However, conditions whereby an individual is continuously exposed to a currently undefined critical level of excessive exercise (i.e., overtraining) may warrant supplementation with vitamin C. Clearly, more research is needed in order to further elucidate the point at which the detrimental effects of exercise begin to outweigh the positive benefits, and at which time intake of supplemental vitamin C may be recommended.

Chapter II - The biomedical significance of human vitamin C (VC) metabolism is reviewed in the light of polymorphisms in xenobiotic enzymes deduced from genetic, biochemical, and epidemiological results to estimate optimal nutrition. VC comprises both ascorbic acid (AsA) and dehydroascorbic acid (DAsA). AsA is oxidized to DAsA via short-lived monodehydroascorbate radicals in a series of xenobiotic reactions and by reactive oxygen species (ROS). DAsA is reversibly reduced by glutaredoxin, but is also irreversibly hydrolyzed into 2,3-diketo-L-gulonate by dehydroascorbatase [EC 3.1.1.17] and non-enzymatic reactions. VC is a cofactor in reactions catalyzed by  $\text{Cu}^+$ -dependent monooxygenases [EC 1.13.12.-] and  $\text{Fe}^{2+}$ -dependent dioxygenases [EC 1.13.11.-]. VC plays a protective role against oxidative stress by ROS and xenobiotics, via monodehydroascorbate radicals. The Vitamin Society of Japan has re-evaluated old data because of the development of life science. The recommended dietary allowance (RDA) of VC is 100 mg/day for adults in Japan to prevent scurvy. RDA is defined as  $\text{EAR}+2\text{SD}$ , i.e. estimated average requirement (EAR) and the standard deviation (SD) obtained by short-term depletion-repletion studies. However, based on VC synthetic rates in rat, Pauling proposed that the optimum intake is 2.3 g/day. This is the problem of RDA vs. optimal nutrition. Optimal nutrition is wider in scope than RDA that covers genetic polymorphisms, long-term health outcome during the lifespan, and xenobiotics. Humans (VC auxotrophs) have relatively low plasma AsA levels and high serum uric acid levels compared to most VC-synthesizing mammals (VC autotrophs) due to gene defects in L-gulonolactone oxidase (GLO [EC 1.1.3.8]) and uricase (urate oxidase) [EC 1.7.3.3], respectively. Extrapolation of metabolic data of VC autotrophs to estimate human optimal nutrition is limited because of the compensatory mechanism for the GLO defect in VC auxotrophs, including DAsA transport by GLUT1, and specific mutations in uricase and dehydroascorbatase. Beneficial effects of long-term VC supplementation remain controversial, perhaps because of 1. genetic heterogeneity in study populations, and 2. the

balance of antioxidant and pro-oxidant activities of VC depending on the xenobiotic conditions. Thus, in addition to the biochemical studies on AsA and DAsA, human genetic analysis on VC-loading experiments and epidemiological survey are needed. There are marked interindividual differences (coefficient of variation >45%) in the metabolism of VC. This difference is evident during oral loading with 1 mmol AsA or DAsA in subjects consuming a diet low in VC (less than 5 mg/day) for 3 days before loading in the cross-over experiment. Since tubular maximum reabsorption of AsA (TmAsA) and glomerular filtration rate (GFR) are similar among subjects, degradation steps of VC may be involved in the personal difference. The metabolisms of three most important water-soluble antioxidants in mammals, i.e., VC, urate and glutathione are different in humans and other animals. The effects of polymorphism A313G (Ile105Val) in the gene for glutathione S-transferase P1 (GSTP1) [EC 2.5.1.18], one of the most active xenobiotic enzymes in the second phase of detoxification, on human VC metabolism were thus studied. In an epidemiologic survey of Mongolians (n = 164) with very low VC intake, serum VC concentration was only 28%, and the level of reactive oxygen metabolites was 128%, when compared with those in Japanese. The variant frequency of GSTP1 among Japanese subjects (n = 210) was AA, 71.0%; GA, 27.0% and GG, 1.9%. In Mongolian subjects (n = 93), it was AA, 62.4%; GA, 36.6%; and GG, 1.1%. In VC loading experiments, at 24 h after administration of 1 mmol of VC to young women (n = 17; age, 21.0 ± 1.1 y, glomerular filtration rate, GFR = 90 ml/min), total VC excretion (46.7 ± 18.1 mg) by AA homozygotes of GSTP1 was greater (p < 0.0069) than that (28.2 ± 14.0 mg) by GA heterozygotes. One hour after administration of VC, blood total VC levels were also significantly different (p < 0.0036) between the homozygotes and heterozygotes. The results of background experiments were as follows: (1) the VC level in 24-h urine after VC loading did not differ between the two orally administered C forms (AsA and DAsA); (2) VC excretion between 0 and 3 h after VC loading was significantly higher (p < 0.05) for DAsA, while those between 3 and 6, 6 and 9, 9 and 12, and 12 and 24 h after VC loading were significantly higher (p < 0.05 or p < 0.01) for AsA; and (3) blood VC concentrations and the increase in VC at 1 h after VC loading were significantly higher (p < 0.05 and p < 0.01, respectively) in the DAsA group than in the AsA group. The difference between AsA and DAsA dynamics in (2) and (3) may be explained by the sodium-dependent active transport of AsA by SVCT1 and 2, and passive transport of DAsA by glucose transporters (GLUTs) in the presence of glutathione. The large species differences in DAsA metabolism are partly explained by the low activity of human dehydroascorbate, which has a unique structure, as deduced by X-ray crystallography, and a unique sequence of 299 amino acids. The anti-oxidant and anti-xenobiotic roles of monodehydroascorbate radicals both *in vivo* and *in vitro* are important. ROS are generated mainly in mitochondria but DAsA transported through GLUT1 into mitochondria is converted into AsA and prevents oxidative stress. Finally RDA and optimal nutrition are discussed from the standpoint of human specific metabolism of VC including prevention against ROS produced by exercise and pathological conditions.

Chapter III - Vitamin C exerts a protective role against some types of cancer, being an essential co-factor for many enzymes and an efficient scavenger of reactive oxygen species (ROS). Among the environmental carcinogenic compounds, N-Nitrosamines cause cancer in a variety of animal species and may be causative agents in human cancer. Population-based

studies show that a low risk of cancer is more closely related to antioxidant-rich whole diets than to individual dietary antioxidants. For that reason, the authors' aim was to investigate the protective effect of vitamin C alone or in combination with isothiocyanates (ITCs) or organosulfur (OSCs) compounds towards N-Nitrosamines-induced oxidative DNA damage in the single cell gel electrophoresis (SCGE)/HepG2 assay. The maximum reduction in NDBA (94%), NPYR (81%) NPIP (80%) and NDMA (61%)-induced oxidative DNA damage was observed at 10 $\mu$ M vitamin C. Moreover, HepG2 cells treated with ITCs or OSCs in combination with vitamin C (10 $\mu$ M) showed a stronger inhibition of oxidative DNA damage induced by NPIP (> 45% and > 67%, respectively) or NDBA (> 30% and > 80%, respectively) than ITCs or OSCs alone. CYP2A6 (82%) activity, and to a lesser extent CYP2E1 (32%) and CYP1A1 (19%) activities were significantly reduced by vitamin C (10 $\mu$ M). Besides, vitamin C (1-10 $\mu$ M) exerted a pronounced increase of UDP-glucuronyltransferase (UGT1A4) activity (171-178%, respectively). Vitamin C was also able to reduce DNA strand breaks (33%) and oxidative DNA damage in purines (12%) and in pyrimidines (35%) induced by H<sub>2</sub>O<sub>2</sub> in HepG2 cells by scavenging of ROS. The anti-apoptotic effect of vitamin C (50 $\mu$ M) was similar in HepG2 and HL-60 cells towards NPIP (74% and 77% of reduction) and NPYR (63% and 65% of reduction), two cyclic N-Nitrosamines. However, the inhibition by vitamin C (50 $\mu$ M) of apoptosis induction by lineal chain N-Nitrosamines, such as NDMA and NDBA, was higher in HL-60 (75% and 80% of reduction) than in HepG2 cells (57% and 66% of reduction). Finally, the scavenging activity of vitamin C towards ROS produced by NPIP and NDBA in both cell lines was tested using 2', 7'-dichrodihydrofluorescein diacetate (H<sub>2</sub>DCFDA). ROS production induced by NPIP and NDBA was reduced by all concentration tested (5-50 $\mu$ M) of vitamin C in a dose-dependent manner. In summary, the modification of phase I and II enzyme activities, free radical scavenging ability and inhibition of apoptosis could be implicated in the protective effects of vitamin C towards N-Nitrosamine toxicity.

Chapter IV - Vitamin C, or ascorbic acid, is an acquired and essential micronutrient involved in many biological and biochemical functions. A growing body of evidence indicates that the current U.S. Recommended Dietary Allowance (RDA) of 50-60 milligrams of vitamin C per day is far below that actually needed to maintain good health. Depletion of vitamin C intake has been linked to the development of cardiovascular diseases, hypertension, stroke, diabetes mellitus, cancer, and Alzheimer's disease. Vitamin C intake from diets rich in fruits and vegetables is usually not sufficient, and daily oral supplementation from different forms of commercial vitamin C products is recommended.

Chapter V - Vitamin C (L-ascorbic acid) protects human health by scavenging toxic free radicals and other reactive oxygen species (ROS) formed in cell metabolism. On the other side, it is well established by *in vitro* experiments that vitamin C is reactive with free iron and produces free radicals, while causing oxidative damage to biomolecules. The interaction of ascorbic acid with transition metal ions could promote their reduction, accompanied by increased H<sub>2</sub>O<sub>2</sub> production and consequently OH $\cdot$  formation. The mixture of metal ions and ascorbate in some vitamin pills has been claimed to generate OH $\cdot$  once the pills dissolve and several reports suggest increases in DNA damage in healthy humans supplemented with vitamin C and iron salts. In epidemiologic studies it is often assumed that antioxidant vitamins act by lowering oxidative damage, but evidence in support of this contention is not

provided or is contradictory. Many studies show an inverse relationship between mortality and vitamin C intake indicating a protective antioxidant activity. On the other side several reports show no significant relationship after controlling for confounding variables. Therefore there is still debate on whether supplements of vitamin C could act as antioxidant or pro-oxidant *in vivo*. Recent research suggests that 3 factors are responsible for the pro- or antioxidant behaviour of vitamin C in biological systems, e.g., cellular environment: 1.) the redox potential of the cellular environment (oxidosis/redosis), 2.) the presence or absence of transition metals, and 3.) the local concentration of ascorbate. This may also explain the observed quite specific pro-oxidant activity of high dose intravenous vitamin C against metal reach malignant tumours. In this paper possible pro- and antioxidant effects of vitamin C will be presented and their impact on human health will be discussed.

Chapter VI - Vitamin C, also known as ascorbic acid, is a very important water-soluble vitamin. It is essential for preserving optimal health and it is used by the body for many purposes. Vitamin C promotes collagen biosynthesis, provides photoprotection, causes melanin reduction, enhances the immunity (anti-virus effect), etc. Vitamin C is a highly effective antioxidant. Even in small amounts vitamin C can protect indispensable molecules in the body, such as proteins, lipids (fats), carbohydrates, and nucleic acids (DNA and RNA) from damage by free radicals and reactive oxygen species that can be generated during normal metabolism as well as through exposure to toxins and pollutants (e.g., smoking). Vitamin C may be involved in the reduction of the risk of certain types of cancer. A number of *in vitro* and *in vivo* experiments have been performed in order to evaluate the ability of ascorbic acid to prevent the adverse effects, increase the effects of, and decrease resistance to chemotherapeutic agents. The problem is that ascorbic acid is very unstable to air, light, heat, moisture, metal ions, oxygen, and base, and it easily decomposes into biologically inactive compounds such as 2,3-diketo-L-gulonic acid, oxalic acid, L-threonic acid, L-xylonic acid and L-lyxonic acid. This makes its use very limited in the field of pharmaceuticals, dermatologicals and cosmetics. In order to overcome the chemical instability of the ascorbic acid numerous researches have been staged toward its encapsulation or immobilization. The ascorbic acid introduced in the body in the greater portion is isolated from the body. However, the encapsulated ascorbic acid within, for example, the polymeric matrix should have significantly higher efficiency. The present review attempts to address some important issues related to various methods which are employed to encapsulate ascorbic acid, such as thermal phase separation, melt dispersion, solvent evaporation, spray drying, homogenization of water and organic phases, etc. This review also gives a comparison of the characteristics of ascorbic acid nano and microparticles prepared by different methods. The materials in which ascorbic acid can be successfully encapsulated are poly (DL-lactide-co-glycolide), tripolyphosphate cross-linked chitosan, liposomes, maltodextrin, dendrimers, etc. Encapsulation efficiency, release rate, size distribution of particles with encapsulated ascorbic acid, are some of the parameters which are used for evaluating encapsulation system characteristics.

Chapter VII - Under circumstances of an adequate dietary content in ascorbic acid, the availability of this vitamin for cells is still not ensured. The reason could be poor intestinal absorption or impaired access to cells in different tissues because, owing to the marked hydrophylicity of this molecule, the rate of free diffusion across plasma membranes is low.

Indeed the role of carrier proteins in vitamin C uptake has been recently recognized. This was formerly believed to occur via passive transport, in which sugar carriers belonging to the GLUT family were assumed to be involved. However, more recently it has been described that ascorbic acid absorption by the intestine and uptake by cells from the blood requires more specific plasma membrane transporters for vitamin C as a substrate and with the higher efficiency that is characteristic of active systems. In this case, the energy for active vitamin C uptake is provided by inwardly directed sodium gradients. The differential tissue distribution of isoforms 1 and 2 of sodium-dependent vitamin C transporters (SVCT) accounts for the general and specific functions of these proteins in anti-oxidant systems responsible for cell homeostasis or more cell-specific roles in which vitamin C is involved, such as trans-epithelial transfer or collagen synthesis. Changes in the expression of these transporters in association with oxidative stress and inflammation have been described. In the present review, their role in physiology and in both the aetiology and pathogenesis of several diseases is discussed.

Chapter VIII - Ascorbic acid (vitamin C) is classified as a water-soluble vitamin. It is a powerful reducing agent and is sensitive to transition metals, light, oxygen, and heat. As a strong antioxidant, ascorbic acid is used as a preservative in the food industry. Humans depend on ascorbic acid for many physiological and biochemical functions such as collagen, carnitine, and neurotransmitter biosynthesis, which is crucial to the maintenance of bones, teeth, and blood vessels. A deficiency in ascorbic acid can lead to scurvy. Unlike most plants, animals, and single-cell organisms, humans cannot synthesize their own supply of ascorbic acid due to lack of the enzyme responsible for the final step in its conversion - gulonolactone oxidase. It must be obtained from dietary sources including fruits, vegetables and supplements. Good dietary sources of vitamin C include citrus fruits, green vegetables, bell peppers, papaya, and tomatoes. However, vitamin C level is reduced in storage and processing. Generally, the U.S. recommended dietary allowance (RDA) for ascorbic acid is from 100–120 mg/per day for adults. Ascorbic acid is an antioxidant that can help neutralize free radicals. Many health benefits have been attributed to ascorbic acid such as protection from viral infections, anti-atherogenesis, anti-carcinogenesis, and immune-modulation. A new study indicates that it has a complex protective role against toxic compounds formed from oxidized lipids, preventing genetic damage and inflammation. The amount of ascorbic acid to cause overdose symptoms in humans varies among individuals, and overdose is generally characterized by diarrhea and possibly indigestion. Ascorbic acid has been implicated with increasing the susceptibility to Vitamin B<sub>12</sub> deficiency, and also has shown to be contraindicative in cancer chemotherapy. High doses of ascorbic acid may have prooxidant effects and have also been implicated in the development of kidney stones. *In vitro* and animal studies have shown that fruit and vegetable components, such as flavonoids and other matrix compounds, might reduce ascorbic acid intestinal uptake. The role of ascorbic acid in human biology and health is still controversial. The health benefits of ascorbic acid have been the subject of much debate. More mechanisms of action and human *in vivo* studies are needed to understand and elucidate the molecular mechanisms of ascorbic acid in health functions. The purpose of this chapter is to review the health benefits and adverse effects of ascorbic acid based on a review of the literature.

**Chapter IX - Background:** Vitamin C is a physiological antioxidant of major importance for protection against diseases and degenerative processes caused by oxidative stress. Ample evidence exists for the detrimental effects of environmental tobacco smoke (ETS) on vitamin C status in exposed populations. Reduced dietary intake has been documented in spouses and preschool children of active smokers, but few studies have been done in children of other age groups. Furthermore, there is no information on meal-pattern differences in vitamin C intake between populations either exposed or not exposed to ETS.

**Objectives:** The authors assessed consumption of foods containing from zero to high amounts of vitamin C and determined contribution of regular meals and snacks to the daily intake of vitamin C in children with either high (HEX) or low (LEX) exposure to ETS.

**Study Design:** The study group consisted of a convenience sample of 508 healthy children aged 2-13 years routinely visiting a clinic in the greater San Juan Metropolitan Area. Dietary intake of vitamin C was obtained with a 24-hour recall questionnaire. Smoke exposure was assessed by measuring a biomarker, urinary cotinine. Children were divided into high and zero-low exposure groups according to the mean value of cotinine/creatinine (15.8 ng/mg).

**Results:** Both groups of children consumed well in excess of the RDA levels for vitamin C, but children with LEX had a significantly higher mean daily intake (123.4 mg) than HEX children (102.4 mg). Both groups consumed similar amounts of total calories as well as calories from vitamin C-containing foods which consisted of about six servings/day. Of these servings, however, children in the LEX group consumed foods with high amounts of vitamin C, while the HEX group consumed foods with lesser amounts. Meal patterns showed that breakfast provided the greatest percent of daily vitamin C for both groups (31% for LEX, 36% for HEX). No differences were noted between groups in the percent of daily intake of vitamin C consumed at lunch or dinner (21% and 23% for LEX and 25% and 25% for HEX, respectively). The major difference in percent of daily intake as well as amount of intake was in snacks. Children with LEX consumed about 26% of their daily vitamin C by consuming snacks with high amounts of vitamin C while HEX children consumed only 15% of their daily vitamin C by consuming snacks with low amounts of vitamin C.

**Conclusions:** Children with high exposure to ETS consumed less vitamin C than children with zero-low exposure levels. Differences might be attributed to consumption of foods containing high amounts of vitamin C by the low exposure group. Snacking behavior appears to be a major factor in daily intake of vitamin C contributing to 26% of daily intake of the diet in children with low exposure but only 15% of the intake in children with high exposure.

**Chapter X -** In humans, vitamin C is a highly effective antioxidant known to protect cells against oxidative damage caused by Reactive Oxygen Species (ROS). Under normal conditions, antioxidants convert ROS to H<sub>2</sub>O to prevent the accumulation of ROS in the body. Oxidative Stress (OS) occurs when this balance is disturbed and results in the overabundance of ROS. ROS have been implicated in more than 100 diseases.

In human female reproduction ROS affects oocyte maturation, fertilization, embryo development and pregnancy. Several studies report a significant role of oxidative stress in the pathophysiology of preeclampsia, fetal embryopathies, female infertility, birth weight, preterm labor, diabetes, miscarriage and intrauterine growth retardation (IUGR). Male infertility has been related to oxidative stress due to oxidatively induced DNA damage. Low

or deficient ascorbate levels have been correlated with low sperm counts, increased numbers of abnormal sperm, reduced motility and agglutination. Decreased ascorbate concentrations in semen are associated with poor breeding performance in bulls, while scorbutic guinea pigs developed defective testicular germinal epithelium. Such studies suggest that ascorbate deficiency can be harmful both to the structure and function of the male reproductive tract—in vitro loss of spermatozoa's motility in human sperm. This chapter attempts to examine the various causes of male and female infertility and the role of OS in various reproductive disorders.

Chapter XI - Epileptic seizures result from excessive discharge in a population of hyperexcitable neurons. Excessive production of ROS (reactive oxygen species) is thought to contribute to epilepsy, and there is a potential connection between ROS and mitochondrial dysfunction in epilepsy. Free radical generation can also induce seizure activity by direct activation of glutamine synthetase, thereby permitting an abnormal buildup of glutamic acid, the excitatory neurotransmitter. The brain is extremely susceptible to oxidative damage induced by these ROS because it generates extremely high levels of ROS due to its very high aerobic metabolism and blood perfusion, and it has a relatively poor enzymatic antioxidant defense. Recent research on vitamin C (ascorbic acid, or ascorbate) has pointed out novel mechanisms of its action such as that of neuromodulator in addition to its well-known antioxidant activity. In the current study, the author reviews the dose-dependent effects of ascorbate in intracellular signaling pathways of oxidative stress in epilepsy, focusing on its modulation of neuronal survival. The author also focuses on ascorbic acid deficiency and treatments in intracellular signaling pathways in the brain as well as in dietary requirements, and he discusses the effects of antiepileptic drugs on plasma ascorbate levels. The author concludes with a note on the putative protective role of vitamin C in the neurodegenerative process as well as in epileptic diseases.

Chapter XII - Physiological condition of Norway spruce (*Picea abies* (L.) Karst.) and consequently vitality of forest ecosystems was intensively studied in the period 1991 – 2007 in northern Slovenia, i.e., in an area influenced by the Šoštanj Thermal Power Plant (ŠTPP). ŠTPP, which is the largest Slovene thermal power plant, used to be the largest Slovene emission source of gaseous pollutants (e.g., SO<sub>2</sub>, NO<sub>x</sub>), and very important source of different inorganic (e.g., heavy metals) as well as organic toxic substances (e.g., PAHs). However, extremely high SO<sub>2</sub> emission (up to 86,000 t in 1993, and > 120.000 in the 1980s, respectively) and dust emissions (up to 8,000 in 1993), have been dramatically reduced after the installation of desulphurization devices in the late 1990s. Indeed in comparison with 1993, SO<sub>2</sub> emissions in 2007 were reduced more than 15-fold and dust emissions more than 35-fold, respectively. These extreme exposures in the past as well as huge changes in environmental pollution during the last two decades have significantly influenced the vitality of forest ecosystems including physiological conditions (e.g., contents of antioxidant) of different tree species in the study area. Therefore, vitamin C (ascorbic acid) as a sensitive, non-specific bioindicator of stress caused either by anthropogenic (e.g., air pollution) or natural stressors (climatic conditions, diseases, altitude gradient, etc.) was included in a permanent survey of forest conditions in northern Slovenia. Atmospheric pollutants such as ozone and sulphur dioxide cause formation of free radicals, which are involved in oxidation of proteins and lipids and injury of plant tissues. Plant cells have evolved a special



detoxification defence system to cope with radicals, including formation of water-soluble antioxidant, such as vitamin C. The most significant findings and conclusions of the present study are as follows: (a) Vitamin C is a good bioindicator of oxidative stress and an early-warning tool to detect changes in the metabolism of spruce needles, although the authors found untypical reaction of antioxidant defence in the case of extremely high SO<sub>2</sub> exposure. (b) Metabolic processes in spruce needles react to air pollution according to severity of pollution and the time of exposure. However, if spruce trees were exposed to high SO<sub>2</sub> ambient levels and/or for a long period of time, the antioxidant defence mechanism would be damaged and the content of vitamin C would not increase as expected. (c) Lower exposure to ambient pollution results in better vitality of trees (e.g., higher contents of total (a + b) chlorophyll), as well as in rising of their defence capabilities (higher contents of vitamin C). (d) Physiological condition of Norway spruce in northern Slovenia has significantly improved since 1995, when the desulphurization devices were built on the ŠTPP, and when emissions of SO<sub>2</sub> as well as heavy metals started dramatically and continuously decreasing in this part of Slovenia.

Chapter XIII - Different heavy metals, such as lead and mercury, are potential chemical contaminants contained in air, water and foods, particularly fish. Several studies have reported that these toxic metals may affect the vascular system. Chronic exposure to mercury and lead has been associated with numerous cardiovascular disorders such as hypertension, endothelial dysfunction and nephrotoxicity. Most of the deleterious effects of mercury and lead on the vascular wall have been attributed to their pro-oxidant properties. Vitamin C, due to its antioxidant properties, may play a protective role in the vascular damage induced by chronic exposure to mercury and lead. It has been described that vitamin C administration prevents the increase of mean arterial blood pressure, restoring the normal expression of endothelial nitric oxide synthase and soluble guanylate cyclase proteins in the vascular wall of lead-exposed rats. This protective role of vitamin C in endothelial functionality suggests that vitamin C supplementation may be beneficial for subjects submitted to chronic heavy metal exposure. This chapter will focus on analyzing the mechanisms of vascular damage induced by mercury and lead and the protective effect of vitamin C on molecular pathways involved in the vascular damage related to their chronic exposure.

Chapter XIV - Endothelial dysfunction (ED) plays a critical role in the development of cardiovascular complications preceding by decades their onset. Reversal of ED has been postulated to prevent atherosclerosis and several attempts have been done in this direction. Vitamin C has been suggested to reverse ED by several mechanisms: it serves as a potent antioxidant; it directly enhances the activity of nitric oxide synthase; the acyl CoA oxidase system and counteracts the action of proinflammatory lipids. Multiple data from experimental and clinical studies have proven protective effects of vitamin C on endothelium. Though, the therapeutic indication is limited by the low bioavailability following oral ascorbate administration and a rapid clearance. While oral, prophylactic approaches of treatment with vitamin C are difficult to implement, a large body of evidence proves the beneficial effects of parenteral administration in critically ill patients. Supraphysiologic levels of ascorbate may facilitate the restoration of vascular function in patients after severe burns and other major traumas. This translates clinically into reduced circulatory shock, fluid requirements and oedema. The effects on the microcirculation seem to be of particular interest since

microcirculation is very susceptible to oxidative stress that acts pathogenically to cause multiple organ failure. High-dose vitamin C administered parenterally counteracts endotoxin-induced ED and vasohyporeactivity in humans and reverses sepsis-induced alteration of the microcirculation in animals.

Mechanisms of ascorbate-mediated improvement of endothelial function, as well as the clinical and experimental evidence, along with actual treatment and dietary recommendations are briefly reviewed.

Chapter XV - *Background*: Chronic obstructive pulmonary disease (COPD) is a major cause of death and disability worldwide. Vitamin C has been suggested to protect the lungs from oxidative damage caused by cigarette smoking. *Objective*: To investigate and compare the quantity of vitamin C intake by COPD patients and controls in Japan. *Methods*: A case-control study was conducted in central Japan. A total of 278 eligible patients (244 men and 34 women), aged 50-75 years with COPD diagnosed within the past four years, were referred by respiratory physicians. During the same period, 340 age-matched controls (272 men and 68 women) were recruited from the community. All participants were screened for respiratory symptoms and underwent spirometric measurements of lung function. Information on dietary supplement usage and habitual food consumption was obtained by face-to-face interviews using a structured questionnaire. *Results*: The total daily dietary vitamin C intake by COPD patients (mean 137.86, SD 84.56 mg) was significantly lower than Japanese adults without the disease (mean 156.80, SD 112.54 mg),  $p = 0.021$ . The prevalence of vitamin C and multivitamin usage were similar between the two groups. It is alarming that 40% of COPD patients did not meet the government recommended level of 100 mg per day. *Conclusion*: Patients with COPD had substantially lower intake of vitamin C than the general population. The finding is important to clinical trials and experimental interventions advocating nutritional supplementation therapy for pulmonary rehabilitation.

Chapter XVI - Ascorbic acid or Vitamin C is essential for collagen formation and for its antioxidant property. It has anti-carcinogenic effects. Cancer is associated with increased cell growth, matrix metalloproteinases (MMPs), which degrade collagen, and transforming growth factor- $\beta$  (TGF- $\beta$ ) that facilitates angiogenesis. In the authors' laboratory, the lower concentrations of ascorbate significantly inhibit cancer cell viability while stimulating MMPs and TGF- $\beta$  expression, indicating elimination of cancer cells with damage to the extracellular matrix (ECM). Conversely, ascorbate at higher concentrations dramatically stimulates cell proliferation and inhibits MMPs and TGF- $\beta$ , implicating growth and ECM advantage. The goal for ascorbate's use in cancer therapy is the counteraction of the MMP-1 and TGF- $\beta$  stimulating effect of the growth inhibitory ascorbate concentration. It is feasible by specific gene silencing using MMP siRNA (small interfering RNA) or preferably by combination with micronutrients or plant extracts, such as *Polypodium leucotomos* (a fern), that have MMP and TGF- $\beta$  inhibitory effects.

Chapter XVII - Vitamin C (L-ascorbic acid) has a well-documented, strong anti-oxidant function, evident as its ability to scavenge reactive oxygen species (ROS) in cells and blood. Additionally, an anti-aging effect has been attributed to vitamin C stemming from its deletion of ROS; however, no scientific evidence has yet proven this assertion. Therefore, the authors manipulated mice to insert a gene deletion that disabled their ability to synthesize vitamin C. In these mice baited with small amounts of vitamin C, the authors could ascertain that aging

progressed faster than in their wild type counterparts. This report gives a full account of the relationship between vitamin C and the aging process while describing the authors' study results.

Expert Commentary - Consumer demand for safer and nutritious food products has led to development and research of new processing technologies. Throughout the centuries, vitamin C has played an important role in human nutrition due to its antioxidant effect and stimulation of the immunological system. Nevertheless, since the human organism does not produce its own vitamin C, it must be sourced from a regular diet or taken as a vitamin supplement. Besides its natural availability it is possible to find vitamin C in many different forms. The development of new food products formulations including vitamin C and new processing operations in order to retain vitamin content, are crucial for reaching out to consumers around the globe, fulfilling dairy requirements and health benefits and thus, in the near future, contributing to the reduction of nutritional deficiencies.



*Chapter I*

---

# **Impact of Vitamin C on Exercise-Induced Oxidative Stress and Tissue Injury**

---

*Kelsey H. Fisher-Wellman\* and Richard J. Bloomer<sup>+</sup>*

University of Memphis, Memphis, TN, USA

## **Abstract**

The 6-carbon lactone known as ascorbic acid (vitamin C) is a principal water soluble micronutrient within biological systems, where it serves as an electron donor for a variety of physiological processes. Vitamin C is perhaps best known for its role as the primary small molecule antioxidant within aqueous environments. Here it assists other enzymatic and nonenzymatic components of the antioxidant defense system in providing protection against free radical-mediated attack, in an effort to minimize oxidative stress. Simply stated, oxidative stress is a condition in which the production of free radicals exceeds antioxidant defenses, potentially leading to oxidative damage to small and large molecules. Oxidative stress is associated with human disease, as well as the aging process. Although multiple stimuli exist, the performance of acute exercise is one such condition in which the production of free radicals is exacerbated. This exercise-induced oxidative stress has commonly been viewed as a detriment to physical performance, as it is believed to interfere with force production capabilities during exercise, as well as accelerate muscle damage and delay recovery in the days following exercise. For this reason, coupled with the aforementioned association of oxidative stress with disease, numerous investigators have attempted to elucidate methods aimed at attenuating such a stress. One such method that has received considerable attention during the past several

---

\* Kelsey Fisher-Wellman Cardiorespiratory/Metabolic Laboratory The University of Memphis 161C Elma Neal Roane Fieldhouse Memphis, TN 38152 Phone:901-678-1547 Email: kfshrwll@memphis.edu.

<sup>+</sup> Richard J. Bloomer (Corresponding Author) Cardiorespiratory/Metabolic Laboratory The University of Memphis 161F Elma Neal Roane Fieldhouse Memphis, TN 38152 Phone: 901-678-4341 Fax: 901-678-3591 Email: rbloomer@memphis.edu Web: <http://memphis.edu/hss/crml>

years is the use of supplemental vitamin C (either alone or in combination with other antioxidant nutrients). Although some investigators have reported a reduction in oxidative stress following vitamin C intake, results are mixed, and controversy exists as to whether such attenuation is really desirable. That is, the consumption of additional vitamin C or other exogenous antioxidants, within otherwise healthy populations, may actually blunt the adaptive improvement in antioxidant defenses commonly observed with regular exercise training. This phenomenon is based on the principle of hormesis and suggests that exercise-induced free radical production may serve as the necessary “signal” for the induction/regulation of a wide variety of favorable adaptations. At the present time, it would appear that vitamin C supplementation likely possesses no additional benefits related to improved performance in otherwise healthy individuals engaged in regular exercise training who consume a quality diet containing adequate amount of fruits, vegetables, whole grains, and antioxidant-rich oils (fish, flax, olive). However, conditions whereby an individual is continuously exposed to a currently undefined critical level of excessive exercise (i.e., overtraining) may warrant supplementation with vitamin C. Clearly, more research is needed in order to further elucidate the point at which the detrimental effects of exercise begin to outweigh the positive benefits, and at which time intake of supplemental vitamin C may be recommended.

## Introduction

Ascorbic acid (Vitamin C) is a water-soluble micronutrient required for a multitude of biological functions, and is perhaps best known for its role as a terminal small-molecule antioxidant [1]. At physiological pH, ascorbic acid most commonly exists in its mono-anion form, ascorbate [1]. Synthesis of vitamin C (a 6-carbon lactone) from glucose occurs in the liver of many mammalian species; however, both guinea pigs and primates (e.g., humans) lack the terminal enzyme in this biosynthetic pathway (L-gulonolactone oxidase), and thus rely on dietary sources [2].

Exogenous consumption of vitamin C, as well as several other antioxidants, comes primarily from the ingestion of fruits and vegetables [3]. Food sources high in vitamin C include citrus fruits (oranges, lemons, limes, grapefruit), papayas, mangos, kiwis, strawberries, tomatoes, spinach, broccoli, peppers (red, yellow and orange), and asparagus. Additional vitamin C is often consumed in the form of a dietary supplement. In fact, research indicates that vitamin C is the most commonly supplemented micronutrient in the United States, with typical dosages ranging from 60-1000mg/day [4]. The popularity of vitamin C supplementation is likely a consequence of its purported health/performance enhancing effects, coupled with its low toxicity even at very high dosages (2-4 grams/day) [4]. The lack of toxicity likely results from an increase in urinary excretion, coupled with a decrease in bioavailability for vitamin C, as dosing is increased.

Once ingested, vitamin C is readily taken up by enterocytes lining the intestinal epithelium and subsequently released into portal circulation, with the majority rapidly being absorbed into peripheral tissues [5]. Almost all tissues, with the exception of red blood cells, absorb and concentrate vitamin C, with tissue levels being approximately 5-100 fold higher than that of the plasma [typical plasma concentrations range from 45-50  $\mu\text{mol}\cdot\text{L}^{-1}$ ] [5].

Intracellular incorporation of vitamin C is carried out by way of one of two known sodium-dependent transporters, termed SVCT 1 and 2 (sodium-dependent vitamin C transporters 1 and 2) [5]. In addition to direct uptake of vitamin C, dehydroascorbic acid (DHA) [the oxidized form of vitamin C] can also be transported intracellularly via several facilitated glucose transporters (GLUT 1, 3, and 4), where it is then immediately reduced back to vitamin C, through the action of reduced glutathione or other unidentified DHA reductase enzymes [5]. This process is referred to as “ascorbate recycling” and may explain how vitamin C is able to accumulate at such high concentrations in most tissues, as the rapid reduction of DHA to vitamin C following transport would serve to maintain the concentration gradient needed for facilitated diffusion of DHA intracellularly [2].

The known biochemical and molecular functions of vitamin C are accounted for by its role as a reducing agent (i.e., electron donor), as two electrons from the double bonds at C-2 and C-3 are available for donation [5]. The oxidation of vitamin C results in the formation of DHA, with the ascorbyl radical (AFR) being formed as an intermediate [1]. The formation of AFR is a consequence of the sequential loss of electrons from vitamin C; however, AFR has a short half-life, is relatively stable, does not react well with other compounds, and can be reversibly reduced back to vitamin C via the cytosolic enzyme thioredoxin reductase or other unidentified AFR reductase enzymes [6]. These properties make vitamin C a potentially ideal electron donor.

In fact, vitamin C serves as an electron donor for eight mammalian enzymes, including those necessary for the synthesis of both carnitine and collagen [1]. Deficiency of vitamin C (either dietary or synthetic) generates defects in the post-translational modification of both carnitine and collagen, resulting in a reduction in fat oxidation [7], as well as the development of the potentially fatal condition known as scurvy [8]. The conversion of the neurotransmitter dopamine to norepinephrine, peptide amidation and tyrosine metabolism are also dependent upon adequate availability of vitamin C [1]. Additionally, vitamin C is involved in the production of the powerful vasodilator nitric oxide, as it serves to maintain the key cofactor (tetrahydrobiopterin) for the enzyme nitric oxide synthase (NOS) in the reduced form [1]. Aside from the multitude of above benefits offered by vitamin C, it is likely best known for its role as the major antioxidant in aqueous environments [9].

Related to its role as an antioxidant, vitamin C is regarded as an ideal free radical scavenger acting within the plasma [2], where it serves to quench aqueous peroxy radicals, oxidants leaking from activated neutrophils and macrophages, as well as other lipid peroxidation products [10,11]. Additionally, vitamin C is easily accessible (multiple food sources and over the counter supplements) and appears to possess high bioavailability. The mechanism described above for intestinal absorption and release into circulation also takes place within tissues, thus providing the ability for vitamin C to compartmentalize and/or translocate to specific sites of attack by reactive oxygen and nitrogen species (RONS), also commonly referred to as “prooxidants” or “free radicals”. This is illustrated by the mobilization of vitamin C and subsequent increased release into circulation to combat the increased production of RONS in response to an acute exercise stimulus [2].

In the presence of RONS, vitamin C is readily oxidized to DHA; however, the preference of vitamin C to donate its electrons in a sequential manner results in the concomitant formation of the AFR. Although by definition the AFR is in fact a free radical, its reactivity

and thus potential to damage the surrounding tissues are relatively minor in comparison to other radicals [1]. In essence, biological systems appear to favor the formation of AFR (albeit a radical species) at the expense of other, more harmful radicals (e.g., alkoxy and hydroxyl radical). Moreover, both the AFR and DHA are capable of being recycled back into vitamin C by way of thiodoxin reductase or other currently unidentified enzymes (AFR-reductase, DHA-reductase) [2]. Lastly, as mentioned earlier, the toxicity of vitamin C is quite low, as even high doses appear well tolerated [4].

Clearly vitamin C is an effective antioxidant within biological systems; however, its ability to also reduce catalytic metals such as iron and copper ( $\text{Fe}^{3+}$  and  $\text{Cu}^{2+}$  to  $\text{Fe}^{2+}$  and  $\text{Cu}^{1+}$ ) has led some to speculate that vitamin C might also possess prooxidant properties *in vivo* [1]. Mixtures of vitamin C with copper or iron have been used for decades to induce *in vitro* oxidative modifications of lipids, proteins and DNA [1]. In the presence of transition metals, hydrogen peroxide is rapidly converted to the harmful hydroxyl radical (via the Fenton reaction), which is capable of promoting extensive oxidative damage to virtually every biomolecule known [12]. However, considerable controversy exists as to whether this mechanism is relevant *in vivo* [13,14], as the body possesses an efficient capability to sequester such metals via the presence of an extensive concentration of metal binding proteins such as ferritin and transferrin [15]. In fact, transferrin iron-binding capacity in plasma is three times greater than the amount of iron needing to be transported [15]. Binding of transition metals to their respective transport protein inhibits their ability to initiate lipid peroxidation, inhibit certain antioxidants, or lead to the formation of hydroxyl radical [15].

In accordance with the “crossover” effect, prooxidant/antioxidant status is primarily mediated by the concentration and form of catalytic metals present, with low concentrations of vitamin C being required for pro-oxidant conditions, whereas high concentrations appear to result in antioxidant effects [9]. In the presence of vitamin C, catalytic metals will initiate radical chain reactions [16]; however, the extent of radicals formed and damage done is contingent upon the concentration of vitamin C [9]. As the vitamin C concentration is lowered, the initiation processes are slowed to an extent, but more importantly, the rate of the antioxidant reactions of vitamin C are also slowed; thus the radical chain length will be longer and more oxidative damage will occur (albeit at a slower rate) [9]. In opposition, high concentrations of vitamin C in the presence of catalytic metals will indeed result in rapid induction of radical formation; however, the excess availability of vitamin C will concomitantly terminate this process, thus preventing extensive further RONS production and oxidative damage.

Taken together, with low levels of catalytic metals, vitamin C will almost always serve as an antioxidant. However, under conditions in which excess availability of transition metals are present (such as the performance of muscle damaging exercise or the presence of certain diseased conditions), excess vitamin C may be problematic and thus contraindicated [9], as is the case in individuals suffering from thalassaemia or haemochromatosis (pathological conditions associated with iron overload) [16]

Related to the effects of supplementation on disease, vitamin C has been shown to decrease lipid peroxidation, as well as protect extracellular low density lipoprotein from metal catalyzed oxidation [10,11] when the concentration of vitamin C is greater than 40  $\mu\text{mol/L}$  [11]. For these reasons, coupled with the aforementioned role of vitamin C in



promoting nitric oxide production, vitamin C has been suggested to protect against atherosclerosis; however, evidence for an effect of supplementation is not conclusive at this time [17-19]. Although supplementation has not proven beneficial in terms of significantly affecting certain disease/health related dependent measures, long term deficiency of vitamin C does appear to increase an individual's risk for cardiovascular disease [20]

Aside from the potential health benefits of vitamin C, it has been widely used by exercise enthusiasts in an effort to attenuate exercise-induced oxidative stress and muscle damage, thereby delaying the onset of fatigue, accelerating the recovery process and ultimately improving performance [21,22]. However, similar to the lack of evidence pertaining to the ability of vitamin C supplementation to retard the development of atherosclerosis, clear evidence for an ergogenic and/or health benefit of vitamin C usage during acute and/or chronic exercise remains a topic of debate. Although, as is the case with disease risk, a diet that is deficient in vitamin C has indeed been shown to result in exacerbated oxidative stress in response to acute aerobic exercise [23].

This chapter is intended to address the efficacy of vitamin C supplementation in attenuating exercise-induced oxidative stress and muscle injury, as well as to provide a brief discussion as to whether such attenuation would promote favorable outcomes on performance and/or overall health. It begins with a general discussion of oxidative stress, its association with human disease and physical performance, mechanisms for radical production *in vivo* (both non-exercise and exercise conditions), specific cellular damage induced by such radicals, the detection of radical species and common biomarkers of oxidative stress and tissue injury, as well as information detailing methods utilized to attenuate oxidative stress. Next is a section highlighting the current research findings pertaining to the ability of vitamin C supplementation to attenuate exercise-induced oxidative stress and tissue injury (in both humans and animals, performing both aerobic and anaerobic exercise), followed by a discussion on the potential consequences of antioxidant supplementation on enhancing and/or attenuating favorable adaptations to chronic exercise. The final section will include a summary of the results, as well as provide suggestions for future research within the area.

## Overview of Oxidative Stress

A free radical is any species capable of existence, containing one or more unpaired electrons [15]. This unpaired electron is thus "free" to react with adjacent molecules in an effort to achieve stability, effectively modifying the function/structure of the once nonradical species, potentially resulting in a chain reaction sequence of radical formation. Although a multitude of free radicals exist [hydrogen atoms, transition metal ions, carbon centered radicals (e.g., trichloromethyl), sulfur centered radicals (e.g., thiy1)] [15], those formed within living systems are primarily initiated by the consumption of molecular oxygen. Moreover, both oxygen and nitrogen centered radicals, as well as the nonradical species created via interaction with such radicals are collectively referred to as RONS, and regarded as the most important class of radicals generated in biological systems [24]. The body's antioxidant defense system serves to protect the cells from excess RONS production and is comprised of both enzymatic (superoxide dismutases, catalase, glutathione peroxidase, etc.) and

nonenzymatic (bilirubin, uric acid) endogenous compounds, as well as exogenous nutrients consumed within the diet (carotenoids, tocopherols, vitamin C, bioflavonoids, etc.) [21].

The production or formation of RONS *in vivo* and their subsequent removal via the antioxidant defense system is a continuous and delicately balanced process present within living systems, in turn eliciting both positive and negative effects on physiological function. This delicate balance (RONS production vs. antioxidant defense) serves to determine the intracellular redox state [25], which plays a role in optimizing cellular function (initiating cell signaling, aiding antibacterial immune responses and apoptosis), as well as gene expression [26]. However, disruption of redox balance in favor of free radical expression, resulting from either exacerbated RONS production and/or decreased antioxidant defenses, is referred to as “oxidative stress”. This oxidative stress occurs secondary to the exposure to certain environmental (radiation, cigarette smoke, ozone) and/or physiological (consumption of dietary nutrients, physical exercise) stressors [27]. Overexpression of RONS can then result in oxidative damage to various biological components, including nucleic acids, lipids and proteins, which over time has the potential to contribute to the development of disease [28].

### Associations with Health and Disease

It is clear that a basal level of RONS production and removal is constantly occurring, in turn eliciting both positive and negative effects on physiological function. Recall from above that the intracellular redox state and/or redox balance is representative of the oxidation/reduction potential present within the cell. This is tightly regulated, similar to that of pH, and is commonly assessed via the ratio between reduced (GSH) and oxidized (GSSG) glutathione (the major non-enzymatic antioxidant) or other thiol/disulfide compounds [24]. Mammalian cells are endowed with signaling pathways that are sensitive to the intracellular redox environment and can thus be activated by oxidative stress [29]. Thus, transient disturbances in redox balance, causing a shift towards a more oxidizing environment, can occur via increased RONS production and/or decreased antioxidant defense and appear to serve as a stimulus for the activation of several cell signaling mechanisms important for optimal physiological function [26]. Examples of specific redox-sensitive regulated functions include; regulation of vascular tone [30], amplification of immune responses and apoptosis [31,32], modulation of insulin receptor kinase activity [33], and increased expression of antioxidant enzymes and/or glutathione in response to MAPK and NF- $\kappa$ B activation in an effort to restore redox balance [29]. The latter example is particularly applicable to exercise, as an increase in RONS during and following acute exercise is believed to serve as the necessary “signal” for the hormetic-associated upregulation in antioxidant defense and associated redox shift (favoring more reducing conditions) commonly observed with chronic exercise training [29].

In general, a more reducing environment is consistent with optimal physiological function and health enhancement, while chronic dysregulation of such balance in favor of a more oxidizing environment is associated with the development of numerous diseased states, in addition to the aging process [34]. Therefore, conditions that favor accelerated and/or chronic production of RONS may serve to overwhelm the capacity of the antioxidant defense

system in place, thereby disrupting normal redox-sensitive signaling and causing a permanent shift in redox balance [26]. Moreover, this permanent shift in the redox environment could then induce damaging effects via direct RONS-mediated oxidative damage to nucleic acids, lipids and proteins [28], as well as through changes in gene expression that promote apoptosis within healthy cells, in addition to systemic inflammation [34].

Both moderate and excessive shifts in redox potential, resulting from chronic oxidative stress, have been suggested to play a role in the functional decline commonly observed with aging, as well as in the pathophysiology of several diseased states [26,34]. In fact, oxidative stress has been suggested to play a primary or secondary role in the development of multiple (>100) acute and chronic human diseases [28] including, but not limited to cardiovascular [atherosclerosis, heart failure [35]], neurodegenerative [multiple sclerosis [36] Parkinson's [37]], inflammatory [rheumatoid arthritis] [38], metabolic [diabetes, obesity] [24], and cancerous [39] diseases.

To summarize, RONS are not inherently harmful; however, in response to chronic exposure to excessive production of RONS, the system can become unbalanced (free radicals>defenses). This may result in a shift in the intracellular redox balance towards a more oxidizing environment, in turn promoting oxidative damage, inflammation, ill-health, and disease.

### Associations with Physical Performance and Tissue Injury

Similar to the discussion above, a currently undefined optimal level of RONS production appears to enhance physical performance, whereas RONS production above and beyond this criterion point appears to decrease performance, as well as promote primary and/or secondary skeletal muscle fatigue and muscle injury. In nonfatigued muscle, exposure to low levels of RONS results in increased force production [2,40,41], while higher concentrations appear to decrease force [40,42]. The former is believed to result from an increase in the release of calcium from the sarcoplasmic reticulum [43,44], as well as enhanced calcium sensitivity within the myofilaments (i.e., leftward shift of the force-calcium relationship) following RONS production [40]. With respect to the latter, deleterious effects are believed to result from RONS-mediated oxidative damage to various contractile, structural and enzymatic components of the activated musculature incurred both during the bout itself, as well in the days following exercise (i.e., recovery period) [45-47].

Recall from above that conditions in which the production of RONS exceed the protective capabilities of the antioxidant defense system (i.e., oxidative stress) can result in oxidative damage to various cellular components (e.g., proteins, lipid, DNA). With respect to acute physical exercise, oxidative damage to myosin thiol groups [48] and other enzymatic proteins would be expected to interfere both with excitation-contraction coupling as well as decrease the rate of contractility [49]. Further impairments in contractility can result from both an increase or decrease in the availability and reuptake of calcium within the sarcoplasmic reticulum, secondary to the oxidation of ryanidine receptors [50], and adenosine triphosphatase pumps [51], respectively. Moreover, because sustainment of muscular contraction is contingent upon adequate regeneration of adenosine triphosphate (ATP),

oxidative damage to various mitochondrial enzymes involved in energy (i.e., ATP) production would also be expected to impair performance [52].

The information in the preceding section is particularly relevant to RONS-mediated damage within the exercise bout itself and represents a potential primary role for RONS in effecting performance. Additionally, secondary production of RONS during the recovery period has been suggested to result in further oxidative stress and tissue injury following the performance of muscle damaging exercise (i.e., protocols involving long duration and or eccentric exercise) [53]. In this respect, initial mechanical trauma/injury imposed upon the musculature during exercise results in the initiation of an inflammatory response, subsequently leading to an increase in inflammatory cytokines and influx of phagocytic cells and neutrophils to the affected area [47]. These phagocytic cells promote secondary RONS generation via respiratory burst activity [53]. Moreover, this increased circulation of inflammatory cytokines and production of RONS may further promote oxidative stress and contribute to delayed muscle injury [54,55], as invading neutrophils have been shown to play a role in both the muscle injury [56] and oxidative damage [57] induced following eccentric contractions.

It should be understood that while the above discussion certainly makes sound scientific sense, direct evidence for RONS actually “causing” decrements in performance is somewhat lacking in humans. None the less, because numerous investigators have reported increases in various oxidative stress biomarkers following acute exercise, coupled with their association with reduced performance, exercise-induced RONS have historically been viewed as detrimental by-products of muscle contraction that should be prevented and/or attenuated in an effort to enhance performance and/or recovery from demanding exercise. For this reason, several researchers have attempted to elucidate methods designed to attenuate such a stress with the use of various antioxidant supplements, pharmacological, or nutritional interventions.

In opposition to this notion, an ever-increasing body of literature is now available in which it is suggested that RONS produced during exercise actually exist as a necessary “signal” for the initiation and/or propagation of several beneficial adaptations to exercise [29,47,58]. Moreover, with respect to muscle damaging exercise, the secondary production of RONS as a component of the inflammatory response may actually assist in degrading damaged tissue, thereby accelerating muscle regeneration and recovery following exercise [59]. Clearly, more research is needed within the area, incorporating both oxidative stress and performance measures within the same study design, in order to provide a more clear understanding of the role of RONS in skeletal muscle function and adaptations to exercise.

## **Formation of RONS: Non-Exercise Conditions**

Free radicals are produced by a variety of mechanisms in biological systems, however all reactions involve either the initial reduction (addition) or oxidation (removal) of an electron via enzymatic or nonenzymatic action [12]. In short, radical species are simply a consequence of chemical reactions occurring within the body. Moreover, RONS are produced as a result of normal cellular metabolism and consist of a variety of both radical (e.g., superoxide, hydroxyl radical, nitrogen monoxide) and nonradical (e.g., hydrogen

peroxide, peroxyxynitrite) species all with various physiological functions and/or consequences [24].

Superoxide radical is the one electron reduction of molecular oxygen and is produced as a byproduct of normal cellular metabolism [59]. As oxygen undergoes a series of one-electron reductions with cytochrome c oxidase in complex IV of the mitochondrial electron transport chain, superoxide radical, hydrogen peroxide, hydroxyl radical and finally, water, are produced [59]. This is due to the preference of molecular oxygen to accept its electrons one at a time [12]. Although the reduction of oxygen is a very efficient process, it seems that some of the electrons transferred may “leak” to oxygen prematurely, resulting in the production of superoxide [24]. The process of energy production via oxidative phosphorylation and subsequent formation (“leakage”) of superoxide intracellularly is a constant process. It is believed that approximately 1-3% of all electrons in the transport chain may “leak” to generate superoxide, rather than contributing to the reduction of oxygen to water [24]. As such, it could be inferred that any situation that results in increased transfer of electrons through the electron transport chain could potentially result in increased formation of superoxide anion, resulting in an acute state of oxidative stress. One situation in which electron transfer is increased includes the performance of physical exercise. This issue is addressed in detail in a later section.

Superoxide can also be produced enzymatically by way of several oxidase enzymes, such as xanthine oxidase or NAD(P)H oxidase. Xanthine oxidase generates superoxide, primarily in response to conditions of ischemia followed by reperfusion, by catalyzing the oxidation of hypoxanthine to xanthine and xanthine to uric acid [60]. Intentional production of superoxide also occurs as a component of the respiratory burst (accelerated oxygen uptake) of phagocytic cells, such as neutrophils, macrophages, and lymphocytes [12]. This mechanism serves to protect the body against invading bacteria and is mediated by the enzyme NAD(P)H oxidase, which is present in the plasma membrane of these cells [59]. This protective mechanism can become problematic however, if phagocytic cells become activated in the wrong location or to excessive extents, thus releasing excess superoxide radical and potentially resulting in cellular damage or disease progression [12].

In either case, superoxide, arising either metabolically or during respiratory burst, is considered to be the “primary” RONS produced in biological systems, which can then interact with other molecules to form “secondary” RONS via enzyme or metal catalyzed processes [24]. In fact, most of the damage caused by superoxide is done by initiating secondary sources of RONS formation, as well as by acting as a potent proinflammatory and proatherogenic signaler [61]. Superoxide can combine with nitric oxide to form the harmful radical species, peroxyxynitrite, which is a long-lived oxidant with the potential to damage DNA [62], as well as lead to the formation of hydroxyl radical [27]. Moreover, the dismutation of superoxide and subsequent formation of hydrogen peroxide may also lay the foundation for the formation of a much more reactive and harmful radical (hydroxyl radical) via the Fenton reaction, further demonstrating the primary role of superoxide formation in initiating a series of downstream reactions that result in secondary RONS production and cellular damage [27].

## Formation of RONS: Exercise Conditions

The two primary radicals produced during exercising conditions are the superoxide radical and nitric oxide (NO·) [47]. Multiple potential sites exist for such formation and include both primary sources in which RONS are generated in direct response to a given condition, as well as secondary sources in which RONS production may occur in response to muscle damage induced through other mechanisms (e.g., high force eccentric muscle actions).

### Primary Sources

Similar to resting conditions, it is commonly believed that RONS produced during exercise is partially due to an increased leakage of electrons and subsequent production of superoxide from the mitochondrial electron transport chain [53]. However, controversy exists as to whether this mechanism is relevant during exercising conditions, as the mitochondria would be expected to be undergoing state 3 respiration [active phosphorylation of adenosine diphosphate (ADP)] [63]. Mitochondrial superoxide production appears contingent upon the reducing potential present within the inner mitochondrial membrane [assessed via the ratio of reduced to oxidized nicotinamide adenine dinucleotide (NADH/NAD) or flavin adenine dinucleotide (FADH<sub>2</sub>/FAD)], as well as the ratio of ATP/ADP [64,65]. Because both the NADH/NAD and ATP/ADP ratios would be expected to be decreased during exercise due to accelerated electron transfer and rapid ATP regeneration, electron leakage from the electron transport chain would be expected to be minimal [63]. However, mitochondrial superoxide production has in fact been shown to occur during conditions of state 3 respiration (albeit to a lesser extent than what was originally hypothesized) and appears to result from electron “leakage” at complex I of the electron transport chain [66]. Moreover, mitochondrial superoxide production has also been shown to occur as a function of increasing temperature (i.e., heat stress) during exercise [67]. This heat stress is believed to promote the instability of ubisemiquinone species bound to Q binding proteins within the electron transport chain, ultimately promoting mitochondrial uncoupling and accelerated electron “leakage” [53]. In addition to superoxide, mitochondria also have been shown to produce NO·, which in the presence of superoxide, rapidly leads to the formation of the harmful radical peroxynitrite [68].

Aside from direct production by the mitochondria, superoxide is also generated by way of certain radical generating enzymes, including xanthine oxidase and NADPH oxidase, with the latter being involved in both primary and secondary generating conditions. Periods of intense exercise can result in a transient ischemic state within certain regions of the body, which then triggers the production of hypoxanthine from ATP and the conversion of xanthine dehydrogenase to xanthine oxidase by cysteine residue modification and/or partial proteolysis [69]. Xanthine oxidase is capable of the direct production of both superoxide and hydrogen peroxide [53]. Superoxide generation also can occur via NADPH oxidase associated with the plasma membrane [70], sarcoplasmic reticulum [71], or triads and transverse tubules [72] of skeletal muscle.

## Secondary Sources

In addition to the primary production of RONS discussed above, in cases of exhaustive, eccentric, or prolonged exercise, secondary RONS generation can occur by way of increased migration of neutrophils and other phagocytic cells as a component of the immune response following tissue injury [53]. This phenomenon is referred to as respiratory burst and is primarily mediated by NADPH oxidase bound to the plasma membrane of invading phagocytic cells. In this respect, the reduction of oxygen to form the superoxide radical is catalyzed by oxidizing the reduced form of nicotinamide adenine dinucleotide phosphate (NADPH), resulting in the formation of  $\text{NADP}^+$  [59].

Recall from above that the production of hydroxyl radical is favored in the presence of free transition metals (e.g., iron, copper). For this reason, the body possesses extensive metal sequestering proteins in an effort to prevent the deleterious effects of their unbound (i.e., “free”) circulation [12]. However, mechanical trauma and/or acidosis induced during intense exercise can result in the destruction of iron containing proteins (e.g., erythrocytes, myoglobin), as well as the release of iron from transferrin, in turn promoting the formation of RONS via metal catalyzed reactions [73].

In the above ways, acute exercise possesses the ability to serve as a powerful RONS generating stimulus. This increased production of RONS may occur from either the increased consumption of oxygen, as well as from a multitude of other primary or secondary mechanisms. At present, increased RONS production appears to occur in response to both aerobic and anaerobic exercise; however the precise source of generation remains to be completely elucidated. It is likely that the increase in RONS observed during and following exercise results from a combination of the above pathways, which all collectively result in the increased presence of oxidized biomolecules.

## Specific Cellular Damage Induced via RONS

Reactive oxygen/nitrogen species can react with lipids, proteins, and DNA to produce stable biomarkers, which can then be measured and analyzed to yield an indication of the overall oxidative stress experienced by the system. Precise cellular damage resulting from RONS is related specifically to which macromolecules are being targeted by the oxidants, the frequency and duration of attack, as well as the tissue specific antioxidant defenses present.

### Methods of Assessing RONS Formation and Tissue Injury

Due to the high reactivity and relatively short half lives of radical species (e.g.,  $10^{-5}$ ,  $10^{-9}$  seconds for superoxide radical and hydroxyl radical, respectively), direct measurement is extremely difficult to employ. However, direct assessment of free radical production is possible via electron spin resonance spectroscopy (ESR) involving spin traps, as well as two other less common techniques such as radiolysis and laser flash photolysis [74]. ESR works by recording the energy changes that occur as unpaired electrons align in response to a

magnetic field [27]. Due to the high cost of such equipment and the high degree of labor associated with each direct method, the majority of free radical research related to exercise has utilized indirect methods, rather than direct methods, for the assessment of resultant oxidative stress.

Indirect assessment of oxidative stress involves the measurement of the more stable molecular products formed via the reaction of radical species with certain biomolecules. Using indirect measurement techniques, free radical production is inferred based on the quantification of specific compounds of oxidatively modified biological molecules and/or a decrease in the antioxidant defense system. A variety of analysis procedures have been used [75], ranging from simple spectrophotometric assays to more complex assays using gas chromatography-mass spectroscopy (GC-MS) and high performance liquid chromatography (HPLC) coupled with electrochemical or chemiluminescence detection. The various techniques can be used in analyzing various body fluids (i.e., blood, urine), as well as muscle and organ tissue. Blood and urine are most commonly used for analysis in the majority of oxidative stress research utilizing human subjects.

## Common Biomarkers of Oxidative Stress

### *Lipids*

Several methods exist for assessing lipid peroxidation, including measurement of the susceptibility of certain isolated lipid fragments in bodily fluids (typically low density lipoprotein (LDL) cholesterol) to oxidation *in vitro*, as well as *in vivo* measurements of certain oxidation products of lipid peroxidation. These end products include conjugated dienes, lipid hydroperoxides (LOOH), and malondialdehyde (MDA; a major aldehyde produced during decomposition of a lipid hydroperoxide). Additionally, thiobarbituric acid reactive substances (TBARS) is an assay used to measure aldehyde products (primarily MDA) formed via decomposition of lipid hydroperoxides. However, the TBARS assay lacks specificity, for in addition to aldehydes, TBA also can react with several other biological molecules (such as carbohydrates, sialic acid, or protoglandins), thus interfering with the assay [76]. Certain hydrocarbons, such as pentane and ethane can also be measured via breath analysis, as an index of lipid peroxidation, as they are produced during peroxidation of polyunsaturated fatty acids. Finally, measurement of F<sub>2</sub>-isoprostanes, a prostaglandin-like compound generated *in vivo* by non-enzymatic peroxidation of arachidonic acid (an omega-6 fatty acid present in the phospholipids of cell membranes), is regarded as the most reliable approach for the assessment of free radical mediated lipid peroxidation [28]. F<sub>2</sub>-isoprostanes can be measured using high performance liquid chromatography (HPLC), HPLC-chemiluminescence (HPLC-CL), gas chromatography-mass spectrometry (GC-MS), and enzyme linked immunosorbent techniques.



## Protein

Proteins are major targets for RONS because of their high overall abundance in biological systems and it has been estimated that proteins interact with the majority (50-75%) of radical species generated [77]. Oxidative damage to proteins can occur directly by interaction of the protein with a radical species or indirectly by interaction of the protein with a secondary product (resulting from interaction of radical with lipid or sugar molecule) [28]. Modifications of a proteins under conditions of oxidative stress can occur via peptide backbone cleavage, cross-linking, and/or modification of the side chain of virtually every amino acid. Moreover, most protein damage is irreparable and oxidative modification of the protein structure can lead to loss of enzymatic, contractile, or structural function in the affected proteins, thus making them increasingly susceptible to proteolytic degradation [78]. The formation and accumulation of protein carbonyls (PC) is one of the most commonly used methods for assessing overall protein oxidation.

## DNA

Potential oxidative damage to DNA by free radicals can occur in a variety of ways, including: modification of all bases, production of base-free sites, base deletions, frame shifts, strand breaks, DNA-protein cross-links, and chromosomal rearrangement [79]. Hydroxyl radical is considered one of the primary radicals involved in DNA damage, as it possesses the ability to react with all components of the DNA molecule. This formation of hydroxyl radical in close proximity to the DNA molecule, likely occurs via the Fenton reaction, as hydrogen peroxide (produced via the dismutation of superoxide) passes through the nuclear membrane and comes into contact with transition metals (likely copper bound to DNA chromosomes), thus generating the highly reactive hydroxyl radical [80].

DNA subjected to attack by radical species results in the formation of a variety of base and sugar modification products. The presence of these modified products is used to indicate oxidative stress, as they are not present during normal nucleotide metabolism. These products can be measured via HPLC, HPLC-CL, GC-MS, and antibody-based techniques [79]. Typically the product, 8-hydroxy-2-deoxyguanosine (8-OHdG) is measured as an index of oxidative damage to DNA. Levels of 8-OHdG can be assessed in muscle and organ tissue, as well as in serum, urine and isolated leukocytes. 8-OHdG has been shown to induce mutation, is found frequently in tumor-related genes, and has been correlated to the incidence of some cancers [81].

## Antioxidant Capacity

The body's antioxidant capacity (AOC) serves to protect the cells from excess RONS production. The AOC is comprised of both endogenous (bilirubin, uric acid, superoxide dismutases, catalase, glutathione peroxidase etc.) and exogenous (carotenoids, tocopherols, vitamin C, bioflavonoids, etc.) compounds [21]. In response to conditions of oxidative stress

the AOC may be temporarily decreased, as its components are used to quench the harmful radicals produced. Thus measurement of the body's antioxidant capacity is utilized as a marker of oxidative stress. Numerous antioxidant capacity assays exist and include: Trolox Equivalent Antioxidant Capacity (TEAC), Ferric Reducing Ability of Plasma (FRAP), Total Radical-Trapping Antioxidant Parameter (TRAP), and Oxygen Radical Absorbance Capacity (ORAC). In addition to measurement of the AOC, assessment of changes in specific antioxidant enzymes [e.g., superoxide dismutase (SOD), glutathione peroxidase (GPx), catalase (CAT), glutathione reductase (GR)] can be assayed and used to indicate the presence of an oxidant stress.

Besides the markers listed above, oxidative stress can also be assessed by measuring a variety of other miscellaneous markers. These include circulating levels of hydrogen peroxide (a byproduct of superoxide production), nitrite/nitrate (used to assess NO•), specific radical generating enzymes such as xanthine oxidase or NADPH oxidase, and specific antioxidants (e.g., vitamin E, vitamin C). Moreover, redox changes in glutathione (the major non-enzymatic endogenous antioxidant) can also be measured as a representation of oxidative stress.

### Common Markers of Tissue Injury

In those studies investigating the effects of exercise-induced muscle damage, quantification of injury has been carried out by a variety of direct and indirect indices. Direct methods have included cytoskeleton disruption (e.g., loss of structural protein, Z-disk streaming) and/or magnetic resonance imaging of the affected muscle. Indirect assessment has included both functional and biochemical measures. Functional measures include muscle force production and range of motion (ROM), both of which are typically decreased following a muscle injury protocol. In addition, although not precisely a functional measure, but rather a subjective assessment that may impact function, the measure of delayed onset muscle soreness (DOMS) is routinely included in such research designs. With extensive muscle injury, DOMS is typically increased. Common biochemical measures include urinary markers of protein degradation (3-methylhistidine), markers of muscle cell membrane disruption [creatine kinase (CK), lactate dehydrogenase (LDH), myoglobin (MYO)], and markers of inflammation [C-reactive protein (CRP), interleukin-6 (IL-6) and other cytokines, cortisol, etc.] [54]. Among the most commonly utilized indices of muscle injury, DOMS and CK appear to peak ~48-72 hours post exercise and may remain significantly elevated for 7-10 days, with the time course being largely dependent on the training status of the test subjects [54].

## **Protective Mechanisms Against RONS**

As was discussed above, the body possesses its own antioxidant defense system that is primarily responsible for eliminating or reducing the harmful effects that can occur via prooxidant species. In addition to the body's endogenous defense system, various

antioxidant consumed in foods and as dietary supplements, as well as other pharmacological agents, have been shown to aid in the attenuation of oxidative stress under various conditions (i.e., at rest, exercise-induced). Moreover, as an adaptation to regular exercise training (both aerobic and anaerobic) an upregulation in the body's endogenous antioxidant defenses has been reported [82], evident by an attenuated oxidative stress response during and following exercise, as well as lower resting values in trained compared to untrained individuals [83,84].

## Antioxidant Defense System

An antioxidant can be defined as any substance that, when present at low concentrations compared with those of an oxidizable substrate (protein, lipid, carbohydrates, DNA), significantly delays or prevents oxidation of that substrate [15]. The body's antioxidant defense system consists of a variety of enzymatic and non-enzymatic antioxidants, arranged in a balanced and coordinated system to aid in the prevention or attenuation of oxidative stress. The attenuation of oxidative stress refers to the ability of the antioxidant defense system to render radical species inactive or to reduce their impact upon RONS generation. The enzymes SOD, GPx, GR, CAT, as well as non-enzymatic endogenous and exogenous antioxidants function together in an elaborate fashion to provide protection *in vivo*.

With respect to enzymatic action, SOD is responsible for the dismutation of the superoxide radical into hydrogen peroxide and oxygen. Three forms of SOD exist, containing manganese (Mn-SOD), copper (Cu-SOD), and Zinc (Zn-SOD) at their active site and are present in both the cytosol (Cu, Zn-SOD) and mitochondria (Mn-SOD). The hydrogen peroxide produced can then be removed by way of CAT or GPx. Glutathione peroxidase function to remove hydrogen peroxide by oxidizing the reduced form of glutathione (GSH) into oxidized glutathione (GSSG). Glutathione reductase then functions to reduce GSSG back to GSH, utilizing NADPH as a source of reducing power. Moreover, GPx has a higher affinity for hydrogen peroxide than CAT, thus glutathione peroxidase represents the primary defender against hydrogen peroxide, where as CAT provides assistance in times of excessive oxidative stress [21].

Several non-enzymatic scavengers/chain breakers of RONS exist such as glutathione and vitamin E. Glutathione exists primarily in the reduced form and functions to scavenge free radicals directly, as well as donates its hydrogen during the reduction of H<sub>2</sub>O<sub>2</sub> or vitamin C radical [27]. Vitamin E is the major chain breaking antioxidant *in vivo*, as it serves to terminate the chain reaction of lipid peroxidation by reacting with the peroxy radical. In fact the amount of vitamin E present in phospholipids of LDL largely determines the oxidation potential of the molecule, thus aiding in the prevention of atherosclerosis [15]. Upon reaction with the peroxy radical, vitamin E then becomes a radical itself. The vitamin E radical is then subsequently reduced by way of vitamin C, forming yet another radical (vitamin C radical), which is further reduced by GSH. The systematic interaction between vitamins E, C, and GSH is a classic example of how the components of the antioxidant defense system work in conjunction with each other to attenuate oxidative damage.

Aside from the aforementioned enzymatic and non-enzymatic antioxidants, various transition metal ion (e.g., iron and copper) sequestering molecules play a key role in the

prevention of free radical mediated damage. Elimination of circulating levels of free transition metals is accomplished via various iron and copper transport proteins, such as transferrin, ceruloplasmin, and albumin. Binding of transition metals to their respective transport protein inhibits their ability to initiate lipid peroxidation, inhibit certain antioxidants (vitamin C), or lead to the formation of hydroxyl radical (by way of the Fenton reaction; [15]. Moreover, transferrin iron-binding capacity in plasma is three times greater than the amount of iron needing to be transported [15], thereby further illustrating the critical importance of transition metal sequestration in the prevention/ attenuation of oxidative damage *in vivo*.

### Nutritional Antioxidants

Because exogenous compounds contribute to the antioxidant capacity of the system, dietary habits and/or antioxidant supplementation may have the ability to decrease an individual's susceptibility to oxidative damage. As such, various antioxidant supplements such as vitamins, carotenoids, carnitine, alpha lipoic acid, coenzyme Q10, and polyphenols [21], as well as the dietary consumption of high amounts of antioxidant-rich foods [85] have been shown to decrease an individual's susceptibility to oxidative damage. Furthermore, other nutrients such as certain essential fatty acids and/or plant sterols have been shown to possess antioxidant and anti-inflammatory properties [86].

### Vitamins

Vitamins C and E are among the most commonly researched antioxidant supplements and have both been shown to exhibit antioxidant properties when administered independently [87,88] and/or in combination [87]. Carotenoids, such as the vitamin A precursor beta-carotene, have also been shown to attenuate oxidative stress when administered alone [89], and in conjunction with vitamins C and E [90]. Vitamins E and C play a key role as chain breaking antioxidants during lipid peroxidation, acting in both the lipid and aqueous phase, respectively. Moreover, the vitamins are often supplemented simultaneously based on the known role of vitamin C in regenerating vitamin E *in vivo* during lipid peroxidation [21]. As vitamin C is the primary focus of this chapter, particular attention will be given to its use as an antioxidant supplement in a later section in relation to studies involving exercise-induced oxidative stress and tissue injury

### Pharmacological Antioxidants

In addition to the nutritional antioxidants listed above, certain pharmacological agents such as thiazolinediones, statins, angiotensin converting enzyme inhibitors (ACE-inhibitors), and angiotensin I receptor blockers have also been shown to possess antioxidant properties *in vivo* [91].

Thiazolidinediones are a relatively new class of oral anti-diabetic agents designed to increase insulin sensitivity. They appear to possess antioxidant properties stemming from their ability to inhibit the activity of nitric oxide synthase (the inducible form, iNOS), thereby reducing the production of the harmful radical species peroxynitrite [92]. HMG-CoA reductase inhibitors (collectively referred to as statins) are a class of lipid lowering drugs, that have been shown to possess antioxidant properties aside from their primary lipid lowering function [93]. Decreased oxidative stress with statin administration is likely due to the ability of the drug to both decrease superoxide production [94] and increase NO $\cdot$  bioavailability [95]. These results were supported by Ceriello and associates [93], who noted an attenuated increase in nitrotyrosine (an indication of peroxynitrite presence) in type II diabetics, following statin supplementation.

ACE inhibitors and AT-1 blockers are a class of antihypertensive drugs designed to inhibit the formation of angiotensin II (a potent vasoconstrictor). In addition to their role in promoting vasodilation, they also have been shown to act as causal antioxidants [96,97], as both angiotensin II and activated AT-1 receptors promote intracellular oxidative stress [96,97]. They are termed causal antioxidants due to their ability to prevent the formation of radical species, rather than simply scavenge already present radicals [91].

## Summary of Antioxidant/Pharmacological Intervention

Whether antioxidant supplementation is delivered via nutritional and/or pharmacological agents, the effect of the treatment appears largely dependent on both the degree of oxidative stress induced during a given stress challenge (e.g., acute exercise test), as well as the basal levels of RONS exposure experienced by an individual on a regular basis. That is, populations that are susceptible to excess RONS production via disease, increased age, and/or classification as overweight or obese, may benefit from diets rich in antioxidants or antioxidant supplementation [98]. Whereas individuals already possessing relatively low levels of oxidative stress (e.g., young, healthy, exercise trained individuals) may not receive much further benefit from antioxidant intervention, as a currently undefined basal level of RONS production is known to be essential for proper physiological function [24].

## Impact of Chronic Exercise on Antioxidant Defense

Acute exercise imposes a physical stress on the body. Numerous studies have shown that oxidative stress biomarkers are increased in response to aerobic (for review, see [99]) and anaerobic (for review, see [100]) exercise. In response to repeated increases in RONS production via regular exercise, the body adapts to counteract the effects of the exercise stress and to prepare for future attacks. This is evidenced by an increase in antioxidant enzymes and glutathione [82,101] as well as by lower levels of resting and exercise-induced oxidative stress in trained compared to untrained individuals [102]. The mechanism whereby regular exercise results in an adaptive increase in antioxidant protection is well described [29].

In brief, exercise-induced RONS appear to serve as the “signal” needed for the activation of MAPKs (p38 and ERK1/ERK2), which in turn activate the redox sensitive transcription factor NF- $\kappa$ B [103], via activation of I $\kappa$ B kinase, which then phosphorylates I $\kappa$ B (the inhibitory subunit of NF- $\kappa$ B). I $\kappa$ B is then ubiquitinated and subsequently degraded via the cytosolic ubiquitin-proteasome pathway, thereby releasing NF- $\kappa$ B to migrate into the nucleus. Several antioxidant enzymes [manganese superoxide dismutase (MnSOD), inducible nitric oxide synthetase (iNOS), glutamylcysteine synthetase (GCS)] contain NF- $\kappa$ B binding sites in their gene promoter region and thus are potential targets for exercise-induced upregulation via the NF- $\kappa$ B signaling pathway [29]. These findings support the idea above of an optimal level of RONS production and suggest that complete elimination of exercise-induced RONS would not be conducive to optimal physiological function.

In summary, oxidative stress is a condition characterized by free radical mediated damage to various biological molecules. The critical importance of further research and understanding in the area is illustrated by the implication of oxidative stress in the pathogenesis of a myriad of acute and chronic human illnesses/diseases. Therefore, further identification of situations in which increased radical species production is promoted, as well as additional methods to combat such a stress (either nutritional, pharmacological, or lifestyle implementation) is essential.

At present, it appears that any condition in which the consumption of molecular oxygen is increased has the potential to result in an acute state of oxidative stress. One such condition is the performance of physical exercise, and exercise-induced oxidative stress is believed to play a role in reducing performance and accelerating fatigue and muscle injury following exercise. However, at present no cause and effect data are available. In fact, a small amount of oxidative stress may serve as a necessary stimulus for an upregulation in the antioxidant defense system, thereby enhancing protection against future oxidative attacks. Thus, whether exercise-induced RONS should be viewed as a detriment or benefit to physical performance/physiological function that should be attenuated and/or utilized remains a topic of debate. The following section will specifically address the current research pertaining to acute exercise, oxidative stress and tissue injury. Specific attention is given to the ability of vitamin C to attenuate such a stress, as well as the potential consequences of such attenuation.

## **Exercise-Induced Oxidative Stress and Tissue Injury**

Since the initial reporting by Dillard and colleagues [104] of an increase in expired pentane following acute aerobic exercise, coupled with the direct measurement of free radical production following treadmill running in rats by Davies et al. [105], numerous (>300) investigations have been conducted within the field of oxidative stress and exercise. Based on research conducted over the past 30 years it appears that acute exercise of sufficient volume and intensity results in the increased production of RONS, in turn promoting transient conditions of oxidative stress. Evidence for this is provided by investigations noting an increase in various oxidative stress biomarkers following both acute aerobic and anaerobic

exercise (for review, see [99]), as well as the direct assessment of free radical production via electron spin resonance following acute exercise in animals [105] and humans [106-111].

## Aerobic Exercise

The majority of research within the field has utilized aerobic exercise as the stimulus to induce oxidative stress. Typical protocols have included submaximal or maximal effort aerobic exercise either on a treadmill or cycle ergometer, with the majority of investigations utilizing a graded exercise test (GXT) to induce an oxidant stress. Most laboratory based protocols have involved short to moderate duration exercise bouts ( $\leq 2$  hours), while a few laboratory protocols, and the more common “field” tests, have included much longer times of exercise ( $> 2$  hours). In addition, some treadmill studies have focused on downhill running, involving eccentric bias in order to induce muscle injury. In general, oxidative stress has been evidenced by an increase in lipid, protein, DNA, and glutathione oxidation, as well as alterations in the antioxidant defense system which are consistent with accelerated RONS production (for review, see [99]).

In those protocols involving long duration and/or eccentric exercise as a stimulus, elevations in muscle damage have been observed, evident by reported increases in various markers of muscle injury (CK and LDH) [112-115] and muscle soreness in the days (1-14) following exercise. It is believed that the initial mechanical trauma to the musculature induced by the exercise bout itself results in a pro-inflammatory response and the secondary recruitment of phagocytic cells, ultimately resulting in increased respiratory burst activity and oxidative stress during the recovery period.

Although a general trend in favor of a transient oxidative insult induced by aerobic exercise is certainly evident, an increase in oxidative stress has not always been observed, as null findings for various biomarkers of oxidative stress have also been reported by several investigators in both animals and humans [99]. Recall from above that in order for oxidative stress to occur RONS production must exceed the ameliorating capabilities of the antioxidant defense system in place. Several factors appear to impact the magnitude of RONS produced, as well as the degree of antioxidant protection. These include the intensity [116,117] and duration [118] of exercise, as well as the age [119], training status [83,84], and dietary intake [3] of the subject population utilized. During low-intensity and duration protocols, antioxidant defenses appear sufficient to combat the elevated production of RONS, but as intensity and/or duration of exercise increases, these defenses are no longer adequate, potentially resulting in oxidative damage to surrounding tissues [120]. With respect to aging, biomarkers of oxidative stress have been shown to be exacerbated as a function of age both during resting and exercising conditions [119]. Regular exercise training has been shown to result in an up-regulation of endogenous antioxidant defenses [58], thereby lowering both resting and exercise-induced oxidative stress [83,84]. Lastly, because exogenous compounds contribute to the antioxidant capacity of the system, the composition of antioxidant present within the diet (primarily determined by the intake of fruits and vegetables) may also impact oxidative stress. These examples are a few of the extraneous variables that appear to impact the actual induction of oxidative stress; however, null findings may also be related to

limitations in measurement technique. That is, if oxidative stress does occur, detection depends to a large degree on the tissue sampled, the timing of a given sample, as well as the sensitivity and specificity of the biomarker chosen [28].

### Anaerobic Exercise

It has been shown that anaerobic exercise results in increased RONS production and collectively, it appears that all forms of anaerobic exercise possess the ability to result in increased oxidative stress [100]. Similar to aerobic exercise, a variety of factors likely impact the oxidative stress response observed, including, specific biomarkers chosen, time course of sampling, tissue sampled, intensity and volume of exercise, as well as the training status and dietary intake of the subjects. The results of the anaerobic research are not unlike those of aerobic nature; there are simply fewer data on the former compared to the latter. As with aerobic exercise, it is currently unclear as to whether increased RONS formation observed during anaerobic exercise represents a necessary or detrimental event.

Taken together, it is clear that both aerobic and anaerobic exercise of sufficient volume, intensity, and duration can lead to an increase in RONS production, which may lead to the oxidation of several biological molecules (lipids, proteins, nucleic acids). Whether or not this condition is indicative of a harmful stimulus however, remains a topic of debate [121,122]). Historically, RONS produced during exercise have been viewed as a detriment to physiological function, as they have been suggested to impair exercise performance and accelerate muscle damage/fatigue [45,49,52]. Moreover, coupled with the association of RONS with human disease [28], methods to reduce radical production and subsequent oxidative damage during and following physical exercise have been a priority of much research activity.

## **Vitamin C Intake in Relation to Exercise-Induced Oxidative Stress and Tissue Injury**

Due to the suggested role of exercise-induced RONS production in impairing muscle performance and accelerating the onset of muscle fatigue/damage during exercise, coupled with the well documented deleterious effects of RONS in relation to overall health and disease, numerous investigators have attempted to attenuate this exercise-mediated oxidative stress. One such method that has received considerable attention over the past several years is the acute and/or chronic ingestion of supplemental vitamin C (either alone or in combination with other antioxidants) in the hours or days preceding an acute exercise bout. It is hypothesized in such studies that additional intake of vitamin C would serve to enhance the capabilities of the antioxidant defense system *in vivo*, thereby increasing the scavenging of RONS and decreasing the oxidative insult experienced during and following exercise. Therefore, intake of vitamin C would be expected to result in attenuation in various markers of oxidative stress and muscle injury, as well as potentially enhance performance. The results



of the relevant studies that have investigated the efficacy of vitamin C will be discussed below in relation to both aerobic and anaerobic exercise, in both humans and animals.

### Aerobic Exercise: Human Studies

The majority of investigations related to the effects of vitamin C on reducing exercise-induced oxidative stress and tissue injury have utilized aerobic exercise as the stimulus. Due to the large number of studies and variability in terms of types of protocols used, results are separated via the mode of aerobic exercise employed, as both concentric (both moderate and long duration) and eccentric protocols have been utilized. For the purposes of this review, moderate duration is considered as any aerobic protocol performed for a duration of less than two hours, whereas long duration refers to exercise involving greater than two hours in duration and/or performed in a field setting (e.g., duathlon, marathon, ultramarathon, etc.). Studies are separated based on whether vitamin C treatment was administered independently or in conjunction with other antioxidants.

### Vitamin C Alone

#### *Concentric, Short Duration Protocols*

With respect to the effects of acute ingestion of vitamin C prior to an acute aerobic exercise stimulus on markers of oxidative stress and tissue injury, Ashton and colleagues [107] reported no increase in the direct production of RONS (PBN adducts measured via electron spin resonance), or in two indirect indices of lipid peroxidation (MDA and LOOH) following acute administration of 1000mg of vitamin C administered two hours prior to the performance of a graded exercise test (GXT), despite an increase in all markers following placebo intake. These results were mimicked in two similar studies conducted by Davison et al. [111,123] over a decade later, in both healthy [111,123] and diabetic [123] subjects. They reporting identical effects of acute vitamin C ingestion in preventing the increase in PBN adducts and MDA following a GXT. In support of the above, several other studies have reported an attenuating effect of acute vitamin C ingestion on various markers of oxidative stress (Nitrite [124], TBARS [125], CD [126], MDA [127], TAC [127]) following acute maximal (GXT) or submaximal aerobic exercise (30 minute treadmill run at 75%  $\text{VO}_{2\text{max}}$  [125,127] or a 10.5 km run [126]). Regarding the effects of acute vitamin C intake in attenuating muscle injury in response to acute concentric aerobic exercise, one study reported an attenuation of both CK and DOMS following intake of 2000mg of vitamin C, taken two hours pre exercise [127].

These effects of acute ingestion of vitamin C in attenuating exercise-induced oxidative stress and tissue injury appear evident despite supplementation (1000mg vitamin C 2h pre exercise) reportedly resulting in exacerbated production of the ascorbate free radical (AFR) [124]. Changes in the levels of AFR are indicative of both an oxidative stress and antioxidant response in the plasma [128]. In this respect, the attenuation of various markers of oxidative stress following vitamin C intake likely results from the scavenging ability of the

vitamin, as the increased production of AFR following supplementation prevents the formation of other more harmful radicals, while resulting in minimal (if any) oxidative damage to the surrounding tissue. That is, vitamin C does not appear to prevent the formation of RONS in response to exercise, rather it merely serves to scavenge the radical species once produced [126], thus preventing the secondary interaction of RONS with surrounding biomolecules (lipid, protein, DNA).

While the above findings are specific to acute vitamin C intake, the effects of chronic supplementation with vitamin C have been reported by two investigators, noting equivocal findings. An attenuating effect on submaximal exercise-induced (30 minute run at 75%  $VO_{2max}$ ) protein oxidation (measured via PC) following intake of 500mg or 1000mg of vitamin C for 21 days was reported by Goldfarb et al. [129]. It should be noted that attenuation did not occur for all measured indices of oxidative stress (TBARS and glutathione) and attenuation was greater with the larger dosage [129]. In opposition, a greater increase in MDA was reported by Bryant et al. [130], despite the use of the same dosage of vitamin C (1000mg/day for 21 days) and a comparable exercise stimulus (90 minutes cycle ride at 60-70%  $VO_{2max}$ ). Disparities between these studies, as well as those using acute supplementation protocols, may have resulted from some unidentified mechanism inherent to chronic compared to acute supplementation of vitamin C.

### Concentric, Long Duration Protocols

Several investigators have reported the effects of both acute and chronic supplementation with vitamin C on the oxidative stress and muscle damage induced by long duration aerobic exercise (protocols of 2.5 hours or greater, as well as those performed in a field setting). Both Nieman et al. [131] and Palmer et al. [132] noted no effects of vitamin C supplementation (1500mg/day) for 7 days prior to an ultramarathon, when coupled with the consumption of a vitamin C carbohydrate drink both before and during the race, on two markers of lipid peroxidation ( $F_2$ -isoprostanes, LOOH). Additionally, supplementation resulted in an exacerbated inflammatory response assessed via changes in circulating cortisol [131,132]. A study by Tauler and colleagues [133] reported no effect of vitamin C supplementation (individual supplementation) on LOOH or the activity of several antioxidant enzymes (GR, GPx, SOD) following a duathlon, despite an increase in CAT activity immediately post exercise in the treatment group. Following a 2.5 hour run (75-80%  $VO_{2max}$ ), supplementation with 1000mg of vitamin C for 8 days resulted in no effects on the inflammatory immune response measured via circulating levels of cortisol, IL-6 or neutrophils/leucocytes [131]. In contrast, Davison et al. [134] noted an attenuation in both cortisol and circulating neutrophils/leucocytes following treatment with 1000mg/day of vitamin C for 14 days, despite no effects on MDA, TAC or IL-6 utilizing a 2.5 hour cycle ride (60%  $VO_{2max}$ ) as the exercise stimulus.

The lack of effect on various markers of oxidative stress, and equivocal results related to the inflammatory response may be a result of the magnitude of RONS produced during such protocols. That is, with long duration protocols the increase in RONS observed during and following exercise may be so great that the RONS produced overwhelm both the endogenous

and exogenously consumed antioxidant defenses, thereby masking the benefit of supplementation. It is possible that larger dosages and or longer durations of treatment (in particular into the recovery period) may be necessary in order to provide significant protection against long duration exercise-induced oxidative stress and inflammation [135].

### Eccentric Protocols

While the above results are in relation to concentric exercise, acute eccentric exercise induced-oxidative stress (MDA) following the performance of a downhill run (30 min at 60%  $VO_{2max}$ ) has been shown to be attenuated by acute ingestion of vitamin C (1000mg 2h pre and 14 days post exercise) [136]. However, unlike the results related to concentric exercise, markers of muscle damage (CK, MYO, DOMS, force production) have been shown to be both exacerbated [136] or unaffected [137] following supplementation. Acute ingestion of vitamin C (1000mg 2h pre and 14 days post exercise) resulted in greater impairments in force production in the days following a downhill run [136], where as chronic supplementation (400mg/day for 14 days) had no effect on DOMS, MYO, or IL-6 following a downhill run [137]. In opposition, Jakeman et al. [138] reported an attenuated decline in muscle function (assessed via peak force production) induced by 60 minutes of box stepping following chronic ingestion of vitamin C at a dosage of 400mg/day for 21 days.

In summary, in relation to vitamin C alone, acute administration prior to the performance of moderate duration aerobic exercise appears to consistently result in attenuation of various markers of oxidative stress and tissue injury. Equivocal results are noted for chronic supplementation. Antioxidant treatment prior to long duration exercise has commonly resulted in a lack of effect on both oxidative stress and tissue injury markers, which is likely related to the greater magnitude of RONS generation inherent to such protocols. Regarding eccentric exercise, while chronic supplementation may have some benefits, acute ingestion of vitamin C appears contraindicated at this point; however, data are scarce in relation to this recommendation.

### Antioxidant Mixtures

The studies discussed thus far have employed antioxidant treatment protocols in the form of vitamin C alone. Due to the complex and interconnected nature of the antioxidant defense system, many investigators have attempted to elicit a synergistic effect by utilizing various combinations of antioxidant mixtures, as opposed to the independent administration of any one antioxidant. In fact, it has been suggested that combined supplementation with both vitamin C and vitamin E may be optimal, due to the previously discussed role of vitamin C in recycling vitamin E following RONS exposure [139].

---

## Concentric, Short Duration Protocols

Chronic ingestion of various antioxidants mixtures has been shown to attenuate various markers of aerobic exercise-induced oxidative damage [90,130,140-142], almost without exception [143]. With respect to lipid peroxidation, Bryant and coworkers [130] reported an increase in exercise (90 minute cycle ride at 60-70%  $VO_{2max}$ ) induced lipid peroxidation (MDA), which was prevented following three weeks of supplementation with 1000mg of vitamin C + 200IU of vitamin E/day in trained men. Moreover, in this same study, supplementation with vitamin C alone (1000mg/day for 3 weeks) resulted in an exacerbated increase in MDA, suggesting that chronic administration of vitamin C alone may not be warranted [130]. In a similar study conducted by Kanter et al. [90] attenuation in exercise-induced lipid peroxidation (assessed via MDA and expired pentane) was reported following treatment with a vitamin C (250mg) vitamin E (148mg), and beta-carotene (7.5mg) mixture. In opposition to the above findings, no effect of supplementation has been reported by two investigators for exercise-induced MDA formation, despite the use of comparable exercise (30 minute run at 80%  $VO_{2max}$ ) and treatment (1000mg vitamin C + 400IU vitamin E/day for 14 days) protocols [141,142]. Additionally, Meijer et al. [144] reported no effects of antioxidant supplementation (200mg vitamin C + 100mg vitamin E + 2mg beta-carotene/day for 12 weeks) on exercise-induced (45 minute cycle ride at 50% max workload) antipyrine (indirect marker of hydroxyl radical formation) and TBARS formation in a population of 60 year old men and women.

With respect to oxidative damage to other biomolecules (protein, glutathione, DNA), three other investigators have reported an attenuation in exercise-induced protein [142] and glutathione [140,141] oxidation following chronic ingestion of a vitamin C and vitamin E mixture (1000mg vitamin C + 400IU vitamin E/day for 14 days) [141,145], as well as vitamin C in combination with glutathione (2000mg vitamin C + 1g GSH/day for 7 days) [140]. The exercise protocol utilized by Sastre et al. [140] consisted of a GXT performed on a treadmill. Regarding DNA oxidation or markers of muscle injury, no study to our knowledge has reported a protective effect of antioxidant supplementation (including vitamin C) [141,143,145]. Null findings in relation to DNA oxidation may have resulted from the use of a less taxing exercise protocol, evident by a failure to induce an increase in 8-OHdG [141,145].

Taken together, it appears that chronic ingestion of various antioxidant mixtures, which contain vitamin C, possess the potential to attenuate lipid peroxidation, as well as protein, and glutathione oxidation, despite having no effect on DNA oxidation. Although other variables are likely involved (i.e., the direct scavenging of the excess antioxidants), these attenuating effects may be due to an increase in the activity of various antioxidant enzymes following supplementation. That is, perhaps antioxidant supplementation serves to increase the activity of endogenous antioxidant defenses, as has been reported by Tauler et al. [146]. In this study an increase in GPx and CAT both at rest and in response to acute exercise (GXT) was reported following supplementation with a vitamin C, vitamin E, and beta-carotene mixture (250mg vitamin E + 15mg beta-carotene/day for 90 days + 500mg vitamin C for last 15 days) [146]. Based on these findings, perhaps the excess availability of non-enzymatic antioxidants

(supplied via supplementation) serves to spare the use of the enzymatic components of the antioxidant defense system, in turn increasing their activity in times of oxidative stress.

### Concentric, Long Duration Protocols

In relation to long duration exercise, Surenda et al. [147] recently reported an attenuation in MDA, as well as a post exercise increase in antioxidant enzyme activity (GPx, CAT), following low dose supplementation with vitamin C (152mg) and vitamin E (50mg) for 30 days prior to a half-marathon. In support of these findings, a post exercise increase in GPx and SOD, coupled with a reduction in CK has been reported in response to a duathlon performed following 4 weeks of overtraining during which subjects were supplemented with selenium (150 $\mu$ g), vitamin C (120mg) and vitamin E (20mg) [148]. Davison et al., [149] reported a post exercise (2.5 hour cycle ride at 60%  $VO_{2max}$ ) reduction in TBARS, despite no effects on  $F_2$ -isoprostanes following supplementation with vitamin C and vitamin E (1000mg vitamin C + 400IU vitamin E/day for 28 days). In opposition to the above investigations reporting significant treatment effects, two other studies have reported no effects of supplementation on lipid peroxidation (MDA, TBARS) [150,151], glutathione oxidation or muscle injury (CK, MYO) [150,151], despite the use of a comparable exercise stimuli (duathlon and a 21km run).

With respect to more strenuous protocols, Rokitzki and colleagues [152] reported an attenuation in CK in response to a marathon race following supplementation with 200mg of vitamin C and 400IU of vitamin E/day for 32 days prior to the race, despite no effects on LDH or lipid peroxidation (TBARS). In direct opposition, Machefer et al. [153] reported no effects of supplementation (150mg vitamin C + 24mg vitamin E + 4.8mg beta-carotene/day for 21 days) on various markers of muscle damage (CK, LDH), despite a significant reduction in TBARS following a six day ultramarathon race. No effect of a vitamin C and vitamin E mixture (1000mg vitamin C + 300IU vitamin E/day for 6 weeks) on various markers of muscle damage (CK, LDH, muscle function) following an ultramarathon has also been reported [154].

Based on the results above, it would appear that chronic supplementation with an antioxidant mixture containing vitamin C has the potential to attenuate markers of muscle damage and oxidative stress, perhaps by way of an up-regulation in antioxidant enzyme activity. However, as the duration of exercise is increased (above a currently undefined level), RONS production likely becomes so great that the capabilities of the antioxidant defense system become overwhelmed, effectively masking any potential benefit of supplementation. Perhaps more importantly, while some studies have reported an attenuation in oxidative stress/muscle injury with supplementation, the majority of studies have reported no effects of such attenuation on exercise performance [149,151-158], with one exception [159], thus adding controversy related to the efficacy of vitamin C supplementation pertaining to exercise.

## Aerobic Exercise and Vitamin C: Animal Models

The results discussed thus far have been in relation to human subjects. In addition, several studies have been conducted investigating the effects of vitamin C on oxidative stress and tissue injury in animals. These investigations are presented below; however, prior to discussion it should be understood that the greater degree of control inherent within animal research, coupled with the ability to analyze various tissues, generally leads to less variability when comparing findings from similar research designs.

With respect to independent administration of vitamin C, acute intravenous infusion of 5000mg of vitamin C, given 15 minutes prior to a 1200m race, prevented any increase in TBARS and resulted in higher levels of TRAP (marker of antioxidant capacity), despite having no effects on CK in horses [160]. Chronic supplementation in rats with vitamin C for 30 (300mg/day) [157] or 60 (500mg/kg a day) days [161], resulted in an attenuation in muscle fatigue following electrical stimulation of the gastrocnemius muscle [157], and the prevention of glutathione oxidation, as well as increase in CK and LDH, despite having no effects on MDA following treadmill running to exhaustion [161]. Lastly, five days of supplementation with vitamin C (2000mg/kg a day) prevented any increase in MDA, PC, or myeloperoxidase (radical generating enzyme) following contractile-induced claudication in rats [162].

Chronic supplementation with a vitamin C and vitamin E mixture [7000mg vitamin C + 5000IU vitamin E/day for 21 days] has been shown to have no effects on markers of oxidative stress (TBARS, MDA, LOOH, TGSH, GPx) or muscle damage (CK) following high intensity, short duration aerobic exercise (2 min run at 70,80,90%  $VO_{2max}$ ) [163] and an 80km endurance race [164] in horses. With respect to rats, You et al. [155] reported an attenuation in PC in response to a downhill treadmill run to exhaustion following two weeks of supplementation with vitamin C(1000mg) and vitamin E (200mg). It should be noted that this attenuation in PC had no impact on exercise performance [155]. In agreement with You et al. [155], treatment with vitamin C and vitamin E (2000mg/kg vitamin C + 200 $\mu$ l of a 70% vitamin solution) for five days prevented any increase in oxidative stress (MDA, PC, myeloperoxidase) following contractile-induced claudication [162].

## Aerobic Exercise, Vitamin C, and Oxidative Stress/Tissue Injury: Summary

A sound scientific rationale for the use of vitamin C in an effort to reduce exercise-induced oxidative stress and tissue injury exists. However, the effects of supplementation appear dependent upon whether vitamin C is administered acutely or given on a chronic basis, as well as whether vitamin C is used independently or in combination with other antioxidants. Moreover, the mode of aerobic exercise employed, as well as the dosage and model (human vs. animal), also appears to impact results. Collectively, the majority of studies (using either vitamin C alone or in combination) have noted an attenuating effect of supplementation, with the most consistent results being observed following acute administration of vitamin C alone prior to moderate duration aerobic exercise. Of those

reporting null findings, supplementation has typically not resulted in detrimental outcomes, with the exception of a few studies reporting an exacerbation in oxidative stress and tissue injury following antioxidant treatment. These results are likely due to variability in terms of circulating transition metals (especially following muscle damaging exercise) and vitamin C present within the subject population.

Recall from above that the combination of excessive levels of catalytic metals (secondary to muscle damaging exercise) coupled with low dose vitamin C would be expected to result in the greatest chance of observing a prooxidant effect of supplementation. Although attenuation in oxidative stress has commonly been observed, whether or not this is representative of a beneficial outcome remains a topic of debate for several reasons. To this our knowledge, only one study exists reporting an ergogenic benefit of vitamin C supplementation [159]. In fact, a decrease in performance as been reported by some investigators following supplementation [165,166]. Moreover, exercise-induced RONS have been suggested to serve as the necessary “signal” responsible for driving several beneficial adaptations to exercise, thus attenuation of this signal may actually blunt this response. A transient elevation in various biomarkers of oxidative stress may simply be a secondary consequence to the activation of this signal and thus may not hold any clinical relevance. This issue is discussed in greater detail in a later section. Clearly more research is needed within the area prior to the establishment of firm guidelines related to when supplementation is or is not warranted in relation to exercise. The next section will address the effects of vitamin C on anaerobic exercise-induced stress.

### Anaerobic Exercise: Human Studies

In opposition to aerobic exercise-induced RONS production, which is chiefly derived from accelerated mitochondrial superoxide production secondary to increased oxygen consumption, RONS produced during anaerobic work bouts are primarily produced by various radical generating enzymes (e.g., XO, NADPH oxidase) in response to conditions of ischemia followed by reperfusion. Recall from above that these RONS have been suggested to interfere with force production capabilities during the bout itself, as well as exacerbated muscle damage following exercise, in turn potentially serving to impair performance and/or prolong the recovery process. Thus, the use of vitamin C (either alone or in combination) has been utilized by several investigators in an effort to blunt both the primary production of RONS via XO and NADPH oxidase, as well as the secondary formation of RONS via respiratory burst and subsequent muscle injury. These studies are discussed below, separated by those that administered vitamin C either independently or in conjunction with other antioxidant agents.

#### Vitamin C Alone

The first study to investigate the effects of independent administration of vitamin C in relation to anaerobic exercise-induced muscle damage was conducted by Kaminski et al.,

[167]. In this study, an attenuation in DOMS was reported by participants in response to 15 minutes of plantar flexion exercise (15 seconds on and 15 seconds off) following supplementation with 3000mg of vitamin C or placebo for three days prior to and 4 days post exercise [167]. No measure of oxidative stress was included in this design. In agreement with these findings, Bryer and coworkers [158] investigated the effects of vitamin C on markers of oxidative stress and muscle damage., given at a dosage of 3000mg/day for 14 days before and 4 days after the performance of 70 maximal eccentric elbow extensions. Vitamin C prevented the increase in glutathione oxidation and attenuated both the increase in CK and DOMS, despite having no effects on muscle force when compared to placebo [158]. In a similar study using maximal eccentric elbow extensions as the exercise stimulus, this same dosage given for only three days pre and post exercise resulted in no effects on DOMS or muscle function [168]. Null findings may be related to an insufficient duration of treatment, failure to measure more sensitive markers of muscle damage, or the use of exercise trained individuals as participants [168]. Those engaged in regular resistance exercise have been shown to experience an attenuation in muscle damage and oxidative stress in response to an acute resistance exercise session, as a result of the “repeated bout effect” and/or up-regulated antioxidant defenses [169].

In relation to an intermittent shuttle run, Thompson and colleagues [170-172] have investigated the effects of acute administration of vitamin C (1000mg given 2 hours pre exercise) [170], as well as chronic ingestion for either five (400mg/day) [171] or 35 (1000mg/day) days [172] on markers of oxidative stress and muscle damage. Both acute administration and five days of supplementation had no effect on MDA, CK, MYO, or DOMS [170,171], with the latter treatment resulting in greater increases in DOMS in the days following the run [171]. On the contrary, chronic treatment for 35 days resulted in a moderate attenuation in MDA and DOMS, without effecting CK or MYO [172].

### Antioxidant Mixtures

The majority of studies in which antioxidant mixtures (containing vitamin C) have been utilized in an effort to reduced anaerobic exercise-induced oxidative stress and tissue injury have utilized eccentric elbow flexion as the stimulus. An antioxidant mixture containing vitamin C (1000mg), vitamin E (400IU), and selenium (90µg) given 14 days preceding and two days post the performance of four sets of 12 eccentric elbow flexion exercises resulted in an attenuation in MDA, PC, CK, and DOMS, without having any effect on glutathione oxidation or performance [156,173]. In opposition to these findings, acute administration of vitamin C (12.5mg/kg) and N-acetyl-cysteine (10mg/kg) given immediately following the performance of 30 (3 x 10) eccentric arm curls at an intensity corresponding to 80% of an individual’s one repetition maximum (1RM) resulted in an exacerbated increase in lipid peroxidation (LOOH, F<sub>2</sub>-isoprostanes) and muscle damage (CK, LDH), as compared to placebo [174]. This acute antioxidant administration, as apposed to the chronic treatment employed in the previous studies, may have not afforded adequate time for antioxidants to become concentrated in sufficient quantities in the plasma or tissue pools, thus preventing any protective effect. Moreover, vitamin C has been shown to possess prooxidant properties



in the presence of an increased concentration of transition metals, particularly when the concentration of vitamin C is relatively low [9]. Therefore, the increase in serum free iron following exercise [174] and its likely interaction with vitamin C to form more harmful radical species, coupled with the potentially inadequate availability of additional vitamin C to combat this prooxidant effect, may partially explain these findings.

Aside from eccentric elbow flexion, other investigators have utilized either eccentric bench press or knee extension in conjunction with antioxidant administration in an effort to attenuate oxidative stress and muscle injury. Bloomer et al. [145] reported no effect of a vitamin C, vitamin E mixture (1000mg vitamin C + 378mg vitamin E/day for 14 days) on various markers of oxidative stress (PC, total peroxides), tissue injury (CK, DOMS), and inflammation (C-reactive protein) following eccentric bench press. In contrast, Shafat et al. [175] noted an attenuated decline in muscle function in response to 30 sets of 10 eccentric knee extensions following supplementation with vitamin C (500mg) and vitamin E (1200IU) for 30 days prior to and seven days post exercise, despite reporting no effects on DOMS. Lastly, although not in relation to eccentric exercise, one study reported no effect of a vitamin C (1000mg), vitamin E (600mg), and beta-carotene (32mg) mixture given for 35 days on LOOH, CK, or LDH following the performance of several basketball related training sessions [176]. Null findings for the above referenced studies may have been related to the subject population utilized, as studies in which no effects of supplementation were reported utilized trained participants [145] or professional basketball players [176]. These individuals likely presented with adequate endogenous antioxidant protection.

#### Anaerobic Exercise, Vitamin C, and Oxidative Stress/Tissue Injury: Summary

Chronic administration of vitamin C (either alone or in combination with other antioxidants) appears to attenuate oxidative stress and muscle damage induced by anaerobic exercise in some instances; however, these results appear evident primarily in untrained individuals. Moreover, acute ingestion of vitamin C prior to muscle damaging exercise may be contraindicated, as it has been shown to exert no effects or exacerbate oxidative stress and tissue injury following intermittent shuttle running or eccentric exercise, respectively. With regard to exercise trained participants, they likely already present with adequate antioxidant protection as a consequence of habitual training, thus any additional intake of antioxidant may not be expected to provide any further benefit during such moderate duration exercise.

## **Interaction between Exercise and Vitamin C Intake on Adaptations to Exercise**

Recall from above that exercise-induced RONS have been suggested to serve as the necessary signal for an adaptive up-regulation in antioxidant defenses, as well as in the regulation/initiation of other beneficial adaptations related to performance and/or health (i.e., shift in redox balance in favor of more reducing conditions). Therefore, it has been suggested

that any attempt to attenuate the exercise-induced increase in RONS production (via antioxidant supplementation) may actually blunt the adaptive increase in antioxidant defenses [103,120].

Related to vitamin C intake, Gomez-Cabrera and coworkers [166] recently reported a decrease in mitochondrial biogenesis, as well as an attenuation in the development of other exercise-induced adaptations following chronic administration of vitamin C in both animals (500mg/kg) and humans (1000mg/day) following a period of aerobic training (3 days a week for 8 weeks). Related to animals, aerobic training resulted in an increase in endurance performance, which was significantly blunted with vitamin C administration. Moreover, vitamin C supplementation prevented any increase in the expression of certain antioxidant enzymes (GPx and Mn-SOD), as well as the protein content of peroxisome proliferator-activated receptor co-activator-1 (PGC-1), mRNA concentration of nuclear respiratory factor-1 (NRF-1), and mitochondrial transcription factor A (mTFA); all of which are involved in mitochondrial biogenesis. Lastly, cytochrome C, which is a common protein marker representative of mitochondrial protein content, was also decreased in response to vitamin C administration [166]. With respect to humans, a non-significant increase in  $VO_{2max}$  occurred following eight weeks of aerobic training. Although not statistically significant, a trend was evident for greater improvements in the placebo group (22.0% increase) compared to those subjects receiving vitamin C (10.8% increase) [166]. These data would suggest that antioxidant supplementation in the form of vitamin C, administered in conjunction with moderate aerobic exercise training, may hamper endurance performance, as well as prevent desirable adaptations in antioxidant defenses.

In agreement with the results above, similar findings in terms of reduced exercise performance following antioxidant supplementation have been reported with the use of vitamin C [165], vitamin E [177], and ubiquinone-10 [178] in both animal and man. Furthermore, pharmacological blocking of exercise-induced RONS production has been reported to blunt the exercise-induced upregulation in MnSOD, nitric oxide synthase (inducible isoform), reduce the phosphorylation of mitogen-activated protein kinase (p38 and ERK1/ERK2), as well as reduce the activation of NF- $\kappa$ B, which was observed under placebo conditions, following the administration of allopurinol (a known inhibitor of xanthine oxidase) administration [103].

It should be understood that the potential negative effects of antioxidant supplementation may exist only when applied to moderate intensity exercise, as administration of antioxidants during competitive and/or exhaustive exercise training periods has been shown to attenuate markers of muscle damage and lipid peroxidation at rest [179,180]. However, these effects in relation to overall health and performance remain controversial.

Collectively, it would seem that an optimal level of RONS produced during exercise is not only necessary, but advantageous in that it serves to drive the desired adaptive response. In support of this notion, adaptations that occur to the body's antioxidant defense system in response to regular exercise appear to not totally eliminate oxidative damage, but merely reduce potential damage from future acute bouts of exercise [100,181], as well as other ROS generating situations. These findings support the idea that complete elimination of exercise-induced RONS would not be conducive to optimal physiological function. On the contrary, the production of RONS above and beyond that currently undefined level, potentially as a

consequence to conditions similar to overtraining (chronic performance of vigorous exercise), may serve to overwhelm the defense system, thereby resulting in oxidative damage, decreased performance, and ill-health/disease. This is evidenced by the increase in disease risk associated with ultra-endurance exercise training [120]. Individuals exposed to these conditions associated with exacerbated RONS formation may benefit from antioxidant supplementation; however, more research is necessary before specific and firm recommendations can be made.

## Conclusion

The use of antioxidants in an effort to reduce exercise-induced oxidative stress and tissue injury has received considerable attention over the past several years. However, evidence in support of such a practice remains inconclusive at this time. If the desired outcome of vitamin C supplementation is an increase in exercise performance, there is currently limited evidence to support this effect, as those studies that have included measures of performance have typically noted null and/or detrimental outcomes following antioxidant treatment [149,151-158], with one exception [159]. On the other hand, if the rationale for vitamin C supplementation is based on the idea that exercise-induced RONS may not be conducive to optimal health, and that vitamin C intake may attenuate the typical rise in oxidative stress, then use of vitamin C may be warranted. However, this is largely dependent on the type and duration of exercise performed, and is dependent on one's own interpretation of the current findings. That is, findings are mixed. Hence, it is difficult to state with certainty that use of vitamin C will result in less exercise-induced oxidative stress and tissue injury. Clearly, some studies do indicate this effect. However, others refute this notion. Moreover, despite any potential effect on the various outcome measures, controversy exists as to whether attenuating the oxidative stress response to exercise is beneficial or perhaps, detrimental. A growing body of evidence is now forming, which supports the notion that transient exposure to increased RONS production is necessary for the initiation of an adaptive upregulation in antioxidant defenses, as well as other health and/or performance related adaptations (e.g., mitochondrial biogenesis). In this respect, moderate exercise may be viewed as both an antioxidant and anti-inflammatory agent, which serves to favor the formation of a more reducing environment *in vivo*, ultimately promoting improvements in overall health. This area of research, in particular the interaction between exercise stress, antioxidant intake, oxidative stress, and overall health, is in particular need of further investigation.

Considering the above, it is certainly possible that during certain conditions (i.e., disease states, acute periods of overtraining, or prolonged periods of strenuous physical training in conjunction with ultra-endurance events and/or sports competition), accelerated exercise-induced oxidative stress may occur. This may subsequently result in detrimental effects on performance and/or health. Under these conditions, exogenous supplementation with antioxidants (including vitamin C) may serve to prevent and/or attenuate these undesirable outcomes.

At the present time, it appears that vitamin C supplementation likely possesses no additional benefits related to improved performance in otherwise healthy individuals engaged

in regular exercise training. Vitamin C may be useful for purposes of attenuating exercise-induced oxidative stress (when used alone or in conjunction with other antioxidants), in particular in relation to short duration aerobic and anaerobic exercise protocols. While more research is indeed needed, the following may be concluded based on the available evidence: If vitamin C is used as a dietary supplement for those involved in strenuous exercise, it should be taken prophylactically for several days prior to exercise (i.e., regularly for individuals who exercise regularly) and at a dosage of 1-3g/day. However, what may be most important in terms of overall health and exercise recovery, coupled with the performance of regular and strenuous exercise, is the regular consumption of adequate amounts of fruits, vegetables, whole grains, and antioxidant-rich oils (fish, flax, olive). Vitamin C supplementation alone will not make up for this lack of effort on the part of the individual.

## References

- [1] Duarte TL, Lunec J. Review: When is an antioxidant not an antioxidant? A review of novel actions and reactions of vitamin C. *Free Radic Res* 2005; 39: 671-686.
- [2] Rose RC, Bode AM. Biology of free radical scavengers: an evaluation of ascorbate. *FASEB J* 1993; 7: 1135-1142.
- [3] Watson TA, Callister R, Taylor RD, Sibbritt DW, MacDonald-Wicks LK, Garg ML. Antioxidant restriction and oxidative stress in short-duration exhaustive exercise. *Med Sci Sports Exerc* 2005; 37: 63-71.
- [4] Johnston CS. Biomarkers for establishing a tolerable upper intake level for vitamin C. *Nutr Rev* 1999; 57: 71-77.
- [5] Levine M, Padayatty SJ, Wang Y, et al. Vitamin C. In: Alexopolous Y, Hebberd K, editors. *Biochemical, Physiological, & Molecular Aspects of Human Nutrition*. Second Edition ed. St. Louis, Missouri: Elsevier 2006; 760-760-796.
- [6] May JM, Cobb CE, Mendiratta S, Hill KE, Burk RF. Reduction of the ascorbyl free radical to ascorbate by thioredoxin reductase. *J Biol Chem* 1998; 273: 23039-23045.
- [7] Johnston CS, Corte C, Swan PD. Marginal vitamin C status is associated with reduced fat oxidation during submaximal exercise in young adults. *Nutr Metab (Lond)* 2006; 3: 35.
- [8] Halliwell B. Vitamin C and genomic stability. *Mutat Res* 2001; 475: 29-35.
- [9] Buettner GR, Jurkiewicz BA. Catalytic metals, ascorbate and free radicals: combinations to avoid. *Radiat Res* 1996; 145: 532-541.
- [10] Polidori MC, Mecocci P, Levine M, Frei B. Short-term and long-term vitamin C supplementation in humans dose-dependently increases the resistance of plasma to ex vivo lipid peroxidation. *Arch Biochem Biophys* 2004; 423: 109-115.
- [11] Carr AC, Frei B. Toward a new recommended dietary allowance for vitamin C based on antioxidant and health effects in humans. *Am J Clin Nutr* 1999; 69: 1086-1107.
- [12] Halliwell B. Oxygen radicals: a commonsense look at their nature and medical importance. *Med Biol* 1984; 62: 71-77.

- 
- [13] Carr A, Frei B. Does vitamin C act as a pro-oxidant under physiological conditions? *FASEB J* 1999; 13: 1007-1024.
- [14] Halliwell B. Vitamin C: poison, prophylactic or panacea? *Trends Biochem Sci* 1999; 24: 255-259.
- [15] Halliwell B. Reactive oxygen species in living systems: source, biochemistry, and role in human disease. *Am J Med* 1991; 91: 14S-22S.
- [16] Herbert V, Shaw S, Jayatilke E. Vitamin C-driven free radical generation from iron. *J Nutr* 1996; 126: 1213S-20S.
- [17] Burton GW, Wronska U, Stone L, Foster DO, Ingold KU. Biokinetics of dietary RRR- $\alpha$ -tocopherol in the male guinea pig at three dietary levels of vitamin C and two levels of vitamin E. Evidence that vitamin C does not "spare" vitamin E in vivo. *Lipids* 1990; 25: 199-210.
- [18] Hasnain BI, Mooradian AD. Recent trials of antioxidant therapy: what should we be telling our patients? *Cleve Clin J Med* 2004; 71: 327-334.
- [19] Cherubini A, Vigna GB, Zuliani G, Ruggiero C, Senin U, Fellin R. Role of antioxidants in atherosclerosis: epidemiological and clinical update. *Curr Pharm Des* 2005; 11: 2017-2032.
- [20] Ginter E. Chronic vitamin C deficiency increases the risk of cardiovascular diseases. *Bratisl Lek Listy* 2007; 108: 417-421.
- [21] Urso ML, Clarkson PM. Oxidative stress, exercise, and antioxidant supplementation. *Toxicology* 2003; 189: 41-54.
- [22] Goldfarb AH. Nutritional antioxidants as therapeutic and preventive modalities in exercise-induced muscle damage. *Can J Appl Physiol* 1999; 24: 249-266.
- [23] Watson TA, Callister R, Taylor R, Sibbritt D, MacDonald-Wicks LK, Garg ML. Antioxidant restricted diet increases oxidative stress during acute exhaustive exercise. *Asia Pac J Clin Nutr* 2003; 12 Suppl: S9.
- [24] Valko M, Leibfritz D, Moncol J, Cronin MT, Mazur M, Telser J. Free radicals and antioxidants in normal physiological functions and human disease. *Int J Biochem Cell* 2007; 39: 44-84.
- [25] Allen RG, Tresini M. Oxidative stress and gene regulation. *Free Radic Biol Med* 2000; 28: 463-499.
- [26] Droge W. Free radicals in the physiological control of cell function. *Physiol Rev* 2002; 82: 47-95.
- [27] Halliwell B, Cross CE. Oxygen-derived species: their relation to human disease and environmental stress. *Environ Health Perspect* 1994; 102 Suppl 10: 5-12.
- [28] Dalle-Donne I, Rossi R, Colombo R, Giustarini D, Milzani A. Biomarkers of oxidative damage in human disease. *Clin Chem* 2006; 52: 601-623.
- [29] Ji LL, Gomez-Cabrera MC, Vina J. Exercise and hormesis: activation of cellular antioxidant signaling pathway. *Ann N Y Acad Sci* 2006; 1067: 425-435.
- [30] Burke TM, Wolin MS. Hydrogen peroxide elicits pulmonary arterial relaxation and guanylate cyclase activation. *Am J Physiol* 1987; 252: H721-32.
- [31] Galter D, Mihm S, Droge W. Distinct effects of glutathione disulphide on the nuclear transcription factor kappa B and the activator protein-1. *Eur J Biochem* 1994; 221: 639-648.

- [32] Hehner SP, Breitkreutz R, Shubinsky G, et al. Enhancement of T cell receptor signaling by a mild oxidative shift in the intracellular thiol pool. *J Immunol* 2000; 165: 4319-4328.
- [33] Schmid E, El Benna J, Galter D, Klein G, Droge W. Redox priming of the insulin receptor beta-chain associated with altered tyrosine kinase activity and insulin responsiveness in the absence of tyrosine autophosphorylation. *FASEB J* 1998; 12: 863-870.
- [34] Chung HY, Cesari M, Anton S, et al. Molecular inflammation: Underpinnings of aging and age-related diseases. *Ageing Res Rev* 2008;.
- [35] Kukreja RC, Hess ML. The oxygen free radical system: from equations through membrane-protein interactions to cardiovascular injury and protection. *Cardiovasc Res* 1992; 26: 641-655.
- [36] Gonsette RE. Oxidative stress and excitotoxicity: a therapeutic issue in multiple sclerosis? *Mult Scler* 2007; 14: 22-34.
- [37] Jenner P. Oxidative stress in Parkinson's disease. *Ann Neurol* 2003; 53 Suppl 3: S26-36; discussion S36-8.
- [38] Bauerova K, Bezek A. Role of reactive oxygen and nitrogen species in etiopathogenesis of rheumatoid arthritis. *Gen Physiol Biophys* 1999; 18 Spec No: 15-20.
- [39] Halliwell B. Oxidative stress and cancer: have we moved forward? *Biochem J* 2007; 401: 1-11.
- [40] Andrade FH, Reid MB, Allen DG, Westerblad H. Effect of hydrogen peroxide and dithiothreitol on contractile function of single skeletal muscle fibres from the mouse. *J Physiol* 1998; 509 ( Pt 2): 565-575.
- [41] Oba T, Koshita M, Yamaguchi M. H<sub>2</sub>O<sub>2</sub> modulates twitch tension and increases Po of Ca<sup>2+</sup> release channel in frog skeletal muscle. *Am J Physiol* 1996; 271: C810-8.
- [42] Nashawati E, Dimarco A, Supinski G. Effects produced by infusion of a free radical-generating solution into the diaphragm. *Am Rev Respir Dis* 1993; 147: 60-65.
- [43] Aghdasi B, Zhang JZ, Wu Y, Reid MB, Hamilton SL. Multiple classes of sulfhydryls modulate the skeletal muscle Ca<sup>2+</sup> release channel. *J Biol Chem* 1997; 272: 3739-3748.
- [44] Favero TG, Zable AC, Abramson JJ. Hydrogen peroxide stimulates the Ca<sup>2+</sup> release channel from skeletal muscle sarcoplasmic reticulum. *J Biol Chem* 1995; 270: 25557-25563.
- [45] Reid MB. Nitric oxide, reactive oxygen species, and skeletal muscle contraction. *Med Sci Sports Exerc* 2001; 33: 371-376.
- [46] Powers SK, Jackson MJ. Exercise-induced oxidative stress: cellular mechanisms and impact on muscle force production. *Physiol Rev* 2008; 88: 1243-1276.
- [47] Jackson MJ. Free radicals generated by contracting muscle: by-products of metabolism or key regulators of muscle function? *Free Radic Biol Med* 2008; 44: 132-141.
- [48] Liu DF, Wang D, Stracher A. The accessibility of the thiol groups on G- and F-actin of rabbit muscle. *Biochem J* 1990; 266: 453-459.
- [49] Goldhaber JI, Qayyum MS. Oxygen free radicals and excitation-contraction coupling. *Antioxid Redox Signal* 2000; 2: 55-64.

- 
- [50] Salama G, Menshikova EV, Abramson JJ. Molecular interaction between nitric oxide and ryanodine receptors of skeletal and cardiac sarcoplasmic reticulum. *Antioxid Redox Signal* 2000; 2: 5-16.
- [51] Scherer NM, Deamer DW. Oxidative stress impairs the function of sarcoplasmic reticulum by oxidation of sulfhydryl groups in the Ca<sup>2+</sup>-ATPase. *Arch Biochem Biophys* 1986; 246: 589-601.
- [52] Haycock JW, Jones P, Harris JB, Mantle D. Differential susceptibility of human skeletal muscle proteins to free radical induced oxidative damage: a histochemical, immunocytochemical and electron microscopical study in vitro. *Acta Neuropathol* 1996; 92: 331-340.
- [53] Sachdev S, Davies KJ. Production, detection, and adaptive responses to free radicals in exercise. *Free Radic Biol Med* 2008; 44: 215-223.
- [54] Bloomer RJ. The role of nutritional supplements in the prevention and treatment of resistance exercise-induced skeletal muscle injury. *Sports Med* 2007; 37: 519-532.
- [55] Bloomer RJ, Goldfarb AH, Wideman L, McKenzie MJ, Consitt LA. Effects of acute aerobic and anaerobic exercise on blood markers of oxidative stress. *J Strength Cond Res* 2005; 19: 276-285.
- [56] Pizza FX, Peterson JM, Baas JH, Koh TJ. Neutrophils contribute to muscle injury and impair its resolution after lengthening contractions in mice. *J Physiol* 2005; 562: 899-913.
- [57] Rader EP, Song W, Van Remmen H, Richardson A, Faulkner JA. Raising the antioxidant levels within mouse muscle fibres does not affect contraction-induced injury. *Exp Physiol* 2006; 91: 781-789.
- [58] Radak Z, Chung HY, Koltai E, Taylor AW, Goto S. Exercise, oxidative stress and hormesis. *Ageing Res Rev* 2008; 7: 34-42.
- [59] Matsuo, M. and Kaneko, T. The chemistry of reactive oxygen species and related free radicals. In: Radak Z, editor. Free Radicals in exercise and aging Champaign, IL: *Human Kinetics* 2000; 1-33.
- [60] Fellman V, Raivio KO. Reperfusion injury as the mechanism of brain damage after perinatal asphyxia. *Pediatr Res* 1997; 41: 599-606.
- [61] Nishikawa T, Edelstein D, Du XL, et al. Normalizing mitochondrial superoxide production blocks three pathways of hyperglycaemic damage. *Nature* 2000; 404: 787-790.
- [62] Ceriello A. Postprandial hyperglycemia and diabetes complications: is it time to treat? *Diabetes* 2005; 54: 1-7.
- [63] Turrens JF. Mitochondrial formation of reactive oxygen species. *J Physiol* 2003; 552: 335-344.
- [64] Boveris A, Chance B. The mitochondrial generation of hydrogen peroxide. General properties and effect of hyperbaric oxygen. *Biochem J* 1973; 134: 707-716.
- [65] Boveris A, Cadenas E, Stoppani AO. Role of ubiquinone in the mitochondrial generation of hydrogen peroxide. *Biochem J* 1976; 156: 435-444.
- [66] Herrero A, Barja G. ADP-regulation of mitochondrial free radical production is different with complex I- or complex II-linked substrates: implications for the exercise paradox and brain hypermetabolism. *J Bioenerg Biomembr* 1997; 29: 241-249.

- [67] Salo DC, Donovan CM, Davies KJ. HSP70 and other possible heat shock or oxidative stress proteins are induced in skeletal muscle, heart, and liver during exercise. *Free Radic Biol Med* 1991; 11: 239-246.
- [68] Giulivi C. Functional implications of nitric oxide produced by mitochondria in mitochondrial metabolism. *Biochem J* 1998; 332 ( Pt 3): 673-679.
- [69] Nishino T, Okamoto K, Kawaguchi Y, et al. Mechanism of the conversion of xanthine dehydrogenase to xanthine oxidase: identification of the two cysteine disulfide bonds and crystal structure of a non-convertible rat liver xanthine dehydrogenase mutant. *J Biol Chem* 2005; 280: 24888-24894.
- [70] Javesghani D, Magder SA, Barreiro E, Quinn MT, Hussain SN. Molecular characterization of a superoxide-generating NAD(P)H oxidase in the ventilatory muscles. *Am J Respir Crit Care Med* 2002; 165: 412-418.
- [71] Xia R, Webb JA, Gnall LL, Cutler K, Abramson JJ. Skeletal muscle sarcoplasmic reticulum contains a NADH-dependent oxidase that generates superoxide. *Am J Physiol Cell Physiol* 2003; 285: C215-21.
- [72] Espinosa A, Leiva A, Pena M, et al. Myotube depolarization generates reactive oxygen species through NAD(P)H oxidase; ROS-elicited Ca<sup>2+</sup> stimulates ERK, CREB, early genes. *J Cell Physiol* 2006; 209: 379-388.
- [73] Bloomer RJ. Effect of exercise on oxidative stress biomarkers. *Adv Clin Chem* 2008; 46: 1-50.
- [74] Knight JA. *Free Radicals, antioxidants, aging, and disease*. 1999.
- [75] Rimbach G, Hohler D, Fischer A, et al. Methods to assess free radicals and oxidative stress in biological systems. *Arch Tierernahr* 1999; 52: 203-222.
- [76] Oh-ishi S, Heinecke JW, Ookawara T, et al. Role of Lipid and Lipoprotein Oxidation. In: Radak Z, editor. *Free Radicals in Exercise and Aging Champaign, IL: Human Kinetics* 2000; 211-258.
- [77] Davies MJ, Fu S, Wang H, Dean RT. Stable markers of oxidant damage to proteins and their application in the study of human disease. *Free Radic Biol Med* 1999; 27: 1151-1163.
- [78] Levine RL, Stadtman ER. Oxidative modification of proteins during aging. *Exp Gerontol* 2001; 36: 1495-1502.
- [79] Valko M, Izakovic M, Mazur M, Rhodes CJ, Telser J. Role of oxygen radicals in DNA damage and cancer incidence. *Mol Cell Biochem* 2004; 266: 37-56.
- [80] Halliwell B, Aruoma OI. DNA damage by oxygen-derived species. Its mechanism and measurement in mammalian systems. *FEBS Lett* 1991; 281: 9-19.
- [81] Lodovici M, Casalini C, Cariaggi R, Michelucci L, Dolara P. Levels of 8-hydroxydeoxyguanosine as a marker of DNA damage in human leukocytes. *Free Radic Biol Med* 2000; 28: 13-17.
- [82] Powers SK, Ji LL, Leeuwenburgh C. Exercise training-induced alterations in skeletal muscle antioxidant capacity: a brief review. *Med Sci Sports Exerc* 1999; 31: 987-997.
- [83] Elosua R, Molina L, Fito M, et al. Response of oxidative stress biomarkers to a 16-week aerobic physical activity program, and to acute physical activity, in healthy young men and women. *Atherosclerosis* 2003; 167: 327-334.



- 
- [84] Fatouros IG, Jamurtas AZ, Villiotou V, et al. Oxidative stress responses in older men during endurance training and detraining. *Med Sci Sports Exerc* 2004; 36: 2065-2072.
- [85] Rice-Evans CA, Miller NJ, Paganga G. Structure-antioxidant activity relationships of flavonoids and phenolic acids. *Free Radic Biol Med* 1996; 20: 933-956.
- [86] Mori TA, Woodman RJ, Burke V, Puddey IB, Croft KD, Beilin LJ. Effect of eicosapentaenoic acid and docosahexaenoic acid on oxidative stress and inflammatory markers in treated-hypertensive type 2 diabetic subjects. *Free Radic Biol Med* 2003; 35: 772-781.
- [87] Lara-Padilla E, Kormanovski A, Grave PA, Olivares-Corichi IM, Santillan RM, Hicks JJ. Increased antioxidant capacity in healthy volunteers taking a mixture of oral antioxidants versus vitamin C or E supplementation. *Adv Ther* 2007; 24: 50-59.
- [88] Roberts LJ, 2nd, Oates JA, Linton MF, et al. The relationship between dose of vitamin E and suppression of oxidative stress in humans. *Free Radic Biol Med* 2007; 43: 1388-1393.
- [89] Sumida S, Doi T, Sakurai M, Yoshioka Y, Okamura K. Effect of a single bout of exercise and beta-carotene supplementation on the urinary excretion of 8-hydroxydeoxyguanosine in humans. *Free Radic Res* 1997; 27: 607-618.
- [90] Kanter MM, Nolte LA, Holloszy JO. Effects of an antioxidant vitamin mixture on lipid peroxidation at rest and postexercise. *J Appl Physiol* 1993; 74: 965-969.
- [91] Ceriello A. New insights on oxidative stress and diabetic complications may lead to a "causal" antioxidant therapy. *Diabetes Care* 2003; 26: 1589-1596.
- [92] Li M, Pascual G, Glass CK. Peroxisome proliferator-activated receptor gamma-dependent repression of the inducible nitric oxide synthase gene. *Mol Cell Biol* 2000; 20: 4699-4707.
- [93] Ceriello A, Taboga C, Tonutti L, et al. Evidence for an independent and cumulative effect of postprandial hypertriglyceridemia and hyperglycemia on endothelial dysfunction and oxidative stress generation: effects of short- and long-term simvastatin treatment. *Circulation* 2002; 106: 1211-1218.
- [94] Christ M, Bauersachs J, Liebetrau C, Heck M, Gunther A, Wehling M. Glucose increases endothelial-dependent superoxide formation in coronary arteries by NAD(P)H oxidase activation: attenuation by the 3-hydroxy-3-methylglutaryl coenzyme A reductase inhibitor atorvastatin. *Diabetes* 2002; 51: 2648-2652.
- [95] Dobrucki LW, Kalinowski L, Dobrucki IT, Malinski T. Statin-stimulated nitric oxide release from endothelium. *Med Sci Monit* 2001; 7: 622-627.
- [96] Munzel T, Keaney JF, Jr. Are ACE inhibitors a "magic bullet" against oxidative stress? *Circulation* 2001; 104: 1571-1574.
- [97] Nickenig G, Harrison DG. The AT(1)-type angiotensin receptor in oxidative stress and atherogenesis: part I: oxidative stress and atherogenesis. *Circulation* 2002; 105: 393-396.
- [98] Freese R, Alfthan G, Jauhiainen M, et al. High intakes of vegetables, berries, and apples combined with a high intake of linoleic or oleic acid only slightly affect markers of lipid peroxidation and lipoprotein metabolism in healthy subjects. *Am J Clin Nutr* 2002; 76: 950-960.

- [99] Fisher-Wellman KH, Bloomer RJ. Acute exercise and oxidative stress: A 30 year history. In Press;.
- [100] Bloomer RJ, Goldfarb AH. Anaerobic exercise and oxidative stress: a review. *Can J Appl Physiol* 2004; 29: 245-263.
- [101] Ji LL. Exercise-induced modulation of antioxidant defense. *Ann N Y Acad Sci* 2002; 959: 82-92.
- [102] Ji LL, Hollander J. Antioxidant Defense: Effects of Aging and Exercise. In: Radak Z, editor. *Free Radicals in Exercise and Aging Champaign, IL: Human Kinetics* 2000; 35-72.
- [103] Gomez-Cabrera MC, Borrás C, Pallardo FV, Sastre J, Ji LL, Vina J. Decreasing xanthine oxidase-mediated oxidative stress prevents useful cellular adaptations to exercise in rats. *J Physiol* 2005; 567: 113-120.
- [104] Dillard CJ, Litov RE, Savin WM, Dumelin EE, Tappel AL. Effects of exercise, vitamin E, and ozone on pulmonary function and lipid peroxidation. *J Appl Physiol* 1978; 45: 927-932.
- [105] Davies KJ, Quintanilha AT, Brooks GA, Packer L. Free radicals and tissue damage produced by exercise. *Biochem Biophys Res Commun* 1982; 107: 1198-1205.
- [106] Ashton T, Rowlands CC, Jones E, et al. Electron spin resonance spectroscopic detection of oxygen-centred radicals in human serum following exhaustive exercise. *Eur J Appl Physiol Occup Physiol* 1998; 77: 498-502.
- [107] Ashton T, Young IS, Peters JR, et al. Electron spin resonance spectroscopy, exercise, and oxidative stress: an ascorbic acid intervention study. *J Appl Physiol* 1999; 87: 2032-2036.
- [108] Bailey DM, Young IS, McEneny J, et al. Regulation of free radical outflow from an isolated muscle bed in exercising humans. *Am J Physiol Heart Circ Physiol* 2004; 287: H1689-99.
- [109] Bailey DM, Lawrenson L, McEneny J, et al. Electron paramagnetic spectroscopic evidence of exercise-induced free radical accumulation in human skeletal muscle. *Free Radic Res* 2007; 41: 182-190.
- [110] Groussard C, Rannou-Bekono F, Machefer G, et al. Changes in blood lipid peroxidation markers and antioxidants after a single sprint anaerobic exercise. *Eur J Appl Physiol* 2003; 89: 14-20.
- [111] Davison GW, Ashton T, Davies B, Bailey DM. In vitro electron paramagnetic resonance characterization of free radicals: relevance to exercise-induced lipid peroxidation and implications of ascorbate prophylaxis. *Free Radic Res* 2008; 42: 379-386.
- [112] Kingsley MI, Kilduff LP, McEneny J, Dietzig RE, Benton D. Phosphatidylserine supplementation and recovery following downhill running. *Med Sci Sports Exerc* 2006; 38: 1617-1625.
- [113] Maughan RJ, Donnelly AE, Gleeson M, Whiting PH, Walker KA, Clough PJ. Delayed-onset muscle damage and lipid peroxidation in man after a downhill run. *Muscle Nerve* 1989; 12: 332-336.

- [114] Sacheck JM, Decker EA, Clarkson PM. The effect of diet on vitamin E intake and oxidative stress in response to acute exercise in female athletes. *Eur J Appl Physiol* 2000; 83: 40-46.
- [115] Sacheck JM, Milbury PE, Cannon JG, Roubenoff R, Blumberg JB. Effect of vitamin E and eccentric exercise on selected biomarkers of oxidative stress in young and elderly men. *Free Radic Biol Med* 2003; 34: 1575-1588.
- [116] Goto C, Higashi Y, Kimura M, et al. Effect of different intensities of exercise on endothelium-dependent vasodilation in humans: role of endothelium-dependent nitric oxide and oxidative stress. *Circulation* 2003; 108: 530-535.
- [117] Goto C, Nishioka K, Umemura T, et al. Acute moderate-intensity exercise induces vasodilation through an increase in nitric oxide bioavailability in humans. *Am J Hypertens* 2007; 20: 825-830.
- [118] Bloomer RJ, Davis PG, Consitt LA, Wideman L. Plasma protein carbonyl response to increasing exercise duration in aerobically trained men and women. *Int J Sports Med* 2007; 28: 21-25.
- [119] Sacheck JM, Cannon JG, Hamada K, Vannier E, Blumberg JB, Roubenoff R. Age-related loss of associations between acute exercise-induced IL-6 and oxidative stress. *Am J Physiol Endocrinol Metab* 2006; 291: E340-9.
- [120] Knez WL, Jenkins DG, Coombes JS. Oxidative stress in half and full Ironman triathletes. *Med Sci Sports Exerc* 2007; 39: 283-288.
- [121] Niess AM, Simon P. Response and adaptation of skeletal muscle to exercise--the role of reactive oxygen species. *Front Biosci* 2007; 12: 4826-4838.
- [122] Vollaard NB, Shearman JP, Cooper CE. Exercise-induced oxidative stress: myths, realities and physiological relevance. *Sports Med* 2005; 35: 1045-1062.
- [123] Davison GW, Ashton T, George L, et al. Molecular detection of exercise-induced free radicals following ascorbate prophylaxis in type 1 diabetes mellitus: a randomised controlled trial. *Diabetologia* 2008; 51: 2049-2059.
- [124] Ashton T, Young IS, Davison GW, et al. Exercise-induced endotoxemia: the effect of ascorbic acid supplementation. *Free Radic Biol Med* 2003; 35: 284-291.
- [125] Alessio HM, Goldfarb AH, Cao G. Exercise-induced oxidative stress before and after vitamin C supplementation. *Int J Sport Nutr* 1997; 7: 1-9.
- [126] Vasankari T, Kujala U, Sarna S, Ahotupa M. Effects of ascorbic acid and carbohydrate ingestion on exercise induced oxidative stress. *J Sports Med Phys Fitness* 1998; 38: 281-285.
- [127] Nakhostin-Roohi B, Babaei P, Rahmani-Nia F, Bohlooli S. Effect of vitamin C supplementation on lipid peroxidation, muscle damage and inflammation after 30-min exercise at 75% VO<sub>2</sub>max. *J Sports Med Phys Fitness* 2008; 48: 217-224.
- [128] Buettner GR, Jurkiewicz BA. Ascorbate free radical as a marker of oxidative stress: an EPR study. *Free Radic Biol Med* 1993; 14: 49-55.
- [129] Goldfarb AH, Patrick SW, Bryer S, You T. Vitamin C supplementation affects oxidative-stress blood markers in response to a 30-minute run at 75% VO<sub>2</sub>max. *Int J Sport Nutr Exerc Metab* 2005; 15: 279-290.

- [130] Bryant RJ, Ryder J, Martino P, Kim J, Craig BW. Effects of vitamin E and C supplementation either alone or in combination on exercise-induced lipid peroxidation in trained cyclists. *J Strength Cond Res* 2003; 17: 792-800.
- [131] Nieman DC, Henson DA, McAnulty SR, et al. Influence of vitamin C supplementation on oxidative and immune changes after an ultramarathon. *J Appl Physiol* 2002; 92: 1970-1977.
- [132] Palmer FM, Nieman DC, Henson DA, et al. Influence of vitamin C supplementation on oxidative and salivary IgA changes following an ultramarathon. *Eur J Appl Physiol* 2003; 89: 100-107.
- [133] Tauler P, Aguilo A, Gimeno I, Fuentespina E, Tur JA, Pons A. Influence of vitamin C diet supplementation on endogenous antioxidant defences during exhaustive exercise. *Pflugers Arch* 2003; 446: 658-664.
- [134] Davison G, Gleeson M. The effect of 2 weeks vitamin C supplementation on immunoendocrine responses to 2.5 h cycling exercise in man. *Eur J Appl Physiol* 2006; 97: 454-461.
- [135] Roberts LJ, 2nd, Oates JA, Linton MF, et al. The relationship between dose of vitamin E and suppression of oxidative stress in humans. *Free Radic Biol Med* 2007; 43: 1388-1393.
- [136] Close GL, Ashton T, Cable T, et al. Ascorbic acid supplementation does not attenuate post-exercise muscle soreness following muscle-damaging exercise but may delay the recovery process. *Br J Nutr* 2006; 95: 976-981.
- [137] Thompson D, Bailey DM, Hill J, Hurst T, Powell JR, Williams C. Prolonged vitamin C supplementation and recovery from eccentric exercise. *Eur J Appl Physiol* 2004; 92: 133-138.
- [138] Jakeman P, Maxwell S. Effect of antioxidant vitamin supplementation on muscle function after eccentric exercise. *Eur J Appl Physiol Occup Physiol* 1993; 67: 426-430.
- [139] Chan AC, Tran K, Raynor T, Ganz PR, Chow CK. Regeneration of vitamin E in human platelets. *J Biol Chem* 1991; 266: 17290-17295.
- [140] Sastre J, Asensi M, Gasco E, et al. Exhaustive physical exercise causes oxidation of glutathione status in blood: prevention by antioxidant administration. *Am J Physiol* 1992; 263: R992-5.
- [141] Goldfarb AH, McKenzie MJ, Bloomer RJ. Gender comparisons of exercise-induced oxidative stress: influence of antioxidant supplementation. *Appl Physiol Nutr Metab* 2007; 32: 1124-1131.
- [142] Bloomer RJ, Goldfarb AH, McKenzie MJ. Oxidative stress response to aerobic exercise: comparison of antioxidant supplements. *Med Sci Sports Exerc* 2006; 38: 1098-1105.
- [143] Davison GW, Hughes CM, Bell RA. Exercise and mononuclear cell DNA damage: the effects of antioxidant supplementation. *Int J Sport Nutr Exerc Metab* 2005; 15: 480-492.
- [144] Meijer EP, Goris AH, Senden J, van Dongen JL, Bast A, Westerterp KR. Antioxidant supplementation and exercise-induced oxidative stress in the 60-year-old as measured by antipyrine hydroxylates. *Br J Nutr* 2001; 86: 569-575.

- [145] Bloomer RJ, Falvo MJ, Schilling BK, Smith WA. Prior exercise and antioxidant supplementation: effect on oxidative stress and muscle injury. *J Int Soc Sports Nutr* 2007; 4: 9.
- [146] Tauler P, Aguilo A, Gimeno I, Fuentespina E, Tur JA, Pons A. Response of blood cell antioxidant enzyme defences to antioxidant diet supplementation and to intense exercise. *Eur J Nutr* 2006; 45: 187-195.
- [147] Sureda A, Tauler P, Aguilo A, et al. Influence of an antioxidant vitamin-enriched drink on pre- and post-exercise lymphocyte antioxidant system. *Ann Nutr Metab* 2008; 52: 233-240.
- [148] Palazzetti S, Rousseau AS, Richard MJ, Favier A, Margaritis I. Antioxidant supplementation preserves antioxidant response in physical training and low antioxidant intake. *Br J Nutr* 2004; 91: 91-100.
- [149] Davison G, Gleeson M, Phillips S. Antioxidant supplementation and immunoendocrine responses to prolonged exercise. *Med Sci Sports Exerc* 2007; 39: 645-652.
- [150] Dawson B, Henry GJ, Goodman C, et al. Effect of Vitamin C and E supplementation on biochemical and ultrastructural indices of muscle damage after a 21 km run. *Int J Sports Med* 2002; 23: 10-15.
- [151] Margaritis I, Palazzetti S, Rousseau AS, Richard MJ, Favier A. Antioxidant supplementation and tapering exercise improve exercise-induced antioxidant response. *J Am Coll Nutr* 2003; 22: 147-156.
- [152] Rokitzki L, Logemann E, Sagredos AN, Murphy M, Wetzel-Roth W, Keul J. Lipid peroxidation and antioxidative vitamins under extreme endurance stress. *Acta Physiol Scand* 1994; 151: 149-158.
- [153] Machefer G, Groussard C, Vincent S, et al. Multivitamin-mineral supplementation prevents lipid peroxidation during "the Marathon des Sables". *J Am Coll Nutr* 2007; 26: 111-120.
- [154] Mastaloudis A, Traber MG, Carstensen K, Widrick JJ. Antioxidants did not prevent muscle damage in response to an ultramarathon run. *Med Sci Sports Exerc* 2006; 38: 72-80.
- [155] You T, Goldfarb AH, Bloomer RJ, Nguyen L, Sha X, McKenzie MJ. Oxidative stress response in normal and antioxidant supplemented rats to a downhill run: changes in blood and skeletal muscles. *Can J Appl Physiol* 2005; 30: 677-689.
- [156] Bloomer RJ, Goldfarb AH, McKenzie MJ, You T, Nguyen L. Effects of antioxidant therapy in women exposed to eccentric exercise. *Int J Sport Nutr Exerc Metab* 2004; 14: 377-388.
- [157] Richardson JH, Allen RB. Dietary supplementation with vitamin C delays the onset of fatigue in isolated striated muscle of rats. *Can J Appl Sport Sci* 1983; 8: 140-142.
- [158] Bryer SC, Goldfarb AH. Effect of high dose vitamin C supplementation on muscle soreness, damage, function, and oxidative stress to eccentric exercise. *Int J Sport Nutr Exerc Metab* 2006; 16: 270-280.
- [159] Aguilo A, Tauler P, Sureda A, Cases N, Tur J, Pons A. Antioxidant diet supplementation enhances aerobic performance in amateur sportsmen. *J Sports Sci* 2007; 25: 1203-1210.

- [160] White A, Estrada M, Walker K, et al. Role of exercise and ascorbate on plasma antioxidant capacity in thoroughbred race horses. *Comp Biochem Physiol A Mol Integr Physiol* 2001; 128: 99-104.
- [161] Marquez R, Santangelo G, Sastre J, et al. Cyanoside chloride and chromocarbe diethylamine are more effective than vitamin C against exercise-induced oxidative stress. *Pharmacol Toxicol* 2001; 89: 255-258.
- [162] Judge AR, Selsby JT, Dodd SL. Antioxidants attenuate oxidative damage in rat skeletal muscle during mild ischaemia. *Exp Physiol* 2008; 93: 479-485.
- [163] Deaton CM, Marlin DJ, Roberts CA, et al. Antioxidant supplementation and pulmonary function at rest and exercise. *Equine Vet J Suppl* 2002; (34): 58-65.
- [164] Williams CA, Kronfeldt DS, Hess TM, et al. Antioxidant supplementation and subsequent oxidative stress of horses during an 80-km endurance race. *J Anim Sci* 2004; 82: 588-594.
- [165] Marshall RJ, Scott KC, Hill RC, et al. Supplemental vitamin C appears to slow racing greyhounds. *J Nutr* 2002; 132: 1616S-21S.
- [166] Gomez-Cabrera MC, Domenech E, Romagnoli M, et al. Oral administration of vitamin C decreases muscle mitochondrial biogenesis and hampers training-induced adaptations in endurance performance. *Am J Clin Nutr* 2008; 87: 142-149.
- [167] Kaminski M, Boal R. An effect of ascorbic acid on delayed-onset muscle soreness. *Pain* 1992; 50: 317-321.
- [168] Connolly DA, Lauzon C, Agnew J, Dunn M, Reed B. The effects of vitamin C supplementation on symptoms of delayed onset muscle soreness. *J Sports Med Phys Fitness* 2006; 46: 462-467.
- [169] Falvo MJ, Bloomer RJ. Review of exercise-induced muscle injury: relevance for athletic populations. *Res Sports Med* 2006; 14: 65-82.
- [170] Thompson D, Williams C, Kingsley M, et al. Muscle soreness and damage parameters after prolonged intermittent shuttle-running following acute vitamin C supplementation. *Int J Sports Med* 2001; 22: 68-75.
- [171] Thompson D, Williams C, Garcia-Roves P, McGregor SJ, McArdle F, Jackson MJ. Post-exercise vitamin C supplementation and recovery from demanding exercise. *Eur J Appl Physiol* 2003; 89: 393-400.
- [172] Thompson D, Williams C, McGregor SJ, et al. Prolonged vitamin C supplementation and recovery from demanding exercise. *Int J Sport Nutr Exerc Metab* 2001; 11: 466-481.
- [173] Goldfarb AH, Bloomer RJ, McKenzie MJ. Combined antioxidant treatment effects on blood oxidative stress after eccentric exercise. *Med Sci Sports Exerc* 2005; 37: 234-239.
- [174] Childs A, Jacobs C, Kaminski T, Halliwell B, Leeuwenburgh C. Supplementation with vitamin C and N-acetyl-cysteine increases oxidative stress in humans after an acute muscle injury induced by eccentric exercise. *Free Radic Biol Med* 2001; 31: 745-753.
- [175] Shafat A, Butler P, Jensen RL, Donnelly AE. Effects of dietary supplementation with vitamins C and E on muscle function during and after eccentric contractions in humans. *Eur J Appl Physiol* 2004; 93: 196-202.

- 
- [176] Schroder H, Navarro E, Mora J, Galiano D, Tramullas A. Effects of alpha-tocopherol, beta-carotene and ascorbic acid on oxidative, hormonal and enzymatic exercise stress markers in habitual training activity of professional basketball players. *Eur J Nutr* 2001; 40: 178-184.
- [177] Sharman IM, Down MG, Sen RN. The effects of vitamin E and training on physiological function and athletic performance in adolescent swimmers. *Br J Nutr* 1971; 26: 265-276.
- [178] Malm C, Svensson M, Sjoberg B, Ekblom B, Sjodin B. Supplementation with ubiquinone-10 causes cellular damage during intense exercise. *Acta Physiol Scand* 1996; 157: 511-512.
- [179] Gomez-Cabrera MC, Pallardo FV, Sastre J, Vina J, Garcia-del-Moral L. Allopurinol and markers of muscle damage among participants in the Tour de France. *JAMA* 2003; 289: 2503-2504.
- [180] Zoppi CC, Hohl R, Silva FC, et al. Vitamin C and e supplementation effects in professional soccer players under regular training. *J Int Soc Sports Nutr* 2006; 3: 37-44.
- [181] Radak Z, Taylor AW, Ohno H, Goto S. Adaptation to exercise-induced oxidative stress: from muscle to brain. *Exerc Immunol Rev* 2001; 7: 90-107.





---

## Human Specific Vitamin C Metabolism and Xenobiotic Polymorphism: The Optimal Nutrition

---

*Yasuo Kagawa<sup>+</sup>, Shizu Higasa<sup>±</sup>, Masaru Tsujimura, Fumio Komatsu,  
Yoshiko Yanagisawa\* and Sadahiko Iwamoto\**

High Technology Center, Kagawa Nutrition University, Sakado, Japan

### Abstract

The biomedical significance of human vitamin C (VC) metabolism is reviewed in the light of polymorphisms in xenobiotic enzymes deduced from genetic, biochemical, and epidemiological results to estimate optimal nutrition. VC comprises both ascorbic acid (AsA) and dehydroascorbic acid (DAsA). AsA is oxidized to DAsA via short-lived monodehydroascorbate radicals in a series of xenobiotic reactions and by reactive oxygen species (ROS). DAsA is reversibly reduced by glutaredoxin, but is also irreversibly hydrolyzed into 2,3-diketo-L-gulonate by dehydroascorbatase [EC 3.1.1.17] and non-enzymatic reactions. VC is a cofactor in reactions catalyzed by Cu<sup>+</sup>-dependent monooxygenases [EC 1.13.12.-] and Fe<sup>2+</sup>-dependent dioxygenases [EC 1.13.11.-]. VC plays a protective role against oxidative stress by ROS and xenobiotics, via monodehydroascorbate radicals. The Vitamin Society of Japan has re-evaluated old data because of the development of life science. The recommended dietary allowance (RDA) of VC is 100 mg/day for adults in Japan to prevent scurvy. RDA is defined as EAR+2SD, i.e. estimated average requirement (EAR) and the standard deviation (SD) obtained by short-term depletion-repletion studies. However, based on VC synthetic rates

---

<sup>+</sup> Manuscript correspondence: Yasuo Kagawa, High Technology Center, Kagawa Nutrition University, 3-9-21 Chiyoda, Sakado, Saitama 350-0288, Japan, E-mail: kagawa@eiyo.ac.jp

<sup>±</sup> E-mail of coauthors: higasa@eiyo.ac.jp, tmasaru@eiyo.ac.jp, komatsu@eiyo.ac.jp, yyanagi@jichi.ac.jp, siwamoto@jichi.ac.jp, Fax/Phone: +81-49-282-3618

\* Division of Human Genetics, Jichi Medical School, Shimotsuke, Tochigi 329-0498, Japan

in rat, Pauling proposed that the optimum intake is 2.3 g/day. This is the problem of RDA *vs.* optimal nutrition. Optimal nutrition is wider in scope than RDA that covers genetic polymorphisms, long-term health outcome during the lifespan, and xenobiotics. Humans (VC auxotrophs) have relatively low plasma AsA levels and high serum uric acid levels compared to most VC-synthesizing mammals (VC autotrophs) due to gene defects in L-gulonolactone oxidase (GLO [EC 1.1.3.8]) and uricase (urate oxidase) [EC 1.7.3.3], respectively. Extrapolation of metabolic data of VC autotrophs to estimate human optimal nutrition is limited because of the compensatory mechanism for the GLO defect in VC auxotrophs, including DAsA transport by GLUT1, and specific mutations in uricase and dehydroascorbate. Beneficial effects of long-term VC supplementation remain controversial, perhaps because of 1. genetic heterogeneity in study populations, and 2. the balance of antioxidant and pro-oxidant activities of VC depending on the xenobiotic conditions. Thus, in addition to the biochemical studies on AsA and DAsA, human genetic analysis on VC-loading experiments and epidemiological survey are needed. There are marked interindividual differences (coefficient of variation >45%) in the metabolism of VC. This difference is evident during oral loading with 1 mmol AsA or DAsA in subjects consuming a diet low in VC (less than 5 mg/day) for 3 days before loading in the cross-over experiment. Since tubular maximum reabsorption of AsA (TmAsA) and glomerular filtration rate (GFR) are similar among subjects, degradation steps of VC may be involved in the personal difference. The metabolisms of three most important water-soluble antioxidants in mammals i.e. VC, urate and glutathione are different in humans and other animals. The effects of polymorphism A313G (Ile105Val) in the gene for glutathione S-transferase P1 (GSTP1) [EC 2.5.1.18], one of the most active xenobiotic enzymes in the second phase of detoxification, on human VC metabolism were thus studied. In an epidemiologic survey of Mongolians (n = 164) with very low VC intake, serum VC concentration was only 28%, and the level of reactive oxygen metabolites was 128%, when compared with those in Japanese. The variant frequency of GSTP1 among Japanese subjects (n = 210) was AA, 71.0%; GA, 27.0% and GG, 1.9%. In Mongolian subjects (n = 93), it was AA, 62.4%; GA, 36.6%; and GG, 1.1%. In VC loading experiments, at 24 h after administration of 1 mmol of VC to young women (n = 17; age, 21.0 ± 1.1 y, glomerular filtration rate, GFR = 90 ml/min), total VC excretion (46.7 ± 18.1 mg) by AA homozygotes of GSTP1 was greater (p < 0.0069) than that (28.2 ± 14.0 mg) by GA heterozygotes. One hour after administration of VC, blood total VC levels were also significantly different (p < 0.0036) between the homozygotes and heterozygotes. The results of background experiments were as follows: (1) the VC level in 24-h urine after VC loading did not differ between the two orally administered C forms (AsA and DAsA); (2) VC excretion between 0 and 3 h after VC loading was significantly higher (p < 0.05) for DAsA, while those between 3 and 6, 6 and 9, 9 and 12, and 12 and 24 h after VC loading were significantly higher (p < 0.05 or p < 0.01) for AsA; and (3) blood VC concentrations and the increase in VC at 1 h after VC loading were significantly higher (p < 0.05 and p < 0.01, respectively) in the DAsA group than in the AsA group. The difference between AsA and DAsA dynamics in (2) and (3) may be explained by the sodium-dependent active transport of AsA by SVCT1 and 2, and passive transport of DAsA by glucose transporters (GLUTs) in the presence of glutathione. The large species differences in DAsA metabolism are partly explained by the low activity of human dehydroascorbate, which has a unique structure, as deduced by X-ray crystallography, and a unique sequence of 299 amino acids. The anti-oxidant and anti-xenobiotic roles of monodehydroascorbate radicals both *in vivo* and *in vitro* are important. ROS are generated mainly in mitochondria but DAsA transported through GLUT1 into mitochondria is converted into AsA and prevents oxidative stress. Finally

RDA and optimal nutrition are discussed from the standpoint of human specific metabolism of VC including prevention against ROS produced by exercise and pathological conditions.

## Abbreviations

(Standard abbreviations of International Union of Biochemistry and Molecular Biology are omitted)

AsA: ascorbic acid

CMV: cytomegalovirus

DAsA: dehydroascorbic acid

DG: dietary goal

EAR: estimated average requirement

EC: Enzyme Commission numbers

GFR: glomerular filtration rate

GLO: L-gulonolactone oxidase [EC 1.1.3.8]

GLUT: glucose transporter

GSH: reduced glutathione: 5-L-glutamyl-L-cysteinyl-glycine

GSSG: oxidized glutathione

GSTO: omega class glutathione transferase

GSTP: glutathione S transferase P [EC 2.5.1.18]

KO: knockout (mice)

8OhdG: 8-oxo-7,8-dihydro-2'-deoxyguanosine

RDA: recommended dietary allowance

ROM: reactive oxygen metabolites

ROS: reactive oxygen species

SD: standard deviation

SOD: superoxide dismutase [EC 1.15.1.1]

SVCT: sodium vitamin C co-transporter

TmAsA: tubular maximum reabsorption of ascorbic acid

UL: tolerable upper limit

VC: vitamin C

## Introduction

In this review article, the biomedical significance of human specific vitamin C (VC) metabolism [1-8] and the effects of polymorphisms in xenobiotic enzymes [5, 8] will be presented based on our experimental results [3-9] to seek optimal human nutrition for VC. VC is a potent antioxidant [10-12] and a cofactor in reactions catalyzed by Cu<sup>+</sup>-dependent monooxygenases (such as dopamine- $\beta$ -hydroxylase [EC 1.14.16.2]) and Fe<sup>2+</sup>-dependent dioxygenases (such as collagen prolyl 4-hydroxylase [EC 1.14.11.2]) [1]. Redox homeostasis is an intricate balance between oxidative and reductive events in the cell and VC plays an

important role in the modulation of the cellular redox state [13]. Oxidative stress caused by xenobiotic substances and reactive oxygen species (ROS) [14] may be removed by VC and other antioxidants [10, 15, 16]. The removal of ROS is vital to the prevention of diabetes and aging [7, 10, 14, 16], as the free radical theory of aging posits that oxidative stress is among the major mechanisms in aging and age-related diseases [7, 10, 14]. To address these problems, both metabolic studies and epidemiological surveys are needed.

### (1) Metabolism of VC and Oxidative Stress

VC is classified into a reduced form, L-ascorbic acid (AsA), and an oxidized form, L-dehydroascorbic acid (DAsA). VC plays a protective role against oxidative stress and xenobiotics *in vivo* [1, 10, 14]. AsA is converted into DAsA by reacting with ROS and xenobiotics via monodehydroascorbate radicals, which are rapidly reduced by various reductases back to AsA [1, 2]. Monodehydroascorbate radicals, a major oxidation product of AsA under oxidative stress, are reconverted to AsA in the cytosol by cytochrome b5 reductase [EC 1.6.2.2] and thioredoxin reductase [EC 1.6.4.5] in reactions involving NADH and NADPH, respectively [1]. The dismutation of a pair of monodehydroascorbate radicals produces one molecule of AsA and one of DAsA. DAsA is spontaneously reduced to AsA by glutathione [1], as well as enzymatically in reactions mediated by glutaredoxin etc. [2]. The irreversible step of VC catabolism is the delactonization of DAsA into 2, 3-diketo-L-gulonate by dehydroascorbatase (gluconolactonase) [EC 3.1.1.17] [3].

ROS are generated continuously by intracellular oxidative events and mitochondria contribute significantly to the production of intracellular ROS [15], which can modify the biological activity of enzymes, modulate intracellular signaling events, and damage biological macromolecules [16]. The mitochondrial DNA has been shown to be extremely susceptible to the mutagenic effects of ROS [16]. Loading cells with VC reduces oxidative cell death [17, 18], inhibits FAS-induced apoptosis [19].

In contrast to the antioxidant properties of VC, pro-oxidant properties have also been described [12, 20, 21]. It has been amply documented that AsA added to the medium of a cell culture increases oxidative damage, and this effect of AsA has been ascribed to the generation of reactive oxygen intermediates in the medium during its auto-oxidation. This effect is also exerted inside the cell as well [20]. This will be discussed in the section (7) of discussion.

VC is synthesized in most mammals (VC autotrophs) by an active five-enzyme process that begins with an activated form of glucose, UDP-glucose and ends with L-gulonolactone oxidase (GLO) which is missing in humans [1, 22]. Humans are VC auxotrophs and have relatively low plasma VC levels [23] and high serum uric acid levels [24] compared to VC autotrophs due to the destructions in genes for GLO and uricase, respectively [25]. Moreover, expression of erythrocyte facilitative glucose transporter 1 (GLUT1) is a specific trait of VC auxotrophs, comprising only higher primates [22, 26], guinea pigs [27], and fruit bats [26]. Human GLUT1 is a very active DAsA transporter by expressing stomatin, which increases the affinity of GLUT1 for DAsA, and transported DAsA is conserved as stable AsA [26]. Because VC auxotrophs genetically compensate for the defective GLO [25, 26], human *in*

*vivo* studies [4, 5, 8] are needed to determine nutritional requirement of VC and to elucidate the effects of polymorphisms in xenobiotic enzymes [4, 5].

## (2) Recommended Dietary Allowances (RDA) for VC and Optimal Nutrition

The recommended dietary allowance (RDA) is based on the estimated average requirement (EAR: the intake sufficient to satisfy the needs of 50% of the subjects and the standard deviation (SD) obtained by balancing studies on large numbers of subjects [28]. Therefore, RDA (defined as EAR+2SD) is intended to cover the nutritional requirements of 97.5% of subjects. In May 2005, RDAs for VC as part of “Dietary Reference Intakes for Japanese, 2005” were released by the Ministry of Health, Labor, and Welfare, Japan [28]. For both men and women from 12 years to over 70 years, an EAR of 85 mg/day was determined from depletion–repletion data [28]. On the basis of this value, considering the coefficient of variation (SD/EAR = 10 %) for interindividual difference, an RDA of 100 mg/day (RDA = EAR+2SD) was derived for both men and women from 12 years to over 70 years [28]. Because similar data were not available for children, an EAR had to be extrapolated on the basis of standard body weight differences and growth factors [28]. RDAs for VC are 90 mg/day for men and 75 mg/day for women in U. S. A. (RDA 2000, for detailed recent values, see section (9) of discussion) [29].

However, Pauling pointed out that the RDA is less than the optimum intake, corresponding to the best health [30]. Based on synthetic rates of VC in rat, 58mg/day/kg body weight, he concluded that the optimum daily intake is about 2.3 g or more, for an adult with energy requirement 2500 kcal/day [30]. This is the problem of RDA *vs.* optimal nutrition [31]. Optimal nutrition for VC covers wider scope than RDA due to the following three reasons: polymorphism, long-term outcome and xenobiotics [31].

**Polymorphism:** The statistics of the RDAs assumes nearly normal distribution of the data [28], which is not always true in populations composed of many genetic polymorphisms [5, 8, 31]. For example, the guideline recommends ethanol intake <20g/day, but some people become intoxicated by only 1g/day, while others can drink 200g/day without significant impaired performance [31]. Optimal personalized nutrition based on polymorphism enables not only appropriate treatment but also prediction of the risk for prophylaxis [31]. Genome-wide association studies on 1,000,000 polymorphisms are used to determine optimal personalized nutrition [32].

**Long term outcome:** Development of a common disease such as atherosclerosis is the result of long-term tissue damage under suboptimal VC intake especially in the presence of oxidative stress [9, 11, 14], but RDA is based on short-term balance studies [28, 29]. Optimal nutrition is based on long-term follow-up studies, while RDA does not [31].

**Xenobiotics:** RDAs for VC are determined on hospitalized subjects [29] in the absence of xenobiotic. A xenobiotic is a chemical which is found in an organism but which is not normally produced or expected to be present in it. It can also cover substances which are present in much higher concentrations than are usual. Specifically, smoking produces various xenobiotics in humans because the human body does not produce them itself, nor are they

part of a normal diet. Metabolism of VC is increased to detoxify xenobiotics as will be discussed in section (4).

In order to evaluate the VC item in the RDAs for Japanese, following the plan of the Vitamin C Research Committee, Vitamin Society of Japan, we have performed depletion-repletion studies in humans [4]. We selected human subjects instead of other animals because humans are unable to synthesize VC [1, 22, 25], and are unable to decompose uric acid [24, 25]. Uric acid, despite being a major antioxidant in human plasma, is both correlated with and predictive of development of cardiovascular disease, conditions associated with oxidative stress [25]. The pro-oxidative effects of uric acid are thought to be involved in cardiovascular disease [24]. VC, as well as vitamin E (VE), is known to be one of the major physiological antioxidants based on *in vivo* experiments [11, 12, 33], *in vitro* chemical reactions [1, 14-16, 34] and numerous epidemiological studies on the incidence of cardiovascular diseases and intake of these antioxidants [10, 33].

We have surveyed Mongolian individuals, whose average lifespan (male, 62 years; female, 69 years; WHO World Health Report, 2005) is much shorter than that of Japanese (male, 79 years; female, 85 years), perhaps because of lower blood VC and VE when compared to levels in Japanese [6], and higher levels oxidative stress [9]. However, interventional trials on the long-term administration of these vitamins have been controversial [10, 33]. For example, in the large (14,641 males), 10-year Physicians' Health Study II randomized controlled trial, VC supplementation (500 mg/day) did not reduce the risk of major cardiovascular events [33]. These data provide no support for the use of these supplements for the prevention of cardiovascular disease in middle-aged and older men [10, 33]. The other antioxidant tested, VE (400 IU/day), was associated with an increased risk of stroke (HR, 1.74 [95% CI, 1.04 - 2.91]) [10, 33]. The discrepancy in the preventive effects of antioxidants may partly result from genetic heterogeneity in the study populations, which limits generalization to other populations. Another cause of the discrepancy may be the pro-oxidant property of VC depending on the condition [20, 21].

### (3) Polymorphism of Xenobiotic Enzymes and VC Metabolism

The completion of the Human Genome Project in 2003, after RDAs for VC had been determined [28, 29], made it possible to find the genetic contributions to diseases and analyze whole-genome samples for genetic variations that contribute to their onset [32]. In genetic epidemiology, a genome-wide association study (GWAS) is an examination of genetic variation across a given genome, designed to identify genetic associations with observable traits [32]. If genetic variations are more frequent in people with the disease, the variations are said to be "associated" with the disease. The associated genetic variations are then considered pointers to the region of the human genome where the disease-causing problem resides. Since the entire genome is analyzed for the genetic associations of a particular disease, this technique allows the genetics of a disease to be investigated in a non-hypothesis-driven manner. In human studies, this might include interindividual difference in VC metabolism [5, 8]. Polymorphisms in genes involved in VC/VE uptake, distribution, metabolism and molecular action may be important determinants for the protective effects of

VC/VE supplementation [10, 33]. Cellular damage by ROS is protected by VC [17, 18, 34]. For example, haptoglobin 2-2 polymorphism is associated with increased production of ROS, and reduces levels of VE and VC [35]. Polymorphisms in xenobiotic enzymes, particularly A313G (Ile105Val) in the gene for glutathione S-transferase P1 (GSTP1) [EC 2.5.1.18] [36-39], have been shown to affect VC metabolism *in vivo* [5, 8]. In a metabolism study, oral loading of DAsA or AsA was performed in subjects who had had a low C diet for 3 days, and VC in the urine and blood was measured [4]. During VC loading human experiments, marked interindividual differences (coefficient of variation (Cv) > 45%) in excretion of total VC has been reported [4, 5]. These large differences may not be due to differences in the VC transport system [26, 40, 41], because estimated tubular maximum absorption of AsA (TmAsA) and glomerular filtration rate (GFR) were similar among the subjects. These transport systems are responsible for the homeostasis of serum VC, in response to VC intake and metabolism [1]. Thus, the differences in VC metabolism caused by polymorphisms in xenobiotic enzymes were studied by VC loading experiments [5, 8].

Although there may be many genetic polymorphisms that may affect VC metabolism, both GSTP and superoxide dismutases (SOD) gave positive results [5]. Single nucleotide polymorphisms in xenobiotic enzymes (GSTP1-1, GSTP1-2, SOD2 and SOD3) in 228 women after recording the exact dietary intake of nutrients and serum vitamin concentrations [6] were analyzed by real-time polymerase chain reaction [5, 8]. Both urinary total VC and blood levels of VC after the oral administration (AsA and DAsA) were significantly affected by polymorphisms in GSTP1-1 [5].

#### (4) Xenobiotics of VC Metabolism

Although RDAs for VC were determined in the absence of xenobiotics, the additional VC is needed by healthy subjects to detoxify various foreign substances [42]. VC synthesis in rat liver is enhanced by several xenobiotics, including aminopyrine and chloretone [1]. The effect of these agents has been linked to induction of enzymes potentially involved in the formation of glucuronate, a precursor of VC. A series of non-glucuronidable xenobiotics (aminopyrine, antipyrine, chloretone, clotrimazole, metyrapone, proadifen, and barbital) added to isolated rat hepatocytes induced glucuronate formation in a few minutes an up to 15-fold increase [1]. These xenobiotics also caused an approximately 2-fold decrease in the concentration of UDP-glucuronate but little if any change in the concentration of UDP-glucose. Depletion of UDP-glucuronate with D-galactosamine markedly decreased the formation of glucuronate both in the presence and in the absence of aminopyrine, confirming the precursor-product relationship between UDP-glucuronate and free glucuronate. Most of the agents did not induce the formation of detectable amounts of glucuronides, indicating that the formation of glucuronate is not due to a glucuronidation-deglucuronidation cycle. With the exception of barbital (which inhibits glucuronate reductase), all of the above mentioned agents also caused an increase in the concentration of VC. The stimulation of VC synthesis exerted by some xenobiotics may be mediated through enhanced gene expression.

In humans owing to the absence of GLO, induction of VC synthesis by above mentioned xenobiotics is impossible. So VC intake more than that recommended by uniform RDA (100

mg/day) is necessary to overcome the toxic effects of xenobiotics. Oral administration of a single dose of 1-<sup>14</sup>C-AsA revealed that smokers had a higher metabolic turnover (140 mg/day) than nonsmokers (100 mg/day) to reach steady-state concentrations and that total body pools were comparable to those in nonsmokers [42]. Cigarette smoke carcinogens are removed in Phase 2 detoxification by the glutathione S-transferase (GST) superfamily, of which GSTP1 is most strongly expressed as GST $\pi$  in the lung and other tissues [36, 37]. VC is known to prevent DNA mutation induced by both xenobiotics and ROS [16, 34]. The link between genome damage and adverse health outcomes is compelling. There is increasing evidence indicating that genome instability, in the absence of overt exposure to xenobiotics, is itself a sensitive marker of nutritional deficiency. Intake of VC above RDA is associated with reduced tissue damage [11, 14, 16]. Nutrigenomics of VC is an emerging and important new field of nutritional science because it is increasingly evident that optimal concentration of VC for the prevention of tissue damage is dependent on genetic polymorphisms that alter the function of genes involved directly or indirectly in DNA repair and metabolism [31].

#### (5) The Outline of Discussions on the Results

Genetic polymorphisms related to xenobiotic or oxidative stress may thus cause interindividual differences in VC requirements [3-9]. After presenting our experimental data in the Results section, the roles of VC as an antioxidant [1,10, 11], especially in the light of human specific VC metabolism (section 1), VC transport [26, 40, 43, 44] (section 2), DAsA reduction [23, 45-49] (section 3), effects of genetic polymorphisms on AsA and DAsA metabolism [5, 8, 50] (section 4), delactonization of DAsA by dehydroascobatase [3, 46] and senescence marker protein 30 (SMP 30) [51-57] (section 5), monodehydroascorbate radicals (section 6), pro-oxidant activities of VC [20, 21] (section 7), the evolutionary origin of human specific VC-related gene structure [25-27] (section 8), and finally, RDAs [28, 29] and optimal human nutrition of VC [31] will be discussed (section 9) after summarizing the effects of genetic polymorphisms [5, 58, 59] and xenobiotics on AsA and DAsA metabolism [31].

## Materials and Methods

### (1) Subjects

A. Japanese group A for analysis of gene variant frequency and preliminary VC level experiments comprised 211 healthy Japanese women (aged 21 - 22 years) and their dietary intake of VC was assessed by 3-day weighted food record, as reported previously [6]. The subject numbers in group A for determining gene variant frequencies were (n = 211 for SOD2; n = 209 for SOD3; n = 210 for GSTP1-1; and n = 210 for GSTP1-2) [59].

B. Japanese group B for VC-loading experiments comprised healthy female university students (n = 17; age, 21.0  $\pm$  1.1 y; height, 157.0  $\pm$  5.8 cm; weight, 53.0  $\pm$  7.0 kg; body mass index; 21.0  $\pm$  2.7) [4]. Average values on blood analysis were all within the normal limits, as



follows: white blood cells,  $6286 \pm 1509/\mu\text{L}$ ; red blood cells,  $4.29 \pm 0.40$  million/ $\mu\text{L}$ ; hemoglobin,  $12.4 \pm 1.1$  g/dL; serum albumin,  $4.6 \pm 0.3$  g/dL; and fasting blood glucose,  $85 \pm 8$  mg/dL.

C. Mongolian group C for oxidative stress and VC levels: A total of 164 healthy subjects, ranging in age from 24 to 66 years (72 males and 92 females) were randomly assembled by native researchers in July 2005 [9]. Subjects lived in Murun city, which is a central town in Khuvsgul Prefecture, located in the northwest of Mongolia, 700 km away from metropolitan Ulaanbaatar. For gene polymorphism analysis, Mongolians from Ulaanbaatar were selected. For the determination of gene polymorphism variant frequencies, Mongolians from Ulaanbaatar were selected from 7 areas in Asia Pacific region [58, 60].

Experimental design was approved by the Human Genome Medical-Ethical Committee of Kagawa Nutrition University (No 222-G, July 6, 2006, for groups A and B, and No. 185-G, May 18, 2005, for group C, and special approval by both Japanese and Mongolian Institutes for group C), and complied with the World Medical Association Declaration of Helsinki (1964, 2000 version). Written consent was obtained from each subject after adequate explanation of the purpose and contents of this study before the experiment. None of the subjects group B smoked during the experimental period, in order to eliminate the xenobiotic effects of smoking on VC metabolism [42], and there were no diabetics, as diabetes inhibits DAsA transport through glucose transporters (GLUTs) [23, 40].

## (2) VC Loading Human Experiment (Figure 1)

The study scheme of VC depleting-repleting experiment is shown in Figure 1 [4], following the classical human experiments on AsA and DAsA requirements [60]. In order to saturate the *in vivo* VC pool of the subjects group B, 500 mg AsA (2.8 mmol) was orally administered 1 week before the loading experiment (Figure 1 left). Subjects group B consumed normal diet until 72 h (3 days) before AsA or DAsA loading (9:00), and thereafter, consumed low-VC diet ( $\text{VC} < 4.9 \pm 0.1$  mg/day; 1,700 kcal/day; protein 70 g/day) until discontinuation of the experiment [4]. Detailed composition of the diets was as previously reported [4]. Because a crossover study design was used, the same experiment was repeated after an interval of about 1 month for each subject [4].

On the day of the loading experiment, 1 mmol AsA (176 mg) or DAsA (174 mg) crystals was orally administered (Figure 1 middle). Urine was collected for 24 h before initiation of the low-VC diet (normal period, Figure 1 left) and two 12-h urine samples were collected on the day before the loading experiment (deficiency period, Figure 1 middle). After oral VC loading, urine was collected after 3, 6, 9, 12 and 24 h (Figure right). To prevent the deterioration of collected or stored urine, oxalic acid was added to collected urine (final concentration 5%). Blood was taken immediately before and at 1 and 3 h after VC loading. During the depletion-repletion experiment period, intake of anything other than the food that was cooked and offered (including drugs and supplements) was prohibited. For drinking water, bottled mineral water was provided. The crossover method was used; the same experiment was repeated after an interval of about 1 month for the subjects. During this interval detailed blood analyses, including VC [5], glutathione [9], vitamin E [9], malon

dialdehyde [9] and superoxide dismutase (by the nitrite method) [62], was performed in seven subjects.

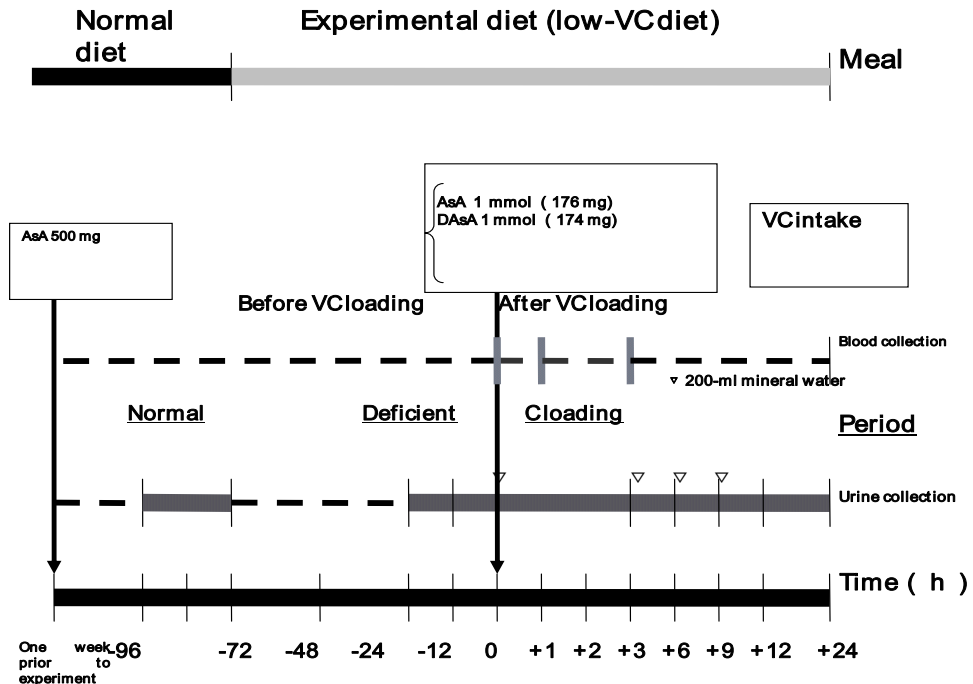

Figure 1. Scheme of human AsA and DAsA loading study. Time “0” was 9 a.m. on the day of the loading experiment, and 1 mmol AsA or DAsA crystals was orally administered at that time. Subjects were healthy female university students (17 females).

### (3) Determination of VC, Oxidants and other Biochemical Components

Solid DAsA (scarcely soluble dimer) was purchased from Wako Pure Chemical Industries, Ltd., Tokyo and AsA was obtained from Kanto Chemical Co., Inc. Tokyo [4, 63]. For *in vitro* experiments, DAsA was always prepared fresh from AsA dissolved in distilled water by bromine oxidation immediately prior to use [46, 64]. The purity of solid DAsA was 80 - 85%, as determined using the method described below [46]. Total VC in DAsA crystals, urine, blood and food was determined as follows: AsA and DAsA were converted into osazone by 2,4-dinitrophenylhydrazine [44, 63, 64], which was extracted by ethyl acetate and subjected to high performance liquid chromatography [63]. The column (GL-PACK PARTISIL-5; Whatmann; size: 250 × 4.6 mm) was eluted with n-hexane: acetic acid: ethyl acetate (4:1:5 v/v) at flow rate of 1.0 ml/min at room temperature and samples were detected at 495 nm. Retention times of 2, 4-dinitrophenylhydrazine and osazone [63] were 6.34 min and 7.32 min, respectively.

Blood biochemistry was analyzed by SRL Inc., Tokyo, using the standard methods of the National Health and Nutrition Survey of Japan [65]. Urinary creatinine was analyzed as reported previously [66].

## Measurement of Reactive Oxygen Metabolites (ROM)

In order to measure ROM, the d-ROM test was performed using FRAS4 (Diacron, Grosseto, Italy), according to the manufacturer's procedures [9]. Briefly, a 20- $\mu$ L blood sample (obtained from a finger tip) and 1 ml of buffered solution (R2 reagent of kit, pH 4.8) were gently mixed in a cuvette, and 10  $\mu$ L of chromogenic substrate (R1 reagent of kit) was added. After mixing, the cuvette was centrifuged for 60 s at 37°C and immediately incubated in the thermostatic block of this analyzer for 5 min at 37°C. Absorbance at 505 nm was then recorded, and the results were expressed in terms of Carr U. It has been established that 1 Carr U corresponds to 0.08 mg/dL H<sub>2</sub>O<sub>2</sub>. Reference values indicated by the manufacturer (Diacron) range from 250 to 300 Carr U; values higher than 300 Carr U suggest oxidative stress [9].

## (4) Single Nucleotide Polymorphism (SNP) Analysis

General gene techniques were as described elsewhere [38, 59, 67]. SNPs in xenobiotic enzymes (GSTP1-1, GSTP1-2, SOD2 and SOD3) were analyzed by real-time polymerase chain reaction for GSTP1-1 [38]. The Ile105Val SNP of GSTP1-1 is expressed in terms of nucleotide number A342G (exon 5), or from the 1st codon AGT of exon 1, equivalent to nt.A1375G. After the common reaction, a TaqMan genotyping system with an ABI PRISM 7900HT unit (Applied Biosystems, Foster City, California, U.S.A.) [59] was used with specific TaqMan probes and primers. Four SNPs, SOD2 Val16Ala (rs4880), SOD3 Arg231Gly (rs1799895), GSTP1 Ile105Val (rs1695) [GSTP1-1 A342G (exon5)] and Ala114Val (rs1138272), were analyzed. The sequences of the TaqMan probes were as follows and polymorphic nucleotides are underlined:

For SOD2 Val16Ala, Fam-AGCAGGCAGCTGGCTCCGACT-TAMRA (Ala) and Vic-TGATCTAGCAGGCAGCTGGCTCCGATT-TAMRA (Val);

For SOD3 Arg231Gly, Fam-GATCAGGCACTCAGAGCGCAAGAATGG-TAMRA (Gly) and Vic-GCACTCAGAGCGCAAGAATCG-TAMRA (Arg);

For GSTP1 Ile105Val, Fam-CAGATCTTGGTGTAGATGAGGGAGTTG-TAMRA (Ile) and Vic-TTGGTGTAGATGAGGGAGTCG-TAMRA (Val);

For GSTP1 Ala114Val, Fam-ACGATCCACATAGTCATCCTTGCTTGCCTAC-TAMRA (Val) and Vic-CACATAGTCATCCTTGCTTGC-TAMRA (Ala).

## (5) Statistical Analysis

After analysis of variance using Stat View-J4.02 (Macintosh version), multiple comparisons were performed by Bonferroni/Dunn test [4]. Correlations between clinical and biochemical values were estimated as reported previously [60].

## Results

### (1) Gene Variant Frequency

The gene variant frequencies of SNPs (SOD2, SOD3, GSTP1-1, and GSTP1-2) in xenobiotic enzymes among groups A, B and C were as follows:

[SNP: total number; genotype: subject number (gene variant frequency in %)]

A. Group A : Japanese.

SOD2: n = 211; AA, 156 (73.9%); AG, 48 (22.7%); GG, 7 (3.3%).

SOD3: n = 209; CC, 192 (91.9%); CG, 17 (8.1%).

GSTP1-1: n = 210; AA, 149 (71.0%); GA, 57 (27.0%); GG, 4 (1.9%).

GSTP1-2 n = 210; CC, 210 (100%).

B. Group B: Japanese, VC depletion-repletion experiment.

SOD2: n = 17; AA, 11 (64.7%); AG, 6 (35.3%).

SOD3: n = 17; CC, 16 (94.1%); CG, 1(5.9%).

GSTP1-1:n = 17; AA, 12 (70.6%); GA, 5 (29.4%).

GSTP1-2: n = 17; CC, 17 (100 %).

C. Group C: Mongolian (undetermined subjects were excluded)

SOD2: n = 94; AA, 55 (58.5%); AG, 32 (34.0%); GG, 7 (7.4%).

SOD3: n = 94; CC, 87 (92.6%); CG, 7 (7.4%).

GSTP1-1: n = 93; AA, 58 (62.4%); GA, 34 (36.6%); GG, 1 (1.1%).

GSTP1-2 n = 94; CC, 94 (100%).

Genotype frequencies of GSTP1-1 were consistent with the Hardy-Weinberg equilibrium, as reported for Italians [38] and other ethnic groups [39]. As there was very few subject with the CG SOD3 polymorphism, and there were no polymorphic differences in GSTP1-2, the association between VC metabolism and SOD2, as well as GSTP1-1, was analyzed. Genotype frequencies of these enzymes among Mongolians were very similar to those of Japanese.

### (2) Results of Epidemiological Survey on VC and Oxidative Stress (Table 1)

When compared with daily food intake of Japanese (values in parenthesis indicate percentage of Japanese intake), Mongolians consumed few VC sources: 79.5 g of vegetables (25.6%), 32.8 g of fruits (28.0%) and 37.4 g of potatoes (58.0%). According to the survey of UNICEF Nutrition Status of Population of Mongolia, Second National Nutrition Survey (Ulaanbaatar 2002), average VC consumption was 57.1 mg/day, which is only 48.8 % of that of Japanese (117 mg/day) [65]. Table 1 shows a comparison of serum concentrations of antioxidants in Mongolians and Japanese. Serum VC concentrations among Japanese group A were  $1.25 \pm 0.25$  mg/dL [6], while that in Mongolian group C was only  $0.35 \pm 0.23$  mg/dL [9]. The oxidation products of guanosine present in DNA and after oxidation excreted in urine were very high among Mongolians (8-hydroxydeoxyguanosine  $11.0 \pm 4.8$  ng/mg creatinine) (Table 1) [9]. As a marker of ROS, the levels of ROM were measured using the d-

ROM test, and the levels were found to be  $429.7 \pm 95.2$  Carr U in Mongolian subjects, whereas Japanese subjects ( $n = 220$ , 21 - 98 y) had levels of  $335.3 \pm 59.8$  ( $p < 0.001$ ) [9]. Although the Mongolian intake of meat and meat products was 172.2 g/day (187 % of Japanese) and milk and milk products was 492g/day (400 % of Japanese), their total cholesterol levels were  $183 \pm 33$  mg/dL (male) and  $185 \pm 34$  mg/dL (female) (only 88% of Japanese [65]). The average blood pressure of Mongolians was  $133 \pm 24$  mm Hg (male) and  $126 \pm 27$  mm Hg (female). Thus, oxidative stress rather than hypercholesterolemia was evident in Mongolians with short lifespan and high cardiovascular diseases. Despite the large difference between Japanese and Mongolians in the blood chemistry in Table 1 [9], the gene variant frequencies in Mongolians were similar to those in Japanese, as described in the previous section (Result (1)).

**Table 1. Serum concentrations of antioxidants in Mongolian subjects, as compared with those in Japanese (urine 8-hydroxy deoxyguanosine, a marker of oxidative stress, is also shown). ALT: alanine transaminase; BUN: blood urea nitrogen; VA: vitamin A; VC: ascorbic acid; VE: vitamin E; MDA: malon dialdehyde; 8-OHdG: 8-hydroxy deoxyguanosine**

		Japanese	Total		Males		Females	
		References	n	M $\pm$ SD	n	M $\pm$ SD	n	M $\pm$ SD
Serum								
Albumin	g/dL	3.8 - 5.3	135	$4.3 \pm 0.4$	72	$4.3 \pm 0.4$	63	$4.3 \pm 0.3$
ALT	IU/L	5 - 35	135	$27.2 \pm 24.4$	72	$30.4 \pm 28.1$	63	$24.4 \pm 19.4$
BUN	mg/dL	8.0 - 23	135	$14.3 \pm 4.3$	72	$15.1 \pm 4.3$	63	$13.5 \pm 4.1$
Fe	$\mu$ g/dL	M, 50 - 200 F, 40 - 180	71	$104.6 \pm 39.4$	39	$119.8 \pm 39.7$	32	$86.0 \pm 30.3$
Uric acid	mg/dL	M 3.8 - 7.5 F 2.4 - 5.8	135	$4.8 \pm 1.4$	72	$5.4 \pm 1.4$	63	$4.1 \pm 1.0$
Folic acid	ng/mL	>3.1	71	$4.1 \pm 1.6$	39	$3.7 \pm 1.3$	32	$4.6 \pm 1.8$
V.A	IU/dL	97 -316	71	$158.7 \pm 56.1$	39	$180.6 \pm 61.2$	32	$132.0 \pm 34.3$
V.C	mg/dL	$1.25 \pm 0.25$	66	$0.35 \pm 0.25$	39	$0.33 \pm 0.26$	27	$0.37 \pm 0.24$
V.E	mg/dL	0.75 - 1.41	38	$0.9 \pm 0.3$	20	$0.8 \pm 0.2$	18	$1.0 \pm 0.3$
MDA	U/L	40.9 - 76.7	66	$109.5 \pm 47.7$	39	$117.2 \pm 49.3$	27	$98.4 \pm 43.7$
Urine								
8-OHdG	ng/mg Cre	0.2 - 9.5	66	$11.0 \pm 4.8$	39	$11.2 \pm 4.0$	27	$10.6 \pm 5.8$

### (3) Results of VC Depleting-Repleting Experiment (Table 2)

The results for total VC excretion after loading with 1 mmol of VC on subjects group B are summarized in Table 2. There was a significant difference ( $p < 0.0069$ ) in VC excretion between AA homozygotes and GA heterozygotes. In AA homozygotes, 26.7% of loaded VC was excreted as total VC, while in GA heterozygotes; it was only 16.1%, which represents a 66% difference between the two groups. This difference was also seen when either AsA ( $p <$

0.0486) or DAsA ( $p < 0.0606$ ) were loaded. During the depletion period, VC levels in 24-h urine were very low and did not differ between the AsA ( $4.7 \pm 2.1$  mg/day, 3.0 - 7.9 mg/day) and DAsA ( $4.1 \pm 1.1$  mg/day, 3.0 - 9.5 mg/day) groups. VC excretion thus increased by 7- to 11-fold after VC loading. There were large inter-individual differences in excretion of VC, but there were statistically not significant small differences in the excretion of urinary creatinine and water (Table 2) [5]. The decreased excretion of VC in GA heterozygotes as compared with that in AA homozygotes cannot be attributed to changes in urine volume or creatinine excretion. The average sample serum creatinine levels in the subjects were  $0.64 \pm 0.08$  mg/dL, while serum Na, Ca, K, Cl and phosphate levels were also within normal limits.

**Table 2. Total Vitamin C excreted after loading with 1 mmol AsA or DAsA in glutathione S-transferase P1 AA homozygotes and GA heterozygotes**

Loaded VC	Total VC excreted	AA: homozygotes GA: heterozygotes			Significance
		AA + GA (17)	AA (12)	GA (5)	
AsA+DasA (calculated as 175 mg)	VC weight (mg)	41.3 ± 18.9	46.7 ± 18.1	28.2 ± 14.0	p < 0.0069
	percent loaded (%)	23.6	26.7	16.1	
	maximum value (mg)	85.0	85.0	52.5	
	minimum value (mg)	3.4	14.1	3.4	
AsA (176 mg)	VC weight (mg)	45.8 ± 21.6	52.3 ± 20.2	30.1 ± 17.6	p < 0.0486
	percent loaded (%)	26.0	29.7	17.1	
	maximum value (mg)	85.0	85.0	52.5	
	minimum value (mg)	3.4	17.6	3.4	
DAsA (174 mg)	VC weight (mg)	36.8 ± 15.0	41.2 ± 14.5	26.4 ± 11.2	p < 0.0609
	percent loaded (%)	21.1	23.7	15.2	
	maximum value (mg)	61.9	61.9	37.6	
	minimum value (mg)	12.0	14.1	12.0	
AsA (176 mg)	total creatinine (mg)	1045 ± 117	1005 ± 80	1139 ± 145	n.s.
	urine volume (ml)	1850 ± 487	1787 ± 480	2003 ± 552	n.s.
DAsA (174 mg)	total creatinine (mg)	1043 ± 173	1000 ± 163	1144 ± 169	n.s.
	urine volume (ml)	1768 ± 384	1765 ± 355	1776 ± 493	n.s.

Values are means ± SD. Loaded percentages were calculated as the ratio total vitamin C excretion against loading dose. There were no GG homozygous subjects.

#### (4) Blood VC Concentrations before and after VC Loading (Table 3)

Tables 3A and 3B summarize total whole blood VC concentrations before and after VC loading, respectively. Before VC loading, the small difference between the two genotypes was not significant for either AsA or DAsA (Table 3A). After VC loading whole blood levels of VC were significantly ( $p < 0.0036$ ) higher in AA homozygotes than in GA heterozygotes (Table 3B). However, the difference between the AA genotype (1.07 mg/dL) and GA

genotype (0.89 mg/dL) was only 17%, while the difference in VC concentrations before and after VC loading was 16 - 27%. This indicates that the change in VC excretion (7-11-fold) is more sensitive than serum VC concentrations in reflecting VC load. Table 3C summarizes the correlation coefficients between 3-h blood VC levels and total amounts of VC excreted during the 24-h period after loading with 1 mmol of AsA or DAsA. When AsA and DAsA are combined, the correlation is significant. Owing to small sample numbers, other correlation coefficients did not reach significance.

**Table 3. Total Vitamin C concentrations in whole blood before and after loading with 1 mmol AsA or DAsA in glutathione S-transferase P1 AA homozygotes and GA heterozygotes**

Total vitamin C concentrations in blood					
A. Before VC loading					
Vitamin C	Blood VC mg/dL	AA: homozygotes, GA: heterozygotes			Significance AA vs. GA
		AA+GA (17)	AA (12)	GA (5)	
AsA+DAsA	average	0.82±0.12	0.84±0.12	0.77±0.12	n.s.
	maximum	1.07	1.07	1.03	
	minimum	0.59	0.59	0.59	
AsA	average	0.82±0.14	0.84±0.12	0.78±0.17	n.s.
	maximum	1.07	1.07	1.03	
	minimum	0.59	0.59	0.59	
DAsA	average	0.81±0.11	0.83±0.11	0.76±0.06	n.s.
	maximum	1.07	1.07	0.83	
	minimum	0.61	0.61	0.66	
B. 1 h after loading (1 mmol VC)					
Loaded VC	Blood VC mg/dL	AA: homozygote, GA: heterozygote			Significance AA vs. GA
		AA + GA(17)	AA (12)	GA (5)	
AsA+DAsA	average	1.01 ± 0.17	1.07 ± 0.15	0.89 ± 0.15	p < 0.0036
	maximum	1.34	1.34	1.07	
	minimum	0.59	0.73	0.59	
AsA	average	0.94 ± 0.14	0.98 ± 0.12	0.86 ± 0.18	n.s.
	maximum	1.13	1.13	1.05	
	minimum	0.59	0.73	0.59	
DAsA	average	1.09 ± 0.16	1.16 ± 0.12	0.92 ± 0.14	p < 0.0030
	maximum	1.34	1.34	1.07	
	minimum	0.79	0.96	0.79	
C. Correlation between blood VC (3 h) and urine VC (24 h)					
		AA+GA(17)	AA (12)	GA (5)	AA vs. GA
AsA+DAsA significance		0.609 p < 0.001	0.553 p < 0.01	0.722 p < 0.05	n.s.
AsA significance		0.662 p < 0.01	0.547 n.s.	0.877 n.s.	n.s.
DAsA significance		0.582 p < 0.05	0.610 p < 0.05	0.522 n.s.	n.s.

Values are means ± SD. There were no GG homozygous subjects.

Blood VC concentrations were then compared between the two groups before and at 1 and 3 h after loading. Blood VC concentrations and the increase in VC at 1 h after loading were significantly higher ( $p < 0.05$  and  $p < 0.01$ , respectively) in the DAsA group than in the AsA group. In addition, there was a marginal association ( $p < 0.066$ ) between SOD2 polymorphism (GG, AG and AA) and serum VC concentrations (0.772, 1.202 and 1.24 mg/dL, respectively) in a group of young women ( $n = 148$ ) consuming normal diet.

The average values related to oxygen stress during the intervals of the cross-over loading experiment, blood analyses of sample subjects ( $n = 7$ ) were as follows: glutathione,  $4.3 \pm 4.1$  mg/dL; vitamin E,  $1.13 \pm 0.22$  mg/dL; malon dialdehyde,  $98.1 \pm 30.7$  U/L; uric acid  $4.5 \pm 0.8$  mg/dL; and superoxide dismutases,  $0.9 \pm 0.2$  U/mL. These values were not significantly ( $p < 0.05$ ) affected 3 h after loading with either AsA or DAsA (data not shown). In addition, average values for general clinical tests were within normal ranges in all subjects.

#### (5) Time Course of VC Excretion after Loading with AsA and DAsA (Table 4 and Figs. 2 and 3)

On AsA loading, urinary VC excretion was highest 3 - 6 h after loading. This corresponds to  $42.8 \pm 13.2\%$  of loaded VC excreted in 24-h urine (Table 4). On the other hand, urinary VC excretion was highest 0 to 3 h after DAsA loading, and this corresponds to 44% in 24-h urine (Table 4). Changes in urinary VC excretion following loading are shown in Figure 2. VC excretion after VC loading was significantly higher in AA homozygotes between 0 and 3, 6 and 9, 9 and 12 h after loading than GA heterozygotes ( $p < 0.05$ ) (Figure 2A). VC excretion after VC loading was significantly higher in the DAsA loading group between 0 and 3 h after loading, but was significantly higher in the AsA loading group during other periods ( $p < 0.05$  or  $p < 0.01$ ) in both genotypes (Figure 2B and 2C).

**Table 4. Rates of total Vitamin C excretion after loading with 1 mmol AsA or DAsA in glutathione S-transferase P1 AA homozygotes and GA heterozygotes**

Time since VC loaded (hour)	AA: homozygote GA: heterozygote		
	AA + GA (n=17)	AA (n=12)	GA (n=5)
<b>A. After the AsA loading</b>			
0 to 3	22.6±10.6	22.3±10.3	23.4±12.5
3 to 6	42.8±13.2	44.4±9.2	38.8±20.9
6 to 9	12.5±4.3	13.5±4.6	10.3±3.0
9 to 12	7.8±3.4	8.2±3.1	6.8±4.1
12 to 24	14.3±10.1	11.6±5.8	20.6±15.5
<b>B. After the DAsA loading</b>			
0 to 3	44.2±11.0	47.0±9.0	37.3±13.4
3 to 6	32.6±8.4	31.1±8.5	36.2±7.8
6 to 9	7.0±4.2	6.9±4.6	7.3±3.5
9 to 12	5.3±2.1	5.1±1.6	5.9±3.2
12 to 24	10.9±5.3	9.9±5.2	13.3±5.4

All values are ratios (%) of the amount of Vitamin C excreted in urine in each time period (0-3, 3-6, 6-9, 9-12, 12-24 h) against that excreted in the 24-h period after loading.

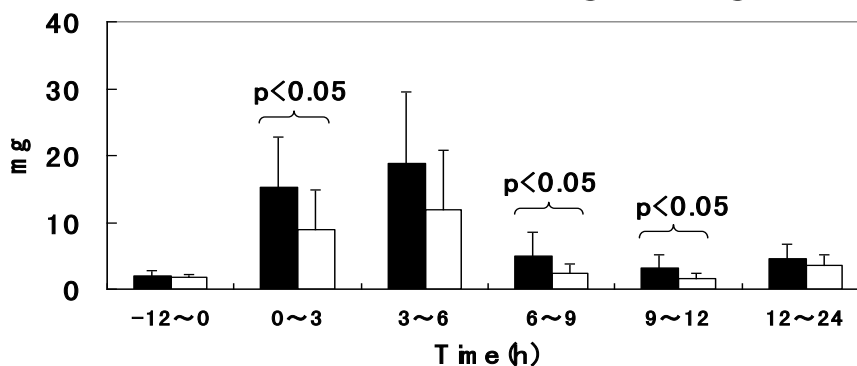
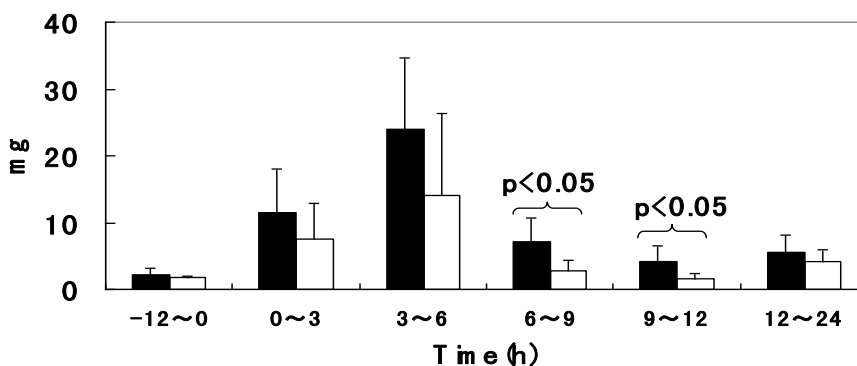
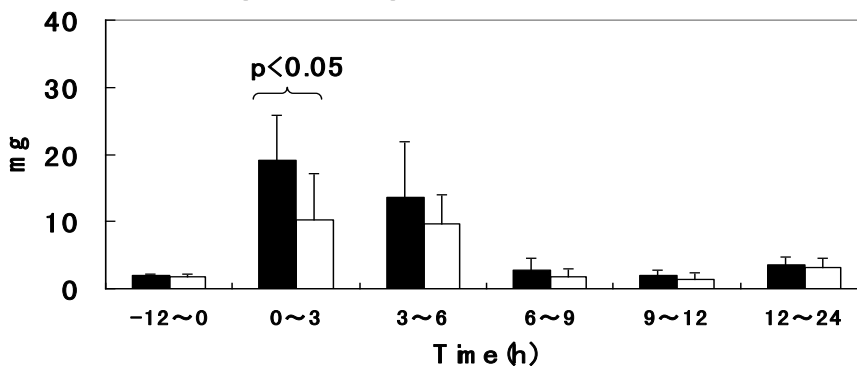

**(A) AsA + DAsA (calculated at 175m g ) loading****(B) AsA (176m g ) loading****(C) DAsA (174m g ) loading**

■ AA homozygotes (n=12) , □ GA heterozygotes (n=5)

Figure 2. Changes in total vitamin C excretion after loading based on GSTP1-1 polymorphism. Panel (A) AsA + DAsA loading. Panel (B) AsA (176 mg) loading. Panel (C) DAsA (174 mg) loading. AsA or DAsA was given at 0 h. Values are means  $\pm$  SD. There were no GG homozygous subjects. Values are means  $\pm$  SD.

Figure 3 indicates the large interindividual differences in the time course of VC excretion among four subjects in group B loaded with AsA (1 m mole) and DAsA (1m mole) under the same condition described in Figure 1. The cause of interindividual difference will be discussed in the following section.

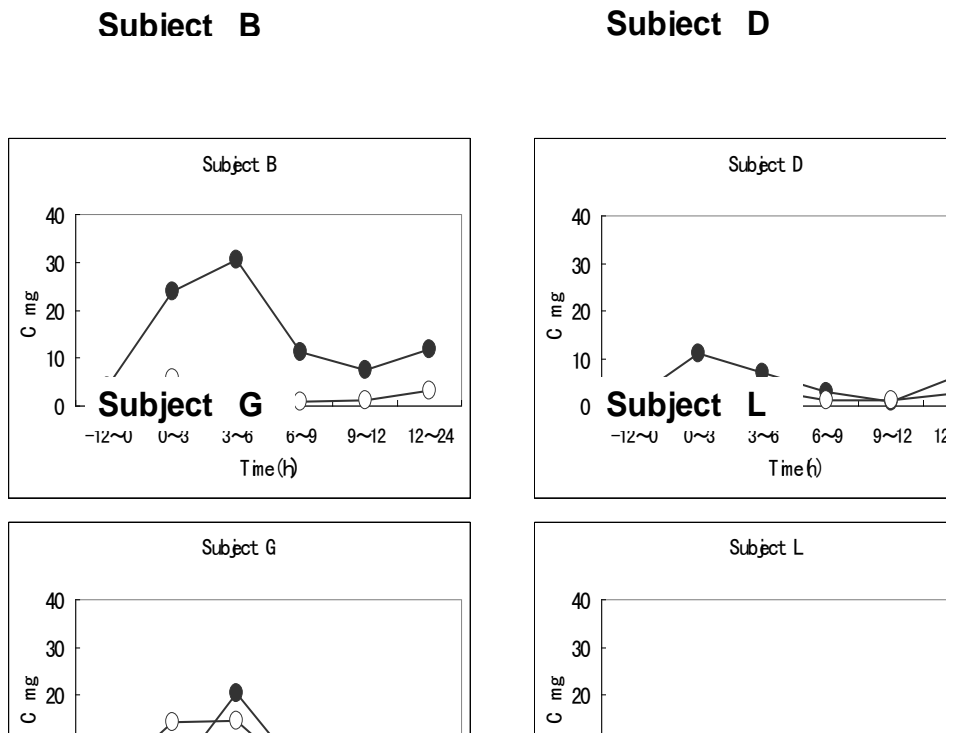

Figure 3. Interindividual difference in the quantities and time course of VC excretion of four subjects after loading AsA and DAsA under the condition described in Figure 1. [31].

## Discussion

### (1) Human Specific VC Metabolism and Antioxidant Activity of VC

VC differs from other vitamins in that an exogenous source is required only by few VC auxotrophs including humans [1, 26, 27], while in all animals VC acts as an antioxidant [1, 11] and a cofactor in the biosynthesis of collagen and catecholamine [1]. VC autotrophs such as rat synthesize VC at the rate of 58mg/day/kg body weight [30] (average VC half life: 2.9 days), while VC auxotrophs including humans consume VC about 2 mg/day/kg body weight (Tables 2 and 3), and less than 1 mg/day/kg in the case of Mongolians (Table 1) (average VC half life: 16 days (7.5 -18.5 days) [42]). To prevent scurvy in humans 10mg/day or 0.2mg/day/kg body weight is enough [28]. Moreover, VC autotrophs increase VC synthesis several fold in the presence of xenobiotics such as aminopyrine and chloretone [1] or under

oxidative stress caused by exercise and pathological conditions [14, 15] to prevent oxidative damage of tissues. However, VC auxotrophs have no VC synthesis in response to xenobiotics and oxidative stress.

The recommended dietary allowance (RDA) of VC is 100 mg/day in Japan (RDA 2005, for adults) [28] (Figure 4), and 90 mg/day for men and 75 mg/day for women in U. S. A. (RDA 2000, for detailed recent values, see section (9) of discussion) [29]. However, Pauling pointed out that the RDA is less than the optimum intake, corresponding to the best health [30]. Based on VC synthetic rates in rat, he concluded that the optimum daily intake is about 2.3 g or more, for an adult with energy requirement 2500 kcal/day [30]. But in humans the metabolic rate of VC was shown to be in the order of 100mg/day after loading 1 m mole (176 mg) of VC [4, 5] (Table 2, 3). Although AsA and DAsA have distinct effects on cell function [69], the utilization of DAsA is nearly equal to that of AsA in humans [4, 5, 61, 70] (Tables 2 and 3). However, in GLO knockout mice, the nutritive value of DAsA is only 10% of that of AsA [71]. In addition, human loading experiments with  $1\text{-}^{14}\text{C}$ -AsA revealed higher metabolic turnover of 140 mg/day and 100 mg/day for smokers and nonsmokers, respectively, to reach steady-state concentrations [42]. Intakes of VC were in the range of 30 to 180 mg/day resulting in plasma steady state VC concentrations between 0.25 and 1.57 mg/dL [42], roughly corresponding to the values in Tables 1 and 2.

In order to compensate VC auxotrophy with urate as an antioxidant, uricase was lost in hominoids during primate evolution [25]. VC auxotrophs metabolize DAsA slower than VC autotrophs do, owing to very low dehydroascorbatase activity in the former [3]. As will be discussed in the next section, human and other VC auxotrophs transport DAsA via GLUT1 very rapidly to prevent DAsA hydrolysis [26], while VC autotrophs do via GLUT4. From above stated human specific VC metabolism, it is impossible to extrapolate metabolic data of VC autotrophs to estimate human RDA.

The other important aspect is the long-term effect of VC level in humans. RDA of VC estimated by short-term depletion-repletion study may not be enough to test the optimum nutrition to prevent age-related diseases and attain healthy longevity. Thus, long term-epidemiological study of VC intake level is needed. National health and nutrition survey in Japan revealed the very large interindividual difference of daily VC intakes (measured by exact food weighing, not by recall method) during 3 days among Japanese ( $n=8,762$ ) [65]. The highest 1% group ingested 810 mg/day mainly from VC supplements, and the lowest 1% group, 8.4 mg/day, though the average intake was  $117 \pm 157$  mg/day [65]. Thus, it was impossible to deduce the optimal intake of VC from the average. So, we surveyed 6 Asia-Pacific countries where no supplement is taken, for their blood biochemistry, nutritional intakes, genetic polymorphisms, daily activity and clinical findings [9, 58-60]. The average VC intake was the lowest in Mongolians (57.1 mg/day, 48.8 % of Japanese) among these countries. Very low blood VC levels ( $0.35 \pm 0.25$  mg/dL) and high oxidative stress (malonaldehyde  $109.5 \pm 47.7$  mg/L, 267 % of Japanese) in Mongolians (Table 1) with the gene variant frequencies in xenobiotic enzymes similar to those in Japanese may explain their short life span [9].

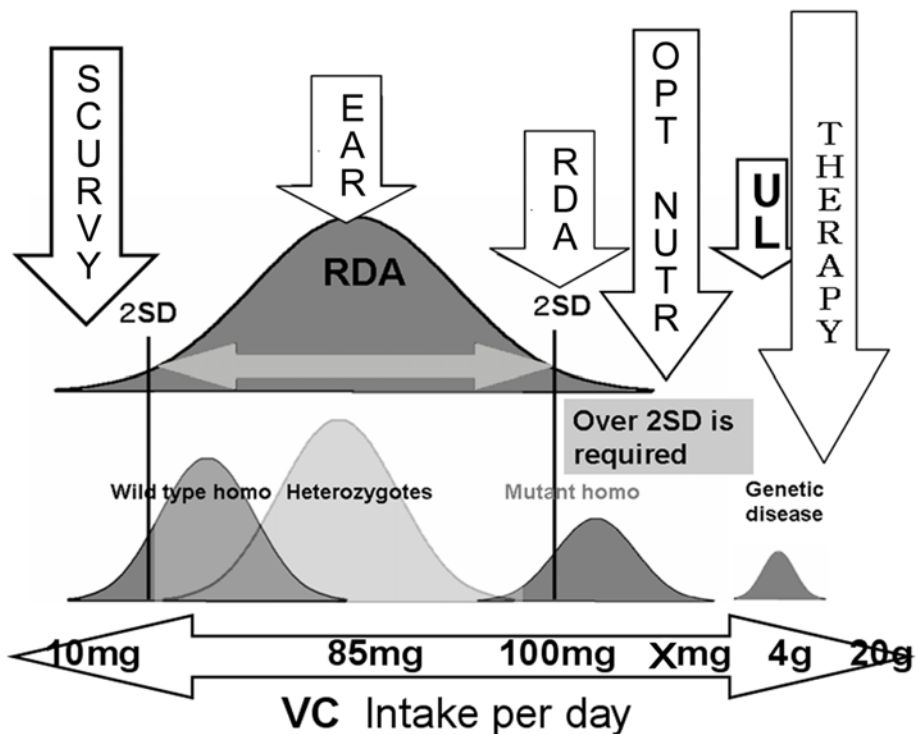

Figure 4. EAR, RDA, Optimal Nutrition and UL, and an example of VC-related genetic polymorphisms [31]. EAR: estimated average requirement for Japanese (12 – 70 years over) [28]. RDA: recommended dietary allowance for Japanese (12 -70 years over) [28]. UL: tolerable upper intake level SD: standard deviation of EAR. RDA is defined as EAR + 2SD. OPT. NUTR.: optimal nutrition. SCURVY: scurvy prevention dose.

According to the free radical theory of ageing [14], VC and other antioxidant supplements are expected to prevent age-related diseases, including cardiovascular diseases caused by oxidative stress and xenobiotics [10, 33, 35]. In fact, *in vivo* studies [10] and epidemiological surveys, including our Mongolian study showing low VC and VE and high oxidative stress (Table 1) [9], have confirmed the preventive effects of VC and VE on oxidative stress [10]. As shown in the results of VC deficient Mongolians (the lowest line of Table 1; 8OHdG), oxidation of guanosine yields potentially mutagenic 8-oxo-7,8-dihydro-2'-deoxyguanosine (8OHdG), which results in GC3TA transversions in 50% of the replicating DNA [72]. In fact, loading mitochondria with AsA via DAsA treatment conferred protection against H<sub>2</sub>O<sub>2</sub>-induced 8OHG formation [43]. However, the interventional trials on the long-term administration of VC remain controversial [10, 33]. This discrepancy regarding the preventive effects of antioxidants may partly be attributed to the genetic heterogeneity of study populations [5, 8], the pro-oxidant property of VC under special conditions [12, 20, 21], the unique VC auxotrophy of humans [1, 25], a lack of uric acid catabolism [24] and study conditions. VC supplementation in human subjects after a 21-km run revealed biochemical and ultrastructural indices of muscle damage [73], perhaps because VC exhibited pro-oxidant properties due to the highly oxidative nature of the monodehydroascorbate

radicals produced during oxidoreductive reactions [20, 21]. VC also prevented exercise-induced expression of the antioxidant enzymes SOD and glutathione peroxidase [74]. Moreover, administration of VC (oral dose of 1 g per day) significantly ( $p = 0.014$ ) hampered endurance capacity. The adverse effects of VC may result from its capacity to reduce the exercise-induced expression of key transcription factors involved in mitochondrial biogenesis [74]. These factors are peroxisome proliferator-activated receptor co-activator 1, nuclear respiratory factor 1, and mitochondrial transcription factor A [74]. Thus, the conditions of VC administration and genetic differences among the subjects may have led to different results.

## (2) Transport and Pharmacokinetics of VC in Human Subjects

In order to evaluate the effects of VC administered to human subjects, analysis of transporters [26, 40, 43] and pharmacokinetics are essential [41, 44, 69, 75]. When VC is loaded and excreted, as shown in Figure 2, ADME (absorption, distribution, metabolism and excretion) must be considered. Both AsA [40] and DAsA [69] are absorbed through the lumen of the intestine and renal tubules by, respectively, enterocytes and renal epithelial cells. Subsequently, VC circulates in the blood and enters all other cells in the body [40]. On AsA loading, urinary VC excretion was highest 3 - 6 h after loading. This corresponds to  $42.8 \pm 13.2\%$  of loaded VC excreted in 24-h urine (Table 4). On the other hand, urinary VC excretion was highest 0 to 3 h after DAsA loading, and this corresponds to 44% in 24-h urine (Table 4). As described in detail later, the difference between AsA and DAsA in the excretion velocity (Figure 2, Table 4) is caused by the difference in each transport mechanism; Na-dependent AsA secondary transport [40, 44] and glucose transporter (GLUT) dependent facilitated DAsA diffusion [26, 43, 45, 69]. If the difference in the VC excretion by the AA homozygotes and GA heterozygotes is caused by the difference in the tubular maximal absorption of AsA ( $T_{mAsA}$ ), the blood VC concentration of GA heterozygotes should be higher than that in AA heterozygote. However, as shown in Table 3B, the blood VC concentration was significantly lower in GA heterozygote than that in AA homozygote. The final overflow beyond  $T_{mAsA}$  is determined by glomerular filtration rate (GFR) [41]. From the creatinine excretion data in Table 2 (1,044 mg/1,809 mL/day), serum creatinine concentration (0.64 mg/dL), GFR is estimated to be 90 mL/min and is nearly the same in AA homozygotes and GA heterozygotes of GSTP-1 when AsA or DAsA are loaded. Thus, the polymorphism-dependent marked interindividual differences (Tables 2 and 3, and Figure 3) are not attributable to the kidney function.

With regard to flux across the plasma membrane, simple diffusion of AsA and DAsA plays only a negligible role because of the highly hydrophilic properties of both [76]. The oil/water distribution coefficients of AsA and DAsA have been determined and compared with values for mannitol and lauric acid. Although DAsA is not ionized, the relative degrees of hydrophobicity of DAsA were approximately equal to mannitol [76]. These findings and recent reports from transport studies [40, 69] do not support the concept that DAsA is hydrophobic and crosses cell membranes rapidly by simple diffusion [63]. Negatively charged AsA does not enter into cell, because the resting membrane potential of the plasma

membrane is negative inside, unless co-transported with sodium ion. Known VC transport mechanisms include the facilitated diffusion of DAsA through glucose transporters (GLUTs,  $K_m = 0.8$  mM) [26, 40, 69], and secondary active transport of AsA through high-affinity ( $K_m = 0.2$  mM) [69] sodium-dependent vitamin C transporters SVCT1 and SVCT2 proteins, which are encoded by Slc23a1 and Slc23a2, respectively [44]. Three members of the glucose transporter family, GLUT1, GLUT3 and GLUT4 are DAsA transporters [40]. GLUT2 is located in the plasma membrane of hepatocytes and pancreatic  $\beta$  cells to respond changes in blood sugar by its very high  $K_m$ . GLUT4 is insulin sensitive low  $K_m$  transporter in muscle and adipocytes. GLUT 6 is a low affinity DAsA transporter, and GLUT8, GLUT10 and GLUT12 belong to the same class as GLUT6. On the other hand, GLUT9 and GLUT 11 belong to the same class as GLUT 5, a fructose transporter in enterocytes unable to transport DAsA. The maximal rates of uptake for AsA and DAsA are similar [40, 69]. AsA is reabsorbed from the renal lumen by SVCTs. SVCT1 and SVCT2 correspond to intestinal and renal sodium-dependent glucose transporter (SGLUT), but the substrate specificity is confined to AsA. Slc23a1 mRNA has been detected in intestine and liver and the S3 segment of the renal proximal tubule to synthesize SVCT1. Its distribution is broader, and all three proximal tubule segments of mouse and human were found to express the transporter, but the S3 segment showed the highest expression [44]. AsA transport in these cells was regulated by a single kinetic component that depends on sodium concentration, pH and temperature. Decreases in AsA concentration increase the apical expression of Slc23a1, perhaps as a result of a feedback system for regulating SVCT1 abundance at the luminal membrane [44].

The VC transport system allows intracellular VC levels to be in the range of 2–4 mM (35–70 mg/dl), despite human plasma VC levels are significantly lower (40–120  $\mu\text{M}$ =0.7–2.1 mg/dl) [43]. Usually, cultured cells accumulate extracellular VC as DAsA, not as AsA [43]. There is dose-dependent increase in intracellular AsA (8 mM) in response to extracellularly administered DAsA (1mM) [43]. However, incubation with extracellular AsA (1mM) did not elevate intracellular AA levels after 30 min of incubation [43]. VC accumulation in activated human neutrophils is increased as much as 10-fold above the mM concentrations present in normal neutrophils [45]. Internal concentrations as high as 14 mM are achieved when external VC is at physiologic concentration. The mechanism is by oxidation of external AsA to DAsA by hydrogen peroxide formation by NADP oxidase stimulated by the addition of several stimulants, preferential transmembrane translocation of DAsA via GLUTs, and intracellular reduction to AsA with glutathione-dependent reactions within minutes. These data indicate that VC accumulation is enhanced in activated human neutrophils and that human neutrophils utilize and recycle external DAsA under physiologic conditions [45]. There is species specificity in DAsA transport. Of all cells, human erythrocytes express the highest level of the GLUT1 glucose transporter [26]. Erythrocyte GLUT1 and associated DAsA uptake are unique traits of humans and the few other mammals that have lost the ability to synthesize AA from glucose. Stomatin, an integral erythrocyte membrane protein, is regulating the switch from glucose to DAsA transport. Mice, a species capable of synthesizing AA, express GLUT4 but not GLUT1 in mature erythrocytes. Thus, erythrocyte-specific coexpression of GLUT1 with stomatin constitutes a compensatory mechanism in mammals that are unable to synthesize VC [26].

It is important to analyze intracellular distribution and transport of DAsA and AsA, especially in mitochondria where most of ROS are produced. DAsA (0.5 mM) enters mitochondria via GLUT1 and accumulates in mitochondrial matrix as AsA (2 mM) [43]. The stereo-selective mitochondrial uptake of D-glucose, with its ability to inhibit mitochondrial DAsA uptake (not inhibited by L-glucose), indicated the presence of mitochondrial GLUT. Computational analysis of N-termini of human GLUT isoforms indicated that GLUT1 had the highest probability of mitochondrial localization. *In vitro* mitochondrial import of GLUT, immunoblot analysis of mitochondrial proteins, and cellular immunolocalization studies indicated that GLUT1 localizes to mitochondrial inner membrane [43]. Loading mitochondria with AsA quenched mitochondrial ROS and inhibited oxidative mitochondrial DNA damage. Uncouplers such as carbonyl cyanide m-chlorophenylhydrazone (CCCP) disrupt membrane potential, and increase mitochondrial respiration [77]. AsA in mitochondria inhibited oxidative stress resulting from rotenone-induced disruption of the mitochondrial respiratory chain and prevented mitochondrial membrane depolarization in response to an uncoupler [43]. GLUT1 in mitochondria confers transport of DAsA into mitochondria since glucose in the cytosol exists almost entirely in the nontransportable form, glucose-6-phosphate. Due to the apparent lack of a glycolytic pathway in mitochondria, GLUT1 on the mitochondrial membrane may exist for the transport of DAsA.

The large inter-individual differences in urinary excretion of VC [4, 5, 8] observed (Figure 3) may not be due to differences in the renal clearance characteristics of AsA, such as tubular maximum reabsorption (TmAsA) [41] or renal threshold for AsA through SVCTs [44]. The mean TmAsA is  $1.54 \pm 0.29$  and  $1.39 \pm 0.33$  mg/min/100 mL GFR for men and women, respectively [41]. These values depend on sodium-dependent active transport of AsA by SVCT1 and 2, and passive transport of DAsA by GLUTs [26, 40, 44]. The mean renal threshold of VC is  $1.51 \pm 0.25$  and  $1.26 \pm 0.16$  mg/dL for men and women, respectively [41]. Homeostasis by renal threshold maintains blood VC levels in a narrow range, irrespective of low VC intake ( $0.82 \pm 0.12$  mg/dL, Table 2A) or high VC intake ( $1.01 \pm 0.17$  mg/dL, Table 2B), and this homeostasis was confirmed in our preliminary experiments in 150 women subjects without VC supplementation (VC intake:  $138 \pm 174$  mg/day; serum VC levels:  $1.19 \pm 0.2$  mg/dL) [6].

There is a strong advocacy movement for supplementation with large doses of VC [30, 75], although the homeostatic blood VC concentration is about 1.2 mg/dL in healthy humans (Table 3), and most VC ingested is excreted in the urine within 6 h (Figure 2). Some authors argue that the biological half-life for VC at high plasma levels is about 30 min, but these reports are the subject of some controversy. Several clinical trials have demonstrated that VC may indeed be effective against tumors when administered intravenously [75]. Oral administration of large dose of VC (5 g) has a maximum limit of intestinal transport via SVCTs, and peak blood VC concentration reaches 4.4 mg/dL. In contrast, with intravenous administration of 30 g of VC every 80 min, blood VC concentrations of 480 mg/dL are easily attained [75]. The peak VC concentration is decreased exponentially after the intravenous injection [75]. Thus, only by intravenous administration, the necessary VC levels to kill cancer cells are reached in both plasma and urine. One limitation of current studies is that pharmacokinetic data at high intravenous doses of VC are sparse, particularly in cancer patients. Further detailed kinetic studies using radioactive VC [42] and stable isotope-labeled

VC [78] as a probe for VC absorption, distribution, pool size, metabolism and excretion in human subjects are needed.

### (3) Glutathione-Dependent DAsA Reduction and Transport

Glutathione is the most abundant non-protein thiol in mammalian cells and participates in multiple functions central to the physiology of cells, acting as a reducing agent, antioxidant, and is involved in the second phase of detoxification of xenobiotics as a substrate of GSTP1 [36-39]. Glutathione is found in cells predominantly as reduced glutathione (GSH). Recycling of AsA from its oxidized forms (DAsA and monodehydroascorbate radicals) with GSH helps to maintain the vitamin in human cells [69, 45], because DAsA is rapidly hydrolyzed (delactonized) enzymatically by dehydroascorbate [3, 47] or non-enzymatically at pH 7.4. The glutathione disulfide-glutathione couple (GSSG/2GSH) can serve as an important indicator of redox environment. There are many redox couples in a cell that work together to maintain the redox environment; the GSSG/2GSH couple is the most abundant redox couple in a cell. Changes of the half-cell reduction potential ( $E_{(hc)}$ ) of the GSSG/2GSH couple appear to correlate with the biological status of the cell: proliferation  $E_{(hc)}$  approximately -240 mV; differentiation  $E_{(hc)}$  approximately -200 mV; or apoptosis  $E_{(hc)}$  approximately -170 mV [13]. These estimates can be used to more fully understand the redox biochemistry that results from oxidative stress [13]. Whereas intracellular DAsA reduction is thought to occur primarily through a direct chemical reaction with glutathione, the role of enzyme-mediated DAsA reduction is important.

Since glutathione-homocysteine transhydrogenase was reported, proteins with glutathione dependent DAsA reductase activity including, thioredoxin reductase [47], glutaredoxin [2], omega class glutathione transferases [48] and even serum albumin [42] have been reported. The most important glutaredoxin reaction has the following properties: for glutathione,  $K_m$  is 2.0 mM and  $V_{max}$  is 5.0  $\mu\text{mol}/\text{min}$  per mg, and for DAsA,  $K_m$  is 250  $\mu\text{M}$  and  $V_{max}$  is 6.0  $\mu\text{mol}/\text{min}$  per mg, with maximal activity being observed at pH 7.5. Cloning and sequencing of the genomic gene corresponding to human Grx1(as) cDNA showed that two different glutaredoxin cDNAs (Grx1(as) and Grx1) were generated from the same genomic gene via alternative splicing [2]. Origination of Grx1(as) and Grx1 from the same gene was confirmed by chromosomal localization of the Grx1(as) gene to chromosome 5q13, the same location where the Grx1 gene was localized [2]. There are two functional Omega class glutathione transferases (GSTO) in humans which have DAsA reductase activity [48]. GSTO1 is polymorphic with several coding region alleles, including an A140D substitution, a potential deletion of E155 and an E208K substitution. GSTO2 is also polymorphic with an N142D substitution in the coding region [2]. NADPH-dependent reduction of DAsA due to thioredoxin reductase (inhibited 68% by 10  $\mu\text{M}$  aurothioglucose) had an apparent  $K_m$  for DAsA (1.5 mM) similar to that of purified thioredoxin reductase. Additionally, aurothioglucose-sensitive, NADPH-dependent DAsA reductase activity was decreased 80% by phenylarsine oxide. Glutathione-dependent DAsA reduction is more than 10-fold that of NADPH-dependent reduction [47]. In addition, proteins, including thioltransferase, protein disulfide isomerase, and 3-alpha-hydroxysteroid dehydrogenase, characterized for other



activities have been identified as having DAsA reductase activity *in vitro* [49]. Whether these previously characterized proteins catalyze the reduction of DAsA *in vivo* is unclear. But 66 kD protein with DAsA-reductase activity was identified as serum albumin. The serum albumin acts as an antioxidant and exerts a significant glutathione-dependent DAsA-reductase activity that may be important in the physiologic recycling of AsA [49].

The ability of intact cells to recycle DAsA to AsA with glutathione, estimated as DAsA-dependent ferricyanide reduction, was decreased in parallel with glutathione depletion by glutathione-S-transferase substrates [69, 45]. In contrast, the sulfhydryl reagent phenylarsine oxide inhibited DAsA reduction to a much greater extent than it decreased glutathione concentration in intact cells. Our allelic analysis showed that subjects AA homozygous for the GSTP1 A-for-G nucleotide substitution at position 313 had higher VC excretion and blood VC levels than GA heterozygous subjects (Table 3) [5]. The difference in VC metabolism between the AA and GA genotypes may be caused by glutathione-dependent VC transport, loss of glutathione by the GSTP1 AA and GA genotypes, or irreversible VC catabolism via DAsA by dehydroascorbate [3].

As shown in Figure 2, there were significant differences between AA homozygotes and GA heterozygotes with regard to the amount of VC excreted after AsA and DAsA loading. VC intake into the blood and VC excretion into the urine was more rapid with DAsA loading than with AsA loading [4, 5]. These results are consistent with an earlier loading experiment with DAsA or AsA (600 mg each, n = 17) [70]. The rapid VC metabolism after DAsA loading [4, 70] (Figure 2) may be caused by rapid passive transport of DAsA by GLUTs [26, 40]. At the same time, DAsA is produced by several xenobiotic reactions [1, 20, 42, 79], particularly dismutation of monodehydroascorbate radicals [1, 69]. DAsA is rapidly reduced into AsA in cells largely by glutathione in both nonenzymatic [1] and enzymatic reactions including glutaredoxin [2], omega class glutathione S transferase [40, 69]. This reduction maintains low intracellular levels of DAsA, and the resulting concentration gradient favors uptake of DAsA across the plasma membrane by passive transport through GLUTs [40, 60]. Decreases in glutathione concentration by oxidative stress or xenobiotic reactions using GSTP1 [39] will decrease both DAsA transport and reduction.

#### (4) Polymorphisms in GSTP1 and Loss of Reduced Glutathione

There was a significant difference ( $p < 0.0069$ ) in VC excretion between AA homozygotes and GA heterozygotes of polymorphism of glutathione S-transferase (GST) (Table 2) [5]. In AA homozygotes, 26.7% of loaded VC was excreted as total VC, while in GA heterozygotes; it was only 16.1%, which represents a 66% difference between the two groups. This difference was also seen when either AsA ( $p < 0.0486$ ) or DAsA ( $p < 0.0606$ ) were loaded [5]. As discussed in VC transport section both GFR and TmAsA were similar between the homozygotes and heterozygotes. These data indicate that the difference between AA homozygotes and GA heterozygotes is caused by VC metabolic process, not by the VC transport step. Cigarette smoke carcinogens are removed in Phase 2 detoxification by the GST superfamily [EC 2.5.1.18] [39]. GSTs are a supergene family of enzymes that catalyze Phase 2 detoxification by conjugating reduced glutathione to hydrophobic and electrophilic

substrates produced during Phase I detoxification by P450. Among the various genes that encode GSTs, GSTP1 is expressed most abundantly in the lung and brain, as well as in various cancers [36, 37]. The polymorphic GSTP1 gene encodes GST $\pi$ , which removes oxidized carcinogens forming DNA-adducts, such as benzo-[a]-pyrene. The polymorphic site in the DNA sequence is characterized by an A to G transition at nucleotide 313 (point mutation in exon 5). The codon variant results in the amino acids Ile105 or Val105 in GST $\pi$  at the electrophilic “H”-site level. The variant GSTP1 GG genotype is associated with lower enzymatic activity and higher DNA adduct levels in human lymphocytes when compared with the AA genotype [57].

GSTP1 is a ubiquitous “disease modifying” gene that affects susceptibility to cancer, Parkinson’s disease and chronic obstructive pulmonary disease through oxidative stress [39]. The odds ratio of lung cancer risk in individuals aged about 50 years with the GG genotype is 2.67, as compared with individuals having AA [36]. In a meta-analysis of bladder cancer susceptibility, the odds ratio for GSTP1 GA when compared with GSTP1 AA was 1.54 ( $p = 0.001$ ), and the association was strongest in Asian countries [37].

It is noteworthy that the GA heterozygotes in GSTP1 showed increased malonaldehyde levels ( $p = 0.04$ ) and lower reduced glutathione levels ( $p = 0.019$ ) when compared with AA homozygotes [38]; thus, the G allele of GSTP1 is associated with imbalanced oxidative stress in patients [38]. This may be the cause of the differences in VC metabolism shown in Table 2 and Figure 2 and Figure 3, via rapid DAsA reduction by glutathione and passive DAsA transport.

There are many xenobiotic enzymes that can affect VC metabolism. However, among 22 polymorphisms in the genes involved in Phase I oxidation of pyrene to 1-hydroxypyrene by CYP1A1 and CYP2E1, and Phase II conjugation of 1-hydroxypyrene by GSTP and GSTM, only GSTP1 A313G and glucuronyl-transferase UGT1A1 T3263G show high levels ( $p < 0.021$ ) of association between urinary 1-hydroxypyrene concentration and genotype in coke oven workers [79]. GSTP1 I105V (rs1695) is highly associated with urinary 1-OHP excretion. The concentrations of urinary 1-OHP (Geometric mean,  $\mu\text{mol/mol creatinine}$ ) in the homozygous major variant carriers and homozygous minor variant carriers for AhR R554K, UGT1A1 -3263T>G and GSTP1 I105V were as follows: 4.20 and 5.12, 5.11 and 3.92, 4.93 and 2.91, respectively [79].

From the above evidence, the effects of polymorphism in xenobiotic enzymes on AsA metabolism are thus evident. However, differences in oxidative stress based on AsA intake are also large (Table 1). Furthermore, the differences in oxidative stress between Mongolians and Japanese are clearly not attributable to gene variant frequencies in SOD2, SOD3, GSTP1 and GSTP2, which are very similar in both ethnic groups.

#### (5) Dehydroascorbate: Crystallographic Structure, and Antixenobiotic Properties

The irreversible step of VC catabolism is the formation of 2, 3-diketo-L-gulonate by dehydroascorbate [EC 3.1.1.17] [3, 46, 80] or by non-enzymatic delactonization, followed by the formation of oxalate or  $\text{CO}_2$  [1, 3, 46]. The nutritional activity of orally ingested

DAsA is almost 10% that of AsA on a molar basis, based on experiments using the inherently scorbutic ODS rat (devoid of GLO) [46]. However, human experiments (Table 2 and 3) [4, 8, 70] have clearly shown that the nutritional activity of DAsA is nearly equal to that of AsA. This discrepancy may be explained by the difference in DAsA metabolism between humans with high reducing power and low dehydroascorbate [3] and ODS rats with 24- to 50-fold higher dehydroascorbate activity when compared with humans [3]. The specific activity of human liver dehydroascorbate is only 0.4 to 1  $\mu\text{mol}/\text{min}/\text{mg}$  protein, while those in rats and cows are 24 and 37  $\mu\text{mol}/\text{min}/\text{mg}$  protein, respectively [3]. Both human [51] and rat [52] dehydroascorbates have been sequenced and identified as senescent marker protein 30 (SMP30) and gluconolactonase [53] with 299 amino acid residues. X-ray crystallography of bacterial (*Xanthomonas campestris*) gluconolactonase identified four residues coordinating with a central calcium ion (E48, N134, N191 and D242), which are also conserved in the corresponding residues of human and rat dehydroascorbate (E17, N103, N155 and D204, respectively) [54]. However, four ionizing residues (E83, K(E)95, E231 and D254) conserved among bovine, rabbit, rat [52] and mouse dehydroascorbate were converted to K83, N95, V232 and N253, respectively, in human dehydroascorbate [51]. These residue changes may explain the large species difference in dehydroascorbate activity in the human liver [3]. To confirm its activity, human dehydroascorbate was produced in *E. coli* BL21 via the pCold II-humanSMP30 vector (A. Ishigami, personal communication). The amino acid sequence of human dehydroascorbate was 91%, which is homologous to that of the bovine enzyme; the activity was found to depend on divalent cations.

The non-enzymatic delactonization of DAsA follows pseudo-first order reaction kinetics,  $-(d[\text{DAsA}]/dt) = k[\text{DAsA}]$ , with  $k$  values ( $\text{s}^{-1} \times 10^{-3} \text{ M}$ ) at pH 6.8, 7.0, 7.2, 7.4 and 7.6 of 0.77, 1.15, 1.76, 2.41 and 3.18, respectively, in the presence of 6.7 mM  $\text{Mg}^{2+}$  [46]. The rapid non-enzymatic hydrolysis of DAsA is prevented by rapid reduction by enzymes with dehydroascorbic acid reductase activity [1, 69], including glutaredoxin [2], thioredoxin [47], omega class glutathione transferase [48] and serum albumin [49], and by non-enzymatic reduction with SH compounds [1].

SMP30 (dehydroascorbate) is the most abundant anti-xenobiotic [80] and anti-aging protein [55] in the liver, accounting for about 1% of total liver protein, as demonstrated by purification to ultracentrifugal homogeneity [53]. SMP30 has lactonase activity toward various aldonolactones and requires  $\text{Zn}^{2+}$  or  $\text{Mn}^{2+}$  as a cofactor. The lactonase reaction is the penultimate step in AsA biosynthesis, and the essential role of SMP30 in the AsA synthetic process was verified in a nutritional study using SMP30 knockout (KO) mice. SMP30 has paraoxanase activity to hydrolyze organophosphorus compounds and to counteract oxidative stress [56]. Administration of organophosphorus compounds stimulate VC metabolism and retard growth, but excess intake of VC under toxic conditions is effective in counteracting toxic effects and restores dehydroascorbate levels [80]. Prevention of oxidative stress depends on antioxidants such as VC and reactions by xenobiotic enzymes. Dehydroascorbate is also known as regucalcin, and its gene expression appears to be a sensitive marker to evaluate the renal impairment caused by chemicals, while its down-regulation seems to be related to damage [57].

The metabolic network to counteract xenobiotics is complex. Stable isotope-labeled VC (30 mg l-[1- $^{13}\text{C}$ ] AsA) was given alone or with Fe (100 mg as ferrous fumarate) to produce

DAsA [78], but no genetic studies have been reported. Experiments are thus needed to determine the body pool, absorption, distribution, metabolism, excretion and half-life of VC [1, 5] using radioactive VC [42] or stable isotope-labeled VC [78] in order to confirm the effects of genetic polymorphisms on VC metabolism in human subjects with different genotypes. Mean ( $\pm$  SD) plasma total VC (AsA + DAsA) concentrations are lower in smokers (1.1 mg/dL) than in nonsmokers (1.3 mg/dL). Oral administration of a single dose of 1-<sup>14</sup>C-AsA revealed that smokers have a higher metabolic turnover (140 mg/day) than nonsmokers (100 mg/day) to reach steady-state concentrations [37].

## (6) Monodehydroascorbate Radicals and Xenobiotics

VC is a cofactor in reactions catalyzed by Cu<sup>+</sup>-dependent monooxygenases for the neurotransmitter supply and Fe<sup>2+</sup>-dependent dioxygenases for collagen synthesis, and also a major antioxidant [1]. The most essential xenobiotic and antioxidant reaction of AsA is the rapid formation of monodehydroascorbate radicals via one electron transfer. The dismutation of a pair of monodehydroascorbate radicals, which is catalyzed by NADH-dependent monodehydroascorbate reductase, produces one molecule of AsA and one of DAsA [69]. Especially in mitochondria levels of superoxide ( $-\bullet\text{O}_2$ ), hydroxyl radical ( $\bullet\text{OH}$ ), and hydrogen peroxide ( $\text{H}_2\text{O}_2$ ) in control and oxidatively stressed purified mitochondria has been determined in the presence and absence of AsA added as DAsA [43]. Levels of  $-\bullet\text{O}_2$  were significantly increased by treating mitochondria with the superoxide generator DMNQ, which was inhibited by preloading mitochondria with 2.0 mM AsA. A significant reduction in  $\bullet\text{OH}$  levels (from 120% to 80%) was achieved by preloading mitochondria with AsA. Mitochondrial AsA also significantly reduced levels of  $\bullet\text{OH}$  and  $\text{H}_2\text{O}_2$  in oxidatively stressed purified mitochondria (both ROS from 145% to 85%). Overall, levels of mitochondrial ROS were attenuated when purified mitochondria were preloaded with AsA [43]. A model of one electron transfer of AsA is oxidation by Fe<sup>3+</sup> (ferricyanide etc.) [23]. Recycling of AsA from its oxidized forms helps to maintain the vitamin in cells [69]. To determine the relative contributions of recycling from the monodehydroascorbate radical and DAsA, erythrocytes were exposed to a trans-membrane oxidant stress from ferricyanide. Ferricyanide was used both to induce oxidant stress across the cell membrane and to quantify AsA recycling [23]. Erythrocytes reduced ferricyanide with generation of intracellular monodehydroascorbate radical, the concentrations of which saturated with increasing intracellular AsA and which were sustained over time in cells incubated with glucose. Ferricyanide also generated DAsA that accumulated in the cells and incubation medium to concentrations much higher than those of the radical, especially in the absence of glucose. Ferricyanide-stimulated AsA recycling from DAsA depended on intracellular GSH but was well maintained at the expense of intracellular AsA when GSH was severely depleted by diethylmaleate. This likely reflects continued radical reduction, which is not dependent on GSH. Erythrocyte hemolysates showed both NAD- and NADPH-dependent monodehydroascorbate radical reduction. The latter was partially due to thioredoxin reductase. GSH-dependent monodehydroascorbate reduction in hemolysates, which was both direct and enzyme-dependent, was greater than that of the radical reductase activity but of lower apparent affinity. Together, these results suggest

an efficient two-tiered system in which high affinity reduction of the monodehydroascorbate radical is sufficient to remove low concentrations of the radical that might be encountered by cells not under oxidant stress, with back-up by a high capacity system for reducing DAsA under conditions of more severe oxidant stress [23, 81].

DAsA is formed by numerous oxidants via two electron transfer, and by dismutation of monodehydroascorbate radicals. Thus, the concentration of DAsA is maintained by the balance between its formation by oxidative stress [13, 23], reduction [2] and hydrolysis [3, 46]. Erythrocytes reduce ferricyanide by generating intracellular monodehydroascorbate radicals, the concentrations of which are saturated with increasing intracellular AsA, and are sustained over time in cells incubated with glucose. Ferricyanide also generates DAsA, which accumulates in cells and incubation media to concentrations much higher than those of the radicals, particularly in the absence of glucose [23]. Ferricyanide-stimulated AsA recycling from DAsA depends on intracellular glutathione, but is well maintained at the expense of intracellular AsA when glutathione is severely depleted by diethylmaleate. This likely reflects continued radical reduction, which is not dependent on glutathione.

Erythrocyte hemolysates show both NAD- and NADPH-dependent monodehydroascorbate radical reduction. The latter is partially due to thioredoxin reductase [69, 47]. Glutathione-dependent DAsA reduction, which is both nonenzymic and enzyme-dependent, is greater when compared with monodehydroascorbate radical reductase activity, but has lower apparent affinity. Taken together, these results suggest an efficient two-tiered system in which high affinity reduction of monodehydroascorbate radicals is sufficient to remove low concentrations that might be encountered by cells not under oxidative stress, with back-up by a high capacity system for reducing DAsA under conditions of more severe oxidative stress. The full antioxidant protection of endothelial cells requires the simultaneous presence of intracellular and extracellular VC at concentrations normally found *in vivo* [1].

VC has a strong antioxidant function, as evidenced by its ability to scavenge superoxide radicals *in vitro* [82]. This property was demonstrated *in vivo* by using a real-time imaging system in which Lucigenin was used as a chemiluminescent probe for detecting superoxide in senescence SMP30 KO mice, which cannot synthesize VC *in vivo*. SMP30 KO mice were given 1.5 g/L VC [VC(+)] for 2, 4 or 8 weeks or were denied VC [VC(-)] [82]. At 4 and 8 weeks, VC levels in brains from VC(-) KO mice were <6% of those in VC(+) KO mice. Accordingly, superoxide-dependent chemiluminescence levels determined by ischemia-reperfusion at the 4- and 8-week test intervals were 3.0-fold and 2.1-fold higher, respectively, in VC(-) KO mice than in VC(+) KO mice. However, total SOD activity and protein levels were not altered. Thus, VC depletion specifically increased superoxide generation in a model of the living brain [82].

## (7) Pro-Oxidant Activity of VC

Generally AsA has been used as a potent antioxidant that can scavenge ROS such as superoxide anion and hydroxyl radicals [1]. However, as stated in the previous section, highly reactive monodehydroascorbate radicals produced from AsA by one electron transfer in the presence of transition metals accelerate the formation of hydroxyl radicals through the

accelerated redox cycling of the metals [13][14]. Thus, AsA added to the medium of a cell culture increases oxidative damage, and this effect of AsA has been ascribed to the generation of reactive oxygen intermediates in the medium during its auto-oxidation. This effect is also exerted inside the cell [20]. To assess thiol oxidation in the cell, CHO cells expressing bacterial alkaline phosphatase in the cytoplasm were used [20]. Alkaline phosphatase activity, which requires the formation of intramolecular disulfide bridges, was shown to appear when the cells were exposed to hydrogen peroxide [20]. This hydrogen peroxide-induced activity increased more than 1.5 fold when AsA had been loaded in the cells by incubation with AsA-2-O-phosphate. Similar enhancing effects were also observed by assessing oxidation of glutathione, formation of protein carbonyls, and generation of reactive oxygen intermediates [20]. The effects by the AsA-2-O-phosphate treatment were totally suppressed by addition of the membrane-permeable chelator deferoxamine to the medium, indicating the involvement of iron ions. Because the same deferoxamine effect was observed with the cells incubated in balanced salt solution with no metal salts added, it was concluded that AsA acts as a pro-oxidant within the cell suffering oxidative stress, and that this effect is elicited through increased redox-cycling of iron in combination with AsA.

Some of the studies suggest that AsA sometimes increases oxidative damage. For example the levels of 8-oxoadenine in DNA from lymphocytes increased upon administration of AsA as a dietary supplement to healthy humans [21].

#### (8) Human Specific Genes for VC Metabolism and Future VC Nutrigenomics

The metabolisms of three most important water-soluble antioxidants in mammals, i.e. VC, urate and glutathione, are different in humans and VC autotrophs. Humans have plasma VC levels [4-6] two to four times lower than that observed in VC autotrophs [25, 80, 71] due to the loss of functional genes of L-gulonolactone oxidase (GLO) [22]. Human GLO gene homologue is located in chromosome 8p21.1, but its exon 11 was deleted by insertion of *Alu* about 69 million years ago [22]. This mutation is thought to have occurred before the divergence of New World monkeys and Old World monkeys and after the divergence time of the promiscian and simian lineage [22]. The loss of GLO had an advantage of less hydrogen peroxide, as long as large amount of VC is supplied from fruits and leaves in the tropical region. In order to compensate VC auxotrophy with urate as an antioxidant, urate oxidase was lost in hominoids during primate evolution [83]. In fact, the nonsense mutation at codon position 33 resulted in the loss of urate oxidase activity in the human, whereas the 13-bp deletion was responsible for the urate oxidase deficiency in the gibbon. Because the disruption of a functional gene by independent events in two different evolutionary lineages is unlikely to occur on a chance basis, these data favor the hypothesis that the loss of urate oxidase may have evolutionary advantages for VC auxotrophs [83]. The mutations in the human dehydroascorbate [51, 52] also supported the loss of DAsA into 2,3-diketo L-gulonate [3, 46]. Transport system of DAsA is also specified in humans. Of all cells, human erythrocytes express the highest level of the GLUT1 glucose transporter [26]. Erythrocyte GLUT1 and associated DAsA uptake are unique traits of VC auxotrophs. Stomatin, an

integral erythrocyte membrane protein, is regulating the switch of GLUT1 from glucose to DAsA transport. Mice, a VC autotroph, express GLUT4 but not GLUT1 in mature erythrocytes. Thus, erythrocyte-specific coexpression of GLUT1 with stomatin constitutes a compensatory mechanism in VC auxotrophs [26].

The impact of the defective VC synthesis by the GLO gene deletion in the sfx mice was surveyed by gene expression profiling with microarray in the liver, femur and kidney [84]. The loss of GLO upregulated the expressions of osteoblast related genes, and downregulated those of cyclophilin etc. [84]. Finally, gene therapy to restore VC synthesis in human cells by correcting the genetic defect of GLO was achieved [86]. Introduction of GLO-expressing vector under the control of the mCMV promoter into both human liver cell line (HEP G2) and GLO-knockout mice, restored VC synthesis in a time and gene dose dependent manner [85]. These cells also produced VC when exogenous L-gulonolactone was supplemented in the media. Serum VC concentrations in GLO knockout mice injected with the GLO expressing vector were elevated to levels comparable to those of the wild type mice (60  $\mu$ M) within 4 days [85].

#### (9) Recommended Dietary Allowances for VC (Figure 4)

A part of this research [4] was started to re-evaluate Recommended Dietary Allowances (RDAs) for VC for Japan [28]. The RDAs were calculated from estimated average requirement (EAR) values (85 mg/day), those estimated to meet the nutrient requirement of half the individuals in a group [28] (Figure 4). On the basis of depletion–repletion data for men, recommended daily VC intake was increased to 100 mg (= EAR  $\times$  1.2) for adults in Japan [28]. In April 2000, RDAs for VC for the U.S. and Canada were released by the Food and Nutrition Board, U.S. National Academy of Sciences [29]. The EAR for VC was selected as 80% saturation of neutrophils with little urinary loss [29]. For men, an EAR of 75 mg/day was determined from depletion–repletion data [29]. On the basis of this value, the RDA for men was increased from 60 to 90 mg/day [29]. Because similar data were not available for women, an EAR had to be extrapolated on the basis of body weight differences between sexes, and an RDA of 75 mg/day was derived [29]. On the basis of Food and Nutrition Board curve fitting calculations using the data, a standard deviation of 19.4% was determined [68]. By using this standard deviation rather than 10%, the RDA for men becomes EAR + (EAR  $\times$  2 SDs) = EAR + 38.8% EAR = 75 mg + 29.1 mg = 104.1 mg. By examining neutrophil data for both men and young women, it is seen that an assumed standard deviation of 10% may be too low. Then based on the following data, RDA of VC for women was increased to 90 mg/day [68]. The depletion–repletion study was performed with healthy young women hospitalized for  $186 \pm 28$  days, using VC doses of 30–2,500 mg/day. The relationship between dose and steady-state plasma concentration was sigmoidal. Only doses above 100 mg were beyond the linear portion of the curve [68]. Plasma and circulating cells saturated at 400 mg/day, with urinary elimination of higher doses. Biomarkers of endogenous oxidant stress, plasma and urine F2-isoprostanes, and urine levels of a major metabolite of F2-isoprostanes were unchanged by VC at all doses, suggesting VC does not alter endogenous lipid peroxidation [68]. The intake of VC 100 mg/day, produced a plasma concentration

similar to  $V_{max}$  of the human sodium-dependent VC tissue transporter (SVCT2) [16, 30]. VC concentrations were determined at steady state over the dose range in neutrophils, monocytes, lymphocytes, and platelets [63]. As for plasma, most cells saturated between 200 and 400 mg/day [68].

There are three important questions raised against the uniform RDA based on the average short-term EAR [28, 29] as follows: (1) the genetic polymorphisms of VC-related enzymes may cause marked interindividual difference in VC metabolism as shown by Tables 1-3 and Figure 3 [4, 5]; (2) the long-term optimal intake of VC may be different from RDA; and (3) the increase of VC requirement by ROS produced by exercise and xenobiotics has already been described on smokers [42, 81], coke oven workers [79] and chronic intoxication [80]. For example, Genetic analysis of polymorphisms especially on xenobiotic enzymes (Tables 2 and 3) [4, 5, 8] will partly answer the question (1) as described in this review. Detailed well controlled interventional [10, 33] and epidemiological studies [9, 10] will partly answer the question (2). Besides RDA, tentative dietary goal for preventing life-style related diseases (DG) is determined for many nutrients. However, DG for VC has not been announced [28, 29].

Pauling recommended to ingest 2.3g or more VC/day for optimal nutrition and health for an adult with energy requirement 2500 kcal/day, based on synthetic rates in rat (VC 58mg/day/kg body weight), proportionality of VC requirement for guinea pig (VC 1.8-4.1g/day/70kg) , and the green foodstuffs eaten by gorilla (VC intake 4.5 g/day) [30]. However, the comparison with rat, guinea pig and monkeys is not pertinent because the rate limiting step in VC catabolism, dehydroascorbate activity per liver protein is about 34-, 14- and 2 fold, respectively, higher than that of humans [3]. The tolerable upper intake level (UL) of VC is not determined officially but stated as around 40 g/day [28], because the intravenous administration of 30 g VC/ 80 min for therapeutic purpose are still tolerated [75]. Johnsons group suggest that both mutations in GLO and uricase during human evolution may have provided a survival advantage to early primates by helping maintain blood pressure during periods of dietary change and environmental stress [25]. In fact, in a randomised, double-blind, placebo-controlled study, treatment of hypertensive patients with ascorbic acid (500 mg/day) lowered mean blood pressure (110 to 100 mmHg,  $p < 0.001$ ) [86]. Moreover, epidemiologic studies support the possible role of uric acid in the onset of essential hypertension [87]. Uric acid causes hypertension in a rat model through the activation of the renin-angiotensin system, downregulation of nitric oxide, and induction of endothelial dysfunction and vascular smooth muscle proliferation [87]. The mutations in GLO and uricase have the inadvertent disadvantage of increasing our risk for hypertension and cardiovascular disease in today's society characterized by Western diet and increasing physical inactivity [25]. Exercise, xenobiotics and pathological conditions can produce an imbalance between ROS and antioxidant, and VC is used as a means to counteract the oxidative stress [88].

## Conclusion



### (1) Human Specific VC Metabolism and Transport

Human VC metabolism is essential to prevent xenobiotic damage [1] and oxidative stress [9] through oxidation of AsA to monodehydroascorbate radicals and DAsA [1, 23]. Oxidative imbalance is an important contributor to aging and degenerative diseases of all animals [14]. However, human VC metabolism is markedly different from that of VC autotrophs [1, 22]. To overcome VC auxotrophy, rapid reducing and transporting through GLUT1 for recycling DAsA [16, 26, 69], high uric acid concentrations [24, 29] and low dehydroascorbate activity [3, 46] developed in the human body. DAsA enters mitochondria via GLUT1 and protects mitochondria from oxidative injury [43]. Since mitochondria contribute significantly to intracellular ROS, protection of the mitochondrial genome and membrane may have pharmacological implications against a variety of ROS-mediated disorders [43].

### (2) Molecular Genetics of VC Metabolism

Studies on oxidoreduction of glutathione [48] and serum albumin [49], explained the rapid DAsA reduction to protect DAsA hydrolysis in slightly alkaline cytosol and serum (pH 7.4). Thus, genetic polymorphisms in xenobiotic enzymes affecting glutathione and other oxidative stress-related substrates affect VC metabolism.

In the VC loading experiments on subjects with polymorphisms in glutathione S transferase 1 (GSTP1), total VC excretion ( $46.7 \pm 18.1$  mg) by AA homozygotes of GSTP1 was greater ( $p < 0.0069$ ) than that ( $28.2 \pm 14.0$  mg) by GA heterozygotes, with no differences seen in GFR (90 ml/min) [4, 5]. In the same subjects, blood total VC levels were also significantly different ( $p < 0.0036$ ) between the homozygotes and heterozygotes [4, 5]. Other polymorphisms in xenobiotic enzymes may also affect VC metabolism.

The pleiotropic functions of dehydroascorbate [3, 46, 80], antixenobiotic paraoxanase [56], anti-aging SMP30 [51, 52], regucalcin [57] and lactonase [53], attracted numerous researchers because it is the most abundant liver protein, accounting for 1% of total protein [53], but it decreases with age [55]. Recent studies by X-ray crystallography [54] and amino acid sequencing (99 amino acids in mammals) [51, 52] revealed that the Ca-coordinating amino acid residues (E17, N103, N155 and D204) are conserved among mammals, and there are human-specific residues (K83, N95, V232 and N253). The VC auxotrophy is compensated by deletion of uricase, mutation of dehydroascorbate [3, 51, 52] and many other changes in the gene expression [84]. The human VC auxotrophy is now restored by introduction of active GLO gene into a human cell line [85].

### (3) VC Loading Experiments

Since the classical loading experiments of AsA and DAsA by Linkswiler [61] for Americans, and by Tsujimura [70] for Japanese, nutritional values of AsA and DAsA have been estimated to be equal in humans [4, 5, 8]. However, the effects of DAsA are only 10% of those of AsA in GLO-knockout rat [71]. The Pauling's recommendation to ingest 2.3g or

more VC/day for optimal nutrition, based on animal VC metabolism [30] is not accepted by the following negative results as follows: (1) compared with other animals rapidly metabolizing DAsA [71], including guinea pig (14 fold active DAsA catabolism [3], and different GLO deletion [27]), VC metabolism in humans are slow to compensate GLO mutations [4, 5, 8] by the low dehydroascobate activity [3, 46]; (2) the poor outcome of large scale trials on long-term administration of VC (500 mg/day) [10, 33]; and harmful decrease of gene expression of antioxidant enzymes and loss of endurance capacity by taking 1g VC/day [73, 74]. The VC-loading data show there is tight control of VC concentrations in healthy young women, as in men [68]. Over the narrow dose range of 30–100 mg, VC concentrations increased substantially in both plasma and cells. At these doses, interindividual differences in time to reach steady state may have been because of differences in absorption, distribution, body size, catabolism, or VC recycling [1]. At higher doses, plasma and cell concentrations were changed minimally, presumably because of urine excretion of the absorbed dose and saturation of the cell transporter SVCT2 [44].

Dietary antioxidants have become increasingly linked to human health and disease. Studies of VC dose–concentration relationships and functional consequences are needed in patients with diabetes, hypertension, hyperlipidemias, renal failure, and chronic heart disease, as well as in smokers, the elderly, and those at risk for infection [10-14]. Examples of high VC consumption by humans under pathological conditions such as inflammation and ischemia have been reported [69].

#### (4) Optimal Nutrition of VC

Finally, the authors are not satisfied with present RDA (VC 100 mg/day for adults, Figure 4) [28], which is different from DG (dietary goal for preventing life-style related diseases) or optimal nutrition based on personalized nutrigenomics [71]. DG for VC (perhaps between 100mg to 500 mg/day) based on epidemiological and interventional studies should be determined.

Optimal nutrition of VC is wider in scope than uniform RDA for VC which is determined mainly by short-term depletion-repletion studies of subjects with many polymorphisms in the absence of xenobiotics. However, optimal nutrition covers problem of interindividual difference due to genetic polymorphisms and long-term health outcome during the lifespan. Optimal personalized nutrition based on polymorphism enables not only appropriate treatment but also prediction of the risk for prophylaxis even in an environment with xenobiotics. Essentially, optimal nutrition of VC means that the dietary 'nutriome' (i.e. nutrient profile and composition) recommendations should be matched to an individual's functional genome to optimize health maintenance even in the presence of xenobiotics [31].

## Acknowledgments

We would like to thank the Bioorganic Chemistry graduates (2005, 2006) of Kagawa Nutrition University for their cooperation in this study. This study was supported by Grants-

in-Aid for Young Scientists (B, #18700612, 2006-2007 for S.H.), and the “High-Tech Research Center” Project for Private Universities: matching fund subsidy (2004-2009 for Y.K.) from the Ministry of Education, Culture, Sports, Science and Technology of Japan.

## References

- [1] Linster, C.L. & Van Schaftingen, E. (2007). Vitamin C. Biosynthesis, recycling and degradation in mammals. *FEBS J.*, 274, 1-22.
- [2] Park, J.B. & Levine, M. (2005). Cloning, sequencing, and characterization of alternatively spliced glutaredoxin 1 cDNA and its genomic gene: chromosomal localization, mRNA stability, and origin of pseudogenes. *J. Biol. Chem.*, 280, 10427-10434.
- [3] Kagawa, Y., Takiguchi, H. & Shimazono, N. (1961). Enzymic delactonization of dehydro-L-ascorbate in animal tissues. *Biochim. Biophys. Acta.*, 51, 413-415.
- [4] Tsujimura, M., Higasa, S., Nakamura, K., Yanagisawa, Y., Iwamoto, S. & Kagawa, Y. (2008). Vitamin C activity of Dehydroascorbic acid in humans –Association between changes in the blood vitamin C concentration or urinary excretion after oral loading. *J. Nutr. Sci. Vitaminol.*, 54, 315-320.
- [5] Higasa, S., Tsujimura, M., Hiraoka, M., Nakayama, K., Yanagisawa, Y., Iwamoto, S. & Kagawa, Y. (2007). Polymorphism of glutathione S-transferase P1 gene affects human vitamin C metabolism. *Biochem. Biophys. Res. Commun.*, 364, 708-713.
- [6] Hiraoka, M. (2001). Nutritional status of vitamin A, E, C, B<sub>1</sub>, B<sub>2</sub>, B<sub>6</sub>, nicotinic acid, B<sub>12</sub>, folate, and  $\beta$ -carotene in young women. *J. Nutr. Sci. Vitaminol.*, 47, 20-27.
- [7] Kagawa, Y., Cha, S., Hasegawa, K., Hamamoto, T. & Endo, H. (1999). Regulation of energy metabolism in human cells in aging and diabetes: FoF1, mtDNA, UCP, and ROS. *Biochem. Biophys. Res. Commun.*, 266, 662-676.
- [8] Higasa, S., Tsujimura, M., Hiraoka, M., Nakayama, K., Yanagisawa, Y., Iwamoto, S. & Kagawa, Y. (2008). Genetic polymorphisms of xenobiotic enzymes affect human vitamin C excretion. *Asia-Pacific J. Public Health*, 20, Suppl, 70-79.
- [9] Komatsu, F., Kagawa, Y., Sakuma, M., Kawabata, T., Kaneko, Y., Otgontuya, D., Chimedregzen, U., Narrantuya, L. & Purvee, B. (2006). Investigation of oxidative stress and dietary habits in Mongolian people, compared to Japanese people. *Nutrition & Metabolism*, 3, 21-27.
- [10] Willcox, B.J., Curb, J.D. & Rodriguez, B.L. (2008). Antioxidants in cardiovascular health and diseases: Key lessons from epidemiologic studies. *Am. J. Cardiol.*, 101 suppl., 75D-86D.
- [11] Frei, B. (1999). On the role of vitamin C and other antioxidants in atherogenesis and vascular dysfunction. *Proc. Soc. Exp. Biol. Med.*, 222, 196-204.
- [12] Carr, A. & Frei, B. (1999). Does vitamin C act as a pro-oxidant under physiological conditions? *FASEB. J.*, 13, 1007-1024.
- [13] Schafer, F.Q. & Buettner, G.R. (2001). Redox environment of the cell as viewed through the redox state of the glutathione disulfide/glutathione couple. *Free Radic. Biol. Med.*, 30, 1191-1212.

- [14] Ames, B.N., Shigenaga, M.K. & Hagen, T.M. (1993). Oxidants, antioxidants, and the degenerative diseases of aging. *Proc. Natl. Acad. Sci. USA.*, 90, 7915-7922.
- [15] Genova, M.L., Pich, M.M., Bernacchia, A., Bianchi, C., Biondi, A., Bovina, C., Falasca, A.I., Formiggini, G., Castelli, G.P. & Lenaz, G. (2004). The mitochondrial production of reactive oxygen species in relation to aging and pathology. *Ann. N.Y. Acad. Sci.*, 1011, 86-100.
- [16] Halliwell, B. & Gutteridge, J.M.C. (1989). *Free Radicals in Biology and Medicine*. Clarendon Press, Oxford U.K.
- [17] Guaiquil, V.H., Vera, J.C. & Golde, D.W. (2001). Mechanism of vitamin C inhibition of cell death induced by oxidative stress in glutathione-depleted HL-60 cells. *J. Biol. Chem.*, 276, 40955-40961.
- [18] Witenberg, B., Kalir, H.H., Raviv, Z., Kletter, Y., Kravtsov, V. & Fabian, I. (1999). Inhibition by ascorbic acid of apoptosis induced by oxidative stress in HL-60 myeloid leukemia cells. *Biochem. Pharmacol.*, 57, 823-832.
- [19] Perez-Cruz, I., Carcamo, J.M. & Golde, D.W. (2003). Vitamin C inhibits FAS-induced apoptosis in monocytes and U937 cells. *Blood*, 102, 336-343.
- [20] Inai, Y., Bi, W., Shiraishi, N. & Nishikimi, M. (2005). Enhanced oxidative stress by L-ascorbic acid within cells challenged by hydrogen peroxide. *J. Nutr. Sci. Vitaminol.*, 51, 398-405.
- [21] Podmore, I.D., Griffiths, H.R., Herbert, K.E., Mistry, N., Mistry, P. & Lunec, J. (1998). Vitamin C exhibits pro-oxidant properties. *Nature*, 392, 559.
- [22] Inai, Y., Ohta, Y. & Nishikimi, M. (2003). The whole structure of the human nonfunctional L-gulonogamma-lactone oxidase gene--the gene responsible for scurvy--and the evolution of repetitive sequences thereon. *J. Nutr. Sci. Vitaminol.*, 49, 315-319.
- [23] May, J.M., Qu, Z.C., Cobb, C.E. (2004). Human erythrocyte recycling of ascorbic acid: relative contributions from the ascorbate free radical and dehydroascorbic acid. *J. Biol. Chem.*, 279, 14975-14982.
- [24] Sautin, Y.Y. & Johnson, R.J. (2008). Uric acid: the oxidant-antioxidant paradox. *Nucleosides Nucleotides Nucleic Acids*, 27, 608-619.
- [25] Johnson, R.J., Gaucher, E.A., Sautin, Y.Y., Henderson, G.N., Angerhofer, A.J. & Benner, S.A. (2008). The planetary biology of ascorbate and uric acid and their relationship with the epidemic of obesity and cardiovascular disease. *Med. Hypotheses.*, 71, 22-31.
- [26] Montel-Hagen, A., Kinet, S., Manel, N., Mongellaz, C., Prohaska, R., Battini, J.L., Delaunay, J., Sitbon, M. & Taylor, N. (2008). Erythrocyte Glut1 triggers dehydroascorbic acid uptake in mammals unable to synthesize vitamin C. *Cell*, 132, 1039-1048.
- [27] Nishikimi, M., Kawai, T. & Yagi, K. (1992). Guinea pigs possess a highly mutated gene for L-gulonog-lactone oxidase, the key enzyme for L-ascorbic acid biosynthesis missing in this species., *J. Biol. Chem.*, 267, 21967-21972.
- [28] Ministry of Health, Labor, and Welfare, Japan. (2005). Dietary Reference Intakes for Japanese, 2005. *Daiichi Shuppan*, 106-109.

- [29] Food and Nutrition Board and Panel on Dietary Antioxidants and Related Compounds. (2000). *Vitamin C*, 5, 95–185.
- [30] Pauling, L. (1970). Evolution and the needs for ascorbic acid. *Proc. Natl. Acad. Sci. USA.*, 67, 1643-1648.
- [31] Kagawa, Y. & Shidoji, Y. (2008). Personalized Vitaminology – Nutrigenomic Education-(in Japanese) *Kempakusha*, 1-222.
- [32] Attia, J., Ioannidis, J.P., Thakkinstian, A., McEvoy, M., Scott, R.J., Minelli, C., Thompson, J., Infante-Rivard, C. & Guyatt, G. (2009). How to use an article about genetic association: A: Background concepts. *JAMA.*, 301, 74-81.
- [33] Sesso, H.D., Buring, J.E., Christen, W.G., Kurth, T., Belanger, C., MacFadyen, J., Bubes, V., Manson, J.E., Glynn, R.J. & Gaziano, J.M. (2008). Vitamins E and C in the prevention of cardiovascular disease in men: the Physicians' Health Study II randomized controlled trial. *JAMA.*, 300, 2123-2133.
- [34] Lutsenko, E. A., Carcamo, J.M. & Golde, D.W. (2002). Vitamin C prevents DNA mutation induced by oxidative stress. *J. Biol. Chem.* **277**, 16895-16899.
- [35] Zingg, J.M., Azzi, A. & Meydani, M. (2008). Genetic polymorphisms as determinants for disease-preventive effects of vitamin E. *Nutr. Rev.*, 66, 406-414.
- [36] Miller, D.P., Asomaning, K., Liu, G., Wain, J.C., Lynch, T.J., Neuber, D., Su, L. & Christiani, D.C. (2006). An association between glutathione S-transferase P1 gene polymorphism and younger age at onset of lung carcinoma. *Cancer*, 107, 1570-1577.
- [37] Kellen, E., Hemelt, M., Broberg, K., Golka, K., Kristensen, V.N., Hung, R.J., Matullo, G., Mittal, R.D., Porru, S., Povey, A., Schulz, W.A., Shen, J., Buntinx, F., Zeegers, M.P. & Taioli, E. (2007). Pooled analysis and meta-analysis of the glutathione S-transferase P1 Ile 105Val polymorphism and bladder cancer: a HuGE-GSEC review. *Am. J. Epidemiol.*, 165, 1221-1230.
- [38] Ballerini, S., Bellincampi, L., Bernardini, S., Iori, R., Cortese, C. & Federici, G. (2003). Analysis of GSTP1-1 polymorphism using real-time polymerase chain reaction. *Clin. Chim. Acta.*, 329, 127-132.
- [39] Vibhuti, A., Arif, E. D. Deepak, B. & Singh, M.A. (2007). Genetic polymorphisms of GSTP1 and mEPHX correlate with oxidative stress markers and lung function in COPD. *Biochem. Biophys. Res. Commun.*, 359, 136-142.
- [40] Wilson, J.X. (2005). Regulation of vitamin C transport. *Annu. Rev. Nutr.*, 25, 105-125.
- [41] Oreopoulos, D.G., Lindeman, R.D., VanderJagt, D.J., Tzamaloukas, A.H., Bhagavan, H.N. & Garry, P.J. (1993). Renal excretion of ascorbic acid: effect of age and sex. *J. Am. Coll. Nutr.*, 12, 537-542.
- [42] Kallner, A.B., Hartmann, D. & Hornig, D.H. (1981). On the requirements of ascorbic acid in man: steady-state turnover and body pool in smokers. *Am. J. Clin. Nutr.*, 34, 1347-1355.
- [43] Sagan, K.C., Cárcamo, J.M. & Golde, D.W. (2005). Vitamin C enters mitochondria via facilitative glucose transporter 1 (Glut1) and confers mitochondrial protection against oxidative injury. *FASEB. J.*, 19, 1657- 1667.
- [44] Castro, T., Low, M., Salazar, K., Montecinos, H., Cifuentes, M., Yanez, A.J., Slebe, J.C., Figueroa, C.D., Reinicke, K., de los Angeles Garcia, M., Henriquez, J.P. &

- Nualart, F. (2008). Differential distribution of the Sodium-vitamin C cotransporter-1 along the proximal tubule of the mouse and human kidney. *Kidney Int.*, 74, 1278-1286.
- [45] Washko, P.W., Wang, Y. & Levine, M. (1993). Ascorbic acid recycling in human neutrophils. *J. Biol. Chem.*, 268, 15531-15535.
- [46] Kagawa, Y. & Takiguchi, H. (1962). Enzymatic studies on ascorbic acid catabolism in Animals II. delactonization of dehydro-L-ascorbic acid. *J. Biochem.*, 51, 197-203.
- [47] May, J. M. (2002). Recycling of vitamin C by mammalian thioredoxin reductase. *Methods. Enzymol.*, 347, 327-332.
- [48] Whitbread, A.K., Tetlow, N., Eyre, H.J., Sutherland, G.J. & Board, P.G. (2003). Characterization of the human Omega class glutathione transferase genes and associated polymorphisms. *Pharmacogenetics*, 13, 131-144.
- [49] Vethanayagam, J. G. G., Green, E. H., Rose, R. C. & Bode, A. M. (1999). Glutathione-dependent ascorbate recycling activity of rat serum albumin. *Free Radic. Biol. Med.*, 26, 1591-1598
- [50] Fenech, M. (2007). Nutrition and genome health. *Forum Nutr.*, 60, 49-65.
- [51] Fujita, T., Mandel, J.L., Shirasawa, T., Hino, O., Shirai, T. & Maruyama, N. (1995). Isolation of cDNA clone encoding human homologue of senescence marker protein-30 (SMP30) and its location on the X chromosome. *Biochim Biophys Acta.*, 1263, 249-252.
- [52] Fujita, T., Shirasawa, T., Uchida, K. & Maruyama, N. (1992). Isolation of cDNA clone encoding rat senescence marker protein-30 (SMP30) and its tissue distribution. *Biochim Biophys Acta.*, 1132, 297-305.
- [53] Kawada, M., Takiguchi, H., Kagawa, Y., Suzuki, K. & Shimazono, N. (1962). Comparative studies on soluble lactonases. *J. Biochem.*, 51, 405-415.
- [54] Chen, C.N., Chin, K.H., Wang, A.H. & Chou, S.H. (2008). The first crystal structure of gluconolactonase important in the glucose secondary metabolic pathways. *J. Mol. Biol.*, 384, 604-614.
- [55] Kondo, Y., Inai, Y., Sato, Y., Handa, S., Kubo, S., Shimokado, K., Goto, S., Nishikimi, M., Maruyama, N. & Ishigami, A. (2006). Senescence marker protein 30 functions as gluconolactonase in L-ascorbic acid biosynthesis, and its knockout mice are prone to scurvy. *Proc. Natl. Acad. Sci.*, 103, 15723-15728.
- [56] Kondo, Y., Ishigami, A., Kubo, S., Handa, S., Gomi, K., Hirokawa, K., Kajiyama, N., Chiba, T., Shimokado, K. & Maruyama, N. (2004). Senescence marker protein-30 is a unique enzyme that hydrolyzes diisopropyl phosphorofluoridate in the liver. *FEBS Lett.*, 570, 57-62.
- [57] Chiusolo, A., Defazio, R., Casartelli, A., Bocchini, N., Mongillo, M., Zanetti, E., Cristofori, P. & Trevisan, A. (2008). Regucalcin down-regulation in rat kidney tissue after treatment with nephrotoxicants. *Toxicol. Lett.* 182, 84-90.
- [58] Kagawa, Y., Yanagisawa, Y., Hasegawa, K., Suzuki, H., Yasuda, K., Kudo, H., Abe, M., Matsuda, S., Ishikawa, Y., Tsuchiya, N., Sato, A., Umetsu, K. & Kagawa, Y. (2002). Single nucleotide polymorphism of thrifty genes for energy metabolism: evolutionary origins and prospects for intervention to prevent obesity-related diseases. *Biochem. Biophys. Res. Commun.*, 295, 207-222.

- [59] Nakayama, K., Lkhagvasuren, M., Yanagisawa, Y., Utsumi, N., Kumada, M., Gotoh, T., Iwamoto, S. & Kagawa, Y. (2008). Comparative study of polymorphisms on genes associated with lifestyle related diseases in Asian and Pacific Populations. *Asia-Pacific J. Publ. Health*, 20, Supplement, 173-179.
- [60] Yanagisawa, Y., Lkhagvasuren, M., Nakayama, K., Iwamoto, S., Charupoonphol, P., Supannatas, S., Kuartei, S., Chimedregzen, U., Kawabata, T., Kaneko, Y., Watanabe, S., Sakuma, M., Komatsu, F., Hasegawa, K. & Kagawa, Y. (2008). Diversity in genes responsible for lifestyle-related diseases in Asia-Pacific Region. *Asia-Pacific J. Publ. Health*, 20, Supplement, 257-261.
- [61] Linkswiler, H. (1957). The effect of the ingestion of ascorbic acid and dehydroascorbic acid upon the blood levels of these two components in human subjects. *J. Nutr.*, 55, 48-54.
- [62] Oyanagi, Y. (1984). Reevaluation of assay methods and establishment of kit for superoxide dismutase activity. *Anal. Biochem.*, 142, 290-296.
- [63] Tsujimura, M., Higasa, S. & Kasai, T. (1996). Quantitative determination of total vitamin C in foods by HPLC using 2,4-dinitrophenylhydrazine as internal standard [in Japanese]. *Vitamins*, 70, 241-248.
- [64] Kagawa, Y. & Shimazono, N. (1970). Catabolism of L-ascorbate in animal tissues. *Methods in Enzymology*, 18, 46-50.
- [65] Ministry of Health, Labor and Welfare of Japan, (2007). The national health and nutrition survey in Japan, 2004. (in Japanese) *Daiichi Publishing Co.*, 1-326.
- [66] Garde, A. H., Hansen, A. M. & Kristiansen, J. (2003). Evaluation, including effects of storage and repeated freezing and thawing, of a method for measurement of urinary creatinine. *Scand. J. Clin. Lab. Invest.*, 63, 521-524.
- [67] Kasashima, K., Ohta, E., Kagawa, Y. & Endo, H. (2006). Mitochondrial functions and estrogen receptor-dependent nuclear translocation of pleiotropic human prohibitin 2. *J. Biol. Chem.*, 281, 36401-36410.
- [68] Levine, M., Conry-Cantilena, C., Wang, Y., Welch, R. W., Washko, P.W., Dhariwa, K.R., Park, J.B., Lazarev, A., Graumlich, J., King, J. & Cantilena, L.R. (1996). A new recommended dietary allowance of vitamin C for healthy young women. *Proc. Natl. Acad. Sci. USA.*, 93, 3704-3709.
- [69] Wilson, J.X. (2002). The physiological role of dehydroascorbic acid. *FEBS Lett.*, 527, 5-9.
- [70] Tsujimura, M., Watanabe, S., Michinaka, K., Tokuhisa, S. & Fujita, A. (1972). Metabolism of ascorbic acid and dehydroascorbic acid in man (in Japanese). *Vitamins*, 45, 136-147.
- [71] Ogiri, Y., Sun, F., Hayami, S., Fujimura, A., Yamamoto, K., Yaita, M., & Kojo, S. (2002). Very low vitamin C activity of orally administered L-dehydroascorbic acid. *J. Agric. Food Chem.*, 50, 227-229.
- [72] Tan, X., Grollman, A.P. & Shibutani, S. (1999). Comparison of the mutagenic properties of 8-oxo-7,8-dihydro-2'-deoxyadenosine and 8-oxo-7,8-dihydro-2'-deoxyguanosine DNA lesions in mammalian cells. *Carcinogenesis*, 20, 2287-2292.
- [73] Dawson, B, Henry, G.J., Goodman, C., Gillam, I., Beilby, J.R., Ching, S., Fabian, V., Dasig, D., Morling, P. & Kakulus, B.A. (2002). Effect of Vitamin C and E

- supplementation on biochemical and ultrastructural indices of muscle damage after a 21 km run. *Int. J. Sports Med.*, 23, 10-15.
- [74] Gomez-Cabrera, M.C., Domenech, E., Romagnoli, M., Arduini, A., Borrás, C., Pallardo, F.V., Sastre, J. & Vina, J. (2008). Oral administration of vitamin C decreases muscle mitochondrial biogenesis and hampers training-induced adaptations in endurance performance. *Am. J. Clin. Nutr.*, 87, 142-149.
- [75] Duconge, J., Miranda-Massari, J.R., Gonzalez, M.J., Jackson, J.A., Warnock, W. & Riordan, N.H. (2008). Pharmacokinetics of vitamin C: insights into the oral and intravenous administration of ascorbate. *P. R. Health Sci. J.*, 27, 7-19.
- [76] Rose, R.C. (1987). Solubility properties of reduced and oxidized ascorbate as determinants of membrane permeation. *Biochim. Biophys. Acta.*, 924, 254-256.
- [77] Kagawa, Y. (1972). Reconstitution of oxidative phosphorylation. *Biochim. Biophys. Acta.*, 265, 297-338.
- [78] Bates, C.J., Jones, K.S. & Bluck, L.J. (2005). Stable isotope-labelled vitamin C as a probe for vitamin C absorption by human subjects. *Br. J. Nutr.*, 91, 699-705.
- [79] Chen, B., Hu, Y., Jin, T., Lu, D., Shao, M., Zheng, L., Wang, Q., Shen, Y., Liu, H., Liu, Y. & Zhou, Y. (2007). The influence of metabolic gene polymorphisms on urinary 1-hydroxypyrene concentrations in Chinese coke oven workers. *Sci. Total Environ.*, 381, 38-46.
- [80] Chakraborty, D., Bhattacharyya, A., Majumdar, K., Chatterjee, K., Chatterjee, S., Sen, A. & Chatterjee, G.C. (1978). Studies on L-ascorbic acid metabolism in rats under chronic toxicity due to organophosphorus insecticides: effects of supplementation of L-ascorbic acid in high doses. *J. Nutr.*, 108, 973-980.
- [81] Lykkesfeldt, J., Loft, S., Nielsen, J.B. & Poulsen, H.E. (1997). Ascorbic acid and dehydroascorbic acid as biomarkers of oxidative stress caused by smoking. *Am. J. Clin. Nutr.*, 65, 959-963.
- [82] Kondo, Y., Sasaki, T., Sato, Y., Amano, A., Aizawa, S., Iwama, M., Handa, S., Shimada, N., Fukuda, M., Akita, M., Lee, J., Jeong, K.S., Maruyama, N., Ishigami, A. (2008). Vitamin C depletion increases superoxide generation in brains of SMP30/GNL knockout mice. *Biochem. Biophys. Res. Commun.* 377, 291-296.
- [83] Wu, X.W., Muzny, D.M., Lee, C.C. & Caskey, C.T. (1992). Two independent mutational events in the loss of urate oxidase during hominoid evolution. *J. Mol. Evol.*, 34, 78-84.
- [84] Yan, J., Jiao, Y., Li, X., Jiao, F., Beamer, W.G., Rosen, C.J. & Gu, W. (2007). Evaluation of gene expression profiling in a mouse model of L-gulonolactone oxidase gene deficiency. *Genet. Mol. Biol.*, 30, 322-329.
- [85] Li, Y., Shi, C.X., Rosenfeld, J., Mossman, K.L., Boo, Y.C. & Schellhorn, H.E. (2008). Restoration of vitamin C synthesis in transgenic Gulo<sup>-/-</sup> mice by helper-dependent adenoviral-based expression of gulonolactone oxidase. *Hum. Gene Ther.*, In press.
- [86] Duffy, S.J., Gokce, N., Holbrook, M., Huang, A., Frei, B., Keaney, J.F. Jr. & Vita, J.A. (1999). Treatment of hypertension with ascorbic acid. *Lancet.*, 354, 2048-2049.
- [87] Feig, D.I., Kang, D.H., Nakagawa, T., Mazzali, M. & Johnson, R.J. (2006). Uric acid and hypertension. *Curr. Hypertens. Rep.*, 8, 111-115.



- [88] Urso, M.L. & Clarkson, P.M. (2003) Oxidative stress, exercise, and antioxidant supplementation. *Toxicology*, 189, 41-54.



*Chapter III*

---

## **Vitamin C Protects from Oxidative DNA Damage and Apoptosis Caused by Food N-Nitrosamines**

---

*Ana I. Haza, Almudena García and Paloma Morales\**

Departamento de Nutrición, Bromatología y Tecnología de los Alimentos, Facultad de Veterinaria, Universidad Complutense de Madrid, Madrid, Spain

### **Abstract**

Vitamin C exerts a protective role against some types of cancer, being an essential co-factor for many enzymes and an efficient scavenger of reactive oxygen species (ROS). Among the environmental carcinogenic compounds, N-Nitrosamines cause cancer in a variety of animal species and may be causative agents in human cancer. Population-based studies show that a low risk of cancer is more closely related to antioxidant-rich whole diets than to individual dietary antioxidants. For that reason, our aim was to investigate the protective effect of vitamin C alone or in combination with isothiocyanates (ITCs) or organosulfur (OSCs) compounds towards N-Nitrosamines-induced oxidative DNA damage in the single cell gel electrophoresis (SCGE)/HepG2 assay. The maximum reduction in NDBA (94%), NPYR (81%) NPIP (80%) and NDMA (61%)-induced oxidative DNA damage was observed at 10 $\mu$ M vitamin C. Moreover, HepG2 cells treated with ITCs or OSCs in combination with vitamin C (10 $\mu$ M) showed a stronger inhibition of oxidative DNA damage induced by NPIP (> 45% and > 67%, respectively) or NDBA (> 30% and > 80%, respectively) than ITCs or OSCs alone. CYP2A6 (82%) activity, and to a lesser extent CYP2E1 (32%) and CYP1A1 (19%) activities were significantly reduced by vitamin C (10 $\mu$ M). Besides, vitamin C (1-10 $\mu$ M) exerted a pronounced increase of UDP-glucuronyltransferase (UGT1A4) activity (171-178%, respectively). Vitamin C was also able to reduce DNA strand breaks (33%) and oxidative DNA damage in purines (12%) and in pyrimidines (35%) induced by H<sub>2</sub>O<sub>2</sub> in

---

\* Corresponding author: Paloma Morales. Tel.: +34-91-394 37 47; fax: +34-91-394 37 43; E-mail: pmorales@vet.ucm.es.

HepG2 cells by scavenging of ROS. The anti-apoptotic effect of vitamin C (50 $\mu$ M) was similar in HepG2 and HL-60 cells towards NPIP (74% and 77% of reduction) and NPYR (63% and 65% of reduction), two cyclic N-Nitrosamines. However, the inhibition by vitamin C (50 $\mu$ M) of apoptosis induction by linear chain N-Nitrosamines, such as NDMA and NDBA, was higher in HL-60 (75% and 80% of reduction) than in HepG2 cells (57% and 66% of reduction). Finally, the scavenging activity of vitamin C towards ROS produced by NPIP and NDBA in both cell lines was tested using 2', 7'-dichlorodihydrofluorescein diacetate (H<sub>2</sub>DCFDA). ROS production induced by NPIP and NDBA was reduced by all concentration tested (5-50 $\mu$ M) of vitamin C in a dose-dependent manner. In summary, the modification of phase I and II enzyme activities, free radical scavenging ability and inhibition of apoptosis could be implicated in the protective effects of vitamin C towards N-Nitrosamine toxicity.

**Keywords:** Vitamin C, N-Nitrosamines, Comet Assay, Oxidative DNA damage, Enzymes Activities, Apoptosis, Reactive Oxygen Species.

## Abbreviations

Endo III:	Endonuclease III
Fpg:	Formamidopyrimidine-DNA glycosylase
H <sub>2</sub> DCFDA:	2',7'-dichlorodihydrofluorescein diacetate
ITCs:	Isothiocyanates compounds
NDBA:	N-Nitrosodibutylamine
NDMA:	N-Nitrosodimethylamine
NPIP:	N-Nitrosopiperidine
NPYR:	N-Nitrosopyrrolidine
OSCs:	Organosulfur compounds
ROS:	Reactive oxygen species
TUNEL:	TdT-dUTP Terminal Nick-End Labeling

## Introduction

N-Nitroso compounds are an important class of human carcinogenic compounds that occur widely in the environment and can be formed endogenously from the interaction of ingested nitrate or nitrite with secondary amines [1]. N-Nitrosamines, known N-Nitroso compounds, are examples of potent food-derived genotoxins that are involved in cancer development [2]. The majority of N-Nitrosamines tested has been shown to cause cancer at different organs in a variety of animal species [3] and may be causative agents in human cancer (Table 1).

**Table 1. N-Nitrosamines in the diet. Carcinogenicity and occurrence (Tricker and Preussmann,1991)**

N-Nitrosamine	Carcinogenicity (following oral administration)		Major dietary source	
	Species	Organotropy	Foodstuff	Concentration (mg/kg)
N-Nitrosodimethylamine (NDMA)	Rat	Liver, kidney, (lung)	Cured meats	1-5
	Mouse	Liver, kidney, lung	Fried bacon	4
	Hamster	Liver, (stomach)	Marine products:	
	Guinea Pig	Liver	Dried fish (Japan)	8.6
	Rabbit	Liver, lung	Dried fish (Greenland)	8.6-38
	Mink	Liver	Dried shrimps (China)	43.9
			Broiled squid (China)	< 300
			Millet flour and grain products (China)	0.5
			Dairy and cheese products	1-6
			Dried milk products	< 7
			Edible oils and fats	< 1
			Pickled fermented vegetables	< 5
		Beer	0.2	
		Alcoholic beverages (whisky)	1	
N-Nitrosopyrrolidine (NPYR)	Rat	Liver, nasal cavity, (vagina, testis)	Cured meats	1.8
	Mouse	Lung	Fried bacon	17
			Pickled vegetables	< 96
			Mixed spices	< 10
			Broiled squid	2.4 13
N-Nitrosopiperidine (NPIP)	Rat	Liver, oesophagus, upper respiratory and digestive tracts, nasal cavity	Cured meats	< 20
	Mouse	Forestomach, liver, lung	Fried bacon	< 9.2
	Hamster	Liver, upper respiratory and digestive tracts	Peppered salami	< 30
			Pepper	< 300
			Mixed spices	0.6-3.5
		Pickled vegetables	< 14	
N-Nitrosodibutylamine (NDBA)	Rat	Liver, urinary bladder, (oesophagus, pharynx)	Cured meats (packed in rubber nettings)	1.5-6
	Mouse	Forestomach, liver, oesophagus, urinary bladder, (lung)	Smoked chicken	< 5.3
	Hamster	Respiratory tract, lung, urinary bladder	Dried fish (Japan)	< 3.1
	Guinea pig	Liver, urinary bladder		

In 1978 the International Agency for Research on Cancer (IARC) classified N-Nitrosodimethylamine (NDMA) as probably carcinogenic to humans (Group 2A) and N-Nitrosopyrrolidine (NPYR), N-Nitrosopiperidine (NPIP) and N-Nitrosodibutylamine (NDBA) as possibly carcinogenic to humans (Group 2B) [4]. NDMA is the most commonly encountered volatile N-Nitrosamine in food samples and it is a potent liver, lung and kidney carcinogen [5, 6]. NPYR and NPIP are structurally homologous cyclic N-Nitrosamines with differing carcinogenic activities. Comparative carcinogenicity studies of these two N-Nitrosamines in rats have shown that NPYR induces mainly liver tumours, whereas NPIP is a potent extrahepatic carcinogen inducing tumours in the esophagus and the nasal cavity [7]. Finally, NDBA is a relatively selective bladder carcinogen in rats, although also induces tumours in other tissues, such as the liver, lung and oesophagus [8].

N-Nitrosamines are pre-genotoxicants that can be metabolized in reactions mediated by cytochrome P450 (CYP450) phase I enzymes to give rise to the ultimate genotoxicants [9]. The first activation step of N-Nitrosamines is thought to be the hydroxylation of the carbon atom located at the  $\alpha$ -position of the N-Nitroso group. The reactive intermediates of N-Nitrosamine metabolism also have the ability to alkylate nucleophilic sites of DNA [10] resulting in alkali labile adducts, which can lead the formation of basic sites and DNA strand breaks. The metabolic activation of NDMA by CYP2E1 is shown in Figure 1.

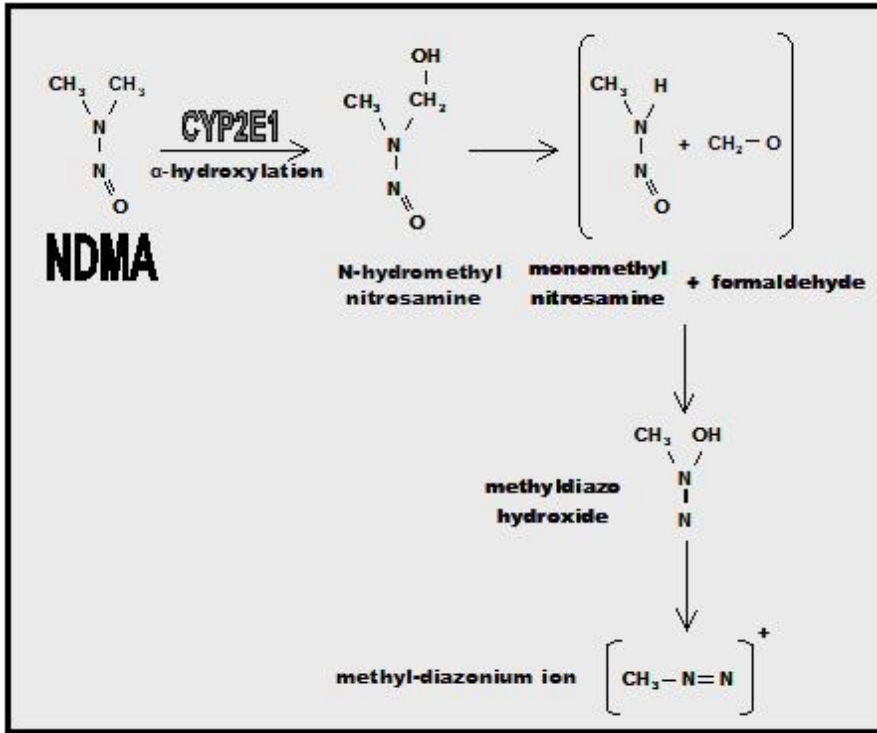

Figure 1. Metabolic activation of N-Nitrosodimethylamine (NDMA) by cytochrome P450 2E1.

The number of carbon atoms of the chains bound to the nitroso group of N-Nitrosamines is one of the determinants of a certain CYP(s) responsible for the activation. Cyclic N-Nitrosamines, such as NPYR and NPIP are primarily activated by CYP2A6. On the other hand, short chain N-Nitrosamines such as NDMA, are activated by CYP2E1, whereas CYP1A1 is involved in the metabolism of the longer chain N-Nitrosamines, such as NDBA [11]. Although alkylation of DNA is generally assumed to be the primary event in the carcinogenicity of N-Nitrosamines, additional events are operational to induce DNA damage. It has been suggested that N-Nitrosamines can cause oxidative stress and cellular injury by the generation of reactive oxygen species (ROS) [12, 13, 14, 15], as well as nuclear single- and double-strand DNA breaks, strand breaks in the mitochondrial DNA and formation of cyclic DNA adducts [16]. Moreover, the DNA of blood leukocytes, including stem cells, may be alkylated by N-Nitrosamine metabolites produced in hepatocytes while the blood circulates through the liver [17].

The increasing appreciation of importance of N-Nitrosamines as potential human carcinogens stimulated intense research on protective dietary factors in chemical carcinogenesis. The cytochrome P450 reaction cycle yields, apart from reactive metabolites [18], a variety of ROS (superoxide, hydrogen peroxide and water) [19] which can react with various cellular targets. To protect molecules against toxic free radicals and other ROS, cells have developed antioxidant defences by endogenous enzymatic and/or non-enzymatic components that prevent radical formation, remove radicals before damage can occur, repair oxidative damage, eliminate damage molecules, and prevent mutations [20]. Though an

efficient antioxidant defence system is present in the cells, it may be overwhelmed under conditions of oxidative stress [14].

Epidemiologic studies have concluded that lifestyles characterized by a high consumption of fruit and vegetables are associated with lower incidences of cancer [21]. These protective effects of vegetables and fruits may result from combined effects of various phenolic phytochemicals, vitamins, isothiocyanates (ITCs), organosulfur (OSCs) compounds rather than from of a single dietary antioxidant [22]. Thus, Chan [23] reported that dietary antioxidants can scavenge free radicals and constitute a strong line of defense in retarding free radical induced cellular damage. While many chemopreventives in fruits and vegetables may have anticancer properties, much interest has focused on vitamin C [24]. About 90% of vitamin C in the average diet comes from fruit and vegetables, being the recommended dietary allowance (RDA) of vitamin C about 80 mg per day.

Vitamin C (ascorbic acid) is one of the few vitamins for which evidence exists for a protective role against some types of cancer [25], protecting against free radical induced cellular damage [23]. It is able to react with and reduces all physiologically relevant ROS and reactive nitrogen species (RNS) [26]. However, several investigations demonstrated that vitamin C and other chemopreventive compounds added in combination are more protective than when added singly [27, 28]. Among the possible mechanisms involved in the anticarcinogenic effects of vitamin C, the inhibition of CYP450 activities, the enhancement of detoxification pathways that convert the reactive compounds to less toxic and more easily excreted products [29], alteration of cell proliferation, stimulation of the repair of carcinogen-induced DNA damage and/or the free radical scavenging efficiency [30] have been also implicated. Vitamin C has the ability to induce phase II enzymes, NAD(P)H:quinone oxidoreductase activity [31] and UDP-glucuronil transferase [32]. In addition, numerous *in vitro* and *in vivo* studies have evaluated the protective effects of vitamin C against several radical generating mutagens [33, 34].

Many investigators have reported that plants of the genus *Allium* such as garlic and onion possess various pharmacological and therapeutic properties with beneficial effects in the field of carcinogenesis [35, 36]. The OSCs, which are specific phytochemicals of the *Allium* genus and are specially abundant in garlic and onion, seem to be the principal agents responsible for this chemopreventive action [37]. Epidemiological studies have also suggested that consumption of *Brassica* vegetables can reduce the risk of cancer in human populations [38]. The tissues of *Brassica* are a good source of many potentially protective dietary factors including phenolics, carotenoids, selenium and glucosinolates. Glucosinolates produce physiological effects in the body following enzymatic hydrolysis to ITCs [39].

Apoptosis is a mode of cell death characterized by plasma membrane blebbing, cell shrinkage, chromatin condensation and fragmentation [40] (Figure 2). Several investigations have reported that apoptosis induced by genotoxic carcinogens such as benzo(a)pyrene [41], heterocyclic amines [42, 43] and N-Nitrosamines [44, 45, 46] seems to have an important role in cancer development. In general, apoptosis of cells exposed to genotoxic compounds is considered to function anticarcinogenic since cells with extensive DNA damage will be removed. On the other hand, it is possible that removal of these cells may give survival and proliferating signals to surrounding cells with less DNA damage, increasing their probability of having mutations. This may cause a selection of these more progressive cancer cells which

may be an important part of neoplastic promotion and progression [41]. A huge literature supports that the large majority of cancer chemopreventive agents induce spontaneous apoptosis in the absence of any apoptosis inducers [47], whereas there are limited research papers with regard to its anti-apoptotic effects [48, 49]. Revel et al. [50, 51] have reported that the protective role of resveratrol towards adverse effects of benzo(a)pyrene in sperm and lung could be related with a reduction of benzo(a)pyrene-induced DNA damage and apoptosis.

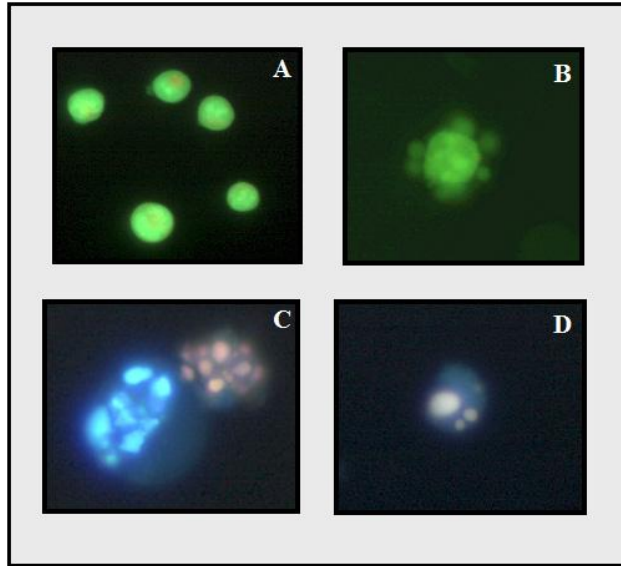

Figure 2. Morphological features characteristic of apoptosis analyzed by fluorescence microscopy using acridine orange (A and B) and Hoechst 33 342 and ethidium bromide (C and D) in HL-60 cells. (A) Untreated cells, (B) membrane blebbing, (C) chromatin condensation and (D) formation of “apoptotic bodies”.

The content of vitamin C among *Brassica* vegetables varies significantly between and within their subspecies. Vitamin C levels varied over 4-fold in broccoli and cauliflower, 2.5-fold in Brussels sprouts and white cabbage, and twice in kale [52]. On the other hand, *Allium* vegetables are also rich in vitamin C, contributing 12.5% of daily-recommended allowance [53]. Thus, it is reasonable to evaluate whether it can show a synergistic or additive effect with ITCs or OSCs on their protection against genotoxic effects induced by N-Nitrosamines. Thus, the aim of the present chapter was to investigate the effects of ITCs or OSCs alone or in combination with vitamin C towards NDMA, NPYR, NPYP and NDBA-induced oxidative DNA damage in HepG2 cells using the single cell gel electrophoresis (SCGE) assay. As the levels of the most phase I enzymes are low in HepG2 cells [54], in this study microsomes from baculovirus-infected cells (expressing human CYP2E1, 2A6 and 1A1) were used to evaluate one feasible mechanism by which vitamin C alone or in combination with ITCs or OSCs exerted its protective effects. In addition, microsomes from baculovirus-infected cells expressing human UDP-glucuronyltransferase (UGT1A4) have been also used. Moreover, the present chapter addresses the antiapoptotic effect and inhibition of ROS production by



vitamin C towards N-Nitrosamines-induced apoptosis. Recent data indicate that exposure to N-Nitrosamines is related with excess occurrence of leukemia [55, 56]. Therefore, in addition to HepG2 cells, the leukemia cell line HL-60 has been also tested in our apoptosis studies [44, 46]. The human leukemia HL-60 cell line has proven to be a good model for studying the apoptotic process induced by chemicals in lymphoid organs [57] and to express relatively high levels of enzymatic isoforms of cytochrome P450 [58].

## Material and Methods

### Chemicals

N-Nitrosamines (Figure 3): N-Nitrosodimethylamine (NDMA), N-nitrosopyrrolidine (NPYR), N-Nitrosopiperidine (NPIP), N-Nitrosodibutylamine (NDBA), vitamin C (L-ascorbic acid), phenethyl isothiocyanate (PEITC), allyl isothiocyanate (AITC), indole-3-carbinol (I3C), diallyl disulfide (DADS), dipropyl sulfide (DPS), dipropyl disulfide (DPDS), dimethyl sulfoxide (DMSO), low melting point agarose (LMP),  $\beta$ -nicotinamide adenine dinucleotide phosphate, glucose-6-phosphate dehydrogenase, D-glucose-6-phosphate, UDP-glucuronic acid, p-nitrophenol, 4-nitrocatechol, coumarin, 7-hydroxycoumarin, 7-ethoxyresorufin, resorufin, 4-methylumbelliferone, 4-methylumbelliperyl- $\beta$ -D-glucuronide, diethyldithiocarbamate (DEDTC), tranlylcypromine and  $\alpha$ -naftoflavone were purchased from Sigma-Aldrich (Spain). Formamidopyrimidine-DNA glycosylase (Fpg) and Endonuclease III (Endo III) were obtained from Trevigen Inc. (Gaithersburg, MD). Magnesium chloride 6-hydrate, di-potassium hydrogen phosphate anhydrous, trichloroacetic acid solution 20% (w/v) and hydrogen peroxide ( $H_2O_2$ ) were obtained from Panreac. Tris (hydroxymethyl) amino methane was purchased from Qbiogene (Montreal, Quebec). 2',7'-dichlorodihydrofluorescein diacetate ( $H_2DCFDA$ ) was obtained from Molecular Probes (Eugene, Oregon, USA). All other chemicals and solvents were of the highest grade commercially available.

N-Nitrosamines and vitamin C, PEITC, AITC, I3C, DPS, DADS and DPDS were dissolved in sterile DMSO (0.1%). The stock solutions were stored deep-frozen ( $-80\text{ }^\circ\text{C}$ ).

### Cell Culture

Human hepatocellular carcinoma cells (HepG2) and human leukemia cells (HL-60) were obtained from the Biology Investigation Center Collection (BIC, Madrid, Spain). HepG2 cells were cultured as a monolayer in Dulbecco's modified Eagle's medium and HL-60 cells were maintained in RPMI 1640 medium. The media were supplemented with 10% v/v heat-inactivated fetal calf serum, 50  $\mu\text{g/ml}$  streptomycin, 50 UI/ml penicillin and 1% v/v L-glutamine. Culture medium and supplements required for the growth of the cell lines were purchased from GIBCO Laboratories (Life Technologies Inc., Gaithersburg, MD, USA). Cell cultures were incubated at  $37\text{ }^\circ\text{C}$  and 100% humidity in a 5%  $\text{CO}_2$  atmosphere.

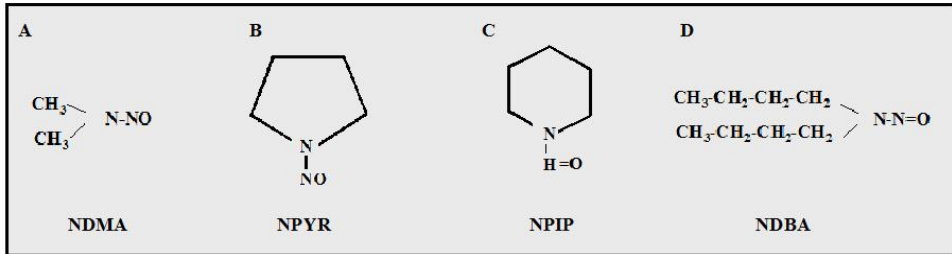

Figure 3. Chemical structure of (A) N-Nitrosodimethylamine (NDMA), (B) N-Nitrosopyrrolidine (NPYR), (C) N-Nitrosopiperidine (NPIP) and (D) Nitrosodibutylamine (NDBA).

### Human Microsomes

Microsomes from baculovirus-infected insect cells expressing human CYP2E1, CYP2A6, CYP1A1 + cytochrome b5 and UGT1A4 were obtained from Gentest (Woburn, MA).

## Analysis of Oxidative DNA Damage Induced by N-Nitrosamines or Vitamin C by Alkaline Comet Assay

Throughout the genotoxicity studies, viability was determined by 3-[(4,5-dimethylthiazol-2-yl)-2,5-diphenyltetrazolium bromide] (MTT) assay and only cultures with a cell viability of more than 80% were used for analysis. The SCGE assay was carried out according to the protocol of Olive et al. [59] with minor modifications. For a more specific characterization of the origin of the expressed DNA breaks, formamidopyrimidine-DNA glycosylase (Fpg) has been used to uncover oxidized purine lesions (Figure 4).

Briefly, HepG2 cells were plated on to multiwell systems at a density of  $1.5 \times 10^5$  cells/ml culture medium. After twenty four hours of growth, the cells were exposed to NDMA (27-135  $\mu$ M), NPYR (5-50  $\mu$ M), NPIP (9-44  $\mu$ M) and NDBA (0.6-3  $\mu$ M) or to vitamin C (1-10  $\mu$ M), for another 24 h at 37 °C and 5% CO<sub>2</sub>. After incubation, 10  $\mu$ l of a suspension  $1 \times 10^5$  cells were mixed with 70  $\mu$ l of LMP agarose type VII (0.75% concentration in PBS), distributed on slides that had been pre-coated with LMP agarose type VII (0.30% concentration in PBS), and left to set on an ice tray. Two slides were prepared for each concentration of the compound tested, one slide for control and another slide to be treated with Fpg enzyme. After solidification, the cells were lysed in darkness for 1 h in a high salt alkaline buffer (2.5 M NaCl, 0.1 M EDTA, 0.01 M Tris, 1% Triton X-100, pH 10). The slides were then equilibrated 3  $\times$  5 min in enzyme buffer (0.04 M HEPES, 0.1 M KCl, 0.5 mM EDTA, 0.2 mg/ml BSA, pH 8). After this time, slides were incubated with 30  $\mu$ l of Fpg at 1  $\mu$ g/ml in enzyme buffer for 30 min at 37 °C in a humid dark chamber. Control slides were incubated with 30  $\mu$ l Fpg buffer only. Following enzyme treatment, the slides were placed in electrophoresis buffer (0.3 M NaOH, 1 mM EDTA, pH 13, cooled in a refrigerator) in

darkness for 40 min. Electrophoresis was performed in a cold-storage room, in darkness, in a Bio-Rad subcell GT unit containing the same buffer, for 30 min at 25 V. After electrophoresis, the slides were neutralized using 0.4 M Tris pH 7.5 and fixed in methanol. Subsequently, the DNA was stained with ethidium bromide (10  $\mu\text{g/ml}$ ) in Tris acetate EDTA (TAE 1X) during 5 min and examined in a fluorescence microscope (Axiostar plus microscope, Zeiss) connected to a computerized image analysis system (Comet Score, 1.0). Olive tail moment (OTM) as defined by Olive et al. [60] was determined and expressed as arbitrary units (AU).  $\text{OTM} = I \times L$ , where I is the fractional amount of DNA in the comet tail and L is the distance from the centre of the comet head to the centre of tail distribution.

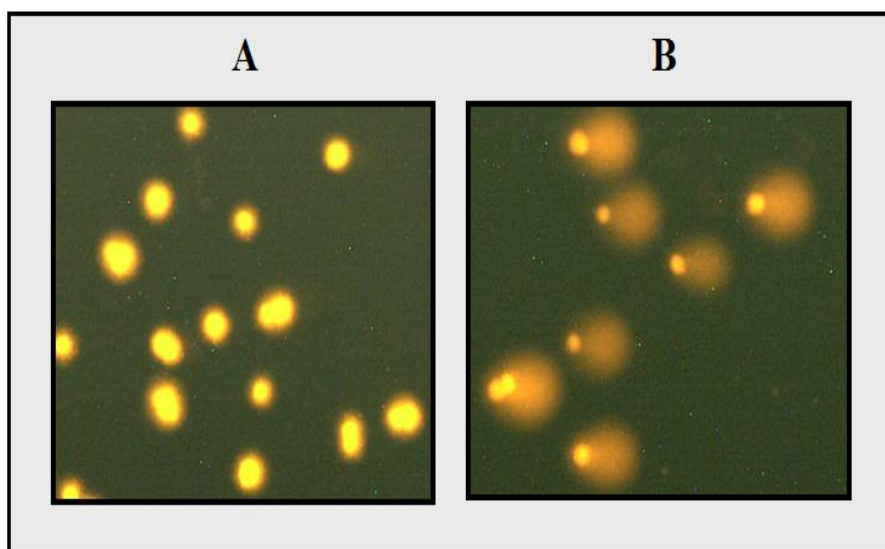

Figure 4. Untreated (A) and treated (B) HepG2 cells with N-Nitrosopyrrolidine (NPYR) and incubated with Fpg enzyme, visualized under fluorescence microscopy and using comet assay.

## **Analysis of Oxidative DNA Damage Induced by a Simultaneous Treatment of N-Nitrosamines and Vitamin C by Alkaline Comet Assay**

HepG2 cells were plated on to multiwell systems at a density of  $1.5 \times 10^5$  cells/ml culture medium. Twenty four hours after seeding, different concentrations of vitamin C were added to the wells and plates were incubated for 24 h at 37 °C and 5% CO<sub>2</sub>. After incubation, cells were simultaneously treated with NDMA (27 mM), NPYR (5 mM), NPIP (44 mM) or NDBA (3 mM) and the corresponding vitamin C (1-10  $\mu\text{M}$ ) concentrations for another 24 h. After the treatments, the cells were processed as described above.

## **Analysis of Oxidative DNA Damage Induced by Simultaneous Treatments of ITCs or OSCs in Combination with Vitamin C and NPIP or NDBA by Alkaline Comet Assay**

HepG2 cells were plated on to multiwell systems at density of  $1.5 \times 10^5$  cells/ml culture medium. Then, twenty-four hours after seeding, different concentrations of ITCs (0.1-1  $\mu\text{M}$ ) or OSCs (0.1-2.5  $\mu\text{M}$ ) compounds in combination with vitamin C (10  $\mu\text{M}$ ) were added to the wells and the plates were incubated for 24 h at 37 °C and 5%  $\text{CO}_2$ . After incubation, the cells were simultaneously treated with NPIP or NDBA and the corresponding ITCs or OSCs concentrations in combination with vitamin C for 24 h at 37 °C and 5%  $\text{CO}_2$ . After the treatments, the cells were processed as described above.

## **Analysis of DNA Damage (Strand Breaks and Oxidized Purines/Pyrimidines) induced by a Simultaneous Treatment of $\text{H}_2\text{O}_2$ and Vitamin C in the Alkaline Comet Assay**

HepG2 cells were plated on to multiwell systems at a density of  $1.5 \times 10^5$  cells/ml culture medium. Twenty four hours after seeding, different concentrations of vitamin C (1-10  $\mu\text{M}$ ) were added to the wells and plates were incubated for 24 h at 37 °C and 5%  $\text{CO}_2$ . After incubation, cells were simultaneously treated with  $\text{H}_2\text{O}_2$  (10  $\mu\text{M}$ ) and the corresponding vitamin C concentrations for another 30 min at 37 °C and 5%  $\text{CO}_2$ . After the treatments, the cells were processed as described above. In this assay, in addition to Fpg enzyme it has been used endonuclease III (Endo III) enzyme to uncover oxidized pyrimidines.

### P-Nitrophenol Hydroxylation Assay (PNH)

Metabolism of p-nitrophenol to p-nitrocatechol was used as a probe to reflect CYP2E1 activity [61, 62]. A 0.5 ml reaction mixture containing 50 pmol human CYP2E1, 1.3 mM  $\text{NADP}^+$ , 3.3 mM glucose-6-phosphate, 0.4 IU/ml glucose-6-phosphate dehydrogenase, 3.3 mM magnesium chloride and 0.5 p-nitrophenol in 50 mM potassium phosphate (pH 7.4) was incubated at 37 °C for 30 min. For inhibition study, these assays were evaluated with the concentrations of vitamin C (1, 5 and 10  $\mu\text{M}$ ), that exerted protective effects towards N-nitrosamines-induced DNA damage. After incubation, the reaction stopped by the addition of 0.1 ml 20% trichloroacetic acid and centrifuged (10,000 g) for 1 min. The supernatant (0.5 ml) was added to 0.25 ml 2 N NaOH and the absorbance measured at 535 nm (with water in the reference cuvette). The amount of p-nitrocatechol formed was determined from a calibration curve containing known amounts of this compound. The reaction conditions were

determined to be linear with time and microsomal protein content. Diethyldithiocarbamate (DEDTC, 500  $\mu\text{M}$ ) was used as a specific inhibitor of CYP2E1 activity [63].

#### Coumarin 7-Hydroxylation Assay (CH)

CYP2A6 is known to be involved in coumarin 7-hydroxylation [64]. A 0.5 ml reaction mixture containing 10 pmol CYP2A6, 0.065 mM  $\text{NADP}^+$ , 3.3 mM glucose-6-phosphate, 0.4 IU/ml glucose-6-phosphate dehydrogenase, 3.3 mM magnesium chloride and 0.4 mM coumarin in 50 mM Tris (pH 7.4) was incubated at 37 °C for 10 min. Further steps were as described above. 100  $\mu\text{l}$  of the supernatant was added to 1.9 ml of 100 mM Tris (pH 9) and the fluorescence was determined with excitation at 368 nm and emission at 456 nm in a spectrofluorometer. The activity was quantified comparing to a standard curve for umbelliferone (7-hydroxycoumarin). Tranylcypramine (1 mM) was shown to be a potent specific inhibitor of coumarin hydroxylation [65].

#### Ethoxyresorufin O-Deethylation Assay (EROD)

Deethylation of ethoxyresorufin to resorufin was detected with fluorescence spectroscopy according to the standard EROD assay for CYP1A1 activity [66]. A 2 ml reaction mixture containing 2.5 pmol CYP1A1, 1.3 mM  $\text{NADP}^+$ , 3.3 mM glucose-6-phosphate, 0.4 IU/ml glucose-6-phosphate dehydrogenase, 3.3 mM magnesium chloride and 1  $\mu\text{g/ml}$  ethoxyresorufin in 100 mM potassium phosphate (pH 7.4) was incubated at 37 °C for 30 min. Further steps were as described above. After incubation, the fluorescence was determined with excitation at 550 nm and emission at 586 nm in a spectrofluorometer. The activity was quantified comparing to a standard curve for resorufin. The amount of resorufin formed was determined from a calibration curve containing known amounts of this compound.  $\alpha$ -naftoflavone (10  $\mu\text{M}$ ) was shown to be a potent specific inhibitor of ethoxyresorufin O-deethylation [67].

#### 4-Methylumbelliferone Glucuronidation Assay

UGT1A4 activity can be determined with different substrates and, among them, 4-methylumbelliferone is the most sensitive and can be used to quantify glucuronidation *in vitro*. The assay is based on the different fluorescence properties showed by 4-methylumbelliferone and its conjugate 4-methylumbelliferone- $\beta$ -D-glucuronide [68]. A sample 100  $\mu\text{g}$  of human UGT1A4 is incubated at 37°C in 0.5 ml of 0.1 M Tris-HCl buffer (pH 7.4) containing 5  $\mu\text{mol}$   $\text{MgCl}_2$  and 0.5  $\mu\text{mol}$  4-methylumbelliferone. For glucuronidation studies, these assays were evaluated with the concentrations of vitamin C (1, 5 and 10  $\mu\text{M}$ ) used by the comet assay. The reaction is started by the addition of 1.5  $\mu\text{mol}$  UDP-glucuronic acid and stopped 10 min after by addition of 0.5 ml of 0.5 M perchloric acid. Unreacted substrate is extracted with 2 ml of chloroform. After centrifugation at 1000 $\times$ g for

10 min, 0.5 ml of the upper water phase containing the glucuronide is transferred to another tube and 0.5 ml of 1.6 M glycine/NaOH (pH 10.3) is added. Fluorescence is measured at 368 nm excitation and 456 nm emission. The amount of 4-methylumbellipheryl- $\beta$ , D-glucuronide formed was determined from a calibration curve containing known amounts of this compound.

Incubations without vitamin C were considered as negative controls (100% enzyme activity). Incubations with vitamin C relative to the negative control were calculated and expressed as percentage of enzymatic activity =  $A_1/A_0 \times 100$ , where  $A_1$  is the absorbance of incubations with vitamin C and  $A_0$  is the absorbance of negative control.

### Cytotoxicity Assays

The HepG2 and HL-60 cell viability was assessed by the MTT reduction and the LDH release assays. Briefly, cells were seeded onto a 96-well plate ( $1 \times 10^6$  cells/ml culture medium) and maintained for 24 h. Vitamin C was then added to the culture medium at 1, 5, 10, 50 and 100  $\mu$ M during 24, 48 and 72 h of treatment at 37°C and 10% humidity in a 5% CO<sub>2</sub> atmosphere. Cells without vitamin C were considered as negative controls. Values presented in this paper are means  $\pm$  standard error of the mean. All vitamin C concentrations were tested in six replicates and the experiments were repeated three times.

### MTT Cell Culture Assay

The MTT 3-[(4,5-dimethylthiazol-2-yl)-2,5-diphenyltetrazolium bromide] assay was performed according to the manufacturer's instructions (cell proliferation kit I, Roche, Indianapolis, USA). After incubations, 10  $\mu$ l of stock MTT solution (0.5 mg/ml) was added to each culture well, and plates were incubated for 4 h at 37°C in a humidified atmosphere of 5% CO<sub>2</sub>. In viable cells, the yellow tetrazolium salt, MTT, is converted into a purple formazan substrate by the mitochondrial enzyme, succinate dehydrogenase (SDH). To dissolve the dark formazan crystal, 100  $\mu$ l of solubilization solution was added to each well and the plates were incubated overnight at 37°C in a humidified atmosphere. After incubation, the contents of the plates were thoroughly mixed for 5 min on a plate shaker. The optical density (OD) of each well was read at 620 nm (test wavelength) and 690 nm (reference wavelength) by an ELISA with a built-in software package for data analysis (iEMS Reader MF, LabSystems, Helsinki, Finland). The results were expressed as the percentage of survival (% SDH) with respect to the control cells according to the following formula: % SDH activity =  $100 (A_1/A_0)$ , where  $A_1$  is the absorbance of the cells exposed to the N-nitrosamines, and  $A_0$  is the absorbance of negative control.

## Lactate Dehydrogenase Assay

The LDH activity was determined using a commercially available kit from Roche (cytotoxicity detection kit, Roche Diagnostics, Indianapolis, USA). Cytosolic LDH is released into the culture medium if the integrity of the cell membrane deteriorates in cells suffering from necrotic cell death [69]. Briefly, following vitamin C treatment, culture medium (100  $\mu$ l) was collected and incubated with the same volume of reaction mixture for 30 min at 37 °C in a humidified atmosphere. LDH activity was measured at 490 nm by an ELISA with a built-in software package for data analysis (iEMS Reader MF, LabSystems, Helsinki, Finland). Background and negative controls were obtained by LDH measurement of assay medium and untreated cell medium, respectively. Total cellular LDH activity was measured in cell lysates obtained by treatment with TritonX-100 solution. Data from control and treated cells were calculated as percentage of LDH leakage (LDH activity in medium/total LDH activity  $\times$  100) and represent the mean of different experiments, each using triplicate wells per concentration.

## Detection of Apoptosis by Tdt-Dutp Terminal Nick-End Labeling (TUNEL) Assay

Apoptotic cell death was measured by the In Situ Cell Death Detection Kit, Fluorescein according to the manufacturer's protocol (Roche, Indianapolis, USA). Our recent works have demonstrated that NDMA (27-135 mM), NPYR (10-50 mM) NPIP (10-45 mM; 5-20 mM; respectively) and NDBA (1-3.5 mM; 0.5-2.5 mM; respectively) induced apoptosis in HepG2 and HL-60 cells from 24 to 72 h of incubation time [44, 45, 46]. In subsequent combined treatments of N-Nitrosamines with vitamin C, we selected N-Nitrosamine doses that induced a percentage of apoptosis above 50% after 72 h incubation time. Thus, HepG2 cells were treated with 68 mM NDMA, 50 mM NPYR, 25 mM NPIP and 2.5 mM NDBA (54, 52, 70 and 51% of apoptotic cells, respectively), whereas it was necessary to use similar or lower concentrations of NDMA (68 mM), NPYR (50 mM), NPIP (20 mM) and NDBA (2 mM) for 72 h to obtain a similar percentage of apoptotic HL-60 cells (49, 51, 74 and 44% of apoptotic cells, respectively).

HL-60 and HepG2 cells were plated onto multiwell systems at a density of  $1.5 \times 10^6$  cells/ml culture medium. Twenty four hours after seeding, HepG2 and HL-60 cells were exposed to N-Nitrosamines or to vitamin C (5, 10 and 50  $\mu$ M) for 72 h at 37°C and 5% CO<sub>2</sub>. In combined treatment experiments, the cells were pre-incubated with vitamin C (5, 10 and 50  $\mu$ M) for 24 h. After incubation, HepG2 and HL-60 cells were simultaneously treated with 68 mM NDMA, 50 mM NPYR, 25 and 20 mM NPIP, respectively, or 2.5 and 2 mM NDBA, respectively, and the corresponding concentrations of vitamin C for 72 h.

Briefly,  $3 \times 10^6$  cells were washed with PBS and fixed in 2% formaldehyde in PBS (1 ml) for 1 h at room temperature. Cells were washed with PBS and incubated with permeabilization solution (0.1% triton X-100 in 0.1% sodium citrate) for 2 min on ice. Subsequently, the cells were incubated with the TUNEL reaction mixture [50  $\mu$ l of enzyme solution (TdT) and 450  $\mu$ l of label solution (fluorescein-dUTP)] for 1 h at 37 °C in the dark in

a humidified atmosphere. After the cells were washed with PBS, the label incorporated into the damaged sites of DNA was detected using a FACS Calibur flow cytometer (Becton and Dickinson) and the Cell Quest software. For each experiment  $10^4$  cells were analyzed. The results are expressed as percentage of apoptotic cells over the total cells, and data are mean  $\pm$  standard deviation (S.D.) of three independent experiments.

### Measurement of ROS

ROS production was determined using 2',7'-dichlorodihydrofluorescein diacetate (H<sub>2</sub>DCFDA) from Molecules Probes (Eugene, Oregon, USA). H<sub>2</sub>DCFDA diffuses through the cell membrane and is hydrolyzed by esterases to non fluorescent dichlorofluorescein (DCFH). In the presence of ROS, this compound is oxidized to highly fluorescent dichlorofluorescein (DCF).

In our previous works we have showed that both NPIP and NDBA increase the ROS production in HL-60 cells (5-20 mM and 0.5-2.5 mM, respectively) after 0.5 h incubation time [44], whereas it was only observed a significant increase of ROS levels in HepG2 cells one hour after treatment with NPIP (10-45 mM) but not with NDBA (1-3.5 mM) [45]. For these experiments, HepG2 and HL-60 cells were cultured in Dulbecco's Modified Eagle's Medium and RPMI 1640 Medium, respectively, without phenol red and without fetal calf serum and subsequently were pre-incubated with vitamin C (5, 10 and 50  $\mu$ M) for 1 h. After pre-treatment with vitamin C, 25 mM NPIP was added for 1 h in HepG2 cells and 20 mM NPIP or 2 mM NDBA was added for 0.5 h in HL-60 cells. Then,  $2.5 \times 10^5$  cells were washed with PBS loaded for 30 min with H<sub>2</sub>DCFDA (10  $\mu$ M) and incubated in a water bath (37°C). The cells were kept on ice and fluorescence intensity was read immediately with FACS Calibur flow cytometer (Becton & Dickinson) and the CellQuest software. For each experiment  $10^4$  cells were analyzed. DCF fluorescence is expressed as percentage of control, and data are mean  $\pm$  standard deviation (S.D.) of three independent experiments.

### Statistical Analyses of Data

Images of 50 randomly selected cells per concentration were evaluated and the test was carried out three times. The reported OTM is the mean  $\pm$  standard deviation (S.D.) of the three independent experiments. Cultures without N-Nitrosamines and vitamin C were considered as negative control and cultures with N-Nitrosamines as positive controls (C<sub>1</sub>). Induction of oxidative DNA damage by N-Nitrosamines was defined as 100% of genotoxicity. On the other hand, in the analysis of DNA damage induced by a simultaneous treatment of H<sub>2</sub>O<sub>2</sub> and vitamin C, cultures without H<sub>2</sub>O<sub>2</sub> and vitamin C were considered as negative controls (C<sub>0</sub>) and cultures with H<sub>2</sub>O<sub>2</sub> as positive controls (C<sub>1</sub>). Induction of DNA damage by H<sub>2</sub>O<sub>2</sub> was defined as 100% of genotoxicity.

Student's *t*-test was used for statistical comparison and differences were considered significant at  $P \leq 0.05$  or  $P \leq 0.01$ . Descriptive and graphical methods were used to characterize the data. All tests were performed with the software package Statgraphics Plus 5.0.



## Results

### DNA Strand Break and Oxidative DNA Damage Induction by N-Nitrosamines

Figure 5 A-D shows the OTM as a measure of DNA damage in the SCGE assay in HepG2 cells exposed to different concentrations of NDMA (27-135 mM), NPYR (5-50 mM), NPIP (9-44 mM) and NDBA (0.6-3 mM) for 24 h and incubated with and without Fpg enzyme. NDMA, NPYR, NPIP and NDBA caused significant increases in DNA damage in comparison to the solvent control. Statistically dose-dependent increase in oxidative DNA damage induced by NDMA, NPYR, NPIP and NDBA was observed at concentrations of 27-135 mM ( $4.84 \pm 1.07$  AU,  $5.42 \pm 0.81$  AU), 5-50 mM ( $7.46 \pm 1.83$  AU,  $8.19 \pm 1.33$  AU), 9-44 mM ( $2.92 \pm 0.35$ ,  $4 \pm 0.46$  AU), and 0.6-3 mM ( $1.41 \pm 0.81$ ,  $1.84 \pm 0.64$  AU), respectively. The corresponding OTM of cells exposed to the solvent control was  $0.83 \pm 0.42$  AU. NPYR exerted greater genotoxic effects than NDMA, NPIP and NDBA.

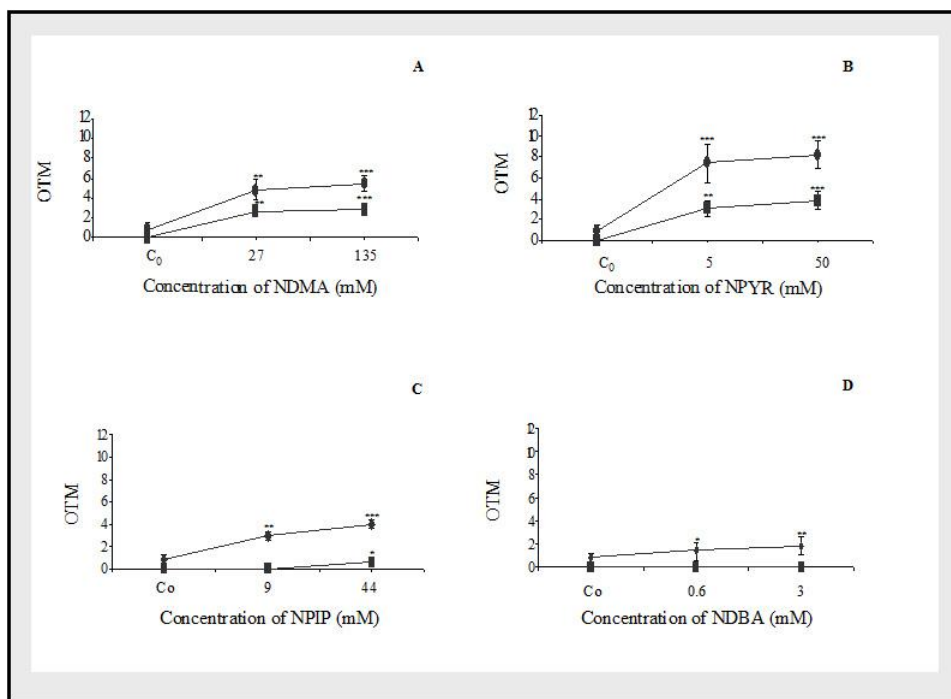

Figure 5. Induction of oxidative DNA damage by NDMA (A), NPYR (B), NPIP (C) and NDBA (D) in human HepG2 cells incubated with (●) and without (■) Fpg enzyme. Asterisks indicate significant difference from control \*\*\* $p \leq 0.001$ , \*\* $p \leq 0.01$  and \* $p \leq 0.05$ .

## DNA Strand Break and Oxidative DNA Damage Induction by Vitamin C

Induction of DNA damage by vitamin C in human HepG2 cells incubated with or without Fpg enzyme, is shown in Figure 6. None of the vitamin C concentrations tested (1, 5 and 10  $\mu\text{M}$ ) in presence or absence of Fpg enzyme, caused DNA damage *per se*. No cytotoxicity has been previously found at the concentrations of vitamin C tested (Figure 12 and 13). This concentration range was therefore used in subsequent studies.

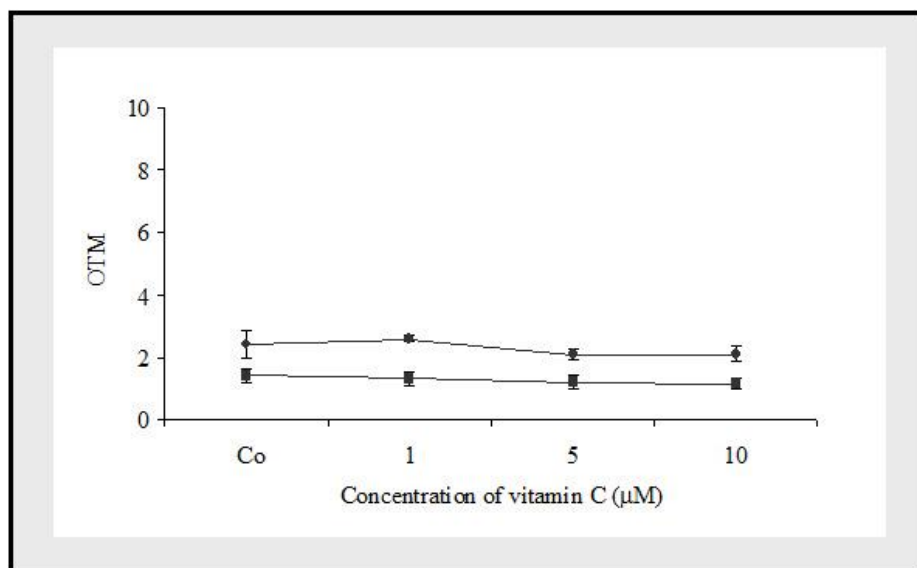

Figure 6. Induction of oxidative DNA damage by vitamin C in human HepG2 cells incubated with (●) and without (■) Fpg enzyme.

## Oxidative DNA Damage Induction by a Simultaneous Treatment of N-Nitrosamines and Vitamin C

In subsequent combined treatment experiments with N-Nitrosamines and vitamin C, the HepG2 cells were always incubated in presence of Fpg enzyme. Figure 7 shows the protective effect of vitamin C on NDMA (27 mM) (A), NPYR (5 mM) (B), NPIP (44 mM) (C) or NDBA (3 mM)(D)-induced oxidative DNA damage. Simultaneous treatment of HepG2 cells with vitamin C and NDMA, NPYR, NDBA or NPIP reduced the genotoxic effects of the N-Nitrosamines in a dose-dependent manner. At concentrations of 1-5  $\mu\text{M}$  vitamin C, the protective effect was higher towards NPYR-induced oxidative DNA damage (78-79%) than against NDMA (39-55%), NDBA (12-14%) and NPIP (3-55%), in presence of Fpg enzyme. However, a concentration of 10  $\mu\text{M}$  vitamin C led to a maximum reduction in NDBA (94%), NPYR (81%), NPIP (80%) and NDMA (61%)-induced oxidative DNA damage, in presence of Fpg enzyme. The protective effect of vitamin C (10  $\mu\text{M}$ ) was higher towards NDBA-induced oxidative DNA damage than against NDMA, NPYR and NPIP.

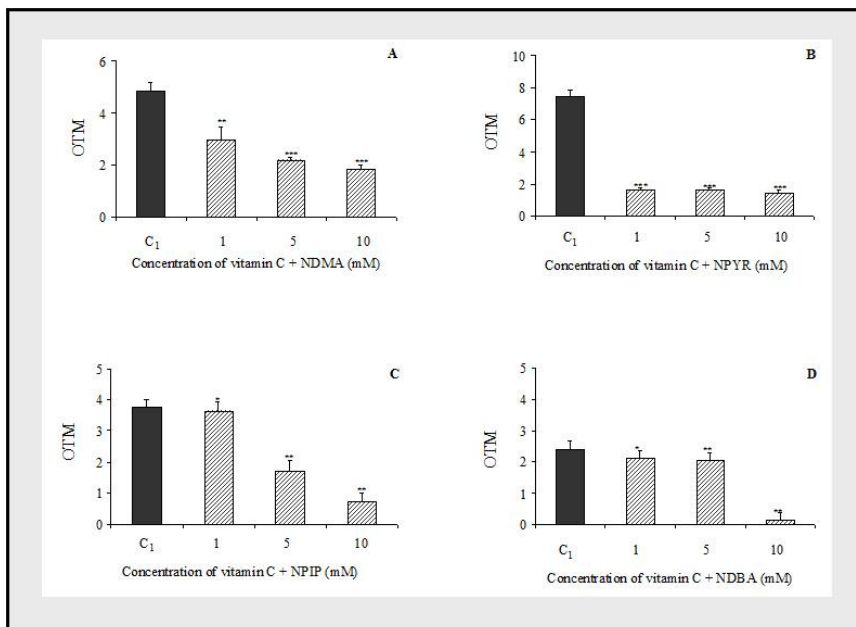

Figure 7. Effect of vitamin C on (A) NDMA, (B) NPYR, (C) NPIP and (D) NDBA-induced oxidative DNA damage in human HepG2 cells. C<sub>1</sub>, (■) HepG2 cells treated with N-Nitrosamines in presence of Fpg enzyme. (▨) HepG2 cells simultaneously treated with N-Nitrosamines and vitamin C in presence of Fpg enzyme. Asterisks indicate significant difference from control \*\*\* $p \leq 0.001$ , \*\* $p \leq 0.01$  and \* $p \leq 0.05$ .

#### Oxidative DNA Damage Induction by a Simultaneous Treatment of NPIP or NDBA and Vitamin C in Combination with ITCs

The effect of AITC, PEITC or I3C (0.1, 0.5 and 1  $\mu\text{M}$ ) alone on NPIP or NDBA-induced oxidative DNA damage in HepG2 cells incubated with Fpg enzyme was previously evaluated in our laboratory [70]. The results obtained in these experiments showed that the higher protective effect of ITCs alone towards oxidative DNA damage induced by NPIP and NDBA was observed at 1 and 0.1  $\mu\text{M}$ , respectively. Thus, in the present chapter it has been presented the protective effect of ITCs alone or in combination with vitamin C (10  $\mu\text{M}$ ) at these concentrations.

Figure 8 A shows the protective effect of AITC, PEITC or I3C alone on NPIP or NDBA-induced oxidative DNA damage in HepG2 cells incubated with Fpg enzyme. At the concentrations tested, AITC did not attenuate the NPIP or NDBA-induced oxidative DNA damage. However, the oxidative DNA damage provoked by NPIP in HepG2 cells was slightly prevented by PEITC and I3C at 1  $\mu\text{M}$  (26 and 28%, respectively), whereas the effect of NDBA was attenuated by 27 and 26% with lower concentrations of PEITC and I3C (0.1  $\mu\text{M}$ ), respectively.

The protective effect of AITC, PEITC or I3C in combination with vitamin C (10  $\mu\text{M}$ ) on NPIP or NDBA-induced oxidative DNA damage in HepG2 cells incubated with Fpg enzyme is shown in Figure 8 B. A significant reduction (63-25%) on NPIP and NDBA-induced

oxidative DNA damage was observed at the exposure concentrations of 1 and 0.1  $\mu\text{M}$  AITC, respectively, in combination with vitamin C. We also observed that combined treatments of PEITC or I3C and vitamin C (10  $\mu\text{M}$ ) reduced significantly the oxidative DNA damage induced by NPIP (1  $\mu\text{M}$ ; 46 and 73%, respectively) and NDBA (0.1  $\mu\text{M}$ ; 67 and 42%, respectively).

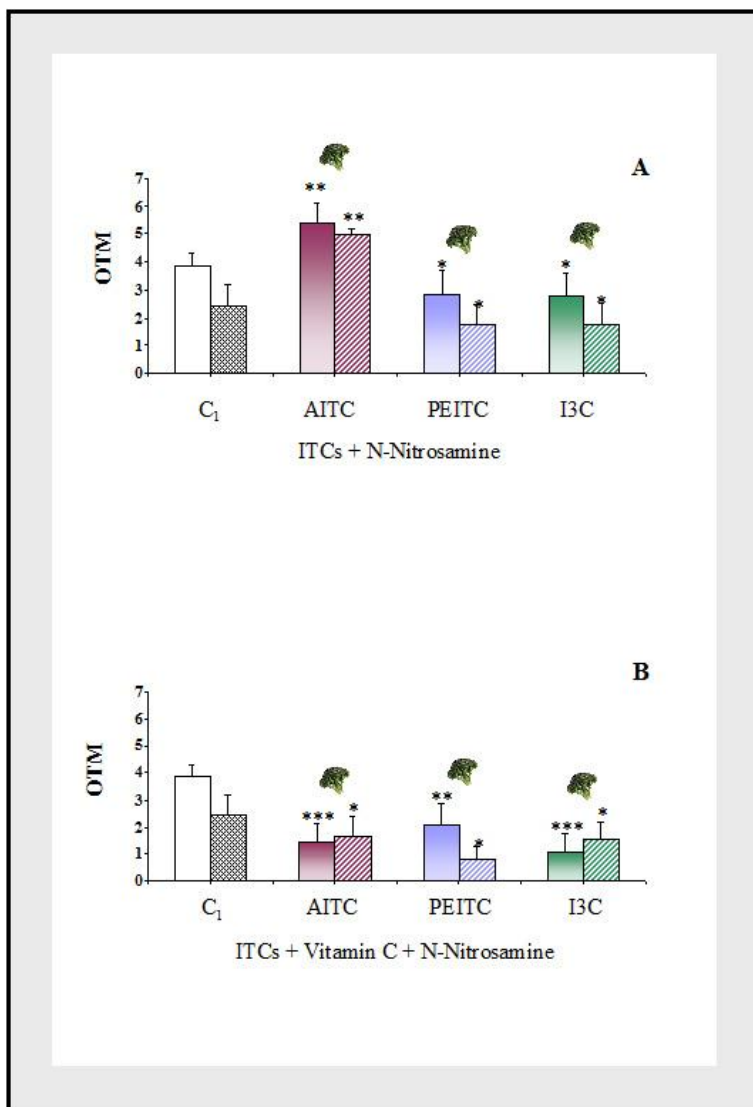

Figure 8. Effect of AITC, PEITC or I3C (A) alone or (B) in combination with vitamin C towards NPIP and NDBA-oxidative DNA damage in human HepG2 cells. C<sub>1</sub>, (□) HepG2 cells treated with NPIP 44 mM or (■) NDBA 3 mM and incubated with Fpg enzyme. (▨) HepG2 cells simultaneously treated with NPIP and AITC, PEITC or I3C (1  $\mu\text{M}$ ) alone or in combination with vitamin C (10  $\mu\text{M}$ ). (▩) HepG2 cells simultaneously treated with NDBA and AITC, PEITC or I3C (0.1  $\mu\text{M}$ ) alone or in combination with vitamin C (10  $\mu\text{M}$ ). Asterisks indicate significant difference from control \*\*\* $p \leq 0.001$ , \*\* $p \leq 0.01$  and \* $p \leq 0.05$ .

## Oxidative DNA Damage Induction by a Simultaneous Treatment of NPIP or NDBA and Vitamin C in Combination with OSCs

The effect of DADS/DPDS (0.1, 1 and 2.5  $\mu\text{M}$ ) or DPS (1, 10 and 50  $\mu\text{M}$ ) alone on NPIP or NDBA-induced oxidative DNA damage in HepG2 cells incubated with Fpg enzyme was previously evaluated in our laboratory [71]. The results obtained in these experiments showed that the higher protective effect of DADS/DPDS alone towards oxidative DNA damage induced by NPIP and NDBA was observed at 1 and 0.1  $\mu\text{M}$ , respectively, whereas it was necessary to use higher concentrations of DPS to observe similar protective effect (10 and 1  $\mu\text{M}$ , respectively). Thus, in the present chapter it has been presented the protective effect of OSCs alone or in combination with vitamin C (10  $\mu\text{M}$ ) at these concentrations.

The protective effect of DADS, DPS or DPDS alone on NPIP or NDBA-induced oxidative DNA damage in HepG2 cells incubated with Fpg enzyme is shown in Figure 9 A. The results obtained showed that the formation of Fpg sensitive sites induced by NPIP was slightly reduced by DADS (1  $\mu\text{M}$ , 14%), DPS (10  $\mu\text{M}$ ; 24%) and DPDS (1  $\mu\text{M}$ , 55%). However, the formation of Fpg sensitive sites induced by NDBA was drastically prevented by lower concentrations of DADS (0.1  $\mu\text{M}$ , 92%), DPS (1  $\mu\text{M}$ , 66%) and DPDS (0.1  $\mu\text{M}$ , 80%).

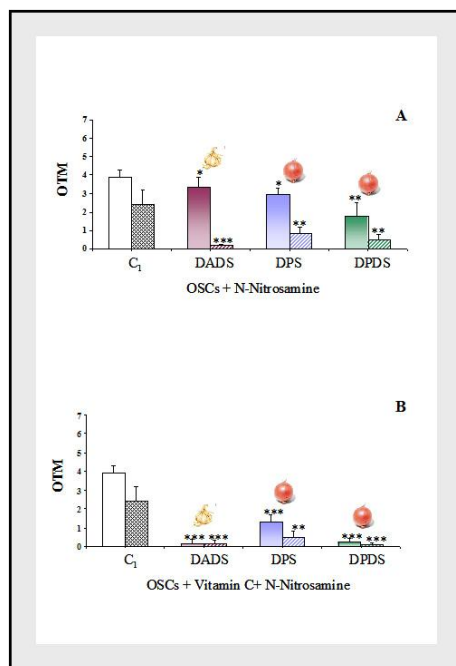

Figure 9. Effect of DADS, DPS or DPDS (A) alone or (B) in combination with vitamin C towards NPIP and NDBA-oxidative DNA damage in human HepG2 cells. C<sub>1</sub>, (□) HepG2 cells treated with NPIP 44 mM or (■) NDBA 3 mM and incubated with Fpg enzyme. (▨) HepG2 cells simultaneously treated with NPIP and DADS (1  $\mu\text{M}$ ), DPS (1  $\mu\text{M}$ ) or DPDS (10  $\mu\text{M}$ ) alone or in combination with vitamin C (10  $\mu\text{M}$ ). (▩) HepG2 cells simultaneously treated with NDBA and DADS (0.1  $\mu\text{M}$ ), DPS (1  $\mu\text{M}$ ) or DPDS (0.1  $\mu\text{M}$ ) alone or in combination with vitamin C (10  $\mu\text{M}$ ). Asterisks indicate significant difference from control \*\*\*p < 0.001, \*\* p < 0.01 and \*p < 0.05.

Figure 9 B shows the results of an experiment with a simultaneous treatment of DADS, DPS or DPDS in combination with vitamin C and NPIP or NDBA. Simultaneous treatment of DADS or DPDS and vitamin C (10  $\mu\text{M}$ ) showed an overall protective effect towards the formation of Fpg sensitive sites induced by NPIP (1  $\mu\text{M}$ , 96 and 95%, respectively) and NDBA (0.1  $\mu\text{M}$ , 94 and 95%, respectively). To a lesser extent, combined treatments of DPS and vitamin C (10  $\mu\text{M}$ ) reduced the formation of Fpg sensitive sites induced by NPIP (10  $\mu\text{M}$ , 67%) and NDBA (1  $\mu\text{M}$ , 80%).

#### DNA Strand Break and Oxidized Purines/Pyrimidines Induction by a Simultaneous Treatment of $\text{H}_2\text{O}_2$ and Vitamin C in Alkaline Comet Assay

The protective effect of vitamin C towards  $\text{H}_2\text{O}_2$ -induced DNA damage is shown in Figure 10. DNA strand breaks induced by  $\text{H}_2\text{O}_2$  were reduced by 20, 21 and 33% at 1, 5 and 10  $\mu\text{M}$ , respectively. The formation of Fpg sensitive sites induced by  $\text{H}_2\text{O}_2$  was prevented by 1-5  $\mu\text{M}$  vitamin C (12–8%, respectively) but not at the highest concentration (10  $\mu\text{M}$ ). Vitamin C also reduced the formation of Endo III sensitive sites induced by  $\text{H}_2\text{O}_2$  at 1-10  $\mu\text{M}$  (29–35%).

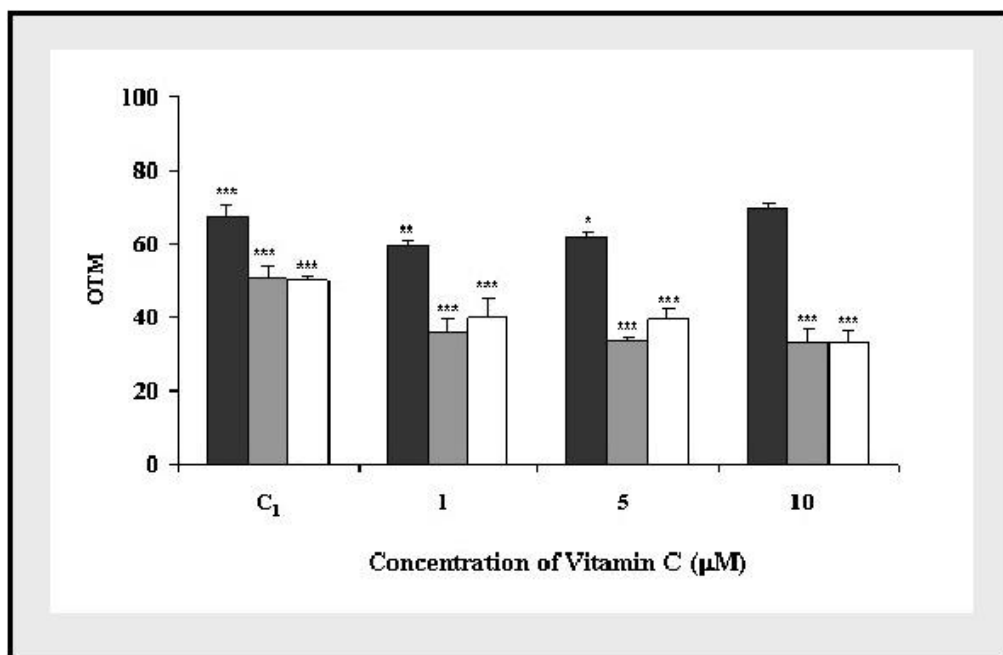

Figure 10. Effect of vitamin C on  $\text{H}_2\text{O}_2$ -induced DNA strand breaks and oxidative DNA damage in human HepG2 cells. C<sub>1</sub>, HepG2 cells treated with 10  $\mu\text{M}$   $\text{H}_2\text{O}_2$  and incubated with (■) Fpg, (▒) Endo III or (□) without enzymes. (■) HepG2 cells simultaneously treated with  $\text{H}_2\text{O}_2$  and vitamin C and incubated with Fpg enzyme, (▒) with Endo III or (□) without enzymes. Asterisks indicate significant difference from control \*\*\* $p \leq 0.001$ , \*\*  $p \leq 0.01$  and \* $p \leq 0.05$ .

## Determination of Enzyme Activities

Figure 11 shows the effect of vitamin C (1-10 $\mu$ M) on p-nitrophenol hydroxylase (CYP2E1), coumarin hydroxylase (CYP2A6), ethoxyresorufin O-deethylation (CYP1A1) and UDP-glucuronyltransferase (UGT1A4) activity. The p-nitrophenol hydroxylase and coumarin hydroxylase activity decreased with increasing concentrations of vitamin C. However, the ethoxyresorufine O-deethylation activity was similar at all the concentrations of vitamin C used. Vitamin C (10  $\mu$ M) strongly reduced the coumarin hydroxylase (82%) activity, while the p-nitrophenol hydroxylase and the ethoxyresorufine O-deethylation activities were slightly and weakly reduced (32-19%) respectively. With regard to phase II enzymes, all concentrations tested of vitamin C (1-10  $\mu$ M) had a pronounced effect on UDP-glucuronyltransferase activity (171-178%, respectively).

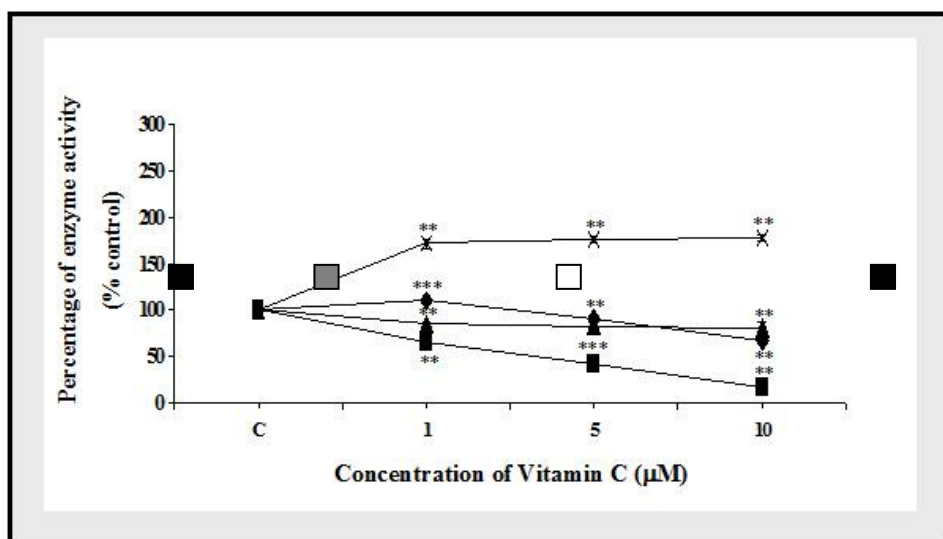

Figure 11. Effect of vitamin C on (◆) p-nitrophenol hydroxylase activity (CYP2E1), (■) coumarin hydroxylase activity (CYP2A6), (▲) ethoxyresorufin O-deethylation activity (CYP1A1) and (×) UDP-glucuronyltransferase activity (UGT1A4). Values are mean of four samples  $\pm$  S.D. and are expressed relative to control. Asterisks indicate significant difference from control \*\*\* $p$   $\leq$  0.001 and \*\*  $p$   $\leq$  0.01.

## Effect of Vitamin C Treatment on Cell Viability

The effect of vitamin C on HepG2 and HL-60 cell viability was evaluated by two cytotoxicity assays, MTT (Figure 12) and LDH release (Figure 13). Vitamin C was tested at concentrations ranging from 1 to 100  $\mu$ M and incubated for 24, 48 and 72 h. As expected, treatment of HepG2 cells with vitamin C showed no toxicity using the MTT assay (Figure 12 A). In contrast to the effect noted on HepG2 cells, treatment of HL-60 cells with vitamin C concentrations of 50 and 100  $\mu$ M for 72 h caused a dose-dependent decrease of cell viability of about 29 and 46%, respectively (Figure 12 B).

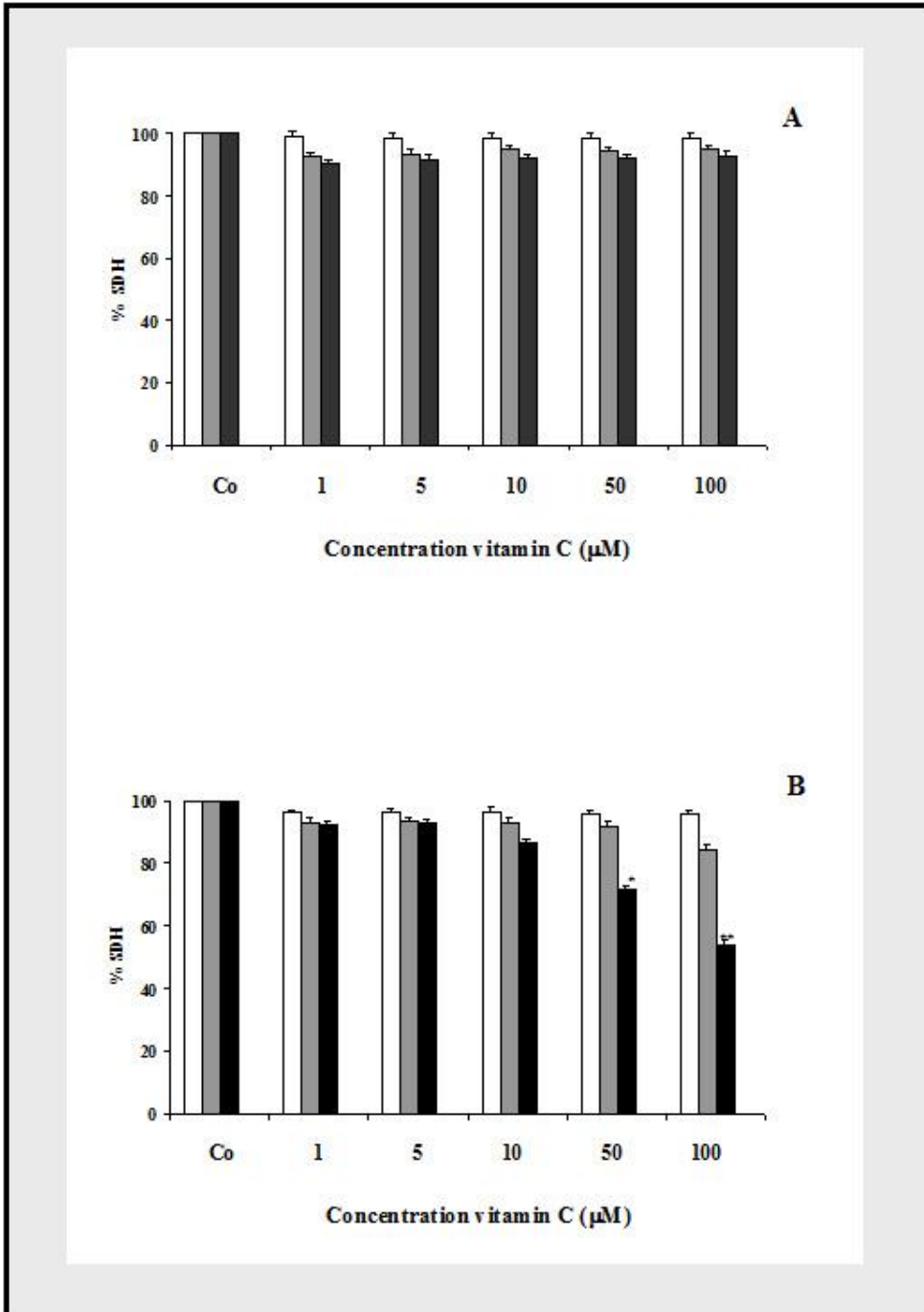

Figure 12. Effect of vitamin C on HepG2 (A) and HL-60 (B) cell viability by MTT assay. Cells were cultured with different doses of vitamin C for 24 (□), 48 (■) and 72 h (■). Asterisks indicate significant difference from control \*\*  $p \leq 0.01$  and \*  $p \leq 0.05$ .



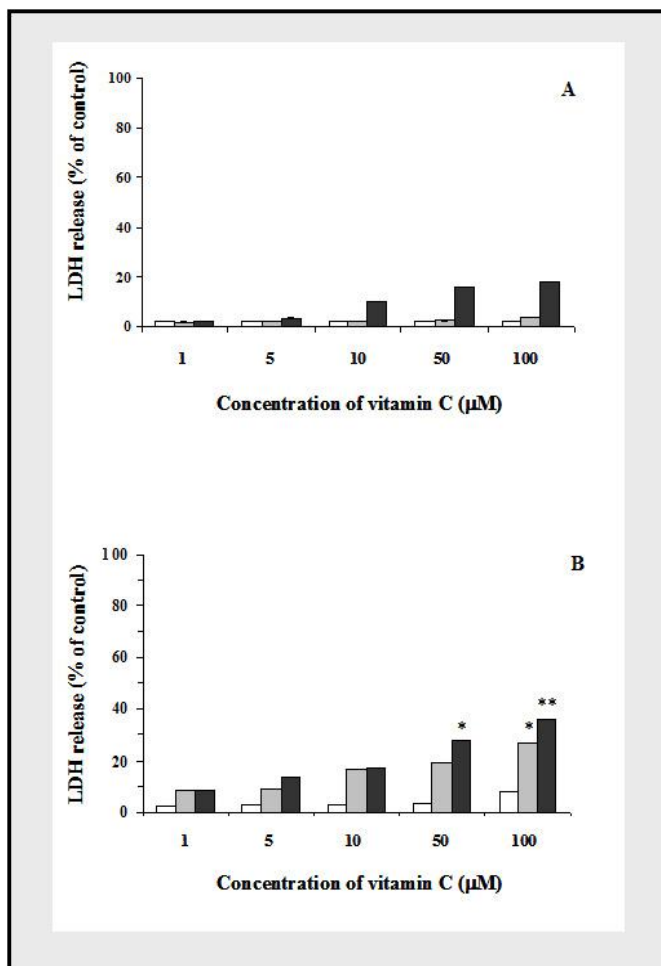

Figure 13. Effect of vitamin C on HepG2 (A) and HL-60 (B) cell viability by LDH assay. Cells were cultured with different doses of vitamin C for 24 (□), 48 (▒) and 72 h (■). Asterisks indicate significant difference from control \*\*  $p \leq 0.01$  and \*  $p \leq 0.05$ .

Cytotoxicity of vitamin C, assessed by measuring LDH release in HepG2 and HL-60 cells, is shown in Figure 13. Similarly, no significant difference in LDH release was observed when HepG2 cells were incubated with vitamin C for 24, 48 and 72 h compared with control (Figure 13 A). However, an increase of LDH release in HL-60 cells was statistically significant with 50 µM at 72 h (28%) and with 100 µM of vitamin C at 48 and 72 h (27 and 36%, respectively; Figure 13 B), suggesting some membrane damage.

#### Effect of Vitamin C on Apoptosis by the TUNEL Assay

Figure 14 shows the induction of apoptosis by vitamin C on HepG2 and HL-60 cells using the TUNEL assay. TUNEL assay is a sensitive test to detect the DNA strand breaks that are a hallmark of the late stages of apoptosis [72]. The baseline percentage of apoptosis on untreated HepG2 and HL-60 cells was around 4% and 8%, respectively.

HepG2 and HL-60 cells were incubated with various concentrations of vitamin C (1-100  $\mu\text{M}$ ) for 72 h. Then, the percentage of apoptotic cells was measured by flow cytometry. The results are expressed as percentage of apoptotic cells over the total cells, and are the mean  $\pm$  standard deviation (SD) of three independent experiments. No significant changes were observed when HepG2 and HL-60 cells were treated with 5-50  $\mu\text{M}$  vitamin C for 72 h (Figure 14). However, substantial increase of apoptotic cells was observed when HL-60 cells were treated with 100  $\mu\text{M}$  vitamin C, about 21%. Based on the results, 5-50  $\mu\text{M}$  vitamin C was used in our apoptosis studies.

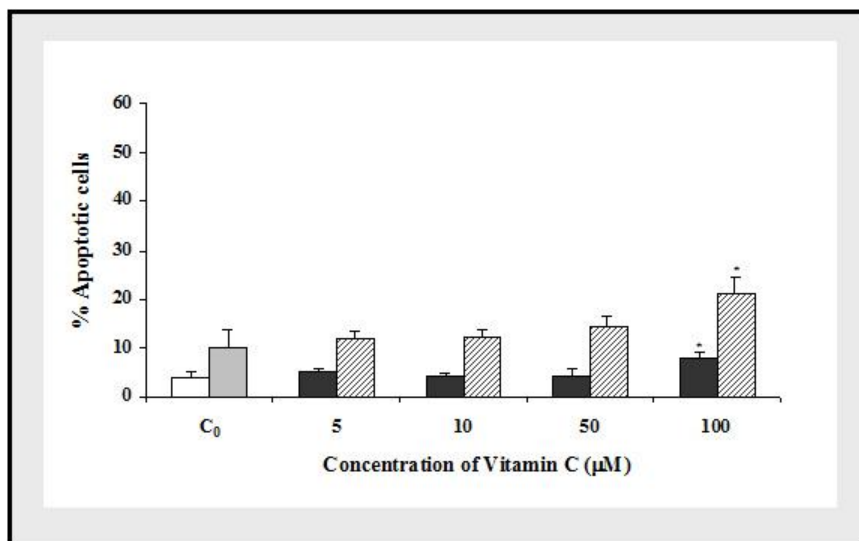

Figure 14. Percentage of apoptotic cells obtained by TUNEL assay and flow cytometry after treatment with vitamin C.  $C_0$ ,  $\square$  untreated HepG2 and  $\blacksquare$  HL-60 cells.  $\blacksquare$  HepG2 and  $\square$  HL-60 cells treated with vitamin C for 72 h. Asterisks indicate significant difference from control \*  $p \leq 0.05$ .

#### Effect of Vitamin C on N-Nitrosamines-Induced Apoptosis by the TUNEL Assay

In subsequent simultaneous treatments with N-Nitrosamines and vitamin C, the HepG2 and HL-60 cells were incubated with the selected concentrations of 5-50  $\mu\text{M}$  vitamin C. The percentage of apoptosis is the mean  $\pm$  SD of three independent experiments. The effect of vitamin C on N-Nitrosamines-induced apoptosis is shown in Figure 15.

Figure 15 A shows the results obtained with a simultaneous treatment of NDMA (68 mM) and vitamin C (5–50  $\mu\text{M}$ ) in HepG2 and HL-60 cells. The protective effect of vitamin C was dose-dependent and significant reductions in the percentage of apoptosis in NDMA HepG2 treated cells (68 mM) were observed at exposure concentrations of 5, 10 and 50  $\mu\text{M}$  (37, 43 and 49% of reduction, respectively). The inhibitory effect of vitamin C towards NDMA-induced apoptosis in HL-60 cells was significantly higher than in HepG2 cells. Vitamin C at 5, 10 and 50  $\mu\text{M}$  reduced the percentage of apoptotic HL-60 cells induced by 68 mM NDMA, by about 56, 65 and 66%, respectively.

As shown in Figure 15 B, vitamin C (5-50  $\mu\text{M}$ ) also caused a dose-dependent protective effect towards apoptosis induced by NPYR (50 mM) in HepG2 and HL-60 cells, being the inhibitory effects of vitamin C very similar in both cell lines. Vitamin C (5-50  $\mu\text{M}$ ) led to 59-65% and 50-63% of reduction in the percentage of apoptotic HepG2 and HL-60 cells induced by 50 mM NPYR, respectively.

Figure 15 C shows the results obtained with a simultaneous treatment of NPIP and vitamin C (5-50  $\mu\text{M}$ ) in HepG2 (25 mM) and HL-60 cells (20 mM). A dose-dependent protective effect of vitamin C was shown against apoptosis induced by NPIP at 5, 10 and 50  $\mu\text{M}$  in HepG2 (60, 67 and 75% of reduction) and HL-60 cells (34, 66% and 77% of reduction), being the reduction of apoptotic cells by vitamin C very similar in both cell lines.

The effect of vitamin C (5-50  $\mu\text{M}$ ) on apoptosis induced by NDBA in HepG2 (2.5 mM) and HL-60 cells (2 mM) is shown in Figure 15 D. Vitamin C (5-50  $\mu\text{M}$ ) also showed a dose-dependent protective effect in NDBA treated HL-60 cells (29-80% of inhibition, respectively). However, all vitamin C concentrations tested (5-50  $\mu\text{M}$ ) decreased the NDBA-induced apoptosis by about 60% in HepG2 cells.

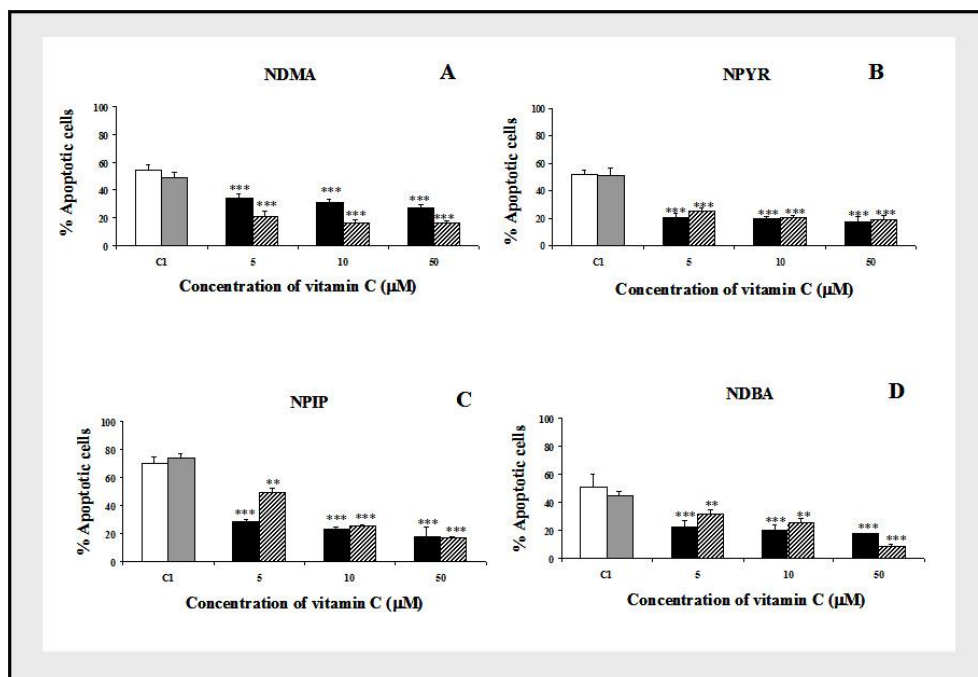

Figure 15. Effect of vitamin C on (A) NDMA, (B) NPYR, (C) NPIP and (D) NDBA-induced apoptosis in HepG2 and HL-60 cells. C<sub>1</sub>, (□) HepG2 and (■) HL-60 cells treated with 68 mM NDMA or 50 mM NPYR or 25 and 20 mM NPIP (respectively) or 2.5 and 2 mM NDBA (respectively) for 72 h. (■) HepG2 and (▨) HL-60 cells simultaneously treated with 68 mM NDMA or 50 mM NPYR or 25 and 20 mM NPIP (respectively) or 2.5 and 2 mM NDBA (respectively) and vitamin C for 72 h. Asterisks indicate significant difference from control \*\*\* $p \leq 0.001$  and \*\*  $p \leq 0.01$ .

## Effect of Vitamin C on NPIP and NDBA-Induced ROS Production

Figure 16 shows the effect of vitamin C on NPIP and NDBA-induced ROS production in HepG2 and HL-60 cells, respectively. In our previous work, it was observed a significant increase in ROS levels after treatment with 25 and 20 mM NPIP in HepG2 and HL-60 cells, respectively, whereas NDBA (2 mM) only induced ROS production in HL-60 cells [44, 45]. For that reason we did not examine the effect of vitamin C on NDBA-induced ROS production in HepG2 cells. In the present chapter, it was not detected significant difference in intracellular ROS levels in both cell lines pre-treated with only vitamin C (5-50  $\mu\text{M}$ ) for 1 h (Figure 16). In combined treatments, high ROS levels induced by NPIP were significantly reduced at all concentration tested of vitamin C (5-50  $\mu\text{M}$ , 29-58% of reduction) in HepG2 cells (Figure 16 A). Similarly, ROS levels induced by NPIP in HL-60 cells were significantly reduced at all concentration tested of vitamin C (5-50  $\mu\text{M}$ , 51-60% of reduction) (Figure 16 B), whereas only 10-50  $\mu\text{M}$  vitamin C partially eliminated intracellular ROS levels induced by NDBA (9-19% of reduction) (Figure 16 C).

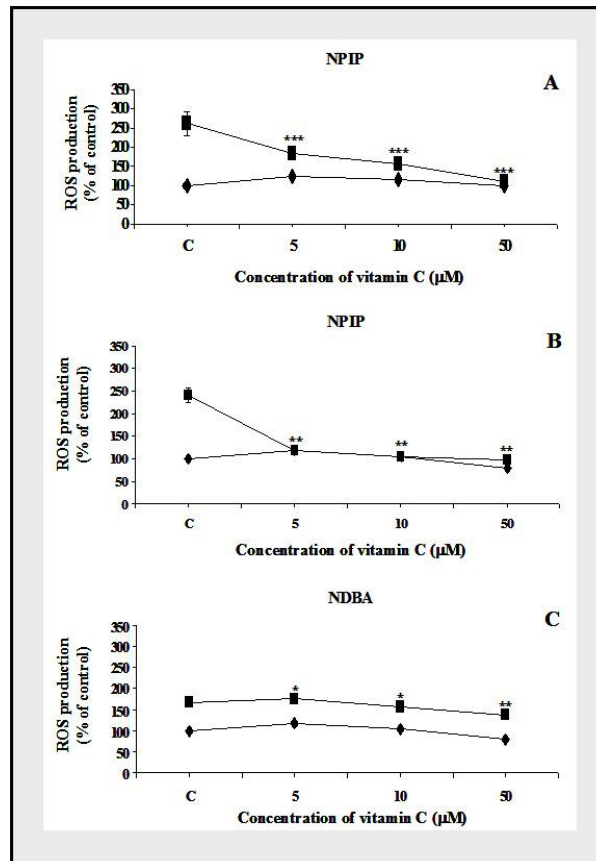

Figure 16. Effect of vitamin C on ROS production in HepG2 (A) and HL-60 cells (B and C) in the absence (◆) or presence (■) of NPIP (25 and 20 mM, respectively) or NDBA (2 mM). DCF fluorescence was measured with a flow cytometer and expressed as % of control. Data are mean  $\pm$  SD. Asterisks indicate significant difference from control \*\*\* $p \leq 0.001$ , \*\* $p \leq 0.01$  and \* $p \leq 0.05$ .

## Conclusion

The main aim of the present chapter was to evaluate the protective effect of vitamin C, a potent antioxidant presents in fruits and vegetables against oxidative DNA damage and apoptosis caused by food N-Nitrosamines. It has been suggested that DNA alkylation and free radical damage are in part involved in the carcinogenic action induced by N-Nitrosamines [12]. Strand breaks or alkali labile sites, including abasic sites, may be results of the action of ROS that arise during the metabolism of N-Nitrosamines in the cell.

To determine the role of oxidative DNA damage in observed effects of N-Nitrosamines, we tested whether NDMA, NPYR, NPIP or NDBA were able to generate oxidized bases. We showed that Fpg treatment enhanced the oxidative DNA damage induced by NDMA, NPYR, NPIP and NDBA (Figure 5). Fpg, an enzyme recognizing mainly 2,6-diamino-4-hydroxy-5-N-methyl formamidopyrimidine and 7,8-dihydro-8-oxo-20 deoxyguanine (8-oxo-G) [73] as well as other oxidized purines introduced strand breaks to DNA of NDMA, NPYR, NPIP and NDBA treated cells. This can be further evidence for oxidative DNA damage caused by the four N-Nitrosamines. These results are in agreement with those of previous studies, which reported that ROS may partially contribute to the genotoxic effect of NDMA in P450 2E1-expressing cells [74]. Our data showed that NDMA was the N-Nitrosamine tested which required the highest concentration (27 mM) to cause a significant increase in oxidative DNA damage (Figure 5). It was necessary low doses of NPYR (5 mM), NPIP (9 mM) and NDBA (3 mM) to obtain a high oxidative DNA damage. These results are consistent with those of previous studies, which reported NDMA to be genotoxic at high concentrations in human hepatoma cell lines and hepatocyte primary cultures [75, 76]. Uhl et al. [77] and Valentin-Severin et al. [76] reported that NDMA was the least active genotoxin of a panel of different genotoxic compounds with HepG2 cells. Our previous results on the mutagenic activity of N-Nitrosamines evaluated by the Ames test [78] indicated that NDMA was mutagenic at higher concentrations than NPYR, NPIP and NDBA.

Interest in chemopreventive functions of antioxidants has grown considerably in recent years. There is considerable evidence that the effects of mutagenic and carcinogenic agents can be altered by many dietary constituents. Vitamin C is an essential dietary nutrient required as a co-factor for many enzymes and a very efficient antioxidant, scavenging reactive oxygen and nitrogen species and protecting cells against free radical-mediated damage [79]. In the present chapter vitamin C exerted protective effect towards the four N-Nitrosamines-induced oxidative DNA damage in HepG2 cells (Figure 7). A concentration of 10  $\mu\text{M}$  vitamin C led to a maximum reduction in NDBA (94%), NPYR (81%), NPIP (80%) and NDMA (61%)-induced oxidative DNA damage, in presence of Fpg enzyme. The protective effect of vitamin C (10  $\mu\text{M}$ ) was higher towards NDBA-induced oxidative DNA damage. These results are consistent with our previous reports [80] showing that the greatest inhibition effect (51%) of the mutagenicity of NDBA was shown by kiwi ethanolic extract (containing around 5  $\mu\text{mol/g}$  (wet/wt) of vitamin C [81]. Lazarová and Slamenová [82] also reported that vitamin C also protected human liver cells HepG2 against oxidative DNA damage induced by benzo(a)pyrene and 5,9-dimethyl-7Hdibenzo[c,g]carbazole.

Population-based studies show that a low risk of cancer is more closely related to antioxidant-rich whole diets than to individual dietary antioxidants. These results imply that

diet as a whole plays a more important role than do individual components. The results obtained in the present chapter suggested that vitamin C alone (Figure 7 C and D) or in combination with ITCs (Figure 8 B) or OSCs (Figure 9 B) is a stronger inhibitor of oxidative DNA damage induced by NPIP or NDBA than ITCs (Figure 8 A) or OSCs alone (Figure 9 A). Eberhardt et al. [83] and Kim et al. [84] reported that the beneficial effects of apples on carcinogenesis may be due, not to the presence of vitamin C alone, but to the synergism elicited by various phenolic ingredients. Furthermore, an epidemiologic study suggested that the inverse relation between the consumption of antioxidant rich diets and the incidence of cancer has to do with the intake of flavonoids rather than with that of vitamins [85]. In contrast, our previous studies [86, 87] and the results of the present chapter suggested that vitamin C alone or in combination with PEITC, AITC or I3C, is a stronger inhibitor of oxidative DNA-damage induced by NPIP and NDBA than ITCs alone. Although the protective effect of vitamin C alone is higher than vitamin C in combination with ITCs or DPS. This could be due to the inhibition of the uptake of vitamin C into cells by ITCs or DPS. Park and Levine [88] reported that intracellular accumulation of ascorbic acid is inhibited by flavonoids via blocking of dehydroascorbic acid and ascorbic acid uptake in HL-60. We also observed that vitamin C in combination with DADS or DPDS (Figure 9 B) exhibited an overall protective effect against oxidative DNA damage induced after NPIP and NDBA treatment. However, the contribution of DADS or DPDS to the protective effect found in combined experiments might not be relevant because it could be caused by vitamin C alone.

N-Nitrosamines require metabolic activation to form reactive intermediates that express their carcinogenicity. One feasible mechanism by which vitamin C exert its protective effect towards N-Nitrosamines is that vitamin C may interact with the enzyme systems catalyzing the metabolic activation of N-Nitrosamines, blocking the production of genotoxic intermediates [37]. Accordingly, the protective effect of vitamin C (5-10  $\mu\text{M}$ ) towards NDMA-induced DNA oxidative damage could be related in part to the reduction of human CYP2E1 activity (32%), while the reduction of oxidative DNA damage induced by NPYR and NPIP may be also attributed in part to the inhibition of human CYP2E1 (32%) and CYP2A6 (82%) activities by vitamin C involved in their metabolism (Figure 11). In addition, not well correlation between human CYPs inhibition and inhibition of DNA damage induced by N-Nitrosamines could be attributed to the incubation of vitamin C with P450 enzymes under cell-free conditions, such as microsomes from baculovirus- infected insect cells expressing human CYP2A6 or CYP2E1, instead living cells (HepG2 cells) as in the comet assay. The disadvantage of the subcellular fractions is that xenobiotic biotransformation is not influenced by xenobiotic transporters, which is normally the case in intact cells and organs [89]. NDBA is mainly activated by CYP1A1 and our results showed that human CYP1A1 activity was weakly reduced (19%) (Figure 11). The lack of CYP1A1 inhibition by vitamin C (1-5  $\mu\text{M}$ ) could be related with the low reduction of oxidative DNA damage induced by NDBA. In contrast, Ueta et al. [90] found that induced CYP1A1 gene expression by cigarette smoke exposure was decreased by vitamin C administration.

However, the protection of vitamin C probably involves more than one mechanism. Other possible mechanism proposed might also include induction of phase II enzymes, which enhance detoxification and excretion of carcinogens [32]. Our results also showed that

vitamin C (1-10  $\mu\text{M}$ ) exerted a pronounced effect on UDP-glucuronyltransferase activity, increasing almost 1.8-fold (171-178%, respectively) (Figure 11). Moreover, there was a good correlation between induction of human UDP-glucuronyltransferase activity by vitamin C and its inhibition of oxidative DNA damage induced by N-Nitrosamines.

The protective role of vitamin C against oxidative stress induced by environmental mutagens has been previously demonstrated [91]. Collins et al. [92] showed that 3-week ingestion of 1–3 kiwi fruits, rich in vitamin C, per day, decreased Endo III and Fpg sensitive sites, as well as decreased *ex vivo* sensitivity toward  $\text{H}_2\text{O}_2$ . Thus, vitamin C is included among the radical trapping antioxidants and is considered one of the most efficient antioxidants [93]. It has been shown that vitamin C reacts directly with superoxide, hydroxyl radicals, and singlet oxygen [94]. Witenberg et al. [95] has also suggested that vitamin C, being an antioxidant, partially neutralizes peroxides and decreases the intracellular oxidative level, and thus protects cells from oxidative DNA damage.

In our study, vitamin C protected against DNA strand breaks and oxidative DNA damage induced by  $\text{H}_2\text{O}_2$ , although it was more effective against oxidative damage in pyrimidines (35%) than in purines (12%) (Figure 10). These findings suggest that one possible mechanism for the protective effect of vitamin C towards oxidative DNA damage induced by N-Nitrosamines could be due to the free radical scavenging efficiency of vitamin C. Qi et al. [96], using HPLC, showed a decrease in 8-oxoguanine in  $\text{H}_2\text{O}_2$ -treated calf thymus DNA, after administering vitamin C (1-250  $\mu\text{M}$ ). Cheng et al. [97] demonstrated an inhibitory effect of vitamin C (50–200  $\mu\text{M}$ ) on ozone-induced 8-oxoguanine in human lung carcinoma cells (A549 cells). Moreover, Lazarová and Slamenová [82] found that pre-treatment of HepG2 cells with 0.5 mM of vitamin C efficiently reduced the level of oxidative DNA damage induced by benzo(a)pyrene, which generates hydroxyl radicals. Overall, the vitamin C is a powerful antioxidant acting both directly via scavenging of ROS and indirectly through regeneration of other antioxidant systems [98].

Apoptosis induced by carcinogens seems to have an important role in cancer development [99, 100, 101]. Accordingly, the mechanism and cell signaling pathways involved in food carcinogen-induced cell death or cell survival and proliferation have recently received much interest [74, 102]. Our results showed that exposure of HepG2 and HL-60 cells to increasing concentrations of NDMA (27-135 mM), NPYR (10-50 mM) NPIP (10-45 mM; 5-20 mM; respectively) and NDBA (1-3.5 mM; 0.5-2.5 mM; respectively) resulted in an elevated percentage of apoptosis via a caspase-dependent pathway [44, 45, 46]. NDBA was the most effective N-Nitrosamine to induce apoptosis in HepG2 and HL-60 cell lines. At 72 h, 2.5 and 2 mM NDBA induced 51 and 44% of apoptotic HepG2 and HL-60 cells, respectively, whereas it was necessary to use doses of 25 and 20 mM NPIP (70 and 75%, respectively), 50 mM NPYR (52 and 51%, respectively) and 68 mM NDMA (54 and 49%, respectively) to obtain a high percentage of apoptotic cells by TUNEL assay. The fact that the percentage of apoptotic cells varied with the type of N-Nitrosamine suggests that the apoptotic effect depended on the chemical structure of N-Nitrosamine.

Recently, much effort has been directed towards the manipulation of the apoptotic process for the treatment and prevention of cancer, and the search for compounds that influence apoptosis [103]. In the present chapter, we first evaluated the cytotoxicity of vitamin C using the MTT and the LDH assay in HepG2 and HL-60 cells. Moreover, in order

to obtain more insight into the vitamin C effect, we explored the feasible induction of apoptosis using the TUNEL assay. Our results showed that the viability of HepG2 cells was not altered by supplementation of the medium with vitamin C at any of the concentrations and times tested (Figure 12 A and 13 A). Lazarová and Slaménová [82] observed that 0.5 mM vitamin C did not induce any cytotoxic effect on HepG2 cells. However, our results reveal that there were significant losses of cell viability, measured by MTT assay, 72 h after treatment of HL-60 cells with 50 and 100  $\mu\text{M}$  vitamin C (29 and 46%, respectively) (Figure 12 B). Also, LDH assay demonstrated that 50  $\mu\text{M}$  at 72 h and 100  $\mu\text{M}$  vitamin C at 48 and 72 h were, in fact, toxic to HL-60 cells, since LDH release was increased up to 36% (Figure 13 B). These findings are in agreement with Blasiak et al. [104] and Bhat et al. [105] who reported that concentrations of vitamin C ranging from 20 to 200  $\mu\text{M}$  are able to cause oxidative DNA breakage in human lymphocytes. Moreover, the percentage of apoptotic cells found in TUNEL assay increased to 21% in HL-60 cells when they were treated with 100  $\mu\text{M}$  vitamin C for 72 h (Figure 14). Previous reports have revealed that vitamin C is selectively toxic to some types of tumor cells [106]. Park et al. [107] showed that vitamin C (0.25-1 mM) induced apoptosis in leukemic cells (HL-60 and NB4), whereas the same concentrations of vitamin C had no significant effect on three ovarian cancer cell lines (SK-OV-3, OVCAR-3 and 2274).

The potential anti-apoptotic of vitamin C by its antioxidant capacity was previously shown in human leukemia (HL-60) [108] and colon carcinoma (HT-29) cells [109]. Vitamin C (50  $\mu\text{M}$ ) exerted similar protective effect in HL-60 and HepG2 cells towards NPYR (65% and 63% of reduction, respectively) (Figure 15 B) and NPIP (77% and 74% of reduction, respectively) (Figure 15 C), two cyclic N-Nitrosamines. However, the inhibitor effect of vitamin C (50  $\mu\text{M}$ ) towards apoptosis induced by lineal chain N-Nitrosamines, such as NDMA (Figure 15 A) and NDBA (Figure 15 D), was higher in HL-60 cells (75% and 80% of reduction, respectively) than in HepG2 cells (57% and 66% of reduction, respectively). Thus, a possible explanation of the variation in the anti-apoptotic effect of vitamin C could be attributed to the differences in the levels of enzymatic activities in HepG2 and HL-60 cells.

We have previously reported that NPIP and NDBA induced a significant ROS production in HL-60 cells [44], whereas ROS levels were only enhanced by NPIP in HepG2 cells, but not by NDBA [45]. Therefore, the scavenging ability of vitamin C was evaluated towards ROS production induced by NPIP in both cell lines and by NDBA in HL-60 cells. It was not detected significant ROS levels after pre-treatment with only vitamin C (5-50  $\mu\text{M}$ ) (Figure 16). In combined treatment experiments, we have observed that vitamin C decreased the ROS production induced by NPIP and NDBA to baseline levels. Accordingly, the inhibition of NPIP and NDBA-induced apoptosis by vitamin C could be related to its ROS trapping ability.

The two major mechanisms regulating apoptosis include the extrinsic pathway triggered by death receptors and the intrinsic pathway mediated by mitochondrial events. The apical proteases in the extrinsic and intrinsic pathways are caspase-8 and caspase-9, respectively. Recently, we have showed that in NPYR and NDMA-induced apoptosis mainly operates the caspase-8-dependent pathway, but there is also a caspase-9-dependent side pathway [46]. However, NPIP and NDBA-induced apoptosis in HepG2 cells was through the activation of both the extrinsic and the intrinsic pathway [45]. Perez-Cruz et al. [110] found that vitamin C



could prevent apoptosis, in monocytic U937 cell line and human monocytes, through inactivation of caspase-8 and as consequence, vitamin C also reduced the activation of caspase-3 in both cell lines. In addition vitamin C inhibits cytochrome C release and consequent activation of caspase-9 and downstream caspase-3, in human endothelial cells [111].

In summary, the protective role of vitamin C towards N-Nitrosamine toxicity could be related with a reduction of N-Nitrosamine-induced oxidative DNA damage and apoptosis. Among feasible mechanisms implicated, the modification of phase I and/or phase II enzyme activities and free radical scavenging ability could contribute to reduce the oxidative DNA damage and apoptosis induced by N-Nitrosamines in HepG2 and HL-60 cells.

## Acknowledgment

This work has been supported by Grant ALI2002-01033 from the Ministerio de Ciencia y Tecnología (Spain) and by Grant 910177 from the Comunidad de Madrid and the Universidad Complutense (UCM). A. García is a recipient of Fellowships from the Universidad Complutense (UCM).

## References

- [1] Lijinsky, W., Conrad, E. & Van De Bogard, R. (1972). Nitrosamines formed by drug/nitrite interactions. *Nature*, 239, 165-174.
- [2] Sugimura, T. (2000). Nutrition and dietary carcinogens. *Carcinogenesis*, 21, 387-395.
- [3] Andrade, A., Reyes, F.G.R. & Rath, S.A. (2005). A method for determination of volatile N-nitrosamines in food by HS-SPME-GC-TEA. *Food Chemistry*, 91, 173-179.
- [4] IARC. (1978). Some N-nitroso compounds. *IARC Monographs on the Evaluation of the Carcinogenic Risk of Chemical to Humans* (pp. 17). Lyon, IARC.
- [5] Flavell, D.J. & Lucas, S.B. (1983). Promotion of N-nitrosodimethylamine initiated bile duct carcinogenesis in the hamster by the human liver fluke, *Opisthorchis viverrini*. *Carcinogenesis*, 4, 927-930.
- [6] Preussmann, R. & Stewart, B.W. (1984). N-nitroso carcinogens. In C.E. Searle (Ed.), *Chemical Carcinogens* (pp. 643-828). Washington, DC: American Chemical Society.
- [7] Gray, R., Peto, R., Brantom, P. & Grasso, P. (1991). Chronic nitrosamine ingestion in 1040 rodents: the effect of the choice of nitrosamine, the species studied, and the age of starting exposure. *Cancer Research*, 51, 6470-6491.
- [8] Rogers, A.E., Sanchez, O., Feinsod, F.M. & Newberne, P.M. (1974). Dietary enhancement of nitrosamine carcinogenesis. *Cancer Research*, 34, 96-99.
- [9] Wong, H.L., Murphy, S.E. & Hecht, S.S. (2003). Comparative metabolism of N-nitrosopiperidine and N-nitrosopyrrolidine by rat liver and esophageal microsomes and cytochrome P450 2A3. *Carcinogenesis*, 24, 291-300.

- [10] Murdok, D.J.L., Barnett, Y.A. & Barnett, C.R. (2004). DNA damage and cytotoxicity in pancreatic  $\beta$ -cells expressing human CYP2E1. *Biochemical Pharmacology*, 68, 523-530.
- [11] Fujita, K.I. & Kamataki, T. (2001). Role of human P450 (CYP) in the metabolic activation of N-alkylnitrosamines: application of genetically engineered *Salmonella typhimurium* YG7108 expressing each form of CYP together with human NADPH-cytochrome P450 reductase. *Mutation Research*, 483, 35-41.
- [12] Bartsch, H., Hietanen, E. & Malaveille, C. (1989). Carcinogenic nitrosamines: free radical aspects of their action. *Free Radical Biology & Medicine*, 7, 637-644.
- [13] Robichová, S., Slamenová, D., Gábelová, A., Sedlák, J., & Jakubikova, J. (2004). An investigation of the genotoxic effects of N-nitrosomorpholine in mammalian cells. *Chemico-biological Interactions*, 148, 163-171.
- [14] Bansal, A.K., Bansal, M., Soni, G. & Bhatnagar, D. (2005). Protective role of vitamin E pretreatment on N-nitrosodiethylamine induced oxidative stress in rat liver. *Chemico-biological Interactions*, 156, 101-111.
- [15] Yeh, S.L., Wang, W.Y., Huang, C.S. & Hu, M.L. (2006). Flavonoids suppresses the enhancing of  $\beta$ -carotene on DNA damage induced by 4-(methylnitrosamino)-1-(3-pyridyl)-1-butanone (NNK) in A549 cells. *Chemico-biological Interactions*, 160, 175-182.
- [16] Korr, H., Botzem, B., Schmitz, C. & Enzmann, H. (2001). N-Nitrosomorpholine induced alterations of unscheduled DNA synthesis, mitochondrial DNA synthesis and cell proliferation in different cell types of liver, kidney, and urogenital organs in the rat. *Chemico-biological Interactions*, 134, 217-233.
- [17] Mirvish, S.S. (1995). Role of N-nitroso compounds (NOC) and N-nitrosation in etiology of gastric, esophageal, nasopharyngeal and bladder cancer and contribution to cancer of known exposures to NOC. *Cancer Letters*, 93, 17-48.
- [18] Stohs, S.J. (1995). Synthetic pro-oxidants: drugs, pesticides and other environmental pollutants. In S. Ahmad (Ed.), *Oxidative Stress and Antioxidant Defenses in Biology* (pp. 117-180). New York, Chapman & Hall.
- [19] Puntarulo, S. & Cederbaum, A. (1997). Production of reactive oxygen species by microsomes enriched in specific human cytochrome P450 enzymes. *Free Radical Biology & Medicine*, 24, 1324-1330.
- [20] Gordon, M.H. (1996). Dietary antioxidants in disease prevention. *Natural Product Reports*, 13, 265-273.
- [21] Møller, P. & Loft, S. (2006). Dietary antioxidants and beneficial effect on oxidatively damaged DNA. *Free Radical Biology & Medicine*, 41, 388-415.
- [22] Lee, K.W., Lee, H.J., Surh, Y.J. & Lee, C.Y. (2003). Vitamin C and cancer chemoprevention: reappraisal. *The American Journal of Clinical Nutrition*, 78, 1074-1078.
- [23] Chan, A.C. (1993). Partners in defense, vitamin E and vitamin C. *Canadian Journal of Physiology and Pharmacology*, 71, 725-731.
- [24] Mayne, S. (2003). Antioxidants nutrients and chronic disease: use of biomarkers of exposure and oxidative stress status in epidemiologic research. *Journal of Nutrition*, 133, 933-940.

- [25] Head, K.A. (1998). Ascorbic acid in the prevention and treatment of cancer. *Alternative Medicine Review*, 3, 174-186.
- [26] Buettner, G.R. (1993). The pecking order of free radicals and antioxidants: lipid peroxidation, alpha-tocopherol, and ascorbate. *Archives of Biochemistry and Biophysics*, 300, 535-543.
- [27] Noorozi, M., Angerson, W.J. & Lean, M.E.J. (1998). Effects of flavonoids and vitamin C on oxidative DNA damage to human lymphocytes. *The American Journal of Clinical Nutrition*, 67, 1210-1218.
- [28] Gajecka, M., Kujawski, L.M., Gawecki, J. & Szyfter, K. (1999). The protective effect of vitamin C and E against B(a)P-induced genotoxicity in human lymphocytes. *Journal of Environmental Pathology, Toxicology and Oncology*, 18, 159-167.
- [29] Gamet-Payraastre, L., Li, P., Lumeau, S., Cassar, G., Dupont, M.A., Chevolleau, S., Gasc, N., Tulliez, J. & Tercé, F. (2000). Sulforaphane, a naturally occurring isothiocyanate, induces cell cycle arrest and apoptosis in HT29 human colon cancer cells. *Cancer Research*, 60, 1426-1433.
- [30] Chaudiere, J. & Ferrari-Iliou, R. (1999). Intracellular antioxidants: from chemical to biochemical mechanisms. *Food and Chemical Toxicology*, 37, 949-962.
- [31] Wang, W. & Higuchi, C.M. (1995). Induction of NAD(P)H: quinone reductase by vitamins A, E and C in Colo205 colon cancer cells. *Cancer Letters*, 98, 63-69.
- [32] Roomi, M.W., Netke, S. & Tsao, C. (1998). Modulation of drug metabolizing enzymes in guinea pig liver by high intakes of ascorbic acid. *International Journal for Vitamin and Nutrition Research*, 68, 42-47.
- [33] Surh, Y.J., Chun, K.S. & Cha, H.H. (2001). Molecular mechanisms underlying chemopreventive activities of anti-inflammatory phytochemicals: down-regulation of COX-2 and iNOS through suppression of NF- $\kappa$ B activation. *Mutation Research*, 480-481, 243-268.
- [34] Surh, Y.J. (2002). Anti-tumor promoting potential of selected spice ingredients with antioxidative and anti-inflammatory activities: a short review. *Food and Chemical Toxicology*, 40, 1091-1097.
- [35] Wargovich, M.J., Uda, N., Woods, C., Velasco, M. & McKee, K. (1996). *Allium* vegetables: their role in the prevention of cancer. *Biochemical Society Transactions*, 24, 811-814.
- [36] Ernst, E. (1997). Can *Allium* vegetables prevent cancer?. *Phytotherapy*, 4, 79-83.
- [37] Guyonnet, D., Siess, M.H., Le Bon, A.M. & Suschetet, M. (1999). Modulation of phase II enzymes by organosulfur compounds from *Allium* vegetables in rat tissues. *Toxicology and Applied Pharmacology*, 154, 50-58.
- [38] Wu, S.J., Ng, L.T. & Lin, C.C. (2005). Effects of antioxidants and caspase-3 inhibitor on the phenylethyl isothiocyanate-induced apoptotic signaling pathways in human PLC/PRF/5 cells. *European Journal of Pharmacology*, 518, 96-106.
- [39] Hwang, E.S. & Jeffery, E.H. (2003). Evaluation of urinary N-acetyl cysteinyl allyl isothiocyanate as a biomarker for intake and bioactivity of Brussels sprouts. *Food and chemical toxicology*, 41, 1817-1825.

- [40] Kerr, J.F., Wyllie, A.H. & Currie, A.R. (1972). Apoptosis: a basic biological phenomenon with wide-ranging implications in tissue kinetics. *British Journal of Cancer*, 26, 239-257.
- [41] Holme, J.A., Gorria, M., Arlt, V.M., Ovrebø, S., Solhaug, A., Tekpli, X., Landvik, N.E., Huc, L., Fardel, O. & Lagadic-Gossmann, D. (2007). Different mechanisms involved in apoptosis following exposure to benzo[a]pyrene in F258 and Hepa1c1c7 cells. *Chemico-biological Interactions*, 167, 41-55.
- [42] Hashimoto, T., Sano, T., Ito, W., Kanazawa, K., Danno, G.I. & Ashida, H. (2004). 3-Amino-1,4-dimethyl-5H-pyrido[4,3-b]indole induces apoptosis and necrosis with activation of different caspases in rat splenocytes. *Bioscience, Biotechnology, and Biochemistry*, 68, 964-967.
- [43] Shiotani, B. & Ashida, H. (2004). 3-Amino-1,4-dimethyl-5H-pyrido[4,3-b]indole (Trp-P-1) triggers apoptosis by DNA double-strand breaks caused by inhibition of topoisomerase I. *Carcinogenesis*, 25, 1149-1155.
- [44] García, A., Morales, P., Arranz, N., Delgado, E., Rafter, J. & Haza, A.I. 2008. Induction of apoptosis and reactive oxygen species production by N-Nitrosopiperidine and N-Nitrosodibutylamine in human leukemia cells. *Journal of Applied Toxicology*, 28, 455-465.
- [45] García, A., Morales, P., Arranz, N., Delgado, E., Rafter, J. & Haza, A.I. (2009). N-Nitrosopiperidine and N-Nitrosodibutylamine induce apoptosis in HepG2 cells via caspase dependent pathway. *Annals of the New York Academy of Science*, (submitted for publication).
- [46] Arranz, N., Morales, P., García, A., Rafter, J. & Haza, A.I. (2009). Induction of apoptosis by N-nitrosopyrrolidine and N-nitrosodimethylamine in human hepatoma and leukemia cells. *Journal of Biochemical and Molecular Toxicology*, (submitted for publication).
- [47] D'Agostini, F., Izzotti, A., Balansky, R.M., Bennicelli, C. & De Flora, S. (2005). Modulation of apoptosis by cancer chemopreventive agents. *Mutation Research*, 591, 173-186.
- [48] Kim, J.G., Koh, S.H., Lee, Y.J., Lee, K.Y., Kim, Y., Kim, S., Lee, M.K. & Kim, S.H. (2005). Differential effects of diallyl disulfide on neuronal cells depend on its concentration. *Toxicology*, 211, 86-96.
- [49] Koh, S.H., Kwon, H., Park, K.H., Ko, J.K., Kim, J.H., Hwang, M.S., Yum, Y.N., Kim, O.H., Kim, J., Kim, H.T., Do, B.R., Kim, K.S., Kim, H., Roh, H., Yu, H.J., Jung, K.H. & Kim, S.H. (2005). Protective effect of diallyl disulfide on oxidative stress-injured neuronally differentiated PC12 cells. *Molecular Brain Research*, 133, 176-186.
- [50] Revel, A., Raanani, H., Younglai, E., Xu, J., Han, R., Savouret, J.F. & Casper, R.F. (2001). Resveratrol, a natural aryl hydrocarbon receptor antagonist, protects sperm from DNA damage and apoptosis caused by benzo(a)pyrene. *Reproductive Toxicology*, 15, 479-486.
- [51] Revel, A., Raanani, H., Younglai, E., Xu, J., Han, R., Savouret, J.F. & Casper, R.F. (2003). Resveratrol, a natural aryl hydrocarbon receptor antagonist, protects lung from DNA damage and apoptosis caused by benzo(a)pyrene. *Journal of Applied Toxicology*, 23, 255-261.

- [52] Vallejo, F., Tomás-Barberán, F.A. & García-Viguera, C. (2002). Potential bioactive compounds in health promotion from broccoli cultivars grown in Spain. *Journal of the Science of Food and Agriculture*, 82, 1293-1297.
- [53] Kondentsova, M., Vrzhesinkaia, O.A., Beketova, N.A., Gobulev, F.V. & Gorbunov, IuN. (2002). Vitamin composition in wild onion species. *Voprosy Pitaniia*, 71, 3-6.
- [54] Westerink, W.M. & Schoonen, W.G. (2007). Cytochrome P450 enzyme levels in HepG2 cells and cryopreserved primary human hepatocytes and their induction in HepG2 cells. *Toxicology in Vitro*, 21, 1581-1591.
- [55] Straif, K., Keil, U., Taeger, D., Holthenrich, D., Sun, Y., Bungers, M. & Weilan, S.K. (2000). Exposure to nitrosamines, carbon black, asbestos, and talc and mortality from stomach, lung, and laryngeal cancer in cohort of rubber workers. *American Journal of Epidemiology*, 152, 297-306.
- [56] Liu, C.Y., Pan, P.C., Wu, M.T., Ho, C.K., Xu, X., Yi, L., Smith, T.J. & Christiani, D.C. (2006). Dietary exposure to nitrites and nitrosamines is associated with childhood acute leukemia. *AACR Meeting Abstracts*, 473-c.
- [57] Holme, J.A., Wiger, R., Hongslo, J.K., Soderlund, E., Brunborg, G. & Dybing, E. (1997). Cell death via interactions of agents with DNA. *Advanced Molecular and Cell Biology*, 20, 145-182.
- [58] Nagai, F., Hiyoshi, Y., Sugimachi, K. & Tamura, H. (2002). Cytochrome P450 (CYP) expression in human myeloblastic and lymphoid cell lines. *Biological & Pharmaceutical Bulletin*, 25, 383-385.
- [59] Olive, P.L., Wlodek, D., Durand, R.E. & Banath, J.P. (1992). Factors influencing DNA migration from individual cells subjected to gel electrophoresis. *Experimental Cell Research*, 198, 259-267.
- [60] Olive, P.L., Banath, J.P. & Durand, R.E. (1990). Heterogeneity in radiation induced DNA damage and repair in tumor and normal cells measured using the 'comet' assay. *Radiation Research*, 122, 86-94.
- [61] Koop, D.R., Laethem, C.L. & Tierney, D.J. (1989). The utility of p-nitrophenol hydroxylation in P450IIE1 analysis. *Drug Metabolism Reviews*, 20, 541-551.
- [62] Tassaneeyakul, W., Veronese, M.E., Birkett, D.J., Gonzalez, F.J. & Miners, J.O. (1993). Validation of 4-nitrophenol as an *in vitro* substrate probe for human liver CYP2E1 using cDNA expression and microsomal kinetic techniques. *Biochemical Pharmacology*, 46, 1975-1981.
- [63] Guengerich, F.P. & Shimada, T. (1991). Oxidation of toxic and carcinogenic chemicals by human cytochrome P-450 enzymes. *Chemical Research in Toxicology*, 4, 391-407.
- [64] Hodgson, E. & Goldstein, J.A. (2001). Metabolism of toxicants: phase I reactions and pharmacogenetics. In E. Hodgson, & R.C. Smart (Eds.), *Introduction to Biochemical Toxicology*, Wiley-Interscience.
- [65] Le Gal, A., Dreáno, Y., Lucas, D. & Berthou, F. (2003). Diversity of selective environmental substrates for human cytochrome P450 2A6: alkoxyethers, nicotine, coumarin, N-nitrosodiethylamine, and Nnitrosobenzylmethylamine. *Toxicology Letters*, 144, 77-91.
- [66] Burke, M.D. & Mayer, R.T. (1983). Differential effects of phenobarbitone and 3-methylcholanthrene induction on the hepatic microsomal metabolism and cytochrome

- P-450-binding of phenoxazone and a homologous series of its n-alkyl ethers (alkoxyresorufins). *Chemico-biological Interactions*, *45*, 243-258.
- [67] Burke, M.D., Thompson, S., Elcombe, C.R., Halpert, J., Haaparanta, T. & Mayer, R.T. (1985). Ethoxy-penthoxy and benzyloxyphehexazones and homologues: A series of substrates to different induced cytochromes P450. *Biochemical Pharmacology*, *34*, 3337-3345.
- [68] Lilienblum, W., Walli, A.K., Bock, K.W. (1982). Differential induction of rat liver microsomal UDP-glucuronyltransferase activities by various inducing agents. *Biochemical Pharmacology*, *31*, 907-913.
- [69] Tyson, C.A. & Green, C.E. (1987). Cytotoxicity measures: choice and methods. E.J. Rauckmann, & G.M. Padillar (Eds.), *The Isolated Hepatocyte, Use in Toxicology and Xenobiotic Biotransformations* (119-158). Orlando, FL: Academic Press.
- [70] García, A., Haza, A.I., Arranz, N., Rafter, J. & Morales, P. (2008). Protective effects of isothiocyanates alone or in combination with vitamin C towards N-Nitrosodibutylamine or N-Nitrosopiperidine-induced oxidative DNA damage in the single-cell gel electrophoresis (SCGE)/HepG2 assay. *Journal of Applied Toxicology*, *28*, 196-204.
- [71] García, A., Haza, A.I., Arranz, N., Delgado, E., Rafter, J. & Morales, P. (2008). Organosulfur compounds alone or in combination with vitamin C protect towards N-Nitrosopiperidine and N-Nitrosodibutylamine-induced oxidative DNA damage in HepG2 cells. *Chemico-biological Interactions*, *173*, 9-18.
- [72] Frohlich, K.U. & Madeo, F. (2000). Apoptosis in yeast, a monocellular organism exhibits altruistic behaviour. *FEBS Letters*, *473*, 6-9.
- [73] Collins, A.R., Duthie, S.J. & Dobson, V.L. (1993). Direct enzymatic detection of endogenous oxidative base damage in human lymphocyte DNA. *Carcinogenesis*, *14*, 1733-1735.
- [74] Lin, H.L., Parsels, L.A., Maybaum, J. & Hollenberg, P.F. (1999). N-Nitrosodimethylamine-mediated cytotoxicity in a cell line expressing P450 2E1: evidence for apoptotic cell death. *Toxicology and Applied Pharmacology* *157*, 117-124.
- [75] Brambilla-Campart, G.B., Canonero, R., Mereto, E. & Ferro, M. (1989). Cytotoxic and genotoxic effects of 10 N-nitroso compounds in a human hepatoma cell line (HepG2): comparison with human hepatocyte primary cultures. *ATLA*, *17*, 22-27.
- [76] Valentin-Severin, I., Le Hegarat, L., Lhuguenot, J.C., Le Bon, A.M. & Chagnon, M.C. (2003). Use of HepG2 cell line for direct or indirect mutagens screening: comparative investigation between comet and micronucleus assays. *Mutation Research*, *536*, 79-90.
- [77] Uhl, M., Helma, C. & Knasmüller, S. (2000). Evaluation of the single cell gel electrophoresis assay with human hematoma (HepG2) cells. *Mutation Research*, *468*, 213-225.
- [78] Ikken, Y., Morales, P., Martínez, A., Marín, M.L., Haza, A.I. & Cambero, M.I. (1998). Mutagenic activity of N-nitrosamines evaluated by the Ames test when using different levels of lyophilized and frozen S9 fraction. *Archiv für Lebensmittelhygiene*, *49*, 25-38.
- [79] Sánchez-Moreno, C., Paniagua, M., Madrid, A. & Martín, A. (2003). Protective effect of vitamin C against the ethanol mediated toxic effects on human brain glial cells. *Journal of Nutritional Biochemistry*, *14*, 606-613.

- [80] Ikken, Y., Cambero, I., Marín, M.L., Martínez, A., Haza, A.I. & Morales, P. (1998). Antimutagenic effect of fruit and vegetable aqueous extracts against N-nitrosamines evaluated by the Ames test. *Journal of Agricultural and Food Chemistry*, *46*, 5194-5200.
- [81] USDA. (1986). United States Standards for Grades of kiwi fruit. Effective October 15.
- [82] Lazarová, M. & Slamenová, D. (2004). Genotoxic effects of a complex mixture adsorbed onto ambient air particles on human cells *in vitro*; the effects of vitamins E and C. *Mutation Research*, *557*, 167-175.
- [83] Eberhardt, M.V., Lee, C.Y. & Liu, R.H. (2000). Antioxidant activity of fresh apples. *Nature*, *405*, 903-904.
- [84] Kim, D.O., Lee, K.W., Lee, H.J. & Lee, C.Y. (2002). Vitamin C equivalent antioxidant capacity (VCEAC) of phenolic phytochemicals. *Journal of Agricultural and Food Chemistry*, *50*, 3713-3717.
- [85] Knekt, P., Kumpulainen, J. & Jarvinen, R. (2002). Flavonoid intake and risk of chronic diseases. *American Journal of Clinical Nutrition*, *76*, 560-568.
- [86] Arranz, N., Haza, A.I., García, A., Möller, L., Rafter, J. & Morales, P. (2006). Protective effects of isothiocyanates towards N-nitrosamine-induced DNA damage in the single-cell gel electrophoresis (SCGE)/HepG2 assay. *Journal of Applied Toxicology*, *26*, 466-473.
- [87] Arranz, N., Haza, A.I., García, A., Rafter, J. & Morales, P. (2007). Protective effect of vitamin C towards N-nitrosamine-induced DNA damage in the single-cell gel electrophoresis (SCGE)/HepG2 assay. *Toxicology In Vitro*, *21*, 1311-1317.
- [88] Park, J.B. & Levine, M. (2000). Intracellular accumulation of ascorbic acid is inhibited by flavonoids via blocking of dehydroascorbic acid and ascorbic acid uptakes in HL60, U937 and Jurkat cells. *The Journal of Nutrition*, *130*, 1297-1302.
- [89] Brandon, E.F.A., Raap, C.D., Meijerman, I., Beijnen, J.H., Schellens, J.H.M. (2003). An update on *in vitro* test methods in human hepatic drug biotransformation research: pros and cons. *Toxicology and Applied Pharmacology*, *189*, 233-246.
- [90] Ueta, E., Suzuki, E., Nanba, E., Tadokoro, Y., Otsuka, Y. & Kurata, T. (2001). Regulation of cigarette smoke-induced cytochrome P4501A1 gene expression in osteogenic disorder Shionogi rat liver and in lung by large ascorbic acid dose. *Bioscience, Biotechnology and Biochemistry*, *65*, 2548-2551.
- [91] Bast, A. & Haenen, G.R.M.M. (2002). The toxicity of antioxidants and their metabolites. *Environmental Toxicology and Pharmacology*, *11*, 251-258.
- [92] Collins, A.R., Harrington, V., Drew, J. & Melvin, R. (2003). Nutritional modulation of DNA repair in a human intervention study. *Carcinogenesis*, *24*, 511-515.
- [93] Frei, B., Stocker, R., England, I. & Ames, B.N. (1990). Ascorbic acid: the most effective antioxidant in human blood plasma. *Advances in Experimental Medicine and Biology*, *264*, 155-163.
- [94] Machlin, L.J. & A., Bendich. (1987). Free radical tissue damage: protective role of antioxidant nutrients. *FASEB Journal*, *1*, 441-445.
- [95] Witenberg, B., Kalir, H.H., Raviv, Z., Kletter, Y., Kravtsov, V. & Fabian, I. (1999). Inhibition by ascorbic acid of apoptosis induced by oxidative stress in HL-60 myeloid leukaemia cells. *Biochemical Pharmacology*, *57*, 823-832.

- [96] Qi, W., Russel, J.R., Dun-Xian, T., Joaquin, J.G., Lucien, C.M., Malgorzata, K. & Juan, R.C. (2000). Chromium(III)-induced 8-hydroxydeoxyguanosine in DNA and its reduction by antioxidants: comparative effects of melatonin, ascorbate, and vitamin E. *Environmental Health Perspectives*, 108, 399–402.
- [97] Cheng, T.J., Kao, H.P., Chan, C.C. & Chang, W.P. (2003). Effects of ozone on DNA single-strand breaks and 8-oxoguanine formation in A549 cells. *Environmental Research*, 93, 279–284.
- [98] Rovichová, S., Slamenová, D., Chalupa, I. & Sebová, L. (2004). DNA lesions and cytogenetic changes induced by N-nitrosomorpholine in HepG2, V79 and VH10 cells: the protective effects of vitamins A, C and E. *Mutation Research*, 560, 91–99.
- [99] Uhal, B.D. (1997). Cell cycle kinetics in the alveolar epithelium. *The American Journal of Physiology (Lung Cellular and Molecular Physiology)*, 272, 1031–1045.
- [100] Green, D.R. & Reed, J.C. (1998). Mitochondria and apoptosis. *Science*, 281, 1309–1312.
- [101] Rich, T., Allen, R.L. & Wyllie, A.H. (2000). Defying death after DNA damage. *Nature*, 407, 777–783.
- [102] Landvik, N.E., Gorria, M., Arlt, V.M., Asare, N., Solhaug, A., Lagadic-Gossman, D. & Holme, J.A. (2007). Effects of nitrated-polycyclic aromatic hydrocarbons and diesel exhaust particle extracts on cell signaling related to apoptosis: Possible implications for their mutagenic and carcinogenic effects. *Toxicology*, 231, 159–174.
- [103] Gosslau, A. & Chen, K.Y. (2004). Nutraceuticals, apoptosis, and disease prevention. *Nutrition*, 20, 95–102.
- [104] Blasiak, J., Trzeciak, A., Dziki, A., Ulanska, J. & Pander, B. (2000). Synergistic effect of vitamin C on DNA damage induced by cadmium. *General Physiology and Biophysics*, 19, 373–379.
- [105] Bhat, S.H., Azmi, A.S., Hanif, S. & Hadi, S.M. (2006). Ascorbic acid mobilizes endogenous copper in human peripheral lymphocytes leading to oxidative DNA breakage: a putative mechanism for anticancer properties. *The International Journal of Biochemistry & Cell Biology*, 38, 2074–2081.
- [106] Bram, S., Froussard, P. & Guichard, M. (1980). Ascorbic acid preferential toxicity for malignant melanoma cells. *Nature*, 284, 629–631.
- [107] Park, S., Han, S.S., Park, C.H., Hahm, E.R., Lee, S.J., Park, H.K., Lee, S.H., Kim, W.S., Jung, C.W., Park, K., Riordan, H.D., Kimler, B.F., Kim, K. & Lee, J.H. (2004). L-Ascorbic acid induces apoptosis in acute myeloid leukemia cells via hydrogen peroxide-mediated mechanisms. *The International Journal of Biochemistry & Cell Biology*, 36, 2180–2195.
- [108] Karasavvas, N., Cárcamo, J.M., Stratis, G. & Golde, D.W. (2005). Vitamin C protects HL60 and U266 cells from arsenic toxicity. *Blood*, 105, 4004–4012.
- [109] Wenzel, U., Nickel, A., Kuntz, S. & Daniel, H. (2004). Ascorbic acid suppresses drug-induced apoptosis in human colon cancer cells by scavenging mitochondrial superoxide anions. *Carcinogenesis*, 25, 703–712.



- 
- [110] Perez-Cruz, I., Cárcamo, J.M. & Golde, D.W. (2003). Vitamin C inhibits FAS-induced apoptosis in monocytes and U937 cells. *Blood*, 102, 336-343.
- [111] Dhar-Mascareño, M., Cárcamo, J.M. & Golde, D.W. (2005). Hypoxia-reoxygenation-induced mitochondrial damage and apoptosis in human endothelial cells are inhibited by vitamin C. *Free Radical Biology & Medicine*, 38, 1311-1322.



*Chapter IV*

---

## **Vitamin C: Dietary Requirements, Dietary Sources, and Adverse Effects**

---

*Chin-San Liu*

Changhua Christian Hospital, Vascular and Genomic Center, Neurology Dept.,  
Chang Jung Christian University, Taiwan

### **Abstract**

Vitamin C, or ascorbic acid, is an acquired and essential micronutrient involved in many biological and biochemical functions. A growing body of evidence indicates that the current U.S. Recommended Dietary Allowance (RDA) of 50-60 milligrams of vitamin C per day is far below that actually needed to maintain good health. Depletion of vitamin C intake has been linked to the development of cardiovascular diseases, hypertension, stroke, diabetes mellitus, cancer, and Alzheimer's disease. Vitamin C intake from diets rich in fruits and vegetables is usually not sufficient, and daily oral supplementation from different forms of commercial vitamin C products is recommended.

### **Introduction**

Ascorbic acid, or vitamin C, was first isolated in 1928 by Albert Szent-Gyorgyi, an achievement for which he was awarded the Nobel Prize in medicine in 1937 [1]. Vitamin C is an essential micronutrient involved in many biological and biochemical functions [2]. It is synthesized by all animals except humans, monkeys, guinea pigs, bats, and several bird species [3]. Biologically, ascorbate is synthesized from glucose in a series of steps catalyzed by enzymes. In humans, the gene that codes for the terminal step in ascorbate synthesis, gulonolactone oxidase, is damaged and has stopped functioning [4, 5]. The cause of this

genetic damage is unknown, although it has been suggested that it may have been due to radiation exposure, or possibly that the gene may have been mutated by a retrovirus [4, 6].

## Natural Sources of Vitamin C

In the mid-18th century, James Lind first demonstrated that the juice of fresh citrus cures scurvy. The active agent, the enolic form of 3-keto-L-gulofurnlactone, or ascorbic acid, was isolated in the late 1920s [1]. By the mid-1930s, methods had been devised to synthesize ascorbic acid, making it widely available at low cost. Because humans are unable to synthesize ascorbic acid, we obtain our daily requirements from natural sources, such as citrus fruits (oranges, lemons, limes, grapefruits) and vegetables (potatoes, broccoli, spinach, Brussels sprouts, red peppers). Ascorbic acid can be easily destroyed by heat; therefore, many foods can lose their ascorbic acid content because of cooking, storage, or oxidation. Ascorbic acid is absorbed from the intestinal tract and has a biological half-life of approximately 30 minutes. There is no storage site in the body; however, some tissues carry higher concentrations (white blood cells, adrenal glands, pituitary gland) [7].

Conventional farming methods, which employ toxic chemical products in order to carry out intensive production, present a great health hazard and severely decrease food quality [8, 9]. Analysis of fruits and vegetables has shown a significant loss of minerals and trace elements in modern diets compared to that of a few decades ago [10, 11]. Moreover, a considerable loss of nutrients in the modern diet has been observed during food processing, long transporting, and incorrect food storage [12, 13]. Vitamin C in foods is irreversibly oxidized by exposure to light, oxygen, and/or heat, and reports suggest that fresh produce or juice may lose 50%–100% of its vitamin C content due to handling and processing [14-16]. Hence, the increased processing of the food supply may be impacting the level of dietary vitamin C available to consumers [17].

## Functions of Vitamin C

A number of metabolic reactions require vitamin C as a cofactor, such as the synthesis of epinephrine from tyrosine. Furthermore, vitamin C involvement is suspected in the process of adrenal steroidogenesis. Other putative biochemical roles of ascorbic acid are in thyroxine synthesis, amino acid metabolism, and aiding in the absorption of iron [18]. Vitamin C can quench aqueous reactive oxygen species [19], plays an important role in antioxidant defense system and immunocompetence [20], and in strengthening resistance to infection [18, 21]. In addition, vitamin C protects against deoxyribonucleic acid (DNA) mutations and, therefore, might be of clinical value in the treatment of certain types of cancer and other diseases [22-26].

Vitamin C is required for the synthesis of collagen, an important structural component of blood vessels, tendons, ligaments, and bone. Ascorbic acid also plays an important role in the synthesis of norepinephrine, a neurotransmitter critical to brain function. In addition, vitamin C is required for the synthesis of carnitine, a small molecule that is essential for the transport

of fat to mitochondria, where it is oxidized and converted to ATP [26]. Recent research also suggests that vitamin C is involved in the metabolism of cholesterol to bile acids, which may have implications for blood cholesterol levels and the incidence of gallstones [27].

Ascorbic acid is also a highly effective antioxidant. Even in small amounts, vitamin C can protect indispensable molecules in the body, such as proteins, lipids, carbohydrates, and nucleic acids (DNA and RNA) from damage by free radicals and reactive oxygen species (ROS) that can be generated during normal metabolism as well as through exposure to toxins and pollutants (e.g. smoking). Vitamin C may also be able to regenerate other antioxidants such as vitamin E [26]. Ascorbic acid quenches reactive oxygen species in both the extracellular and intracellular compartments. It also regenerates oxidized  $\alpha$ -tocopherol in biological membranes, thereby protecting against ROS-induced oxidation [28-30]. As an antioxidant, ascorbic acid helps maintain proper cardiovascular function by protecting the vascular endothelium and helps to protect against bowel cancer by deactivating potentially damaging nitrosamines in the gut [31, 32].

## The Recommended Dietary Allowance of Vitamin C

The Recommended Dietary Allowance (RDA) of ascorbic acid for human adults was originally set at 60 mg per day by the Food and Nutrition Board in 1943, and was increased to its current dose of 90 mg per day in 2000 [23]. The RDA for vitamin C is based on twice the amount of vitamin C needed to prevent scurvy as well as on the threshold of the vitamin C needed to spill vitamin C into urinary excretion [2, 23]. Moreover, the RDA for vitamin C is based on estimates of vitamin C absorption, on losses associated with food preparation, and on estimated rates of depletion, turnover, and catabolism [2, 23]. People vary widely in their requirements for vitamin C [33]. Many studies have demonstrated that higher doses than the RDA for vitamin C can improve the immune system as well as prevent and treat a wide range of pathologic conditions [34-37]. Levine et al. postulated that in order to establish an RDA for a vitamin, it is necessary to determine vitamin concentrations in plasma and tissues in relation to vitamin dose for a wide range of doses, true bioavailability or vitamin absorption at each dose, vitamin urinary excretion at each dose, and potential toxicity [38]. In theory, these data could be obtained from nutrition depletion-repletion studies in combination with pharmacokinetic principles. For vitamin C, however, the information is unavailable, incomplete, or flawed [39-44].

The RDA of vitamin C is also based on weight, age, and sex of healthy individuals. RDA requirements differ between countries, with the highest value being close to 110 mg/day [45]. Stone concluded that the optimum intake rate should be 3000–5000 mg per day for most people based on the production of ascorbic acid from rats based on body weight. However, extrapolating the need in humans based on the amounts per kilogram of another animal may not be accurate [45-47]. Other researchers have concluded that establishing an RDA of vitamin C based on weight, age, and sex is anachronistic and too simplistic, and that the current RDAs might be seriously inadequate guidelines for health [23, 33, 48].

Recommendations for consumption of high doses of vitamin C are not supported by all researchers. A recent meta-analysis on a potential effect of vitamin C on the common cold conducted by Douglas et al. showed that there seems to be no justification for routine megadose (1–3 g/day) vitamin C supplementation in the normal population [49], although prophylaxis may be justified in those exposed to severe physical exercise or cold stress or both. Moreover, numerous reviews suggest that intake of vitamin C much higher than the RDA, although without reaching the megadoses of vitamin C consumption proposed by some researchers, may reduce the risk or risk factors for chronic diseases such as heart disease and certain types of cancer [2, 50-53].

## Supplements

L-ascorbic acid is available in many forms, but there is little scientific evidence that any one form is better absorbed or more effective than another. Natural and synthetic L-ascorbic acid are chemically identical and there are no known differences in their biological activities or bioavailability [54]. Mineral salts of ascorbic acid are buffered and, therefore, less acidic than ascorbic acid. Sodium ascorbate and calcium ascorbate are the most common forms. Sodium ascorbate generally provides 131 mg of sodium per 1,000 mg of ascorbic acid, and pure calcium ascorbate provides 114 mg of calcium per 1,000 mg of ascorbic acid. One such supplement, Ester-C<sup>®</sup>, contains mainly calcium ascorbate, but also contains small amounts of the vitamin C metabolites dehydroascorbate (oxidized ascorbic acid), calcium threonate, and trace levels of xylonate and lyxonate. Although these metabolites are supposed to increase the bioavailability of vitamin C, the only published study in humans found no difference in absorption or urinary excretion of vitamin C between Ester-C<sup>®</sup> and commercially available ascorbic acid tablets [55]. Ester-C<sup>®</sup> should not be confused with ascorbyl palmitate, which is also marketed as "vitamin C ester". Ascorbyl palmitate is actually ascorbic acid that has been esterified to a fatty acid, resulting in a fat-soluble form of vitamin C. Ascorbyl palmitate has been added to a number of skin creams due to interest in its antioxidant properties as well as the important role of vitamin C in collagen synthesis [56]. Although ascorbyl palmitate is also available as an oral supplement, it is likely that most of it is hydrolyzed to ascorbic acid and palmitic acid in the digestive tract before it is absorbed.

Vitamin C induced peak values of plasma close to 220  $\mu\text{mol/L}$  when 3 g was administered orally 6 times per day [57]. Padayatty et al., however, showed that single supplement gram doses produced transient peak plasma concentrations that were at most two- or three-fold higher than those from vitamin C contained in five to nine daily servings of fruits and vegetables, which only produced a plasma concentration of 80  $\mu\text{mol/L}$ . The U.S. department of Agriculture and the National Cancer Institute recommend that five servings of fruits and vegetables be eaten daily, even if recent analysis has suggested that this consumption should be higher [58, 59]. If these recommendations are followed, daily vitamin C intake will be 210 to 280 mg, depending on food cofactors [2]. Amounts >500 mg/day would be difficult to obtain from dietary sources alone and would require supplements [60].

## Safety of Vitamin C

### Oxidative Damage

It has been suggested that vitamin C alone or mixed with *N*-acetyl-cysteine could be toxic, acting as a pro-oxidant [61, 62]. There is also evidence, however, that ascorbic acid is not a pro-oxidant *in vivo*, even with iron co-supplementation [26, 63]. Increased iron stores are positively associated with increased oxidative DNA damage [64]. Because vitamin C assists in the absorption of dietary iron, some research has focused on whether increased vitamin C intake inopportunistically increases iron stores. Supplementary doses of 500 mg/day have been shown to have little effect on iron bioavailability [65]. Moreover, most published studies on the subject strongly indicate that vitamin C doses up to 2000 mg/day do not increase body iron stores enough to produce any clinically significant adverse effects [66]. In addition, several *in vivo* studies on the effects of high concentrations of vitamin C have revealed no evidence that ascorbic acid elicits genotoxic effects [67-71]. Furthermore, a recent study in healthy human subjects showed that intravenous infusion of 7.5 g on each of six consecutive days did not induce any increase in pro-oxidant markers [72].

### Kidney Stones

Although a few studies have shown that high doses of vitamin C can lead to increased levels of oxalate and, therefore, increased risk for kidney stone formation [2, 38], a growing body of evidence suggests otherwise. Auer et al. demonstrated that 8 g/day, divided into four doses of 2 g, for 8 consecutive days, can cause harmful calcium oxalate crystalluria secondary to relative hyperoxaluria in persons who have a predisposition for increased crystal aggregation [73]. The authors, however, note that the response to vitamin C ingestion in their subjects is probably rare. Wandzilak et al. observed a modest increase in urinary oxalate after experimental administration of high doses of vitamin C (5 and 10 g/day for 5 days) [74]. Their results, however, appear to be due to *in vitro* conversion of ascorbate to oxalate during the analytical procedure rather than to *in vivo* conversion. Consequently, these authors concluded that no genuine increase in urinary oxalate was demonstrable despite a greatly increased ascorbate intake. In another study by Auer et al., ingestion of 4 g/day of ascorbic acid for 5 days did not affect the principal risk factors associated with calcium oxalate kidney stone formation [75]. Curhan et al. showed that large doses of vitamin C (1.5 g or more) actually reduced the risk of kidney stone formation [76, 77]. Based on these and other findings, these authors stated that the restriction of higher doses of vitamin C because of the possibility of kidney stone development is unwarranted. Evidence indicates that high intake of vitamin C does not increase oxalate excretion or induce the potential formation of kidney stones [53, 78, 79]. Moreover, no effect of high-dose ascorbic acid ingestion was found on the daily urinary excretion of uric acid [80].

## Others

Gastrointestinal distress seems to be the most common adverse effect of high vitamin C intake [57]. When these symptoms occur, the vitamin C dosage is usually  $>2$  g/day. Single oral doses of 5–10 g produce transient intestinal discomfort caused by osmotic diarrhea [78]. The symptoms generally disappear within a week or two with no further consequences, and can occasionally be attributed to other components such as sorbitol [81]. Harmful effects including hypoglycemia, rebound scurvy, infertility, mutagenesis, and destruction of vitamin B12 have been mistakenly attributed to large doses of vitamin C [2]. Health professionals should recognize that vitamin C does not produce these effects [82]. Other studies have demonstrated that large doses of vitamin C are safe [35, 83-85]. A recent review demonstrated that vitamin C supplements of 2000 mg/day are safe for most adults and that intakes of up to 4000 mg/day are well tolerated in the general population [78]. No consistent or compelling data demonstrating serious adverse effects of vitamin C in humans have been established, although the tolerable upper limit intake has been estimated at 2000 mg/day [86].

## Vitamin C in Health and Disease

### Ischemic Heart Disease

It has been shown that oxidation of low-density lipoprotein (LDL) and lipid membranes plays an important role in atherosclerosis [87]. Although the mechanism is still unclear, it has been suggested vitamin C protects circulating and membrane lipids from free radicals. Vitamin C is believed to protect lipids indirectly by reconstituting the active forms of vitamin E [88]. Atherosclerotic plaques impair endothelium-dependent vasodilation in human coronary and peripheral blood vessels [87, 89-91], and it has been suggested that short-term administration of ascorbic acid may reverse this endothelial dysfunction [92, 93]. Indeed, there is emerging evidence linking high intake of vitamin C with reduced mortality from heart disease [94]. A cross-sectional survey of population groups throughout Europe noted an inverse relationship between plasma levels of vitamin C and ischemic heart disease [95].

### Hypertension

Nitric oxide (NO), a labile endothelial relaxing factor, is derived from L-arginine by the enzyme NO synthase [96]. Essential hypertension is characterized by impaired endothelium-dependent vasodilation to specific agonists caused by an alteration in the L-arginine-NO pathway [97-101]. This appears to be associated with the production of superoxide anions, which impair the ability of the endothelium to induce NO-mediated relaxations of vascular smooth muscles [102-104]. In patients with essential hypertension, this impaired endothelial vasodilation can be improved by the administration of vitamin C, an effect that can be reversed by a NO synthase inhibitor [105]. A cross-sectional study showed an association



between higher vitamin C intake and lower blood pressure [106]. Furthermore, vitamin C also appears to improve the endothelium-dependent vasomotor capacity of coronary arteries in patients with hypertension and ischemic heart disease [107].

### Congestive Heart Failure

Patients with congestive heart failure (CHF) demonstrate systemic vasoconstriction and reduced peripheral perfusion. Although an increased sympathetic tone and an activated renin-angiotensin system have been proposed to be involved in the reduced vasodilator capacity in heart failure, clinical studies have documented that endothelial dysfunction of peripheral resistance arteries and an impaired flow-dependent, endothelium-mediated dilation of conduit arteries appear to be commonplace in patients with CHF [108]. An important functional consequence of endothelial dysfunction is the inability of a vessel to dilate in response to endothelium-derived NO after physiological stimuli [109, 110]. It has been hypothesized that this is caused by reduced synthesis of NO possibly due to a reduced NO-synthase gene expression [111], although other mechanisms such as reduced availability of L-arginine or enhanced inactivation of NO by free radicals may be involved as well [112]. Vitamin C has been shown to improve endothelial dysfunction in patients with CHF by increasing the availability of nitric oxide [113]. This finding suggests that endothelial dysfunction in patients with CHF may be due to accelerated degradation of nitric oxide by free radicals.

### Coronary Heart Disease

Until recently, the results of most prospective studies indicated that low or deficient intakes of vitamin C were associated with an increased risk of cardiovascular diseases and that modest dietary intakes of about 100 mg/day were sufficient to reduce cardiovascular disease risk among nonsmoking men and women [26]. Other studies, however, failed to find significant reductions in the risk of coronary heart disease (CHD) among vitamin C supplement users in well-nourished populations [114, 115]. One of the notable exceptions to the above-mentioned findings was reported in the First National Health and Nutrition Examination Survey (NHANES I) Epidemiologic Follow-up Study. This study found that the risk of death from cardiovascular diseases was 42% lower in men and 25% lower in women who consumed more than 50 mg/day of dietary vitamin C and who regularly took vitamin C supplements, corresponding to a total vitamin C intake of about 300 mg/day [116]. Another exception comes from a 16-year follow-up study of more than 85,000 women, in which higher vitamin C intakes were shown to be cardioprotective [117]. The study showed that vitamin C intake of more than 359 mg/day from diet plus supplements or supplement use itself was associated with a 28% reduction in risk for CHD. In women who did not take vitamin C supplements, however, dietary vitamin C intake was not significantly associated with CHD risk. More recently, a pooled analysis of 9 prospective cohort studies, including more than 290,000 adults who were free of CHD at baseline and followed for an average of 10 years, found that those who took more than 700 mg/day of supplemental vitamin C had a

25% lower risk of CHD than those who did not take vitamin C supplements [118]. Data from the National Institutes of Health (NIH) indicate that plasma and circulating cells in healthy, young subjects became fully saturated with vitamin C at a dose of about 400 mg/day [45], suggesting that the maximum reduction of CHD risk may require vitamin C intakes high enough to saturate plasma and circulating cells [119].

## Stroke

With respect to vitamin C and cerebrovascular disease, a prospective study that followed more than 2,000 residents of a rural Japanese community for 20 years found that the risk of stroke in those with the highest serum levels of vitamin C was 29% lower than in those with the lowest serum levels of vitamin C [120]. In addition, the risk of stroke in those who consumed vegetables 6-7 days per week was 54% lower than in those who consumed vegetables 0-2 days per week. In that population, serum levels of vitamin C were highly correlated with fruit and vegetable intake. Therefore, as in many studies on the association between vitamin C intake and cardiovascular disease risk, it is difficult to separate the effects of vitamin C on stroke risk from the effects of other components of fruits and vegetables, emphasizing the benefits of a diet rich in fruits and vegetables. In fact, plasma vitamin C levels may be a good biomarker for fruit and vegetable intake and other lifestyle factors that may contribute to a reduced risk of stroke. A recent 10-year prospective study of 20,649 adults found that those in the top quartile of plasma vitamin C concentrations experienced a 42% lower risk of stroke compared with those in the lowest quartile [121].

## Diabetes Mellitus

The prevalence of diabetes mellitus (DM) has increased worldwide in the last decade and is frequently complicated by microvascular disease or macrovascular disease or both. Nephropathy, neuropathy and retinopathy are common sequela of microvascular angiopathy. Cardiovascular disease, cerebral vascular events, myocardial infarction, and peripheral arterial occlusive disease comprise the most common types of macrovascular angiopathy. The National Cholesterol Educational Program Adult Treatment Panel III reported that diabetes is associated with CHD risk, as well as with the high incidence and mortality rates seen in this population [122]. Patients with diabetes present with high blood glucose and lipid concentrations that can induce a series of toxic responses leading to atherosclerotic changes. Vitamin C shares the same transporters as glucose, GLUT-mediated transport of DHA is competitively inhibited by glucose [123]. This raises the possibility that changes in serum glucose levels, especially those occurring during disease, may attenuate the bioavailability of vitamin C, thereby leading to secondary pathologies due to the depletion of circulating vitamin C. Indeed, this characteristic type of secondary pathology has been observed in patients with hyperglycemic conditions caused by diabetes [124]. Patients with diabetes have lower serum ascorbic acid levels than individuals without diabetes, and low serum vitamin C

concentration is now regarded as an important contributing factor for increased oxidative stress and endothelial dysfunction [125].

In the study by Tousoulis et al., patients with type 2 diabetes and coronary artery disease (CAD) were treated with or without vitamin C supplement (2g/day) for 4 weeks. Forearm blood flow and vasodilatory response were measured. The results revealed that acute high dose vitamin C improved vasodilatory response to reactive hyperemia and decreased the levels of tissue plasminogen activator and von Willebrand factor [126]. A recent study showed that supplementary vitamin C 1000 mg/day can reduce diabetes-associated complications. Patients with diabetes were randomized into two groups. Participants in one group received vitamin C 500 mg/day for 6 weeks, and those in the other group received a dose of 1000 mg/day for 6 weeks. The results revealed that the concentrations of fasting blood sugar, triglyceride, low-density lipoprotein cholesterol, hemoglobin A1C, and serum insulin were significantly lower in the high-dose group than in the low-dose group. The researchers postulated that the reduction in laboratory values was due to the antioxidant capacity of vitamin C [127].

Andrea Natali and her colleagues measured the effect of vitamin C on acetylcholine (ACh)-induced vasodilatation and on forearm glucose uptake during systemic hyperinsulinemia. In their study, a high dose of vitamin C (12 mg per min) was infused into the brachial artery in patients with essential hypertension [128]. The contralateral forearm was used as the control for comparison. In response to insulin, tested blood flow increased after vitamin C infusion. The rate of insulin-stimulated whole-body glucose disposal, considered a marker of insulin resistance, decreased after vitamin C infusion, but not significantly. Forearm O<sub>2</sub> uptake was similar in the forearms with or without vitamin C infusion. They conclude that in the deep forearm tissues of patients with essential hypertension and insulin resistance, an acute improvement in endothelial function, obtained with pharmacological doses of vitamin C, restores insulin-mediated vasodilatation but does not improve insulin-mediated glucose uptake. According to their results, endothelial dysfunction in patients with essential hypertension is unlikely to be responsible for metabolic insulin resistance.

Rather than infusing vitamin C, Chen et al. investigated the effects of orally administered high-dose vitamin C on attenuation of endothelial dysfunction and insulin resistance in patients with Type 2 diabetes. They found that plasma vitamin C levels were lower in 109 diabetic subjects than in healthy controls. The researchers then recruited 32 of the 109 diabetic subjects with low plasma vitamin C levels to participate in a randomized, double-blind, placebo controlled study of vitamin C (800 mg/day for 4 weeks). Insulin sensitivity (determined by glucose clamp) and forearm blood flow in response to ACh, sodium nitroprusside (SNP), or insulin (determined by plethysmography) were determined before and after 4 weeks of treatment. In the vitamin C group, basal plasma vitamin C increased after treatment, but the level was significantly lower than expected for healthy subjects. No significant changes in fasting glucose, SIClamp, or forearm blood flow in response to ACh, SNP, or insulin were observed after vitamin C supplements. They conclude that high-dose oral vitamin C therapy, resulting in incomplete replenishment of vitamin C levels, does not improve endothelial dysfunction and insulin resistance in type 2 diabetes [129].

A study conducted in Japan reported that lymphocyte vitamin C level was significantly lower in type 2 diabetic patients, although a similar reduction in vitamin C levels was not observed in plasma [130]. Plasma vitamin C concentration reflects the transient utilization of digestive foods such as fruit, supplements, and vegetables. It has been reported that lymphocytes maintain a vitamin C concentration as large as 80- to 100-fold across the plasma membrane and that they have cell-membrane transporting mechanisms between vitamin C and glucose. Lymphocytes participate in many immune responses, and high levels of antioxidant activity have been reported in these cells [131]. In diabetes, therefore, the measurement of lymphocyte vitamin C might be a more reliable antioxidant biomarker than plasma vitamin C level. Similar results have been found in type 1 diabetes [132]. Plasma ascorbic acid status depends on the interactions of dietary vitamin C intake, plasma insulin, and glucose concentrations. Insulin can promote the uptake of vitamin C, but hyperglycemia will inhibit renal vitamin C re-absorption. In type 1 DM, an adequate dietary vitamin C intake is often associated with an unexpectedly low ascorbic acid status in lymphocytes. Vitamin C may play a role as an aldose reductase inhibitor. In addition, water-soluble antioxidants, such as ascorbic acid, in body fluids are potentially very important as adjuncts to tighten glycemic control in the management of diabetes.

In the European Prospective Investigation of Cancer–Norfolk study, Harding et al. administered a semi-quantitative food frequency questionnaire to a population of 21,831 healthy individuals aged 40 to 75 years [133]. Plasma vitamin C concentration was determined and habitual intake of fruit and vegetables was assessed. At the end of the 12-year follow-up study, diabetes was incidentally diagnosed in 3.4% (n=735) of that population. Their results revealed an inverse correlation between plasma vitamin C levels and the risk of developing diabetes. They proposed that the mechanisms might be related to the high fiber content in fruit and vegetables, which may reduce obesity, or possibly to the antioxidative capacity of vitamin C, which may protect against the development of diabetes.

### Scurvy and Oral Health

Scurvy occurs because of reduced intake or malabsorption of vitamin C. At-risk groups include the poor (because of reduced access to groceries), food faddists, widowers, and individuals with purported allergies to multiple fruit and vegetable products. Other at-risk groups include persons with gastrointestinal disease (e.g. colitis), anatomical abnormalities, or poor dentition. Cancer patients on chemotherapy who have increased nausea and diarrhea are also at risk, as are patients on hemodialysis. Psychiatric disorders (e.g. depression, schizophrenia, or anorexia) have also been recognized as putting patients at risk for reduced intake of vitamin C. Alcoholic persons represent one of the largest groups at risk for scurvy because they may have poorly balanced diets and because alcohol decreases the absorption of vitamin C [134]. Patients with scurvy exhibit various systemic manifestations. Severe constitutional symptoms (e.g. weakness, fatigue, or myalgia) may be secondary to anemia, which develops in 75% of patients because of blood loss, concomitant folate deficiency, or altered iron absorption [7, 135]. Anemia is most commonly normochromic normocytic [7]. Myalgia occurs because of the reduced production of carnitine [135]. Scurvy causes changes

in the skin as a result of defective collagen synthesis. Classic changes on the legs and buttocks, where hydrostatic pressure is greatest, are hyperkeratotic papules with corkscrew hairs and perifollicular hemorrhage. Petechiae becoming confluent into large ecchymoses and even palpable purpura may occur on the lower legs because of blood vessel fragility. The legs can become edematous because of soft tissue hemorrhage or heart failure secondary to anemia. The nails may develop splinter hemorrhages. Alopecia can occur because of defective disulfide bonding. Because of defective collagen production, wounds heal poorly and even old scars can break down [134]. Oral manifestations of scurvy include gingival edema, bleeding, and ulcerations, secondary bacterial infections, and the loosening of teeth [136, 137]. Periodontal disease is causally related to anaerobic bacteria. Tissue damage occurs as a result of complex molecular interactions between pathogenic bacteria and host immune responses. In susceptible patients, both local and systemic factors affect the pathogenesis of the infection. Vitamin C deficiency has been shown histologically to result in a lack of collagen formation by affecting the hydroxylation of proline and increasing the permeability of the oral mucosa to endotoxins [138]. Vitamin C also enhances the mobility of polymorphonuclear leukocytes, and a deficiency of vitamin C is associated with decreased host immune responses [139, 140]. Animals placed on a diet deficient in vitamin C exhibit adverse changes in the periodontium related to a lack of collagen formation characterized by degenerative soft and hard tissue changes, distorted nuclear morphology of polymorphonuclear leukocytes, and reduced chemotactic responses [141-144]. Vitamin C has long been a candidate for modulating periodontal disease. A recent study, which evaluated the role of dietary vitamin C as a contributing factor for periodontal disease, has shown that there is a relationship between reduced dietary vitamin C and increased risk for periodontal disease in the general population [145].

Ascorbic acid affects *in vitro* growth of bacteria and may also act *in vivo* to decrease the development of dental caries. A double-blind study has evaluated the possible association between vitamin C in plasma, the number of carious lesions, the relative numbers of selected species of the oral cariogenic flora, and the rate of salivary secretion [145]. The amount of visible plaque and the numbers of decayed tooth surfaces were significantly higher in the low vitamin C group.

Collagen is the major organic matrix component of dentin. It has been shown *in vitro* that treatment with ascorbate enhanced the formation of mineralized nodules and collagenous proteins [146]. Calcium threonate may be one of the metabolites influencing the mineralization process [147]. Ogawara et al. demonstrated that a mutant strain of wistar rat, characterized by hereditary lack of L-gulono-galactone oxidase, was unable to synthesize ascorbic acid when given an ascorbic acid-free diet. The rats also showed a significant reduction in both size and mineral apposition rate of dentin and a reduction in bone formation in the mandible [148]. Based on these findings, the authors concluded that ascorbic acid deficiency hampers dentin formation.

## Cancer

Proposed mechanisms of action for vitamin C activity in the prevention and treatment of cancer include enhancement of the immune system by increased lymphocyte production; stimulation of collagen formation, necessary for “walling off” tumors; inhibition of hyaluronidase, keeping the ground substance around the tumor intact and preventing metastasis [149]; inhibition of oncogenic viruses; correction of an ascorbate deficiency, often seen in cancer patients; expedited wound healing after cancer surgery [150]; enhancement of the effect of certain chemotherapy drugs, such as tamoxifen, cisplatin, and DTIC [151-153]; reduction of the toxicity of other chemotherapeutic agents, such as Adriamycin [154]; prevention of cellular free radical damage [155]; and neutralization of carcinogenic substances [156]. Studies conducted in Scotland and Japan have revealed the potential benefit of high dose vitamin C for the treatment of end-stage cancer [157, 158]. Studies conducted at the Mayo Clinic, however, did not find a similar benefit elicited by high doses of ascorbic acid [159]. Numerous epidemiological studies have pointed to the importance of dietary and supplemental ascorbate in the prevention of various types of cancer including bladder, breast, cervical, colorectal, esophageal, lung, pancreatic, prostate, salivary gland, stomach, leukemia, and non-Hodgkin’s lymphoma.

## The Common Cold

The role of vitamin C in the prevention and treatment of the common cold remains controversial. A review of controlled studies suggests a reduction of at least 80% in the incidence of pneumonia in vitamin C groups and substantial treatment benefit from vitamin C in elderly patients hospitalized with pneumonia or bronchitis [160, 161]. It seems that the preventive effects of supplementation are mainly limited to subjects with low dietary vitamin C intake, although therapeutic effects may occur in wider population groups [160]. Research has shown that long-term daily supplementation with large doses (1 g daily during winter months) of vitamin C does not appear to prevent colds, but there may be a modest benefit in reducing the duration of cold symptoms [162, 163].

## Smokers

Smokers have a higher requirement for vitamin C than nonsmokers [164]. Vitamin C concentrations in smokers are inversely related to cigarette consumption [165-168]. This is most likely due to increased demand as a result of increased oxidative stress [165, 166]. In one study, vitamin C supplementation (2000 mg/day for 5 days) significantly reduced the amount of urinary F2-isoprostanes, an indicator of oxidative stress [168]. The current RDA for smokers is 110 mg/day for women and 125 mg/day for men [88], although it has been proposed that smokers require up to 180 mg/day to maintain plasma vitamin C concentrations comparable to those in nonsmokers [168].

## Alzheimer's Disease

There is evidence in patients with Alzheimer's disease (AD) that there is increased sensitivity of the cerebral cortex to free radicals, perhaps related to lower activity of antioxidant enzymes such as superoxide dismutase [78, 169]. The major targets for oxidation in the brain are lipids and lipoproteins. Supplementation with vitamin E and C significantly increases the concentrations of both vitamins in plasma and CSF and significantly decreases the *in vitro* oxidation of plasma lipoproteins [170]. In contrast, supplementation with vitamin E alone did not decrease lipoprotein oxidation. Two recent studies found patients with AD have low plasma vitamin C concentrations despite an adequate diet and that supplementation with vitamin C appears to lower the risk of AD [41, 42].

## Others

In critically ill patients and after severe burns, the rapid restoration of depleted ascorbate levels with high-dose parenteral vitamin C may reduce circulatory shock, fluid requirements and edema. Oxidative stress is associated with reduced ascorbate levels. Ascorbate is particularly effective in protecting the vascular endothelium, which is especially vulnerable to oxidative stress. The restoration of ascorbate levels may have therapeutic effects in diseases involving oxidative stress. The rapid replenishment of ascorbate is of special clinical significance in critically ill patients who experience drastic reductions in ascorbate levels, which may be a causal factor in the development of circulatory shock. Supraphysiological levels of ascorbate, which can only be achieved by the parenteral and not by the oral administration of vitamin C, may facilitate the restoration of vascular function in critically ill patients [171].

The factors that influence vitamin C levels in a general population of 5527 subjects visiting the Changhua Christian Hospital during recent 10 years are listed in Table 1. Correlation analysis of the factors related to elevated vitamin C levels revealed a reciprocal trend between age and vitamin C level. The analysis also revealed a significant negative association between glucose, insulin, BUN, and urate concentrations, and serum vitamin C levels. Our results also demonstrated that serological vitamin C content is a predictable biomarker for hyperlipidemia, hypertension, CVD, Parkinson's disease, and familial dementia regardless of genetic predisposition. In addition, there was a negative correlation between serum ascorbate level and factors related to lipid metabolism such as oxidized LDL, adiponectin, IMT, and plaque index, a finding supported by previously reported studies [172-175]. It has been reported that serum levels of hsCRP, a marker of inflammation, and VCAM, an adhesion marker, increase when vitamin C concentrations decrease [176]. Based on the data in our survey, we conclude that vitamin C is an important biomarker for several vascular diseases and that it dominates the redox states of human physiological conditions. Supplementations from vegetables, fruits and medications are strongly suggested for a healthy diet

**Table 1. Table Factors influencing degree of Vitamin C in linear correlation analysis**

Variable	Vitamin C (Bivariate 2-tailed)	
	Correlation coefficient	p-value
<b>General</b>		
Age (years)	-0.110	0.001**
Gender (male/female)	0.175	0.000***
BMI (kg/m <sup>2</sup> )	-0.099	0.013*
<b>Biochemical factor</b>		
Glucose (mmol/L)	-0.106	0.035*
Insulin ( $\mu$ U/mL)	-0.246	0.000***
BUN (mg/dl)	-0.154	0.005**
Urate (mg/dl)	-0.100	0.020*
<b>Lipid metabolic molecules</b>		
LDL (mg/dL)	0.099	0.023*
oxLDL (U/L)	-0.261	0.000***
ApoA1 (mg/dL)	0.238	0.002**
Adiponectin ( $\mu$ g/dL)	-0.265	0.000***
IMT	-0.123	0.008*
plaque / TOTAL_PI	-0.162	0.000***
<b>Inflammation molecules</b>		
VCAM (ng/mL)	-0.340	0.000***
hsCRP (mg/L)	-0.182	0.022*
<b>Redox molecules</b>		
GSH (nmol/mg)	-0.221	0.000***
MDA ( $\mu$ M)	-0.163	0.001**
Vit A ( $\mu$ g/dL)	-0.134	0.001**
Vit E ( $\mu$ M)	0.174	0.000***
<b>Disease</b>		
Disease situation	-0.525	0.000***
Hyperlipidemia degree (individual)	-0.173	0.000***
Familial hyperlipidemia	-0.234	0.000***
Hypertension (individual)	-0.239	0.000***
Familial Hypertension	-0.291	0.000***
Hypertension degree (individual)	-0.175	0.000***
CVD (individual)	-0.160	0.001**
Familial CVD	-0.260	0.000***
Parkinson's disease (individual)	-0.250	0.000***
Familial Dementia	-0.288	0.014*

\*. Correlation is significant at the 0.05 level (2-tailed).

\*\*, Correlation is significant at the 0.01 level (2-tailed).

\*\*\*. Correlation is significant at the 0.001level (2-tailed).



## Conclusion

Vitamin C intake can prevent and treat a large panel of diseases. The current RDA of vitamin C for nonsmoking women and men is 75 mg and 90 mg, respectively. The totality of the evidence reported herein suggests that these doses of vitamin C are optimal in this population both as an essential nutrient as well as an effective antioxidant. However, the RDA for vitamin C does not cover the need for vitamin C in daily bodily functions. Evidence from a number of studies shows that consumption of vitamin C at doses higher than the RDA enhances the immune system and decreases the risk of DNA damage. Vitamin C greater than 400 mg/day can protect against oxidative stress, certain cancers, and degenerative and chronic diseases. While higher dosages are generally well tolerated, the tolerable upper level of vitamin C is 2 g.

Modern farming methods lead to a lowering in food quality, inducing a considerable loss of micronutrients. The result is that people do not have sufficient intake of vitamin C through food consumption. Consequently, even if vitamin C requirements vary greatly among individuals, it is suggested that vitamin C supplementation is not only completely safe, but also necessary to achieve optimal health. Therefore, in agreement with the current literature, we advise healthy people to consume five servings of fruits and vegetables daily, added to 1 g of vitamin C supplementation divided in two or three doses during the day, in order to ensure an optimal allowance in vitamin C.

In response to the aggressive promotion and advertising by health food advocates of the need for nutritional and antioxidant supplements, patients may seek information from healthcare providers about this issue. Clinicians should be cognizant about such issues and should be prepared to provide their patients with evidence-based recommendations. In their comprehensive approach to patient care, clinicians should base the need for recommending dosages in excess of the RDA on sound data supported by a nutritional analysis and the patients' plasma vitamin C concentration (normal: >0.2 mg/dl) levels.

## References

- [1] Leger, D. (2008). Scurvy: reemergence of nutritional deficiencies. *Can Fam Physician*, 54, 1403-6
- [2] Levine, M., S.C. Rumsey, R. Daruwala, J.B. Park&Y. Wang (1999). Criteria and recommendations for vitamin C intake. *JAMA*, 281, 1415-23
- [3] Linster, C.L.&E. Van Schaftingen (2007). Vitamin C. Biosynthesis, recycling and degradation in mammals. *Febs J*, 274, 1-22
- [4] Nishikimi, M.&K. Yagi (1991). Molecular basis for the deficiency in humans of gulonolactone oxidase, a key enzyme for ascorbic acid biosynthesis. *Am J Clin Nutr*, 54, 1203S-08S
- [5] Nishikimi, M., R. Fukuyama, S. Minoshima, N. Shimizu&K. Yagi (1994). Cloning and chromosomal mapping of the human nonfunctional gene for L-gulono-gamma-lactone oxidase, the enzyme for L-ascorbic acid biosynthesis missing in man. *J Biol Chem*, 269, 13685-8

- [6] Challem, J.J. (1997). Did the loss of endogenous ascorbate propel the evolution of Anthropeidea and Homo sapiens? *Med Hypotheses*, 48, 387-92
- [7] Olmedo, J.M., J.A. Yiannias, E.B. Windgassen&M.K. Gornet (2006). Scurvy: a disease almost forgotten. *Int J Dermatol*, 45, 909-13
- [8] Belpomme, D., P. Irigaray, L. Hardell, R. Clapp, L. Montagnier, S. Epstein&A.J. Sasco (2007). The multitude and diversity of environmental carcinogens. *Environ Res*, 105, 414-29
- [9] He, Z.L., X.E. Yang&P.J. Stoffella (2005). Trace elements in agroecosystems and impacts on the environment. *J Trace Elem Med Biol*, 19, 125-40
- [10] Davis, D.R., M.D. Epp&H.D. Riordan (2004). Changes in USDA food composition data for 43 garden crops, 1950 to 1999. *J Am Coll Nutr*, 23, 669-82
- [11] Thomas, D. (2003). A study on the mineral depletion of the foods available to us as a nation over the period 1940 to 1991. *Nutr Health*, 17, 85-115
- [12] Reddy, M.B.&M. Love (1999). The impact of food processing on the nutritional quality of vitamins and minerals. *Adv Exp Med Biol*, 459, 99-106
- [13] Vanderslice, J.T.&D.J. Higgs (1991). Vitamin C content of foods: sample variability. *Am J Clin Nutr*, 54, 1323S-27S
- [14] Gil, M.I., F. Ferreres&F.A. Tomas-Barberan (1999). Effect of postharvest storage and processing on the antioxidant constituents (flavonoids and vitamin C) of fresh-cut spinach. *J Agric Food Chem*, 47, 2213-7
- [15] Johnston, C.S.&D.L. Bowling (2002). Stability of ascorbic acid in commercially available orange juices. *J Am Diet Assoc*, 102, 525-9
- [16] Severi, S., G. Bedogni, G.P. Zoboli, A.M. Manzieri, M. Poli, G. Gatti&N. Battistini (1998). Effects of home-based food preparation practices on the micronutrient content of foods. *Eur J Cancer Prev*, 7, 331-5
- [17] Johnston, C.S. (2005). Strategies for healthy weight loss: from vitamin C to the glycemic response. *J Am Coll Nutr*, 24, 158-65
- [18] Hemila, H. (1992). Vitamin C and the common cold. *Br J Nutr*, 67, 3-16
- [19] Cathcart, R.F., 3rd (1985). Vitamin C: the nontoxic, nonrate-limited, antioxidant free radical scavenger. *Med Hypotheses*, 18, 61-77
- [20] Jacob, R.A. (1990). Assessment of human vitamin C status. *J Nutr*, 120 Suppl 11, 1480-5
- [21] Hemila, H. (1994). Does vitamin C alleviate the symptoms of the common cold?--a review of current evidence. *Scand J Infect Dis*, 26, 1-6
- [22] Sweetman, S.F., J.J. Strain&V.J. McKelvey-Martin (1997). Effect of antioxidant vitamin supplementation on DNA damage and repair in human lymphoblastoid cells. *Nutr Cancer*, 27, 122-30
- [23] Pauling, L. (1974). Are recommended daily allowances for vitamin C adequate? *Proc Natl Acad Sci U S A*, 71, 4442-6
- [24] Prasad, K.N.&R. Kumar (1996). Effect of individual and multiple antioxidant vitamins on growth and morphology of human nontumorigenic and tumorigenic parotid acinar cells in culture. *Nutr Cancer*, 26, 11-9
- [25] Ames, B.N. (1998). Micronutrients prevent cancer and delay aging. *Toxicol Lett*, 102-103, 5-18

- [26] Carr, A.C.&B. Frei (1999). Toward a new recommended dietary allowance for vitamin C based on antioxidant and health effects in humans. *Am J Clin Nutr*, 69, 1086-107
- [27] Simon, J.A.&E.S. Hudes (2000). Serum ascorbic acid and gallbladder disease prevalence among US adults: the Third National Health and Nutrition Examination Survey (NHANES III). *Arch Intern Med*, 160, 931-6
- [28] Berger, T.M., M.C. Polidori, A. Dabbagh, P.J. Evans, B. Halliwell, J.D. Morrow, L.J. Roberts, 2nd&B. Frei (1997). Antioxidant activity of vitamin C in iron-overloaded human plasma. *J Biol Chem*, 272, 15656-60
- [29] Dasgupta, A.&T. Zdunek (1992). In vitro lipid peroxidation of human serum catalyzed by cupric ion: antioxidant rather than prooxidant role of ascorbate. *Life Sci*, 50, 875-82
- [30] Premkumar, K.&C.L. Bowlus (2003). Ascorbic acid reduces the frequency of iron induced micronuclei in bone marrow cells of mice. *Mutat Res*, 542, 99-103
- [31] May, J.M., Z.C. Qu, S. Juliao&C.E. Cobb (2005). Ascorbic acid decreases oxidant stress in endothelial cells caused by the nitroxide tempol. *Free Radic Res*, 39, 195-202
- [32] Kyrtopoulos, S.A., B. Pignatelli, G. Karkanias, B. Golematis&J. Esteve (1991). Studies in gastric carcinogenesis. V. The effects of ascorbic acid on N-nitroso compound formation in human gastric juice in vivo and in vitro. *Carcinogenesis*, 12, 1371-6
- [33] Pauling, L. (1970). Evolution and the need for ascorbic acid. *Proc Natl Acad Sci U S A*, 67, 1643-8
- [34] Bendich, A.&L. Langseth (1995). The health effects of vitamin C supplementation: a review. *J Am Coll Nutr*, 14, 124-36
- [35] Hemila, H. (1999). Vitamin C supplementation and common cold symptoms: factors affecting the magnitude of the benefit. *Med Hypotheses*, 52, 171-8
- [36] Wintergerst, E.S., S. Maggini&D.H. Hornig (2007). Contribution of selected vitamins and trace elements to immune function. *Ann Nutr Metab*, 51, 301-23
- [37] Yeom, C.H., G.C. Jung&K.J. Song (2007). Changes of terminal cancer patients' health-related quality of life after high dose vitamin C administration. *J Korean Med Sci*, 22, 7-11
- [38] Levine, M., C. Conry-Cantilena, Y. Wang, R.W. Welch, P.W. Washko, K.R. Dhariwal, J.B. Park, A. Lazarev, J.F. Graumlich, J. King&L.R. Cantilena (1996). Vitamin C pharmacokinetics in healthy volunteers: evidence for a recommended dietary allowance. *Proc Natl Acad Sci U S A*, 93, 3704-9
- [39] Levine, M., C.C. Cantilena&K.R. Dhariwal (1993). In situ kinetics and ascorbic acid requirements. *World Rev Nutr Diet*, 72, 114-27
- [40] Jacob, R.A., F.S. Pianalto&R.E. Agee (1992). Cellular ascorbate depletion in healthy men. *J Nutr*, 122, 1111-8
- [41] Blanchard, J., K.A. Conrad, R.A. Mead&P.J. Garry (1990). Vitamin C disposition in young and elderly men. *Am J Clin Nutr*, 51, 837-45
- [42] Blanchard, J. (1991). Depletion and repletion kinetics of vitamin C in humans. *J Nutr*, 121, 170-6
- [43] Heseker, H.&R. Schneider (1994). Requirement and supply of vitamin C, E and beta-carotene for elderly men and women. *Eur J Clin Nutr*, 48, 118-27
- [44] Washko, P.W., R.W. Welch, K.R. Dhariwal, Y. Wang&M. Levine (1992). Ascorbic acid and dehydroascorbic acid analyses in biological samples. *Anal Biochem*, 204, 1-14

- [45] Levine, M., Y. Wang, S.J. Padayatty&J. Morrow (2001). A new recommended dietary allowance of vitamin C for healthy young women. *Proc Natl Acad Sci U S A*, 98, 9842-6
- [46] Stone, I. (1966). Hypoascorbemia, the genetic disease causing the human requirement for exogenous ascorbic acid. *Perspect Biol Med*, 10, 133-4
- [47] Stone, I. (1966). On the genetic etiology of scurvy. *Acta Genet Med Gemellol (Roma)*, 15, 345-50
- [48] Challem, J.J. (1999). Toward a new definition of essential nutrients: is it now time for a third 'vitamin' paradigm? *Med Hypotheses*, 52, 417-22
- [49] Douglas, R.M., H. Hemila, E. Chalker&B. Treacy (2007). Vitamin C for preventing and treating the common cold. *Cochrane Database Syst Rev*, CD000980
- [50] Ames, B.N. (2004). A role for supplements in optimizing health: the metabolic tune-up. *Arch Biochem Biophys*, 423, 227-34
- [51] Ames, B.N. (2005). Increasing longevity by tuning up metabolism. To maximize human health and lifespan, scientists must abandon outdated models of micronutrients. *EMBO Rep*, 6 Spec No, S20-4
- [52] Ames, B.N. (2006). Low micronutrient intake may accelerate the degenerative diseases of aging through allocation of scarce micronutrients by triage. *Proc Natl Acad Sci U S A*, 103, 17589-94
- [53] Hathcock, J.N. (1997). Vitamins and minerals: efficacy and safety. *Am J Clin Nutr*, 66, 427-37
- [54] Gregory, J.F., 3rd (1993). Ascorbic acid bioavailability in foods and supplements. *Nutr Rev*, 51, 301-3
- [55] Johnston, C.S.&B. Luo (1994). Comparison of the absorption and excretion of three commercially available sources of vitamin C. *J Am Diet Assoc*, 94, 779-81
- [56] Austria, R., A. Semenzato&A. Bettero (1997). Stability of vitamin C derivatives in solution and topical formulations. *J Pharm Biomed Anal*, 15, 795-801
- [57] Deruelle, F.&B. Baron (2008). Vitamin C: is supplementation necessary for optimal health? *J Altern Complement Med*, 14, 1291-8
- [58] Guenther, P.M., K.W. Dodd, J. Reedy&S.M. Krebs-Smith (2006). Most Americans eat much less than recommended amounts of fruits and vegetables. *J Am Diet Assoc*, 106, 1371-9
- [59] Lachance, P.&L. Langseth (1994). The RDA concept: time for a change? *Nutr Rev*, 52, 266-70
- [60] Levine, M., K.R. Dhariwal, R.W. Welch, Y. Wang&J.B. Park (1995). Determination of optimal vitamin C requirements in humans. *Am J Clin Nutr*, 62, 1347S-56S
- [61] Childs, A., C. Jacobs, T. Kaminski, B. Halliwell&C. Leeuwenburgh (2001). Supplementation with vitamin C and N-acetyl-cysteine increases oxidative stress in humans after an acute muscle injury induced by eccentric exercise. *Free Radic Biol Med*, 31, 745-53
- [62] Podmore, I.D., H.R. Griffiths, K.E. Herbert, N. Mistry, P. Mistry&J. Lunec (1998). Vitamin C exhibits pro-oxidant properties. *Nature*, 392, 559
- [63] Gomez-Cabrera, M.C., E. Domenech, M. Romagnoli, A. Arduini, C. Borrás, F.V. Pallardo, J. Sastre&J. Vina (2008). Oral administration of vitamin C decreases muscle

- mitochondrial biogenesis and hampers training-induced adaptations in endurance performance. *Am J Clin Nutr*, 87, 142-9
- [64] Tanaka, H., N. Fujita, R. Sugimoto, N. Urawa, S. Horiike, Y. Kobayashi, M. Iwasa, N. Ma, S. Kawanishi, S. Watanabe, M. Kaito & Y. Takei (2008). Hepatic oxidative DNA damage is associated with increased risk for hepatocellular carcinoma in chronic hepatitis C. *Br J Cancer*, 98, 580-6
- [65] Hunt, J.R., S.K. Gallagher & L.K. Johnson (1994). Effect of ascorbic acid on apparent iron absorption by women with low iron stores. *Am J Clin Nutr*, 59, 1381-5
- [66] Cook, J.D., S.S. Watson, K.M. Simpson, D.A. Lipschitz & B.S. Skikne (1984). The effect of high ascorbic acid supplementation on body iron stores. *Blood*, 64, 721-6
- [67] Abramsson-Zetterberg, L. (1996). Ascorbic acid is not clastogenic and does not modify the effect of extended low-dose-rate gamma-irradiation in mouse bone marrow. *Int J Radiat Biol*, 70, 77-81
- [68] Hoda, Q., M.A. Azfer & S.P. Sinha (1993). Modificatory effect of vitamin C and vitamin B-complex on meiotic inhibition induced by organophosphorus pesticide in mice *Mus musculus*. *Int J Vitam Nutr Res*, 63, 48-51
- [69] Norkus, E.P., W. Kuenzig & A.H. Conney (1983). Studies on the mutagenic activity of ascorbic acid in vitro and in vivo. *Mutat Res*, 117, 183-91
- [70] Sahu, K. & R.K. Das (1994). Reduction of clastogenic effect of clofazimine, an antileprosy drug, by vitamin A and vitamin C in bone marrow cells of mice. *Food Chem Toxicol*, 32, 911-5
- [71] Speit, G., M. Wolf & W. Vogel (1980). The SCE-inducing capacity of vitamin C: investigations in vitro and in vivo. *Mutat Res*, 78, 273-8
- [72] Muhlhofer, A., S. Mrosek, B. Schlegel, W. Trommer, F. Rozario, H. Bohles, D. Schremmer, W.G. Zoller & H.K. Biesalski (2004). High-dose intravenous vitamin C is not associated with an increase of pro-oxidative biomarkers. *Eur J Clin Nutr*, 58, 1151-8
- [73] Auer, B.L., D. Auer & A.L. Rodgers (1998). Relative hyperoxaluria, crystalluria and haematuria after megadose ingestion of vitamin C. *Eur J Clin Invest*, 28, 695-700
- [74] Wandzilak, T.R., S.D. D'Andre, P.A. Davis & H.E. Williams (1994). Effect of high dose vitamin C on urinary oxalate levels. *J Urol*, 151, 834-7
- [75] Auer, B.L., D. Auer & A.L. Rodgers (1998). The effect of ascorbic acid ingestion on the biochemical and physicochemical risk factors associated with calcium oxalate kidney stone formation. *Clin Chem Lab Med*, 36, 143-7
- [76] Curhan, G.C., W.C. Willett, E.B. Rimm & M.J. Stampfer (1996). A prospective study of the intake of vitamins C and B6, and the risk of kidney stones in men. *J Urol*, 155, 1847-51
- [77] Curhan, G.C., W.C. Willett, F.E. Speizer & M.J. Stampfer (1999). Intake of vitamins B6 and C and the risk of kidney stones in women. *J Am Soc Nephrol*, 10, 840-5
- [78] Hathcock, J.N., A. Azzi, J. Blumberg, T. Bray, A. Dickinson, B. Frei, I. Jialal, C.S. Johnston, F.J. Kelly, K. Kraemer, L. Packer, S. Parthasarathy, H. Sies & M.G. Traber (2005). Vitamins E and C are safe across a broad range of intakes. *Am J Clin Nutr*, 81, 736-45
- [79] Hoffer, A. (1985). Ascorbic acid and kidney stones. *Can Med Assoc J*, 132, 320

- [80] Schmidt, K.H., V. Hagmaier, D.H. Hornig, J.P. Vuilleumier&G. Rutishauser (1981). Urinary oxalate excretion after large intakes of ascorbic acid in man. *Am J Clin Nutr*, 34, 305-11
- [81] Hill, R.E.&K.R. Kamath (1982). "Pink" diarrhoea: osmotic diarrhoea from a sorbitol-containing vitamin C supplement. *Med J Aust*, 1, 387-9
- [82] Levine, M. (1986). New concepts in the biology and biochemistry of ascorbic acid. *N Engl J Med*, 314, 892-902
- [83] Diplock, A.T. (1995). Safety of antioxidant vitamins and beta-carotene. *Am J Clin Nutr*, 62, 1510S-16S
- [84] Hanck, A. (1982). Tolerance and effects of high doses of ascorbic acid. Dosis facit venenum. *Int J Vitam Nutr Res Suppl*, 23, 221-38
- [85] Johnston, C.S. (1999). Biomarkers for establishing a tolerable upper intake level for vitamin C. *Nutr Rev*, 57, 71-7
- [86] Frei, B.&M.G. Trabe (2001). The new US Dietary Reference Intakes for vitamins C and E. *Redox Rep*, 6, 5-9
- [87] Anderson, T.J., I.T. Meredith, A.C. Yeung, B. Frei, A.P. Selwyn&P. Ganz (1995). The effect of cholesterol-lowering and antioxidant therapy on endothelium-dependent coronary vasomotion. *N Engl J Med*, 332, 488-93
- [88] Bsoul, S.A.&G.T. Terezhalmay (2004). Vitamin C in health and disease. *J Contemp Dent Pract*, 5, 1-13
- [89] Casino, P.R., C.M. Kilcoyne, A.A. Quyyumi, J.M. Hoeg&J.A. Panza (1993). The role of nitric oxide in endothelium-dependent vasodilation of hypercholesterolemic patients. *Circulation*, 88, 2541-7
- [90] Creager, M.A., J.P. Cooke, M.E. Mendelsohn, S.J. Gallagher, S.M. Coleman, J. Loscalzo&V.J. Dzau (1990). Impaired vasodilation of forearm resistance vessels in hypercholesterolemic humans. *J Clin Invest*, 86, 228-34
- [91] Zeiher, A.M., H. Drexler, H. Wollschlager&H. Just (1991). Modulation of coronary vasomotor tone in humans. Progressive endothelial dysfunction with different early stages of coronary atherosclerosis. *Circulation*, 83, 391-401
- [92] Hamabe, A., B. Takase, A. Uehata, A. Kurita, F. Ohsuzu&S. Tamai (2001). Impaired endothelium-dependent vasodilation in the brachial artery in variant angina pectoris and the effect of intravenous administration of vitamin C. *Am J Cardiol*, 87, 1154-9
- [93] Ting, H.H., F.K. Timimi, E.A. Haley, M.A. Roddy, P. Ganz&M.A. Creager (1997). Vitamin C improves endothelium-dependent vasodilation in forearm resistance vessels of humans with hypercholesterolemia. *Circulation*, 95, 2617-22
- [94] Sahyoun, N.R., P.F. Jacques&R.M. Russell (1996). Carotenoids, vitamins C and E, and mortality in an elderly population. *Am J Epidemiol*, 144, 501-11
- [95] Gey, K.F., G.B. Brubacher&H.B. Stahelin (1987). Plasma levels of antioxidant vitamins in relation to ischemic heart disease and cancer. *Am J Clin Nutr*, 45, 1368-77
- [96] Palmer, R.M., D.S. Ashton&S. Moncada (1988). Vascular endothelial cells synthesize nitric oxide from L-arginine. *Nature*, 333, 664-6
- [97] Panza, J.A., P.R. Casino, D.M. Badar&A.A. Quyyumi (1993). Effect of increased availability of endothelium-derived nitric oxide precursor on endothelium-dependent

- vascular relaxation in normal subjects and in patients with essential hypertension. *Circulation*, 87, 1475-81
- [98] Panza, J.A., P.R. Casino, C.M. Kilcoyne&A.A. Quyyumi (1993). Role of endothelium-derived nitric oxide in the abnormal endothelium-dependent vascular relaxation of patients with essential hypertension. *Circulation*, 87, 1468-74
- [99] Panza, J.A., P.R. Casino, C.M. Kilcoyne&A.A. Quyyumi (1994). Impaired endothelium-dependent vasodilation in patients with essential hypertension: evidence that the abnormality is not at the muscarinic receptor level. *J Am Coll Cardiol*, 23, 1610-6
- [100] Panza, J.A., A.A. Quyyumi, J.E. Brush, Jr.&S.E. Epstein (1990). Abnormal endothelium-dependent vascular relaxation in patients with essential hypertension. *N Engl J Med*, 323, 22-7
- [101] Taddei, S., A. Viridis, P. Mattei&A. Salvetti (1993). Vasodilation to acetylcholine in primary and secondary forms of human hypertension. *Hypertension*, 21, 929-33
- [102] Grunfeld, S., C.A. Hamilton, S. Mesaros, S.W. McClain, A.F. Dominiczak, D.F. Bohr&T. Malinski (1995). Role of superoxide in the depressed nitric oxide production by the endothelium of genetically hypertensive rats. *Hypertension*, 26, 854-7
- [103] Mugge, A., J.H. Elwell, T.E. Peterson&D.G. Harrison (1991). Release of intact endothelium-derived relaxing factor depends on endothelial superoxide dismutase activity. *Am J Physiol*, 260, C219-25
- [104] Sunman, W., A.D. Hughes&P.S. Sever (1993). Free-radical scavengers, thiol-containing reagents and endothelium-dependent relaxation in isolated rat and human resistance arteries. *Clin Sci (Lond)*, 84, 287-95
- [105] Taddei, S., A. Viridis, L. Ghiadoni, A. Magagna&A. Salvetti (1998). Vitamin C improves endothelium-dependent vasodilation by restoring nitric oxide activity in essential hypertension. *Circulation*, 97, 2222-9
- [106] Ness, A.R., D. Chee&P. Elliott (1997). Vitamin C and blood pressure--an overview. *J Hum Hypertens*, 11, 343-50
- [107] Solzbach, U., B. Hornig, M. Jeserich&H. Just (1997). Vitamin C improves endothelial dysfunction of epicardial coronary arteries in hypertensive patients. *Circulation*, 96, 1513-9
- [108] Drexler, H., D. Hayoz, T. Munzel, B. Hornig, H. Just, H.R. Brunner&R. Zelis (1992). Endothelial function in chronic congestive heart failure. *Am J Cardiol*, 69, 1596-601
- [109] Drexler, H., A.M. Zeiher, H. Wollschlager, T. Meinertz, H. Just&T. Bonzel (1989). Flow-dependent coronary artery dilatation in humans. *Circulation*, 80, 466-74
- [110] Hornig, B., V. Maier&H. Drexler (1996). Physical training improves endothelial function in patients with chronic heart failure. *Circulation*, 93, 210-4
- [111] Smith, C.J., D. Sun, C. Hoegler, B.S. Roth, X. Zhang, G. Zhao, X.B. Xu, Y. Kobari, K. Pritchard, Jr., W.C. Sessa&T.H. Hintze (1996). Reduced gene expression of vascular endothelial NO synthase and cyclooxygenase-1 in heart failure. *Circ Res*, 78, 58-64
- [112] Belch, J.J., A.B. Bridges, N. Scott&M. Chopra (1991). Oxygen free radicals and congestive heart failure. *Br Heart J*, 65, 245-8

- [113] Hornig, B., N. Arakawa, C. Kohler&H. Drexler (1998). Vitamin C improves endothelial function of conduit arteries in patients with chronic heart failure. *Circulation*, 97, 363-8
- [114] Kushi, L.H., A.R. Folsom, R.J. Prineas, P.J. Mink, Y. Wu&R.M. Bostick (1996). Dietary antioxidant vitamins and death from coronary heart disease in postmenopausal women. *N Engl J Med*, 334, 1156-62
- [115] Losonczy, K.G., T.B. Harris&R.J. Havlik (1996). Vitamin E and vitamin C supplement use and risk of all-cause and coronary heart disease mortality in older persons: the Established Populations for Epidemiologic Studies of the Elderly. *Am J Clin Nutr*, 64, 190-6
- [116] Enstrom, J.E., L.E. Kanim&M.A. Klein (1992). Vitamin C intake and mortality among a sample of the United States population. *Epidemiology*, 3, 194-202
- [117] Osganian, S.K., M.J. Stampfer, E. Rimm, D. Spiegelman, F.B. Hu, J.E. Manson&W.C. Willett (2003). Vitamin C and risk of coronary heart disease in women. *J Am Coll Cardiol*, 42, 246-52
- [118] Knekt, P., J. Ritz, M.A. Pereira, E.J. O'Reilly, K. Augustsson, G.E. Fraser, U. Goldbourt, B.L. Heitmann, G. Hallmans, S. Liu, P. Pietinen, D. Spiegelman, J. Stevens, J. Virtamo, W.C. Willett, E.B. Rimm&A. Ascherio (2004). Antioxidant vitamins and coronary heart disease risk: a pooled analysis of 9 cohorts. *Am J Clin Nutr*, 80, 1508-20
- [119] Frei, B. (2003). To C or not to C, that is the question! *J Am Coll Cardiol*, 42, 253-5
- [120] Yokoyama, T., C. Date, Y. Kokubo, N. Yoshiike, Y. Matsumura&H. Tanaka (2000). Serum vitamin C concentration was inversely associated with subsequent 20-year incidence of stroke in a Japanese rural community. The Shibata study. *Stroke*, 31, 2287-94
- [121] Myint, P.K., R.N. Luben, A.A. Welch, S.A. Bingham, N.J. Wareham&K.T. Khaw (2008). Plasma vitamin C concentrations predict risk of incident stroke over 10 y in 20 649 participants of the European Prospective Investigation into Cancer Norfolk prospective population study. *Am J Clin Nutr*, 87, 64-9
- [122] Haffner, S. (2005). Rationale for new American Diabetes Association Guidelines: are national cholesterol education program goals adequate for the patient with diabetes mellitus? *Am J Cardiol*, 96, 33E-36E
- [123] Rumsey, S.C., O. Kwon, G.W. Xu, C.F. Burant, I. Simpson&M. Levine (1997). Glucose transporter isoforms GLUT1 and GLUT3 transport dehydroascorbic acid. *J Biol Chem*, 272, 18982-9
- [124] Chen, L., R.H. Jia, C.J. Qiu&G. Ding (2005). Hyperglycemia inhibits the uptake of dehydroascorbate in tubular epithelial cell. *Am J Nephrol*, 25, 459-65
- [125] Will, J.C.&T. Byers (1996). Does diabetes mellitus increase the requirement for vitamin C? *Nutr Rev*, 54, 193-202
- [126] Tousoulis, D., C. Antoniadis, C. Tountas, E. Bosinakou, M. Kotsopoulou, P. Toutouzias&C. Stefanadis (2003). Vitamin C affects thrombosis/ fibrinolysis system and reactive hyperemia in patients with type 2 diabetes and coronary artery disease. *Diabetes Care*, 26, 2749-53



- [127] Afkhami-Ardekani, M.&A. Shojaoddiny-Ardekani (2007). Effect of vitamin C on blood glucose, serum lipids & serum insulin in type 2 diabetes patients. *Indian J Med Res*, 126, 471-4
- [128] Natali, A., A.M. Sironi, E. Toschi, S. Camastra, G. Sanna, A. Perissinotto, S. Taddei&E. Ferrannini (2000). Effect of vitamin C on forearm blood flow and glucose metabolism in essential hypertension. *Arterioscler Thromb Vasc Biol*, 20, 2401-6
- [129] Chen, H., R.J. Karne, G. Hall, U. Campia, J.A. Panza, R.O. Cannon, 3rd, Y. Wang, A. Katz, M. Levine&M.J. Quon (2006). High-dose oral vitamin C partially replenishes vitamin C levels in patients with Type 2 diabetes and low vitamin C levels but does not improve endothelial dysfunction or insulin resistance. *Am J Physiol Heart Circ Physiol*, 290, H137-45
- [130] Yamada, H., K. Yamada, M. Waki&K. Umegaki (2004). Lymphocyte and plasma vitamin C levels in type 2 diabetic patients with and without diabetes complications. *Diabetes Care*, 27, 2491-2
- [131] Bergsten, P., R. Yu, J. Kehrl&M. Levine (1995). Ascorbic acid transport and distribution in human B lymphocytes. *Arch Biochem Biophys*, 317, 208-14
- [132] Cunningham, J.J. (1998). The glucose/insulin system and vitamin C: implications in insulin-dependent diabetes mellitus. *J Am Coll Nutr*, 17, 105-8
- [133] Harding, A.H., N.J. Wareham, S.A. Bingham, K. Khaw, R. Luben, A. Welch&N.G. Forouhi (2008). Plasma vitamin C level, fruit and vegetable consumption, and the risk of new-onset type 2 diabetes mellitus: the European prospective investigation of cancer--Norfolk prospective study. *Arch Intern Med*, 168, 1493-9
- [134] Hirschmann, J.V.&G.J. Raugi (1999). Adult scurvy. *J Am Acad Dermatol*, 41, 895-906; quiz 07-10
- [135] Nguyen, R.T., D.M. Cowley&J.B. Muir (2003). Scurvy: a cutaneous clinical diagnosis. *Australas J Dermatol*, 44, 48-51
- [136] Lowe, G., M. Woodward, A. Rumley, C. Morrison, H. Tunstall-Pedoe&K. Stephen (2003). Total tooth loss and prevalent cardiovascular disease in men and women: possible roles of citrus fruit consumption, vitamin C, and inflammatory and thrombotic variables. *J Clin Epidemiol*, 56, 694-700
- [137] Marshall, R. (2002). Oral lesions in scurvy. *Aust Dent J*, 47, 82; author reply 82-3
- [138] Alfano, M.C., S.A. Miller&J.F. Drummond (1975). Effect of ascorbic acid deficiency on the permeability and collagen biosynthesis of oral mucosal epithelium. *Ann N Y Acad Sci*, 258, 253-63
- [139] Sandler, J.A., J.I. Gallin&M. Vaughan (1975). Effects of serotonin, carbamylcholine, and ascorbic acid on leukocyte cyclic GMP and chemotaxis. *J Cell Biol*, 67, 480-4
- [140] Goetzl, E.J., S.I. Wasserman, I. Gigli&K.F. Austen (1974). Enhancement of random migration and chemotactic response of human leukocytes by ascorbic acid. *J Clin Invest*, 53, 813-8
- [141] Alvares, O., L.C. Altman, S. Springmeyer, W. Ensign&K. Jacobson (1981). The effect of subclinical ascorbate deficiency on periodontal health in nonhuman primates. *J Periodontal Res*, 16, 628-36
- [142] Alvares, O.&I. Siegel (1981). Permeability of gingival sulcular epithelium in the development of scorbutic gingivitis. *J Oral Pathol*, 10, 40-8

- [143] Goldschmidt, M.C. (1991). Reduced bactericidal activity in neutrophils from scorbutic animals and the effect of ascorbic acid on these target bacteria in vivo and in vitro. *Am J Clin Nutr*, 54, 1214S-20S
- [144] Hunt, A.M.&K.J. Paynter (1959). The effects of ascorbic acid deficiency on the teeth and periodontal tissues of guinea pigs. *J Dent Res*, 38, 232-43
- [145] Nishida, M., S.G. Grossi, R.G. Dunford, A.W. Ho, M. Trevisan&R.J. Genco (2000). Dietary vitamin C and the risk for periodontal disease. *J Periodontol*, 71, 1215-23
- [146] Vaananen, M.K., H.A. Markkanen, V.J. Tuovinen, A.M. Kullaa, A.M. Karinpa, H. Luoma&E.A. Kumpusalo (1994). Dental caries and mutans streptococci in relation to plasma ascorbic acid. *Scand J Dent Res*, 102, 103-8
- [147] Rowe, D.J., S. Ko, X.M. Tom, S.J. Silverstein&D.W. Richards (1999). Enhanced production of mineralized nodules and collagenous proteins in vitro by calcium ascorbate supplemented with vitamin C metabolites. *J Periodontol*, 70, 992-9
- [148] Ogawara, M., K. Aoki, T. Okiji&H. Suda (1997). Effect of ascorbic acid deficiency on primary and reparative dentinogenesis in non-ascorbate-synthesizing ODS rats. *Arch Oral Biol*, 42, 695-704
- [149] Cameron, E.&L. Pauling (1973). Ascorbic acid and the glycosaminoglycans. An orthomolecular approach to cancer and other diseases. *Oncology*, 27, 181-92
- [150] Sukolinskii, V.N.&T.S. Morozkina (1989). [Prevention of postoperative complications in patients with stomach cancer using an antioxidant complex]. *Vopr Onkol*, 35, 1242-5
- [151] Kurbacher, C.M., U. Wagner, B. Kolster, P.E. Andreotti, D. Krebs&H.W. Bruckner (1996). Ascorbic acid (vitamin C) improves the antineoplastic activity of doxorubicin, cisplatin, and paclitaxel in human breast carcinoma cells in vitro. *Cancer Lett*, 103, 183-9
- [152] Lee, Y.S.&R.D. Wurster (1994). Potentiation of anti-proliferative effect of nitroprusside by ascorbate in human brain tumor cells. *Cancer Lett*, 78, 19-23
- [153] Prasad, K.N., C. Hernandez, J. Edwards-Prasad, J. Nelson, T. Borus&W.A. Robinson (1994). Modification of the effect of tamoxifen, cis-platin, DTIC, and interferon-alpha 2b on human melanoma cells in culture by a mixture of vitamins. *Nutr Cancer*, 22, 233-45
- [154] Fujita, K., K. Shinpo, K. Yamada, T. Sato, H. Niimi, M. Shamoto, T. Nagatsu, T. Takeuchi&H. Umezawa (1982). Reduction of adriamycin toxicity by ascorbate in mice and guinea pigs. *Cancer Res*, 42, 309-16
- [155] Dumitrescu, C., M. Belgun, R. Olinescu, L. Lianu&C. Bartoc (1993). Effect of vitamin C administration on the ratio between the pro- and antioxidative factors. *Rom J Endocrinol*, 31, 81-4
- [156] Aidoo, A., L.E. Lyn-Cook, S. Lensing&W. Wamer (1994). Ascorbic acid (vitamin C) modulates the mutagenic effects produced by an alkylating agent in vivo. *Environ Mol Mutagen*, 24, 220-8
- [157] Ohno, S., Y. Ohno, N. Suzuki, G. Soma&M. Inoue (2009). High-dose vitamin C (ascorbic acid) therapy in the treatment of patients with advanced cancer. *Anticancer Res*, 29, 809-15

- [158] Campbell, A., T. Jack & E. Cameron (1991). Reticulum cell sarcoma: two complete 'spontaneous' regressions, in response to high-dose ascorbic acid therapy. A report on subsequent progress. *Oncology*, 48, 495-7
- [159] Moertel, C.G., T.R. Fleming, E.T. Creagan, J. Rubin, M.J. O'Connell & M.M. Ames (1985). High-dose vitamin C versus placebo in the treatment of patients with advanced cancer who have had no prior chemotherapy. A randomized double-blind comparison. *N Engl J Med*, 312, 137-41
- [160] Hemila, H. & R.M. Douglas (1999). Vitamin C and acute respiratory infections. *Int J Tuberc Lung Dis*, 3, 756-61
- [161] Hunt, C., N.K. Chakravorty, G. Annan, N. Habibzadeh & C.J. Schorah (1994). The clinical effects of vitamin C supplementation in elderly hospitalised patients with acute respiratory infections. *Int J Vitam Nutr Res*, 64, 212-9
- [162] Douglas, R.M., E.B. Chalker & B. Treacy (2000). Vitamin C for preventing and treating the common cold. *Cochrane Database Syst Rev*, CD000980
- [163] Van Straten, M. & P. Josling (2002). Preventing the common cold with a vitamin C supplement: a double-blind, placebo-controlled survey. *Adv Ther*, 19, 151-9
- [164] Weber, P., A. Bendich & W. Schalch (1996). Vitamin C and human health--a review of recent data relevant to human requirements. *Int J Vitam Nutr Res*, 66, 19-30
- [165] Cross, C.E. & B. Halliwell (1993). Nutrition and human disease: how much extra vitamin C might smokers need? *Lancet*, 341, 1091
- [166] Lykkesfeldt, J., S. Loft, J.B. Nielsen & H.E. Poulsen (1997). Ascorbic acid and dehydroascorbic acid as biomarkers of oxidative stress caused by smoking. *Am J Clin Nutr*, 65, 959-63
- [167] Lykkesfeldt, J., H. Prieme, S. Loft & H.E. Poulsen (1996). Effect of smoking cessation on plasma ascorbic acid concentration. *Bmj*, 313, 91
- [168] Reilly, M., N. Delanty, J.A. Lawson & G.A. FitzGerald (1996). Modulation of oxidant stress in vivo in chronic cigarette smokers. *Circulation*, 94, 19-25
- [169] Sasazuki, S., S. Sasaki, Y. Tsubono, S. Okubo, M. Hayashi & S. Tsugane (2006). Effect of vitamin C on common cold: randomized controlled trial. *Eur J Clin Nutr*, 60, 9-17
- [170] VanderJagt, D.J., P.J. Garry & H.N. Bhagavan (1989). Ascorbate and dehydroascorbate: distribution in mononuclear cells of healthy elderly people. *Am J Clin Nutr*, 49, 511-6
- [171] McGregor, G.P. & H.K. Biesalski (2006). Rationale and impact of vitamin C in clinical nutrition. *Curr Opin Clin Nutr Metab Care*, 9, 697-703
- [172] Das, S., R. Ray, Snehlata, N. Das & L.M. Srivastava (2006). Effect of ascorbic acid on prevention of hypercholesterolemia induced atherosclerosis. *Mol Cell Biochem*, 285, 143-7
- [173] Kritchevsky, S.B., T. Shimakawa, G.S. Tell, B. Dennis, M. Carpenter, J.H. Eckfeldt, H. Peacher-Ryan & G. Heiss (1995). Dietary antioxidants and carotid artery wall thickness. The ARIC Study. Atherosclerosis Risk in Communities Study. *Circulation*, 92, 2142-50
- [174] Aguirre, R. & J.M. May (2008). Inflammation in the vascular bed: importance of vitamin C. *Pharmacol Ther*, 119, 96-103

- [175] Vincent, H.K., C.M. Bourguignon, A.L. Weltman, K.R. Vincent, E. Barrett, K.E. Innes&A.G. Taylor (2009). Effects of antioxidant supplementation on insulin sensitivity, endothelial adhesion molecules, and oxidative stress in normal-weight and overweight young adults. *Metabolism*, 58, 254-62
- [176] Tahir, M., B. Foley, G. Pate, P. Crean, D. Moore, N. McCarroll&M. Walsh (2005). Impact of vitamin E and C supplementation on serum adhesion molecules in chronic degenerative aortic stenosis: a randomized controlled trial. *Am Heart J*, 150, 302-6

---

## Pro-Oxidant vs. Antioxidant Effects of Vitamin C

---

*Borut Poljsak<sup>1</sup> and John G. Ionescu<sup>2,3</sup>*

<sup>1</sup>Laboratory for ageing process research, Chair of Environmental Health, Faculty of Health Studies, University of Ljubljana, Slovenia

<sup>2</sup>Spezialklinik Neukirchen, Neukirchen, Germany

<sup>3</sup>Dept. of Medical Nutrition, Donau University Krems, Austria

### Abstract

Vitamin C (L-ascorbic acid) protects human health by scavenging toxic free radicals and other reactive oxygen species (ROS) formed in cell metabolism. On the other side, it is well established by *in vitro* experiments that vitamin C is reactive with free iron and produces free radicals, while causing oxidative damage to biomolecules. The interaction of ascorbic acid with transition metal ions could promote their reduction, accompanied by increased H<sub>2</sub>O<sub>2</sub> production and consequently OH<sup>•</sup> formation. The mixture of metal ions and ascorbate in some vitamin pills has been claimed to generate OH<sup>•</sup> once the pills dissolve and several reports suggest increases in DNA damage in healthy humans supplemented with vitamin C and iron salts. In epidemiologic studies it is often assumed that antioxidant vitamins act by lowering oxidative damage, but evidence in support of this contention is not provided or is contradictory. Many studies show an inverse relationship between mortality and vitamin C intake indicating a protective antioxidant activity. On the other side several reports show no significant relationship after controlling for confounding variables. Therefore there is still debate on whether supplements of vitamin C could act as antioxidant or pro-oxidant *in vivo*. Recent research suggests that 3 factors are responsible for the pro- or antioxidant behaviour of vitamin C in biological systems, e.g. cellular environment: 1.) the redox potential of the cellular environment (oxidosis/redosis), 2.) the presence or absence of transition metals and 3.) the local concentration of ascorbate. This may also explain the observed quite specific pro-oxidant activity of high dose intravenous vitamin C against metal reach malignant

tumours. In this paper possible pro- and antioxidant effects of vitamin C will be presented and their impact on human health will be discussed.

## 1. Introduction

Natural antioxidants are generally considered to be beneficial fruit and vegetable components. Vitamin C is present in almost all foods of plant origin. It is an essential micronutrient in man, due to the absence of L-gulonolactone oxidase. Vitamin C has several important roles and there are many enzymes utilizing ascorbate as a co-factor. The term vitamin C refers to both ascorbic acid (AA) and dehydroascorbic acid (DHA), since both exhibit anti-scorbutic activity. Ascorbic acid, the functional and primary *in vivo* form of the vitamin, is the enolic form of an  $\alpha$ -ketolactone (2,3-didehydr L -threo-hexano-1,4-lactone). The two enolic hydrogen atoms give the compound its acidic character and provide electrons for its function as a reductant and antioxidant. Its one-electron oxidation product, the ascorbyl radical, readily dismutates to ascorbate and DHA, the two-electron oxidation products. Both the ascorbyl radical and DHA are readily reduced back to ascorbic acid *in vivo*. Because of its ability to donate electrons, ascorbic acid is an effective antioxidant. The vitamin readily scavenges reactive oxygen species (ROS) and reactive nitrogen species (RNS) (e.g., hydroxyl, superoxide, singlet oxygen, and peroxyxynitrite, nitroxide radicals, respectively) as well as peroxy and hypochlorite (Frei et al., 1989; Halliwell and Whiteman 1997). The one- and two-electron oxidation products of ascorbate are relatively nontoxic and easily regenerated by the ubiquitous reductants glutathione and NADH or NADPH. Both the one- and the two-electron oxidation products of the vitamin are readily regenerated *in vivo*—chemically and enzymatically—by reduced glutathione, nicotinamide adenine dinucleotide (NADH), and nicotinamide adenine dinucleotide phosphate (NADPH) dependent reductases (May et al. 1998; Park and Levine 1996). In addition to scavenging reactive oxygen species and reactive nitrogen species, vitamin C can regenerate other small molecule antioxidants, such as  $\alpha$ -tocopherol, glutathione (GSH), urate, and  $\beta$ -carotene, from their respective radical species (Halliwell 1996). Many cells possess enzymes that can convert dehydroascorbate or ascorbate radical back to ascorbate at the expense of GSH or NADH. Glutathione dependent dehydroascorbate reductase enzymes have been identified in plants and in several mammalian tissues. Evidence that GSH and ascorbate interact *in vivo* is provided by studies on animals treated with the inhibitors of GSH synthesis (Halliwell and Gutteridge 1999). Severe glutathione depletion in newborn rats is lethal, but death can be prevented by high doses of ascorbate (but not DHA).

## 2. The *In Vitro* Evidence for an Antioxidative Role of Vitamin C

At physiological concentrations, vitamin C is a potent free radical scavenger in the plasma, protecting cells against oxidative damage caused by ROS (Carr and Frei 1999). The

antioxidant property of ascorbic acid is attributed to its ability to reduce potentially damaging ROS, and forming a relatively stable ascorbyl free radical. Ascorbate has the ability to act as a reducing agent. One electron donated by ascorbate gives ascorbyl radical, also named monodehydroascorbate (MDHA) or semi dehydroascorbate (SDA). It can be further oxidized to give dehydroascorbate (DHA). DHA is unstable and breaks down rapidly, producing diketo-L-gulonic acid which breaks down to oxalic and L-threonic acid (Figure 1, Ascorbic acid redox cycle). At physiological pH the acid form is largely ionized (ascorbate) since the  $pK_{a1}$  of ascorbic acid is 4.25 (Halliwell and Gutteridge 1999).

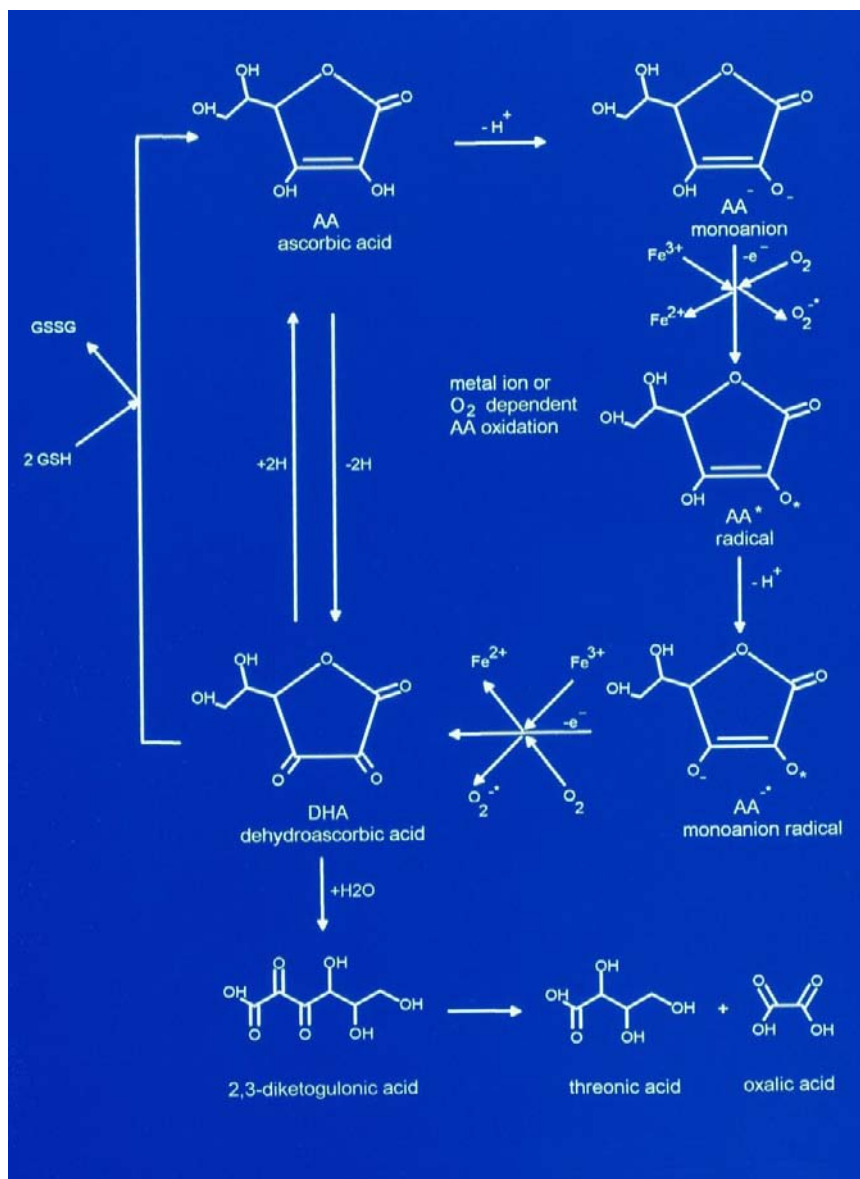
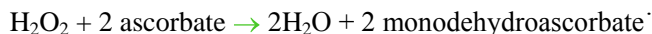
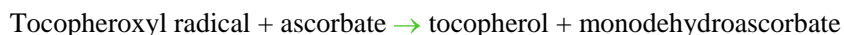

Figure 1. Ascorbic acid redox cycle and catabolic pathways.

Basic intracellular reaction in which ascorbic acid and ROS are involved (McKersie 1996):



The indirect role of the ascorbate as an antioxidant is to regenerate membrane-bound antioxidants, such as alpha-tocopherol that scavenge peroxy radicals and singlet oxygen, respectively:



The above reactions indicate that there are two different products of ascorbate oxidation: monodehydroascorbate and dehydroascorbate which represent one and two electron transfers, respectively. The monodehydroascorbate can either dismutate spontaneously, or is reduced to ascorbate by NAD(P)H monodehydroascorbate reductase:



The dehydroascorbate is unstable at pH greater than 6 and decomposes to tartrate and oxalate (McKersie 1996). To prevent this, dehydroascorbate is rapidly reduced to ascorbate by dehydroascorbate reductase, using reducing equivalents from glutathione:



*In vitro* tests performed under physiological conditions show a better viability of ascorbic acid pretreated cells, which might be the consequence of ascorbic acid prevention of oxidant-induced apoptosis (Deutsch 1998). In the absence of added metal ions, however, vitamin C inhibits the formation of 8-oxodG in purified DNA exposed to peroxynitrite or UV light (Hu and Shih 1997, Fiala et al. 1996). Also the study of Panayiotidis et al. (1997) has shown reduced strand breakage, as determined by the comet assay in lymphocytes. Results of cytotoxicity tests in *S. cerevisiae* cells pretreated with ascorbic acid and subsequently treated with Cr(VI) indicate a preventive effect of ascorbic acid (Poljsak et al. 2005) regarding intracellular oxidation. These results are in agreement with those of Blankenship et al. (1997) on CHO cells.

When sufficient exogenous iron (as ferrous ammonium sulfate) is added to plasma to saturate transferrin and result in nonprotein-bound, bleomycin-detectable iron (BDI), endogenous and exogenous vitamin C inhibits rather than promotes lipid peroxidation (Berger et al. 1997).



Overall, *in vitro* studies have shown that vitamin C either has no effect (Dabbagh and Frei, 1995) or inhibits (Berger et al., 1997; Dasgupta and Zdunek 1992) metal ion dependent lipid oxidation in plasma and other biological fluids.

## 2.1 The *In Vitro* Evidence for a Pro-Oxidative Role of Vitamin C

Ascorbic acid quenches free radicals by providing hydrogen atoms that can pair up with unpaired electrons on free radicals. In this process ascorbic acid becomes an ascorbyl radical, which is relatively unreactive toward biomolecules (Buettner 1993; Halliwell and Gutteridge 1999). Relatively unreactive means that ascorbyl radical is not reactive enough to cause damage to biomolecules. However, ascorbic acid can also act as a pro-oxidant in the presence of transition metals, depending on the environment in which the molecule is present (Paolini et al. 1999 ; Halliwell 1999)). The interaction of ascorbic acid with transition metal ions could promote their reduction, accompanied by increased H<sub>2</sub>O<sub>2</sub> production (Halliwell 1999; Clement 2001; Lay and Levina 1998), and consequently OH<sup>·</sup> formation. The ascorbate acts as reducing agent to iron and other transition metals, easily permitted by the standard redox potentials (Fe<sup>3+</sup>-ferritin/ferritin, Fe<sup>2+</sup>: SRP=-0.19V; ascorbate<sup>·-</sup>, H<sup>+</sup>/ascorbate<sup>-</sup>: SRP=0.28V) (Halliwell and Gutteridge 1999).



Ascorbic acid reduces Fe(III) to Fe(II) that reduce oxygen to hydroxyl radical (Halliwell and Gutteridge 1999). Cells have low-molecular-mass intracellular »pools« of iron. If these come into contact with ascorbate, pro-oxidant effects may occur. The ability of ascorbic acid to enhance the release of transition metals from protein complexes, and to reduce them to catalytic forms, has implicated this compound to be a prooxidant as well (Dreosti 1991). Iron and copper are essential for cellular life as enzyme cofactors. Thus they could participate in the autooxidation of ascorbic acid. Vitamin C in the presence of high body iron stores, reveals prooxidant properties (Food and Drug Administration 1993; Herbert 1993; Simopoulos et al. 1993.) Vitamin C is especially dangerous in the presence of high body iron stores, which make vitamin C violently prooxidant (Herbert 1993; Simopoulos et al. 1993). The reduction of transition metal ions by ascorbate could also have deleterious effects via the production of hydroxyl radicals or lipid alkoxy radicals (LO<sup>·</sup>) by reaction of the reduced metal ions with hydrogen peroxide or lipid hydroperoxides (LOOH) (Halliwell 1996; Buettner and Jurkiewicz 1996). This effect can be prevented if enough anti-oxidants e.g. glutathione are available (Ionescu, 2002)

However, due to the capacity of metal ions to undergo one-electron transfers, which enables them to become powerful catalysts of autooxidation reactions, cells sequester these metal ions into proteins since metal-bound ions are less effective than free-radical catalysts (Halliwell and Gutteridge 1999). Cells must establish fine-tuned mechanisms which allow cells to accumulate sufficient levels of Fe and Cu for normal biochemical reactions, yet prevent the accumulation of these metals to levels which unleash their toxic effects. Many

autooxidation reactions within the cell produce superoxide by addition of an electron to molecular oxygen (Anderson and Phillips 1999). It was reported that  $O_2^{\cdot -}$  is produced from ascorbate (AH) autooxidation by dioxygen (Scarpa 1983), yet it has been shown (Buettner 1993) that aerobic oxidation of ascorbate strictly requires a metal catalyst (Figure 1).

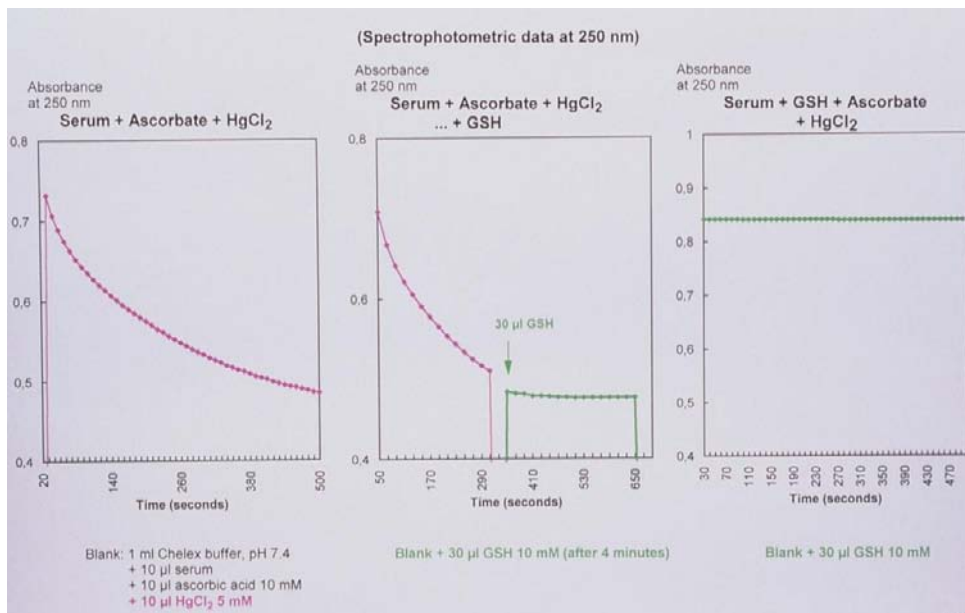

Figure 2. The prevention of mercury II induced ascorbate oxidation by reduced glutathione.

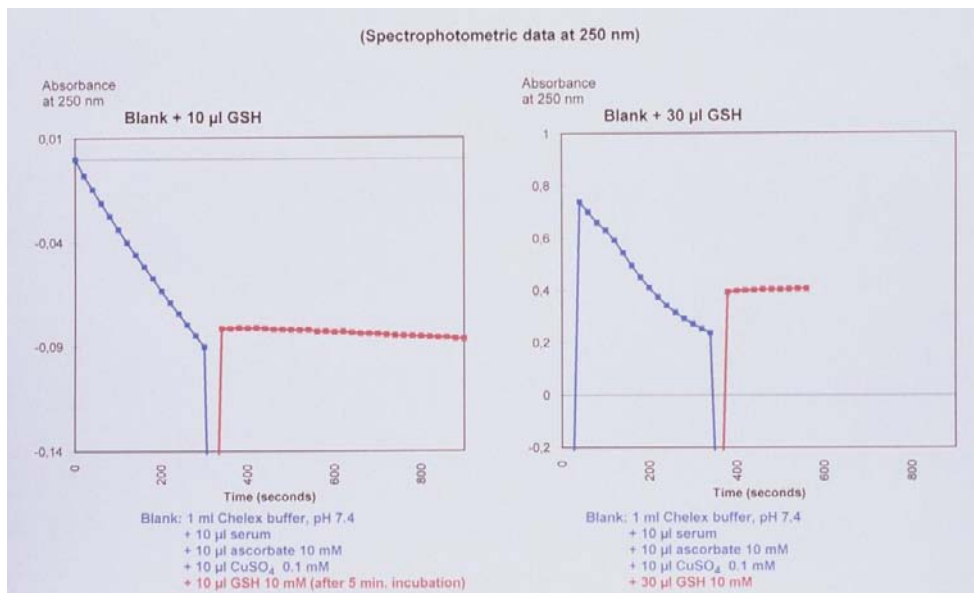

Figure 3. The prevention of copper II induced ascorbate oxidation by reduced glutathione.

Antioxidants, which are reducing agents, capable of reacting with molecular oxygen (e.g. ascorbic acid) will generate superoxide radicals under aerobic conditions. This will dismutate to  $\text{H}_2\text{O}_2$  that can enter cells and react with superoxide or reduced metal ions to form highly damaging hydroxyl radicals (Anderson and Phillips 1999). Even though  $\text{H}_2\text{O}_2$  production from ascorbate and dioxygen is thermodynamically favored, a direct oxidation of ascorbate by dioxygen does not occur. Thus, the spin restriction of dioxygen is a kinetic barrier that prevents the oxidation of organic biomolecules regardless of thermodynamic considerations (Miller et al. 1990). In the absence of transitional metals, the rate constant for the reaction of dioxygen with ascorbate has been reported to be  $6 \times 10^{-7} \text{ s}^{-1}$ , which results in an observed second rate order constant of approximately  $2 \times 10^{-3} \text{ M}^{-1} \text{ s}^{-1}$ . Mitochondrial respiration keeps  $\text{O}_2 \approx 0\text{-}10 \text{ }\mu\text{M}$  in the cell while intracellular concentration of GSH  $\approx 1 \text{ mM}$  (Buettner 1993).

In the study of Poljsak et al. (2005) it was demonstrated that hydroxyl radicals are generated following the interaction of Cr(VI) with ascorbic acid *in vitro*. This is believed to involve the reduction of the metal ion by ascorbic acid, followed by the reduction of oxygen to  $\text{H}_2\text{O}_2/\text{HO}^\bullet$ . Stearns et al. (1995) found out that the reduction of Cr(VI) by ascorbate under physiological conditions produced Cr(V) and carbon-based radicals as intermediates which reacted with DNA to produce Cr-DNA adducts and DNA single-strand breaks, respectively. Low concentrations of ascorbate enhance oxygen radical activity whilst high concentrations scavenge hydroxyl radicals, singlet oxygen and lipid peroxides.

A study by Anderson et al. (1997) examined DNA damage in lymphocytes with comet assay. Vitamin C supplementation significantly elevated plasma vitamin C concentration, but had no effect on oxidative DNA damage either with or without an *ex vivo* hydrogen peroxide challenge. However, a statistically significant increase in bleomycin-induced aberrations was found after vitamin C supplementation. In the study of Green et al. (1994) vitamin C acted as a pro-oxidant when added to isolated lymphocytes *in vitro*. Addition of vitamin C to purified DNA or isolated nuclei in the presence of redox active metal ions *in vitro* results in single-strand breaks and base modifications such as 8-oxodG (Drouin et al. 1996; Fischer-Nielsen et al. 1992, Hu and Shih 1997). The results of Sugiyama et al. (Sugiyama et al. 1991a; Sugiyama 1991b; Sugiyama 1991c) on Chinese hamster V-79 cells showed increased cytotoxicity of Cr(VI) in ascorbic acid pretreated cells.

Other reports on the effect of ascorbic acid alone on different types of cultured cells are confusing and contradictory (Witenberg et al. 1999; Barroso et al. 1997; Sakagami et al. 2000; Satoh et al. 1998; Blankenship et al. 1997). Furthermore, vitamin C may be able to promote metal ion-dependent hydroxyl radical production in biological fluids, but only under certain unphysiological conditions (Smith et al. 1997; Winterbourn, 1981).

Addition of  $\text{Fe}^{2+}$  (but not  $\text{Fe}^{3+}$ ) and  $\text{H}_2\text{O}_2$  to human serum results in rapid generation of hydroxyl radical (Fenton reaction, Figure 4). On the other side, addition of ascorbate to  $\text{Fe}^{3+}$ -loaded serum leads to an immediate increase of superoxide generation, through ascorbate autooxidation (Figure 5) (Ionescu 2002).

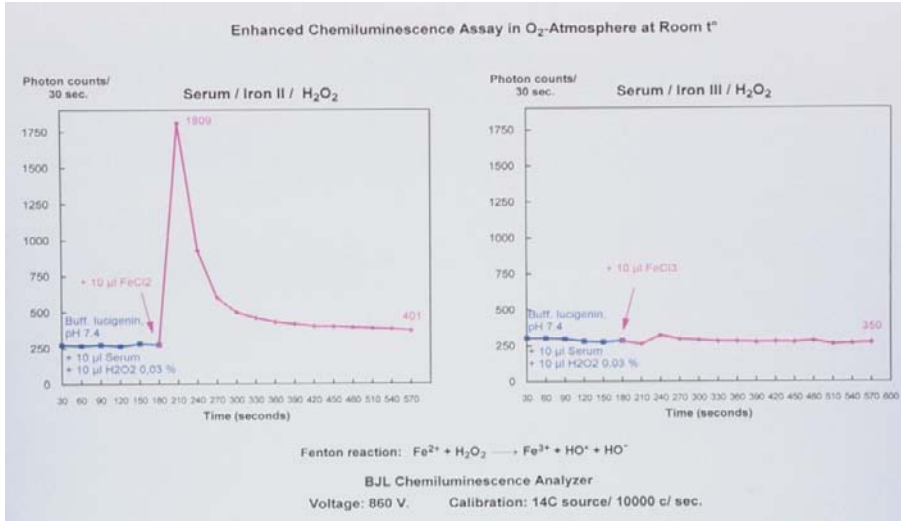

Figure 4. Iron II / Iron III / H<sub>2</sub>O<sub>2</sub> dependent free radical generation.

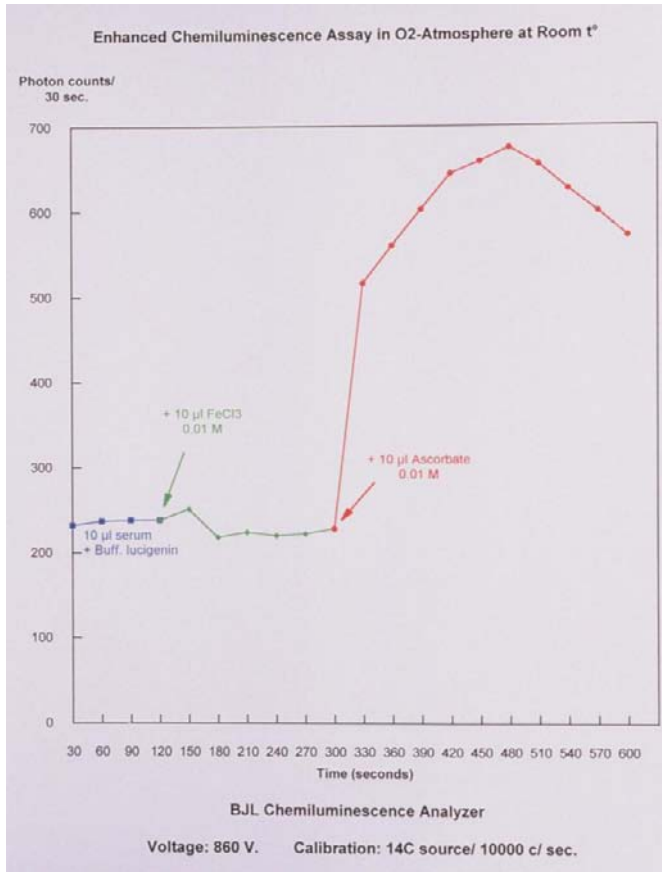

Figure 5. Iron (III) and ascorbate induced free radical activity in serum.

### 3. The *In Vivo* Evidence for a Prooxidative or an Antioxidative Role of Vitamin C

The human oxidative biomarkers data on the role of vitamin C are controversial and appear inconsistent. Some studies examining different biomarkers after vitamin C treatment showed a vitamin C-dependent reduction in oxidative DNA damage, whereas some studies found either no change or an increase in the levels of selected DNA lesions. Carr and Frei (1999) examined nine human vitamin C supplementation studies, four of them showed a reduction in *ex vivo* or *in vivo* DNA oxidation (Cadenas et al. 1997; Fraga et al. 1991; Lee et al. 1998; Panayiotidis and Collins 1997), whereas two showed no change (Prieme et al. 1997; Anderson et al. 1997); another three showed a decrease in some markers and an increase in others (Podmore et al. 1998; Cooke et al. 1998; Rehman et al. 1998). Porkkala-Sarataho et al. (2000) observed that neither vitamin E nor vitamin C, nor the combination influenced the urinary excretion rate of 7-hydro-8-oxo-2-deoxyguanosine. In the study of Podmore and colleagues (1998) the results of supplemented volunteers with 500 mg of vitamin C daily reported 8-oxogua levels were significantly reduced relative to baseline and placebo, whereas the levels of 8-oxoadenine were significantly elevated. Since 8-oxoadenine is at least 10 times less mutagenic than 8-oxogua, the authors conclude that the overall effect of ascorbate intake is “profound protective” (Podmore’s reply to Levine et al, 1998). On the same line, Vojdani et al (2000) report in a placebo-controlled study that increasing concentrations of vitamin C administered to humans (500mg, 1000mg and 5000mg per day, respectively) showed no DNA oxidation products, but a decrease of apoptosis and an increase of NK-cell cytotoxic activity.

In the study from Fraga et al. (1991) volunteers were supplemented with iron and vitamin C and levels of 13 different types of oxidized DNA bases in white blood was monitored. There were no control groups given either iron or vitamin C alone, nor was there a placebo group. Results revealed an inverse correlation between mean plasma vitamin C concentrations and total oxidative DNA damage. This study does not provide compelling evidence for a pro-oxidant effect of vitamin C and iron cosupplementation on DNA damage, but supports an antioxidant effect (Carr and Frei 1999). Inverse correlations of lymphocyte ascorbate and glutathione concentrations with oxidized DNA bases in another study of 105 apparently healthy adults suggest that these two intracellular antioxidants protect human lymphocytes against oxidative damage (Lenton et al. 1999).

Urinary excretion of DNA oxidant damage products, which is thought to represent the balance of total body DNA damage and repair has been investigated. This is a nonspecific measure used to assess changes due to micronutrient status. Except for the study by Cooke et al. (1998), no relationships between vitamin C intake and urinary markers of DNA damage were observed (DRI for vitamin C, Food and Nutrition Board, Institute of Medicine 2000).

The five measured DNA and chromosome damage *ex vivo* after supplementing the subjects with vitamin C were discussed by the Food and Nutrition Board, Institute of Medicine 2000 (DRI for vitamin C). Single large doses of vitamin C (1 g/day or more) provided protection against lymphocyte DNA strand break damage induced *ex vivo* by radiation or hydrogen peroxide (H<sub>2</sub>O<sub>2</sub>) as measured by the comet assay (Green et al. 1994; Panayiotidis and Collins 1997). In contrast, Crott and Fenech (1999) reported that a single 2-

g dose of vitamin C neither caused DNA damage nor protected cells against hydrogen peroxide-induced toxicity. Two other studies measured DNA chromosome damage after treatment of lymphocytes with bleomycin, a test for genetic instability. Following vitamin C supplementation for two weeks, Pohl and Reidy (1989) found decreased chromosome breaks and Anderson et al. (1997) reported no effects on DNA damage but increased chromosome aberrations. Since the findings of these studies were inconsistent, *ex vivo* damage cannot be used to estimate a vitamin C requirement (DRI for vitamin C, Food and Nutrition Board, Institute of Medicine 2000).

A study using rats challenged with paraquat showed an antioxidant role for vitamin C when given before paraquat treatment, but a pro-oxidant role when given after the challenge, as determined by expiratory ethane (Kang et al. 1998). Similar effect was reported by Poljsak et al. (1995) on vitamin C pre-treated yeast cells which were later exposed to chromium.

Additionally, pretreatment of Chinese hamster V-79 cells with ascorbic acid enhanced the cytotoxicity of chromate and enhanced the DNA-protein cross-links (Sugiyama et al. 1991b). A study conducted by Quievryn et al. (2002) showed that increasing intracellular ascorbate levels by pretreating cultures with dehydroascorbic acid (DHA) significantly increased Asc-DNA crosslink levels. O'Brien et al. (2002) found that increasing the molar ratio of ascorbate to Cr(VI) beyond 2 led to a general reduction in Cr-DNA adducts, because at these higher relative levels of ascorbate, more coordinate sites on Cr are occupied by ascorbate and, thus, prevent further Cr-DNA interaction. Moreover, reactive ascorbyl and carbon-based radicals are generated at ratios of above or below 3, respectively. At an Asc:Cr(VI) ratio of 12, fewer ICLs were observed compared to the ratio of 0.5, suggesting that higher relative molar amounts of Asc interfere with the formation of both, mono and bi-functional adducts (O'Brien et al. 2002). Another animal study has reported an antioxidant role for vitamin C in guinea pigs co-supplemented with vitamin C and iron. In the study of Collins et al. (1997) autoxidation of liver microsomes obtained from iron-supplemented guinea pigs resulted in increased accumulation of MDA compared with control animals or animals co-supplemented with iron and vitamin C. An important point to note about studies in animals that can synthesize vitamin C, such as rats, is that the results may not reflect the situation in humans. According to Carr and Frei (1999) several vitamin C and iron co-supplementation studies, both in animals and humans, indicate that vitamin C inhibits rather than promotes iron-dependent oxidative damage. Similarly, a study carried out in humans to assess the effects of simultaneous iron and vitamin C supplementation has yielded mixed results with respect to various types of oxidized DNA bases in leukocytes. Reanalysis of the data from this study (Rehman et al. 1998) suggest that vitamin C acts as an antioxidant, rather than a pro-oxidant, *in vivo* in the presence of iron (Carr and Frei 1999).

Although vitamin C induced Fenton chemistry occurs readily *in vitro*, its relevance *in vivo* has been a matter of some controversy, the main point of contention being the availability of catalytic metal ions *in vivo* (Halliwell and Gutteridge 1986). It has yet to be proven that oxidative damage *in vivo* can be ameliorated by supplementation with large doses of ascorbic acid. The dose of ascorbate which is protective *in vitro*, may not be relevant *in vivo* (Griffiths 2001). According to Simopoulos (1993), for genetic reasons more than 10% of American whites and perhaps as many as 30% of American blacks have high body iron. Vitamin C is known to increase the gastrointestinal absorption of nonheme iron by reducing

**Patient. B.H. (38), atopic eczema.**

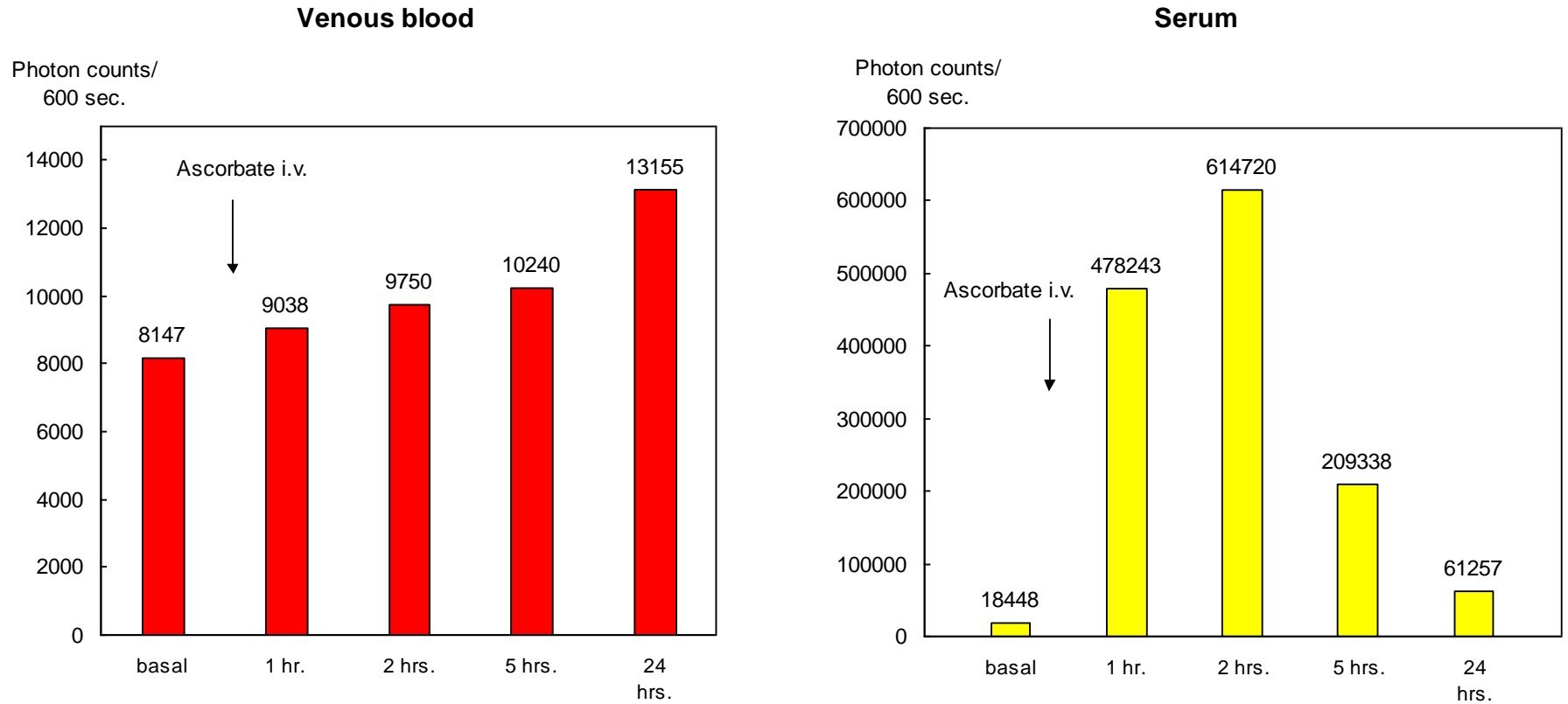

Figure 6. Free radical activity in (a) venous blood and (b) serum before and after 20 g ascorbate i.v.

it to a form that is more easily absorbed (Bendich and Cohen 1990). Individuals with iron overload generally have low plasma levels of vitamin C, possibly due to interaction with the elevated levels of ‘catalytic’ iron in these individuals, and therefore vitamin C administration has been proposed to be harmful in these people (Halliwell 1996; Herbert 1994). According to Herbert (1994) for consumer protection, every advertisement and label for vitamin C and/or iron supplements should warn: “Do not take this product until your blood iron status has been determined”. Six percent of Americans are in negative iron balance, and this product may help them. Twelve percent of Americans are in positive iron balance and this product may hurt them.”

Intravenous administration of large doses of ascorbate (20g) in metal-sensitive atopic eczema patients resulted in a 24-48 hours of worsening of their clinical symptoms, with increased erythema and itching. The simultaneous monitoring of the evolution of free radical generation in whole blood and serum showed a dramatic increase of superoxide and hydrogen peroxide in serum, and a moderate ROS increase in whole blood (Figure 6, Ionescu 2002).

Carr and Frei (1999) analyzed 44 *in vivo* studies done on vitamin C, 38 of them showed a reduction in markers of oxidative DNA, lipid, and protein damage, 14 showed no change and only 6 showed an increase in oxidative damage after supplementation with vitamin C. According to Carr and Frei (1999) the answer to the question: “Does vitamin C act as a pro-oxidant under physiological conditions?” appears to be ‘no’. However, there is still debate on whether supplements of vitamin C could act as pro-oxidants *in vivo*. Vitamin supplements taken by millions of people do not increase life expectancy and some of them, such as beta carotene, vitamin A, and vitamin E may raise the risk of a premature death, according to a latest review of 67 studies with more than 230,000 subjects (Bjelakovic et al. 2007). On the other hand, the same study concludes that “vitamin C and selenium had no significant effect on mortality”.

### 3.1 Vitamin C and Epidemiological Studies

Epidemiological data in humans is confused although some minor benefits to overall mortality risk, coronary heart disease and subsequent risk of stroke, in particular, appear associated with vitamin C supplementation (Enstrom, et al. 1992; Gale et al. 1995; Osganian et al. 2003), despite markers of oxidative damage generally being unaffected (Prieme et al. 1997). A large majority of 26 examined epidemiological studies by Enstrom (2008) show a modest decrease in mortality from all causes, cancer, and cardiovascular diseases with an increase of vitamin C intake, particularly for levels of vitamin C intake around the current U.S. RDA of 75-90 mg per day per adults (Enstrom 2008). However, several other studies show no significant relationship after controlling for confounding variables. According to Enstrom (2008) there does not appear to be a relation between mortality and vitamin C supplement intake *per se*. The strongest inverse relation has been observed in those studies that have analyzed serum vitamin C and total mortality. In the same line, low levels of vitamin C in plasma and leucocytes are closely related to an increased myocardial infarct and stroke risk (Gey et al., 1993; Ramirez and Flowers 1980; Nyssönen et al., 1997; Myint et al., 2008). The potential roles of vitamin C and selenium on mortality need further study



according to Bjelakovic et al. (2007). Furthermore, recent research is rather documenting that vitamin C supplementation confers cardioprotection and has anti-atherosclerotic effects (Shinke et al., 2007; Morel et al., 2003; Nam et al., 2003).

### 3.2. The Possible Explanation of the Dual Role of Antioxidants vs. Pro-Oxidants

Numerous epidemiological studies have shown an inverse association between vitamin C intake, or plasma status, and the risk from different types of cancers (Block 1991; Jenner, et al., 1998). There are several possible explanations for the potential negative effect of antioxidant supplements. Reactive oxygen species in moderate concentrations are essential mediators of defense against unwanted cells. Thus, if administration of antioxidant supplements decreases free radicals, it may interfere with essential defensive mechanisms for ridding the organism of damaged cells, including those that are precancerous and cancerous (Salganik 2001). Thus, antioxidant supplements may actually cause some harm (Vivekananthan et al., 2003; Bjelakovic et al., 2004a; Bjelakovic et al., 2004b; Miller et al., 2005; Bjelakovic et al., 2007; ; Caraballoso et al., 2003). Our diets typically contain safe levels of vitamins, but high-level antioxidant supplements could potentially upset an important physiologic balance (Vivekananthan et al., 2003; Bjelakovic et al., 2004a; Bjelakovic et al., 2004b; Miller et al., 2005; Bjelakovic et al., 2007; Caraballoso et al., 2003). In the same line, a systematic Review and Meta-analysis done by Bjelakovic et al. (2007) conclude that treatment with beta carotene, vitamin A, and vitamin E may increase mortality. There are still many gaps in our knowledge of the mechanisms of bioavailability, biotransformation, and action of antioxidant supplements.

Selman et al. (2006) suggest different possible explanations regarding general inability of antioxidants, including vitamin C, in their antioxidative action:

- I. *In vivo* vitamin C may act more as a pro-oxidant than an antioxidant (Can and Frei 1999; Childs et al., 2001; Rehman et al., 1998) possibly necessitating increased activation of the defence system to maintain the status quo.
- II. Alternatively, vitamin C may successfully scavenge ROS (Carr and Frei 1999) but this may not be translated into damage reduction and lifespan enhancement. Vitamin C may negatively affect the endogenous scavenging and repair systems, either directly (Nemoto et al., 1997; Podmore et al., 1998), or indirectly via systems that sense reduced radical production.

The ability of vitamin C to decrease the activity of endogenous antioxidant systems was reported by (Selman et al., 2006). Mice exhibited a significantly reduced expression of several genes in the liver linked to free-radical scavenging, including Mn-superoxide dismutase and glutathione peroxidase in the vitamin C treated group. Authors suggest that high dietary doses of vitamin C are ineffective at prolonging lifespan in mice because any positive benefits derived as an antioxidant are offset by compensatory reductions in

endogenous protection mechanisms, leading to no net reduction in accumulated oxidative damage. Carr and Frei (1999) suggested that if tissues are already saturated due to an adequate intake of vitamin C at baseline, subsequent supplementation cannot have an effect on tissue vitamin C levels and thus oxidative stress biomarkers. Levine and co-workers (1996) investigated the pharmacokinetics of vitamin C and found that in healthy humans, tissue saturation (measured in peripheral blood leukocytes) occurred at vitamin C intakes of ~100 mg/day, which corresponds to a plasma concentration of ~50 mmol/l.

Carr and Frei (1999) pointed out an important point of distinction between vitamin C acting as a pro-oxidant or an antioxidant is the moment when the vitamin is added to the system (Kang et al., 1998; Otero et al., 1997). For example, vitamin C acts as an antioxidant if added before initiation of LDL oxidation by copper, but acts as a pro-oxidant if added to LDL that is already (mildly) oxidized (Otero et al., 1997). Since transition-metal ions are liberated from metalloproteins as a primary mechanism of injury by oxidative damage (Halliwell and Gutteridge 1999; Swain et al., 1994; Kang et al., 1998), administration of a powerful antioxidant (i.e., powerful reducing agent) after oxidative damage has started could promote damage—i.e., be pro-oxidant—and the more powerful the antioxidant is as a reducing agent, the more problems it might cause (Halliwell 2000). As already observed *in vitro* (Ionescu 2002, Fig 2), the autooxidation of supplemented vitamin C in the presence of transition metals also depends on the concentrations of other antioxidants in the system, such as reduced glutathione, NADH, NADPH.

A reason why vitamin C and other antioxidant supplements would be expected to increase lung cancer and mortality in smokers (alpha-tocopherol/beta-carotene cancer prevention (ATBC) study. (1994)) is that vitamin C supplements drive nicotine out of the blood into the urine (Herbert et al., 1994), causing smokers to reach for that next cigarette (more carcinogens) that much faster to sustain their nicotine ‘high’.

More studies are warranted in which the effects of vitamin C supplementation on more than one biomarker of oxidative damage are determined. This is particularly important, according to Carr and Frei (1999) because several studies in which more than one oxidative biomarker was measured showed an antioxidant role of vitamin C with respect to lipid oxidation, but not DNA oxidation (Hu and Shih 1997) or protein oxidation (Frei et al., 1989; Frei, et al., 1988; Cross et al., 1993). These discrepancies may be due to the differential ability of the various macromolecules, i.e., DNA, lipids, and proteins, to bind metal ions and the redox activity of the bound metal ions (Halliwell and Gutteridge 1986).

### 3.3. Redox Balance and Cancer

The consensus opinion has been that five servings of fruits and vegetables containing the above nutrients would reduce the incidence of various cancers (Hwang et al., 1994; National Research Council 1992; Shklar and Schwartz 1994). The ingestion of these foods would provide a wide range of phytochemicals acting as chemopreventives. Hoffer et al. (2008) reported that scientific interest in the interaction between ascorbic acid and cancer has increased in recent years with evidence that in millimolar concentrations—which are attainable only after parenteral administration—it is selectively cytotoxic to many neoplastic

cell lines (Bran et al., 1980; Sestili et al., 1996; Chen et al., 2005), potentiates cytotoxic agents (Song et al., 1995; Kurbacher et al., 1996; Kassouf et al., 2006; Grad et al., 2001; Abdel-Latif et al., 2005) and demonstrates anticancer activity alone and in combination with other agents in tumor-bearing rodents (Sarna and Bhola 1993; Verrax et al., 2006; Taper et al., 2004). Simultaneously, theoretical interest has arisen in the potential of redox-active molecules to modify cancer biology (Verrax et al., 2006) especially when administered together with cytotoxic drugs (Tetef et al., 1995; Diaz et al., 2005; Doroshow 2006).

DNA mutation is likely a major contributor to the age-related development of cancer (Deng et al., 1998; Halliwell 2000). Attenuation of oxidative stress induced mutations through vitamin C could provide a potential cancer prevention mechanism (Li and Schellhorn 2007). Paradoxically, ascorbic acid may also function as a prooxidant, promoting oxidative damage to DNA (Stich et al., 1976). This occurs in the presence of free transition metals, such as copper and iron, which are reduced by ascorbate and, in turn, react with hydrogen peroxide, leading to the formation of highly reactive and damaging hydroxyl radicals, *via* the Fenton reaction (Stich et al., 1976). However, the relevance of such abnormal physiological conditions *in vivo* has been questioned, as most transition metals exist in inactive, proteinbound form *in vivo* (Halliwell and Gutteridge 1986). However, ascorbic acid may also display a pro-oxidant activity, which is more profound in cancer cells and causes cell death, when used at pharmacological concentrations (0.3–20 mmol/L), (Chen et al., 2005). Increased generation of hydrogen peroxide (by ascorbic acid autooxidation) *in vivo* may be exploited as a means for inducing tumor-specific cytotoxicity (Gonzales et al. 2005). An explanation for this quite specific anticancer activity of vitamin C is provided by recent research reporting highly increased levels of transition metals in malignant tumors (Ionescu et al., 2006; Ionescu 2007a; Yaman et al 2005) (Fig 79-911), leading to *in situ* auto-oxidation of the vitamin and generation of  $H_2O_2/HO^{\bullet}$  with apoptosis induction.

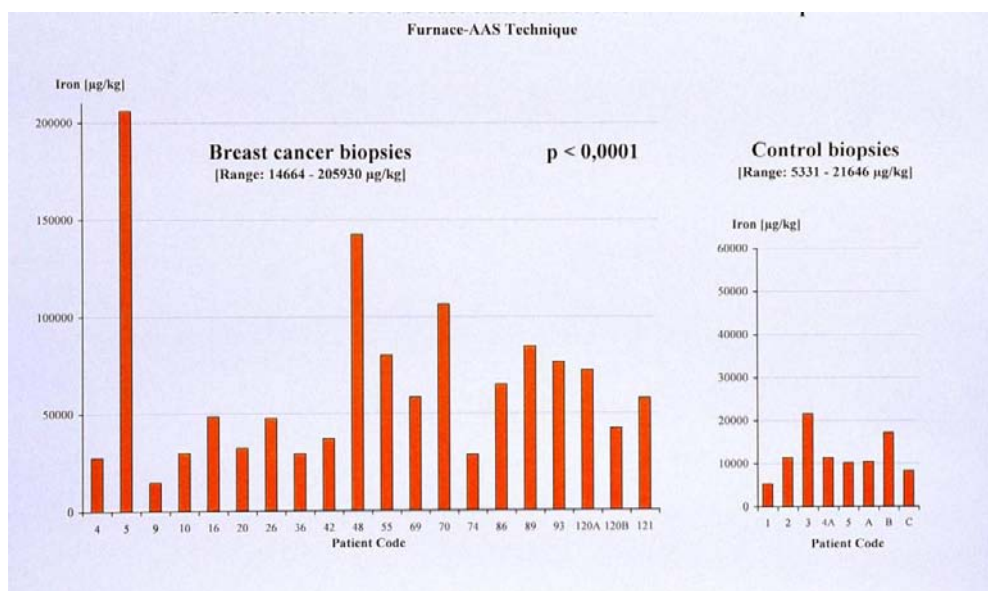

Figure 7. Iron content of 20 breast cancer and 8 control human biopsies.

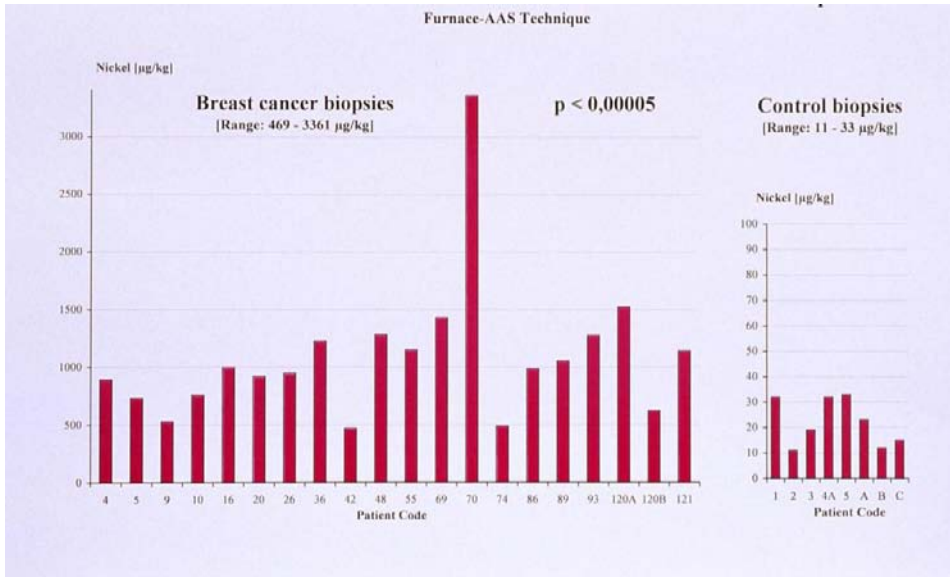

Figure 8. Nickel content of 20 breast cancer and 8 control human biopsies.

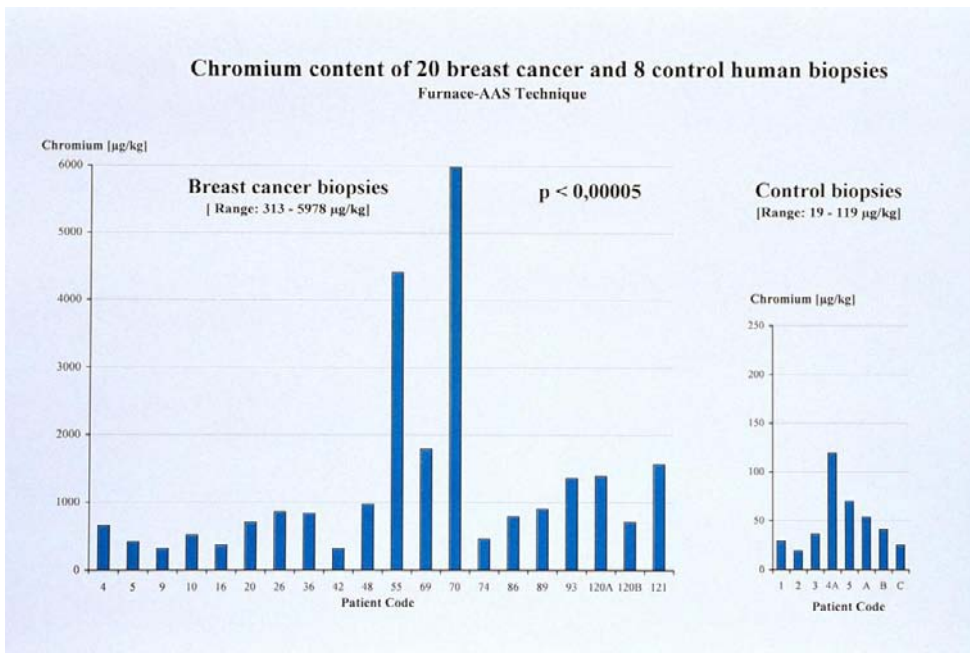

Figure 9. Chromium content of 20 breast cancer and 8 control human biopsies.

Antioxidants can modify cellular oxidative balance resulting in proliferation stimulation (increased viability) or protect damaged cells from oxidative-stress induced suicide (apoptosis), and thereby accelerate cancer progression in higher eucaryotes. Antioxidants can sometimes suppress apoptosis, and sometimes facilitate it (Hampton and Orrenius 1998; Clement and Pervais 1999, Halliwell 2000). Apoptosis is accompanied by an intracellular shift towards increased oxidation, but too much oxidation will stop apoptosis by oxidising

and inactivating the caspase enzymes (Hampton and Orrenius 1998). On the other hand, low quantities of reactive oxygen species often stimulate cell proliferation (Burdon 1995). In addition, when an inappropriate pro-oxidant activity develops in normal cells, the reactive oxygen metabolites generated could damage the DNA and cellular membranes. The initiation of programmed cell death in tumor cells could result in the loss of malignant cellular integrity. In contrast, (reducing agents) antioxidants that quench free radicals or reactive oxygen products in transforming tumor cells may allow these selected cells to proliferate, enhance DNA repair and become therapeutically more resistant to treatment. Cancer cells are known to accumulate large amounts of antioxidants, such as glutathione, which, in turn, render these cells resistant to classic anticancer therapies (Luisini 2001, Yeh 2006). According to Schwartz (1996) when an antioxidant activity occurs in transformed cells an enhanced growth may result. The result of this modification of the tumor population would be the inadvertent enhanced survival and selection of tumor cell clones.

Increasing cellular viability with ascorbic acid pretreatment in Cr(VI)-induced toxicity was reported by Poljsak et al. (2002; 2005) in yeast cells. This might not always be beneficial. Chromium-induced growth-arrest and apoptosis are at the molecular decision point between chromium toxicity and chromium carcinogenesis (Singh et al., 1998; Carlisle et al., 2000). When normal growing cells come in contact with carcinogenic forms of chromium, they may respond by undergoing growth arrest, apoptosis and necrosis. A population of genetically damaged cells may also emerge, which exhibits either intrinsic or induced resistance to apoptosis (Carlisle et al., 2000). Such cells may be predisposed to neoplasia as a result of their altered growth/death ratio, disrupted cell cycle control, or genomic instability. This, however, raises the question of whether ascorbic acid-decreased Cr(VI) toxicity may actually increase the incidence of cancer (in higher eukaryotes) by allowing the inappropriate survival of genetically damaged cells. Besides, cells have their own endogenous antioxidants (superoxid dismutase, catalase, glutathione) and the addition of one single synthetic antioxidant could interfere with the complex antioxidant (redox) network and decrease the activity of endogenous defense. Because vitamin C is essential for collagen maturation and stabilization, it has been suggested that ascorbic acid may reduce tumor spreading by potentiating the stability of the extracellular matrix, especially since neoplastic invasion exhibits similar pathological manifestations as vitamin C deficiency (Gonzales et al., 2005). Unfortunately, the effects of vitamin C deficiency on metastasis caused by reduced collagen stabilization have not yet been examined *in vivo* due to the lack of appropriate animal models (Li and Schellhorn 2007). Though not fully understood, there are two opposing views on the role of the collagen-stabilizing function of vitamin C on tumor growth. First, by stabilizing collagen, ascorbic acid fortifies the extracellular matrix and stromal structures, leading to better confinement of neoplastic cells to their primary sites and preventing tumor growth and metastasis (Gonzales et al., 2005). Second, the same function may also facilitate the formation of new blood vessels, providing the prerequisite for malignant tumor growth (Telang et al., 2007). The interplay of these effects *in vivo*, especially under pharmacological levels of vitamin C, is far from clear (Li and Schellhorn 2007). In addition to angiogenesis, cancer cells can also modify their energy metabolic pathways to adapt to the low oxygen microenvironment in the interior of a solid tumor (Leo et al., 2004; Vaupel 2004). This is achieved by activation of hypoxia-responsive gene expression networks controlled by

hypoxia-inducible factor-1a (HIF-1a) (Harris 2002; Schofield and Ratcliffe 2004). The negative impact of ascorbate on HIF-1a expression raises the question of whether intracellular vitamin C can inhibit the hypoxia-induced adaptation of solid tumor and thus restrict tumor growth and metastasis (Li and Schellhorn 2007). In high doses, ascorbic acid can trigger hemolysis in glucose-6-phosphate dehydrogenase deficient subjects, especially in the presence of infection and fever (Levine et al., 1999). Because oxalic acid is a major end metabolite of ascorbic acid oxidation, even limited oxidation of a large i.v. dose of ascorbic acid to oxalic acid could be dangerous. Acute tumor hemorrhage and necrosis have been reported within days after starting i.v. ascorbic acid in patients with advanced cancer (Cameron and Campbell 1974).

In 1997 the World Cancer Research Fund and the American Institute for Cancer Research issued an authoritative statement: "Food, nutrition and the prevention of cancer: a global perspective". They rated the anti-cancer effects of ascorbate as "probable" only for stomach cancer (its role is in its inhibitory effects on nitrosamine formation (Mirvish et al., 1998; Halliwell B. 2000) rather than antioxidant effects), "possible" for prostate, mouth, pharynx, oesophagus, lung, pancreas and cervical cancers and "insufficient data" for cancers of the colon, rectum, larynx, breast and bladder (Halliwell B. 2000). The controversy in beneficial vs. harmful vitamin C properties may also reflect a misinterpretation of epidemiology. Fruits, grains and vegetables contain multiple components that might exert protective effects against disease. It could be any, or any, combination of those factors that is a true protective agent. High plasma ascorbate levels or high ascorbate intake could simply be a marker of a good diet rather than a true protective factor (Rietjens et al., 2001). However, the direct inverse relationship between serum vitamin C levels and mortality cannot be neglected.

## 4. Conclusion

There will be continuous interest in the use of vitamin C for the treatment of human diseases, as well as in the vitamin C induced prevention of disease development. Herbert (1994) suggests that vitamin C (and other antioxidants) are mischaracterized by describing them solely as "antioxidants". They in fact are redox agents, antioxidants in some circumstances (like the physiological quantities found in food), and pro-oxidants (producing billions of harmful free radicals) in other circumstances (often so in the pharmacologic quantities found in ill-designed supplements). However, epidemiological studies and clinical trials examining the ability of antioxidant vitamins (either individually or in combination) to affect disease outcome, rarely address possible underlying mechanisms. Thus, in these studies it is often assumed that antioxidant vitamins act by lowering oxidative damage, but evidence in support of this contention is not provided (DRI for vitamin C, Food and Nutrition Board, Institute of Medicine 2000). Whereas fruit and vegetable consumption decreases the amount of free-radical damage to DNA and the human body, supplements of vitamin C do not decrease the oxidative damage in some of the studies. Results from most intervention trials with single antioxidant in pharmacological doses do not support a protective effect. Recent studies suggest that well-known antioxidants (vitamin E, C, beta carotene) contribute a

relatively small part of the total antioxidants. It should be noted that the protective effect of certain diet is not equivalent to the protective effect of antioxidants in the diet. Positive effects of the protective substances that originate from food are greater because of the synergic activity between individual antioxidant substances (Rietjens et al., 2001), nutritional fibers and secondary vegetal substances. Dr. Bjelakovic's team (2007) evaluated 67 randomized clinical trials with 232,550 subjects. The evidence suggests it would be safer to obtain the compounds not as supplements, but by eating plenty of fruit and vegetables. Fruits and vegetable contain at least several hundred different types of antioxidants (i.e., electron or hydrogen donating reductants) which may directly react with free radicals. Another mechanism involves activation of genes encoding proteins in the antioxidant defense.

The outcome of latest epidemiologic studies is contradictory. Many studies show an inverse relationship between mortality and vitamin C intake. However, several studies show no relationship at all or no significant relationship after controlling for confounding variables. Several reports suggest a pro-oxidant or adverse effect from vitamin C *in vitro* and *in vivo*. It is well established by *in vitro* experiments that vitamin C is reactive with free iron and produces the ascorbate radical, while causing oxidative damage to biomolecules (DRI for vitamin C, Food and Nutrition Board, Institute of Medicine 2000). Scientists have claimed increases in DNA damage in healthy humans supplemented with vitamin C and iron salts, as well as ascorbyl radical formation in subjects with sepsis following ascorbate loading. However, other studies show vitamin C as protective antioxidant that can prevent oxidative stress. Whether vitamin C functions as an antioxidant or prooxidant is determined by at least 3 factors: 1) the redox potential of the cellular environment; 2) the presence/absence of transition metals; and 3) the local concentrations of ascorbate (Ionescu 1998; Gonzales et al., 2005; Ionescu 2006).

Ascorbic acid has been described as “of all the paradoxical compounds, ascorbic acid probably tops the list. It is truly a two-headed Janus, a Dr. Jekyll-Mr. Hyde, an oxymoron of antioxidants” (Porter 1993). As already Paracelsus realized that “Sola dosis facit venenum”, similar is the fact that intakes of vitamin C below the recommended daily allowance are associated with increased free radical damage to DNA (Rehman et al., 1998; Fraga et al., 1996) due to its ability to react with the “free” metal ions in the Fenton-like chemical reactions.

The thesis that pro-oxidant effect of vitamin C depends on its unbalance with other antioxidants, minerals and other nutrients, among them many still unknown, opens many questions regarding the best way to minimize the oxidative damage through food intake. Enough fruits and vegetables seem to be just the first step to this goal. Experiments on pigs show that supplementation of diet with different types of fruits and vegetables (apples, strawberries and tomatoes) have different effects on lowering the level of oxidative stress; so does their combinations (Pajk Žontar et al; 2006). Which combination of fruits and vegetable is best for humans? A controlled intervention should take into account the subject's blood redox potential and his total antioxidant activity, as already described (Ionescu 2007b), Figure 10.

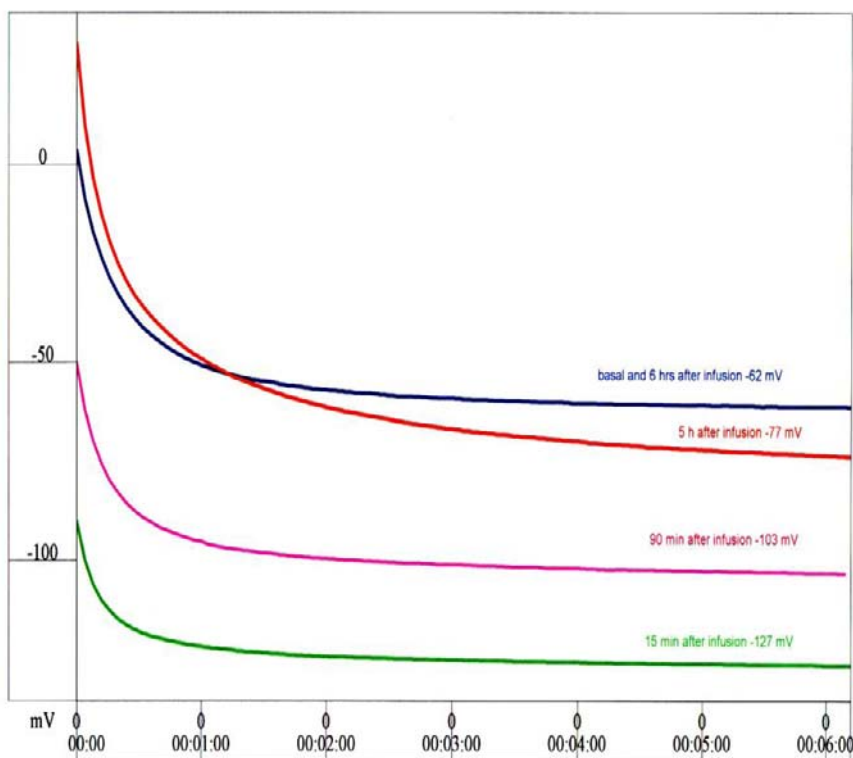

Figure 10. Effects of 8.5 g intravenous vitamin C administration on serum redox potential in a MCS patient (male, 42 yrs).

According to well known biologists thesis, no animal species is optimally adapted to environment (Dawkins, 1999), especially in changeable environment. Despite the new finding on speeding up of genetic changes in humans (Hawkes, 2007), human genes didn't change much during last 10.000 years, but all produced food does due to normal selection that agriculture does (Watson, Berry 2007). Moreover todays fruits and vegetables are depleted of some essential micronutrients because of intensified type of production (Poljšak, 2006) or because of post harvest processes - transport, storage etc (Tijksens, 2004). What is the content of nutrients of specific fruits and vegetables we eat? How to measure with non invasive methods the specific needs of vitamin C and other nutrients of each individual? The path of food supplements seems to be at the present time even more uncertain. However there is a general trend to increase of processed food and food supplements. In most countries of the world the consumption of fruit and vegetables is below the minimal level of 400 g per day advised by WHO and FAO (FAO/WHO 2004). Even in countries that had in the past high consumption of fruit and vegetables their consumption has been lowering (López-Torres, Barja, 2008). The addition of different food supplements to the diet with seems to be, besides consumption of fruit and vegetables, for different reasons, and especially in different clinical conditions, a need as well. But more research is needed to find solutions that are closer to optimal human diet.



## References

- [1] Abdel-Latif, M.M.& Raouf ,A.A.& Sabra, K., et al. (2005). Vitamin C enhances chemosensitization of esophageal cancer cells in vitro. *J Chemother*, 17, 539–549.
- [2] Anderson, D. & Phillips, B. J. & Yu, T. & Edwards, A. J. & Ayes, R. & Butterworth, K. R. (1997). The effects of vitamin C supplementation on biomarkers of oxygen radical generated damage in human volunteers with ‘low’ or ‘high’ cholesterol levels. *Environ. Mol. Mutagen.* 30, 161–174.
- [3] Anderson, D. & Phillips, B.J. (1999). Comparative *in vitro* and *in vivo* effects of antioxidants. *Food Chem Toxicol*, 37, 1015-1025.
- [4] Barroso M.P. & Gomez-Diaz C. & Lopez-Lluch, G. & Malagon M.M. & Crane F.L. & Navas P. (1997). Ascorbate and alpha-tocopherol prevent apoptosis induced by serum removal independent of Bcl-2. *Arch Biochem Biophys.* 343, 243-248.
- [5] Beatty, E.R. & England, T.G. & Geissler, C.A. & Aruoma, O.I. & Halliwell B. (1999). Effects of antioxidant vitamin supplementation on markers of DNA damage and plasma antioxidants. *Proc Nutr Soc*, 58 (abstr), 44.
- [6] Bendich, A. & Cohen, M. (1990). Ascorbic acid safety: analysis of factors affecting iron absorption. *Toxicol. Lett.*, 51, 189–201.
- [7] Berger, T. M. & Polidori, M. C. & Dabbagh, A. & Evans, P. J. & Halliwell, B. & Morrow, J. D. & Roberts, L. J., Frei, B. (1997). Antioxidant activity of vitamin C in iron-overloaded human plasma. *J. Biol. Chem.* 272, 15656–15660.
- [8] Bjelakovic G. & Nikolova D. & Gluud L.L. & Simonetti R.G. & Gluud C. (2007). Mortality in randomized trials of antioxidant supplements for primary and secondary prevention: systematic review and meta-analysis. *JAMA*, 297, 842–57.
- [9] Bjelakovic G. & Nikolova D. & Simonetti R.G. & Gluud C. (2004a). Antioxidant supplements for preventing gastrointestinal cancers. *Cochrane Database Syst Rev*, 4, CD004183.
- [10] Bjelakovic G. & Nikolova D. & Simonetti R.G. & Gluud C.(2004b). Antioxidant supplements for prevention of gastrointestinal cancers: a systematic review and meta-analysis. *Lancet*, 364, 1219–28.
- [11] Blankenship L.J. & Carlisle D.L. & Wise J.P. & Orenstein J.M. & Dye L.E. & Patierno S.R. (1997). Induction of apoptotic cell death by particulate lead chromate: differential effects of vitamins C and E on genotoxicity and survival. *Toxicol Appl Pharmacol* 146, 2, 270-80.
- [12] Block, G. (1991) Vitamin C and cancer prevention: the epidemiologic evidence. *Am. J. Clin. Nutr.* 53, 270–282.
- [13] Bram, S.& Froussard, P., , M .et al. (1980). Vitamin C preferential toxicity for malignant melanoma cells. *Nature*, 284: 629–631.
- [14] Buettner G.R. (1993). The pecking order of free radicals and antioxidants: lipid peroxidation,  $\alpha$ -tocopherol, and ascorbate. *Arch Biochem Biophys* 300, 535-543.
- [15] Buettner, G. R. & Jurkiewicz, B. A. (1996). Catalytic metals, ascorbate and free radicals: combinations to avoid. *Radiat. Res.*, 145, 532–541.
- [16] Burdon R.H. (1995). Superoxide and hydrogen peroxide in relation to mammalian cell proliferation. *Free Rad Biol Med*, 18, 775–94.

- [17] Cadenas, S. & Barja, G. & Poulsen, H. E. & Loft, S. (1997). Oxidative DNA damage estimated by oxo8dG in the liver of guinea-pigs supplemented with graded dietary doses of ascorbic acid and  $\alpha$ -tocopherol. *Carcinogenesis* 18, 2373–2377.
- [18] Cameron, E. & Campbell, A. (1974). The orthomolecular treatment of cancer. II. Clinical trial of high-dose ascorbic acid supplements in advanced human cancer. *Chem Biol Interact*, 9, 285–315.
- [19] Carr, A., & Frei, B., (1999). Does vitamin C act as a pro-oxidant under physiological conditions? *FASEB J.* 13, 1007-1024.
- [20] Caraballoso M. & Sacristan M. & Serra C. & Bonfill X. (2003). Drugs for preventing lung cancer in healthy people. *Cochrane Database Syst Rev*, 2, CD002141.
- [21] Carlisle D.L. & Pritchard D.E. & Singh J. & Owens B.M. & Blankenship L.J. & Orenstein J.M. & Patierno S.R. (2000). Apoptosis and P53 induction in human lung fibroblasts exposed to chromium(VI): effect of ascorbate and tocopherol. *Toxicol Sci*, 55, 60-68.
- [22] Chen Q. & Espey M.G. & Krishna M.C. & Mitchell J.B. & Corpe C.P. & Buettner G.R. & Shacter E. & Levine M. (2005). Pharmacologic ascorbic acid concentrations selectively kill cancer cells: action as a pro-drug to deliver hydrogen peroxide to tissues. *Proc Natl Acad Sci USA*, 102, 13604–9.
- [23] Childs, A. & Jacobs, C. & Kaminski, T. & Halliwell, B. & Leeuwenburgh .C. (2001). Supplementation with vitamin C and N-acetyl-cysteine increases oxidative stress in humans after an acute muscle injury induced by eccentric exercise. *Free Radic. Biol. Med.*, 31, 745-153.
- [24] Clement M.V. & Pervaiz S. (1999). Reactive oxygen intermediates regulate cellular response to apoptotic stimuli. *Free Rad Res*, 30, 247–52.
- [25] Clement M.V. & Ramalingam J. & Long L.H. & Halliwell B. (2001). The in vitro cytotoxicity of ascorbate depends on the culture medium used to perform the assay and involves H<sub>2</sub>O<sub>2</sub>. *Antioxid Redox Signal*, 3, 1, 157-63.
- [26] Collis, C. S. & Yang, M. & Diplock, A. T. & Hallinan, T. & Rice-Evans, C. A. (1997). Effects of co-supplementation of iron with ascorbic acid on antioxidant-pro-oxidant balance in the guinea pig. *Free Rad. Res.* 27, 113–121.
- [27] Cooke M.S. & Evans M.D. & Podmore I.D. & Herbert K.E. & Mistry N. & Mistry P. & Hickenbotham P.T. & Hussieni A. & Griffiths H.R. & Lunec J. (1998). Novel repair action of vitamin C upon in vivo oxidative DNA damage. *FEBS Lett* 439, 363–367.
- [28] Cross, C. E. & O'Neill, C. A. & Reznick, A. Z. & Hu, M. L. & Marcocci, L. & Packer, L. & Frei, B. (1993). Cigarette smoke oxidation of human plasma constituents. *Ann. NY Acad. Sci.* 686, 72–89.
- [29] Crott J.W & Fenech M. (1999). Effect of vitamin C supplementation on chromosome damage, apoptosis and necrosis ex vivo. *Carcinogenesis*, 20, 1035–1041.
- [30] Dabbagh, A. J. & Frei, B. (1995). Human suction blister interstitial fluid prevents metal ion-dependent oxidation of low density lipoprotein by macrophages and in cell-free systems. *J. Clin. Invest.* 96, 1958–1966.
- [31] Dasgupta, A. & Zdunek, T. (1992) *In vitro* lipid peroxidation of human serum catalyzed by cupric ion: antioxidant rather than prooxidant role of ascorbate. *Life Sci.* 50, 875–882.

- [32] Dawkins, R.(1982/1999). *The Extended Phenotype: The long Reach of the Gene*, Oxford, New York: Oxford University Press; 1999
- [33] Deng X.S. & Tuo J.S. & Poulsen H.E. & Loft S. (1998). Prevention of oxidative DNA damage in rats by Brussels sprouts. *Free Radic Res.*, 28, 323–33.
- [34] Deutsch J.C. (1998). Ascorbic acid oxidation by hydrogen peroxide. *Anal biochem*, 255, 1-7.
- [35] Diaz, Z.& Colombo, M.& Mann, K.K. et al. (2005). Trolox selectively enhances arsenic-mediated oxidative stress and apoptosis in APL and other malignant cell lines. *Blood*, 105, 1237–1245.
- [36] Dietary Reference Intakes for Vitamin C, Vitamin E, Selenium, and Carotenoids (2000). A report of the panel on dietary antioxidants and related compounds, Subcommittees on upper reference levels of nutrients and interpretation and uses of dietary reference intakes, and the standing committee on the scientific evaluation of dietary reference intakes, Food and Nutrition Board, Institute of Medicine, National Academy Press, Washington, D.C. From internet: [http://books.nap.edu/openbook.php?record\\_id=9810](http://books.nap.edu/openbook.php?record_id=9810)
- [37] Doroshow, J.H. (2006). Redox modulation of chemotherapy-induced tumor cell killing and normal tissue toxicity. *J Natl Cancer Inst*, 98, 223–225.
- [38] Dreosti I.E. (1991). Free radical pathology and the genome. In: Dreosti, IE (Eds.), *Trace elements, micronutrients, and free radicals* (149-171).New Jersey, The Humana Press.
- [39] Drouin, R.& Rodriguez, H. & Gao, S. W. & Gebreyes, Z. & O'Connor, T. R. & Holmquist, G. P. & Akman, S. A. (1996). Cupric ion/ascorbate/hydrogen peroxide-induced DNA damage: DNA-bound copper ion primarily induces base modifications. *Free Rad. Biol. Med.* 21, 261–273 39.
- [40] Enstrom J (2008). *The epidemiology of vitamin C*. Elsevier.
- [41] Enstrom, J. & Kanim, L. & Klein, M.A. (1992). Vitamin C intake and mortality among a sample of the United States population. *Epidemiology* 3, 194-202.
- [42] Fiala, E. S. & Sodum, R. S. & Bhattacharya, M. & Li, H. (1996). Epigallocatechin gallate, a polyphenolic tea antioxidant, inhibits peroxynitrite-mediated formation of 8-oxodeoxyguanosine and 3-nitrotyrosine. *Experientia* 52, 922–926.
- [43] Fischer-Nielsen, A. & Poulsen, H. E., & Loft, S. (1992). 8-Hydroxydeoxyguanosine Hydroxydeoxyguanosine in vitro: effects of glutathione, ascorbate, and 5-aminosalicylic acid. *Free Rad. Biol. Med.* 13, 121–126 40.
- [44] Food and Agriculture Organization/ World Health Organization (2004):Fruit and Vegetables for Health: Report of a Joint FAO/WHO Workshop, 1-3 September 2004, Kobe, Japan.
- [45] Food and Drug Administration. November 1-3. (1993). FDA Conference on Antioxidant Vitamins and Cancer and Cardiovascular Disease. Washington. DC: Office of Special Nutritionals, 1993( transcript).
- [46] Fraga, C. G. & Motchnik, P. A. & Shigenaga, M. K. & Helbock, H. J. & Jacob, R. A. & Ames, B. N. (1991). Ascorbic acid protects against endogenous oxidative DNA damage in human sperm. *Proc. Natl. Acad. Sci. U. S. A.* 88, 11003–11006.

- [47] Fraga, C.G. & Motchnik, P.A. & Wyrobek, A.J. & Rempel, D.M. & Ames B.N. (1996). Smoking and low antioxidant levels increase oxidative damage to sperm DNA. *Mutat Res*, 351, 199–203.
- [48] Frei B. & England L. & Ames B.N. (1989). Ascorbate is an outstanding antioxidant in human blood plasma. *Proc Natl Acad Sci USA*, 86, 6377–6381.
- [49] Frei, B. & Stocker, R. & Ames, B.N. (1988). Antioxidant defenses and lipid peroxidation in human blood plasma. *Proc. Natl. Acad. Sci. U. S. A.* 85, 9748–9752.
- [50] Gale, C.R. & Martyn, C.N. & Winter, P.D. & Cooper, C. (1995). Vitamin C and risk of death from stroke and coronary heart disease in cohort of elderly people. *Br Med J* 310, 1563–1566.
- [51] Gey KF, & Stähelin HB, & Eichholzer M. (1993) Poor plasma status of carotene and vitamin C is associated with higher mortality from ischemic heart disease and stroke: Basel Prospective Study. *Clin Investig* 71(1):3-6.
- [52] Gonzalez, M.J. & Miranda-Massari, J.R. & Mora, E.M. & Guzman, A. & Riordan, N.H. & Riordan, H.D. & Casciari, J.J. & Green, M.H.L. Lowe, J.E. & Waugh, A.P.W. & Aldridge, K.E. Cole, J. & Arlett, C.F. (1994). Effect of diet and vitamin C on DNA strand breakage in freshly-isolated human white blood cells. *Mutat Res*, 316, 91–102.
- [53] Gonzalez, M.J. & Miranda-Massari, J.R. & Mora, E.M. & Guzman, A. & Riordan, N.H. & Riordan, H.D. & Casciari, J.J. & Jackson, J.A. & Roman-Franco A. (2005). Orthomolecular oncology review: ascorbic acid and cancer 25 years later. *Integr Cancer Ther*, 4, 32–44.
- [54] Grad, J.M. & Bahlis, N.J. & Reis, I., et al. (2001). Ascorbic acid enhances arsenic trioxide-induced cytotoxicity in multiple myeloma cells. *Blood*, 98, 805–813.
- [55] Green, M. H. L. & Lowe, J. E. & Waugh, A. P. W. & Aldridge, K. E. & Cole, J. & Arlett, C. F. (1994). Effect of diet and vitamin C on DNA strand breakage in freshly-isolated human white blood cells. *Mutat. Res.* 316, 91–102.
- [56] Griffiths, H.R. & Lunec J. (2001). Ascorbic acid in the 21<sup>st</sup> century – more than a simple antioxidant. *Environmental Toxicology and Pharmacology*, 10, 173–182
- [57] Halliwell B. & Gutteridge J. 1999. Free radicals in biology and medicine, 3<sup>rd</sup> edition, Oxford: Clarendon Press
- [58] Halliwell B. (1999). Vitamin C: poison, prophylactic or panacea? *Trends Biochem Sci*, 24, 255–9.
- [59] Halliwell B. (2000). The antioxidant paradox. *Lancet*, 355, 1179–1180.
- [60] Halliwell B. (2000). Vitamin C and genomic stability. *Mutat Res*, 475, 29–35.
- [61] Halliwell B. (2000). Why and how should we measure oxidative DNA damage in nutritional studies? How far have we come? *Am J Clin Nutr.* , 72, 1082–7.
- [62] Halliwell B. & Whiteman M. (1997). Antioxidant and prooxidant properties of vitamin C. In: Packer L, Fuchs J, eds. *Vitamin C in Health and Disease*. New York: Marcel Dekker; 1997; Pp. 59–73.
- [63] Halliwell, B. & Gutteridge, J. M. C. (1986). Oxygen free radicals and iron in relation to biology and medicine: some problems and concepts. *Arch. Biochem. Biophys.*, 246, 501–514.
- [64] Halliwell, B. (1996) Vitamin C: antioxidant or pro-oxidant *in vivo*? *Free Rad. Res.* 25, 439–454

- [65] Hampton, M.B. & Orrenius S. (1998). Redox regulation of apoptotic cell death. *Biofactors*, 18, 1–5.
- [66] Harris A.L. (2002). Hypoxia: a key regulatory factor in tumour growth. *Nat Rev Cancer.*, 2, 38–47.
- [67] Hawkes, J. & Wang, E.& Cochran, G.M. & Moyzis, R. (2007). Recent Acceleration of Human Adaptive Evolution. – Proceedings of the National Accademy of Sciences of the United States of America, 104(52), 20753-20758.
- [68] Herbert V. & Shaw S, Jayatilleke E. & Stopler-Kasdan T. (1994). Most free-radical injury is iron-related: it is promoted by iron, hemin, holoferritin and vitamin C. and inhibited by Desferoxamine and apoferritin. *Stem Cells*, 12, 289-303.
- [69] Herbert V. (1993). Dangers of iron and vitamin C supplements. *J Am Diet Assoc*, 93, 526-7.
- [70] Herbert, V. (1994). The antioxidant supplement myth. *Am. J. Clin. Nutr.*, 60, 157–158.
- [71] Hoffer, L.J.& Levine, M.& Assouline, S.& Melnychuk, D.& Padayatty, S.J.& Rosadiuk, K.& Rousseau, C.& Robitaille, L. & Miller WH Jr. (2008).Phase I clinical trial of i.v. ascorbic acid in advanced malignancy. *Ann Oncol*, 19(11):1969-74.
- [72] Hu, M. L. & Shih, M. K. (1997). Ascorbic acid inhibits lipid peroxidation but enhances DNA damage in rat liver nuclei incubated with iron ions. *Free Rad. Res.* **26**, 585–592.
- [73] Hwang, M.T. & Ferrario, T. & Ho, C.T. (1994) Cancer chemoprevention by phytochemicals in fruits and vegetables: an overview. *ACS Symp. Ser.*, 546, 2-16.
- [74] Ionescu J.G. & Merk, M, & Dowes F (1998) Clinical application of redox potential testing in the blood. *Syllabus of 33<sup>rd</sup> AAEM Annual Meeting, Baltimore, USA*, p503-512,
- [75] Ionescu J.G. : Simple chemiluminescence assays for reactive oxygen species in different clinical conditions. Proceedings of the Free Radical Symposium Taiwan, June 6-13, 2002
- [76] Ionescu, J.G.& Novotny, J& Stejskal, V& Latsch, A& Blaurock-Busch, E& Eisenmann-Klein, M (2006) Increased levels of transition metals in breast cancer tissue. *Neuro Endocrinol Lett* 27 Suppl 1, 36-9
- [77] Ionescu, J.G. (2007a) Heavy Metal Accumulation in Malignant Tumours as Basis for a New Integrative Therapy Model. *Anti-Aging Therapeutics (Eds.: Klatz R. and Goldman R.)*, Vol IX, Chapter 27, 189-201.
- [78] *Eds.: Klatz R., Goldamn R.)*, Vol IX, Chapter 27, 189-201
- [79] Ionescu J.G. (2007b) Klinische Relevanz der Redox und chemoluminiszenz Bestimmungen bei Allergien, Haut- und Umwelterkrankungen. in „Säueren-Basen-Schlacken“, Markt W, Reiter B, Ekmekcioglu C (Eds.) Springer Verlag, Wien/New York, p. 73-81
- [80] Jackson J.A. & Roman-Franco A. (2005). Orthomolecular oncology review: ascorbic acid and cancer 25 years later. *Integr Cancer Ther.* 4, 32–44.
- [81] Jenner, A. & England, T. G. & Aruoma, O. I. & Halliwell, B. (1998). Measurement of oxidative DNA damage by gas chromatography-mass spectrometry: ethanethiol prevents artifactual generation of oxidized DNA bases. *Biochem. J.* 331, 365–369.

- [82] Kang S.A. & Gang Y.J. & Park M. (1998). In vivo dual effects of vitamin C on paraquat-induced lung damage: dependence on released metals from the damaged tissue. *Free Rad Res*, 28, 93–107.
- [83] Kassouf, W.& Highshaw, R.& Nelkin, G.M. et al. (2006). K3 sensitize human urothelial tumors to gemcitabine. *J Urol*, 176, 1642–1647.
- [84] Kurbacher, C.M.& Wagner, U.& Kolster, B. et al. (1996). Ascorbic acid (vitamin C) improves the antineoplastic activity of doxorubicin, cisplatin, and paclitaxel in human breast carcinoma cells in vitro. *Cancer Lett*, 1996, 103: 183–189.
- [85] Lay P.A. & Levina A. (1998). Activation of molecular oxygen during the reactions of Chromium (VI/V/IV) with biological reductants: Implications for chromium-induced genotoxicities. *J Am Chem Soc*, 120, 6704–6714.
- [86] Lee, B. M. & Lee, S. K. & Kim, H. S. (1998). Inhibition of oxidative DNA damage, 8-OHdG, and carbonyl contents in smokers treated with antioxidants (vitamin E, vitamin C, b-carotene and red ginseng). *Cancer Lett*. 132, 219–227.
- [87] Lenton K.J. & Therriault H. & Fulop T. & Payette H. & Wagner J.R. (1999.) Glutathione and ascorbate are negatively correlated with oxidative DNA damage in human lymphocytes. *Carcinogenesis*, 20, 607–613.
- [88] Leo C.& Giaccia A.J.& Denko N.C. (2004). The hypoxic tumor microenvironment and gene expression. *Semin Radiat Oncol.*, 14, 207–14.
- [89] Levine, M& Daruwala, R C& Park, J B& Rumsey, S C& Wang, Y (1998). Does vitamin C have a pro-oxidant effect?. *Nature (London)* 395,231-232, *author reply* 232.
- [90] Levine, M.,& Rumsey, S.C.,& Daruwala, R. et al. (1999). Criteria and recommendations for vitamin C intake. *JAMA*, 281, 1415–1423.
- [91] Levine, M. & Conry-Cantilena, C. & Wang, Y. & Welch, R. W. & Washko, P. W. & Dhariwal, K. R. & Park, J. B. & Lazarev, A. & Graumlich, J. F. & King, J. & Cantilena, L. R. (1996). Vitamin C pharmacokinetics in healthy volunteers: evidence for a recommended dietary allowance. *Proc. Natl. Acad. Sci. U. S. A.* **93**, 3704–3709.
- [92] Li Y. & Schellhorn HE. (2007). New developments and novel therapeutic perspectives for vitamin C. *J Nutr. Oct*, 137, 2171–84.
- [93] López-Torres, M.& Barja, G. (2008). Lowered methionine ingestion as responsible for the decrease in rodent mitochondrial oxidative stress in protein and dietary restriction: Possible implications for humans. *Biochemica et Biophysica Acta* 1780, 1337-1347.
- [94] Lusini L, & Tripodi SA,& Rossi R,& Giannerini F,& Giustarini D,& del Vecchio MT, & Barbanti G,& Cintorino M, &Tosi P, &Di Simplicio P. (2001) Altered glutathione anti-oxidant metabolism during tumor progression in human renal-cell carcinoma. *Int J Cancer*.91(1):55-9.
- [95] May J.M.&Cobb C.E.& Mendiratta S.& Hill K.E. &Burk R.F. (1998). Reduction of the ascorbyl free radical to ascorbate by thioredoxin reductase. *J Biol Chem* 273, 23039–23045.
- [96] McKersie B.D. (1996). Oxidative stress. Dept of Crop science, University of Guelph [online]. 1996 [8.02.2004]. Available form: URL: <http://www.agronomy.psu.edu/Courses/AGRO518/Oxygen.htm#activation> (8.2.2004)

- [97] Miller E.R. & Pastor-Barriuso R. & Dalal D. & Riemersma R.A. & Appel L.J. & Guallar E. (2005). Meta-analysis: high-dosage vitamin E supplementation may increase all-cause mortality. *Ann Intern Med*, 142, 37–46.
- [98] Miller, D.M. & Buettner, G. & Aust, S.D. (1990). Transition metals as catalysts of autooxidation reactions. *Free Radic Biol Med*, 8, 95-108.
- [99] Mirvish S. & Grandjean A. & Reimers K. & Connelly B. (1998). Effect of ascorbic acid dose taken with a meal on nitrosoproline excretion in subjects ingesting nitrate and proline. *Nutr Canc*, 31, 106-110.
- [100] Morel O, & Jesel L, & Hugel B, & Douchet MP, & Zupan M, & Chauvin M, & Freyssinet JM, & Toti F. (2003) Protective effects of vitamin C on endothelium damage and platelet activation during myocardial infarction in patients with sustained generation of circulating microparticles. *J Thromb Haemost* 1(1):171-7
- [101] Myint PK, & Luben RN, & Welch AA, & Bingham SA, & Wareham NJ, & Khaw KT. (2008) Plasma vitamin C concentrations predict risk of incident stroke over 10 y in 20 649 participants of the European Prospective Investigation into Cancer Norfolk prospective population study. *Am J Clin Nutr* 87(1):64-9.
- [102] Nam CM, & Oh KW, & Lee KH, & Jee SH, & Cho SY, & Shim WH, & Suh I. (2003) itamin C intake and risk of ischemic heart disease in a population with a high prevalence of smoking. *J Am Coll Nutr* 22(5):372-8.
- [103] National Research Council. (1992). Diet nutrition and cancer. *National Academy Press*, Washington, DC.
- [104] Nemoto, S. & Otsuka, M. & Arakawa, N. & (1997). Effect of high concentration of ascorbate on catalase activity in cultured cells and tissues of guinea pigs. *J. Nutr. Sci. Vitaminol.*, 43, 297-203.
- [105] Nyssönen K, & Parviainen MT, & Salonen R, & Tuomilehto J, & Salonen JT. (1997) Vitamin C deficiency and risk of myocardial infarction: prospective population study of men from eastern Finland. *BMJ* 314(7081):634-8.
- [106] O'Brien T. & Mandel H.G. & Pritchard D.E. & Patierno S.R. (2002). Critical role of Cr-DNA interactions in the formation of Cr-induced polymerase arresting lesions. *Biochemistry*, 41, 12529-12537.
- [107] Osganians, .K. & Stampfer, M.J. & Rimm, U., Spiegelman D. & Hu, F.B. & Manson, J.E. & Willett, W.C. (2003). Vitamin C and risk of coronary heart disease in women. *J. Am. Coll. Cardiol*, 42, 246-252.
- [108] Otero, P. & Viana, M. & Herrera, E. & Bonet, B. (1997). Antioxidant and prooxidant effects of ascorbic acid, dehydroascorbic acid and flavonoids on LDL submitted to different degrees of oxidation. *Free Rad. Res.* 27, 619–626.
- [109] Pajk Žontar, T. & Rezar, V. & Levant, A. & Salobir, J. (2006). Efficiency of various nutrients on reduction for oxidative stress in pigs as model for humans; In Gašperlin, L. & Žlender, B. (eds.): Carcinogenic and anticarcinogenic food components: 24<sup>th</sup> Food Technology days 2006 dedicated to Prof. F. Bitenc. – Ljubljana: University of Ljubljana, Biotechnical faculty, pg.199-206.
- [110] Panayiotidis M. & Collins A.R. (1997). Ex vivo assessment of lymphocyte antioxidant status using the comet assay. *Free Rad Res*, 27,533–537.

- [111] Paolini M. & Pozzetti L. & Pedulli G.F. & Marchesi E. & Cantelli-Forti G. (1999). The nature of prooxidant activity of vitamin C. *Life Sci* 23, 64, 273-278.
- [112] Park J.B. & Levine M. (1996). Purification, cloning and expression of dehydroascorbic acid-reducing activity from human neutrophils: Identification as glutaredoxin. *Biochem J*, 315, 931-938.
- [113] Podmore, I. D. & Griffiths, H. R. & Herbert, K. E. & Mistry, N. & Mistry, P. & Lunec, J. (1998). Vitamin C exhibits pro-oxidant properties. *Nature (London)* 392, 559.
- [114] Pohl H. & Reidy J.A. (1989). Vitamin C intake influences the bleomycin-induced chromosome damage assay: Implications for detection of cancer susceptibility and chromosome breakage syndromes. *Mutat Res*, 224, 247-252.
- [115] Poljsak, B. & Gazdag, Z., & Pesti, M., & Farkas, N., & Plesnicar, S., & Raspor, P. (2002). The role of antioxidant vitamins on chromium(VI) induced damage. *Toxicology Letters*, 144(1), 144.
- [117] Poljsak, B. & Gazdag, Z., & Jenko-Brinovec, S., & Fujs, S., & Pesti, M., & Belagy, J., & Plesnicar, S., & Raspor, P. (2005). Pro-oxidative vs antioxidative properties of ascorbic acid in chromium(VI)-induced damage: an in vivo and in vitro approach. *Journal of Applied Toxicology*, 25(6), 535-548
- Poljsak, B., & Raspor, P. (2008). The antioxidant and pro-oxidant activity of vitamin C and trolox in vitro: a comparative study. *J Appl Toxicol*. 28(2):183-8.
- [118] Poljšak, B. & Erjavec, M. & Likar, K. & Pandel Mikuš, R. (2006). The use of vitamin and mineral supplements in nutrition. *Obzor. Zdr. N.*, 40, 1-10
- [119] Porkkala-Sarataho, E. & Salonen, J.T. & Nyyssonen, K. & Kaikkonen, J. & Salonen, R. & Ristonmaa, U. & Diczfalusy, U. & Brigelius-Flohe, R. & Loft, S. & Poulsen, H.E. (2000). Long term effects of vitamin E, vitamin C and combined supplementation on urinary 7-hydro-8-oxo-2'-deoxyguanosine, serum cholesterol oxidation products, and oxidation resistance of lipids in nondepleted men. *Art. Thromb. Vasc. Biol.* 20, 2087.
- [120] Porter W.L. (1993). Paradoxical behaviour of antioxidants in food and biological systems. *Toxic Ind Health*, 9, 93-122.
- [121] Prieme, H. & Loft, S. & Nyyssonen, K. & Salonen, J. T., Poulsen, H. E. (1997). No effect of supplementation with vitamin E, ascorbic acid, or coenzyme Q10 on oxidative DNA damage estimated by 8-oxo-7,8-dihydro-2'-deoxyguanosine excretion in smokers. *Am. J. Clin. Nutr.* 65, 503-507.
- [122] Quievryn G. & Peterson E. & Messer J. & Zhitkovich A. (2003). Genotoxicity and mutagenicity of chromium(VI)/ascorbate-generated DNA adducts in human and bacterial cells. *Biochemistry* 42, 1062-1070.
- [123] Ramirez J, & Flowers NC. (1980) Leukocyte ascorbic acid and its relationship to coronary artery disease in man. *Am J Clin Nutr* 33(10):2079-87.
- [124] Rehman A. & Collis, C.S. & Yang, M. & Kelly, M. & Diplock, A.T. & Halliwell, B. & Fuce-Evans, C. (1998). The effects of iron and vitamin C cosupplementation on oxidative damage to DNA in healthy volunteers. *Biochem. Biophys. Res. Commun*, 246, 293-298.



- [125] Rietjens, I. & Boersma, M. & de Haan, L. & et al. (2001). The pro-oxidant chemistry of the natural antioxidants vitamin C, vitamin E, carotenoids and flavonoids. *Environ Toxicol Pharmacol*, 11, 321-333.
- [126] Sakagami H. & Satoh K. & Hakeda Y. & Kumegawa M. (2000). Apoptosis-inducing activity of vitamin C and vitamin K. *Cell Mol Biol*, 46, 129-143.
- [127] Salganik RI (2001). The benefits and hazards of antioxidants: controlling apoptosis and other protective mechanisms in cancer patients and the human population. *J Am Coll Nutr* 20, 464-72.
- [128] Sarna, S. & Bhola, R.K. (1993). Chemo-immunotherapeutical studies on Dalton's lymphoma in mice using cisplatin and ascorbic acid: synergistic antitumor effect in vivo and in vitro. *Arch Immunol Ther Exp* 1993; 41: 327-333.
- [129] Satoh K. & Ida Y. & Hosaka M. & Arakawa H. & Maeda M. & Ishihara M. & Kunii S. & Kanda Y. & Toguchi M. & Sakagami H. (1998). Induction of apoptosis by cooperative action of vitamins C and E. *Anticancer Res*, 18, 4371-4375.
- [130] Scarpa, M. & Stevanato, R. & Viglino, P. & Rigo, A. (1983). Superoxide ion as active intermediate in the autoxidation of ascorbate by molecular oxygen. Effect of superoxide dismutase. *J Biol Chem* 258,11, 6695-7.
- [131] Schofield CJ, Ratcliffe PJ. (2004). Oxygen sensing by HIF hydroxylases. *Nat Rev Mol Cell Biol.*, 5, 343-54.
- [132] Schwartz JL. (1996). The dual roles of nutrients as antioxidants and prooxidants: their effects on tumor growth. *J. Nutr.*, 126 1221S-1227S.
- [133] Selman, C., & McLaren, J., & Meyer, C., & Duncan, J., & Redman, p., & Collins, A., Duthie, G., Speakman, J. (2006). Life-long vitamin C supplementation in combination with cold exposure does not affect oxidative damage or lifespan in mice, but decreases expression of antioxidant protection genes. In: *Mechanisms of ageing and development*, Volume 127, Issue 12, pp. 897-904.
- [134] Sestili, P.& Brandi, G.& Brambilla, L. et al. (1996). Hydrogen peroxide mediates the killing of U937 tumor cells elicited by pharmacologically attainable concentrations of ascorbic acid: cell death prevention by extracellular catalase or catalase from cocultured erythrocytes or fibroblasts. *J Pharmacol Exp Ther*, 277, 1719-1725.
- [135] Shinke T, &Shite J, &Takaoka H, &Hata K, &Inoue N, &Yoshikawa R, &Matsumoto H, &Masai H, &Watanabe S, &Ozawa T, &Otake H, &Matsumoto D, &Hirata K, &Yokoyama M. (2007) Vitamin C restores the contractile response to dobutamine and improves myocardial efficiency in patients with heart failure after anterior myocardial infarction. *Am Heart J* 154(4), 645.e1-8.
- [136] Shklar, G. & Schwartz, J.L. (1994). A common pathway for the destruction of cancer cells: experimental evidence and clinical implications (review). *Int. J. Oncol.*, 4, 213-224.
- [137] Sies H.& Stahl W. (1995). Vitamins E and C, beta-carotene, and other carotenoids as antioxidants . *Am J Clin Nutr* 62,1315S-1321.
- [138] Simopoulos A.P. & Herbert V. & Jacobson B. (1993). *Genetic nutrition: designing a diet based on your family medical history*. New York: Macmillan.

- [139] Singh J, & Carlisle DL, & Pritchard DE, & Patierno SR. (1998) Chromium-induced genotoxicity and apoptosis: relationship to chromium carcinogenesis. *Oncol Rep* 5(6):1307-18.
- [140] Smith, M. A. & Richey Harris, P. L. & Sayer, L. M. & Beckman, J. S. & and Perry, G. (1997). Widespread peroxynitrite-mediated damage in Alzheimer's disease. *J. Neurosci.* 17, 2653–2657.
- [141] Song, E.J. & Yang, V.C. & Chiang, C.D. & Chao, C.C. (1995). Potentiation of growth inhibition due to vincristine by ascorbic acid in a resistant human non-small cell lung cancer cell line. *Eur J Pharmacol*, 292, 119–125.
- [142] Stearns, D.M. & Kennedy, L.J. & Courtney, K.D. & Giangrande, P.H. & Phieffer, L.S. & Wetterhahn, K.E. (1995). Reduction of chromium(VI) by ascorbate leads to chromium-DNA binding and DNA strand breaks in vitro. *Biochemistry* 34, 3, 910-9.
- [143] Stich H.F., & Karim J., Koropatnick J., & Lo L. (1976). Mutagenic action of ascorbic acid. *Nature*, 260, 722–4.
- [144] Sugiyama M. & Tsuzuki K. & Hidaka T. & Ogura R. & Yamamoto M. (1991). Reduction of chromium(VI) in Chinese hamster V-79 cells. *Biol Trace Elem Res* 30, 1, 1-8.
- [145] Sugiyama M. & Tsuzuki K. & Ogura R. (1991). Effect of ascorbic acid on DNA damage, cytotoxicity, glutathione reductase, and formation of paramagnetic chromium in Chinese hamster V-79 cells treated with sodium chromate(VI). *J Biol Chem* 266, 6, 3383-3386.
- [146] Sugiyama M. (1991). Effects of vitamins on chromium(VI) induced damage. *Environ Health Perspect* 92:63-70.
- [147] Swain J.A, Darley-Usmar V. & Gutteridge J.M.C. (1994). Peroxynitrite releases copper from caeruloplasmin: implications for atherosclerosis. *FEBS Lett*, 342, 49–52.
- [148] Taper, H.S. & Jamison, J.M. & Gilloteaux, J., et al. (2004). Inhibition of the development of metastases by dietary vitamin C:K3 combination. *Life Sci*, 75, 955–967.
- [149] Telang S., & Clem A.L., & Eaton J.W., & Chesney J. (2007). Depletion of ascorbic acid restricts angiogenesis and retards tumor growth in a mouse model. *Neoplasia*, 9, 47–56.
- [150] Tetef, M. & Margolin, K. & Ahn, C., et al. (1995). Mitomycin C and menadione for the treatment of lung cancer: a phase II trial. *Invest New Drugs*, 13, 157–162.
- [151] Tijssens, P. *Discovering the Future: Modelling Quality Matters*. – Wageningen University, 2004
- [152] The alpha-tocopherol, beta-carotene cancer prevention study. (1994). *N. Engl. J. Med.* 330, 1029.
- [153] Vaupel P. (2004). The role of hypoxia-induced factors in tumor progression. *Oncologist*, 9, 10–7.
- [154] Verrax, J. & Stockis, J. & Tison, A., et al. (2006). Oxidative stress by ascorbate/menadione association kills K562 human chronic myelogenous leukaemia cells and inhibits its tumour growth in nude mice. *Biochem Pharmacol*, 72, 671–680.

- 
- [155] Vivekananthan DP, & Penn MS, & Sapp SK, & Hsu A, & Topol EJ. Use of antioxidant vitamins for the prevention of cardiovascular disease: meta-analysis of randomised trials. *Lancet* (2003) 361:2017–23.
- [156] Vojdani A, & Bazargan M, & Vojdani E, & Wright J. New evidence for antioxidant properties of vitamin C. *Cancer Detect Prev.* (2000) 24(6):508-23.
- [157] Watson, J. D., & Berry, A. DNA: The Secret of Life. Ljubljana: Modrijan, 2007.
- [158] Winterbourn, C. C. (1981). Hydroxyl radical production in body fluids: roles of metal ions, ascorbate and superoxide. *Biochem. J.* 198, 125–131.
- [159] Witenberg B. & Kalir H.H. & Raviv Z. & Kletter Y. & Kravtsov V. & Fabian I. (1999). Inhibition of ascorbic acid of apoptosis induced by oxidative stress in HL-60 myeloid leukemia cells. *Biochem Pharmacol* 57, 823-832.
- [160] Yaman M, & Atici D, & Bakirdere S, & Akdeniz I. (2005) Comparison of trace metal concentrations in malign and benign human prostate. *J Med Chem* 48(2):630-4.
- [161] Yeh CC, & Hou MF, & Wu SH, & Tsai SM, & Lin SK, & Hou LA, & Ma H, & Tsai LY. (2006) A study of glutathione status in the blood and tissues of patients with breast cancer. *Cell Biochem Funct* 24(6):555-9.



---

## Encapsulation Devices for Vitamin C

---

*Magdalena Stevanović<sup>1</sup> and Dragan Uskoković<sup>1</sup>*

<sup>1</sup>Institute of Technical Sciences of the Serbian Academy of Sciences and Arts,  
Belgrade, Serbia

### Abstract

Vitamin C, also known as ascorbic acid, is a very important water-soluble vitamin. It is essential for preserving optimal health and it is used by the body for many purposes. Vitamin C promotes collagen biosynthesis, provides photoprotection, causes melanin reduction, enhances the immunity (anti-virus effect), etc. Vitamin C is a highly effective antioxidant. Even in small amounts vitamin C can protect indispensable molecules in the body, such as proteins, lipids (fats), carbohydrates, and nucleic acids (DNA and RNA) from damage by free radicals and reactive oxygen species that can be generated during normal metabolism as well as through exposure to toxins and pollutants (e.g. smoking). Vitamin C may be involved in the reduction of the risk of certain types of cancer. A number of *in vitro* and *in vivo* experiments have been performed in order to evaluate the ability of ascorbic acid to prevent the adverse effects, increase the effects of, and decrease resistance to chemotherapeutic agents. The problem is that ascorbic acid is very unstable to air, light, heat, moisture, metal ions, oxygen, and base, and it easily decomposes into biologically inactive compounds such as 2,3-diketo-L-gulonic acid, oxalic acid, L-threonic acid, L-xylic acid and L-lyxonic acid. This makes its use very limited in the field of pharmaceuticals, dermatologicals and cosmetics. In order to overcome the chemical instability of the ascorbic acid numerous researches have been staged toward its encapsulation or immobilization. The ascorbic acid introduced in the body in the greater portion is isolated from the body. However, the encapsulated ascorbic acid within, for example, the polymeric matrix should have significantly higher efficiency. The present review attempts to address some important issues related to various methods which are employed to encapsulate ascorbic acid, such as thermal phase separation, melt dispersion, solvent evaporation, spray drying, homogenization of water and organic phases, etc. This review also gives a comparison of the characteristics of ascorbic acid nano and microparticles prepared by different methods. The materials in

which ascorbic acid can be successfully encapsulated are poly (DL-lactide-co-glycolide), tripolyphosphate cross-linked chitosan, liposomes, maltodextrin, dendrimers, etc. Encapsulation efficiency, release rate, size distribution of particles with encapsulated ascorbic acid, are some of the parameters which are used for evaluating encapsulation system characteristics.

## 1. Introduction

Ascorbic acid (vitamin C) is essential for preserving optimal health and it is used by the body for many purposes [1]. Vitamin C has many functions such as: stimulates white blood cells and antibody production; it is vital component of all body cells; essential for manufacture of collagen; needed for healthy connective tissue, skin, bones and vascular system; it is powerful antioxidant; required for proper wound healing and tissue regeneration; has powerful effects on the production of important chemicals for the control of hormones and brain function; assists iron absorption and it is natural antihistamine [2].

The problem is that ascorbic acid easily decomposes into biologically inactive compounds making its use very limited in the field of pharmaceuticals, dermatological products and cosmetics [1]. In order to overcome chemical instability of ascorbic acid, a considerable amount of research has been staged towards its encapsulation or immobilization. Ascorbic acid cannot be synthesised and stored in the body. The ascorbic acid introduced in the body in the greater portion is isolated from the body. However, the encapsulated ascorbic acid within, for example, polymeric particles should have significantly higher stability and efficiency [3].

Encapsulation provides an invaluable tool to the pharmaceutical and/or cosmetic formulator, providing great flexibility in the choice of delivery mechanisms and excipients that can be used [4-7]. For example, active pharmaceutical ingredients can be delivered in systems that would otherwise be unacceptable or hostile to them. For example, water-soluble ingredients can be delivered in non-aqueous systems such as ointments. The matrix of the capsule can be chosen from a wide variety of materials (usually selected from a list of materials “generally recognized as safe” (GRAS)\* for pharmaceutical applications [8]) to meet the needs of the application as well as regulatory demands, e.g., biodegradability. Multiple actives can also be delivered in the same particle; indeed, mutually chemically incompatible actives can be formulated together. A further way to exploit this technology is to encapsulate one ingredient that can facilitate, or stabilize, a second [9,10]. By isolating problematic ingredients, formulation and processing issues are minimized; undesirable properties can be masked.

Micro and nanoparticles can be used to deliver a wide variety of substances as hydrophilic or hydrophobic drugs, proteins, vaccines, biological macromolecules, vitamins etc. and they can be administrated in different ways in the body [11-18].

---

\* Generally recognized as safe (GRAS)--substances for which use in food has a proven track record of safety based either on a history of use before 1958 or on published scientific evidence, and that need not be approved by the FDA prior to being used.

The purpose of this review is to point out on instability and inefficiency of vitamin C and possible solution for these problems. A number of topics are discussed including various methods which are employed in encapsulating ascorbic acid. The materials in which ascorbic acid can be successfully encapsulated are poly (DL-lactide-co-glycolide), tripolyphosphate cross-linked chitosan, liposomes, maltodextrin, etc. This review also gives a comparison of the characteristics of ascorbic acid nano and microparticles prepared by different methods. Encapsulation efficiency, release rate, size distribution of particles with encapsulated ascorbic acid, are some of the parameters which are used for evaluating encapsulation system characteristics.

## 2. Controlled Release of Active Substances

Controlled release of bioactive substances requires that the encapsulated material retain its biological activity or the activity of acceptable degradation products [3, 19-23]. Encapsulation of these molecules is commonly performed not only to retain and/or to slowly release them, but to provide a more stable environment for the encapsulated species [24].

Controlled drug delivery technology represents one of the frontier areas of science, which involves multidisciplinary scientific approach [25-29]. These delivery systems offer numerous advantages compared to conventional dosage forms, which include improved efficacy, better stability of the encapsulated substances, reduced toxicity, etc. Such systems often use macromolecules as carriers for the medicaments. By doing so, treatments that would not otherwise be possible are now in conventional use. Nano and microparticles because of their attractive properties occupy unique position in controlled release of active substances [30].

One of the major goals in designing micro and nanoparticles as a delivery system is to control particle size, surface properties and release of active substances in order to achieve the site-specific action of the substances at the optimal rate and dose regimen [31].

One often hears of a vitamin deficit in human body, and vitamins are crucial for its normal metabolic activity. System for the controlled delivery of vitamins can bring to the more balanced and efficient concentration of vitamins throughout the extended period of time [3].

Micro and nanoparticles for encapsulation and controlled release of vitamins can be prepared from a variety of materials such as liposomes, synthetic polymers, polysaccharides, etc. [11-18].

## 3. Vitamins

Vitamins are crucial for normal physiologic functioning of the organism, and vitamin deficiencies are relatively often associated with modern life style including inappropriate dietary habits, increased vitamin requirements or different diseases. Vitamins are classified as either water-soluble or fat soluble. In humans there are thirteen vitamins: four fat-soluble (A, D, E and K) and nine water-soluble (eight B vitamins and vitamin C) [32-37].

### 3.1. Water- Soluble Vitamins

Water-soluble vitamins dissolve easily in water, and in general, are readily excreted from the body, to the degree that urinary output is a strong predictor of vitamin consumption [38-40].

The water-soluble vitamins, excluding vitamin C, popularly are termed the B-complex vitamins. There are eight of them, namely; B1 (thiamine), B2 (riboflavin), B3 (niacin), B6 (pyridoxine), B9 (folic acid), B12 (cobalamin), pantothenic acid, and biotin [41-43]. Each nutrient in the B vitamin complex performs a unique role in maintaining proper metabolic functioning and is essential for well-being. Vitamin C (ascorbic acid) is one of the most important water-soluble vitamins in biological systems. Vitamin C is well-known for its superior antioxidant power and is the leading vitamin for immune support. Because water-soluble vitamins are not readily stored, consistent daily intake is important.

## 4. Vitamin C

L-ascorbic acid ( $C_6H_8O_6$ ) is the trivial name of vitamin C. The chemical name is 2-oxo-L-threo-hexono-1,4-lactone-2,3-enediol [44,45]. L-ascorbic and dehydroascorbic acid are the major dietary forms of vitamin C (Figure 1). Ascorbic acid is a six-carbon lactone with a molecular weight of 176.13g/mol (Figure 1). All commercial forms of ascorbic acid except ascorbyl palmitate are soluble in water [46].

L-ascorbic acid and its fatty acid esters are used as food additives, antioxidants, browning inhibitors, reducing agents, stabilizers, etc. Ascorbyl palmitate has been used for its greater lipid solubility in antioxidant preparations. pH has a great influence on stability of ascorbic acid [46-48]. Most of the plants and animals synthesize ascorbic acid from D-glucose or D-galactose (Figure 2). A majority of animals produce relatively high levels of ascorbic acid from glucose in liver [46].

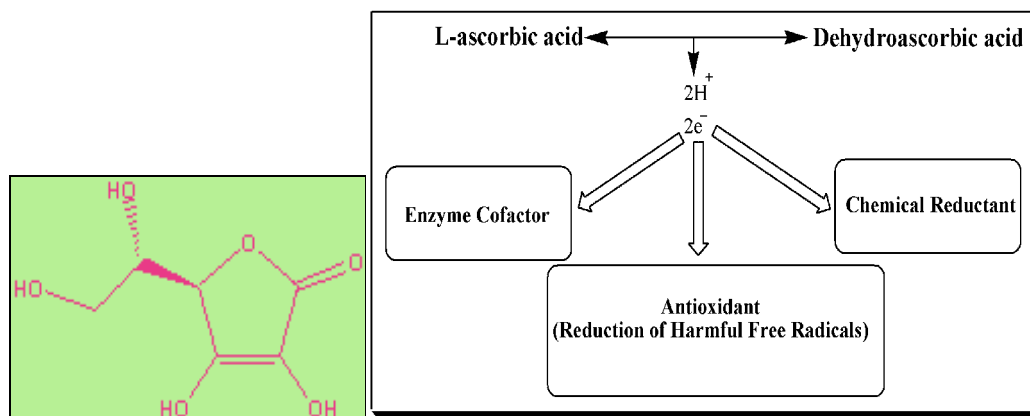

Figure 1. L-Ascorbic acid.



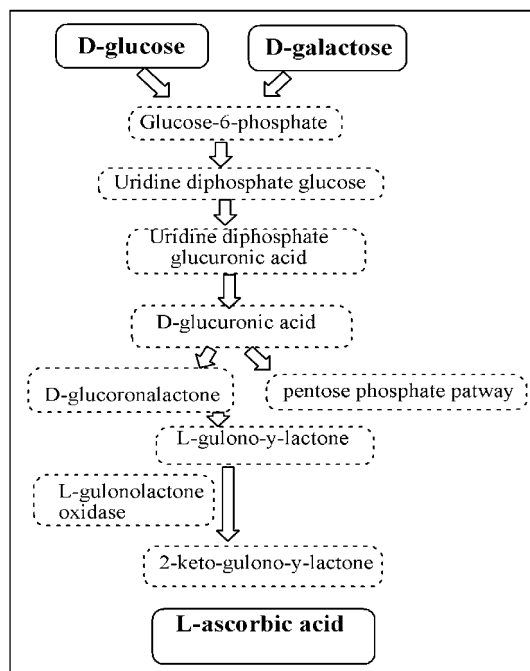

Figure 2. Biosynthesis of L-Ascorbic acid in animals.

The major metabolites of ascorbic acid in human are dehydroascorbic acid, 2,3-diketogulonic acid and oxalic acid (Figure 3) [49-52].

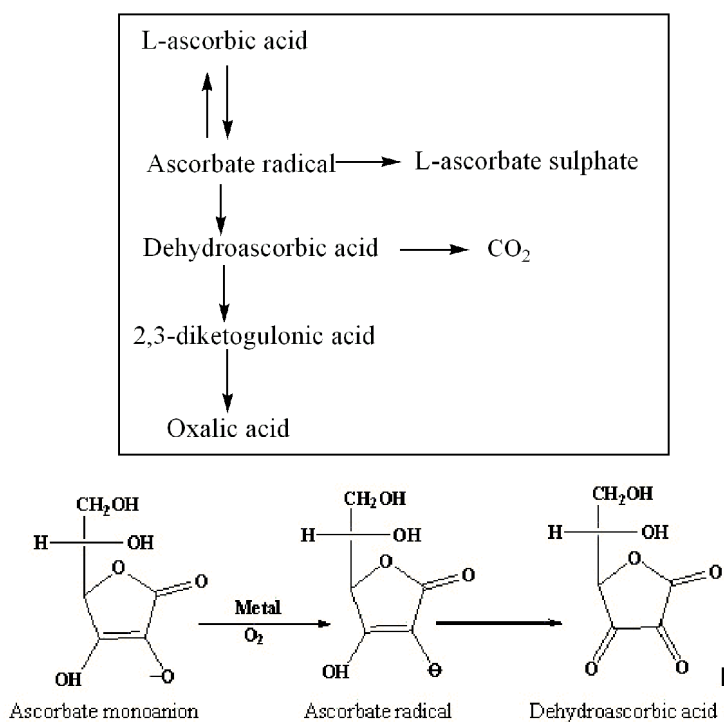

Figure 3. Catabolism of ascorbic acid.

#### 4.1. Sources of Vitamin C in our Diets

While vitamin C is widespread in plant materials, it is found sparingly in animal tissues [53]. Of all the animals studied, only a few, including humans, require a dietary source of vitamin C. The other species are capable of synthesizing the vitamin in such tissues as liver and kidneys [46, 54]. Humans and other primates cannot synthesize ascorbate because of multiple mutations in the gene encoding gulonolactone oxidase, the terminal enzyme in the biosynthetic pathway of the vitamin. Thus, humans have to obtain vitamin C from other sources (Figure 4.). Vegetables and fruits contain relatively high concentrations of vitamin C, e.g., green and red peppers, collard greens, broccoli, spinach, tomatoes, potatoes, strawberries, and oranges and other citrus fruits. Meat, fish, poultry, eggs, and dairy products contain smaller amounts, and grains contain none.

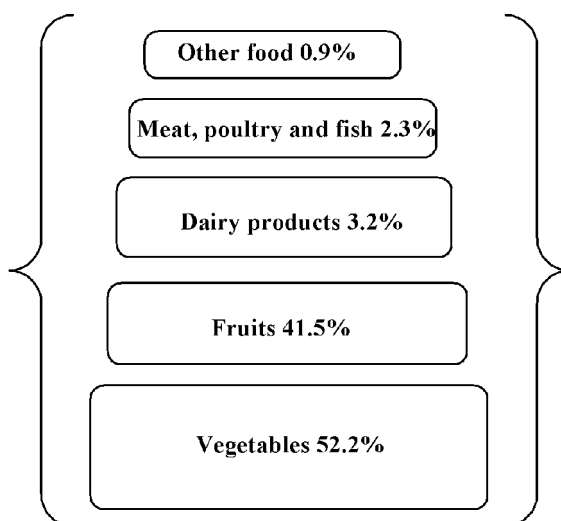

Figure 4. Sources of Vitamin C in our diets.

#### 4.2. How Does Vitamin C Protect Us from Various Diseases?

Because it is needed by every cell in the body, deficiency of vitamin C has widespread consequences. It is very important to put into perspective the many health benefits of vitamin C and the role of vitamin C deficiency in increasing the risk of many common and serious diseases, including some common cancers [55-58]. Vitamin C promotes a healthy immune system, helps wounds heal, maintains connective tissue and aids in the absorption of iron. The prevention and treatment of cancer considers different mechanisms of vitamin C activity, such as [59,60]:

- Enhancement of the immune system by increased lymphocyte production [61].
- Stimulation of collagen formation necessary for "walling off" tumours [62].
- Inhibition of hyaluronidase [62].
- Inhibition of oncogenic micro-organisms [63].

- Correction of an ascorbate deficiency, often seen in cancer patients [64].
- Enhancement of the effect of certain chemotherapy drugs [65].
- Reduction of the toxicity of other chemotherapeutic agents (i.e. doxorubicin) [65,66].
- Prevention of cellular free radical damage [67]., and
- Neutralization of carcinogenic substances [68].

Vitamin C also prevents the adverse effects, increases the effects of and decreases resistance to chemotherapeutic agents [69]. With respect to colorectal cancer, vitamin C has been shown to inhibit this type of cancer in rodents [70, 71]. The use of vitamin C supplements could substantially reduce the risks of colorectal cancer [71].

There is evidence that vitamin C may play roles in stress reactions, in infectious disease, or in wound healing [72-74]. Vitamin C deficiency in humans has been known for centuries as scurvy. People with scurvy lose weight and are easily fatigued. They develop internal and subcutaneous hemorrhages. Early symptoms of scurvy such as fatigue may result from diminished levels of carnitine, needed to derive energy from fat, or decreased synthesis of the neurotransmitter norepinephrine. Therefore, many nutritionists believe that the human intake of ascorbic acid should be many times more than that intake level which produces deficiency symptoms. Scurvy is rare in developed countries because it can be prevented by as little as 10 mg of vitamin C daily [75, 76]. However, recent cases have occurred in children and the elderly on very restricted diets [76, 77]

The amount of vitamin C required to prevent chronic disease appears to be more than that required for prevention of scurvy [78]. Much of the information regarding vitamin C and the prevention of chronic disease is based on prospective studies, in which vitamin C intake is assessed in large numbers of people who are followed over time to determine whether they develop specific chronic diseases.

The recommended dietary allowances of the Food and Nutrition Board of the National Research Council are 30 mg per day for 1- to 3-month infants, 80 mg per day for growing boys and girls, and 100 mg per day for pregnant and lactating women. These values represent an intake which tends to maintain tissue and plasma concentrations in a range similar to that of other well-nourished species of animals [79, 80].

#### 4.3. Instability and Inefficiency of Vitamin C and Possible Solution for these Problems

As it was already said, ascorbic acid is known to be very unstable and easily destroyed during processing by temperature, pH, oxygen, UV light, etc. [81-86]. For example, the stability of ascorbic acid decreases with increases in temperature and pH. This destruction by oxidation is a serious problem in that a considerable quantity of the vitamin C content of foods is lost during processing, storage, and preparation.

One of the ways of suppressing vitamin C decomposition is to derivatize the vitamin C as a salt such as ascorbyl palmitate or magnesium ascorbyl phosphate [87]. Ascorbyl palmitate is mostly used in commercial antioxidant preparations [46, 88].

Segall et al. were investigating the stability of ascorbyl palmitate, sodium ascorbyl phosphate and magnesium ascorbyl phosphate in topical formulations by direct reverse phase high performance liquid chromatography after sample dilution with a suitable buffer - organic solvent mixture [89]. Ascorbyl palmitate, sodium ascorbyl phosphate and magnesium ascorbyl phosphate are derivatives of ascorbic acid which differ in hydrophilic properties. They are widely used in cosmetic and pharmaceutical preparations. According to the results, ascorbyl esters showed significant differences: sodium ascorbyl phosphate and magnesium ascorbyl phosphate are more stable derivatives of vitamin C than ascorbyl palmitate and may be used in cosmetic products. However, the instability problem of vitamin C still remains unsolved in cosmetic, dermatological and pharmaceutical applications.

In order to overcome some of these shortcomings of ascorbic acid, i.e. to make ascorbic acid much more stable and more efficient, the encapsulation technique may be suitable.

## 5. Encapsulation Techniques for Vitamin C

Encapsulation techniques are widely used in pharmaceutical and other sciences [90, 91]. Encapsulation is a well-known technique in the art for protecting components that are sensitive to the elements or for providing time-released delivery of active ingredients. Certain ingredients are easy to encapsulate using conventional techniques. Others, such as sensitive water-soluble components like vitamin C, are very difficult to encapsulate so that controlled protection and release is provided. Figure 5 represents a microparticle with an encapsulated active substance.

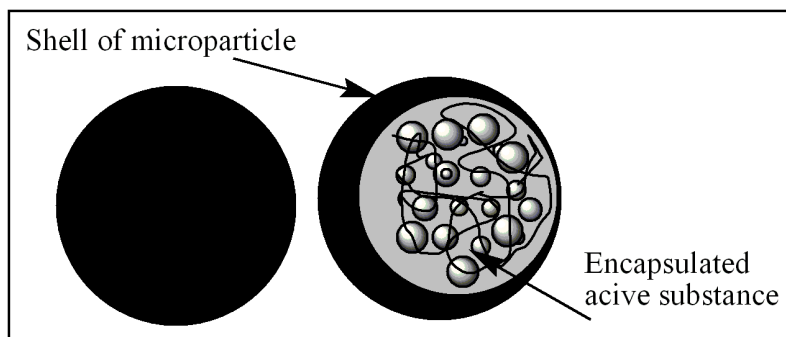

Figure 5. Structure of microparticle.

The choice of a particular method of encapsulation is mainly determined by drug solubility and molecular stability considerations. Many studies have been done on vitamin C with variables optimized to determine the most stable way of encapsulating this vitamin. The commonly utilized techniques for encapsulation of ascorbic acid within micro or nanoparticle are thermal phase separation (coacervation), melt dispersion, solvent evaporation, spray drying, homogenization of water and organic phases, etc.

### 5.1. Thermal Phase Separation

By use of encapsulation, both the release profile of a drug substance and its stability can be modified. Additionally, an unpleasant taste can be masked. By use of coacervation (thermal phase separation), the drug substance is coated with a polymer shell leading to the formation of microcapsules [90]. Ethyl cellulose is the most widely used polymer in the coacervation process [92-96]. Several factors such as stirring speed, cooling rate, concentration of phase-separation inducing agent and viscosity/molecular weight of ethyl cellulose show an effect on the encapsulation efficiency and the release behavior of the encapsulated drug. In their investigation Uddin et. al. encapsulated ascorbic acid using this technique [96]. Ethyl cellulose has been used as the wall forming material. Molecular weight of the ethyl cellulose was varied and it was determined that molecular weight of ethyl cellulose and the addition of polyisobutylene significantly influenced the aggregation and release rate of microcapsules which contains ascorbic acid. It was determined that microencapsulation product size decreased as the molecular weight of ethyl cellulose increased.

### 5.2. Melt Dispersion

In the melt dispersion technique, the drug-containing molten wax phase is emulsified into a heated, emulsifier-containing external phase. Depending on the solubility of the drug, the external phase can be either aqueous (for water-insoluble drugs) or nonaqueous (for water-soluble drugs). On cooling the emulsion, the liquid droplets congeal and suspension of the wax microparticles is formed. The microparticles are then separated, mostly by filtration or centrifugation, sometimes washed to remove free drug crystals and surfactants, dried and sized. Carnauba wax was used in the melt dispersion method for encapsulation of ascorbic acid [96].

### 5.3. Solvent Evaporation

The emulsification-evaporation method [97-100], spontaneous emulsification-solvent diffusion method (SESD) [101, 102], nanoprecipitation method [103, 104], solvent evaporation and spray-drying [105-107] are all widely used in preparing micro and nanoparticles of various sizes. Each of these methods employs a similar first step, where an aqueous drug solution is emulsified in an organic polymer solution to form a water-in-oil dispersion (w/o) [108]. If appropriate, the drug may also be dispersed as a solid powder in an organic polymer solution, or codissolved in a common solvent with the polymer. In solvent evaporation technique, the drug substance is dispersed homogeneously in the polymer. After the formation of a stable emulsion, the organic solvent is evaporated either by reducing the pressure or by continuous stirring. The particle size is found to be influenced by the type and concentration of stabilizer, homogenizer speed and the polymer concentration [109].

However, this technique leads to low encapsulation efficiencies for water-soluble drugs [90, 110].

The solvent evaporation technique was used to investigate effects of varying temperature, core-to-wall ratio and the presence of plasticizers (triethyl citrate) on the microencapsulated ascorbic acid [96]. Results showed that the presence of plasticizer decreased the release rate. Two core-to-wall ratios used were 1:1 and 3:1. No significant effect was found. Similarly, the two temperatures used for solvent evaporation of 28°C and 55°C, showed no significant effect on the release rate. The spray drying technique used four different polymer-coating materials, whether singly or as a mixture. They were gel, starch, ethyl cellulose and  $\beta$ -cyclodextrin. The results showed that ascorbic acid loss during spray drying was 20%. Each of the various coating materials resulted in capsule sizes mostly between the 90-280 $\mu$ m fractions. However, the encapsulated ratio of ascorbic acid was not very high, less than 50%. This means that less than 50% of ascorbic acid used in the technique was actually microencapsulated.

#### 5.4. Spray Drying

Spray-drying is a well-known technique that generates solid powders from solution or suspension and has special applications in the pharmaceutical industry in manufacturing drug delivery systems and controlled release formulations. Consisting of a single step process that involves atomisation of the liquid feed which is injected into a drying chamber containing hot air or nitrogen. The droplets instantly dry into solid particles that are subsequently collected in the drying chamber. The two factors that can influence the properties of the output material are the spray-dried particle formulation factors and the spray-drying parameters [111]. Spray-drying was used as preparation method of vitamin C/Eudragit® microspheres [71]. Vitamin C/Eudragit® microspheres obtained by this method showed potential for delivery of vitamin C by oral route [71]. Spray-drying was, also, used by Finotelli and co-workers for obtaining microcapsules with different content of ascorbic acid for application in the food industry as fortification [112].

#### 5.5. Homogenization of Water and Organic Phases

Spherical nanoparticles of the poly (D,L-lactide-co-glycolide) (PLGA) in the size range 110-170 nm were produced using physicochemical method with solvent/non-solvent systems [1, 17, 113]. The encapsulation of the ascorbic acid in the PLGA polymer matrix was performed by homogenization of water and organic phases (modified precipitation method) (Figure 6). The PLGA commercial granules have been dissolved in acetone and after that the aqueous solution of the ascorbic acid has been added in PLGA solution in acetone while continuously been homogenized. Concentration of ascorbic acid in water was varied in order to obtain particles with different ratio of PLGA and ascorbic acid (PLGA/ascorbic acid 85/15%wt, PLGA/ascorbic acid 70/30%wt, PLGA/ascorbic acid 50/50%wt and PLGA/ascorbic acid 30/70%wt) [1, 113]. The introduction of 15% of ascorbic acid does not influence the size, while further increase of ascorbic acid concentration increases the size of

PLGA particles. After the precipitation with alcohol methanol or ethanol, the particles are stabilized due to the zeta potential created by stabilizer. This was followed by centrifugation, decantation and drying of the particles. Polyvinyl pyrrolidone (povidone, PVP) or polyvinyl alcohol (PVA) were used as a stabilizers of the particles.

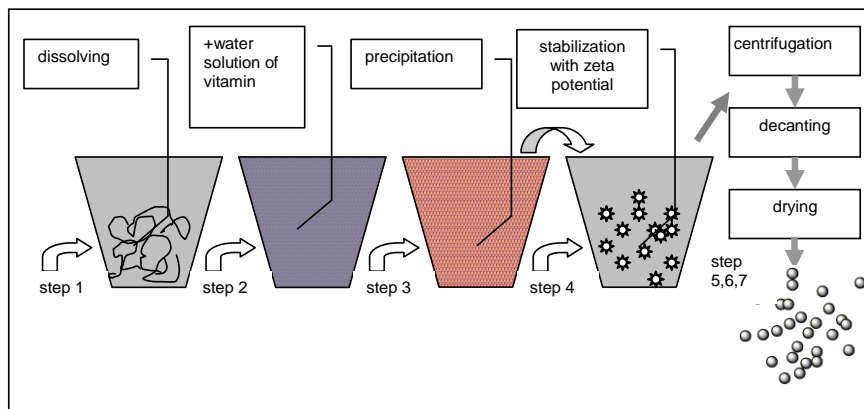

Figure 6. Schematics for obtaining of the PLGA/vitamin nanoparticles [43].

Desai et al. reports the encapsulation of vitamin C within sodium alginate beads by an alternative approach [114]. The alternative encapsulation process mainly involves immobilization of vitamin C in hydrated zinc oxide layers and encapsulation of prepared immobilized particles in sodium alginate bead. The immobilization of vitamin C in hydrated zinc oxide layers was achieved by a coprecipitation process. Fourier transform infrared spectroscopy showed that the vitamin C was found to be stable after its immobilization.

Hydrated zinc oxide as an inorganic matrix for immobilization of vitamin C was, also, used by Yang and coworkers [87]. Encapsulation of vitamin C within a biocompatible layered inorganic material was achieved by coprecipitation reaction, in which the layered inorganic lattice and its intercalate of vitamin C are simultaneously formed. The nanometer sized powders of vitamin C intercalate thus prepared was again encapsulated with silica nanosol to form a nanoporous shell structure. This ternary nanohybrid of vitamin C layered inorganic core-SiO<sub>2</sub> shell exhibited an enhanced storage stability and a sustained releasing of vitamin C. Furthermore, the encapsulation of vitamin C with inorganic mineral was very helpful in delivering vitamin C molecules into skin through stratum corneum, facilitating transdermal penetration of vitamin C in topical application.

## 6. Materials in which Ascorbic Acid Can Be Encapsulated

Structure, properties and applications of micro and nanoparticles are strongly affected by the properties of the material used in their formulation. For each application and drug, one must evaluate the properties of the system (drug and particle) and determine the optimal

formulation for a given drug delivery application. Encapsulation of vitamin C improves and broadens its applications in the field of pharmaceuticals, dermatologicals products, cosmetics, food industry, etc. Materials in which ascorbic acid can be encapsulated are polyacylglycerol monostearate [115], tripolyphosphate cross-linked chitosan [59, 116-118], poly (DL-lactide-co-glycolide) [1, 3, 113], liposomes [119], maltodextrin [112], carnuba wax [96] etc.

Ascorbic acid is known to be involved in iron metabolism in animals [120]. Ascorbic acid enhances the absorption of iron from the intestines by reducing ferric iron to the ferrous state, a more soluble form that is easily absorbed. Ascorbic acid is also involved with adenosine triphosphate (ATP) in the release and reduction of ferric iron from ferritin, and its subsequent incorporation with the iron-binding proteins, apoferritin and transferring, into tissue ferritin. Lee et al. have reported l-ascorbic acid microencapsulation within polyacylglycerol monostearate (PGMS) for milk fortification [115]. Polyacylglycerol monostearate was used as a coating material for microencapsulating the ascorbic acid and iron complex. The highest efficiency (94.2%) of microencapsulation was found with the ratio of 5:1 as the coating to core material. The release of ascorbic acid from the microcapsules increased sharply from 1.6 to 6.7% up to 5 days of storage. The results indicate that L-ascorbic acid microencapsulated within PGMS can be applied to fortify milk.

Chitosan is a hydrophilic, biocompatible, and biodegradable, polysaccharide of low toxicity. In recent years, it has been used for development of oral controlled drug delivery systems. It is also a well-known dietary food additive. Desai *et al.* demonstrated the cross-linked chitosan as a wall material for the encapsulation of vitamin C by a spray-drying technique [59, 116-118]. Chitosan was cross-linked with nontoxic cross-linking agent, i.e., tripolyphosphate. Vitamin C-encapsulated chitosan microspheres of different size, surface morphology, loading efficiency, and zeta potential with controlled-release property could be obtained by varying the manufacturing parameters (inlet temperature, flow rate) and using the different molecular weight and concentration of chitosan. Vitamin C-encapsulated chitosan microcapsules were spherical in shape with a smooth surface.

Phospholipid vesicles (liposomes) are one of the most widely studied drug carriers in the recent past [121]. Kirby et al studied the stabilization of ascorbic acid by microencapsulation in liposomes [119]. The liposomes containing encapsulated ascorbic acid were prepared using the dehydration/rehydration method. Phosphatidylcholine, cholesterol and DL- $\alpha$ -tocopherol were used to form the liposomes. These were varied to study the efficiency of ascorbic acid encapsulation. Cholesterol was used to decrease liposome permeability, which was expected to increase stability. Results show no significant difference in encapsulation efficiencies with varying levels of cholesterol. All results showed encapsulation efficiencies around 53-58%.

Biodegradable polymeric biomaterials are preferred candidates for developing therapeutic devices such as controlled/sustained release drug delivery vehicles [3, 17]. This application demand materials with specific physical, chemical, biological, biomechanical and degradation properties to provide efficient therapy. Polymers like polylactides (PLA), polyglycolides (PGA), poly(lactide-co-glycolides) (PLGA) are approved by the World Health Organization and Food and Drug Administration as materials that can be used in medicine and pharmacy. PLGA has been successful as a biodegradable polymer because it undergoes hydrolysis in the body to produce the original monomers, lactic acid and glycolic acid [3].



These two monomers under normal physiological conditions, are by-products of various metabolic pathways in the body. Since the body effectively deals with the two monomers, there is very minimal systemic toxicity associated with using PLGA for drug delivery or biomaterial applications. PLGA particles are used for the controlled delivery of several classes of medicaments like anticancer agents, antihypertensive agents, immunomodulatory drugs, hormones, nucleic acid, proteins, peptides, antibodies, vitamins, etc. Different vitamins can be encapsulated within poly(lactide-co-glycolide) polymeric matrix such as vitamin A,  $\beta$ -carotene (a pigment which is converted into retinol in the body), vitamin K<sub>5</sub>, vitamin E, vitamin B<sub>12</sub>, folic acid (folate-the anion form, vitamin B<sub>9</sub>) and vitamin C [3]. With the encapsulation of the ascorbic acid into the PLGA polymer matrix it is possible to overcome its chemical instability and achieve its higher efficiency in the body. System for the controlled delivery PLGA/vitamin C can bring to the more balanced and efficient concentration of the vitamin throughout the extended period of time (Figure 7.) [1, 113].

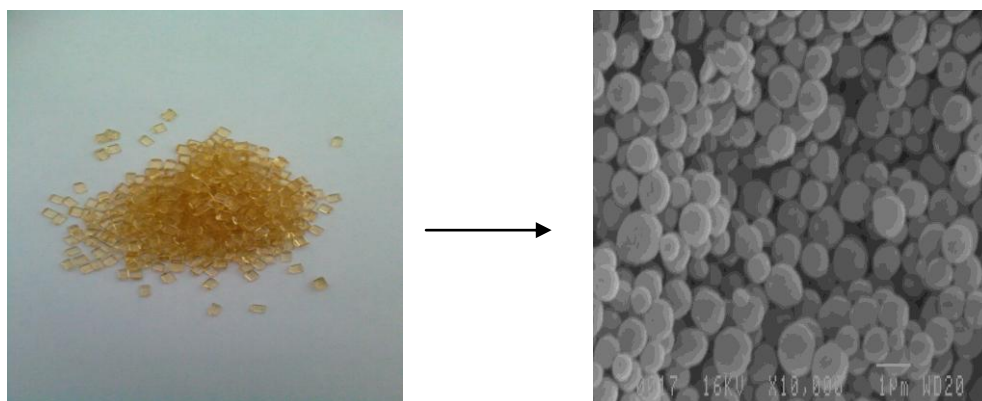

Figure 7. Photo of PLGA commercial granules and SEM image of obtained PLGA/vitamin C nanoparticles.

Maltodextrins are non-sweet nutritive polysaccharides consisted of:  $\alpha$  (1-4)-linked D-glucose produced by acid or enzymatic hydrolysis of corn starch. Microcapsules of ascorbic acid using spray drying technique and three types of covering materials (derivates of starch, capsul (chemically modified starch by incorporation of lipophilic component) and maltodextrin) were obtained by Finotelli et al. [112]. Microcapsules containing 10 and 20% of ascorbic acid were produced.

Dendrimers have unique characteristics including monodispersity and modifiable surface functionality, along with highly defined size and structure. This makes these polymers attractive candidates as carriers in drug delivery applications. Drug delivery can be achieved by coupling a drug to polymer through one of two approaches. Hydrophobic drugs can be complexed within the hydrophobic dendrimer interior to make them water-soluble or drugs can be covalently coupled onto the surface of the dendrimer [122]. The dendrimers present a good ability to load water-soluble drugs like vitamin C.

Cheng et al. introduced a new method with practical value of intercalating and stabilizing vitamin C within an inorganic layered material montmorillonite (MMT) [123]. Toxicity assessment pointed out the margin of safety and toxicity rankings for feasibility of L-ascorbic acid-montmorillonite (LAA-MMT) composites in practical applications.

Production of methacrylate microparticles for the delivery of ascorbic acid via the oral route was described by Esposito *et. al.*[71]. As polymers different acrylic compounds were considered, namely Eudragit® RL, L and RS [71]. Results indicates that the release pattern of the vitamin C is slowly influenced by Eudragit® type or mixture used for microparticle production. Differently from other studies [124] were the release kinetics of the encapsulated drug is clearly dependent from the different solubility of the polymers at the pH of the receiving buffer, in this case the release rate of the drug does not seem to be heavily affected by the nature of the polymer.

Carnauba wax was used in melt dispersion method of microencapsulation. Results show spherical particles with encapsulated ascorbic acid of approximately 50 µm in size [96, 125].

Hydrated zinc oxide has high biocompatibility and skin affinity, so it can be applicable as the cosmetic ingredient [87, 114]. It was very often used as an inorganic matrix for immobilization anionic L-ascorbate species, since it has positive surface charge. The immobilized vitamin C shows superior storage stability in aqueous medium compared to the pure sodium L-ascorbate, and an excellent time-controlled releasing behavior [87].

## 7. Characteristics of Ascorbic Acid Nano and Microparticles Prepared by Different Methods

Encapsulation efficiency, release rate, size distribution of particles with encapsulated ascorbic acid, are some of the parameters which are used for evaluating encapsulation system characteristics.

Uddin et al. studied the effect of process variables on ascorbic acid characteristics [96]. They chose four different encapsulation techniques – thermal phase separation, melt dispersion, solvent evaporation and spray drying.

Ascorbic acid is highly oxidative which can cause a problem in food systems. In the processing stage, it can change colour from white to yellow which affects food colours. Also, it can react with other ingredients and bring about undesirable changes in the colour and taste of the food. The results show that microencapsulated ascorbic acid could prevent the ascorbic acid color change, retard its core release rate, and generally mask its acid taste [96]. In the thermal phase separation, molecular weight of ethyl cellulose and the addition of polyisobutylene significantly influenced the aggregation and release rate of microcapsules. Results show that there is a significant difference in release ratios with different molecular weights of ethyl cellulose. The higher the molecular weight, the lower is the initial release rate. Molecular rate was not a factor for complete release as high or low molecular weight gave a release rate of ~1.0 in 20 minutes. This compares favourably to free ascorbic acid, which achieved a release ratio of 1.0 after only 20 seconds of dissolution.

In the melt dispersion method, spherical particles were prepared by using carnauba wax [96]. The ascorbic acid release rate was found to be slower in the case of carnauba-

encapsulated ascorbic acid than that made by ethyl cellulose using other methods. This shows that carnauba wax keeps the ascorbic acid more stable. In the solvent evaporation methods, a higher molecular weight of ethyl cellulose and the addition of plasticizer were also found to be important for good encapsulation. In the spray drying method, loss of ascorbic acid was found to be minimum during microencapsulation. Uddin et al found that the loss of ascorbic acid during encapsulation by spray drying was 20% [96]. Starch and  $\beta$ -cyclodextrin encapsulated ascorbic acid delayed the degradation of ascorbic acid during storage at 38°C and relative humidity 84.0%.

Trindade and Grosso studied the stability of ascorbic acid microencapsulated in granules of rice starch and in gum arabic. Microcapsules made from starch were larger than those made from gum Arabic [126]. Ninety percent of starch microcapsules had diameters  $\leq 57 \mu\text{m}$  with an average of 20.5  $\mu\text{m}$  while 90% of gum arabic microcapsules had diameters  $< 27 \mu\text{m}$  with an average of 8.0  $\mu\text{m}$ .

Using the simplistic method, spherical and uniform particles powder has been obtained from the commercial granules of poly(DL-lactide-co-glycolide), where the mean particles size are in the range from 110 to 170nm. The various concentrations of the vitamin C have been encapsulated within PLGA particles. The results of the determination of the particle yield for various PLGA/ascorbic acid ratios were similar for each of the samples and in all cases greater than 50% [1,113]. The loading efficiency was determined to be greater than 90% in all ratios of PLGA/ascorbic acid particles [1, 113]. The degradation of the PLGA without and with ascorbic acid has been followed as well as morphological changes which occurred during the degradation [1,127]. The degradation have been tracked for eight weeks and it has been determined that PLGA completely degrades within this period fully releasing all encapsulated ascorbic acid (Figure 8.). In the first 24 days, the samples degrade slower while latter the pace of the degradation increases. In the first 24 days of the degradation, for all samples, less than the 10% of the encapsulated ascorbic acid have been released [1, 113]. At the beginning the particles maintain the initial shape, but after 24 days the particles start being agglomerated, creating the porous film, where the porosity increases until the complete degradation of the samples. By the end of the experiment the nanoparticles have fully degraded and there were no more traces of them in the solution. PLGA degrades via backbone hydrolysis (bulk erosion) and the degradation products are the monomers, lactic acid and glycolic acid. It could be expected that the faster degradation of the lower molar mass fraction, present in copolymer, increases the local acidity, thereby, accelerating the hydrolysis of higher molar mass species. In another words, when acid accumulation creates a local pH drop, catalytic degradation of the polymer itself occurs. The different ionized forms of the ascorbic acid have different redox properties, so that the redox-chemistry of the ascorbic acid is highly pH dependent [128-130]. Ascorbic acid decomposes into biologically inactive compounds by auto-oxidation only at alkaline pH [131]. In the solution with low pH, decomposition of the ascorbic acid can happen for example under the influence of the enzymes (enzymatic oxidation) [131].

The biological behaviour of PLGA nanospheres without and with encapsulated ascorbic acid is discussed in terms of *in vitro* toxicity in human hepatoma cells and *in vivo* biodistribution in rat after intravenous injection [132]. Neither PLGA nanospheres nor PLGA/ascorbic acid 85/15% nanoparticles significantly affected the viability of the HepG2

cells [132]. PLGA nanospheres with encapsulated ascorbic acid exhibit prolonged blood circulation accompanied by time dependent reduction in lung, liver and spleen, and addition in kidney, stomach and intestine [132]

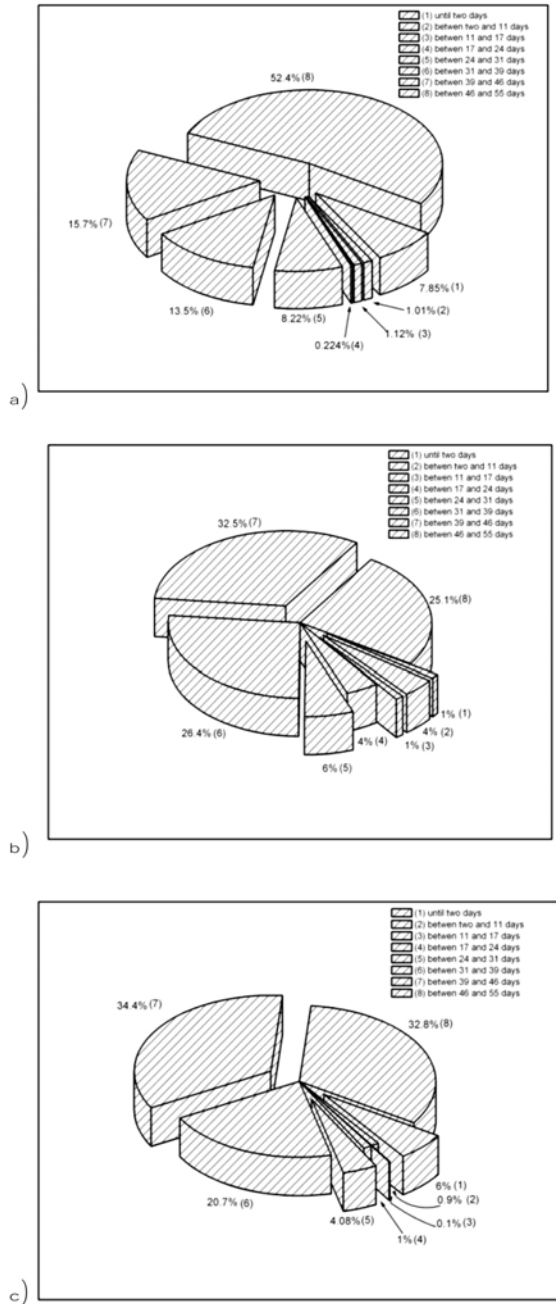

Figure 8. Release of the ascorbic acid in percentages over the period of time of the degradation for a) PLGA/ascorbic acid 85/15%; b) PLGA/ascorbic acid 70/30% and c) PLGA/ascorbic acid 50/50% (relative review) [113].

Vitamin C/Eudragit® microspheres obtained by spray-drying method were unable to slow down the release of the drug with respect to the free form of ascorbic acid but these microspheres showed a good morphology and size distribution that permit to propose them as candidate for the delivery of vitamin C as associated therapy in the treatment of colorectal cancer by oral route [71].

The procedure of obtaining microparticles with encapsulated ascorbic acid by spray drying was described by Finotelli and co-workers [112]. The morphology of the Capsul/vitamin C particles was observed by a scanning electron microscopy, whose analysis showed a tendency of agglomeration. Particle size analysis showed a multi-modal particle size distribution, but with a main mode in intermediate diameters range (4–8  $\mu\text{m}$ ). The particle yield was 52%. Ascorbic acid stability was studied for particles stored, at both, room temperature and at 45°C showing 100% of retention at the beginning. Microcapsules containing 20% of ascorbic acid recovered by a mixture presented 7% of ascorbic acid reduction in samples for up to 60 days stored at 28°C temperature.

Spray drying technique was also used by Desai and co-workers for encapsulation of vitamin C in tripolyphosphate cross-linked chitosan microspheres [59, 116-118]. Results showed a mean particle size of 6.1-9.0  $\mu\text{m}$  which was influenced by the amount of cross-linking agent. Encapsulation efficiency was around 58% but decreased as the amount of tripolyphosphate solution increased. The amount of crosslinking affected the release rate and particle size.

## **8. Applications of Micro and Nanoparticles with Ascorbic Acid**

In recent years, micro and nanoparticles have attracted considerable attention as potential drug delivery devices in view of their applications in the controlled release of drugs, their ability to target particular organs/tissues, as carriers of DNA in gene therapy, and in their ability to deliver divers drugs through a different route of administration [91].

Encapsulation of vitamin C within micro or nanoparticles proposes many advantages. Primarily, encapsulation can help to stabilise vitamin C. Many studies have been done on this vitamin with variables optimized to determine the most stable way of encapsulating vitamin C and to give the highest retention possible [87]. Particles containing encapsulated ascorbic acid can be used in numerous applications. Numerous products are using currently vitamin C because of its significant properties, particularly its anti-oxidizing effect. Vitamin C has ability of quenching or stabilizing free radicals that lead over time to degenerative diseases, including cancer, cardiovascular disease, cataracts, and other diseases.

PLGA nanospheres are very efficient mean of transdermal transport of medicaments in the body, e.g. ascorbic acid [133, 134].

Ascorbic acid providing photoprotective capabilities by inhibiting UVA and UVB radiation-induced damage by neutralizing the oxygen-free radicals in the skin, it prevents UV immunosuppression, stimulates collagen synthesis and has anti-inflammatory properties [135, 136]. Here, not only does encapsulation provide a convenient formulation vehicle, but it also enhanced the stability of the encapsulated payload at an elevated temperature.

Ascorbic acid is added extensively to many types of food products for two quite different purposes: as a vitamin supplements to reinforce dietary intake of vitamin C, and as an antioxidant, to protect the sensory and nutritive quality of the food itself [119]. Encapsulation is a technology that can improve the retention time of the different nutrient, especially vitamin C, in the food and allow controlled release at specific times, during food consumption or in the intestinal gut.

The increased stability of vitamin C within micro and nanoparticles makes them ideal for use in different product forms i.e. as tablets, creams, gel, sprays, etc. in the fields of medicine, pharmacy, cosmetology, dermatology and the food industry.

## Conclusion

By encapsulating the vitamin C into the micro or nanoparticles it is assumed that its chemical instability can be overcome as well as higher, more efficient and equally distributed concentration throughout extended period of time can be achieved. Various techniques of encapsulation produce different results. The process of encapsulation itself can be optimized; by applying suitable material in which vitamin C will be encapsulated, by varying the ratio of core to wall materials, by adding the additives, by varying the temperature within the process, by changing the time and velocity of the centrifugation etc; and all this in line of achieving the most efficient encapsulation and stability of vitamin C. Micro and nano-particles with encapsulated vitamin C have wide spectra of use in medicine, pharmacy, cosmetics, food production etc.

## References

- [1] Stevanović, M. Savić, J. Jordović, B. Uskoković, D. (2007). Fabrication, in vitro degradation and the release behaviours of poly(DL-lactide-co-glycolide) nanospheres containing ascorbic acid. *Colloids and Surfaces B: Biointerfaces*, 59 (2), 215-223.
- [2] Leibovitz, B. Siegel, B.V. (1978). Ascorbic acid, neutrophil function, and the immune response. *International Journal for Vitamin and Nutritional Research*, 48, 159-164.
- [3] Stevanović, M. Uskoković, D. (2009). Poly(lactide-co-glycolide)-based micro and nanoparticles for the controlled drug delivery of vitamins Poly (DL-lactide-co-glycolide) for controlled drug delivery of vitamins. *Current Nanoscience*, 5(1), 1-1514.
- [4] Vasir, J. K. Reddy, M. K. Labhasetwar, V. D. (2005). Nanosystems in drug targeting: opportunities and challenges, *Current Nanoscience*, 1, 47-64.
- [5] Caruthers, S. D. Wickline, S. A. Lanza, G. M. (2007). Nanotechnological applications in medicine, *Current Opinion in Biotechnology*, 18, 26-30.
- [6] Emerich, D. F. Thanos, C. G. (2006). The pinpoint promise of nanoparticle-based drug delivery, *Biomolecular Engineering*, 23, 171-184.
- [7] Greene, M. E. (2007). Understanding cell interactions is a snap: Nanobiotechnology. *Nano Today*, 2 (3), 11.

- 
- [8] Rados, C. (2004). GRAS: Time-Tested, and Trusted, Food Ingredients. *FDA Consumer magazine*, 38, 2.
- [9] Vandervoort, J. Ludvig, A. (2002). Biocompatible stabilizers in the preparation of PLGA nanoparticles: a factorial design study. *International Journal of Pharmaceutics*, 238(1-2), 77-92.
- [10] Stevanović, M. Jordović, B. Nedić, Z. Miličević, D. (2007). The stabilizer influence on morphological characteristics of poly (DL-lactide-co-glycolide) nanospheres. *Material Science Forum*, 555, 447-452.
- [11] Nafee, N. Taetz, S. Schneider, M. Schaefer, U. F. Lehr, C.-M. (2007) Chitosan-coated PLGA nanoparticles for DNA/RNA delivery: effect of the formulation parameters on complexation and transfection of antisense oligonucleotides. *Nanomedicine: Nanotechnology, Biology and Medicine*, 3 (3), 173-183.
- [12] Kozubek, A. Gubernator, J. Przeworska, E. Stasiuk, M. (2001). Liposomal drug delivery, a novel approach: PLARosomes, *Acta Biochimica Polonica*, 47 (3), 639-649.
- [13] Lian, T. Ho, R. J. Y. (2001). Trends and developments in liposome drug delivery systems, *Journal of Pharmaceutical Sciences*, 90 (6), 667-680.
- [14] Medina, O.P. Zhu, Y. Kairemo, K. (2004). Targeted liposomal drug delivery in cancer, *Current Pharmaceutical Design*, 10 (24), 2981-2989.
- [15] D'Emanuele, A. Attwood, D. Abu-Rmaileh, R. (2004). The use of a dendrimer-propranolol prodrug to bypass efflux transporters and enhance oral bioavailability, *Journal of Controlled Release*, 95, 447-453.
- [16] Liu, M. Frechet, J. M. (1999). Designing dendrimers for drug delivery, *Pharmaceutical Sciences Technology Today*, 10, 393-401.
- [17] Stevanović, M. Ignjatović, N. Jordović, B. Uskoković, D. (2007). Stereological analysis of the poly (DL-lactide-co-glycolide) submicron sphere prepared by solvent/non-solvent chemical methods and centrifugal processing. *Journal of Materials Science: Materials in Medicine*, 18 (7), 1339-1344.
- [18] Yoo, H. S. (2006). Preparation of biodegradable polymeric hollow microspheres using O/O/W emulsion stabilized by Labrafil, *Colloids and Surfaces B: Biointerfaces*, 52, 47-51.
- [19] Sahoo, S. K. Parveen, S. Panda, J. J. (2007). The present and future of nanotechnology in human health care. *Nanomedicine*, 3 (1), 20-31.
- [20] Sumer, B. Gao, J. (2008). Theranostic nanomedicine for cancer. *Nanomedicine*, 3 (2), 137-140.
- [21] Besenbache, F. Sutherland, D. S. Hovgaard, M. B. From nanoscience to nanotechnology: Utilising the nanoscale. *Toxicology Letters*, 172 (1), S34.
- [22] Moghimi, S. M. Hunter, A. C. Murray, J. C. (2005). Nanomedicine: current status and future prospects. *FASEB Journal*, 19, 311-330.
- [23] Wong, S. Y. Pelet, J. M. Putnam, D. (2007). Polymer systems for gene delivery-past, present and future, *Progress in Polymer Science*, 32 (8-9), 799-837.
- [24] Ishida, M. Sakai, H. Sugihara, S. Aoshima, S. Yokoyama, S. Abe, M. (2003). Controlled release of vitamin E from thermo-responsive polymeric physico-gel. *Chemical and Pharmaceutical Bulletin*, 51(11), 1348—1349.

- [25] Mu, L. Feng, S. S. (2003). A novel controlled release formulation for the anticancer drug paclitaxel (Taxol(R)): PLGA nanoparticles containing vitamin E TPGS. *Journal of Controlled Release*, 86, 33-48.
- [26] Ratnam, V. D. Ankola, D. Bhardwaj, V. Sahana, D. K. Ravi Kumar, M. N. V. (2006). Role of antioxidants in prophylaxis and therapy: A pharmaceutical perspective, *Journal of Controlled Release*, 113 (3), 189-207.
- [27] R. Langer, Perspectives: Drug delivery - drugs on target. *Science*, 293 (2001) 58-59
- [28] Feng, S. S. Mu, L. Yin Win, K. Huang, G. (2004). Nanoparticles of biodegradable polymers for clinical administration of paclitaxel. *Current Medicinal Chemistry*, 11, 413-424
- [29] Ravi Kumar, M. N. V. Bakowsky, U. Lehr, C. M. (2004). Preparation and characterization of cationic PLGA nanospheres as DNA carriers. *Biomaterials*, 25, 1771-1777.
- [30] Mainardes, R. Evangelista, R. (2005). PLGA nanoparticles containing praziquantel: effect of formulation variables on size distribution. *International Journal of Pharmaceutics*, 290, 137-144.
- [31] Ito, F. Fujimori, H. Makino, K. (2007). Incorporation of water-soluble drugs in PLGA microspheres, *Colloids and Surfaces B: Biointerfaces*, 54, 173-178.
- [32] Holick, M. F. (2008). Sunlight, UV-radiation, vitamin D and skin cancer: how much sunlight do we need? *Advances in Experimental Medicine and Biology*, 624, 1-15.
- [33] Holick, M. F. Chen, T. C. (2008). Vitamin D deficiency: a worldwide problem with health consequences. *The American Journal of Clinical Nutrition*, 87(4), 1080S-1086S.
- [34] Martinez-Sancho, C. Herrero-Vanrell, R. Negro, S. (2006). Vitamin A palmitate and aciclovir biodegradable microspheres for intraocular sustained release. *International Journal of Pharmaceutics*, 326 (1-2), 100-106.
- [35] Ribeiro, H. S. Chu, B. S. Ichikawa, S. Nakajima, M. (2008). Preparation of nanodispersions containing  $\beta$ -carotene by solvent displacement method. *Food Hydrocolloids*, 22 (1), 12-17.
- [36] Mu, L. Feng, S. S. (2002). Vitamin E TPGS used as emulsifier in the solvent evaporation/extraction technique for fabrication of polymeric nanospheres for controlled release of paclitaxel (Taxol). *Journal of Controlled Release*, 80 (1-3), 129-144.
- [37] Brown, D. J. Goodman, J. (1998). A review of vitamins A, C and E and their relationship to cardiovascular disease, *Clinical excellence for nurse: the international journal of NPACE, practitioners 2* (1), 10-22.
- [38] Fukuwatari, T. Shibata, K. (2008). Urinary water-soluble vitamins and their metabolite contents as nutritional markers for evaluating vitamin intakes in young Japanese women. *Journal of Nutritional Science and Vitaminology*, 54 (3), 223-229.
- [39] Liebman, M., Chai, W. W. Harvey, E. Boenisch, L. (1997). Effect of supplemental ascorbate and orange juice on urinary oxalate. *Nutrition Research*, 17(3), 415-425.
- [40] Wandzilak, T. R. D'Andre, S. D. Davis, P. A. Williams, H. E. (1994). Effect of high dose vitamin C on urinary oxalate levels. *The Journal of Urology*, 151(4), 834-837.
- [41] Kafriksen, M. E. Oakley, G. Pharmaceutical methods of delivering folic acid. US Patent 6 190 693, Februar 2001.



- [42] Zhao, H. Yung, L. Y. L. (2008). Selectivity of folate conjugated polymer micelles against different tumor cells. *International Journal of Pharmaceutics*, 349 (1-2), 256-268.
- [43] Stevanović, M. Radulović, A. Jordović, B. Uskoković, D. (2008). Poly(DL-lactide-co-glycolide) nanospheres for the sustained release of folic acid. *Journal of Biomedical Nanotechnology*, 4 (3), 349-358.
- [44] Moser, U. Bendich, A. Vitamin C. In: Machlin L.J. , editor. Handbook of Vitamins. Marcel Dekker, New York, (1990), Ch5.
- [45] Bors, W. Buettner, G. R. The Vitamin C Radical and Its Reactions in Vitamin C in Health and Disease, eds. L. Packer and J. Fuchs, Marcel Dekker, New York, (1997),75.
- [46] Naidu, A. (2003). Vitamin C in human health and disease is still a mystery ? An overview. *Nutrition Journal*, 2, 1-10.
- [47] Ikeda, S. (1961). Reduction of dehydro-L-ascorbic acid in green leaves. *Plant and Cell Physiology*, 2 (3), 291-299
- [48] Bode, M. Cunningham, L. Rose, R. C. (1990). Spontaneous decay of oxidized ascorbic acid (dehydro-L-ascorbic acid) evaluated by high-pressure liquid chromatography. *Clinical Chemistry*, 36 (10), 1807-1809.
- [49] Niwa, M. Saito, Y. Ishii, Y. Hayashi, H. Method for producing 2-keto-L-gulonic acid, USA patent 5 834 263 (1998)
- [50] Hornig, D. (1975). Metabolism of ascorbic acid. *World Review of Nutrition and Dietetics*, 23, 225-258.
- [51] Hancock, R. Viola, R. (2005). Biosynthesis and Catabolism of L-Ascorbic Acid in Plants. *Critical Reviews in Plant Sciences*, 24 (3), 167-188.
- [52] Irwin, M. I. Hutchins, B. K. (1976). A conspectus of research on vitamin C requirements of man. *The Journal of Nutrition*, 106, 823-879.
- [53] Smirnoff, N. (1996). The function and metabolism of ascorbic acid in plants. *Annals of Botany*, 78, 661-669.
- [54] Auer, B. L. Auer, D. Rodgers, A. L. (1998). The effect of ascorbic acid ingestion on the biochemical and physicochemical risk factors associated with calcium oxalate kidney stone formation. *Clinical Chemistry and Laboratory Medicine*, 36(3), 143-147.
- [55] Chen, Q. Espey, M. G. Krishna, M. C. Mitchell, J. B. Corpe, C. P. Buettner, G. R. Shacter, E. Levine, M. (2005). Pharmacologic ascorbic acid concentrations selectively kill cancer cells: action as a pro-drug to deliver hydrogen peroxide to tissues. *Proceedings of the National Academy of Sciences of the United States of America*, 102 (38), 13604-13609.
- [56] Lee, Y. S. Wurster, R. D. (1994). Potentiation of anti-proliferative effect of nitroprusside by ascorbate in human brain tumor cells. *Cancer Letters*, 78, 19-23.
- [57] Aidoo, A. Lyn-Cook, L. E. Lensing, S. Wamer, W. (1994). Ascorbic acid (vitamin C) modulates the mutagenic effects produced by an alkylating agent in vivo. *Environmental and Molecular Mutagenesis*, 24, 220-228.
- [58] Cameron, E. Pauling, L. (1978). Supplemental ascorbate in the supportive treatment of cancer: Reevaluation of prolongation of survival times in terminal human cancer. *Proceedings of the National Academy of Sciences of the United States of America*, 75, 4538-4542.

- [59] Desai, K. G. H. Park, H. J. (2005), Encapsulation of vitamin C in tripolyphosphate cross-linked chitosan microspheres by spray drying. *Journal of Microencapsulation*, 22 (2), 179-192.
- [60] Chen, Q. Espey, M. G. Sun, A. Y. Pooput, C. Kirk, K. L. Krishna, M. C. Khosh, D. B. Drisko, J. Levine, M. (2008). Pharmacologic doses of ascorbate act as a prooxidant and decrease growth of aggressive tumor xenografts in mice, *Proceedings of the National Academy of Sciences of the United States of America*, 105(32), 11105-11109.
- [61] Vohra, K. Khan, A. J. (1990). Improvement of neutrophil migration by systemic vitamin C in neonates. *Journal of Perinatology*, 10, 134-136.
- [62] Shklar, G. Schwartz, J. L. (1996). Ascorbic acid and cancer. *Sub-cellular Biochemistry*, 25, 233-247.
- [63] Zhang, H. M. Wakisaka, N. (1997). Vitamin C inhibits the growth of a bacterial risk factor for gastric carcinoma: helicobacter pylor. *Cancer*, 80, 1897-1903.
- [64] Dyke, G. W. Craven, J. L. (1994). Effect of vitamin C supplementation on gastric mucosal damage. *Carcinogenesis*, 15, 291-295.
- [65] Kurbacher, C. M. Wagner, U. Kolster, B. Andreotti, P. E. Krebs, D. Bruckner, H. W. (1996). Ascorbic acid (vitamin C) improves the antineoplastic activity of doxorubicin, cisplatin, and paclitaxel in human breast carcinoma cells in vitro. *Cancer Letter*, 103, 183-189
- [66] Shimpo, K. Nagatsu, T. Yamada, K. Sato, T. Niimi, H. Shamoto, M. Takeuchi, T. Umezawa, H. Fujita, K. (1991). Ascorbic acid and adriamycin toxicity. *American Journal of Clinical Nutrition*, 54, 1298S-1301S.
- [67] Flag, E. W. Coates, R. J. Greenberg, R. S. (1995). Epidemiologic studies of antioxidants and cancer in humans. *Journal of American College of Nutrition*, 14, 419-427
- [68] Block, G. (1991). Epidemiologic evidence regarding vitamin C and cancer. *American Journal of Clinical Nutrition*, 54, 1310S-1314S
- [69] Shils, M. Olson, J. Shike, M. Ross, C. (1999). Modern nutrition in health and disease. UK: Lippincot Williams and Wilkins.
- [70] Logue, T. Frommer, D. (1980). The influence of oral vitamin C in supplement on experimental colorectal tumour induction. *Australian and New Zealand Journal of Medicines*, 10, 588-596.
- [71] Esposito, E. Cervellati, F. Menegatti, E. Nastruzzi, C. Cortesi, R. (2002). Spray dried Eudragit microparticles as encapsulation devices for vitamin C. *International Journal of Pharmaceutics*, 242, 329-334.
- [72] Hodges, R. E. Hood, J. Canham, J. E. Sauberlich, H. E. Baker, E.M. (1971). Clinical manifestations of ascorbic acid deficiency in man. *American Journal of Clinical Nutrition*, 24, 432-443.
- [73] Losonczy, K. G. Harris, T. B. Havlik, R. J. (1996). Vitamin E and vitamin C supplement use and risk of all-cause and coronary heart disease mortality in older persons: the Established Populations for Epidemiologic Studies of the Elderly. *The American Journal of Clinical Nutrition*, 64(2), 190-196.

- [74] Osganian, S. K. Stampfer, M. J. Rimm, E. Spiegelman, D. Hu, F. B. Manson, J. E. Willett, W. C. (2003). Vitamin C and risk of coronary heart disease in women. *Journal of the American College of Cardiology*, 42(2), 246-252.
- [75] Simon, J. A. Hudes, E. S. (2000). Serum ascorbic acid and gallbladder disease prevalence among US adults: the third national health and nutrition examination survey (NHANES III). *Archives of Internal Medicine*, 160 (7), 931-936.
- [76] Stephen, R. Utecht, T. (2001). Scurvy identified in the emergency department: a case report. *Journal of Emergency Medicine*, 21(3), 235-237.
- [77] Weinstein, M. Babyn, P. Zlotkin, S. (2000). An orange a day keeps the doctor away: scurvy in the year. *Pediatrics*, 108 (3), E55.
- [78] Carr, A.C. Frei, B. (1999). Toward a new recommended dietary allowance for vitamin C based on antioxidant and health effects in humans. *The American Journal of Clinical Nutrition*, 69(6), 1086-1107.
- [79] Levine, M. Wang, Y. Padayatty, S. J. Morrow, J. (2001) A new recommended dietary allowance of vitamin C for healthy young women. *Proceedings of the National Academy of Sciences of the United States of America*, 98(17), 9842-9846.
- [80] Levine, M. Conry-Cantilena, C. Wang, Y. Welch, R. W. Washko, P. W. Dhariwal, K. R. Park, J. B. Lazarev, A. Graumlich, J. F. Kings, J. Cantilena L. R. (1996). Vitamin C pharmacokinetics in healthy volunteers: evidence for a recommended dietary allowance. *Proceedings of the National Academy of Sciences of the United States of America*, 93(8), 3704-3709.
- [81] Margolis, S. A. Park, E. (2001). Stability of ascorbic acid in solutions stored in autosampler vials. *Clinical Chemistry*, 47, 1463-1464.
- [82] Pierucci, A. P. Andrade, L. R. Baptista, E. B. Volpato, N. M. Rocha-Leão, M. H. (2006). New microencapsulation system for ascorbic acid using pea protein concentrate as coat protector. *Journal of Microencapsulation*, 23(6), 654-662.
- [83] Rubin, H. DeRitter, E. Johnson, J. B. (1976). Stability of vitamin C (ascorbic acid) in tablets, *Journal of Pharmaceutical Science*, 6, 963-968.
- [84] Washko, P. W. Welch, R. W. Dhariwal, K. R. Wang, Y. Levine, M. (1992). Ascorbic acid and dehydroascorbic acid analyses in biological samples, *Analytical Biochemistry*, 204(1), 1-14.
- [85] Austri, R. Semenzato, A. Bettero, A. (1997). Stability of vitamin C derivatives in solution and topical formulations. *Journal of Pharmaceutical and Biomedical Analysis*, 15 (6), 795-801.
- [86] Gallarate, M. Carlotti, M. E. Trotta, M. Bovo, S. (1999). On the stability of ascorbic acid in emulsified systems for topical and cosmetic use. *International Journal of Pharmaceutics*, 188(2), 233-241.
- [87] Yang, J. H. Lee, S. Y. Han, Y. S. Park, K. C. Choy, J. H. (2003). Efficient transdermal penetration and improved stability of L-ascorbic acid encapsulated in an inorganic nanocapsule, *Bulletin of the Korea Chemical Society*, 24(4), 499-503.
- [88] Spiclin, P. Gasperlin, M. Kmetec, V. (2001). Stability of ascorbyl palmitate in topical microemulsions, *International Journal of Pharmaceutics*, 222, 271-279

- [89] Segall, A. I. Moyano, M. A. (2008). Stability of vitamin C derivatives in topical formulations containing lipoic acid, vitamins A and E. *International Journal of Cosmetic Science*, 30(6), 453-458.
- [90] Wieland-Berghausen, S. Schote, U. Frey, M. Schmidt, F. (2002). Comparison of microencapsulation techniques for the water-soluble drugs nitenpyram and clomipramine HCl. *Journal of Controlled Release*, 85(1-3), 35-43.
- [91] Ravi Kumar, M. N. V. (2000). Nano and microparticles as controlled drug delivery devices. *Journal of Pharmacy & Pharmaceutical Sciences*, 3 (2), 234-258.
- [92] Miller, R. E. Anderson, J. L. Encapsulation Process and its Products, US Patent 3, 155, 590, November, 1964.
- [93] Yoshiyuki, K. Hirata, G. Samejima, M. (1983). Studies on microcapsules II: influence of molecular weight of ethylcellulose in the microencapsulation of ascorbic acid. *Chemical & Pharmaceutical Bulletin*, 31, 4476-4482.
- [94] Benita, S. Donbrow, M. (1982). Effect of polyisobutylene on ethylcellulose-walled microcapsules: Wall structure and thickness of Salicylamide and Theophylline microcapsules. *Journal of Pharmaceutical Sciences*, 71 (2), 205-210.
- [95] Yalabik-Kas, H. S. (1983). Microencapsulation and in vitro dissolution of oxazepam from ethylcellulose microcapsules. *Drug Development and Industrial Pharmacy*, 9 (6), 1047-1060.
- [96] Uddin, M. S. Hawlader, M. N. A. Zhu, H. J. (2001). Microencapsulation of ascorbic acid: effect of process variables on product characteristics. *Journal of Microencapsulation*, 18(2), 199-209.
- [97] Prabha, S. Labhasetwar, V. (2004). Nanoparticle-mediated wild-type p<sup>53</sup> gene delivery results in sustained antiproliferative activity in breast cancer cells. *Molecular Pharmacology*, 1, 211-219.
- [98] Sahoo, S. K. Labhasetwar, V. (2005). Enhanced antiproliferative activity of transferrin-conjugated paclitaxel-loaded nanoparticles is mediated via sustained intracellular drug retention. *Molecular Pharmacology*, 2, 373-383.
- [99] Song, K. C. Lee, H. S. Choung, I. Y. Cho, K. I. Ahn, Y. Choi, E. J. (2006). The effect type of organic phase solvents on the particle size of poly(D,L-lactide-co-glycolide) nanoparticles. *Colloids and Surfaces A: Physicochemical and Engineering Aspects*, 276, 162-167.
- [100] Astete, C. E. Kumar, C. S. S. R. Sabliov, C. M. (2007). Size control of poly(D,L-lactide-co-glycolide) and poly(D,L-lactide-co-glycolide)-magnetite nanoparticles synthesized by emulsion evaporation technique. *Colloids and Surfaces A: Physicochemical and Engineering Aspects*, 299, 209-216.
- [101] Zhang, H. Cui, W. Bei, J. Wang, S. (2006). Preparation of poly(lactide-co-glycolide-co-caprolactone) nanoparticles and their degradation behaviour in aqueous solution. *Polymer Degradation and Stability*, 91 (9), 1929-1936.
- [102] Lee, S. J. Jeong, J. R. Shin, S. C. Kim, J. C. Chang, Y. H. Lee, K. H. Kim, J. D. (2005). Magnetic enhancement of iron oxide nanoparticles encapsulated with poly(D,L-lactide-co-glycolide). *Colloids and Surfaces A: Physicochemical and Engineering Aspects*, 255, 19-25.

- [103] Bilati, U. Allémann, E. Doelker, E. (2005). Development of a nanoprecipitation method intended for the entrapment of hydrophilic drugs into nanoparticles. *European Journal of Pharmaceutical Sciences*, 24, 67-75.
- [104] Govender, T. Stolnik, S. Garnett, M. C. Illum, L. Davis, S. S. (1999). PLGA nanoparticles prepared by nanoprecipitation: drug loading and release studies of a water soluble drug. *Journal of Controlled Release*, 57, 171-185.
- [105] Rivera, P. A. Martinez-Oharriz, M. C. Rubio, M. Irache, J. M. Espuelas, S. (2004). Fluconazole encapsulation in PLGA microspheres by spray-drying. *Journal of Microencapsulation*, 21 (2), 203-211.
- [106] Atuah, K. N. Walter, E. Merkle, H. P. Alpar, H. O. (2003). Encapsulation of plasmid DNA in PLGA-stearylamine microspheres: a comparison of solvent evaporation and spray-drying methods. *Journal of Microencapsulation*, 20(3), 387-399.
- [107] Takashima, Y. Saito, R. Nakajima, A. Oda, M. Kimura, A. Kanazawa, T. Okada, H. (2007) Spray-drying preparation of microparticles containing cationic PLGA nanospheres as gene carriers for avoiding aggregation of nanospheres. *International Journal of Pharmaceutics*, 343(1-2), 262-269.
- [108] O'Donnell, P. B. McGinity, J. W. (1997). Preparation of microspheres by the solvent evaporation technique. *Advanced Drug Delivery Reviews*, 28(1), 25-42
- [109] Kwon, H. Y. Lee, J. Y. Choi, S. W. Jang. Y. Kim, J. H. (2001). Preparation of PLGA nanoparticles containing estrogen by emulsification-diffusion method. *Colloids and Surfaces A Physicochemical and Engineering Aspects*, 182, 123-130.
- [110] Bodmeier, R. Wang, H. Hermann, J. (1994). Microencapsulation of chlorpheniramine maleate, a drug with intermediate solubility properties, by a non-aqueous solvent evaporation technique. *STP Pharma. Sciences*, 4 (4), 275-281.
- [111] Seville, P. C. Spray-dried powders for pulmonary drug delivery, *Critical Reviews in Therapeutic Drug Carrier*, 24 (4), 307-360.
- [112] Finotelli, P. V. Rocha-Leao M. H. M. (2005). Microencapsulation of ascorbic acid in maltodextrin and capsul using spray-drying. *2<sup>nd</sup> Mercosur Congress on Chemical Engineering and 4<sup>th</sup> Mercosur Congress on Process Systems Engineering*, Rio de Janeiro, Brazil pp 1-11
- [113] Stevanović, M. M. Jordović, B. Uskoković D. P. ( 2007). Preparation and characterization of poly(D,L-lactide-co-glycolide) nanoparticles containing ascorbic acid. *Journal of Biomedicine and Biotechnology*, article id 84965.
- [114] Desai, K. G. Liu, C. Park, H. J. (2005). Characteristics of vitamin C immobilized particles and sodium alginate beads containing immobilized particles. *Journal of Microencapsulation*, 22(4), 363-376.
- [115] Lee, J-B. Ahn, J. Lee, J. Kwak, H-S. (2004) L-ascorbic acid microencapsulated with polyacylglycerol monostearate for milk fortification. *Bioscience Biotechnology and Biochemistry*, 68 (3), 495-500.
- [116] Desai, K. G. H. Park, H. J. (2005), Recent developments in microencapsulation of food ingredients, *Drying Technology*, 23 (7), 1361 — 1394.
- [117] Desai, K. G. H. Park, H. J. (2006), Effect of manufacturing parameters on the characteristics of vitamin C encapsulated tripolyphosphate-chitosan microspheres prepared by spray-drying. *Journal of Microencapsulation*, 23 (1), 91-103

- [118] Desai, K. G. H. Park, H. J. (2006), Characteristics of vitamin C encapsulated tripolyphosphate-chitosan microspheres as affected by chitosan molecular weight. *Journal of Microencapsulation*, 23 (1), 79-90.
- [119] Kirby, C. J. Whittle, C. J. Rigby, N. Coxon, D. T. Law, B. A. (1991). Stabilisation of ascorbic acid by microencapsulation in liposomes. *International Journal of Food Science and Technology*, 26 (5), 437-449.
- [120] Van Duijin, M. M. Van der Zee, J. Van Steveninck, J. Van den Broek, P. J. A. (1998). Ascorbate stimulates ferricyanide reduction in HL-60 cells through a mechanism distinct from the NADH-dependent plasma membrane reductase. *Journal of Biological Chemistry*, 273 (22), 13415-13420.
- [121] Dhoot, N. O. Wheatley, M. A. (2003). Microencapsulated liposomes in controlled drug delivery: Strategies to modulate drug release and eliminate the burst effect. *Journal of Pharmaceutical Sciences*, 92(3), 679-689.
- [122] Patri, A. K. Kukowska-Latallo, J. F. Baker, J. R. (2005). Targeted drug delivery with dendrimers: comparison of the release kinetics of covalently conjugated drug and non-covalent drug inclusion complex. *Advances Drug Delivery Reviews*, 57(15), 2203-2214.
- [123] Chen, B.-Y. Lee, Y-H. Lin, W-C. Lin, F-H. Lin, K.-F. (2006). Understanding the characteristics of L-ascorbic acid-montmorillonite nanocomposite: chemical structure and biotoxicity, *Biomedical Engineering Applications, Basis & Communications*, 18 (1), 30-36
- [124] Esposito, E. Cortesi, R. Cervellati, F. Menegatti, E. Nastruzzi, C. (1997). Biodegradable microparticles for sustained delivery of tetracycline to the periodontal pocket: formulatory and drug release studies. *Journal of Microencapsulation*, 14, 175-187.
- [125] Wilson, N. Shah, N. P. (2007). Microencapsulation of Vitamins, *ASEAN Food Journal* 14 (1), 1-14.
- [126] Trindade, M. A. Grosso, C. R. F. (2000). The stability of ascorbic acid microencapsulated in granules of rice starch and in gum Arabic. *Journal of Microencapsulation*, 17 (2), 169-176.
- [127] Stevanović, M. M. Jordović, B. Uskoković, D. P. (2008). Morphological changes of poly(DL-lactide-co-glycolide) nanoparticles containing ascorbic acid during in vitro degradation process, *Journal of Microscopy*, 2532 (3), 511-516.
- [128] Bors, W. Buettner, G. R. The Vitamin C Radical and Its Reactions in Vitamin C in Health and Disease, eds. L. Packer and J. Fuchs, Marcel Dekker, New York, (1997), 75.
- [129] Rozario, F. In vivo and in vitro studies on heavy doses and fluorescent-labelled vitamin C using ESR and fluorescence spectroscopy, Doctoral Dissertation, Vom Fachbereich Chemie der Technischen Universität Kaiserslautern, (2005)
- [130] Buettner, G. R. (1988). In the absence of catalytic metals ascorbate does not autooxidize at pH 7: ascorbate as test for catalytic metals. *Journal of Biochemical and Biophysical Methods*, 16 (1), 27-40.
- [131] Kim, Y-R. Yu, S-W. Lee, S-R. Hwang, Y-Y. Kang, S-O. (1996). A heme –containing ascorbate oxidase from *Pleurotus ostreatus*. *Journal of Biological Chemistry*, 271(6), 3105-3111.

- 
- [132] Stevanović, M. Maksin, T. Petković, J. Filipič, M. Uskoković, D. (2009). An innovative, quick and convenient labeling method for the investigation of pharmacological behavior and the metabolism of poly(DL-lactide-co-glycolide) nanospheres. *In vitro* cell interaction and *in vivo* biodistribution of poly (dl-lactide-co-glycolide) nanospheres without and with encapsulated ascorbic acid, *Journal of Controlled Release Nanotechnology*, submitted, 20(3), 335102 (12pp).
- [133] Yokoyama, T. Huang, C. C. (2005). Nanoparticle technology for the production of functional materials, *KONA*, 23, 7-17.
- [134] Semenzato, A. Austria, R. Dall'Aglio, C. Bettero, A. (1995). High performance liquid chromatographic determination of ionic compounds in cosmetic emulsions: Application to magnesium ascorbyl phosphate, *Journal of Chromatography A*, 705 (2), 385-389
- [135] Eberlein-Konig, B. Placzek, M. Przybilla, B. (1997). Phototoxic lysis of erythrocytes from humans is reduced after oral intake of ascorbic acid and d-alpha-tocopherol. *Photodermatology Photoimmunology & Photomedicine*, 13, 173-177.
- [136] Pojarova, M. Ananchenko, G. S. Udachin, K. A. Daroszevska, M. Perret, F. Coleman, A. W. Ripmeester J. A. (2006). Solid lipid nanoparticles of p-hexanoyl calix [4] arene as a controlling agent in the photochemistry of a sunscreen blocker. *Chemistry of Materials*, 18 (25), 5817-5819.





*Chapter VII*

---

## **Molecular Bases of the Cellular Handling of Vitamin C**

---

### **Transport and Metabolism in Health and Disease**

*J.J.G. Marin<sup>\*</sup>, M.A. Serrano, M.J. Perez<sup>1</sup> and R.I.R. Macias*

Laboratory of Experimental Hepatology and Drug Targeting,

<sup>1</sup>Research Unit, University Hospital

Biomedical Research Center for the Study of Liver and Gastrointestinal Diseases  
(CIBERehd), Instituto de Salud Carlos III,  
University of Salamanca, Spain

### **Abstract**

Under circumstances of an adequate dietary content in ascorbic acid the availability of this vitamin for cells is still not ensured. The reason could be poor intestinal absorption or impaired access to cells in different tissues because, owing to the marked hydrophylicity of this molecule, the rate of free diffusion across plasma membranes is low. Indeed the role of carrier proteins in vitamin C uptake has been recently recognized. This was formerly believed to occur via passive transport, in which sugar carriers belonging to the GLUT family were assumed to be involved. However, more recently it has been described that ascorbic acid absorption by the intestine and uptake by cells from the blood requires more specific plasma membrane transporters for vitamin C as a substrate and with the higher efficiency that is characteristic of active systems. In this case, the energy for active vitamin C uptake is provided by inwardly directed sodium gradients. The differential tissue distribution of isoforms 1 and 2 of sodium-dependent vitamin C transporters (SVCT) accounts for the general and specific functions of these

---

\* Contact Information: Jose J. G. Marin, Department of Physiology and Pharmacology, Campus Miguel de Unamuno E.I.D. S-09, 37007-Salamanca, Spain, Telephone: 34-923-294674, Fax: 34-923-294669, E-mail: jjgmarin@usal.es

proteins in anti-oxidant systems responsible for cell homeostasis or more cell-specific roles in which vitamin C is involved, such as trans-epithelial transfer or collagen synthesis. Changes in the expression of these transporters in association with oxidative stress and inflammation have been described. In the present review, their role in physiology and in both the aetiology and pathogenesis of several diseases is discussed.

## 1. Introduction

Although the active form of vitamin C is ascorbic acid (AA), the oxidized form dehydroascorbic acid (DHA) is also useful, because once inside the cell DHA can be biotransformed or recycled into AA by several enzymatic mechanisms. Owing to the importance of vitamin C in cellular homeostasis, both AA and DHA are efficiently taken up by cells via plasma membrane transporters belonging to two different families of proteins of solute carriers (SLC2A and SLC23).

An impaired expression and/or function of these transporters could be involved in several situations in which low levels of vitamin C in tissues have been found, regardless of normal or enhanced amounts of this compound in the diet. This occurs for instance in leucocytes in acute infections and several other pathological conditions (Basu & Schorah, 1982).

Different unhealthy life habits, such as cigarette smoking, reduce vitamin C intake. However, even when this is maintained vitamin C deficiency may persist in tissues due to impaired vitamin C uptake. Both events may lead vitamin C levels in the leucocytes of smokers to become reduced (Pelletier, 1975; Kallner et al., 1981; Schectman et al., 1989).

The shared characteristic of many situations leading to reduced contents of vitamin C in serum and leucocytes, despite normal levels of intake, is the enhanced generation of oxygen reactive species, which involves an increased turnover of AA (Cochrane et al., 1983; Anderson et al., 1988; Frei et al., 1989). How these changes regulate the expression of vitamin C transporters is as yet unknown. However, there is evidence, reviewed below, of the existence of important relationships between vitamin C handling and several diseases that affect many different organs.

## 2. Synthesis and Metabolism of Vitamin C

Vitamin C is a carbohydrate compound related to glucose whose active form is AA. This molecule contains an ene-diol group that confers electron lability, which makes it able to participate in oxidation-reduction reactions through its electron donating and electron accepting properties. Thus, AA is a strong reducing agent, and is the co-factor of reactions catalyzed by  $\text{Cu}^{2+}$ -dependent monooxygenases and  $\text{Fe}^{2+}$ -dependent dioxygenases (Linster & Van Schaftingen, 2007). As a vitamin, AA and DHA are present in food components, mainly from plant sources, at levels several orders of magnitude higher than most of other vitamins. This characteristic is because vitamin C is chemically related to monosaccharides, i.e., compounds that are very abundant in plants (Linster & Van Schaftingen, 2007). Another characteristic of vitamin C is that it cannot be considered as an actual vitamin for many

species of vertebrates, because some of them, even mammals, have the ability to synthesize AA (Linster & Van Schaftingen, 2007).

Several metabolic pathways that permit the synthesis of vitamin C by species of fungi, plants and animals have been described. In vertebrates able to synthesize vitamin C, this occurs from D-glucuronate, which is produced by direct hydrolysis of UDP-glucuronate, catalyzed by UDP-glucuronidase (Linster & Van Schaftingen, 2007), which is located in the endoplasmic reticulum membrane (Bossuyt & Blanckaert, 1995). D-glucuronic acid is reduced to L-gulonic acid by the action of a NADPH-dependent oxido-reductase, glucuronate reductase, which belongs to the aldo-keto reductase family of enzymes (Mano et al., 1961). L-gulonic acid is then biotransformed into L-gulonolactone by the  $Mn^{2+}$ -dependent cytosolic enzyme gulonolactonase (Winkelman & Lehninger, 1958; Bublitz & Lehninger, 1959), which has been identified as regucalcine or senescent marker protein 30 (SMP30) (Kondo et al., 2006), a protein probably involved in ageing because its expression in several organs, such as liver, kidney and lung decreases during ageing (Fujita et al., 1992) and because its absence in knock-out mice has been associated with senescence (Mori et al., 2004). Moreover, silencing the SMP30 gene in mice results in vitamin C deficiency (Kondo et al., 2006).

The last step in vitamin C synthesis is the oxidation of L-gulonolactone to L-ascorbic acid, which is catalyzed by L-gulonolactone oxidase (GLO) (Chatterjee et al., 1960) (Figure 1). The subcellular localization of GLO is also the membrane or endoplasmic reticulum (Koshizaka et al., 1988). Owing to mutations in the *GLO* gene, the functional expression of this enzyme does not occur in several species, such as guinea pigs, humans, and others (Nishikimi et al., 1992; Ohta & Nishikimi, 1999), for which AA is a vitamin. These genetic variants have occurred in the primate *GLO* orthologue by the accumulation of random mutations (Ohta & Nishikimi, 1999), whereas in the case of guinea pigs there has been a deletion affecting two exons (Nishikimi et al., 1992).

During evolution, inactivation of the *GLO* gene has happened often, which suggests that this event may confer some evolutionary advantage to certain species (Linster & Van Schaftingen, 2007). In this respect, it should be considered that GLO activity results in the production of hydrogen peroxide and subsequent consumption of glutathione (Banhegyi et al., 1996). Accordingly, in species with a diet rich in vitamin C, the risk of producing hydrogen peroxide has been abolished by inactivation of the *GLO* gene.

In species with a conserved ability to synthesize vitamin C, this may be increased in response to several stimuli, such as the need to inactivate xenobiotic compounds by conjugation with glucuronic acid. This enhances the hydrolysis of UDP-glucuronic acid and the synthesis of L-ascorbic acid (Linster & Van Schaftingen, 2007) (Figure 1).

Glutathione, together with vitamin C, is one of the most abundant reducing agents in mammalian cells. Glutathione is involved in recycling of DHA to AA and plays a role in the control of the *de novo* synthesis of AA. Thus, when cells are depleted of glutathione an increase in the synthesis of AA occurs. The actual mechanism accounting for this protective response is as yet unknown (Linster & Van Schaftingen, 2007).

Regarding control of the vitamin C biosynthesis pathway, this is mainly regulated by the transformation of UDP-glucuronic acid into D-glucuronic acid. Thus, an increase in the activity of the enzyme responsible results in an enhanced production of vitamin C (Linster &

Van Schaftingen, 2003). Down-stream in this biochemical pathway is the limiting enzyme of the overall process; namely, GLO (Chatterjee et al., 1960).

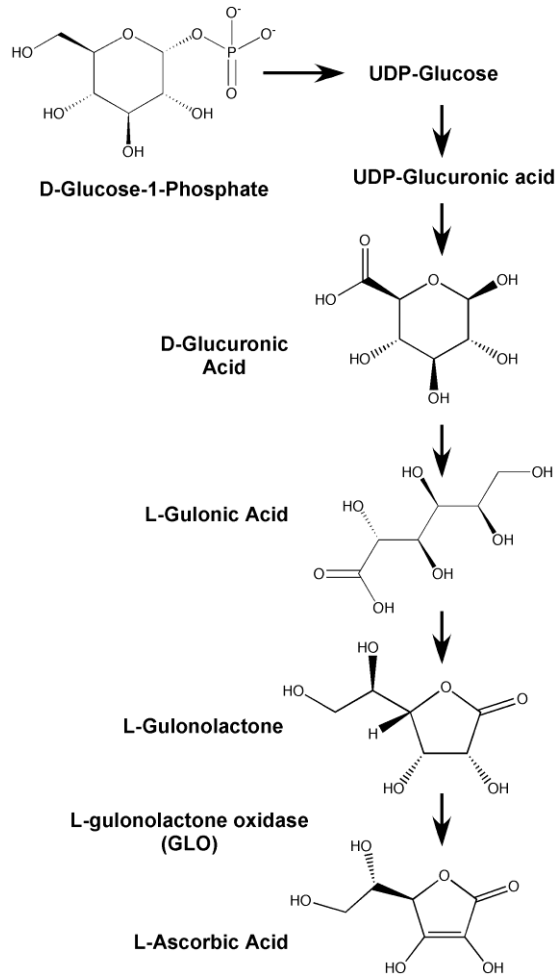

Figure 1. Simplified schematic representation of the pathway responsible for ascorbic acid synthesis.

The major product of vitamin C oxidation is semi-DHA, which is generated in many reactions that use AA as co-factor, such as those catalyzed by mono- and di-oxygenases (Linster & Van Schaftingen, 2007). The recycling of semi-DHA to AA takes place in the cytoplasm through the activity of cytochrome B5 reductase and thioredoxine reductase, two reactions that require NADH and NADPH, respectively (Ito et al., 1981).

The catabolism of vitamin C starts with the formation of DHA from AA (Linster & Van Schaftingen, 2007). DHA is hydrolyzed to generate 2,3-diketo-L-gulonolactone, which has no anti-scurvy activity (Bode et al., 1990). In the absence of hydrogen peroxide, this metabolite is spontaneously degraded to oxalate and L-erythrulose (Simpson & Ortwerth, 2000). Owing to the high reactivity of L-erythrulose, the accumulation of this ketose may be

involved in protein modifications, such as those occurring in the lens of diabetic patients and in senile cataracts (Simpson & Ortwerth, 2000) (Figure 2).

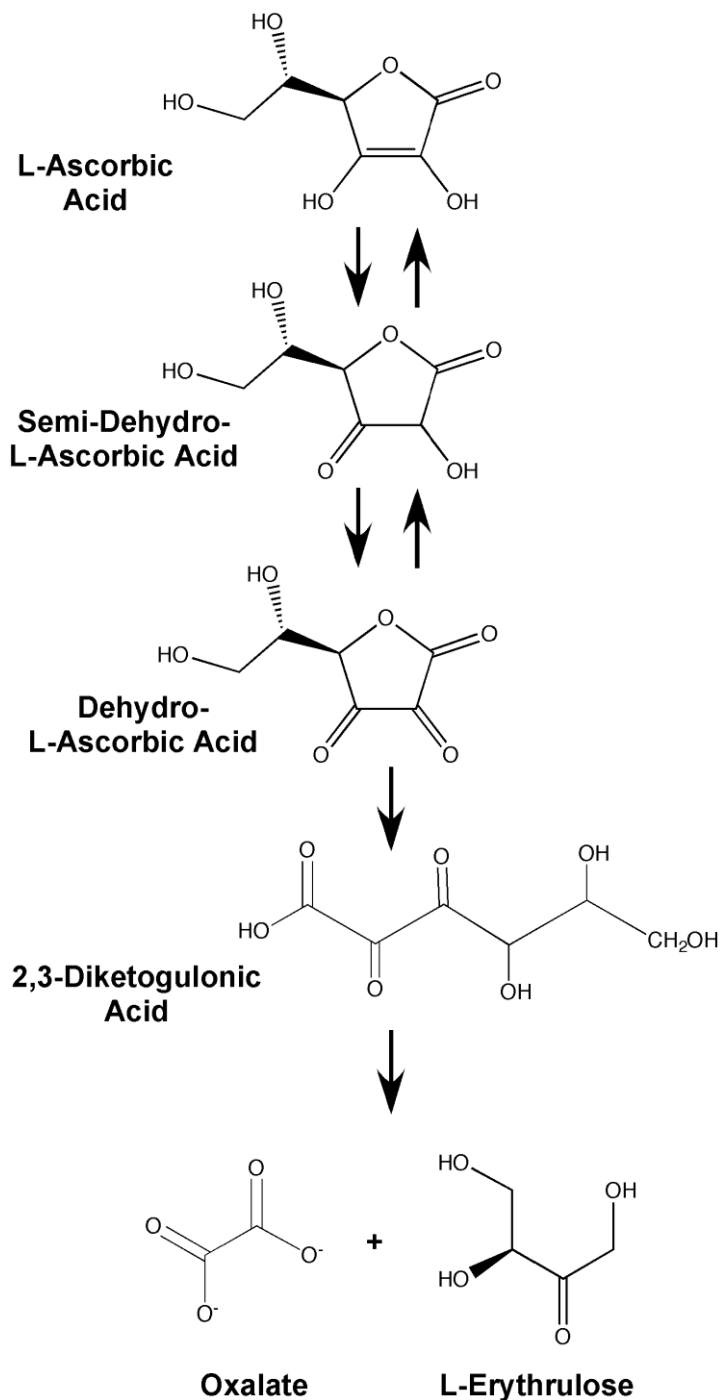

Figure 2. Simplified schematic representation of the reactions involved in vitamin C recycling and degradation.

### 3. Transport of Ascorbic Acid and Dehydroascorbic Acid

In both species able to synthesize AA and in those that need to obtain the compound from external sources, their cells use vitamin C to carry out vital functions. Accordingly, this compound must cross the plasma membrane to enter the cells. Owing to its size and polarity, simple diffusion of vitamin C (both AA and DHA) across the lipid bilayer is very poor (Rose, 1987) and hence its uptake requires the participation of plasma membrane proteins that mediate passive or active secondary transport systems (Wilson, 2005). The protein responsible for this process depends on whether the transported compound is in the reduced (AA) or oxidized (DHA) form.

The cellular uptake of DHA is carried out by passive hexose transporters belonging to the GLUT family (gene symbol *SLC2A*); more specifically, by the GLUT1, GLUT3 and GLUT4 isoforms (Figure 3). The driving force for this transport is supplied by the inwardly-directed electrochemical gradient of DHA (Figure 3). Once inside cells DHA is reduced to AA. This may occur through the activity of several enzymatic systems. This permits intracellular DHA concentrations to be maintained low and hence favours uptake by passive transport. This mechanism of DHA uptake has been described in several cell types, such as astrocytes, enterocytes and osteoblasts (Agus et al., 1997; Daskalopoulos et al., 2002). However, GLUT-mediated DHA uptake is particularly important in cells unable to carry out AA uptake, with a very active metabolism, such as neutrophils (Vera et al., 1998). Owing to the role of vitamin C in collagen synthesis, osteogenesis, and bone remodelling, the uptake of DHA via GLUT plays a key role in osteoblast homeostasis (Qutob et al., 1998). Moreover, the presence of GLUT in astrocytes has been suggested to be involved in enhanced vitamin C uptake as a mechanism of defence against ischemia-induced oxidative stress in nervous tissue (Siushansian et al., 1997; Huang et al., 2001). Since DHA uptake depends on the inwardly-directed concentration gradient and because the serum concentration of DHA is generally low (approximately 2  $\mu\text{M}$ ) (Dhariwal et al., 1991), under normal conditions the overall GLUT-mediated DHA uptake is low (Spielholz et al., 1997).

In contrast, the serum concentrations of AA are much higher, close to 60  $\mu\text{M}$  (Dhariwal et al., 1991). This, and the fact that AA is efficiently taken up through sodium-dependent secondary active transporters, supports the concept that vitamin C is mainly taken up by the latter rather than through the former mechanism.

The proteins responsible for this process belong to the family of nucleobase transporters (gene symbol *SLC23*). The main AA transporters are the sodium-dependent carriers SVCT1 (*SLC23A1*) and SVCT2 (*SLC23A2*). Thus, thanks to the energy of the inwardly-directed sodium gradient maintained by  $\text{Na}^+/\text{K}^+$ -ATPase activity, AA uptake may occur even against an electrochemical gradient, with a  $\text{Na}^+/\text{AA}$  stoichiometry of 2:1 (Figure 3). Both isoforms of SVCTs differ in their kinetic characteristics, as will be commented below. These differences, together with their tissue-specific distribution, suggest a dissimilar role for these isoforms. Accordingly, SVCT1 may be involved in maintaining the general homeostasis of AA by determining intestinal absorption and renal elimination of this vitamin, whereas SVCT2, which is particularly highly expressed in metabolically active cells, may be involved in the protection of these cells against oxidative stress.

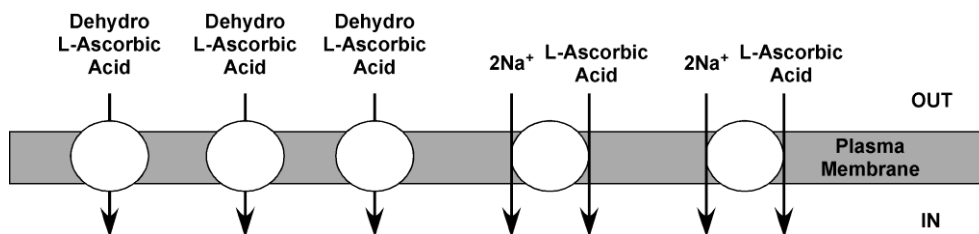

Figure 3. Schematic representation of the transporters responsible for the uptake of ascorbic acid and dehydroascorbic acid.

In spite of the existence of differences in size and chromosomal localization, there are important similarities in the genomic organization of the genes encoding SVCT1 and SVCT2. Thus, *SLC23A1* has a size of 16,096 bp and is localized in chromosome at 5q31.2-32.3, whereas the size of *SLC23A2* is approximately ten-fold bigger (158,398 bp). The chromosomal localization of *SLC23A2* is 20p12.2-12.3. However, the size of the ORFs of both genes is similar (1,791 and 1,953 bp for *SLC23A1* and *SLC23A2*, respectively). Moreover, both nucleotide sequences have 58% similarity (Stratakis et al., 2000; Wang et al., 2000). There is a marked analogy (86-95%) with the mRNA sequence of some SCVT1 and SVCT2 orthologues, such as those of mice, rats and guinea pigs (Daruwala et al., 1999; Clark et al., 2002).

In humans, the structure of both proteins is also similar. The amino acid sequence comprises 598 and 650 aa in the case of SVCT1 and SVCT2, respectively, with 65% similarity to each other (Daruwala et al., 1999). This level of similarity is also found in the isoforms of mice and rats (Faaland et al., 1998; Tsukaguchi et al., 1999). Regarding molecular weight, there is some degree of controversy. Thus, in transfected cells, analysis by electrophoresis revealed the existence of bands between 65 and 75 KDa, which probably depends on the degree of protein glycosylation (Lutsenko et al., 2004; Kang et al., 2007), whereas *in vivo*, the band detected is of approximately 50 KDa (Savini et al., 2007; Savini et al., 2008).

Hydropathy plot analyses predict a similar structure for both isoforms of SVCTs. They have 12 transmembrane domains, with both the amine and carboxyl ends located intracellularly. SVCT1 and SVCT2 differ in the fact that the latter contains two additional regions of 12 and 44 aa located at positions 2 and 38, respectively (Liang et al., 2001). Regarding glycosylation sites, there are two possibilities in the extracellular loop between transmembrane domains 3 and 4 - Asn<sup>138</sup> and Asn<sup>144</sup> for SVCT1 and Asn<sup>188</sup> and Asn<sup>196</sup> for SVCT2 - and a third site (Asn<sup>230</sup>) only for SVCT1 in the extracellular loop between transmembrane domains 5 and 6 (Liang et al., 2001). The glycosylation of SVCTs plays an important role in their maturation, which determines the functionality of these transporters (Subramanian et al., 2008). Both isoforms contains several sites for potential phosphorylation. Thus, in SVCT1 there are five sites for protein kinase C (PKC)-dependent phosphorylation and another site for PKA-dependent phosphorylation, whereas in SVCT2 there are six sites for PKC-dependent phosphorylation (Daruwala et al., 1999; Wang et al., 1999).

Regarding substrate specificity, both SVCT1 and SVCT2 are highly selective for L-ascorbic acid. These carriers are unable to transport either D-ascorbic acid, DHA or any vitamin C derivatives. The ability of SVCTs to transport L-AA is strictly dependent on the presence of sodium. Indeed replacing extracellular sodium by lithium, potassium or choline results in the abolition of vitamin C transport (Liang et al., 2001). The optimal pH for the function of both SVCT isoforms is 7.5. At lower pH, the affinity of these carriers for AA is decreased and hence the efficiency of the transport is also lowered (Liang et al., 2001). When kinetic characteristics were measured in several experimental models, marked differences between both isoforms have been found (Savini et al., 2008). Thus, the values of the apparent affinity constant ( $K_M$ ) are higher for SVCT1 (65-237  $\mu\text{M}$ ) than for SVCT2 (8-62  $\mu\text{M}$ ), which indicates that the affinity for the substrate is several-fold higher in SVCT2 than in SVCT1. In contrast, the capacity of SVCT1, as determined by measurements of maximal velocity of transport ( $V_{\text{max}}$ ), is higher than that of SVCT2. In other words, SVCT1 can be considered as a transporter of high capacity and low affinity, whereas SVCT2 is a transport of low capacity and high affinity.

Non-functional variants of human isoforms SVCT1 and SVCT2 have been described. One variant of SVCT1 has been identified in the Caco-2 cell line from human colon adenocarcinoma. This variant is characterized by the addition of 12 bp during alternative splicing, resulting in four additional amino acids – VGLH – that are inserted between E-155 and V-156 of the functional protein (Wang et al., 1999). For SVCT2, a variant has been also reported. This was found in 293T cells derived from HEK 293 embryonic renal cells upon transfection with the T antigen from SV40 (Lutsenko et al., 2004). Regarding the characteristics of this variant, this was generated by the deletion of 345 bp, resulting in the loss of transmembrane domains 5 and 6 and part of 4. This truncated protein is not able to carry out AA transport, but it may have a regulatory role regarding the function of SVCT2 and, to a lesser extent, also SVCT1 (Lutsenko et al., 2004).

The expression levels of vitamin C transporters are decreased in aged people even in individuals with diets rich in vitamin C (Brubacher et al., 2000). These findings are consistent with the experimental data obtained in rat hepatocytes isolated from aged animals. These cells have a lower ability to take up vitamin C than cells isolated from young rats, in agreement with a lower expression level of vitamin C transport proteins (Michels et al., 2003). In a recent study carried out by our group, different ontogenic patterns for Svct1 and Svct2 in the rat liver were found. The abundance of mRNA for Svct1 increased after birth and decreased in aged animals, whereas that of Svct2 was not significantly modified along the different life stages in this species (Vaquero et al., 2009). The expression levels of these transporters are also dissimilar in both sexes, at least in mice. Thus, in females of this species SVCT1 is expressed at higher levels and serum concentrations of AA are also consistently higher, whereas urinary elimination is lower than in males (Kuo et al., 2004).

There are important differences between both isoforms regarding their tissue distribution and physiological role. In general, SVCT1 is highly expressed in liver, intestine and kidney (Tsukaguchi et al., 1999), whereas SVCT2 is ubiquitously expressed, although it is particularly abundant in the brain, retina, placenta, bone, and chondrocytes (Rajan et al., 1999; Tsukaguchi et al., 1999), as will be described in more detail below.



**Intestine:** Both isoforms are expressed in epithelial cells of intestinal mucosa (Maulen et al., 2003). SVCT1 is located at the apical membrane, which suggests a role in the intestinal absorption of AA contained in the diet (MacDonald et al., 2002). In contrast, SVCT2 is located at the basolateral membrane of these cells (Boyer et al., 2005), which points to a role in the uptake of vitamin C from blood in periods of lack or reduced absorption.

**Liver:** In spite of the relevant role of this organ in the maintenance of vitamin C homeostasis, and the importance of this vitamin in the detoxification of endogenous and exogenous substances by the liver, contributing to the prevention of excessive oxidative stress during these processes, there is little information available about the distribution of SVCT1 and SVCT2 in the liver. Recent evidence suggests that the expression levels of both isoforms are similar in human liver parenchyma (Savini et al., 2008; Vaquero et al., 2009), whereas in rat liver the expression of Svct1 is higher than that of Svct2 (Michels et al., 2003; Vaquero et al., 2009). Regarding their cellular and subcellular localization, we observed that Svct1 was mainly located at the sinusoidal membrane of rat hepatocytes, which suggests a major role for vitamin C uptake by these cells (Vaquero et al., 2009), whereas Svct2 was mainly expressed in endothelial and Kupffer cells (Vaquero et al., 2009). It should be considered that regarding vitamin C homeostasis, important differences between rodents and humans exist, which is due to the fact that the former may synthesize AA, an ability that is missing in our species.

**Kidney:** With immunohistochemistry techniques, SVCT1 has been detected at the apical membrane of proximal tubular cells (Lee et al., 2006), which supports the notion that this carrier may play a role in vitamin homeostasis by reducing the urinary loss of AA.

**Brain:** SVCT2 has been identified in neuroepithelial cells of the choroid plexus (Tsukaguchi et al., 1999), where it may play a role in the transfer of AA from blood to the cerebrospinal fluid. SVCT2 has also been suggested to account for vitamin C uptake by neurons, playing an important role in the functional maturation and defence against oxidative stress of these cells (Qiu et al., 2007). Moreover, some glial cells also express this transporter (Mun et al., 2006).

**Lung:** Both SVCT1 and SVCT2 have been detected in the respiratory system. Immunohistochemistry studies have revealed the localization of these transporters at the apical membrane of the epithelial cells of the airways, from the trachea to the bronchioles (Jin et al., 2005). The exact role of vitamin C transporters in this localization is unknown. The presence of the proteins in this membrane suggests that AA uptake occurs from the fluid layering the airway surface. How vitamin C reaches this fluid and what its role is in this location are interesting, but yet not understood, issues. In this respect, it has been suggested that vitamin C might be involved in the activation of the cystic fibrosis transmembrane conductance regulator chloride channel (CFTR) (Fischer et al., 2004).

**Eye:** SVCT2 accounts for high concentrations of AA in the lens, which permits vitamin C, together with glutathione, to play an important role in preventing photooxidative stress caused by UV radiation. The efficient activity of SVCT2 explains why in humans AA concentrations in lens are close to 1-3 mM. In contrast, in species with nocturnal activity, such as rodents, the expression of Svct2 and AA concentrations in the lens are markedly lower (0.1-0.3  $\mu$ M) (Varma, 1987; Hegde & Varma, 2004).

**Bone:** Vitamin C transporters are also expressed in bone, where several factors favouring bone development, such as  $\text{Ca}^{2+}$ ,  $\text{Zn}^{2+}$  and dexamethasone, have been found to stimulate the expression of SVCT2 (Fujita et al., 2001; Wu et al., 2003a; Wu et al., 2003b). Moreover, the expression of SVCT2 induces osteoblast differentiation and bone mineralization (Wu et al., 2004). SVCT2-mediated uptake of AA by chondrocytes is crucial for hydroxyproline generation, which is needed for collagen synthesis (McNulty et al., 2005).

**Adrenal glands:** The expression of SVCT2 in this tissue accounts for the fact that both the cortex and the medulla are the tissues with highest vitamin C concentrations in the body (Patak et al., 2004). The reason is probably the need of AA as cofactor in the synthesis of catecholamines and steroid hormones.

**Skin:** both isoforms are expressed in human skin. SVCT1 is present in epidermal keratinocytes, whereas SVCT2 has been described in both the dermis and epidermis, expressed in keratinocytes, fibroblasts and endothelial cells (Steiling et al., 2007).

**Placenta:** Since vitamin C is required for normal foetal development, it must be transferred from the mother across the placenta. Indeed, SVCT2 has been found expressed in chorionic villi in first trimester placentas, although at term it has not been detected (Biondi et al., 2007). In rat placenta, both isoforms have been detected at term, Svct2 being more abundant than Svct1 (Perez et al., 2007).

## **4. Relationship between the Cellular Handling of Vitamin C and Disease**

Owing to the important role of AA in many different functions in a wide variety of cells, vitamin C deficiency is the cause of many alterations including, anaemia, scurvy, enhanced susceptibility to infection, gingival bleeding, muscular degeneration, impaired scar formation, capillary haemorrhages and atheroma plaque formation. More complex neural changes have also been associated with vitamin C deficiency such as depression, hypochondriasis, hysteria, and several psychomotor alterations (Naidu, 2003). On the other hand, an excess of vitamin C intake rarely causes toxicity because both AA and DHA are highly water-soluble and easy to eliminate from the body. The only potential complication is interference with intestinal copper absorption when the dietary content of vitamin C is too high (Finley & Cerklewski, 1983). Although in the past it has been proposed that AA would favour urinary oxalate excretion and stone formation, this concept, which may be derived from the observation of *in vitro* conversion of AA into oxalate during storage and processing of the samples, has now been ruled out (Gerster, 1997). Even though a certain part of oxalate in the urine derives from metabolized AA, the intake of high doses of vitamin C does not increase the risk of calcium oxalate kidney stones. This is probably due to the existence of physiological regulatory factors, such as saturable gastrointestinal absorption and renal tubular reabsorption, and the fact that the metabolic transformation of AA to oxalate is also limited (Gerster, 1997). Below we shall review the changes in vitamin C handling in several pathological situations. In some of them, it has been possible to establish a clear relationship with transport processes, whereas in others, only alterations in vitamin C levels in serum or tissues have so far been identified.

#### 4.1. Diabetes Mellitus

Patients with diabetes mellitus usually have lower levels of vitamin C in serum and leucocytes (Cunningham et al., 1991). It has been suggested that vitamin C plays a role in preventing protein glycosylation and sorbitol accumulation, which induce severe damage in different organs of these patients, such as in the eye and kidneys (Will & Byers, 1996).

Diabetes mellitus affects vitamin C homeostasis through an alteration of glucose concentrations in blood and body fluids and through the impaired ability of some cells to take up glucose. Hyperglycaemia in diabetes, similar to that caused by surgery and sepsis, may competitively inhibit GLUT-mediated DHA uptake. Moreover, it has been suggested that diabetes causes low intracellular levels of glucose in some tissues, resulting in reduced activity of the pentose phosphate pathway. This induces a reduction in the intracellular levels of NADPH and reduced glutathione, which results in an imbalance between DHA and AA. This, together with the impairment in DHA uptake, may account for increased levels of DHA in serum and decreased intracellular concentrations of AA in many cell types, in particular in leucocytes.

In addition to the acute inhibitory effect, chronic exposure to hyperglycaemia may also affect vitamin C uptake through a down-regulation of GLUT transporters; mainly GLUT1 in skeletal muscle (Korcok et al., 2003). In contrast, incubation of L6 skeletal muscle cells with media containing low glucose concentrations has been reported to induce an up-regulation of GLUT, which results in an enhanced ability to carry out facilitated uptake of DHA (Korcok et al., 2003). Moreover, insulin and insulin-like growth factor-I (IGF-I) are able to activate DHA transport, although with 10-fold lesser efficiency than insulin (Qutob et al., 1998).

In diabetes mellitus type I, but also in other pathological conditions such as nephropathy, the maximal velocity of transport for DHA uptake is diminished (Ng et al., 1998). These changes account for a delay in DHA uptake and hence an unbalanced recycling of AA occurs. Accordingly, in serum and the sciatic nerve of rats with streptozotocin-induced diabetes, AA concentrations have been found to be decreased, whereas those of DHA were increased (Obrosova et al., 2001; Obrosova et al., 2003). This has important repercussions. For instance, since certain level of intracellular AA is required for collagen synthesis by osteoblasts (Franceschi et al., 1995), deficient AA recycling in these cells may contribute to the presence of osteopenia. This is consistent with the observation that when diabetic pregnant rats were fed with vitamin C-rich diet, the skeletal development of the offspring was improved, and osteopenia was reduced (Braddock et al., 2002).

#### 4.2. Eye Disease

Vitamin C is an important anti-oxidant agent in the eyes (Taylor et al., 1991), where it may help to prevent or at least delay the formation of cataracts by reducing the oxidative stress that causes the clouding in the crystalline lens (Palmquist et al., 1984). Indeed, in eyes with cataracts lower antioxidant capacities have been found (Jacques & Chylack, 1991), which has been suggested to be due to a lower content in vitamin C (Bron & Brown, 1987).

In addition to reducing the risk of suffering cataracts, vitamin C administration also delays the development of glaucoma (Hankinson et al., 1992) due in part to a vitamin C-induced reduction in intraocular pressure (Fishbein & Goodstein, 1972). Moreover, vitamin C also improves the symptoms of retinopathy (Sinclair et al., 1992). In agreement with the above-described beneficial effects, people with high levels of vitamin C, vitamin E and selenium have a 70% lower risk of developing macular degeneration (Sinclair et al., 1992).

Using human lens epithelial cells, an enhanced SVCT2 expression in response to the incubation of cultures with the pro-oxidant agent tert-butyl hydroperoxide (1,1-dimethylethyl hydroperoxide) has been found. The authors of that study suggested that this transport system might be transcriptionally regulated by the degree of oxidative stress (Kannan et al., 2001).

In streptozotocin-induced diabetes in rats, a lower ability of retinal pigment epithelial cells to accumulate AA has been found (Salceda & Contreras-Cubas, 2007). Under normal conditions, this probably occurs with the participation of sodium-dependent vitamin C transporters. Accordingly, a role for SVCT impairment in oxidative stress as an important causative factor in the pathogenesis of diabetic retinopathy has been suggested (Salceda & Contreras-Cubas, 2007).

#### 4.3. Cardiovascular Diseases

The beneficial properties of vitamin C play a key role in maintaining the health status of the cardiovascular system. Thus, vitamin C contributes to maintaining serum cholesterol levels and blood pressure low and protects the organism from many different oxidative challenges (Whitaker, 1985; Trout, 1991; Rath, 1993). Moreover, vitamin C inhibits the oxidative modification in LDL, which reduces the risk of atherosclerosis (Frei, 1991) and improves arterial function owing to its participation in vascular collagen synthesis. Moreover, it prevents the adhesion of white blood cells to the endothelial wall of arteries (Lehr et al., 1995; Weber et al., 1996).

In a US population study, a certain inverse association of serum AA levels and mortality has been found (Simon et al., 2001). This is probably due in part to the ability of AA to prevent heart attack by myocardial infarction and stroke by cerebrovascular accident (Gale et al., 1995). The same study also revealed an enhanced risk of fatal cardiovascular disease in populations with lower serum AA levels (Simon et al., 2001).

#### 4.4. Infection, Surgery and Inflammation

Vitamin C also improves defence against infections. Both humoral and cellular immunity are favoured by vitamin C administration (Leibovitz & Siegel, 1978). Moreover, vitamin C also has an antiviral effect through the stimulation of interferon synthesis (Geber et al., 1975). However, a common finding in severe infections is the presence of decreased levels of vitamin C in serum and leucocytes (Basu & Schorah, 1982).

Regarding the anti-inflammatory effect, low levels of vitamin C have been associated with enhanced histamine concentrations in serum. Supplementation in such patients with

vitamin C results in an antihistaminic effect, with a significant reduction in serum histamine levels (Bouhuys, 1974). Owing to its anti-oxidant, and probably anti-histaminic, activity vitamin C is beneficial in the treatment of asthma (McNally, 1953). Bronchial spasm caused by noxious stimuli or when pain tension increases during exercise is relieved by vitamin C (Schachter & Schlesinger, 1982).

In inflammatory processes associated with surgery, trauma or sepsis there is a decreased concentration of AA in serum and leucocytes (Lee et al., 1988; Louw et al., 1992; Borrelli et al., 1996; Schorah et al., 1996; Fain et al., 2003). In this sense, orthopaedic surgery has been associated with an increased DHA/AA ratio in urine, suggesting that surgical stress induces the oxidation of AA to DHA (Kubin et al., 2003). This is probably a reflection of the situation in body regions where the inflammation is most intense. Thus, in damaged skin the DHA/AA ratio is also increased (Kim et al., 1994). As a clinical consequence, in severely ill patients, surgery-induced depletion of AA may favour diffuse haemorrhage (Blee et al., 2002).

It has been reported that upon feeding animals with diets rich in AA, or even infusing the compound intravenously, the amount of vitamin C in tissues undergoing an inflammatory process is not enhanced (Demling et al., 1994). The reason for this reduced access of vitamin C to the cells is unknown. It has been suggested that pro-inflammatory cytokines, such as TNF $\alpha$  and IL-1 $\beta$ , would be able to inhibit AA uptake by human endothelial cell expressing SVCT2 (Seno et al., 2004).

In astrocytes, when septic challenge was mimicked by incubation with lipopolysaccharide and the pro-inflammatory cytokine interferon- $\gamma$ , an inhibition of both the reduction of DHA to AA and SVCT2-mediated AA uptake was observed, resulting in a reduction of the ability of these cells to maintain intracellular levels of AA (Korcok et al., 2002).

#### 4.5. Diseases of the Skin and Skeletal and Muscular Systems

In patients with rheumatoid arthritis, blood vitamin C concentrations are low. This suggests a role for this vitamin in protection against damage induced by the inflammatory process in joints (Lunec & Blake, 1985; Halliwell et al., 1987). A rapid reduction in the availability of vitamin C at the inflammatory site, such as in rheumatoid joints, induces an acceleration of proteolytic damage (Halliwell et al., 1987).

Pain associated with intense muscular activity is relieved by vitamin C because this is due to an accumulation of free radicals, which damage the muscle tissue, induce swelling, and stimulate pain receptors (Dekkers et al., 1996).

Using human keratinocytes as an *in vitro* experimental model, it has been observed that exposure to UV-light results in an enhanced ability to take up AA. This is due to the stimulation of the translocation of SVCT1 from the cytosol to the plasma membrane. Moreover, vitamin C regulates the inflammatory response of the skin exposed to UV-light by inhibiting the production of IL-8 and the monocyte chemoattractant protein-1 (MCP-1) (Kang et al., 2007).

#### 4.6. Gastrointestinal Diseases

It has been suggested that in patients with inflammatory disease of the gastric mucosa associated with chronic gastritis there is an alteration in vitamin C transport. Vitamin C is present in gastric juice at high concentrations (Sobala et al., 1989; Schorah et al., 1991), as occurs in other epithelia where the secretion of vitamin C plays a role in protective defence against oxidant challenge (Paterson & O'Rourke, 1987). In general, the concentrations of vitamin C in gastric juice are decreased in chronic gastritis. This is associated with an inflammatory response because the change is not present in chemical gastritis due to duodenal reflux, a condition where the invasion of the gastric mucosa by leucocytes is very poor. The administration of vitamin C is unable to restore the levels of vitamin C in gastric juice in patients with chronic gastritis in spite of the marked increase in serum vitamin C levels that are achieved in these cases. The hypothesis advanced to explain these findings is that in chronic gastritis there is impairment in the transport system responsible for the secretion of AA in gastric juice. Alternatively, the amount of vitamin C secreted is normal but the infiltration by leucocytes and the generation of free radicals by these cells transform AA into DHA, which is efficiently reabsorbed. Moreover, this situation has been associated with an enhanced risk of developing gastric cancer (Sobala et al., 1991).

#### 4.7. Liver Diseases

In many liver diseases there is an enhanced requirement of several vitamins, including vitamin C, with two aims: to help the liver tissue to restore its structure and/or function, and to compensate the decreased ability of this organ to store and distribute such vitamins (Leevy et al., 1970). In experimental hepatocellular cholestasis induced in rats by administration of naphthyl isothiocyanate, a decreased liver content in vitamin C has been reported (Ohta et al., 2000). This is consistent with recent findings by our group using a model of maternal hypercholanemia during pregnancy induced by obstructive cholestasis in rats. We have found an enhanced expression of SVCT1 and SVCT2 in maternal liver, foetal liver and placenta, probably as part of the defensive response to oxidative stress and enhanced consumption of vitamin C (Perez et al., 2007). When the situation was investigated *in vitro* by using human hepatoblastoma HepG2 cells, both bile acids and bilirubin, which become accumulated during cholestasis, were found to be able to induce the expression of vitamin C transporters. More precisely, taurocholic acid, ursodeoxycholic acid and bilirubin induced an up-regulation of SVCT2, whereas only bilirubin was able to enhance the expression of SVCT1 (Perez et al., 2008).

The results obtained with placental cells (JAR) were not exactly the same. Both taurocholic acid and ursodeoxycholic acid stimulated the expression of SVCT1 and SVCT2, whereas bilirubin only induced an up-regulation of SVCT2 (Perez et al., 2008). These changes were consistent with alterations in the expression levels of several nuclear receptors, such as FXR, SHP, PXR and CAR (Perez et al., 2008), which upon activation by biliary compounds participate in the regulation of the expression of the enzymes and transporters involved in the homeostasis of bile acids and bilirubin (Handschin & Meyer, 2005).

#### 4.8. Cancer

Regarding cancer prevention, diets rich in vitamin C are efficient at reducing the risk of developing cancer of the breast, cervix, colon, rectum, oesophagus, larynx, lung, oral cavity, prostate and stomach (Block, 1991, 1992; Frei, 1994; Levine et al., 1996; Feiz & Mobarhan, 2002). However, it has been described that in men there is a relationship between serum AA levels and enhanced risk of death due to cancer. Surprisingly this relationship was the inverse in women (Simon et al., 2001).

## 5. Conclusion

In addition to insufficient dietary content of vitamin C, changes in the ability of organs involved in vitamin C homeostasis to efficiently take up and eliminate AA and DHA may dramatically affect the degree of defensive capacity against oxidative damage or may impair several cell functions that require vitamin C. Moreover, several pathological circumstances may affect the function and/or expression of vitamin C transporters and hence alter its bioavailability for the whole body or just certain specific cells. Thus, although our knowledge about the actual role of vitamin C transporters in many diseases is scarce, intense investigation is currently under way to elucidate the molecular bases of these mechanisms. Future advances may permit the development of pharmacological interventions to modulate vitamin C uptake and improve the bioavailability of this compound.

## Acknowledgments

This study was supported in part by the Instituto de Salud Carlos III, FIS (Grant PI080151), the Junta de Castilla y Leon (Grants GR75-2008, SA021B06, SA033A08, SA03508, SA03608 and SAN673SA07/08), Spain; Ministerio de Ciencia y Tecnologia, Plan Nacional de Investigacion Cientifica, Desarrollo e Innovacion Tecnologica (Grant BFU2006-12577), Spain; Fundacion de Investigacion Mutua Madrileña (VI Conv); The group is member of the Network for Cooperative Research on Membrane Transport Proteins (REIT), co-funded by the Ministerio de Educacion y Ciencia, Spain and the European Regional Development Fund (ERDF) (Grant BFU2007-30688-E/BFI) and belongs to the CIBERehd (Centro de Investigacion Biomedica en Red) for Hepatology and Gastroenterology Research (Instituto de Salud Carlos III, Spain).

The authors thank N. Skinner for revision of the English text of the manuscript.

## References

- [1] Agus DB, Gambhir SS, Pardridge WM, Spielholz C, Baselga J, Vera JC & Golde DW. (1997). Vitamin C crosses the blood-brain barrier in the oxidized form through the glucose transporters. *J Clin Invest* 100, 2842-2848.
- [2] Anderson R, Theron AJ & Ras GJ. (1988). Ascorbic acid neutralizes reactive oxidants released by hyperactive phagocytes from cigarette smokers. *Lung* 166, 149-159.
- [3] Banhegyi G, Csala M, Braun L, Garzo T & Mandl J. (1996). Ascorbate synthesis-dependent glutathione consumption in mouse liver. *FEBS Lett* 381, 39-41.
- [4] Basu TK & Schorah CJ. (1982). *Vitamin C in Health and Disease*. Croom Helm Ltd., London.
- [5] Biondi C, Pavan B, Dalpiaz A, Medici S, Lunghi L & Vesce F. (2007). Expression and characterization of vitamin C transporter in the human trophoblast cell line HTR-8/SVneo: effect of steroids, flavonoids and NSAIDs. *Mol Hum Reprod* 13, 77-83.
- [6] Blee TH, Cogbill TH & Lambert PJ. (2002). Hemorrhage associated with vitamin C deficiency in surgical patients. *Surgery* 131, 408-412.
- [7] Block G. (1991). Epidemiologic evidence regarding vitamin C and cancer. *Am J Clin Nutr* 54, 1310S-1314S.
- [8] Block G. (1992). The data support a role for antioxidants in reducing cancer risk. *Nutr Rev* 50, 207-213.
- [9] Bode AM, Cunningham L & Rose RC. (1990). Spontaneous decay of oxidized ascorbic acid (dehydro-L-ascorbic acid) evaluated by high-pressure liquid chromatography. *Clin Chem* 36, 1807-1809.
- [10] Borrelli E, Roux-Lombard P, Grau GE, Girardin E, Ricou B, Dayer J & Suter PM. (1996). Plasma concentrations of cytokines, their soluble receptors, and antioxidant vitamins can predict the development of multiple organ failure in patients at risk. *Crit Care Med* 24, 392-397.
- [11] Bossuyt X & Blanckaert N. (1995). Mechanism of stimulation of microsomal UDP-glucuronosyltransferase by UDP-N-acetylglucosamine. *Biochem J* 305 ( Pt 1), 321-328.
- [12] Bouhuys A. (1974). Letter: Colds and antihistaminic effects of vitamin C. *N Engl J Med* 290, 633.
- [13] Boyer JC, Campbell CE, Sigurdson WJ & Kuo SM. (2005). Polarized localization of vitamin C transporters, SVCT1 and SVCT2, in epithelial cells. *Biochem Biophys Res Commun* 334, 150-156.
- [14] Braddock R, Siman CM, Hamilton K, Garland HO & Sibley CP. (2002). Gamma-linoleic acid and ascorbate improves skeletal ossification in offspring of diabetic rats. *Pediatr Res* 51, 647-652.
- [15] Bron AJ & Brown NA. (1987). Perinuclear lens retrodots: a role for ascorbate in cataractogenesis. *Br J Ophthalmol* 71, 86-95.
- [16] Brubacher D, Moser U & Jordan P. (2000). Vitamin C concentrations in plasma as a function of intake: a meta-analysis. *Int J Vitam Nutr Res* 70, 226-237.
- [17] Bublitz C & Lehninger AL. (1959). The enzymic conversion of L-gulonate to L-ascorbate by rat-liver enzymes. *Biochim Biophys Acta* 32, 290-291.



- [18] Chatterjee IB, Chatterjee GC, Ghosh NC, Ghosh JJ & Guha BC. (1960). Biological synthesis of L-ascorbic acid in animal tissues: conversion of D-glucuronolactone and L-gulonolactone into L-ascorbic acid. *Biochem J* 76, 279-292.
- [19] Clark AG, Rohrbaugh AL, Otterness I & Kraus VB. (2002). The effects of ascorbic acid on cartilage metabolism in guinea pig articular cartilage explants. *Matrix Biol* 21, 175-184.
- [20] Cochrane CG, Spragg R & Revak SD. (1983). Pathogenesis of the adult respiratory distress syndrome. Evidence of oxidant activity in bronchoalveolar lavage fluid. *J Clin Invest* 71, 754-761.
- [21] Cunningham JJ, Ellis SL, McVeigh KL, Levine RE & Calles-Escandon J. (1991). Reduced mononuclear leukocyte ascorbic acid content in adults with insulin-dependent diabetes mellitus consuming adequate dietary vitamin C. *Metabolism* 40, 146-149.
- [22] Daruwala R, Song J, Koh WS, Rumsey SC & Levine M. (1999). Cloning and functional characterization of the human sodium-dependent vitamin C transporters hSVCT1 and hSVCT2. *FEBS Lett* 460, 480-484.
- [23] Daskalopoulos R, Korcok J, Tao L & Wilson JX. (2002). Accumulation of intracellular ascorbate from dehydroascorbic acid by astrocytes is decreased after oxidative stress and restored by propofol. *Glia* 39, 124-132.
- [24] Dekkers JC, van Doornen LJ & Kemper HC. (1996). The role of antioxidant vitamins and enzymes in the prevention of exercise-induced muscle damage. *Sports Med* 21, 213-238.
- [25] Demling R, Ikegami K, Picard L & Lalonde C. (1994). Administration of large doses of vitamin C does not decrease oxidant-induced lung lipid peroxidation caused by bacterial-independent acute peritonitis. *Inflammation* 18, 499-510.
- [26] Dhariwal KR, Hartzell WO & Levine M. (1991). Ascorbic acid and dehydroascorbic acid measurements in human plasma and serum. *Am J Clin Nutr* 54, 712-716.
- [27] Faaland CA, Race JE, Ricken G, Warner FJ, Williams WJ & Holtzman EJ. (1998). Molecular characterization of two novel transporters from human and mouse kidney and from LLC-PK1 cells reveals a novel conserved family that is homologous to bacterial and Aspergillus nucleobase transporters. *Biochim Biophys Acta* 1442, 353-360.
- [28] Fain O, Paries J, Jacquart B, Le Moel G, Kettaneh A, Stirnemann J, Heron C, Sitbon M, Taleb C, Letellier E, Betari B, Gattegno L & Thomas M. (2003). Hypovitaminosis C in hospitalized patients. *Eur J Intern Med* 14, 419-425.
- [29] Feiz HR & Mobarhan S. (2002). Does vitamin C intake slow the progression of gastric cancer in Helicobacter pylori-infected populations? *Nutr Rev* 60, 34-36.
- [30] Finley EB & Cerklewski FL. (1983). Influence of ascorbic acid supplementation on copper status in young adult men. *Am J Clin Nutr* 37, 553-556.
- [31] Fischer H, Schwarzer C & Illek B. (2004). Vitamin C controls the cystic fibrosis transmembrane conductance regulator chloride channel. *Proc Natl Acad Sci U S A* 101, 3691-3696.
- [32] Fishbein SL & Goodstein S. (1972). The pressure lowering effect of ascorbic acid. *Ann Ophthalmol* 4, 487-491.

- [33] Franceschi RT, Wilson JX & Dixon SJ. (1995). Requirement for Na(+)-dependent ascorbic acid transport in osteoblast function. *Am J Physiol* 268, C1430-1439.
- [34] Frei B. (1991). Ascorbic acid protects lipids in human plasma and low-density lipoprotein against oxidative damage. *Am J Clin Nutr* 54, 1113S-1118S.
- [35] Frei B. (1994). Reactive oxygen species and antioxidant vitamins: mechanisms of action. *Am J Med* 97, 5S-13S; discussion 22S-28S.
- [36] Frei B, England L & Ames BN. (1989). Ascorbate is an outstanding antioxidant in human blood plasma. *Proc Natl Acad Sci U S A* 86, 6377-6381.
- [37] Fujita I, Hirano J, Itoh N, Nakanishi T & Tanaka K. (2001). Dexamethasone induces sodium-dependant vitamin C transporter in a mouse osteoblastic cell line MC3T3-E1. *Br J Nutr* 86, 145-149.
- [38] Fujita T, Uchida K & Maruyama N. (1992). Purification of senescence marker protein-30 (SMP30) and its androgen-independent decrease with age in the rat liver. *Biochim Biophys Acta* 1116, 122-128.
- [39] Gale CR, Martyn CN, Winter PD & Cooper C. (1995). Vitamin C and risk of death from stroke and coronary heart disease in cohort of elderly people. *BMJ* 310, 1563-1566.
- [40] Geber WF, Lefkowitz SS & Hung CY. (1975). Effect of ascorbic acid, sodium salicylate, and caffeine on the serum interferon level in response to viral infection. *Pharmacology* 13, 228-233.
- [41] Gerster H. (1997). No contribution of ascorbic acid to renal calcium oxalate stones. *Ann Nutr Metab* 41, 269-282.
- [42] Halliwell B, Wasil M & Grootveld M. (1987). Biologically significant scavenging of the myeloperoxidase-derived oxidant hypochlorous acid by ascorbic acid. Implications for antioxidant protection in the inflamed rheumatoid joint. *FEBS Lett* 213, 15-17.
- [43] Handschin C & Meyer UA. (2005). Regulatory network of lipid-sensing nuclear receptors: roles for CAR, PXR, LXR, and FXR. *Arch Biochem Biophys* 433, 387-396.
- [44] Hankinson SE, Stampfer MJ, Seddon JM, Colditz GA, Rosner B, Speizer FE & Willett WC. (1992). Nutrient intake and cataract extraction in women: a prospective study. *BMJ* 305, 335-339.
- [45] Hegde KR & Varma SD. (2004). Protective effect of ascorbate against oxidative stress in the mouse lens. *Biochim Biophys Acta* 1670, 12-18.
- [46] Huang J, Agus DB, Winfree CJ, Kiss S, Mack WJ, McTaggart RA, Choudhri TF, Kim LJ, Mocco J, Pinsky DJ, Fox WD, Israel RJ, Boyd TA, Golde DW & Connolly ES, Jr. (2001). Dehydroascorbic acid, a blood-brain barrier transportable form of vitamin C, mediates potent cerebroprotection in experimental stroke. *Proc Natl Acad Sci U S A* 98, 11720-11724.
- [47] Ito A, Hayashi S & Yoshida T. (1981). Participation of a cytochrome b5-like hemoprotein of outer mitochondrial membrane (OM cytochrome b) in NADH-semidehydroascorbic acid reductase activity of rat liver. *Biochem Biophys Res Commun* 101, 591-598.
- [48] Jacques PF & Chylack LT, Jr. (1991). Epidemiologic evidence of a role for the antioxidant vitamins and carotenoids in cataract prevention. *Am J Clin Nutr* 53, 352S-355S.

- [49] Jin SN, Mun GH, Lee JH, Oh CS, Kim J, Chung YH, Kang JS, Kim JG, Hwang DH, Hwang YI, Shin DH & Lee WJ. (2005). Immunohistochemical study on the distribution of sodium-dependent vitamin C transporters in the respiratory system of adult rat. *Microsc Res Tech* 68, 360-367.
- [50] Kallner AB, Hartmann D & Hornig DH. (1981). On the requirements of ascorbic acid in man: steady-state turnover and body pool in smokers. *Am J Clin Nutr* 34, 1347-1355.
- [51] Kang JS, Kim HN, Jung da J, Kim JE, Mun GH, Kim YS, Cho D, Shin DH, Hwang YI & Lee WJ. (2007). Regulation of UVB-induced IL-8 and MCP-1 production in skin keratinocytes by increasing vitamin C uptake via the redistribution of SVCT-1 from the cytosol to the membrane. *J Invest Dermatol* 127, 698-706.
- [52] Kannan R, Stolz A, Ji Q, Prasad PD & Ganapathy V. (2001). Vitamin C transport in human lens epithelial cells: evidence for the presence of SVCT2. *Exp Eye Res* 73, 159-165.
- [53] Kim M, Otsuka M, Yu R, Kurata T & Arakawa N. (1994). The distribution of ascorbic acid and dehydroascorbic acid during tissue regeneration in wounded dorsal skin of guinea pigs. *Int J Vitam Nutr Res* 64, 56-59.
- [54] Kondo Y, Inai Y, Sato Y, Handa S, Kubo S, Shimokado K, Goto S, Nishikimi M, Maruyama N & Ishigami A. (2006). Senescence marker protein 30 functions as gluconolactonase in L-ascorbic acid biosynthesis, and its knockout mice are prone to scurvy. *Proc Natl Acad Sci U S A* 103, 5723-5728.
- [55] Korcok J, Dixon SJ, Lo TC & Wilson JX. (2003). Differential effects of glucose on dehydroascorbic acid transport and intracellular ascorbate accumulation in astrocytes and skeletal myocytes. *Brain Res* 993, 201-207.
- [56] Korcok J, Wu F, Tymk K, Hammond RR & Wilson JX. (2002). Sepsis inhibits reduction of dehydroascorbic acid and accumulation of ascorbate in astroglial cultures: intracellular ascorbate depletion increases nitric oxide synthase induction and glutamate uptake inhibition. *J Neurochem* 81, 185-193.
- [57] Koshizaka T, Nishikimi M, Ozawa T & Yagi K. (1988). Isolation and sequence analysis of a complementary DNA encoding rat liver L-gulonogamma-lactone oxidase, a key enzyme for L-ascorbic acid biosynthesis. *J Biol Chem* 263, 1619-1621.
- [58] Kubin A, Kaudela K, Jindra R, Alth G, Grunberger W, Wierrani F & Ebermann R. (2003). Dehydroascorbic acid in urine as a possible indicator of surgical stress. *Ann Nutr Metab* 47, 1-5.
- [59] Kuo SM, MacLean ME, McCormick K & Wilson JX. (2004). Gender and sodium-ascorbate transporter isoforms determine ascorbate concentrations in mice. *J Nutr* 134, 2216-2221.
- [60] Lee JH, Oh CS, Mun GH, Kim JH, Chung YH, Hwang YI, Shin DH & Lee WJ. (2006). Immunohistochemical localization of sodium-dependent L-ascorbic acid transporter 1 protein in rat kidney. *Histochem Cell Biol* 126, 491-494.
- [61] Lee W, Davis KA, Rettmer RL & Labbe RF. (1988). Ascorbic acid status: biochemical and clinical considerations. *Am J Clin Nutr* 48, 286-290.
- [62] Leevy CM, Thompson A & Baker H. (1970). Vitamins and liver injury. *Am J Clin Nutr* 23, 493-499.

- [63] Lehr HA, Frei B, Olofsson AM, Carew TE & Arfors KE. (1995). Protection from oxidized LDL-induced leukocyte adhesion to microvascular and macrovascular endothelium in vivo by vitamin C but not by vitamin E. *Circulation* 91, 1525-1532.
- [64] Leibovitz B & Siegel BV. (1978). Ascorbic acid, neutrophil function, and the immune response. *Int J Vitam Nutr Res* 48, 159-164.
- [65] Levine M, Conry-Cantilena C, Wang Y, Welch RW, Washko PW, Dhariwal KR, Park JB, Lazarev A, Graumlich JF, King J & Cantilena LR. (1996). Vitamin C pharmacokinetics in healthy volunteers: evidence for a recommended dietary allowance. *Proc Natl Acad Sci U S A* 93, 3704-3709.
- [66] Liang WJ, Johnson D & Jarvis SM. (2001). Vitamin C transport systems of mammalian cells. *Mol Membr Biol* 18, 87-95.
- [67] Linster CL & Van Schaftingen E. (2003). Rapid stimulation of free glucuronate formation by non-glucuronidable xenobiotics in isolated rat hepatocytes. *J Biol Chem* 278, 36328-36333.
- [68] Linster CL & Van Schaftingen E. (2007). Vitamin C. Biosynthesis, recycling and degradation in mammals. *FEBS J* 274, 1-22.
- [69] Louw JA, Werbeck A, Louw ME, Kotze TJ, Cooper R & Labadarios D. (1992). Blood vitamin concentrations during the acute-phase response. *Crit Care Med* 20, 934-941.
- [70] Lunec J & Blake DR. (1985). The determination of dehydroascorbic acid and ascorbic acid in the serum and synovial fluid of patients with rheumatoid arthritis (RA). *Free Radic Res Commun* 1, 31-39.
- [71] Lutsenko EA, Carcamo JM & Golde DW. (2004). A human sodium-dependent vitamin C transporter 2 isoform acts as a dominant-negative inhibitor of ascorbic acid transport. *Mol Cell Biol* 24, 3150-3156.
- [72] MacDonald L, Thumser AE & Sharp P. (2002). Decreased expression of the vitamin C transporter SVCT1 by ascorbic acid in a human intestinal epithelial cell line. *Br J Nutr* 87, 97-100.
- [73] Mano Y, Suzuki K, Yamada K & Shimazono N. (1961). Enzymic studies on TPN L-hexonate dehydrogenase from rat liver. *J Biochem* 49, 618-634.
- [74] Maulen NP, Henriquez EA, Kempe S, Carcamo JG, Schmid-Kotsas A, Bachem M, Grunert A, Bustamante ME, Nualart F & Vera JC. (2003). Up-regulation and polarized expression of the sodium-ascorbic acid transporter SVCT1 in post-confluent differentiated CaCo-2 cells. *J Biol Chem* 278, 9035-9041.
- [75] McNally NJ. (1953). Preliminary report on the use of vitamin C in asthma. *Ir Med Assoc* 33, 175-178.
- [76] McNulty AL, Vail TP & Kraus VB. (2005). Chondrocyte transport and concentration of ascorbic acid is mediated by SVCT2. *Biochim Biophys Acta* 1712, 212-221.
- [77] Michels AJ, Joisher N & Hagen TM. (2003). Age-related decline of sodium-dependent ascorbic acid transport in isolated rat hepatocytes. *Arch Biochem Biophys* 410, 112-120.
- [78] Mori T, Ishigami A, Seyama K, Onai R, Kubo S, Shimizu K, Maruyama N & Fukuchi Y. (2004). Senescence marker protein-30 knockout mouse as a novel murine model of senile lung. *Pathol Int* 54, 167-173.

- [79] Mun GH, Kim MJ, Lee JH, Kim HJ, Chung YH, Chung YB, Kang JS, Hwang YI, Oh SH, Kim JG, Hwang DH, Shin DH & Lee WJ. (2006). Immunohistochemical study of the distribution of sodium-dependent vitamin C transporters in adult rat brain. *J Neurosci Res* 83, 919-928.
- [80] Naidu KA. (2003). Vitamin C in human health and disease is still a mystery? An overview. *Nutr J* 2, 7.
- [81] Ng LL, Ngkeekwong FC, Quinn PA & Davies JE. (1998). Uptake mechanisms for ascorbate and dehydroascorbate in lymphoblasts from diabetic nephropathy and hypertensive patients. *Diabetologia* 41, 435-442.
- [82] Nishikimi M, Kawai T & Yagi K. (1992). Guinea pigs possess a highly mutated gene for L-gulonogamma-lactone oxidase, the key enzyme for L-ascorbic acid biosynthesis missing in this species. *J Biol Chem* 267, 21967-21972.
- [83] Obrosova IG, Fathallah L, Liu E & Nourooz-Zadeh J. (2003). Early oxidative stress in the diabetic kidney: effect of DL-alpha-lipoic acid. *Free Radic Biol Med* 34, 186-195.
- [84] Obrosova IG, Fathallah L & Stevens MJ. (2001). Taurine counteracts oxidative stress and nerve growth factor deficit in early experimental diabetic neuropathy. *Exp Neurol* 172, 211-219.
- [85] Ohta Y, Kongo M, Sasaki E, Ishiguro I & Harada N. (2000). Protective effect of melatonin against alpha-naphthylisothiocyanate-induced liver injury in rats. *J Pineal Res* 29, 15-23.
- [86] Ohta Y & Nishikimi M. (1999). Random nucleotide substitutions in primate nonfunctional gene for L-gulonogamma-lactone oxidase, the missing enzyme in L-ascorbic acid biosynthesis. *Biochim Biophys Acta* 1472, 408-411.
- [87] Palmquist BM, Philipson B & Barr PO. (1984). Nuclear cataract and myopia during hyperbaric oxygen therapy. *Br J Ophthalmol* 68, 113-117.
- [88] Patak P, Willenberg HS & Bornstein SR. (2004). Vitamin C is an important cofactor for both adrenal cortex and adrenal medulla. *Endocr Res* 30, 871-875.
- [89] Paterson CA & O'Rourke MC. (1987). Vitamin C levels in human tears. *Arch Ophthalmol* 105, 376-377.
- [90] Pelletier O. (1975). Vitamin C and cigarette smokers. *Ann NY Acad Sci* 258, 156-168.
- [91] Perez MJ, Castano B, Gonzalez-Buitrago JM & Marin JJ. (2007). Multiple protective effects of melatonin against maternal cholestasis-induced oxidative stress and apoptosis in the rat fetal liver-placenta-maternal liver trio. *J Pineal Res* 43, 130-139.
- [92] Perez MJ, Castano B, Jimenez S, Serrano MA, Gonzalez-Buitrago JM & Marin JJ. (2008). Role of vitamin C transporters and biliverdin reductase in the dual pro-oxidant and anti-oxidant effect of biliary compounds on the placental-fetal unit in cholestasis during pregnancy. *Toxicol Appl Pharmacol* 232, 327-336.
- [93] Qiu S, Li L, Weeber EJ & May JM. (2007). Ascorbate transport by primary cultured neurons and its role in neuronal function and protection against excitotoxicity. *J Neurosci Res* 85, 1046-1056.
- [94] Qutob S, Dixon SJ & Wilson JX. (1998). Insulin stimulates vitamin C recycling and ascorbate accumulation in osteoblastic cells. *Endocrinology* 139, 51-56.

- [95] Rajan DP, Huang W, Dutta B, Devoe LD, Leibach FH, Ganapathy V & Prasad PD. (1999). Human placental sodium-dependent vitamin C transporter (SVCT2): molecular cloning and transport function. *Biochem Biophys Res Commun* 262, 762-768.
- [96] Rath M. (1993). *Eradicating heart disease*. Health Now, San Francisco, CA. .
- [97] Rose RC. (1987). Solubility properties of reduced and oxidized ascorbate as determinants of membrane permeation. *Biochim Biophys Acta* 924, 254-256.
- [98] Salceda R & Contreras-Cubas C. (2007). Ascorbate uptake in normal and diabetic rat retina and retinal pigment epithelium. *Comp Biochem Physiol C Toxicol Pharmacol* 146, 175-179.
- [99] Savini I, Catani MV, Arnone R, Rossi A, Frega G, Del Principe D & Avigliano L. (2007). Translational control of the ascorbic acid transporter SVCT2 in human platelets. *Free Radic Biol Med* 42, 608-616.
- [100] Savini I, Rossi A, Pierro C, Avigliano L & Catani MV. (2008). SVCT1 and SVCT2: key proteins for vitamin C uptake. *Amino Acids* 34, 347-355.
- [101] Schachter EN & Schlesinger A. (1982). The attenuation of exercise-induced bronchospasm by ascorbic acid. *Ann Allergy* 49, 146-151.
- [102] Schectman G, Byrd JC & Gruchow HW. (1989). The influence of smoking on vitamin C status in adults. *Am J Public Health* 79, 158-162.
- [103] Schorah CJ, Downing C, Piripitsi A, Gallivan L, Al-Hazaa AH, Sanderson MJ & Bodenham A. (1996). Total vitamin C, ascorbic acid, and dehydroascorbic acid concentrations in plasma of critically ill patients. *Am J Clin Nutr* 63, 760-765.
- [104] Schorah CJ, Sobala GM, Sanderson M, Collis N & Primrose JN. (1991). Gastric juice ascorbic acid: effects of disease and implications for gastric carcinogenesis. *Am J Clin Nutr* 53, 287S-293S.
- [105] Seno T, Inoue N, Matsui K, Ejiri J, Hirata K, Kawashima S & Yokoyama M. (2004). Functional expression of sodium-dependent vitamin C transporter 2 in human endothelial cells. *J Vasc Res* 41, 345-351.
- [106] Simon JA, Hudes ES & Tice JA. (2001). Relation of serum ascorbic acid to mortality among US adults. *J Am Coll Nutr* 20, 255-263.
- [107] Simpson GL & Ortwerth BJ. (2000). The non-oxidative degradation of ascorbic acid at physiological conditions. *Biochim Biophys Acta* 1501, 12-24.
- [108] Sinclair AJ, Girling AJ, Gray L, Lunec J & Barnett AH. (1992). An investigation of the relationship between free radical activity and vitamin C metabolism in elderly diabetic subjects with retinopathy. *Gerontology* 38, 268-274.
- [109] Siushansian R, Tao L, Dixon SJ & Wilson JX. (1997). Cerebral astrocytes transport ascorbic acid and dehydroascorbic acid through distinct mechanisms regulated by cyclic AMP. *J Neurochem* 68, 2378-2385.
- [110] Sobala GM, Pignatelli B, Schorah CJ, Bartsch H, Sanderson M, Dixon MF, Shires S, King RF & Axon AT. (1991). Levels of nitrite, nitrate, N-nitroso compounds, ascorbic acid and total bile acids in gastric juice of patients with and without precancerous conditions of the stomach. *Carcinogenesis* 12, 193-198.
- [111] Sobala GM, Schorah CJ, Sanderson M, Dixon MF, Tompkins DS, Godwin P & Axon AT. (1989). Ascorbic acid in the human stomach. *Gastroenterology* 97, 357-363.

- [112] Spielholz C, Golde DW, Houghton AN, Nualart F & Vera JC. (1997). Increased facilitated transport of dehydroascorbic acid without changes in sodium-dependent ascorbate transport in human melanoma cells. *Cancer Res* 57, 2529-2537.
- [113] Steiling H, Longet K, Moodycliffe A, Mansourian R, Bertschy E, Smola H, Mauch C & Williamson G. (2007). Sodium-dependent vitamin C transporter isoforms in skin: Distribution, kinetics, and effect of UVB-induced oxidative stress. *Free Radic Biol Med* 43, 752-762.
- [114] Stratakis CA, Taymans SE, Daruwala R, Song J & Levine M. (2000). Mapping of the human genes (SLC23A2 and SLC23A1) coding for vitamin C transporters 1 and 2 (SVCT1 and SVCT2) to 5q23 and 20p12, respectively. *J Med Genet* 37, E20.
- [115] Subramanian VS, Marchant JS, Reidling JC & Said HM. (2008). N-Glycosylation is required for Na<sup>+</sup>-dependent vitamin C transporter functionality. *Biochem Biophys Res Commun* 374, 123-127.
- [116] Taylor A, Jacques PF, Nadler D, Morrow F, Sulsky SI & Shepard D. (1991). Relationship in humans between ascorbic acid consumption and levels of total and reduced ascorbic acid in lens, aqueous humor, and plasma. *Curr Eye Res* 10, 751-759.
- [117] Trout DL. (1991). Vitamin C and cardiovascular risk factors. *Am J Clin Nutr* 53, 322S-325S.
- [118] Tsukaguchi H, Tokui T, Mackenzie B, Berger UV, Chen XZ, Wang Y, Brubaker RF & Hediger MA. (1999). A family of mammalian Na<sup>+</sup>-dependent L-ascorbic acid transporters. *Nature* 399, 70-75.
- [119] Vaquero J, Marin JJ, Hierro C, Monte MJ, Jiménez F, González San-Martin F, Blázquez AG & Macias RR. (2009). Cellular heterogeneity in the expression of vitamin c transporters (SVCT1 and SVCT2) in normal and pathological liver parenchyma. *J Hepatology* 50: 1: S52.
- [120] Varma SD. (1987). Ascorbic acid and the eye with special reference to the lens. *Ann N Y Acad Sci* 498, 280-306.
- [121] Vera JC, Rivas CI, Zhang RH & Golde DW. (1998). Colony-stimulating factors signal for increased transport of vitamin C in human host defense cells. *Blood* 91, 2536-2546.
- [122] Wang H, Dutta B, Huang W, Devoe LD, Leibach FH, Ganapathy V & Prasad PD. (1999). Human Na<sup>(+)</sup>-dependent vitamin C transporter 1 (hSVCT1): primary structure, functional characteristics and evidence for a non-functional splice variant. *Biochim Biophys Acta* 1461, 1-9.
- [123] Wang Y, Mackenzie B, Tsukaguchi H, Weremowicz S, Morton CC & Hediger MA. (2000). Human vitamin C (L-ascorbic acid) transporter SVCT1. *Biochem Biophys Res Commun* 267, 488-494.
- [124] Weber C, Erl W, Weber K & Weber PC. (1996). Increased adhesiveness of isolated monocytes to endothelium is prevented by vitamin C intake in smokers. *Circulation* 93, 1488-1492.
- [125] Whitaker MJ. (1985). *Reversing heart disease*. Warner Books, New York.
- [126] Will JC & Byers T. (1996). Does diabetes mellitus increase the requirement for vitamin C? *Nutr Rev* 54, 193-202.
- [127] Wilson JX. (2005). Regulation of vitamin C transport. *Annu Rev Nutr* 25, 105-125.

- 
- [128] Winkelman J & Lehninger AL. (1958). Aldono- and uronolactonases of animal tissues. *J Biol Chem* 233, 794-799.
- [129] Wu X, Itoh N, Taniguchi T, Hirano J, Nakanishi T & Tanaka K. (2004). Stimulation of differentiation in sodium-dependent vitamin C transporter 2 overexpressing MC3T3-E1 osteoblasts. *Biochem Biophys Res Commun* 317, 1159-1164.
- [130] Wu X, Itoh N, Taniguchi T, Nakanishi T & Tanaka K. (2003a). Requirement of calcium and phosphate ions in expression of sodium-dependent vitamin C transporter 2 and osteopontin in MC3T3-E1 osteoblastic cells. *Biochim Biophys Acta* 1641, 65-70.
- [131] Wu X, Itoh N, Taniguchi T, Nakanishi T, Tatsu Y, Yumoto N & Tanaka K. (2003b). Zinc-induced sodium-dependent vitamin C transporter 2 expression: potent roles in osteoblast differentiation. *Arch Biochem Biophys* 420, 114-120.



---

## **Vitamin C: Daily Requirements, Dietary Sources and Adverse Effects**

---

*Jun Yang<sup>1\*</sup>, Jiaren Liu<sup>2</sup> and John Parry<sup>3</sup>*

<sup>1</sup>Frito-Lay R&D, Plano, TX, USA

<sup>2</sup>Department of Anesthesia, Harvard Medical School, Boston, MA, USA

<sup>3</sup>Agricultural Research Station, Virginia State University, Petersburg, VA, USA

### **Abstract**

Ascorbic acid (vitamin C) is classified as a water-soluble vitamin. It is a powerful reducing agent and is sensitive to transition metals, light, oxygen, and heat. As a strong antioxidant, ascorbic acid is used as a preservative in the food industry. Humans depend on ascorbic acid for many physiological and biochemical functions such as collagen, carnitine, and neurotransmitter biosynthesis, which is crucial to the maintenance of bones, teeth, and blood vessels. A deficiency in ascorbic acid can lead to scurvy. Unlike most plants, animals, and single-cell organisms, humans cannot synthesize their own supply of ascorbic acid due to lack of the enzyme responsible for the final step in its conversion - gulonolactone oxidase. It must be obtained from dietary sources including fruits, vegetables and supplements. Good dietary sources of vitamin C include citrus fruits, green vegetables, bell peppers, papaya, and tomatoes. However, vitamin C level is reduced in storage and processing. Generally, the US recommended dietary allowance (RDA) for ascorbic acid is from 100 - 120 mg/per day for adults. Ascorbic acid is an antioxidant that can help neutralize free radicals. Many health benefits have been attributed to ascorbic acid such as protection from viral infections, anti-atherogenesis, anti-carcinogenesis, and immune-modulation. A new study indicates that it has a complex protective role against toxic compounds formed from oxidized lipids, preventing genetic damage and inflammation. The amount of ascorbic acid to cause overdose symptoms in humans varies among individuals, and overdose is generally characterized by diarrhea and possibly indigestion. Ascorbic acid has been implicated

---

\* Corresponding Author

with increasing the susceptibility to Vitamin B<sub>12</sub> deficiency, and also has shown to be contraindicative in cancer chemotherapy. High doses of ascorbic acid may have prooxidant effects and have also been implicated in the development of kidney stones. *In vitro* and animal studies have shown that fruit and vegetable components, such as flavonoids and other matrix compounds, might reduce ascorbic acid intestinal uptake. The role of ascorbic acid in human biology and health is still controversial. The health benefits of ascorbic acid have been the subject of much debate. More mechanisms of action and human *in vivo* studies are needed to understand and elucidate the molecular mechanisms of ascorbic acid in health functions. The purpose of this chapter is to review the health benefits and adverse effects of ascorbic acid based on a review of the literature.

## Introduction

Vitamin C, known as ascorbic acid and ascorbate, is an essential vitamin for humans. It is found in plants, animals, and single-cell organisms. Most mammals synthesize ascorbate from glucose; however, due to a genetic defect, humans, guinea pigs, and some other primates are not able to make the enzyme, L-gulonolactone oxidase, required for its synthesis (Shils 1994). A deficiency in vitamin C in humans can lead to scurvy (Guthrie 1989), and may cause small cell-type anemia, atherosclerotic plaques, hemorrhages, poor wound healing, frequent infections, bone fragility and joint pain, rough skin and blotchy bruises, bleeding gums and loosened teeth, muscle degeneration, pain, hysteria, and depression (Whitney et al., 2002). Good sources of vitamin C are fruits and vegetables. An excessive intake of vitamin C such as gram doses and overdoses may lead to abdominal bloating, diarrhea, hyperoxalemia in dialysis patients, over absorption of iron, and hemolysis in patients with glucose-6-phosphate dehydrogenase deficiency (Jacob and Sotoudeh, 2002).

Fruits and vegetables that are rich in vitamin C include citrus, green leafy vegetables, cantaloupe, tomatoes, mangoes, and papayas. Despite its abundance in fruits and vegetables, vitamin C is easily destroyed by light, heat, oxygen, and transition metals during storage and processing (Johnston 2001). So it must be stored in a dark, cold, and non-metallic container. It is easily oxidized and hence is used as a reductant and as a preservative. While prolonged storage of unprocessed fruits and vegetables leads to the loss of vitamin C, food processing such as freezing and canning preserves vitamin C well.

Vitamin C is crucial to the maintenance of bones, teeth, gums, ligaments, and blood vessels. Due to its antioxidant activity, vitamin C has been used to help patients with ischemic heart disease. Data suggest that vitamin C may have a benefit on blood flow in the heart but more research is needed to confirm these findings. Many health promotional uses for vitamin C have been proposed, and some have been found to be beneficial in scientific studies. However, some research in asthma, heart disease, cancer, and diabetes remains inconclusive.

## Physiological and Biochemical Functions of Vitamin C

Vitamin C [2-oxo-L-threo-hexono-1,4-lactone-2,3-enediol *or* (*R*)-3,4-dihydroxy-5-((*S*)-1,2-dihydroxyethyl) furan-2 (*5H*)-one, C<sub>6</sub>H<sub>12</sub>O<sub>6</sub>], white to light-yellow crystals or powder, is a water-soluble ketolactone with a molecular weight of 176.13 g/mol (Figure 1). The L-enantiomer of ascorbic acid is commonly known as vitamin C. The molecular structures of vitamin C and its oxidized form dehydroascorbic acid are similar to that of glucose. The pKa of ascorbic acid is 4.2 in most biological systems. Vitamin C is acidic, behaving as a vinylogous carboxylic acid, wherein the double bond resonates electron pairs among the hydroxyl group carbons and the carbonyl. There are two resonance structures for the deprotonated form, differing in the position of the double bond. Ascorbic acid rapidly interconverts into two unstable diketone tautomers by proton transfer. The proton of the enol (stable form) is lost, and reacquired by electrons from the double bond, to produce a diketone.

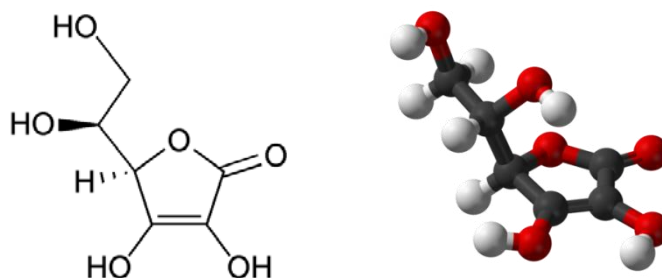

Figure 1. The chemical structure of ascorbic acid.

Vitamin C undergoes reversible oxidation and reduction and plays an important role as a redox agent in biological systems (Kuroyanagi et al., 2002), which accelerates hydroxylation reactions in a number of biosynthetic pathways. It exists in the body primarily in its reduced form. The oxidized form - dehydroascorbic acid (DHA) also has antiscorbutic (scurvy preventive) activity since it is easily reduced intracellularly to ascorbic acid (Figure 2). As an *in vivo* antioxidant, ascorbic acid donates electrons and is also readily converted back to its reduced form by glutathione. Vitamin C is specifically required for the activity of several enzymes involved in amino acid, hormone, collagen, and carnitine synthesis and metabolism (Englard and Seifter, 1986). Within these reactions, ascorbate directly or indirectly donates electrons to enzymes that require prosthetic metal ions in a reduced form. For example, vitamin C serves as a cofactor for prolyl and lysyl hydroxylase in the biosynthesis of collagen (Levine 1986). Table 1 lists enzymes requiring ascorbic acid as a cofactor or cosubstrate. As a cofactor of prolyl and lysyl hydroxylases, ascorbate is an essential part of the molecular cross-linking that gives collagen its elasticity. Non-hydroxylated collagen is unstable and cannot form the triple helix required for normal structure of subcutaneous tissue, cartilage, bone, and teeth. The failure of cells to deposit collagen fibrils and intracellular cement substance leads to delayed wound healing. Ascorbic acid plays a role in the synthesis of collagen, which promotes the formation of hydroxyproline (Peterkovsky 1991).

**Table 1. Ascorbic acid as a cofactor or cosubstrate in enzymes.**

Enzyme	Functionality
Proline hydroxylase	Collagen synthesis
Procollagen-proline, 2-oxoglutarate 3-dioxygenase	Collagen synthesis
Lysine hydroxylase	Collagen synthesis
$\gamma$ -butyrobetaine, 2-oxoglutarate-4-dioxygenase	Carnitine synthesis
Trimethyllysine 2-oxoglutarate dioxygenase	Carnitine synthesis
Dopamine $\beta$ -monooxygenase	Catecholamine synthesis
Peptidylglycine $\alpha$ -amidating monooxygenase	Peptide amidation
4-hydroxyphenylpyruvate dioxygenase	Tyrosine metabolism

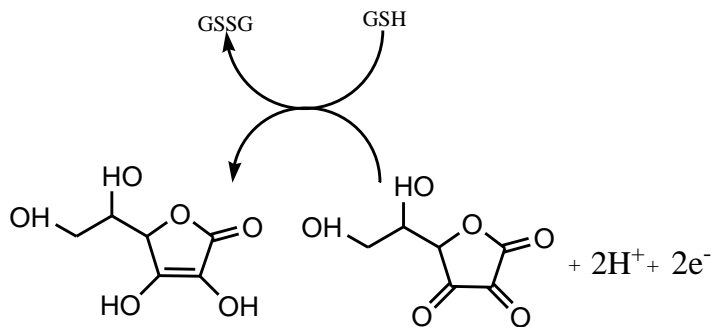

Figure 2. Ascorbic acid recycling: the regeneration of the active (reduced) form of ascorbate from the oxidized form. Oxidation of ascorbic acid to dehydroascorbic acid and reversible reduction of dehydroascorbic acid by glutathione (GSH). GSSG = oxidized glutathione.

Because of its ability to donate electrons and be readily regenerated, vitamin C is an effective antioxidant *in vivo*. It efficiently neutralizes reactive oxygen species (ROS) and reactive nitrogen species (RNS) such as hydroxyl, peroxy, superoxide radicals, peroxynitrite, nitroxide radicals, and hypochlorite, which offers direct antioxidant protection to tissues subjected to free-radical stress such as eye, brain, phagocytes, and sperm. In addition, vitamin C offers indirect antioxidant protection by regenerating other antioxidants such as  $\alpha$ -tocopherol, glutathione, and flavonoids (Jacob and Sotoudeh, 2002). Ascorbate reduces unstable oxygen, nitrogen, and sulphur-centered radicals. ROS are highly reactive, leading to damage at the molecular level, which is due to their oxidation of proteins, lipids, and nucleic acids. ROS can oxidize ascorbate by the removal of one electron to semidehydroascorbate and further to dehydroascorbate by removal of a hydrogen atom. The ROS is reduced to water, while the oxidized forms of ascorbate are relatively stable and unreactive, and do not cause cellular damage. Vitamin C serves as a primary defense against aqueous radicals in blood (Niki 1991). Normal plasma levels of vitamin C range from 0.6 to 2.0 mg/dL. It is distributed throughout the body and is considered the most important antioxidant in extracellular fluid, with high levels found in tissues including the eye lens, adrenal, and pituitary glands, which have at least twice the amount as in plasma (Levine 1986). Ascorbate reduces nitrates and prevents the formation of carcinogenic nitrosamines (Mirvish 1974). Ascorbate efficiently traps peroxy radicals in the aqueous phase before they initiate lipid oxidation in lipid-rich membranes, and protects human plasma lipids against peroxidative damage induced by aqueous peroxy radicals (Frei et al., 1989). In addition, ascorbate may

reduce the oxidized form of vitamin E back to its active form leading to the protection of lipid membranes from oxidation (van den Berg et al., 1990).

Vitamin C is primarily absorbed in a dose-dependent active transport process in the intestine (Rumsey & Levine, 1998). It is actively co-transported with sodium against an electrochemical gradient into intestinal epithelial cells. Facilitated diffusion of ascorbate follows a concentration and electrochemical gradient. Once it enters the cells, a concentration gradient is created by both brush border absorption and intracellular reduction of dehydro-L-ascorbic acid to ascorbate (Jacob 1999). The intestinal absorption of vitamin C is 80-90% efficient. However, this efficiency rate declines with increased intake. Resorption of ascorbate in the kidneys occurs by facilitated diffusion, and ascorbate and its metabolites, such as oxalate, are found in the urine only in excess. Oxalate accounts for one of the few potential clinical toxicities of vitamin C supplementation which may contribute to oxalic acid renal stones (Johnston 2001). Vitamin C is proposed to participate in electron transport reactions (Szent-Gyorgyi 1960), and is required for neurotransmitter synthesis (Levine 1986), carnitine synthesis (Leibovitz and Mueller, 1993), cholesterol metabolism, cytochrome P-450 activity, detoxification (Shils 1994), antioxidant activity (Sies et al., 1992), regulation of cell respiration, and adenosine triphosphate (ATP) production in osteoblasts (Komarova et al., 2000). Vitamin C regulates iron distribution and storage by maintaining a normal ratio of ferritin to hemosiderin. As a specific electron donor, vitamin C also appears to participate in the synthesis of brain neurotransmitters and pituitary peptide hormones as mentioned above.

## Health Benefits

In 1970, Linus Pauling was the first to realize vitamin C's crucial importance in the maintenance of a healthy immune system, and proposed that regular intake of vitamin C could help prevent and shorten the duration of the common cold. However, the use of vitamin C in the prevention and treatment of the common cold and respiratory infections remains controversial. Block et al (2004) investigated if antioxidants reduce plasma C-reactive protein (CRP) in active and passive smokers since CRP may have effect on the progression of atherosclerosis. The results showed that vitamin C supplementation (515 mg/d) caused a 24% reduction ( $p < 0.036$ ) in plasma CRP, whereas the antioxidant mixture and placebo yielded a 4.7% reduction. Vitamin C may have a role inhibiting series-2 prostaglandins in carcinoma cells (Beetens and Hermen, 1983). It also has been shown to stabilize protein, p53, which is involved in the control of cell proliferation (Reddy et al., 2001), and approximately 50% of all cancers have a deficiency in protein p53. Ascorbic acid is involved in the synthesis of corticosteroids, modulation of components in microsomal drug-metabolizing system, the nervous system, and conversion of cholesterol to bile acids (Katsuki 1996). Ascorbate and its radical potentiate the activation of transcription factor NF- $\kappa$ B, which has been associated with inhibition of cell proliferation (Sakagami and Satoh, 1997). Recent research has shown that vitamin C has a complex protective role against toxic compounds formed from oxidized lipids, preventing genetic damage and inflammation. This appears to be a major pathway by

which the body can remove the toxic byproducts of fat metabolism, and it could relate to cancer prevention (Blair 2008; Sowell et al., 2004).

Vitamin C was proposed as a chemopreventive agent 60 years ago (Klenner 1949; McCormick 1952). Many research results including an array of *in vitro* and *in vivo* (animals and humans) studies have been published on ascorbic acid and cancer (Padayatty et al., 2003; Tamayo and Richardson, 2003). This topic was extensively and comprehensively reviewed by Cameron et al. (1979) and González et al. (2005). Thirty years ago, Cameron et al (1979) reviewed the scientific basis to support the use of ascorbic acid as a therapeutic agent in the treatment of cancer. However, some clinicians could not reproduce Pauling and Cameron's earlier reports on the therapeutic effect of vitamin C, which brings the effect of ascorbic acid on cancer to be a subject of great controversy (Moertel et al., 1986). Cameron and Pauling (1976) suggested that consumption of large doses of vitamin C were helpful in cancer patients. The oxidation products of ascorbic acid such as dehydroascorbic acid, 2,3-diketogulonic acid, and 5-methyl 1-3, 4-dehydroxytetrone, have demonstrated anticancer activity (Edgar 1970; Poydock 1982; Tsao et al., 1989). González et al. (2005) updated and reviewed literatures for the use of ascorbic acid (intravenous route) as adjuvant treatment for cancer patients. Recently, Padayatty et al. (2006) concluded that vitamin C therapy may have anticancer effects in certain cancers after examining 3 well-documented cases that were in advanced states; however, further safety and efficacy studies are warranted. Evidence also suggests that vitamin C may help in the prevention of cancer by enhancing the immune response and accelerating the detoxification of carcinogenic compounds (Hercberg et al., 1998).

Numerous case-control studies have shown an inverse relationship between vitamin C intake from fruits and vegetables and cancers of the larynx, pharynx, oral cavity, esophagus, lung, stomach, colon, rectum, and breast (hormone-dependent) (Carr and Frei, 1999). As an antioxidant, vitamin C inhibits the formation of carcinogenic N-nitroso compounds which are implicated in gastric and lung cancers. In some cohort studies, an inverse association between vitamin C intake and cancer risk has been found in subjects consuming up to 110 mg/day. However, this association has not been observed in subjects consuming higher intakes, suggesting that the intake of ascorbic acid above the level that will saturate tissues may not provide further protection from cancer (Carr and Frei, 1999). Conversely, Levine et al. (1996) reported that vitamin C supplementation had no effect on stomach cancer and colorectal adenoma in intervention trials.

Two recent findings from randomized trials of the relationship between supplemental antioxidants and cancer risk have not supported beneficial claims (Gaziano et al., 2008; Lin et al., 2008). In the Physicians' Health Study II, 14,641 male physicians in the United States aged 50 years or older, including 1,307 men with a history of cancer, were randomly enrolled and supplemented with 500 mg of vitamin C daily and 400 IU of vitamin E every other day (Gaziano et al., 2008). The results showed that there were 1,008 confirmed cases of prostate cancer and 1,943 total cancers during a follow-up after 8 years. Compared with placebo, there was no significant effect from vitamin C on prostate cancer and total cancer. Vitamin C had no significant effect on colorectal, lung, or other site-specific cancers. It was concluded that vitamin C supplementation could not lower the risk of prostate or total cancer in this large, long-term trial of male physicians, which provides no support for the use of vitamin C

supplements in prevention of cancer in middle-aged and older men. In the Women's Antioxidant Cardiovascular Study with a double-blind, placebo-controlled  $2 \times 2 \times 2$  factorial trial of vitamin C, 8,171 women were randomly enrolled into treatment and placebo groups. The treatment groups consumed 500 mg of ascorbic acid daily, natural-source vitamin E (600 IU of  $\alpha$ -tocopherol every other day), and  $\beta$ -carotene (50 mg every other day). Duration and combined use of the three antioxidants also had no effect on cancer incidence and cancer death. There were no statistically significant effects of use of any antioxidant on total cancer incidence. They concluded that supplementation with vitamin C, vitamin E, or  $\beta$ -carotene offers no overall benefit in the primary prevention of total cancer mortality (site). Lee et al (2001) and Blair (2008) have reported that vitamin C induces lipid hydroperoxide decomposition to the DNA-reactive bifunctional electrophiles 4-oxo-2-nonenal, 4,5-epoxy-2(*E*)-decenal, and 4-hydroxy-2-nonenal. 4,5-Epoxy-2(*E*)-decenal is a precursor of etheno-2'-deoxyadenosine, a highly mutagenic compound found in human DNA. They concluded that vitamin C-mediated formation of genotoxins from lipid hydroperoxides in the absence of transition metal ions might be ascribed to its lack of efficacy as a cancer chemoprevention agent.

In epidemiologic studies, vitamin C levels in plasma were positively associated with coronary heart disease (CHD) and stroke (Levine et al., 1996). The relative risk of CHD and stroke was reduced by 26% with serum vitamin C levels of 63-153  $\mu\text{mol/L}$  compared with concentrations of 6-23  $\mu\text{mol/L}$  (*Panel on Dietary Antioxidants and Related Compounds*). Vitamin C inhibited LDL oxidation, a process which is involved in the formation of atherosclerotic plaques (Harris 1996). Some studies have shown beneficial effects of high doses of vitamin C on endothelial-dependent vasodilation (May 2000; Carr and Frei, 1999). In a study pooled from the analysis of 9 cohort studies, the results indicated that dietary intake of antioxidant vitamins was only weakly linked to a reduced CHD risk. However, high vitamin C intake was associated with a lowered incidence of major CHD events (Knekt et al., 2004). The cardioprotective function of vitamin C may be ascribed to lowering blood pressure (Ness et al., 1997), protecting membrane lipids from free radical damage (Anderson et al., 1995), protecting lipids indirectly by sparing or reconstituting the active forms of vitamin E (Tappel 1962), reversing endothelial dysfunction (Hamabe et al., 2001), lowering ischemic heart disease (Gey et al., 1987), improving the endothelium-dependent vasomotor capacity of coronary arteries (Solzbach et al., 1997), and modulating congestive heart failure (CHF) by increasing the availability of nitric oxide (Hornig et al., 1998).

## Daily Requirements

Vitamin C is generally regarded as safe (GRAS) in amounts obtained from foods. It is commonly used as an antioxidant food additive. Its sodium, potassium, and calcium salts are water-soluble thus cannot protect lipids from oxidation. To enhance lipid solubility, ascorbic acid is esterified to long-chain fatty acids (ascorbyl palmitate or ascorbyl stearate) that can be utilized as food antioxidants in lipid-soluble systems. Vitamin C supplements are also GRAS in recommended amounts, although there are rarely reported side effects including nausea, vomiting, heartburn, abdominal cramps, diarrhea, and headache. For some populations,

including patients with periodontal disease, smokers, pregnant and lactating women, and the elderly, special attention with respect to vitamin C requirements are warranted.

Recommendations regarding vitamin C intake began with the prevention of scurvy, which was many years before the compound was identified. The vitamin C content in human body ranges from 300 mg at near scurvy to a maximum of approximately 2 grams. The level of the vitamin in the body tissues and fluids varies greatly, with high concentration in leukocytes, eye, adrenals, pituitary, and brain, whereas low concentrations are found in plasma and saliva. Recommended intakes of about 30 milligrams per day do not usually 'saturate' the body tissues with vitamin C and, indeed, this may not be necessary. But to saturate body tissues, no more than 100 to 130 milligrams per day are required. The term of Recommended Dietary Allowance (RDA) is the dietary intake level that is sufficient to meet nutrient requirements of 97-98% of healthy individuals in a particular life stage and gender group. A report issued in April, 2000 by the Institute of Medicine (National Academy of Sciences) increased the RDA of vitamin C to: 75 mg per day for women; 90 mg for men; smokers should add an additional 35 mg per day because their metabolic turnover of vitamin C is more rapid, as is their rate of oxidative stress. The updated RDAs for individuals at different ages, pregnant, and lactating women are listed in Table 2. In healthy people, intake levels greater than the RDA do not appear to be helpful. Vitamin C may be more important for people with certain diseases or conditions. At vitamin C intakes below 100 mg/day, absorption is efficient, and little or no ascorbic acid is excreted in the urine. The oxidized form of the vitamin is readily reduced back to ascorbic acid so that only small amounts are lost via catabolism. Absorption becomes less efficient upon at larger intakes of ascorbic acid, and unmetabolized vitamin C is excreted in the urine (Jacob 1999).

Tolerable upper intake level (TUIL) refers the highest level of daily intake that is likely to pose no risk of adverse health effects to the general adult population aged 18 years and older. In 2000, the Food and Nutrition Board set the TUIL for vitamin C at 2,000 mg/day (Higdon 2003). High intakes of vitamin C are generally well tolerated; a Tolerable Upper Level was set at 2 grams based on gastrointestinal upset that sometimes accompanies excessive intakes. For vitamin C, this is estimated at 2,000 mg for adults; 400 mg for children aged 1-3 years; 650 mg for children aged 9-13, and 1,800 mg for young adults aged 14-18 years old. As intake increases above this level, the risk of toxicity increases.

**Table 2. Vitamin C requirements for humans (milligram per day)**

Ages (months or Years)	Male	Female
0-6 m	40	40
7-12 m	50	50
1-3 y	15	15
4-8 y	25	25
9-13 y	45	45
14-18 y	75	65
19 or older	90	75
Pregnant 18 y		80
Pregnant females 19 y or older		85
Lactating 18 y		115
Lactating 19 y		120

The data from the National Academy of Sciences (2000)



## Dietary Sources

It has long been known that a diet rich in vitamin C from fruits and vegetables provides protection against cancer and heart disease. The body does not manufacture or store vitamin C. It is therefore important to include plenty of vitamin C-containing foods such as fruits and vegetables in the diet. From the USDA National Nutrient Database, the vitamin C content from common fruits and vegetables is listed in Table 3, and Table 4, respectively. All fruits and vegetables contain some vitamin C. Fruits and vegetables that tend to be the higher sources of vitamin C include guavas, currant, cloudberries, kiwi, lemon, peppers, mustard spinach, kale, cauliflower, and broccoli. Vitamin C can be lost from foods in cooking because of its water solubility, and sensitivity to heat, light, and oxygen. The addition of alkalis, such as bicarbonate of soda, and the use of copper cookware can also destroy it.

**Table 3. The contents of Vitamin C (total ascorbic acid) in per 100 grams fresh fruits**

Fruits Names	Scientific Name	NDB No.	Vitamin C (mean $\pm$ S.E.) (mg/100 g fresh)
Guavas, common	<i>Psidium guajava</i>	09139	228.3 $\pm$ 0.0
Currants, european black	<i>Ribes nigrum</i>	09083	181.0 $\pm$ 0.0
Cloudberries (Alaska Native)	<i>Rubus chamaemorus</i> L.	35027	158.0 $\pm$ 0.0
Kiwi fruit (Chinese gooseberries)	<i>Actinidia chinensis</i>	09148	92.7 $\pm$ 3.4
Lemons with peel	<i>Citrus limon</i>	09151	77.0 $\pm$ 0.0
Oranges, with peel	<i>Citrus sinensis</i>	09205	71.0 $\pm$ 0.0
Jujube	<i>Ziziphus jujuba</i>	09146	69.0 $\pm$ 0.0
Persimmons, native	<i>Diospyros virginiana</i>	09265	66.0 $\pm$ 0.0
Oranges, navels	<i>Citrus sinensis</i>	09202	59.1 $\pm$ 2.0
Strawberries	<i>Fragaria X ananassa</i>	09316	58.8 $\pm$ 2.7
Pineapple, extra sweet variety	<i>Ananas comosus</i>	09430	56.4 $\pm$ 4.0
Oranges, all commercial varieties	<i>Citrus sinensis</i>	09200	53.2 $\pm$ 0.7
Lemons, without peel	<i>Citrus limon</i>	09150	53.0 $\pm$ 0.0
Clementines	<i>Citrus clementina hort. ex Tanaka</i>	09433	48.8 $\pm$ 3.0
Oranges, California, valencias	<i>Citrus sinensis</i>	09201	48.5 $\pm$ 1.0
Pineapple, all varieties	<i>Ananas comosus</i>	09266	47.8 $\pm$ 3.2
Oranges, Florida	<i>Citrus sinensis</i>	09203	45.0 $\pm$ 0.0
Currants, red and white		09084	41.0 $\pm$ 0.0
Grapefruit, pink and red, California and Arizona	<i>Ribes rubrum</i>		38.1 $\pm$ 1.1
Grapefruit, pink and red, Florida	<i>Ribes rubrum</i>	09084	37.0 $\pm$ 0.0
Grapefruit, white, Florida	<i>Citrus paradisi</i>	09118	37.0 $\pm$ 0.0
Guavas, strawberry	<i>Psidium cattleianum</i>	09140	37.0 $\pm$ 0.0
Melons, cantaloupe	<i>Cucumis melo</i>	09181	36.7 $\pm$ 1.4
Grapefruit, pink and red and white, all areas	<i>Citrus paradisi</i>	09112	34.4 $\pm$ 0.7
Squash, zucchini, baby	<i>Cucurbita spp.</i>	11953	34.1 $\pm$ 0.0
Grapefruit, white, all areas	<i>Citrus paradisi</i>	09116	33.3 $\pm$ 0.9
Grapefruit, white, California	<i>Citrus paradisi</i>	09117	33.3 $\pm$ 0.9
Grapefruit, pink and red, all areas	<i>Citrus paradisi</i>	09112	31.2 $\pm$ 1.4
Mangos	<i>Mangifera indica</i>	09176	27.7 $\pm$ 1.7
Gooseberries	<i>Ribes spp.</i>	09107	27.7 $\pm$ 1.8
Raspberries	<i>Rubus spp.</i>	09302	26.2 $\pm$ 5.6
Melons, casaba	<i>Cucumis melo</i>	09183	21.8 $\pm$ 0.0
Squash, winter, butternut	<i>Cucurbita moschata</i>	11485	21.0 $\pm$ 0.0
Blackberries	<i>Rubus spp.</i>	09042	21.0 $\pm$ 0.0

Table 3. Continued.

Fruits Names	Scientific Name	NDB No.	Vitamin C (mean $\pm$ S.E.) (mg/100 g fresh)
Cranberry, low bush or lingenberry (Alaska Native)	<i>Vaccinium vitis-idaea</i>	35030	21.0 $\pm$ 0.0
Turnips	<i>Brassica rapa (Rapifera Group)</i>	11564	21.0 $\pm$ 0.0
Blueberries, wild (Alaska Native)	<i>Vaccinium alaskaenese</i>	35155	18.3 $\pm$ 0.0
Melons, honeydew	<i>Cucumis melo</i>	09184	18.0 $\pm$ 1.6
Squash, summer, scallop	<i>Cucurbita spp.</i>	11475	18.0 $\pm$ 0.0
Squash, summer, all varieties	<i>Cucurbita spp.</i>	11641	17.0 $\pm$ 0.7
Squash, summer, zucchini, includes skin	<i>Cucurbita spp.</i>	11477	17.0 $\pm$ 0.0
Pineapple, traditional varieties	<i>Ananas comosus</i>	09429	16.9 $\pm$ 2.5
Quinces	<i>Cydonia oblonga</i>	09296	15.0 $\pm$ 0.0
Squash, winter, all varieties	<i>Cucurbita spp.</i>	11643	12.3 $\pm$ 0.0
Squash, winter, hubbard	<i>Cucurbita maxima</i>	11489	11.0 $\pm$ 0.0
Squash, winter, acorn	<i>Cucurbita maxima</i>	11482	11.0 $\pm$ 0.0
Grapes, red or green (European type, such as Thompson seedless)	<i>Vitis vinifera</i>	09132	10.8 $\pm$ 0.9
Plums, wild (Northern Plains Indians)	<i>Prunus spp.</i>	35206	10.3 $\pm$ 0.0
Pomegranates	<i>Punica granatum</i>	09286	10.2 $\pm$ 1.0
Cherries, sour, red	<i>Prunus cerasus</i>	09063	10.0 $\pm$ 0.0
Apricots	<i>Prunus armeniaca</i>	09021	10.0 $\pm$ 0.2
Blueberries	<i>Vaccinium spp.</i>	09050	9.7 $\pm$ 0.0
Plums	<i>Prunus spp.</i>	09279	9.5 $\pm$ 0.8
Bananas	<i>Musa acuminata Colla</i>	09040	8.7 $\pm$ 0.4
Squash, summer, crookneck and straightneck	<i>Cucurbita spp.</i>	11467	8.4 $\pm$ 2.2
Watermelon	<i>Citrullus lanatus</i>	09326	8.1 $\pm$ 2.4
Persimmons, Japanese	<i>Diospyros kaki</i>	09263	7.5 $\pm$ 0.0
Cherries, sweet	<i>Prunus avium</i>	09070	7.0 $\pm$ 1.6
Peaches	<i>Prunus persica</i>	09236	6.6 $\pm$ 1.1
Chokecherries, pitted (Northern Plains Indians)	<i>Prunus virginiana L.</i>	35204	5.5 $\pm$ 0.0
Blackberries, wild (Alaska Native)	<i>Rubus spp.</i>	35015	4.7 $\pm$ 0.0
Apples with skin	<i>Malus domestica</i>	09003	4.6 $\pm$ 0.5
Squash, Indian (Navajo)			4.5 $\pm$ 0.0
Pears			4.2 $\pm$ 0.3
Apples, without skin	<i>Malus domestica</i>	09004	4.0 $\pm$ 0.0
Pears, Asian	<i>Pyrus pyrifolia (Burman f.) Nakai</i>	09340	3.8 $\pm$ 0.0
Huckleberries (Alaska Native)	<i>Vaccinium alaskaense</i>	35043	2.8 $\pm$ 0.0
Squash, winter, spaghetti	<i>Cucurbita spp.</i>	11492	2.1 $\pm$ 0.2
Figs	<i>Ficus carica</i>	09089	2.0 $\pm$ 0.0
Loquats	<i>Eriobotrya japonica</i>	09174	1.0 $\pm$ 0.0
Chokecherries, pitted (Shoshone Bannock)	<i>Prunus virginiana L.</i>	35179	0.7 $\pm$ 0.0

The data from the USDA National Nutrient Database for Standard Reference. NDB No.: The number of USDA National Nutrient Database.

**Table 4. The contents of Vitamin C (total ascorbic acid) in per 100 grams fresh vegetables.**

Vegetable Names	Scientific Name	NDB No	Vitamin C (mean $\pm$ S.E.) (mg/100 g fresh)
Peppers, hot chili, green	<i>Capsicum frutescens</i>	11670	242.5 $\pm$ 0.0
Mustard spinach (tendergreen)	<i>Brassica rapa (Perviridis Group)</i>	11274	130.0 $\pm$ 0.0
Kale	<i>Brassica oleracea (Acephala Group)</i>	11233	120.0 $\pm$ 0.0
Cauliflower, green	<i>Brassica oleracea (Botrytis group)</i>	11965	88.1 $\pm$ 9.3
Broccoli	<i>Brassica oleracea var. italica</i>	11090	89.2 $\pm$ 4.0
Peppers, sweet, green	<i>Capsicum annuum</i>	11333	80.4 $\pm$ 3.6
Cress, garden	<i>Lepidium sativum</i>	11203	69.0 $\pm$ 0.0
Kohlrabi	<i>Brassica oleracea (Gongylodes Group)</i>	11241	62.0 $\pm$ 0.0
Papayas	<i>Carica papaya</i>	09226	61.8 $\pm$ 2.2
Cabbage, red	<i>Brassica oleracea (Capitata Group)</i>	11112	57.0 $\pm$ 0.0
Swamp cabbage (skunk cabbage)	<i>Ipomoea aquatica</i>	11503	55.0 $\pm$ 0.0
Cauliflower	<i>Brassica oleracea (Botrytis Group)</i>	11135	46.4 $\pm$ 4.4
Watercress	<i>Nasturtium officinale</i>	11591	43.0 $\pm$ 0.0
Cabbage	<i>Brassica oleracea (Capitata Group)</i>	11109	36.6 $\pm$ 3.4
Collards	<i>Brassica oleracea var. viridis</i>	11161	35.3 $\pm$ 5.0
Peppers, hot chile, sun-dried	<i>Capsicum annuum</i>	11962	31.4 $\pm$ 0.0
Garlic	<i>Allium sativum</i>	11215	31.2 $\pm$ 1.6
Cabbage, savoy	<i>Brassica oleracea (Capitata Group)</i>	11114	31.0 $\pm$ 0.0
New Zealand spinach	<i>Tetragonia tetragonioides</i>	11276	30.0 $\pm$ 0.0
Chard, Swiss	<i>Beta vulgaris subsp. vulgaris</i>	11147	30.0 $\pm$ 0.0
Radishes, white icicle	<i>Raphanus sativus</i>	11637	29.0 $\pm$ 0.0
Spinach	<i>Spinacia oleracea</i>	11457	28.1 $\pm$ 4.1
Onions, welsh	<i>Allium fistulosum</i>	11293	27.0 $\pm$ 0.0
Chicory greens	<i>Cichorium intybus</i>	11152	24.0 $\pm$ 0.0
Lettuce, cos or romaine	<i>Lactuca sativa var. logifolia</i>	11251	24.0 $\pm$ 0.0
Tomatoes, green	<i>Lycopersicon esculentum</i>	11527	23.4 $\pm$ 0.1
Radishes, oriental	<i>Raphanus sativus (Longipinratus Group)</i>	11430	22.0 $\pm$ 0.0
Okra	<i>Abelmoschus esculentus</i>	11278	21.1 $\pm$ 2.3
Yambean (jicama)	<i>Pachyrhizus spp.</i>	11603	20.2 $\pm$ 0.0
Potatoes, white, flesh and skin	<i>Solanum tuberosum</i>	11354	19.7 $\pm$ 0.8
Onions, spring or scallions (includes tops and bulb)	<i>Allium cepa or Allium fistulosum</i>	11291	18.8 $\pm$ 0.0
Lettuce, green leaf	<i>Lactuca sativa var. crispa</i>	11253	18.0 $\pm$ 0.0
Yam	<i>Dioscorea spp.</i>	11601	17.1 $\pm$ 5.2
Parsnips	<i>Pastinaca sativa</i>	11298	17.0 $\pm$ 0.0
Tomatoes, orange	<i>Lycopersicon esculentum</i>	11695	16.0 $\pm$ 0.0
Radishes	<i>Raphanus sativus</i>	11429	14.8 $\pm$ 1.9
Tomatoes, red, ripe, raw, year round average	<i>Lycopersicon esculentum</i>	11529	12.7 $\pm$ 1.1
Leeks (bulb and lower leaf-portion)	<i>Allium ampeloprasum</i>	11246	12.0 $\pm$ 0.0

**Table 4. Continued.**

Vegetable Names	Scientific Name	NDB No	Vitamin C (mean $\pm$ S.E.) (mg/100 g fresh)
Gourd, dishcloth (towelgourd)	<i>Luffa aegyptiaca</i>	11220	12.0 $\pm$ 0.0
Potatoes, skin	<i>Solanum tuberosum</i>	11362	11.4 $\pm$ 0.3
Gourd, white-flowered (calabash)	<i>Lagenaria siceraria</i>	11218	10.1 $\pm$ 0.0
Avocados, all commercial varieties	<i>Persea americana</i>	09037	10.0 $\pm$ 0.5
Tomatoes, yellow	<i>Lycopersicon esculentum</i>	11696	9.0 $\pm$ 0.0
Pumpkin	<i>Cucurbita spp.</i>	11422	9.0 $\pm$ 0.0
Potatoes, red, flesh and skin	<i>Solanum tuberosum</i>	11355	8.6 $\pm$ 0.6
Celeriac	<i>Apium graveolens</i>	11141	8.0 $\pm$ 0.0
Radicchio	<i>Cichorium intybus</i>	11952	8.0 $\pm$ 0.0
Shallots	<i>Allium ascalonicum</i>	11677	8.0 $\pm$ 0.0
Onions	<i>Allium cepa</i>	11282	7.4 $\pm$ 0.1
Carrots	<i>Daucus carota</i>	11124	5.9 $\pm$ 1.1
Potatoes, russet, flesh and skin	<i>Solanum tuberosum</i>	11353	5.7 $\pm$ 0.9
Ginger root	<i>Zingiber officinale</i>	11216	5.0 $\pm$ 0.0
Chicory roots	<i>Cichorium intybus</i>	11154	5.0 $\pm$ 0.0
Onions, sweet	<i>Allium cepa</i>	11294	4.8 $\pm$ 0.3
Lettuce, red leaf	<i>Lactuca sativa var. crispa</i>	11257	3.7 $\pm$ 0.6
Lettuce, butterhead (includes boston and bibb types)	<i>Lactuca sativa var. capitata</i>	11250	3.7 $\pm$ 0.7
Cucumber, peeled	<i>Cucumis sativus</i>	11206	3.2 $\pm$ 0.7
Celery	<i>Apium graveolens</i>	11143	3.1 $\pm$ 1.2
Chicory, witloof	<i>Cichorium intybus</i>	11151	2.8 $\pm$ 0.3
Cucumber, with peel	<i>Cucumis sativus</i>	11205	2.8 $\pm$ 0.0
Lettuce, iceberg (includes crisphead types)	<i>Lactuca sativa var. capitata</i>	11252	2.8 $\pm$ 0.2
Carrots, baby	<i>Daucus carota</i>	11960	2.6 $\pm$ 0.2
Eggplant	<i>Solanum melongena</i>	11209	2.2 $\pm$ 0.3

The data from the USDA National Nutrient Database for Standard Reference. NDB No.: The number of USDA National Nutrient Database.

## Adverse Effects

High doses of vitamin C have been associated with multiple adverse effects, including severe diarrhea, nausea, kidney stones, and gastritis. Rarely, flushing, faintness, dizziness, and fatigue have been noted. Large doses may precipitate hemolysis in patients with glucose 6-phosphate dehydrogenase deficiency. Although vitamin C is remarkably nontoxic at high levels (10 to 100 times the RDA taken orally), some minor toxic effects have been reported (González et al., 2005). Barnes (1974) has documented that the side effects of excess vitamin C include fatigue, renal stones, oxaluria, glycosuria, acidosis, gastrointestinal disturbances, vitamin B<sub>12</sub> destruction, prothrombin and cholesterol disturbances. High doses of vitamin C should be avoided for those with conditions aggravated by acid loading, such as cirrhosis, gout, renal tubular acidosis, or paroxysmal nocturnal hemoglobinuria.

## Prooxidant Effects

Concerns on use of vitamin C have been raised over potentially deleterious transition metal ion-mediated prooxidant effects. However, the antioxidant or prooxidant characteristics of vitamin C depend on the redox potential of the environment and the concentration of ascorbate. Its prooxidant activity has been linked to cytotoxic effect in a series of cell lines (González et al., 1998; Tsao et al., 1989; Yamamoto et al., 1987, Poydock 1982; Bram et al., 1980; Sakagami and Satoh, 1997). Vitamin C has been found to boost chemical carcinogenesis in a rodent model (Shklar et al., 1993; Cohen and Bhagavan, 1995), which may be explained by the prooxidant activity and the subsequent enhancement of free radical formation by the carcinogen 7,12-dimethylbenz[ $\alpha$ ]anthracene.

The theory behind the prooxidant activity of ascorbic acid is that it participates in the Fenton reaction where free transition metals are reduced by ascorbic acid then react with hydrogen peroxide or lipid hydroperoxides to form hydroxyl radicals ( $\text{OH}^\bullet$ ) or alkoxy radicals ( $\text{LO}^\bullet$ ) (Carr and Frei, 1999). The primary transition metals that would be reduced in living tissues include iron(III) and copper(II). The reactions are summarized in Figure 3. *In vitro* cell culture studies have clearly shown that the addition of ascorbic acid increased oxidative DNA damage; however, it is speculated that the increase in oxidation was related to free transition metals in the media. This is completely different compared to *in vivo* systems where transition metals are bound to proteins such as ferritin, transferrin, and ceruloplasmin, and free metals are normally found at very low concentrations (Halliwell and Gutteridge, 1986; Carr and Frei, 1999).

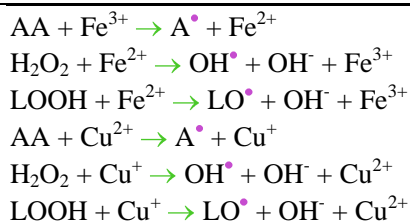

AA = reduced ascorbic acid.  $\text{A}^\bullet$  = oxidized ascorbic acid. LOOH = lipid hydroperoxide.  $\text{LO}^\bullet$  = alkoxy radical.

Figure 3. Production of free radicals by the Fenton reaction (Carr and Frei, 1999).

Prooxidant activity of ascorbic acid under physiological conditions is of interest because some of the resulting compounds produced can be very destructive including  $\text{OH}^\bullet$  and  $\text{LO}^\bullet$  that can damage normal biological compounds including unsaturated fatty acids, proteins, and nucleic acids. The oxidation of unsaturated fatty acids can lead to a feedback loop that will continue to produce a growing number of  $\text{LO}^\bullet$  unless they are quenched by other free radicals or antioxidant compounds such as vitamin E or glutathione. If the feedback loop is not quenched, phospholipids in plasma membranes or triglycerides in lipoproteins may become oxidized and cause cells to necrotize or lipoproteins to be taken up by a macrophages leading to the production of foam cells that contribute to fatty streaks in the development of atherosclerosis. The oxidation of proteins can lead to changes in structure and halt enzyme function by inducing conformational change. Some changes to proteins may lead to the

induction of apoptosis. Nucleic acid oxidation by free radicals can have serious consequences. It is possible to oxidize DNA with free radicals that can change the DNA sequence altering genes associated with normal cell cycle control including oncogenes and/or tumor suppressor genes which can lead to the development of cancer.

The most publicized study on the prooxidant activity of ascorbic acid was performed by Podmore et al, 1998 and published in Nature. The research group found that volunteers supplemented with 500 milligrams of ascorbic acid had significant increases, compared to baseline, placebo, and the washout phases, in their levels of the oxidized nucleic acid, adenine, which was converted to 8-oxoadenine. In a 2005 study by Hinerger et al, it was found that the removal of ascorbic acid (5 grams) from the standard cocktail used in EDTA chelation therapy significantly improved oxidative stress markers including reduced plasma malondialdehyde, increased total blood glutathione, increased red blood cell glutathione peroxidase, increased red blood cell superoxide dismutase, and decreased DNA scission. The researchers proposed that the mechanism for the higher levels of the oxidative stress markers were the prooxidant effects caused by the high concentration of ascorbic acid in the standard cocktail. In another study, it was found that the addition of ascorbic acid enhanced DNA single strand breakage and toxicity in U937 human myeloid leukemia cells exposed to peroxynitrite (Guidarelli et al, 2001). Yen et al, 2002 found that human lymphocytes treated with ascorbic acid *in vitro* had increased damage to DNA. The concentration of ascorbic acid that caused the greatest damage was 0.82 millimolar which damaged approximately 9.4 % more compared to control. In three higher concentrations of ascorbic acid, up to 4.25 millimolar, there was a reduction in DNA damage; however, the DNA damage in the three concentrations were still higher than the control (Yen et al, 2002). A study by Lee et al, 2001 found that ascorbic acid induced lipid hydroperoxide decomposition to DNA reactive compounds including 4,5-epoxy-2(E)-decenal which is a precursor to etheno-2'-deoxyadenosine which is an extremely mutagenic compound. Oxidative stress is increased significantly following liver transplant, and it is thought to be caused by reperfusion of blood flow. In a recent investigation of the ability of ascorbic acid to attenuate oxidative stress markers in rat liver during cold ischemia/reperfusion it was found that 0.25 and 0.5 millimolar ascorbic acid increased the level of reduced/oxidized glutathione, decreased lipid peroxidation, and decreased mitochondrial swelling compared to control and was ascribed as having an antioxidant effect; however, at 2 millimolar, ascorbic acid augmented the markers suggesting the higher concentration had a prooxidant effect (Park and Lee, 2008).

### Ascorbic Acid and Vitamin B<sub>12</sub> Deficiency

Some early studies suggested that megadoses of ascorbic acid may degrade vitamin B<sub>12</sub> in food systems, which in turn may lead to decreased bioavailability and ultimately deficiency with all of the complex health afflictions associated. Doses of ascorbic acid of 500 mg or more may reduce the availability of vitamin B<sub>12</sub> from food, and doses of 1 gram or more may lead to the development of vitamin B<sub>12</sub> deficiency (Mix, 1999). The mechanism suggested is that redox reactions of ascorbic acid, iron, and other antioxidants convert vitamin B<sub>12</sub> into a biologically unusable analog. A study by Herbert et al, 1976 investigated

the effect of ascorbic acid on vitamin B<sub>12</sub> destruction and found that in one extraction method and a pure crystalline vitamin B<sub>12</sub> control sample, the amount of B<sub>12</sub> was decreased by approximately one-half when exposed to 2.5% ascorbic acid compared to samples with no supplementary ascorbic acid. Another study by Herbert et al, 1978 investigated the effects of ascorbic acid on vitamin B<sub>12</sub> degradation from 3 different sources: liver homogenate, pooled serum, and crystalline cyanocobalamin. Different concentrations of ascorbic acid (0, 0.001, 0.01, 0.1, and 1 %) were added to the solutions before and after boiling. When added before boiling, there were significant reductions in B<sub>12</sub>, and they were dose dependent. There were also reductions of B<sub>12</sub> in 5 of the 6 total concentrations of 0.1 and 1 percent ascorbic acid when it was added after boiling.

Elevated homocysteine level is a well known risk factor for cardiovascular and cerebrovascular disease. Vitamin B<sub>12</sub> and folate (vitamin B<sub>6</sub>) are required to recycle homocysteine to the essential amino acid, methionine. The reaction is a transmethylation where methyltetrahydrofolate transfers a methyl group to cobalamin (vitamin B<sub>12</sub>) forming methylcobalamin. Methylcobalamin then transfers the methyl group to homocysteine through the enzyme, methionine synthase, forming methionine. It has been suggested that megadoses of ascorbic acid (greater than 500 mg/day) may lead to vitamin B<sub>12</sub> deficiency, and the deficiency could possibly lead to a decrease in the ability to convert homocysteine to methionine. In a logical progression, this means there will be a higher systemic concentration of homocysteine and an increased risk of cardio/cerebrovascular disease (Mix 1999). Vitamin B<sub>12</sub> deficiency can also lead to megaloblastic (pernicious) anemia and neural damage (Groff and Gropper, 1999). Megaloblastic anemia results from a decrease in DNA synthesis and the failure of red blood cells to divide properly. This, in turn, leads to the release of large immature erythrocytes into the blood. The neuropathy related to vitamin B<sub>12</sub> deficiency is caused by the demyelination of nerve cells that is possibly due to the lack of methionine that is normally regenerated from the methyl group transfer explained above, and methionine is essential in the formation of myelin (Groff and Gropper, 1999).

### Cancer Treatment Contraindication

Ascorbic acid supplementation under a certain chemotherapy treatment has been shown to be contraindicative in a recent study (Frank et al, 2006). 5-aminolevulinic (ALA) acid and photosensitization induces cancer cell death by forming reactive oxygen species that lead to apoptosis by oxidizing DNA, proteins, and lipids in cancer cells. Ascorbic acid supplementation, at different concentrations, was recently shown to significantly reduce *in vitro* cell death in rat DS-sarcoma cancer cells when exposed to ALA photosensitization, and the reduction was dose dependent (Frank et al, 2006).

### Megadosing and Hemolysis

Megadoses of ascorbic acid have shown to have a hemolytic (red blood cell rupture) effect in glucose-6-phosphatase deficiency. Doses of intravenous ascorbic acid (up to 80

grams) was shown to have a hemolytic effect in a patient with the deficiency (Rees et al, 1993), and a study of glucose-6-phosphatase deficient rats found that the survival rate of erythrocytes was reduced in the presence of ascorbic acid. In the study, rat red blood cells were dosed with 0.9, 1.7, and 3.3 mg/mL ascorbic acid in Ringer's solution. The results showed that there was a decrease in the survival of the cells, and the decrease was dose-dependent (Udomratn, 1977).

### Urolithiasis (Kidney Stones)

The most common type of kidney stone is comprised of calcium oxalate, and oxalate is one of the metabolites of the breakdown of ascorbic acid. It was previously suggested that high intakes of ascorbic acid would increase the plasma concentration of oxalic acid (McMichael, 1978), and it was later shown that the intake of ascorbic acid between 2 and 2.5 grams per day significantly increased the urinary output of oxalic acid (Schmidt et al, 1981). This suggests that supplemental or a high intake of ascorbic acid may contribute to the development of kidney stones.

### Furan

The Department of Health and Human Services lists furan as a carcinogen, and the International Agency for Research on Cancer lists furan as possibly carcinogenic. These listings are based on several animal studies that subjected animals to high doses of furan. The current concern is whether furan in foods can cause cancer at low doses over the long-term. Furan is produced during food preservation techniques such as canning that involve heat, and some ascorbic acid will spontaneously decompose and convert to furfural (similar to furan) under heat and non-oxidative conditions (Adams and de Kimpe, 2009). A recent study examined the formation of furan from ascorbic acid and found that dry heating ascorbic acid produced 2 millimols of furan per mol ascorbic acid (Limacher et al, 2007).

### Ascorbic Acid Intestinal Uptake Affected by Flavonoids

Flavonoids are polyphenols that are widely distributed in foods, especially fruits and vegetables. Dehydroascorbic acid and ascorbic acid are transported into cells by sodium-independent glucose transporters (GLUT 1 and GLUT 3) and sodium-dependent ascorbic acid transporters, respectively. The inhibition of dehydroascorbic acid uptake by flavonoids was examined by using Chinese hamster ovary cells overexpressing rat GLUT 1 or human GLUT 3. It was found that myricetin at 18 and 22  $\mu\text{mol/L}$  inhibited one-half of dehydroascorbic acid uptake in the cells overexpressing GLUT 1 and GLUT 3 (Park and Levine, 2000). Myricetin and quercetin competitively inhibited dehydroascorbic acid uptake, and  $K_i$  values were around 14 and 15  $\mu\text{mol/L}$ , respectively, in Jurkat cells. Song et al (2002) reported that flavonoids reversibly inhibited vitamin C transport in transfected cells with  $IC_{50}$  values of 10-50  $\mu\text{M}$  in Chinese hamster ovary cells. The results indicated that quercetin (a



flavonol) is the most potent inhibitor. Quercetin significantly decreased ascorbate absorption in normal rats given ascorbate plus quercetin compared with rats given ascorbate alone. Vitamin C plays an important role in embryogenesis and fetal growth as well as in the progression of pregnancy and delivery. A recent study has shown that flavonoids (genistein and quercetin) inhibit [ $^{14}\text{C}$ ] ascorbic acid uptake in a dose-dependent and non-competitive manner in the human trophoblast cell line HTR-8/SVneo (Biondi et al., 2007).

### Future Study

By definition, an antioxidant is a substance that, in small quantities, reacts with radicals to prevent the oxidation of other substances, and the resulting radical produced is relatively stable and does not promote oxidation (Atkins and Beran, 1992; Croft, 1998). However, based on Le Chatlier's principle, it is possible for an antioxidant compound to have prooxidant activity at sufficiently high concentrations. It has been demonstrated in the presented research that high concentrations of ascorbic acid may have prooxidant activity *in vivo*. Continued study of the prooxidant activities and detrimental effects of megadosing ascorbic acid should continue. As of now, there has been a very broad focus on the prooxidant effects of ascorbic acid and the relation to DNA damage, and it seems apparent that high doses of ascorbic acid have adverse implications. Future studies should narrow their focus on the mechanisms of the reactions involved in the damage and determine the ranges of ascorbic acid concentrations which are the safest and also most dangerous.

The world's human population is continuing to extend its average survival age, and with age, comes diminishing bodily functions. One of the functions that degrades with age is the ability to absorb vitamin B<sub>12</sub>. The early studies that determined that ascorbic acid altered the chemical structure of vitamin B<sub>12</sub> should be revisited to determine a satisfactory method for protecting this vitamin for biological usage.

## Conclusion

Vitamin C is uniquely important to the health and wellbeing of humans. It plays a crucial role as a component of enzymes involved in the synthesis of collagen and carnitine, and it is water-soluble antioxidant, which makes it indispensable for the development, normal growth, and functionality in human.

Epidemiological studies show that dietary intake of fruits and vegetables high in vitamin C have been associated with a reduced risk of various types of cancer, particularly cancers of the mouth, esophagus, stomach, colon, and lung. However, it is not clear that the benefit comes specifically from the vitamin C in the fruits and vegetables because higher intakes of vitamin C by supplementation have not been found to be associated with this protective effect. We postulate that synergistic and additive actions of vitamin C and other bioactive phytochemicals present in fruits and vegetables play a crucial role in prevention of some types of cancers. Therefore, the most prudent recommendation for supplying vitamin C is to consume sufficiently high quantities of fruits and vegetables daily.

## References

- [1] Shils, M. Modern nutrition in health and disease. In: Shils M, Olson J, Shike M, eds. *Modern Nutrition in Health and Disease*. 8<sup>th</sup> ed. Philadelphia, Pa: Lea and Febiger; 444-445, 1994.
- [2] Guthrie, H. *Introductory Nutrition*. 7th ed. St. Louis, Mo: Mosby College Publishing; 381-382, 1989.
- [3] Whitney, E. N., Cataldo, C. B., & Rolfes, S. R. (2002). *Understanding normal and clinical nutrition*. Belmont, CA: Wadsworth/Thompson Learning. 335-341.
- [4] Jacob, R. A. & Sotoudeh, G. (2002). Vitamin C function and status in chronic disease. *Nutr Clin Care*. 5, 66-74.
- [5] Johnston, CS. Vitamin C. In: *Present Knowledge in Nutrition*, Ed 8. Edited by Bowman B.A. and Russell R.M. Washington, DC: ISLI Press; 175-183, 2001.
- [6] Kuroyanagi, M., Shimamura, E., Kim, M., et. al. (2002). Effects of L-ascorbic acid on lysyl oxidase in the formation of collagen cross-links. *Biosci Biotechnol Biochem*. 66(10), 2077-2082.
- [7] Englard, S. & Seifter, S. (1986). The biochemical functions of ascorbic acid. *Annu Rev Nutr*. 6, 365-406.
- [8] Levine, M. (1986). New concepts in the biology and biochemistry of ascorbic acid. *N Engl J Med*. 1986;314:892-902.
- [9] Peterkofsky, B. (1991). Ascorbate requirements for hydroxylation and secretion of procollagen: relation to inhibition of collagen synthesis in scurvy. *Am J Clin Nutr*, 54 Suppl, 35S-40S.
- [10] Niki, E. (1991). Action of ascorbic acid as a scavenger of active and stable oxygen radicals. *Am J Clin Nutr*. 54, 1119s-1124s.
- [11] Mirvish, S. (1974). Experimental evidence for inhibition of N-nitroso compound formation as a factor in a negative correlation between vitamin C consumption and the incidence of certain cancers. *Cancer Res*. 54, 1948s-1951s.
- [12] Frei, B., England, L. & Ames, B. (1989). Ascorbate is an outstanding antioxidant in human blood plasma. *Proc Natl Acad Sci U S A*. 86, 6377-6381.
- [13] van den Berg, J. J., Kuypers, F. A., Roelofsen, B. & Op den Kamp, J. A. (1990). The cooperative action of vitamins E and C in the protection against peroxidation of parinaric acid in human erythrocyte membranes. *Chem Phys Lipids*. 53, 309-320.
- [14] Rumsey, S. C. & Levine, M. (1998). Absorption, transport, and disposition of ascorbic acid in humans - Chemistry, Metabolism, and Uses. *J Nutr Biochem*. 9, 116-130.
- [15] Jacob, RA. Chapter 29: Vitamin C. In: Shils, M.E., Olson, J.A., Shike, M. Rose, A.C., eds. *Modern Nutrition in Health and Disease*. 9<sup>th</sup> ed. Baltimore, MD: Williams & Wilkins; 467-483, 1999.
- [16] Leibovitz, B. & Mueller, J. (1993). Carnitine. *J Optimal Nutr*. 2, 90-109.
- [17] Sies, H., Stahl, W. & Sundquist, A. (1992). Antioxidant functions of vitamins. *Ann N Y Acad Sci*. 669, 7-20.
- [18] Komarova, S. V., Ataullakhanov, F. I. & Globus, R. K. (2000). Bioenergetics and mitochondrial transmembrane potential during differentiation of cultured osteoblasts. *Am J Physiol Cell Physiol*. 279, c1220-1229.

- [19] Pauling, L. Vitamin C and the Common Cold. Freeman, San Francisco, CA, 1970
- [20] Block, G., Jensen, C., Dietrich M., et al. (2004). Plasma C-reactive protein concentrations in active and passive smokers: influence of antioxidant supplementation. *J Am Coll Nutr*, 23, 141-147.
- [21] Beetens, J. R. & Hermen, A. G. (1983). Ascorbic acid and prostaglandin formation. *Int J Vitam Nutr Res*. 24(suppl), 131s-144s.
- [22] Reddy, V. G., Khanna, D. & Singh, N. (2001). Vitamin C augments chemotherapeutic response of cervical carcinoma beta cells by stabilizing p53. *Biochem Biophys Res Comm*. 282, 409-415.
- [23] Katsuki, H. (1996). Vitamin C and nervous tissue: *in vivo* and *in vitro* aspects. *Subcell Biochem*. 25, 293-311.
- [24] Sakagami, H. & Satoh, K. (1997). Pro-oxidant action of two antioxidants: ascorbic acid and gallic acid. *Anticancer Res*. 17, 221-224.
- [25] Blair, I. A. (2008). DNA Adducts with Lipid Peroxidation Products. *J. Biol. Chem*. 283, 15545-15549.
- [26] Sowell, J., Frei, B., & Stevens, J. F. (2004). Vitamin C conjugates of genotoxic lipid peroxidation products: Structural characterization and detection in human plasma. *Proc Natl Acad Sci U.S.A.* 101, 17964-17969.
- [27] Klenner, F. R. (1949). The treatment of polyomyelitis and other virus diseases with vitamin C. *South Med Surg*. 3, 7-12.
- [28] McCormick, W. J. (1952). Ascorbic acid as a chemotherapeutic agent. *Arch Pediat*. 69, 151-155.
- [29] Padayatty, S. J., Katz, A., Wang, Y., et al. (2003). Vitamin C as an antioxidant: evaluation of its role in disease prevention. *J Am Coll Nutr*. 22, 18-35.
- [30] Tamayo, C. & Richardson, M. A. (2003). Vitamin C as a cancer treatment: state of the science and recommendation for research. *Altern Ther*. 9, 94-102.
- [31] Cameron, E., Pauling, L. & Leibovitz, B. (1979). Ascorbic acid and cancer: a review. *Cancer Res*. 39, 663-681.
- [32] González, M. J., Miranda-Massari, J. R., Mora, E. M. et al. (2005). Orthomolecular Oncology Review: Ascorbic Acid and Cancer 25 Years Later. *Integrative Cancer Therapies*. 4(1), 32-44.
- [33] Moertel, C. G., Fleming, T. R., Creagan, E. T. et al. (1985). High-dose vitamin C versus placebo in the treatment of patients with advanced cancer who have had no prior chemotherapy: a randomized double-blind comparison. *N Engl J Med* 312, 137-141.
- [34] Cameron, E. & Pauling, L. (1976). Supplemental ascorbate in supportive treatment of cancer: prolongation of survival times in terminal human cancer. *Proc Natl Acad Sci U.S.A.* 73, 3685-3689.
- [35] Edgar, J. A. (1970). Dehydroascorbic acid and cell division. *Nature*. 227, 24-26.
- [36] Poydock, M. E. (1982). Effect of combined ascorbic acid and B12 on survival of mice implanted with Ehrlich carcinoma and L1210 leukemia. *Am J Clin Nutr*. 54, 1261s-1265s.
- [37] Tsao, C. S., Dunhan, W. B. & Leung, P. Y. (1989). Effect of ascorbic acid and its derivatives on the growth of human mammary tumor xenografts in mice. *Cancer J*. 5, 53-59.

- [38] Padayatty, S. J., Riordan, H. D., Hewitt, S. M., Katz, A., Hoffer, L. J. & Levine, M. (2006). Intravenously administered vitamin C therapy: three cases. *CMAJ* 28, 937-942.
- [39] Herberg, S., Galan, P., Perziosi, P., Alvarez, M. J. & Vazques, C. (1998). The potential role of antioxidant vitamins in preventing cardiovascular diseases and cancers. *Nutrition*. 14, 513-520.
- [40] Carr, A. C. & Frei, B. (1999). Toward a new recommended dietary allowance for vitamin C based on antioxidant and health effects in humans. *Am J Clin Nutr*. 69, 1086 - 1107.
- [41] Panel on Dietary Antioxidants and Related Compounds, Institute of Medicine. Chapter 5: Vitamin C. In: Dietary Reference Intakes for Vitamin C, Vitamin E, Selenium, and Carotenoids. A Report of the Institute of Medicine. Washington, DC: National Academy Press; 95-185, 2000.
- [42] Levine, M., Rumsey, S., Wang, Y. Vitamin C. In: Ziegler E.E., Filer L.J. eds. Present Knowledge in Nutrition. 7<sup>th</sup> ed. Washington, DC: ILSI Press; 146-159, 1996.
- [43] Gaziano, J. M., Glynn, R. J., Christen, W. G., Kurth, T., Belanger, C., Macfadyen, J., Bubes, V., Manson, J. E., Sesso, H. D. & Buring, J. E. (2008). Vitamins E and C in the Prevention of Prostate and Total Cancer in Men: The Physicians' Health Study II Randomized Controlled Trial. *JAMA*, 301(1), (doi:10.1001/jama.2008.862).
- [44] Lin, J., Cook, N. R., Albert, C., Zaharris, E., Gaziano, J. M., Van Denburgh, M., Buring, J. E. & Manson, J. E. (2008). Vitamins C and E and Beta Carotene Supplementation and Cancer Risk: A Randomized Controlled Trial. *J Natl Cancer Inst*. 0: djn438v1-23.
- [45] Lee, S. H., Oe, T. & Blair, I. A. (2001). Vitamin C-Induced Decomposition of Lipid Hydroperoxides to Endogenous Genotoxins. *Science*, 292, 2083 - 2086.
- [46] Harris, JR. ed. Ascorbic acid: biochemistry and biomedical cell biology. In: Subcellular Biochemistry. New York, NY: Plenum Press; vol 25, 1996.
- [47] May, J. M. (2000). How does ascorbic acid prevent endothelial dysfunction? *Free Radic Biol Med*. 28, 1421-1429.
- [48] Knekt, P., Ritz, J., Pereira, M. A., et al. (2004). Antioxidant vitamins and coronary heart disease risk: a pooled analysis of 9 cohorts. *Am J Clin Nutr*, 80, 1508 - 1520.
- [49] Ness, A. R., Chee, D. & Elliott, P. (1997). Vitamin C and blood pressure-an overview. *J Hum Hypertens*. 11, 343-50.
- [50] Anderson, T. J., Meredith, I. T., Yeung, A. C., et. al. (1995). The effect of cholesterol-lowering and antioxidant therapy on endothelium-dependent coronary vasomotion. *N Engl J Med*. 332, 488-93.
- [51] Tappel, A. L. (1962). Vitamin E as the biological lipid antioxidant. *Vitam Horm*, 20, 493.
- [52] Hamabe, A., Takase, B., Uehata, A., et. al. (2001). Impaired endothelium-dependent vasodilation in the brachial artery in variant angina pectoris and the effect of intravenous administration of vitamin C. *Am J Cardiol*. 87, 1154-1159.
- [53] Gey, K. F., Brubacher, G. B. & Stahelin, H. B. (1987). Plasma levels of antioxidant vitamins in relation to ischemic heart disease and cancer. *Am J Clin Nutr*. 45(5 Suppl), 1368-1377.

- [54] Solzbach, U., Hornig, B., Jeserich, M., et al. (1997). Vitamin C improves endothelial dysfunction of epicardial coronary arteries in hypertensive patients. *Circulation*, 96, 1513-1519.
- [55] Hornig, B., Arakawa, N., Kohler, C., et al. (1998). Vitamin C improves endothelial function of conduit arteries in patients with chronic heart failure. *Circulation*, 97, 363-368.
- [56] Higdon, J. An evidence-based approach to vitamins and Minerals. New York: Thieme; 65-72, 2003.
- [57] USDA Nutrient Database for Standard Reference, Release 21 [Online], U.S. Department of Agriculture, Agricultural Research Service. <http://www.nal.usda.gov/fnic/foodcomp> [Access February 10, 2009].
- [58] Barness, L. A. (1974). Safety consideration with high ascorbic acid dosage. *Ann N Y Acad Sci.* 258, 253-258.
- [59] González, M. J., Mora, E., Riordan, N. H., Riordan, H. D. & Mojica, P. (1998). Rethinking vitamin C and cancer: an update on nutritional oncology. *Cancer Prev Int.* 3, 215-224.
- [60] Yamamoto, K., Takahashi, M. & Niki, E. (1987). Role of iron and ascorbic acid in the oxidation of methyl linoleate micelles. *Chem Lett.* 1, 49-52.
- [61] Bram, S., Froussard, P., Guichard, M., et al. (1980). Vitamin C preferential toxicity for malignant melanoma cells. *Nature.* 284, 629-631.
- [62] Tsao, C. S., Dunhan, W. B. & Leung, P. Y. (1989). Effect of ascorbic acid and its derivatives on the growth of human mammary tumor xenografts in mice. *Cancer J.* 5, 53-59.
- [63] Shklar, G., Schwartz, J., Trickler, D. & Cheverie, S. R. (1993). The effectiveness of a mixture of beta carotene, alpha tocopherol, glutathione and ascorbic acid for cancer prevention. *Nutr Cancer.* 20, 145-151.
- [64] Cohen, M. & Bhagavan, H. N. (1995). Ascorbic acid and gastrointestinal cancer. *J Am Coll Nutr.* 14, 565-578.
- [65] Carr, A. & Frei, B. (1999). Does vitamin C act as a pro-oxidant under physiological conditions? *FASEB* 13, 1007-1024.
- [66] Halliwell, B. & Gutteridge, J. M. C. (1986). Oxygen free radicals and iron in relation to biology and medicine: some problems and concepts. *Free Radical Biol Med*, 246, 501-514.
- [67] Podmore, I. D., Griffiths, H. R., Herbert, K. E., Mistry, N., Mistry, P. & Lunec, J. (1998). Vitamin C exhibits pro-oxidant properties. *Nature* 392, 559.
- [68] Hininger, I., Waters, R., Osman, M., Garrel, C., Fernholz, K., Roussel, A. M. & Anderson, R. A. (2005). Acute prooxidant effects of vitamin C in EDTA chelation therapy and long-term antioxidant benefits of therapy. *Free Radical Biol Med*, 38, 1565-1570.
- [69] Guidarelli, A., de Sanctis, R., Cellini, B., Fiorani, M., Dacha, M. & Cantoni, O. (2001). Intracellular ascorbic acid enhances the DNA single-strand breakage and toxicity induced by peroxynitrite in U937 cells. *Biochem J*, 356, 509-513.
- [70] Yen, G-C., Duh, P-D. & Tsai, H-L. (2002). Antioxidant and pro-oxidant properties of ascorbic acid and gallic acid. *Food Chem*, 79, 307-313.

- [71] Park, S-W. & Lee, S-M. (2008). Antioxidant and prooxidant properties of ascorbic acid on hepatic dysfunction induced by cold ischemia/reperfusion. *Eur J Pharmacol*, 580, 401-406.
- [72] Mix, J. A. (1999). Do megadoses of vitamin C compromise folic acid's role in the metabolism of plasma homocysteine. *Nutr Res*, 19, 161-165.
- [73] Herbert, V., Jacob, E. & Wong, K-TJ. (1976). Destruction of vitamin B<sub>12</sub> by vitamin C. *Am J Clin Nutr*, 30, 297-299.
- [74] Herbert, V., Jacob, E., Wong, K-TJ., Scott, J. & Pfeffer, R. D. (1978). Low serum vitamin B<sub>12</sub> levels in patients receiving ascorbic acid in megadoses: studies concerning the effect of ascorbate on radioisotope vitamin B<sub>12</sub> assay. *Am J Clin Nutr*, 31, 253-258.
- [75] Groff, J.L. & Gropper, S.S. *Advanced Nutrition and Human Metabolism*. (3rd ed.). Wadsworth/Thompson Learning: Belmont, CA. pp 295-302. 1999.
- [76] Frank, J., Flaccus, A., Schwarz, C., Lambert, C. & Biesalski, H. K. (2006). Ascorbic acid suppresses cell death in rat DS-sarcoma cancer cells induced by 5-aminolevulinic acid-based photodynamic therapy. *Free Radical Biol Med*, 40, 827-836.
- [77] Rees, D. C., Kelsey, H. & Richards, J. D. M. (1993). Acute haemolysis induced by high dose ascorbic acid in glucose-6-phosphate dehydrogenase deficiency. *BMJ* 306, 841-842.
- [78] Udomratn, T., Steinberg, M. H., Campbell, G. D. & Oelshlegel, F. J. (1977). Effects of ascorbic acid on glucose-6-phosphatase dehydrogenase-deficient erythrocytes: studies in animal model. *Blood*, 49, 471-475.
- [79] Michael, A. J. (1978). Kidney stone hospitalization in relation to vitamin C consumption in Australia 1966-1978. *Commun Health Studies*, 2, 9-13.
- [80] Schmidt, K-H., Hagmaier, V., Hornig, D. H., Vuilleumier, J-P. & Rutishauser, G. (1981). Urinary oxalate excretion after large intakes of ascorbic acid in man. *Am J Clin Nutr*, 34, 305-311.
- [81] Adams, A. & de Kimpe, N. (2009). Formation of pyrazines from ascorbic acid and amino acids under dry roasting conditions. *Food Chem* doi: 10.1016/j.foodchem.
- [82] Limacher, A., Kerler, J., Conde-Petit, B. & Blank, I. (2007). Formation of furan and methylfuran from ascorbic acid in model food systems. *Food Additives and Contaminants*, 24 (suppl 1), 143.
- [83] Park, J. B. & Levine, M. (2000). Intracellular Accumulation of Ascorbic Acid Is Inhibited by Flavonoids via Blocking of Dehydroascorbic Acid and Ascorbic Acid Uptakes in HL-60, U937 and Jurkat Cells. *Journal of Nutrition*. 130, 1297-1302.
- [84] Song, J., Kwon, O., Chen, S., Daruwala, R., Eck, P., Park, J. B. & Levine, M. (2002). Flavonoid Inhibition of Sodium-dependent Vitamin C Transporter 1 (SVCT1) and Glucose Transporter Isoform 2 (GLUT2), Intestinal Transporters for Vitamin C and Glucose. *J. Biol. Chem.*, 277, 18, 15252-15260.
- [85] Biondi, C., Pavan, B., Dalpiaz, A., Medici, S. & Lunghi, L. (2007). Expression and characterization of vitamin C transporter in the human trophoblast cell line HTR-8/SVneo: effect of steroids, flavonoids and NSAIDs. *MHR*, 13, 77-83.

- [86] Atkins, PW. & Beran, JA. *General Chemistry* (2nd ed.). Scientific American Books: New York. 1992.
- [87] Croft, K. D. (1998). The Chemistry and Biological Effects of Flavonoids and Phenolic Acids. *Annals New York Academy of Sciences*, 854, 435-443.





---

## **Vitamin C Intake: Types of Foods Consumed and Meal Pattern Differences in Children with High or Low Exposure to Environmental Tobacco Smoke\***

---

*Alan M. Preston, Luis Vázquez Quiñones, Cynthia M. Pérez,  
Ernesto Pérez Torres and Cindy Rodríguez*

University of Puerto Rico, Medical Sciences Campus,  
School of Medicine, Department of Biochemistry  
and Graduate School of Public Health –  
Department of Biostatistics and Epidemiology, Puerto Rico

### **ABSTRACT**

**Background:** Vitamin C is a physiological antioxidant of major importance for protection against diseases and degenerative processes caused by oxidative stress. Ample evidence exists for the detrimental effects of environmental tobacco smoke (ETS) on vitamin C status in exposed populations. Reduced dietary intake has been documented in spouses and preschool children of active smokers, but few studies have been done in children of other age groups. Furthermore, there is no information on meal-pattern differences in vitamin C intake between populations either exposed or not exposed to ETS.

**Objectives:** We assessed consumption of foods containing from zero to high amounts of vitamin C and determined contribution of regular meals and snacks to the

---

\* A version of this chapter was also published in *Passive Smoking and Health Research*, edited by N.A. Jeorgensen published by Nova Science Publishers, Inc. It was submitted for appropriate modifications in an effort to encourage wider dissemination of research.

daily intake of vitamin C in children with either high (HEX) or low (LEX) exposure to ETS.

**Study Design:** The study group consisted of a convenience sample of 508 healthy children aged 2-13 years routinely visiting a clinic in the greater San Juan Metropolitan Area. Dietary intake of vitamin C was obtained with a 24-hour recall questionnaire. Smoke exposure was assessed by measuring a biomarker, urinary cotinine. Children were divided into high and zero-low exposure groups according to the mean value of cotinine/creatinine (15.8 ng/mg).

**Results:** Both groups of children consumed well in excess of the RDA levels for vitamin C, but children with LEX had a significantly higher mean daily intake (123.4 mg) than HEX children (102.4 mg). Both groups consumed similar amounts of total calories as well as calories from vitamin C-containing foods which consisted of about six servings/day. Of these servings, however, children in the LEX group consumed foods with high amounts of vitamin C, while the HEX group consumed foods with lesser amounts. Meal patterns showed that breakfast provided the greatest percent of daily vitamin C for both groups (31% for LEX, 36% for HEX). No differences were noted between groups in the percent of daily intake of vitamin C consumed at lunch or dinner (21% and 23% for LEX and 25% and 25% for HEX, respectively). The major difference in percent of daily intake as well as amount of intake was in snacks. Children with LEX consumed about 26% of their daily vitamin C by consuming snacks with high amounts of vitamin C while HEX children consumed only 15% of their daily vitamin C by consuming snacks with low amounts of vitamin C.

**Conclusions:** Children with high exposure to ETS consumed less vitamin C than children with zero-low exposure levels. Differences might be attributed to consumption of foods containing high amounts of vitamin C by the low exposure group. Snacking behavior appears to be a major factor in daily intake of vitamin C contributing to 26% of daily intake of the diet in children with low exposure but only 15% of the intake in children with high exposure.

## Introduction

While the focus of this book is directed toward the adverse health effects of environmental tobacco smoke (ETS), a brief description of the background which led to the identification of ETS as a contributor to the development of several major chronic diseases began with basic findings in studies with active smokers.

In the case of vitamin C, a relationship with smoking was noted as early as 1953 [1]. Curiously enough, the original impetus to examine this relationship was the observation of gingivitis and deposition of calculi in Danish Royal Marines who reported heavy tobacco use. Since vitamin C is the nutrient most frequently associated with these conditions, studies were carried out with five volunteers (three smokers and two nonsmokers) who were fed equivalent amounts of vitamin C and blood samples were collected for 12 days. The investigators noted a marked decrease in blood ascorbate level of the smokers and made the tentative conclusion that “the blood level of ascorbic acid appears to be lowered by smoking” [1]. These results were confirmed and extended to show that smokers not only have lowered blood levels [2-27] but also ingest lesser quantities of vitamin C [7, 9-12, 14-17, 20, 21, 24, 27-48], which is a result of consuming fewer vitamin C-containing foods [10, 13, 15, 18, 20-

24, 27, 28, 30, 32-35, 37, 38, 40-46, 48-61]. It should be noted, however, that only part of the decreased plasma levels is attributed to the lower intake of fruits and vegetables. After adjusting for vitamin C-containing foods, smokers still have lower plasma concentrations than nonsmokers [20, 21], which indicate that smoking per se predisposes to lower vitamin C status. The overall consequence of compromised vitamin C status is increased risk of oxidation of biological molecules with subsequent damage leading to a plethora of tobacco-related illnesses. (Summarized in the 2004 report of the Surgeon General: "The Health Consequences of Smoking) [62].

Concomitant to the revelation of the dangers of smoking came the increasing awareness that exposure to ETS also carries risks for adverse health effects. In 1993, the Environmental Protection Agency (EPA) made the announcement that ETS presents "a serious and substantial health problem in the United States" [63]. Despite extreme lobbying campaigns by the tobacco industry and aggressive marketing strategies to discredit EPA findings [64-66], evidence accumulated to implicate exposure to ETS as posing disease risks similar to active smoking [67], and that ETS has a detrimental effect on vitamin C status, especially in the causation of cardiovascular irregularities [68, 69]. Indeed it is important to note that nonsmokers exposed to ETS share many characteristics of tobacco users. Spouses, preschool children and adolescents' co-habiting space with smokers have eating patterns more like those of smokers than those of nonsmokers with decreased intake of vitamin C-containing foods [70-79] and reduced concentration of blood ascorbate even after correction for intake of vitamin C [80-82].

While information on vitamin C status of populations exposed to ETS is extensive, it is far from complete. In the presentation reported here, we examine an understudied age group, children aged 2-13 years, and provide the first report of differences between non-and lightly exposed children versus children with heavy exposure to ETS on regular meal patterns (i.e. breakfast, lunch, dinner and snacks).

## Subjects and Methods

Our study group included 508 healthy children aged 2-13 years who routinely visited the Pediatric Care Clinic of the Cataño Health Center, a satellite program of the University of Puerto Rico Pediatrics Department. Cataño is an industrial municipality of approximately 31,000 inhabitants that is located across the harbor from San Juan. Blue-collar workers make up the bulk of the population. The municipality is highly homogeneous in terms of socioeconomic factors, and children visiting the clinic are representative of children residing in the community as a whole. However, the method of subject selection, basically by convenience, constituted a nonprobability sample, and therefore no statistical inferences should be drawn regarding the generalizability of the findings to a broader population.

## Data Collection: Dietary Questionnaires

The dietary questionnaires were administered during the period from August 1993 through November 1996. When mothers ( $n = 705$ ) arrived at the clinic with their children, they were given an informed consent form for participation in the study. Although everyone who was contacted agreed to participate, but failure to adhere to the study protocol reduced the response rate to nearly 75% ( $n = 528$ ). The reasons for non-participation included incomplete dietary information ( $n = 27$ ), or inability to provide a urine or blood sample ( $n = 150$ ). The rates of non-compliance were rather evenly distributed across age, sex and body mass index (BMI) and should not result in any appreciable bias in the study. The study protocol was approved by the Institutional Review Board of the University of Puerto Rico, Medical Sciences Campus.

Dietary data were obtained by using a 24-hour-recall method [83]. Meals were recorded as follows: breakfast, mid-morning snack (Snack 1), lunch, mid-afternoon snack (Snack 2), dinner, evening snack (Snack 3). Mothers supplied this information for their youngest children, and children aged  $\geq 8$  years also contributed some information. The interviewers recorded detailed descriptions of all foods and beverages consumed, including cooking methods and brand names. Use of vitamin and mineral supplements was also noted. Because the study focused on food sources of vitamin C, 20 children taking vitamin C supplements were excluded from the study. The remaining 508 children were included in the statistical analysis.

## Clinical and Laboratory Procedures: Blood and Urine Samples

Children provided fasting blood and urine samples, which were collected from 8:00 am to 10:00 am at the clinic immediately before administration of the 24-hour dietary recall. Urine samples were refrigerated and cotinine concentrations were determined within 48 hours by using an enzyme linked immunosorbent assay (Solar Care Technologies, Bethesda, PA). In a previous study, this assay was verified against gas-liquid chromatography and was found accurate for measuring cotinine concentrations  $\geq 3$  ng/mL [84]. To adjust for urine dilution, urinary cotinine concentrations were standardized to creatinine. Creatinine was measured colorimetrically by using picric acid in an alkaline environment [85].

Blood samples were obtained by venipuncture and were drawn into EDTA-coated tubes. Plasma was separated by centrifugation at 2000 X g for 20 minutes at 4°C. Supernatant fluids were analyzed for ascorbic acid content by derivatization with 2,4 dinitrophenyl hydrazine [86] within 6 hours of collection.

## Determination of Dietary Ascorbate

Vitamin C intakes were estimated from the 24-hour dietary recall interviews. To determine the vitamin C contents of the foods consumed, we used the Minnesota Nutrition Data System 32, which contains over 6,000 brand-name foods, fast foods, and more than

1,600 other foods. In addition, it is a comprehensive nutrient database including data derived from the US Department of Agriculture tables, food manufacturers, the scientific literature, and foreign food consumption tables; hence, it contains many ethnic foods that are commonly eaten in Puerto Rico.

## Statistical Analysis

While information has been collected on the age, gender, BMI and socioeconomic status of our population, these factors are not considered in the statistical analysis. Our focus is solely on the effect of dietary differences in vitamin C as influenced by exposure to ETS.

Data analysis was facilitated through the use of a computer-software developed for Microsoft Access SQL with visual basic application to evaluate a complex combination of dietary and environmental factors on vitamin C status [87]. Unpaired student's t test was used to assess whether the mean values for vitamin C intake, energy intake, portions of vitamin C foods and blood ascorbate in the LEX group differed from the mean values in the HEX group [88]. All statistical analysis were performed using SAS software (version 8e [89]).

## Results

Levels of exposure to ETS have been quantified by using the biomarker cotinine as corrected for dilution through use of the cotinine/creatinine ratio. Distribution of cotinine/creatinine ratios in our population has been previously described [82, 90]. These results show a range from zero to 266 ng/mg and a mean of 15.8 ng/mg. It should be clearly pointed out that children in this study are being classified into two groups - those below and equal to the mean which includes zero to light exposure (LEX) and those above the mean which are children with heavier exposure to ETS (HEX). Cutoff values for completely non-exposed populations are generally below 10 ng/mg [91, 92], but cutoffs for nonsmokers exposed to ETS have reached 80 ng/mg [93], therefore, our mean of 15.8 ng/mg is a reasonable representation of light exposure. As a comparison, active smokers (>10 cigarettes/day) sustain urinary cotinine/creatinine concentrations greater than 1,000 ng/mg [94].

Table 1 shows vitamin C and energy intake mean values, mean number of portions of vitamin C-containing foods ingested per day and mean blood levels of ascorbate. LEX children (n = 375) ingested a significantly greater amount (p = 0.02) of vitamin C than HEX children (n = 133), but energy intakes were the same for each group (p > 0.05). The mean number of portions of vitamin C-containing foods eaten per day was about 6 for both groups (p > 0.05). Mean blood ascorbate levels were slightly higher in the LEX group (0.89 mg/dl) in agreement with literature [81-83], but the difference between groups did not reach statistical significance (p > 0.05).

Results from the 24-hour recall questionnaires itemized 117 different foods. A copy of the entire food list is available on request from the first author. Eighty-eight (75.2%) of these foods contained vitamin C. To simplify data presentation, foods were classified into five

categories based on vitamin C content and summarized in Table 2. These categories were arranged for simplicity of comparison to Estimated Average Requirements (EAR's) and Recommended Dietary Allowances (RDA's) for children aged 2-13 years [95]. Designation of the categories into low, moderate, medium and high was arbitrary and should not be interpreted as nutritional standards.

Figure 1 shows the distribution of the total energy intake between vitamin C-containing and non-vitamin C containing foods for LEX and HEX groups. In each case, more total calories were obtained from non-vitamin C containing foods; however, there were no differences between groups (53% vs. 52%). From the information in Tables 1 and 2 and Figure 1, two inferences can be made. First, although 75% of foods from the 24-hour recall questionnaires contained vitamin C, the 25% of foods not containing vitamin C comprised the majority of energy intake. This is not surprising since non-vitamin C-containing food groups contain most meat, breads, cereals, desserts and condiments with higher fat content and a high caloric density. Vitamin C-containing foods in the other hand, such as fruits and vegetables, contain fewer calories and a greater nutrient density. The second inference is that

**Table 1. Mean Levels of Vitamin C Intake, Energy Intake, Portions of Vitamin C-containing Foods per day and Blood Ascorbate by Exposure Group**

	Exposure Group		P value
	LEX <sup>a</sup> (n=375)	HEX <sup>b</sup> (n=133)	
Vitamin C Intake (mg/day) <sup>c</sup> Mean ± SD	123.4 ± 118.8	102.4 ± 75.6	0.02
Energy Intake (Kcal/day) <sup>c</sup> Mean ± SD	1,672.2 ± 593.2	1,634.1 ± 655.3	0.54
Portions Vitamin C foods <sup>c</sup> (number/day) Mean ± SD	6.1 ± 2.6	6.1 ± 2.5	0.94
Blood Ascorbate (mg/dl) <sup>c</sup> Mean ± SD	0.89 ± 0.21	0.88 ± 2.3	0.43

a) Cotinine/creatinine ≤ 15.8 ng/mg

b) Cotinine/creatinine > 15.8 ng/mg

c) Student's t test assuming unequal variances

**Table 2. Classification of Food Groups**

Category	Designation	Vitamin C Content (mg/portion)	Food Types
1	No vitamin C	Zero-trace	Most meats, dairy, breads and cereals, miscellaneous (1)
2	Low vitamin C	1-10	Some meats and dairy, legumes, vegetables, miscellaneous (1)
3	Moderate vitamin C	11-26	Some cereals, vegetables and fruits (2)
4	Medium vitamin C	27-75	Some fruits and fruit juices (3)
5	High vitamin C	> 75	Some fruits and fruit juices (4)

(1) Condiments, desserts

(2) Apples, pears, peaches, bananas

(3) Pineapples, cherries, grapes

(4) Oranges, strawberries, passion fruit, West India cherries (acerolas)

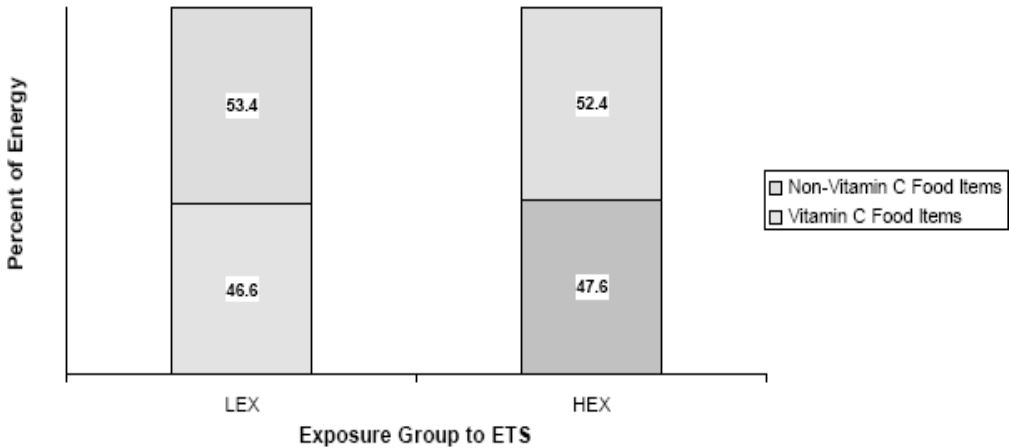

Figure 1. Percent of energy from vitamin C food items and non vitamin C food items.

since there is no difference in total energy intake or mean number of portions of vitamin C-containing foods consumed per day and that the LEX children ingest significantly more vitamin C than HEX children, it is the quality and not the bulk of the diet that is the causative factor in explaining the difference in vitamin C intake between the two groups.

These conclusions are bourn out in Figures 2 and 3, which show vitamin C intake per dietary category and percent of total intake per category. The overwhelming choice of vitamin C-containing foods in LEX (56%) is foods high on vitamin C while HEX children select lesNur amounts of high vitamin C foods (44%). Further evidence is provided in Figure 4 which shows the percent of children LEX and HEX selecting foods from each food category.

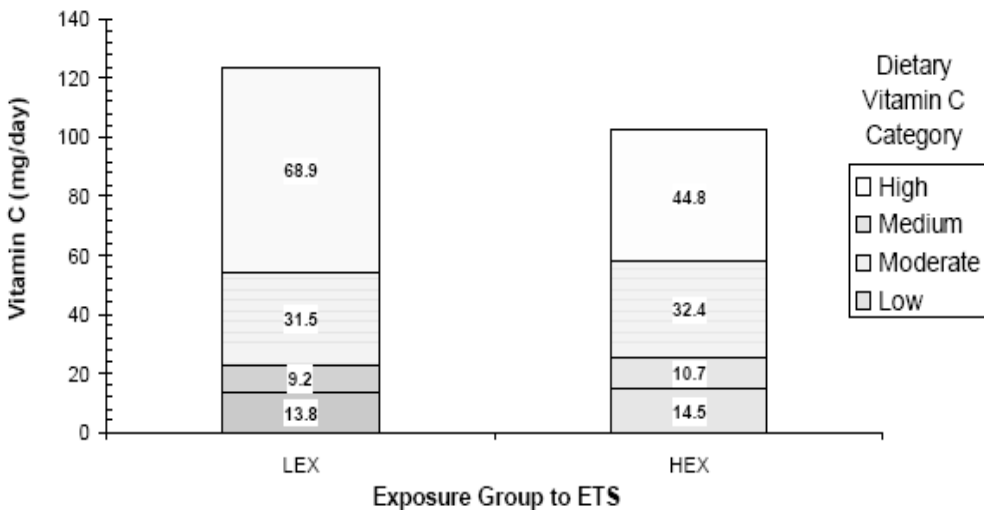

Figure 2. Food source of vitamin C by smoke exposure group.

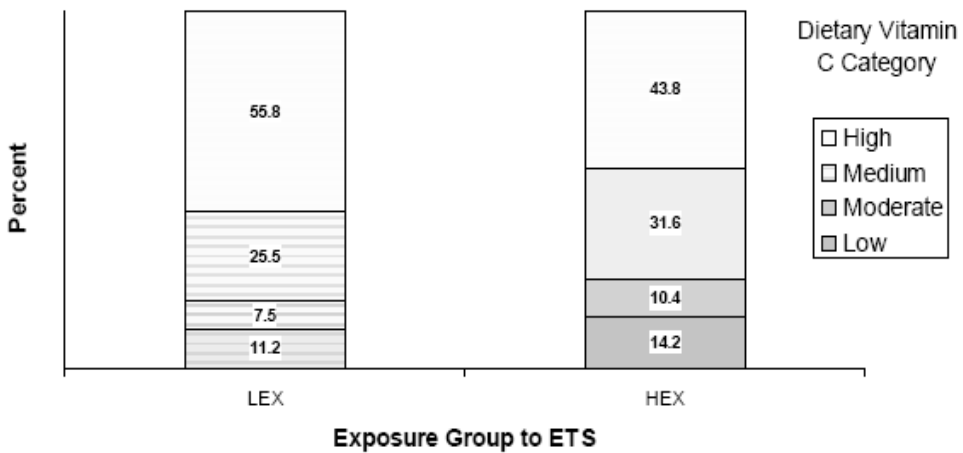

Figure 3. Percent of total vitamin C intake per food source by smoke exposure group.

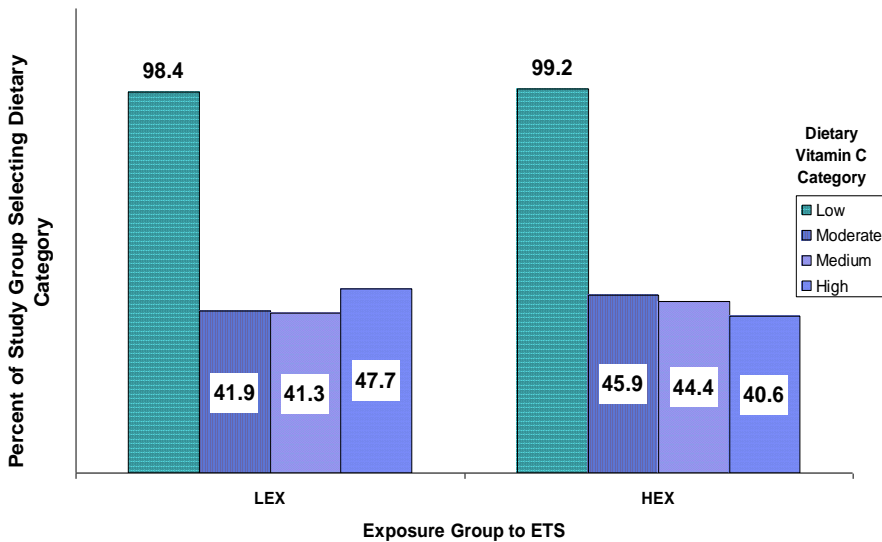

Figure 4. Percent of study group selecting dietary category by smoke exposure group.

Recall that from Table 1, we know that total portions of vitamin C-containing foods ingested per day are about 6 for both LEX and HEX groups. Almost all children selected foods from the low vitamin C-containing category (98% for LEX, 99% for HEX); however, LEX children made a greater percent of selection from the high vitamin C-containing category than HEX children (48% vs. 41%), again suggesting that a vitamin C-rich diet is related to lower exposure to ETS.

Figures 5 and 6 show vitamin C intake and percent of vitamin C intake expressed per type of meal. Intake in mg/day was similar for LEX and HEX groups for breakfast, lunch and dinner, but snacks for LEX children provided more than twice the amount of vitamin C than



for HEX children (32.0 mg vs. 15.3 mg). Percentage-wise, breakfast comprised the greatest amount of vitamin C among all meals and had a higher contribution for HEX than LEX (35.5% vs. 30.6%). Snacks supplied a much higher percent of daily intake of vitamin C for LEX than HEX children (26.0% vs. 14.9%). When the amount of vitamin C was compared per time the snack was eaten (Figure 7), the greatest amount of vitamin C was consumed in snack 1 (midmorning snack) for both groups; however, the LEX children consumed almost as much vitamin C in snack 1 as did the HEX children for the entire day (14 mg vs. 15 mg).

Results of vitamin C intake as affected by smoke exposure are summarized in Table 3. When expressed as LEX/HEX ratio it is clearly seen that while foods containing moderate to medium amounts of vitamin C are consumed in roughly equal proportions, the LEX children consume more than twice the amount of high vitamin C-containing foods than HEX children, while only about one-fifth the amount of low vitamin C-containing foods. Likewise, meal pattern analysis shows that breakfast, lunch and dinner have equal LEX/HEX ratios; however, LEX children consume more than twice the amount of vitamin C in snacks than do HEX children.

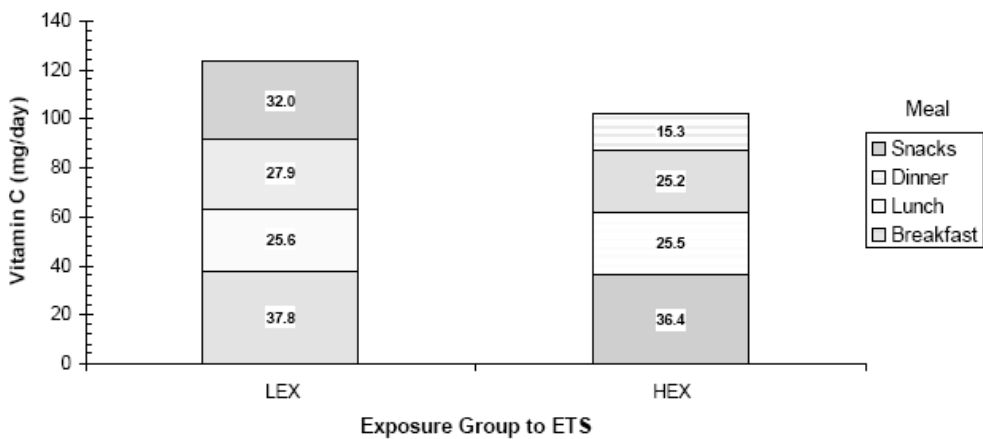

Figure 5. Vitamin C intake per meal by smoke exposure group.

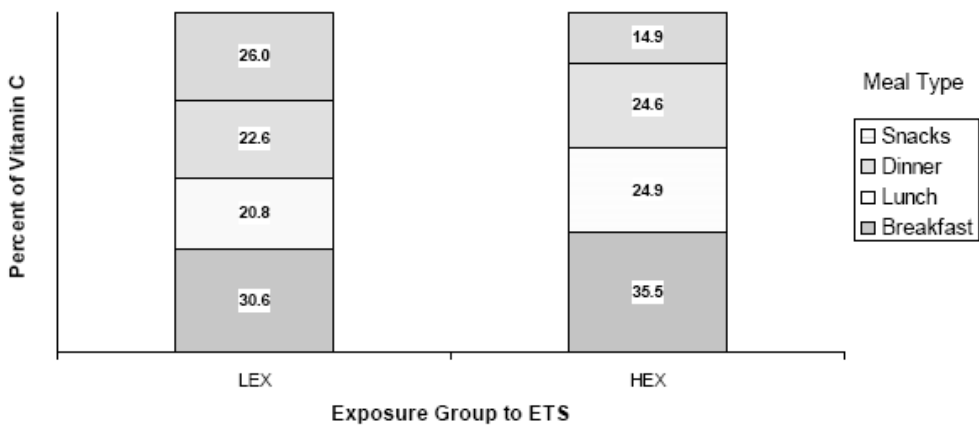

Figure 6. Percent of total vitamin C intake per meal type by smoke exposure group.

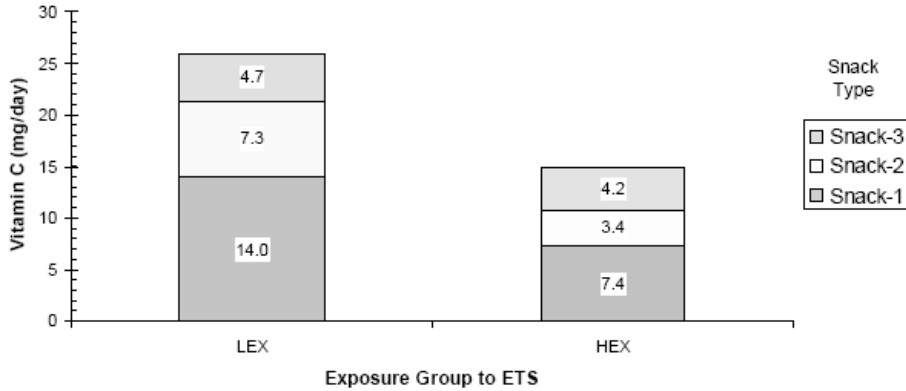

Figure 7. Vitamin C intake per snack by smoke exposure group.

**Table 3. Vitamin C Intake: Summary of Food Choices and Meal Patterns of Children with Low and High Exposure to ETS**

Food Category – Vitamin C Content	Mg Vitamin C/day		Ratio LEX-HEX
	LEX	HEX	
Low	5.6	31.4	0.2
Moderate	9.9	8.6	1.2
Medium	33.8	26.2	1.3
High	74.1	36.2	2.1
Mean Total/day	123.4	102.4	
Meal Category – Vitamin C Content			
Breakfast	37.8	36.4	1.0
Lunch	25.6	25.5	1.0
Dinner	27.9	25.2	1.1
Snacks	32.1	15.3	2.1
Mean Total/day	123.4	102.4	

## Discussion

As with any research study, the method of data collection is an important consideration. In the present study, results were obtained using one 24-hour recall questionnaire per subject. This approach raises concern as to how representative is the data for a typical day. However, most large-scale nutritional surveys are conducted in this exact or similar manner, and information is deemed appropriate for generalizations to groups as a whole [96, 97].

It should be noted that in this presentation smoke exposure is classified according to a biomarker, urinary cotinine. This is a departure from the more typical method used which is based upon self-reported smoke exposure [70, 72-82]. We prefer using cotinine as determinant for the following reason. Several investigators in this area have made the observation that self-reports are subject to errors such as poor recall or under-reported

exposure [98-101]. Younger children may be unaware of random smoke exposure and while only 35% of children in the US younger than 18 years live in homes where residents or visitors smoke [102], a national survey reported that virtually all children of similar ages have at least low levels of cotinine in their system [103]. Indeed, data from this same survey documented that 87.9% of non-tobacco users had detectable levels of serum cotinine [104]. To sum up, it is more logical to expect that measurement of children's exposure to a component of tobacco smoke would better predict ETS than would a self-reported smoke exposure. Consequently, we agree with Jarvis et al. [105] who recommend that investigators should supplement or replace questionnaire data with quantitative measures of actual smoke exposure.

One result of this study has been the confirmation of previous findings that show exposure to ETS results in reduced levels of vitamin C intake due to decreased consumption of food with high vitamin C content [70-79]. Previous studies have included mainly preschool children and adults so our population of children aged 2-13 years can extend conclusions for an understudied age group. As to whether the reduced intake of vitamin C in our subjects could have any clinical significance, the probability is unlikely. Both LEX and HEX children consumed well in excess of National Research Council required amounts of vitamin C (20-45 mg/d) [95]. In fact, we have shown that blood levels of ascorbate in our population of children are overwhelming in the normal to saturated categories [106]. However, not all children are as well fed as ours and suboptimal to low vitamin C status in other populations has been implicated as a major risk factor in cardiovascular diseases and all-cause mortality [107].

The principal finding in this study is related to meal pattern. To our knowledge, this is the first report of the effect of ETS on vitamin C intake during the daily dietary regimen. Breakfast provided the greatest amount and percentage of total vitamin C intake for the day in both LEX and HEX children. This result is unsurprising since fruits and juices are traditionally served at this meal. Likewise, lunch and dinner provided lesser but similar amounts of vitamin C for both groups. The unexpected finding was the contribution of snacks to the amount of daily vitamin C intake, which was 15% in HEX children and 26% in LEX children. It is well documented that snacking behavior among US children has increased dramatically over the past 25 years [108]. Snacks are generally considered of low dietary quality and major sources of fat and calories disposing toward overweight and obesity [109-111]. While these conclusions may often be valid our study shows that snacks can also be a major source of an important nutrient, indeed one-fourth of the daily intake of vitamin C is provided for children not exposed to ETS. A recent study examining snacking patterns in US adults shows a positive relationship with eating frequency and vitamin C intake [112]. In fact, when snacks contain nutrient dense foods, higher intake of such beneficial nutrients as folic acid, calcium, magnesium, iron, potassium and dietary fiber have been documented in studies with adolescents [113] and adults [112, 114].

Closer examination of snacking behavior reveals that snack #1 (midmorning) provided much more vitamin C than did snack #2 (mid-afternoon) or snack #3 (evening). A large percentage of our study groups attends preschool and elementary school and brings to school with them a snack prepared at home. Our data indicate that children from LEX households bring snacks with high vitamin C content, while children from HEX households bring snacks

with lower vitamin C content. The simple addition of a fruit or vitamin C–fortified beverage versus a soft drink or a cookie can be all that is needed to dramatically increase daily intake of vitamin C. This message should be directed to all caregivers, whether smokers or nonsmokers, that healthy snack food choices could make a major difference in benefiting their children’s nutritional status.

## Conclusion

We have studied the effect of high and low exposure to environmental tobacco smoke in children on their consumption of vitamin C-containing foods and at which daily meals the vitamin C-containing foods are eaten. Children with high exposure consumed foods with a lower vitamin C-content than did children with low smoke exposure. Meal patterns show that breakfast provided the greatest percentage of total daily vitamin C for both exposure groups with lunch and dinner providing lesser but similar amounts. The major difference in the percent and amount of daily intake was in snacks. Children with high exposure consumed 15% of their daily total as snacks while children with low exposure consumed 26%. This finding suggests that selection of nutritive snacks could greatly improve the overall diet, and that this message should be directed even more emphatically at children with high smoke exposure.

## Acknowledgements

This project was supported by the National Research Initiative of the USDA Cooperative State Research, Education and Extension Service, grant no. 2003-35200-13590. The authors wish to thank the Department of Pediatrics, University of Puerto Rico for providing access to patients at their satellite facility, the Cataño Health Center personnel for their help in sampling and María Rivera for manuscript preparation.

## References

- [1] Bourquin A, Musmanno E. Preliminary report on the effect of smoking on the ascorbic acid content of whole blood. *Amer. J. Digest. Dis.* 1953; 20: 75-7.
- [2] Taber RI, Larson PS. In vivo and in vitro studies on the question of biological relationship between nicotine and ascorbic acid. *Arch. Int. Pharmacodyn. Ther.* 1964; 151: 243-59.
- [3] Brook M, Grimshaw JJ. Vitamin C concentration of plasma and leukocytes as related to smoking habit, age, and sex of humans. *Am. J. Clin. Nutr.* 1968; 21: 1254-8.
- [4] Pelletier O. Smoking and vitamin C levels in humans. *Am. J. Clin. Nutr.* 1968; 21: 1259-67.
- [5] Pelletier O. Vitamin C and cigarette smokers. *Ann. N.Y. Acad. Sci.* 1975; 258: 156-68.

- 
- [6] Sauberlich HE. Vitamin C status: methods and findings. *Ann. N.Y. Acad. Sci.* 1975; 258: 438-50.
- [7] Smith JL, Hodges RE. Serum levels of vitamin C in relation to dietary and supplemental intake of vitamin C in smokers and nonsmokers. *Ann. N.Y. Acad. Sci.* 1987; 498: 144-52.
- [8] Murata A, Shiraishi I, Fukusaki K, Kitahara T, Harada Y. Lower levels of vitamin C in plasma and urine of Japanese male smokers. *Internat. J. Vit. Nutr. Res.* 1989; 59: 184-9.
- [9] Shectman G, Byrd JC, Gruchow HW. The influence of smoking on vitamin C status in adults. *Am. J. Public. Health.* 1989; 79: 158-62.
- [10] Bolton-Smith C, Casay CE, Gey KF, Smith WCS, Tunstall-Pedoe H. Antioxidant vitamin intakes assessed using a food frequency questionnaire: correlation with biochemical status in smokers and non-smokers. *Br. J. Nutr.* 1991; 65: 337-46.
- [11] Shectman G, Byrd JC, Hoffmann R. Ascorbic acid requirements for smokers: analysis of a population survey. *Am. J. Clin. Nutr.* 1991; 53: 1466-70.
- [12] Bui MH, Sauty A, Collet F, Leuenberger P. Dietary vitamin C intake and concentrations in the body fluids and cells of male smokers and nonsmokers. *J. Nutr.* 1992; 122: 312-16.
- [13] Duthie GG, Arthur JR, Beattie JAG, et al. Cigarette smoking, antioxidants, lipid peroxidation, and coronary heart disease. *Ann. N.Y. Acad. Sci.* 1993; 686: 120-9.
- [14] Shectman G. Estimating ascorbic acid requirements for cigarette smokers. *Ann. N.Y. Acad. Sci.* 1993; 686: 335-46.
- [15] Bolton-Smith C. Antioxidant vitamin intake in Scottish smokers and nonsmokers. *Ann. N.Y. Acad. Sci.* 1993; 686: 347-60.
- [16] Dickinson VA, Block G, Russek-Cohen E. Supplement use, other dietary and demographic variables, and serum vitamin C in NHANES II. *J. Am. Coll. Nutr.* 1994; 13: 22-32.
- [17] Giraud DW, Martin D, Driskell JA. Plasma and dietary vitamin C and E levels of tobacco chewers, smokers, and nonusers. *J. Am. Diet. Assoc.* 1995; 95: 798-800.
- [18] Faraque MO, Khan MR, Rahman M, Ahmed F. Relationship between smoking and antioxidant nutrient status. *Br. J. Nutr.* 1995; 73: 625-32.
- [19] Lykkersfeldt J, Priemé H, Loft S, Poulsen HE. Effect of smoking cessation on plasma ascorbic acid concentration. *BMJ* 1996; 313:91.
- [20] Marangon K, Herbeth B, Lecomte E, et al. Diet, antioxidant status, and smoking habits in French men. *Am. J. Clin. Nutr.* 1998; 67: 231-9.
- [21] Lykkersfeldt J, Christen LM, Wallock LM, Chang HM, Jacob RA, Ames BN. Ascorbate is depleted by smoking and repleted by moderate supplementation: a study in male smokers and nonsmokers with matched dietary antioxidant intakes. *Am. J. Clin. Nutr.* 2000; 71: 530-6.
- [22] Wrieden WL, Hannah MK, Bolton-Smith C, Tavendale R, Morrison C, Tunstall-Pedoe H. Plasma vitamin C and food choice in the third Glasgow MONICA population survey. *J. Epidemiol. Comm. Health.* 2000; 54: 355-60.
- [23] Wei W, Kim Y, Boudreau N. Association of smoking with serum and dietary levels of antioxidants in adults: NHANES III, 1988-1994. *Am J Public Health* 2001; 91: 258-64.

- [24] Alberg AJ. The influence of cigarette smoking on circulating concentrations of antioxidant micronutrients. *Toxicol.* 2002; 180:121-37.
- [25] de Oliveira AM, Rondo PHD, Barros SBD. Concentration of ascorbic acid in the plasma of pregnant smokers and nonsmokers and their newborns. *Int. J. Vit. Nutr. Res.* 2004; 74: 193-8.
- [26] Teramoto K, Daimon M, Hasegawa R, et al. Acute effect of oral vitamin C on coronary circulation in young healthy smokers. *Am. Heart. J.* 2004; 148: 300-5.
- [27] Galan P, Viteri, FE, Bertrais S, et al. Serum concentrations of  $\beta$  carotene, vitamins C and E, zinc and selenium are influenced by sex, age, diet, smoking status, alcohol consumption and corpulence in a general French adult population. *Eur. J. Clin. Nutr.* 2005; 59: 1181-90.
- [28] Fehily AM, Phillips KM, Yarnell JWG. Diet, smoking, social class, and body mass index in the Caerphilly Heart Disease Study. *Am. J. Clin. Nur.* 1984 ; 40: 827-33.
- [29] Keith RE, Mossholder SB. Ascorbic acid status of smoking and nonsmoking adolescent females. *Internat. J. Vit. Nutr. Res.* 1986; 56: 363-6.
- [30] Subar AF, Harlan LC, Mattson ME. Food and nutrient intake differences between smokers and nonsmokers in the US. *Am. J. Public Health.* 1990; 80: 1323-9.
- [31] Gridley G, McLaughlin JK, Blot WJ. Dietary vitamin C intake and cigarette smoking. *Amer. J. Public Health.* 1990; 81: 1526.
- [32] Cade JE, Margetts BM. Relationship between diet and smoking - is the diet of smokers different? *J. Epidemiol. Community Health.* 1991; 45: 270-2.
- [33] Bolton-Smith C, Woodward M, Brown CA, Tunstall-Pedoe H. Nutrient intake by duration of ex-smoking in the Scottish Heart Health Study. *Br. J. Nutr.* 1993; 69: 315-32.
- [34] Subar AF, Harlan LC. Nutrient and food group intake by tobacco use status: the 1987 National Health Interview Survey. *Ann. N.Y. Acad. Sci.* 1993; 686: 310-21.
- [35] McPhillips JB, Eaton CB, Gans KM, et al. Dietary differences in smokers and nonsmokers from two southeastern New England communities. *J. Am. Diet. Assoc.* 1994; 94: 287-92.
- [36] Schwartz J, Weiss ST. Relationship between dietary vitamin C intake and pulmonary function in the First National Health and Nutrition Examination Survey (NHANES I). *Am. J. Clin. Nutr.* 1994; 59: 110-14.
- [37] Zondervan KT, Ocke MC, Smit HA, Seidell JC. Do dietary and supplementary intakes of antioxidants differ with smoking status? *Int. J. Epidemiol.* 1996; 25: 70-9.
- [38] Dallongeville J, Marécaux N, Fruchart J-C, Amouyer P. Cigarette smoking is associated with unhealthy patterns of nutrient intake: a meta-analysis. *J. Nutr.* 1998; 178: 1450-7.
- [39] Klesges LM, Murray DM, Brown JE, Cliver SP, Goldenberg RL. Relations of cigarette smoking and dietary antioxidants with placental calcification. *Am. J. Epidemiol.* 1998; 147: 127-35.
- [40] Phillips ELR, Arnett DK, Himes JH, McGovern PG, Blackburn H, Luepker RV. Differences and trends in antioxidant dietary intake in smokers and nonsmokers, 1980-1992: the Minnesota Heart Survey. *Ann. Epidemiol.* 2000; 10: 417-23.

- 
- [41] Ma J, Hampl JS, Betts NM. Antioxidant intakes and smoking status: data from the Continuing Survey of Food by Individuals. *Am. J. Clin. Nutr.* 2000; 71: 774-80.
- [42] Palaniappan U, Jacobs Starkey L, O'Loughlin J, Gray-Donals K. Fruit and vegetable consumption is lower and saturated fat intake is higher among Canadians reporting smoking. *J. Nutr.* 2001; 131: 1952-8.
- [43] Van Hoydonck PGA, Tenne EHM, Schouten EG. A dietary oxidative balance score of vitamin C,  $\beta$  carotene and iron intakes and mortality risk in male smoking Belgians. *J. Nutr.* 2002; 132: 756-61.
- [44] Arab L, Carriquiry A, Steck-Scott S, Gaudet MM. Ethnic differences in the nutrient intake adequacy of premenopausal US woman: results from the Third National Health Examination Survey. *J. Am. Diet. Assoc.* 2003; 103: 1008-14.
- [45] Dyer AR, Stamler J, Ueshima H, Zhou BF, INTERMAP Research Group. Dietary intake in male and female smokers, ex-smokers, and never smokers: the INTERMAP Study. *J. Hum. Hypertens.* 2003; 17: 641-54.
- [46] Nam CM, Oh KW, Lee KH, et al. Vitamin C intake and risk of ischemic heart disease in a population with a high prevalence of smoking. *J. Am. Coll. Nutr.* 2003; 22: 372-8.
- [47] Voko Z, Hollander M, Hofman A, Koudstaal PJ, Breteler MMB. Dietary antioxidants and risk of ischemic stroke: the Rotterdam Study. *Neurol.* 2003; 61: 1273-5.
- [48] Koh W-P, Yuan J-M, Sun C-L, Lee HP, Yu MC. Middle-aged and older Chinese men and women in Singapore who smoke have less healthy diets and lifestyles than nonsmokers. *J. Nutr.* 2005; 135: 2473-7.
- [49] Whichelow MJ, Golding JF, Treasure FP. Comparison of some dietary habits of smokers and non-smokers. *Brit. J. Addict.* 1988; 83: 295-304.
- [50] Morabia A, Wynder EL. Dietary habits of smokers, people who never smoked and ex-smokers. *Am. J. Clin. Nutr.* 1990; 52: 933-7.
- [51] Hebert JR, Kabat GC. Differences in dietary intake associated with smoking status. *Eur. J. Clin. Nutr.* 1990; 44: 185-93.
- [52] Whichelow MJ, Erainclioglu SW, Cox BD. A comparison of the diets of non-smokers and smokers. *Br. J. Addict.* 1991; 86: 71-81.
- [53] Nuttens MC, Roman M, Ruidavets JB, et al. Relationship between smoking and diet: the MONICA-France project. *J. Intern. Med.* 1992; 231: 349-56.
- [54] La Vecchia C, Negri C, Franceschi S, Parazzini F, Decarli A. Differences in dietary intake with smoking, alcohol, and education. *Nutr. Cancer.* 1992; 17: 297-304.
- [55] Midgette AS, Baron JA, Rohan TE. Do cigarette smokers have diets that increase their risk of coronary heart disease and cancer? *Am. J. Epidemiol.* 1993; 137: 521-9.
- [56] Dallongeville J, Marécaux N, Richard F, et al. Cigarette smoking is associated with differences in nutritional habits and related to lipoprotein alterations independently of food and alcohol intake. *Eur. J. Clin. Nutr.* 1996; 50: 647-54.
- [57] Prattala RS, Laaksonen MT, Rahkonen OJ. Smoking and unhealthy food habits: how stable is the association? *Eur. J. Public Health.* 1998; 8: 28-33.
- [58] Curtin F, Morabia A, Bernstein MS. Relation of environmental tobacco smoke to diet and health habits: variations according to the site of exposure. *J. Clin. Epidemiol.* 1999; 52: 1055-62.

- [59] Hampl JS, Betts NM. Cigarette use during adolescence: effects on nutritional status. *Nutr. Rev.* 1999; 57: 215-21.
- [60] Millen BE, Quatromoni PA, Nam B-H, et al. Dietary patterns, smoking, and sub-clinical heart disease in women: opportunities for primary prevention from the Framingham Nutrition Studies. *J. Am. Diet Assoc.* 2004; 104: 208-14.
- [61] Park S-Y, Murphy SP, Wilkens LR, et al. Dietary patterns using the food guide pyramid groups are associated with socio-demographic and lifestyle factors: the Multiethnic Cohort Study. *J. Nutr.* 2005; 135: 843-9.
- [62] US Department of Health and Human Services. The health consequences of smoking: a report of the surgeon general. Atlanta, GA. U.S. Department of Health and Human Services, Centers for Disease Prevention and Health Promotion, Office on Smoking and Health, 2004. <http://www.surgeongeneral.gov/library>.
- [63] US Department of Health and Human Services. Prevention Report, June/July 1993. Washington, DC. Office of Disease, Prevention and Health.
- [64] Muggli ME, Forster JL, Hurt RD, Repace JL. The smoke you don't see: uncovering tobacco industry scientific strategies aimed against environmental tobacco smoke policies. *Am. J. Public Health.* 2001; 91: 1419-23.
- [65] Ong EK, Glantz SA. Constructing "sound science" and "good epidemiology": tobacco, lawyers and public relations. *Amer. J. Public Health.* 2001; 91: 1749-57.
- [66] Hong M-K, Bero LA. How the tobacco industry responded to an influential study of the health effects of secondhand smoke. *BMJ* 2002; 325: 1413-6.
- [67] National Cancer Institutes. Health effects of exposure to environmental tobacco smoke: the report of the California Environmental Protection Agency. Smoking and Tobacco Control Monograph no. 10. Bethesda, MD. US. Department of Health and Human Services, National Cancer Institute, NIH Pub. No. 99-4645, 1999.
- [68] Valkonen MM, Kuusi T. Vitamin C prevents the acute atherogenic effect of passive smoking. *Free Radic. Biol. Med.* 2000; 28: 428-36.
- [69] Barnoya J, Glantz SA. Cardiovascular effects of second hand smoke: nearly as large as smoking. *Circulation* 2005; 111: 2684-98.
- [70] Koo LC, Ho J H-C, Rylander R. Life history correlates of environmental tobacco smoke: a study on non-smoking Hong Kong Chinese wives with smoking versus nonsmoking husbands. *Soc. Sci. Med.* 1988; 26: 751-60.
- [71] Marchand LL, Wilkens LR, Hankin JH, Haley NJ. Dietary patterns of female nonsmokers with and without exposure to environmental tobacco smoke. *Cancer Causes Control* 1991; 2: 11-6.
- [72] Matanoski G, Kanchanaraksa S, Lantry D, Chang Y. Characteristics of nonsmoking women in NHANES I and NHANES I epidemiologic follow-up study with exposure to spouses who smoke. *Am. J. Epidemiol.* 1995; 142: 149-57.
- [73] Crawley HF, While D. Parental smoking and the nutrient intake and food choice of British teenagers aged 16-17 years. *J. Epidemiol. Commun. Health.* 1996; 50: 306-12.
- [74] Johnson RK, Wang MQ, Smith MJ, Connolly G. The association between parental smoking and the diet quality of low-income children. *Pediatr.* 1996; 97: 312-7.



- [75] Koo LC, Kabat GC, Rylander R, Tominaga S, Kato I, Ho J H-C. Dietary and lifestyle correlates of passive smoking in Hong Kong, Japan, Sweden and the U.S.A. *Soc. Sci. Med.* 1997; 45: 159-69.
- [76] Osler M. The food intake of smokers and nonsmokers: the role of partner's smoking behavior. *Prevent. Med.* 1998; 27: 438-43.
- [77] Rylander R, Axelsson G, Megevand Y, Dahlberg C, Lilieqvist T, Sundh V. Dietary habits for non-smoking females living with smokers or non-smokers. *Eur. J. Public Health.* 1999, 9: 142-5.
- [78] Forastiere F, Mallone S, Lo Presti E et al. Characteristics of nonsmoking exposed to spouses who smoke: epidemiologic study on environment and health in women from four Italian areas. *Environ. Hlth. Perspec.* 2000; 108: 1171-7.
- [79] Hampl JS, Taylor CA, Booth CL. Differences in dietary problems of nonsmoking adults married to smokers vs. nonsmokers. *Am. J. Health Promot.* 2001; 16: 1-6.
- [80] Tribble DL, Giuliano LJ, Fortmann SP. Reduced plasma ascorbate concentration in nonsmokers regularly exposed to environmental tobacco smoke. *Am. J. Clin. Nutr.* 1993; 58: 886-90.
- [81] Strauss RS. Environmental tobacco smoke and serum vitamin C levels in children. *Pediatr.* 2001; 107: 540-2.
- [82] Preston AM, Rodríguez C, Rivera CE, Sahai H. Influence of environmental tobacco smoke on vitamin C status in children. *Am. J. Clin. Nutr.* 2003; 77: 167-72.
- [83] Gibson RS. Principles of nutritional assessment. New York: Oxford University Press, 1990.
- [84] Tappin D, Ford RP, Wild CJ. Smoking at the end of pregnancy measured by cord blood cotinine assay. *NZ Med. J.* 1995; 108: 108-9.
- [85] Cook JGH. Factors influencing the assay of creatinine. *Ann. Clin. Biochem.* 1975; 12: 219-32.
- [86] Omaye ST, Turnbull JD, Sauberlich HE. Selected methods for the determination of ascorbic acid in animal cells, tissues and fluids. *Methods Enzymol.* 1979; 62: 3-10.
- [87] Preston AM, Vázquez-Quñones L, Pérez-Torres E, Rodríguez C. Presentation of computer software for use in nutritional epidemiology. *FASEB J.* 2004; 18: A397.
- [88] Rosner B. Fundamentals of biostatistics, 6<sup>th</sup> edition. Belmont, CA: Thomson Brooks/Cole, 2006.
- [89] SAS Institute Inc. SAS/STAT user's guide version 8e. Cary, NC: SAS Institute Inc., 2005.
- [90] Preston AM, Rodríguez C, Rivera CE, Sahai H. Determinants of environmental tobacco smoke in a population of Puerto Rican children. *Nicotine Tob. Res.* 2001; 3: 61-70.
- [91] Greenberg RA, Haley NJ, Etzel RA, Loda FA. Measuring the exposure of infants to tobacco smoke. *N. Engl. J. Med.* 1984; 310: 1075-8.
- [92] Thompson SG, Stone R, Nanchahal K, Wald NJ. Relation of urinary cotinine concentration to cigarette smoking and to exposure to other people's smoke. *Thorax* 1990; 45: 356-61.
- [93] Spierto FW, Hannon WH, Kendrick JS, Bennett JT, Pirkle J, Gargiullo P. Urinary cotinine levels in women enrolled in a smoking cessation study during and after pregnancy. *J. Smoking-Related Dis.* 1994; 5: 65-76.

- [94] Wall MA, Johnson J, Jacob P, Benowitz NJ. Cotinine in the serum, saliva and urine of nonsmokers, passive smokers and active smokers. *Am. J. Public Health.* 1988; 78: 699-701.
- [95] Food and Nutrition Board, Institute of Medicine. National Research Council. Dietary reference intakes for vitamin C, vitamin E, selenium and carotenoids. Washington, DC: National Academy Press, 2000.
- [96] National Center for Health Statistics: Plan and operation of the Second National Health and Nutrition Examination Survey, 1976-1980 Hyattsville, MD; National Center for Health Statistics, 1981 [DMMS publication (PMS) 81-1317].
- [97] National Center for Health Statistics: Plan and operation of the Third National Health and Nutrition Examination Survey, 1988-1994; Series 1-programs and collection procedures. *Vital Health Stat.* 1, 1994; 1-407.
- [98] Pérez-Stable EJ, Marin G, Marin BV, Benowitz NL. Misclassification of smoking status by self-reported cigarette consumption. *Am. Rev. Respir. Dis.* 1992; 145: 53-7.
- [99] Apseoff G, Ashton HM, Friedman H, Gerber N. The importance of measuring cotinine levels to identify smokers in clinical trials. *Clin. Pharmacol. Ther.* 1994; 56: 460-2.
- [100] Pérez-Stable EJ, Benowitz NL, Marin G. Is serum cotinine a better measure of cigarette smoking than self report? *Prevent. Med.* 1995; 24: 171-9.
- [101] Wells AJ, English PB, Posner SF, Wagenknecht LE, Perez-Stable EJ. Misclassification rates for current smokers misclassified as nonsmokers. *Am. J. Public Health.* 1998; 88: 1503-9.
- [102] Schuster MA, Franke T, Pham CB. Smoking patterns of household members and visitors in homes with children in the United States. *Arch. Peadiatr. Adolesc. Med.* 2002; 156: 1094-1100.
- [103] Mannino DM, Caraballo R, Benowitz N, Repace J. Predictors of cotinine levels in US children: data from the Third National Health and Nutrition Examination Survey. *Chest* 2001; 120: 718-24.
- [104] Pirkle JL, Flegal KM, Bernert JT, Brody DJ, Etzel RA, Maurer KR. Exposure of the US population to environmental tobacco smoke: the Third National Health and Nutrition Examination Survey, 1988 to 1991. *JAMA* 1996; 275: 1233-40.
- [105] Jarvis MJ, Strachan DP, Feyerabend C. Determinants of passive smoking in children in Edinburgh, Scotland. *Amer. J. Public Health.* 1992; 82: 1225-9.
- [106] Preston AM, Rodríguez C, Rivera CE. Plasma ascorbate in a population of children: influence of age, gender, vitamin C intake, BMI and smoke exposure. *PR Health Sci. J.* 2006; In Press.
- [107] Simon JA, Hudes ES, Tice JA. Relation of serum ascorbic acid to mortality among US adults. *J. Am. Coll. Nutr.* 2001; 20: 255-63.
- [108] Jahns L, Siega-Riz AM, Popkin BM. The increasing prevalence of snacking among US children from 1977 to 1996. *J. Pediatr.* 2001, 138: 493-8.
- [109] Nicklas TA, Baranowski T, Cullen KW, Berenson G. Eating patterns, dietary quality and obesity. *J. Am. Coll. Nutr.* 2001; 20: 599-608.
- [110] Sanigorski AM, Bell AC, Kremer PJ, Swinburn BA. Lunch box contents of Australian school children: room for improvement. *Eur. J. Clin. Nutr.* 2005; 59: 1310-16.

- 
- [111] Kubik MY, Lytle LA, Story M. School wise food practices are associated with body mass index in middle school students. *Arch. Pediatr. Adolesc. Med.* 2005; 159: 1111-4.
- [112] Kerver JM, Yang EJ, Obayashi S, Bianchi L, Song WO. Meal and snack patterns are associated with dietary intake of energy and nutrients in US adults. *J. Amer. Diet. Assoc.* 2006; 106: 46-53.
- [113] Bigler-Doughten S, Jenkins RM. Adolescent snacks: nutrient density and nutritional contribution to total intake. *J. Amer. Diet. Assoc.* 1987; 87: 1678-9.
- [114] Gatenby SJ. Eating frequency: methodology and dietary aspects. *Br. J. Nutr.* 1997; 77: Suppl. 1 S7-S20.



---

## The Role of Vitamin C in Human Reproduction

---

*E. Tzagaraki, C. Sofocleous, G. Tounta, A. Mavrou and A. Kolialexi\**

Department of Medical Genetics, Athens University School of Medicine, Athens, Greece

### Abstract

In humans, vitamin C is a highly effective antioxidant known to protect cells against oxidative damage caused by Reactive Oxygen Species (ROS). Under normal conditions, antioxidants convert ROS to H<sub>2</sub>O to prevent the accumulation of ROS in the body. Oxidative Stress (OS) occurs when this balance is disturbed and results in the overabundance of ROS. ROS have been implicated in more than 100 diseases.

In human female reproduction ROS affects oocyte maturation, fertilization, embryo development and pregnancy. Several studies report a significant role of oxidative stress in the pathophysiology of preeclampsia, fetal embryopathies, female infertility, birth weight, preterm labor, diabetes, miscarriage and intrauterine growth retardation (IUGR). Male infertility has been related to oxidative stress due to oxidatively induced DNA damage. Low or deficient ascorbate levels have been correlated with low sperm counts, increased numbers of abnormal sperm, reduced motility and agglutination. Decreased ascorbate concentrations in semen are associated with poor breeding performance in bulls, while scorbutic guinea pigs developed defective testicular germinal epithelium. Such studies suggest that ascorbate deficiency can be harmful both to the structure and function of the male reproductive tract. In vitro loss of spermatozoa's motility in human sperm This chapter attempts to examine the various causes of male and female infertility and the role of OS in various reproductive disorders.

---

\* Corresponding author: Aggeliki Kolialexi, Department of Medical Genetics, Athens University, «Aghia Sofia» Children's Hospital, 115 27 Athens, Greece, Tel: 30 210 7467463, Fax: 30 210 7795553, e- mail: akolial@med.uoa.gr.

## 1. Ascorbic Acid in the Human Body

Ascorbic acid, one of the most important elements of human nutrition has been correlated with fertility through its essential role in hormone secretion, gamete production and gonadal tissue remodeling [1]. Although ascorbic acid is accumulated by a number of human body tissues, it is most abundant in the pituitary, the adrenal gland and the gonads [2]. Ascorbic acid is essential for collagen biosynthesis, oxidation, hormone secretion, gamete production and gonadal tissue remodeling [3].

## 2. Ascorbic Acid and Collagen Biosynthesis

Collagen is a structural protein found in the extracellular matrix as a major tissue supporting module. Collagen synthesis occurs during tissue development as well as at sites of tissue damage. Collagen molecule is formed by three polypeptide strands (pro- collagen) twisted together to produce a trihelical conformation. Ascorbic acid is involved in the hydroxylation of proline and lysine residues, during the post- translational processing of pro- collagen. [4]. Hydroxyproline is necessary for collagen helix formation while hydroxylysine for collagen cross- link formation Expression studies with transgenic mice unable to produce vitamin C, proved that ascorbic acid deficiency leads to defective collagen synthesis and preservation [5-7].

In human reproduction, collagen synthesis is important for follicular development, luteum development and the remodeling of the ovulated follicle. Ovaries have long been recognized as a site of ascorbic acid accumulation, with the highest concentrations being found in thecal cells of the follicle, luteal cells of the corpus luteum, granulosa cells and the peripheral cytoplasm of the oocyte [8]. *In vitro* follicle culture systems supplemented with ascorbic acid, show increased number of intact follicles implying an increased potential of basal lamina expansion during development. Since scorbutic guinea pigs showed significant follicular degeneration and lack of ovulation, it is assumed that ascorbic acid is directly correlated to the biosynthesis of collagen, follicular growth and development [9, 10]. Ascorbic acid is also known to promote follicle survival by preventing apoptosis in preantral follicles subjected to oxidative stress [11].

## 3. Ascorbic Acid and Menstrual Cycle

The ovarian content of ascorbic acid changes throughout the menstrual cycle with ascorbic acid's excretion being increased in the late follicular phase, declined directly before ovulation and increased again immediately after ovulation [12]. The midcycle surge of Luteinizing Hormone (LH) triggers events within the follicle that lead in follicle rupture and luteinization of the follicle wall. In response to the LH preovulatory surge, ascorbic acid uptake by the ovaries is blocked, and ascorbic acid concentration is decreased, suggesting a regulatory function of the vitamin [13]. During the ovarian cycle, in response to LH, ovaries

produce increasing concentrations of progesterone. Ascorbic acid stimulates the production of progesterone by luteinizing granulosa cells and consequently increased progesterone concentrations block the uptake of ascorbic acid [14].

Ascorbic acid has also been implicated in the regulation of oxytocin secretion by the ovaries, suggesting a role in birth and breastfeeding [15]. It has been reported that ascorbic acid concentrations in luteal cells, corpus luteum and granulosa cell undergoes endocrine control while the presence of active ascorbic acid transport mechanisms in ovarian granulosa- luteal cells supports the major role of the vitamin in the menstrual cycle [16, 17].

Increased ascorbic acid concentration in follicular fluid compared to serum ascorbate's level during the ovulation and / or post- ovulation steroidogenesis, is suggestive for its important role in ovarian cycle [14, 18]. As the female reproductive system secretes estrogens and progesterone, to help develop corpus luteum ascorbic acid is perceived in all stages of luteal development with the highest amounts present in the midluteal phase while collagen as a main component of the luteal extracellular matrix shows the highest concentration in the mature tissue [19]. Ovulation and luteolysis are characterized by leukocytic infiltration known to generate superoxide in quantities sufficient to cause cell injury and death. Protection against Reactive Oxygen Species (ROS) is provided by ovarian antioxidants, most notably ascorbic acid and other vital agents, like vitamin E and glutathione [20-22]. Ascorbic acid inhibits apoptosis in granulosa cells, implying that this oxidant is important in the prevention of atresia and apoptosis [8, 17, 23].

### **3. Ascorbic Acid and Oxidative Stress in Female Reproduction**

In oocytes and embryos, various metabolic pathways and enzymes are known to produce endogenous ROS. ROS are produced continuously in mitochondria, due to the "leakage" of high energy electrons along the electron transport chain [24, 25]. Extensive research demonstrated that the production of ROS in early mouse embryos cultured *in vitro* is possibly due to the xanthine oxidase system [26] or other enzymatic systems and exogenous factors such as amine oxidase. Amine oxidases, a family of enzymes including monoamine and diamine oxidases (histaminases), tissue polyamine oxidases and serum oxidases are involved in the production of hydrogen peroxide and aldehydes. Hydrogen peroxide is involved in apoptosis and destroys cancer cells implanted into areas where cell death occurs. In mouse embryos progressive deterioration and death is correlates to hydrogen peroxide and/or aldehydes production by serum amine oxidase during oxidation of endogenous amines [27]. Oxygen consumption, metallic cations, visible light and spermatozoa are also implicated in the production of ROS [27-30] especially in the case of assisted reproductive technologies and *in vitro* fertilization. [31]. Porcine embryos cultured under low (5%) and high (20%) oxygen concentrations, showed differences in developmental outcome to the blastocyst stage, in the accumulation of hydrogen superoxide ( $H_2O_2$ ) as well as in DNA fragmentation. Low oxygen concentrations, decrease hydrogen superoxide content, leading to reduced DNA fragmentation and improved developmental potential [32].

## 5. Oxidative Stress

Oxidative stress is induced by both Reactive Oxygen Species (ROS) and Reactive Nitrogen Species (RNS). In physiological state, these damaging factors, a known as free radical species, are in balance with antioxidants in the human body. Any disturbance of this balance can result in the occurrence of oxidative stress in t cells.

From intracellular signaling networks to cell death: the dual role of reactive oxygen species in seed physiology.

Bailly C, El-Maarouf-Bouteau H, Corbineau F.

C R Biol. 2008 Oct;331(10):806-14. Epub 2008 Sep 4. Review.

### Reactive Oxygen Species (ROS)

Reactive oxygen species are generated constantly as part of normal aerobic life when oxygen is reduced along the electron transport chain in mitochondria [33]. They are formed as intermediates in a variety of normal enzyme reactions. ROS act as defense molecules, generated by phagocytes to kill invading pathogens. On the other hand, due to the presence of an unpaired electron, ROS can be extremely toxic for cells.

There are three main types of ROS: superoxide ( $O_2^-$ ), hydrogen peroxide ( $H_2O_2$ ) and hydroxyl (OH). Superoxide is produced as a byproduct of *mitochondrial respiration*. In *phagocytes*, superoxide is produced in large quantities by *NADPH oxidase* and is mainly used in oxygen-dependent killing mechanisms of invading pathogens. Superoxide is so toxic that intracellular levels above 1nM are lethal. In its *ihydroperoxyl* radical form, superoxide can initiate *lipid* peroxidation of polyunsaturated fatty acids. Hydrogen peroxide ( $H_2O_2$ ) is formed by the reaction between superoxide and superoxide dismutase (SOD). Through Fenton reaction, hydrogen peroxide can easily be converted to hydroxyl radicals, by interacting with  $Fe^{+2}$ . Hydroxyl radical has a very short *in vivo* half- life ( $10^{-9}$ sec) but is characterized by a high reactivity, thus making it deleterious for the cells. It is so toxic that can damage almost all biological macromolecules in a living cell; nucleic acids, lipids (lipid peroxidation), amino acids, and carbohydrates. ROS have been implicated in more than 100 diseases, including defects in the reproductive tract in humans.

### Reactive Nitrogen Species (RNS)

Reactive Nitrogen Species include molecules like nitric oxide (NO), nitrogen dioxide (NO<sub>2</sub>) and peroxyxynitrate [33]. Nitric oxide is synthesized during the enzymatic conversion of L- arginine to L- citrulline a reaction catalyzed by e nitric oxide synthase (NOS). There are three types of nitric oxide synthase, one of which is the endothelial NO synthase (eNOS synthase), eNOS is expressed in thecal cells, granulosa cells and in the surface of oocyte during the follicular development [34]. Nitric oxide is highly reactive and can damage



proteins, carbohydrates, nucleic acids and lipids. On the other hand it acts as a key signaling molecule in various physiological processes.

## Antioxidants

Under normal conditions, scavenging molecules act in the human body to detoxify free radicals. There are two main types of such molecules, widely known as antioxidants; the enzymatic and the non- enzymatic antioxidants.

### Enzymatic Antioxidants

Enzymatic antioxidants, also known as natural antioxidants, are protein molecules protecting cells from free radicals [33]. Three main enzymes are known to act as antioxidants in the human body; Superoxide Dismutase (SOD), Catalase and glutathione peroxidase. SODs are metal-containing enzymes that depend on a bound manganese, copper or zinc for their antioxidant activity and catalyze the conversion of two superoxides into hydrogen peroxide and oxygen. Hydrogen peroxide is less toxic than superoxide.. Nearly all organisms living in the presence of oxygen contain *isoforms* of *superoxide dismutase* (SOD), which also catalyzes the neutralization of superoxide. Catalase is found in liver and neutralizes hydrogen peroxide, producing water and oxygen. It completes the detoxification reaction started with SOD. Glutathione peroxidase, like catalase, degrades hydrogen peroxide. They also reduce organic peroxides to alcohols, providing another route for eliminating toxic oxidants. In addition to these enzymes, glutathione reductase, ceruloplasmine, hemoxygenase and possibly several other enzymes may participate in enzymatic control of oxygen radicals and their products.

### Non-Enzymatic Antioxidants

Non- enzymatic antioxidants, commonly known as dietary supplements, include small mass molecules, capable of detoxifying free radicals in the human body. Most important non-enzymatic antioxidants are vitamin E and C, glutathione, beta- carotene, carotene, selenium, zinc, uric acid, hypotaurine and taurine.

## 6. Oxidative Stress and Human Reproduction

Reactive Oxygen Species (ROS) have a dual role in human reproduction. They can serve as key signaling molecules mediating physiological processes involving the female reproductive tract, such as oocyte maturation, ovarian steroidogenesis, ovulation, implantation, formation of blastocyst, luteolysis and luteal maintenance in pregnancy [35-38]. A very fragile balance between ROS and antioxidant enzymes in the ovarian tissues exists

ROS play a role in pathological processes during menstrual cycle and pregnancy in females, as well as in sperm function in males. There is a growing literature concerning the effects of oxidative stress in female reproduction, showing involvement of ROS in the pathophysiology of pre-eclampsia [39-41], hydatidiform mole [42-44], free radical-induced birth defects [45], abortions [46], IUGR, infertility, diabetes and the effect on birth weight [47, 48]. In addition, male infertility has been correlated with increased generation of ROS in semen [49-53]. It has been observed that levels of ascorbic acid raises significantly from early trimester of pregnancy and reaches a peak at term, in all the placental and fetal tissues. This observation is an evidence of the increased requirements of antioxidant defense during gestational development. Vitamin C seems to play an important role in protecting fetal tissues from various abnormalities. Deficiencies in antioxidants during pregnancy as well as a placental oxidant-antioxidant imbalance, can affect fetoplacental unit development even in the absence of clinical symptoms [54].

## **7. Oxidative Stress and Ovarian Function**

ROS and NOS are involved in, folliculogenesis and steroidogenesis [55]. Biomarkers of OS are expressed in normal human ovaries but their concentration in the follicular fluid is significantly lower than in serum [35]. OS are involved in the pathophysiology of polycystic ovarian disease [56, 57]. In patients with tubal factor infertility undergoing ovarian stimulation, increased NO are disrupting to implantation and pregnancy, [58]. Moreover, as NO levels were higher in women with tubal or peritoneal factor infertility, a role of NO as an infertility factor is indicated [59].

## **8. Oxidative Stress and the Endometrium**

Conflicting findings exist concerning the levels of ROS in the peritoneal fluid and the possible implication in the pathophysiology of endometriosis. Increased generation of ROS by macrophages in the peritoneal fluid, as well as increased lipid peroxidation in patients with endometriosis, have been reported [60]. Further evidence on the role of oxidative stress in the pathophysiology of endometriosis are provided by studies regarding decreased peritoneal fluid antioxidants, elevated oxidized lipoproteins [61-63], and other lipid peroxidation markers [64-66]. Free radicals mediate the release of TNF- $\alpha$  by activated macrophages of the peritoneal fluid in patients with endometriosis, thus inducing toxic effects on gametes and leading to endometriosis [67]. While increased levels of NO and NOS have been found in the endometrium of women with endometriosis [68-70] further studies failed to demonstrate a positive correlation between ROS in the peritoneal fluid and endometriosis [71, 72]. However, larger cohort studies are needed for the evaluation of oxidative stress in the pathophysiology of endometriosis.

## 9. Oxidative Stress and Embryo Development

The fertilization and embryo development *in vivo* occur in a low oxygen environment [73]. This is evidenced by the increased implantation and pregnancy rates seen in ART procedures when antioxidant-supplemented medium is used rather than standard medium without antioxidants [74]. Furthermore, addition of ascorbic acid during cryopreservation reduces the levels of hydrogen peroxide, preventing the establishment of an oxidative environment in mammalian embryos [75]. Oxidative stress is implicated in defective embryo development and embryo growth retardation [76, 77], due to cell-membrane and DNA damage as well as induced apoptosis. Increased concentrations of ROS can have toxic effects on the intracellular and intercellular environment, which can result in impaired cellular growth in the embryo or embryo fragmentation. Subsequently, OS-mediated damage of cellular components can be harmful, as demonstrated by thalidomide-induced embryopathy [73, 78]

## 10. Preterm Labor and Miscarriage

Implantation and a subsequent successful pregnancy is a very well organized process involving complex interactions between embryo and uterine environment. Placentation includes a series of complicated events, that result in the establishment of maternal circulation in the placenta. During this process, OS markers are most abundant in normal pregnancies and under specific circumstances, can result in early pregnancy or recurrent pregnancy loss of unknown etiology [79, 80]. Although the role of OS in labor initiation remains unknown, a lot of studies indicate an increase of free radicals superoxide and nitric oxide as well as increased lipid peroxidation, induced by term labor [81, 82]. On the other hand, OS may also be implicated in preterm labor, due to focal collagen damage in the fetal membranes [34].

## 11. Oxidative Stress and Pre-Eclampsia

Pre-eclampsia (PE), a pregnancy-specific condition, with an incidence of about 5% of all pregnancies and 11% of all first pregnancies is a leading cause of maternal morbidity and mortality worldwide [34]. Clinical manifestations include hypertension and proteinuria after 20 weeks of gestation, in previously normotensive, non-proteinuric women [83]. Consequently, PE is still a major cause of intrauterine hypoxia and growth restriction (IUGR), preterm labor, and perinatal death. Although the pathophysiology of the disease remains undetermined it is proposed that endothelial cell dysfunction, incomplete trophoblast invasion and impaired placental perfusion, immune maladaptation and inflammation are involved. Once the diagnosis is established delivery remains the only successful therapeutic approach [84].

Oxidative stress (OS) is a major contributor to endothelial cell dysfunction and an imbalance between oxidants and antioxidants has been observed in women with established PE [85]. Altered release of placental debris may either cause this imbalance or be a consequence of it [86, 87]. In pre-eclamptic placenta ROS production seems increased, as evidenced by increased peroxynitrite formation [88]. The concentration of anti-oxidants, including vitamin C, in the maternal circulation is decreased in women with PE, possibly due to reduced anti-oxidant activity. Increased ROS combined with inadequate anti-oxidant capacity could potentially lead to lipid peroxidation, leukocyte activation, platelet adhesion, and vasoconstriction [89]. Accordingly, OS seems to be the link connecting defective trophoblast invasion causing placental hypoperfusion, endothelial dysfunction, immune maladaptation and inflammation [90].

### Vitamin C Supplementation and Pregnancy Outcomes

OS in women with established PE is supported by increased plasma and placenta levels of specific OS markers (8-epi-prostaglandin  $F_{2a}$  and lipid peroxide) combined with decreased levels of anti-oxidants such as vitamin C and E [91-93]. Maternal serum vitamin C levels during the second trimester in uncomplicated pregnancies are positively correlated with birth weight and length in full-term babies [47]. OS and free radicals have been implicated in several pregnancy related complications, including diabetic embryopathy, preterm labor, IUGR (Intrauterine Growth restriction) and luteal phase defect [94-97].

In the majority of clinical trials studying the supplementation with antioxidants a combination of vitamins C and E was used as their ratio was assumed to be of great importance. Multiple studies suggested that vitamin C exerts a “redox” recycling effect on oxidized vitamin E within lipoproteins and membranes, indicating that the combination of the two vitamins may be essential [98, 99].

A Cochrane review evaluated the effects of vitamin C supplementation, alone or combined with other supplements, on pregnancy outcomes, including PE. Five randomized controlled trials, involving 766 pregnant women were evaluated. No significant difference was found between women supplemented with vitamin C alone or combined with other supplements compared with placebo for the risk of stillbirth, perinatal death, birth weight, or IUGR even though they were at increased risk of giving birth preterm. Women supplemented with vitamin C combined with other supplements were at decreased risk for developing PE when using a fixed-effect model (RR 0.47, 95% CI 0.30-0.75), but the difference was not significant when using a random-effect model (RR 0.52, 95% CI 0.23-1.20). The authors considered the data to be inadequate to establish if vitamin C supplementation is beneficial during pregnancy [100].

A large number of surveys in high-risk populations have shown that antioxidant treatment lowered the prevalence of PE. In one of these randomized controlled trials, women at high-risk for PE were supplemented with antioxidants or placebo, starting at 16-22 weeks of gestation, with a daily dosage of 1000 mg of vitamin C and 400 IU of vitamin E. Only 8% of women receiving antioxidant vitamins developed PE versus 17% of the control group. In

addition, women supplemented with vitamins showed a 21% decrease in PE plasma markers during pregnancy [101].

More recent trials however, did not show an important reduction in the risk of PE or hypertensive gestational disorders, in women supplemented with vitamins C and E during pregnancy [102, 103]. A multicenter randomized placebo-controlled trial, among 1877 healthy women, between 14 and 22 weeks of gestation, supplemented with vitamin C and E (1000mg/day and 400 IU/day respectively) until delivery no reduction in the risks of PE, adverse neonatal outcomes, and IUGR was observed [104].

Studies that followed, tried to answer many unresolved problems such as whether antioxidant vitamins are beneficial in high risk women and women who had PE during previous pregnancy [105, 106]. In a subsequent randomized placebo-controlled trial, 2410 pregnancies at high risk of PE were enrolled at gestational age between 14<sup>+0</sup>-21<sup>+6</sup> weeks and received vitamins C and E or placebo until delivery. The results were not supportive of the prophylactic action of antioxidant vitamins as the rate of PE was not reduced in women at risk. In fact, earlier onset of PE and increased frequency in low birth weight babies were observed in women treated with vitamins [105]. Recently, another double-blind placebo controlled study, tried to link antioxidant therapy with PE. A total of 734 either hypertensive patients or patients with a medical history of PE were supplemented with a combined dosage of 1000mg/day for vitamin C and 400 IU/day for vitamin E or placebo starting between 12 and 19 weeks of gestation to delivery. The study showed no significant reduction in the incidence of PE between treated pregnant women and the placebo group (13.8% and 15.6%, respectively). Additionally no difference in mean gestational age at delivery, rates of perinatal mortality, abruptio placentae, preterm delivery and low birth weight infants was noted [106].

Other trials concerning different pregnancy complications came up with more promising results. Luteal phase defect is a common endocrine disorder associated with infertility and spontaneous miscarriage [107]. Henmi et al. [108] tried to assess the effectiveness of vitamin C supplementation in patients with such defects. In this study, the clinical pregnancy rate after treatment was significantly higher in the vitamin C supplementation group than the control group. Furthermore, 53% of supplemented with vitamin C cases were generally improved, whereas 22% of patients had spontaneous improvement.

Since the potential role of oxidative stress in pathophysiology of PE and other pregnancy complications was proposed, a large number of trials have been conducted in order to investigate the possible prophylactic or therapeutic role of antioxidant vitamins. The majority of these studies do not support routine vitamin C and E supplementation during pregnancy to reduce the risk of PE and other serious complications of pregnancy. Nevertheless, further investigation is required in order to answer questions concerning the dosage and the time of intervention that could provide more positive results in certain groups of patients.

#### Ascorbic Acid, Oxidative Stress and Male Infertility

The role of ascorbate in the male reproductive tract is identified since early '40's with studies reporting direct effects of ascorbate deficiency on male fertility. Low or deficient ascorbate levels have been correlated with low sperm counts, increased numbers of abnormal

sperm, reduced motility and agglutination [109-112]. Decreased ascorbate concentrations in semen are associated with poor breeding performance in bulls, while scorbutic guinea pigs developed defective testicular germinal epithelium [113]. Such studies suggest that ascorbate deficiency can be harmful both to the structure and function of the male reproductive tract. In vitro loss of spermatozoa's motility in human sperm, incubated under high oxygen tensions [114] was also demonstrated. This motility loss is mediated by peroxidative damage to the sperm plasma membrane which is normally enriched with unsaturated fatty acids to become flexible enough to participate to oocyte fertilization [115]. Due to this special constitution plasma membrane is susceptible to peroxidative damage, as ROS attack the double bonds associated with the membrane's fatty acids. Spermatozoa's cytoplasm contains low concentrations of scavenging enzymes [116], while seminal plasma is rich in antioxidants that protects the spermatozoa from oxidative damage [117]. These include protective enzymes that are secreted into the extracellular space (e.g. glutathione peroxidase, superoxide dismutase), as well as small molecular mass scavengers, such as vitamin C, hypotaurine, uric acid and alpha tocopherol [118]. Ejaculates from infertile men show decreased seminal antioxidant capacity and exhibit an inverse correlation with fertility [119-121]. Since similar levels of antioxidant enzymes are present in seminal plasma (SOD and catalase) of fertile and infertile individuals, it is suggested that reduced antioxidant activity in seminal plasma correlates to oxidative damage in spermatozoa, due to deficiencies in small molecular mass scavengers, such as vitamin C [51, 122, 123]. There are several studies that suggest that male infertility would be improved by dietary vitamin C increased intake [112, 124, 125].

## References

- [1] Millar, J. Vitamin C--the primate fertility factor? *Med Hypotheses*, 1992 38, 292-5.
- [2] Chinoy, NJ. Ascorbic acid levels in mammalian tissues and its metabolic significance. *Comp Biochem Physiol A Comp Physiol*, 1972 42, 945-52.
- [3] Luck, MR; Jeyaseelan, IScholes, RA. Ascorbic acid and fertility. *Biol Reprod*, 1995 52, 262-6.
- [4] Padh, H. Vitamin C: newer insights into its biochemical functions. *Nutr Rev*, 1991 49, 65-70.
- [5] Pinnell, SR. Regulation of collagen biosynthesis by ascorbic acid: a review. *Yale J Biol Med*, 1985 58, 553-9.
- [6] Wisdom, SJ; Wilson, R; McKillop, JHWalker, JJ. Antioxidant systems in normal pregnancy and in pregnancy-induced hypertension. *Am J Obstet Gynecol*, 1991 165, 1701-4.
- [7] Maeda, N; Hagihara, H; Nakata, Y; Hiller, S; Wilder, JReddick, R. Aortic wall damage in mice unable to synthesize ascorbic acid. *Proc Natl Acad Sci U S A*, 2000 97, 841-6.
- [8] Zreik, TG; Kodaman, PH; Jones, EE; Olive, DLBehrman, H. Identification and characterization of an ascorbic acid transporter in human granulosa-lutein cells. *Mol Hum Reprod*, 1999 5, 299-302.

- 
- [9] Rose, UM; Hanssen, RGKloosterboer, HJ. Development and characterization of an in vitro ovulation model using mouse ovarian follicles. *Biol Reprod*, 1999 61, 503-11.
- [10] Murray, AA; Molinek, MD; Baker, SJ; Kojima, FN; Smith, MF; Hillier, SGSpears, N. Role of ascorbic acid in promoting follicle integrity and survival in intact mouse ovarian follicles in vitro. *Reproduction*, 2001 121, 89-96.
- [11] Murray, M; Sefton, RM; Croft, KDButler, AM. Differential regulation of endobiotic-oxidizing cytochromes P450 in vitamin A-deficient male rat liver. *Br J Pharmacol*, 2001 134, 1487-97.
- [12] Loh, HSWilson, CW. Relationship of human ascorbic-acid metabolism to ovulation. *Lancet*, 1971 1, 110-2.
- [13] Parlow, AF. A rapid bioassay method for LH and factors stimulating LH secretion. *Fed Proc*, 1958 17, 402.
- [14] Stansfield, DAFInt, AP. The entry of ascorbic acid into the corpus luteum in vivo and in vitro and the effect of luteinizing hormone. *J Endocrinol*, 1967 39, 27-35.
- [15] Luck, MRJungclas, B. Catecholamines and ascorbic acid as stimulators of bovine ovarian oxytocin secretion. *J Endocrinol*, 1987 114, 423-30.
- [16] Sato, T; Iesaka, T; Jyujou, T; Taya, KIshikawa, J. Prostaglandin-induced ovarian ascorbic acid depletion. *Endocrinology*, 1974 95, 417-20.
- [17] Behrman, HR; Preston, SL; Aten, RF; Rinaudo, PZreik, TG. Hormone induction of ascorbic acid transport in immature granulosa cells. *Endocrinology*, 1996 137, 4316-21.
- [18] Aten, RF; Duarte, KMBehrman, HR. Regulation of ovarian antioxidant vitamins, reduced glutathione, and lipid peroxidation by luteinizing hormone and prostaglandin F2 alpha. *Biol Reprod*, 1992 46, 401-7.
- [19] Luck, MRZhao, Y. Identification and measurement of collagen in the bovine corpus luteum and its relationship with ascorbic acid and tissue development. *J Reprod Fertil*, 1993 99, 647-52.
- [20] Buettner, GR. The pecking order of free radicals and antioxidants: lipid peroxidation, alpha-tocopherol, and ascorbate. *Arch Biochem Biophys*, 1993 300, 535-43.
- [21] Frei, B. Reactive oxygen species and antioxidant vitamins: mechanisms of action. *Am J Med*, 1994 97, 5S-13S; discussion 22S-28S.
- [22] Meister, A. Glutathione-ascorbic acid antioxidant system in animals. *J Biol Chem*, 1994 269, 9397-400.
- [23] Tilly, JLTilly, KI. Inhibitors of oxidative stress mimic the ability of follicle-stimulating hormone to suppress apoptosis in cultured rat ovarian follicles. *Endocrinology*, 1995 136, 242-52.
- [24] Miquel, J; Economos, AC; Fleming, JJohnson, JE, Jr. Mitochondrial role in cell aging. *Exp Gerontol*, 1980 15, 575-91.
- [25] Shigenaga, MK; Hagen, TMAMES, BN. Oxidative damage and mitochondrial decay in aging. *Proc Natl Acad Sci U S A*, 1994 91, 10771-8.
- [26] Nasr-Esfahani, MMJohnson, MH. The origin of reactive oxygen species in mouse embryos cultured in vitro. *Development*, 1991 113, 551-60.
- [27] Parchment, RE; Lewellyn, A; Swartzendruber, DPierce, GB. Serum amine oxidase activity contributes to crisis in mouse embryo cell lines. *Proc Natl Acad Sci U S A*, 1990 87, 4340-4.

- [28] Nasr-Esfahani, M; Johnson, MHAitken, RJ. The effect of iron and iron chelators on the in-vitro block to development of the mouse preimplantation embryo: BAT6 a new medium for improved culture of mouse embryos in vitro. *Hum Reprod*, 1990 5, 997-1003.
- [29] Alvarez, JG; Minaretzis, D; Barrett, CB; Mortola, JFThompson, IE. The sperm stress test: a novel test that predicts pregnancy in assisted reproductive technologies. *Fertil Steril*, 1996 65, 400-5.
- [30] Wang, X; Falcone, T; Attaran, M; Goldberg, JM; Agarwal, ASharma, RK. Vitamin C and vitamin E supplementation reduce oxidative stress-induced embryo toxicity and improve the blastocyst development rate. *Fertil Steril*, 2002 78, 1272-7.
- [31] Betts, DHMadan, P. Permanent embryo arrest: molecular and cellular concepts. *Mol Hum Reprod*, 2008 14, 445-53.
- [32] Kitagawa, Y; Suzuki, K; Yoneda, AWatanabe, T. Effects of oxygen concentration and antioxidants on the in vitro developmental ability, production of reactive oxygen species (ROS), and DNA fragmentation in porcine embryos. *Theriogenology*, 2004 62, 1186-97.
- [33] Bailly, C; El-Maarouf-Bouteau, HCorbineau, F. From intracellular signaling networks to cell death: the dual role of reactive oxygen species in seed physiology. *C R Biol*, 2008 331, 806-14.
- [34] Agarwal, A; Gupta, SSharma, RK. Role of oxidative stress in female reproduction. *Reprod Biol Endocrinol*, 2005 3, 28.
- [35] Jozwik, M; Wolczynski, SSzamatowicz, M. Oxidative stress markers in preovulatory follicular fluid in humans. *Mol Hum Reprod*, 1999 5, 409-13.
- [36] Suzuki, T; Sugino, N; Fukaya, T; Sugiyama, S; Uda, T; Takaya, R; Yajima, ASasano, H. Superoxide dismutase in normal cycling human ovaries: immunohistochemical localization and characterization. *Fertil Steril*, 1999 72, 720-6.
- [37] Ishikawa, M. [Oxygen radicals-superoxide dismutase system and reproduction medicine]. *Nippon Sanka Fujinka Gakkai Zasshi*, 1993 45, 842-8.
- [38] Vega, M; Johnson, MC; Diaz, HA; Urrutia, LR; Troncoso, JLDevoto, L. Regulation of human luteal steroidogenesis in vitro by nitric oxide. *Endocrine*, 1998 8, 185-91.
- [39] Tranquilli, AL; Bezzeccheri, V; Giannubilo, SR; Scagnoli, C; Mazzanti, LGarzetti, GG. Amniotic vascular endothelial growth factor (VEGF) and nitric oxide (NO) in women with subsequent preeclampsia. *Eur J Obstet Gynecol Reprod Biol*, 2004 113, 17-20.
- [40] Takagi, Y; Nikaido, T; Toki, T; Kita, N; Kanai, M; Ashida, T; Ohira, SKonishi, I. Levels of oxidative stress and redox-related molecules in the placenta in preeclampsia and fetal growth restriction. *Virchows Arch*, 2004 444, 49-55.
- [41] Sagol, S; Ozkinay, EOzsener, S. Impaired antioxidant activity in women with preeclampsia. *Int J Gynaecol Obstet*, 1999 64, 121-7.
- [42] Harma, M; Kocyigit, ADemir, N. Role of plasma nitric oxide in complete hydatidiform mole. *Eur J Gynaecol Oncol*, 2004 25, 333-5.
- [43] Harma, MKocyigit, A. Comparison of protein carbonyl and total plasma thiol concentrations in patients with complete hydatidiform mole with those in healthy pregnant women. *Acta Obstet Gynecol Scand*, 2004 83, 857-60.



- [44] Harma, M, Erel, O. Increased oxidative stress in patients with hydatidiform mole. *Swiss Med Wkly*, 2003 133, 563-6.
- [45] Loeken, MR. Free radicals and birth defects. *J Matern Fetal Neonatal Med*, 2004 15, 6-14.
- [46] Lagod, L; Paszkowski, T; Sikorski, R, Rola, R. [The antioxidant-prooxidant balance in pregnancy complicated by spontaneous abortion]. *Ginekol Pol*, 2001 72, 1073-8.
- [47] Lee, BE; Hong, YC; Lee, KH; Kim, YJ; Kim, WK; Chang, NS; Park, EA; Park, HSHann, HJ. Influence of maternal serum levels of vitamins C and E during the second trimester on birth weight and length. *Eur J Clin Nutr*, 2004 58, 1365-71.
- [48] Jain, SK; Wise, R; Yanamandra, K; Dhanireddy, R, Bocchini, JA, Jr. The effect of maternal and cord-blood vitamin C, vitamin E and lipid peroxide levels on newborn birth weight. *Mol Cell Biochem*, 2008 309, 217-21.
- [49] Aitken, RJ, Clarkson, JS. Cellular basis of defective sperm function and its association with the genesis of reactive oxygen species by human spermatozoa. *J Reprod Fertil*, 1987 81, 459-69.
- [50] Aitken, RJ; Clarkson, JS, Fishel, S. Generation of reactive oxygen species, lipid peroxidation, and human sperm function. *Biol Reprod*, 1989 41, 183-97.
- [51] Aitken, RJ, Krausz, C. Oxidative stress, DNA damage and the Y chromosome. *Reproduction*, 2001 122, 497-506.
- [52] Sharma, R, Agarwal, A. Role of reactive oxygen species in male infertility. *Urology*, 1996 48, 835-50.
- [53] Sikka, SC. Relative impact of oxidative stress on male reproductive function. *Curr Med Chem*, 2001 8, 851-62.
- [54] Hininger, I; Favier, M; Arnaud, J; Faure, H; Thoulon, JM; Hariveau, E; Favier, A, Roussel, AM. Effects of a combined micronutrient supplementation on maternal biological status and newborn anthropometrics measurements: a randomized double-blind, placebo-controlled trial in apparently healthy pregnant women. *Eur J Clin Nutr*, 2004 58, 52-9.
- [55] Shiotani, M; Noda, Y; Narimoto, K; Imai, K; Mori, T; Fujimoto, K, Ogawa, K. Immunohistochemical localization of superoxide dismutase in the human ovary. *Hum Reprod*, 1991 6, 1349-53.
- [56] Sabuncu, T; Vural, H, Harma, M. Oxidative stress in polycystic ovary syndrome and its contribution to the risk of cardiovascular disease. *Clin Biochem*, 2001 34, 407-13.
- [57] Yilmaz, M; Bukan, N; Ayvaz, G; Karakoc, A; Toruner, F; Cakir, N, Arslan, M. The effects of rosiglitazone and metformin on oxidative stress and homocysteine levels in lean patients with polycystic ovary syndrome. *Hum Reprod*, 2005 20, 3333-40.
- [58] Battaglia, C; Regnani, G; Marsella, T; Facchinetti, F; Volpe, A; Venturoli, S, Flamigni, C. Adjuvant L-arginine treatment in controlled ovarian hyperstimulation: a double-blind, randomized study. *Hum Reprod*, 2002 17, 659-65.
- [59] Lee, TH; Wu, MY; Chen, MJ; Chao, KH; Ho, H, Yang, YS. Nitric oxide is associated with poor embryo quality and pregnancy outcome in in vitro fertilization cycles. *Fertil Steril*, 2004 82, 126-31.

- [60] Zeller, JM; Henig, I; Radwanska, EDmowski, WP. Enhancement of human monocyte and peritoneal macrophage chemiluminescence activities in women with endometriosis. *Am J Reprod Immunol Microbiol*, 1987 13, 78-82.
- [61] Murphy, AA; Palinski, W; Rankin, S; Morales, AJParthasarathy, S. Evidence for oxidatively modified lipid-protein complexes in endometrium and endometriosis. *Fertil Steril*, 1998 69, 1092-4.
- [62] Murphy, AA; Palinski, W; Rankin, S; Morales, AJParthasarathy, S. Macrophage scavenger receptor(s) and oxidatively modified proteins in endometriosis. *Fertil Steril*, 1998 69, 1085-91.
- [63] Murphy, AA; Santanam, N; Morales, AJParthasarathy, S. Lysophosphatidyl choline, a chemotactic factor for monocytes/T-lymphocytes is elevated in endometriosis. *J Clin Endocrinol Metab*, 1998 83, 2110-3.
- [64] Liu, Y; Luo, LZhao, H. Levels of lipid peroxides and superoxide dismutase in peritoneal fluid of patients with endometriosis. *J Tongji Med Univ*, 2001 21, 166-7.
- [65] Ho, HN; Wu, MY; Chen, SU; Chao, KH; Chen, CDYang, YS. Total antioxidant status and nitric oxide do not increase in peritoneal fluids from women with endometriosis. *Hum Reprod*, 1997 12, 2810-5.
- [66] Szczepanska, M; Kozlik, J; Skrzypczak, JMikolajczyk, M. Oxidative stress may be a piece in the endometriosis puzzle. *Fertil Steril*, 2003 79, 1288-93.
- [67] Lee, KS; Joo, BS; Na, YJ; Yoon, MS; Choi, OHKim, WW. Relationships between concentrations of tumor necrosis factor-alpha and nitric oxide in follicular fluid and oocyte quality. *J Assist Reprod Genet*, 2000 17, 222-8.
- [68] Ota, H; Igarashi, S; Hatazawa, JTanaka, T. Endothelial nitric oxide synthase in the endometrium during the menstrual cycle in patients with endometriosis and adenomyosis. *Fertil Steril*, 1998 69, 303-8.
- [69] Khorram, OLessey, BA. Alterations in expression of endometrial endothelial nitric oxide synthase and alpha(v)beta(3) integrin in women with endometriosis. *Fertil Steril*, 2002 78, 860-4.
- [70] Wu, MY; Chao, KH; Yang, JH; Lee, TH; Yang, YSHo, HN. Nitric oxide synthesis is increased in the endometrial tissue of women with endometriosis. *Hum Reprod*, 2003 18, 2668-71.
- [71] Bedaiwy, MA; Falcone, T; Sharma, RK; Goldberg, JM; Attaran, M; Nelson, DRAgarwal, A. Prediction of endometriosis with serum and peritoneal fluid markers: a prospective controlled trial. *Hum Reprod*, 2002 17, 426-31.
- [72] Wang, Y; Sharma, RK; Falcone, T; Goldberg, JAgarwal, A. Importance of reactive oxygen species in the peritoneal fluid of women with endometriosis or idiopathic infertility. *Fertil Steril*, 1997 68, 826-30.
- [73] Burton, GJ; Hempstock, JJauniaux, E. Oxygen, early embryonic metabolism and free radical-mediated embryopathies. *Reprod Biomed Online*, 2003 6, 84-96.
- [74] Catt, JWWhenman, M. Toxic effects of oxygen on human embryo development. *Hum Reprod*, 2000 15 Suppl 2, 199-206.
- [75] Lane, M; Maybach, JM Gardner, DK. Addition of ascorbate during cryopreservation stimulates subsequent embryo development. *Hum Reprod*, 2002 17, 2686-93.

- [76] Guerin, P; El Mouatassim, SMenezo, Y. Oxidative stress and protection against reactive oxygen species in the pre-implantation embryo and its surroundings. *Hum Reprod Update*, 2001 7, 175-89.
- [77] Agarwal, A; Saleh, RABedaiwy, MA. Role of reactive oxygen species in the pathophysiology of human reproduction. *Fertil Steril*, 2003 79, 829-43.
- [78] Parman, T; Wiley, MJWells, PG. Free radical-mediated oxidative DNA damage in the mechanism of thalidomide teratogenicity. *Nat Med*, 1999 5, 582-5.
- [79] Jauniaux, E; Watson, AL; Hempstock, J; Bao, YP; Skepper, JNBurton, GJ. Onset of maternal arterial blood flow and placental oxidative stress. A possible factor in human early pregnancy failure. *Am J Pathol*, 2000 157, 2111-22.
- [80] Jauniaux, E; Hempstock, J; Greenwold, NBurton, GJ. Trophoblastic oxidative stress in relation to temporal and regional differences in maternal placental blood flow in normal and abnormal early pregnancies. *Am J Pathol*, 2003 162, 115-25.
- [81] Myatt, LCui, X. Oxidative stress in the placenta. *Histochem Cell Biol*, 2004 122, 369-82.
- [82] Mocatta, TJ; Winterbourn, CC; Inder, TEDarlow, BA. The effect of gestational age and labour on markers of lipid and protein oxidation in cord plasma. *Free Radic Res*, 2004 38, 185-91.
- [83] Roberts, JMLain, KY. Recent Insights into the pathogenesis of pre-eclampsia. *Placenta*, 2002 23, 359-72.
- [84] ACOG practice bulletin. Diagnosis and management of preeclampsia and eclampsia. Number 33, January 2002. *Obstet Gynecol*, 2002 99, 159-67.
- [85] Biesalski, HKMcGregor, GP. Antioxidant therapy in critical care--is the microcirculation the primary target? *Crit Care Med*, 2007 35, S577-83.
- [86] Redman, CWSargent, IL. Placental debris, oxidative stress and pre-eclampsia. *Placenta*, 2000 21, 597-602.
- [87] Chua, S; Wilkins, T; Sargent, IRedman, C. Trophoblast deportation in pre-eclamptic pregnancy. *Br J Obstet Gynaecol*, 1991 98, 973-9.
- [88] Myatt, L; Rosenfield, RB; Eis, AL; Brockman, DE; Greer, Ilyall, F. Nitrotyrosine residues in placenta. Evidence of peroxynitrite formation and action. *Hypertension*, 1996 28, 488-93.
- [89] Hubel, CA. Oxidative stress in the pathogenesis of preeclampsia. *Proc Soc Exp Biol Med*, 1999 222, 222-35.
- [90] Roberts, JMRedman, CW. Pre-eclampsia: more than pregnancy-induced hypertension. *Lancet*, 1993 341, 1447-51.
- [91] Hubel, CA; McLaughlin, MK; Evans, RW; Hauth, BA; Sims, CJRoberts, JM. Fasting serum triglycerides, free fatty acids, and malondialdehyde are increased in preeclampsia, are positively correlated, and decrease within 48 hours post partum. *Am J Obstet Gynecol*, 1996 174, 975-82.
- [92] Staff, AC; Halvorsen, B; Ranheim, THenriksen, T. Elevated level of free 8-iso-prostaglandin F<sub>2</sub>alpha in the decidua basalis of women with preeclampsia. *Am J Obstet Gynecol*, 1999 181, 1211-5.

- [93] Wang, YWalsh, SW. Antioxidant activities and mRNA expression of superoxide dismutase, catalase, and glutathione peroxidase in normal and preeclamptic placentas. *J Soc Gynecol Investig*, 1996 3, 179-84.
- [94] Karowicz-Bilinska, A; Suzin, JSieroszewski, P. Evaluation of oxidative stress indices during treatment in pregnant women with intrauterine growth retardation. *Med Sci Monit*, 2002 8, CR211-6.
- [95] Raijmakers, MT; Dechend, RPoston, L. Oxidative stress and preeclampsia: rationale for antioxidant clinical trials. *Hypertension*, 2004 44, 374-80.
- [96] Rodrigo, R; Parra, M; Bosco, C; Fernandez, V; Barja, P; Guajardo, JMessina, R. Pathophysiological basis for the prophylaxis of preeclampsia through early supplementation with antioxidant vitamins. *Pharmacol Ther*, 2005 107, 177-97.
- [97] Woods, JR, Jr.; Plessinger, MAMiller, RK. Vitamins C and E: missing links in preventing preterm premature rupture of membranes? *Am J Obstet Gynecol*, 2001 185, 5-10.
- [98] Hamilton, IM; Gilmore, WS; Benzie, IF; Mulholland, CWStrain, JJ. Interactions between vitamins C and E in human subjects. *Br J Nutr*, 2000 84, 261-7.
- [99] May, JM; Qu, ZCMendiratta, S. Protection and recycling of alpha-tocopherol in human erythrocytes by intracellular ascorbic acid. *Arch Biochem Biophys*, 1998 349, 281-9.
- [100] Rumbold, ACrowther, CA. Vitamin C supplementation in pregnancy. *Cochrane Database Syst Rev*, 2005 CD004072.
- [101] Chappell, LC; Seed, PT; Briley, AL; Kelly, FJ; Lee, R; Hunt, BJ; Parmar, K; Bewley, SJ; Shennan, AH; Steer, PJPoston, L. Effect of antioxidants on the occurrence of preeclampsia in women at increased risk: a randomised trial. *Lancet*, 1999 354, 810-6.
- [102] Beazley, D; Ahokas, R; Livingston, J; Griggs, MSibai, BM. Vitamin C and E supplementation in women at high risk for preeclampsia: a double-blind, placebo-controlled trial. *Am J Obstet Gynecol*, 2005 192, 520-1.
- [103] Rumbold, A; Duley, L; Crowther, CAHaslam, RR. Antioxidants for preventing preeclampsia. *Cochrane Database Syst Rev*, 2008 CD004227.
- [104] Rumbold, AR; Crowther, CA; Haslam, RR; Dekker, GARobinson, JS. Vitamins C and E and the risks of preeclampsia and perinatal complications. *N Engl J Med*, 2006 354, 1796-806.
- [105] Poston, L; Briley, AL; Seed, PT; Kelly, FJShennan, AH. Vitamin C and vitamin E in pregnant women at risk for pre-eclampsia (VIP trial): randomised placebo-controlled trial. *Lancet*, 2006 367, 1145-54.
- [106] Spinnato, JA, 2nd; Freire, S; Pinto, ESJL; Cunha Rudge, MV; Martins-Costa, S; Koch, MA; Goco, N; Santos Cde, B; Cecatti, JG; Costa, R; Ramos, JG; Moss, NSibai, BM. Antioxidant therapy to prevent preeclampsia: a randomized controlled trial. *Obstet Gynecol*, 2007 110, 1311-8.
- [107] Insler, V. Corpus luteum defects. *Curr Opin Obstet Gynecol*, 1992 4, 203-11.
- [108] Henmi, H; Endo, T; Kitajima, Y; Manase, K; Hata, HKudo, R. Effects of ascorbic acid supplementation on serum progesterone levels in patients with a luteal phase defect. *Fertil Steril*, 2003 80, 459-61.
- [109] Wilson, L. Sperm agglutinins in human semen and blood. *Proc Soc Exp Biol Med*, 1954 85, 652-5.

- 
- [110] Kupperman, HSEpstein, JA. Endocrine therapy of sterility. *Am Pract Dig Treat*, 1958 9, 547-63.
- [111] Harris, WA; Harden, TEDawson, EB. Apparent effect of ascorbic acid medication on semen metal levels. *Fertil Steril*, 1979 32, 455-9.
- [112] Dawson, EB; Harris, WAPowell, LC. Relationship between ascorbic acid and male fertility. *World Rev Nutr Diet*, 1990 62, 1-26.
- [113] Phillips, PHLardy, HA. A Yolk-Buffer Pabulum for the Preservation of Bull Semen *J Dairy Sci*, 1940 23, 399-404.
- [114] MacLeod, J. The role of oxygen in the metabolism and motility of human spermatozoa. *Am J Physiol*, 1943 138, 512-518.
- [115] Jones, R; Mann, TSherins, R. Peroxidative breakdown of phospholipids in human spermatozoa, spermicidal properties of fatty acid peroxides, and protective action of seminal plasma. *Fertil Steril*, 1979 31, 531-7.
- [116] Saleh, RA Agarwal, A. Oxidative stress and male infertility: from research bench to clinical practice. *J Androl*, 2002 23, 737-52.
- [117] Potts, RJ; Notarianni, LJJefferies, TM. Seminal plasma reduces exogenous oxidative damage to human sperm, determined by the measurement of DNA strand breaks and lipid peroxidation. *Mutat Res*, 2000 447, 249-56.
- [118] van Overveld, FW; Haenen, GR; Rhemrev, J; Vermeiden, JPBast, A. Tyrosine as important contributor to the antioxidant capacity of seminal plasma. *Chem Biol Interact*, 2000 127, 151-61.
- [119] Smith, R; Vantman, D; Ponce, J; Escobar, JLissi, E. Total antioxidant capacity of human seminal plasma. *Hum Reprod*, 1996 11, 1655-60.
- [120] Barbieri, ER; Hidalgo, ME; Venegas, A; Smith, RLissi, EA. Varicocele-associated decrease in antioxidant defenses. *J Androl*, 1999 20, 713-7.
- [121] Hendin, BN; Kolettis, PN; Sharma, RK; Thomas, AJ, Jr. Agarwal, A. Varicocele is associated with elevated spermatozoal reactive oxygen species production and diminished seminal plasma antioxidant capacity. *J Urol*, 1999 161, 1831-4.
- [122] Zini, A; Finelli, A; Phang, DJarvi, K. Influence of semen processing technique on human sperm DNA integrity. *Urology*, 2000 56, 1081-4.
- [123] Zini, A; Garrels, KPhang, D. Antioxidant activity in the semen of fertile and infertile men. *Urology*, 2000 55, 922-6.
- [124] Akmal, M; Qadri, JQ; Al-Waili, NS; Thangal, S; Haq, ASaloom, KY. Improvement in human semen quality after oral supplementation of vitamin C. *J Med Food*, 2006 9, 440-2.
- [125] Eskenazi, B; Kidd, SA; Marks, AR; Slotter, E; Block, GWyrobek, AJ. Antioxidant intake is associated with semen quality in healthy men. *Hum Reprod*, 2005 20, 1006-12.



---

## **Effects of Vitamin C on Oxidative Stress-Induced Molecular Pathways in Epilepsy**

---

*Mustafa Nazırođlu\**

Department of Biophysics, Medical Faculty, Süleyman Demirel University,  
Isparta, Turkey

### **Abstract**

Epileptic seizures result from excessive discharge in a population of hyperexcitable neurons. Excessive production of ROS (reactive oxygen species) is thought to contribute to epilepsy, and there is a potential connection between ROS and mitochondrial dysfunction in epilepsy. Free radical generation can also induce seizure activity by direct activation of glutamine synthetase, thereby permitting an abnormal buildup of glutamic acid, the excitatory neurotransmitter. The brain is extremely susceptible to oxidative damage induced by these ROS because it generates extremely high levels of ROS due to its very high aerobic metabolism and blood perfusion, and it has a relatively poor enzymatic antioxidant defense. Recent research on vitamin C (ascorbic acid, or ascorbate) has pointed out novel mechanisms of its action such as that of neuromodulator in addition to its well-known antioxidant activity. In the current study, I review the dose-dependent effects of ascorbate in intracellular signaling pathways of oxidative stress in epilepsy, focusing on its modulation of neuronal survival. I also focus on ascorbic acid deficiency and treatments in intracellular signaling pathways in the brain as well as in dietary requirements, and I discuss the effects of antiepileptic drugs on plasma ascorbate levels. I conclude with a note on the putative protective role of vitamin C in the neurodegenerative process as well as in epileptic diseases.

---

\* Corresponding address: Prof. Dr. Mustafa Nazırođlu, Department of Biophysics, Medical Faculty, Süleyman Demirel University, TR-32260, Morfoloji Binasi, Cünür, Isparta, Turkey. Tel: +90 246 2113310; Fax: +90 246 2371165; E-mail: mnaziroglu@med.sdu.edu.tr

**Keywords:** Vitamin C, ascorbate, calcium ions, non-antioxidant, oxidative stress, brain, neurodegeneration, epilepsy.

## List of Abbreviations

ADPR	ADP-Ribose
CNS	central nervous system
CSF	cerebrospinal fluid
MDA	malondialdehyde
NMDA	N-methyl-D-aspartate
PARP-1	polyADP-ribose polymerase 1
PTZ	pentylentetrazole
ROS	reactive oxygen species
SOD	superoxide dismutase
TBARS	thiobarbituric acid reactive substances
TRPM2	transient potential melastatin 2

## Introduction

Epilepsies are chronic dynamic significant medical problems. Some types of epilepsy, such as status epilepticus, have a mortality rate of 10–12%. The development of epilepsy is a plastic-adaptive process. This condition is characterized by prolonged or repetitive epileptic discharges resulting in persistent clinical alterations of normal brain function and cognitive state. Recent studies suggest that seizures can be associated with oxidative stress [1,2]. Free radical generation can induce seizure activity by direct activation of glutamine synthetase, thereby permitting an abnormal buildup of excitatory neurotransmitter glutamic acid. The onset of oxygen-induced convulsions in epileptic patients and animals is correlated with a decrease in the cerebral content of GABA, the neurotransmitter, because of the inhibition of the enzyme glutamate decarboxylase by reactive oxygen species (ROS). If ROS are not controlled by the enzymatic and nonenzymatic antioxidants, they can cause oxidative injury, i.e., peroxidation of cell membrane phospholipids, proteins (receptor and enzymes) and DNA. The brain is extremely susceptible to oxidative damage induced by these ROS because it generates extremely high levels of ROS due to its very high aerobic metabolism and blood perfusion, and it has a relatively poor enzymatic antioxidant defense [3]. The brain contains polyunsaturated fatty acids which can readily be peroxidized [4]. Lipid peroxidation causes injury to cells and intracellular membranes and may lead to cell destruction and subsequently cell death. Brains are protected by antioxidants from peroxidative damage [5]. It has been suggested that ascorbic acid has neuroprotective properties in some experimental models of seizure activity induced by various agents such as iron, methylmalonic acid and pentylentetrazole (PTZ) [6]. Ascorbate, the anionic form of L-ascorbic acid, is a water-soluble antioxidant vitamin that is found throughout the body and is highly concentrated in the brain. Vitamin C—ascorbic acid, or ascorbate—has also many functions in the brain and



in the neuronal microenvironment; it functions as a neuromodulator as well as an antioxidant/free radical scavenger [7,8].

## Oxidative Stress

Free radicals are frequent products of biological redox reactions and invariably those involving one-electron transfer processes. They are also generated in biological systems as a result of exposure to a wide variety of external factors including certain drugs, pollutants, heavy metals, heat, UV or visible light, and other forms of ionizing radiation [9, 10]. The generation of the reactive species in an uncontrolled fashion causes significant reversible or irreversible damage to a wide range of biological molecules including DNA, lipids, proteins, carbohydrates or any nearby molecule causing a cascade of chain reactions resulting in cellular damage and disease [11]. Many of these processes are chain reactions with a single initiating radical species which is propagated to large number of target molecules. There is considerable interest in the reactions of these species, the damage they induce, and their relationship in the physiology and pathology of a variety of diseases and processes including cancer [10]. There are two major types of free radical species: reactive oxygen species (ROS) and reactive nitrogen species (RNS).

Three major types of ROS are superoxide ( $O_2^{\cdot-}$ ), hydrogen peroxide ( $H_2O_2$ ) and hydroxyl radical ( $OH^{\cdot}$ ). Superoxide, although a free radical, is not a particularly damaging species: it is mostly reductive in nature and its main significance is probably as a source of  $H_2O_2$  and as a reductant of transition metal ions. Its reaction with nitric oxide (NO) radical, which is presently believed to be the identity of Endothelium Derived Relaxing Factor, may also prove to be to be physiological important [11].  $H_2O_2$  is an oxidising agent but not especially reactive and its main significance lies in it being a source of hydroxyl radicals in the presence of reactive transition metal ions. In the absence of metal catalysts, superoxide and  $H_2O_2$  are readily removed (see below) and are virtually harmless. Some oxidative enzymes can directly generate the  $H_2O_2$  radical. The hydroxyl radical is an extremely reactive oxidizing radical that will react with most biomolecules at diffusion- controlled rates. It therefore will not diffuse a significant distance within a cell before reacting and has an extremely short half-life but it capable of causing great damage within a small radius of its site of production. Therefore, it can modify purines and pyrimidines and cause strand breaks resulting DNA damage [10, 11].

Singlet oxygen is another non-radical, ROS often associated with oxygen free radicals; it can lead to and be generated by free radical reactions, but will not be further considered here. Other free radicals of importance are wide range of carbon-centred radicals that arise from the attaching of an oxidising radical (e.g.,  $OH^{\cdot}$ ) on a biological molecule (RH) such as a lipid, nucleic acid, carbohydrate or protein. These react very rapidly with oxygen to form the corresponding peroxy radicals ( $ROO^{\cdot}$ ). In turn, these peroxy radicals can participate in reactions that generate alkoxy radicals ( $RO^{\cdot}$ ). Sulphur atoms can also be the centre for free radicals (thiyl radicals,  $RS^{\cdot}$ ) formed, for example, in the oxidation of glutathione. Finally, certain foreign compounds can be activated to free radical species [9].

NO is synthesized during the enzymatic conversion of L- arginine to L- citrulline by nitric oxide synthase (NOS). With an unpaired electron, NO, which is a highly reactive free radicals, damages proteins, carbohydrates, nucleotides and lipids and, together with inflammatory mediators, results in cell and tissue damage [12]. NO potentially relaxes arterial and venous smooth muscles and, less strongly, inhibits platelet aggregation and adhesion [13]. NO donors, acting as vasodilating agents, are therefore a possible therapeutic approach [14]. Reactive nitrogen species have been associated with asthma, ischemia/reperfusion injury, septic shock and atherosclerosis via ion channel activation [10]. The two common examples of reactive oxygen species are NO and nitrogen dioxide [15]. NO is produced by the enzyme NO synthase. There are 3 types of NOS: Neuronal NOS (nNOS) and endothelial (eNOS) are constitutive NOS synthases, and responsible for the continuous basal release of NO. The iNOS is present in mononuclear phagocytes (monocytes and macrophages) and produces a large amount of NO [13].

Under circumstances that are not yet well understood, NO reacts with superoxide radical ( $O_2^{\cdot-}$ ) to form peroxynitrite (ONOO) [15], a compound that, having a pKa of 6.8, can be protonated at physiological pH to form peroxynitrous acid (ONOOH) [16]. Peroxynitrous acid is unstable, giving rise to a chemical species with hydroxyl radical (OH)-like reactivity and to nitrogen dioxide ( $NO_2$ ), two free radicals that spontaneously degrade to the more stable nitrate ( $NO_3$ ) [17,18]. In situ, peroxynitrite is formed by a NOS1- (or NOS2) catalyzed reaction when the concentrations of L-arginine are suboptimal and thus  $O_2$  is produced by the enzyme [15, 17]. Peroxynitrite can be synthesized after persistent inhibition of mitochondrial respiratory chain activity by NO [18].

Oxidation proteins appear to play a causative role in many chronic diseases of aging including neurodegenerative diseases such as epilepsy and Alzheimer's disease. Frank and Gupta [19] reviewed role of oxidative stress in neurodegenerative diseases as follows; a) cell from old individuals are more susceptible to oxidative damage than cells from young donors; b) oxidative protein modification is not random; c) some of the damage can be prevented by antioxidant, but there is an age-dependent difference; and d) an age-related impairment recognition and destruction of modified proteins exist.

## Structure and Properties of Vitamin C

Vitamin C occurs in two forms, namely the reduced ascorbic acid and the oxidized dehydroascorbic acid. Only the L isomer of ascorbic acid has activity. Although the majority of the vitamin exists as ascorbic acid, both forms are biologically active. Ascorbate acts in the aqueous phase and it reduces superoxide and peroxy radical. It exists as the enolate anion at physiological pH. Dehydroascorbate formed by a second reduction or dismutation reaction and it recycled by dehydroascorbate reductases, a GSH dependent enzyme. Dehydroascorbyl radical may also dismutate to ascorbate and dehydroascorbate [3].

In foods, the reduced form of ascorbic acid may reversibly oxidize to the dehydro form with dehydroascorbic acid further oxidized to the inactive the irreversible compound of diketogulonic acid. This change takes place readily, and thus ascorbic acid is very susceptible through oxidation, a change that is accelerated by heat and light. Ascorbic acid is so readily

oxidized to dehydroascorbic acid that other compounds may be protected against oxidation. This antioxidant property is used in the addition of the vitamin in canning of certain fruits to prevent oxidation changes that cause darkening. Reversible oxidation-reduction of ascorbic acid with dehydroascorbic acid is the most important chemical property of ascorbic acid and the basis for its known physiological activities and stabilities. Ascorbic acid is the least stable, and therefore most easily destroyed, of all vitamins [20].

### Metabolism of Vitamin C

Absorbed ascorbic acid is excreted in urine, sweat, and feces. Fecal loss is minimal and even with large intakes in humans only 6-10 mg daily is excreted by this route. Loss in sweat is also probably low. In rats and rabbits,  $\text{CO}_2$  is the major excretory mechanism for vitamin C. Humans don't normally utilize the  $\text{CO}_2$  catabolic pathway, with the main loss occurring in the urine. Urinary excretion of vitamin C depends on the body stores, intake, and renal function. Mechanism and mode of elimination are a function of glomerular filtration rate of ascorbic acid and are dependent on plasma ascorbate concentration. Substantial quantities of L-ascorbic acid are excreted in urine after concentration in blood plasma exceeds its usually threshold of approximately 1.4 mg per 100 ml [8,20].

### Vitamin C in the Brain as a Scavenger of Free Oxygen Radicals

As a water-soluble compound, ascorbic acid may be a front-line defense against free radicals created by metabolism. Ascorbic acid has been found to react with hydrogen peroxide, the hydroxyl radical, peroxy radical and singlet oxygen to form the semidehydroascorbate radical and dehydroascorbate [21].

Ascorbic acid acts in the plasma to scavenge free radicals, dissipating these reactive species before they can react with biological membranes and lipoproteins. This was demonstrated by a study in which human blood plasma exposed to a water-soluble radical inhibitor, or to oxidants generated by polymorphonuclear leukocytes, did not show any signs of lipid peroxidation as long as ascorbate was present [8]. In addition, plasma devoid of ascorbate but no other endogenous antioxidants, such as  $\alpha$ -tocopherol, was found to be extremely susceptible to lipid peroxidative damage. Animal studies have reported that marginal ascorbate deficiency induced by diet leads to myocardial injury as evidenced by lipid peroxidation: this damage was prevented by ascorbic acid supplementation [21].

The brain is enriched in several low molecular mass antioxidants, especially ascorbate. Ascorbate concentrations in cerebrospinal fluid (CSF) are higher than in plasma, and neurons and glia have transport systems that concentrate ascorbate even more, to millimolar intracellular levels [4]. Compared to average concentrations of ascorbate in human blood plasma (27–51  $\mu\text{M}$ ) ascorbate levels in human tissues are generally far higher and they are particularly high in pituitary (up to 1.5 mM) and brain (up to 0.8 mM). Neurons readily take up ascorbate, whereas astrocytes take up dehydroascorbate and convert it to ascorbate intracellularly [4]. Indeed, it has been proposed that neurons may release dehydroascorbate for

'recycling' back to ascorbate by astrocytes [22]. Levels of ascorbate in CSF and brain remain high even when the plasma level decreases, indicative of the importance of ascorbate to central nervous system function [5]. Key roles include its involvement in dopamine hydroxylation, collagen synthesis and formation of myelin sheath [23]. Mice lacking sodium-vitamin C transporter 2 shows severely decreased ascorbate levels in the blood, brain and other tissues indicating that this may be the most important transporter for brain ascorbate uptake. These mice die within a few minutes of birth with respiratory failure and brain hemorrhage [24], indicating that ascorbate is essential in the lung and brain to cope with birth hyperoxia (sudden exposure to 21% O<sub>2</sub>, much higher than intrauterine O<sub>2</sub> levels) [5].

Ascorbic acid is probably the most important water soluble antioxidant in the brain extracellular fluid, in addition to its cooperative antioxidant role in regenerating reduced  $\alpha$ -tocopherol in membranes [7]. Although ascorbic acid has an important antioxidant role to counter oxidative stress, ascorbic acid will also form reactive oxidants, especially in the presence of transition metals, and evidence suggests that ascorbic acid participates in prooxidant reactions under certain conditions. If iron or copper ions become available, e.g., in damaged brain, ascorbate could conceivably stimulate oxidative damage by reducing Fe(III) and Cu<sup>2+</sup> ions to the Fe<sup>2+</sup> and Cu<sup>+</sup> forms, which are more active in making hydroxyl radical from hydrogen peroxide and in decomposing lipid peroxides [5]. By contrast, ascorbate can inhibit damage by heme protein/peroxide mixtures by reacting with and removing ferryl and amino acid radical [25]. Hence the net effect of ascorbate at sites of central nervous system injury is hard to predict. Administration of dehydroascorbate to mice decreased neuronal damage in one stroke model, suggesting that overall (at least in this model) ascorbate is beneficial [25]. Frei et al. [8] demonstrated that in human blood plasma ascorbate is the only endogenous antioxidant that can completely protect the lipids from detectable prooxidative damage induced by aqueous peroxy radicals. Under this type of oxidative stress, ascorbate is a much more effective antioxidant than the protein thiols, vitamin E, bilirubin, or urate. Hence, ascorbate appears to trap virtually all peroxy radicals in the aqueous phase before they can diffuse into plasma lipids. Once ascorbate has been consumed completely, the remaining water-soluble antioxidants can trap only part of the aqueous peroxy radical [8].

Vitamin E is a family of four tocopherol and four tocotrienols that inhibit lipid peroxidation by scavenging peroxy radicals using a phenolic hydroxyl group [1]. The tocopheroxy radical is poorly reactive, and may be removed using ascorbate. In the brain,  $\alpha$ -tocopherol seems to be the main or only form of vitamin E [26] although  $\gamma$ -tocopherol has been detected in human CSF [27].

## Vitamin C, Oxidative Stress and Epilepsy

Although the exact etiology of epilepsy still needs to be clarified, the whole process can be related to the decrease of lipid peroxidation content [2]. A variety of biochemical processes, including the activation of membrane phospholipases, proteases and nucleases which cause degradation of membrane phospholipids, proteolysis of cytoskeleton proteins and protein phosphorylation are showed during seizures [28]. In particular, polyphosphoinositides play an important role in convulsive process. Several alterations

in membrane phospholipids metabolism result in liberation of free fatty acids, particularly free arachidonic acid, diacylglycerols, eicosanoids, lipid peroxides and free radicals in brain. These lipid metabolites along with abnormal ion homeostasis and lack of energy regeneration may contribute to neuronal injury [29]. Many previous studies have demonstrated that oxidative stress might be involved in the pathophysiology of epilepsy in penicillin [30], ferric chloride [31], kainite [32], pilocarpine [2] and PTZ-induced epilepsy [33-37]. In fact, several recent studies have demonstrated an increase in diverse biochemical hallmarks of ROS formation, such as thiobarbituric acid reactive substances (TBARS), malondialdehyde (MDA) [2,38,39], protein carbonyl [40] and NO [41]. There are also conflicting reports on oxidative stress and epilepsy. For example, Verrotti et al. [42] recently reported that we observed no difference in oxidative stress between epileptic patients and healthy control subjects.

Frantseva et al. [36] presented evidence that lipid peroxidation increases during seizures in the kindling model of epilepsy, suggesting that free radical increase during seizures occur independent of iron salts or excitotoxins. Ayyildiz et al. [30] reported that the most effective dose of ascorbic acid (100 mg/kg) prevented increase in level of lipid peroxidation in the penicillin-induced epilepsy in rats. Shin et al. [43] reported that treatment with ascorbic acid, at doses of 50 and 100 mg/kg, significantly attenuated trimethyltin-induced seizures as well as the initial oxidative stress. The effects of ascorbate are complex, and other mechanisms, unrelated to its reactive species scavenger ability, are claimed to explain the neuroprotective actions of this vitamin [44]. Oliveira et al. [44] reported that 30 mg/kg ascorbate prevented total protein carbonylation, but did not prevent PTZ-induced convulsions. Similar dissociation was observed when the effect of 100 mg/kg ascorbate on PTZ-induced convulsions and protein carbonylation was investigated, since this dose of ascorbate potentiated PTZ-induced convulsions, but did not further increase total protein carbonylation [44].

Wang et al. [45] provided evidence to support involvement of free radical intermediates in iron-ascorbic acid reactions. Moreover, it was reported that ascorbate acts as prooxidant in the presence of iron and shows excellent scavenging properties in the absence of iron [46]. They also suggested that no further benefit could be achieved by increasing the intake of ascorbate, while the prooxidant action will increase, and the net effect is to shift to the deleterious side [46]. Some authors reported that they did not observe protective effect of vitamin C at high doses in the presence of high iron in epileptic rats [30].

### Treatment of Epilepsy with Vitamin C in Experimental Animal Models

There are different models of induction of epilepsy in experimental animals. The striatum has been chosen as the target for the injection of PTZ because of the strong GABAergic tonus that exists in this structure that makes it particularly sensitive to the effects of PTZ and other GABAergic antagonists [47]. Accordingly, the striatum is activated during seizures induced by different agents, such as methylmalonic acid, DL-homocysteic acid, 4-aminopyridine and PTZ [Reviewed in 48]. It has been suggested that ascorbate has neuroprotective properties in some experimental model of seizure activity induced by various

agents, such as iron [49] and PTZ [44]. In fact ascorbate administration attenuates kainite-elicited lipid peroxidation and neuronal loss in the rat hippocampus [50] and decreases the number and duration of methylmalonic acid-induced convulsive episodes [51]. Accordingly, an effective anticonvulsant dose of GM1 ganglioside, besides increasing catalase activity [52], increases cerebral ascorbate content [52], further suggesting a protective role for ascorbate in the inhibition of methylmalonic acid-induced convulsions. Accordingly, Yamamoto et al. [49] demonstrated that an ascorbate synthetic derivative prevents the occurrence of ferric-ion-induced epileptic discharges in a rat model of post-traumatic epilepsy. Further evidence for an anticonvulsant role for ascorbate comes from a study that reported ascorbate, at high doses (300 mg/kg) protected against PTZ-induced convulsion, further suggesting an anticonvulsant and neuroprotective role for ascorbic acid [44]. They reported that ascorbate at a dose that no effect on PTZ-induced convulsions or inhibition of  $\text{Na}^+$ ,  $\text{K}^+$ -ATPase activity (30 mg/kg) attenuated the increase in striatal protein carbonyl content induced by PTZ. Conversely, they showed that systemic ascorbate administration (300 mg/kg) significantly prevented PTZ-induced effects, namely convulsion and increase in total striatal protein carbonylation (it is an oxidative stress marker) and  $\text{Na}^+$ ,  $\text{K}^+$ -ATPase activity inhibition. The fact that ascorbate, at the low doses (50-200 mg/kg), has been reported to enhance amphetamine-induced behavior activation [53] and conditioned place preference [54], and that ascorbate at a high dose (500 mg/kg), had either no, or an opposing effect, on these behaviors [54] constitutes further evidence for a biphasic effect of ascorbate on central nervous system functions. Recent study of Ayyildiz et al. [30] reported that ascorbic acid, high dose (800 mg/kg), did not significantly change either the frequency or amplitude of penicillin-induced epileptic activity in rat. However,  $\alpha$ -tocopherol at high dose (500 mg/kg) had maximal anticonvulsant effect in the penicillin-induced epileptiform activity in other study of Ayyildiz et al. [55]. Ascorbic acid has been reported to significantly increase the latency to first seizure, reduce seizure severity, and improve survival in the pilocarpine model at a dose of 250 mg/kg given 30 minutes before pilocarpine [56], but is reported to be ineffective in the kainic acid model at 50 mg/kg [57]. In a recent study of Xu and Stringer [6] ascorbic acid was dissolved in physiological saline and administered intraperitoneally at a dose of 250 mg/kg 10 minutes before the convulsants (pilocarpine, kainic acid and PTZ) and they were observed that ascorbic acid had significant anticonvulsant activity against pilocarpine although vitamin C did not significant effects against PTZ- or kainic acid-induced seizures. Recently, Santos et al. [2] reported that vitamin C pretreatment decreased hippocampal lipid peroxidation and brain seizures in pilocarpine-induced epileptic rats.

### Vitamin C, Oxidative Stress and Antiepileptic Drugs

There are conflicting reports on antiepileptic drugs, oxidative stress and ascorbic acid in humans and animals. Generally previous papers are reporting oxidant role of antiepileptic drugs, whereas recent papers are reporting antioxidant role of antiepileptic drugs. In addition, the reports are also conflicting type of antiepileptic drugs. For example, valproic acid is commonly used in the treatment of epilepsy and it induced oxidative stress although new

antiepileptic drug therapy [58, 59], whereas topiramate, induces antioxidant role in epileptic animals and humans [38].

Alteration in antioxidant enzyme resulting in reduction in GSH-Px activity and elevated glutathione reductases has been demonstrated in children and adults receiving valproic acid therapy [58, 59]. Sometimes, such changes have been associated with elevated serum lipid peroxidative levels in children receiving chronic valproic acid therapy [58, 59]. Sudha et al. [60] reported that antiepileptic drug (phenobarbital) showed a significant increase in plasma ascorbic acid levels in erythrocytes of ten epileptic patients compared to their pre-treatment condition.

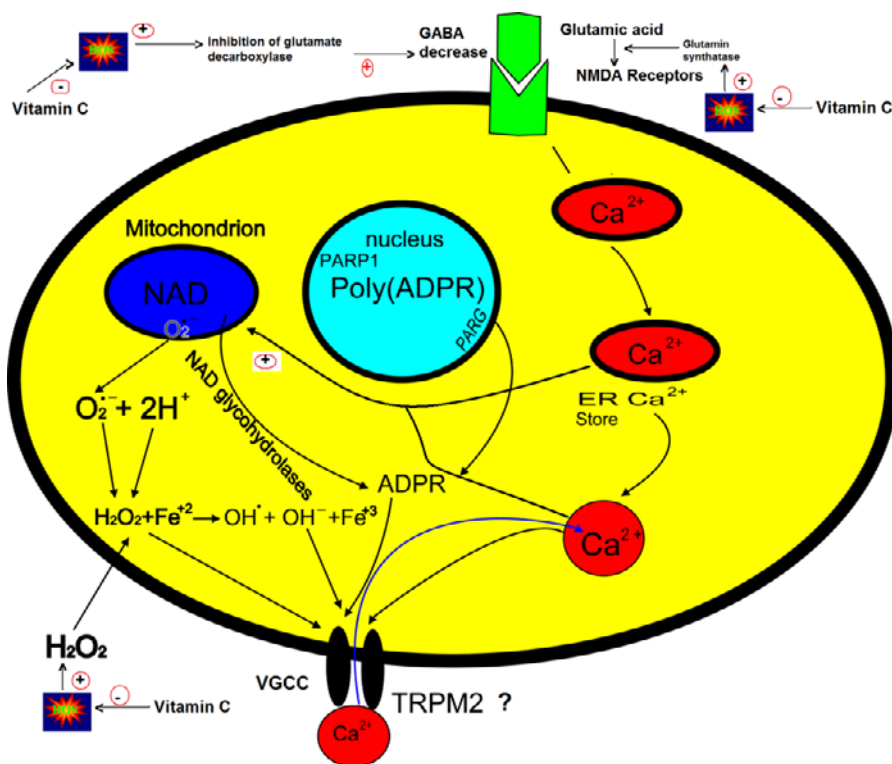

Figure 1. A large number of studies seizure-induced cell damage to excitotoxic mechanisms [see reference 28]. Free radical generation can induce seizure activity by direct activation of glutamine synthetase thereby permitting an abnormal build up of excitatory neurotransmitter glutamic acid. The onset of oxygen induced convulsions in epileptic patients and animals is correlated with a decrease in cerebral content of neurotransmitter GABA because of inhibition of enzyme glutamate decarboxylase by the reactive oxygen species (ROS). Convulsions can result in augmented glutamate release, leading to Ca<sup>2+</sup> uptake through *N-methyl-D-aspartate* (NMDA) and voltage-gated Ca<sup>2+</sup> channels (VGCC). Mitochondria were reported to accumulate Ca<sup>2+</sup> provided cytosolic Ca<sup>2+</sup> rises exceed 400 nM or provided mitochondrial uptake dominates mitochondrial Ca<sup>2+</sup> extrusion [62], thereby leading to depolarization of mitochondrial membranes. On the other hand, exposure of mitochondria high free Ca<sup>2+</sup> was shown to increase formation of ROS [63]. Sustained depolarization of mitochondrial membranes and enhanced ROS production. ROS activates transient potential melastatin 2 (TRPM2) channels and Ca<sup>2+</sup> influx increases by activation of TRPM2 via ROS [61]. The molecular pathway may be a cause of epileptic seizures and the subject should urgently investigate.

## Future Directions

Many antiepileptic drugs are metabolized to generate reactive metabolites with the capability of covalent binding to macromolecules as proteins or other vital biomolecules and hence elicit systemic toxicity. There are conflicting reports on interaction of antiepileptic drugs, oxidative stress and ascorbic acid supplementation in the systemic toxicity of cells. Hence, there is a need for further studies on the interaction of new antiepileptic drugs, oxidative stress and ascorbic acid supplementation in epileptic animals and humans.

Transient receptor potential (TRP) channels were first described in *Drosophila*, where photoreceptors carrying *trp* gene mutations exhibit a transient voltage response to continuous light [61]. Like many other cells, neurons contain polyADP-ribose polymerase 1 (PARP-1), an enzyme that responds to DNA damage by cleaving NAD<sup>+</sup> and attaching ADP-ribose (ADPR) residues to nuclear proteins to facilitate DNA repair. Overactivation of PARP-1 can kill cells by depleting NAD<sup>+</sup>, preventing energy and is involved in opening TRPM2 cation channels (Figure 1). Deletion of exon 11 of TRPM2 is known to cause dysregulation of cellular calcium homeostasis in response to oxidative stress in epilepsy [66]. There is no report on the role of TRP in epileptic patients and animals via free oxygen radicals. There is also no report on the effect of ascorbic acid in the channels in epileptic cells. Hence, the subjects should be clarified in future experiments.

**Table 1. Effects of Vitamin C doses on epileptic seizures in rat models**

Vitamin C dose (mg/kg)	Epilepsy induced by	Effect	Reference
High (300)	PTZ	Anticonvulsant	Yamamoto et al. [49]
High (500)	Amphetamine	Convulsant	Pierce et al. [54]
High (800)	Penicillin	No effect	Ayyildiz et al. [30]
Intermediate (100-200)	Penicillin	Anticonvulsant	Ayyildiz et al. [30]
Intermediate (100)	PTZ	Convulsant	Oliveira et al. [44]
Intermediate (250)	Pilocarpine	Anticonvulsant	Xavier et al. [56]
Intermediate (250)	Pilocarpine	Anticonvulsant	Xu and Stringer [64]
Intermediate (250)	PTZ	No effect	Xu and Stringer [64]
Intermediate (250)	Kainic acid	No effect	Xu and Stringer [64]
Intermediate (250)	Pilocarpine	Anticonvulsant	Santos and Freitas [2]
Low (30)	PTZ	No effect	Oliveira et al. [44]
Low (50)	Amphetamine	anticonvulsant	Wambebe and Skomba [53]
Low (50)	Kainic acid	No effect	Sumanont et al. [55]

PTZ; pentylentetrazol;

## References

- [1] Nazıroğlu, M. Molecular Mechanisms of vitamin E on intracellular signaling pathways in brain. In: *Reactive Oxygen Species and Diseases*. Ed.; Laszlo Goth, Research Signpost Press: Kerala, India. pp 2007,239-256.
- [2] Santos LFL, Freitas RLM, 2008 *Pharm Biochem Behaviour* 89, 1-5.



- 
- [3] Çimen, B. Free radical metabolism in human erythrocytes. *Clin Chim Acta*, 2008,390,1-11.
- [4] Rice, ME. Ascorbate regulation and its neuroprotective role in the brain, *Trends Neurosci* 2000,23,209-216.
- [5] Halliwell, B. Oxidative stress and neurodegeneration: where are we now? *J Neurochem* 2006, 97,1634-1658.
- [6] Xu, K; Stringer, JL. Antioxidant and free radical scavengers do not consistently delay seizure onset in animal models of acute seizures. *Epilepsy and Behavior*, 2008,13,77-82.
- [7] Niki E. Action of ascorbic acid as a scavenger of active and stable oxygen radicals. *Am J Clin Nutr*. 1991, 54(6 Suppl), 1119S-1124S.
- [8] Frei, B; England, L; Ames, BN. Ascorbate is an outstanding antioxidant in human blood plasma, *Proc Natl Acad Sci USA* 1989,86,6377-6381.
- [9] Cheeseman, KH; Slater, TF. An introduction to free radical biochemistry. *Br Med Bull*. 1993, 49, 481-493.
- [10] Halliwell, B; Gutteridge, JMC. Free radicals, other reactive species and disease. In: *Free radicals in Biology and Medicine*, 3<sup>rd</sup> ed.; Halliwell, B., Gutteridge, J.M.C., Eds.; Oxford University Press: New York, pp 1999,639-645.
- [11] Akyol, O; Herken, H; Uz, E; Fadillioglu, E; Unal, S; Sogut, S; Ozyurt, H; Savas, HA. The indices of endogenous oxidative and antioxidative processes in plasma from schizophrenic patients. The possible role of oxidant/antioxidant imbalance. *Prog Neuropsychopharmacol Biol Psychiatry* 2002,26: 995-1005.
- [12] Szabo, C. Roles of poly(ADP-ribose) polymerase activation in the pathogenesis of diabetes mellitus and its complications. *Pharmacol Res*. 2005,52,60-71.
- [13] Nathan, C; Xie, OW. Regulation of biosynthesis of nitric oxide. *J Biol Chem*. 1994,269, 13725-13728.
- [14] Xu, S; Touyz, RM. Reactive oxygen species and vascular remodelling in hypertension: still alive. *Can J Cardiol*. 2006;22: 947-951.
- [15] Xia, Y; Roman, L.J; Masters, B.S; Zweier, J.L. Inducible nitric-oxide synthase generates superoxide from the reductase domain. *Biol Chem* 1998;273:22635-22639.
- [16] Beckman JS; Beckman, TW; Chen, J; Marshall, PA; Freeman, BA. Apparent hydroxyl radical production by peroxynitrite: implications for endothelial injury from nitric oxide and superoxide. *Proc Natl Acad Sci USA* 1990,87,1620-1624.
- [17] Heinzl, B; John, M; Klatt, P; Bohme, E; Mayer, B. Ca<sup>2+</sup>/calmodulin-dependent formation of hydrogen peroxide by brain nitric oxide synthase. *Biochem J*, 1992;281(Pt 3): 627-630.
- [18] Clementi, E; Brown, GC; Feelisch, M; Moncada, S. Persistent inhibition of cell respiration by nitric oxide: crucial role of S-nitrosylation of mitochondrial complex I and protective action of glutathione. *Proc Natl Acad Sci USA* 1998,95,7631-76636.
- [19] Frank, B; Gupta, S. A review of antioxidants and Alzheimer's disease. *Ann Clin Psychiatry* 2005,17,269-286.
- [20] McDowell, L.R. Vitamin C. In: *Vitamins in animal nutrition*. Academic Press Inc., San Diego, California, USA. 1989, pp365-387.

- [21] Basu, TK. Potential role of antioxidant vitamins. In: *Antioxidant in human health and disease*. Eds: Tapan K. Basu, Norman J. Temple, Manohar L. Garg. CABI Publishing, New York USA. pp 1999, 14-25.
- [22] Swanson, RA; Ying, W; Kauppinen, TM. Astrocyte influences on ischemic neuronal death. *Curr Mol Med*, 2004, 4, 193-205.
- [23] Passage, N; Norreel, J.C; Noack-Fraissignes, P; Sangué. *Nat Med* 2004,10,396-401.
- [24] Sotiriou, S. *Nat Med* 2002,8,514-517.
- [25] Rice-Evans C, Okunade G. *Free Radic Res Commun* 1989, 7,45-54.
- [26] Hayton, S; Muller, D.P. Vitamin E in neural visual function. *Ann NY Acad Sci* 2004,1031,263-270.
- [27] Vatassery G.T; et al. *J Am Coll Nutr* 2004, 23,233-238.
- [28] Kovács, R., Schuchmann, S., Gabriel, S., Kann, O., Kardos, J., Heinemann, U., 2002. Free radical-mediated cell damage after experimental status epilepticus in hippocampal slice cultures. *J. Neurophysiol.* 88, 2909-2918.
- [29] Patel, M. Mitochondrial dysfunction and oxidative stress: cause and consequence of epileptic seizures. *Free Radic. Biol. Med.* 2004,37,1951-1962.
- [30] Ayyildiz, M; Coskun, S; Yildirim, M; Agar, E. The effects of ascorbic acid on penicillin-induced epileptiform activity in rats. *Epilepsia* 2007,48,1388-1395.
- [31] Singh and Pathak, 1990 *Epilepsia* 31,
- [32] Bruce, A.J; Baudry, M. Oxygen free radicals in rat limbic structures after kainate-induced seizures. *Free Radic Biol Med.* 1995,18,993-1002.
- [33] Eraković, V; Zupan, G; Varljen, J; Simonić A. Pentylentetrazol-induced seizures and kindling: changes in free fatty acids, superoxide dismutase, and glutathione peroxidase activity. *Neurochem Int* 2003, 42, 173-178.
- [34] Akbas, S.H; Yegin, A; Ozben, T. Effect of pentylentetrazol-induced epileptic seizure on the antioxidant enzyme activities, glutathione and lipid peroxidation levels in rat erythrocytes and liver tissues. *Clin Biochem* 2005, 38, 1009-1014.
- [35] Armağan, M; Kutluhan, S; Yılmaz, M; Yılmaz, N; Bülbül, M; Vural, H; Soyupek, S; Nazıroğlu, M. Topiramate and vitamin E modulates antioxidant enzymes, nitric oxide and lipid peroxidation in pentylentetrazol-induced nephrotoxicity in rats. *Basic Clin Pharm Toxicol* 2008, 103, 166-170.
- [36] Frantseva MV; Perez Velazquez JL; Tsoraklidis, G; Mendonca, A.J; Adamchik, Y; Mills, L.R; Carlen, P.L; Burnham, M.W. Oxidative stress is involved in seizure-induced neurodegeneration in the kindling model of epilepsy, *Neuroscience* 2000, 97,431-435.
- [37] Deniz Onay, B; Tasdemir, E; Tümer, C; Bilgin, H.M; Atmaca, M. Dose dependent effects of ghrelin on pentylentetrazole-induced oxidative stress in a rat seizure model. *Peptides* 2008, 29,448-455.
- [38] Nazıroğlu M, Kutluhan S, Yılmaz M. Selenium and Topiramate modulates oxidative stress and Ca<sup>+2</sup> -ATPase, EEG records in pentylentetrazol-induced brain seizures in rats. *J Membr Biol* 2008, 225, 39-49.
- [39] Kutluhan S; Nazıroğlu M; Çelik Ö; Yılmaz, M. Protective effects of selenium and topiramate on lipid peroxidation and antioxidant vitamin levels in blood of pentylentetrazol-induced epileptic rats. *Biol. Trace Elem. Res.* 2009, (e-pub)

- [40] Patsoikis N, Zervoudakis G 2004 *Neuroscience Lett* 357,
- [41] Bashkatova, V; Narkevich, V; Vitskova, G; Vanin, A. The influence of anticonvulsant and antioxidant drugs on nitric oxide level and lipid peroxidation in the rat brain during penthylenetetrazole-induced epileptiform model seizures. *Prog Neuropsychopharmacol Biol Psychiatry*. 2003;27:487-492.
- [42] Verrotti, A; *Epilepsy Res* 2008,78,171-177.
- [43] Shin EJ, Suh SK, Lim et al. *Neuroscience* 2005, 133,715-727.
- [44] Oliveira, MS; Furian, AF; Royes, LFF; Figuera, MR; De Carvalho, J; Fiorenza NG; Mello, CF. Ascorbate modulates pentylentetrazol-induced convulsion biphasically, *Neuroscience* 2004, 128,721-728.
- [45] Wang, X; Liu J., *Free Rd Biol Med* 1992, 12,121-126.
- [46] Fischer-Nielsen A; Poulsen HE; Loft S. 8-Hydroxydeoxyguanosine in vitro: effects of glutathione, ascorbate, and 5-aminosalicylic acid. *Free Radic Biol Med* 1992,13,121-126.
- [47] Scheel-Krüger, 1986 *Acta Nurol Scand* suppl 107, 1-54.
- [48] Acharya, M.M; Hattiangady, B; Shetty, A.K. Progress in neuroprotection strategies for preventing epilepsy. *Prog Neurobiol* 2008,84,363-404.
- [49] Yamamoto, N; Kabuta, H; Matsumoto, S; Ogawa, N; Yokoi, I.  $\alpha$ -tocophryl-L-ascorbate-2-O-phosphate diester, a hydroxyl radical scavenger, prevents the occurrence of epileptic foci in a rat model of post-traumatic epilepsy. *Pathophysiology*, 2002, 8,205-214.
- [50] MacGregor, DG; Higgins, MJ; Jones, PA; Maxwell, WL; Watson, MW; Graham, DI; Stone, TW. Ascorbate attenuates the systemic kainate-induced neurotoxicity in the rat hippocampus. *Brain Res*. 1996, 727, 133-44.
- [51] Figuera, MR.; Queiroz, CM; Stracke, MP.; Brauer, MC.; González-Rodríguez, LL; Frussa-Filho, R; Wajner, M; de Mello, CF. Ascorbic acid and alpha-tocopherol attenuate methylmalonic acid-induced convulsions. *Neuroreport*, 1999,10,2039-2043.
- [52] Figuera, MR; Bonini, JS; Frussa-Filho, R; Dutra-Filho, CS; Hagen, ME; Rubin, MA; Mello, CF. Monosialoganglioside increases catalase activity in cerebral cortex of rats. *Free Radic Res*. 2004,38,495-500.
- [53] Wambebe and Skomba, 1986. *Psychopharmacology*
- [54] Pierce et al., 1995 *Brain Res* 688
- [55] Ayyildiz, M; Yildirim, M; Agar E. The effect of vitamin E on penicillin-induced epileptiform activity in rats. *Exp Brain Res* 2006,174,109-113.
- [56] Xavier, S.M; Barbosa, C.O; Barros, D.O; Silva, R.F; Oliveira, A.A; Freitas, R.M. Vitamin C antioxidant effects in hippocampus of adult Wistar rats after seizures and status epilepticus induced by pilocarpine. *Neurosci Lett* 2007,420,76-79.
- [57] Sumanont, Y; Murakami, Y; Tohda, M; Vajragupta, O; Watanabe, H; Matsumoto, K. Prevention of kainic acid-induced changes in nitric oxide levels and neuronal cell damage in the rat hippocampus by manganese complexes of curcumin and diacetylcurcumin. *Life Sci*, 2006,78,1884-1891.
- [58] McGirr et al., 1985

- 
- [59] Cengiz M, Yüksel A, Seven M. The effects of carbamazepine and valproic acid on the erythrocyte glutathione, glutathione peroxidase, superoxide dismutase and serum lipid peroxidation in epileptic children. *Pharmacol Res.* 2000;41:423-425.
- [60] Sudha, K; Rao, A.V; Rao, A. Oxidative stress and antioxidant in epilepsy. *Clin Chim Acta*, 2001, 303, 19-24.
- [61] Nazıroğlu, M. New molecular mechanisms on the activation of TRPM2 channels by oxidative stress and ADP-ribose. *Neurochem Res*, 2007,32,1990-2001.
- [62] Colegrove SL; Albrecht MA; Friel DD. Dissection of mitochondrial  $\text{Ca}^{2+}$  uptake and release fluxes in situ after depolarization-evoked  $[\text{Ca}^{2+}]_i$  elevations in sympathetic neurons. *J Gen Physiol* 2000,115,351-370.
- [63] Dykens JA. Isolated cerebral and cerebellar mitochondria produce free radicals when exposed to elevated  $\text{Ca}^{2+}$  and  $\text{Na}^+$ :implications for neurodegeneration. *J Neurochem* 1994,63,584-591.
- [64] Xu, K; Stringer, JL. Antioxidant and free radical scavengers do not consistently delay seizure onset in animal models of acute seizures. *Epilepsy and Behavior* 2008,13,77-82.
- [65] Wambebe, C; Sokomba, E. Some behavioural and EEG effects of ascorbic acid in rats. *Psychopharmacology (Berl)*. 1986,89,167-70.
- [66] McQuillin, A; Bass, NJ; Kalsi, G; Lawrence, J; Puri, V; Choudhury, K; Detera-Wadleigh, SD; Curtis, D; Gurling, HM. Fine mapping of a susceptibility locus for bipolar and genetically related unipolar affective disorders, to a region containing the C21ORF29 and TRPM2 genes on chromosome 21q22.3. *Mol Psychiatry*. 2006,11,134-142.

Chapter XII

---

## Vitamin C as a Stress Bioindicator of Norway Spruce: A Case Study in Slovenia

---

*Samar Al Sayegh Petkovšek\* and Boštjan Pokorny*

ERICo Velenje, Ecological Research and Industrial Cooperation, Velenje, Slovenia

### Abstract

The physiological condition of Norway spruce (*Picea abies* (L.) Karst.) and consequently the vitality of forest ecosystems was intensively studied in the period 1991–2007 in northern Slovenia, i.e., in the area influenced by the Šoštanj Thermal Power Plant (ŠTPP). ŠTPP, which is the largest Slovene thermal power plant, which used to be the largest Slovene emission source of gaseous pollutants (e.g. SO<sub>2</sub>, NO<sub>x</sub>) and a very important source of different inorganic (e.g., heavy metals) as well as organic toxic substances (e.g. PAHs). However, extremely high SO<sub>2</sub> emission (up to 86,000 t in 1993, and > 120.000 in the 1980s, respectively) and dust emissions (up to 8,000 in 1993), have been dramatically reduced after the installation of desulphurization devices in the late 1990s. Indeed in the comparison with 1993, SO<sub>2</sub> emissions in 2007 were reduced more than 15-fold and dust emissions more than 35-fold, respectively. These extreme exposures in the past as well as huge changes in environmental pollution during the last two decades have significantly influenced the vitality of forest ecosystems including physiological conditions (e.g., contents of antioxidant) of different tree species in the study area. Therefore, vitamin C (ascorbic acid) as a sensitive, non-specific bioindicator of stress caused either by anthropogenic (e.g., air pollution) or natural stressors (climatic conditions, diseases, altitude gradient, etc.) was included in a permanent survey of forest conditions in northern Slovenia. Atmospheric pollutants such as ozone and sulphur dioxide cause formation of free radicals, which are involved in oxidation of proteins and lipids and injury of plant tissues. Plant cells have evolved a special detoxification defence

---

\*Corresponding author. Phone: +386 (0)3 898 1953; fax: +386 (0)3 898 1942; e-mail address: samar.petkovsek@erico.si

system to cope with radicals, including formation of water-soluble antioxidants, such as vitamin C. The most significant findings and conclusions of the present study are as follows: (a) Vitamin C is a good bioindicator of oxidative stress and an early-warning tool to detect changes in the metabolism of spruce needles, although we found untypical reaction of antioxidant defence in the case of extremely high SO<sub>2</sub> exposure. (b) Metabolic processes in spruce needles react to air pollution according to severity of pollution and the time of exposure. However, if spruce trees were exposed to high SO<sub>2</sub> ambient levels and/or for a long period of time, the antioxidant defence mechanism would be damaged and the content of vitamin C would not increase as expected. (c) Lower exposure to ambient pollution results in better vitality of trees (e.g., higher contents of total (a + b) chlorophyll), as well as in rising of their defence capabilities (higher contents of vitamin C). (d) Physiological conditions of Norway spruce in northern Slovenia has significantly improved since 1995, when the desulphurization devices were built on the ŠTPP, and when emissions of SO<sub>2</sub> as well as heavy metals started dramatically and continuously decreasing in this part of Slovenia.

## 1. Introduction

Atmospheric (including pollution) and climate changes, along with increasing demands upon the forest resources, are three main factors which affected the forest health status at global and local scale (Percy, 2002). The disturbance in supply and allocation of water, nutrients and energy affected the productivity of forest ecosystems and their resistance to biotic and abiotic stressors (Mc Laughlin & Percy, 1999). As a result of human activities (industrial processes, traffic, use of chemical agents in agriculture and households, combustion of fossil fuels, etc.), plants are exposed to far greater amounts of harmful substances than before; moreover, the situation is even more crucial since the environment has been confronted with totally new substances, and consequently plants are not (as yet) adapted to them (Larcher, 1995; Market et al., 2003). The nature of the damages caused by individual chemical substances is modified by the other environmental and stress-inducing factors, result in a multiplying effects which usually exceed the tolerant level of organisms (*ibid.*)

Biochemical and physiological indicators of stress caused atmospheric pollutants are used in many studies considering forest health status (Batič et al., 2001; Simončič, 2001; Nyberg et al., 2001; Fürst et al., 2003; Haberer et al., 2006; Al Sayegh Petkovšek et al., 2008; Hofer et al., 2008). Among them, vitamin C (ascorbic acid) is often used as a very promising, sensitive, but rather non-specific bioindicator of environmental stress.

Vitamin C is one of the most important vitamin in human diet, obtained mainly from vegetables, fruits and other plant material. It is implicated in many physiological processes (for example in photosynthesis by regulation of electron flow); moreover, vitamin C is an essential co-factor for the synthesis of zeaxanthin. However, the most significant is its role of being an antioxidant (Foyer, 1993; Larcher, 1995; Cross et al., 1998; Perl-Trevers & Perl, 2002; Esposito et al., 2009). Atmospheric pollutants (sulphur dioxide, nitrogen oxides, ozone, peroxyacetyl nitrat (PAN), hydrocarbons, etc.) cause the formation of free radicals, which are involved in the oxidation of proteins and lipids; moreover, injury of several plant tissues can also appear. Vitamin C is an exceptional antioxidant that scavenges, either directly or

indirectly, all of the damaging free radicals commonly encountered in plant cell (Foyer, 1993). As primary antioxidant it reacts with hydrogen peroxide ( $\text{H}_2\text{O}_2$ ), with superoxid ( $\text{O}_2^-$ ), hydroxyl radical ( $\text{OH}^\cdot$ ), and lipid hydroperoxides (Yu, 1994), respectively; furthermore, it is also important secondary antioxidant since it maintenance the  $\alpha$ -tocopherol (vitamin E) pool to cope with radicals in deeper layer of membranes. Vitamin E is an efficient lipophilic antioxidant which is incorporated into photosynthetic membranes, and serves to reduce the possibility of damages caused by singlet oxygen or lipid peroxides (Foyer, 1993; Hofer et al., 2008).

In last two decades, permanent survey (biomonitoring) has been performing in northern Slovenia with the aim to assess the forest health condition in the emission area of the largest Slovenian thermal power plant of Šoštanj (ŠTPP) by using the Norway spruce (*Picea abies* (L.) Karst.) needles as bioindicator. In the present paper, a particular attention is focused on the determination antioxidant defence mechanisms (e.g. content of vitamin C) against the pollution stress in Norway spruce, and on assessing the bioindicative value of vitamin C as a sensitive and early-warning bioindicator of environmental pollution with inorganic substances.

## 2. Material and Methods

### 2.1. Study Area and Sampling Procedures

The study area is (used to be) exposed to huge amounts of pollutants due to its close vicinity to the largest Slovene thermal power plant of Šoštanj. It has been emitting huge amounts of  $\text{SO}_2$ ,  $\text{NO}_x$  and  $\text{CO}_2$  (Table 1); moreover, annual emissions of heavy metals reached up to 298 t of Zn, 60.6 t of Cr, 22.1 t of Pb, 4.5 t of As, 0.3 t of Hg, and 0.2 t of Cd before installation of desulphurization devices in 1995 and 2000, respectively. A pronounced impact of air pollution was observed in many environmental segments in the study area (e.g. soils and vegetables: Kugonič & Stropnik, 2001; forest stands: Ribarič Lasnik et al., 2001; Al Sayegh Petkovšek et al., 2008; mushrooms: Al Sayegh Petkovšek et al., 2002; lichens: Poličnik et al., 2004, 2008; aquatic organisms: Mazej & Germ, 2009; wild-living ruminants: Pokorny, 2000, 2006; Pokorny et al., 2004).

ŠTPP is located at the bottom of the Šalek Valley, at an altitude of 370 m, in the central northern part of Slovenia (Figure 1), in the alpine and pre-alpine vegetation province with moderate continental climate. Prevailing winds are from the west and east, which has an important impact on the distribution of pollutants in the area. In this respect it is important that the ground layer of the frequent thermal inversions usually does not exceed 100 m, which is far below the height of the power station chimneys. Therefore, pollutants are spread over the hilly margins up to 1100 m above sea level, where the upper inversion layer occurs (Šalej, 1999).

**Table 1. Annual emissions of SO<sub>2</sub>, NO<sub>x</sub>, CO, CO<sub>2</sub> and dust from ŠTPP in the period 1991-2007 (source: Rotnik, 2008)**

year	SO <sub>2</sub> (t)	NO <sub>x</sub> (t)	CO (t)	CO <sub>2</sub> (t)	dust (t)
1991	80,390	11,057	440	3,142,725	7,495
1992	79,988	9,009	505	3,587,029	6,085
1993	86,101	9,770	523	3,731,473	8,121
1994	80,516	9,483	484	3,434,461	4,917
1995*	51,663	10,025	761	3,581,956	2,765
1996	51,804	10,154	626	3,287,774	1,845
1997	53,093	11,572	739	3,698,747	2,377
1998	55,053	11,963	734	3,821,570	2,316
1999	47,665	9,096	589	3,334,732	1,077
2000*	44,253	10,379	541	3,540,040	460
2001	18,071	11,403	693	3,887,053	467
2002	22,871	12,779	931	4,740,476	632
2003	13,334	10,936	1,033	4,366,652	480
2004	7,951	8,877	1,300	4,536,876	419
2005	10,341	9,054	1,236	4,622,632	332
2006	6,190	9,130	1,394	4,662,431	158
2007	5,450	8,600	1,269	4,906,889	262
all together	714,734	173,287	13,798	66,883,516	40,208

Note: \*Two desulphurization devices were installed in February 1995 and in November 2000, respectively.

To assess the condition of forests in the study area, spruce needles have been used as a bioindicator for last two decades. Norway spruce, the most common Slovenian forest tree species, is a suitable bioindicator of environmental and man-induced stress, used all over Europe, including Slovenia (Bermadinger-Stabentheiner, 1995; Videgar Gorjup et al. 2000; Batič et al., 1995, 1999, 2001; Simončič, 2001; Fürst et al., 2003; Modrzynski, 2003; Muzika et al., 2004; Bytnerowicz et al., 2005; Al Sayegh Petkovšek et al., 2008). Spruce needles were sampled in the autumn in every year in the period 1991 – 2007 at ten sampling sites, which differ regarding altitude, direction and distance from the ŠTPP (Table 2). Special attention in the present paper is focused on location Zavodnje, which is strongly affected by air pollution since it is situated just below the belt of the upper thermal inversion, i.e. where the largest deposition of pollutants is expected (Table 3). There selected spruce trees grow in a very close vicinity of the weather station at which concentrations of sulphur dioxide, nitrogen oxides and ozone in the air have been continuously measured during study period; therefore, data on exposure of sampled trees are precisely known.

Sampling of current-year needles of Norway spruce was done following the procedure described in the ICP recommendation (Anonymous, 1987). Five vital trees being 60-100 years old were selected per site; from each tree needles from the seventh spindle of branches from the top were collected. Branches were cut off and left overnight in the dark at 4°C for further processing of needles. Needles were frozen in liquid nitrogen and lyophilized prior to biochemical analysis.



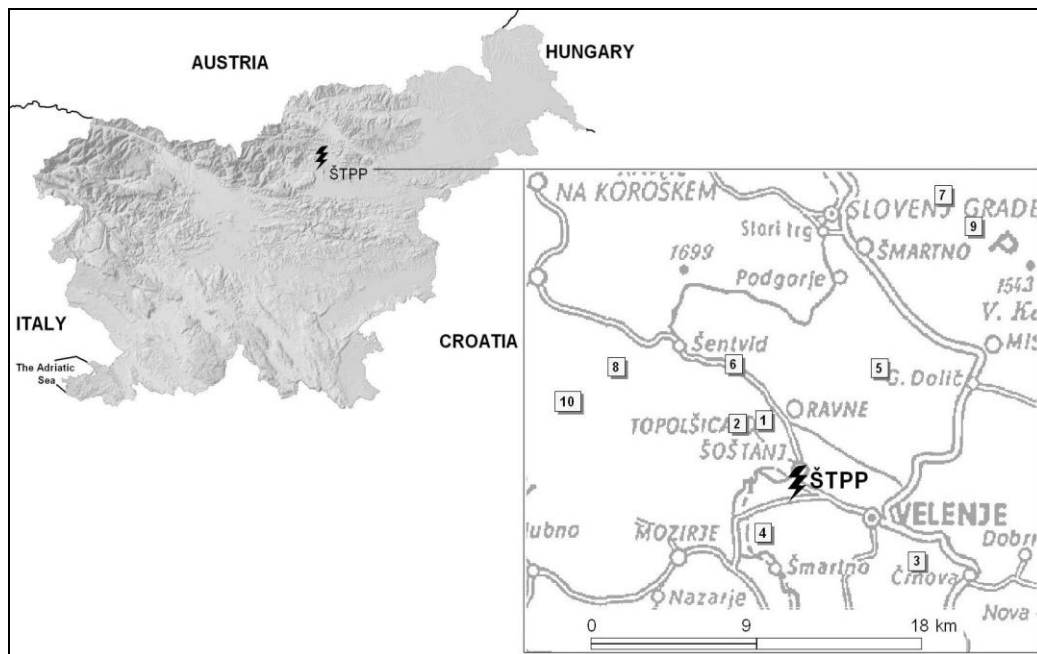

Figure 1. The locations of the Štanj Thermal Power Plant (ŠTPP) and sampling sites in the emission area of ŠTPP. The sampling sites are marked with figures, which are shown in Table 2.

**Table 2. Description of sampling sites**

No. of location	Sampling site	distance from the ŠTPP (m)	direction from the ŠTPP	altitude (m)
1.	Lajše	3,700	SW	400
2.	Topolšica	5,400	NW	400
3.	Laze	5,700	SE	460
4.	Veliki Vrh	3,500	SW	570
5.	Graška gora	7,600	NE	730
6.	Zavodnje	7,600	NW	760
7.	Brneško sedlo	18,100	NE	1,030
8.	Kramarica	12,700	NW	1,070
9.	Kope	17,500	NE	1,400
10.	Smrekovec	14,600	NW	1,555

## 2.2. Biochemical Analysis

Contents of vitamin C, vitamin E and photosynthetic pigments (chlorophyll a and b) were determined by high performance liquid chromatography (Hewlett Packard, 1050) according to Grill and Esterbauer (1973), Bui-Nguyen (1980), Wimanlasiri & Wills (1983) and Pfeifhofer (1989), and total sulphur by colorimetric titration using a AOK-S (adsorbed organic halogens) analyser (Euroglas Research, 1998). Following standard reference materials were

used for analytical quality control: vitamin C and vitamin E: Bucks Fluk, no. 95210; chlorophyll a: FLUKA 25739; and chlorophyll b: FLUKA 25749, respectively.

**Table 3. Mean annual deposition of SO<sub>2</sub> (µg/m<sup>3</sup>) at selected locations in the period 1991-2007 (source: Rotnik, 2008)**

year	Zavodnje	Veliki Vrh	Topolšica	Graška gora
1991	50	80	40	30
1992	55	76	58	42
1993	47	58	55	47
1994	49	53	34	50
1995*	26	49	20	27
1996	33	57	20	28
1997	42	53	18	36
1998	43	63	20	32
1999	42	72	17	32
2000*	31	56	18	34
2001	20	51	11	15
2002	19	51	14	16
2003	15	45	16	10
2004	8	30	6	6
2005	12	33	5	6
2006	8	20	4	6
2007	7	14	3	5

Note: \*Two desulphurization devices were installed in February 1995 and in November 2000, respectively. Bold figures exceeded the permitted levels defined by Slovene and European legislation (20 µg/m<sup>3</sup>) (Official Gazzete of the Republic of Slovenia, No. 52/2002; Directive 2008/50/EC of the European parliament and the Council of 21 May 2008 on ambient air quality and cleaner air for Europe).

### 2.3. Statistical Analysis

All results presented in the paper represent annual mean values, calculated on the basis of data provided for selected five spruce trees per sampling site, sampled at ten locations in the emission area of the ŠTTP in the period 1991-2007. *Microsoft Excel* was used for calculation of mean values and standard errors. Existence of correlations between different parameters was tested by calculating *Spearman rank coefficient (R)* using *Statistica for Windows 7.1* software package (StatSoft, 2006); the limit of statistical significance was set up at  $p < 0.05$ . In the following sections, all results are given as mg/g on a dry weight basis.

### 3. Results

#### 3.1. Mean Annual Content of Vitamin C in Spruce Needles

Physiological condition of spruce trees, sampled in the area influenced by the ŠTPP, was investigated by determination of contents of vitamin C and photosynthetic pigments in current-year Norway spruce needles. Mean annual concentrations of vitamin C are presented in Figure 2. Since the content of vitamin C in green parts of higher plants had already been confirmed as a suitable bioindicator of oxidative stress caused by air pollution (Perl-Treves & Perl, 2002; Langebartels et al., 2002; Eposito et al., 2009), a determination of relation between mean annual contents of vitamin C in needles and mean annual emissions of sulphur dioxide from ŠTPP was emphasized in this study.

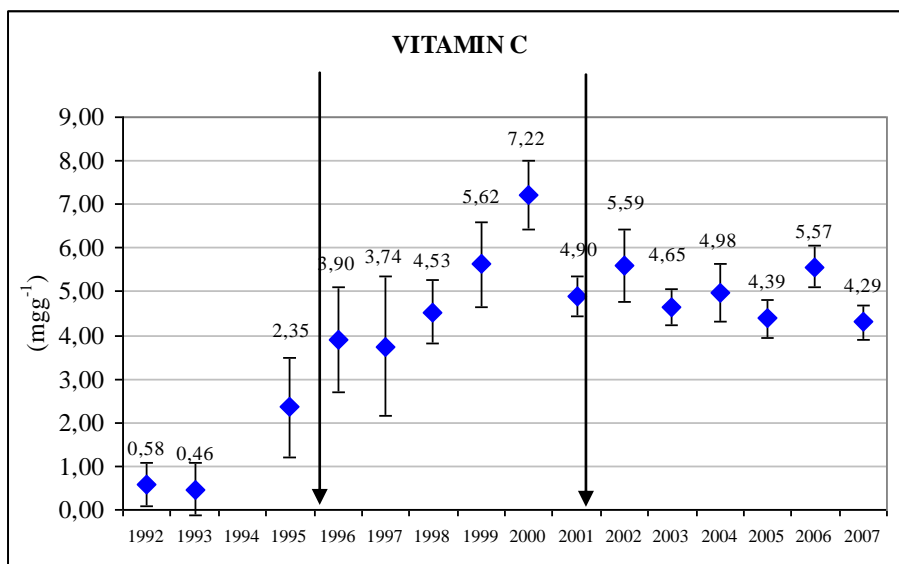

Figure 2. Mean content of vitamin C in current-year needles of spruce located in the emission area of the ŠTPP in the period 1992-2007. The arrows marked the years in which desulphurization devices were installed (Unit 4 in February 1995 and Unit 5 in November 2000, respectively).

As a rule, the defence mechanism of plants and consequently content of vitamin C in their tissues should increase with increasing air pollution (Foyer, 1993; Larcher, 1995; Cross et al., 1998; Perl-Trevers and Perl, 2002). However, in the period of the largest emissions of sulphur dioxide (1991-1994), the lowest mean concentrations of vitamin C in spruce needles were found (Figure 2). Immediately after the first significant reduction of SO<sub>2</sub> emissions in 1995, contents of vitamin C in needles started increasing and reaching the peak in 2000, although emissions remained almost unchanged in that period. Such a trend is comparable with some previous studies from highly polluted areas (e.g. Grill et al., 1979; Bermadinger et al., 1990; Batič et al., 2001). If spruces trees were exposed to high SO<sub>2</sub> emissions and for a long time, the antioxidant defence mechanism would be damaged and the content of vitamin C would not increase as expected. In our study area, previous huge emission of SO<sub>2</sub> were firstly significantly reduced after the installation of the desulphurization devices on the fourth

unit of the ŠTPP in February 1995, it is most likely that after a long lasting stress in 1980's and 1990's the defence mechanism in spruce needles has started repairing and the normal mechanism of formation of antioxidant has been re-establishing after the implantation of this mitigation measure. After the second significantly reduction of emissions of SO<sub>2</sub> (after the installation of the desulphurization devices on the fifth unit of the ŠTPP in November 2000) the contents of vitamin C drastically diminished and remained almost equal.

In order to assess the health status of investigated trees we also measured the photosynthetic pigments, since oxidative stress tends to reduce chlorophyll content, especially chlorophyll a. The mean annual concentrations of total chlorophyll (a + b) in current-year needles are shown in Figure 3. A trend of increasing spruce vitality after 1995 was confirmed; moreover, the chlorophyll content exceeded the limit value (1.5 mg/g – value indicating tree injury) (Köstner et al., 1990) for the first time in that year and remained above this value until 2007 (with slightly decrease in year 1996, 1997 and 2002). Presumably, decrease of the total pigment contents in these three years were not correlated with air pollution, since emissions of air pollutants remained unchanged in that period. A lower vitality of trees (i.e. lower contents of pigment) in these three years reflects the impact of natural stressors (e.g. high summer T and drought in year 1996 and 2002, respectively).

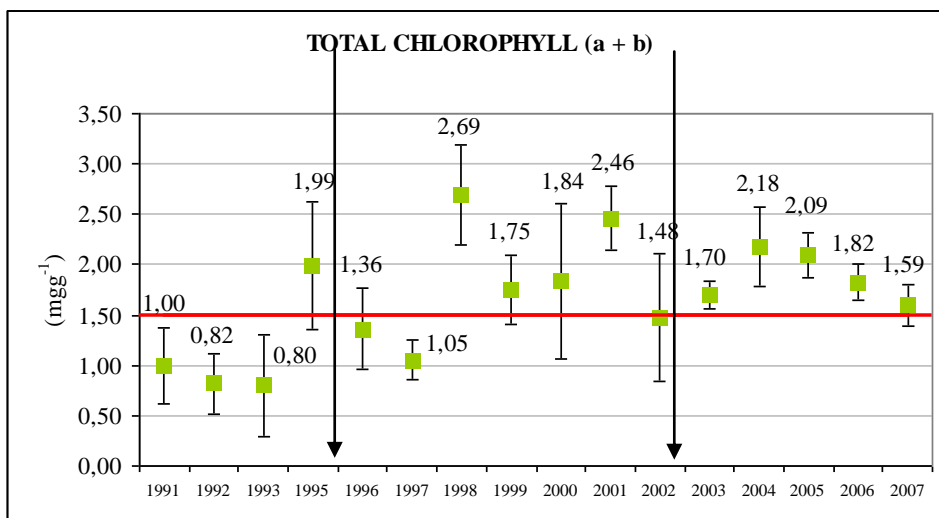

Figure 3. Mean annual concentration of total chlorophyll (a + b) in current-year needles of spruce located in the emission area of ŠTPP. The horizontal line represents the limit value (1.5 mg/g). The arrows marked the years in which desulphurization devices were installed (Unit 4 in February 1995 and Unit 5 in November 2000, respectively).

### 3.2. Correlation Analysis

Since content of vitamin C in spruce needles, may be affected either by natural stressors (extreme temperatures, drought, ultraviolet radiation, etc.) or by air pollution, we tested the existence of correlation between two stress-inducing factors (altitude and deposition of SO<sub>2</sub> at selected locations) and mean annual content of vitamin C in spruce needles. Due to

untypical reaction of trees to extremely high exposure to SO<sub>2</sub> in the first study years we confirmed the existence of negative correlation between mean annual SO<sub>2</sub> emissions and mean annual concentration of ascorbic acid for the study period (Figure 4). Moreover, mean annual concentrations of total chlorophyll (a + b) and vitamin E were significantly affected by SO<sub>2</sub> emissions (Figures 5, 6; Table 4), as well.

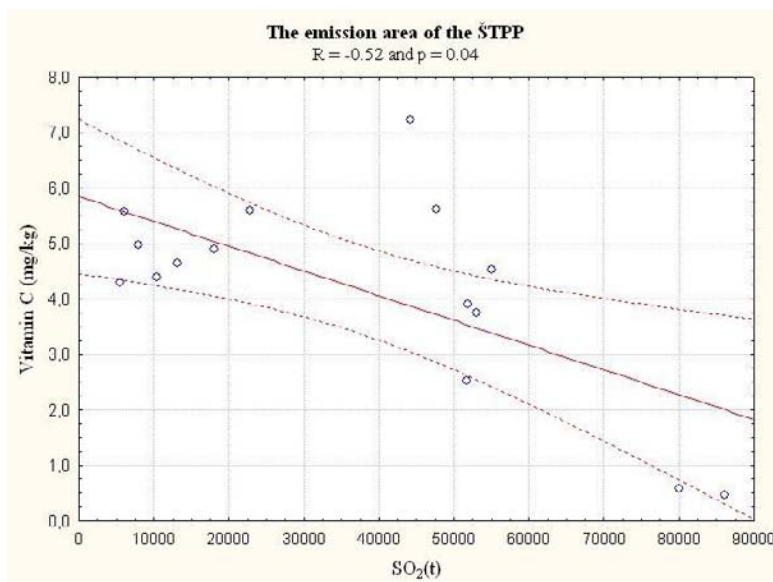

Figure 4. Correlation between mean annual emissions of SO<sub>2</sub> and mean annual contents of vitamin C in spruce needles.

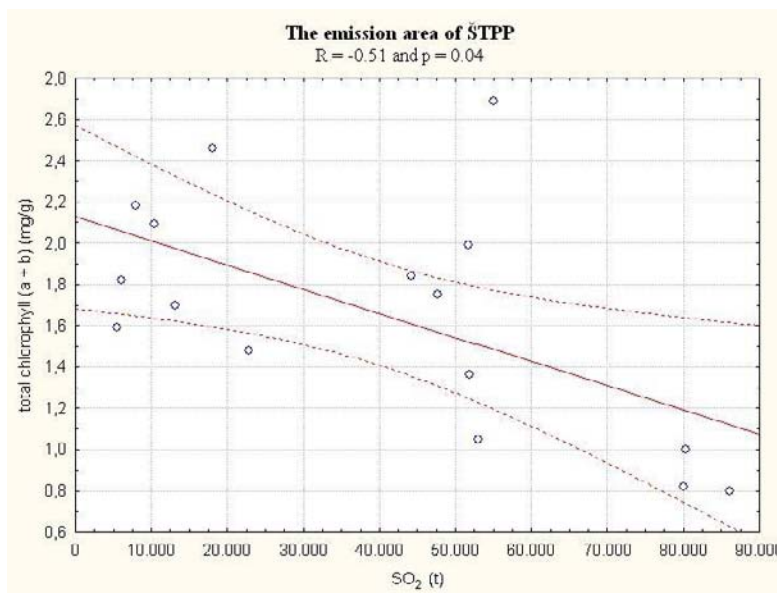

Figure 5. Correlation between mean annual emissions of SO<sub>2</sub> and mean annual concentration of total chlorophyll (a + b) in spruce needles.

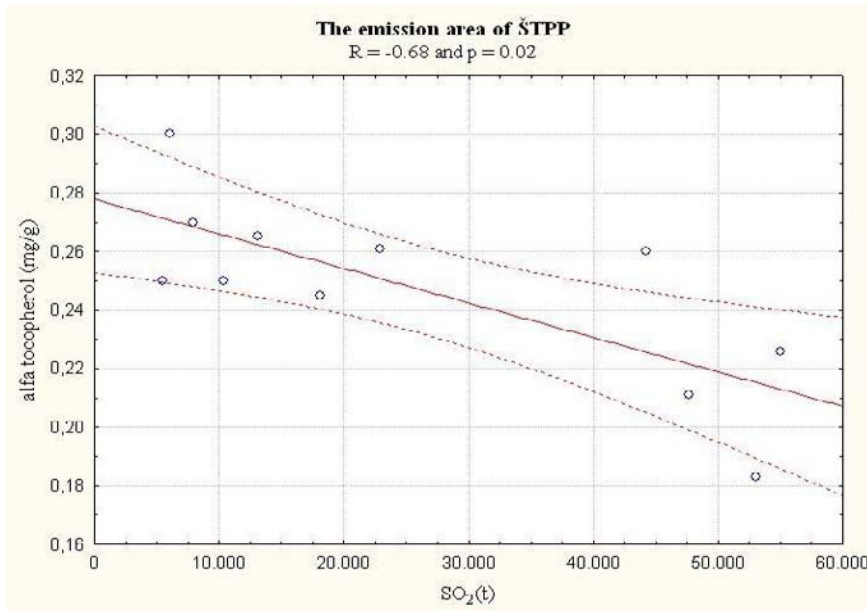

Figure 6. Correlation between mean annual emissions of SO<sub>2</sub> and mean annual concentration  $\alpha$  tocopherol (vitamin E) in spruce needles.

**Table 4. Correlations between mean annual concentrations of selected parameters, in spruce needles in the emission area of ŠTTP**

	vitamin E	chlorophyll (a + b)	emission of SO <sub>2</sub>
vitamin C	ns	ns	ns
$\alpha$ tocopherol	-	ns	R = -0.68; p = 0.02
chlorophyll (a + b)	-	-	R = -0.51; p = 0.04

Note: ns: not significant.

The impact of altitude on vitamin C content in spruce needles was tested per every single year. It was established that in study area altitude does not affected the content of vitamin C in spruce needles. Normally (e.g. in areas, where the impacts of air pollution is absent), the content of vitamin C increase with rising altitude. For northern Slovenia, however, it is evident that stress caused by higher altitude does not prevail over the stress caused by air pollution. Indeed, the locations at lower altitudes are more exposed to the emissions from the ŠTTP, that is indicated by mean annual contents of total sulphur in spruce needles (Table 6). Total sulphur in spruce needles could reflect the exposure of spruce trees to SO<sub>2</sub> emissions, since mean annual total sulphur content in needles was directly correlated with the mean annual SO<sub>2</sub> emissions in the period of 1991– 2007 (R = 0.91; p = 0.000001; n = 16). Analyses of single year needles indicated that sulphur content in spruce needles is highest at sites close to the power plant (Veliki Vrh, Topolšica, Lajše) and where altitude coincides with that of frequent thermic inversions (Zavodnje) (Ribarič Lasnik et al., 2001; Tausz et al., 2002).

**Table 5. Correlations between annual concentrations of selected parameters, in spruce needles for location Zavodnje**

	vitamin E	chlorophyll (a + b)	deposition of SO <sub>2</sub>	deposition of O <sub>3</sub>
vitamin C	ns	R = 0.57; p = 0.03	ns	R = -0.52; p = 0.06
α tocopherol	-	ns	ns	ns
chlorophyll (a + b)	-	-	R = -0.56; p = 0.03	ns
deposition of SO <sub>2</sub>	-	-	-	ns

Note: ns: not significant

**Table 6. The mean contents of total sulphur (mg/g) in current-year spruce needles**

	Lajše	Topolšica	Laze	Veliki Vrh	Graška gora	Zavodnje	Brneško sedlo	Kramarica	Kope	Šmrekovec
1991	1.84	1.89	1.42	2.13	1.45	1.57	1.33	1.62	1.26	1.39
1992	2.01	2.14	1.39	2.47	1.57	1.61	1.40	1.88	1.35	1.45
1993	1.99	1.81	1.53	1.51	2.19	1.69	1.57	1.69	1.40	1.42
1994	/	/	/	2.50	/	1.60	1.30	/	/	1.50
1995	1.51	1.60	1.42	1.69	/	1.52	1.00	1.32	0.95	1.11
1996	1.54	1.57	1.24	1.61	/	1.66	1.23	1.50	1.07	1.34
1997	1.66	1.40	1.14	1.69	1.39	1.45	1.31	1.47	1.06	1.07
1998	1.65	1.52	1.40	1.65	1.32	1.35	1.21	1.49	0.99	1.12
1999	1.74	1.59	0.97	1.94	0.37	1.50	1.20	1.35	1.12	1.29
2000	1.75	1.60	1.16	2.19	1.48	1.51	1.31	1.48	1.11	1.12
2001	1.32	1.44	0.97	1.52	1.07	1.32	1.06	1.25	1.09	1.05
2002	1.46	1.46	1.00	1.74	1.18	1.44	1.02	1.07	1.01	1.09
2003	1.24	1.24	0.78	1.22	1.04	1.20	0.96	1.16	0.96	1.08
2004	1.26	1.30	0.96	1.20	1.26	1.10	0.86	0.94	0.90	1.02
2005	0.97	0.97	0.83	1.10	0.97	1.07	0.80	0.95	1.03	0.83
2006	0.97	1.00	0.83	0.87	0.80	0.90	0.70	0.77	0.97	0.90
2007	0.83	0.87	0.83	0.87	0.93	1.03	0.73	0.80	0.80	0.83

Note: Bold figures exceeded levels of total sulphur characteristic for spruce needles from areas which are not loaded with sulphur dioxide (0.97 /kg) (Kalan et al. 1995).

In addition, ozone concentrations in the air influence the content of vitamin C in spruce needles as well (Larcher, 1995). Since data on ozone deposition are precisely known only for location Zavodnje, the existence of correlation was tested for this sampling plot. There content of vitamin C in spruce needles, was significantly affected by ozone concentrations; indeed, content of vitamin C decreased with increasing concentration of ozone (Figure 8) (R = -0.52; p = 0.056). Due to long lasting influence of air pollution on the physiological status of spruce trees (Table 3), their defence mechanism is damaged; consequently, the elevated concentrations of ozone additionally lead to decrease in the content of vitamin C.

Together with temporal increase in annual contents of vitamin C in spruce needles, sampled at Zavodnje, concentrations of photosynthetic pigment increased as well (R = 0.57; p = 0.03) (Figure 5). It is evident that better physiological status of spruce is correlated with increasing antioxidant production (rising defence capabilities) and better vitality of spruce trees, grown at sampling site Zavodnje.

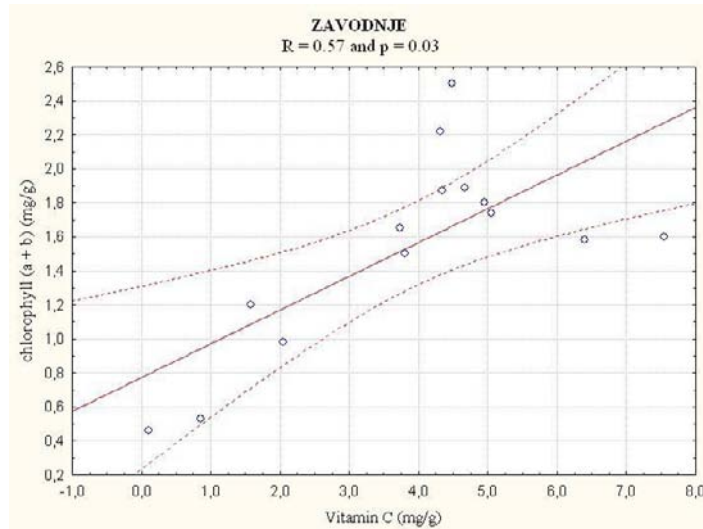

Figure 7. Relation between contents of vitamin C and total chlorophyll (a + b) in spruce needles, sampled at location Zavodnje across the study period.

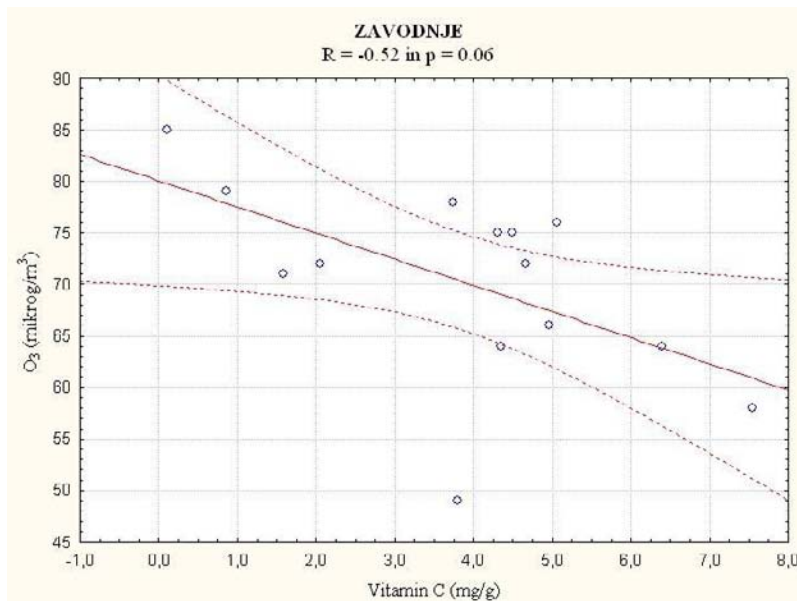

Figure 8. Relation between contents of vitamin C in spruce needles and mean annual imissions of ozone at location Zavodnje across the study period.

## 4. Conclusion

On the basis of data collected during the permanent biomonitoring of forest ecosystem performed in the period 1991-2007 in northern Slovenia the most significant findings and conclusions are as follows: (a) Vitamin C is a good bioindicator of oxidative stress and an



early-warning tool to detect changes in the metabolism of spruce needles, although we found untypical reaction of antioxidant defence in the case of extremely high SO<sub>2</sub> exposure. (b) Metabolic processes in spruce needles react to air pollution according to severity of pollution and the time of exposure. However, if spruce trees were exposed to high SO<sub>2</sub> ambient levels and/or for a long period of time, the antioxidant defence mechanism would be damaged and the content of vitamin C would not increase as expected. (c) Lower exposure to ambient pollution results in better vitality of trees (e.g. higher contents of total (a + b) chlorophyll), as well as in rising of their defence capabilities (higher contents of vitamin C). (d) Physiological condition of Norway spruce in northern Slovenia has significantly improved since 1995, when the desulphurization devices were built on the ŠTPP, and when emissions of SO<sub>2</sub> as well as heavy metals started dramatically and continuously decreasing in this part of Slovenia.

## References

- [1] Al Sayegh Petkovšek, S., Batič, F. & Ribarič Lasnik, C. (2008). Norway spruce needles as bioindicator of air pollution in the area influence of the Šoštanj thermal power plant, Slovenia. *Environmental pollution*, 151, 287-291.
- [2] Al Sayegh Petkovšek, S., Pokorný, B., Ribarič Lasnik, C., Vrtačnik, J. (2002). Vsebnost Cd, Pb, Hg in As v trosnjakih gliv iz gozdnate krajine Šaleške doline. *Zbornik gozdarstva in lesarstva*, 67, 5-46.
- [3] Anonymous (1987). Manual and methodologies and criteria for harmonized sampling, assessment, monitoring and analyses of the effect of air pollution on forests. ECE/NEP for Europe. Geneva.
- [4] Batič, F., Kalan, P., Kraigher, H., Šircelj, H., Simončič, P., Vidregar-Gorjup, N. & Turk, B., (1999). Bioindication of different stresses in forest decline studies in Slovenia. *Water Air and Soil Pollution*, 116, 377-382.
- [5] Batič, F., Vidregar-Gorjup, N., Šircelj, H., Simončič, P. & Turk, B. (2001). The analyses of photosynthetic pigments, ascorbic acid and macronutrients – a tool for evaluation of the effect of air pollution in Norway spruce (*Picea abies* (L.) Karst.). *Journal of Forest Science* 47, 39-48.
- [6] Bermadinger, E., Guttenberger, H. & Grill, D. (1990). Physiology of young Norway spruce. *Environmental Pollution*, 68, 319-330.
- [7] Bui-Nguyen, H. M. (1980). Application of high-performance liquid chromatography to the separation of ascorbic acid to the isoascorbic acid. *Journal of Chromatography*, 196, 163-165.
- [8] Burmandiger-Stabentheiner, E. (1995). Stress-Physiological Investigation on Spruce Trees (*Picea abies* (L.) Karst.) from the “Achenkirch Altitude Profiles”. *Phyton*, 29, 255-301.
- [9] Bytnerowitz, A., Badea, O., Popescu, F., Musselman, R., Tanase, M., Barbu, I., Fraczek, W., Gembasu, N., Surdu, A., Danescu, F., Postelnicu, D., Cenusă, R. &

- Vasile, C. (2005). Air pollution, precipitation chemistry and forest health in the Retezat Mountains, Southern Carpathians, Romania. *Environmental Pollution*, 137, 546-567.
- [10] Cross, C.E., van der Vliet, A., Louie, S., Thiele J.J. & Halliwell, B. (1998). Oxidative stress and antioxidants at biosurfaces: plants, skin, and respiratory tract surface. *Environmental Health Perspectives*, 106, 1241-1251.
- [11] Directive 2008/50/EC of the European parliament and the Council of 21 May 2008 on ambient air quality and cleaner air for Europe.
- [12] Eposito, M. P., Ferreira, M. L., Sant'anna, S. M. R., Domingos, M. & Souza S. R. (2009). Relationship between leaf antioxidant and ozone injury in *Nicotiana tabacum* "Bel-W3" under environmental conditions in São Paulo, SE – Brazil. *Atmospheric Environment*, 43, 619-623.
- [13] Euroglass Research & Application laboratory, 1998. *Determination of total sulphur in spruce needle samples by ECS 1600/3000, analyses report*.
- [14] Föyer, C. H. Ascorbic acid. In: Alscher, R.G., Hess, J. L., editor. *Antioxidants in higher plants*. CRP Press, Inc., 1993, 32-59.
- [15] Fränzle, O. (2003). Bioindicators and environmental stress assessment: In: B. A. Market, A. M. Breure, H. G. Zechmeister, editors. *Trace Metals and other Contaminants in the Environment 6: Bioindicator & Biomonitoring, Principles, concepts and applications*, Elsevier, 41-85.
- [16] Fürst, A., Smidt, S. & Herman, F. (2003). Monitoring the impact of sulphur with the Austrian Bioindicator Grid. *Environmental Pollution*, 125, 13-19.
- [17] Grill, D. & Esterbauer, H. (1973). Quantitative Bestimmung wasserlöslicher Sulfhydrylverbindung in gesunden und SO<sub>2</sub>-geschädigten Nadeln von *Picea abies*. *Phyton*, 15, 87-101.
- [18] Grill, D., Esterbauer, H. & Welt, R. (1979). Einfluss von SO<sub>2</sub> auf das Ascorbinsäuresystem der Fichtenndeln. *Phytopathology*, 96, 361-368.
- [19] Haberer, K., Jaeger, L. & Rennenberg, H. (2006). Seasonal patterns of ascorbate in the needles of Scots Pine (*Pinus sylvestris* L.) trees: Correlation analyses with atmospheric O<sub>3</sub> and NO<sub>2</sub> gas mixing ratios and meteorological parameters. *Environmental Pollution*, 139, 224-231.
- [20] Hofer, N., Alexou, M., Heerdt, C., Löw, M., Werner, M., Matyssek, R., Rennenberg, H. & Haberer, K. (2008). Seasonal differences and within-canopy variations of antioxidants in mature spruce (*Picea abies*) trees under elevated ozone in a free-air exposure system. *Environmental pollution*, 154, 241-253.
- [21] Kalan, J., Kalan, P. & Simončič, P. (1995). Preučevanje gozdnih tal na stalnih raziskovalnih ploskvah. Zbornik gozdarstva in lesarstva, 47, 57-84.
- [22] Köstner, B., Czygan, F.C. & Lange, O.L. (1990). An analysis of needle yellowing in the healthy and chlorotic Norway spruce (*Picea abies*) in a forest decline area of the Fichtelgebirge (NE: Bavaria). *Trees*, 4, 55-67.
- [23] Kugonič, N. & Stropnik, M. (2001). Vsebnost težkih kovin v tleh in rastlinah na kmetijskih površinah v Šaleški dolini, letno poročilo, DP 24/02/01. Velenje, ERICo, 183 str.
- [24] Kunert, K.J. & Ederer, M. (1985). Leaf aging and lipid peroxidation: The role of antioxidant vitamin C and E. *Physiologia Plantarum*, 65, 85-88.

- [25] Langebartels, C., Schraudner, M., Heller, W., Ernst, D. & Sandermann, H. (2002). Oxidative stress and defense reaction in plants exposed to air pollution and UV-B radiation. In: D. Inze, M. Van Montagu, editors. *Oxidative stress in Plants*. New York, Taylor & Francis Inc, 105-136.
- [26] Larcher, W. *Physiological plant ecology. Ecophysiology and stress physiology of functional groups*. Third edition. Berlin, Heidelberg, Springer Verlag, 1995.
- [27] Market B. A., Breure A. M. & Zechmeister H. G. (2003). Definitions, strategies and principles for bioindication/biomonitoring of the environment. In: B. A. Merket, A. M Breure, H. G. Zechmeister, editors. *Trace Metals and other Contaminants in the Environment 6: Bioindicator & Biomonitoring, Principles, concepts and applications*, Elsevier Science, 3-39.
- [28] Mazej, Z. & Germ, Z. (2009). Trace element accumulation and distribution in four aquatic macrophytes. *Chemosphere*, 74, 642-647.
- [29] McLaughlin S.B. & Percy K.E. (1999). Forest health in North America: Some perspective and potential roles of climate and air pollution. *Water air and soil pollution*, 116, 151-197
- [30] Modrzynski, J. (2003). Defoliation of older Norway spruce (*Picea abies* (L.) Karst.) stands in the polish Sudety and Carpatian mountains. *Forest Ecology and Management*, 181, 289-299.
- [31] Muzika, R. M., Guyette, R. P., Zielonka, T. & Liebhold A. M. (2004). The influence of O<sub>3</sub>, NO<sub>2</sub> and SO<sub>2</sub> on growth of *Picea abies* and *Fagus sylvatica* in the Carpathian Mountains. *Environmental Pollution*, 130, 65-71.
- [32] Official Gazzete of the Republic of Slovenia, No. 52/2002.
- [33] Percy, K.E. (2002). Is air pollution an important factor in forest health? In: R.C Szaro, editor. *Effects of air pollution on forest health and biodiversity in forests of the Carpatian mountains*. IOS Press, 23-43
- [34] Perl-Treves, R. & Perl, A. (2002). Oxidative Stress: An introduction. In: D. Inze, M. Van Montagu, editors. *Oxidative stress in Plants*. New York, Taylor & Francis Inc, 1-32.
- [35] Pfeifhofer, H. W. (1989). On the pigment content of Norway spruce needles infected with *Chrysomyxa rhododendri*, and the carotenoids of the fungus Aeciospores. *European Journal of Forest Pathology*, 19, 363-369.
- [36] Poličnik, H., Batič, F. & Ribarič Lasnik, C. (2004). Monitoring of short-term heavy metal deposition by accumulation in epiphytic lichens (*Hypogymnia physodes* (L.) Nyl.). *Journal of atmospheric chemistry*, 49, 223-230.
- [37] Poličnik, H., Simončič, P. & Batič, F. (2008). Monitoring air quality with lichens: A comparison between mapping in forest sites and in open areas. *Environmental pollution*, 151, 395-400.
- [38] Pokorny, B. (2000). Roe deer *Capreolus capreolus* as an accumulative bioindicator of heavy metals in Slovenia. *Web Ecology*, 1, 54-62.
- [39] Pokorny, B. (2006). Roe deer (*Capreolus capreolus* L.) antlers as an accumulative and reactive bioindicator of lead pollution near the largest Slovene thermal power plant. *Veterinarski Arhiv*, 76, S131-S142.

- [40] Pokorný, B., Glinšek, A. & Ribarič Lasnik, C. (2004). Roe deer antlers as a historical bioindicator of lead pollution in the Šalek Valley, Slovenia. *Journal of atmospheric chemistry*, 49, 175-189.
- [41] Ribarič Lasnik, C., Bienelli Kalpič, A., Batič, F. & Vrtačnik, J. (2001). Biomonitoring of forest ecosystem in areas influenced by the Šoštanj and Trbovlje Thermal Power Plants. *Journal of Forest Science*, 47, 61-67.
- [42] Rotnik, U. Bilten TEŠ. *Poročilo o proizvodnji, vzdrževanju in ekoloških obremenitvah okolja TE Šoštanj v letu 2007*. Velenje, AV Studio d.o.o, Velenje, 2008.
- [43] Šalej, M. Historično-geografski oris Šaleške doline in njenega obrobja. In: T. Ravnikar, editor. *Razprave o zgodovini mesta in okolice*. Velenje, Mestna občina, 11-37.
- [44] Simončič, P. (2001). Nutrient condition for spruce (*Picea abies* (L.) Karst.) in the area affected by a Thermal Power Plant in Slovenia. *Journal of Forest Science*, 47, 67-72.
- [45] Širčelj, H., Batič, F. & Štampar, F. (1999). Effects of drought stress on pigment, ascorbic acid and free acid content in leaves of two apple tree cultivars. *Phyton*, 39, 97-100.
- [46] StatSoft 2006. *Statistica for Windows 7.1*. Tulsa, StatSoft, CD.
- [47] Stefan, K. (1990). Vergleich der schwefelanalyseedated des Österreichischen Bioindikatornetzes in Jahr 1989 mit den Etgebnissen vorangegangener Jahre. (Bericht BIN-S 62/1990). Forstliche Bundesversuchsanstalt. Institut für Immissionsforschung and Forstchemie, Wien, 70 p.
- [48] Tausz, M., Morales, D., Jimenez, M.S. & Grill, D. (1999). Photoprotection in forest trees under field condition. *Phyton*, 39, 25-28.
- [49] Tausz, M., Wonisch, A., Ribarič Lasnik, C., Batič, F. & Grill, D. (2002). Multivariate Analyses of Tree Physiological Attributes – Applications in Field Studies. *Phyton*, 42, 215-221.
- [50] Wimanlasiri, P., Wills, R.B. (1983). Simultaneous analyses of ascorbic acid in fruit and vegetables by high performance liquid chromatography. *Journal of Chromatography*, 256, 368-371.
- [51] Yu, B. P. (1994). Cellular defenses against damage from reactive oxygen species. *Physiol. Rev.*, 74, 139-162.

Reviewed by Dr. Primož Simončič, Slovenian Forestry Institute (Gozdarski inštitut Slovenije), Večna pot 2, 1000 Ljubljana, Slovenija, primoz.simoncic@gozdis.si.

---

## **Protective Effect of Vitamin C on Vascular Damage and Arterial Hypertension Induced by Low-Level Mercury and Lead Exposure**

---

*Antonio J. López-Farré<sup>1\*</sup>, José J. Zamorano-León<sup>1</sup>, Daniel Sacristán<sup>1</sup>,  
Maria Marques<sup>2</sup>, Carlos Macaya<sup>1</sup>  
and Alberto Barrientos<sup>2</sup>*

<sup>1</sup>Cardiovascular Research Unit, Cardiology Department and <sup>2</sup>Nephrology Department,  
Hospital Clinico San Carlos, Madrid, Spain

### **Abstract**

Different heavy metals, such as lead and mercury, are potential chemical contaminants contained in air, water and foods, particularly fish. Several studies have reported that these toxic metals may affect the vascular system. Chronic exposure to mercury and lead has been associated with numerous cardiovascular disorders such as hypertension, endothelial dysfunction and nephrotoxicity. Most of the deleterious effects of mercury and lead on the vascular wall have been attributed to their pro-oxidant properties. Vitamin C, due to its antioxidant properties, may play a protective role in the vascular damage induced by chronic exposure to mercury and lead. It has been described that vitamin C administration prevents the increase of mean arterial blood pressure, restoring the normal expression of endothelial nitric oxide synthase and soluble guanylate cyclase proteins in the vascular wall of lead-exposed rats. This protective role of vitamin C in endothelial functionality suggests that vitamin C supplementation may be beneficial for subjects submitted to chronic heavy metal exposure. This chapter will

---

\* Correspondence to: Antonio José López Farré, C/ Profesor Martín Lagos s/n, CP:28040, Cardiovascular Research Unit, Cardiology Department, Hospital Clínico San Carlos, Madrid, Spain. Email: [icarinv.hcsc@salud.madrid.org](mailto:icarinv.hcsc@salud.madrid.org); Telephone:+34 913303000 ext. 7747.

focus on analyzing the mechanisms of vascular damage induced by mercury and lead and the protective effect of vitamin C on molecular pathways involved in the vascular damage related to their chronic exposure.

## Introduction

Despite the efforts of Western countries to reduce possible exposure to heavy metals, nowadays frequent poisoning still occurs with these compounds. Heavy metal poisoning has long been recognized as a health hazard. Heavy metals have historically been used in a number of industrial processes, including manufacture of batteries, paints, pipes, etc. However, in many Western countries exposure to heavy metals has declined significantly, although in countries where industrial regulators are nonexistent or not strictly enforced heavy metal exposure remains a public health problem.

However, the effects of chronic exposure to low levels of heavy metal are more difficult to determine. Long-term exposure to low levels of heavy metals may result in their gradual accumulation and the development of a number of disorders and diseases including learning and behaviour problems, cardiovascular and kidney diseases, hypertension and cancer.

Although many of the mechanisms involved in the deleterious biological effects of heavy metals remain to be investigated, a growing amount of evidence indicates that heavy metals are able to generate reactive oxygen species (ROS) that result in lipid peroxidation, DNA damage and depletion of cell antioxidant defence systems.

Antioxidants are present in human blood, cells and tissues. They are derived from intrinsic antioxidant defence systems and also from extrinsic sources such as diet and pharmacotherapy. Among the antioxidants, vitamin C has been shown to have beneficial effects on the inhibition of oxidative stress and exert cardioprotective properties. Several studies have postulated that vitamin C intake is an effective treatment for heavy metal poisoning. This chapter describes the main molecular mechanisms involved in the development of cardiovascular diseases associated with prolonged exposure to low doses of mercury and lead, two heavy metals that are present in the environment, and the possible cardiovascular benefits of vitamin C treatment.

### 1. Mercury: An Environmental Risk Factor

Mercury is a highly reactive heavy metal. Environmental mercury is ubiquitous and, consequently, it is practically impossible for humans to avoid exposure to some form of mercury. There are three different forms of mercury [1, 2]:

- 1) elemental mercury, also known as liquid mercury, which is liquid at room temperature and is released into the environment as mercury vapour
- 2) inorganic mercury salts
- 3) organic mercury; methylmercury is the most frequently encountered compound derived from mercury in the environment

Elemental mercury can be found in commonly-used objects such as glass thermometers, electric switches, fluorescent light bulbs and some medical equipment. Another use of mercury is as dental composite fillings in primary molars, but it has recently been replaced in most developed countries by bismuth, which has properties similar to mercury but shows less toxicity. Inorganic mercury can be found in batteries, chemistry laboratories, some disinfectants and some types of drugs. The principal source of organic mercury exposure to humans is fish, which is enriched in methylmercury. Dietary methylmercury is absorbed from the gastrointestinal tract, readily enters the bloodstream and is distributed to all tissues in about 30 hours. Methylmercury is accumulated in hair and toenails, which both can be used as indicators of long-term mercury exposure in population studies.

### 1.1. Molecular Mechanism of Mercury Toxicity

Exposure to toxic levels of inorganic mercury mainly results in neurologic and renal damage. Organic mercury compounds show less ability to produce nephrotoxicity. As with other heavy metal exposure, mercury toxicity has been mainly attributed to oxidative stress processes (Figure 1).

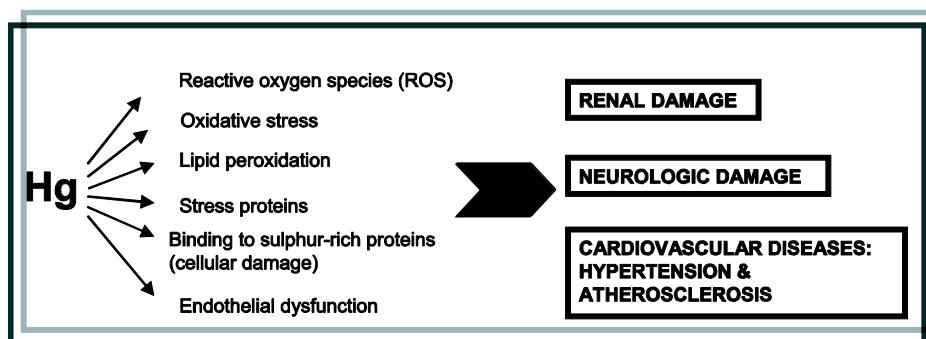

Figure 1. Mechanisms implicated in mercury intoxication.

In the kidney, the pars recta of the proximal tubules of the nephrons are the most susceptible regions for the toxic effects of mercury [3]. This nephrotoxicity related to mercury compounds is due to the binding capacity of mercury to proteins and to molecules involved in the transport and uptake of ions into renal tubular cells [4]. Mercury has a high affinity to bind to reduced sulphur atoms, especially to thiol-containing molecules such as glutathione, cysteine, homocysteine, N-acetylcysteine and albumin [5]. Plasma mercury binds to albumin and other large plasma proteins.

There are several studies suggesting that mercury exposure induces oxidative stress. Oxidative stress-induced by mercury seems to be mainly mediated by thiols depletion, especially glutathione. Lund et al. demonstrated that low doses of mercury may avoid mitochondrial glutathione, enhancing hydrogen peroxide formation [6]. Increased levels of hydrogen peroxide increases the oxidative processes favouring lipid peroxidation. Lipid peroxidation processes induced by mercury exposure seems to affect a number of organs. In

this regard, Mahboob et al. demonstrated in mercury-exposed mice an increased lipid peroxidation, particularly in the kidney, testis and epididymus [7]. These data support that chronic mercury exposure causes a systemic toxicity although determined organs as kidney are more susceptible to be damaged. It has also been reported that in addition to glutathione levels, the levels of other cellular antioxidants, including vitamin C, were depleted in the kidney of mercury-exposed rats [8].

A sign of mercury exposure-induced cell damage is the overexpression of cellular stress proteins. Goering et al. showed accumulation of heat-shock protein-72 (hsp-72) and glucose-regulated protein-94 (grp-94) in rat kidneys. Hsp72 was mainly localized in the renal medulla and grp94 in the renal cortex [9]. This heterogeneous accumulation of hsps and grp may reflect the existence of distinct tissue-specific or regional-specific protective mechanisms.

## 1.2. Mercury and Cardiovascular Disease

Mercury, in its distinct forms, causes toxic damage mainly in the kidneys and the nervous system. However, there are also data about the effect of chronic exposure of mercury in other organs and systems, including the cardiovascular system.

Epidemiological studies analysing the mortality and the incidence of cardiovascular diseases associated with chronic mercury exposure are scarce. In 1995, Salonen et al. reported an increased risk of coronary heart disease among residents of Knopis area in Finland whose hair samples showed increased levels of mercury probably related to locally contaminated fresh-water fish [10].

Fish intake is a major source of exposure to mercury, mainly in the form of methylmercury. In recent years more attention has been given to possible adverse effects of methylmercury exposure. In Finland, a high mercury content in hair was associated with an increased progression of atherosclerosis and risk of cardiovascular disease [11]. It is noteworthy that these adverse effects of cardiovascular disease have been observed at methylmercury levels much lower than those associated with neurotoxicity. Although the mechanisms by which mercury exerts its negative effects are not well known, the high affinity for thiol groups and its ability to bind selenium into an insoluble complex could reduce antioxidative defences and promote radical stress and lipid peroxidation in the human body [12, 13].

Mercury may promote atherosclerosis and hence increase the risk of myocardial infarction in several ways. As mentioned, mercury promotes free radical generation in experimental models [14-16]. Mercury levels, which may induce lipid peroxidation, were a strong predictor of oxidized low-density lipoprotein levels in the Kuopio Ischemic Heart Disease Study [10]. Mercury compounds may also promote platelet aggregability and blood coagulability, inhibit endothelial-cell formation and migration, and affect apoptosis and the inflammatory response [17-20]. Increased rates of cardiovascular disease were found among mercury-exposed workers [21, 22], and mercury levels in hair predicted the progression of carotid atherosclerosis in a longitudinal study [11].

A study from Guallar et al. has shown that toenail mercury level was directly associated with the risk of myocardial infarction supporting the supposition that the mercury content



may diminish the cardioprotective effect of fish intake [23]. In this regard, it has been suggested that mercury may counterbalance the beneficial cardiovascular effects of n-3 fatty acids in fish [10, 24, 25]. The United States Health Professionals Follow-up Study did not show an association between mercury and risk for coronary heart disease, but dentist, with elemental mercury exposure, made up 63.6% of controls [26].

Blood pressure is a good indicator of risk for cardiovascular disease. In the Greenland Inuit population, autopsies revealed that methyl mercury levels in organs are generally high and blood pressure levels are similar to those of the populations of industrialized countries [27]. Epidemiologic studies relating methylmercury and blood pressure have reported inconsistent findings. However, long-term experimental studies have suggested that low-dose methylmercury exposure can lead to irreversible hypertension that remains for many months after cessation of exposure. More recently, Wiggers et al. demonstrated that low mercury concentration cause oxidative stress and endothelial dysfunction in the arterial wall [28]. These authors showed that chronic exposure to low mercury concentrations did not affect systolic blood pressure but increased phenylephrine-induced vasoconstriction and reduced acetylcholine-induced vasodilatation. It seems to be associated with reduction of nitric oxide bioavailability induced by increases in the oxidative stress [29].

Independently of the peroxidative effect induced by mercury exposure, it has been postulated other explanations for the mercury effects on blood pressure. One of these mechanisms is through a direct effect of mercury on vascular viability. Functional integrity of the endothelium is crucial for the maintenance of blood flow and anti-thrombotic capacity, because the endothelium synthesizes and releases a number of factors that control relaxation and contraction of the vascular wall, thrombogenesis, fibrinolysis and activation/inhibition of platelets [30]. In this regard, mercury can induce changes in platelet aggregation by binding to the thiol groups present in the platelet membrane  $\text{Na}^+/\text{K}^+$  ATPase [31]. Mercury also blocks sodium channels including the oxidation of cysteinyl residues.

Both *in vivo* and *in vitro* studies have reported endothelial damage after mercury exposure [32-34]. However, contradictory data exist about the molecular mechanisms that induce endothelial injury by mercury.

In summary, although there is evidence from epidemiological studies that supports an increased risk of cardiovascular disease in the presence of high mercury levels, the evidence of mercury exposure and blood pressure need more epidemiological studies.

## 2. Lead Toxicity

Lead exposure is closely associated with negative effects on human health. Lead is present in the environment—in air, food, water, brass, plumbing fixtures, soil, etc. Lead present in the air contributes to lead in food through deposits of dust and rain containing lead on crops and soil. Furthermore, lead has been widely used in the production of paint, batteries, gasoline, plumbing pipes and solder, shot, radiation shields and many other products. Thanks to the efforts of health authorities and governments, the use of lead in many products as gasoline, paints or ceramic products has been dramatically reduced.

In the general non-smoking and adult population the main way for lead exposure pathway is food and water contaminated with lead. Average daily lead intake for adults in the UK is estimated at 1.6  $\mu\text{g}$  from air, 20  $\mu\text{g}$  from drinking water and 28  $\mu\text{g}$  from food. Drinking water seems to be responsible for approximately 20 percent of the total daily exposure experienced by the majority of the U.S population. However, in the case of children, lead paint is the major source of lead exposure. The U.S. department of Housing and Urban development estimated that 38 millions home in the United State contained lead paint. Of those, 24 millions contained significant lead-based paint hazards. In 1984, as many as 3 to 4 million American children were estimated to have blood lead levels greater than healthy levels [35-37].

### 2.1. Lead Exposure Hypertension and Oxidative Stress

The severity of lead toxicity depends on the duration, frequency and amount of exposure. In this regard, multiples studies developed in animals and human population have supported the casual relationship between low-level lead exposure and hypertension [38]. Numerous researching groups have tried to clarify the molecular mechanisms by which exposure to low levels of lead induces hypertension. The results of these studies have showed various molecular pathways involved to lead-induced hypertension. At present, there are three main mechanisms by which lead seem to trigger hypertension:

1. increase in oxidative stress
2. inhibition of nitric oxide synthesis
3. reduction of the smooth muscle cells of the cyclic-GMP generating system

E. D. Willis published the earliest paper regarding lead-induced oxidative stress in 1965. It is now well recognized the ability of lead to stimulate the oxidative state. Although the mechanisms by which lead induces oxidative stress are not completely understood, evidence indicates that multiple mechanisms may be involved.

Lead exposure causes oxidative stress in the kidneys and in cardiovascular tissues in vivo and in endothelial cells and vascular smooth muscle cells in vitro. Moreover, animal studies have shown that lead-induced oxidative stress is, at least in part, responsible for lead-induced hypertension. In this regard, reactive oxygen species inactivate endothelial-dependent vasorelaxation. Ding et al. showed that L-arginine infusion lowers arterial pressure to a much greater extent in lead-exposed rats than in control animals [39]. It was also found reduction of nitric oxide availability in lead-treated rats. In this work, it was further showed that the rise in arterial pressure was accompanied by reduction of renal blood flow, related to a rise in renal vascular resistance similar to that observed in rats treated with a nitric oxide generating inhibitor [40].

Lead may also favour the oxidative stress altering the antioxidant enzyme activities such as superoxide dismutase, catalase and glutathione peroxidase [41-43]. Because lead as other heavy metals such as mercury, have a high affinity for sulfhydryl groups, lead is shown to inhibit overall enzymes having functional SH groups. This inhibitory effect of lead on

various antioxidants enzymes would probably result in impaired antioxidant defences by cells and render more vulnerable to oxidative attacks.

The main receptor of nitric oxide is soluble guanylate cyclase which after nitrite oxide binding generates cyclic GMP (cGMP). cGMP acts as second messenger to stimulate the nitric oxide dependent vasorelaxation. Khalil-Manesh et al. demonstrated an induced plasma and urinary concentration of cGMP in rats with-lead induced hypertension [44]. Marques et al. showed that, despite upregulation of endothelial nitric oxide synthase (eNOS), the vasorelaxation response to acetylcholine was reduced in isolated aortic from lead-exposed rats. It was accompanied by an impaired vasodilatory response to exogenous nitric oxide in lead-exposed rats. It was also associated with reduction in the vascular expression of both  $\alpha_1$  and  $\beta_1$  soluble guanylate cyclase subunits in the vascular wall of lead-exposed rats [45]. These findings further confirmed in in vitro lead-exposed vascular smooth muscle cells which showed downregulation of the soluble guanylate cyclase after lead exposure. In lead-induced downregulation may be also involved the release of endothelin from the endothelium. In this regard, Molero et al. found that incubation with an endothelin type A receptor antagonist partially reversed lead-induced downregulation of soluble guanylate cyclase and cGMP production [46] (Figure 2).

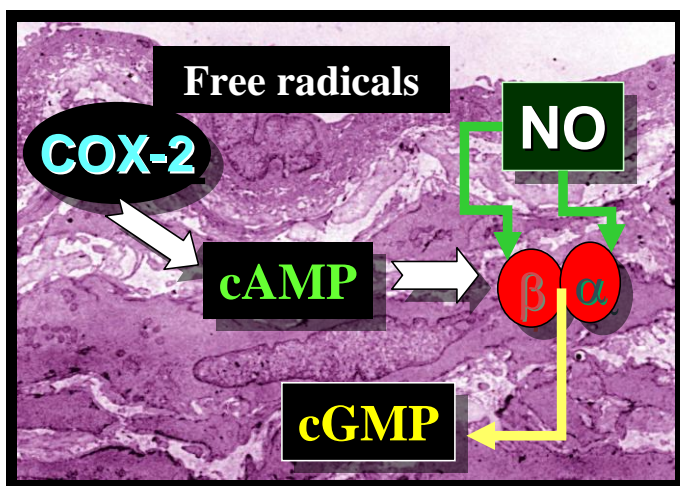

Figure 2. Proposed mechanism by which lead induced downregulation of soluble guanylate cyclase expression in the vascular wall. In brief, free radicals stimulated cyclooxygenase-2 expression which increased cyclic AMP production. Cyclic AMP downregulates soluble guanylate cyclase expression.

### 3. Vitamin C and Cardiovascular Protection against Mercury and Lead

Reactive oxygen species (e.g., superoxide, hydrogen peroxide and hydroxyl radical) are intermediary metabolites that are normally produced in the course of oxygen metabolism. An excess in the production of oxygen species and/or impaired antioxidant defence capacity leads to oxidative stress. Hypertension is one of the main risk cardiovascular factors. There is

a narrow relationship between hypertension and oxidative stress. As example, hypertension and oxidative stress dramatically improved within 3 weeks of moderate physical activity and after the consumption of a diet rich in natural antioxidants (fruits and vegetables).

Antioxidants are present in human blood, cells and tissues. Antioxidants from dietary sources have attracted interest, specially vitamins C, E and other carotenoids. These antioxidants protect against oxidative stress. Therefore, it is plausible that antioxidants might play a role in preventing from the negative effects associated with ROS production induced by mercury and lead.

Vitamin C (ascorbic acid) is a potent water-soluble antioxidant in humans and is included among the most abundant antioxidants. The National Health and Nutrition Examination Surveys and the Eastern Finland Study supported a protective role for vitamin C against coronary artery and cardiovascular diseases, reducing oxidative stress [47-49]. According to results obtained by different research groups may be thought that vitamin C would have protective effect against oxidative stress induced by heavy metal exposure.

The main disorder that mercury and lead exposure induces is the development of oxidative stress that can derive in cardiovascular disease. The oxidative stress on the cardiovascular system may induce diverse harmful effects as:

- a. oxidative modification of low-density lipoproteins (LDL), endothelial dysfunction and atherosclerosis
- b. pro-inflammatory response
- c. reduction of NO availability and smooth muscle cell cGMP formation

Despite vitamin C have demonstrated to have protective effects against oxidative mechanisms, controversial data exist about its protective effect during mercury intoxication [2].

In this regard, Fukino and collaborators reported levels of vitamin C, glutathione and other cellular antioxidants were avoided in a rat model after mercury exposure [8]. However, in other animal study, Aposhian and collaborators evaluated the antioxidant properties and the scavenger capacity of vitamin C, glutathione and lipoic acid, alone or in combination with DMPS (2,3-dimercapto-1-propanesulfonate) or DMSA (meso-2,3-dimercaptosuccinic acid) in mercury-exposed rats. Neither vitamin C nor the other antioxidants compounds reduced mercury blood levels. Only DMPS and DMSA showed reduction of mercury renal concentrations [50]. In view of the published data, other treatments besides vitamin C administration may be considered as possible against mercury exposure.

In this regard, other compounds distinct to vitamin C, generally precedents of plant extracts, have shown antioxidant properties against mercury intoxication. For example, ginkgo biloba is a know free radical scavenger that have demonstrated to possess antioxidant activity [51]. It is thought that the antioxidant properties of ginkgo biloba is caused by its flavonoid glucoides and terpenoids contents in this plant, that removes  $O_2^-$  and OH radicals [51]. In rats, administration of ginkgo biloba extracts (EGb761) after mercury exposure restored the activity of lactate dehydrogenase and glutathione to normal levels [52].

Thymoquinone is the main active constituent of the volatile oil extracted from the black seed, and have also showed protective antioxidant effects. In a study developed in mercury-

exposed rats, a protective effect of thymoquinone treatment was observed in the rat kidney [53].

In humans, the majority of studies have shown beneficial effects on vitamin C treatment after lead intoxication. In a long cross-sectional study followed in 19578 individuals, Simon and Hudes [54] analyzed the association between serum vitamin C concentrations and the prevalence of elevated blood lead levels. This study showed an inverse relationship between serum vitamin C levels and blood lead concentrations. However, there were no correlations between vitamin C intake and blood lead concentrations [54]. Another study developed in African American women, vitamin C supplementation significantly reduced blood lead levels, showing a negative correlation between vitamin C and lead serum levels [55]. Dawson and Harries observed that after lead-contained drink intake, vitamin C treatment produced a reduction in lead retention [56].

Several *in vitro* and *in vivo* studies have been realized to determine the beneficial effects of vitamin C treatment on the deleterious effects of lead on the cardiovascular system. While animal studies have shown that vitamin C treatment has beneficial effects against lead exposure, studies in humans have not shown similar evidence. Lead-induced hypertension is the issue that has received more attention regarding the deleterious effect of lead in the cardiovascular system. Evidence of the participation of oxidative stress in the pathogenesis of lead-induced hypertension comes from an experiment that demonstrated normalization of arterial pressure with infusion of the superoxide scavenger drug tempol in lead-exposed rats [39]. A number of other investigators have demonstrated the critical role of oxidative stress in the pathogenesis of lead-induced endothelial dysfunction and hypertension in experimental animals. In this regard, Vaziri et al. observed that lazaroid, a non-chelating antioxidant, improved nitric oxide availability and reduced blood pressure in lead-exposed rats [57]. Taken together, these findings suggest that lead reduced the availability of endothelium-dependent nitric oxide in the vascular wall. It was further supported by the fact that tempol, a superoxide scavenger drug, normalized arterial pressure in lead-exposed rats [39]. Marques et al. demonstrated that concomitant administration of lead and vitamin C prevented an increase in mean arterial blood pressure, improved relaxation to both acetylcholine and sodium nitroprusside and restored the normal protein expression of endothelial nitric oxide synthase and soluble guanylate cyclase in the vascular wall [45]. Courtois et al. showed that vitamin C partially restored the expression of soluble guanylate cyclase in lead-induced isolated rat aortic segments [58]. Moreover, vitamin C prevented lead-induced cyclooxygenase-2 expression in the isolated rat aortic segments that was not observed with rofecoxib, an inhibitor of cyclooxygenase-2 activity that failed to modify superoxide anion production induced by lead exposure of the vascular wall. It suggests that a superoxide anion was involved in the upregulation of cyclooxygenase-2 expression elicited by lead [58].

Taken together, the above-described studies provide evidence that lead exposure causes oxidative stress and alterations of the nitric oxide pathway which culminate in development of arterial hypertension. The treatment of oxidative stress is traditionally equated with the administration of antioxidants like vitamin C. However, perhaps the identification of the source and control of the production of reactive oxygen species should be more useful.

In conclusion, both mercury and lead induced oxidative stress not only by stimulation of reactive oxygen species generation but also by depletion of the antioxidant systems with the cardiovascular-related cells.

## References

- [1] SJ, S.F., M. Mittal, and A. Mehta, Heavy metal induced oxidative stress & its possible reversal by chelation therapy. *Indian J Med Res*, 2008. 128(4): p. 501-23.
- [2] Valko, M., H. Morris, and M.T. Cronin, Metals, toxicity and oxidative stress. *Curr Med Chem*, 2005. 12(10): p. 1161-208.
- [3] Zalups, R.K., Molecular interactions with mercury in the kidney. *Pharmacol Rev*, 2000. 52(1): p. 113-43.
- [4] McGoldrick, T.A., et al., Renal cysteine conjugate C-S lyase mediated toxicity of halogenated alkenes in primary cultures of human and rat proximal tubular cells. *Arch Toxicol*, 2003. 77(7): p. 365-70.
- [5] Hultberg, B., A. Andersson, and A. Isaksson, Interaction of metals and thiols in cell damage and glutathione distribution: potentiation of mercury toxicity by dithiothreitol. *Toxicology*, 2001. 156(2-3): p. 93-100.
- [6] Lund, B.O., D.M. Miller, and J.S. Woods, Mercury-induced H<sub>2</sub>O<sub>2</sub> production and lipid peroxidation in vitro in rat kidney mitochondria. *Biochem Pharmacol*, 1991. 42 Suppl: p. S181-7.
- [7] Mahboob, M., et al., Lipid peroxidation and antioxidant enzyme activity in different organs of mice exposed to low level of mercury. *J Environ Sci Health B*, 2001. 36(5): p. 687-97.
- [8] Fukino, H., et al., Effect of zinc pretreatment on mercuric chloride-induced lipid peroxidation in the rat kidney. *Toxicol Appl Pharmacol*, 1984. 73(3): p. 395-401.
- [9] Goering, P.L., et al., Mercury induces regional and cell-specific stress protein expression in rat kidney. *Toxicol Sci*, 2000. 53(2): p. 447-57.
- [10] Salonen, J.T., et al., Intake of mercury from fish, lipid peroxidation, and the risk of myocardial infarction and coronary, cardiovascular, and any death in eastern Finnish men. *Circulation*, 1995. 91(3): p. 645-55.
- [11] Salonen, J.T., et al., Mercury accumulation and accelerated progression of carotid atherosclerosis: a population-based prospective 4-year follow-up study in men in eastern Finland. *Atherosclerosis*, 2000. 148(2): p. 265-73.
- [12] Cuvin-Aralar, M.L. and R.W. Furness, Mercury and selenium interaction: a review. *Ecotoxicol Environ Saf*, 1991. 21(3): p. 348-64.
- [13] Naganuma, A., Y. Koyama, and N. Imura, Behavior of methylmercury in mammalian erythrocytes. *Toxicol Appl Pharmacol*, 1980. 54(3): p. 405-10.
- [14] Magos, L., Physiology and toxicology of mercury. *Met Ions Biol Syst*, 1997. 34: p. 321-70.
- [15] Clarkson, T.W., The toxicology of mercury. *Crit Rev Clin Lab Sci*, 1997. 34(4): p. 369-403.

- 
- [16] Jansson, G. and M. Harms-Ringdahl, Stimulating effects of mercuric- and silver ions on the superoxide anion production in human polymorphonuclear leukocytes. *Free Radic Res Commun*, 1993. 18(2): p. 87-98.
- [17] Kostka, B., Kinetic evaluation of ADP-induced platelet aggregation potentiation by methylmercury chloride. *J Trace Elem Exp Med*, 1991. 4: p. 1-9.
- [18] Wierzbicki, A.S., et al., The apolipoprotein E2 allele modulates activity and maximal velocity of the sodium-lithium countertransporter. *Am J Hypertens*, 2002. 15(7 Pt 1): p. 633-7.
- [19] Kishimoto, T., et al., Inhibitory effect of methylmercury on migration and tube formation by cultured human vascular endothelial cells. *Arch Toxicol*, 1995. 69(6): p. 357-61.
- [20] InSug, O., et al., Mercuric compounds inhibit human monocyte function by inducing apoptosis: evidence for formation of reactive oxygen species, development of mitochondrial membrane permeability transition and loss of reductive reserve. *Toxicology*, 1997. 124(3): p. 211-24.
- [21] Barregard, L., G. Sallsten, and B. Jarvholm, Mortality and cancer incidence in chloralkali workers exposed to inorganic mercury. *Br J Ind Med*, 1990. 47(2): p. 99-104.
- [22] Boffetta, P., et al., Mortality from cardiovascular diseases and exposure to inorganic mercury. *Occup Environ Med*, 2001. 58(7): p. 461-6.
- [23] Guallar, E., et al., Mercury, fish oils, and the risk of myocardial infarction. *N Engl J Med*, 2002. 347(22): p. 1747-54
- [24] Committee on the Toxicological Effects of Methylmercury, B.o.t.E.S.a.T., Commission on Life Sciences., ed. *Toxicological effects of methylmercury*. ed. N.R. Council. 2000: Washington DC.
- [25] Rissanen, T., et al., Fish oil-derived fatty acids, docosahexaenoic acid and docosapentaenoic acid, and the risk of acute coronary events: the Kuopio ischaemic heart disease risk factor study. *Circulation*, 2000. 102(22): p. 2677-9.
- [26] Scarlett JM, Gutenmann WH, Lisk DJ. A study of mercury in the hair of dentists and dental-related professionals in 1985 and subcohort comparison of 1972 and 1985 mercury hair levels. *J Toxicol Environ Health*. 1988;25(3):373-81.
- [27] Mulvad, G., et al., The Inuit diet. Fatty acids and antioxidants, their role in ischemic heart disease, and exposure to organochlorines and heavy metals. An international study. *Arctic Med Res*, 1996. 55 Suppl 1: p. 20-4.
- [28] Wiggers GA, Stefanon I, Padilha AS, Peçanha FM, Vassallo DV, Oliveira EM. Low nanomolar concentration of mercury chloride increases vascular reactivity to phenylephrine and local angiotensin production in rats. *Comp Biochem Physiol C Toxicol Pharmacol*. 2008; 147(2):252-60.
- [29] Wiggers GA, Peçanha FM, Briones AM, Pérez-Girón JV, Miguel M, Vassallo DV, Cachofeiro V, Alonso MJ, Salaices M. Low mercury concentrations cause oxidative stress and endothelial dysfunction in conductance and resistance arteries. *Am J Physiol Heart Circ Physiol*. 2008; 295(3):H1033-H1043.
- [30] Luscher, T.F. and M. Barton, Biology of the endothelium. *Clin Cardiol*, 1997. 20(11 Suppl 2): p. II-3-10.

- [31] Kumar SV, Maitra S, Bhattacharya S. In vitro binding of inorganic mercury to the plasma membrane of rat platelet affects Na<sup>+</sup>-K<sup>+</sup>-Atpase activity and platelet aggregation. *Biometals*. 2002;15(1):51-7.
- [32] Zimmermann, H.D., et al., Intra- and extrarenal vascular changes in the acute renal failure of the rat caused by mercury chloride. *Virchows Arch A Pathol Anat Histol*, 1977. 372(4): p. 259-85.
- [33] Russell, S.B., The mechanism of action of mercuric chloride on the isolated perfused rat kidney. *Eur J Clin Invest*, 1975. 5(4): p. 319-25.
- [34] Anniko, M. and L. Sarkady, Morphological changes of labyrinthine blood vessels following metal poisoning. *Acta Otolaryngol*, 1977. 83(5-6): p. 441-8.
- [35] Russell Jones, R., The continuing hazard of lead in drinking water. *Lancet*, 1989. 2(8664): p. 669-70.
- [36] Jacobs, D.E., et al., The prevalence of lead-based paint hazards in U.S. housing. *Environ Health Perspect*, 2002. 110(10): p. A599-606.
- [37] Farfel, M.R. and J.J. Chisolm, Jr., An evaluation of experimental practices for abatement of residential lead-based paint: report on a pilot project. *Environ Res*, 1991. 55(2): p. 199-212.
- [38] (ATSDR), A.f.T.S.a.D.R., *Toxicological profile for lead*. (Draft for Public Comment), P.H.S.A. Department of Health and Human Services, GA., Editor. 2005. p. 43-59.
- [39] Ding, Y., N.D. Vaziri, and H.C. Gonick, Lead-induced hypertension. II. Response to sequential infusions of L-arginine, superoxide dismutase, and nitroprusside. *Environ Res*, 1998. 76(2): p. 107-13.
- [40] Dursun N, Arifoglu C, Süer C, Keskinol L. Blood pressure relationship to nitric oxide, lipid peroxidation, renal function, and renal blood flow in rats exposed to low lead levels. *Biol Trace Elem Res*. 2005, 104(2):141-9.
- [41] Sugawara, E., et al., Lipid peroxidation and concentration of glutathione in erythrocytes from workers exposed to lead. *Br J Ind Med*, 1991. 48(4): p. 239-42.
- [42] Chiba, M., et al., Indices of lead-exposure in blood and urine of lead-exposed workers and concentrations of major and trace elements and activities of SOD, GSH-Px and catalase in their blood. *Tohoku J Exp Med*, 1996. 178(1): p. 49-62.
- [43] Han, S.G., et al., Correlates of oxidative stress and free-radical activity in serum from asymptomatic shipyard welders. *Am J Respir Crit Care Med*, 2005. 172(12): p. 1541-8.
- [44] Khalil-Manesh, F., et al., Lead-induced hypertension: possible role of endothelial factors. *Am J Hypertens*, 1993. 6(9): p. 723-9.
- [45] Marques, M., et al., Alteration of the soluble guanylate cyclase system in the vascular wall of lead-induced hypertension in rats. *J Am Soc Nephrol*, 2001. 12(12): p. 2594-600.
- [46] Molero, L., et al., Involvement of endothelium and endothelin-1 in lead-induced smooth muscle cell dysfunction in rats. *Kidney Int*, 2006. 69(4): p. 685-90.
- [47] Simon, J.A. and E.S. Hudes, Serum ascorbic acid and cardiovascular disease prevalence in U.S. adults: the Third National Health and Nutrition Examination Survey (NHANES III). *Ann Epidemiol*, 1999. 9(6): p. 358-65.



- 
- [48] Hu, H., et al., Determinants of bone and blood lead levels among community-exposed middle-aged to elderly men. The normative aging study. *Am J Epidemiol*, 1996. 144(8): p. 749-59.
- [49] Manton, W.I., S.J. Rothenberg, and M. Manalo, The lead content of blood serum. *Environ Res*, 2001. 86(3): p. 263-73.
- [50] Aposhian, H.V., et al., Vitamin C, glutathione, or lipoic acid did not decrease brain or kidney mercury in rats exposed to mercury vapor. *J Toxicol Clin Toxicol*, 2003. 41(4): p. 339-47.
- [51] Mahady, G.B., Ginkgo biloba for the prevention and treatment of cardiovascular disease: a review of the literature. *J Cardiovasc Nurs*, 2002. 16(4): p. 21-32.
- [52] Tunali-Akbay, T., et al., Protective effects of Ginkgo biloba extract against mercury(II)-induced cardiovascular oxidative damage in rats. *Phytother Res*, 2007. 21(1): p. 26-31.
- [53] Fouda, A.M., et al., Thymoquinone ameliorates renal oxidative damage and proliferative response induced by mercuric chloride in rats. *Basic Clin Pharmacol Toxicol*, 2008. 103(2): p. 109-18.
- [54] Simon, J.A. and E.S. Hudes, Relationship of ascorbic acid to blood lead levels. *JAMA*, 1999. 281(24): p. 2289-93.
- [55] West, W.L., et al., Maternal low level lead and pregnancy outcomes. *J Nutr*, 1994. 124(6 Suppl): p. 981S-986S.
- [56] Dawson, E.B., et al., The effect of ascorbic acid supplementation on the blood lead levels of smokers. *J Am Coll Nutr*, 1999. 18(2): p. 166-70.
- [57] Vaziri, N.D., et al., Altered nitric oxide metabolism and increased oxygen free radical activity in lead-induced hypertension: effect of lazaroid therapy. *Kidney Int*, 1997. 52(4): p. 1042-6.
- [58] Courtois, E., et al., Lead-induced downregulation of soluble guanylate cyclase in isolated rat aortic segments mediated by reactive oxygen species and cyclooxygenase-2. *J Am Soc Nephrol*, 2003. 14(6): p. 1464-70



*Chapter XIV*

---

## **Vitamin C in the Treatment of Endothelial Dysfunction**

---

*Alin Stirban*\*

Diabetes Clinic, Heart and Diabetes Center NRW, Ruhr- University Bochum,  
Bad Oeynhausen, Germany.

### **Abstract**

Endothelial dysfunction (ED) plays a critical role in the development of cardiovascular complications preceding by decades their onset. Reversal of ED has been postulated to prevent atherosclerosis and several attempts have been done in this direction. Vitamin C has been suggested to reverse ED by several mechanisms: it serves as a potent antioxidant; it directly enhances the activity of nitric oxide synthase; the acyl CoA oxidase system and counteracts the action of proinflammatory lipids. Multiple data from experimental and clinical studies have proven protective effects of vitamin C on endothelium. Though, the therapeutic indication is limited by the low bioavailability following oral ascorbate administration and a rapid clearance. While oral, prophylactic approaches of treatment with vitamin C are difficult to implement, a large body of evidence prove beneficial effects of parenteral administration in critically ill patients. Supraphysiologic levels of ascorbate may facilitate the restoration of vascular function in patients after severe burns and other major traumas. This translates clinically into reduced circulatory shock, fluid requirements and oedema. The effects on the microcirculation seem to be of particular interest since microcirculation is very susceptible to oxidative stress that acts pathogenically to cause multiple organ failure. High-dose vitamin C administered parenterally counteracts endotoxin-induced ED and vasohyporeactivity in humans and reverses sepsis-induced alteration of the microcirculation in animals.

---

\* Tel.: 00495731 973724, email: [astirban@hdz-nrw.de](mailto:astirban@hdz-nrw.de).

Mechanisms of ascorbate-mediated improvement of endothelial function, as well as the clinical and experimental evidence, along with actual treatment and dietary recommendations are briefly reviewed.

Endothelial dysfunction (ED) is an early and reversible sign of atherosclerosis [1], represents a good predictor for cardiovascular risk [2] and its improvement was postulated to prevent atherosclerosis. ED accompanies states related to high cardiovascular (CV) risk, such as smoking [3], dyslipidemia [4], arterial hypertension [5], obesity [6], hyperhomocysteinemia [7], coronary artery disease [8], congestive heart failure [9] and type 1 [10] and type 2 [11] diabetes mellitus. Several attempts have been made to improve ED in high-risk populations like treatment with vitamin C [12] and E [13], L-arginine [14], tetrahydrobiopterin [15], sildenafil [16], folic acid [17], benfotiamine [18], etc [19]. The interest for vitamin C is easy to understand since it represents an inexpensive treatment, has modest side-effects and is commonly substituted by over-the counter products.

#### Mechanisms of Endothelium-Mediated Vasodilatation

Nitric oxide (NO) plays a major role in mediating the effects of endothelium. NO is mainly produced within endothelial cells together with L-citrulline from the substrate L-arginine by the enzyme endothelial NO-synthase (eNOS). Tetrahydrobiopterin is an essential cofactor for eNOS [20] and its depletion alters eNOS function, which instead of producing NO, reduces molecular oxygen to superoxide anions, thus acting pro-oxidant [21].

NO induces relaxation of vascular smooth muscle cells (VSMC) by enhancing the activity of the enzyme guanylyl cyclase, which catalyzes the production of cyclic guanosin-5-monophosphate (cGMP) leading to a decrease of intracellular calcium concentration, relaxation of VSMC and vasodilatation [22]. The concentration of cGMP is also regulated by the activity of the enzyme phosphodiesterase type 5, which is responsible for its degradation [23].

#### Mechanisms of Vitamin C Improving ED

Vitamin C has been suggested to reverse ED by several mechanisms: it serves as a potent antioxidant, it directly enhances the activity of eNOS, the acyl CoA oxidase system and counteracts the action of proinflammatory lipids [24].

Oxidative stress reduces the availability of NO mainly by 3 mechanisms. First, nitric oxide reacts with reactive oxygen species resulting in the formation of peroxynitrite – a powerful oxidant with toxic potential [25] - second, oxidized low density lipoprotein (LDL) can react directly with and inactivate nitric oxide [26] and third, oxidative stress increases formation of advanced glycation end products (AGE) which can inactivate NO themselves [27]. All these mechanisms reduce the bioavailability of NO for vascular effects. Oxidized LDL can also decrease NO effectiveness by lowering its production (it lowers the uptake of L-arginine and impairs the signal transduction, as well as the agonist receptor dependent

stimulation of eNOS) and decreasing its effects (it alters the activation of guanylyl cyclase) [28]. Vitamin C prevents LDL oxidation and regenerates LDL associated  $\alpha$  tocopherol, thereby inhibiting the pro-oxidant LDL activity [29].

Furthermore, vitamin C enhances the availability of tetrahydrobiopterin or the affinity of eNOS for tetrahydrobiopterin and maintains high intracellular concentrations of glutathione primarily by a sparing effect, which may enhance the synthesis or increase the stabilization of NO through formation of S-nitrosothiols [28].

Another mechanism by which vitamin C improves vascular reactivity could be the increased prostacyclin synthesis seen in cultured human endothelial cells and in vivo in subjects with hypercholesterolemia. Though, this mechanism is believed to play a minor role in subjects undergoing aspirin treatment [30].

Recent data suggest that vitamin C and E increase the number of endothelial progenitor cells by modulating multiple gene expression pathways [31].

It has been suggested that vitamin C inhibits the reaction of NO with superoxides only at very high extra cellular concentrations, that are usually achieved in vivo solely by intravenous infusion [24] and that normal extra cellular concentrations of 30-150  $\mu\text{mol/l}$  are unlikely to prevent the NO-superoxide interaction [32]. Indeed, intravenous vitamin C administration increases L-arginine induced dilatation of epicardial coronary arteries probably by increasing NO availability induced by L-arginine [28].

During sepsis, a marked impairment in blood flow through the capillary bed occurs. Intravenous administration of ascorbate restores capillary blood flow through a mechanism that is eNOS dependent and has a long-lasting action [33].

Vitamin C reduces inflammation, thus acting protective on the endothelium. Several studies have suggested that vitamin C reduces monocyte adhesion on the endothelium in cell-cultures [34] and in animal models [35], though other studies found no reduction in inflammatory parameters [36,37] or adhesion molecules [36] in diabetic patients (at oral vitamin C doses of 500 and 1500 mg/day). A systematic review on this topic has been recently made available, describing effects of ascorbic acid on different cell types and suggesting that available evidence generally supports a salutary role for this vitamin in ameliorating the earliest stages of atherosclerosis [38].

## **Clinical Studies Showing ED Improvement by Vitamin C Treatment**

### In Subjects with Coronary Artery Disease or Heart Failure

Several studies have suggested that vitamin C improves ED in subjects with coronary artery disease (CAD) [28,30,39,40]. Intravenous vitamin C administration in 28 patients with CAD and stable angina augmented the L-arginine dependent coronary segment vasodilatation measured by quantitative angiography. Authors concluded that vitamin C may have beneficial effects on NO bioavailability induced by L-arginine in this population [28].

Gokce and coworkers [39] investigated in a randomized, double-blind, placebo-controlled study, the effects of a single-dose (2 g) and long-term (500 mg/d for 30 days) oral

ascorbic acid treatment on endothelium-derived NO-dependent flow-mediated dilation (FMD) of the brachial artery in patients with angiographically established CAD. FMD was examined by high-resolution vascular ultrasound at baseline, 2 hours after the single dose, and 30 days after the long-term treatment in 46 patients with CAD. FMD improved after acute administration, an effect that was sustained after the long-term treatment. Endothelium-independent dilatation (after sublingual nitroglycerin administration) remained unaltered by treatment.

Similar results were reported in subjects with chronic heart failure where vascular effects of vitamin C (25 mg/min intra-arterial) and placebo on the radial artery function were assessed at rest and during reactive hyperemia. Vitamin C restored vascular reactivity after acute intra-arterial administration and after 4 weeks of oral therapy (2g/day) [41].

### In Subjects with Diabetes Mellitus

Intrabrachial infusion of vitamin C has been shown to restore endothelial function in subjects with diabetes mellitus (DM) [42] or during experimental hyperglycemia in non-diabetic subjects [43].

Ting and coworkers [42] showed that intraarterial administration of vitamin C (24 mg/min) improves endothelium-dependent vasodilation in forearm resistance vessels of patients with non-insulin-dependent DM. Measurements of forearm blood flow using venous occlusion plethysmography during intraarterial infusion of methacholine (0.3-10 micrograms/min) were performed. No effect on healthy controls could be seen. Endothelium independent vasodilatation to nitroprusside and to verapamil remained unaltered in both groups by vitamin C treatment.

Though, Darko and coworkers treated 35 subjects with type 2 DM with vitamin C (1.5 g daily in three doses) or matching placebo for 3 weeks in a randomized, double-blind, parallel-group design [44]. They assessed endothelial function by measuring forearm blood flow responses to brachial artery infusion of the endothelium-dependent vasodilator acetylcholine (with nitroprusside as an endothelium-independent control) and by the pulse wave responses to systemic albuterol (endothelium-dependent vasodilator) and glyceryl trinitrate (endothelium-independent vasodilator). Authors found no significant improvement in oxidative stress, blood pressure or endothelial function following treatment with vitamin C in this population.

In order to differentiate between DM and CAD as potential treatment targets for vitamin C, Antoniadou and coworkers [36] have investigated the effects of treatment with 2g of vitamin C/day for 4 weeks on healthy subjects, subjects with DM and CAD and subjects with DM without CAD. Compared to controls, both diabetic groups showed impaired vascular function assessed by strain-gauge plethysmography of the left arm. The forearm vasodilatory response to reactive hyperemia was reversed in subjects with DM plus CAD, but not in subjects with DM without CAD. The authors' explanation was that the contribution of oxidative stress to the development of ED is greater in the presence of atherosclerosis and antioxidant treatment might be more effective in such populations.

## Vitamin C Supplementation in Smokers

Acute effects of intra-arterial infusion of the antioxidant vitamin C (18 mg/min) in 10 control subjects and 10 chronic smokers have been investigated by Heitzer and coworkers [45] by assessing forearm blood flow responses to the endothelium-dependent vasodilator acetylcholine (7.5, 15, 30, and 60 micrograms/min) and the endothelium-independent vasodilator sodium nitroprusside (1, 3, and 10 micrograms/min) using venous occlusion plethysmography. In chronic smokers, forearm blood flow responses to acetylcholine was improved by concomitant intraarterial infusion of vitamin C, while the vasodilator responses to sodium nitroprusside was not affected. No effect was seen in the control group.

Antoniades and coworkers [46] investigated the effect of single and combined antioxidant treatment with vitamins C and E on endothelial function and plasma levels of plasminogen activator inhibitor (PAI-1), von Willebrand factor (vWF), tissue plasminogen activator (tPA) and factor VII (fVII), in 41 smokers. Forearm blood flow was measured using venous occlusion strain-gauge plethysmography in response to reactive hyperemia (endothelium-dependent) or to sublingual nitroglycerin administration (endothelium-independent). Subjects were randomly divided into 4 groups receiving vitamin C 2g/day (group A), vitamin C 2g/day plus vitamin E 400 IU/day (group B), vitamin C 2g/day plus vitamin E 800 IU/day (group C) or no antioxidants (controls, group D), for 4 weeks. After treatment, endothelium-dependent vasodilatation was increased only in groups B ( $p < 0.05$ ) and C ( $p < 0.001$ ). Endothelium-independent vasodilatation remained unchanged in all groups. Authors concluded that combined administration of vitamin C and vitamin E at high dosages, improves endothelial function and decreases plasma levels of PAI-1, vWF and PAI-1/tPA ratio in chronic smokers.

In contrast to these data, Raitakari and coworkers [12] investigated the acute (2g) and long-term (1g/day for 8 weeks) effect of oral vitamin C in 20 healthy young adult smokers. Oral vitamin C therapy improved FMD acutely, but it had no beneficial long-term effect.

A study by Hirai and coworkers demonstrated that under constant infusion of vitamin C (10 mg/min for 120 min) insulin sensitivity and FMD improves in chronic smokers and nonsmokers with impaired glucose tolerance [47]. Previous *in vitro* data suggested that oxidative stress impairs insulin signal transduction [48], one possible explanation for the insulin sensitizing effect of vitamin C in this study.

## Vitamin C in Subjects with Hypertension

Solzbach and coworkers investigated in 22 hypertensive patients without relevant CAD, the endothelium-dependent vascular responses of the left anterior descending coronary artery (LAD) to acetylcholine and papaverine-induced flow-dependent vasodilatation (FDD) before and immediately after intravenous infusion of 3 g vitamin C or placebo. Segmental responses of the coronary artery luminal area were analyzed with quantitative coronary angiography. The vasoconstrictor response during acetylcholine was reduced and FDD was augmented by vitamin C. Authors concluded that vitamin C improves endothelium-dependent vasoreactivity of coronary arteries in hypertensive subjects without CAD [49].

## Vitamin C and Lipid Induced ED

By measuring FMD before and hourly for 6 hours following a high-fat meal (900 kcalories, 50 g of fat) in twenty healthy, normocholesterolemic subjects, Plotnick and coworkers demonstrated that a decrease in endothelial function for up to 4 hours occurs and that this effect can be prevented by oral pretreatment with the antioxidant vitamins C (1 g) and E (800 IU) [50]. In another study performed in 10 healthy volunteers, vascular dysfunction due to increased free fatty acid concentration induced by Intralipid/heparin infusion could be reversed by concomitant intraarterial infusion of ascorbic acid (24 mg/min) [51].

Recently it has been suggested that high-dose vitamin C improves endothelial function of harvested saphenous vein segments in an *ex vivo* model, providing evidence that not only the arterial segment, but also the venous one can benefit from ascorbic acid replacement [52].

## Endpoint Data to Oral Vitamin C Substitution

The Physicians' Health Study II was a randomized, double-blind, placebo-controlled factorial trial of vitamin E and vitamin C completed between 1997 and 2007 [53]. A number of 14,641 US male physicians aged 50 years and above were enrolled, including 754 men (5.1%) with CAD at randomization. The intervention consisted of supplements of 400 IU vitamin E every other day and 500 mg vitamin C daily. Results showed that neither vitamin E nor vitamin C supplementation reduced the risk of major cardiovascular events in middle-aged and older men. These data are in line with previous studies showing that a combination of vitamin E and vitamin C provides no cardiovascular benefits in postmenopausal women with CAD and a potential for harm was even suggested [54].

In contrast, 500 mg/d of vitamin C reduced restenosis rates in patients after percutaneous transluminal coronary angioplasty [55]. A combination of 136 IU of vitamin E plus 250 mg of slow-release vitamin C twice daily administered for 6 years reduced the progression of intima media thickness in hypercholesterolemic subjects [56].

## Vitamin C in Critically Ill Patients

While oral, prophylactic approaches of treatment with vitamin C are controversial, a large body of evidence proves beneficial effects of parenteral administration in critically ill patients. Extensive data on this topic have been reviewed [57,24,58].

Oxidative stress implies a depletion of vitamin C and therefore ascorbate supplementation might play a clinical role in the treatment of diseases characterized by increased oxidative stress. Supraphysiologic levels of ascorbate may facilitate the restoration of vascular function in patients after severe burns and other major traumas. This translates clinically into reduced circulatory shock, fluid requirements and oedema [57]. The effects on the microcirculation seem to be of particular interest since microcirculation is very susceptible to oxidative stress that acts pathogenically to cause multiple organ failure. High-



dose vitamin C administered parenterally counteracts endotoxin-induced ED and vasohyporeactivity in humans and reverses sepsis-induced alteration of the microcirculation in animals [58].

In ICU patients, a high-dose antioxidant protocol for 7 days (including vitamin C intravenously) reduced by 28% the relative risk for mortality and significantly shortened both hospital and ICU length of stay [59].

## Summary and Conclusions

One limitation of oral therapy with vitamin C is the reduced bioavailability and rapid clearance [57]. Acute, parenteral administration has proven effectiveness for the reversal of ED in subjects with CAD [28], diabetes [42] and hypertension [49]. Vitamin C administration does not alter endothelial function in healthy subjects and seems not to influence endothelium independent vasodilatation in either population [42,39,45].

Oral therapy can acutely improve endothelial function in high-risk subjects (e.g. with CAD) at doses of around 2g vitamin C. Long-term effects require an oral dose of 500 mg-2g/day [39,41]. In subjects with diabetes mellitus, oral therapy seems to be less effective in correcting ED in the absence of CAD and bring benefit when CAD is present [36].

Whether long-term effects of vitamin C supplementation in smokers exist, remained controversial [46,12].

A recent consensus stated that only parenteral administration of vitamin C can counteract oxidative stress [24]. One explanation why oral treatments with vitamin C translated into improvement of ED in some studies, could be that beneficial effects of vitamin C on endothelium are not limited to its antioxidant effects.

Even though oral vitamin C supplementation reduced restenosis rates in patients after percutaneous transluminal coronary angioplasty [55] and co-administered with vitamin E reduced the progression of intima media thickness [56], the Physicians' Health Study II showed that vitamin C supplementation did not reduce the risk of major cardiovascular events in middle-aged and older men. In postmenopausal women, the combination with vitamin E could even be harmful [54].

Therefore, the strongest benefit from vitamin C treatment seems be for the intravenous administration in critically ill patients [59].

In light of existing evidence, dietary consumption of food rich in vitamin C can be encouraged, but no specific recommendations can be made regarding the supplementation with over-the-counter products containing vitamin C.

## References

- [1] Ross, R. The pathogenesis of atherosclerosis: a perspective for the 1990s. *Nature*, 1993. 362: 801-809.

- [2] Witte, DR; Westerink, J; de Koning, EJ; van der, GY; Grobbee, DE; Bots, ML. Is the association between flow-mediated dilation and cardiovascular risk limited to low-risk populations? *J Am Coll Cardiol*, 2005. 45: 1987-1993.
- [3] Celermajer, DS; Adams, MR; Clarkson, P; Robinson, J; McCredie, R; Donald, A; Deanfield, JE. Passive smoking and impaired endothelium-dependent arterial dilatation in healthy young adults. *N Engl J Med*, 1996. 334: 150-154.
- [4] Sorensen, KE; Celermajer, DS; Georgakopoulos, D; Hatcher, G; Betteridge, DJ; Deanfield, JE. Impairment of endothelium-dependent dilation is an early event in children with familial hypercholesterolemia and is related to the lipoprotein(a) level. *J Clin Invest*, 1994. 93: 50-55.
- [5] Panza, JA. Endothelium-dependent vasodilatation and essential hypertension. *N Engl J Med*, 1994. 331: 951-
- [6] Tack, CJ; Ong, MK; Lutterman, JA; Smits, P. Insulin-induced vasodilatation and endothelial function in obesity/insulin resistance. Effects of troglitazone. *Diabetologia*, 1998. 41: 569-576.
- [7] Coppola, A; Astarita, C; Oliviero, M; Fontana, D; Picardi, G; Esposito, K; Marfella, R; Coppola, L; Giugliano, D. Impairment of coronary circulation by acute hyperhomocysteinemia in type 2 diabetic patients. *Diabetes Care*, 2004. 27: 2055-2056.
- [8] Tousoulis, D; Charakida, M; Stefanadis, C. Endothelial function and inflammation in coronary artery disease. *Heart*, 2005.
- [9] Zelis, R; Mason, DT; Braunwald, E. A comparison of the effects of vasodilator stimuli on peripheral resistance vessels in normal subjects and in patients with congestive heart failure. *J Clin Invest*, 1968. 47: 960-970.
- [10] Clarkson, P; Celermajer, DS; Donald, AE; Sampson, M; Sorensen, KE; Adams, M; Yue, DK; Betteridge, DJ; Deanfield, JE. Impaired vascular reactivity in insulin-dependent diabetes mellitus is related to disease duration and low density lipoprotein cholesterol levels. *J Am Coll Cardiol*, 1996. 28: 573-579.
- [11] Tooke, JE; Goh, KL. Vascular function in Type 2 diabetes mellitus and pre-diabetes: the case for intrinsic endotheiopathy. *Diabet Med*, 1999. 16: 710-715.
- [12] Raitakari, OT; Adams, MR; McCredie, RJ; Griffiths, KA; Stocker, R; Celermajer, DS. Oral vitamin C and endothelial function in smokers: short-term improvement, but no sustained beneficial effect. *J Am Coll Cardiol*, 2000. 35: 1616-1621.
- [13] Neunteufl, T; Priglinger, U; Heher, S; Zehetgruber, M; Soregi, G; Lehr, S; Huber, K; Maurer, G; Weidinger, F; Kostner, K. Effects of vitamin E on chronic and acute endothelial dysfunction in smokers. *J Am Coll Cardiol*, 2000. 35: 277-283.
- [14] Siasos, G; Tousoulis, D; Vlachopoulos, C; Antoniadis, C; Stefanadi, E; Ioakeimidis, N; Andreou, I; Zisimos, K; Papavassiliou, AG; Stefanadis, C. Short-term treatment with L-arginine prevents the smoking-induced impairment of endothelial function and vascular elastic properties in young individuals. *Int J Cardiol*, 2008. 126: 394-399.
- [15] Maier, W; Cosentino, F; Lutolf, RB; Fleisch, M; Seiler, C; Hess, OM; Meier, B; Luscher, TF. Tetrahydrobiopterin improves endothelial function in patients with coronary artery disease. *J Cardiovasc Pharmacol*, 2000. 35: 173-178.

- [16] Vlachopoulos, C; Tsekoura, D; Alexopoulos, N; Panagiotakos, D; Aznaouridis, K; Stefanadis, C. Type 5 phosphodiesterase inhibition by sildenafil abrogates acute smoking-induced endothelial dysfunction. *Am J Hypertens*, 2004. 17: 1040-1044.
- [17] Mangoni, AA; Sherwood, RA; Asonganyi, B; Swift, CG; Thomas, S; Jackson, SH. Short-term oral folic acid supplementation enhances endothelial function in patients with type 2 diabetes. *Am J Hypertens*, 2005. 18: 220-226.
- [18] Stirban, A; Negrean, M; Stratmann, B; Gawlowski, T; Horstmann, T; Gotting, C; Kleesiek, K; Mueller-Roesel, M; Koschinsky, T; Uribarri, J; Vlassara, H; Tschoepe, D. Benfotiamine prevents macro- and microvascular endothelial dysfunction and oxidative stress following a meal rich in advanced glycation end products in individuals with type 2 diabetes. *Diabetes Care*, 2006. 29: 2064-2071.
- [19] Hadi, HA; Carr, CS; Al, SJ. Endothelial dysfunction: cardiovascular risk factors, therapy, and outcome. *Vasc Health Risk Manag*, 2005. 1: 183-198.
- [20] Heitzer, T; Krohn, K; Albers, S; Meinertz, T. Tetrahydrobiopterin improves endothelium-dependent vasodilation by increasing nitric oxide activity in patients with Type II diabetes mellitus. *Diabetologia*, 2000. 43: 1435-1438.
- [21] Wever, RM; Luscher, TF; Cosentino, F; Rabelink, TJ. Atherosclerosis and the two faces of endothelial nitric oxide synthase. *Circulation*, 1998. 97: 108-112.
- [22] Halcox, JP; Nour, KR; Zalos, G; Mincemoyer, RA; Waclawiw, M; Rivera, CE; Willie, G; Ellahham, S; Quyyumi, AA. The effect of sildenafil on human vascular function, platelet activation, and myocardial ischemia 1. *J Am Coll Cardiol*, 2002. 40: 1232-1240.
- [23] Stirban, A; Laude, D; Elghozi, JL; Sander, D; Agelink, MW; Hilz, MJ; Ziegler, D. Acute effects of sildenafil on flow mediated dilatation and cardiovascular autonomic nerve function in type 2 diabetic patients. *Diabetes Metab Res Rev*, 2008.
- [24] Lehr, HA; Germann, G; McGregor, GP; Migeod, F; Roesen, P; Tanaka, H; Uhlig, C; Biesalski, HK. Consensus meeting on "Relevance of parenteral vitamin C in acute endothelial dependent pathophysiological conditions (EDPC)". *Eur J Med Res*, 2006. 11: 516-526.
- [25] Darley-Usmar, VM; Hogg, N; O'Leary, VJ; Wilson, MT; Moncada, S. The simultaneous generation of superoxide and nitric oxide can initiate lipid peroxidation in human low density lipoprotein. *Free Radic Res Commun*, 1992. 17: 9-20.
- [26] Myers, PR; Wright, TF; Tanner, MA; Ostlund, RE, Jr. The effects of native LDL and oxidized LDL on EDRF bioactivity and nitric oxide production in vascular endothelium. *J Lab Clin Med*, 1994. 124: 672-683.
- [27] Stirban A; Negrean M; Götting C; Uribarri J; Gawlowski T; Stratmann B; Kleesiek K; Koschinsky T; Vlassara H; Tschoepe D. Dietary advanced glycation end products and oxidative stress: in vivo effects on endothelial function and adipokines. *Ann N Y Acad Sci*, 2008. 276-279.
- [28] Tousoulis, D; Xenakis, C; Tentolouris, C; Davies, G; Antoniadis, C; Crake, T; Stefanadis, C. Effects of vitamin C on intracoronary L-arginine dependent coronary vasodilatation in patients with stable angina. *Heart*, 2005. 91: 1319-1323.
- [29] Vergnani, L; Hatrik, S; Ricci, F; Passaro, A; Manzoli, N; Zuliani, G; Brovkovich, V; Fellin, R; Malinski, T. Effect of native and oxidized low-density lipoprotein on

- endothelial nitric oxide and superoxide production : key role of L-arginine availability. *Circulation*, 2000. 101: 1261-1266.
- [30] Levine, GN; Frei, B; Koulouris, SN; Gerhard, MD; Keaney, JF, Jr.; Vita, JA. Ascorbic acid reverses endothelial vasomotor dysfunction in patients with coronary artery disease. *Circulation*, 1996. 93: 1107-1113.
- [31] Fiorito, C; Rienzo, M; Crimi, E; Rossiello, R; Balestrieri, ML; Casamassimi, A; Muto, F; Grimaldi, V; Giovane, A; Farzati, B; Mancini, FP; Napoli, C. Antioxidants increase number of progenitor endothelial cells through multiple gene expression pathways. *Free Radic Res*, 2008. 42: 754-762.
- [32] Jackson, TS; Xu, A; Vita, JA; Keaney, JF, Jr. Ascorbate prevents the interaction of superoxide and nitric oxide only at very high physiological concentrations. *Circ Res*, 1998. 83: 916-922.
- [33] Tysl, K; Li, F; Wilson, JX. Septic impairment of capillary blood flow requires nicotinamide adenine dinucleotide phosphate oxidase but not nitric oxide synthase and is rapidly reversed by ascorbate through an endothelial nitric oxide synthase-dependent mechanism. *Crit Care Med*, 2008. 36: 2355-2362.
- [34] Weber, C; Erl, W; Weber, K; Weber, PC. Increased adhesiveness of isolated monocytes to endothelium is prevented by vitamin C intake in smokers. *Circulation*, 1996. 93: 1488-1492.
- [35] Carr, AC; Zhu, BZ; Frei, B. Potential antiatherogenic mechanisms of ascorbate (vitamin C) and alpha-tocopherol (vitamin E). *Circ Res*, 2000. 87: 349-354.
- [36] Antoniadis, C; Tousoulis, D; Tountas, C; Tentolouris, C; Toutouza, M; Vasiliadou, C; Tsioufis, C; Toutouzas, P; Stefanadis, C. Vascular endothelium and inflammatory process, in patients with combined Type 2 diabetes mellitus and coronary atherosclerosis: the effects of vitamin C. *Diabet Med*, 2004. 21: 552-558.
- [37] Upritchard, JE; Sutherland, WH; Mann, JI. Effect of supplementation with tomato juice, vitamin E, and vitamin C on LDL oxidation and products of inflammatory activity in type 2 diabetes. *Diabetes Care*, 2000. 23: 733-738.
- [38] Aguirre, R; May, JM. Inflammation in the vascular bed: importance of vitamin C. *Pharmacol Ther*, 2008. 119: 96-103.
- [39] Gokce, N; Keaney, JF, Jr.; Frei, B; Holbrook, M; Olesiak, M; Zachariah, BJ; Leeuwenburgh, C; Heinecke, JW; Vita, JA. Long-term ascorbic acid administration reverses endothelial vasomotor dysfunction in patients with coronary artery disease. *Circulation*, 1999. 99: 3234-3240.
- [40] Tousoulis, D; Davies, G; Toutouzas, P. Vitamin C increases nitric oxide availability in coronary atherosclerosis. *Ann Intern Med*, 1999. 131: 156-157.
- [41] Hornig, B; Arakawa, N; Kohler, C; Drexler, H. Vitamin C improves endothelial function of conduit arteries in patients with chronic heart failure. *Circulation*, 1998. 97: 363-368.
- [42] Ting, HH; Timimi, FK; Boles, KS; Creager, SJ; Ganz, P; Creager, MA. Vitamin C improves endothelium-dependent vasodilation in patients with non-insulin-dependent diabetes mellitus. *J Clin Invest*, 1996. 97: 22-28.

- [43] Beckman, JA; Goldfine, AB; Gordon, MB; Creager, MA. Ascorbate restores endothelium-dependent vasodilation impaired by acute hyperglycemia in humans. *Circulation*, 2001. 103: 1618-1623.
- [44] Darko, D; Dornhorst, A; Kelly, FJ; Ritter, JM; Chowienczyk, PJ. Lack of effect of oral vitamin C on blood pressure, oxidative stress and endothelial function in Type II diabetes. *Clin Sci (Lond)*, 2002. 103: 339-344.
- [45] Heitzer, T; Just, H; Munzel, T. Antioxidant vitamin C improves endothelial dysfunction in chronic smokers. *Circulation*, 1996. 94: 6-9.
- [46] Antoniadou, C; Tousoulis, D; Tentolouris, C; Toutouza, M; Marinou, K; Goumas, G; Tsioufis, C; Toutouzas, P; Stefanadis, C. Effects of antioxidant vitamins C and E on endothelial function and thrombosis/fibrinolysis system in smokers. *Thromb Haemost*, 2003. 89: 990-995.
- [47] Hirai, N; Kawano, H; Hirashima, O; Motoyama, T; Moriyama, Y; Sakamoto, T; Kugiyama, K; Ogawa, H; Nakao, K; Yasue, H. Insulin resistance and endothelial dysfunction in smokers: effects of vitamin C. *Am J Physiol Heart Circ Physiol*, 2000. 279: H1172-H1178.
- [48] Rudich, A; Tirosh, A; Potashnik, R; Hemi, R; Kanety, H; Bashan, N. Prolonged oxidative stress impairs insulin-induced GLUT4 translocation in 3T3-L1 adipocytes. *Diabetes*, 1998. 47: 1562-1569.
- [49] Solzbach, U; Hornig, B; Jeserich, M; Just, H. Vitamin C improves endothelial dysfunction of epicardial coronary arteries in hypertensive patients. *Circulation*, 1997. 96: 1513-1519.
- [50] Plotnick, GD; Corretti, MC; Vogel, RA. Effect of antioxidant vitamins on the transient impairment of endothelium-dependent brachial artery vasoactivity following a single high-fat meal. *JAMA*, 1997. 278: 1682-1686.
- [51] Pleiner, J; Schaller, G; Mittermayer, F; Bayerle-Eder, M; Roden, M; Wolzt, M. FFA-induced endothelial dysfunction can be corrected by vitamin C. *J Clin Endocrinol Metab*, 2002. 87: 2913-2917.
- [52] Sharif, MA; Bayraktutan, U; Arya, N; Badger, S; O'Donnell, M; Young, I; Soong, C. Effects of Antioxidants on Endothelial Function in Human Saphenous Vein in an Ex vivo Model. *Angiology*, 2008.
- [53] Sesso, HD; Buring, JE; Christen, WG; Kurth, T; Belanger, C; MacFadyen, J; Bubes, V; Manson, JE; Glynn, RJ; Gaziano, JM. Vitamins E and C in the prevention of cardiovascular disease in men: the Physicians' Health Study II randomized controlled trial. *JAMA*, 2008. 300: 2123-2133.
- [54] Waters, DD; Alderman, EL; Hsia, J; Howard, BV; Cobb, FR; Rogers, WJ; Ouyang, P; Thompson, P; Tardif, JC; Higginson, L; Bittner, V; Steffes, M; Gordon, DJ; Proschan, M; Younes, N; Verter, JI. Effects of hormone replacement therapy and antioxidant vitamin supplements on coronary atherosclerosis in postmenopausal women: a randomized controlled trial. *JAMA*, 2002. 288: 2432-2440.
- [55] Tomoda, H; Yoshitake, M; Morimoto, K; Aoki, N. Possible prevention of postangioplasty restenosis by ascorbic acid. *Am J Cardiol*, 1996. 78: 1284-1286.

- [56] Salonen, RM; Nyyssonen, K; Kaikkonen, J; Porkkala-Sarataho, E; Voutilainen, S; Rissanen, TH; Tuomainen, TP; Valkonen, VP; Ristonmaa, U; Lakka, HM; Vanharanta, M; Salonen, JT; Poulsen, HE. Six-year effect of combined vitamin C and E supplementation on atherosclerotic progression: the Antioxidant Supplementation in Atherosclerosis Prevention (ASAP) Study. *Circulation*, 2003. 107: 947-953.
- [57] McGregor, GP; Biesalski, HK. Rationale and impact of vitamin C in clinical nutrition. *Curr Opin Clin Nutr Metab Care*, 2006. 9: 697-703.
- [58] Biesalski, HK; McGregor, GP. Antioxidant therapy in critical care--is the microcirculation the primary target? *Crit Care Med*, 2007. 35: S577-S583.
- [59] Collier, BR; Giladi, A; Dossett, LA; Dyer, L; Fleming, SB; Cotton, BA. Impact of high-dose antioxidants on outcomes in acutely injured patients. *JPEN J Parenter Enteral Nutr*, 2008. 32: 384-388.

---

## Vitamin C Intake by Japanese Patients with Chronic Obstructive Pulmonary Disease

---

*Fumi Hirayama and Andy H. Lee\**

School of Public Health, Curtin University of Technology, Perth, Australia

### Abstract

*Background:* Chronic obstructive pulmonary disease (COPD) is a major cause of death and disability worldwide. Vitamin C has been suggested to protect the lungs from oxidative damage caused by cigarette smoking. *Objective:* To investigate and compare the quantity of vitamin C intake by COPD patients and controls in Japan. *Methods:* A case-control study was conducted in central Japan. A total of 278 eligible patients (244 men and 34 women), aged 50-75 years with COPD diagnosed within the past four years, were referred by respiratory physicians. During the same period, 340 age-matched controls (272 men and 68 women) were recruited from the community. All participants were screened for respiratory symptoms and underwent spirometric measurements of lung function. Information on dietary supplement usage and habitual food consumption was obtained by face-to-face interviews using a structured questionnaire. *Results:* The total daily dietary vitamin C intake by COPD patients (mean 137.86, SD 84.56 mg) was significantly lower than Japanese adults without the disease (mean 156.80, SD 112.54 mg),  $p = 0.021$ . The prevalence of vitamin C and multivitamin usage were similar between the two groups. It is alarming that 40% of COPD patients did not meet the government recommended level of 100 mg per day. *Conclusion:* Patients with COPD had substantially lower intake of vitamin C than the general population. The finding is important to clinical trials and experimental interventions advocating nutritional supplementation therapy for pulmonary rehabilitation.

---

\* Correspondence: Professor Andy H. Lee, School of Public Health, Curtin Health Innovation Research Institute, Curtin University of Technology, GPO Box U 1987, Perth, WA, 6845, Australia, Phone:+61-8-92664180, Fax:+61-8-92662958, Email: Andy.Lee@curtin.edu.au

## Introduction

### Chronic Obstructive Pulmonary Disease

Chronic obstructive pulmonary disease (COPD) is characterized by airflow limitation that is not fully reversible. The most common symptoms of COPD are breathlessness, or a 'need for air', excessive sputum production, and a chronic cough (World Health Organization 2007). It is a major cause of death and disability worldwide, and will be the fourth leading cause of death by 2030 (World Health Organization 2007). The prevalence of COPD increases with age and the principal risk factor is smoking (Fukuchi et al. 2004). The burden of COPD has been increasing over the past 40 years in Japan because of continued tobacco consumption (Teramoto et al. 2003). According to a review study, while 95% of COPD patients are, or have been, cigarette smokers, about 20% of smokers develop COPD (Madison & Irwin 1998). Therefore, other factors may protect against or contribute to the development of the disease. Because of the high burden and societal cost associated with COPD, new methods of prevention are important. The risk of COPD may be reduced through an appropriate diet (Sridhar 1995).

### Fruits and Vegetables

High fruit intake is inversely related to the risk of COPD (Celik & Topcu 2006; Van Duyn & Pivonka 2000; Watson et al. 2002). Increased vegetable consumption also reduces the COPD risk (Celik & Topcu 2006; La Vecchia, Decarli & Pagano 1998; Watson et al. 2002). A case-control study of 150 COPD patients and 116 controls in the United Kingdom reported that low vegetable intake increased the risk of COPD among subjects with more than 10 pack-years of smoking (Watson et al. 2002). In another Turkish case-control study of 40 male smokers with COPD and 36 male non-smokers without COPD, a high intake of vegetables and fruits was found to be protective against COPD (Celik & Topcu 2006). Moreover, a large Italian cohort study (22560 men and 24133 women aged over 15 years) demonstrated a significant reduction in COPD risk by increasing vegetable intake (La Vecchia, Decarli & Pagano 1998). Two reviews concluded that a high level of fruit and vegetable consumption could enhance ventilatory function and reduce airway obstruction (Schunemann, Freudenheim & Grant 2001; Smit, Grievink & Tabak 1999). On the basis of available evidence, it is likely that vegetable intake reduces the risk of COPD, even amongst smokers (Van Duyn & Pivonka 2000).

### Vitamins

The effects of dietary supplementation on patients with respiratory diseases have been extensively investigated in the literature. For example, vitamin E can reduce the risk of pneumonia among male smokers (Hemila et al. 2006; Hemila et al. 2004) and lower plasma



lipid peroxide levels and thus prevents further oxidative damage (Daga et al. 2003), whereas vitamin A supplementation can improve pulmonary function (Paiva et al. 1996).

Only two cross-sectional studies reported dietary supplements usage by patients with COPD. For Japanese patients, energy drink (11.1%) was the most popular supplement for men, whereas women preferred vinegar (11.8%) and multivitamins (11.8%) (Hirayama et al. 2009). For Australian patients, multivitamins and minerals were the most popular supplements used by both men (36%) and women (38%) (George et al. 2004). Vitamin C supplement was ranked fifth for male (4.9%) and third for female (8.8%) in Japan (Hirayama et al. 2009), but was ranked third for male (10%) and female (12%) in Australia (George et al. 2004).

There has been little research into dietary vitamin C intake by COPD patients. A cross-sectional study of 6555 subjects in the Netherlands showed that current smokers had a lower vitamin C intake than never smokers. Furthermore, a high vitamin C intake could improve lung function when compared with a low intake of anti-oxidants (Grievink et al. 1998). Similarly, a USA study involving 2526 adults aged 30-74 years found dietary vitamin C intake was positively associated with lung function level (Schwartz & Weiss 1994). Apart from these two studies, little information is available from the literature. The aim of the present study was to investigate the quantity of dietary vitamin C intake by Japanese COPD patients and compare with controls without the disease. The study constituted part of a research project on assessing the association between dietary factors and the risk of COPD.

## Methods

### Study Design and Subjects

A case-control study was conducted in central Japan in 2006. Three hundred COPD patients referred by respiratory physicians were recruited from the outpatient departments of six hospitals in Aichi, Gifu and Kyoto. According to the standard protocol (Global Initiative for Chronic Obstructive Lung Disease 2007), diagnosis of COPD was confirmed by spirometry with  $FEV_1/FVC < 0.7$ , where  $FEV_1$  = forced expiratory volume in one second and FVC = forced vital capacity. Predicted  $FEV_1$  was calculated using the Japanese Respiratory Society's Guidelines (The Japanese Respiratory Society 2004), viz, for Japanese men:

$$\text{predicted } FEV_1 \text{ (L)} = 0.036 * \text{height (cm)} - 0.028 * \text{age} - 1.178;$$

for Japanese women,

$$\text{predicted } FEV_1 \text{ (L)} = 0.022 * \text{height (cm)} - 0.022 * \text{age} - 0.005.$$

Inclusion criteria for cases were: (i) age between 50 and 75 years; (ii) had COPD as the primary functionally limiting illness which was diagnosed within the past four years. Subjects were excluded if they had a recent stroke, dementia or other health conditions that prohibited them from being interviewed. Twenty-two eligible patients were subsequently excluded due

to missing or incomplete demographic and lifestyle details. The remaining 278 patients (244 men and 34 women) were available for analysis. No statistically significant differences were found between the included and excluded cases in terms of clinical and other variables. Permission to recruit patients and access to medical records were granted by the participating hospitals in Japan.

During the same period, 400 community-dwelling adults were recruited from the same catchment areas as the cases. These controls were approached and interviewed at shopping malls, community centres or when they attended health checks at hospitals. They were selected to be frequency matched to the cases by age ( $\pm 5$  years). The same exclusion criteria as cases were applied, resulting in 340 eligible controls (272 men and 68 women). All participants underwent spirometric measurements of respiratory function to avoid misclassification of case-control status. Approval of the study protocol was obtained from the Human Research Ethics Committee of Curtin University (approval number HR 90/2005) and the six hospitals in Japan.

## Interview

A face-to-face interview using a structured questionnaire was administered by the first author to collect information from each participant. Demographic and lifestyle characteristics solicited included age, gender, weight (kg), height (m), education level (high school or below; college or university), cigarette smoking (never smoker; ex-smoker; current smoker) and alcohol drinking status (non-drinker; drinker). For the cases, each interview was conducted in the presence of their next-of-kin to minimize recall error, and appointment was made via their respiratory physician. The purpose of the study was explained to each participant before obtaining their formal written consent. Confidentiality of the information provided, and the right to withdraw without prejudice, were ensured and maintained throughout the study. All interviews, averaging 30 minutes in duration, took place in the hospital outpatient departments for cases and their place of recruitment for controls.

## Food Frequency Questionnaire

Information on habitual food consumption was obtained using a 138-item food questionnaire taken from the Japan Public Health Center-based prospective study on cancer and cardiovascular disease (Ishihara et al. 2003a). Its validity and reproducibility had been established for the Japanese population (Ishihara et al. 2003b). The reference recall period for dietary variables was set at 5 years before diagnosis for cases or 5 years before interview for controls. The questionnaire asked about the usual consumption of 30 vegetables and 16 fruits. The vegetable items included six pickled vegetables (Chinese radish, green leaf vegetable, plum, Chinese cabbage, cucumber, eggplant), seven cruciferous vegetables (cabbage, Chinese radish, komatsuna, broccoli, Chinese cabbage, leaf mustard, chard or Swiss chard), six green leafy vegetables (spinach, Chinese chive, garland chrysanthemum, bok choy, mugwort, green pepper), four yellow vegetables (carrot, tomato, pumpkin, tomato juice), and

seven other vegetables (onion, cucumber, bean sprout, snap bean, lettuce, bitter melon, loofah). The fruit items included three citrus fruits (mandarin orange, other oranges, and 100 percent orange juice) and 13 other fruits (apple, persimmon, strawberry, grape, melon, watermelon, peach, pear, banana, papaya, kiwi fruit, pineapple, and 100 percent apple juice). The frequency of intake of vegetables and fruits was classified by nine categories: 'almost never', 'once to three times per month', 'once to twice per week', 'three to four times per week', 'five to six times per week', 'once per day', 'twice to three times per day', 'four to six times per day', and 'seven or more times per day'. Standard portion size was specified for each item, with three choices of amount: small (50 percent smaller), medium (same as the standard), and large (50 percent larger). Nine frequency choices for juice were available, ranging from 'almost never' to 'ten or more glasses per day'. The amounts of fruit and vegetable consumed (in grams) per day were calculated from the responses recorded.

### Dietary Supplement Usage

Specific dietary supplements were classified into five categories, namely, multivitamin, beta-carotene, vitamin C, vitamin E, and miscellaneous, following the convention adopted by the Japan Public Health Center-based prospective study on cancer and cardiovascular disease (Ishihara et al. 2003a). The brand name, frequency, duration and dosage of all supplements consumed by each participant were recorded. Users of dietary supplements were defined as subjects who used at least one category of dietary supplement on a weekly basis for one year or longer (Ishihara et al. 2003a).

### Other Measurements

A further question on 'life-long physical activity involvement' was appended to the questionnaire, defined as "doing active sports or vigorous exercise long enough to get sweaty, at least twice a week", over the entire life course (O'Brien Cousins & Tan 2002). Response options were dichotomous: 'has never been involved to not any more involved in such activity' and 'has always been involved in such activity'.

Two screening instruments, Medical Research Council's "dyspnoea" scale (Bestall et al. 1999) and the Australian Lung Foundation's "Feeling Short of Breath" scale (The Australian Lung Foundation 2004), were used to assess respiratory symptoms of each individual. The latter scale consisted of five simple questions: (i) Do you cough several times most days? (ii) Do you bring up phlegm or mucous most days? (iii) Do you get out of breath more easily than others your age? (iv) Are you over 40 years old? (v) Are you smoker or ex-smoker?

### Statistical Analysis

Descriptive statistics were first applied to summarise participant characteristics and lung function measures. The daily intakes of vegetables and fruits (g) were derived from the

frequency and quantity recorded, accounting for the edible portion of each food. For every unit (per 100g) of food intake, its vitamin C content (mg) was retrieved from the Japanese Food Composition Table; see Appendix. The total dietary vitamin C intake for each subject was estimated by multiplying each vitamin C content with the corresponding quantity of food consumed and then summing across all foods. The amounts of dietary vitamin C intake between case and control groups were compared by t-tests, whereas chi-square tests were conducted for vitamin C and multivitamin supplements usage. All statistical analyses were undertaken using the SPSS for Windows package version 13.

## Results

Table 1 presents the characteristics of the participants by case-control status and gender. The average age of subjects was about 66 years. The mean body mass index (BMI, five years ago) of COPD patients was lower than that of controls. The majority of participants had high school or below education and were seldom involved in physical activity over the life course. A substantial proportion of COPD patients (21.8% for male and 27.3% for female) continued to smoke after their diagnosis of COPD and, as expected, had significantly lower level of lung function measures than controls.

**Table 1. Characteristics of participants by case-control status and gender**

Variable	COPD patients		Controls	
	Male (n = 244)	Female (n = 34)	Male (n = 272)	Female (n = 68)
Mean age (years)	66.51 (SD 6.82)	66.10 (SD 6.13)	65.15 (SD 5.41)	66.12 (SD 5.76)
Mean BMI five years ago (kg/m <sup>2</sup> )	22.09 (SD 2.94)	20.67 (SD 3.89)	23.61 (SD 2.85)	23.30 (SD 3.25)
Education: high school or below	195 (80.2%)	26 (78.8%)	166 (61.9%)	47 (70.1%)
Life-long physical activity: never to not any more involved	185 (75.8%)	29 (85.3%)	182 (68.2%)	56 (82.4%)
Alcohol drinkers	150 (61.5%)	8 (23.5%)	202 (74.5%)	21 (30.9%)
Cigarette smoking status				
Ex-smoker	188 (77.4%)	20 (60.6%)	133 (49.1%)	3 (4.4%)
Current smoker	53 (21.8%)	9 (27.3%)	63 (23.2%)	2 (2.9%)
Mean smoking (pack-years)	65.03 (SD 24.91)	43.25 (SD 31.67)	30.90 (SD 28.81)	2.04 (SD 9.68)
FEV <sub>1</sub>	1.64 (SD 0.69)	1.15 (SD 0.47)	2.56 (SD 0.51)	1.76 (SD 0.35)
FVC	3.08 (SD 0.83)	2.07 (SD 0.52)	3.31 (SD 0.60)	2.17 (SD 0.41)
FEV <sub>1</sub> /FVC (%)	52.70 (SD 14.71)	55.30 (SD 14.47)	78.06 (SD 5.96)	81.74 (SD 5.66)
FEV <sub>1</sub> % predicted	56.68 (SD 22.32)	56.52 (SD 19.40)	86.54 (SD 14.04)	93.85 (SD 13.76)

Table 2 compares the habitual intake of vitamin C from vegetables, fruits and other foods between case and control groups. The COPD patients had significantly lower daily intake of vitamin C from vegetables ( $p < 0.001$ ) than controls whereas their mean intakes from fruits and other sources were similar. Overall, the total daily dietary vitamin C intake by COPD patients (mean 137.86, SD 84.56 mg) was significantly less than their counterparts without the disease (mean 156.80, SD 112.54 mg),  $p = 0.021$ .

**Table 2. Comparison of habitual vitamin C intake (mg/day) between COPD patients and controls**

Food item	COPD patients	Controls	t-test
	Mean (SD) mg/day	Mean (SD) mg/day	p value
Total Vegetables	49.42 (30.29)	62.53 (45.27)	0.000
Carrot	0.75 (0.87)	1.04 (1.18)	0.000
Spinach	9.34 (9.84)	11.05 (11.93)	0.057
Pumpkin	3.11 (3.79)	4.70 (5.23)	0.000
Cabbage	5.06 (5.09)	6.69 (7.88)	0.002
Chinese radish	3.13 (2.91)	3.36 (2.90)	0.324
Sweet pepper	4.80 (6.41)	6.85 (7.76)	0.000
Tomato	5.97 (6.12)	6.65 (5.93)	0.162
Chinese chive	0.33 (0.55)	0.47 (0.69)	0.009
Broccoli	10.10 (15.66)	7.31 (10.55)	0.011
Onion	1.47 (1.59)	1.60 (1.60)	0.323
Cucumber	1.36 (1.58)	1.98 (2.27)	0.000
Chinese cabbage	1.89 (1.82)	2.21 (2.34)	0.066
Bean sprout	0.47 (0.60)	0.55 (0.55)	0.066
Snap bean	0.27 (0.54)	0.33 (0.78)	0.255
Lettuce	0.16 (0.21)	0.22 (0.25)	0.005
Sweet potato	1.20 (2.70)	1.61 (4.17)	0.161
Potato	2.80 (3.05)	3.14 (2.89)	0.156
Total Fruits	70.90 (63.48)	78.66 (75.03)	0.172
Mandarin orange	25.15 (32.57)	30.27 (36.54)	0.070
Apple	0.64 (1.02)	0.94 (1.77)	0.009
Persimmon	27.56 (34.05)	27.50 (34.28)	0.983
Strawberries	11.34 (17.78)	12.23 (16.31)	0.518
Grapes	0.63 (1.01)	0.86 (1.24)	0.012
Melon	0.77 (2.14)	0.82 (1.58)	0.755
Watermelon	1.14 (1.88)	1.71 (3.68)	0.013
Peach	0.87 (1.65)	1.33 (2.43)	0.006
Pear	0.56 (0.88)	0.55 (0.80)	0.898
Banana	2.24 (2.85)	2.45 (2.60)	0.325
Other sources	17.54 (17.81)	15.61 (15.97)	0.156
Meat	0.79 (0.64)	0.76 (0.58)	0.502
Processed meat	1.55 (2.35)	1.57 (2.08)	0.913
Fish	0.24 (0.24)	0.26 (0.30)	0.252
Sea foods	0.11 (0.12)	0.12 (0.14)	0.363
Pickles	14.16 (17.35)	12.11 (15.62)	0.128
Seaweeds	0.68 (0.70)	0.77 (0.69)	0.096
Total intake	137.86 (84.56)	156.80 (112.54)	0.021

Table 3 gives the prevalence of vitamin C and multivitamin supplementation by the participants. The consumption of these dietary supplements appeared to be low for Japanese adults. No significant association between supplement usage and case-control status was evident according to chi-square tests.

**Table 3. Prevalence of vitamin C and multivitamin supplementation by participants**

Supplement	COPD patients	Controls	Chi-square test
	n (%)	n (%)	p value
Vitamin C	15 (5.4%)	13 (3.8%)	0.350
Multivitamin	21 (7.6%)	27 (7.9%)	0.858
Vitamin C or multivitamin	34 (12.2%)	38 (11.2%)	0.685

## Discussion

The present study provided the first report documenting the dietary vitamin C intake by patients with COPD in Japan. A major strength was that spirometric measurements of lung function and screening tests for respiratory symptoms were performed on all participants, thus ensuring no misclassification of the case-control status. Information on habitual food consumption was obtained using a validated and reliable questionnaire specifically developed for the Japanese population. A reference recall period of five years was adopted to minimize recall error and to avoid possible changes in dietary exposure, because the diagnosis of the disease was confirmed for all patients within the past four years.

The vitamin C intake by COPD patients was found to be substantially lower than the general population of Japanese adults. This finding has important implications to clinical trials and experimental interventions advocating nutritional supplementation therapy for pulmonary rehabilitation. The dietary allowance requirement for smokers is 100 mg/day (National Research Council 1989). The Japanese Ministry of Health, Labour and Welfare also recommends 100 mg/day for people aged over 11 years (Ministry of Health, Labour and Welfare 2004). According to the Japanese government report in 2003, the average vitamin C intake (excluding dietary supplements) was 125.7 mg per day among adults 50 years and over (Ministry of Health, Labour and Welfare 2005). Although the mean intake by our participants exceeded the recommended level, it is alarming that 40% of COPD patients and 33% of controls consumed less than the daily requirement of 100 mg.

It is known that anti-oxidant enzymes form a first line of defence in the lungs, whereas uric acid and the anti-oxidant (pro)-vitamins, such as vitamins E, C and carotenoids from diet, form another line of defence (Grievink, Smit & Brunekreef 2000). For smokers, oxidant-antioxidant imbalances as a result of lung tissue damage (Kondo et al. 1994). Vitamins C, E, and beta-carotene are antioxidant vitamins and may protect the lungs from oxidative damage by smoking or air pollution. In particular, vitamin C is a free-radical scavenger present in intracellular and extracellular lung fluids (Smit 2001). Therefore, sufficient dietary intake of vitamin C is especially important for COPD patients.

Several limitations should be considered in conjunction with the findings. Habitual dietary assessment was based on self-report. Responses from the COPD patients inevitably incurred some recall bias due to possible memory and cognitive loss as a consequence of their disease. Therefore, face-to-face interviews were conducted in the presence of patients' next-of-kin to increase the response rate and to improve the accuracy of their answers. Moreover, data were collected solely by the same investigator (first author) in order to eliminate inter-interviewer bias. Although the control subjects were recruited from the same catchment areas as the cases and should be representative of the Japanese elderly population, the possibility of selection bias still existed because of their voluntary participation in the study. Information bias, however, was unlikely since all participants were blinded to the study hypothesis. Another limitation was the exclusion of dietary supplements towards the calculation of total vitamin C intake. There are many types and brands of vitamin C and multivitamin supplements available in the market, with different strength and dosage, so that estimation of intake amount from these sources is difficult. Consequently, the observed findings cannot be generalized to other populations, especially in view of the relatively small number of female participants recruited into the study.

## Conclusion

Smoking is acknowledged as the major cause of COPD, but evidence has suggested that vitamin C might protect the lungs from oxidative damage by cigarette smoking (Smit 2001). The present case-control study found Japanese COPD patients had lower dietary vitamin C intake than their counterparts without the disease. More research is required to ascertain the protective role of vitamin C, before its incorporation into dietary guidelines and nutritional supplementation therapy for pulmonary rehabilitation. Besides experimental research, clinical trials and long-term prospective cohort studies are recommended to provide laboratory and epidemiological evidence of the beneficial effect of vitamin C on both the risk and mortality rate of COPD.

## Acknowledgments

The authors are grateful to the Japanese respiratory physicians for recruitment of COPD patients, and to all participants who volunteered their time for the project.

## References

- [1] Bestall, JC, Paul, EA, Garrod, R, Garnham, R, Jones, PW & Wedzicha, JA 1999, 'Usefulness of the Medical Research Council (MRC) dyspnoea scale as a measure of disability in patients with chronic obstructive pulmonary disease', *Thorax*, vol. 54, no. 7, pp. 581-6.

- [2] Celik, F & Topcu, F 2006, 'Nutritional risk factors for the development of chronic obstructive pulmonary disease (COPD) in male smokers', *Clin Nutr*, vol. 25, no. 6, pp. 955-61.
- [3] Daga, MK, Chhabra, R, Sharma, B & Mishra, TK 2003, 'Effects of exogenous vitamin E supplementation on the levels of oxidants and antioxidants in chronic obstructive pulmonary disease', *J Biosci*, vol. 28, no. 1, pp. 7-11.
- [4] Fukuchi, Y, Nishimura, M, Ichinose, M, Adachi, M, Nagai, A, Kuriyama, K, Nishimura, K, Ishioka, S, Aizawa, H & Zaher, C 2004, 'COPD in Japan: the Nippon Epidemiology study', *Respirology*, vol. 9, pp. 458-65.
- [5] George, J, Ioannides-Demos, LL, Santamaria, NM, Kong, DC & Stewart, K 2004, 'Use of complementary and alternative medicines by patients with chronic obstructive pulmonary disease', *Med J Aust*, vol. 181, no. 5, pp. 248-51.
- [6] Global Initiative for Chronic Obstructive Lung Disease 2007, *Global Strategy for the diagnosis, management, and prevention of chronic obstructive pulmonary disease* National heart lung and blood institute and World Health Organization, 2007. Retrieved May 4, from [http://www.goldcopd.dk/index\\_uk.htm](http://www.goldcopd.dk/index_uk.htm)
- [7] Grievink, L, Smit, HA & Brunekreef, B 2000, 'Anti-oxidants and air pollution in relation to indicators of asthma and COPD: a review of the current evidence', *Clin and Experimental Allergy*, vol. 30, pp. 1344-54.
- [8] Grievink, L, Smit, HA, Ocke, MC, van 't Veer, P & Kromhout, D 1998, 'Dietary intake of antioxidant (pro)-vitamins, respiratory symptoms and pulmonary function: the MORGEN study', *Thorax*, vol. 53, no. 3, pp. 166-71.
- [9] Hemila, H, Kaprio, J, Albanes, D & Virtamo, J 2006, 'Physical activity and the risk of pneumonia in male smokers administered vitamin E and beta-carotene', *Int J Sports Med*, vol. 27, no. 4, pp. 336-41.
- [10] Hemila, H, Virtamo, J, Albanes, D & Kaprio, J 2004, 'Vitamin E and beta-carotene supplementation and hospital-treated pneumonia incidence in male smokers', *Chest*, vol. 125, no. 2, pp. 557-65.
- [11] Hirayama, F, Lee, AH, Binns, CW & Taniguchi, H 2009, 'Dietary supplementation by Japanese patients with chronic obstructive pulmonary disease', *Complement Ther Med*, vol. 17, no. 1, pp. 37-43.
- [12] Ishihara, J, Sobue, T, Yamamoto, S, Sasaki, S & Tsugane, S 2003a, 'Demographics, lifestyles, health characteristics, and dietary intake among dietary supplement users in Japan', *Int J Epidemiol*, vol. 32, no. 4, pp. 546-53.
- [13] Ishihara, J, Soube, T, Yamamoto, S, Yoshimi, I, Sasaki, S, Kobayashi, M, Takahashi, K, Itoi, Y & Akabane, S 2003b, 'Validity and reproducibility of a self-administered food frequency questionnaire in the JPHC study cohort II: study design, participant profile and results in comparison with cohort I', *J Epidemiol.*, vol. 13, no. 1 Supple, pp. S134-47.
- [14] Kondo, T, Tagami, S, Yoshioka, A, Nishimura, M & Kawakami, Y 1994, 'Current smoking of elderly men reduces antioxidants in alveolar macrophages', *Am J Respir Crit Care Med*, vol. 149, no. 1, pp. 178-82.
- [15] La Vecchia, C, Decarli, A & Pagano, R 1998, 'Vegetable consumption and risk of chronic disease', *Epidemiology*, vol. 9, no. 2, pp. 208-10.



- 
- [16] Madison, JM & Irwin, RS 1998, 'Chronic obstructive pulmonary disease', *Lancet*, vol. 352, no. 9126, pp. 467-73.
- [17] Ministry of Health, Labour and Welfare 2004, *Baseline of dietary intake in Japan*. Retrieved Jan 27, from <http://www.mhlw.go.jp/houdou/2004/11/h1122-2.html>
- [18] Ministry of Health, Labour and Welfare 2005, *National health and national survey in 2003*. Retrieved 9 April, from <http://www.mhlw.go.jp/houdou/2005/04/h0421-1b.html>
- [19] National Research Council 1989, *Recommended dietary allowances*, Natinal Academy Press, Washington, DC. Retrieved 2009, from [http://books.nap.edu/openbook.php?record\\_id=1349&page=115](http://books.nap.edu/openbook.php?record_id=1349&page=115)
- [20] O' Brien Cousins, S & Tan, M 2002, 'Sources of efficacy for walking and climbing stairs among older adults', *Phys Occup Ther Geriatr*, vol. 20, no. 3/4, pp. 51-68.
- [21] Paiva, SA, Godoy, I, Vannucchi, H, Favaro, RM, Geraldo, RR & Campana, AO 1996, 'Assessment of vitamin A status in chronic obstructive pulmonary disease patients and healthy smokers', *Am J Clin Nutr*, vol. 64, no. 6, pp. 928-34.
- [22] Schunemann, HJ, Freudenheim, JL & Grant, BJ 2001, 'Epidemiologic evidence linking antioxidant vitamins to pulmonary function and airway obstruction', *Epidemiol Rev*, vol. 23, no. 2, pp. 248-67.
- [23] Schwartz, J & Weiss, ST 1994, 'Relationship between dietary vitamin C intake and pulmonary function in the First National Health and Nutrition Examination Survey (NHANES I)', *Am J Clin Nutr*, vol. 59, no. 1, pp. 110-4.
- [24] Smit, HA 2001, 'Chronic obstructive pulmonary disease, asthma and protective effects of food intake: from hypothesis to evidence?' *Respir Res*, vol. 2, no. 5, pp. 261-4.
- [25] Smit, HA, Grievink, L & Tabak, C 1999, 'Dietary influences on chronic obstructive lung disease and asthma: a review of the epidemiological evidence', *Proc Nutr Soc*, vol. 58, pp. 309-19.
- [26] Sridhar, MK 1995, 'Nutrition and lung health', *BMJ*, vol. 310, pp. 75-6.
- [27] Teramoto, S, Yamamoto, H, Yamaguchi, Y, Matsuse, T & Ouchi, Y 2003, 'Global burden of COPD in Japan and Asia', *Lancet*, vol. 362, no. 9397, pp. 1764-5.
- [28] The Australian Lung Foundation 2004, *Managemant tools*, June 16 2006. Retrieved March 2, from <http://www.copdx.org.au/checklist/index.asp>
- [29] The Japanese Respiratory Society 2004, *Guidelines for the diagnosis and treatment of COPD (chronic obstructive pulmonary disease)*, Medical Review Co Ltd, Tokyo.
- [30] Van Duyn, MA & Pivonka, E 2000, 'Overview of the health benefits of fruit and vegetable consumption for the dietetics professional: selected literature', *J Am Diet Assoc*, vol. 100, no. 12, pp. 1511-21.
- [31] Watson, L, Margetts, B, Howarth, P, Dorward, M, Thompson, R & Little, P 2002, 'The association between diet and chronic obstructive pulmonary disease in subjects selected from general practice', *Eur Respir J*, vol. 20, no. 2, pp. 313-8.
- [32] World Health Organization 2007, *Chronic obstructive pulmonary disease (COPD)*, 2007. Retrieved July 25, from <http://www.who.int/en/>

## Appendix. Vitamin C content of foods\*.

Food	Vitamin C (mg/100g)
Vegetables	
Carrot	6
Spinach	65
Pumpkin	39
Cabbage	44
Chinese radish	15
Sweet pepper	80
Tomato	20
Chinese chive	25
Broccoli	160
Onion	7
Cucumber	13
Chinese cabbage	22
Bean sprout	12
Snap bean	9
Lettuce	6
Sweet potato	30
Potato	23
Fruits	
Mandarin orange	35
Apple	3
Persimmon	70
Strawberry	80
Grape	4
Melon	22
Watermelon	6
Peach	10
Pear	3
Banana	10
Others	
Steak	1
Grilled beef	2
Stir-fried pork	1
Deep-fried pork	2
Stewed pork	1
Grilled chicken	3
Deep-fried chicken	2
Ham	50
Sausage	10
Salmon, trout	2
Bonito, tuna	1
Sea bream	2
Horse mackerel, sardine	1
Pacific saury, mackerel	3
Prawn	2
Short-necked clam	2
Salted pickle of Chinese radish	15
Salted pickle of green leafy vegetable	60
Pickled Chinese cabbage	29
Pickled cucumber	11
Pickled egg plant	4
Wakame	2
Nori	89

\* Source: Japan Epidemiological Association 2003, *Journal of Epidemiology*, vol. 13, no. 1 Supple, pp. S163-168.

---

# Reciprocal Effects of Ascorbate on Cancer Cell Growth and the Expression of Matrix Metalloproteinases and Transforming Growth Factor-Beta: Modulation by Gene Silencing or *P. Leucotomos*

---

*Neena Philips\**

School of Natural Sciences, Fairleigh Dickinson University, Teaneck, NJ, USA

## Abstract

Ascorbic acid or Vitamin C is essential for collagen formation and for its antioxidant property. It has anti-carcinogenic effects. Cancer is associated with increased cell growth, matrix metalloproteinases (MMPs), which degrade collagen, and transforming growth factor- $\beta$  (TGF- $\beta$ ) that facilitates angiogenesis. In our laboratory, the lower concentrations of ascorbate significantly inhibit cancer cell viability while stimulating MMPs and TGF- $\beta$  expression, indicating elimination of cancer cells with damage to the extracellular matrix (ECM). Conversely, ascorbate at higher concentrations dramatically stimulates cell proliferation and inhibits MMPs and TGF- $\beta$ , implicating growth and ECM advantage. The goal for ascorbate's use in cancer therapy is the counteraction of the MMP-1 and TGF- $\beta$  stimulating effect of the growth inhibitory ascorbate concentration. It is feasible by specific gene silencing using MMP siRNA (small interfering RNA) or preferably by combination with micronutrients or plant extracts, such as *Polypodium leucotomos* (a fern), that have MMP and TGF- $\beta$  inhibitory effects.

---

\* Neena Philips, Ph.D., Associate Professor of Biological Sciences, Fairleigh Dickinson University, H-DH4-03, Teaneck, NJ 07666, USA, Ph no: 201 692 6494 Fax: 201 692 7349. Email: [nphilips@fdu.edu](mailto:nphilips@fdu.edu), [neenaphilips@optonline.net](mailto:neenaphilips@optonline.net).

**Keywords:** Vitamin C, Cancer, Viability, Matrix-metalloproteinases, Tissue inhibitor of matrix metalloproteinases, Transforming Growth Factor-beta, *P. leucotomos*

## Ascorbic Acid

Ascorbic acid or vitamin C is essential for collagen formation and thereby extracellular matrix (ECM) integrity, scurvy prevention and tumor encapsulation. Ascorbic acid is a cofactor for prolyl hydroxylase, which hydroxylates proline residues for collagen structure, and also regulates the expression of collagen genes at the levels of transcription and mRNA stability [1-3].

Ascorbic acid is a potent antioxidant physiologically via the scavenging of reactive oxygen species (ROS), reactive nitrogen species and lipid hydroperoxides [4]. Radical species are highly reactive and trigger lipid peroxidation and cellular damage [4]. Ascorbic acid also regenerates other cellular antioxidants such as vitamin E, glutathione (GSH) and betacarotene from their radical species [4,5]. Ascorbate is depleted in biological fluids in vivo under conditions of oxidative stress and inflammation [4].

## Cancer and Ascorbic Acid

Ascorbic acid is a major regulator of the ECM and regulates cancer biology. It inhibits the invasiveness of several cancers such as gastric, oral, pulmonary, fibrosarcoma and melanoma [5-10]. It eliminates breast, oral, epidermoid and endometrial cancer cells [11-17]. Ascorbic acid is preferentially cytotoxic to cancer cells, because of its rapid cell division, whereas nonmalignant cells are 10-20 times less sensitive [18].

There are several mechanisms of ascorbate's anti-carcinogenic activity. The generation of reactive oxygen species is higher in gastric neoplasia than in nonplastic tissue and vitamin C retards gastric tumor growth by reducing the reactive oxygen species [12]. Oxidation of estrogen to reactive metabolites induces renal tumors in syrian hamsters that are inhibited by vitamin C by the removal of reactive superoxide radicals [11]. Vitamin C inhibits the growth of human mammary tumor xenografts from its chemical structure (the lactone functional group), depletion of bioavailability of lysine and cysteine, immune system improvement and adduct formation of its metabolites with cellular components [18].

Ascorbic acid has synergistic effects in combination with other vitamins or chemotherapeutic drugs. In combination with vitamin K, vitamin C (100 $\mu$ M to 1mM) inhibits the growth of breast, endometrial and oral epidermoid cancer cells at 10-50 fold lower concentrations [19]. The growth inhibition is counteracted by catalase, indicating the involvement of hydrogen peroxide, and from the reactivation of nucleases that induce cell toxicity [19]. In addition, the combination of vitamin C, vitamin K, and diverse chemotherapeutics synergistically inhibits endometrial adenocarcinoma cell growth [20]. There is synergistic toxicity of the chemotherapeutics (adriamycin, mitomycin, bleomycin, methotrexate, vincristine, cyclophosphamide) and vitamins (C and K) from reduced protein synthesis, reactive oxygen species, ATP depletion, and DNA single strand breaks

[20]. Topical application of vitamin C to skin has photo-protective effects, due to its reducing properties [5]. Combination of vitamin C and avemar (wheat germ extract with immunostimulatory properties) synergistically inhibits tumor metastasis without altering tumor growth, whereas vitamin C alone is ineffective on rat nephroblastoma [21].

Conversely, tumors accumulate high concentrations of ascorbate that may give it a metabolic advantage [16,17]. In rat models, higher concentrations of ascorbic acid (250mM to 500mM) promote carcinogenesis and induce proliferation/neoplastic lesions in the urinary bladder [16,17]. Human tumors contain high levels of ascorbic acid that is transported into cells by GLUT transporters in the form of dehydroascorbic acid and reduced/retained intracellularly as ascorbic acid after reduction by cellular glutathione [22,23]. The increased intracellular concentration of vitamin C may give tumors a metabolic advantage [23].

### Cancer Cell Growth and Extracellular Matrix Remodeling by Ascorbic Acid

The hallmarks of cancer include cell growth and metastasis facilitated by the matrix metalloproteinases (MMPs) and transforming growth factor (TGF- $\beta$ ), which remodel the extracellular matrix (ECM) [24-28]. The activity of MMPs is inhibited by tissue inhibitor of matrix metalloproteinases (TIMPs).

### Matrix Metalloproteinases (MMPs)

The matrix metalloproteinases (MMPs) are also called matrixins or collagenases. They play a central role in the remodeling of the ECM. The ECM is composed of three basic components: a fibrous material such as collagen and elastin, linking proteins including laminin and fibronectin and space-filling molecules such as glycosaminoglycans. There are three predominant groups of MMPs. The collagenases cleave interstitial (structural) collagens [25]. MMP-1 is the predominant one in this group. Gelatinases, such as MMP-2 and MMP-9, degrade basement membrane collagens and acts synergistically with collagenases to degrade denatured structural collagens. The third group is the stromelysins that degrade basement membrane collagens as well as proteoglycans and matrix glycoproteins [25]. The other MMP classes include membrane-type MMPs (MT-MMP) and elastases. MMPs are regulated in expression or activity at several different levels: gene expression, activation, and inhibition of activity by tissue inhibitors of matrix metalloproteinases (TIMPs). Epithelial cells, fibroblasts and mast cells are some of the cell types that produce MMPs.

Matrix metalloproteinases play an integral role in cancer pathogenesis [29]. Cancer invasion and metastasis, including ovary, lung, prostate, breast and pancreatic, parallel increased expression of MMPs [29]. MMPs activate growth factors such as transforming growth factor- $\beta$  (TGF- $\beta$ ) and vascular endothelial growth factor (VEGF), which contribute to tumorigenesis by inducing angiogenesis [30]. MMPs also contribute to cancer progression by degrading the E cadherin molecules that holds cells together [31,32].

## Transforming Growth Factor Beta (TGF- $\beta$ )

TGF- $\beta$  is a potent cytokine involved in cell cycle regulation, the immune response and in tissue remodeling [33]. There are three isoforms of TGF- $\beta$  (1,2, and 3), with TGF- $\beta$  1 being the predominant isoform [36]. TGF- $\beta$  is secreted in an inactive form, non-covalently bound to a dimer of latency associated peptide (LAP). Activation of TGF- $\beta$  involves dissociation of mature TGF- $\beta$  from LAP. Signal transduction is via a complex of transmembrane serine/threonine kinase receptors [34]. Although there are three types of receptors that specifically bind TGF- $\beta$ , only type I (T $\beta$ RI) and type II (T $\beta$ RII) have intrinsic serine/threonine kinase activity. Type III (T $\beta$ RIII) facilitates ligand binding to T $\beta$ RII. Once ligand binding has occurred, T $\beta$ RI and T $\beta$ RII form a heteromeric complex and phosphorylate Smads [35-36]. Phosphorylated Smad 2 /3 bind Smad 4 with concomitant translocation to the nucleus [36]. The inhibitory Smads, mainly Smad 6 and -7, block signal transduction by interacting with T $\beta$ RI to prevent phosphorylation and subsequent activation of Smad 2/3 [9,29-45].

TGF- $\beta$  has differential effects in different cell types [27]. TGF- $\beta$  enhances collagen formation and inhibits MMP expression in fibroblasts, without altering cell growth [5]. In epithelial cells, it inhibits growth and stimulates the expression of MMPs [6,9]. Cancer metastasis is associated with enhanced MMPs and TGF- $\beta$  expression [37].

## Reciprocal Effects of Ascorbate on Cell Growth and MMPs or TGF- $\beta$ Expression

In our laboratory, ascorbate is inhibitory to cancer cell survival at the lower concentrations (till 30 mM for renal adenocarcinoma cells, and 3mM for melanoma and mammary cancer cells) following which it causes dramatic proliferation of these cells [37]. The growth inhibitory ascorbate doses stimulate the expression of the ECM remodeling MMPs and TGF- $\beta$ , whereas the growth stimulatory doses are inhibitory to MMPs and TGF- $\beta$  expression [37].

The inhibition of MMP expression by the growth stimulatory ascorbate dose in the cancer cell lines suggests beneficial effects on the extracellular matrix [37]. Increased deposition of the extracellular matrix has been postulated to encapsulation tumors [38-40].

The cancer cell growth inhibition by the lower ascorbate concentrations may be by apoptotic and non-apoptotic mechanisms [42,43]. The apoptotic mechanism includes increased activity of p53, p21, Bax and caspase-3. An increase in the expression of p53 and its downstream protein p21 activates pro-apoptotic Bax protein that triggers apoptosis [41]. Cell cycle arrest may be another mechanism for the growth inhibition of cancer cells by ascorbate. The heat shock proteins (HSPs) may also be stimulated in the surviving cells. The HSPs are induced on cellular stress and have similar and specific effects. While HSP-70 is constitutively expressed HSP-27 induces differentiation and HSP-90 stabilizes oncogenic proteins, including MMPs [44-46].

The growth inhibitory doses of ascorbate induce MMPs in the cancer cell lines, indicating damage to the ECM [37]. MMP induction often correlates with cell loss [44-46].

The beneficial effect of ascorbate on growth inhibition of cancer cells is thus offset by the stimulation of MMPs, for it also suggests increased metastatic potential in the surviving cancer cells. The counteraction of the MMP stimulation by the growth inhibitory ascorbate dose by combination with agents that inhibit MMPs becomes the goal in the use of ascorbate for cancer management. While synthetic MMP inhibitors may not exhibit specificity, specific gene silencing with siRNA oligonucleotides may be effective [48-51]. Specific MMP gene silencing by siRNAs inhibit chondrosarcoma invasion, breast tumors or angiogenic phenotype of melanoma cells [47-51]. Combination of growth inhibitory ascorbate doses with other micronutrients or plant extracts that inhibit MMPs offer a safe alternative to gene therapy. *Polypodium leucotomos* (PL), a tropical fern plant belonging to a natural order polypodiaceae, has potential for combination with ascorbate in cancer management. PL is rich in polyphenols and has potent skin protective effects, topically and systemically [52-54]. It has antioxidant, anti-inflammatory and photoprotective properties: inhibits oxidative stress, lipid peroxidation, dermal mast cell infiltration, inflammatory cytokines, DNA damage and UV induced tumors [52-54]. In addition, PL inhibits MMP-1 expression in fibroblasts and keratinocytes [54].

The induction of TGF- $\beta$  is another integral factor to tumor pathology via induction of MMPs, angiogenesis and cancer metastasis. The inhibition of TGF- $\beta$  expression is a target for cancer therapy. The regulation of TGF- $\beta$  expression by ascorbate parallels MMP expression [37]. It may indicate similar regulation of these genes by ascorbate or that ascorbate at the lower concentrations increases TGF- $\beta$  expression which in turn simultaneously inhibits cell viability and stimulates MMPs in the cancer cells [37]. Combination therapy may lower TGF- $\beta$  and MMPs simultaneously, in making ascorbate beneficial to cancer management.

In summary, ascorbate has inverse effects on growth and the expression of the ECM remodeling MMPs and TGF- $\beta$ , in a dose-dependent manner [37]. The lower concentrations of ascorbate significantly inhibit cancer cell viability while stimulating MMPs and TGF- $\beta$  expression, indicating elimination of cancer cells with damage to the extracellular matrix (ECM). Conversely, ascorbate at higher concentrations dramatically stimulate cell proliferation and inhibit MMPs and TGF- $\beta$  expression, implicating growth and ECM advantage [37]. The counteraction of the MMP stimulating effect of the cytotoxic ascorbate concentration with a micronutrient or plant extract [*Polypodium leucotomos* (a fern extract)] that inhibits MMPs may inhibit cancer viability without the induction of MMPs and thereby make ascorbate beneficial in cancer management [37].

## Acknowledgement

February 20, 2009. Marvin Tuason, Kartik Sharma, Rassmei Son, Sheila Slavick for contributions.

## References

- [1] Booth B; Uitto J. The effects of ascorbic acid on procollagen production and prolyl-hydroxylase activity, *Biochem. Biophysics* (1981) 675: 117-122.
- [2] Davidson J; LuValle P; Zoia O; Quaglino D; Giro M. Ascorbate differentially regulates elastin and collagen biosynthesis in vascular smooth muscle cells and skin fibroblasts by pretranslational mechanisms. *Amer Soc Biochem and Mol Biol* (1997) 272: 345-352.
- [3] Greesin J; Murad S; Pinnell S. Ascorbic acid stimulates collagen production without altering intracellular degradation in cultured human skin fibroblasts. *Biochem and Biophysics* (1985) 866: 272-274.
- [4] Naidu A. Vitamin C in human health and disease is still a mystery? An overview. *Nutr J*, (2003) 2:7-11.
- [5] Darr D; Combs S; Dunston S; Manning T; Pinnell S. Topical Vitamin C protects porcine skin from ultraviolet radiation-induced damage. *British Journal of Dermatology* (1992) 127: 247-253.
- [6] Merryman JJ; Neilsen N; Staton DD. Transforming growth factor-beta enhances the ultraviolet-mediated stress response in p53<sup>-/-</sup> keratinocytes. *Int. J. Oncol.* (1998) 13: 781-789.
- [7] Philips N; Onwubalili N. Anti transforming growth factor-beta (TGF- $\beta$ ) increases the expressions of matrix metalloproteinase-1 (MMP-1) and growth factors in a renal adenocarcinoma cell line. *Bios* (2002) 73: 86-90.
- [8] Philips N; McFadden K. Inhibition of transforming growth factor-beta and matrix metalloproteinases by estrogen and prolactin in breast cancer cells. *Cancer Letters* (2004) 206: 63-68.
- [9] Philips N. An anti TGF- $\beta$  increased the expression of transforming growth factor- $\beta$ , matrix metalloproteinase-1 and elastin, and its effects were antagonized by ultraviolet radiation in epidermal keratinocytes. *J. Dermatol. Sci.* (2003) 33: 177-179.
- [10] Chen SJ; Yuan W; Mori Y; Levenson A; Trojanowaska M; Varga J. Stimulation of type I collagen transcription in human skin fibroblasts by TGF- $\beta$ : involvement of Smad 3. *J. Invest. Dermatol* (1999) 112: 49-57.
- [11] Liehr JG; Wheeler WJ. Inhibition of estrogen-induced renal carcinoma in Syrian hamsters by vitamin C. *Cancer Res.* (1983) 43: 4638-4642.
- [12] Oliveira CP; Kassab P; Lopasso FP; Souza HP; Janiszewski M; Laurindo FR; K. Iriya; Laudanna AA. Protective effect of ascorbic acid in experimental gastric cancer: reduction of oxidative stress. *World J. Gastroenterol* (2003) 9: 446-448.
- [13] Lutsenko E; Carcamo J; Golde D. Vitamin C prevents DNA mutation induced by oxidative stress. *J. Biol. Chem.* (2002) 277: 16895-16899.
- [14] Potdar P; Kandarkar S; Sirsat S. Modulation by Vitamin C of tumor incidence and inhibition in oral carcinogenesis. *Funct. Dev. Morphol.* (1992) 3:167-172.
- [15] Liu J; Nagao N; Kageyama K; Miwa N. Antimetastatic and anti-invasive ability of phospho-ascorbyl palmitate through intracellular ascorbate enrichment and the resultant antioxidant action. *Oncol. Res.* (1999) 11: 479-487.



- [16] Cohen SM; Anderson TA; Oliveria LM; Arnold LL. Tumorigenicity of sodium ascorbate in male rats. *Cancer Res.* (1998) 58: 2557-2561. Repeat at 22.
- [17] Murai T; Mori S; Hosono M; Takashima A; Machino S; Oohara T; Yamashita H; Makino S; Matsuda T; Wanibuchi H; Fukushima S. Strain differences in sensitivity to the promoting effects of sodium L-ascorbate in a two-stage rat urinary bladder carcinogenesis model. *Jpn. J. Cancer Res.* (1997) 88: 245-253. Repeat at 23.
- [18] Tsao CS. Inhibiting effect of ascorbic acid on the growth of human mammary tumor xenografts. *Am. J. Clin. Nutr.* (1991) 45: 1274S-80S.
- [19] Noto V; Henryk S; Taper S; Jiang YH; Janssens J; Bonte J; De Loecker W. Effects of sodium ascorbate (Vitamin C) and 2-methyl-1, 4-naphthoquinone (Vitamin K) treatment on humor tumor cell in vitro. I. Synergism of combined vitamin C and K action. *Cancer* (1989) 63: 901-906.
- [20] De Loecker W; Janssens J; Bonte J; Taper H. Effects of Sodium Ascorbate Vitamin C and 2-methyl-1,4-naphthoquinone (vitamin k) treatment on human tumor cell growth in-vivo. II. Synergism with combined chemotherapy action. *Anticancer Res.* (1993) 13: 103-106.
- [21] Hidvegi M; Raso E; Omoskozi-Farkas R; Sandor P; Lapis K; Szende B. Effects of avemar and avemar + vitamin C on tumor growth and metastasis in experimental animals. *Anticancer Res.* (1998) 18: 2353-2358.
- [22] Winkler B; Orselli S; Rex T. The redox couple between glutathione and ascorbic acid: a chemical and physiological perspective. *Free Radic. Biol. Med.* (1994) 17: 333-349.
- [23] Agus D; Vera J; Golde D. Stromal cell oxidation. *Cancer Res.* (1999) 59: 4555-4558.
- [23] Kao RT; Stern R. Collagenases in human breast carcinoma cell lines, *Cancer Res.* (1986) 46: 1349-1354.
- [24] Westermarck J; Kahari VM. Regulation of matrix metalloproteinase expression in tumor invasion. *FASEB J.* (1999) 12: 781-792.
- [25] Cox G; O'Byrne KJ. Matrix metalloproteinases and cancer. *Anticancer Res.* (2001) 21: 4207-4220.
- [26] Mauviel A; Chung KY; Agarwal A; Tamai K; Uitto J. Cell-specific induction of distinct oncogenes of the Jun family is responsible for differential regulation of collagenase gene expression by transforming growth factor-beta in fibroblasts and keratinocytes. *J. Biol. Chem.* (1996) 271: 10917-10923.
- [27] Philips N; Keller T; Gonzalez S. TGF- $\beta$  like regulation of matrix metalloproteinases by anti transforming growth factor- $\beta$  and anti transforming growth factor- $\beta$ 1 antibodies in dermal fibroblasts: implications to wound healing, *Wound Rep. Reg.* (2004) 12: 53-59.
- [28] Liotta LA; Stetler-Stevenson W. Metalloproteinases and malignant conversion: Does correlation imply casuality? *Journal of National Cancer Institute* (1989) 81: 556- 557.
- [29] Rundhaug JE. Matrix metalloproteinases, Angiogenesis and Cancer. *Clinical Cancer Research* (2003) 9: 551- 554.
- [30] Noël A; Jost M, Maquoi E. Matrix metalloproteinases at cancer tumor-host interface. *Semin. Cell. Dev. Biol.* (2007) 19: 52-60.

- [31] Liotta LA; Tryggvason K; Garbisa S; Hart I; Foltz CM; Shafie S. Metastatic potential correlates with enzymatic degradation of basement membrane collagen. *Nature* (1980) 284: 67-68.
- [32] Wang XJ. Role of TGF- $\beta$  signaling in skin carcinogenesis. *Micro. Res. Tech.* (2001) 52: 420-429.
- [33] Wrana JL; Attisano L; Wiesser R; Ventura F; Massague J. Mechanism of activation of the TGF-beta receptor. *Nature* (1994) 370: 341-347.
- [34] Derynck R. TGF-beta-receptor-mediated signaling. *Trends Biochem. Sci.* (1994) 19: 548-553.
- [35] Kawabata M; Miyazono K. Signal transduction of the TGF-beta superfamily by Smad proteins. *J. Biochem.* (1999) 125: 9-16.
- [36] Philips N; Keller T; Holmes C. Reciprocal Effects of Ascorbate on Cancer Cell Growth and the Expression of Matrix Metalloproteinases and Transforming Growth Factor-beta. *Cancer Letters* (2007) 256: 49-55.
- [37] Head KA. Ascorbic acid in the prevention and treatment of cancer. *Altern. Med. Rev.* (1998) 3: 174-186.
- [38] Philips N; Devaney J. Beneficial regulation of type I collagen and matrixmetalloproteinase -1 expression by estrogen, progesterone, and its combination in skin fibroblasts. *J. Am. Aging Assoc.* (2003) 26: 59-62.
- [39] Frazier K; Williams S; Kothapalli D; Klapper H; Grotendorst GR. Stimulation of fibroblast cell growth, matrix production, granulation tissue formation by connective tissue growth factor. *J. Invest. Dermatol.* (1996) 107: 404-411.
- [40] Lin SY; Lai WW; Chou CC; Kuo HM; Li TM; Chung GJ; Yang JH. Sodium ascorbate inhibits growth via the induction of cell cycle arrest and apoptosis in human malignant melanoma A375.S2 cells. *Melanoma Res.* (2006) 16: 509-519.
- [41] Verrax J; Cadrobbi J; Marques C; Taper H; Habraken Y; Piette J; Calderon P B. Ascorbate potentiates the cytotoxicity of menadione leading to an oxidative stress that kills cancer cells by a non-apoptotic caspase-3 independent form of cell death. *Apoptosis* (2004): 223-233.
- [42] Zhang H. P53 Plays a central role in UVA and UVB induced cell damage and apoptosis in Melanoma cells. *Cancer Letters* (2005) 244: 229-238.
- [43] Garrido C; Schmitt E; Cande C; Vahsen N; Parcellier A; Kroemer G. HSP27 and 70: Potential oncogenic apoptotic inhibitors. *Cell Cycle* (2003) 2: 579-584.
- [44] Neckers L. Heat shock protein 90: the cancer chaperone. *J. Biosci.* (2007) 32: 517-530.
- [45] Trautinger F; Kindas- Mügge I; Dekrout B; Knobler RM; Metze D. Expression of the 27-kDa heat shock protein in human epidermis and in epidermal neoplasms: an immunohistological study. *Br. J. Dermatol.* (1995) 133: 194-202.
- [46] Overall CM; Kleinfeld O. Validating matrix metalloproteinases as drug targets and anti-targets for cancer therapy. *Nature Rev. Cancer* (2006) 6: 227-239.
- [47] Yuan J; Charyl MD; Scully SP. RNAi mediated MMP-1 silencing inhibits human chondrosarcome invasion. *Journal of Orthopaedic Research* (2005) 23: 1467-1474.
- [48] Xiaoling J; Dutton CM; Wen-Ning Q; Block JA; Garamszegi N; Scully SP. siRNA Mediated Inhibition of MMP-1 Reduces Invasive Potential of a Human Chondrosoma Cell Line. *Journal of Cellular Physiology* (2005) 202: 723-730.

- 
- [49] Sateesh K; Lakka SS; Gondi CS; Estes N; Rao JS. RNAi-mediated downregulation of urokinase plasminogen activator receptor and matrix metalloproteinase-9 in human breast cancer cells results in decreased tumor invasion, angiogenesis and growth. *International Journal of Cancer* (2007) 121: 2307-2316.
- [50] El Mourabit H; Fahem A; Hornebeck W; Bernard P; Bellon G. Silencing of Membrane-Type 1 Metalloprotease (MT1-MMP) by Specific siRNAs Suppresses the Angiogenic Phenotype of Dermal Endothelial Cells and Inhibits Type 1 Collagen Invasion by Melanoma Cells. *J. Invest. Dermatol.* (2004) 123: 1523-1747.
- [51] Philips N; Smith J; Keller T; Gonzalez S. Predominant effects of Polypodium leucotomos on membrane integrity, lipid peroxidation, and expression of elastin and matrix metalloproteinase-1 in ultraviolet radiation exposed fibroblasts, and keratinocytes. *J. Dermatol. Sci.* (2003) 32: 1-9.
- [52] Gonzalez S; Alcaraz MV; Cuevas J; Perez M; Jaen P; Alvarez M.; Villarrubia V. An extract of the fern polypodium leucotomos (Difur<sup>®</sup>) modulates Th1/Th2 cytokines balance in vitro and appears to exhibit anti-angiogenic activities in vivo: pathogenic relationships and therapeutic implications. *Anticancer Research* (2000) 20: 1567-1576.
- [53] Bernd A; Ramirez-Bosca A; Huber H; Diaz-Alperi H; Thaci D; Sewell A; Auintanilla-Almagro E; Holzmann H. In vitro studies on the immunomodulating effects of polypodium leucotomos extract on human leukocyte fractions. *Arzneim-Forsch Drug Res.* (1995) 45: 901-904.



*Chapter XVII*

---

## **Shortage of Vitamin C Accelerates Aging**

---

*Akihito Ishigami\**

Department of Biochemistry, Faculty of Pharmaceutical Sciences,  
Toho University, Chiba, Japan

### **Introduction**

Vitamin C (L-ascorbic acid) has a well-documented, strong anti-oxidant function, evident as its ability to scavenge reactive oxygen species (ROS) in cells and blood (1-5). Additionally, an anti-aging effect has been attributed to vitamin C stemming from its deletion of ROS; however, no scientific evidence has yet proven this assertion. Therefore, we manipulated mice to insert a gene deletion that disabled their ability to synthesize vitamin C. In these mice baited with small amounts of vitamin C, we could ascertain that aging progressed faster than in their wild type counterparts. This report gives a full account of the relationship between vitamin C and the aging process while describing our study results.

#### Senescence Marker Protein-30 (SMP30) Decreases with Aging

In 1991, SMP30 was originally identified as a novel protein in the rat liver, the expression of which decreases androgen-independently with aging (6-11). To examine the physiological function of SMP30, we established SMP30 knockout mice (Figure 1). These mice were viable and fertile although, when fed autoclaved mouse chow containing ~55 mg/kg of vitamin C, were lower in body weight and shorter in life span than the wild type

---

\* Akihito Ishigami, Ph.D. Department of Biochemistry, Faculty of Pharmaceutical Sciences, Toho University, Miyama 2-2-1, Funabashi, Chiba 274-8510, Japan. Phone/FAX: +81-47-472-1536, E-mail: ishigami@phar.toho-u.ac.jp

controls (12,13). The mean survival time of these SMP30 knockout mice was approximately 6 months (Figure 2). On the other hand, wild type mice survived for approximately 24 months. Although phenotypical analysis during the survival interval of SMP30 knockout mice uncovered no obvious abnormalities, immediate postmortem examination revealed atrophy in almost all their abdominal organs. Thus, aging progressed by about four times the speed in SMP30 knockout mice over that in the controls.



Figure 1. SMP30 knockout and wild type mice. The SMP30 knockout mouse is born normal and is unchanged in any obvious way from the wild type mouse.

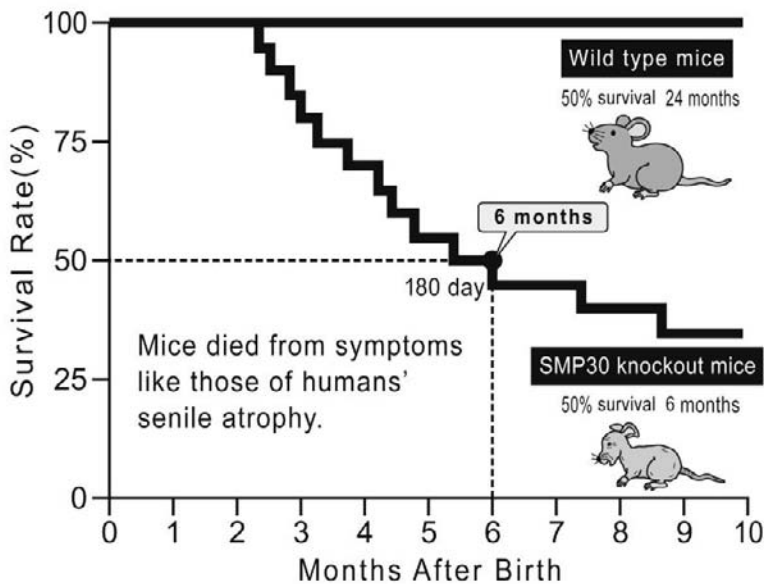

Figure 2. Shortened life span of SMP30 knockout mice. Twenty male SMP30 knockout and twenty male wild type mice were used. SMP30 knockout mice displayed an increased mortality rate starting at about 3 months of age compared to the cumulative survival rates for both strains.

## SMP30 Is a Gluconolactonase (GNL)

The physiological functions of SMP30 have not been understood throughout the more than ten years since its discovery, despite proof that amounts of SMP30 decreased during the aging process. However, in 2004, we found an amino acid sequence homology between rat SMP30 and two kinds of bacterial gluconolactonase (GNL: EC 3.1.1.17) derived from *Nostoc punctiforme* and *Zymomonas mobilis*, data that were retrieved from the public genome database of the National Center for Biotechnology Information (NCBI). Through subsequent biochemical study, we identified SMP30 as the lactone-hydrolyzing enzyme GNL of animal species <sup>(14)</sup>. SMP30 purified from the rat liver had lactonase activity toward the aldonolactones D- and L-glucono- $\gamma$ -lactone, D- and L-gulono- $\gamma$ -lactone, and D- and L-galactono- $\gamma$ -lactone, with a requirement for Zn<sup>2+</sup> or Mn<sup>2+</sup> as a cofactor. Furthermore, in SMP30 knockout mice, no GNL activity was detectable in the liver. Thus, we concluded that SMP30 is a unique GNL in the liver.

## SMP30/GNL Knockout Mice Cannot Synthesize Vitamin C

Humans, monkeys and guinea pigs cannot synthesize vitamin C internally, because of their many genetic mutations of the enzyme, L-gulono- $\gamma$ -lactone oxidase (GLO), located at the end of vitamin C's synthetic procedure (Figure 3). However, mice bear no mutation in GLO and can, therefore, synthesize vitamin C. SMP30/GNL is an enzyme with one GLO located forward from the terminus. Therefore, we assumed that the SMP30/GNL knockout mice should be not able to synthesize vitamin C *in vivo*. To verify this assumption, we performed a nutritional study by using a vitamin C-deficient diet. SMP30/GNL knockout mice fed a vitamin C-deficient diet did not thrive; i.e., they decreased in weight and displayed symptoms typical of scurvy such as bone fractures, a decrease in bone density because of imperfect construction of the collagen fiber and rachitic rosary (an abnormality in rib cartilage formation) (Figure 4) (14). Moreover, SMP30/GNL knockout mice died by 135 days after starting this vitamin C-deficient diet. The vitamin C levels in their livers and kidneys at the time of death were <1.6% of that in wild type control mice. The fact that SMP30/GNL knockout mice developed scurvy-like symptoms when fed a vitamin C-deficient diet verified the pivotal role of SMP30 in vitamin C biosynthesis. Moreover, by using SMP30/GNL knockout mice, we demonstrated that the alternative pathway of vitamin C synthesis involving D-glucurono- $\gamma$ -lactone operates *in vivo* (Figure3), although its flux is fairly small (14).

## A Shortage of Vitamin C Accelerates Aging

It cannot be said that the vitamin C deficiency promoted aging, because SMP30/GNL knockout mice died of scurvy, when fed a vitamin C-deficient diet. A most important point is that scurvy is a disease, whereas aging is not. Aging refers to a slow gradual decrease of

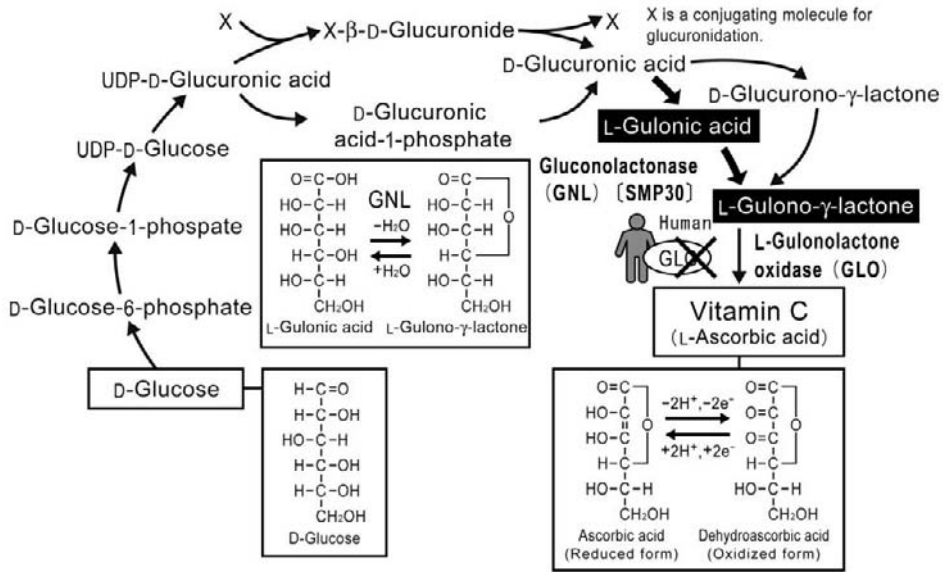

Figure 3. Vitamin C biosynthesis pathway. The pathway from D-glucose to L-gulonic acid is shared with that of early steps in the uronic acid cycle. X is a conjugating molecule for glucuronidation. SMP30 is a gluconolactonase (GNL), which catalyzes from L-gulonic acid to L-gulono-γ-lactone. In humans, L-gulonolactone oxidase (GLO) is absent because of mutation.

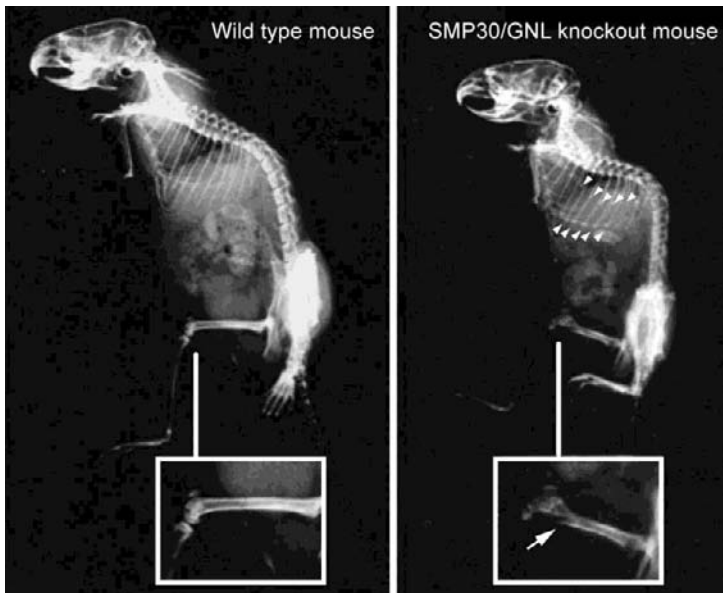

Figure 4. Osteogenic disorder of SMP30/GNL knockout mice. X-ray images show the skeletal structures of SMP30/GNL knockout and wild type mice. Insets: enlargements of the femoral region in which an arrow points to the distal femur fracture of an SMP30/GNL knockout mouse. Arrowheads indicate a rachitic rosary at the junction of costae and costal cartilage.

physiological functions of the body as time passes. Yet our SMP30/GNL knockout mice died early (as measured by survival times), as previously stated, about four times faster than their



wild -type counterparts, and this observation was documented before SMP30 was identified as a GNL (Figure 2). At that time, no symptoms of scurvy were noted in the SMP30/GNL knockout mice, presumably because the autoclaved mouse chow they ate contained ~55 mg/kg of vitamin C. We now know that this amount of vitamin C is too small to maintain normal levels in tissues; in fact, each mice was taken about 2.5% a day of vitamin C. However, we can say that aging progressed ~four times faster than normal in these knockout mice, because they received too little vitamin C over a long period of time. Thus, these results indicate that a shortage of vitamin C accelerated aging. Until now, there was no scientific evidence for this conclusion despite the conventional wisdom that vitamin C has an anti-aging influence. This, then, is the first report of research that used SMP30/GNL knockout mice to show in a scientific manner that the shortage of vitamin C decreased life.

### Rough Estimate of Vitamin C Intake that Promotes Human Aging

The recommended amount of vitamin C intake daily for humans is about 100 mg (~5 or 6 strawberries) according to the "Japanese dietary reference intake of vitamin C" published by the Japan Ministry of Health, Labor and Welfare. When one takes only 2.5 mg (2.5% of 100 mg) of vitamin C for the long term, aging accelerates according to our experiment results with the SMP30/GNL knockout mice. However, this calculation does not apply when vitamin C intake stops briefly, i.e., for several days, because the healthy body stockpiles a supply of vitamin C. Aging accelerates only in the long term when as little as 2.5 mg a day of vitamin C is taken for a period of about three years; after that interval, a vitamin C deficiency can kill one in ten individuals according to our rough estimate (Figure 5). Moreover, half of those so-deprived can be calculated to die in about 13 years. However, this theoretical value applies only to the experimental results in the SMP30/GNL knockout mice and does not guarantee the same outcome in humans.

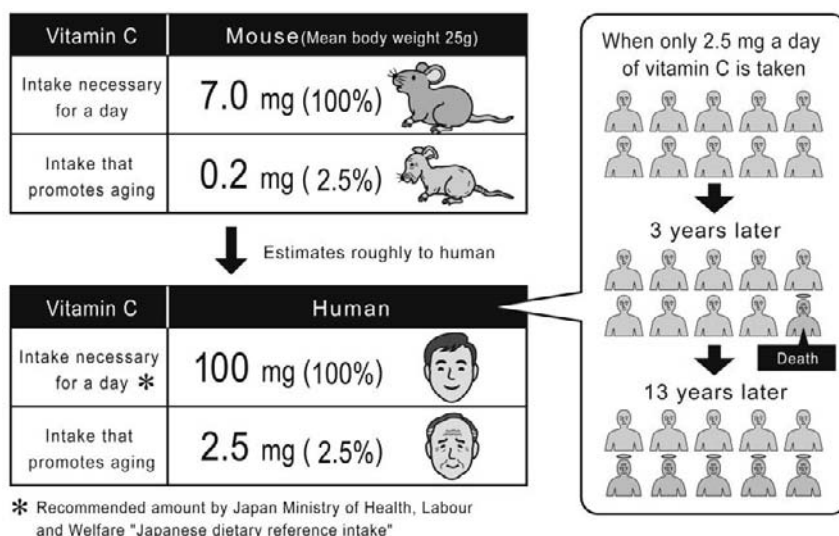

Figure 5. Rough estimate of vitamin C intake that promotes aging in humans.

## Future of the SMP30/GNL Knockout Mouse

Humans cannot synthesize vitamin C internally. Therefore, it can be said that the SMP30/GNL knockout mice, which is also incapable of synthesizing vitamin C, is a closely related model animal to humans. In both species, the strong antioxidative effect of vitamin C, efficiently deletes ROS. Since the correlation between aging and the bodily content of ROS is well-established, our experimental results obtained from SMP30/GNL knockout mice is an extremely reliable predictor of the related condition in humans. Clearly, our results indicate that one should always bear in mind the necessity of taking sufficient vitamin C from fresh fruits and vegetables to avoid a life-shortening deficiency.

## References

- [1] Bielski BH, Richter HW and Chan PC: Some properties of the ascorbate free radical. *Ann N Y Acad Sci* 258:231-237, 1975.
- [2] Nishikimi M: Oxidation of ascorbic acid with superoxide anion generated by the xanthine-xanthine oxidase system. *Biochem Biophys Res Commun* 63:463-468, 1975.
- [3] Bodannes RS and Chan PC: Ascorbic acid as a scavenger of singlet oxygen. *FEBS Lett* 105:195-196, 1979.
- [4] Kondo Y, Sasaki T, Sato Y, Amano A, Aizawa S, Iwama M, Handa S, Shimada N, Fukuda M, Akita M, Lee J, Jeong KS, Maruyama N and Ishigami A: Vitamin C depletion increases superoxide generation in brains of SMP30/GNL knockout mice. *Biochem Biophys Res Commun* 377:291-296, 2008.
- [5] Sato Y, Kajiyama S, Amano A, Kondo Y, Sasaki T, Handa S, Takahashi R, Fukui M, Hasegawa G, Nakamura N, Fujinawa H, Mori T, Ohta M, Obayashi H, Maruyama N and Ishigami A: Hydrogen-rich pure water prevents superoxide formation in brain slices of vitamin C-depleted SMP30/GNL knockout mice. *Biochem Biophys Res Commun* 375:346-350, 2008.
- [6] Ishigami A and Maruyama N: Significance of SMP30 in gerontology. *Geriatr Gerontol IntGeriatrics & Gerontology International* 7:316-325, 2007.
- [7] Fujita T, Uchida K and Maruyama N: Purification of senescence marker protein-30 (SMP30) and its androgen-independent decrease with age in the rat liver. *Biochim Biophys Acta* 1116:122-128., 1992.
- [8] Fujita T, Shirasawa T, Uchida K and Maruyama N: Isolation of cDNA clone encoding rat senescence marker protein-30 (SMP30) and its tissue distribution. *Biochim Biophys Acta* 1132:297-305., 1992.
- [9] Mori T, Ishigami A, Seyama K, Onai R, Kubo S, Shimizu K, Maruyama N and Fukuchi Y: Senescence marker protein-30 knockout mouse as a novel murine model of senile lung. *Pathol Int* 54:167-173, 2004.
- [10] Maruyama N, Ishigami A, Kuramoto M, Handa S, Kubo S, Imasawa T, Seyama K, Shimosawa T and Kasahara Y: Senescence marker protein-30 knockout mouse as an aging model. *Ann N Y Acad Sci* 1019:383-387, 2004.

- 
- [11] Feng D, Kondo Y, Ishigami A, Kuramoto M, Machida T and Maruyama N: Senescence marker protein-30 as a novel antiaging molecule. *Ann N Y Acad Sci* 1019:360-364, 2004.
- [12] Ishigami A, Fujita T, Handa S, Shirasawa T, Koseki H, Kitamura T, Enomoto N, Sato N, Shimosawa T and Maruyama N: Senescence marker protein-30 knockout mouse liver is highly susceptible to tumor necrosis factor- $\alpha$ - and Fas-mediated apoptosis. *Am J Pathol* 161:1273-1281, 2002.
- [13] Ishigami A, Kondo Y, Nanba R, Ohsawa T, Handa S, Kubo S, Akita M and Maruyama N: SMP30 deficiency in mice causes an accumulation of neutral lipids and phospholipids in the liver and shortens the life span. *Biochem Biophys Res Commun* 315:575-580, 2004.
- [14] Kondo Y, Inai Y, Sato Y, Handa S, Kubo S, Shimokado K, Goto S, Nishikimi M, Maruyama N and Ishigami A: Senescence marker protein 30 functions as gluconolactonase in L-ascorbic acid biosynthesis, and its knockout mice are prone to scurvy. *Proc Natl Acad Sci U S A* 103:5723-5728, 2006.



*Expert Commentary*

---

## **The Importance of Food Processing on Vitamin C: Present and Future Trends**

---

*Rui M. S. Cruz<sup>1\*</sup>, Margarida C. Vieira<sup>2+</sup> and Cristina L. M. Silva<sup>1</sup>*

<sup>1</sup>CBQF/Escola Superior de Biotecnologia, Universidade Católica Portuguesa, Rua Dr. António Bernardino de Almeida, Porto, Portugal

<sup>2</sup>Instituto Superior de Engenharia, Universidade do Algarve, Campus da Penha, Faro, Portugal

### **Abstract**

Consumer demand for safer and nutritious food products has led to development and research of new processing technologies. Throughout the centuries, vitamin C has played an important role in human nutrition due to its antioxidant effect and stimulation of the immunological system. Nevertheless, since the human organism does not produce its own vitamin C, it must be sourced from a regular diet or taken as a vitamin supplement. Besides its natural availability it is possible to find vitamin C in many different forms. The development of new food products formulations including vitamin C and new processing operations in order to retain vitamin content, are crucial for reaching out consumers around the Globe, fulfilling dairy requirements and health benefits and thus, in a near future, contributing for the reduction of nutritional deficiencies.

Vitamin C plays an important role in human nutrition due to its antioxidant effect and stimulation of the immunological system and is considered to be one of the important indices of food quality. However, it is also one of the least stable vitamins, easily destroyed during

---

\* E-mails: [rcruz@ualg.pt](mailto:rcruz@ualg.pt), [clsilva@esb.ucp.pt](mailto:clsilva@esb.ucp.pt)

+ E-mail: [mvieira@ualg.pt](mailto:mvieira@ualg.pt)

processing and storage of foodstuffs. The development of new processing technologies and new food products compositions are of extreme importance towards vitamin C preservation and availability, and thus fulfilling the consumer requirements. This commentary will focus on the importance of food processing on vitamin C availability, including a present overview and possible future trends.

Nowadays, the research and application of new processing operations, in order to increase process efficiency, i.e. reducing or destroying undesired parameters and preserving the desired ones, such as vitamin C, and thus producing healthier and natural products, are some of the main goals of the Food Industry. Several studies applying new processing technologies, such as high pressure processing [1; 2; 3; 4; 5; 6; 7], ultrasound applications [8; 9; 10; 11] and ohmic heating [12; 13; 14] proved to be excellent solutions, since they showed good vitamin C content retention compared with the traditional processing treatments. Nevertheless, for a realistic approach and an efficient treatment application it is imperative to perform a suitable scale-up between laboratory studies and the industrial application.

On the other hand, the production of new and healthier food products containing vitamin C in their composition, due to additional fortification, is undoubtedly, another available resource that increases the consumers' dietary selection. In this specific area, there are several food products, such as breakfast cereals, energetic bars, beverages and sweets. However, this vitamin C fortification should not disguise or promote products that might have questionable nutritional quality and thus, induce the consumer to an erroneous diet and compromise health care. The food products supplemented with vitamin C do not always work as expected, since this vitamin has a high reactivity, being degraded by several mechanisms and thus showing less bioavailability during processing and storage. This condition can be overcome by microencapsulation, which is a modern technology to incorporate health promoting ingredients into foods, without reducing its bioavailability. The microencapsulation main concept is the controlled release of the encapsulated ingredient at the right place and the right time [15; 16; 17].

A commitment between vitamin C fortification and safety must be also regarded by establishing safe levels, avoiding insufficient or overconsumption of some nutrients, and thus accomplishing with success the planned nutritional objectives.

We think that the possibility for consumers to individually select food products composition, including nutrients fortification, and particularly vitamin C, aiming to develop products for a particular health problem or even for a specific gender or age will be in a near future an optimistic view that may contribute for the reduction of individual nutritional deficiencies and thus enhancing health care. However, this type of solution must be accompanied by health experts, responsible government food laws and corresponding authorities.

The Food Industry will continue to seek out for new processing technologies and developing new food products, contributing for the design of healthier, safer and less processed food solutions and consequently satisfying the consumers' nutritional requirements.

## References

- [1] Broeck, V., Ludikhuyze, L., Weemaes, C., Van Loey, A. & Hendrickx, M. (1998). Kinetics for isobaric-isothermal degradation of L-ascorbic acid. *Journal of Agricultural and Food Chemistry*, 46, 2001-2006.
- [2] Norton, T. & Sun, D. (2008). Recent advances in the use of high pressure as an effective processing technique in the food industry. *Journal of Food and Bioprocess Technology*, 1, 2-34.
- [3] Sancho, F., Lambert, Y., Demazeau, G., Largeteau, A., Bouvier, J. & Narbonne, J. (1999). Effect of ultra-high hydrostatic pressure on hydrosoluble vitamins. *Journal of Food Engineering*, 39, 247-253.
- [4] San Martín, M. F., Barbosa-Cánovas, G. V. & Swanson, B. G. (2002). Food processing by high hydrostatic pressure. *Critical Reviews in Food Science and Nutrition*, 42, 627-645.
- [5] Sánchez-Moreno, C., Plaza, L., Elez-Martínez, P., Ancos, B., Martín-Belloso, O. & Cano, M. P. (2005). Impact of high pressure and pulsed electric fields on bioactive compounds and antioxidant activity of orange juice in comparison with traditional thermal processing. *Journal of Agricultural and Food Chemistry*, 53, 4403-4409.
- [6] Butz, P., García, A. F., Lindauer, R., Dieterich, S., Bognár, A. & Tauscher, B. (2003). Influence of ultra high pressure processing on fruit and vegetable products. *Journal of Food Engineering*, 56, 233-236.
- [7] García, A. F., Butz, P., Bognár, A. & Tauscher, B. (2001). Antioxidative capacity, nutrient content and sensory quality of orange juice and an orange-lemon-carrot juice product after high pressure treatment and storage in different packaging. *European Food Research and Technology*, 213, 290-296.
- [8] Cruz, R. M. S., Vieira, M. C. & Silva, C. L. M. (2008). Effect of heat and thermosonication treatments on watercress (*Nasturtium officinale*) vitamin C degradation kinetics. *Journal of Innovative Food Science & Emerging Technologies*, 9, 483-488.
- [9] Vercet, A., Burgos, J. & López-Buesa, P. (2001). Manothermosonication of foods and food-resembling systems: effect on nutrient content and nonenzymatic browning. *Journal of Agricultural and Food Chemistry*, 49, 483-489.
- [10] Tiwari, B. K., O' Donnell, C. P., Muthukumarappan, K. & Cullen, P. J. (2009). Ascorbic acid degradation kinetics of sonicated orange juice during storage and comparison with thermally pasteurised juice. *LWT-Food Science and Technology*, 42, 700-704.
- [11] Zenker, M., Heinz, V. & Knorr, D. (2003). Application of ultrasound assisted thermal processing for preservation and quality retention of liquid foods. *Journal of Food Protection*, 66, 1642-1649.
- [12] Castro, I., Teixeira, J. A., Salengke, S., Sastry, S. K. & Vicente, A. A. (2004). Ohmic heating of strawberry products: electrical conductivity measurements and ascorbic acid degradation kinetics. *Innovative Food Science and Emerging Technologies*, 5, 27-36.

- [13] Lima, M., Heskitt, B. F., Burianek, L. L., Nokes, S. E. & Sastry, S. K. (1999). Ascorbic acid degradation kinetics during conventional and ohmic heating. *Journal of Food Processing and Preservation*, 23, 421-443.
- [14] Leizeron, S. & Shimoni, E. (2005). Effect of ultrahigh-temperature continuous ohmic heating treatment on fresh orange juice. *Journal of Agricultural and Food Chemistry*, 53, 3519-3524.
- [15] Kirby, C. J., Whittle, C. J., Rigby, N., Coxon, D. T. & Law, B. A. (1991). Stabilization of ascorbic acid by microencapsulation. *International Journal of Food Science and Technology*, 26, 437-449.
- [16] Gouin, S. (2004). Microencapsulation: industrial appraisal of existing technologies and trends. *Trends in Food Science & Technology*, 15, 330-347.
- [17] Lee, J., Ahn, J., Lee, J. & Kwak, H. (2004). L-ascorbic acid microencapsulated with polyacylglycerol monostearate for milk fortification. *Bioscience, Biotechnology, and Biochemistry*, 68, 495-500.



---

# Index

---

## A

- A $\beta$ , 249  
abdominal cramps, 243  
abiotic, 314  
abnormalities, 136, 286, 378  
absorption, xi, 3, 51, 65, 68, 72, 78, 84, 128, 129, 130, 131, 136, 144, 145, 162, 173, 186, 190, 196, 213, 218, 221, 222, 238, 241, 244, 253  
ACE inhibitors, 17, 37  
acetate, 54, 95  
acetone, 194  
acetylcholine, 135, 147, 333, 335, 337, 346, 347  
acidic, 130, 154, 239  
acidity, 199  
acidosis, 11, 248  
ACS, 177  
actin, 34  
active site, 15  
active smokers, xiii, 261, 262, 265, 278  
active transport, ix, 46, 66, 67, 218, 241  
acute infection, 214  
acute leukemia, 121  
acute myeloid leukemia, 124  
acute renal failure, 340  
adaptation, 15, 39, 170  
additives, 188, 202  
adducts, 21, 70, 89, 90, 159, 162, 180  
adenine, 10, 11, 93, 154, 250, 352  
adenocarcinoma, 220, 368, 370, 372  
adenoma, 242  
adenomyosis, 294  
adenosine, 7, 10, 196, 241  
adenosine triphosphate, 196, 241  
adhesion, 139, 152, 224, 232, 288, 302, 345  
adipocytes, 66, 353  
adiponectin, 139  
adolescent female, 274  
adolescents, 263, 271, 276  
ADP, 10, 35, 300, 308, 309, 312, 339  
adrenal cortex, 233  
adrenal gland, 128, 282  
adriamycin, 150, 206, 368  
ADS, 93  
adult population, 244, 274, 334  
adult respiratory distress syndrome, 229  
advanced glycation end products, 344, 351  
aerobic exercise, 5, 18, 19, 20, 21, 22, 23, 24, 26, 27, 30, 40  
aetiology, xii, 214  
affective disorder, 312  
African American women, 337  
ageing, 64, 153, 181, 215  
agglutination, xiv, 281, 290  
aggregation, 131, 193, 198, 209  
aging, vii, xvi, 1, 6, 7, 19, 34, 35, 36, 48, 71, 77, 79, 80, 142, 144, 291, 302, 326, 341, 377, 379, 381, 382  
aging process, vii, xvii, 1, 6, 377, 379  
air pollution, xiv, 313, 315, 316, 319, 320, 322, 323, 325, 327, 362, 364  
air quality, 327  
airway surface, 221  
airways, 221  
alanine, 57  
Alaska, 245, 246  
albumin, 16, 69, 331  
alcohol, 136, 195, 274, 275, 358  
alcohol consumption, 274  
aldehydes, 12, 283  
alkali, 113  
alkaline, 74, 77, 94, 199, 264

- alkaline phosphatase, 74  
alkenes, 338  
alkylation, 90, 113  
allele, 69, 70, 339  
*Allium cepa*, 247, 248  
allopurinol, 30  
alpha, 16, 33, 43, 69, 119, 150, 156, 166, 173, 182, 211, 233, 257, 290, 291, 294, 296, 311, 352  
alpha-tocopherol, 33, 43, 119, 156, 166, 173, 182, 211, 291, 296, 311, 352  
ALT, 57  
alternative, 68, 195, 220, 364, 371, 379  
alternative medicine, 364  
alters, 344, 345  
alveolar macrophages, 364  
American Diabetes Association, 148  
amines, 88, 91, 219, 283, 291  
amino acid, ix, 13, 46, 70, 71, 77, 128, 219, 220, 239, 251, 258, 284, 304, 379  
ammonium, 156  
amphetamine, 306  
anaemia, 222  
anaerobic, 5, 11, 15, 17, 18, 20, 21, 27, 28, 29, 32, 35, 38, 137  
analog, 250  
analysis of variance, 55  
androgen, 230, 377, 382  
anemia, 136, 238, 251  
angiogenesis, xvi, 169, 182, 367, 369, 371, 373, 375  
angiogenic, 371, 375  
angiography, 345, 347  
angiotensin converting enzyme (ACE), 16, 17, 37  
angiotensin II, 17  
animal models, 169, 309, 312, 345  
animal studies, xii, 238, 252, 334, 337  
animal tissues, 79, 83, 190, 229, 236  
anorexia, 136  
anthracene, 249  
anthropogenic, xiv, 313  
anti-angiogenic, 375  
antiapoptotic, 92  
anti-apoptotic, x, 88, 92, 116  
antibacterial, 6  
antibody, 13, 186  
anticancer, 91, 124, 167, 169, 197, 204, 242  
anticancer activity, 167, 170, 242  
anticancer drug, 204  
anticonvulsant, 306, 308, 311  
antigen, 220  
antihypertensive agents, 197  
antihypertensive drugs, 17  
antineoplastic, 150, 178, 206  
antioxidant complex, 150  
antioxidative, 154, 161, 387  
antisense, 203  
antisense oligonucleotides, 203  
antitumor, 119, 181  
antiviral, 224  
AOC, 13  
aortic stenosis, 152  
APL, 175  
apoptotic, x, 88, 92, 93, 99, 100, 110, 111, 115, 116, 119, 122, 173, 174, 177, 370, 374  
apoptotic cells, 99, 100, 110, 111, 115, 116  
apoptotic effect, x, 88, 92, 115, 116  
apoptotic mechanisms, 370  
aqueous humor, 235  
aqueous solution, 194, 208  
arachidonic acid, 12, 305  
arginine, 132, 133, 146, 284, 293, 302, 334, 340, 344, 345, 350, 351, 352  
arrest, 119, 169, 292, 370, 374  
arsenic, 124, 175, 176  
arsenic trioxide, 176  
ART, 287  
arterial hypertension, 337, 344  
arteries, 133, 147, 148, 224, 257, 339, 352  
artery, 135, 146, 147, 148, 151, 180, 256, 336, 344, 345, 346, 347, 350, 352, 353  
articular cartilage, 229  
aryl hydrocarbon receptor, 120  
ASEAN, 210  
Asia, 33, 53, 63, 79, 83, 365  
Asian, 70, 83, 246  
Asian countries, 70  
aspartate, 300, 307  
asphyxia, 35  
aspirin, 345  
assessment, 11, 12, 14, 19, 179, 198, 277, 325, 326, 363  
association, 275, 276  
asthma, 225, 232, 238, 302, 364, 365  
astrocytes, 218, 225, 229, 231, 234, 303, 310  
astroglial, 231  
asymptomatic, 340  
atherogenesis, xii, 37, 80, 237  
atherosclerosis, xv, 5, 7, 15, 33, 49, 132, 146, 151, 182, 224, 241, 249, 302, 332, 336, 338, 343, 344, 345, 346, 349, 352, 353  
Atherosclerosis Risk in Communities (ARIC), 151

atherosclerotic plaque, 238, 243  
atmosphere, 93, 98, 99, 100  
atoms, 5, 90, 154, 157, 301, 331  
atopic eczema, 163, 164  
ATP, 8, 10, 129, 196, 241, 368  
ATPase, 35, 218, 306, 310, 333  
atresia, 283  
atrophy, 378  
Australia, 355, 357  
Austria, 144, 153, 211  
autonomic nerve, 351  
autooxidation, 157, 159, 166, 167, 179

**B**

B lymphocytes, 149  
B vitamins, 187  
bacteria, 9, 137, 150  
bacterial, 71, 74, 137, 180, 206, 229, 379  
bacterial cells, 180  
bacterial infection, 137  
bananas, 266  
barrier, 159, 228, 230  
basal lamina, 282  
basement membrane, 369, 374  
basketball, 29, 43  
batteries, 330, 331, 333  
Bax, 370  
Bcl-2, 173  
BDI, 156  
beef, 366  
behavior, xiii, 193, 198, 211, 262, 271, 277, 306  
behaviours, 202  
beneficial effect, xv, 91, 114, 118, 224, 243, 330, 337, 343, 345, 348, 349, 350, 363, 370, 371  
benefits, viii, xii, xvii, 2, 3, 5, 23, 31, 134, 164, 165, 181, 190, 237, 257, 330, 348, 365, 385  
benign, 183  
benzo(a)pyrene, 91, 113, 115, 120  
beta cell, 255  
beta-carotene, 16, 24, 25, 29, 37, 43, 143, 146, 166, 181, 182, 359, 362, 364  
beverages, 264, 386  
bias, 19, 264, 363  
bicarbonate, 245  
bile, 117, 129, 226, 234, 241  
bile acids, 129, 226, 234, 241  
bile duct, 117  
bilirubin, 6, 13, 226  
biliverdin reductase, 233  
bioactive compounds, 121, 387

bioavailability, 2, 3, 17, 129, 130, 131, 134, 144, 165, 203, 227, 250, 333, 344, 345, 349, 368, 386  
biochemistry, 33, 54, 63, 68, 146, 254, 256, 309  
biocompatibility, 198  
biocompatible, 195, 196  
biodegradability, 186  
biodegradable, 196, 203, 204  
biodiversity, 327  
bioflavonoids, 6, 13  
biogenesis, 30, 31, 42, 65, 84, 145  
biological activity, 48, 187  
biological macromolecules, 48, 186, 284  
biological systems, vii, xi, 1, 4, 5, 8, 9, 13, 36, 153, 180, 188, 239, 301  
biomaterials, 196, 197  
biometals, 340  
biomolecules, x, 4, 11, 12, 22, 24, 153, 157, 159, 171, 301, 308  
biomonitoring, 315, 324, 327  
biopsies, 167, 168  
biosynthesis, vii, xi, xii, 62, 72, 81, 82, 141, 149, 185, 215, 231, 233, 237, 239, 282, 290, 309, 372, 379, 380, 383  
biosynthetic pathways, 239  
biotic, 314  
biotin, 188  
biotransformation, 114, 123, 165  
bipolar, 312  
birth, xiii, 220, 281, 283, 286, 288, 289, 293, 304  
birth weight, xiii, 281, 286, 288, 289, 293  
bismuth, 331  
bladder, 70, 81, 89, 118, 138, 170, 369, 373  
bladder cancer, 70, 81, 118  
blastocyst, 283, 285, 292  
blocks, 35, 333  
blood and body fluids, 223  
blood flow, 135, 149, 238, 250, 295, 333, 334, 340, 345, 346, 347, 352  
blood glucose, 53, 134, 149  
blood lead levels, 334, 337, 341  
blood plasma, 123, 176, 230, 254, 303, 304, 309  
blood pressure, xv, 57, 76, 132, 147, 224, 243, 256, 329, 333, 337, 340, 346, 353  
blood urea nitrogen, 57  
blood vessels, xii, 128, 132, 169, 237, 238, 340  
blood-brain barrier, 228, 230  
bloodstream, 331  
body fluid, 12, 136, 183, 223, 273  
body mass, 52, 264, 274, 279, 360

- body mass index (BMI), 52, 140, 264, 265, 274, 278, 279, 360
- body size, 78
- body weight, 49, 62, 75, 76, 129, 377
- Bohr, 147
- boiling, 251
- bonding, 137
- bonds, 36
- bone density, 379
- bone marrow, 143, 145
- bovine, 71, 291
- brain, xiv, 35, 43, 70, 74, 128, 139, 186, 220, 233, 240, 241, 244, 299, 300, 303, 304, 305, 306, 308, 309, 310, 311, 341, 382
- brain damage, 35
- brass, 333
- Brassica oleracea*, 247
- Brassica rapa*, 246, 247
- Brazil, 209, 326
- breakdown, 252, 297
- breakfast, xiii, 262, 263, 264, 268, 269, 272, 386
- breast cancer, 167, 168, 177, 183, 208, 372, 375
- breast carcinoma, 150, 178, 206, 373
- breastfeeding, 283
- breathlessness, 356
- breeding, xiv, 281, 290
- broccoli, 2, 92, 121, 128, 190, 245, 358
- bromine, 54
- bronchioles, 221
- bronchitis, 138
- bronchoalveolar lavage, 229
- bronchospasm, 234
- Brussels, 92, 119, 128, 175
- buffer, 94, 97, 192, 198
- burns, xv, 139, 343, 348
- bypass, 203
- by-products, 8, 34, 197
- 
- C**
- 
- Ca<sup>2+</sup>, 34, 35, 36, 222, 307, 309, 312
- cabbage, 92, 247, 358, 361, 366
- CAD, 135, 345, 346, 347, 348, 349
- cadherin, 369
- cadmium, 124
- caffeine, 230
- calcification, 274
- calcium, 7, 71, 130, 131, 145, 150, 205, 222, 230, 236, 243, 252, 271, 300, 308, 344
- calcium oxalate, 131, 145, 205, 222, 230, 252
- calibration, 96, 97, 98
- calmodulin, 309
- cancer cells, xvi, 68, 91, 119, 124, 167, 169, 173, 174, 181, 205, 208, 251, 258, 283, 367, 368, 370, 371, 372, 374, 375
- cancer progression, 168, 369
- cancer treatment, 255
- candidates, 196, 197
- capillary, 222, 345, 352
- caprolactone, 208
- capsule, 186, 194
- CAR, 226, 230
- carbazole, 113
- carbohydrate, 22, 39, 214, 301
- carbohydrates, xi, 12, 15, 129, 185, 284, 285, 301, 302
- carbon, vii, 1, 2, 5, 89, 90, 121, 159, 162, 188, 301
- carbon atoms, 90
- carboxyl, 219
- carboxylic, 239
- carcinogen, 89, 91, 115, 249, 252
- carcinogenesis, xii, 90, 91, 114, 117, 143, 169, 182, 234, 237, 249, 369, 372, 373, 374
- carcinogenic, ix, xvi, 87, 88, 89, 113, 121, 124, 138, 169, 191, 240, 242, 252, 367, 368
- carcinogenicity, 89, 90, 114
- carcinogens, 52, 70, 90, 91, 114, 115, 117, 142, 166
- carcinoma, 81, 93, 115, 116, 145, 150, 178, 206, 241, 255, 372, 373
- cardiovascular disease, x, 5, 33, 50, 57, 64, 77, 80, 81, 127, 133, 134, 149, 164, 183, 201, 204, 224, 256, 271, 293, 330, 332, 333, 336, 339, 340, 341, 353, 358, 359
- cardiovascular function, 129
- cardiovascular risk, 235, 344, 350, 351
- cardiovascular system, 224, 332, 336, 337
- caregivers, 272
- Carica papaya, 247
- carotene, 16, 24, 25, 29, 37, 43, 79, 118, 143, 146, 154, 164, 165, 166, 170, 176, 178, 181, 182, 197, 204, 243, 257, 274, 275, 285, 359, 362, 364
- carotenoids, 6, 13, 16, 91, 181, 230, 278, 327, 336, 362
- Carpathian, 327
- carrier, xii, 213, 221
- cartilage, 229, 239, 379, 380
- caspase, 115, 116, 119, 120, 169, 370, 374
- CAT, 14, 15, 22, 24, 25
- catabolic, 155, 303
- catabolism, 48, 65, 69, 71, 76, 78, 82, 129, 216, 244

- catalase, 6, 13, 169, 181, 285, 290, 296, 306, 311, 334, 340, 368
- catalyst, 158
- cataract, 230, 233
- cataract extraction, 230
- cataracts, 201, 217, 223, 224
- catecholamine, 62, 222, 291
- category a, 267
- cDNA, 68, 79, 82, 121, 382
- cell culture, 48, 74, 249
- cell cycle, 119, 169, 250, 370, 374
- cell death, 48, 80, 91, 99, 115, 122, 167, 169, 173, 177, 181, 251, 258, 283, 284, 292, 374
- cell division, 255, 368
- cell growth, xvi, 367, 368, 369, 370, 373, 374
- cell killing, 175
- cell line, x, 75, 78, 88, 93, 111, 112, 113, 115, 116, 117, 121, 122, 167, 175, 182, 220, 228, 230, 232, 249, 253, 258, 291, 370, 372, 373
- cell membranes, 12, 66
- cell metabolism, x, 153
- cell signaling, 6, 115, 124
- cellular homeostasis, 214
- cellular immunity, 224
- cellulose, 193, 194, 198
- central nervous system (CNS), 300, 304, 306
- cereals, 266, 386
- cerebral cortex, 138, 311
- cerebrospinal fluid, 221
- cerebrovascular accident, 224
- cerebrovascular disease, 134, 251
- ceruloplasmin, 16, 249
- cervical cancer, 170
- cervical carcinoma, 255
- cervix, 227
- channels, 307, 308, 312, 333
- chelators, 292
- chemical agents, 314
- chemical reactions, 8, 50, 171
- chemicals, 72, 93, 121, 186
- chemiluminescence, 12, 73, 177, 294
- chemoattractant, 225
- chemoprevention, 118, 177, 243
- chemopreventive agents, 92, 120
- chemosensitization, 173
- chemotaxis, 149
- chemotherapeutic agent, xi, 138, 185, 191, 255
- chemotherapeutic drugs, 368
- chemotherapy, xii, 136, 138, 151, 175, 191, 238, 251, 255, 373
- children, xiii, 49, 191, 244, 261, 262, 263, 264, 265, 266, 267, 268, 269, 271, 272, 276, 277, 278, 307, 312, 334, 350
- chimneys, 315
- Chi-square, 362
- chitosan, xi, 186, 187, 196, 201, 206, 209, 210
- Chitosan, 196, 203
- chloride, 42, 93, 96, 97, 221, 229, 305, 338, 339, 340, 341
- chloroform, 97
- chlorophyll, xv, 314, 317, 320, 321, 322, 323, 324, 325
- CHO cells, 74, 156
- cholestasis, 226, 233
- cholesterol, 12, 57, 129, 135, 146, 148, 173, 180, 196, 224, 241, 248, 256, 350
- chondrocytes, 220, 222
- chondrosarcoma, 371
- chorionic villi, 222
- choroid, 221
- chromatin, 91, 92
- chromatography, 12, 264
- chromium, 162, 168, 169, 174, 178, 180, 182
- chromosome, 13, 68, 74, 82, 161, 174, 180, 219, 312
- chronic cough, 356
- chronic disease, 118, 123, 130, 141, 191, 254, 262, 302, 364
- chronic myelogenous, 182
- chronic obstructive pulmonary disease (COPD), xvi, 70, 81, 355, 356, 357, 360, 361, 362, 363, 364, 365
- cigarette smoke, 6, 114, 123, 151, 228, 233, 272, 273, 275, 356
- cigarette smokers, 151, 228, 233, 272, 273, 275, 356
- cigarette smoking, xvi, 214, 274, 277, 278, 355, 358, 363
- circulation, 2, 3, 8, 11, 200, 274, 287, 288, 350
- cirrhosis, 248
- cisplatin, 138, 150, 178, 181, 206
- citrus, xii, 2, 128, 149, 190, 237, 238, 359
- claudication, 26
- climate change, 314
- clinical diagnosis, 149
- clinical symptoms, 164, 286
- clinical trials, xvi, 68, 170, 278, 288, 296, 355, 362, 363
- clinically significant, 131
- clone, 82, 382
- cloning, 180, 234
- CMV, 47

- CO<sub>2</sub>, 71, 93, 94, 95, 96, 98, 99, 303, 315, 316  
cobalamin, 188, 251  
Cochrane, 144, 151, 173, 174, 214, 229, 288, 296  
coding, 69, 235  
codon, 55, 70, 75  
coefficient of variation, ix, 46, 49, 51  
coenzyme, 16, 37, 180  
cofactors, 130, 157  
cohort, 121, 133, 176, 230, 242, 243, 286, 356, 363, 364  
coke, 70, 76, 84  
colds, 138  
colitis, 136  
collagen, vii, xi, xii, xvi, 3, 47, 62, 72, 128, 130, 136, 137, 149, 169, 185, 186, 190, 201, 214, 218, 222, 223, 224, 237, 239, 253, 254, 282, 283, 287, 290, 291, 304, 367, 368, 369, 370, 372, 374, 379  
colon, 116, 119, 124, 170, 220, 227, 242, 253  
colon cancer, 119, 124  
colorectal cancer, 191, 201  
combined effect, 91  
common symptoms, 356  
communities, 274  
community, xvi, 134, 148, 263, 341, 355, 358  
complementary DNA, 231  
complex interactions, 287  
complications, xv, 35, 37, 135, 149, 150, 288, 289, 296, 309, 343  
components, vii, xii, 1, 6, 7, 13, 14, 15, 25, 83, 90, 114, 132, 134, 154, 170, 179, 192, 214, 238, 241, 287, 368, 369  
condensation, 91, 92  
conductance, 221, 229, 339  
confounding variables, xi, 153, 164, 171  
congestive heart failure (CHF), 133, 147, 243, 344, 350  
conjugated dienes, 12  
conjugation, 70, 215  
connective tissue, 186, 190, 374  
consumers, xvii, 128, 385, 386  
contaminants, xv, 329  
contractions, 8, 35, 42  
control group, 161, 288, 289, 347, 360, 361  
controlled studies, 138  
controlled trials, 288  
conversion, xii, 3, 10, 36, 131, 222, 228, 229, 237, 241, 284, 285, 302, 373  
convulsion, 306, 311  
cooking, 128, 245, 264  
copper, 4, 11, 13, 15, 124, 157, 166, 167, 175, 182, 222, 229, 245, 249, 285, 304  
coronary angioplasty, 348, 349  
coronary artery disease, 135, 148, 180, 344, 345, 350, 352  
coronary heart disease, 133, 148, 164, 176, 179, 206, 207, 230, 243, 256, 273, 275, 332, 333  
corpus luteum, 282, 283, 291  
correlation, 59, 114, 115, 136, 139, 140, 161, 254, 273, 290, 320, 323, 337, 373, 382  
correlation analysis, 140  
correlation coefficient, 59  
correlations, 161, 318, 337  
cortex, 222, 233, 332  
corticosteroids, 241  
cortisol, 14, 22  
cotinine, xiii, 262, 264, 265, 270, 277, 278  
counterbalance, 333  
covalent, 210, 308  
covering, 197  
COX-2, 119  
cranberry, 246  
C-reactive protein, 14, 29, 241, 255  
creatine kinase, 14  
creatinine, xiii, 54, 56, 58, 65, 70, 83, 262, 264, 265, 266, 277  
CREB, 36  
critically ill, xv, 139, 234, 343, 348, 349  
cross-linking, 13, 196, 201, 239  
cross-sectional study, 132, 337, 357  
CRP, 14, 241, 326  
cryopreservation, 287, 294  
cryopreserved, 121  
crystal structure, 36, 82  
crystalline, 223, 251  
crystalluria, 131, 145  
crystals, 53, 54, 193, 239  
CSF, 139, 300, 303, 304  
culture, 48, 74, 94, 95, 96, 98, 99, 142, 150, 174, 249, 282, 292  
curcumin, 311  
CVD, 139, 140  
cyanide, 67  
cyanocobalamin, 251  
cycles, 293  
cyclic AMP, 234, 335  
cycling, 40, 74, 292  
cyclists, 40  
cyclodextrin, 194, 199  
cyclooxygenase, 147, 337, 341

cyclooxygenase-2, 337, 341  
 cysteine, 10, 28, 36, 42, 131, 144, 331, 338, 368  
 cystic fibrosis, 221, 229  
 cytochrome, 9, 30, 48, 89, 90, 93, 94, 117, 118, 121, 123, 216, 230, 241  
 cytokines, 8, 14, 225, 228, 370, 371, 375  
 cytomegalovirus, 47  
 cytometry, 110  
 cytoplasm, 74, 216, 282, 290  
 cytoskeleton, 14, 304  
 cytosol, 15, 48, 67, 77, 225, 231  
 cytosolic, 3, 18, 215, 307  
 cytotoxic, 116, 122, 161, 166, 249, 368, 371  
 cytotoxicity, 99, 102, 107, 115, 118, 122, 156, 159, 162, 167, 174, 176, 182, 374

## D

dairy, xvii, 190, 266, 385  
 data analysis, 98, 99  
 data collection, 270  
 database, 265, 379  
 decay, 205, 228, 291  
 decomposition, 12, 191, 199, 243, 250  
 defects, viii, 3, 46, 284, 286, 289, 293, 296  
 deficiency, xii, xiv, 5, 52, 53, 75, 84, 136, 137, 138, 141, 149, 150, 169, 179, 190, 191, 204, 206, 222, 237, 238, 241, 248, 250, 251, 258, 281, 282, 289, 299, 303, 382, 383  
 deficit, 187, 233  
 definition, 4, 144, 253  
 degenerative disease, 77, 80, 144, 201  
 degradation, ix, 13, 46, 79, 133, 141, 187, 196, 199, 200, 202, 208, 210, 217, 232, 234, 251, 304, 344, 372, 374, 387, 388  
 degradation process, 210  
 degrading, 8, 369  
 dehydration, 196  
 dehydrogenase, 10, 14, 36, 69, 93, 96, 97, 98, 170, 232, 238, 248, 258, 336  
 delivery, 186, 187, 192, 194, 196, 197, 198, 201, 202, 203, 204, 208, 209, 210, 253, 287, 289  
 dementia, 139, 357  
 demyelination, 251  
 dendrimers, xi, 186, 197, 203, 210  
 density, 4, 12, 94, 95, 96, 99, 174, 266, 279, 344, 350, 351, 379  
 dental caries, 137  
 dentin, 137  
 deoxyribonucleic acid, 128  
 Department of Agriculture, 257, 265

Department of Health and Human Services, 252, 276, 340  
 depolarization, 36, 67, 307  
 deposition, 262, 316, 318, 320, 323, 327, 370  
 depressed, 147  
 depression, 136, 222, 238  
 derivatives, 144, 192, 207, 208, 220, 255, 257  
 dermatology, 202  
 dermis, 222  
 destruction, 11, 132, 181, 191, 248, 251, 300, 302  
 detection, 5, 12, 20, 35, 38, 39, 99, 122, 180, 255  
 detoxification, ix, xiv, 46, 52, 68, 70, 91, 114, 221, 241, 242, 285, 313  
 detoxifying, 285  
 developed countries, 191, 331  
 deviation, 76  
 dexamethasone, 222  
 diabetes, x, xiii, 7, 35, 39, 48, 53, 78, 79, 127, 134, 135, 136, 148, 149, 223, 224, 229, 235, 238, 281, 286, 309, 344, 346, 349, 350, 351, 352, 353  
 diabetes mellitus, x, 39, 127, 134, 148, 149, 223, 229, 235, 309, 344, 346, 349, 350, 351, 352  
 diabetic nephropathy, 233  
 diabetic neuropathy, 233  
 diabetic patients, 135, 149, 217, 345, 350, 351  
 diabetic retinopathy, 224  
 dialysis, 238  
 diaphragm, 34  
 diarrhea, xii, 132, 136, 237, 238, 243, 248  
 diarrhoea, 146  
 diesel, 124  
 dietary fiber, 271  
 dietary habits, 16, 79, 187, 275  
 dietary intake, xiii, 19, 20, 51, 52, 133, 202, 243, 244, 253, 261, 274, 275, 279, 362, 364, 365  
 dietary supplementation, 42, 356  
 diethyldithiocarbamate, 93  
 diets, x, 17, 53, 87, 113, 127, 128, 136, 165, 190, 191, 220, 225, 227, 275  
 differentiation, 68, 222, 236, 254, 370  
 diffusion, xi, 3, 65, 66, 193, 209, 213, 218, 241, 301  
 digestive tract, 130  
 dilation, 133, 346, 350  
 dimer, 54, 370  
 direct measure, 11, 18  
 disability, xvi, 355, 356, 363  
 disabled, xvi, 377  
 discharges, 300, 306  
 discomfort, 132  
 disease progression, 9

diseases, xii, xiii, 7, 48, 50, 63, 64, 76, 77, 80, 83, 128, 130, 133, 139, 144, 164, 214, 226, 227, 244, 255, 256, 261, 262, 271, 301, 302, 330, 332, 339, 348, 356

disorder, 123, 289, 336, 380

dispersion, xi, 185, 192, 193, 198

displacement, 204

disposition, 143, 254

dissociation, 305, 370

distilled water, 54

distress, 132, 229

distribution, xi, xii, 49, 50, 65, 66, 67, 68, 72, 78, 82, 95, 149, 151, 186, 187, 198, 201, 204, 213, 218, 220, 221, 231, 233, 241, 266, 315, 327, 338, 382

disulfide, 6, 36, 68, 69, 74, 80, 93, 120, 137

divergence, 74

diversity, 142

division, 255, 368

dizziness, 248

DNA breakage, 116, 124

DNA lesions, 84, 124, 161

DNA repair, 52, 123, 169, 308

DNA strand breaks, x, 87, 89, 106, 109, 115, 182, 297

docosahexaenoic acid, 37, 339

donor, vii, 1, 3, 241, 302

dopamine, 3, 47, 304

dosage, 22, 23, 26, 28, 32, 132, 179, 187, 257, 288, 289, 359, 363

dosing, 2

double bonds, 3, 290

down-regulation, 72, 83, 119, 223

drinking water, 53, 334, 340

drug carriers, 196

drug delivery, 187, 194, 196, 197, 201, 202, 203, 208, 209, 210

drug delivery systems, 194, 196, 203

drug release, 210

drug targets, 374

drug therapy, 307

drug-induced, 124

drugs, xiv, 17, 53, 118, 138, 167, 186, 191, 193, 194, 197, 201, 204, 208, 209, 299, 301, 306, 308, 311, 331, 368

drying, xi, 185, 192, 193, 194, 195, 196, 197, 198, 199, 201, 206, 209

duration, 8, 11, 19, 20, 21, 22, 23, 25, 26, 28, 29, 31, 32, 39, 138, 241, 274, 306, 334, 350, 358, 359

dyslipidemia, 344

dysregulation, 308

<b>E</b>
----------

*E. coli*, 71

eating, 171, 263, 271

eclampsia, 287, 292, 295, 296

ECM, xvi, 367, 368, 369, 370, 371

ecology, 327

ecosystems, xiv, 313, 314

edema, 137, 139

Education, 81, 272, 360

EEG, 310, 312

efflux transporter, 203

efflux transporters, 203

egumes, 266

eicosanoids, 305

eicosapentaenoic acid, 37

elastin, 369, 372, 375

elderly, 39, 78, 138, 143, 146, 151, 176, 191, 230, 234, 244, 341, 363, 364

electric field, 387

electrical conductivity, 387

electron, vii, 1, 3, 5, 8, 9, 10, 11, 19, 21, 35, 38, 72, 73, 74, 154, 155, 156, 157, 171, 201, 214, 239, 240, 241, 283, 284, 301, 302, 314

electron microscopy, 201

electron pairs, 239

electron paramagnetic resonance, 38

electron spin resonance, 11, 19, 21

electrons, 3, 5, 9, 10, 11, 154, 157, 239, 240, 283

electrophoresis, x, 87, 92, 94, 121, 122, 123, 219

elementary school, 271

ELISA, 98, 99

embryo, xiii, 281, 283, 287, 291, 292, 293, 294, 295

embryogenesis, 253

emission, xiv, 97, 98, 313, 315, 317, 318, 319, 320, 322

emission source, xiv, 313

emulsification, 193, 209

emulsifier, 193, 204

emulsions, 211

enantiomer, 239

encapsulated, xi, 185, 186, 187, 192, 193, 194, 195, 196, 197, 198, 199, 201, 202, 207, 208, 209, 210, 211, 386

encapsulation, xi, 185, 186, 187, 192, 193, 194, 195, 196, 197, 198, 199, 201, 202, 206, 209, 368, 370

encoding, 82, 171, 190, 219, 231, 382

endocrine, 283, 289

endometrial cancer, 368

endometriosis, 286, 294



- endometrium, 286, 294  
 endonuclease, 96  
 endoplasmic reticulum, 215  
 endothelial dysfunction, xv, 37, 77, 132, 133, 134, 135, 146, 147, 149, 243, 256, 257, 288, 329, 333, 336, 337, 339, 350, 351, 353  
 endothelial progenitor cells, 345  
 endothelin-1, 340  
 endothelium, xv, 37, 39, 129, 132, 133, 139, 146, 147, 179, 232, 235, 243, 256, 333, 335, 337, 339, 340, 343, 344, 345, 346, 347, 349, 350, 351, 352, 353  
 endotoxemia, 39  
 endotoxins, 137  
 endurance, 26, 30, 31, 37, 41, 42, 65, 78, 84, 145  
 energy, xii, 8, 9, 11, 49, 63, 76, 79, 83, 169, 191, 213, 218, 265, 266, 279, 283, 305, 308, 314, 357  
 England, 123, 173, 176, 177, 230, 254, 274, 309  
 environment, xi, 6, 7, 31, 68, 79, 80, 88, 142, 153, 157, 171, 172, 187, 249, 264, 277, 287, 314, 327, 330, 333  
 environmental conditions, 326  
 environmental factors, 265  
 Environmental Protection Agency (EPA), 263, 276  
 environmental tobacco smoke, vii, xiii, 261, 262, 272, 275, 276, 277, 278  
 enzymatic, vii, viii, xiv, 1, 6, 7, 8, 12, 13, 14, 15, 25, 43, 45, 69, 70, 71, 90, 91, 93, 98, 116, 122, 197, 199, 214, 218, 283, 284, 285, 299, 300, 302, 374  
 enzymatic activity, 70, 98  
 epidemiologic studies, x, 76, 80, 153, 171, 243  
 epidemiology, 50, 170, 175, 276, 277  
 epidermis, 222, 374  
 epilepsy, xiv, 299, 300, 302, 304, 305, 306, 308, 310, 311, 312  
 epileptic seizures, vii, 307, 308, 310  
 epinephrine, 128  
 epithelia, xii, 214, 226  
 epithelial cell, 65, 148, 221, 224, 228, 231, 232, 241, 370  
 epithelial cells, 65, 221, 224, 228, 231, 241, 370  
 epithelium, xiv, 2, 124, 149, 234, 281, 290  
 epoxy, 243, 250  
 EPR, 39  
 equilibrium, 56  
 ERK1, 18, 30  
 erosion, 199  
 erythrocyte, 48, 67, 75, 80, 254, 312  
 erythrocyte membranes, 254  
 erythrocytes, 11, 67, 72, 75, 181, 211, 251, 252, 258, 296, 307, 309, 310, 338, 340  
 esophageal cancer, 173  
 esophagus, 89, 242, 253  
 ESR, 11, 210  
 essential fatty acids, 16  
 esterases, 100  
 esters, 130, 188, 192  
 estrogen, 83, 209, 283, 368, 372, 374  
 ethane, 12, 162  
 ethanol, 49, 122, 195  
 ethers, 122  
 ethnic groups, 56, 71  
 ethyl acetate, 54  
 ethylcellulose, 208  
 etiology, 118, 144, 287, 304  
 etiopathogenesis, 34  
 eukaryotes, 169  
 Europe, 132, 316, 318, 325, 326  
 European Regional Development Fund, 227  
 evaporation, xi, 185, 192, 193, 194, 198, 199, 204, 208, 209  
 evolution, 63, 75, 76, 80, 84, 141, 164, 215  
 excitotoxic, 307  
 excitotoxicity, 34, 233  
 exclusion, 358, 363  
 excretion, ix, 2, 37, 46, 51, 57, 58, 59, 60, 61, 62, 65, 67, 68, 69, 70, 72, 77, 78, 79, 81, 114, 129, 130, 131, 144, 146, 161, 179, 180, 222, 258, 282, 303  
 exercise performance, 20, 25, 26, 30, 31  
 extracellular matrix, xvi, 169, 282, 283, 367, 368, 369, 370, 371  
 extraction, 204, 251  
 extraneous variable, 19  
 extrapolation, vii  
 extrusion, 307

<b>F</b>
----------

- fabrication, 204  
 factor VII, 347  
 factorial, 203, 243, 348  
 FAD, 10  
*Fagus sylvatica*, 327  
 failure, xvi, 24, 28, 133, 228, 239, 251, 264, 295, 340, 343, 348  
 familial hypercholesterolemia, 350  
 family, xii, 66, 70, 181, 213, 215, 218, 229, 235, 283, 304, 373  
 FAO, 172, 175  
 farming, 128, 141

- FAS, 48, 80, 125, 383  
fast food, 264  
fasting, 53, 135, 295, 264  
fasting glucose, 135  
fat, 3, 32, 129, 130, 187, 191, 242, 266, 271, 275, 348, 353  
fat soluble, 187  
fatigue, 5, 7, 18, 20, 26, 41, 136, 191, 248  
fats, xi, 185  
fax, 87, 313  
FDA, 175, 186, 203  
feces, 303  
females, 53, 54, 220, 244, 274, 277, 286  
femur, 75, 380  
fern, xvi, 367, 371, 375  
ferritin, 4, 157, 196, 241, 249  
fertility, 282, 289, 290, 297  
fertilization, xiii, 281, 283, 287, 290, 293  
fetal, xiii, 93, 100, 233, 253, 281, 286, 287, 292  
fetal tissue, 286  
fever, 170  
fiber, 136, 271, 379  
fiber content, 136  
fibrils, 239  
fibrinolysis, 148, 333, 353  
fibroblasts, 174, 181, 222, 369, 370, 371, 372, 373, 374, 375  
fibronectin, 369  
fibrosarcoma, 368  
fibrosis, 221, 229  
filtration, ix, 46, 47, 51, 65, 193, 303  
Finland, 98, 99, 179, 332, 336, 338  
fish, viii, xv, 2, 32, 190, 329, 331, 332, 333, 338, 339  
flavonoids, xii, 37, 114, 119, 123, 142, 179, 181, 228, 238, 240, 252, 258, 336  
flow, 54, 100, 110, 112, 133, 135, 149, 196, 238, 250, 295, 314, 333, 334, 340, 345, 346, 347, 350, 351, 352  
fluid, xv, 139, 174, 221, 229, 232, 240, 283, 286, 292, 294, 300, 303, 304, 343, 348  
fluorescence, 92, 95, 97, 100, 112, 210  
fluorescent light, 331  
flushing, 248  
focusing, xiv, 299  
folate, 79, 136, 197, 205, 251  
folic acid, 188, 197, 204, 205, 258, 271, 344, 351  
follicles, 282, 291  
follicle-stimulating hormone, 291  
follicular, 282, 283, 284, 286, 292, 294  
follicular fluid, 283, 286, 292, 294  
food additives, 188  
Food and Drug Administration, 157, 175, 196  
food industry, xii, 194, 196, 202, 237, 387  
food intake, 56, 171, 277, 360, 365  
food production, 202  
food products, xvii, 202, 385, 386  
foodstuffs, 76, 386  
forest ecosystem, xiv, 313, 314, 324, 328  
forest resources, 314  
forests, 316, 325, 327  
formaldehyde, 99  
fortification, 194, 196, 386, 388  
fossil fuels, 314  
Fourier transform infrared spectroscopy, 195  
fracture, 379, 380  
fragility, 137, 238  
fragmentation, 91, 283, 287, 292  
free radical scavenger, 3, 32, 142, 154, 301, 309, 312, 336  
free-radical, 147, 157, 165, 170, 177, 240, 340, 362  
fructose, 66  
fruit juices, 266  
fruits, viii, x, xii, 2, 19, 32, 56, 75, 91, 113, 115, 127, 128, 130, 134, 139, 141, 144, 166, 171, 172, 177, 190, 237, 238, 242, 245, 252, 253, 263, 266, 271, 303, 314, 336, 356, 358, 359, 361, 382  
fumarate, 72  
fungi, 215  
fungus, 327  
furan, 239, 252, 258
- G**
- GABA, 300, 307  
GABAergic, 305  
gallbladder disease, 143, 207  
gallstones, 129  
gamete, 282, 286  
Gamma, 228  
gas, 12, 177, 264, 326  
gas chromatograph, 12, 177  
gasoline, 333  
gastric, 118, 143, 206, 226, 229, 234, 242, 368, 372  
gastric mucosa, 206, 226  
gastritis, 226, 248  
gastrocnemius, 26  
gastrointestinal, 136, 162, 173, 222, 244, 248, 257, 331  
gastrointestinal tract, 331  
gauge, 346, 347

- GCS, 18
- gel, x, 87, 92, 121, 122, 123, 194, 202, 203
- gender, 244, 265, 278, 358, 360, 386
- gene expression, 6, 7, 51, 72, 75, 78, 84, 114, 123, 133, 147, 169, 178, 345, 352, 369, 373
- gene promoter, 18
- gene silencing, xvi, 367, 371
- gene therapy, 75, 201, 371
- generalization, 50
- generalizations, 270
- generation, xiv, 8, 10, 11, 15, 23, 33, 35, 37, 48, 73, 74, 84, 90, 159, 160, 164, 167, 177, 179, 214, 222, 226, 286, 299, 300, 301, 307, 332, 338, 351, 368, 382
- genes, 13, 36, 48, 50, 52, 70, 74, 75, 82, 83, 165, 171, 172, 181, 219, 235, 250, 312, 368, 371
- genetic defect, 75, 238
- genetic disease, 144
- genetic instability, 162
- genetic mutations, 379
- genetics, 50
- Geneva, 325
- genistein, 253
- genome, 50, 52, 77, 79, 82, 175, 379
- genomic, 32, 68, 79, 169, 176, 219
- genomic instability, 169
- genotoxic, 91, 92, 101, 102, 113, 114, 118, 122, 131, 255
- genotoxins, 88, 243
- genotypes, 58, 60, 69, 72
- Germany, 153, 343
- gerontology, 382
- gestation, 287, 288, 289
- gestational age, 289, 295
- gingival, 137, 149, 222
- gingivitis, 149, 262
- ginkgo biloba, 336, 341
- ginseng, 178
- gland, 138
- glaucoma, 224
- glial cells, 122, 221
- glucose, ix, 2, 3, 46, 47, 48, 51, 53, 65, 66, 67, 73, 75, 82, 93, 96, 97, 127, 134, 135, 136, 139, 149, 170, 188, 197, 214, 223, 228, 231, 238, 239, 248, 251, 252, 258, 332, 347, 380
- glucose metabolism, 149
- glucose tolerance, 347
- GLUT, xii, 3, 47, 65, 66, 67, 134, 213, 218, 223, 252, 369
- GLUT4, 63, 66, 67, 75, 218, 353
- glutamate, 231, 300, 307
- glutamic acid, xiv, 299, 300, 307
- glutamine, xiv, 93, 299, 300, 307
- glutathione peroxidase, 6, 13, 15, 65, 165, 250, 285, 290, 296, 310, 312
- glycation, 344, 351
- glycine, 47, 98
- glycoproteins, 369
- glycosaminoglycans, 150, 369
- glycosylation, 219, 223
- goals, 148, 187, 386
- gonads, 282
- gout, 248
- government, 333, 355, 362, 386
- GPO, 355
- GPx, 14, 15, 22, 24, 25, 26, 30
- granules, 194, 197, 199, 210
- granulosa cells, 283, 284, 291
- grapefruit, 2
- grapes, 266
- Greece, 281
- Greenland, 333
- growth factors, 49, 223, 233, 292, 367, 369, 372, 373, 374
- growth inhibition, 182, 368, 370, 371
- GST, 52, 70
- GSTP, 47, 51, 66, 70
- guidelines, 27, 129, 363
- Guinea, 81, 233
- gums, 238

<b>H</b>
----------

- half-life, 3, 68, 72, 128, 301
- halogenated, 338
- halogens, 317
- handling, 128, 214, 222
- haptoglobin, 51
- harm, 165, 348
- harmful effects, 14, 336
- harvest, 172
- hazards, 181, 334, 340
- headache, 243
- Health and Human Services, 252, 276, 340
- health care, 203, 386
- health effects, 32, 142, 143, 207, 244, 256, 262, 263, 276
- health status, 224, 314, 320
- healthcare, 141
- heart attack, 224

- heart disease, 78, 130, 132, 133, 146, 148, 164, 176, 179, 206, 207, 230, 234, 235, 238, 243, 245, 256, 273, 275, 276, 332, 339
- heart failure, 7, 133, 137, 147, 148, 181, 243, 257, 344, 346, 350, 352
- heartburn, 243
- heat, xi, xii, 10, 36, 93, 128, 185, 237, 238, 245, 252, 301, 302, 332, 370, 374, 387
- heat shock protein, 370, 374
- heating, 252, 386, 387, 388
- heavy metals, xiv, xv, 301, 313, 315, 325, 327, 329, 330, 334, 339
- height, 52, 315, 357, 358
- Helicobacter pylori*, 229
- helix, 239, 282
- hematoma, 122
- heme, 210, 304
- hemodialysis, 136
- hemoglobin, 53
- hemorrhages, 136, 137, 170, 191, 238, 304
- hepatitis C, 145
- hepatocellular, 93, 145, 226
- hepatocellular carcinoma, 93, 145
- hepatocytes, 51, 66, 90, 121, 220, 221, 232
- hepatoma, 113, 120, 122, 199
- heterogeneity, viii, 46, 50, 65, 235
- heterogeneous, 332
- heterozygote, 59, 65
- heterozygotes, ix, 46, 57, 58, 59, 60, 65, 69, 70, 77
- hexane, 54
- Higgs, 142
- high pressure, 386, 387
- high risk, 289, 296
- high school, 358, 360
- high-fat, 348, 353
- high-level, 165
- high-performance liquid chromatography, 325
- high-risk populations, 288, 344
- hippocampal, 306, 310
- hippocampus, 306, 311
- histamine, 224
- histochemical, 35
- Hoechst, 92
- homeostasis, xii, 47, 51, 67, 214, 218, 221, 223, 226, 227, 305, 308
- homocysteine, 251, 258, 293, 331
- homogeneity, 71
- homogenized, 194
- homology, 379
- homozygote, 59, 65
- Hong Kong, 276, 277
- hormone, 239, 242, 282, 291, 353
- hormones, 186, 197, 222, 241
- hospital, 349, 358, 364
- hospitalized, 49, 76, 138, 229
- hospitals, 357, 358
- host, 137, 235
- household, 278
- households, 271, 314
- housing, 340
- HPLC, 12, 13, 83, 115
- HSP, 370
- HSP27, 374
- human brain, 122, 150, 205
- human erythrocyte membrane, 254
- human genome, 50
- Human Genome Project, 50
- Human Kinetics, 35, 36, 38
- human leukemia cells, 93, 120
- human lung fibroblasts, 174
- human neutrophils, 66, 82, 180
- human subjects, 12, 26, 50, 65, 68, 72, 83, 84, 131, 296
- hydatidiform mole, 286, 292, 293
- hydrate, 93
- hydrazine, 264
- hydro, 12, 66, 124, 161, 180, 186, 196, 209, 282, 314
- hydrocarbon, 120
- hydrocarbons, 12, 314
- hydrogen atoms, 5, 154, 157
- hydrogen peroxide, 4, 9, 10, 13, 14, 15, 34, 35, 66, 72, 74, 75, 80, 90, 93, 124, 157, 159, 161, 164, 167, 173, 174, 175, 205, 215, 216, 249, 283, 284, 285, 287, 301, 303, 304, 309, 315, 331, 335, 368
- hydrolysis, 63, 71, 73, 77, 91, 196, 197, 199, 215
- hydrolyzed, viii, 45, 68, 100, 130, 216
- hydroperoxides, 12, 157, 243, 249, 315, 368
- hydrophilic, 66, 186, 196, 209
- hydrophobic, 66, 70, 186, 197
- hydrophobicity, 66
- hydrostatic pressure, 136, 387
- hydroxyl, 4, 9, 11, 13, 16, 24, 72, 74, 115, 154, 157, 159, 167, 239, 240, 249, 284, 301, 302, 303, 304, 309, 311, 335
- hydroxylation, 89, 97, 121, 137, 239, 254, 304
- hydroxyproline, 222, 239
- hyperbaric oxygen therapy, 233
- hypercholesterolemia, 57, 146, 151, 345
- hyperemia, 135, 148, 346, 347

- hyperglycaemia, 223  
 hyperglycemia, 35, 37, 136, 346, 353  
 hyperhomocysteinemia, 344, 350  
 hyperinsulinemia, 135  
 hyperlipidemia, 139, 140  
 hyperoxaluria, 131, 145  
 hypertension, vi, 132, 140, 147, 295, 296, 329, 334, 335, 347  
 hypertensive, 37, 76, 147, 233, 257, 289, 347, 353  
 hypertriglyceridemia, 37  
 hypochondriasis, 222  
 hypoglycemia, 132  
 hypoperfusion, 288  
 hypothesis, 50, 75, 226, 363, 365  
 hypoxia, 125, 169, 177, 182, 287  
 hypoxia-inducible factor, 170  
 hypoxic, 178  
 hysteria, 222, 238
- I
- I3C, 93, 103, 104, 114  
 IARC, 89, 117  
 ICU, 349  
 idiopathic, 294  
 IGF, 223  
 IGF-I, 223  
 IL-1, 225  
 IL-6, 14, 22, 23, 39  
 IL-8, 225, 231  
 image analysis, 95  
 images, 380  
 imaging, 14, 73  
 imbalances, 362  
 immobilization, xi, 185, 186, 195, 198  
 immune function, 143  
 immune response, 6, 11, 22, 136, 137, 202, 232, 242, 370  
 immune system, 129, 137, 141, 190, 241, 368  
 immunity, vii, xi, 185  
 immunocompetence, 128  
 immunohistochemical, 292  
 immunohistochemistry, 221  
 immunological, xvii, 385  
 immunomodulatory, 197  
 immunostimulatory, 369  
 immunosuppression, 201  
 impaired glucose tolerance, 347  
 impairments, 7, 23  
 implementation, 18  
 in situ, 167, 312  
 in vitro fertilization, 283, 293  
 inactivation, 117, 133, 215  
 inactive, xi, 15, 167, 185, 186, 199, 302, 370  
 incidence, 13, 36, 50, 114, 129, 134, 138, 148, 166, 169, 243, 254, 287, 289, 332, 339, 364, 372  
 inclusion, 210  
 income, 276  
 incubation, 66, 73, 74, 94, 95, 96, 97, 98, 99, 100, 114, 223, 224, 225, 335  
 incubation time, 99, 100  
 India, 266, 308  
 Indian, 149, 246, 338  
 Indians, 246  
 indication, xv, 11, 17, 343  
 indicators, 314, 331, 364  
 indices, 14, 21, 22, 41, 65, 84, 296, 309, 385  
 indirect measure, 12  
 individual differences, 58, 67  
 indole-3-carbinol, 93, 120  
 induction, viii, x, 2, 4, 19, 51, 77, 88, 109, 114, 116, 121, 122, 167, 174, 206, 231, 250, 291, 305, 370, 371, 373, 374  
 industrial, 263, 314, 330, 386, 388  
 industrial application, 386  
 industrialized countries, 333  
 industry, xii, 194, 196, 202, 237, 263, 276, 387  
 inefficiency, 187  
 infants, 191, 277, 289  
 infections, xii, 137, 151, 214, 224, 237, 238, 241  
 infectious disease, 191  
 inferences, 263, 266  
 infertility, xiii, 132, 281, 286, 289, 290, 293, 294, 297  
 inflammation, xii, 7, 14, 23, 29, 34, 39, 78, 139, 214, 225, 237, 241, 287, 288, 345, 350, 368  
 inflammatory, 7, 8, 16, 19, 22, 31, 37, 119, 149, 201, 224, 225, 226, 302, 332, 336, 345, 352, 371  
 inflammatory disease, 226  
 inflammatory mediators, 302  
 inflammatory response, 8, 19, 22, 225, 226, 332, 336  
 influence, 273, 274, 278  
 infrared spectroscopy, 195  
 infusions, 340  
 ingest, 76, 78, 262, 267  
 ingestion, 2, 20, 21, 23, 24, 28, 29, 39, 83, 115, 117, 131, 145, 166, 178, 205  
 inhibition, x, 80, 87, 91, 92, 96, 111, 113, 114, 115, 116, 120, 137, 145, 182, 225, 231, 241, 252, 254, 300, 302, 306, 307, 309, 330, 333, 334, 351, 368, 370, 371, 372

inhibitor, 30, 37, 97, 114, 116, 119, 132, 136, 232, 253, 303, 334, 337, 347, 368, 369

inhibitory, xvi, 110, 111, 115, 170, 223, 334, 367, 370

inhibitory effect, xvi, 110, 111, 115, 170, 223, 334, 367

initiation, 4, 8, 29, 31, 53, 166, 169, 287

injection, 68, 199, 305

injury, 5, 7, 8, 11, 14, 16, 18, 19, 20, 21, 23, 24, 25, 26, 27, 28, 29, 31, 34, 35, 41, 42, 77, 82, 90, 144, 166, 174, 177, 231, 233, 283, 300, 302, 303, 304, 305, 309, 313, 314, 320, 326, 333

inorganic, xiv, 195, 197, 198, 207, 313, 315, 330, 331, 339, 340

iNOS, 17, 18, 119, 302

insecticides, 84

insertion, 74

insight, 116

instability, xi, 10, 52, 162, 185, 186, 187, 192, 197, 202

instruments, 359

insulin, 6, 17, 34, 66, 135, 136, 139, 149, 152, 223, 229, 346, 347, 350, 352, 353

insulin resistance, 135, 149, 350

insulin sensitivity, 17, 152, 347

insulin-like growth factor, 223

integrin, 294

integrity, 99, 169, 291, 297, 333, 368, 375

interaction, x, 5, 13, 15, 22, 29, 31, 35, 88, 153, 157, 159, 162, 164, 166, 211, 308, 338, 345, 352

interferon, 150, 224, 225, 230

interleukin-6, 14

International Agency for Research on Cancer, 252

internet, 175

interstitial, 174, 369

intervention, 17, 38, 83, 123, 170, 171, 242, 289, 348

intestinal tract, 128

intestine, xii, 65, 66, 200, 213, 220, 241

intima, 348, 349

intoxication, 76, 331, 336, 337

intracellular signaling, xiv, 48, 284, 292, 299, 308

intraocular, 204, 224

intraocular pressure, 224

intrauterine growth retardation, xiii, 281, 296

intravenous, xi, 26, 68, 76, 84, 131, 145, 146, 153, 172, 199, 242, 251, 256, 345, 347, 349

intravenously, 68, 225, 349

intrinsic, 116, 169, 330, 350, 370

inversion, 315, 316

ionic, 211

ionizing radiation, 301

ions, x, xi, 5, 74, 153, 156, 157, 159, 162, 166, 171, 177, 183, 185, 236, 239, 243, 300, 301, 304, 331, 339

irradiation, 145

ischaemia, 42

ischaemic heart disease, 339

ischemia, 9, 27, 73, 78, 218, 250, 258, 302

ischemic, 10, 132, 133, 146, 176, 179, 238, 243, 256, 275, 310, 339

ischemic heart disease, 132, 133, 146, 176, 179, 238, 243, 256, 275, 339

ischemic stroke, 275

isoforms, xii, 67, 93, 148, 213, 218, 219, 220, 221, 222, 231, 235, 285, 370

isothermal, 387

isotope, 68, 72, 84

IUGR, xiii, 281, 286, 287, 288, 289

## J

JAG, 273

JAMA, 43, 81, 173, 178, 256, 278, 341, 353

Japan, viii, xvi, 45, 49, 50, 54, 63, 75, 79, 81, 83, 135, 138, 175, 277, 355, 356, 357, 358, 359, 362, 364, 365, 366, 377, 381

Japanese, vi, ix, xvi, 46, 49, 50, 52, 53, 56, 57, 63, 64, 71, 78, 79, 81, 83, 134, 148, 204, 246, 273, 355, 357, 358, 360, 362, 363, 364, 365, 381

Japanese women, 52, 204, 357

joint pain, 238

joints, 225

Jordan, 228

Jun, 237, 373

Jung, 120, 124, 127, 143, 231

## K

K<sup>+</sup>, 218, 306, 333, 340

kainic acid, 306, 311

kappa, 33

kappa B, 33

keratinocytes, 222, 225, 231, 371, 372, 373, 375

kidney, xii, 66, 75, 82, 83, 89, 118, 131, 145, 200, 205, 215, 220, 222, 229, 231, 233, 238, 248, 252, 330, 331, 332, 337, 338, 340, 341

kidney stones, xii, 131, 145, 222, 238, 248, 252

kinase, 6, 14, 18, 30, 34, 219, 370

kinase activity, 6, 34, 370

kinetic studies, 68

kinetics, 71, 120, 124, 143, 198, 210, 235, 387, 388  
 King, 83, 143, 178, 232, 234  
 knockout, 47, 63, 72, 75, 78, 82, 84, 231, 232, 377,  
 378, 379, 380, 381, 382, 383  
 Kobe, 175  
 Korea, 207  
 Korean, 143

## L

L1, 353  
 LAA, 198  
 labor, xiii, 12, 281, 287, 288  
 laboratory studies, 386  
 lactate dehydrogenase, 14, 336  
 lactating, 191, 244  
 lactic acid, 196, 199  
 lamina, 282  
 laminin, 369  
 laryngeal cancer, 121  
 larynx, 170, 227, 242  
 latency, 306, 370  
 lawyers, 276  
 layering, 221  
 LDH, 14, 19, 25, 26, 28, 29, 98, 99, 107, 109, 115  
 LDL, 12, 15, 132, 139, 140, 166, 179, 224, 232, 243,  
 336, 344, 351, 352  
 lead, 262  
 lead pollution, 327, 328  
 leakage, 9, 10, 99, 283  
 learning, 330  
 legumes, 266  
 lens, 217, 221, 223, 224, 228, 230, 231, 235, 240  
 lesions, 94, 137, 149, 179, 369  
 lettuce, 359  
 lleukemia, 80, 93, 116, 120, 121, 123, 124, 138, 182,  
 183, 250, 255  
 leukemia cells, 80, 93, 120, 124, 183, 250  
 leukocyte, 149, 180, 229, 232, 288, 375  
 leukocytes, 13, 36, 90, 137, 149, 162, 166, 244, 272,  
 303, 339  
 Levant, 179  
 life course, 359, 360  
 life expectancy, 164  
 life span, 64, 377, 378, 383  
 lifespan, viii, 46, 50, 57, 78, 144, 165, 181  
 lifestyle, 18, 83, 134, 276, 277, 358  
 lifestyles, 91, 275, 364  
 ligand, 370  
 linoleic acid, 228  
 lipid metabolism, 139

lipid oxidation, 157, 166, 240  
 lipid peroxides, 159, 294, 304, 305, 315  
 lipids, xi, xii, xiv, xv, 4, 6, 7, 11, 20, 129, 132, 139,  
 149, 166, 180, 185, 230, 237, 240, 241, 243, 251,  
 284, 285, 301, 302, 304, 313, 314, 343, 344  
 lipophilic, 197, 315  
 lipopolysaccharide, 225  
 lipoprotein, 4, 12, 36, 37, 132, 135, 139, 174, 230,  
 275, 286, 303, 332, 344, 350, 351, 352  
 liposomes, xi, 186, 187, 196, 203, 210  
 liquid chromatography, 12, 54, 192, 205, 228, 264,  
 317, 325, 328  
 liquid nitrogen, 316  
 lithium, 220, 339  
 liver cells, 113  
 liver disease, 226  
 liver transplant, 250  
 L-lactide, 194, 208, 209  
 loading, ix, 46, 51, 53, 54, 57, 58, 59, 60, 61, 62, 63,  
 65, 69, 77, 78, 79, 171, 196, 199, 209, 248  
 locus, 312  
 London, 178, 180, 228  
 long period, xv, 314, 325, 381  
 longevity, 63, 144  
 longitudinal study, 332  
 losses, 116, 129  
 low molecular weight, 198  
 low risk, x, 87, 113  
 low-density, 132, 135, 230, 332, 336, 352  
 low-density lipoprotein, 132, 135, 230, 332, 336,  
 352  
 low-income, 276  
 low-intensity, 19  
 low-level, 334  
 lumen, 65, 66  
 luminal, 66, 347  
 lung, xvi, 52, 70, 81, 89, 92, 115, 120, 121, 123, 138,  
 166, 170, 174, 178, 182, 200, 215, 227, 229, 232,  
 242, 253, 304, 355, 357, 359, 360, 362, 364, 365,  
 369, 382  
 lung cancer, 70, 166, 174, 182, 242  
 lung disease, 365  
 lung function, xvi, 81, 355, 357, 359, 360, 362  
 lungs, xvi, 355, 362, 363  
 lutein, 290  
 luteinizing hormone, 291  
*Lycopersicon esculentum*, 247, 248  
 lymphocytes, 9, 70, 74, 76, 116, 119, 124, 136, 149,  
 156, 159, 161, 162, 178, 250, 294  
 lymphoid, 93, 121

lymphoid organs, 93  
 lymphoma, 138, 181  
 lysine, 282, 368  
 lysis, 211

## M

mackerel, 366  
 macromolecules, 11, 48, 166, 186, 187, 284, 308  
 macronutrients, 325  
 macrophages, 3, 9, 174, 249, 286, 294, 302, 364  
 macular degeneration, 224  
 Madison, 356, 365  
 magnesium, 96, 97, 191, 192, 211, 271  
 magnetic field, 12  
 magnetic resonance imaging, 14  
 magnetite, 208  
 malabsorption, 136  
 male infertility, 286, 290, 293, 297  
 malignancy, 177  
 malignant, xi, 124, 153, 167, 169, 173, 175, 257, 373, 374  
 malignant melanoma, 124, 173, 257, 374  
 malignant tumors, 167  
 malondialdehyde, 12, 250, 295, 300, 305  
 malondialdehyde (MDA), 305  
 maltodextrin, xi, 186, 187, 196, 197, 209  
 Mammalian, 6  
 mammalian cell, 68, 84, 118, 173, 215, 232  
 mammalian tissues, 154, 290  
 mammals, viii, 46, 48, 67, 74, 77, 79, 81, 141, 215, 232, 238  
 Mandarin, 361, 366  
 manganese, 15, 18, 285, 311  
 manganese superoxide dismutase, 18  
 mangoes, 238  
 manipulation, 115  
 mannitol, 66  
 manufacturer, 55, 98, 99  
 manufacturing, 194, 196, 209  
 MAPK, 6  
 MAPKs, 18  
 marketing, 263  
 marrow, 143, 145  
 masking, 23, 25  
 mass spectrometry, 12, 177  
 mast cell, 369, 371  
 maternal, 226, 233, 287, 288, 293, 295  
 matrix, xi, xii, xvi, 67, 137, 169, 185, 186, 194, 195, 197, 198, 238, 282, 283, 367, 368, 369, 370, 371, 372, 373, 374, 375

matrix metalloproteinase, xvi, 367, 369, 372, 373, 374, 375  
 maturation, xiii, 169, 219, 221, 281, 285  
 MCP-1, 225, 231  
 MCS, 172  
 MDA, 12, 21, 22, 23, 24, 25, 26, 28, 57, 140, 162, 300, 305  
 meals, xiii, 261, 269, 272  
 mean arterial blood pressure, xv, 329, 337  
 measurement, 11, 12, 14, 18, 20, 36, 83, 99, 136, 271, 291, 297  
 measures, 5, 8, 14, 31, 122, 271, 359, 360  
 meat, 57, 266, 361  
 media, 73, 75, 93, 223, 249, 348, 349  
 mediators, 165, 302  
 medication, 139, 297  
 medicine, 127, 176, 196, 202, 257, 292  
 medulla, 222, 233  
 melanin, vii, xi, 185  
 melanoma, 150, 235, 368, 370, 371  
 melatonin, 124, 233  
 melon, 359  
 melt, xi, 185, 192, 193, 198  
 membrane permeability, 339  
 membranes, xi, 129, 132, 169, 213, 240, 249, 287, 288, 296, 300, 303, 304, 307, 315  
 memory, 363  
 menadione, 182, 374  
 menstrual cycle, 282, 283, 286, 294  
 mercury, xv, 158, 329, 330, 331, 332, 333, 334, 335, 336, 338, 339, 340, 341  
 meta-analysis, 70, 81, 130, 173, 183, 228, 274  
 metabolic, viii, 7, 46, 48, 52, 63, 70, 72, 82, 84, 89, 114, 118, 128, 135, 140, 144, 169, 187, 188, 197, 215, 222, 244, 283, 290, 369  
 metabolic pathways, 82, 169, 197, 215, 283  
 metabolic rate, 63  
 metabolite, 76, 170, 204, 216  
 metabolites, ix, 46, 47, 90, 123, 130, 137, 150, 169, 189, 241, 252, 305, 308, 335, 368  
 metabolizing, 78, 119, 241  
 metal ions, x, xi, 5, 153, 156, 157, 159, 162, 166, 171, 183, 185, 239, 243, 301  
 metal salts, 74  
 metalloproteinases, xvi, 367, 368, 369, 372, 373, 374  
 metalloproteins, 166  
 metals, xi, xii, xv, 4, 11, 13, 16, 27, 29, 32, 74, 153, 157, 159, 166, 167, 171, 173, 177, 178, 179, 210, 237, 238, 249, 301, 304, 314, 315, 325, 327, 329, 330, 334, 338, 339



- metastases, 182  
metastasis, 138, 169, 369, 370, 371, 373  
metastatic, 371  
meteorological, 326  
metformin, 293  
methane, 93  
methanol, 95, 195  
methionine, 178, 251  
methodology, 279  
methyl group, 251  
methylmercury, 330, 331, 332, 333, 338, 339  
Mg<sup>2+</sup>, 71  
micelles, 205, 257  
microarray, 75  
microcirculation, xv, 295, 343, 348, 354  
microemulsions, 207  
microencapsulation, 193, 196, 198, 199, 207, 208, 209, 210, 386, 388  
microenvironment, 169, 178, 301  
micrograms, 346, 347  
micronucleus, 122  
micronutrients, xvi, 141, 144, 172, 175, 274, 367, 371  
micro-organisms, 190  
microparticles, vii, xi, 179, 185, 187, 193, 198, 201, 206, 208, 209, 210  
microscope, 95  
microscopy, 92, 95, 201  
microsomes, 92, 114, 117, 118, 162  
microspheres, 194, 196, 201, 203, 204, 206, 209, 210  
microvascular, 134, 232, 351  
middle-aged, 50, 243, 341, 348, 349  
migration, 11, 121, 149, 206, 332, 339  
milk, 57, 196, 209, 388  
milligrams, x, 127, 244, 250  
mineral water, 53  
mineralization, 137, 222  
mineralized, 137, 150  
minerals, 128, 142, 144, 171, 357  
Ministry of Education, 79  
Minnesota, 264, 274  
miscarriage, xiii, 281, 289  
misinterpretation, 170  
missions, xiv, 313, 319, 322  
Missouri, 32  
mitochondria, ix, 10, 15, 36, 46, 48, 65, 67, 72, 77, 82, 129, 283, 284, 307, 312, 338  
mitochondrial damage, 125  
mitochondrial DNA, 48, 67, 90, 118  
mitochondrial membrane, 10, 67, 230, 307, 339  
mitogen, 30  
mitogen-activated protein kinase, 30  
MMP, xvi, 367, 369, 370, 371, 372, 374, 375  
MMP-2, 369  
MMP-9, 369  
MMPs, xvi, 367, 369, 370, 371  
MnSOD, 18, 30  
modalities, 33  
models, 144, 169, 220, 300, 305, 308, 309, 312, 332, 345, 369  
modulation, xii, xiv, 6, 38, 48, 123, 175, 237, 241, 299  
moisture, xi, 185  
molar ratio, 162  
mole, 62, 63  
molecular mass, 290, 303  
molecular mechanisms, xii, 238, 312, 330, 333, 334  
molecular oxygen, 5, 9, 18, 158, 159, 178, 181, 344  
molecular structure, 239  
molecular weight, 188, 193, 196, 198, 199, 208, 210, 219, 239  
molecules, vii, xi, 1, 5, 9, 12, 15, 18, 20, 90, 129, 140, 152, 167, 185, 187, 195, 263, 284, 285, 292, 301, 331, 345, 369  
Møller, 118  
Mongolia, 53, 56  
monoamine, 283  
monocyte chemoattractant protein (MCP), 225, 231  
monocytes, 76, 80, 117, 125, 225, 235, 294, 302, 345, 352  
monolayer, 93  
monomers, 196, 199  
mononuclear cell, 40, 151  
monosaccharides, 214  
montmorillonite, 197, 210  
montmorillonite (MMT), 197, 198  
morbidity, 287  
morphological, 199, 203  
morphology, 137, 142, 196, 201  
mortality, xi, 121, 132, 134, 146, 148, 153, 164, 165, 166, 170, 171, 175, 176, 179, 206, 224, 234, 243, 271, 275, 278, 287, 289, 300, 332, 349, 363, 378  
mortality rate, 134, 300, 363, 378  
mortality risk, 164, 275  
mRNA, 30, 66, 79, 219, 220, 296, 368  
mtDNA, 79  
mucosa, 137, 221, 226  
multidisciplinary, 187  
multiple myeloma, 176  
multiple sclerosis (MS), 7, 34

murine model, 232, 382  
 muscarinic receptor, 147  
 muscle cells, 223, 334, 335, 344  
 muscle contraction, 8, 34  
 muscle force, 14, 28, 34  
 muscle injury, 5, 7, 8, 14, 18, 19, 20, 21, 24, 25, 27,  
 29, 35, 41, 42, 144  
 muscle performance, 20  
 muscle tissue, 225  
 muscles, 36, 41, 132, 302  
 mutagenesis, 132  
 mutagenic, 48, 65, 84, 113, 124, 145, 150, 161, 205,  
 243, 250  
 mutation, 13, 52, 70, 74, 78, 81, 167, 372, 379, 380  
 mutations, viii, 46, 75, 76, 78, 90, 91, 128, 167, 190,  
 215, 308, 379  
 myalgia, 136  
 myelin, 251, 304  
 myeloid, 80, 123, 124, 183, 250  
 myeloma, 176  
 myeloperoxidase, 26, 230  
 myocardial infarction, 134, 179, 181, 224, 332, 338,  
 339  
 myocardial ischemia, 351  
 myocytes, 231  
 myoglobin, 11, 14  
 myopia, 233  
 myosin, 7  
 myricetin, 252

<b>N</b>
----------

Na<sup>+</sup>, 218, 235, 306, 312, 333, 340  
 N-acety, 28, 42, 119, 131, 144, 228, 331  
 NaCl, 94  
 NAD, 9, 10, 36, 37, 73, 91, 119, 156, 308  
 NADH, 10, 36, 48, 72, 154, 166, 210, 216, 230  
 nanomedicine, 203  
 nanometer, 195  
 nanoparticles, 186, 187, 193, 194, 195, 197, 199,  
 201, 202, 203, 204, 208, 209, 210, 211  
 nanoscience, 203  
 nanotechnology, 203  
 National Academy of Sciences, 75, 205, 206, 207,  
 244  
 National Health Interview Survey, 274  
 National Institutes of Health (NIH), 134, 276  
 National Research Council, 166, 179, 191, 271, 278,  
 362, 365  
 natural, xiv, xvii, 120, 128, 181, 186, 243, 285, 313,  
 320, 336, 371, 385, 386

nausea, 136, 243, 248  
 necrosis, 120, 169, 174, 294, 383  
 necrotic cell death, 99  
 needles, xv, 314, 315, 316, 319, 320, 321, 322, 323,  
 324, 325, 326, 327  
 neonatal, 289  
 neonates, 206  
 neoplasia, 169, 368  
 neoplasms, 374  
 neoplastic, 92, 166, 169, 369  
 neoplastic cells, 169  
 nephroblastoma, 369  
 nephropathy, 223  
 nephrotoxicity, xv, 310, 329, 331  
 nerve, 223, 233, 251, 351  
 nerve cells, 251  
 nerve growth factor, 233  
 nervous system, 241, 332  
 network, 72, 169, 230  
 neurodegeneration, 300, 309, 310, 312  
 neurodegenerative, xiv, 7, 299, 302  
 neurodegenerative diseases, 302  
 neuromodulator, xiv, 299, 301  
 neuronal cells, 120  
 neuronal death, 310  
 neuronal loss, 306  
 neuronal survival, xiv, 299  
 neurons, xiv, 221, 233, 299, 303, 308, 312  
 neuropathy, 134, 251  
 neuroprotection, 311  
 neuroprotective, 300, 305, 309  
 neurotoxicity, 311, 332  
 neurotransmitter, xii, xiv, 3, 72, 128, 191, 237, 241,  
 299, 300, 307  
 neurotransmitters, 241  
 neutral lipids, 383  
 neutralization, 138, 285  
 neutrophil, 76, 202, 206, 232  
 neutrophils, 3, 8, 9, 11, 22, 66, 75, 82, 150, 180, 218  
 New England, 274  
 New York, 118, 120, 175, 176, 177, 181, 205, 210,  
 235, 256, 257, 259, 277, 309, 310, 327  
 New Zealand, 206, 247  
 NF-κB, 6, 18, 30  
 niacin, 188  
 Nicotiana tabacum, 326  
 nicotinamide, 10, 11, 93, 154, 352  
 nicotine, 121, 166, 272, 277  
 nicotinic acid, 79  
 Nielsen, 84, 151, 159, 175, 311

- nitrate, 14, 88, 179, 234, 240, 302  
Nitric oxide (NO), 10, 14, 17, 132, 133, 147, 284,  
286, 292, 301, 302, 305, 326, 327, 336, 344, 345,  
346  
nitric oxide synthase, xv, 3, 17, 30, 37, 231, 284,  
294, 302, 309, 329, 335, 337, 343, 351, 352  
nitric-oxide synthase, 309  
Nitrite, 21  
nitrogen, 3, 5, 9, 11, 34, 57, 91, 113, 154, 194, 240,  
284, 301, 302, 314, 316, 368  
nitrogen dioxide, 284, 302  
nitrogen oxides, 314, 316  
nitrosamines, 96, 98, 117, 118, 121, 122, 123, 129,  
240  
nitroso compounds, 117, 118, 122, 234, 242  
nitroxide, 143, 154, 240  
nitroxide radicals, 154, 240  
NK-cell, 161  
NMDA, 300, 307  
N-methyl-D-aspartate, 300, 307  
N-N, v, ix, 87, 88, 89, 90, 91, 92, 93, 94, 95, 99, 100,  
101, 102, 103, 110, 113, 114, 115, 116, 117, 118,  
120, 122  
NO synthase (NOS), 132, 147, 284, 302  
nodules, 137, 150  
non-enzymatic, viii, 6, 12, 14, 15, 24, 45, 68, 71, 90  
non-enzymatic antioxidants, 15, 24  
non-Hodgkin's lymphoma, 138  
nonsense mutation, 75  
non-small cell lung cancer, 182  
nonsmokers, 52, 63, 72, 138, 262, 263, 265, 272,  
273, 274, 275, 276, 277, 278, 347, 356  
nontoxic, 142, 154, 196, 248  
norepinephrine, 3, 128, 191  
Norfolk, 136, 148, 149, 179  
normal conditions, xiii, 218, 224, 281, 285  
normal distribution, 49  
normalization, 337  
North America, 327  
Norway, vi, xiv, 313, 315, 316, 319, 325, 326, 327  
Norway spruce, xiv, 313, 315, 316, 319, 325, 326,  
327  
NSAIDs, 228, 258  
nuclear, 13, 30, 33, 65, 83, 90, 137, 226, 230, 308  
nuclear receptors, 226, 230  
nuclei, 159, 177  
nucleic acid, xi, 6, 7, 20, 129, 185, 197, 240, 249,  
250, 284, 285, 301  
nucleotide sequence, 219  
nucleotides, 55, 302  
nucleus, 18, 370  
nurse, 204  
nutrition, vii, viii, xvii, 45, 47, 49, 52, 63, 64, 76, 78,  
83, 129, 151, 170, 179, 180, 181, 206, 207, 254,  
282, 309, 354, 385  
nutritional assessment, 277  
nutritional deficiencies, xvii, 141, 385, 386  
nutritional supplements, 35
- O**
- obese, 17  
obesity, 7, 80, 83, 136, 271, 278, 344, 350  
obstruction, 356, 365  
obstructive lung disease, 365  
occlusion, 346, 347  
O-D, 97  
ODS, 71, 150  
oedema, xv, 343, 348  
Ohmic, 387  
oil, 66, 193, 336, 339  
oleic acid, 37  
oligonucleotides, 203, 371  
omega-6, 12  
oncogenes, 250, 373  
oncology, 119, 150, 151, 176, 177, 255, 257  
onion, 91, 121, 359  
oocyte, xiii, 281, 282, 283, 284, 285, 290, 294  
optimal health, vii, xi, 31, 141, 144, 185, 186  
oral cavity, 227, 242  
orange juice, 142, 204, 359, 387, 388  
Oregon, 93, 100  
organ, xvi, 12, 13, 221, 226, 228, 343, 348  
organic, xi, xiv, 137, 159, 185, 192, 193, 194, 208,  
285, 313, 317, 330, 331  
organic peroxides, 285  
organic solvent, 192, 193  
organism, xvii, 49, 122, 165, 187, 224, 385  
orthopaedic, 225  
osmotic, 132, 146  
ossification, 228  
osteoblastic cells, 233, 236  
osteoblasts, 218, 223, 236, 241, 254  
osteopenia, 223  
osteopontin, 236  
outpatient, 357, 358  
ovarian cancer, 116  
ovaries, 282, 283, 286, 292  
ovary, 252, 293, 369  
overload, 4, 164  
over-the-counter, 349

overtraining, viii, 2, 25, 31  
 overweight, 17, 152, 271  
 ovulation, 282, 283, 285, 291  
 oxalate, 71, 131, 145, 146, 156, 204, 205, 216, 222, 230, 241, 252, 258  
 oxalic, xi, 53, 155, 170, 185, 189, 241, 252  
 oxalic acid, xi, 53, 170, 185, 189, 241, 252  
 oxidants, 3, 11, 73, 118, 157, 164, 170, 228, 285, 288, 303, 304, 357, 364  
 oxidation products, 12, 56, 154, 161, 180, 242  
 oxide nanoparticles, 208  
 oxygen, xiii, 14, 32, 33, 34, 55, 88, 147, 176, 178, 181, 257, 281, 283, 284, 285, 292, 294, 303, 308, 310  
 oxygen consumption, 27  
 oxytocin, 283, 291  
 ozone, xiv, 6, 38, 115, 124, 313, 314, 316, 323, 324, 326

## P

p38, 18, 30  
 p53, 208, 241, 255, 370, 372  
 Pacific, 53, 83, 366  
 paclitaxel, 150, 178, 204, 206, 208  
 PAHs, xiv, 313  
 PAI-1, 347  
 pain, 225, 238  
 PAN, 314  
 pancreas, 170  
 pancreatic, 66, 118, 138, 369  
 pantothenic acid, 188  
 papayas, 2, 238  
 paradox, 35, 80, 176  
 paradoxical, 171  
 paramagnetic, 38, 182  
 parenchyma, 221, 235  
 parental smoking, 276  
 parenteral, xv, 139, 166, 343, 348, 349, 351  
 Parkinson, 7, 34, 70, 139, 140  
 parotid, 142  
 PARP, 300, 308  
 PARP-1, 300, 308  
 particles, xi, 123, 186, 187, 194, 195, 197, 198, 199, 201, 202, 209  
 passive, ix, xii, 46, 67, 69, 70, 213, 218, 241, 255, 276, 277, 278  
 passive smokers, 241, 255, 278  
 pathogenesis, xii, 18, 137, 214, 224, 295, 309, 337, 349, 369  
 pathogenic, 137, 375

pathogens, 284  
 pathology, 80, 134, 175, 301, 371  
 pathophysiological, 351, 296  
 pathophysiology, xiii, 7, 281, 286, 287, 289, 295, 305  
 pathways, xiv, xv, 6, 11, 35, 82, 91, 115, 116, 119, 155, 169, 197, 215, 239, 283, 299, 308, 330, 334, 345, 352  
 Pb, 315, 325  
 PC12 cells, 120  
 pears, 266  
 penicillin, 93, 305, 306, 310, 311  
 pentane, 12, 18, 24  
 pentylenetetrazole, 310  
 peptide, 3, 13, 197, 240, 241, 370  
 perfusion, xiv, 133, 287, 299, 300  
 perinatal, 35, 287, 288, 289, 296  
 periodontal, 137, 149, 150, 210, 244  
 periodontal disease, 137, 150, 244  
 periodontium, 137  
 peripheral blood, 132, 166  
 peritoneal, 286, 294  
 peritonitis, 229  
 permeability, 137, 149, 196, 339  
 permeabilization, 99  
 permeation, 84, 234  
 peroxide, 15, 33, 34, 74, 162, 167, 181, 283, 284, 285, 288, 293, 304, 331, 357  
 Peroxisome, 37  
 peroxydinitrite, 9, 10, 17, 154, 156, 175, 182, 240, 250, 257, 288, 295, 302, 309, 344  
 personal communication, 71  
 Perth, 355  
 pesticide, 118, 145  
 PGA, 196, 275  
 phagocytic, 8, 9, 11, 19  
 pharmaceuticals, xi, 185, 186, 196  
 pharmacogenetics, 121  
 pharmacokinetics, 65, 143, 166, 178, 207, 232  
 pharmacological, 8, 15, 16, 17, 18, 30, 77, 91, 135, 167, 169, 170, 211, 227  
 pharmacotherapy, 330  
 pharynx, 170, 242  
 phenol, 100  
 phenolic, 37, 91, 114, 123, 304  
 phenolic acids, 37  
 phenotype, 371  
 phlegm, 359  
 phosphate, 11, 58, 67, 74, 93, 96, 97, 154, 170, 191, 192, 211, 223, 236, 238, 248, 258, 311, 352

- phosphodiesterase, 344, 351  
phospholipids, 12, 15, 249, 297, 300, 304, 383  
phosphorylates, 18  
phosphorylation, 10, 30, 84, 219, 304, 370  
photolysis, 11  
photoreceptors, 308  
photosynthetic, 315, 317, 319, 320, 323, 325  
physical activity, 36, 336, 359, 360  
physical exercise, 6, 7, 9, 18, 20, 40, 130  
physicochemical, 145, 194, 205  
physiology, vii, xii, 68, 214, 284, 292, 301, 327  
phytochemicals, 91, 119, 123, 166, 177, 253  
pigment epithelium, 234  
pigments, 317, 319, 320, 325  
pituitary, 128, 240, 241, 244, 282, 303  
placebo, 21, 28, 30, 76, 135, 151, 161, 241, 242,  
250, 255, 288, 289, 293, 296, 345, 346, 347, 348  
placenta, 220, 222, 226, 233, 287, 288, 292, 295  
placental, 226, 233, 234, 274, 286, 287, 288, 295  
planetary, 80  
plant sterols, 16  
plantar flexion, 28  
plants, xii, 91, 154, 188, 205, 214, 215, 237, 238,  
314, 319, 326, 327  
plaque, 137, 139, 140, 222  
plaques, 132, 238, 243  
plasma levels, 68, 132, 164, 240, 263, 347  
plasma membrane, xi, 9, 10, 11, 66, 69, 91, 136, 210,  
213, 214, 218, 225, 249, 290, 340  
plasma proteins, 331  
plasmid, 209  
plasminogen, 347, 375  
plastic, 300  
plasticizer, 194, 199  
platelet, 179, 288, 302, 332, 333, 339, 340, 351  
platelet aggregation, 302, 333, 339, 340  
platelets, 40, 76, 234, 333  
play, xv, 7, 8, 15, 16, 18, 136, 191, 221, 224, 253,  
286, 302, 304, 329, 336, 345, 348, 369  
PLC, 12, 13, 119  
plethysmography, 135, 346, 347  
plexus, 221  
PLGA, 194, 195, 196, 197, 199, 200, 201, 203, 204,  
209  
PMS, 278  
pneumonia, 138, 356, 364  
point mutation, 70  
poison, 33, 176  
poisoning, 330, 340  
polarity, 218  
pollutants, xi, xiv, 118, 129, 185, 301, 313, 314, 315,  
316, 320  
pollution, xiv, 313, 314, 315, 316, 319, 320, 322,  
323, 325, 326, 327, 328, 362, 364  
poly(ADP-ribose) polymerase, 309  
polyamine, 283  
polycyclic aromatic hydrocarbon, 124  
polycystic ovary syndrome, 293  
polyisobutylene, 193, 198, 208  
polymer, 193, 194, 196, 197, 198, 199, 205  
polymer matrix, 194, 197  
polymerase, 51, 55, 81, 179, 300, 308, 309  
polymerase chain reaction, 51, 55, 81  
polymers, 187, 197, 198, 204  
polymorphism, ix, 46, 49, 51, 53, 56, 60, 61, 66, 70,  
79, 81, 83  
polymorphisms, vii, viii, 45, 47, 49, 51, 52, 63, 64,  
70, 72, 76, 77, 78, 79, 81, 82, 83, 84  
polymorphonuclear, 137, 303, 339  
polypeptide, 282  
polyphenols, 16, 252, 371  
polysaccharides, 187, 197  
polyunsaturated fatty acids, 12, 284, 300  
polyvinyl alcohol, 195  
Portugal, 385  
positive correlation, 286  
positive relationship, 271  
postmenopausal women, 148, 348, 349, 353  
postmortem, 378  
postoperative, 150  
post-translational, 3  
potassium, 93, 96, 97, 220, 243, 271  
potatoes, 56, 128, 190, 361, 366  
poultry, 190  
powders, 194, 195, 209  
power, xiv, 15, 71, 188, 313, 315, 322, 325, 327  
power plant, xiv, 313, 315, 322, 325, 327  
precipitation, 194, 326  
prediction, 49, 79  
preeclampsia, xiii, 281, 292, 295, 296  
preference, 3, 9, 306  
pregnancy, xiii, 226, 233, 253, 277, 281, 285, 286,  
287, 288, 289, 290, 292, 293, 295, 296, 341  
pregnant, 191, 223, 244, 274, 288, 289, 292, 293,  
296  
prejudice, 358  
premature death, 164  
premenopausal, 275  
preparation, 272  
preschool, xiii, 261, 263, 271

preschool children, xiii, 261, 263, 271  
 preservative, xii, 237, 238  
 press, 29, 85  
 pressure, xv, 57, 76, 132, 136, 147, 193, 205, 224,  
 228, 229, 243, 256, 329, 333, 334, 337, 340, 346,  
 353, 386, 387  
 preterm delivery, 289  
 preventive, 33, 50, 64, 81, 138, 156, 239  
 primate, 63, 75, 215, 233, 290  
 primates, 2, 48, 76, 149, 190, 238  
 priming, 34  
 PRISM, 55  
 probability, 67, 91, 271  
 probe, 68, 73, 84, 96, 121  
 productivity, 314  
 progenitor cells, 345  
 progesterone, 283, 296, 374  
 program, 36, 148, 263  
 pro-inflammatory, 19, 225, 225, 336  
 pro-inflammatory response, 19, 336  
 prolactin, 372  
 proliferation, xvi, 68, 77, 91, 98, 115, 118, 168, 173,  
 241, 367, 369, 370, 371  
 promoter, 18, 75  
 promoter region, 18  
 pro-oxidant, ix, xi, xv, 4, 33, 46, 48, 50, 52, 65, 74,  
 80, 118, 131, 144, 153, 157, 159, 161, 162, 164,  
 165, 166, 167, 169, 170, 171, 174, 176, 178, 180,  
 181, 224, 233, 257, 329, 344, 345  
 prophylactic, xv, 33, 289, 343, 348  
 prophylaxis, 38, 39, 49, 79, 130, 204, 296  
 propofol, 229  
 proportionality, 76  
 propranolol, 203  
 prostaglandin, 12, 255, 288, 291, 295  
 prostaglandins, 241  
 prostate, 138, 170, 183, 227, 242, 369  
 proteases, 116, 304  
 protection, vii, xii, xiii, 1, 15, 17, 18, 19, 23, 29, 34,  
 65, 73, 77, 82, 92, 114, 161, 164, 166, 181, 192,  
 218, 225, 230, 233, 237, 240, 242, 245, 254, 261,  
 295  
 protective mechanisms, 181, 332  
 protective role, vii, viii, ix, xii, xiv, xv, 45, 48, 87,  
 91, 92, 115, 117, 123, 237, 241, 299, 306, 329,  
 336, 363  
 protein disulfide isomerase, 69  
 protein kinase C (PKC), 219  
 protein oxidation, 13, 22, 166, 295  
 protein structure, 13

protein synthesis, 368  
 proteinuria, 287  
 proteoglycans, 369  
 proteolysis, 304  
 prothrombin, 248  
 protocol, 14, 21, 24, 94, 99, 264, 349, 357, 358  
 protocols, 8, 19, 21, 22, 23, 24, 25, 32  
 PTZ, 300, 305, 308  
 public health, 330  
 Puerto Rico, 261, 263, 264, 265, 272  
 pulmonary rehabilitation, xvi, 355, 362, 363  
 pure water, 382  
 purification, 71  
 purines, x, 87, 113, 115, 301  
 purpura, 137  
 PVA, 195  
 PVP, 195  
 pyrene, 70, 91, 113, 115, 120  
 pyridoxine, 188

## Q

quality control, 318  
 quality of life, 143  
 Quebec, 93  
 quercetin, 252, 253  
 quinone, 91, 119

## R

race, 22, 25, 26, 42  
 radiation, 6, 121, 128, 161, 201, 204, 221, 301, 320,  
 327, 333, 372, 375  
 radical formation, 4, 5, 24, 90, 171, 249  
 radical reactions, 301  
 radioisotope, 258  
 radius, 301  
 random, 149, 215, 271, 288, 302  
 range, 3, 14, 55, 63, 66, 67, 76, 78, 102, 129, 145,  
 166, 191, 194, 199, 201, 240, 265, 301  
 RDA, viii, x, xii, xiii, 45, 47, 49, 51, 63, 64, 75, 76,  
 78, 91, 127, 129, 130, 138, 140, 141, 144, 164,  
 237, 244, 248, 262, 266  
 reactive nitrogen, 91, 154, 240, 301, 368  
 reactive oxygen species (ROS), viii, ix, x, xvi, 45,  
 48, 87, 88, 90, 129, 153, 154, 240, 281, 283, 284,  
 285, 292, 300, 301, 307, 308, 330, 368, 377  
 reactivity, 4, 11, 216, 284, 302, 339, 345, 346, 350,  
 386  
 reagent, 55, 69, 147  
 receptors, 7, 17, 35, 116, 225, 226, 228, 230, 370

recovery, vii, 1, 5, 7, 8, 19, 23, 27, 32, 38, 40, 42  
 rectum, 170, 227, 242  
 recycling, 3, 23, 69, 72, 73, 77, 78, 79, 80, 82, 141,  
 215, 216, 217, 223, 232, 233, 240, 288, 296, 304  
 red blood cells, 2, 53, 251, 252  
 redox-active, 167  
 reductases, 48, 154, 302, 307  
 regenerate, 129, 154, 156  
 regeneration, 8, 10, 115, 186, 231, 240, 305  
 regressions, 151  
 regular, viii, xiii, xvii, 2, 15, 17, 28, 30, 32, 43, 241,  
 261, 263, 385  
 regulation, viii, 2, 6, 19, 25, 29, 33, 35, 72, 83, 119,  
 177, 223, 226, 232, 241, 283, 291, 309, 314, 370,  
 371, 373, 374  
 regulators, 34, 330  
 rehydration, 196  
 relaxation, 33, 147, 333, 337, 344  
 remodeling, 218, 282, 309, 369, 370, 371  
 renal, 65, 66, 67, 72, 78, 136, 178, 218, 220, 222,  
 230, 241, 248, 303, 331, 332, 334, 336, 340, 341,  
 368, 370, 372  
 renal epithelial cells, 65  
 renal failure, 78  
 renal function, 303, 340  
 renal medulla, 332  
 renin, 77, 133  
 renin-angiotensin system, 77, 133  
 reoxygenation, 125  
 repair system, 165  
 reparation, 129, 209  
 reperfusion, 9, 27, 74, 250, 258, 302  
 repression, 37  
 reproduction, vii, xiii, 281, 282, 285, 292, 295  
 research design, 14, 26  
 residues, 71, 77, 282, 295, 308, 333, 368  
 resistance, xi, 28, 32, 35, 128, 133, 135, 146, 147,  
 149, 169, 180, 185, 191, 314, 334, 339, 346, 350,  
 353  
 resolution, 35, 346  
 resources, 314  
 respiration, 10, 67, 159, 241, 284, 309  
 respiratory, xvi, 8, 9, 11, 19, 27, 30, 65, 67, 151,  
 221, 229, 231, 241, 302, 304, 326, 355, 356, 357,  
 358, 359, 362, 363, 364  
 respiratory failure, 304  
 responsiveness, 34  
 restenosis, 348, 349, 353  
 Resveratrol, 120  
 retardation, 287

retention, 201, 202, 208, 337, 386, 387  
 reticulum, 7, 10, 34, 35, 36, 215  
 retina, 220, 234  
 retinal pigment epithelium, 234  
 retinol, 197  
 retinopathy, 134, 224, 234  
 rheumatoid arthritis, 7, 34, 225, 232  
 riboflavin, 188  
 ribose, 300, 308, 309, 312  
 risk factors, 130, 131, 145, 205, 235, 351, 364  
 risks, 191, 263, 289, 296  
 RNA, xi, xvi, 129, 185, 203, 367  
 RNAi, 374, 375  
 rofecoxib, 337  
 Romania, 326  
 room temperature, 54, 99, 201, 330  
 rosiglitazone, 293

## S

safety, 144, 173, 186, 198, 242, 386  
 saline, 306  
 saliva, 244, 278  
 Salmonella, 118  
 salts, x, 130, 153, 171, 243, 305, 330  
 SAS, 265, 277  
 satellite, 263, 272  
 saturated fat, 275  
 saturation, 75, 78, 166  
 scanning electron microscopy (SEM), 197, 201  
 scavenger, ix, 3, 87, 142, 154, 254, 294, 301, 305,  
 309, 311, 336, 337, 362, 382  
 schizophrenia, 136  
 schizophrenic patients, 309  
 Schmid, 34, 232  
 school, 271, 278, 279, 358, 360  
 scurvy, viii, xii, 3, 45, 63, 64, 80, 82, 128, 129, 132,  
 136, 144, 149, 191, 207, 216, 222, 231, 237, 238,  
 239, 244, 254, 368, 379, 381, 383  
 SDH, 98  
 sea level, 315  
 search, 115  
 second hand smoke, 276  
 secretion, 137, 226, 254, 282, 283, 291  
 seed, 284, 292, 336  
 seeding, 95, 96, 99  
 seizure, xiv, 299, 300, 305, 307, 309, 310, 312  
 seizures, vii, xiv, 299, 300, 304, 305, 307, 308, 309,  
 310, 311, 312  
 selenium, 25, 28, 91, 164, 224, 274, 278, 285, 310,  
 332, 338

- semen, xiv, 281, 286, 290, 296, 297
- senescence, 52, 73, 82, 215, 230, 231, 232, 377, 382, 383
- senile, 217, 232, 382
- sensing, 181, 230
- sensitivity, 7, 17, 20, 115, 135, 138, 152, 245, 347, 373
- separation, xi, 185, 192, 193, 198, 325
- sepsis, xvi, 171, 223, 225, 343, 345, 349
- septic shock, 302
- sequencing, 68, 77, 79
- Serbia, 185
- serine, 370
- serotonin, 149
- serum albumin, 53, 68, 71, 77, 82
- severity, xv, 306, 314, 325, 334
- shape, 196, 199
- shares, 134
- shock, xv, 36, 139, 302, 332, 343, 348, 370, 374
- shortage, 381
- short-term, viii, 32, 45, 49, 63, 76, 78, 132, 327, 350, 351
- sialic acid, 12
- side effects, 243, 248
- sign, 332, 344
- signal transduction, 344, 347, 370
- signaling, xiv, 6, 7, 18, 33, 34, 48, 115, 119, 124, 284, 285, 292, 299, 308, 374
- signaling pathways, xiv, 6, 115, 119, 299, 308
- sildenafil, 344, 351
- silica, 195
- silver, 339
- similarity, 219
- Singapore, 275
- SiO<sub>2</sub>, 195
- siRNA, xvi, 367, 371, 374
- sites, 3, 10, 13, 18, 89, 100, 105, 106, 113, 115, 162, 169, 219, 282, 304, 316, 317, 322, 327
- skeletal muscle, 7, 8, 10, 34, 35, 36, 38, 39, 41, 42, 223
- skin, 130, 136, 186, 195, 198, 201, 204, 222, 225, 231, 235, 238, 246, 247, 248, 326, 369, 371, 372, 374
- Slovenia, vi, xiv, 153, 313, 315, 316, 318, 322, 324, 325, 327, 328
- smoke, vii, xiii, 6, 52, 70, 114, 123, 174, 261, 262, 269, 270, 272, 275, 276, 277, 278, 360
- smoke exposure, 114, 269, 270, 272, 278
- smoking cessation, 151, 273, 277
- smooth muscle, 77, 132, 302, 334, 335, 336, 340, 344
- smooth muscle cells, 334, 335, 344
- SNP, 55, 56, 135
- SO<sub>2</sub>, xiv, 313, 315, 316, 318, 319, 320, 321, 322, 323, 325, 326, 327
- socioeconomic status, 265
- SOD, 14, 15, 22, 25, 30, 47, 51, 65, 74, 284, 285, 290, 300, 340
- soil, 327, 333
- soil pollution, 327
- soils, 315
- solidification, 94
- solubility, 188, 192, 193, 198, 209, 243, 245
- solvent, xi, 101, 185, 192, 193, 194, 198, 199, 203, 204, 209
- solvents, 93, 208
- sorbitol, 132, 146, 223
- Spain, 87, 93, 117, 121, 213, 227, 329
- specificity, 12, 20, 66, 67, 220, 371
- spectrophotometric, 12
- spectroscopy, 11, 12, 38, 97, 195, 210
- speed, 193, 378
- sperm, xiv, 92, 120, 175, 176, 240, 281, 286, 289, 292, 293, 297
- sperm function, 286, 293
- spermatozoa, xiv, 281, 283, 290, 293, 297
- spin, 11, 19, 21, 38, 159
- spinach, 2, 128, 142, 190, 245, 247, 358
- spindle, 316
- spirometry, 357
- spleen, 200
- spontaneous abortion, 293
- SPSS, 360
- SQL, 265
- St. Louis, 32, 254
- stability, 5, 32, 79, 169, 176, 186, 187, 188, 191, 192, 193, 195, 196, 198, 199, 201, 202, 207, 210, 368
- stabilization, 169, 196, 345
- stabilizers, 188, 195, 203
- stable angina, 345, 351
- stages, 109, 146, 220, 283, 345
- standard deviation, viii, 45, 47, 49, 64, 75, 100, 110
- starch, 194, 197, 199, 210
- statin, 17
- statins, 16, 17
- statistical analysis, 264, 265
- statistical inference, 263
- status epilepticus, 300, 310



- steady state, 63, 76, 78  
 stem cells, 90  
 sterile, 93  
 steroid hormones, 222  
 steroidogenesis, 128, 283, 285, 286, 292  
 steroids, 228, 258  
 stimulus, 3, 6, 11, 18, 19, 20, 21, 22, 28  
 stock, 93, 98  
 stoichiometry, 218  
 stomach, 121, 138, 150, 170, 200, 227, 234, 242, 253  
 storage, xii, 83, 95, 128, 142, 172, 191, 195, 196,  
     198, 199, 222, 237, 238, 241, 386, 387  
 strain, 137, 346, 347  
 strains, 378  
 S-transferase (GST), 52, 70  
 strategies, 263, 276, 311, 327  
 strawberries, 2, 171, 190, 266, 381  
 strength, 362, 363  
 streptococci, 150  
 stress reactions, 191  
 stressors, xiv, 6, 313, 314, 320  
 striatum, 305  
 stroke, x, 50, 127, 134, 148, 164, 176, 179, 224, 230,  
     243, 275, 304, 357  
 stromal, 169  
 structural protein, 14, 282  
 Subcellular, 256  
 subcutaneous tissue, 239  
 substances, xiv, 12, 48, 49, 51, 138, 171, 186, 187,  
     191, 221, 253, 300, 305, 313, 314, 315  
 substrates, 35, 69, 70, 77, 97, 121, 122  
 suffering, 4, 74, 99, 224  
 sugar, xii, 13, 66, 135, 213  
 sulfate, 156  
 sulphur, xiv, 240, 313, 314, 316, 317, 319, 322, 323,  
     326, 331  
 sunlight, 204  
 supernatant, 96, 97  
 superoxide, 9, 10, 173, 181, 284, 285, 292, 301  
 superoxide dismutase, 6, 13, 18, 47, 51, 54, 60, 83,  
     138, 147, 165, 181, 250, 284, 285, 290, 292, 293,  
     294, 296, 300, 310, 312, 334, 340  
 supplemental, viii, 2, 20, 133, 138, 204, 242, 252,  
     273  
 supply, xii, 72, 128, 143, 237, 314, 381  
 suppression, 37, 40, 119  
 suppressor, 250  
 surface properties, 187  
 surfactants, 193  
 Surgeon General, 263  
 surgery, 138, 223, 224, 225, 228  
 surgical, 225, 228, 231  
 survival, xiv, 76, 91, 98, 115, 169, 173, 205, 252,  
     253, 255, 282, 291, 299, 306, 370, 378, 380  
 survival rate, 252, 378  
 surviving, 370, 371  
 susceptibility, xii, 12, 16, 35, 70, 180, 222, 238, 312  
 SV40, 220  
 sweat, 303  
 Sweden, 277  
 sweets, 386  
 swelling, 225, 250  
 swimmers, 43  
 sympathetic, 133, 312  
 symptoms, xii, xvi, 42, 132, 136, 138, 142, 143, 164,  
     191, 224, 237, 286, 355, 356, 359, 362, 364, 379,  
     381  
 syndrome, 229, 293  
 synergistic, 23, 181, 253, 368  
 synergistic effect, 23, 368  
 synovial fluid, 232  
 synthetic MMP inhibitors, 371  
 synthetic polymers, 187  
 systolic blood pressure, 333
- T**
- T cell, 34  
 Taiwan, 127, 177  
 tamoxifen, 138, 150  
 taurocholic acid, 226  
 Taxol, 204  
 teeth, xii, 137, 150, 237, 238, 239  
 temperature, 10, 54, 66, 99, 191, 194, 196, 201, 202,  
     330, 388  
 temporal, 295, 323  
 tendons, 128  
 tension, 34, 225  
 testis, 332  
 tetracycline, 210  
 thermodynamic, 159  
 thiobarbituric acid, 12, 300, 305  
 thioredoxin, 3, 32, 48, 68, 71, 73, 82, 178  
 Thomson, 277  
 threonine, 370  
 threshold, 67, 129, 303  
 thrombosis, 148, 353  
 thrombotic, 149, 333  
 thymus, 115  
 tissue plasminogen activator, 135, 347  
 titration, 317

T-lymphocytes, 294  
 TNF, 225, 286  
 TNF- $\alpha$ , 286  
 tobacco, vii, xiii, 261, 262, 263, 271, 272, 273, 274, 275, 276, 277, 278, 356  
 tobacco smoke, xiii, 261, 262, 271, 272, 275, 276, 277, 278  
 tocopherols, 6, 13  
 tocotrienols, 304  
 Tokyo, 54, 365  
 tomato, xii, 2, 171, 190, 237, 238, 352, 358  
 Topiramate, 310  
 total cholesterol, 57  
 total energy, 266, 267  
 total plasma, 292  
 toxic, x, xii, xiv, xv, 52, 72, 90, 91, 116, 121, 122, 128, 131, 134, 153, 157, 237, 241, 248, 284, 285, 286, 287, 313, 329, 331, 332, 344  
 toxic effect, 52, 72, 122, 157, 248, 286, 287, 331  
 toxic metals, xv, 329  
 toxic substances, xiv, 313  
 toxicities, 241  
 toxicology, 119, 338  
 toxins, xi, 129, 185  
 trace elements, 128, 143, 340  
 trachea, 221  
 traits, 50, 67, 75  
 transcript, 175  
 transcription factor, 18, 30, 33, 65, 241  
 transduction, 370, 374  
 transfection, 203, 220  
 transfer, xii, 9, 10, 72, 73, 74, 214, 221, 239, 251, 301  
 transferrin, 4, 11, 16, 156, 208, 249  
 transformation, 215, 222  
 transforming growth factor (TGF), xvi, 367, 369, 370, 371, 372, 373, 374  
 transgenic, 85, 282  
 transition metal, x, xii, 4, 5, 11, 13, 15, 27, 29, 74, 153, 157, 166, 167, 171, 177, 237, 238, 243, 249, 301, 304, 309  
 transition metal ions, x, 5, 153, 157, 243, 301  
 translocation, 66, 83, 225, 353, 370  
 transmembrane, 66, 219, 220, 221, 229, 254, 370  
 trans-membrane, 72  
 transplant, 250  
 transport processes, 222  
 traps, 11, 240  
 trauma, 8, 11, 19, 225  
 trichloroacetic acid, 93, 96

triggers, 10, 81, 120, 282, 370  
 triglycerides, 249, 295  
 trophoblast, 228, 253, 258, 287, 288  
 Trp, 120  
 tubular, ix, 46, 47, 51, 65, 67, 148, 221, 222, 248, 331, 338  
 tumor cells, 116, 150, 169, 181, 205  
 tumor growth, 169, 181, 182, 368, 369, 373  
 tumor invasion, 373, 375  
 tumor metastasis, 369  
 tumor necrosis factor, 294, 383  
 tumor progression, 178, 182  
 tumorigenic, 142  
 tumors, 68, 137, 167, 178, 368, 369, 370, 371  
 tumour, 177, 182, 206  
 tumour growth, 177, 182  
 tumours, xi, 89, 154, 190  
 Turkey, 299  
 turnover, 52, 63, 72, 82, 129, 214, 231, 244  
 type 1 diabetes, 39, 136  
 type 2 diabetes, 135, 148, 149, 351, 352  
 type 2 diabetes mellitus, 149  
 tyrosine, 3, 34, 128, 240, 297

## U

U.S. Department of Agriculture, 257  
 ubiquitin, 18  
 UDP-glucuronosyltransferase, 228  
 UGT, 70  
 ultrasound, 346, 386, 387  
 ultraviolet, 320, 372, 375  
 underlying mechanisms, 170  
 UNICEF, 56  
 uniform, 51, 76, 78, 199  
 United States, 2, 123, 148, 177, 205, 206, 207, 242, 263, 278, 333  
 university students, 52, 54  
 urea, 57  
 urea nitrogen, 57  
 uric acid, viii, 6, 9, 13, 46, 48, 50, 60, 65, 76, 77, 80, 131, 285, 290, 362  
 uric acid levels, viii, 46, 48  
 urinary bladder, 369, 373  
 urinary oxalate, 131, 145, 204, 222  
 urine, ix, 12, 13, 46, 51, 53, 54, 56, 57, 58, 59, 60, 65, 67, 69, 76, 78, 166, 222, 225, 231, 241, 244, 264, 273, 278, 303, 340  
 urokinase, 375  
 US Department of Health and Human Services, 276  
 USDA, 123, 142, 245, 246, 248, 257, 272

UV, 156, 191, 201, 204, 221, 225, 235, 301, 327, 371

UV light, 156, 191

UV radiation, 221

UV-radiation, 204

## V

validity, 358

valproic acid, 306, 307, 312

variability, 21, 26, 27, 142

variables, 24, 149, 192, 198, 201, 204, 208, 273, 358

variance, 55

variant angina, 146, 256

variation, 50, 116

vascular disease, 139

vascular diseases, 139

vascular endothelial growth factor (VEGF), 292, 369

vascular system, xv, 186, 329

vascular wall, xv, 329, 333, 335, 337, 340

vasoconstriction, 133, 288, 333

vasoconstrictor, 17, 347

vasodilatation, 135, 333, 344, 345, 346, 347, 349, 350, 351

vasodilation, 17, 39, 132, 146, 147, 243, 256, 346, 351, 352, 353

vasodilator, 3, 133, 346, 347, 350

vasomotor, 133, 146, 243, 352

VCAM, 139, 140

vector, 71, 75

vegetation, 315

vein, 348

venipuncture, 264

verapamil, 346

vertebrates, 215

vesicles, 196

vessels, xii, 128, 132, 146, 169, 237, 238, 340, 346, 350

vincristine, 182, 368

vinegar, 357

VIP, 296

viral infection, xii, 230, 237

virus, xi, 185, 255

viruses, 138

viscosity, 193

vitamin A, 16, 57, 79, 145, 164, 165, 197, 291, 357, 365

vitamin B1, 132, 197, 248, 250, 251, 253, 258

vitamin B12, 132, 197, 248, 250, 251, 253, 258

vitamin B12 deficiency, 250, 251

vitamin B6, 251

vitamin D, 204

vitamin K, 181, 197, 368

vitamin supplementation, 40, 142, 173

## W

water-soluble, vii, ix, xi, xii, xiv, 2, 46, 74, 136, 185, 186, 187, 188, 192, 193, 194, 197, 204, 208, 222, 237, 239, 243, 253, 300, 303, 304, 314, 336

weight loss, 142

Weinberg, 56

well-being, 188, 253

wells, 95, 96, 99

Western countries, 330

wheat germ, 369

white blood cells, 53, 128, 176, 186, 224

whole grain, viii, 2, 32

wild type, xvii, 75, 377, 378, 379, 380

World Health Organization (WHO), 50, 175, 196, 356, 364, 365

wound healing, 138, 186, 191, 238, 239, 373

## X

X chromosome, 82

xenobiotics, viii, 45, 48, 49, 51, 52, 63, 64, 68, 72, 76, 77, 78, 232

xenografts, 206, 255, 257, 368, 373

X-ray crystallography, ix, 46, 71, 77

## Y

Y chromosome, 293

yeast, 122, 162, 169

yield, 11, 199, 201

young adults, 32, 152, 244, 350

young men, 36

young women, ix, 46, 60, 76, 78, 79, 83, 144, 207

## Z

zeta potential, 195, 196

zinc (Zn), 15, 195, 198, 236, 274, 285, 315, 338

zinc oxide, 195, 198

