

Bob 4-1886

*Amordesai
USA*

ORDNANCE MEMORANDA NO. 27.

HOTCHKISS REVOLVING CANNON,

PREPARED UNDER THE DIRECTION OF

BRIG. GEN. STEPHEN V. BENÉT,
CHIEF OF ORDNANCE, U. S. ARMY,

BY

LIEUT. H. D. BORUP.

PUBLICATION AUTHORIZED BY THE SECRETARY OF WAR.

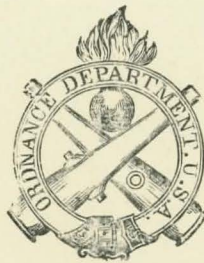

WASHINGTON:
GOVERNMENT PRINTING OFFICE.
1886.

MEM 27

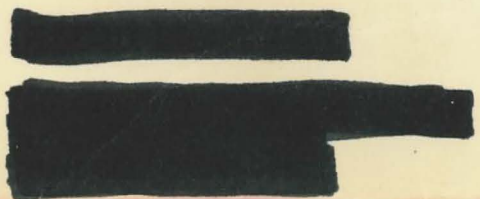

TABLE OF CONTENTS.

THE REVOLVING CANNON.		Page.
Nomenclature and description		9
The group of barrels		9
The breech and its mechanism		10
The frame		15
The sights		16
The carriage		16
The limber		18
The caisson		19
The equipments		19
THE FLANK DEFENSE GUN.		
The sights		23
The carriage		24
The equipments		25
The ammunition		25
To dismount the piece		28
To assemble the piece		29
Action of the mechanism		31
DIRECTIONS CONCERNING MANAGEMENT OF THE REVOLVING CANNON.		
Management of piece before firing		33
Management during firing		34
Unloading		38
Management after firing		38
Ammunition		41
General rules		41
Tactics		41
APPENDIX.		
The naval guns		43
The sights		44
The carriages		45
TABLES.		
Army material: guns		47
Army material: ammunition		48
Army material: mounts, carriage, and equipments		49
Naval material: gun		50
Naval material: ammunition		51
Naval material: mounts, carriage, and equipments		52
Ballistic data: firing table of the 1.45-inch gun		53

LIST OF PLATES.

- I. Plan of field gun and details of breech mechanism.
- II. The field gun—sectional views.
- III. 1.85-inch naval gun—breech mechanism.
- IV. 1.85-inch naval gun—breech mechanism.
- V. The sights.
- VI. Carriage for the light field gun.
- VII. Shield for the light field gun.
- VIII. Tool box for the light field gun.
- IX. Limber for light field gun.
 - X. Ammunition chest on the light field gun limber.
- XI. Caisson body.
- XII. Equipments for light field gun.
- XIII. Equipments for light field gun.
- XIV. Charger.
 - XV. Feed trough.
- XVI. Pouch.
- XVII. U. S. carriage for flank defense gun.
- XVIII. German mount for flank defense gun.
 - XIX. French caponnière carriage for flank defense gun.
- XX. Ammunition.
- XXI. Fuses.
- XXII. Deck carriage for 2.1-inch naval gun.

NOTE.

This description of the Hotchkiss revolving cannon pertains to the Army types, but a brief notice of the naval guns appears in the Appendix.

The breech mechanism of the 1.85-inch naval gun is illustrated, partly because it is shown on a larger scale than that for the Army piece, and partly because it is a later type, and has some modifications introduced. A plate showing the deck carriage of the largest naval piece—the 2.1 inch—is also included, as it is possible that it may form part of the armament of our permanent fortifications.

In compiling this report on the Hotchkiss revolving cannon, the following authorities have been made use of:

- The Hotchkiss revolving cannon, by Lieut. E. W. Very, U. S. A.
- Règlement sur le service du canon-revolver, approuvé par le Ministre de la guerre le 9 septembre 1883.
- Exercice du canon-revolver, système Hotchkiss, 2^e tirage.
- Die 3.7^{cm} Revolver-Kanone, Nomenclatur und Beschreibung derselben, sowie der Munition.
- Reports of the Chief of Ordnance, U. S. A.
- Letter from the Hotchkiss Company.
- Letter from Lieut. E. W. Very, U. S. A.
- "Engineering," London.*

THE HOTCHKISS REVOLVING CANNON.

The Hotchkiss revolving cannon as made for field service is designed to reinforce and complete the effective zone of action of light artillery. There are two sizes; the caliber (1.45 inch) and details of rifling being the same in both, the difference consisting principally in the weight and length, and also in the size of cartridge. The table on page 47 shows more exactly what these differences are.

NOMENCLATURE AND DESCRIPTION OF THE REVOLVING CANNON.

The revolving cannon consists of: (1) The group of barrels; (2) the breech and its mechanism; (3) the frame; (4) the sights; (5) the carriages; (6) the equipments.

THE GROUP OF BARRELS.

The group of barrels, Plates I-IV, is composed of 5 steel barrels, 2 bronze disks, 1 steel barrel shaft, and 1 pin-wheel.

The barrels AA are made of Whitworth compressed steel. On the interior the bore is divided into the smooth and the rifled part, the former being composed of the conical cartridge-case chamber, the projectile chamber, and the conical frustum joining them. The rifling lands are narrow, the twist being left-handed. On the exterior each barrel is divided into the *chase* and *breech*, the former being conical and the latter cylindrical, with a thread on its rear end.

The five barrels are grouped around the *barrel-shaft*, B, their axes being parallel to it and to each other. They are maintained in position by two *bronze disks*, C C', each of which is pierced with six holes, the central one

for the shaft, and the circumferential ones for the barrels. The shaft is united to each disk by means of a securing pin passing radially through the former, and a small boss projecting from one face of the latter. The rear disk is screwed to the barrels, while the forward one is forced on them. The front extremity of the shaft rests in the frame, and the rear one, after passing through the front face of the breech, terminates in the pin-wheel. Two arrows are engraved on the rear disk, marked respectively "*Mount*" and "*Dismount*," which are of importance in these operations.

The *pin-wheel* *b* (Plates II-IV) is a steel cylinder, having five studs or pins *b*, *b*₂, &c., projecting from its rear face. It is screwed on to the rear end of the barrel shaft; any tendency to separation being prevented by the steel *locking-pin* *Z*, (Fig. 1, Plate III).

THE BREECH AND ITS MECHANISM.

The breech mechanism of the field gun is shown in Plates I and II. The later models have had slight changes introduced, such as oil-channels leading to the bearings of the barrel-shaft and worm-shaft; a recess in the straight surface of the cam; and instead of one flange on each side of the breech piece, by which it is joined to the frame, there are now two, the frame lying between them. These details may be seen in Plates III and IV.

(*a*) The breech serves for the reception of the mechanism, and consists of the following parts: (1) The breech proper; (2) the recoil-plate, with two assembling-screws; (3) the door, with hinge, bolt, and button; (4) the loading-trough cover, with knob and hinge.

(1) The breech (*D*) is a cast-iron block, cylindro-prismatic in form, containing the breech mechanism, and made as solid as possible, especially in the front half, in order to resist the shock of discharge. It forms the rear bearing of the barrel-shaft, its front face being bored through for this purpose. In the left semicircle of this face are the openings of the loading-trough *M* and the extractor *L*. Beginning at the former and extending in an arc towards the right is the loading-channel *R*, whose width is about equal to the diameter of a cartridge head. Its depth is greatest at the loading-trough, and constantly diminishes until it attains the level of the

face, thus forming an inclined plane, by which the cartridges, as they travel on it, are gradually forced into the barrels from the point they have been left by the loading-piston. Directly below the shaft-bearing is the recess containing two holes for the recoil-plate N' .

On the under side of the breech and in the front half a passage is formed through which the withdrawn cases are expelled. A small channel, $2'$, Fig. 1, Plate III, leads obliquely from the firing-pin close behind the recoil-plate; through it the point of the pin can drop out, in case it is accidentally broken.

Towards the rear is the bed for the head of the elevating-screw, and around it are tapped holes for the assembling-screws of the cover-plate. (See Fig. 1, Plate VI.)

On the upper face, to the left and front, is the loading-trough, or receiver, which is somewhat longer than a cartridge; and near by, to the left, in the top of two conical frustra cast on the flange, are the sockets for the pins of the feed-trough. Close behind the forward one an arrow is engraved, Plate I "plan." To the right of the receiver three holes are drilled and tapped to receive the screws of the cover hinge-plate. Not far from this place, and at the highest element of the breech, is the opening of an oil-hole leading to the bearing of the barrel-shaft. In front of the hole an arrow is engraved. Farther to the right a tapped hole connects this shaft with the exterior of the breech. It serves for the passage of the pin-wheel locking-pin z , in taking the gun apart or putting it together, and is habitually closed by a steel screw, x . At the extreme rear is the bed for the button, and concentric with it is a circular channel for its locking rim.

On the right and left sides flanges are cast by which the breech is united to the bars or shafts E of the frame, the whole being secured by two screw-bolts, e , on each side. The right bearing of the *worm-shaft* F is situated in the right wall of the breech, below the top flange and behind the rear assembling-bolt, and to it a small oil-hole leads from above. In the left upper flange, Plate II, Fig. 1, are two holes at right angles, one of which forms a bearing for the arbor of the cog-wheel and the other a nut for the stop-screw of this arbor.

The interior of the breech constitutes the chamber for the mechanism, and is provided with channels, guideways, and bearings for the various parts composing it. The right journal of the worm-shaft, as has been previously stated, rests in the right breech wall. The bearing of the other journal is on the upper end of a block, *y*, forming part of the breech casting, and projecting from its floor a little to the left of the axis of the piece; while on the other side of this line is the channel N for the firing-pin, extending in an oblique direction from a point near the right rear lower corner to the front face of the breech, passing through the recoil-plate. This channel is not continuous, the middle section being omitted. The wall of the rear portion is slotted, forming a guideway for the firing-pin arm.

Two guideways, one above the other, are made in the left wall of the breech, in which the racks pertaining to the apparatus for loading, M, and extracting, L, travel; between them is the bearing for the arbor of the cog-wheel. The forward prolongation of the upper way passes by the receiver, the left wall of which is slotted for the passage of the brass cross-piece connecting the rack with the loading-piston. The receiver is open at top, but when not in use is closed by a cover. Near the top of the loading-trough and on the right are two lugs to which the *feed-gate* P is hinged, and below them is the toe *p*, Fig. 2, Plate III, designed to prevent the gate from coming in contact with the side of the loading-trough. In order to free the fired case from the extractor-claws, after its withdrawal from the barrel, an *ejector*, LL, is provided, and situated so that the case will fall through the *ejector-hole*, Plate IV, Fig. 1.

(2) The *recoil-plate* N', a small steel disk, fits closely in its bed in the front face of the breech, and is secured thereto by two steel screws. It is bored through in the middle for the point of the firing-pin, and receives the shock of the cartridge when fired.

(3) The bronze *breech-door* *d* serves to close the breech, and to give access to the mechanism. It is concave on the inside face, and is furnished with a shoulder against which the short arm of the *mainspring* *o* bears, and with two *lugs*, *o'*, for the swivel-pin of this spring. The breech and door are connected at their lower edges by a steel hinge-pin. A groove is made in the left lower corner of the door, and the hinge-pin correspondingly

notched, in order that the extractor-link may have room to move in its rearward swing. A stop-screw prevents the pin from turning. On the upper edge of the door is the channel previously spoken of for the locking-rim of the button.

(4) The *loading-trough cover* is a bronze plate connected to a similar one by a steel pin, so as to form a hinge. Three screws connect the second plate with the breech. The cover has a knob, and, together with its hinge, is curved to correspond with the breech. When not in use the cover is closed, its office being to protect the trough.

(b) The mechanism consists of the apparatus for revolving, loading, firing, and extracting, viz: (1) The crank-shaft; (2) the hand-crank; (3) the worm; (4) the extractor-crank and stop-screw; (5) the extractor; (6) the loading-piston and feed-gate lifter; (7) the cog-wheel; (8) the feed-gate; (9) the firing-pin; (10) the mainspring.

(1) The steel crank-shaft F lies horizontally in the breech and at right angles to the barrel-shaft. Its right bearing is in the right breech-wall, and its left one in the block Y, forming part of the breech-casting, and already described. It projects outward on the right, and at this point is provided with the hand-crank. The shaft is composed of four cylinders of different diameters and lengths, a fillet being between the two on the right. The first carries the hand-crank; the second rests in the right bearing; the third forms the left journal and also carries the worm, to which it is secured by a groove and feather; and the fourth receives the extractor-crank, which is kept in place by the steel stop-screw K.

(2) The *hand-crank f* is curved twice in opposite directions, one extremity having an ordinary handle and the other terminating in a grooved boss, which is put on the end of the worm shaft and retained there by the draw-latch *f*.

(3) The *worm H* is a hollow phosphor-bronze casting, composed of two cylinders having the same axis. On the exterior of the larger is a spiral or worm thread, partly inclined and partly straight, *i. e.*, without any pitch; and on the exterior of the smaller, a cam, G. The rotation of the group of barrels and the retraction of the firing-pin are effected by the worm and cam, respectively.

(4) The extractor-crank I has the ordinary shape, the handle being replaced by a stud of a little less diameter than the link-slot in which it moves. It is secured to the left end of the worm-shaft by a steel stop-screw, *k*.

(5) The *extractor* L is composed of a rack, link, and claw. The rack L' is a long rectangular piece of bronze, grooved on its upper face, the right fillet being provided with teeth and the left one planed smooth. The lower face is tenoned on its left edge. The two guides, thus formed, slide in corresponding ways situated in the left breech-wall. On the right face of the rack, and near its rear end, a steel arm is riveted in four places. The arm is slotted, and receives the stud on the extractor-crank. Two steel extractor-claws are attached to a projection on the front extremity of the same face by means of two steel screws.

(6) *The loading-piston and feed-gate lifter* M.—It consists of a rack, a rectangular bronze piece, having teeth projecting from the right longitudinal half of its under face; the other half, the left and the upper faces, are in contact with the guideway, located in the left breech-wall, above and parallel to that for the extractor-rack. The loading-piston is a hollow cylinder of the same metal, connected at the rear with the corresponding part of the rack by a cross-piece. The under side of the piston is provided with oil grooves. The feed-gate lifter is wedge-shaped, and is fastened to the right forward side by a riveted screw. It is shown at *m'*, Fig. I, Plate IV. In order to prevent the primer being struck by the piston, the front face of the latter is hollowed out. Near this end an arrow, marked "Mount," is engraved, which is of importance in putting the mechanism together. The prolongation of the loading-trough to the rear forms the guideway of the piston.

(7) The *bronze cog-wheel* *m* is placed between the two racks with which it gears. From the left face an arbor projects, which is grooved circumferentially. The point of the stop-screw enters this and prevents the wheel having any motion other than rotation.*

* In the 37^{mm} naval gun the cog-wheel is provided with a nave-box, and revolves independently. The axle is a bolt screwed into the breech-wall and kept there by a stop-screw.

(8) The *feed-gate* P is of steel and shaped to correspond with the cartridge. It is hinged to the lugs on the side of the receiver, the pin being of steel. The gate hangs almost vertically when the gun is not in action, but as soon as the revolution commences it is raised by the lifter on the end of the loading-piston as it moves forward, and drops back as it recedes. A toe serves to prevent the gate from coming in contact with the wall of the trough, thus enabling the lifter to engage on the under side of the gate. The lower face and the left one are curved so as to facilitate the entrance of the cartridge. If this is not shaped properly difficulties are apt to arise in loading, especially when firing under a considerable angle of depression. The function of the gate is to prevent the cartridges from crowding down upon the piston, and to secure their regular uninterrupted entrance into the receiver.

(9) The *firing-pin* N is a steel cylinder with rounded conical extremities. A collar near the rear is provided with an arm having a hook-shaped end, which lies against the cam. The guideway of the arm is the slot in the rear section of the channel for the pin.

(10) The *mainspring* O is a flat piece of steel having two arms. Near the extremity of the shorter one a "shoe" is riveted; it embraces the larger arm and limits its play. The bend of the spring forms a bearing for the steel swivel-pin which is supported by the lugs in the breech door. The short arm rests against the shoulder on the lower part of this door and the long one presses against the rear end of the firing-pin.

THE FRAME.

The *frame* E (Plates I and VI) is a bronze casting, and is composed of two side bars joined by two cross-pieces. The bars are parallel in their posterior, and are slightly convergent in their anterior part. Their inner faces are concaved. The breech is connected to them in the manner previously described; the rear cross-piece curves under the barrels near the trunnions, which form part of the casting, and the other bends upwards in front of the piece, and is bored for the journal of the barrel-shaft. An oil-hole leads to the bearing from above. On the face of the left trunnion the year of fabrication and gun number are marked, and on the left one the weight.

THE SIGHTS.

The rear sight.—The rear sight (Plate V) consists of the *stem*, *slide*, and *support*. The *stem*, suitably graduated, is a straight piece of brass, the cross-section being triangular with rounded corners. The *slide* is a small box placed on the head of the stem, and capable of being moved perpendicularly to it by means of a screw working in a nut in its end. This screw terminates on the right in a milled head, and on the left in a journal which revolves in the left end of the box. The shape of this end is finished to correspond to the other. Two set-screws pass through it into an annular groove in the journal. By this device the screw is only withdrawn from the box when the set-screws are renewed. A plate is fastened to the upper side of the box, and has the sighting-notch and graduation on its top and rear faces, respectively.

The *support* is a brass casting fastened to the rear of the right frame bar, and is pierced with a canal for the stem. A stop-screw, bearing against a flat spring, serves to retain the stem at the desired elevation. The downward travel is limited by a shoulder below the head of the stem. The stop-screw is prevented from being accidentally lost by having a retaining shoulder on its inner end. The screw is originally inserted through the channel formed in the prolongation of its bed. The head is subsequently fastened to the screw. The recess in which the retaining shoulder lies is shown in Fig. 7.

The front sight.—The front sight is a piece of steel divided into a threaded base, an annular shoulder, and a hexagonal stem, terminating in a cone. The latter is roughened to prevent glare. The position of this sight varies, it being sometimes placed on the right rim-base, and sometimes on the right frame-bar, a little in rear of the forward barrel-disk. Its seat in the last case is a bronze casting having a tapped socket for the lower end of the sight. It is joined to the frame by three screws.

CARRIAGES.

There are two carriages and caissons provided for the field-piece, one for the light and the other for the heavy gun. The principles of construction are the same in both, the chief difference consisting in the latter being

heavier, stronger, and larger than the former. There is also a little variation in the way the trunnion saddles are fitted to their seats.

The carriage (Plate VI).—The trail of the carriage is formed of two brackets connected by bolts and two transoms, and having a gun-metal rest for carrying the trunnion-saddle, the rear ends being connected by the trail eye-piece, made of cast-steel, to prevent wear on the limber-hook. The brackets diverge at the trunnions. The axle-tree is made of tough steel. The wheels have metallic naves and ring-tires.

This carriage has a gun-traversing arrangement capable of giving 4° deflection to the right or left. It consists of a cast-steel saddle, with trunnion bearings, and works in the gun-metal rest riveted to the brackets.

The elevating and traversing arrangement consists of a steel ball-and-socket *elevating screw*, which allows the breech of the gun to move freely in any direction. The elevating screw works in an oscillating bearing. This bearing or nut, and with it the elevating screw, can be traversed right and left by means of a small hand-wheel on the left side of the trail, and this causes the trunnion-saddle with the gun to pivot around the center of the saddle. On the right side of the trail there is a compressing handle to lock the elevating screw, so as to make it immovable during fire and whilst traveling.

The *handspike* of iron-tubing, is hinged to the trail so as to fold back for traveling. A *tool-box*, Plate VIII, is placed between the brackets, making thus an additional transom connection for them.

To suppress the recoil of the gun, and prevent all vibrations from the slack of the wheel hubs on the axles, &c., a brake of the following description is used:

Each axle-arm has a screw cut on its extremity; this carries a nut forming a conical cap, partly enveloping the inner side of the wheel nave, which is also conical, to fit the inside of the cap, and has a crank-arm by which it can be revolved on the axle. When screwed up, this cap grips the cone of the nave of the wheel until the latter is immovably locked by the friction of the cones. On the base of the trail is a heel which is driven into the soil by the weight above when the piece is unlimbered. This assists in suppressing the recoil.

This brake is used both for firing and traveling, and in the latter case has the advantage of not requiring a stoppage of the carriage to adjust it, as is necessary with the shoe-brake.

The carriage of the revolving cannon is sometimes provided with a light steel shield for the protection of the gunners from small-arm fire, Plate VII.

This shield is in three parts, made to fold together, thus forming seats for two men. It can, when coming into action, be unfolded immediately, leaving only the muzzles of the gun and the wheels exposed. The plates are $\frac{3}{16}$ inch (5^{mm}) in thickness, and are proof against the fire of any existing military rifle, should even two bullets hit the same spot.

The carriage carries the following implements :

On the right bracket: 1 sponge staff.

On trail : 1 trail handspike.

Beneath trail : 2 handspikes.

In tool-box : 1 feed-trough, 1 hand-crank, 1 rear sight, 1 screw-driver, 1 oil-can, 1 reserve main-spring, 1 reserve firing-pin, 1 hammer, 1 punch, 1 universal wrench.

The limber (Plate IX).—The limber is formed of four futchells, the outside ones of flat steel, the inside ones and the splinter-bar being of angle iron, a platform-board and foot-board of oak. The axle-tree is of hollow wrought iron ; the wheels are the same as for the carriage.

The futchells and splinter-bar are all riveted together, and the cast-steel limber-hook is riveted in between the inside futchells ; the axle-tree is secured to the bed by three bearings, and the whole forms a solid frame work.

The limber has swing splinter-bars of steel, to which the traces of the horses are attached, and the shaft is rigged for double draught. The swingle-tree is also of steel.

The ammunition-chest (Plate X) is made of steel plate, and is divided horizontally into two compartments, the lower being further subdivided into three by vertical partitions. The middle space has a drawer for tools at top. The lid, which forms the seat for part of the detachment, is hinged in front, and locked by two straps and turn-buckles on the opposite side. The

rear face of the chest is divided longitudinally, the lower half hinged at bottom, giving access to the under compartment. The ends of the straps on the upper lid project sufficiently beyond the buckles to bear against the lower door and keep it closed. This door when opened is retained in the proper position by a curved strap on each end, sliding in a guideway. The upper lid straps have two notches in each.

On the limber are carried—

Beneath: 1 prolonge, 1 bucket.

Front: 1 shovel, 1 axe, 1 pick-axe.

Top: 1 cushion.

Interior upper compartment: 200 rounds of ammunition.

Lower compartment: 100 rounds of ammunition in 10 steel chargers ready for rapid firing. These are in the outer sections.

Middle section: 2 charger-pouches or passing-boxes.

Drawer: 3 spare sponge brushes, 1 screw-driver, 1 grease-box, pin-cers, cleaning brush, 1 hammer, 1 universal wrench.

The caisson (Plate XI).—The caisson consists of the limber (identical with the gun-limber) and the body, carrying 2 ammunition chests similar to those of the limber, except that the lower is wholly occupied by the ammunition compartment. It is constructed entirely of steel and iron, and is fitted with brakes like those on the carriage. There are 2 foot-boards.

The accessories carried are—

On limber: same as gun-limber.

In limber: same as gun-limber.

On body: 1 spare pole, 1 spare swingle-tree, 2 spare splinter-bars, 1 spare wheel, 2 cushions.

In body (*i. e.*, in chests): 800 rounds of ammunition.

THE EQUIPMENTS.

The equipments carried have been enumerated in the section concerning the carriages, but as some of them require a description the list is repeated here for convenience.

On the carriage are: (1) 1 sponge-shaft; (2*) 1 chair and shoe; (3) 1 trail handspike; (4*) 2 handspikes (in tool-box); (5) 1 feed-trough (in tool-

box); (6†) 1 hand-crank (in tool-box); (7†) 1 rear sight (in tool-box); (8*) 1 screw-driver (in tool-box); (9*) 1 oil-can (in tool-box); (10†) 1 spare mainspring (in tool-box); (11†) 1 spare firing-pin (in tool-box); (12*) 1 hammer (in tool-box); (13*) 1 punch (in tool-box); (14*) 1 universal wrench (in tool-box).

On gun-limber: (15*) 1 prolonge; (16) 1 bucket; (17*) 1 shovel; (18*) 1 axe; (19*) 1 pickaxe; (20*) 1 cushion; (21) 10 steel chargers; (22) 2 charger-pouches; (23) 3 spare sponge brushes (in drawer); (24*) 1 screw-driver (in drawer); (25*) 1 grease-box (in drawer); (26*) 1 pincers (in drawer); (27*) 1 cleaning-brush (in drawer); (28*) 1 hammer (in drawer); (29*) 1 universal wrench (in drawer).

On caisson-limber: Same as gun-limber.

On caisson body: (30†) 40 steel chargers; (31*) 1 spare pole; (32*) 1 spare swingle-tree; (33*) 2 spare splinter bars; (34*) 1 spare wheel; (35*) 2 cushions.

Those articles marked with a † have been described previously. Those against which a * is set need no explanation. Some of these are illustrated, and their dimensions given in the following plates:

Plate VI, Figs. 1, 3, chain and shoe, handspikes; Plate XII, Fig. 10, hammer; Fig. 11, punch; Fig. 9, universal wrench; Figs. 1, 2, shovel; Figs. 3, 4, pickaxe; Figs. 5, 6, axe (the position of the last three is shown in Fig. 5, Plate X); Fig. 7, screw-driver; Fig. 8, oil-can; Figs. 12, 13, 14, grease-box. Plate XIII shows the sponge-staff, prolonge, bucket, cleaning-brush, and straps.

The *sponge-staff* is a round beech-wood pole, one end of which forms the rammer and the other receives the sponge. The latter end terminates in a brass cylinder which is slotted longitudinally on two diameters perpendicular to each other. A ring slides on this part, its travel being limited by two studs, the forward one retains the ring by entering a groove cut in it. The brush is made of wire and bristles, and has a wooden foot. The foot is embraced by the cylinder, and is secured therein by pushing the clamping-ring forward and locking it by means of the stud and groove. The opposite end of the staff serves to drive out cartridges when this becomes

necessary. The face is hollowed so as not to bear against the fuze, and the exterior is strengthened by a brass coating.

The *trail handspike* (Plate VI) is a piece of tube-iron bent to the proper shape, and hinged to the trail. In traveling it is revolved forward so as to lie in a bracket on top of the tool-box, and when unlimbered it is returned to its former position.

The *feed-trough* (Plates II and XV).—The feed-trough is a sluiceway, the cross-section corresponding to a longitudinal section of the cartridge. It is open at top and bottom for the entrance and exit of the ammunition, and slotted on the broad face to facilitate the insertion of the cartridges and to enable the loading number to keep them from undue jarring when the piece is firing, which is effected by pressing on them by hand. When in position the trough is inclined to the vertical, to relieve the weight on the feed-gate. To retain it in position two pins, which are secured to the back face near the lower edge, are inserted in the sockets on the breech.

The *charger* (Plate XIV) is a zinc box of trapezoidal cross-section, having an opening extending almost the entire length of one of the broad faces. Near the end of this side is riveted a hinge-plate which bridges the opening. A plate bent at right angles is the other leaf of the hinge, and it forms the end of this face, and a door for the middle section of the base of the box. A locking-lever is pivoted near one end of the hinge-pin, and while one of the arms rests on the door the latter is kept closed. Before going into action the case is filled with ammunition and the door locked. When slipped into the feed-trough of the gun the locking-lever catches against its side, is pressed back, the door falls open and the cartridge enters the trough.

In the ordinary service of the piece the loading number keeps the trough full by transferring the cartridges by hand from the pouch. If rapid firing be required, then the *chargers* are made use of.

Charger-pouch or passing-box (Plate XVI).—This has leather sides and wooden base and top. The back of the pouch is curved to correspond to the stomach, the pouch being suspended from the neck, and strapped around the waist of one of the detachments. The box is arranged to carry 20 cartridges, in three rows. The bottom board is stepped, and has cavi-

ties in it similar to the nose of the projectile, the top being bored correspondingly. Owing to the step arrangement the heads of the cartridges project above the cover in a similar manner so as to come readily to the hand.

THE FLANK-DEFENSE GUN.

The flank-defense gun is designed as a defensive weapon to effectually cover the ditches and approaches of permanent fortifications, and to offer an effective obstruction to the siege operations of an enemy.

The theory of this piece is given in Ordnance Notes, No. 178, a translation from the French, by Lieutenant (now Captain) Birnie. The following is a brief abstract of the principles of construction :

“If we fire from a rifled gun tube a projectile case inclosing a number of similar balls arranged in layers, so that the center of gravity of each ball is equally distant from the axial line of the case, and arrange the case to take the rifling and to *remain intact* during its passage through the tube, but to open when it leaves the tube, then the balls will spread in a sheaf-like surface, or *gerbe*, of which the angle at the summit will depend upon the twist of the rifling and the general form upon the curvature of the individual trajectories of the balls. We can hence calculate the elements of the *gerbe*.”

* * * “By properly calculating the twist of the rifling of the second tube, the *gerbes* of balls may be delivered so that the dangerous zones of the two will be joined.”

“By successively bringing to the same position a series of rifled tubes arranged to give dangerous zones successively interior to and joining each other, we can form a continuous dangerous zone.” * * *

“The Hotchkiss revolving cannon practically realizes this conception; it has five tubes which occupy, successively, exactly the same position at the moment of firing. The ditch is searched from the point * * * which corresponds to the tube giving the greatest dispersion, by rifling the tubes with a twist separately calculated for each, and by giving the piece an inclination dependent upon the height * * * of the line of fire of the *caponière*.”

The caliber is 1.57 inch (40^{mm}). "The number of grooves in each tube of the revolving cannon of this type is 12. They have a uniform twist of—

39".4 in tube No. 1.

52".75 in tube No. 2.

86".6 in tube No. 3.

137".8 in tube No. 4.

263".8 in tube No. 5."

"The twist of the rifling of the tubes is determined by a calculation based upon the mean length and width of the ditches and the mean height of the lines of fire in the flanking batteries of the fronts to be armed."

"The flank-defense revolving cannon is used at a single angle of fire for each front, which is determined by a simple graphic method. The pointing having been once determined should not thereafter be changed under any pretext. This arm is then always ready; neither darkness, fog, nor smoke will impede its action."

THE SIGHTS.

The rear sight.—The details of this sight are shown in Plate V. It consists of the usual graduated stem sliding in a support which is fastened by screws to the outside of the right frame bar near the rear extremity. The upper end of the stem has a "peep" sight on it, and the body is embraced by a collar provided with a set-screw. By means of the screw the collar can be held opposite any point of the scale, and as the base of the collar rests on the upper face of the support, any desired elevation can be given to the gun. The piece being aimed *once for all* should never be altered when established.

The front sight.—The top of this sight is notched instead of being pointed. The shaft is cylindrical and has two flanges projecting from opposite sides of the base, each of which is provided with a countersunk screw-hole. Its position is near the right rim-base. Details of this sight are also given in this plate.

THE CARRIAGE.

The flank-defense gun does not seem to have any fixed pattern of carriage. The kind varies with the requirements of the services of different countries which depend on the limiting conditions of the emplacements in which the guns are to be mounted.

For the United States service an experimental carriage, Plate XVII, was constructed some years ago and subjected to some trial (for description see the report of the Chief of Ordnance, U. S. A., for 1879); but the definite details for a carriage have not yet been determined.

The German mount consists of a fixed pivot on the sole of an embrasure. It is not unlike the general system of ship-mounts for the 1.45-inch and 1.85-inch naval guns. (See Plate XVIII.) Also description of 1.45-inch naval gun below.

The French use a mount called the *caponière* carriage (Plate XIX), which allows the position of the gun to be readily changed, should it be desirable. This carriage consists of two brackets connected in the usual manner, and mounted on a pair of low wheels provided with brakes similar to those in use in the field-gun carriage. The principal feature requiring notice is the table from which the cartridges are supplied to the feed-trough. This is pivoted on the prolongation of the trunnion-bed, the connection being by a curved strap leading from the front of the table. At the rear of the table is fastened the upper end of a link arrangement, the lower portion of which consists of two branches. A guideway on the left bracket receives one of them, while the other is connected to a crank on the end of a shaft passing through the cheeks of the carriage. An arm joins the shaft and elevating screw, so that any movement of the latter involves a corresponding one of the former, and hence of the table. Any changes in the elevation of the gun is accompanied by a similar one on the part of the table, which consequently always keeps its proper position with respect to the feed-trough.

Recoil is prevented by the device attached to the base of the trail.

THE EQUIPMENTS.

The list of equipments for this piece includes those carried in the armament-box and limber-drawer in the field piece, together with such accessories as pertain to the maneuvering of the carriage, such as hand-spikes, levers, &c.

THE AMMUNITION.

The ammunition (Plate XX) for the revolving cannon resembles that used in breech-loading small arms, and consists of (1) the case, with primer and powder; (2) the projectile; (3) the fuse.

(1) *The case*.—Of this there are two kinds, the *wrapped* case, and the *drawn* case, the kind supplied being dependent upon the preference of the service using the ammunition.

The *wrapped case* is formed by rolling a trapezoidal sheet of brass around a mandrel, and bending one end inwards at right angles. The case is bottle shaped. The cups are made of copper, and are placed at the base of the case with its bent-in edge between them, one cup being within and the other outside it. The head of the cartridge is a sheet-iron disk riveted in three places to both cups. The cartridge is center-fire, the primer presenting no novelty.

The *drawn case* is, as its name implies, drawn from the solid to the shape required. The iron-head is omitted.

The case forms the gas check, and after cessation of the pressure resumes almost its original form, so that its withdrawal offers no difficulty to the extractor. The charge of powder is loaded into the case and shaken down, and on top of it is placed a felt lubricating wad, which leaves sufficient end to the case to allow it to be crimped to the base of the projectile.

(2) *The projectile*.—Four different kinds are used, viz: Cast-iron shell, steel shell, case-shot, canister (flank-defense gun).

The general exterior of both descriptions of shells is the same, being of the cylindro-ogival pattern, with the base slightly rounded. The nose of the steel shell is carried to a sharp point, the fuse being in the base; that of the cast-iron shell is truncated to afford a seat for the nose-fuse. Both have a brass central rifling band. A series of grooves being cut around the body

of the shell, a thin brass belt is forced over them, presenting a smooth exterior surface. When the gun is fired the quickly acting powder pressure molds the belt into the circular grooves, thus leaving barely sufficient shearing surface to insure perfect rotation, whilst the annular creases caused by the grooves give space for an easy flow of the sheared metal. The steel shell has an independent cap which screws into the walls of the interior cavity prolonged outwards to its full diameter. The inner wall of this cap is provided with a wedge groove. When the shell charge explodes, the powder pressure forces the lips of the groove tight against the fuse and the shell, thus holding the whole base intact until the fracture of the cylinder of the shell takes place. The object of this device is to prevent the base of the shell being blown out, without the walls rupturing, a fault common to ordinary base-fuse projectiles. The steel shells are tempered.

The *case-shot* is a thin drawn brass case almost hemispherical at the head, filled with hardened lead balls (the number and size depending on the caliber of the gun), packed with sawdust. The bottom edge of the case is turned in snugly over a sheet-iron bottom.

The *canister* is used with the flank-defense gun and is made of tinned iron, containing 24 hardened lead bullets. It is forced into the anterior extremity of the cartridge-case.

(3) *The fuse* (Plate XXI).—Three descriptions of percussion-fuses are used in accordance with the special service of the projectile. All steel shell are provided with the Hotchkiss base-fuse. All cast-iron shell for naval use have the Desmarest nose-fuse, and all cast-iron shell for military use have the Hotchkiss nose-fuse.

The Hotchkiss base-fuse consists of three main parts: The body (F); the plunger (K); and the detonating-cap (G H). The body is of gun-metal, the lower exterior (L) being threaded to screw into the base of the shell, and provided with a broad shoulder (*i*) bevelled to a thin edge to form a gas-check. The plunger is composed of a body of lead cast in a cylindrical case of hard brass, and holding a wire, roughened so as to give sufficient hold to the surrounding lead. The rear end of this firing-pin projects below the bottom of the plunger, whilst its front end is sunk a little below the front surface, which is hollowed to leave it clear and intact. The entire

length of this wire is so arranged that when inserted in the body the rear end of it rests against the rear of the fuse-chamber, whilst the front end of the plunger rests against the lower surface of the cap, thus holding the plunger steady. The detonating-cap is a small hollow brass cap, containing the magazine, and screwed into the front end of the body.

When the gun is fired, the powder-pressure on the head of the fuse seals it gas-tight; the plunger drives to the rear along the brass wire, the lead setting up and gripping the wire firmly. The fuse is then armed, and on the projectile striking any object the plunger drives forward, the point of the wire detonating the composition, which drives its blast through the vent in the top of the fuse.

The Hotchkiss nose-fuse consists of four main parts: The body (S); the plunger (T); the head (S₁); and the safety-plug (V).

The body is cylindrical and of brass, with a screw-thread and a strong shoulder at the upper end for securing in the shell. The outside of the shoulder is shaped to the ogive. A chamber is fashioned in the body whose base has a conical hole bored for the safety-plug.

The plunger is a brass hollow cylinder with a lead lining to give it weight, and containing a chamber in which is a small charge of powder with a fulminate cap over it, the whole being covered with foil as a preservative against moisture. A small brass wire (*u*) is inserted in the lower part of the plunger, bent up, so that the ends project through the safety-plug hole.

The safety-plug is a lead stopper forced tightly into the hole in the bottom, and, by pinching the ends of the brass wire, holding the plunger steady.

The head is of gun-metal, the outside following the ogival contour, and being provided with a screw-thread for securing it in the body. In the center of the lower surface is fixed a small steel point forming a striker for the fulminate.

When the shell is fired the plunger is forced to the rear, driving the safety-plug into the shell. The small wires being free to let the plunger drive forward, hold it steady with the rotation of the shell and keep it from

dropping forward on the descending arc of a high trajectory. On impact the plunger drives forward and the little magazine is exploded by contact with the steel point.

The *Desmarest nose-fuse* has the merit of simplicity of construction, although, as it is intended to act by direct impact, it is unreliable on graze. It consists of a gun-metal body (A), which screws into the shell and has a shoulder shaped to the ogive. In the base of the chamber of this body a percussion-cap (*a*) is inserted mouth down, and occupying the same position as the safety-plug in ordinary fuses. A plunger (B) of light wood having an iron striking wire (*b*) fixed in its base, is pressed tightly into the open nose of the fuse and is held secure by two brass suspending wires. The nose of the fuse is closed water-tight by putty. The plunger being very light is sufficiently supported against the shock of discharge by the suspending wires.

No preparation is necessary before using this fuse, and, as above stated, it acts by direct impact, the plunger being driven down and thus exploding the cap.

TO DISMOUNT THE PIECE.

Raise the button and open the breech-door, taking care to press the mainspring with one hand to keep the door from flying open.

Withdraw the firing-pin by pulling it straight out.

Turn the mainspring completely over, take out its swivel-pin, when the former can be removed. [Note that unless the spring is in this position, *i. e.*, turned completely over, the swivel cannot be taken out nor put back.]

Unscrew the stop-pin of the extractor-crank and turn the crank-handle until the line marked "dismount" on the rear disk corresponds with the arrow on the breech.

The worm-shaft is drawn out by pulling on the crank-handle, the extractor-crank and worm being carefully stripped and carried out of the breech.

The hand-crank can afterwards be detached from the worm-shaft. Should the worm-shaft stick a hooked bar may be inserted in the breech, the hook against the end of the shaft and the angle supported by the breech-

wall, the long arms being pushed ; or, the bar may be used on that part of the shaft outside the gun.

Pull out the extractor, and then the loading-piston.

Unscrew the stop-pin of the cog-wheel and withdraw the latter. This should only be done exceptionally.

Loosen the stop-screw of the hinge-pin belonging to the breech-door, pull out the pin and remove the door.

The gun should rarely be dismantled completely, and, if possible, only at an arsenal or navy-yard. The piece is taken entirely apart in the following manner :

The mechanism being dismantled, turn the barrels until the arrow marked "dismount" on the rear barrel-disk coincides with the one on the upper face of the breech.

Remove the closing screw from the mounting-hole and drive out the locking-bolt of the pin-wheel by the application of a drift and hammer. Causing the "dismount" arrow to assume the above position brings the locking-bolt in line with the mounting-hole, the small end of the bolt being presented.

Unscrew the pin-wheel. Should it stick, its turning with the shaft and barrels may be prevented by inserting a piece of wood in the teeth (for example, the handle of the hammer). The barrels may then be turned by hand, causing the main shaft to be screwed out of the pin-wheel, which can then be removed.

Unscrew the four bolts which secure the frame to the breech and draw the latter off backwards, taking care to support the barrels.

Remove the group of barrels.

The barrels are never unscrewed from the disks, except to replace a damaged one. This operation must always be done in a proper workshop.

TO ASSEMBLE THE PIECE.

This operation is done very nearly in the inverse order of the dismantling. Supposing the piece has been taken apart completely, the order is as follows:

Place the group of barrels in the frame, inserting the front journal of the shaft in its bearing; and after lifting the breech onto the frame, push it

close to the barrels, introducing the rear journal of the shaft in its seat in the front face of the breech.

Before the breech is wholly in place, the pin-wheel should be screwed to the shaft, and as soon as it is home, which will be shown by the correspondence of the arrows on it and the shaft, the group of barrels must be revolved by hand until the arrow on the rear disk, marked "mount," is opposite the one on the breech. In this position the seat of the pin-wheel locking-bolt is in line with the mounting-hole. Drop the locking-bolt in and drive it home with a drift and hammer. This must be done carefully, as otherwise the pin will rub during the revolution of the barrels. To ascertain if this is the case, turn the group by hand, and if any difficulty is experienced, and the bolt has been inserted as far as possible, remove it, grind the head, and replace the pin.

Put in the closing screw, and also the screw-bolts that unite the breech and frame.

Enter the cog-wheel in its place and secure it with its stop-screw.

Put in the loading piston and push it forward until the arrow on it is opposite that on the left side of the trough.

The extractor is now placed in its guide-way, the teeth in the rack engaging in those of the cog-wheel.

Insert the worm-shaft, and as it passes the right bearing, slip on the worm, and then the extractor-crank, the stud of which has been previously inserted in the link. The most convenient position for doing this is when both lie almost in the same direction towards the rear and bottom of the breech. For this purpose the feather on the shaft should be up. When effected, engage the stop-screw in the crank-boss.

The hand-crank is put on the worm-shaft, the groove and feather being placed to correspond, and the latch engaged in its notch.

Bring up the door, pass the hinge-pin in from the right, taking care that its groove is properly arranged for the extractor-link, after which its securing-pin may be put in.

Fasten the mainspring to the breech-door, observing the instructions concerning this part, given in the directions for dismounting. Turn the spring over.

Insert the firing-pin.

Close the breech-door and screw down the button.

ACTION OF THE MECHANISM.

By turning the hand-crank, the entire mechanism is caused to move. The worm engages between the two lowest studs on the pin-wheel, and while the straight part of the thread is passing between them the barrels are stationary, but as soon as the helix is reached they commence to revolve. The stud of the extractor-crank being constantly in the link, the rotation of the former causes the latter and with it the rack to move to and fro. As the cog-wheel is geared with this rack, and with the one joined to the loading-piston, a forward or backward movement on the part of the extractor is accompanied by an opposite one on the part of the loader. The arrangement is such that their velocity is at the maximum while the barrels are at rest, which is while the straight portion of the worm-thread is passing between the studs on the pin-wheel. The cam pushes back the firing-pin, thereby compressing the mainspring, and as soon as the shoulder on the cam is passed the pin is thrown violently forward by the spring.

We may now follow the operations of the piece through one cycle of its operations. The crank being turned, the loading-piston slides to the rear, and as soon as the lifter clears the feed-gate, the latter drops, allowing a cartridge to fall from the feed-trough into the receiver. The piston returns and forces the cartridge almost wholly into the barrel, the lifter raising the feed-gate and cutting off the supply. During this period the straight part of the worm-thread has been between the lowest studs on the pin-wheel, but as soon as the cartridge has entered the barrel the helix comes in contact with the studs, forcing the barrels one-fifth of a revolution to the right. Suppose now that this operation has been repeated until all barrels but one are loaded. The crank is now at the firing-point, the hook on the firing-pin being at the shoulder of the cam. The feed-gate is down, the loading-piston is at the rear of its course, and a cartridge has dropped in front of it; barrel No. 1 is in line with the loading-trough; barrel No. 2 is at the right upper quarter with its cartridge almost home; barrel No. 3 is at the right side with its cartridge completely home; barrel

No. 4 is at the lowest point ready for firing; barrel No. 5 is at the lower left quarter with its empty cartridge-case. The firing-pin is at its rear limit ready to drop from the cam, and the extractor is at its front limit with its claw around the head of the case on barrel No. 5. The straight part of the worm-thread has just entered between the lowest pins. Commencing to turn the crank, this part of the worm travels between the pins, the barrels remain stationary, the cam releases the firing-pin which fires barrel No. 4. The extractor and loading-piston move in opposite directions, the former pulling out its case, and the latter driving in its cartridge and lifting the feed-gate cutting off the ammunition in the feed-trough. The crank is now 180 degrees from its starting point, the spiral part of the worm is entering between the pins, and the extractor and loading-piston are about to reverse their directions, having completed their work. The barrels commence to revolve and the firing-pin to move backwards. The cartridges in barrels 1 and 2 sliding up the inclined plane, are pushed home, the one in No. 3 comes to the firing-point, the fired case in No. 4 moves to the extractor, and barrel 5, which is empty, comes up in front of the receiver for a new cartridge.

Thus, while the motion of the crank is continuous, that of the barrels is intermittent. During each stoppage a cartridge is introduced in one barrel, another is fired in a second, and a case is extracted from a third.

DIRECTIONS CONCERNING MANAGEMENT.

DIRECTIONS CONCERNING THE MANAGEMENT OF THE REVOLVING CANNON BEFORE, DURING, AND AFTER FIRING.

MANAGEMENT BEFORE FIRING.

Before firing a careful examination is made of—

- (a) The gun.
- (b) The equipments.
- (c) The ammunition.

(a) *Examination of the gun.*—After all oil-holes have been filled, the hand-crank is put on, the breech-door opened, and the crank slowly turned to see that all parts of the mechanism move properly, and that the worm-thread is free from burs. Should any be found they must immediately be removed by the armorer, and the damaged parts well oiled. The extractor-hooks are then examined; they must not be injured.

After ascertaining that the mechanism is correctly assembled, it is lightly oiled, the firing-pin replaced, the breech-door closed, and the whole set in motion, to make certain that the barrels revolve smoothly. The rotation must be performed easily, uniformly, and without special effort. Should a small resistance be experienced while turning, the cause might be due to a bur on the butt-plate. This is sometimes caused by back action of the firing-pin due to the gun not being properly assembled. The barrels should, in the first place, be revolved several times to see if grinding will not remove the bur. If this does not succeed, and the resistance is of such a nature

that miss-fires are to be feared, the obstruction must be gotten rid of by the armorer, who should use a scraper. A file should never be employed.

The firing-pin must be examined before it is inserted to ascertain if the point is straight and uninjured, as otherwise burs might form on the butt-plate, rendering miss-fires liable to happen.

Filing the firing-pin is prohibited, because it injures its proper working, causing miss-fires to occur, either through its striking the primer eccentrically or with insufficient force.

The various sites and their seats are marked with their respective gun-numbers, and should be carefully scrutinized.

The carriage or mount must receive attention, and the brakes and elevating-gear tested.

All oil-holes must be filled with oil.

(b) *The equipments.*—The equipments are entered on an inventory, which should be verified before going into action. Each article bears the number of the piece to which it belongs. The list of equipments is given on page 19.

(c) *The ammunition.*—Since obstacles in loading are generally caused by badly made or deformed cartridges, the ammunition should be carefully examined before it is used. On account of the peculiar construction of the gun, this cannot be done during the firing. The ammunition must not exhibit any deformation, and the projectile must sit firmly and centrally in its case. Special care is to be taken to see that the fuse is firmly screwed in.

MANAGEMENT DURING FIRING.

Since both the method of firing and the construction of the gun neither render possible nor necessary any particular manipulation while in use, only the following points are to be regarded.

(1) During the firing all parts rubbing on each other must be kept well oiled.

Oil-holes are (a) on the hand crank; (b) on the worm-shaft; (c) on the barrel-shaft, on the upper front face of the breech, and in the front cross-piece of the frame.

(2) The loading number must not place his hands on that part of the frame-bar in front of the breech, as they are liable to be crushed when the revolution of the barrels commences.

(3) The loading number should always insert two fingers in the slot of the feed-case and press lightly on the cartridges in order to prevent any from entering obliquely into the receiver, which would cause obstacles to arise in loading. When firing under an angle of great depression, care should be taken that the feed-trough is always supplied with cartridges, as otherwise the last one is liable to fall obliquely into the receiver and interfere with the revolution of the barrels.

(4) If while revolving a resistance should be manifested which cannot be overcome without great effort, the service is to be stopped immediately, and the cause of the obstacle searched for, which might be due to one of the following:

(a) On account of inattention on the part of the loading number, a cartridge has entered the loading trough in a wrong position, and cannot be pushed into the barrel. The cartridges lying above are removed, the one in question placed properly, and the service continued.

(b) In case none of the cartridges in the feed-trough impede the revolution, the stoppage may be due to one already in one of the barrels; and in most cases it will be found that some cartridge has not been completely pushed in. In spite of previous examination, it may happen that a cartridge has been injured in transportation, that the projectile has become loosened in the case, or that the shell has increased in size, especially near the head. The breech-door is carefully opened, the firing-pin taken out, the cartridges in the feed-trough and receiver removed, and the hand crank slowly turned backwards, until the cartridge in question comes in front of the receiver, when it is extracted either by hand, the screw-driver, or by means of the rammer inserted from the front. Afterwards, having ascertained by further turning that the movement is not impeded, the firing-pin is replaced, the breech-door closed, and the service continued.

(c) It is important that the hand crank should be in the position immediately succeeding the firing of a cartridge at the moment the receiver is about to be filled; otherwise the first cartridge which falls into it will gen-

erally prevent the loading-piston from raising the feed-gate, causing the movement to be sharply arrested. The feed-trough must be removed, the cartridge in the receiver taken out, and the hand crank placed as stated above.

(*d*) A cartridge has missed fire, which will not be detected on account of the rapid uninterrupted firing. The extractor has loosened and withdrawn the case, leaving the projectile fast in the barrel, so that there is not sufficient space left for the following cartridge to enter. The firing-pin and cartridges in the feed-trough, as well as the one partly in place, are removed by hand, and the projectile remaining in the barrel driven out by the rammer inserted in the muzzle. The scattered powder is swept from the trough and barrel, and the firing resumed.

(*e*) In case of a miss-fire it sometimes happens, especially when shooting under an angle of depression, that the cartridge-case after being extracted does not fall freely. The hand crank must then be lightly moved, first backwards and then forward, which in general will be sufficient to disengage the case.

(*f*) Should the extractor break, which will be indicated by irregular extraction, the mechanism must be dismantled, the broken hook changed, and the fired shells removed. This is accomplished by turning the barrels so as to bring them successively before the loading-trough, where they are drawn out by hand or pushed back by the rammer.

(*g*) The butt-plate may become deteriorated by the shock of the pin, and in this case must be removed and replaced by a spare one. This necessitates the dismantling of the mechanism and the separation of the breech from the barrels.

(*h*) If other causes hinder the entrance of a cartridge—as, for example, if a primer is knocked out—the cartridge is removed, and the obstacle dislodged with the hand or by a suitable instrument.

(*i*) The extractor tears the head from a fired cartridge and leaves the case in the barrel, the succeeding cartridge, coming in contact with the case, sticks and cannot be wholly pushed in. The firing-pin is taken out, and the cartridges in the feed-trough, the receiver, and in those barrels which precede the clogged one are renewed, and the latter brought in front of

the receiver by turning the handle backwards. Generally this cartridge is so tightly wedged in that it cannot be withdrawn by the hand or the screw-driver. In that event it is driven out by the rammer, the case removed, and the service continued.

(k) If the stoppage of the turning has any cause other than those mentioned, which is not immediately recognized, the firing-pin and ammunition are removed, and the gun thoroughly gone over.

In the first place, the proper position of the barrels in the disks is to be examined to ascertain if the lines on the barrels are opposite those on the rear disk. If no essential deviation is found here, then a search is to be made to see whether the revolution is obstructed by any little bur, which has formed on the butt-plate, either through the rubbing of the firing-pin or by defects in the cartridge-head. To ascertain this a thin plate is put between the butt-plates and rear disk. Generally burs are effaced by the action of the cartridges themselves, but sometimes they produce no effect on them. When this is the case, the group of barrels must be separated from the breech, and the obstructions cleared away by the armorer, who must not remove any metal from the butt-plate.

In addition, the movement may be impeded through injury to the mechanism in consequence of insufficient care in putting together the worm and pin wheel the mainspring and firing-pin or extractor-crank and link. The damaged parts are to be well oiled, and the crank turned to see if the difficulty cannot be obviated by the mutual rubbing of the various members. If this is not sufficient the armorer must attend to the matter. The use of sharp instruments is prohibited.

If the examination should reveal a deviation between the lines on any of the barrels and the corresponding ones on the rear disk, it shows that the barrel in question no longer occupies its proper position. This is of importance only when the space between the barrel and butt-plate has been diminished to such an extent that the extractor-hooks are ground by the rotation, or the cartridge-head strikes the plate before it is in the firing position. In this case the repairs needed are of a more serious nature, since, in general, the disks will have to be replaced by new ones.

Any screwing of the barrels is forbidden, except when it is noticed that the grinding of the extractor-hooks is becoming so considerable that the further use of the gun is endangered. Only rarely should a loosened barrel be screwed back into the disk.

Finally, in order that no interruption should occur in the firing, the feed-trough should always be supplied with ammunition and the crank turned with perfect uniformity. The habitual rate is thirty revolutions per minute, which may be increased to sixty in exceptional cases. Whenever the gunner at the crank experiences any difficulty in turning, he should promptly stop, and the cause searched for, which will probably be found in one of the foregoing.

UNLOADING.

After the order is given to cease fire, the cartridges remaining in the barrels must not be discharged, but the gun is to be unloaded in the following way:

Open the breech-door and let it down carefully; that is, care should be taken that it does not fall down. Take out the firing-pin and turn the group of barrels back by means of the crank, bringing the loaded barrels successively in front of the loading-trough, where the cartridges are removed. This is done either with the fingers or else by putting the end of the screw-driver between the cartridge-head and the barrel, and pushing the cartridge into the trough. Should it fit the barrel too closely, the rammer is inserted in the barrel from the muzzle, and the cartridge carefully driven out. In this case, in order to avoid any chance of injury occurring to the gunners, a light rope is fastened to that part of the staff projecting from the muzzle, the ends of the rope being in the hands of the necessary men, who then haul back on the line.

It is strictly forbidden to unload the piece with the extractor while turning the crank, because by so doing the case is easily torn from the projectile, or at least loosened, and the cartridge rendered useless.

MANAGEMENT AFTER FIRING.

After firing, the gun, as a rule, can be cleansed without dismounting the mechanism, because the cartridges when properly fabricated allow no

escape of gas to the rear, and hence fouling of the parts in the breech can occur but to a small extent. In this case, the barrels are carefully and thoroughly washed with soap and water, dried, and oiled with a flannel rag. The gun should be elevated, and the barrels be brought successively in front of the ejector-hole and then washed, in order to prevent any water entering the breech and fouling the mechanism. The latter is thoroughly wiped throughout with cotton waste and oiled, the crank being turned to aid the operation. On the exterior the barrels are washed with fresh water and dried.

After long use the entire piece should be thoroughly cleaned.

The interior.—(a) *The barrels.*—Having dismantled the breech mechanism, depress the gun so that the water will escape through the muzzle, bring each barrel successively in front of the loading-trough, close its rear end by a wooden plug (kept in the equipment-chest) surrounded by a greased rag, wet the sponge, introduce it in the muzzle, and continue until the water issues in as clear a state as it enters. Dry the bore with rags placed on the end of the staff.

(b) *The mechanism.*—Wash and dry, successively, with the greatest care those parts of the mechanism which have been fouled during the firing, viz, the point of the firing-pin, the extractor-hooks, link, and rack, the cog-wheel, the loading-piston and rack, the extractor-crank. Wash and dry the exterior of the worm. Clean the worm-shaft, the mainspring, and button with dry rags. Treat in the same way such parts of the interior of the breech as are not varnished, particularly the channels of the firing-pin and loading-piston; the latter with a wiper-brush covered with cloth. Screw-holes, bearings for the worm-shaft, breech-door hinge, pin and channel of the button must be similarly cleaned. Those portions of the breech from which the varnish has disappeared should be given a coating in the manner described below.

The exterior.—The entire piece may be washed and dried, and those parts which are not varnished or lacquered (the barrels, for example) should be oiled. The butt-plate and entire front face of the breech can be cleaned by a rag wrapped around a flat copper strip, and put between the breech and rear disk.

Varnishing.—The exterior of the barrels and certain parts of the interior of the breech are covered with a layer of varnish or lacquer, and in cleaning they should not be rubbed with greased rags. If the varnish has disappeared in any place, it should be renewed in the following manner: Clean the part with spirits of turpentine, and wipe with a dry rag. Apply the varnish, and as soon as it adheres so as to form a continuous surface this part of the operation is finished. When the coat is dry, it should be wiped with a rag or brush, and then varnished cold, using a brush almost dry, and taking care to make the edges join the uninjured part so as to show no joint or break in the surface.

The varnish is composed of Spanish white infused in water mixed with $\frac{1}{10}$ part of alcohol. The operation should be performed if possible in a warm place free from dust.

Rust and Verdigris.—Rust on iron and steel must be removed by repeated oiling, and rubbing with linen or flannel rags, or with a piece of wood. Verdigris on brass or bronze should be softened with hot water and taken off by attrition.

The use of files or brick dust is absolutely forbidden. Should the mechanism be very much rusted, which will rarely be the case, it must be taken apart and cleaned with emery. This operation must be done by skilled labor only, and under the immediate supervision of a master mechanic or of an officer.

Oiling.—The mechanism having been dismantled, and its various parts, together with the barrels, having been washed and carefully dried with woolen rags, the several bores and such places in the interior of the breech as are not varnished are oiled. The guide-bed of the loading-piston is treated in a similar manner by means of an oiled rag wrapped around a sponge head. An oiled brush or rag is then passed over all parts of the mechanism. An excess of oil on the worm or pin wheel need cause no misgiving. Wipe and then oil the breech ends of the barrels by causing them to pass in front of a sponge, covered first with a dry cloth and then with an oiled one, the sponge being placed in the loading-trough. Wipe and oil the front face of the breech by putting in the rear end of one of the barrels a plug covered successively with a dry and an oiled rag, and causing the

barrels to revolve. Oil lightly the swivel-pin of the mainspring and both bearings of the worm-shaft; and when the piece is assembled grease with an oiled rag the exterior of the worm-shaft and the hand-crank. The door-hinge pin, that of the feed-gate, the button, and the trigger mechanism of the 1.85-inch naval guns, should also be oiled and the oil-holes filled. When the breech is separated from the barrels wash its front face with the greatest care, and then oil it. This applies also to the rear ends of the barrels.

THE AMMUNITION.

The fired cases must, when practicable, be collected after the firing has ceased. If possible a receptacle, such as a bucket or tub, should be placed under the ejector-hole to receive the cases as they drop out. They should be washed with warm water and soap within thirty-six hours, the primer having been previously driven out with the tools usually employed for this purpose. The cases are dried and reloaded if practicable; otherwise they must be turned in to the proper depot, where this will be done.

GENERAL RULES.

Fill oil-holes before firing.

Never grease varnished parts.

Never unscrew a barrel.

The use of files or sharp cleaning materials is forbidden.

Unnecessary turning of the mechanism is forbidden, because its principal parts when thrown into action are just as much strained and worn when firing is not taking place as when it is.

Whenever the interior of the piece is examined commence by removing the firing-pin.

TACTICS.

The field-gun.—The field tactics of this piece do not differ materially from those published for the Gatling gun, in Tidball's Artillery Manual, page 170 *et seq.* Due regard should be paid to Part II of this report.

APPENDIX.

THE NAVAL GUNS.

The naval guns are made in three sizes, as follows:

The 1.45-inch (37^{mm}), designed for defensive service against torpedo-boats and effective offensive service against open-deck batteries, or in boat and naval brigade work.

The 1.85-inch (47^{mm}), and the 2.1-inch (53^{mm}), designed to do the same work as that attributed to the lighter gun, except that they are excluded by their weight from boat and naval brigade service. The power of these guns is sufficient to enable them to take part in the same work attributed to the main batteries of vessels of war.

The general features of these guns do not vary from what has already been described, except such as are necessitated by the requirements of a different service. The dimensions, weights, &c., of the material and ammunition are set forth in the tables on pages 50, 51, 52.

The guns.—The 1.45-inch gun is arranged so as to follow a shifting target, such as a torpedo-boat. It is, therefore, necessary that the gunner who aims should have control of the firing. This is effected in the following manner: A stock or shoulder piece shaped like a

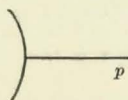

is tenoned at *p* and enters a mortise in the rear end of the left-frame bar, where it

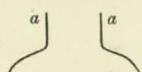
is held by a spring. A handle  is joined to the under side of the breech by the screws at *a a*. The hand-crank on the end of the worm-

shaft is replaced by a bevel-wheel, which gears into another secured to the end of a short shaft, extending obliquely downwards to the rear. The hand-crank is attached to the outer end.

The curved branch of the stock rests against the left shoulder of the gunner, who stands directly behind the piece with his eye on the sights. His left arm is on the outside of the stock, the hand grasping the handle. The right hand at the crank controls the firing. The piece has no recoil, and is mounted so that the gunner can point it in any direction. There is a line scored on the small shaft, and another on its bearing attached to the frame. Near the first the word "Fire" is engraved. When the two lines coincide the firing-pin is about to slip off the cam. The gunner is enabled by a glance to tell when his piece is about to fire.

The 1.85-inch gun being considerably heavier, a second man is required at the crank. The handle under the piece is also dispensed with, but the stock is arranged to compensate for it, as shown in Plate XV. Here the gunner grasps one of the handles. To give him control of the firing, a trigger is provided. It (Plates III and XV) is a bent lever pivoted at the angle, and connected to the lower end of a sear by a bolt in the usual way. The sear travels in the hole made for it in the bottom of the breech, and is constantly pressed upwards by the sear-spring acting on its foot, except when the trigger is pulled. The projection on the upper face of the sear engages in the firing-pin notch when the latter is over it. If rapid firing is desired, the gunner simply holds back the trigger. This device occurs only in the 1.85-inch naval gun.

The 2.1-inch gun does not differ from the Army patterns.

THE SIGHTS.

The 1.45-inch gun.—The rear sight is composed of a base, four assembling screws, a spring, a pivot, and a leaf. The first four parts are similar to the corresponding parts on the sight of a musket, and need no particular description. The leaf is a bar having its right edge serrated. The alternate teeth are pointed, and the others are prolonged and have notches on the upper edge. The points and notches correspond to such units (100 meters, 100 yards cable lengths, &c.) as may be prescribed. The leaf is arranged

for the natural drift of the projectile. When not in use the leaf lies flat on the breech-piece.* The position of the sight is on the breech a little to the right of the axis of the piece.

The front sight is the same as for the heavy field-gun, except that it is screwed into a socket formed in a strap which spans the frame-bars over the front barrel disk. The socket is to the right of the axis of the piece.

The 1.85-inch gun.—The rear sight consists of a stem, support, and slide. The stem is a rectangular steel bar, graduated on one face, and toothed so as to form a rack on the opposite. It rests in a support, and is moved vertically by a pinion. The *slide* consists of a *box*, a *sight-plate*, and *translating-screw*. The box is fastened permanently to the top of the stem, and contains the bearings for the translating-screw. The sight-plate has a boss projecting from its lower face, through which the translating-screw passes, the rotation of which imparts a lateral movement to the plate. This sight is placed on the top of the breech to the right of the axis of the piece, and in front of the worm-shaft. The *front* sight is the same as used in the 1.45-inch gun.

The 2.1-inch gun.—The rear sight, same as for the light field-gun, except that the support is fastened to the left frame-bar. The *front sight* is the same as for the light field-gun except that the support is on the left-frame bar.

THE CARRIAGES.

The 1.45-inch gun.—This has three mountings provided for it, two for service at sea and one for operations on land.

Sea service.—The mounts are either for the rail or deck, and may be used either on ship or in boats. The principles of construction are the

same in both, and are as follows: A -shaped casting similar to Fig. 2, Plate XVIII, constitutes the fork. The trunnions rest in the upper branch, and the lower forms a pivot which rests in the socket. This part is either a

*The French navy have under test and will probably adopt a modification of this, called the ladder sight, whose main difference is simply that in place of a single upright two are used, the notches joining the two like the steps of a ladder. It is less liable to get twisted, and it is also claimed that it gives greater steadiness to the eye. As yet it is not a standard sight.

flanged casting bolted to the rail of the deck or a pedestal similarly secured to the deck. This piece with its fork can be shifted from one carriage to the other. There are two clamps provided, one for locking the pivot and the other the trunnions (see Plate XV).

For land service the carriage resembles the Army one in size and weight, but the trunnion-saddle is replaced by the pivot-socket, so that the gun with its fork can be transferred to it. The elevating apparatus is also modified, and the limber is arranged for hand draft.

The 1.85-inch gun.—Its weight being too great for hand draft, this piece has no land-carriage. For use on ship the mounts are similar to those for the 1.45-inch gun, viz, the rail and the deck mount. The latter is called the "crinoline carriage," from its shape.

The boat-carriage is of a peculiar type, consisting of a heavy bed-plate, mounted on rollers for fore and aft traverse, and having a pivot-bolt at each end and a large pivot in the center. On this central pivot is mounted a gun-carriage, whose rear end is arranged with transverse gear which connects with its bed-plate. This carriage also has elevating-gear.

The 2.1-inch gun.—This piece has but one carriage, that for the deck, the boat, land, and rail mounts being omitted. It consists (Plate XXII) of heavy circular bed-plate provided with bolt-holes for securing to deck. The central part is raised and fastened to another disk, the curved surface of which is provided with teeth. The top carriage is composed of two trapezoidal-shaped brackets, connected by transoms, and furnished with the usual elevating apparatus. The pivot, which is central, passes through the bed, the carriage being non-recoil. The traversing handle is on the left. It is connected by bevel-wheels to the worm-shaft, passing through the brackets. The worm-thread gears in the teeth on the upper plate.

THE EQUIPMENTS.

These do not differ essentially from those supplied with the Army guns.

Army material.

GUNS.

	Light field.		Heavy field.		Flank defense.	
	English.	Metric.	English.	Metric.	English.	Metric.
Caliber	1.45 in.	37 mm.	1.45 in.	37 mm.	1.57 in.	40 mm.
Length of gun.....	46.4 in.	1,180 mm.	70.4 in.	1,790 mm.	70.4 in.	1,790 mm.
Extreme length (to end of crank when turned to the rear).....	53.4 in.	1,360 mm.	74.8 in.	1,900 mm.	74.8 in.	1,900 mm.
Length from trunnion centers to face of breech.....	19.7 in.	500 mm.	27.9 in.	710 mm.	27.9 in.	710 mm.
Distance between trunnion faces.....	16.3 in.	415 mm.	19 in.	484 mm.	19 in.	484 mm.
Mean height of trunnion centers above tread.....	35 in.	890 mm.	42.4 in.	1,080 mm.	47.2 in.	1,200 mm.
Length of gun-barrel.....	29.1 in.	740 mm.	50.1 in.	1,276 mm.	50.1 in.	1,276 mm.
Number of barrels.....	5	5	5	5	5	5
Weight of each barrel.....	30.8 lbs.	14 k.	79 lbs.	36 k.	75 lbs.	34 k.
Length of rifled bore.....	24.7 in.	627 mm.	43.4 in.	1,121 mm.	43.6 in.	1,176 mm.
Total length of bore in calibers.....	20	20	34.5	34.5	32	32
Lands:						
Number.....	12	12	12	12	12	12
Width.....	0.059 in.	1.5 mm.	0.059 in.	1.5 mm.	0.098 in.	2.5 mm.
Height.....	0.0015 in.	0.4 mm.	0.0015 in.	0.4 mm.	0.0015 in.	0.4 mm.
Pitch of rifling.....	6°	6°	6°	6°	(see page).	
Length of line of sight.....	33.34 in.	847 mm.	26.89 in.	683 mm.	27.75 in.	705 mm.
Height of line of sight above axis of firing barrel.....	4.87 in.	124 mm.	5.66 in.	144.5 mm.	5.12 in.	130.5 mm.
Horizontal distance of line of sight to right of firing barrel.....	6.05 in.	154 mm.	6.85 in.	174 mm.	6.69 in.	170 mm.
Weight of gun complete.....	495 lbs.	225 k.	1,045 lbs.	475 k.	1,162 lbs.	528 k.

Army material—Continued.

AMMUNITION.

	Light field.		Heavy field.		Flank defense.	
	English.	Metric.	English.	Metric.	English.	Metric.
Common shell:						
Length	3.66 in.	93 mm.	4.37 in.	111 mm.
Average number of burst pieces..	15	15	19	19
Ratio of weight to spherical shot .	2.5	2.5	2.86	2.86
Weight empty	14.4 oz.	413 gr.	16 oz.	470 gr.
Weight of bursting charge	0.7 oz.	20 gr.	0.8 oz.	25 gr.
Weight of fuze	1.9 oz.	55 gr.	1.9 oz.	55 gr.
Loaded weight	16 oz.	480 gr.	19 oz.	550 gr.
Case shot:						
Weight	1.25 lbs.	570 gr.	1.25 lbs.	570 gr.	29 oz.	850 gr.
Number of bullets	28	28	28	28	24	24
Weight of each bullet	0.7 oz.	19 gr.	0.7 oz.	19 gr.	1.1 oz.	32 gr.
Diameter of rifling belt.....	1.49 in.	37.8 mm.	1.49 in.	37.8 mm.
Weight of empty cartridge-case	3 oz.	85 gr.	3.4 oz.	110 gr.	8.8 oz.	260 gr.
Weight of powder charge	2.8 oz.	80 gr.	3.8 oz.	112 gr.	3 oz.	90 gr.
Total weight of cartridge complete (common shell)	1.4 lbs.	654 gr.	1.7 lbs.	775 gr.
Total weight of cartridge complete (case shot).....	740 gr.	1.75 lbs.	795 gr.	2.5 lbs.	1,110 gr.
Total length of cartridge complete ...	6.57 in.	167 mm.	8.1 in.	206 mm.	8.1 in.	206 mm.

Army material—Continued.

MOUNTS, CARRIAGES, AND EQUIPMENTS.

	Light field.		Heavy field.		Flank defense.	
	English.	Metric.	English.	Metric.	English.	Metric.
Diameter of wheels	45.2 in.	1,150 mm.	55.1 in.	1,400 mm.	59 in.	500 mm.
Width of tread	47.2 in.	1,200 mm.	60.2 in.	1,530 mm.	37.4 in.	950 mm.
Weight of one wheel.....	99 lbs.	45 k.	187 lbs.	85 k.
Weight of gun-carriage (without shield)	550 lbs.	250 k.	990 lbs.	450 k.	1,276 lbs.	580 k.
Weight of shield.....	220 lbs.	100 k.	282 lbs.	128 k.	176 lbs.	80 k.
Weight of limber (empty)	605 lbs.	275 k.	913 lbs.	415 k.
Weight of limber (loaded)	1,067 lbs.	485 k.	1,452 lbs.	660 k.
Number of rounds in limber	300	300	300	300
Total weight of gun, carriage, and limber fully equipped	2,112 lbs.	960 k.	3,487 lbs.	1,585 k.
Weight of body of ammunition-wagon (empty).....	825 lbs.	375 k.	1,496 lbs.	680 k.
Weight of body of ammunition-wagon (loaded)	2,024 lbs.	920 k.	2,904 lbs.	1,320 k.
Number of rounds in wagon-body.....	800	800	800	800
Number of rounds in wagon-limber ..	300	300	300	300
Total weight of ammunition-wagon and limber fully equipped	3,091 lbs.	1,405 k.	4,356 lbs.	1,980 k.
Total number of rounds transported per gun	1,400	1,400	1,400	1,400
Angle of trail of gun-carriage	29°	29°	27°	27°	38°	38°
Extreme angle of elevation	+18°	+18°	+20°	+20°	+10°	+10°
Extreme angle of depression.....	- 5°	- 5°	- 5°	- 5°	-10°	-10°
Extreme angle of depression with horizontal training apparatus.....	4°	4°	4°	4°

Naval materials.

GUNS.

	37 millimeters.		47 millimeters.		53 millimeters.	
	English.	Metric.	English.	Metric.	English.	Metric.
Caliber	1.45 in.	37 mm.	1.85 in.	47 mm.	2.09 in.	53 mm.
Length of gun	46.4 in.	1,180 mm.	68.1 in.	17.30 mm.	84.25 in.	2,140 mm.
Extreme length, including stock	55.9 in.	1,420 mm.	78.7 in.	2,000 mm.	} Has no stock.	
Length from pivot center to tip of stock	31.5 in.	800 mm.	37.8 in.	960 mm.		
Distance between trunnion faces	16.3 in.	415 mm.	21.5 in.	546 mm.	24.3 in.	618 mm.
Mean height of trunnion centers above deck	46.4 in.	1,180 mm.	46.4 in.	1,180 mm.	35.8 in.	910 mm.
Length of gun-barrel	29.1 in.	740 mm.	46.2 in.	1,175 mm.	56.3 in.	1,431 mm.
Number of barrels	5	5	5	5	5	5
Weight of each barrel	31 lbs.	14 k.	97 lbs.	44 k.	176 lbs.	80 k.
Length of rifled bore	24.7 in.	627 mm.	39.3 in.	998 mm.	47.2 in.	1,201 mm.
Total length of bore in caliber	20	20	25	25	27	27
Lands:						
Number	12	12	20	20	24	24
Width	0.06 in.	1.5 mm.	0.16 in.	1.5 mm.	.067 in.	1.7 mm.
Height	0.16 in.	0.4 mm.	0.016 in.	0.4 mm.	.016 in.	0.4 mm.
Angle of rifling	6°	6°	8°	8°	6° 20'	6° 20'
Length of line of sight	33.34 in.	847 mm.	43.4 in.	1,102 mm.	39.4 in.	1,000 mm.
Height of line of sight above axis of firing barrel	8.24 in.	211 mm.	11.5 in.	294 mm.	7.16 in.	182 mm.
Horizontal distance of line of sight to right of axis of firing barrel	} 1.77 in.	45 mm.	2.16 in.	55 mm.	} To left of barrel.	
Weight of gun including stock					462 lbs	210 k.

Naval materials—Continued.

AMMUNITION.

	37 millimeters.		47 millimeters.		53 millimeters.	
	English.	Metric.	English.	Metric.	English.	Metric.
Steel shell:						
Length	3.74 in.	95 mm.	5.19 in.	132 mm.	6.17	157 mm.
Radius of ogive in diameters	2	2	2	2	2	2
Radius of weight to spherical shot	2.78	2.78	2.95	2.95	2.95	2.95
Weight, empty	15.75 oz.	450 gr.	2.23 lbs.	1,014 gr.	3.33	1,514 gr.
Weight of bursting charge	0.5 oz.	15 gr.	1.6 oz.	45 gr.	2.1 oz.	60 gr.
Weight of fuze	1.4 oz.	40 gr.	1.9 oz.	56 gr.	1.9 oz.	56 gr.
Loaded weight	1.1 lb.	505 gr.	2.45 lbs.	1,115 gr.	3.58 lbs.	1,630 gr.
Common shell:						
Length	3.66 in.	93 mm.	4.99 in.	127 mm.	6.34 in.	161 mm.
Radius of ogive in diameters	2.17	2.17	2.42	2.42	2.55	2.55
Ratio of weight to spherical shot	2.5	2.5	2.85	2.85	2.85	2.85
Weight, empty	14.4 oz.	413 gr.	2.20 lbs.	1,000 gr.	3.31 lbs.	1,505 gr.
Weight of bursting charge	0.77 oz.	22 gr.	1.6 oz.	45 gr.	2.5 oz.	70 gr.
Weight of fuze	0.7 oz.	20 gr.	0.7 oz.	20 gr.	1.9 oz.	55 gr.
Loaded weight	1 lb.	455 gr.	2.36 lbs.	1,075 gr.	3.58 lbs.	1,630 gr.
Case shot:						
Weight	1.25 lbs.	570 gr.	2.44 lbs.	1,110 gr.	4.22	1,920 gr.
Number of bullets	28	28	30	30	58	58
Weight of each bullet	0.7 oz.	19 gr.	1.1 oz.	32 gr.	1 oz.	28 gr.
Diameter of rifling belt	1.49 in.	37.8 mm.	1.93 in.	48.1 mm.	2.14 in.	54.3 mm.
Weight of empty cartridge case	3 oz.	85 gr.	7.7 oz.	222 gr.	10.1 oz.	290 gr.
Weight of powder charge	2.8 oz.	80 gr.	7 oz.	200 gr.	14.3 oz.	410 gr.
Total weight of cartridge complete (steel shell)	1.5 lbs.	6.75 gr.	3.4 lbs.	1,545 gr.	5.1 lbs.	2,345 gr.
Total weight of cartridge complete (common shell)	1.4 lbs.	625 gr.	3.3 lbs.	1,505 gr.	4.5 lbs.	2,345 gr.
Total weight of cartridge complete (case shot)	1.5 lbs.	740 gr.	3.4 lbs.	1,550 gr.	5.8 lbs.	2,630 gr.
Total length of cartridge complete	6.57 in.	167 gr.	9.25 in.	235 mm.	12.42 in.	315.5 mm.

Naval materials—Continued.

MOUNTS, CARRIAGES, AND EQUIPMENTS.

	37 millimeters.		47 millimeters.		53 millimeters.	
	English.	Metric.	English.	Metric.	English.	Metric.
Ship mount:						
Weight of pivot.....	0.77 lb.	35 k.	158 lbs.	72 k.
Mean weight of rail-socket	44 lbs.	20 k.	139 lbs.	63 k.
Weight of fixed stand.....	396 lbs.	180 k.	462 lbs.	210 k.
Extreme angles of elevation and de- pression (ship mount).....	{ +15° -35°	{ +15° -35°	{ +20° -20°	{ +20° -20°	{ +20° -10°	{ +20° -10°
Weight of 53 mm. ship carriage.....	1,672 lbs.	760 k.
Mean total weight of gun and mount (without shield).....	583 lbs.	265 k.	1,562 lbs.	710 k.	3,872 lbs.	1,760 k.
Weight of chest with accessories and spare parts.....	92 lbs.	42 k.	136 lbs.	62 k.	66 lbs.	30 k.
Weight of boat fixtures.....	55 lbs.	25 k.	154 lbs.	70 k.
Weight of boat carriage.....	649 lbs.	295 k.
Landing mount:						
Weight of gun-carriage complete.....	633 lbs.	290 k.
Weight of limber (empty).....	572 lbs.	260 k.
Weight of limber (loaded).....	990 lbs.	450 k.
Number of rounds in limber.....	300	300
Diameter of wheels.....	45.2 in.	1,150 mm.
Total weight of gun-carriage and lim- ber, fully equipped.....	2,090 lbs.	950 k.
Extreme angle of elevation and de- pression (landing mount).....	{ +12° - 5°	{ +12° - 5°
Weight of ammunition box with 60 rounds.....	108 lbs.	49 k.
Weight of ammunition box with 24 rounds.....	105 lbs.	47.7 k.
Weight of ammunition box with 24 rounds.....	147 lbs.	0.67 k.

HOTCHKISS REVOLVING CANNON, CAL. 1.45-INCH. (37 ^m/_m.)

PLATE I.

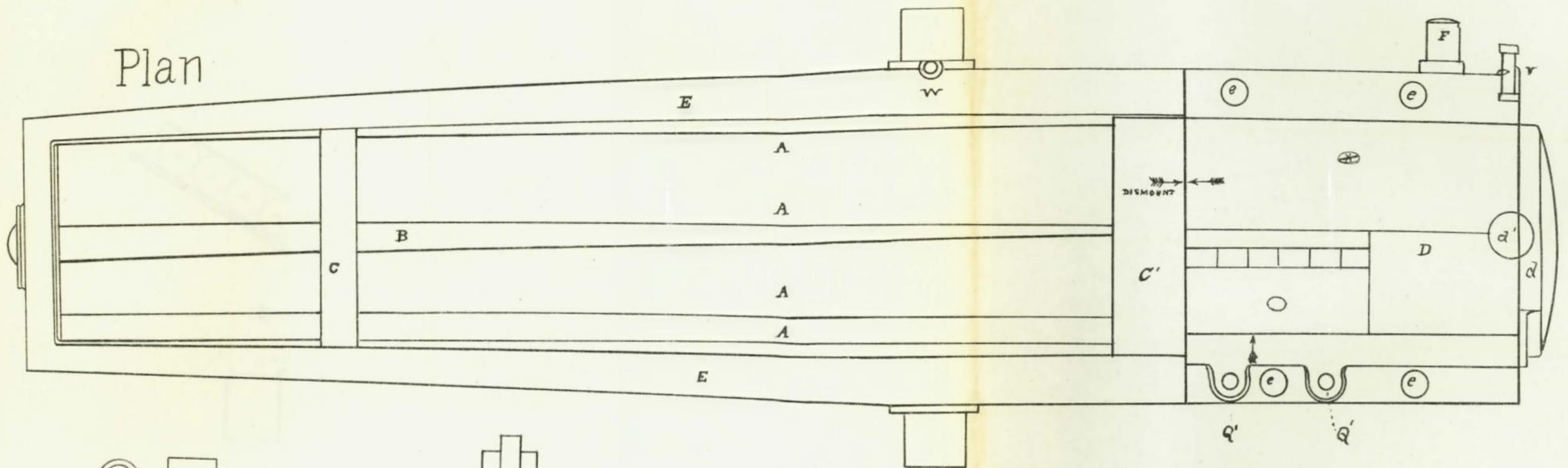

Details of Breech Mechanism

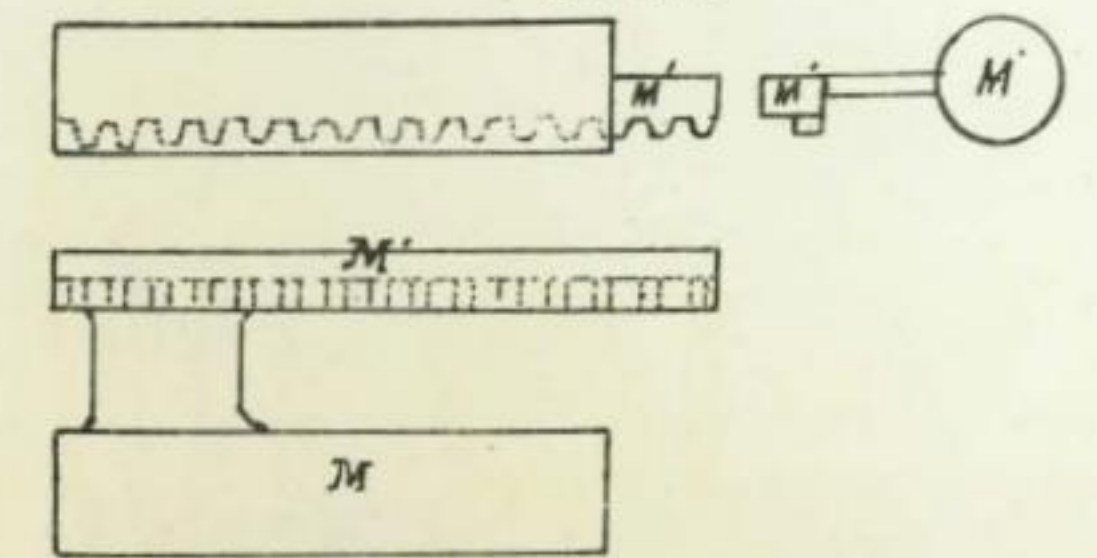
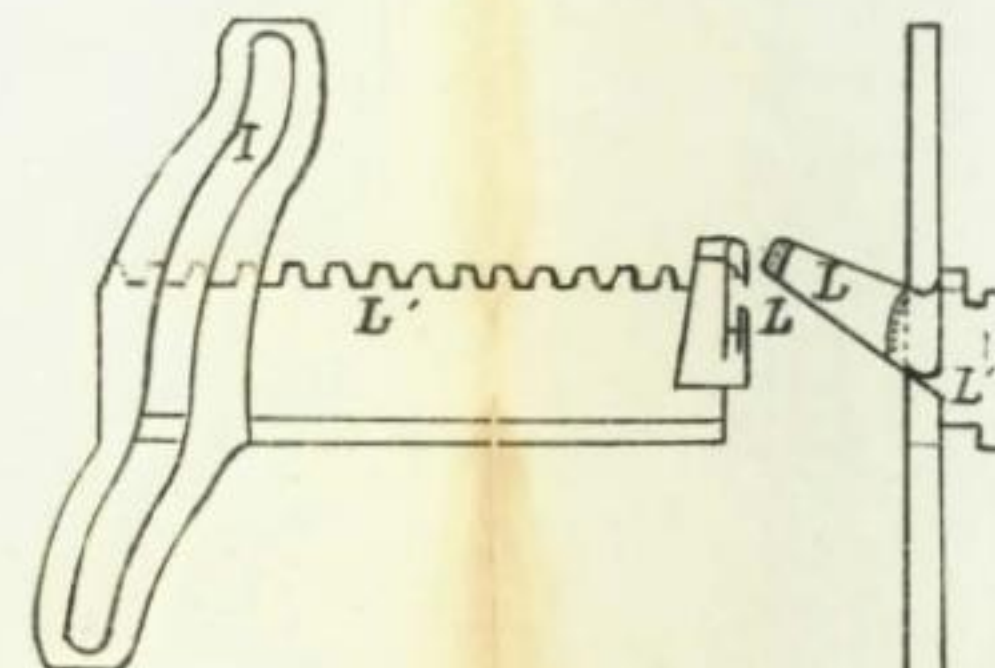
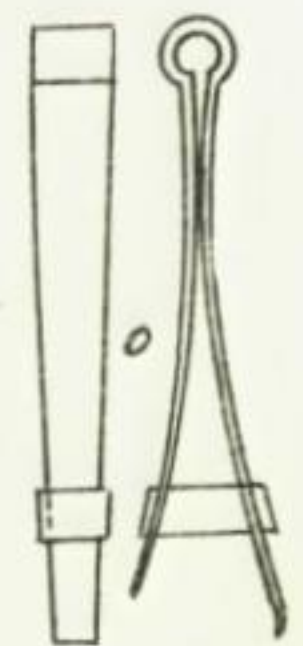
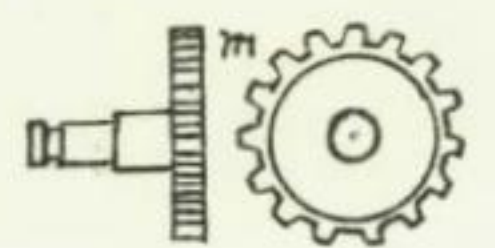
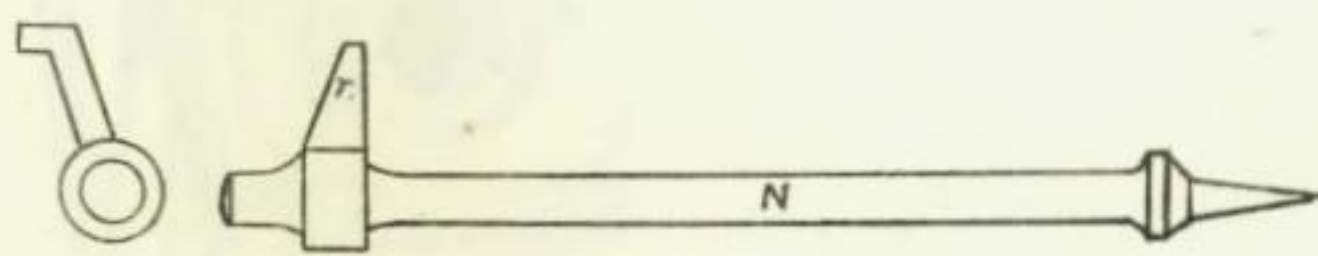
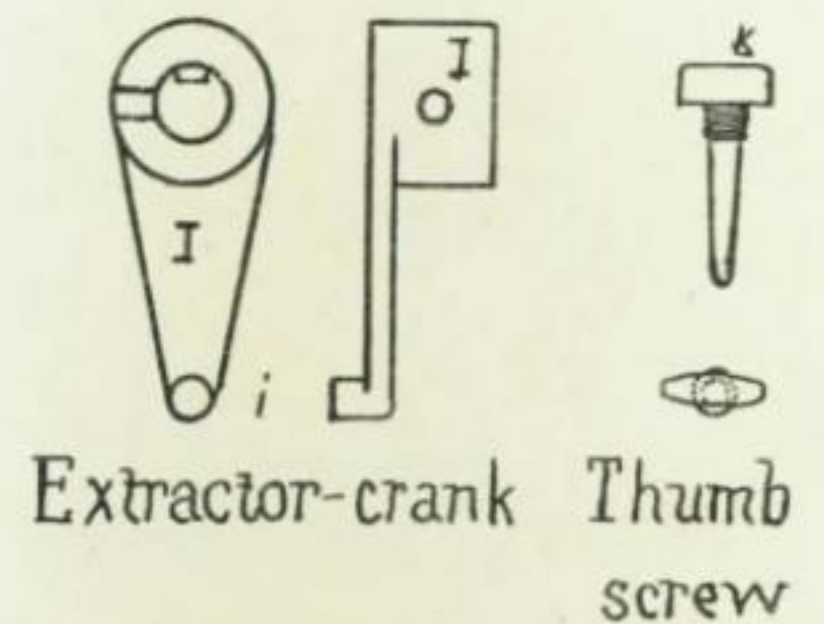
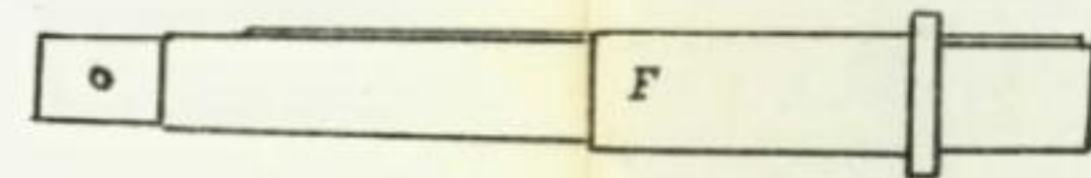
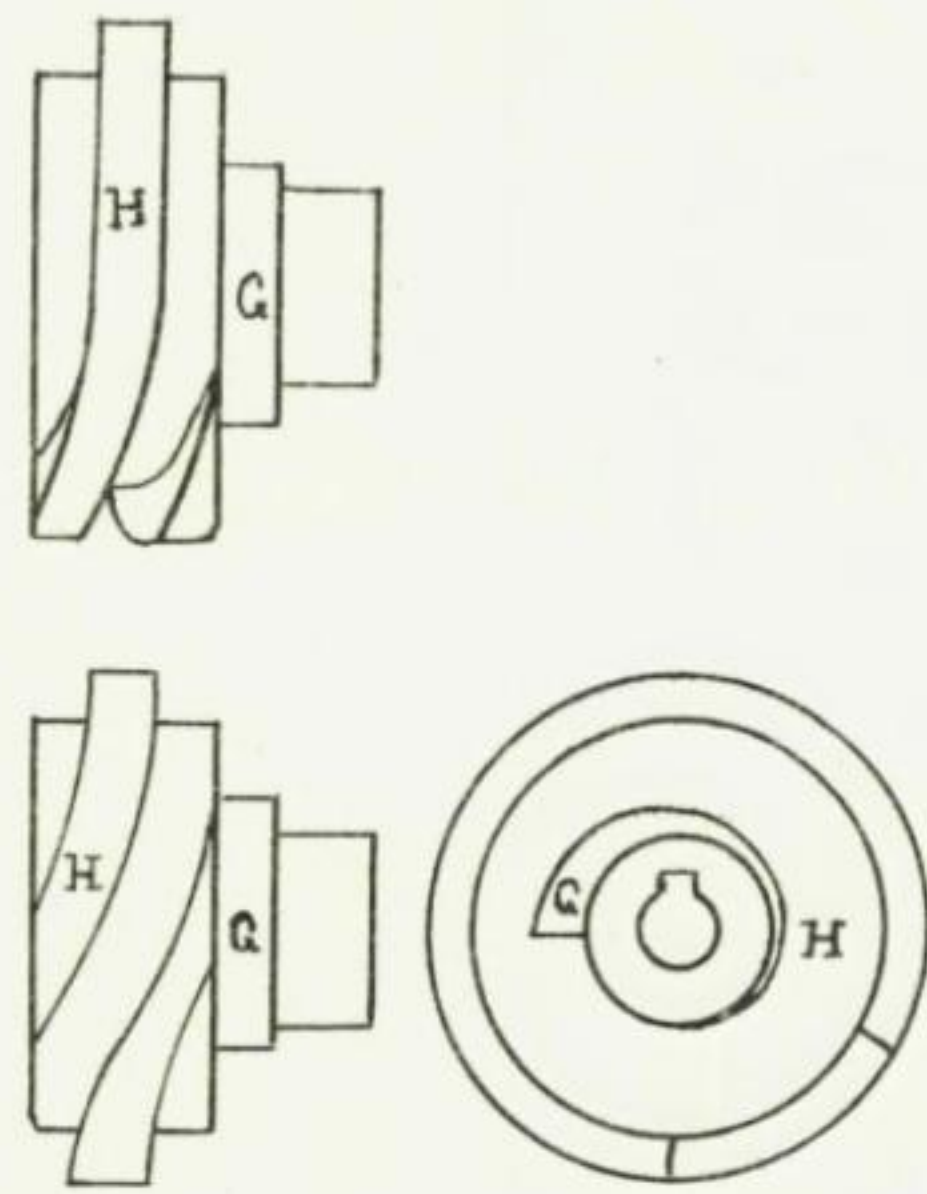
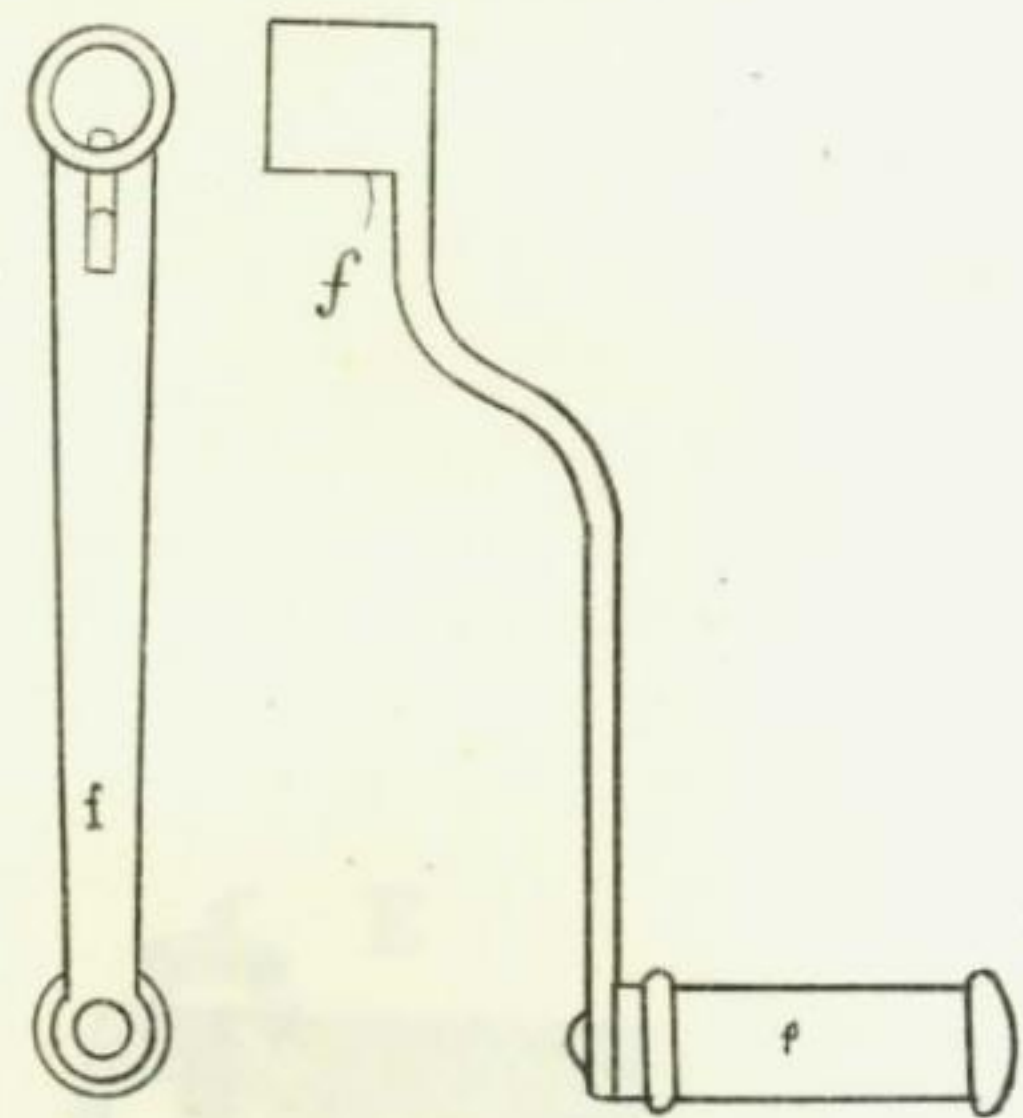

HOTCHKISS REVOLVING CANNON, CAL. 1.45-INCH. (37^m/_{m.}) PLATE II.

Front-view
of breech-block

Section through E F

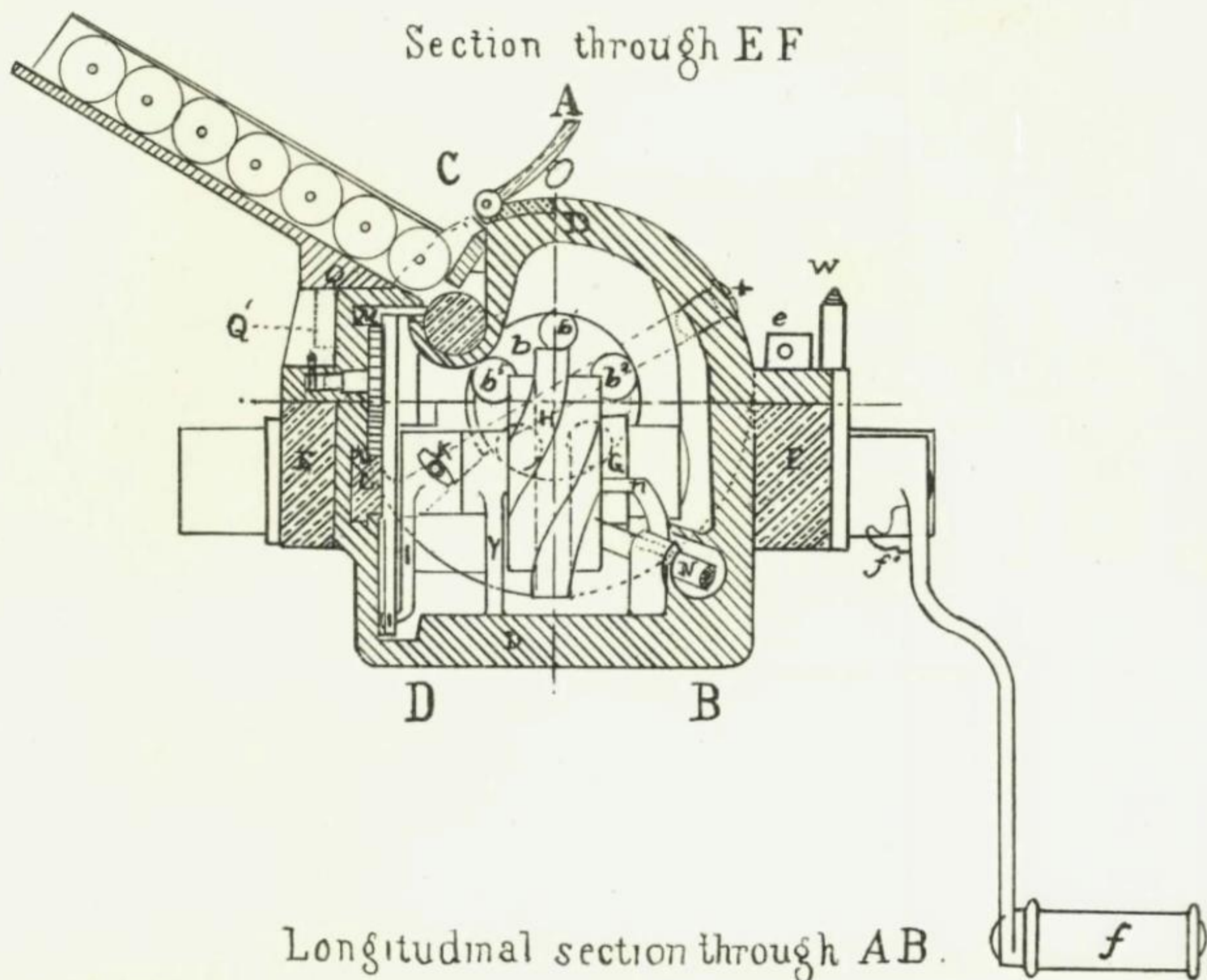

Longitudinal section through AB.

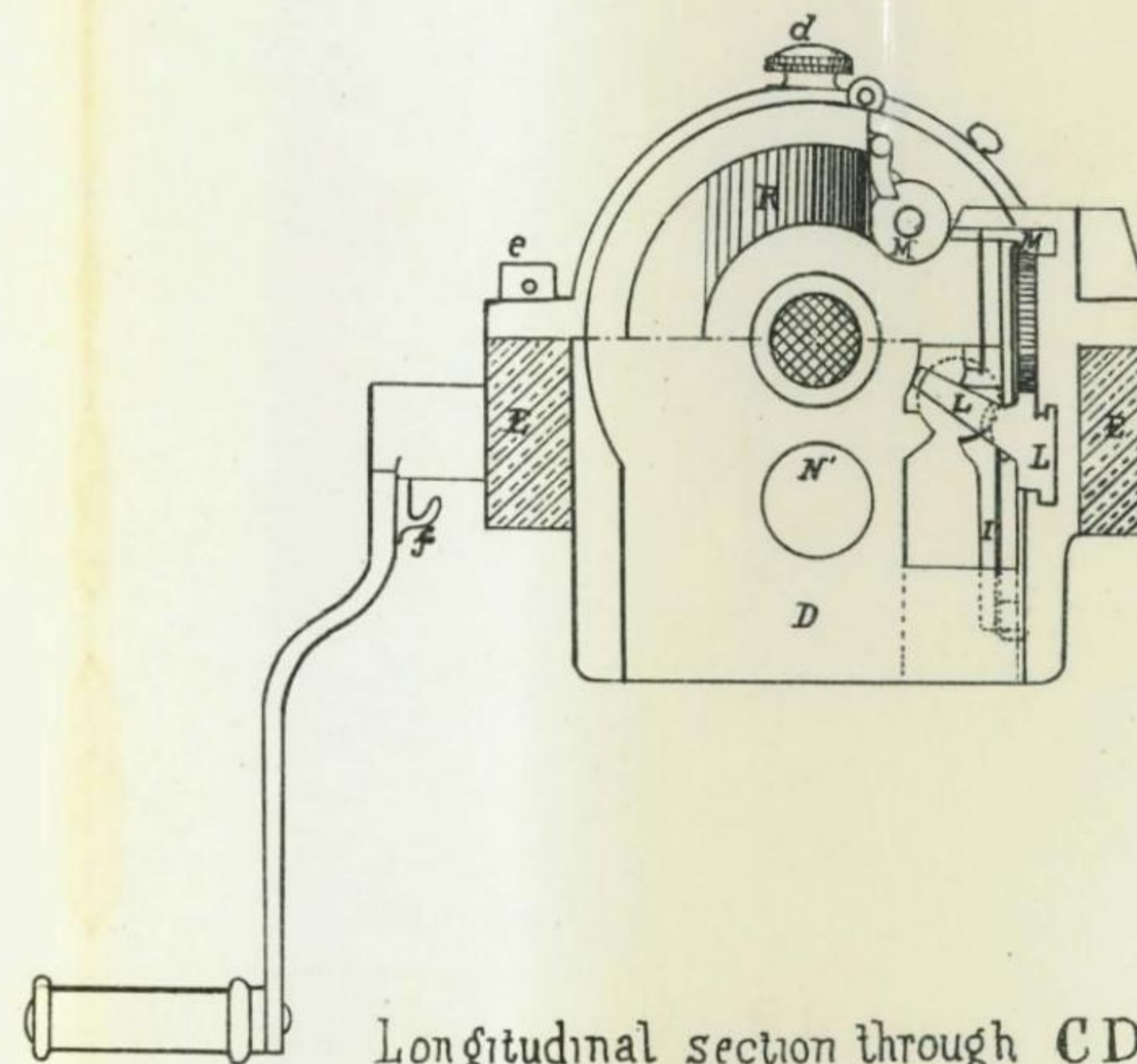
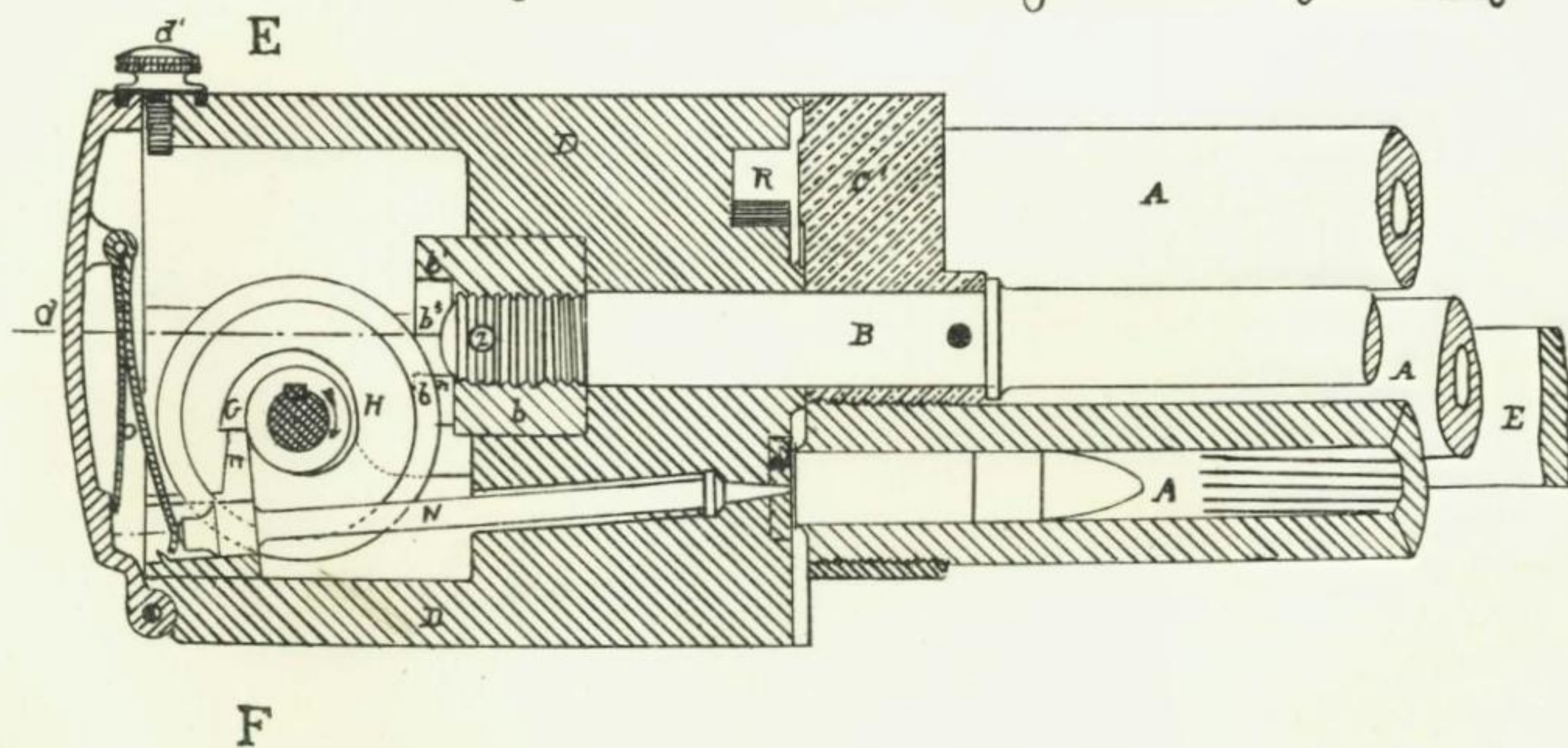

Longitudinal section through CD.

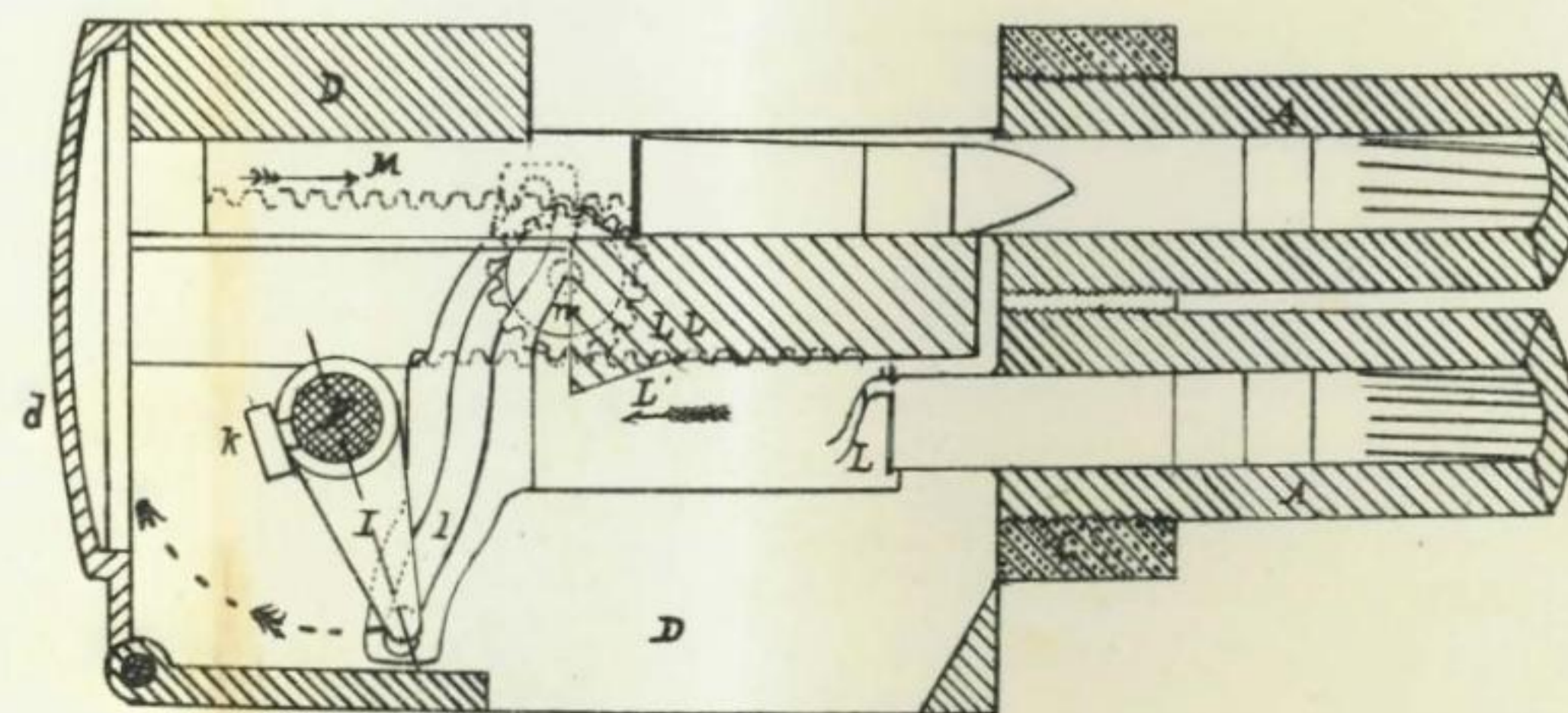

HOTCHKISS

PLATE III.

185 Inch (47^m) NAVAL GUN, - BREECH MECHANISM.

Section on AB.

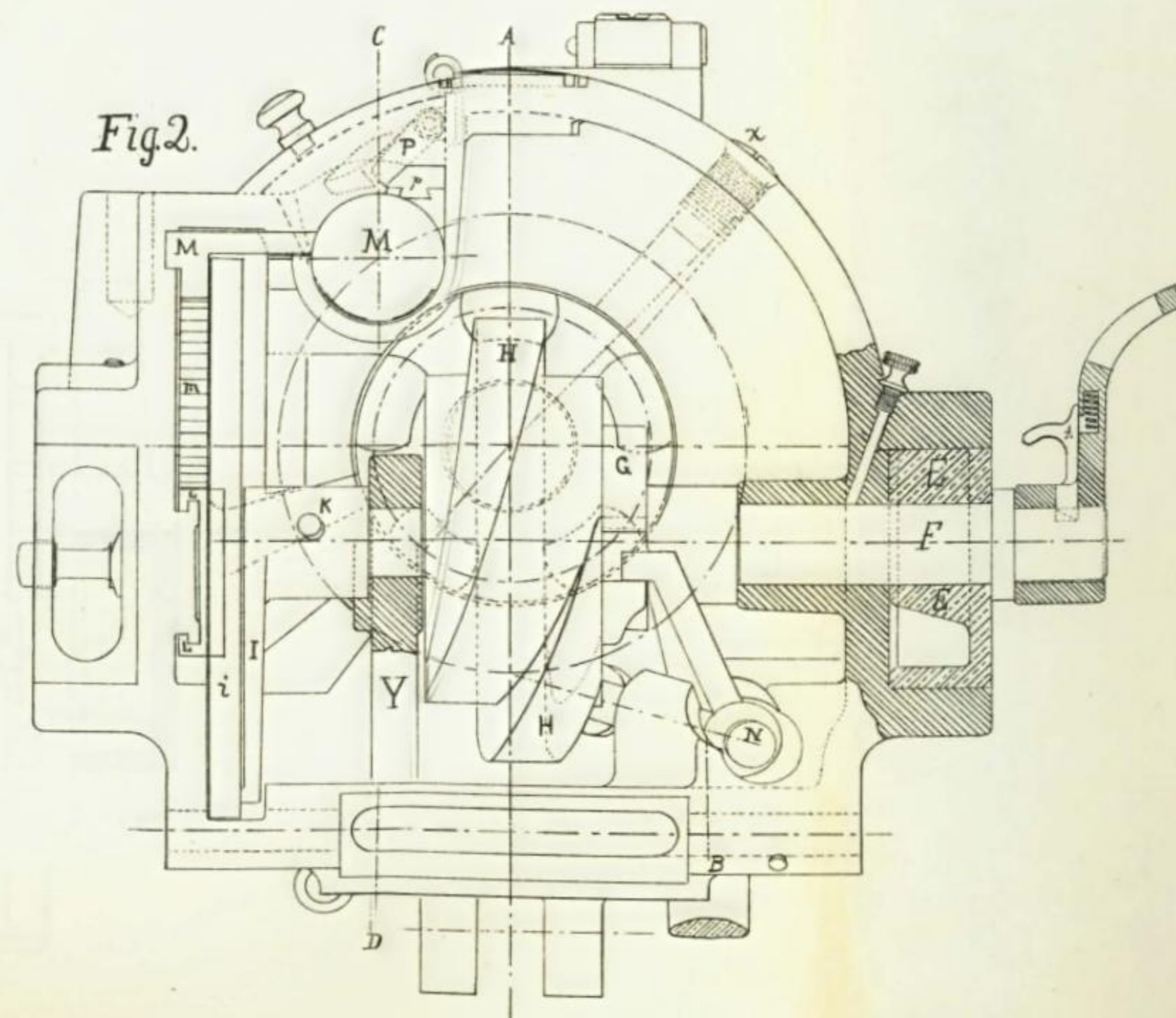
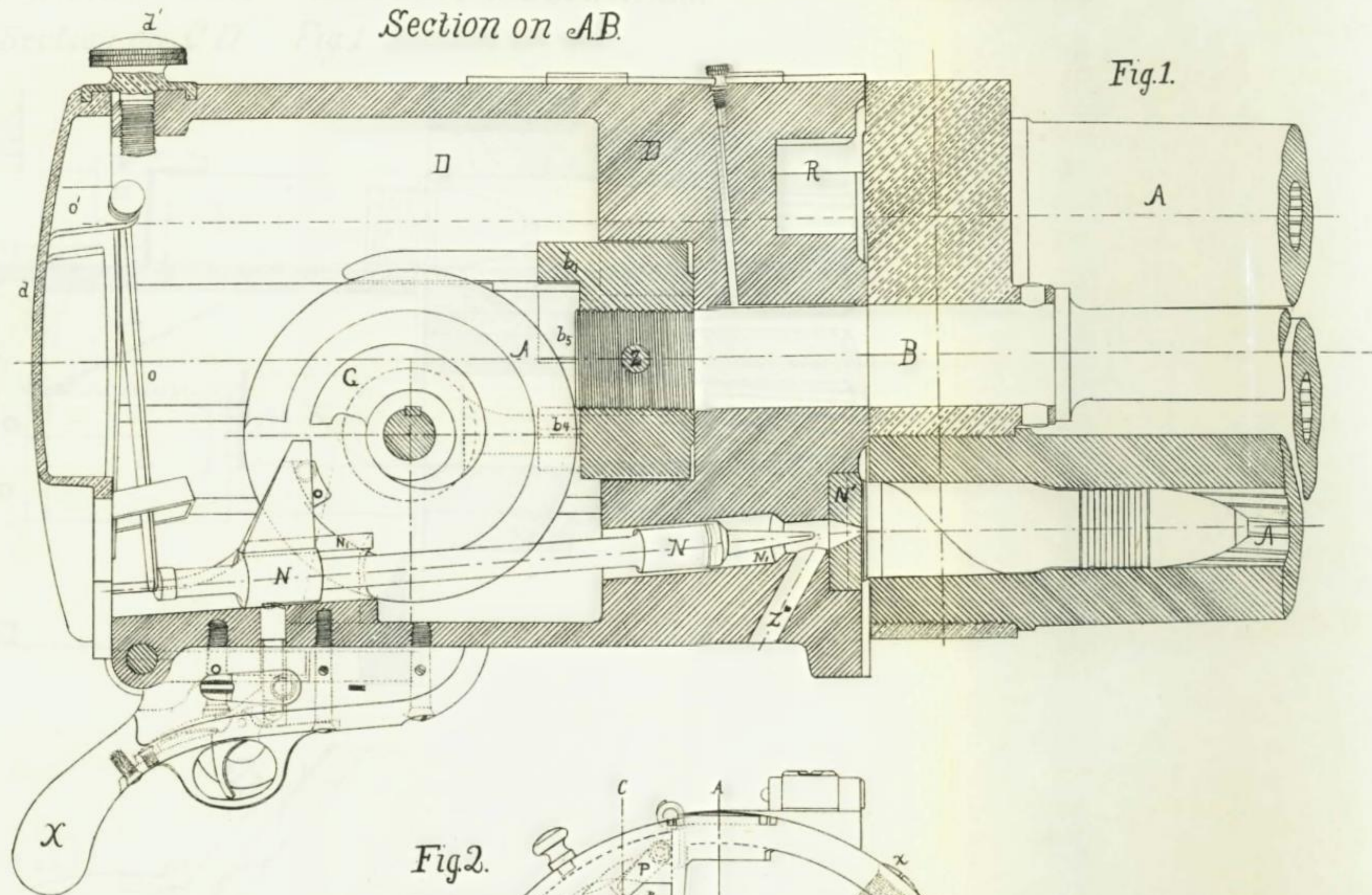

HOTCHKISS

SIGHTS-FLANK DEFENSE GUN

REAR SIGHT-FIELD GUN

PLATE V.

Fig. 1.



Fig. 2.

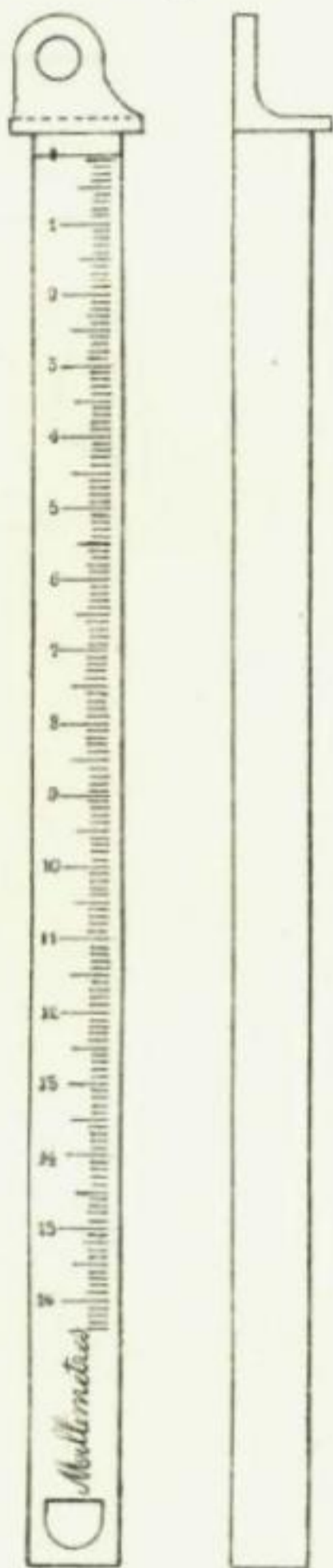

Fig. 3.

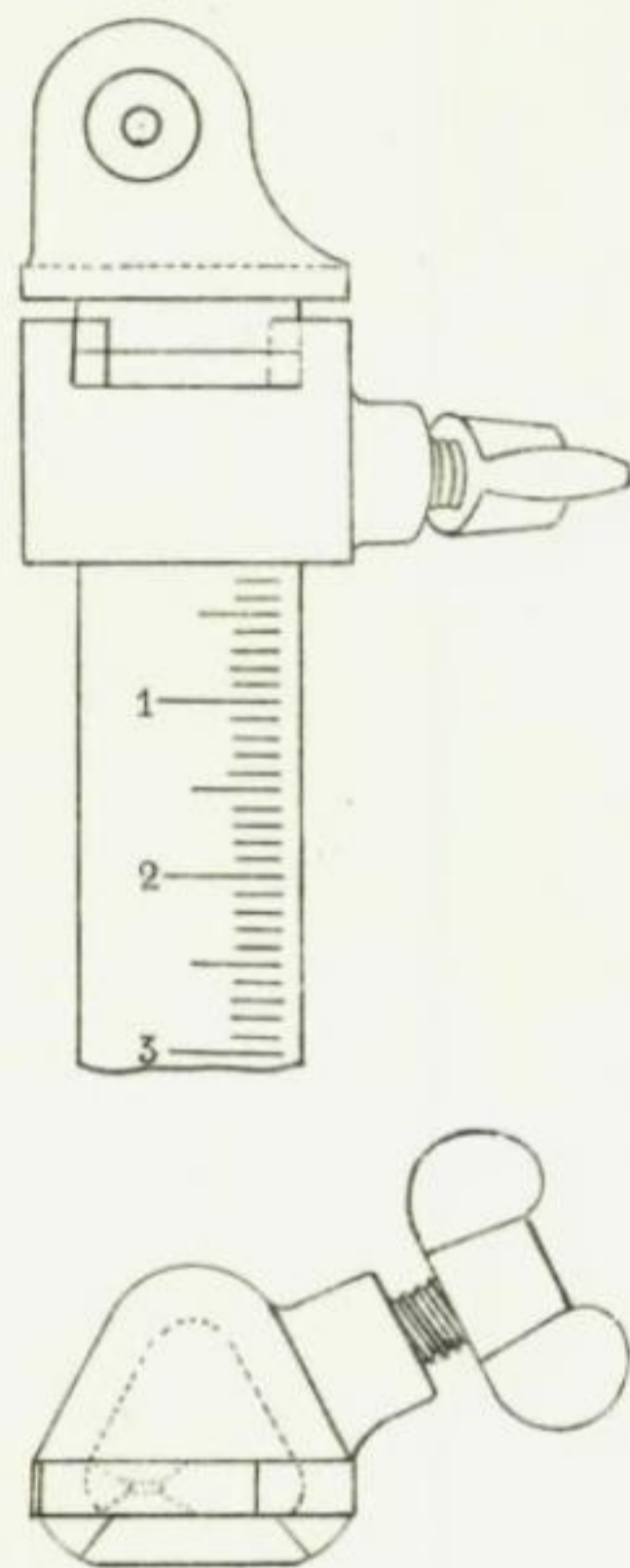

Fig. 4.

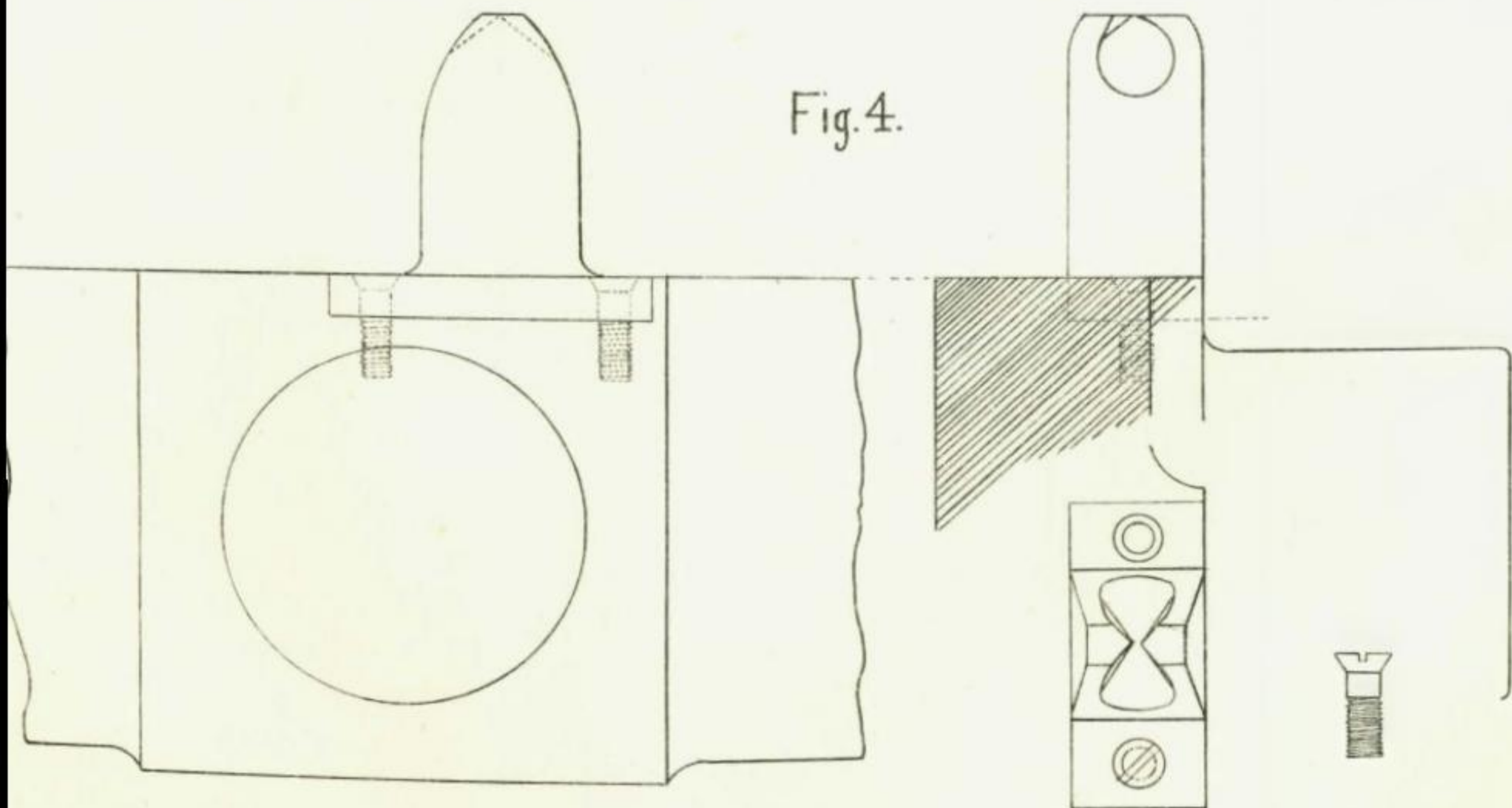

Fig. 5.

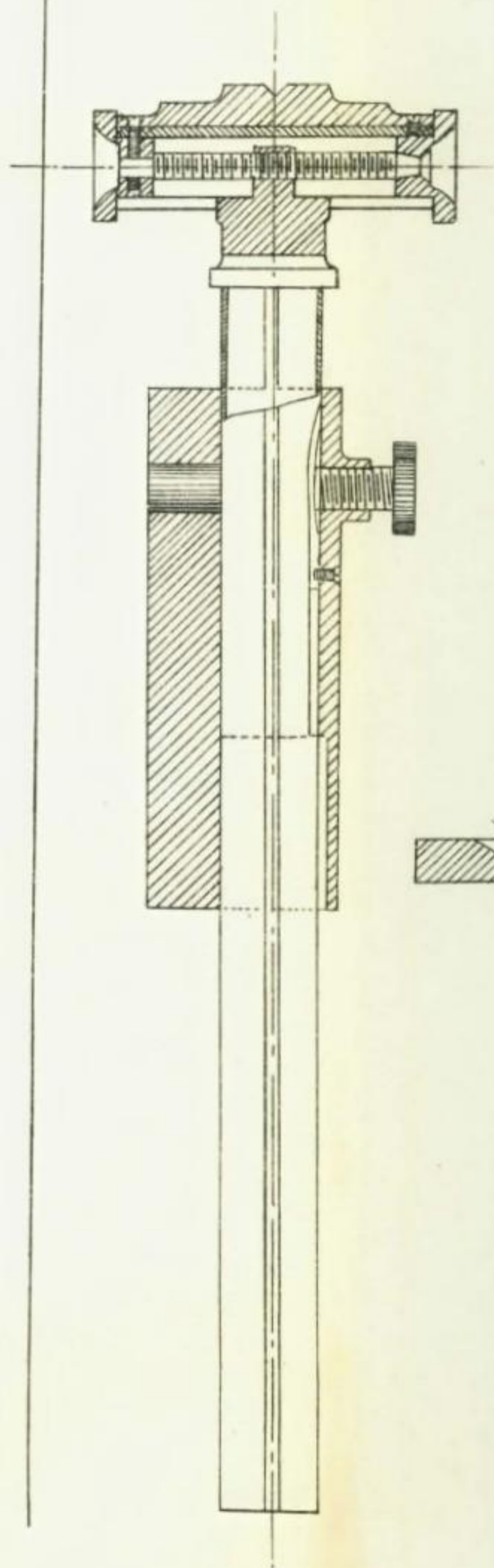

Fig. 6.



Fig. 8.

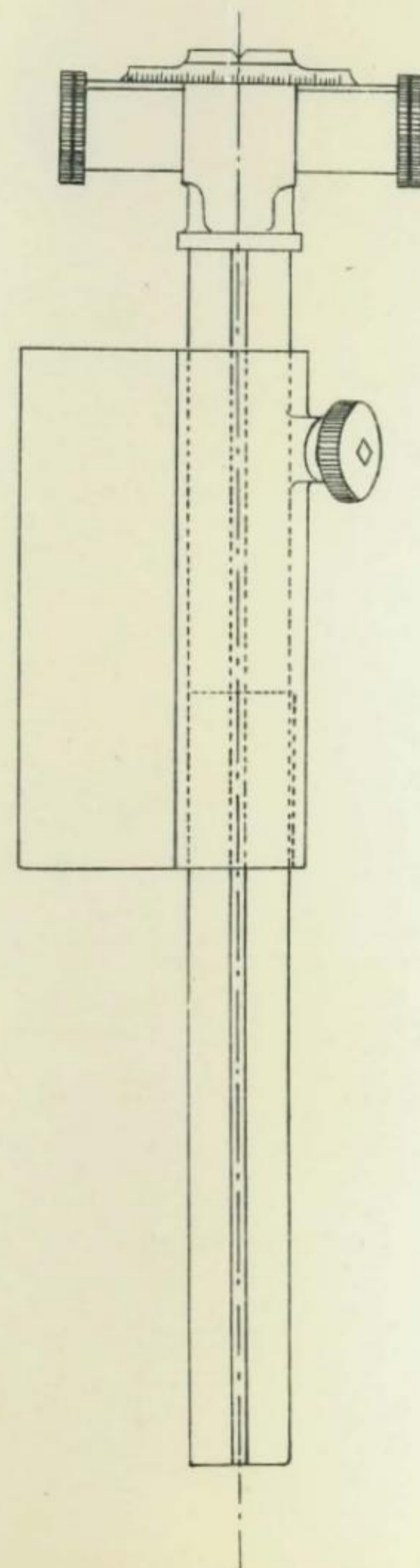
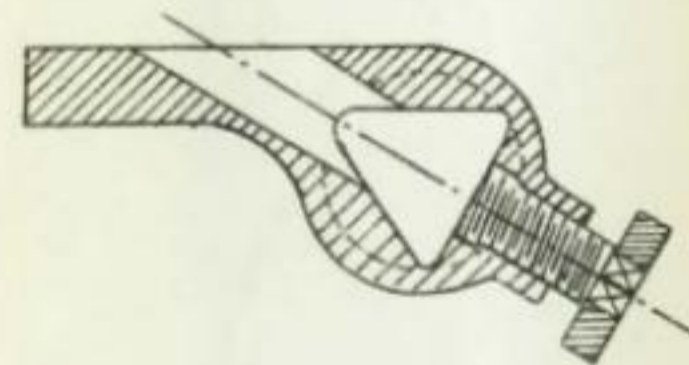
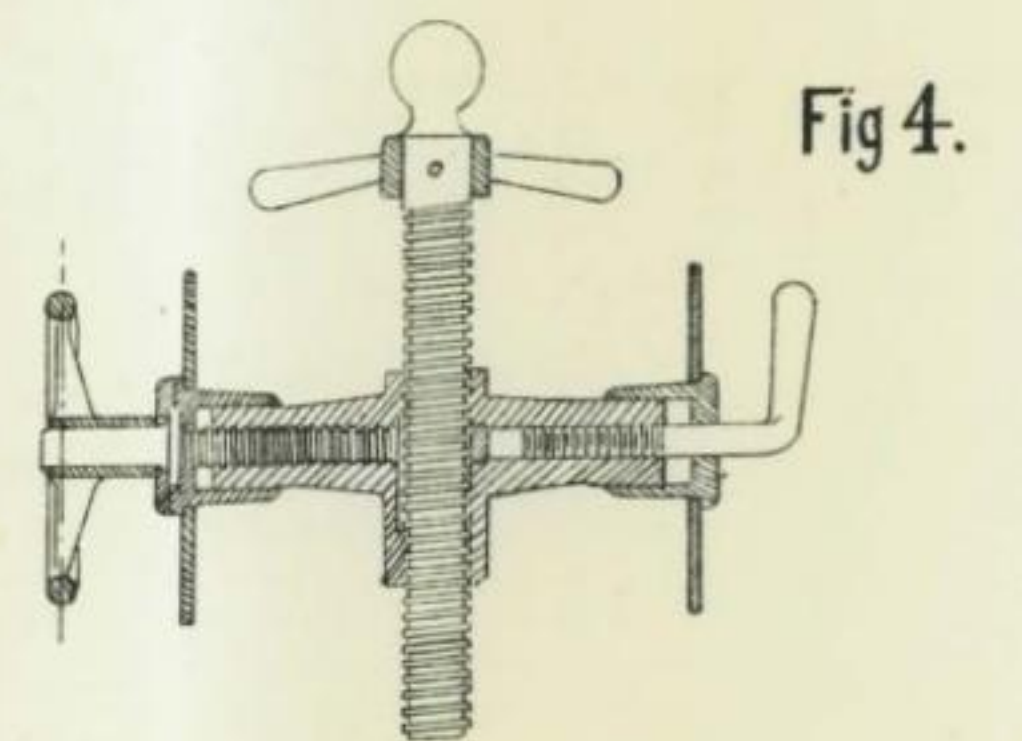
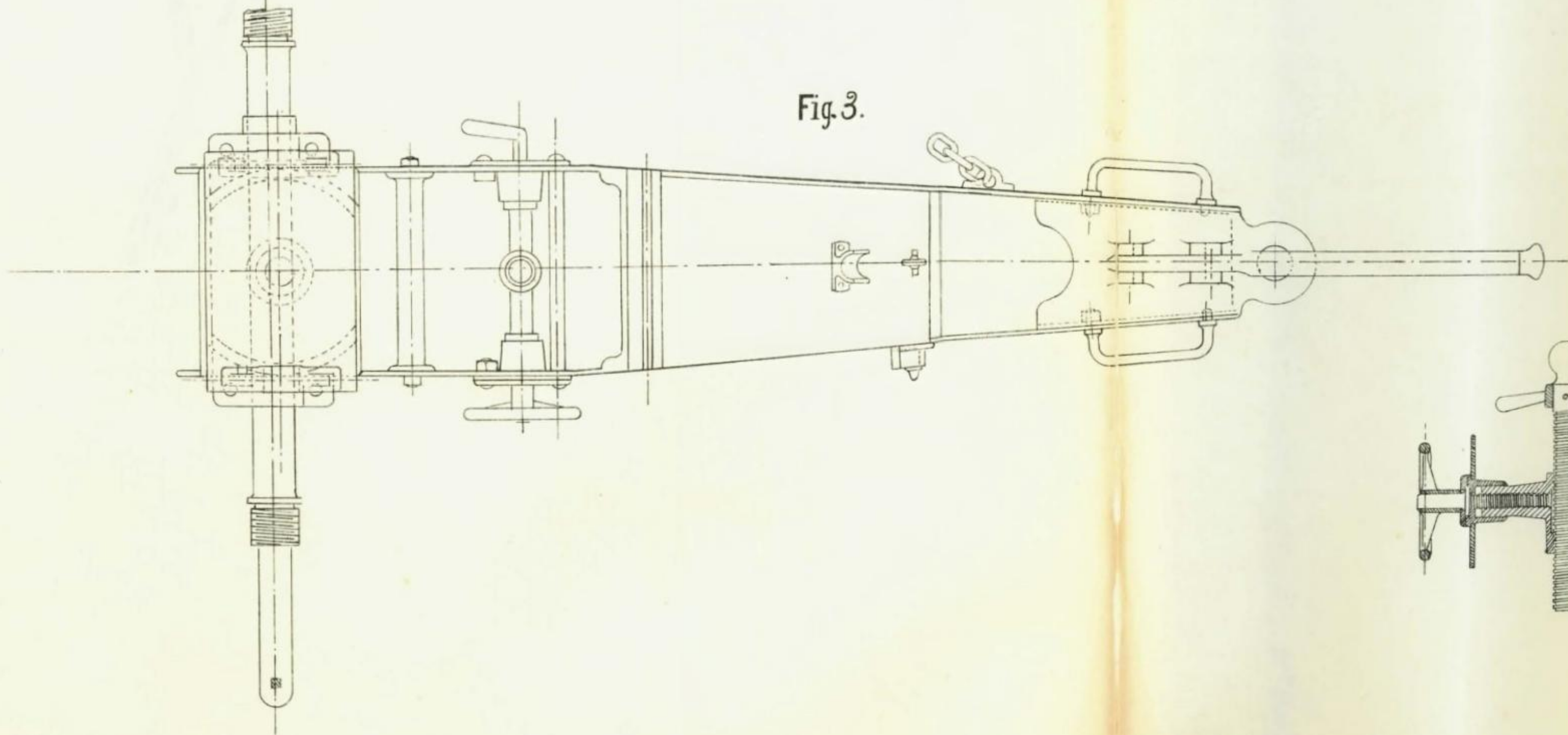
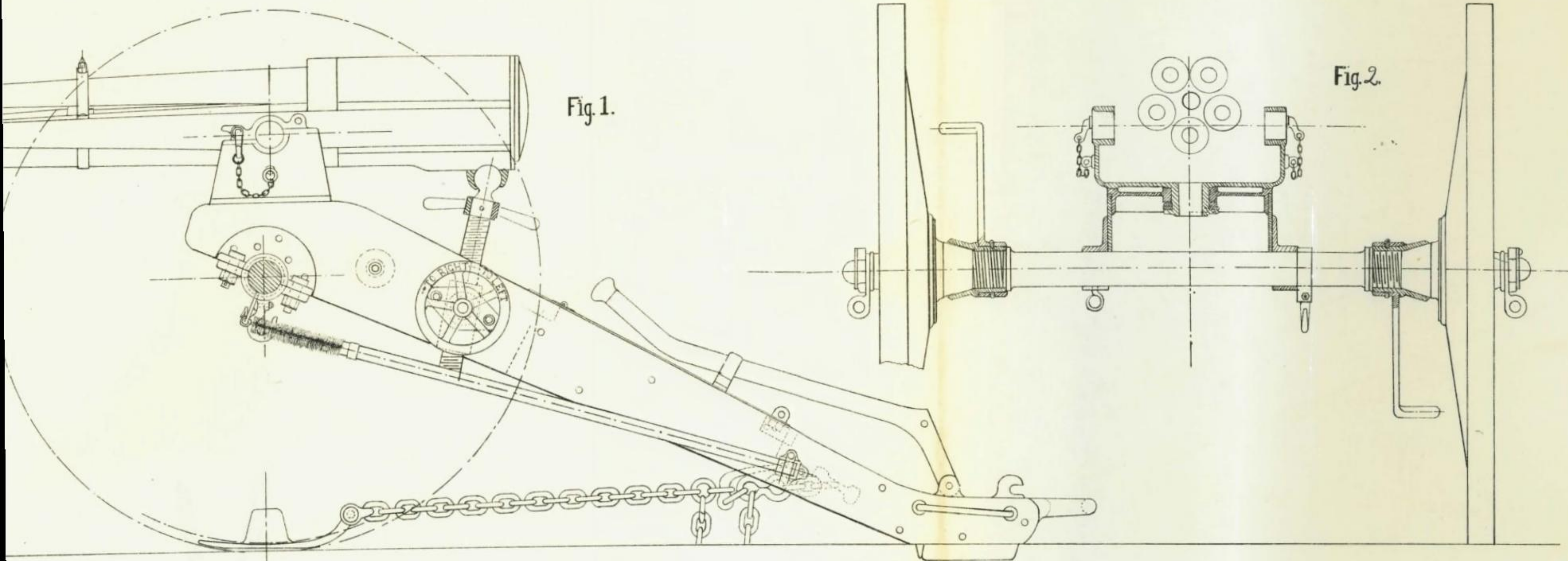

Fig. 7.





STEEL SHIELD FOR HOTCHKISS REVOLVING CANNON, CAL. 1.45-INCH. (37^m/_m.)

Fig. 1.

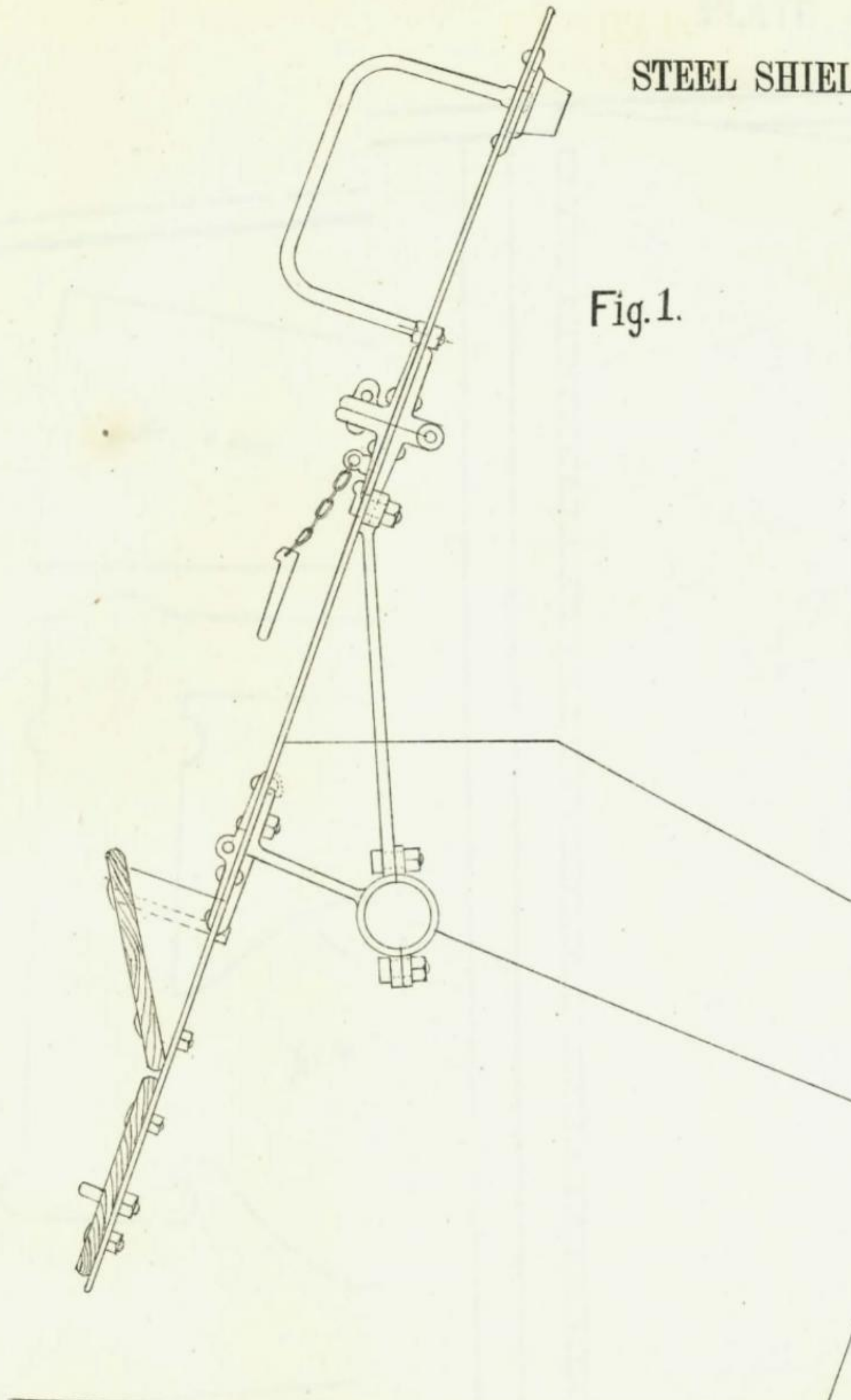
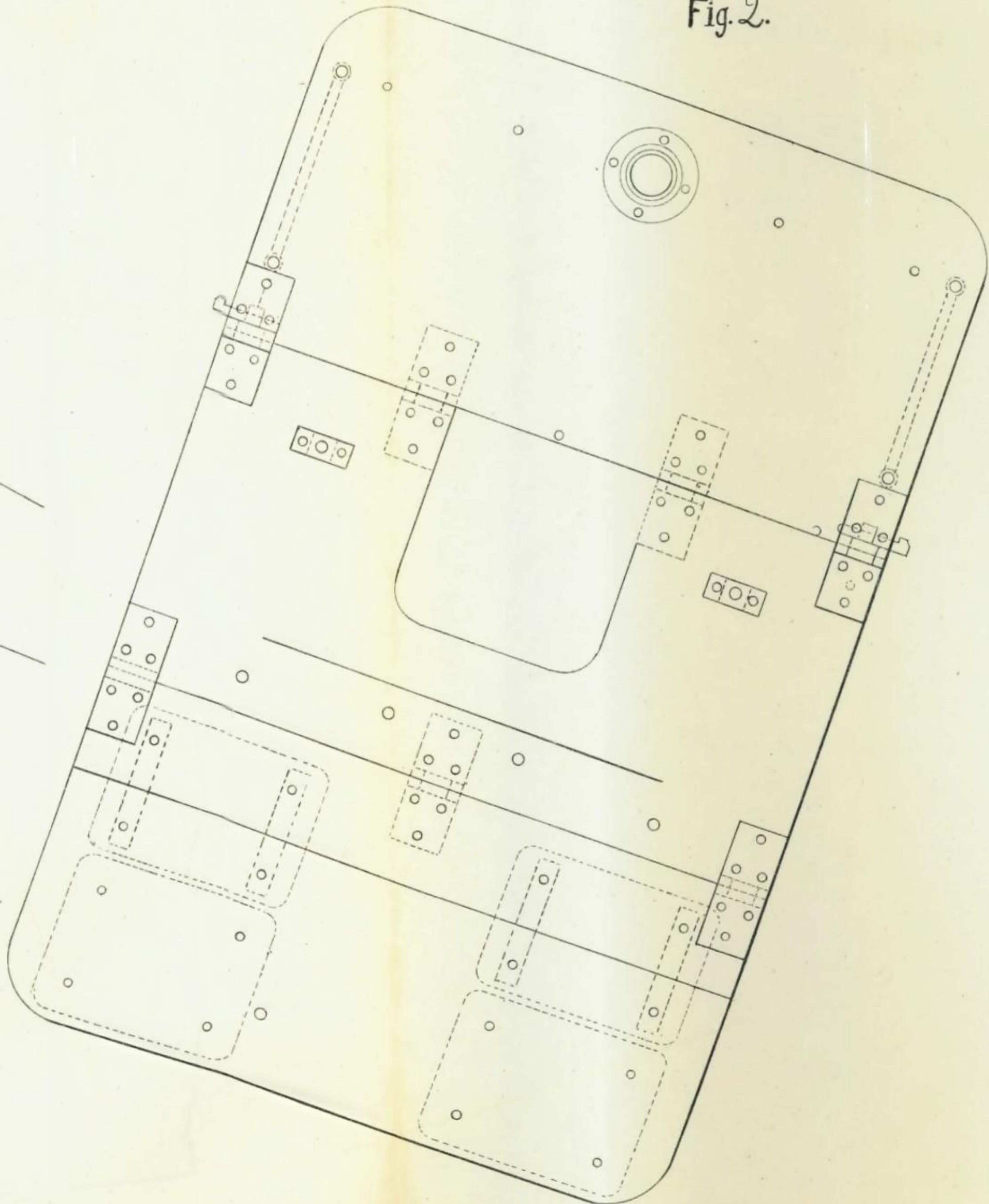
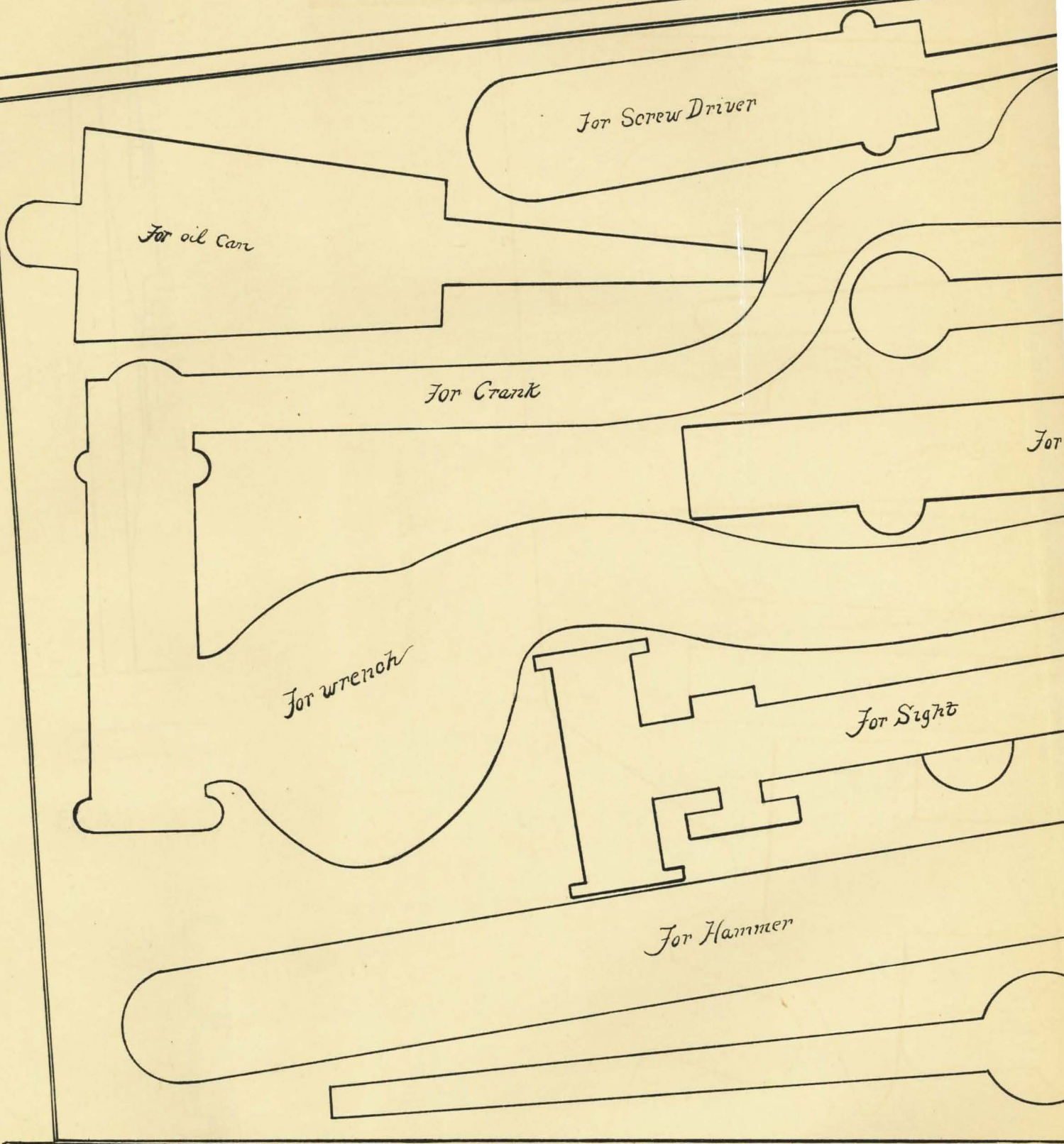

Fig. 2.



TOOL BOX FOR HOTCHKISS REVOLVING



For oil can

For Screw Driver

For Crank

For

For wrench

For Sight

For Hammer

NNON, CAL. 1.45-INCH. ($37\frac{m}{m}$.)

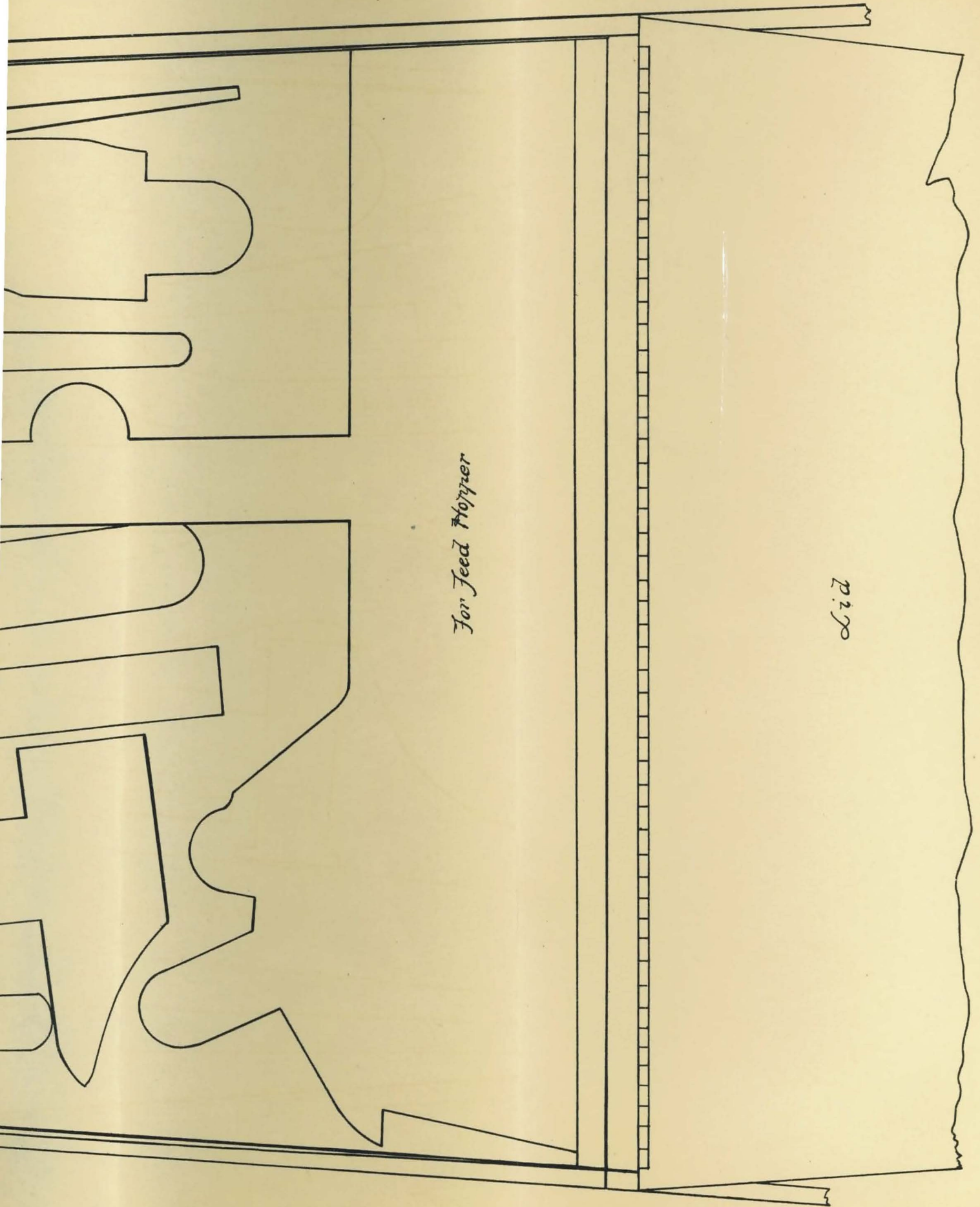

Fig. 1.

Fig. 2.

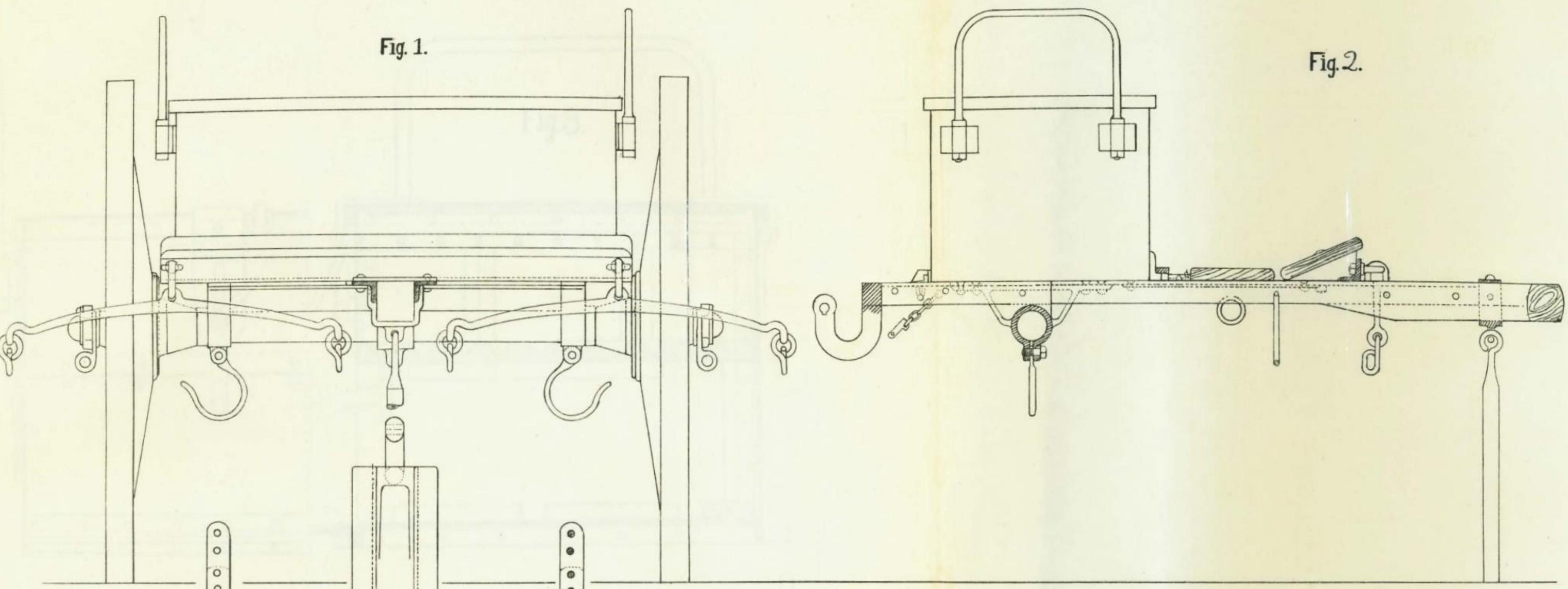

Fig. 3.

Fig. 4.

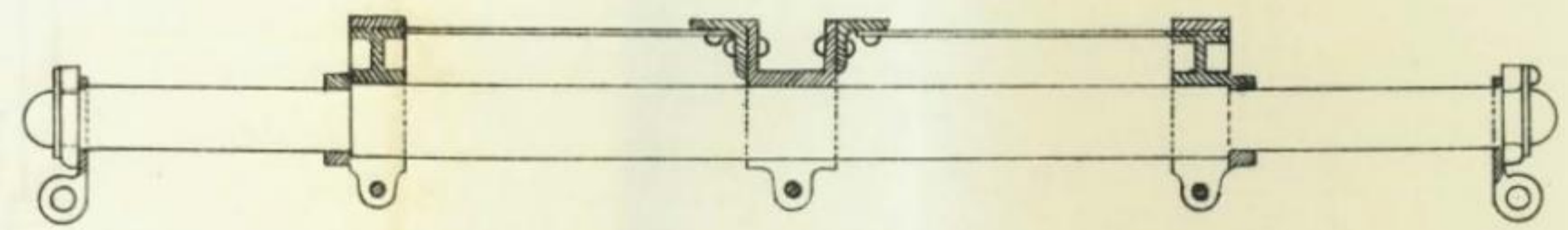
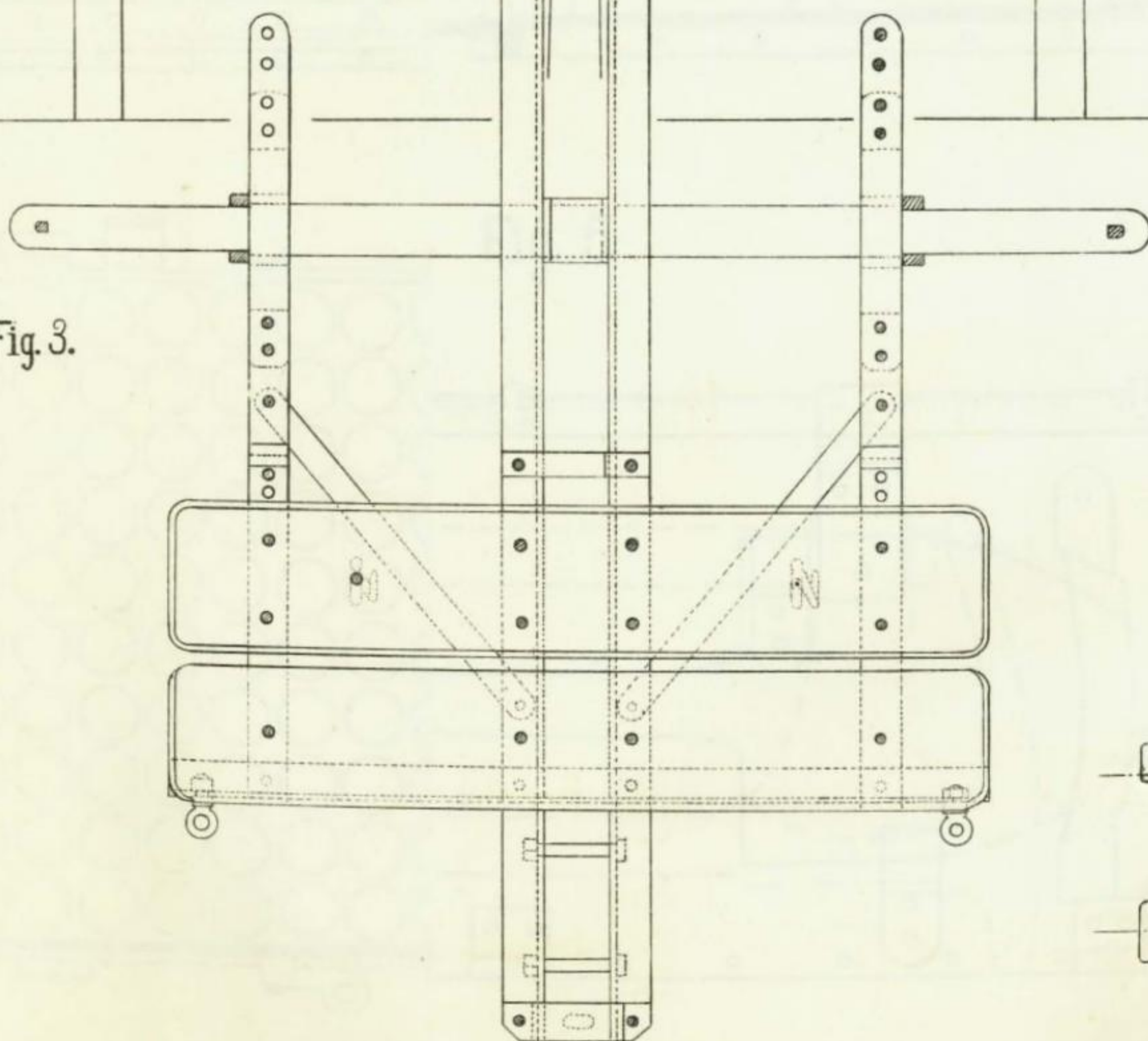
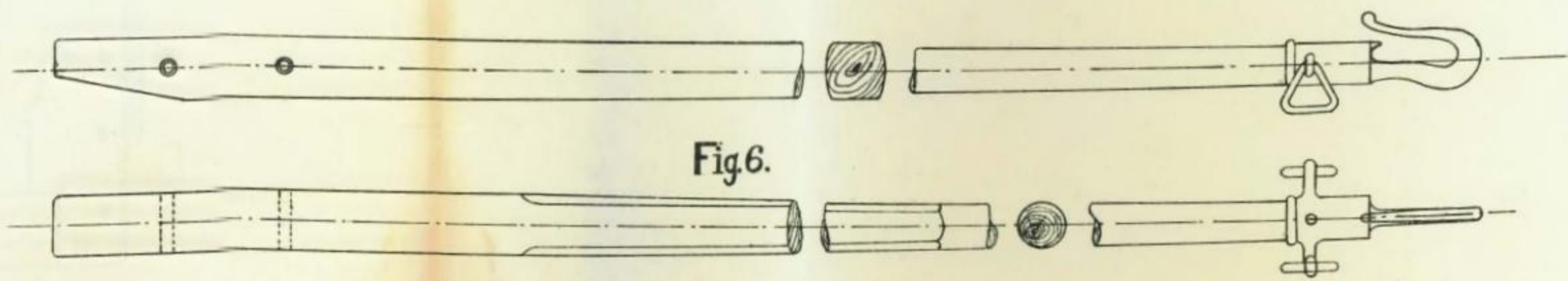

Fig. 5.



AMMUNITION CHEST FOR HOTC

Fig.1.

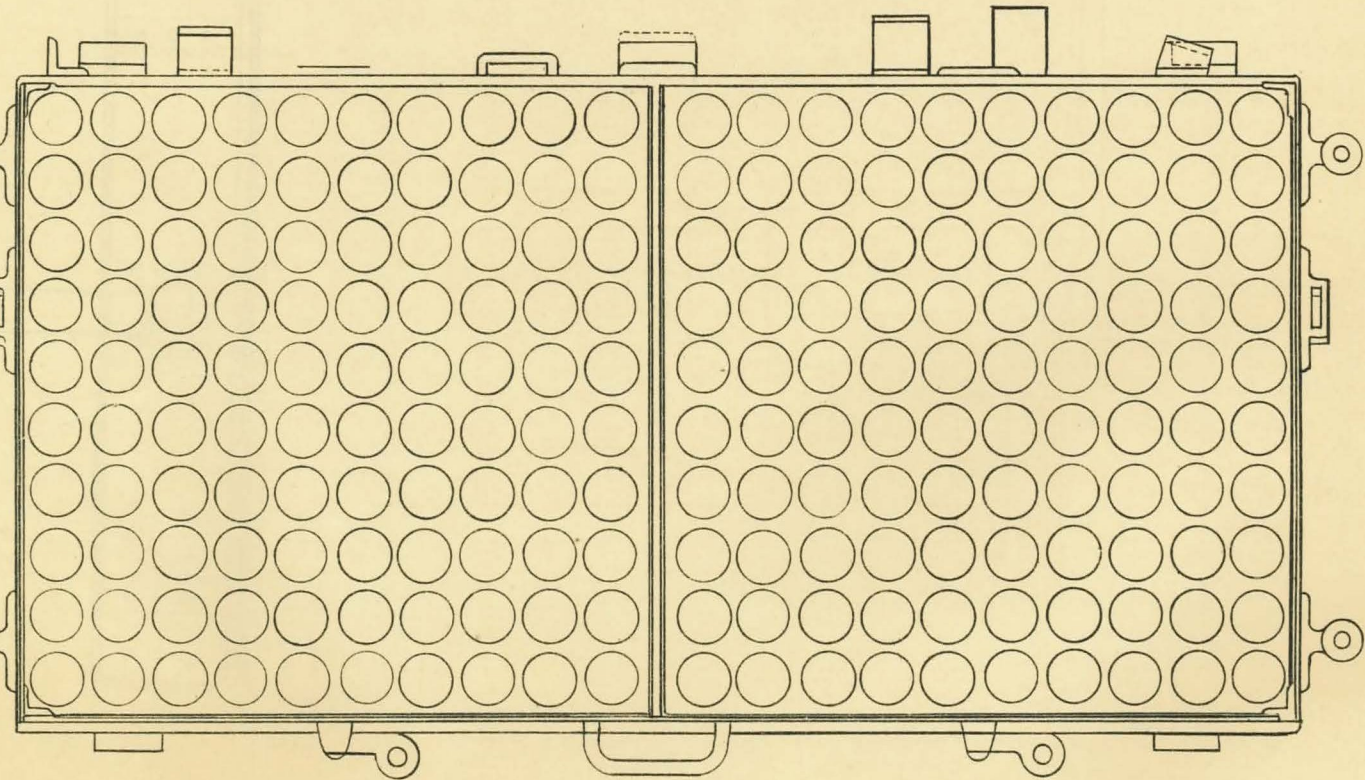
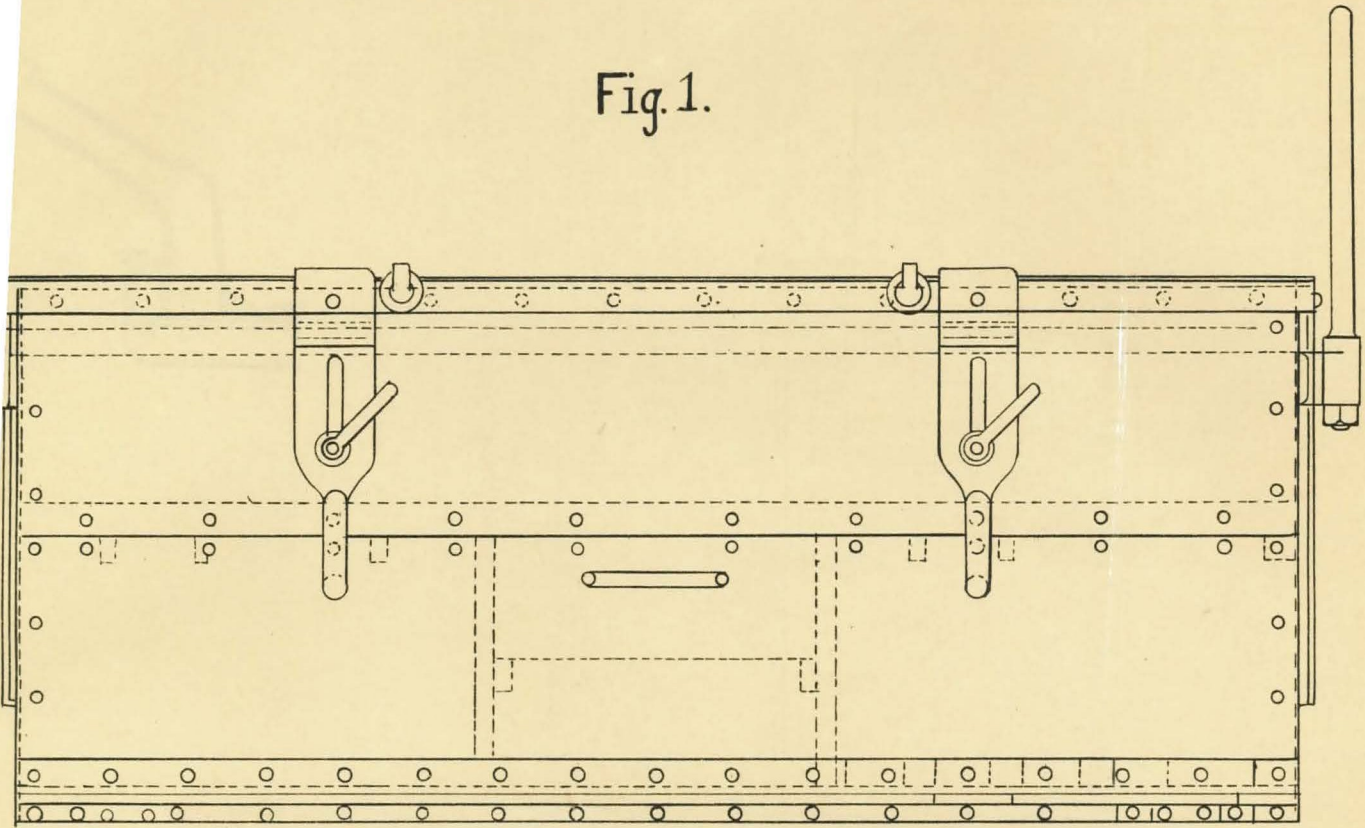

Fig.4.

Fig. 2.

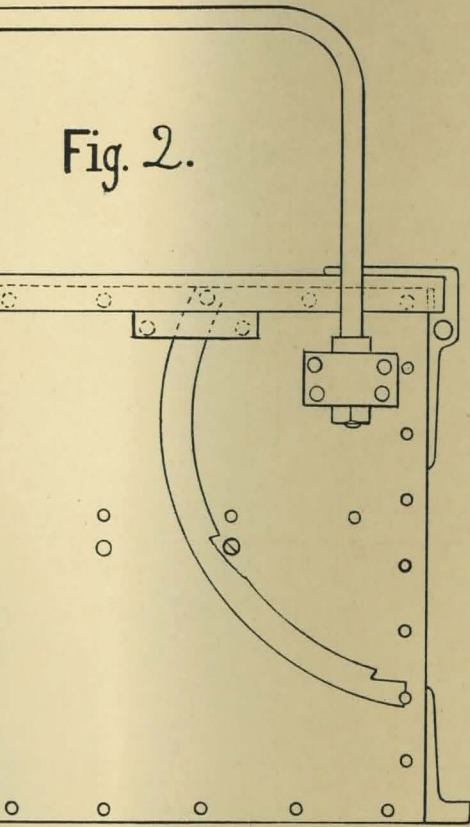

Fig. 3.

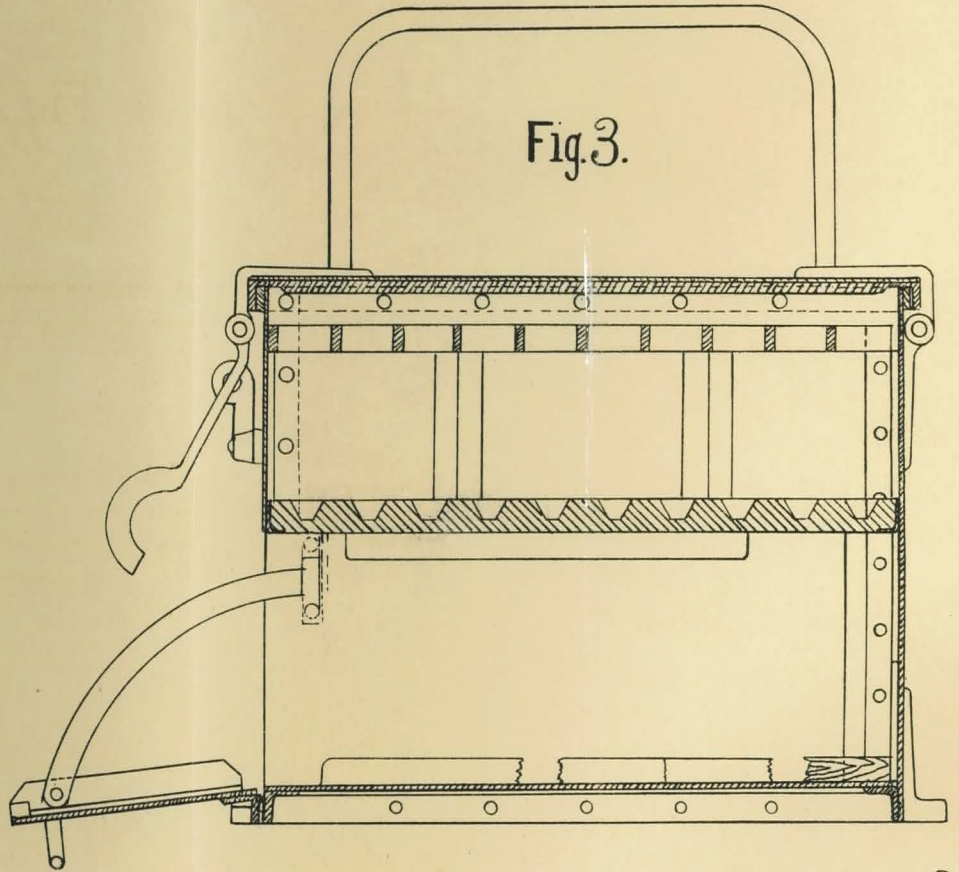
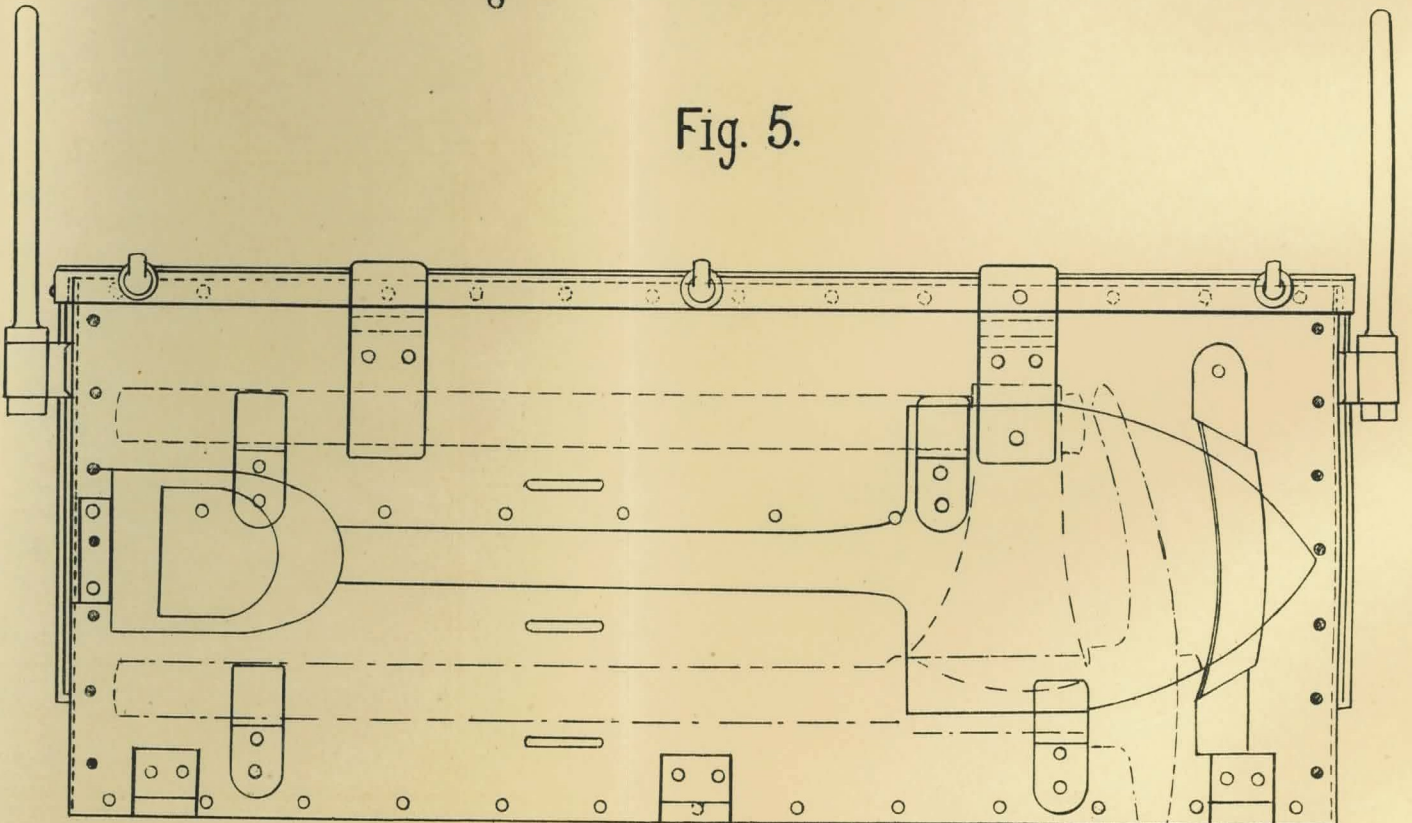

Fig. 5.



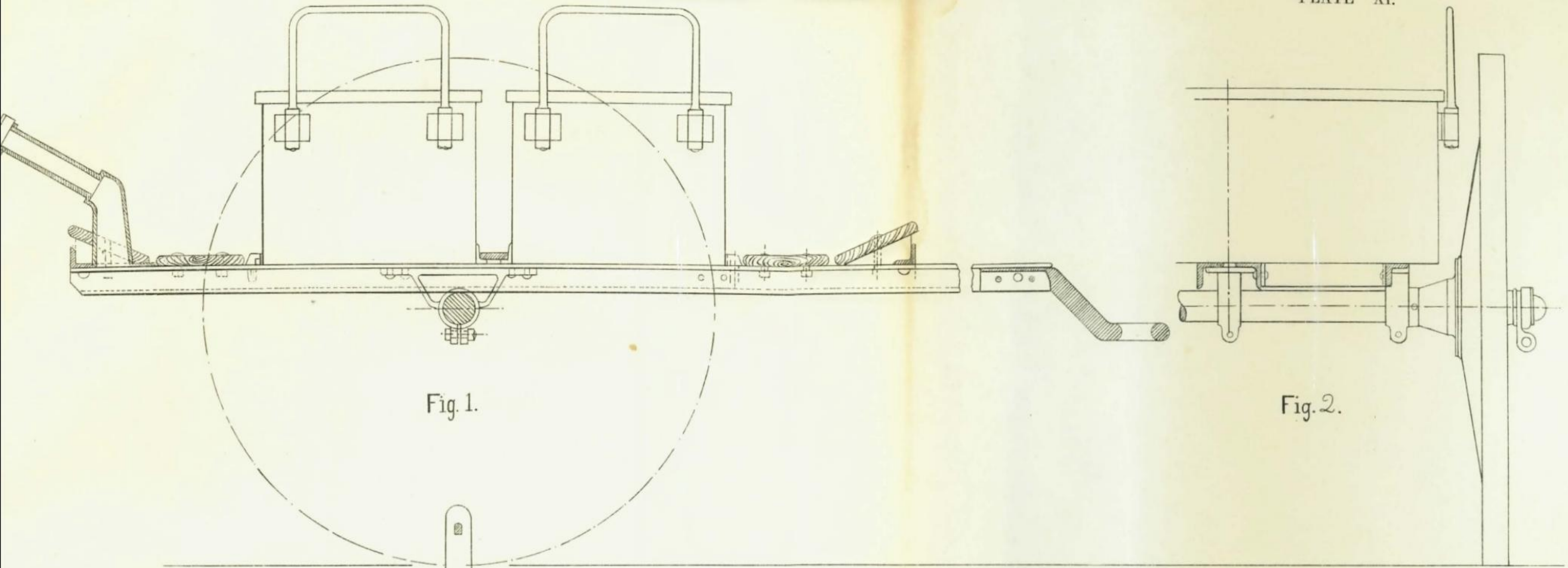

Fig. 1.

Fig. 2.

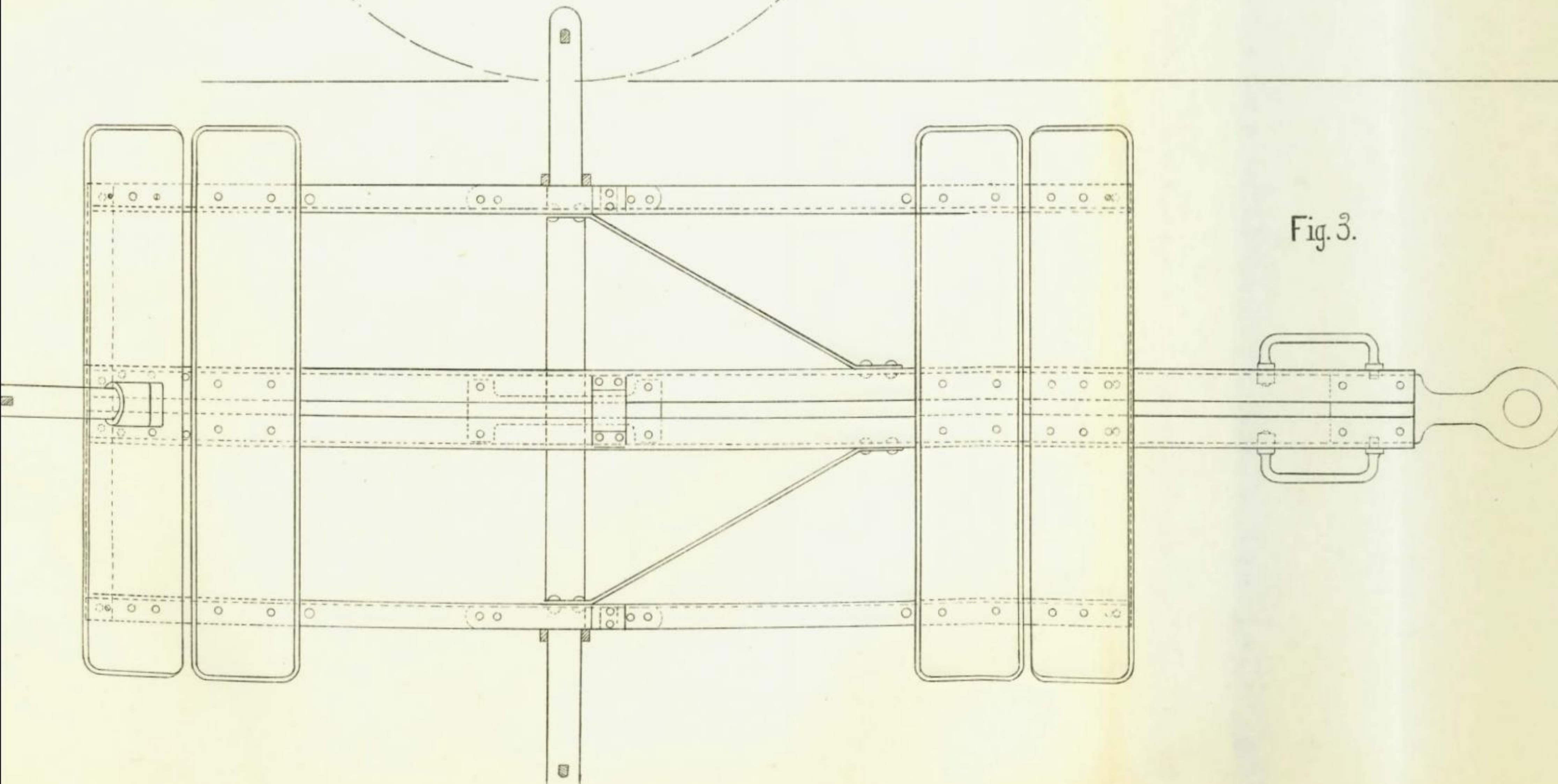

Fig. 3.

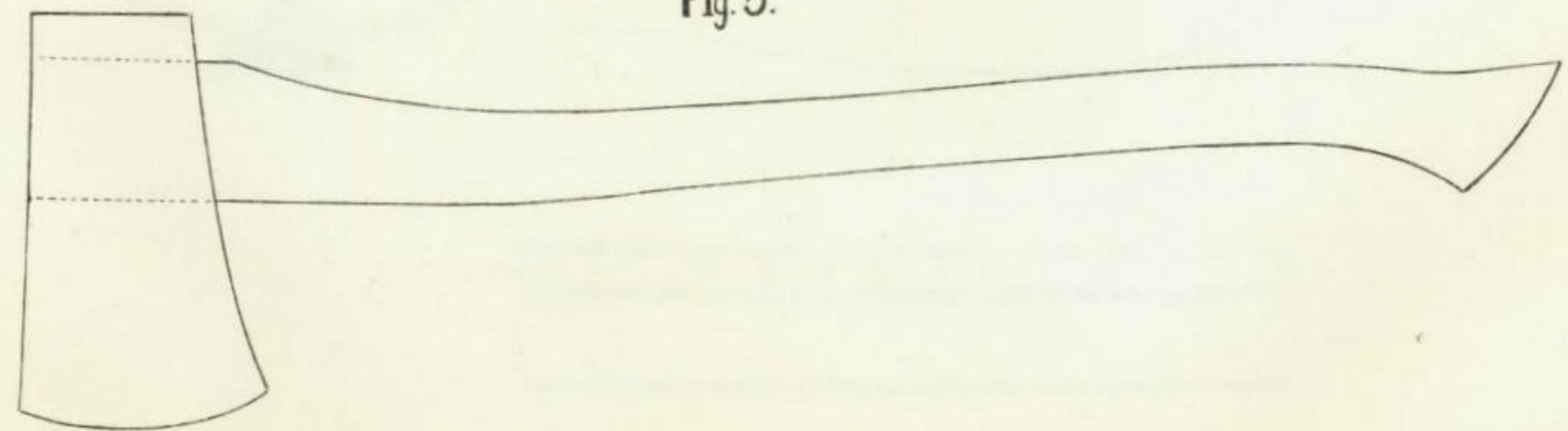
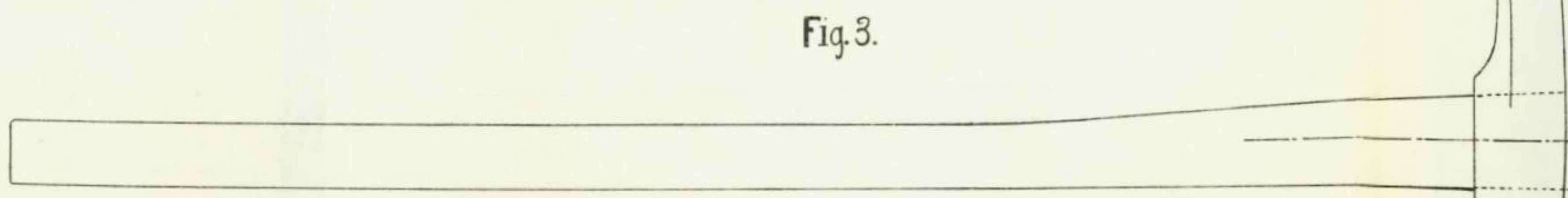
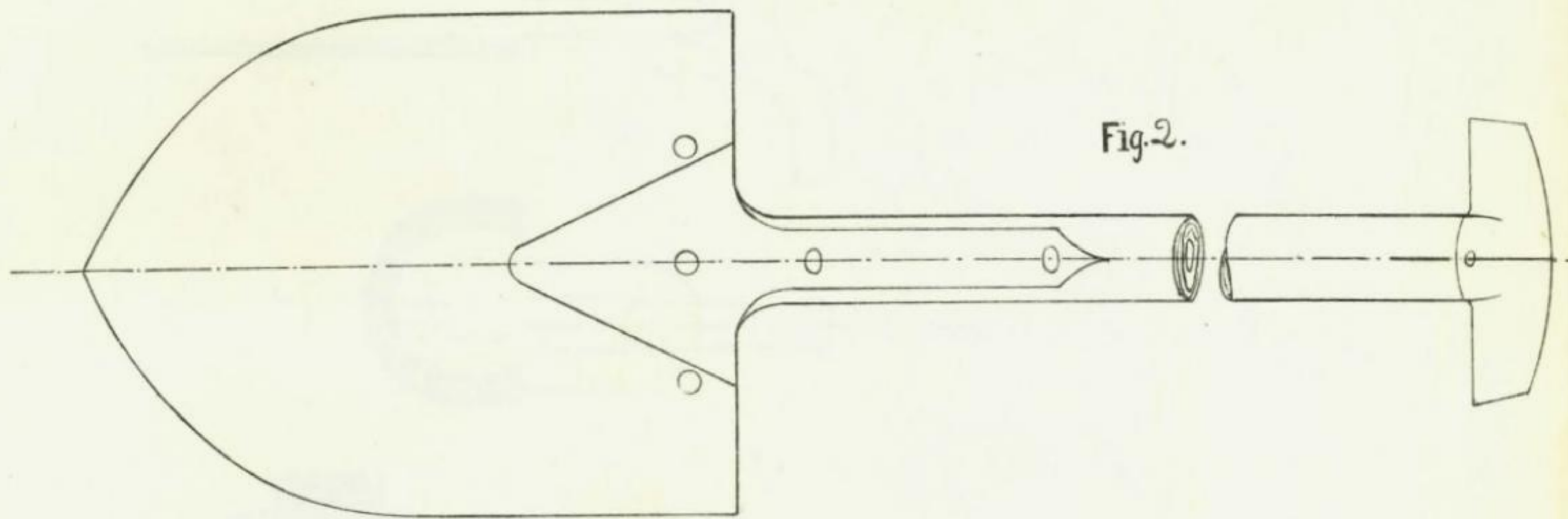
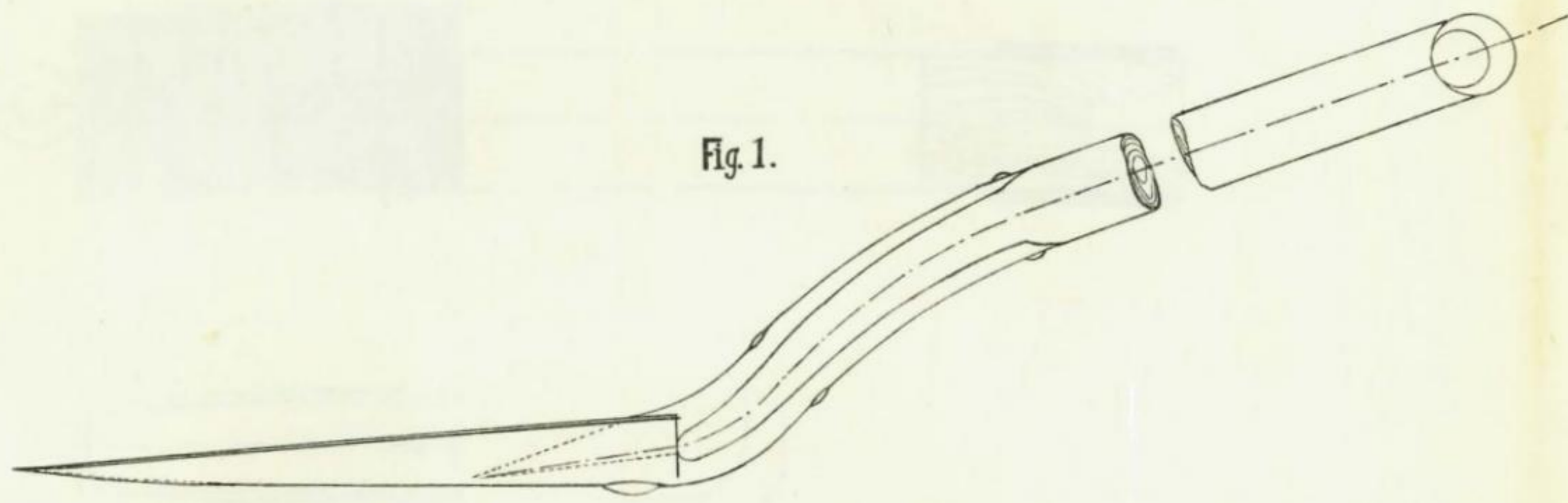

Fig. 6.

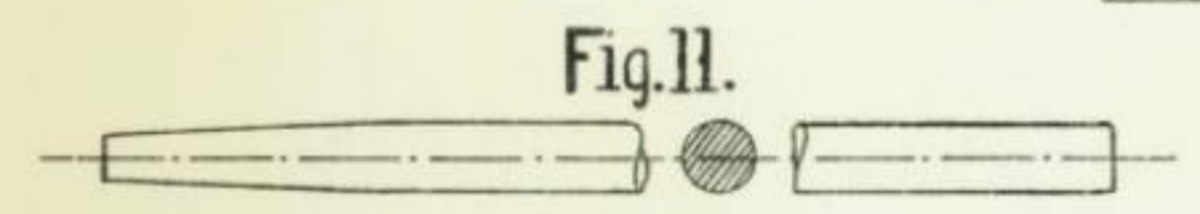
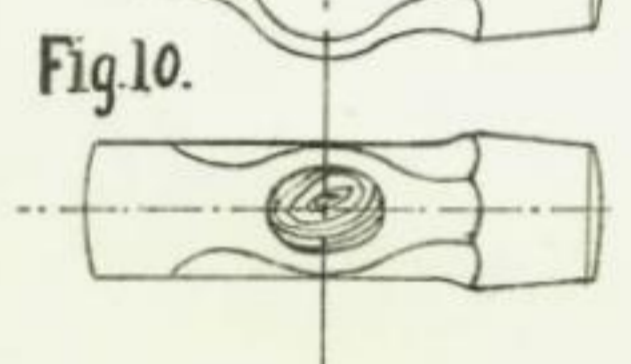
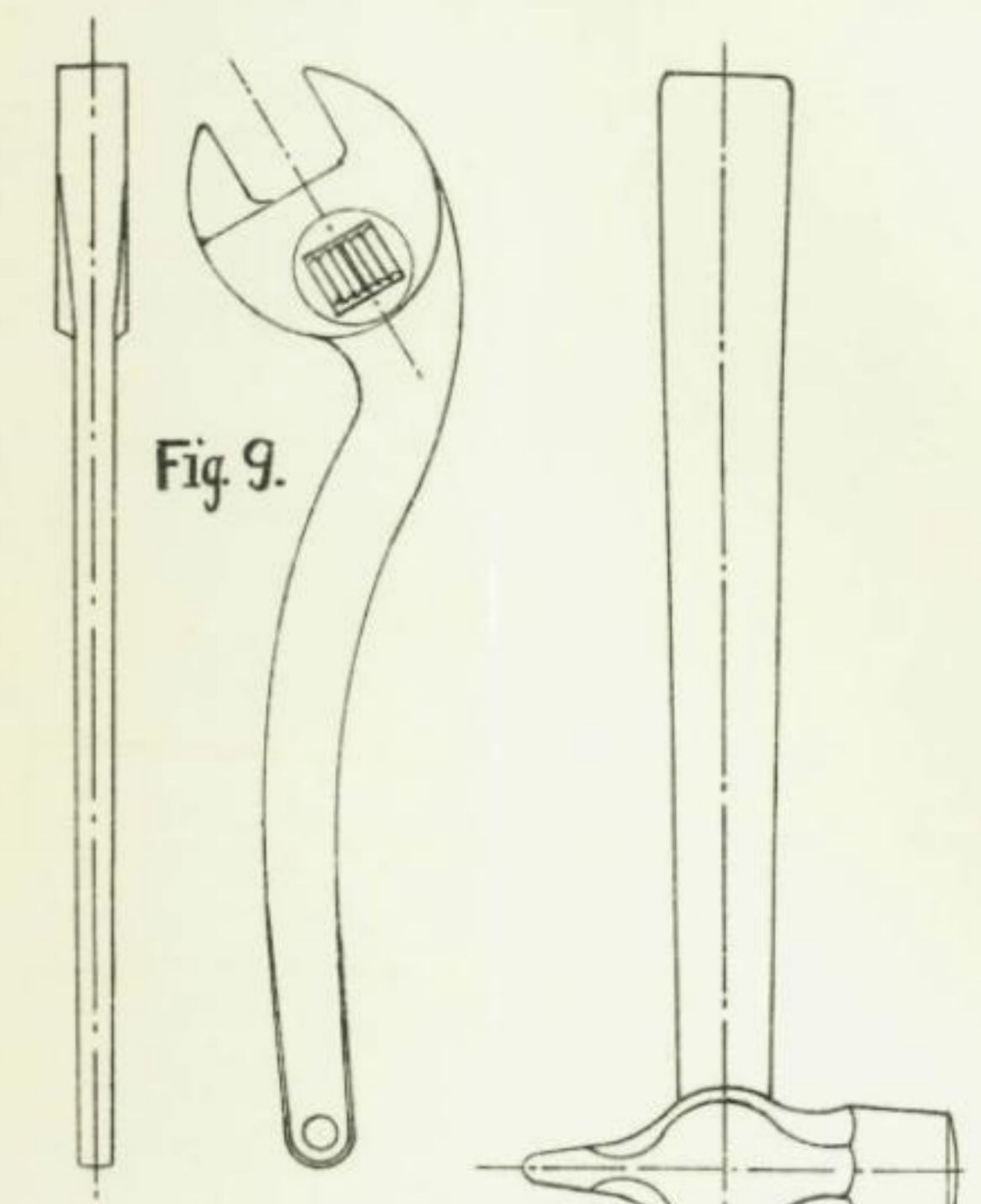
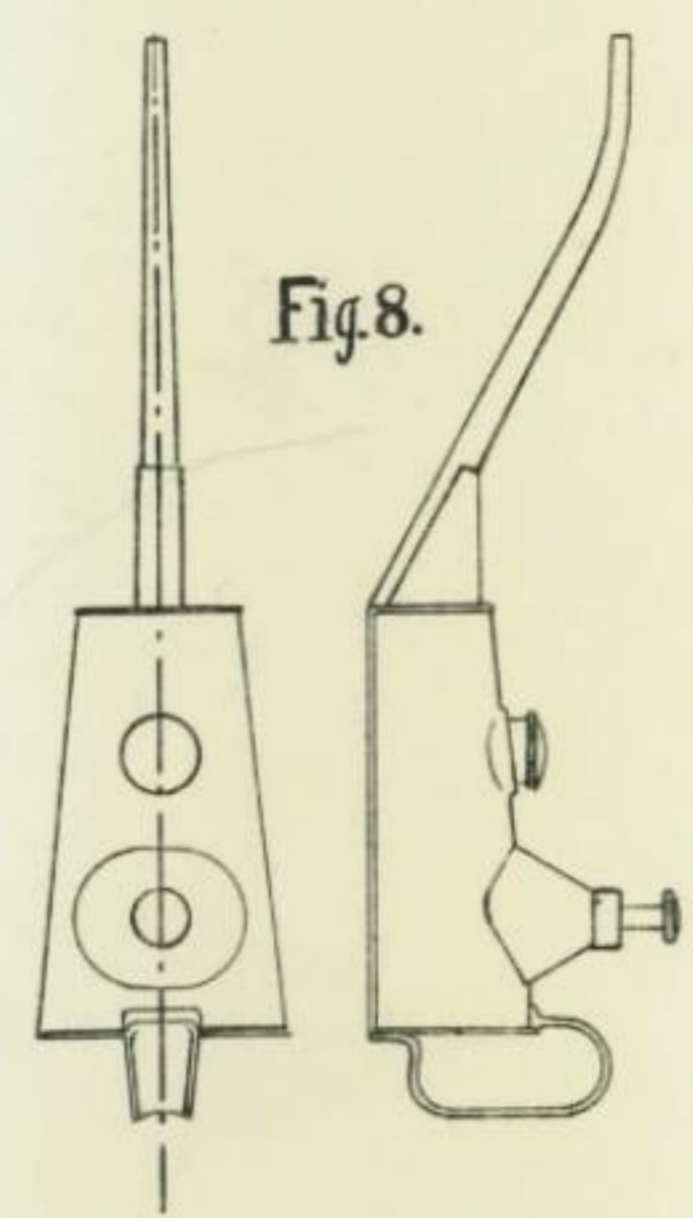
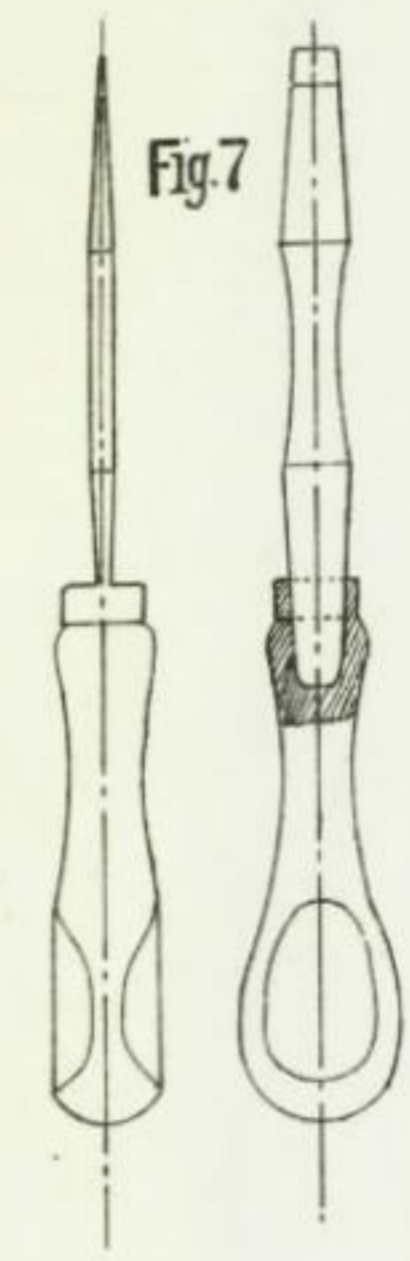
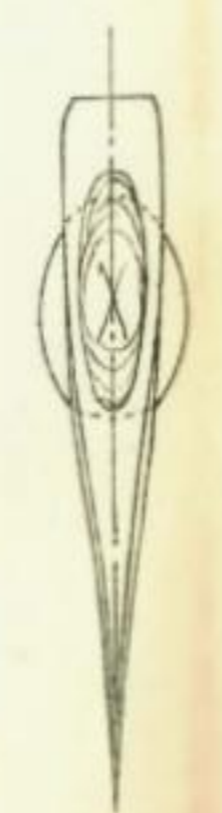

Fig. 4.

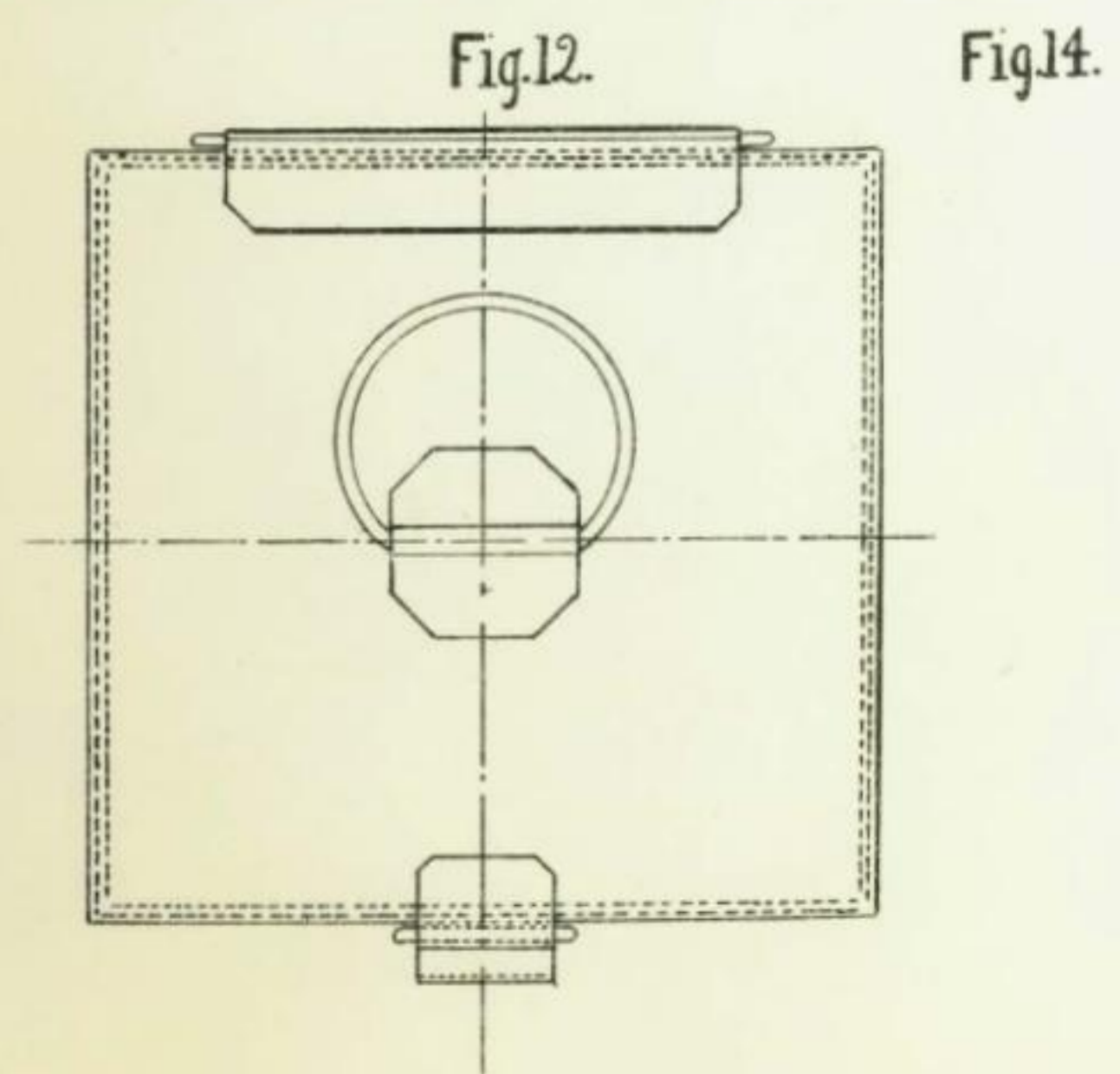
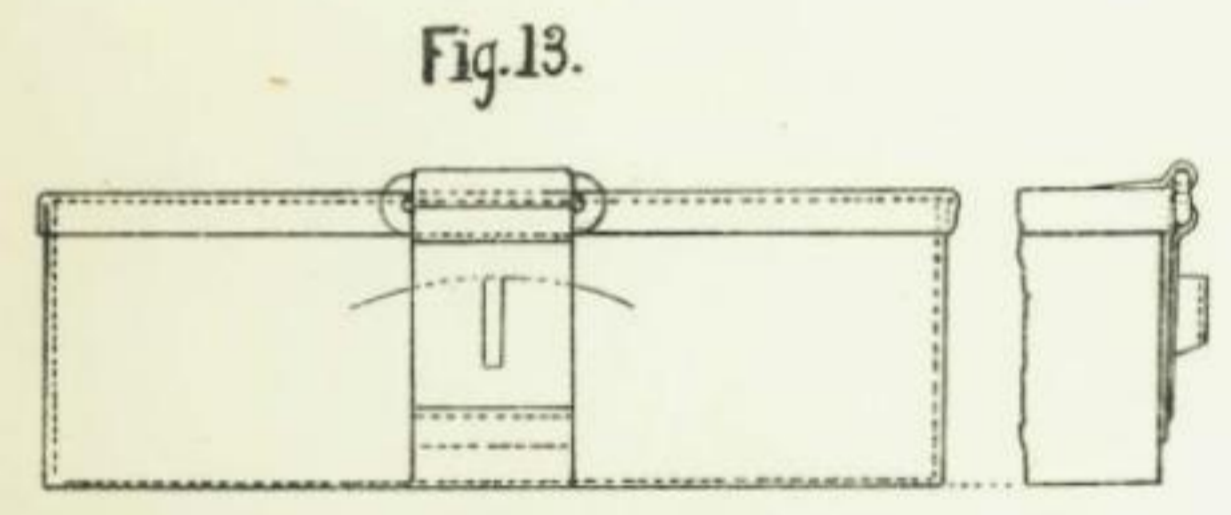
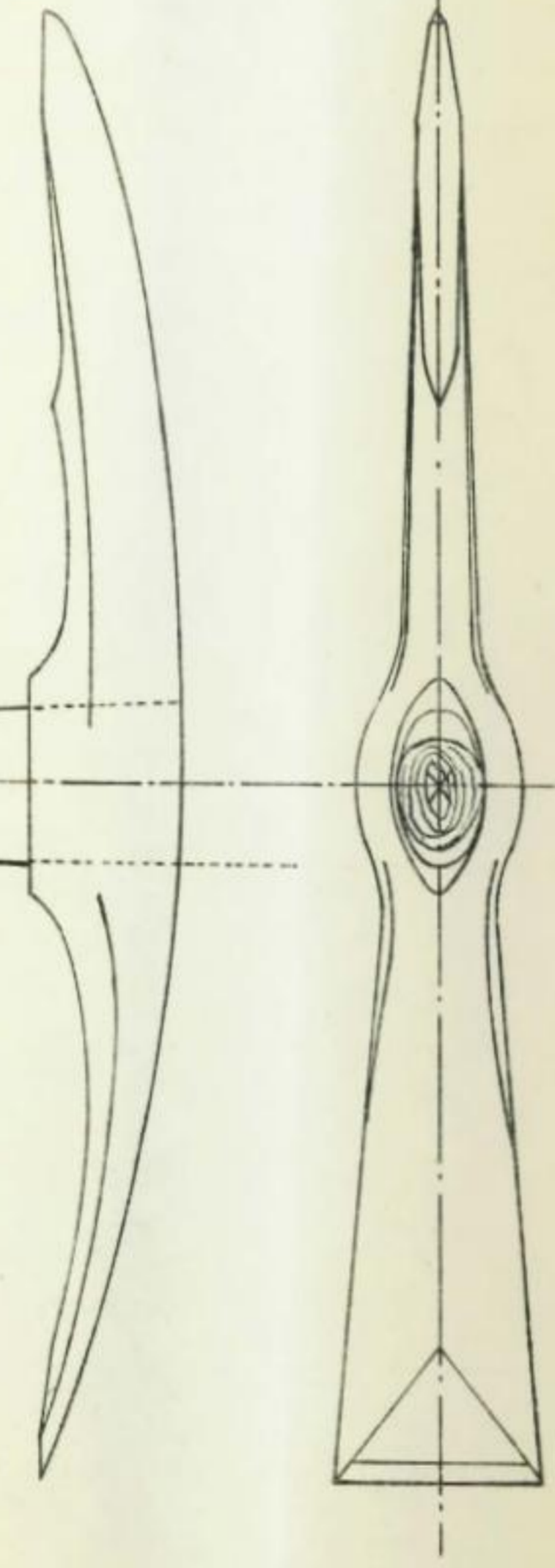
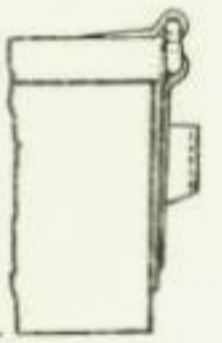
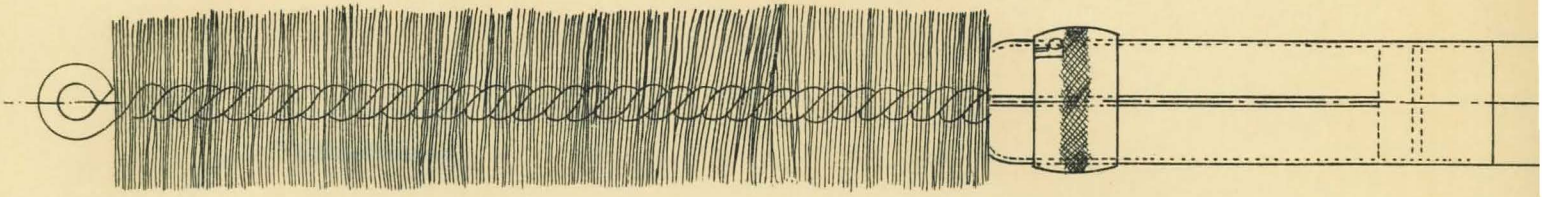
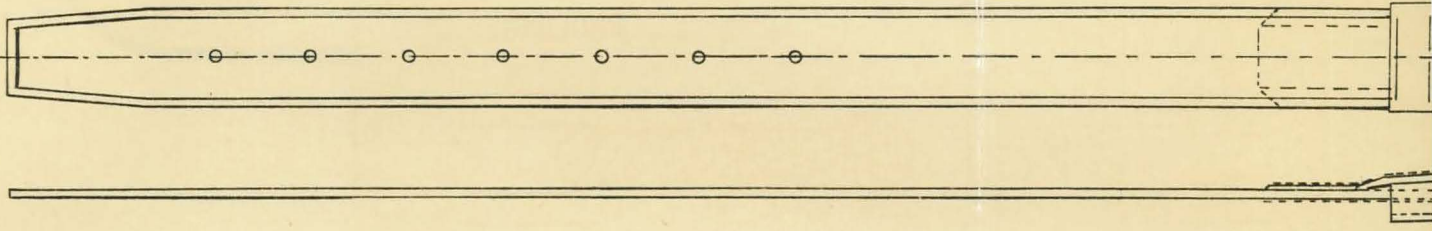

Fig. 14.





STRAPS FOR TOOLS.



PROLONGE.

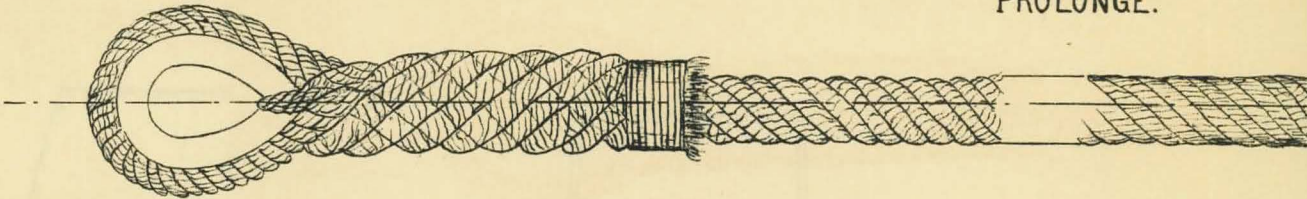

BUCKET.

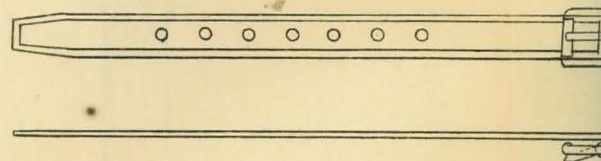
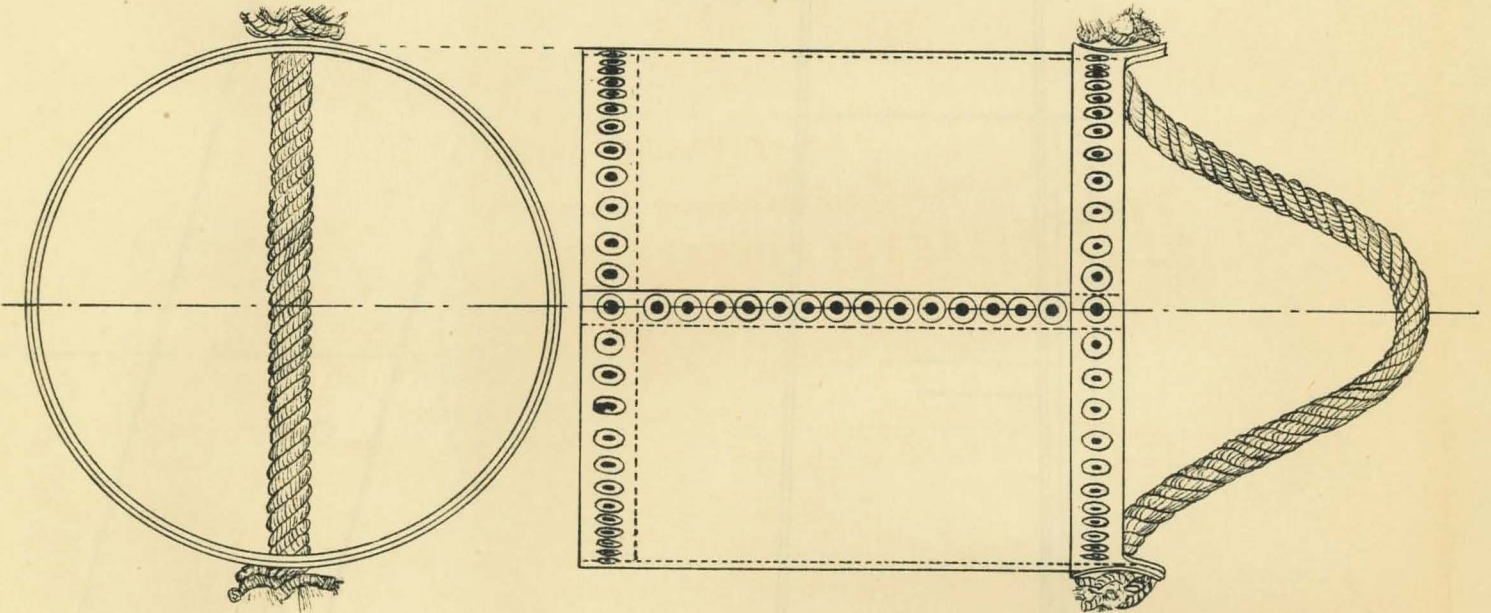

CHARGER.

FOR HOTCHKISS REVOLVING CAL

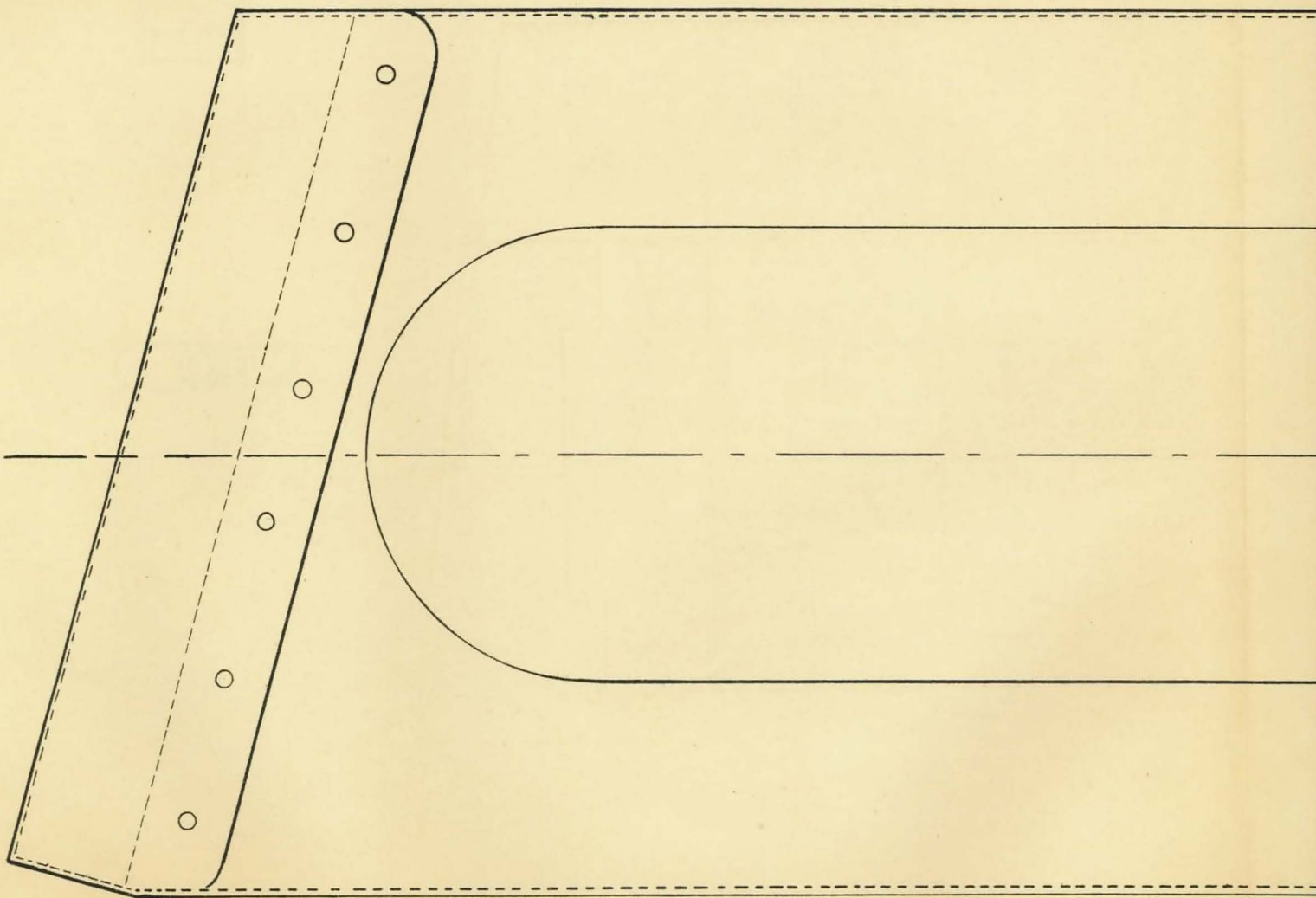
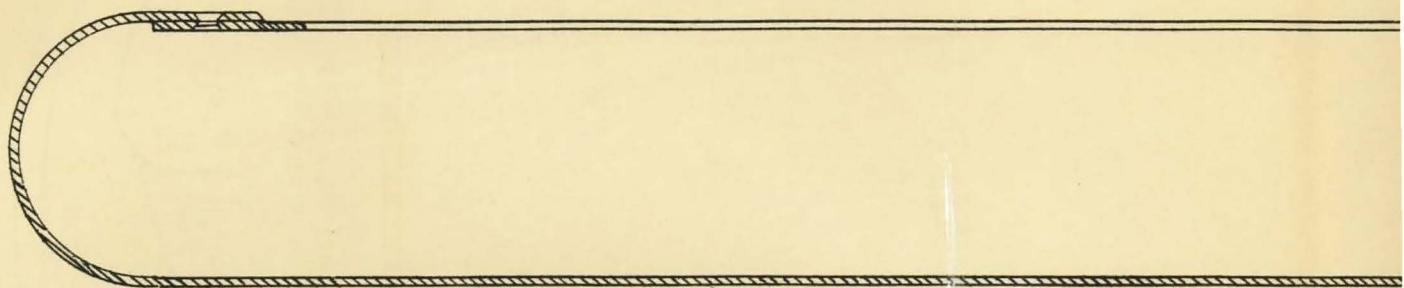

ANNON, CAL. 1.45-INCH. ($37 \frac{m}{m}$)

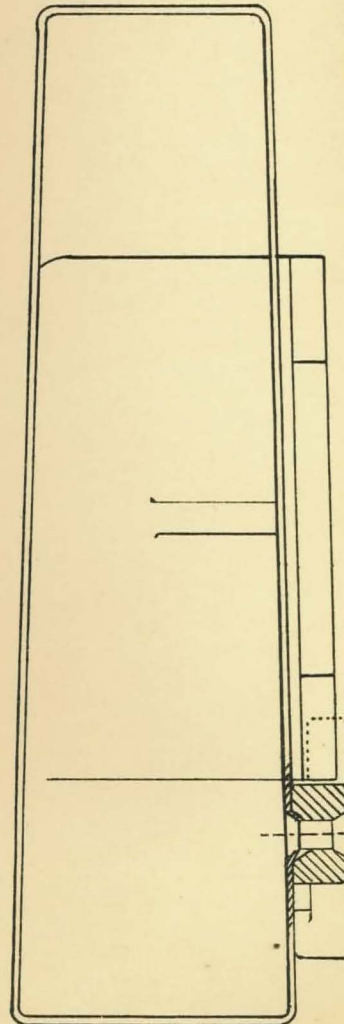
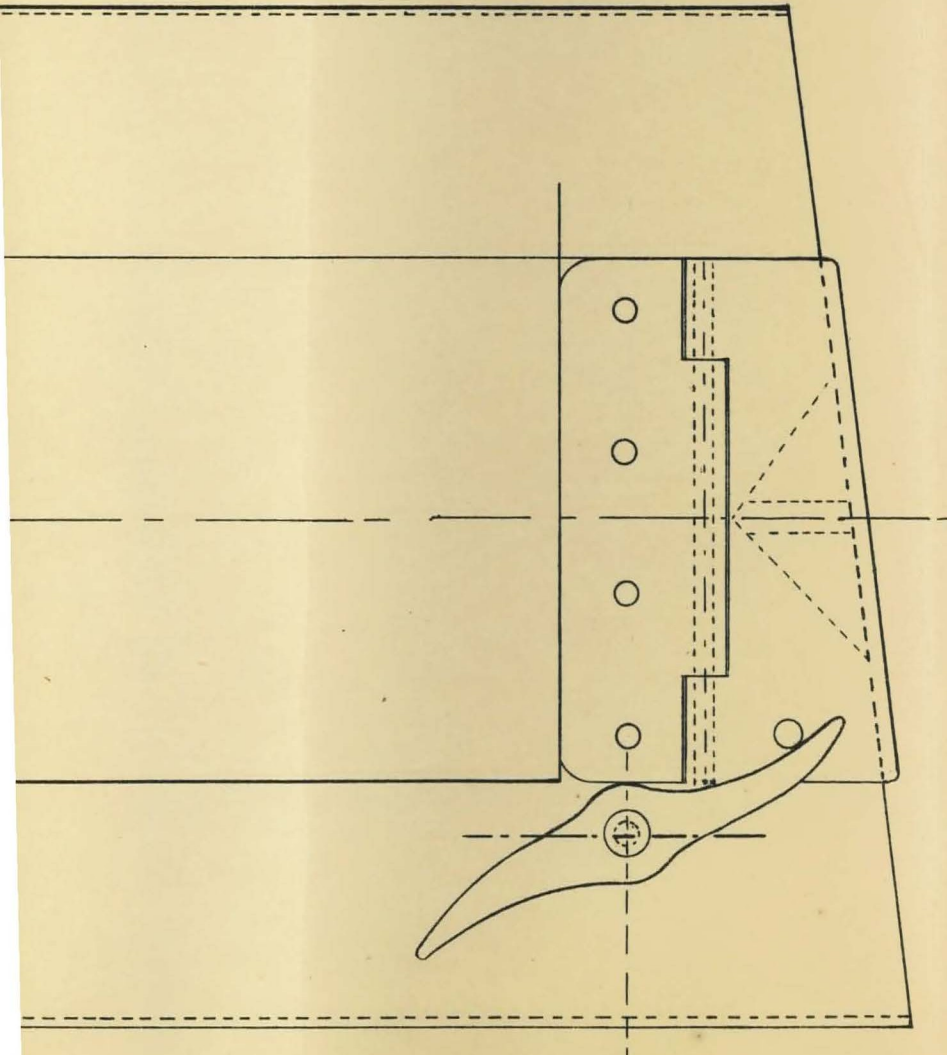
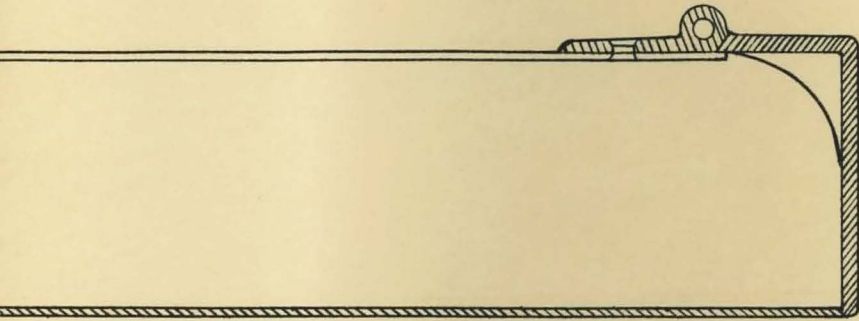

FEED-TROUGH.
FOR HOTCHKISS REVOLVING CANNON, CAL. 1.45-INCH. (37^m/_m) PLATE XV.

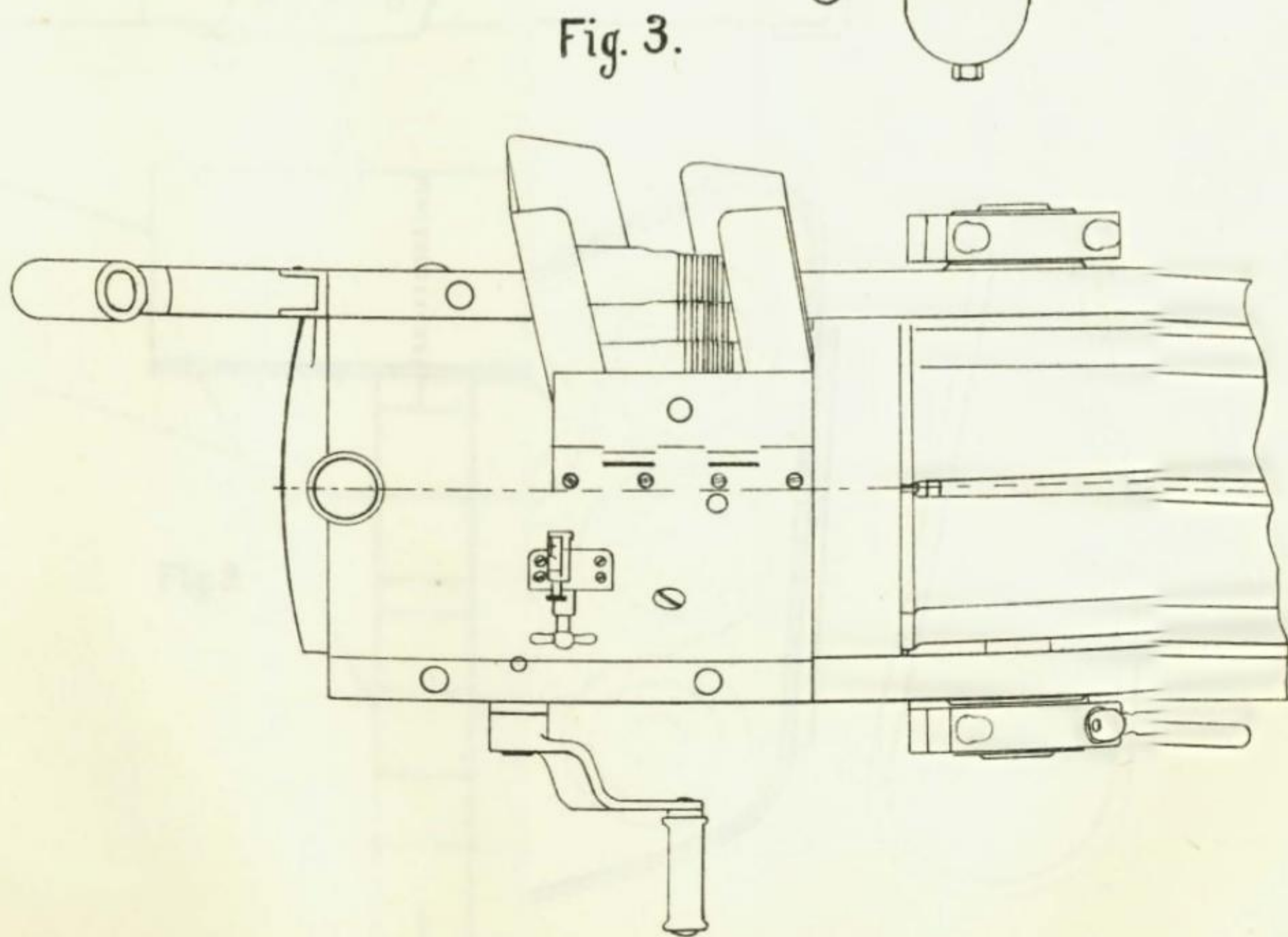
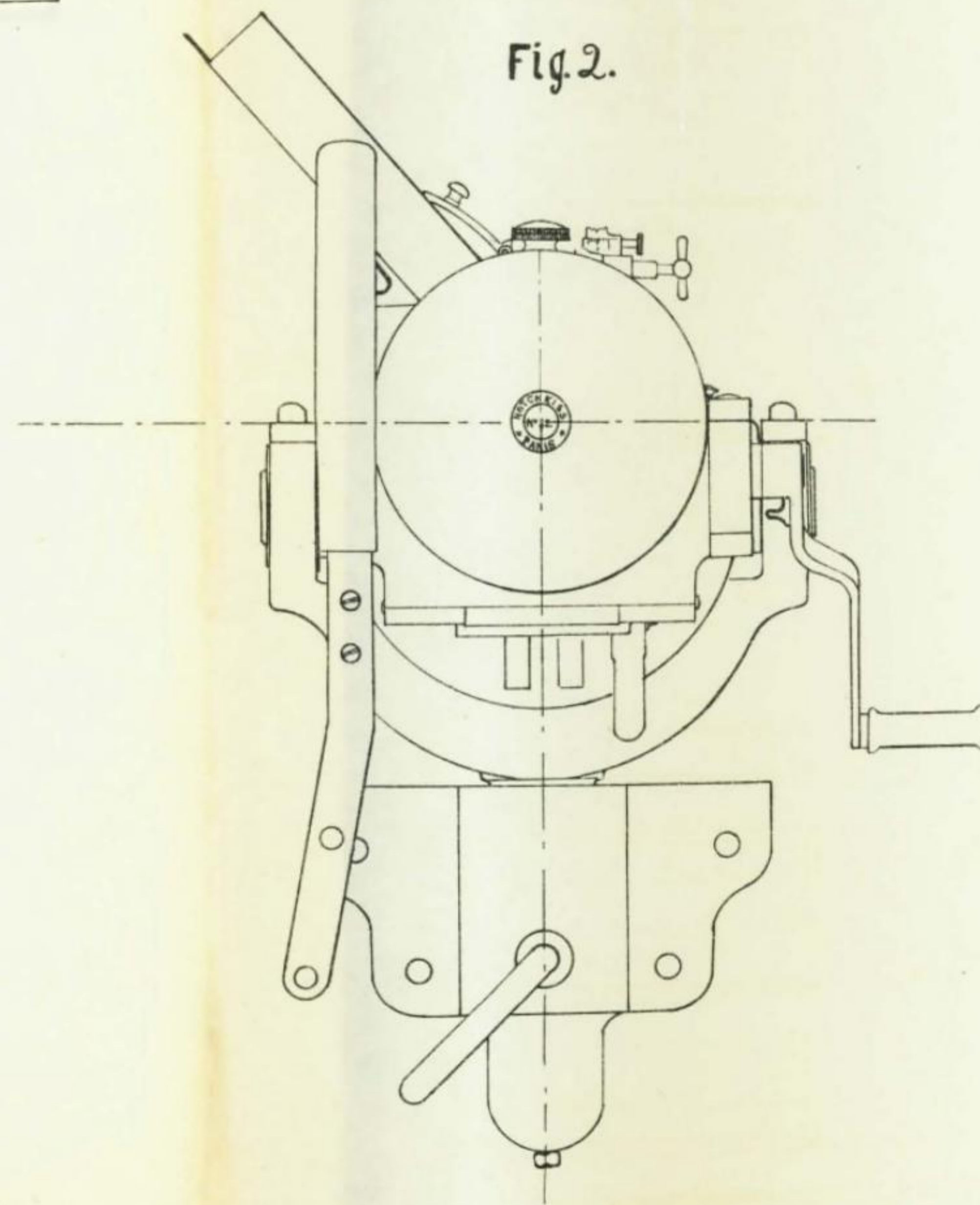
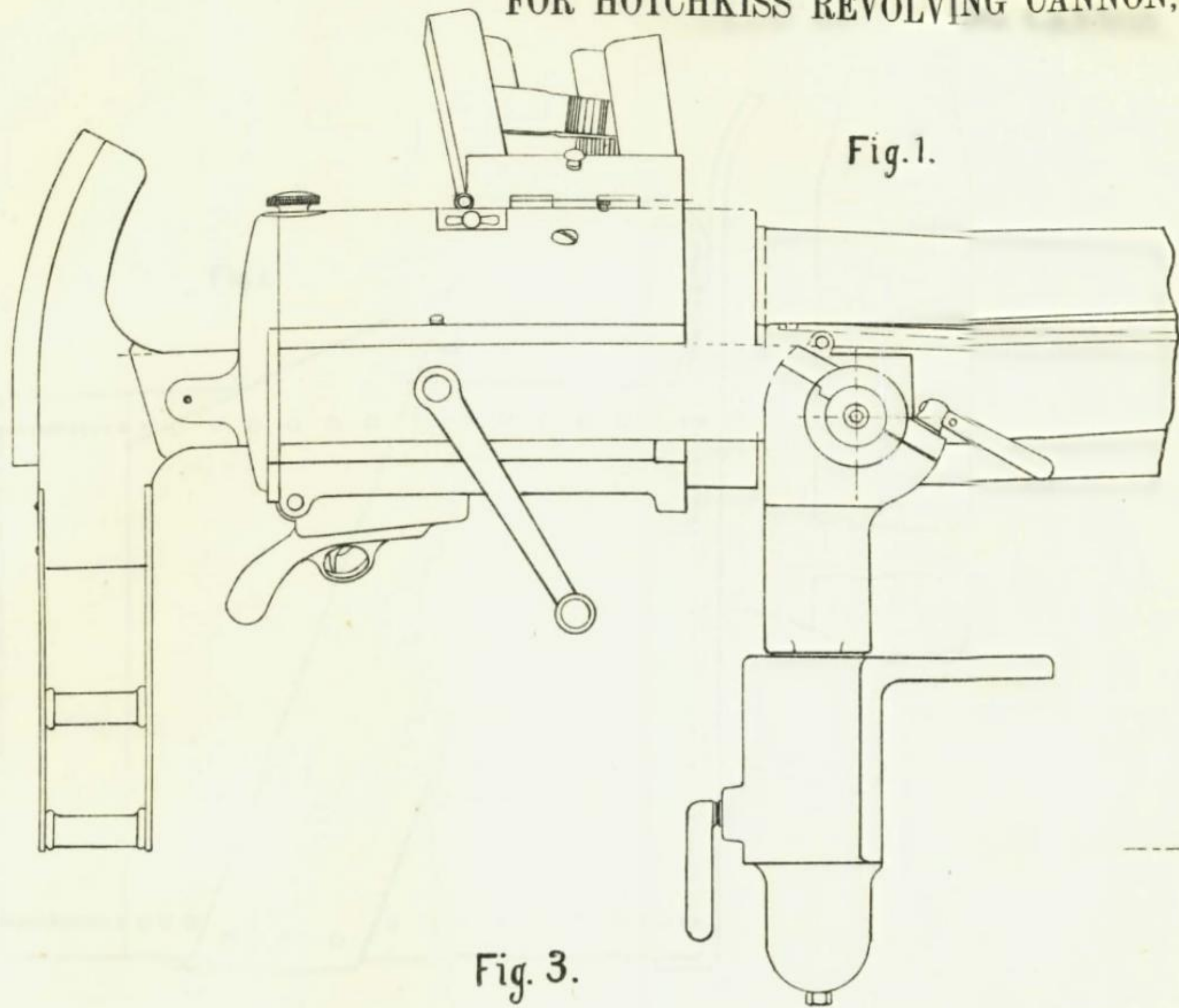

CHARGER-POUCH OR PASS BOX.

FOR HOTCHKISS REVOLVING CANNON, CAL. 1.45-INCH. (37^m/_m.)

Fig. 1.

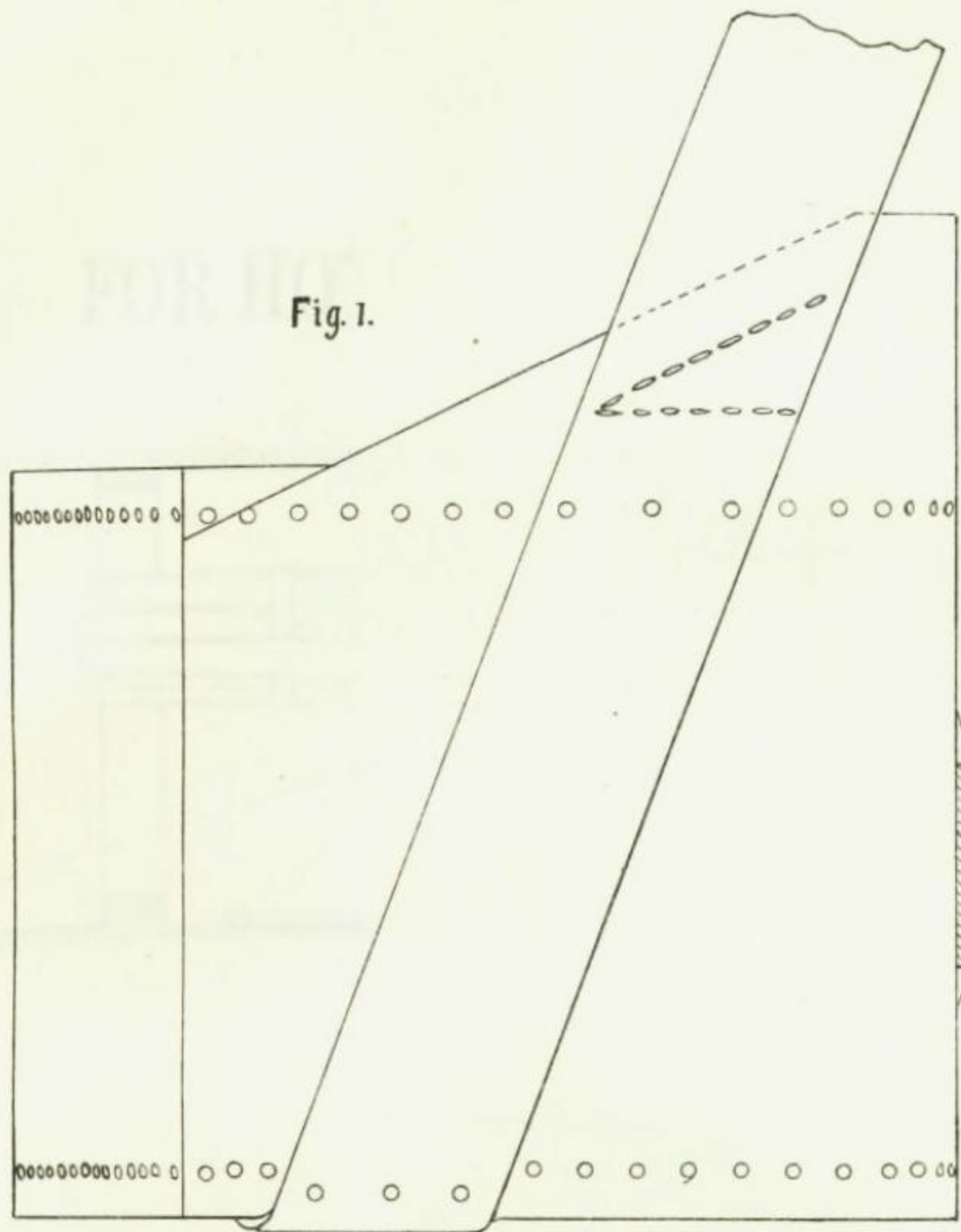

Fig. 2.

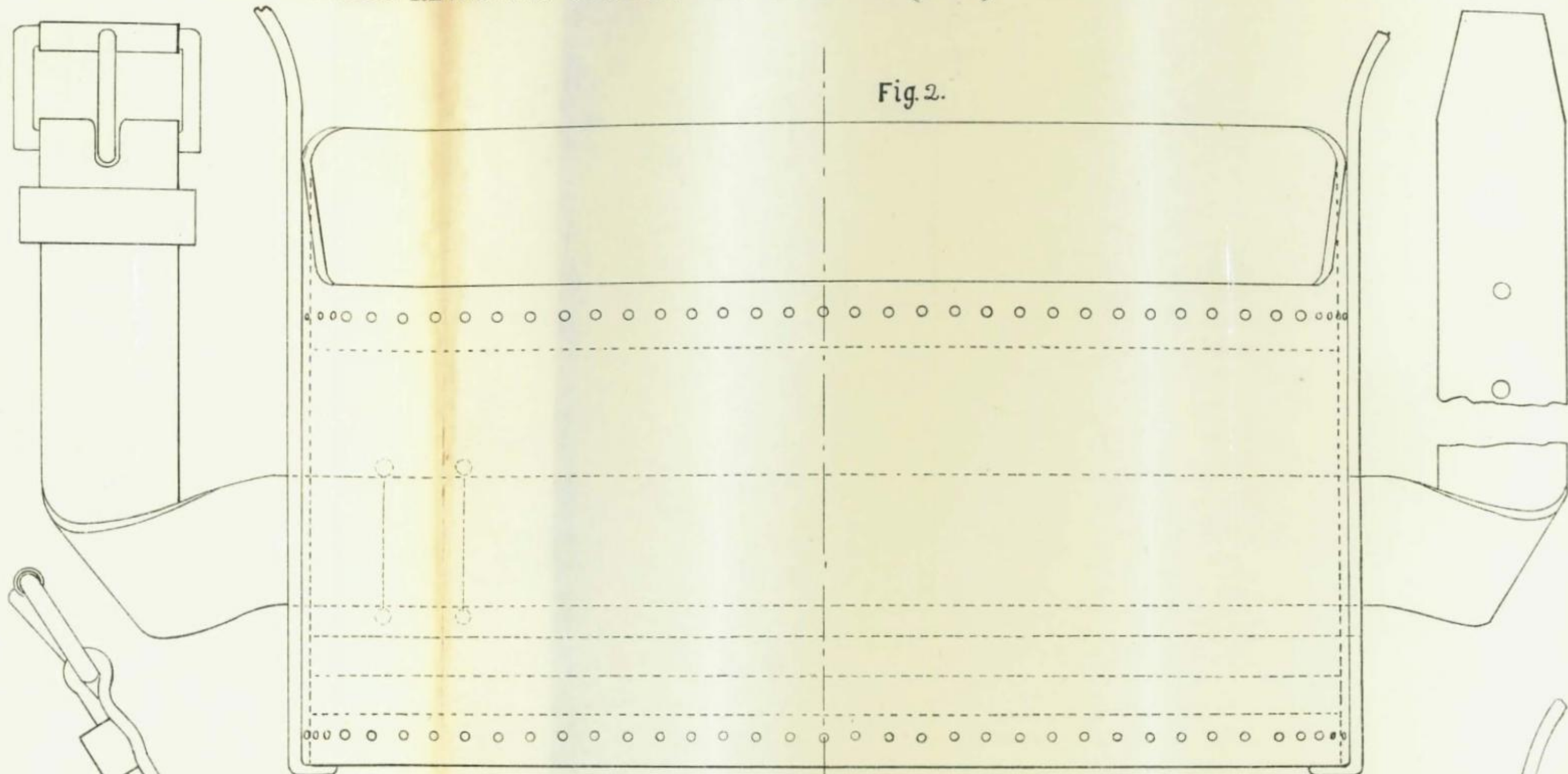

Fig. 3.

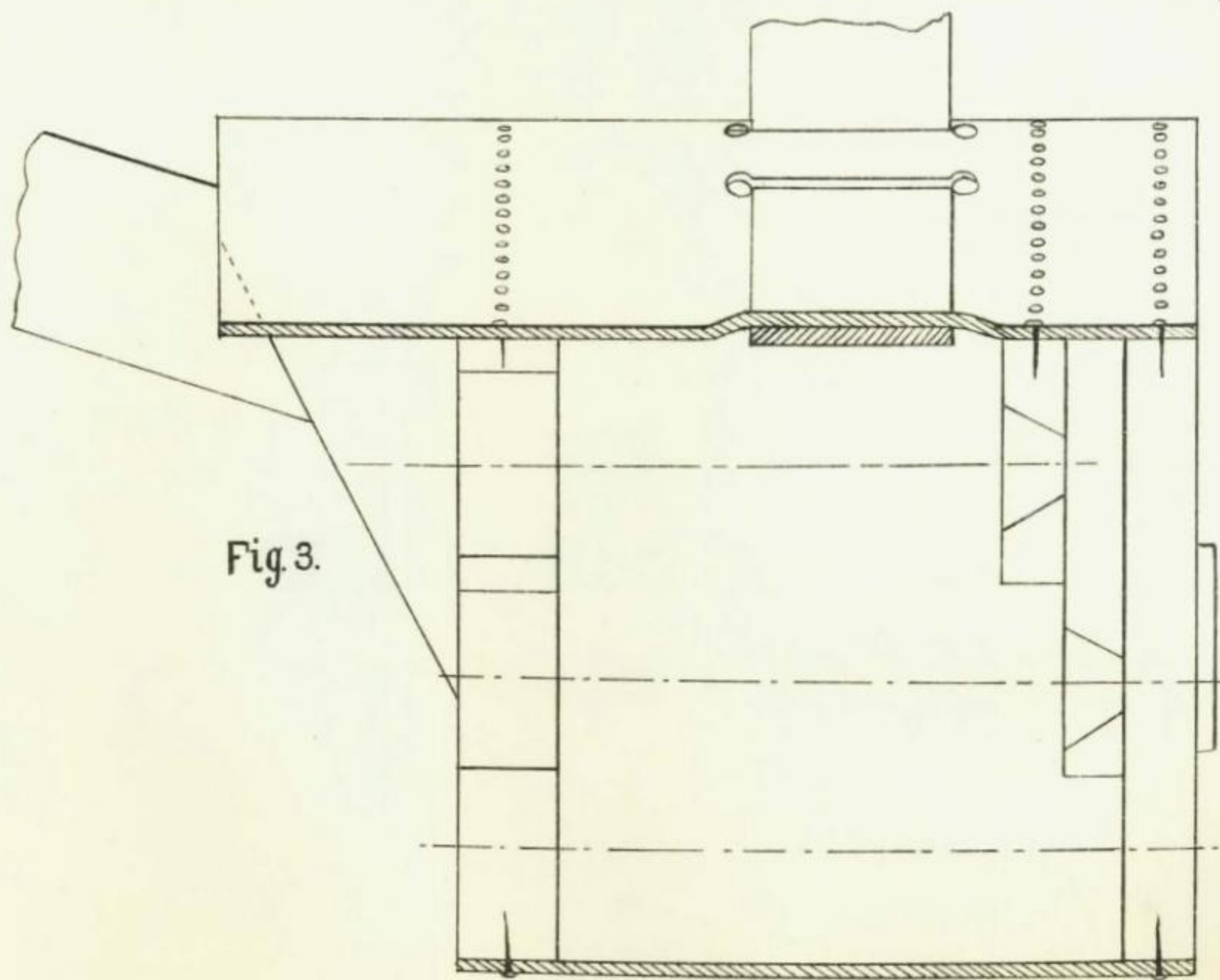
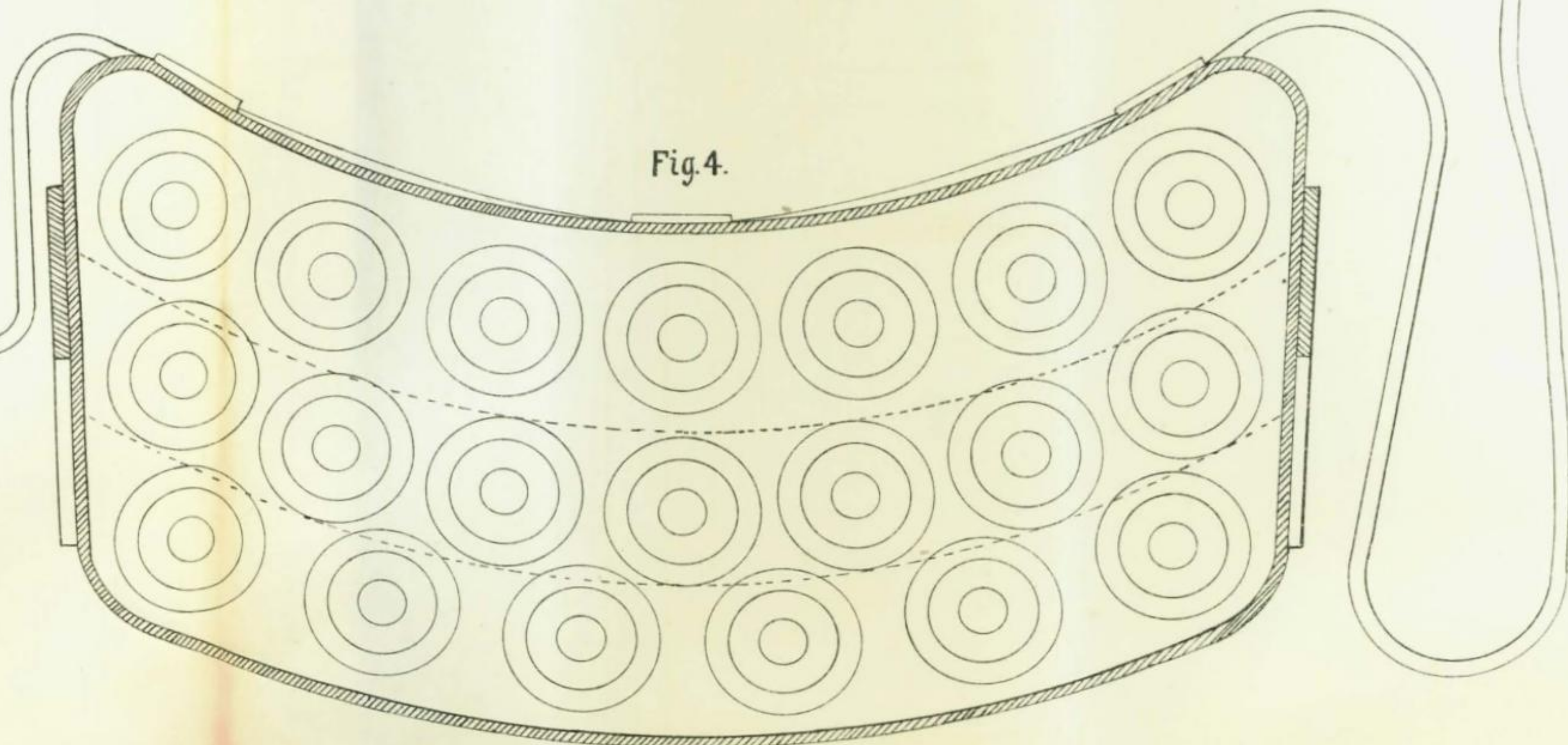
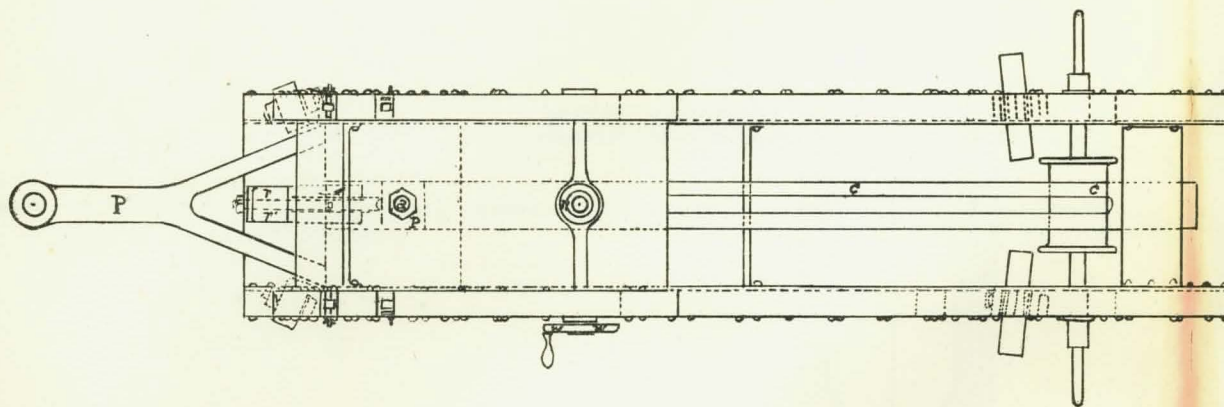
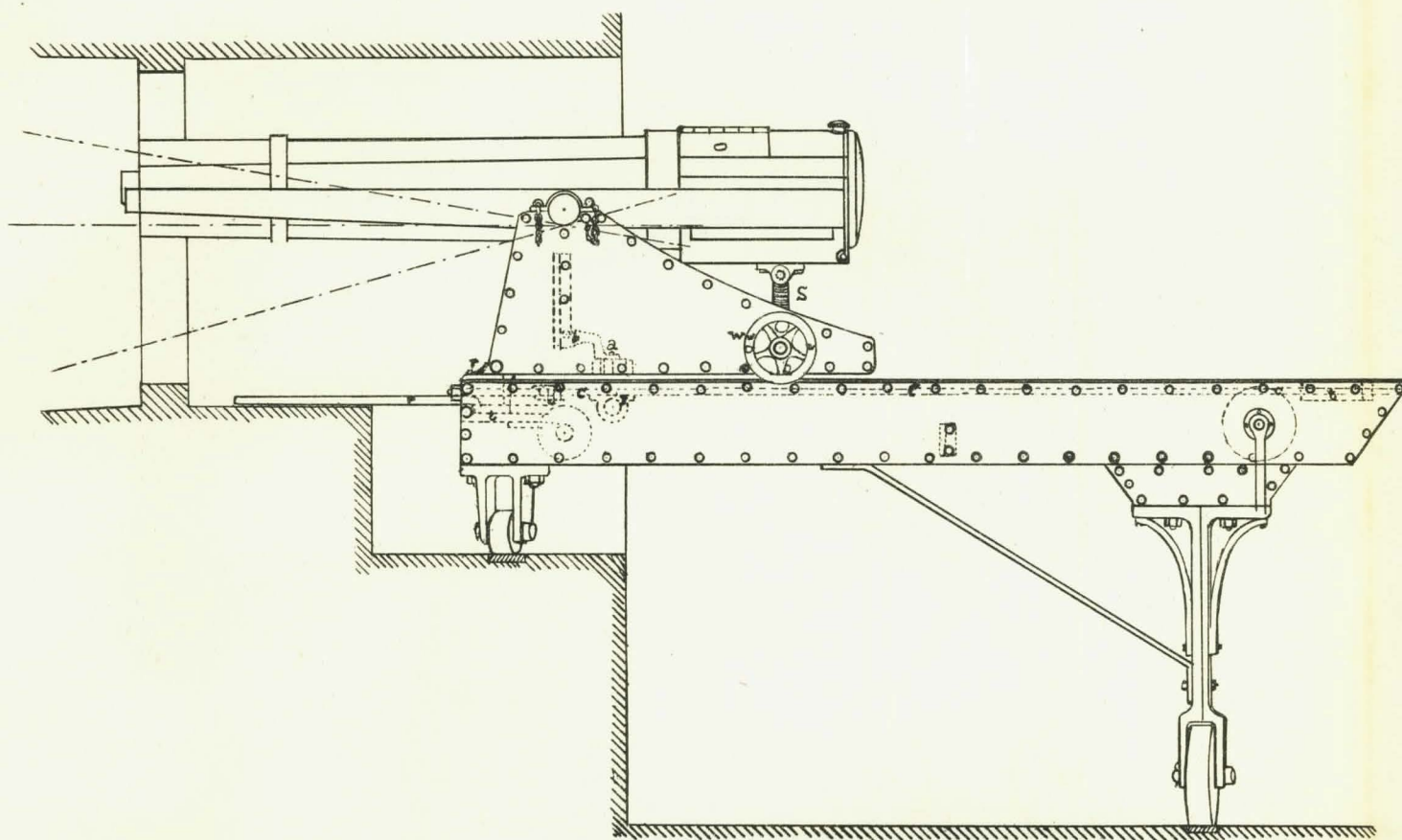

Fig. 4.



EXPERIMENTAL CARRIAGE FOR HOTCHKISS FLANK DEFENSE REVOLVING CA



GERMAN MOUNT

FOR HOTCHKISS FLANK DEFENSE REVOLVING CANNON, CAL. 1.57-INCH. (40^{m/m.})

Fig. 1.

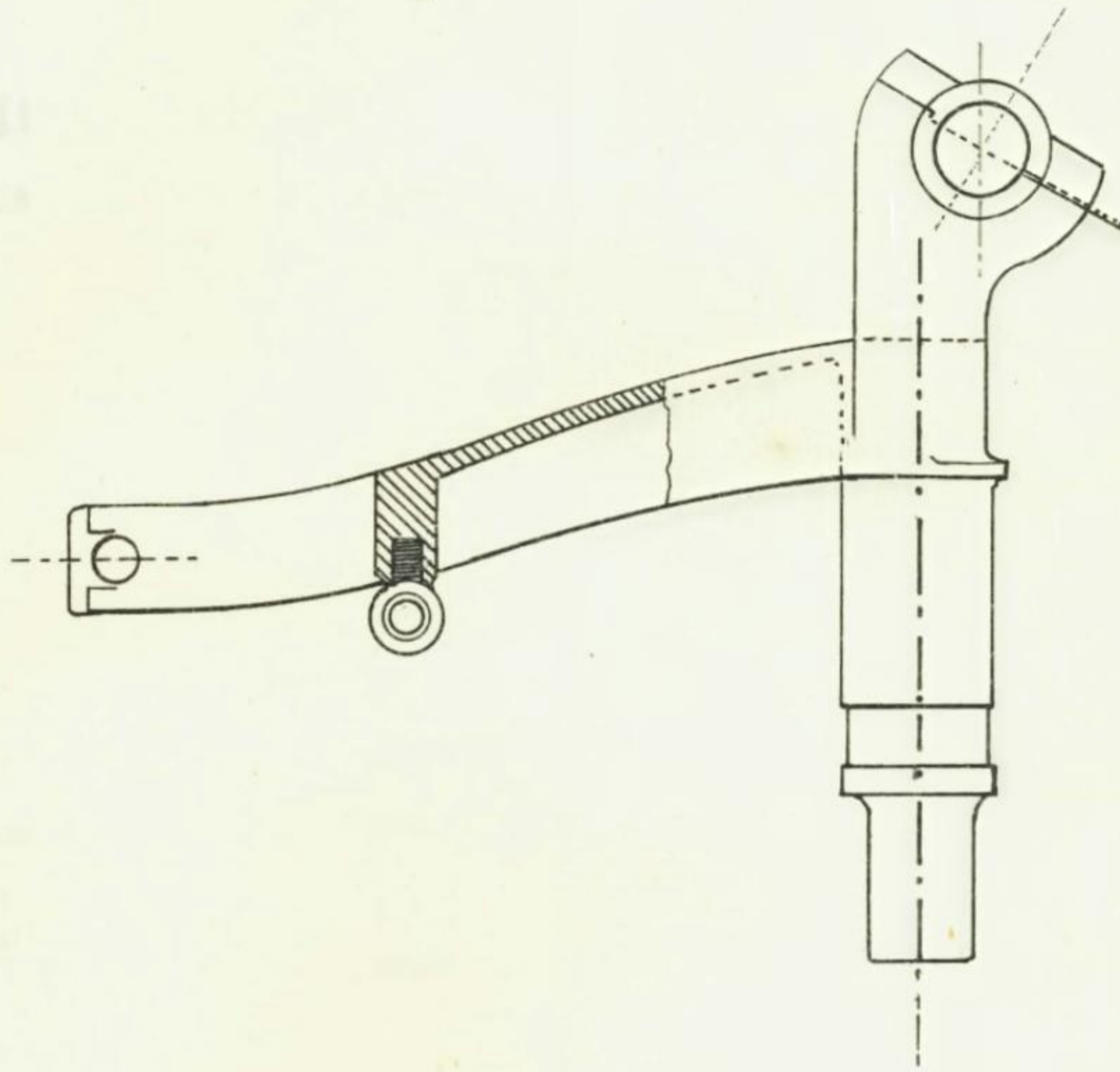

Fig. 2.

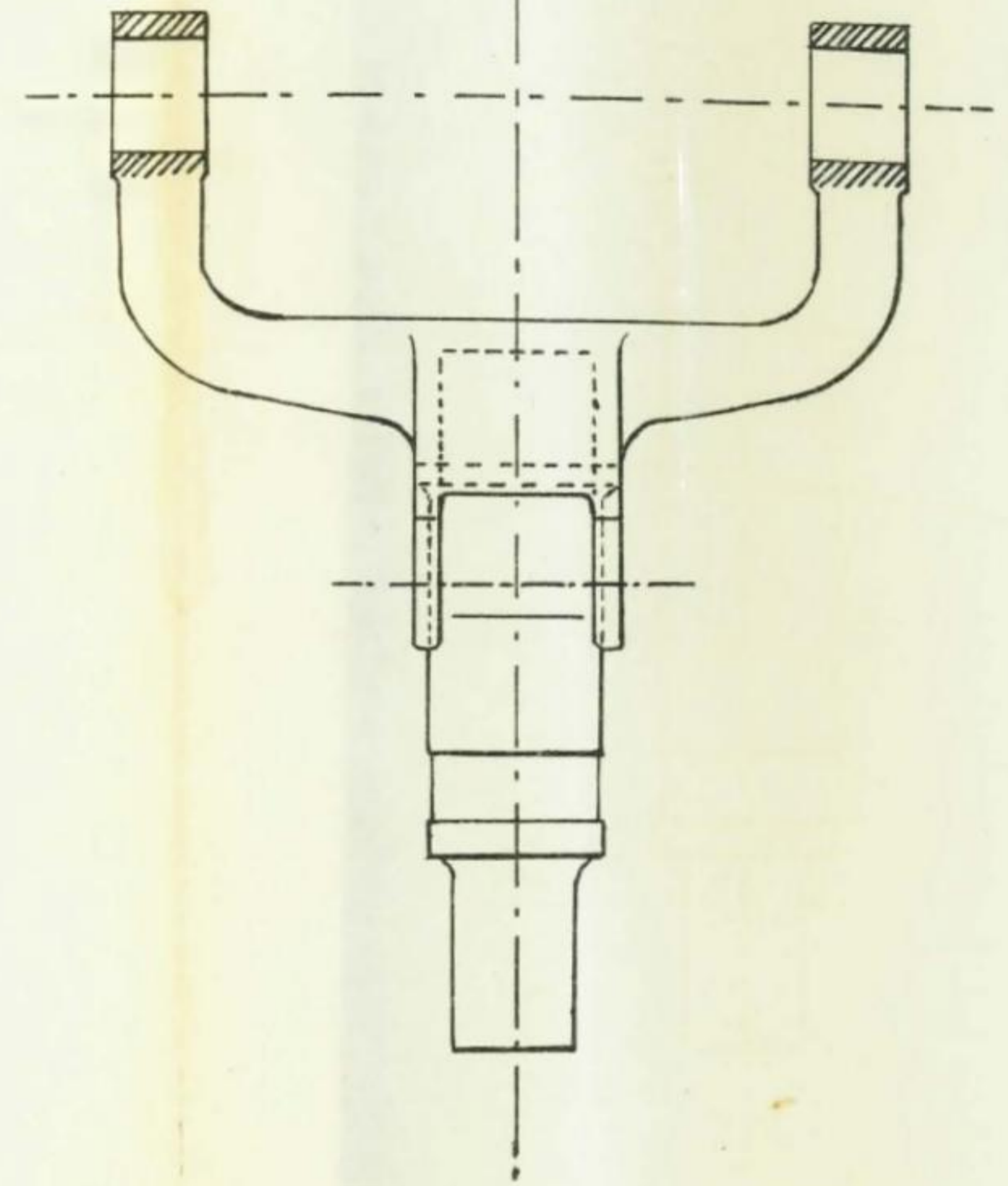

Fig. 3.

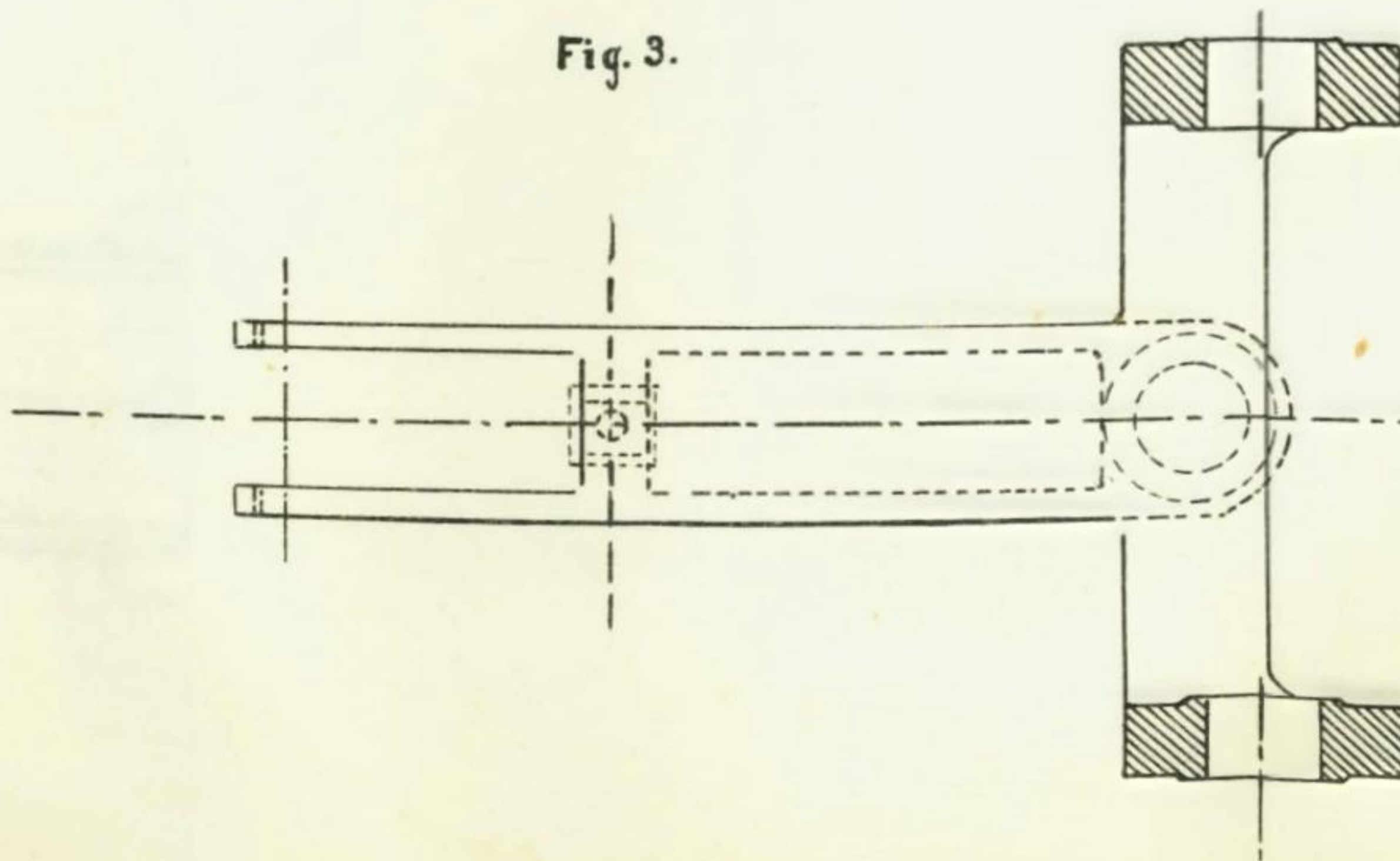
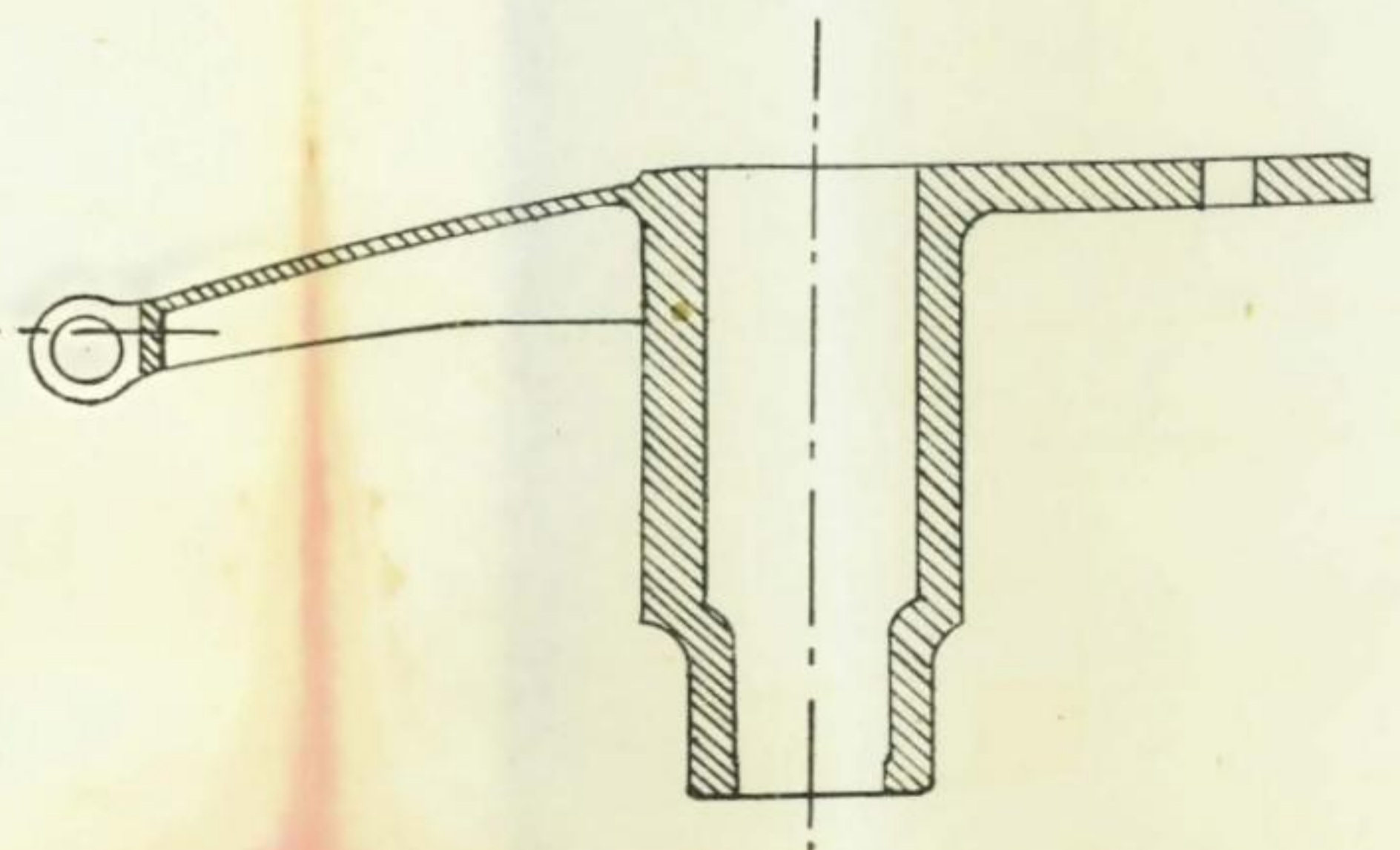

Fig. 4.



HOTCHKISS

FLANK DEFENSE GUN ON FRENCH CAPONNIERE CARRIAGE.

Fig. 1.

Fig. 2.

Fig. 3.

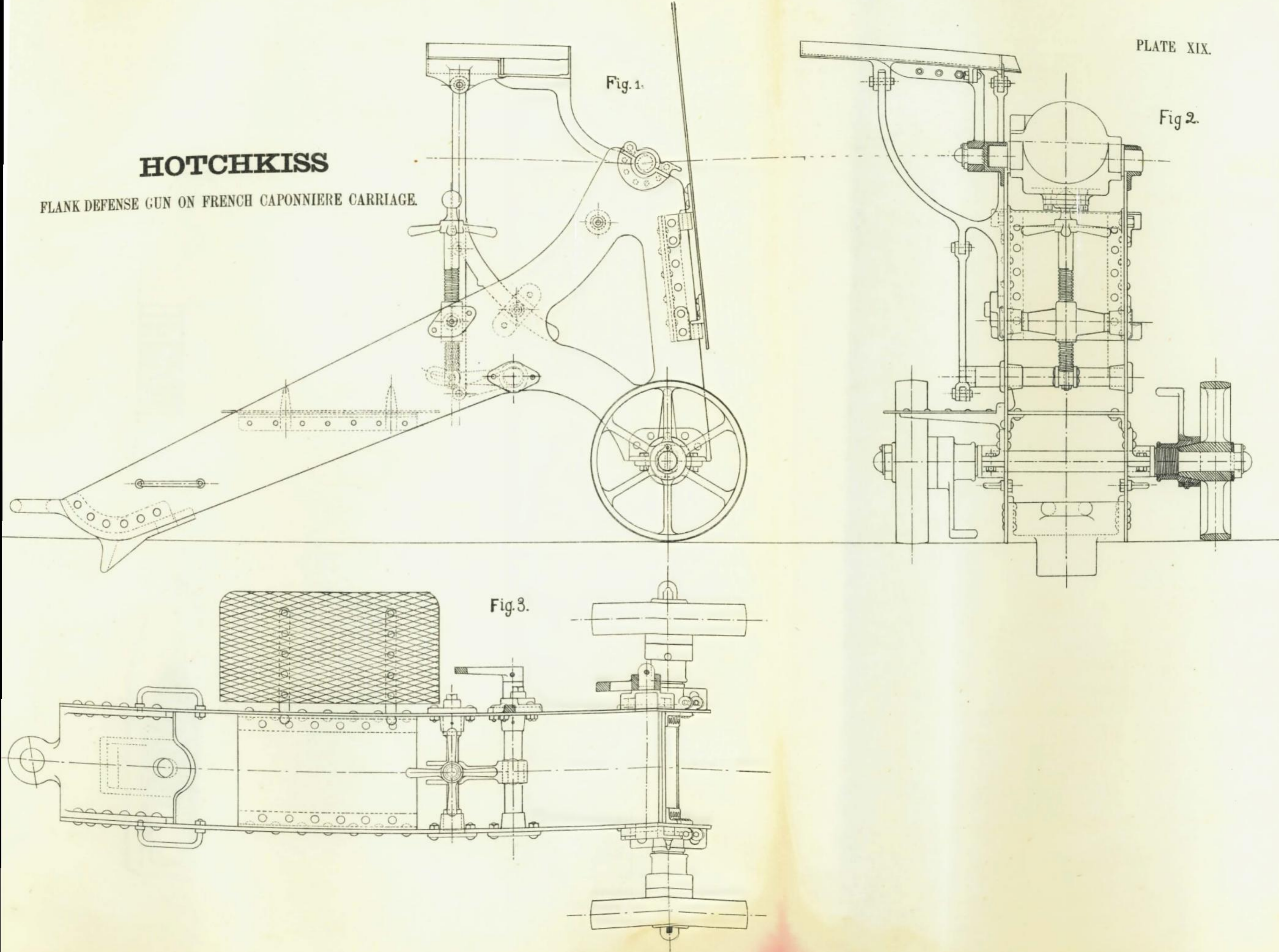

AMMUNITION

FOR HOTCHKISS REVOLVING CANNON, CAL. 1.45-INCH. (37^m/_m.)

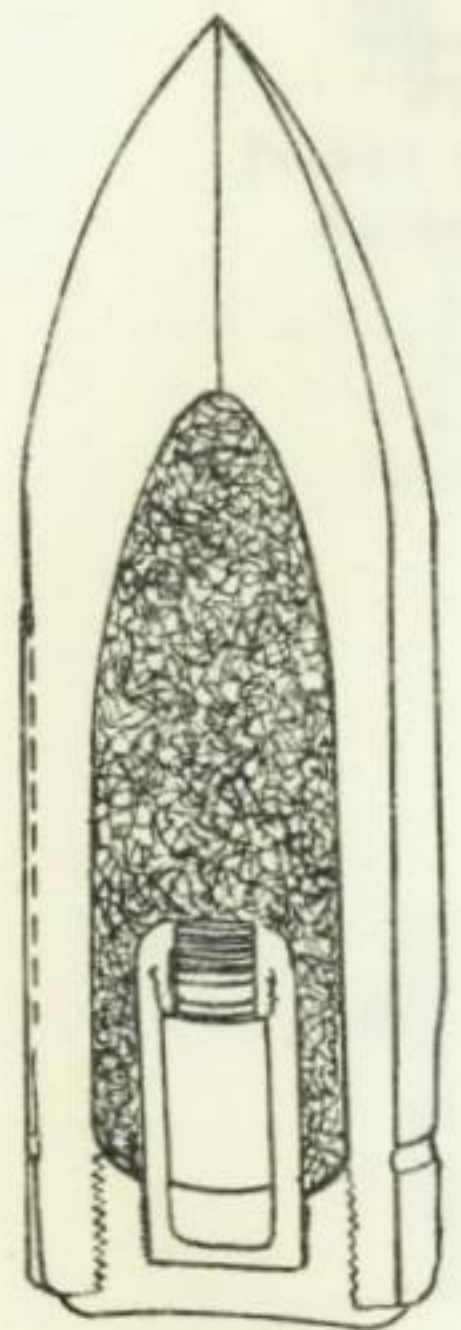
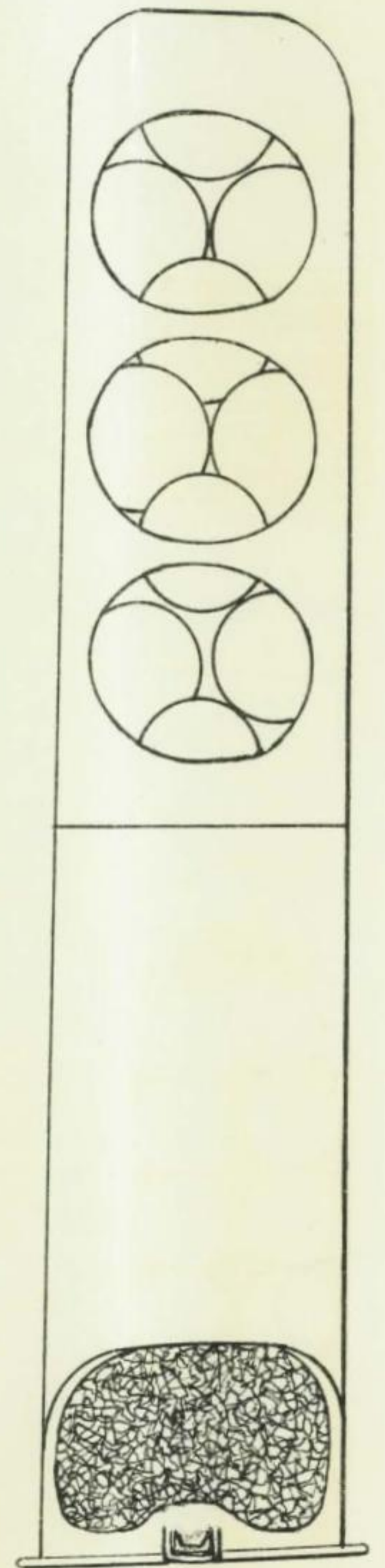
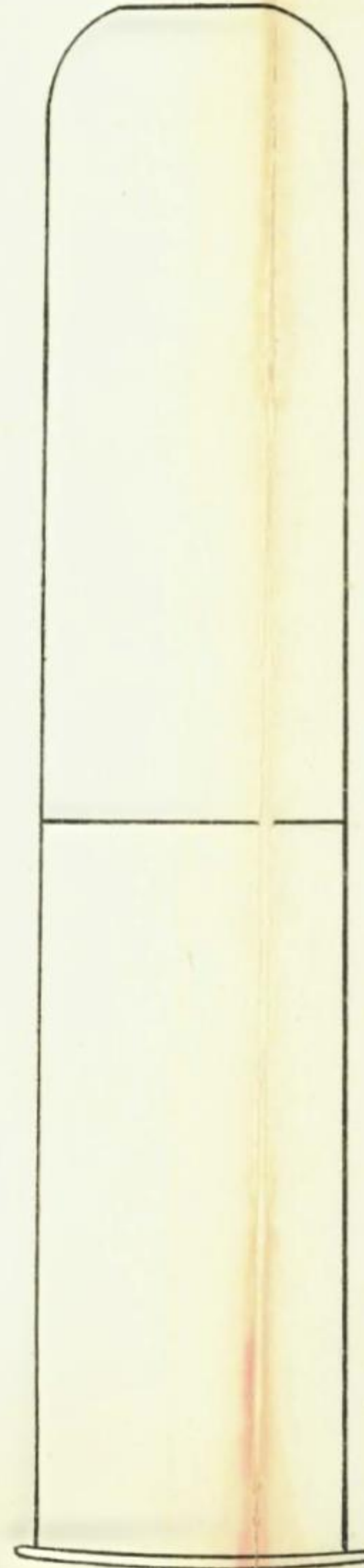
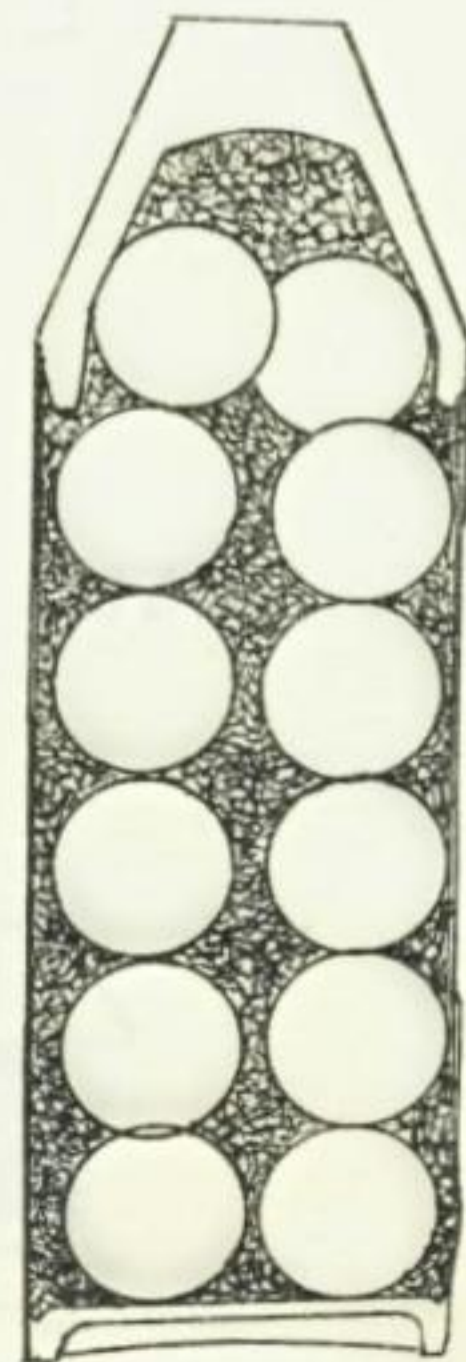
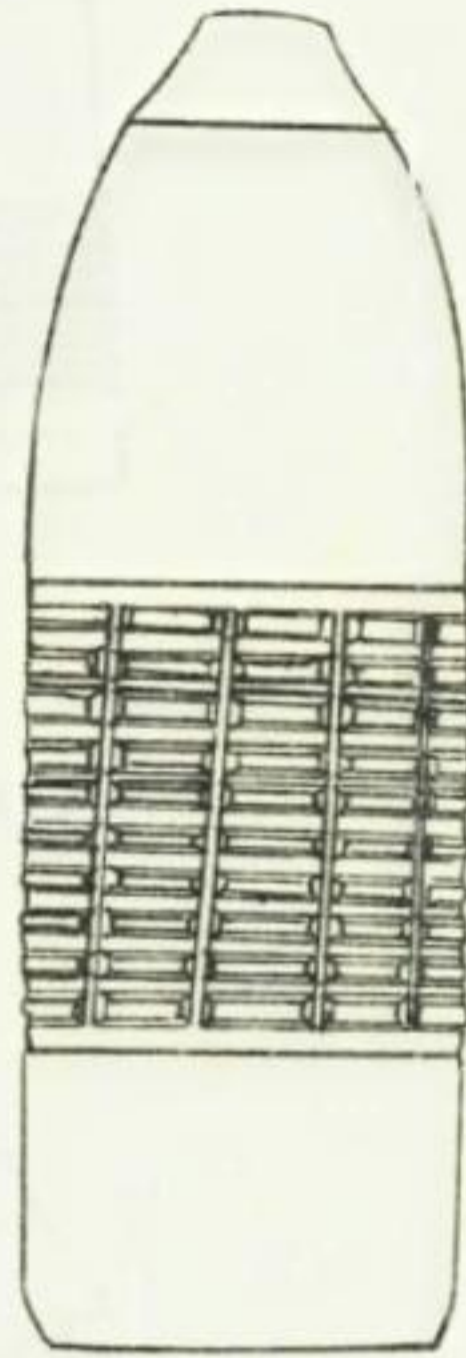
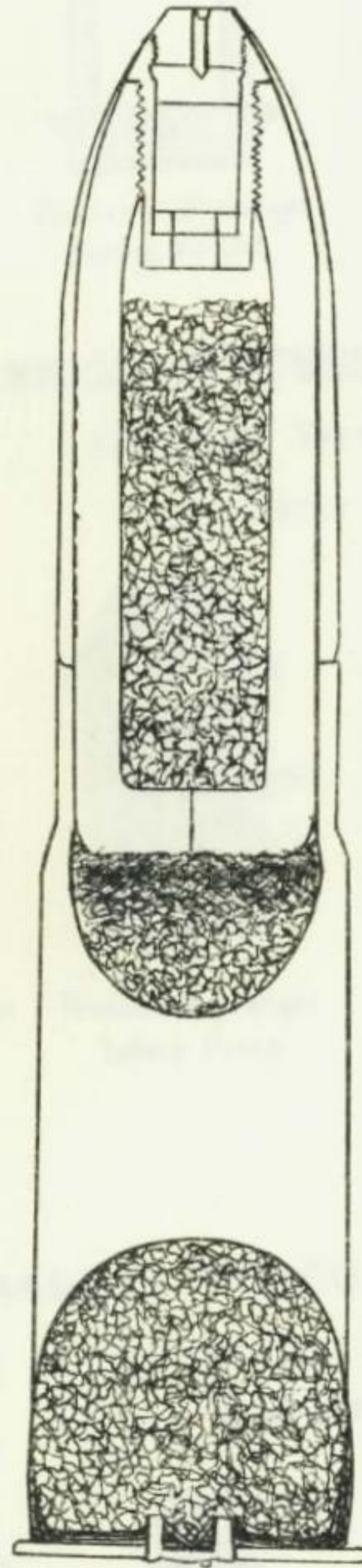
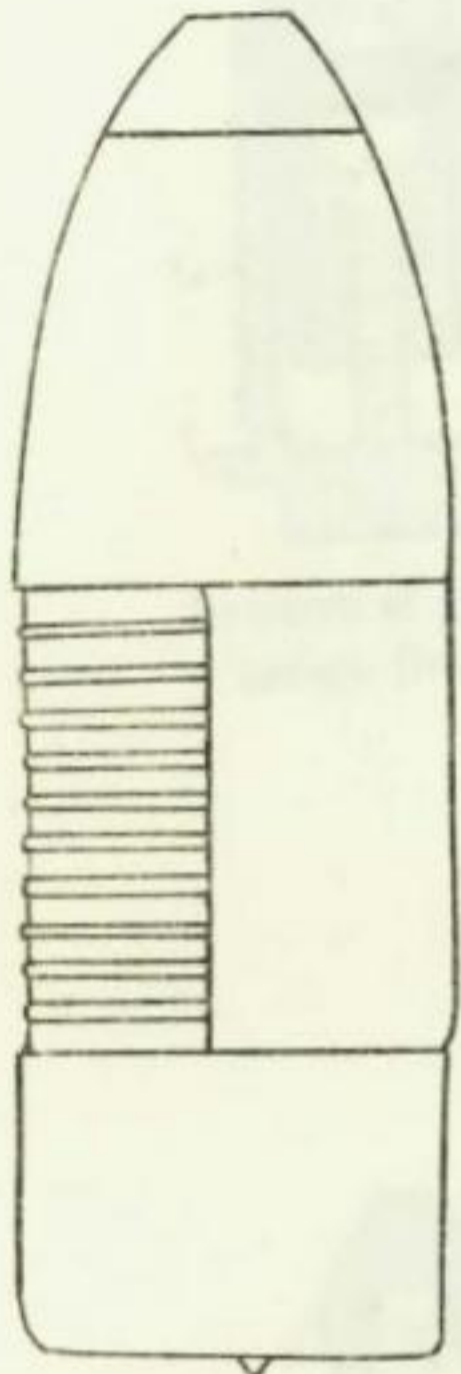

HOTCHKISS BASE PERCUSSION FUZE

for Steel Shell

Full size.

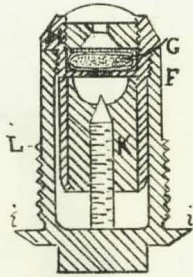

Position of plunger before firing

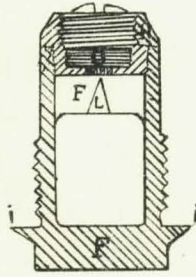

Position of plunger during flight

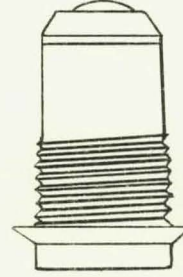

HOTCHKISS PERCUSSION FUZE

for Land Service

Full size

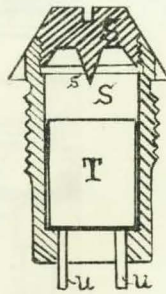

Position of plunger during flight

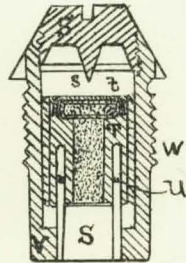

Position of plunger before firing

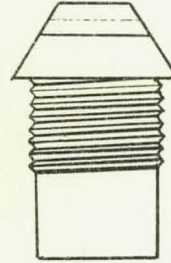

Safety plug

DESMAREST PERCUSSION FUZE

for Common Shell

Full size

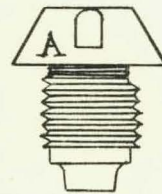
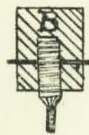
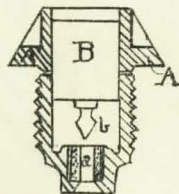

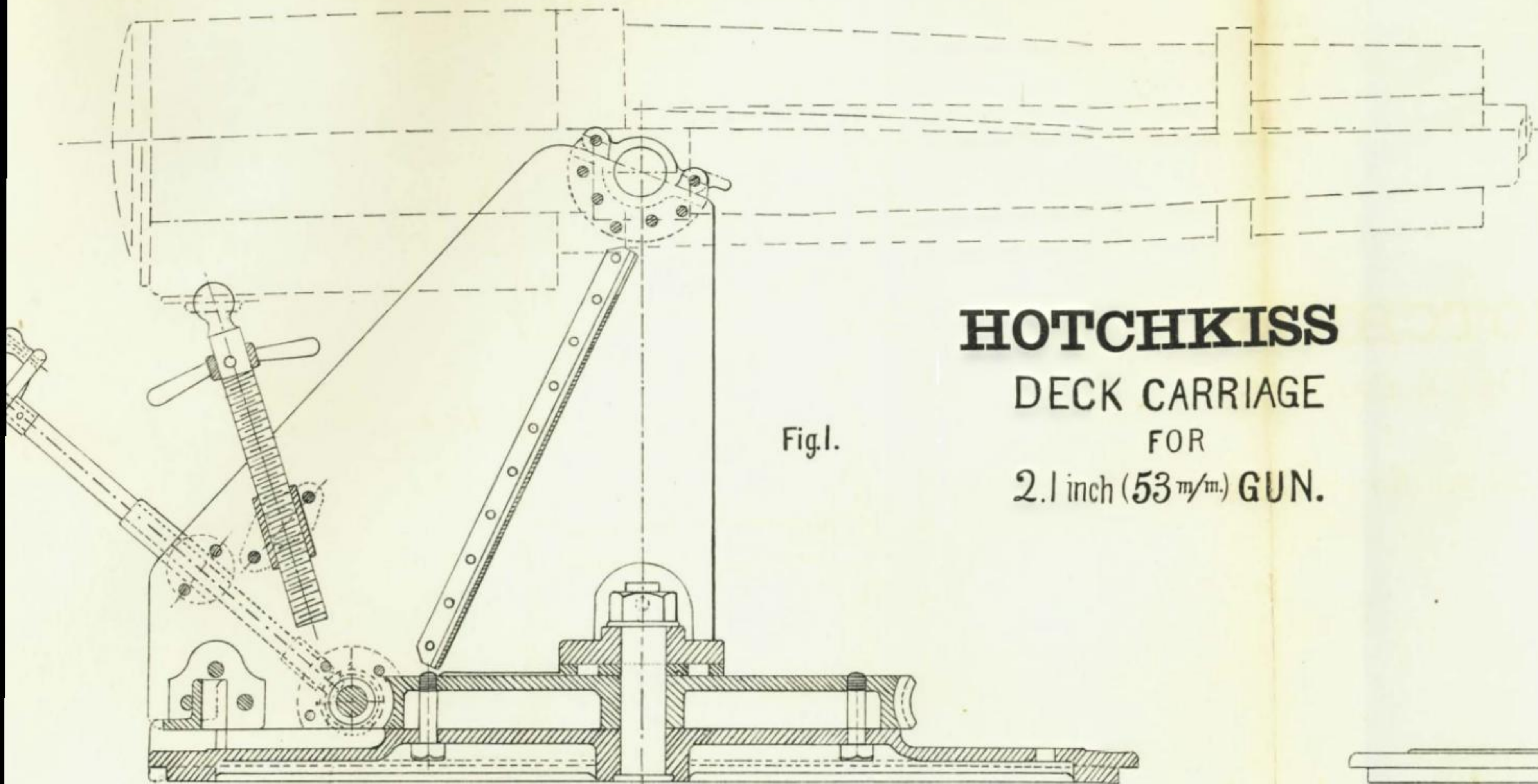

Fig. 1.

HOTCHKISS
DECK CARRIAGE
FOR
2.1 inch (53^m/m.) GUN.

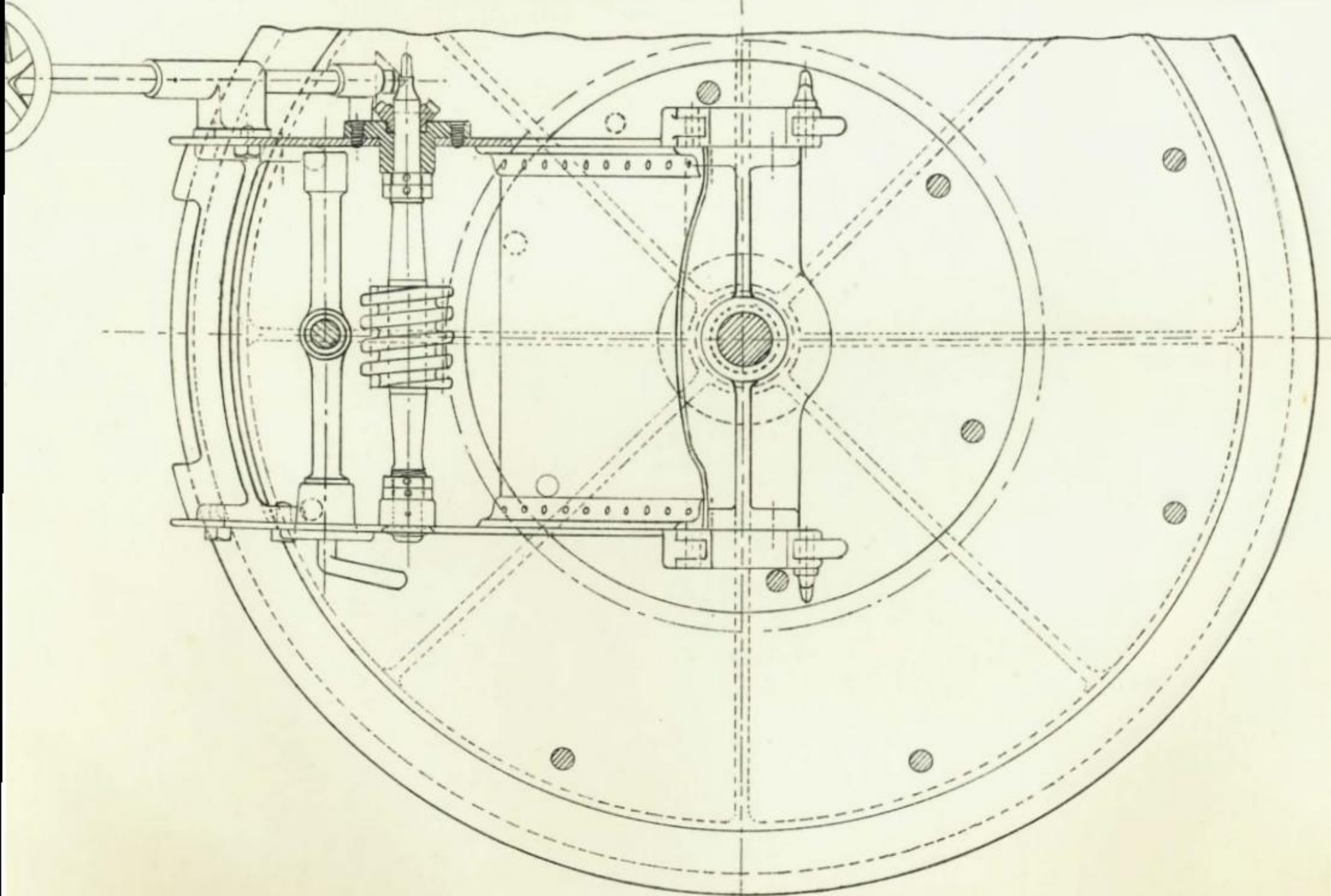

Fig. 3.

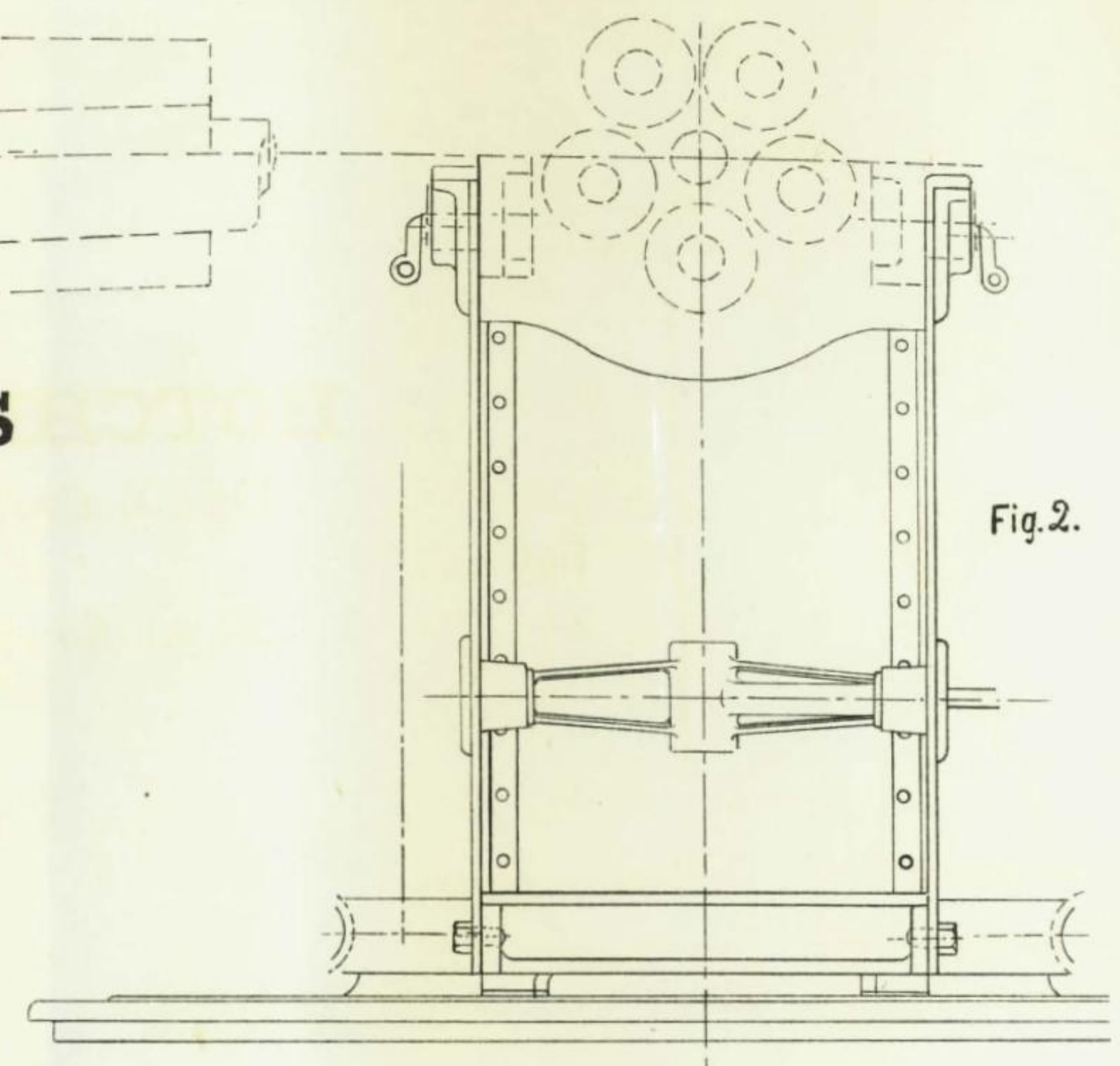

Fig. 2.