

Lawrence K. Wang  
Chih Ted Yang *Editors*

# Modern Water Resources Engineering

# Modern Water Resources Engineering

For further volumes:  
<http://www.springer.com/series/7645>



VOLUME 15  
HANDBOOK OF ENVIRONMENTAL ENGINEERING

# Modern Water Resources Engineering

Edited by

**Lawrence K. Wang, Ph.D., P.E., D.EE**

*Ex-Dean & Director*

*Zorex Corporation, Newtonville, New York, USA*

*Lenox Institute of Water Technology, Newtonville, NY, USA*

*Krofta Engineering Corporation, Lenox, Massachusetts, USA*

**Chih Ted Yang, Ph.D., P.E., D.WRE**

*Borland Professor of Water Resources*

*Department of Civil and Environmental Engineering*

*Colorado State University, Fort Collins, Colorado, USA*

 Humana Press

*Editors*

**Lawrence K. Wang, Ph.D., P.E., D.EE**

Ex-Dean & Director

Zorex Corporation, Newtonville, New York, USA

Lenox Institute of Water Technology, Newtonville, NY, USA

Krofta Engineering Corporation, Lenox, Massachusetts, USA

lenox.institute@gmail.com

**Chih Ted Yang, Ph.D., P.E., D.WRE**

Borland Professor of Water Resources

Department of Civil and Environmental Engineering

Colorado State University, Fort Collins, Colorado, USA

ctyang@engr.colostate.edu

ctyang23@gmail.com

ISBN 978-1-62703-594-1

ISBN 978-1-62703-595-8 (eBook)

DOI 10.1007/978-1-62703-595-8

Springer New York Heidelberg Dordrecht London

Library of Congress Control Number: 2013955598

© Springer Science+Business Media New York 2014

This work is subject to copyright. All rights are reserved by the Publisher, whether the whole or part of the material is concerned, specifically the rights of translation, reprinting, reuse of illustrations, recitation, broadcasting, reproduction on microfilms or in any other physical way, and transmission or information storage and retrieval, electronic adaptation, computer software, or by similar or dissimilar methodology now known or hereafter developed. Exempted from this legal reservation are brief excerpts in connection with reviews or scholarly analysis or material supplied specifically for the purpose of being entered and executed on a computer system, for exclusive use by the purchaser of the work. Duplication of this publication or parts thereof is permitted only under the provisions of the Copyright Law of the Publisher's location, in its current version, and permission for use must always be obtained from Springer. Permissions for use may be obtained through RightsLink at the Copyright Clearance Center. Violations are liable to prosecution under the respective Copyright Law.

The use of general descriptive names, registered names, trademarks, service marks, etc. in this publication does not imply, even in the absence of a specific statement, that such names are exempt from the relevant protective laws and regulations and therefore free for general use.

While the advice and information in this book are believed to be true and accurate at the date of publication, neither the authors nor the editors nor the publisher can accept any legal responsibility for any errors or omissions that may be made. The publisher makes no warranty, express or implied, with respect to the material contained herein.

Printed on acid-free paper

Humana Press is a brand of Springer

Springer is part of Springer Science+Business Media ([www.springer.com](http://www.springer.com))

# Preface

The past 35 years have seen the emergence of a growing desire worldwide that positive actions be taken to restore and protect the environment from the degrading effects of all forms of pollution—air, water, soil, thermal, radioactive, and noise. Since pollution is a direct or indirect consequence of waste, the seemingly idealistic demand for “zero discharge” can be construed as an unrealistic demand for zero waste. However, as long as waste continues to exist, we can only attempt to abate the subsequent pollution by converting it to a less noxious form. Three major questions usually arise when a particular type of pollution has been identified: (1) How serious are the environmental pollution and water resources crisis? (2) Is the technology to abate them available? and (3) Do the costs of abatement justify the degree of abatement achieved for environmental protection and water conservation? This book is one of the volumes of the *Handbook of Environmental Engineering* series. The principal intention of this series is to help readers formulate answers to the above three questions.

The traditional approach of applying tried-and-true solutions to specific environmental and water resources problems has been a major contributing factor to the success of environmental engineering, and has accounted in large measure for the establishment of a “methodology of pollution control.” However, the realization of the ever-increasing complexity and interrelated nature of current environmental problems renders it imperative that intelligent planning of pollution abatement systems be undertaken. Prerequisite to such planning is an understanding of the performance, potential, and limitations of the various methods of environmental protection available for environmental scientists and engineers. In this series of handbooks, we will review at a tutorial level a broad spectrum of engineering systems (processes, operations, and methods) currently being utilized, or of potential utility, for pollution abatement. We believe that the unified interdisciplinary approach presented in these handbooks is a logical step in the evolution of environmental engineering.

Treatment of the various engineering systems presented will show how an engineering formulation of the subject flows naturally from the fundamental principles and theories of chemistry, microbiology, physics, and mathematics. This emphasis on fundamental science recognizes that engineering practice has in recent years become more firmly based on scientific principles rather than on its earlier dependency on empirical accumulation of facts. It is not intended, though, to neglect empiricism where such data lead quickly to the most economic design; certain engineering systems are not readily amenable to fundamental scientific analysis, and in these instances we have resorted to less science in favor of more art and empiricism.

Since an environmental engineer must understand science within the context of applications, we first present the development of the scientific basis of a particular subject, followed by exposition of the pertinent design concepts and operations, and detailed explanations of their applications to environmental conservation or protection. Throughout the series, methods of system analysis, practical design, and calculation are illustrated by numerical examples.

These examples clearly demonstrate how organized, analytical reasoning leads to the most direct and clear solutions. Wherever possible, pertinent cost data have been provided.

Our treatment of environmental engineering is offered in the belief that the trained engineer should more firmly understand fundamental principles, be more aware of the similarities and/or differences among many of the engineering systems, and exhibit greater flexibility and originality in the definition and innovative solution of environmental system problems. In short, an environmental engineer should by conviction and practice be more readily adaptable to change and progress.

Coverage of the unusually broad field of environmental engineering has demanded an expertise that could be provided only through multiple authorships. Each author (or group of authors) was permitted to employ, within reasonable limits, the customary personal style in organizing and presenting a particular subject area; consequently, it has been difficult to treat all subject materials in a homogeneous manner. Moreover, owing to limitations of space, some of the authors' favored topics could not be treated in great detail, and many less important topics had to be merely mentioned or commented on briefly. All authors have provided an excellent list of references at the end of each chapter for the benefit of the interested readers. As each chapter is meant to be self-contained, some mild repetition among the various texts was unavoidable. In each case, all omissions or repetitions are the responsibility of the editors and not the individual authors. With the current trend toward metrication, the question of using a consistent system of units has been a problem. Wherever possible, the authors have used the British system (fps) along with the metric equivalent (mks, cgs, or SIU) or vice versa. The editors sincerely hope that this redundancy of units' usage will prove to be useful rather than being disruptive to the readers.

The goals of the *Handbook of Environmental Engineering* series are: (1) to cover entire environmental fields, including air and noise pollution control, solid waste processing and resource recovery, physicochemical treatment processes, biological treatment processes, biotechnology, biosolids management, flotation technology, membrane technology, desalination technology, water resources, natural control processes, radioactive waste disposal, hazardous waste management, and thermal pollution control; and (2) to employ a multimedia approach to environmental conservation and protection since air, water, soil, and energy are all interrelated.

This book is Vol. 15 of the *Handbook of Environmental Engineering* series, which has been designed to serve as a water resources engineering reference book as well as a supplemental textbook. We hope and expect it will prove of equal high value to advanced undergraduate and graduate students, to designers of water resources systems, and to scientists and researchers. The editors welcome comments from readers in all of these categories. It is our hope that the book will not only provide information on water resources engineering, but will also serve as a basis for advanced study or specialized investigation of the theory and analysis of various water resources systems.

This book, *Modern Water Resources Engineering*, covers topics on principles and applications of hydrology, open channel hydraulics, river ecology, river restoration, sedimentation and sustainable use of reservoirs, sediment transport, river morphology, hydraulic

engineering, GIS, remote sensing, decision-making process under uncertainty, upland erosion modeling, machine learning method, climate change and its impact on water resources, land application, crop management, watershed protection, wetland for waste disposal, water conservation, living machines, bioremediation, wastewater treatment, aquaculture system management, environmental protection models, and glossary for water resources engineers.

The editors are pleased to acknowledge the encouragement and support received from their colleagues and the publisher during the conceptual stages of this endeavor. We wish to thank the contributing authors for their time and effort, and for having patiently borne our reviews and numerous queries and comments. We are very grateful to our respective families for their patience and understanding during some rather trying times.

***Lawrence K. Wang***  
***Newtonville, New York, USA***

***Chih Ted Yang***  
***Fort Collins, Colorado, USA***





# Contents

Preface . . . . .	v
Contributors . . . . .	xix
1. Introduction to Hydrology <i>Jose D. Salas, Rao S. Govindaraju, Michael Anderson, Mazdak Arabi, Félix Francés, Wilson Suarez, Waldo S. Lavado-Casimiro, and Timothy R. Green . . . . .</i>	<i>I</i>
1. Introduction . . . . .	2
2. Hydroclimatology . . . . .	3
2.1. The Hydroclimatic System . . . . .	4
2.2. Hydroclimatic System Patterns: Atmospheric Patterns . . . . .	4
2.3. Hydroclimatic System Patterns: Coupled Atmosphere-Ocean Patterns . . . . .	5
2.4. Hydroclimatic System Patterns: Ocean System Patterns . . . . .	6
2.5. Interactions Across Scales and Extreme Events . . . . .	7
2.6. Climate Change . . . . .	8
2.7. Remarks . . . . .	8
3. Surface Water Hydrology . . . . .	9
3.1. Precipitation . . . . .	9
3.2. Interception and Depression Storage . . . . .	12
3.3. Infiltration . . . . .	13
3.4. Evaporation and Evapotranspiration . . . . .	17
3.5. Runoff . . . . .	31
4. Soil Moisture Hydrology . . . . .	34
4.1. Basic Concepts and Definitions . . . . .	34
4.2. Soil Moisture Recycling . . . . .	37
4.3. Variability of Soil Moisture . . . . .	37
4.4. Scaling of Soil Moisture . . . . .	38
5. Hydrology of Glaciers . . . . .	40
5.1. Basic Concepts and Definitions . . . . .	41
5.2. Glacial and Snow Fusion Methods . . . . .	42
5.3. Glacier Equipment . . . . .	45
6. Watershed and River Basin Modeling . . . . .	45
6.1. Basic Concepts and Definitions . . . . .	47
6.2. Brief Example . . . . .	50
6.3. Model Calibration and Testing . . . . .	55
6.4. Sensitivity Analysis . . . . .	57
6.5. Uncertainty Analysis . . . . .	58
7. Risk and Uncertainty Analyses in Hydrology . . . . .	61
7.1. Introduction . . . . .	61
7.2. Frequency Analysis of Hydrologic Data . . . . .	63
7.3. Stochastic Methods in Hydrology and Water Resources . . . . .	82
7.4. Nonstationarity . . . . .	93
8. Advances in Hydrologic Data Acquisition and Information Systems . . . . .	94
8.1. Satellite Precipitation Estimation . . . . .	94
8.2. Spaceborne Methods for Estimating Surface Waters: Rivers, Wetlands, and Lakes . . . . .	96
8.3. Spaceborne Methods for Estimating Soil Moisture, Evaporation, Vegetation, Snow, Glaciers, and Groundwater . . . . .	98

8.4. Advances in Measuring Large River Systems . . . . .	101
8.5. Using Dendrohydrology for Extending Hydrologic Data . . . . .	102
8.6. Developments in Hydrologic Information Systems . . . . .	103
Acknowledgements . . . . .	103
References . . . . .	104
<b>2. Open-Channel Hydraulics: From Then to Now and Beyond</b>	
<b><i>Xiaofeng Liu</i></b> . . . . .	<b>127</b>
1. Introduction . . . . .	127
1.1. Specific Energy . . . . .	130
1.2. Specific Momentum (Specific Force) . . . . .	133
1.3. Resistance . . . . .	135
1.4. Rise of the Computer . . . . .	137
2. Numerical Modeling of Open-Channel Hydraulics . . . . .	137
2.1. Review of Numerical Modeling of Open-Channel Flows . . . . .	137
2.2. One-Dimensional Modeling of Open-Channel Flows . . . . .	138
2.3. Two-Dimensional Modeling of Open-Channel Flows . . . . .	140
2.4. Three-Dimensional CFD Modeling of Open-Channel Flows . . . . .	149
3. Modern and Future Challenges . . . . .	153
3.1. Revisiting Past Projects . . . . .	154
3.2. Effects of Climate Variability . . . . .	155
3.3. Challenges of Natural Open Channels in the Arid Environment . . . . .	156
3.4. Discovering and Implementing New Synergies . . . . .	156
References . . . . .	157
<b>3. River Ecology</b>	
<b><i>Zhao-Yin Wang and Bao-Zhu Pan</i></b> . . . . .	<b>159</b>
1. River Ecosystems . . . . .	159
1.1. Background Information of Rivers . . . . .	159
1.2. Spatial Elements of River Ecosystems . . . . .	160
1.3. Ecological Conditions . . . . .	163
1.4. Biological Assemblages . . . . .	167
1.5. Ecological Functions of Rivers . . . . .	171
2. Ecological Stresses to Rivers . . . . .	176
2.1. Natural Stresses . . . . .	177
2.2. Human-Induced Stresses . . . . .	180
2.3. Introduction of Exotic Species . . . . .	187
3. Assessment of River Ecosystems . . . . .	191
3.1. Indicator Species . . . . .	191
3.2. Metrics of Biodiversity . . . . .	195
3.3. Bioassessment . . . . .	213
3.4. Habitat Evaluation and Modeling . . . . .	217
References . . . . .	230
<b>4. River Restoration</b>	
<b><i>Hyoseop Woo</i></b> . . . . .	<b>237</b>
1. Introduction . . . . .	238
1.1. Scope . . . . .	238
1.2. Backgrounds and Basic Concepts . . . . .	239
2. Overview of River and Disturbances Affecting River . . . . .	242
2.1. Overview of River in Terms of Restoration . . . . .	242
2.2. Overview of Disturbances Affecting Rivers . . . . .	250
3. River Restoration Planning and Design . . . . .	252
3.1. River Restoration Planning . . . . .	252
3.2. River Restoration Design . . . . .	257

4. Restoration Implementation, Monitoring, and Adaptive Management . . . . .	269
4.1. Restoration Implementation . . . . .	270
4.2. Monitoring Techniques . . . . .	271
4.3. Adaptive Management . . . . .	273
Appendix: Guidelines and Handbooks of River Restoration (Written in English) (in Chronological Order) . . . . .	275
References . . . . .	275
5. Sediment Management and Sustainable Use of Reservoirs	
<b>Gregory L. Morris . . . . .</b>	<b>279</b>
1. Introduction . . . . .	280
2. Reservoir Construction and Sedimentation . . . . .	281
3. Reservoirs and Sustainability . . . . .	283
3.1. Economic Analysis and Sustainable Use . . . . .	283
3.2. Sustainability Criteria . . . . .	284
4. Sedimentation Processes and Impacts . . . . .	285
4.1. Longitudinal Sedimentation Patterns . . . . .	285
4.2. Reservoir Deltas . . . . .	286
4.3. Turbid Density Currents . . . . .	287
4.4. Reservoir Volume Loss and Reservoir Half-Life . . . . .	290
4.5. Sedimentation Impacts Above Pool Elevation . . . . .	292
4.6. Sedimentation Impacts Below the Dam . . . . .	292
4.7. Sedimentation Impact Thresholds . . . . .	293
5. Predicting Future Conditions . . . . .	293
5.1. Reservoir Surveys to Measure Sedimentation . . . . .	293
5.2. Future Sedimentation Rate and Pattern . . . . .	295
5.3. Sediment Yield . . . . .	296
5.4. Climate Change and Sediment Yield . . . . .	297
5.5. Reservoir Trap Efficiency . . . . .	299
5.6. Sediment Bulk Density . . . . .	300
5.7. Preliminary Sedimentation Assessment for a Single Reservoir . . . . .	301
5.8. Regional Analysis . . . . .	302
6. Classification of Sediment Management Strategies . . . . .	303
7. Reduce Sediment Inflow from Upstream . . . . .	304
7.1. Reduce Sediment Production . . . . .	305
7.2. Sediment Trapping Above the Reservoir . . . . .	309
8. Route Sediments . . . . .	309
8.1. Timewise Variation in Sediment Yield . . . . .	310
8.2. Sediment Rating Relationships . . . . .	311
8.3. Sediment Bypass by Offstream Reservoir . . . . .	312
8.4. Sediment Bypass at Onstream Reservoirs . . . . .	314
8.5. Turbid Density Currents . . . . .	315
8.6. Sediment Routing by Reservoir Drawdown . . . . .	317
9. Recover, Increase, or Reallocate Storage Volume . . . . .	318
9.1. Pressure Flushing for Localized Sediment Removal . . . . .	319
9.2. Empty Flushing . . . . .	319
9.3. Downstream Impacts of Flushing . . . . .	321
9.4. Flushing Equations . . . . .	323
9.5. Dredging . . . . .	324
9.6. Dry Excavation . . . . .	326
9.7. Raise the Dam . . . . .	326
9.8. Structural Modifications . . . . .	327
9.9. Reuse of Reservoir Sediments . . . . .	327

10. Toward Achieving Sustainable Use . . . . .	328
10.1. Modeling of Sediment Management Activities . . . . .	328
10.2. Implementation Steps . . . . .	330
10.3. Additional Resources . . . . .	332
References . . . . .	333
<b>6. Sediment Transport, River Morphology, and River Engineering</b>	
<b><i>Chih Ted Yang</i></b> . . . . .	<b>339</b>
1. Introduction . . . . .	340
2. Sediment Transport . . . . .	340
2.1. Basic Approaches . . . . .	340
2.2. Unit Stream Power Formulas for Rivers and Reservoirs . . . . .	343
2.3. Unit Stream Power Formula for Surface Erosion . . . . .	349
3. Minimum Energy Dissipation Rate Theory . . . . .	351
4. Generalized Sediment Transport Model for Alluvial River Simulation (GSTARS) . . . . .	353
5. River Morphology and Hydraulic Engineering . . . . .	355
6. Hydraulic Engineering Case Studies Using GSTARS . . . . .	359
6.1. Mississippi River Lock and Dam No. 26 Replacement Project . . . . .	359
6.2. Lake Mescalero Unlined Emergency Spillway . . . . .	360
6.3. Tarbela Reservoir Sedimentation Study . . . . .	362
6.4. Channel Degradation Downstream of the Mosul Dam in Iraq and Sediment Deposition in the Upper Rhone River in Switzerland . . . . .	365
6.5. Bed Sorting and Armoring Downstream from a Dam . . . . .	366
6.6. Reservoir Delta Formation . . . . .	367
7. Summary and Conclusions . . . . .	368
References . . . . .	369
<b>7. GIS and Remote Sensing Applications in Modern Water Resources Engineering</b>	
<b><i>Lynn E. Johnson</i></b> . . . . .	<b>373</b>
1. Introduction . . . . .	377
2. Overview of Geographic Information Systems and Remote Sensing . . . . .	378
2.1. GIS Basics . . . . .	378
2.2. GIS Data Development and Maintenance . . . . .	379
2.3. Remote Sensing . . . . .	380
2.4. GIS Data Models and Geodatabases . . . . .	381
2.5. GIS Analysis Functions . . . . .	382
2.6. User Interfaces and Interaction Modes . . . . .	384
2.7. GIS System Planning and Implementation . . . . .	385
2.8. GIS Software . . . . .	386
3. GIS for Surface Water Hydrology . . . . .	386
3.1. GIS Data for Surface Water Hydrology . . . . .	386
3.2. GIS for Surface Water Hydrology Modeling . . . . .	390
4. GIS for Floodplain Management . . . . .	395
4.1. Floodplain Mapping Requirements . . . . .	395
4.2. Floodplain Geodatabase . . . . .	396
4.3. Floodplain Hydraulic Modeling with GIS . . . . .	397
5. GIS for Water Supply Systems . . . . .	400
5.1. Overview . . . . .	400
5.2. GIS-Based Water Supply Demand Forecasting . . . . .	400
5.3. Pipe Network Design with GIS . . . . .	400

6. GIS for Groundwater Hydrology . . . . .	403
6.1. Overview . . . . .	403
6.2. GIS for Groundwater Modeling . . . . .	403
6.3. Case Example: MODFLOW for Rio Grande Valley . . . . .	405
References . . . . .	408
8. Decision Making Under Uncertainty: A New Paradigm for Water Resources Planning and Management <i>Patricia Gober</i> . . . . .	<b>411</b>
1. Introduction . . . . .	412
2. Climate Uncertainty and Vulnerability . . . . .	413
2.1. Sources of Climate Uncertainty . . . . .	413
2.2. Stationarity Assumption . . . . .	415
2.3. Extremes Matter! . . . . .	416
2.4. Vulnerability to Extreme Events . . . . .	419
3. Decision Making Under Uncertainty . . . . .	420
3.1. Problems of Deep Uncertainty . . . . .	420
3.2. Scenario Planning . . . . .	421
3.3. Simulation/Exploratory Modeling . . . . .	423
3.4. Elements of Robust Decision Making . . . . .	423
3.5. Anticipatory Governance . . . . .	424
3.6. WaterSim: An Example of DMUU . . . . .	425
4. Human Factors in the Water Sector . . . . .	430
4.1. Water Planning as a Social Process . . . . .	430
4.2. Boundary Science . . . . .	431
4.3. Decision Theater . . . . .	431
5. Sustainable Water Systems . . . . .	433
References . . . . .	433
9. Upland Erosion Modeling <i>Pierre Y. Julien, Mark L. Velleux, Un Ji, and Jaehoon Kim</i> . . . . .	<b>437</b>
1. Upland Erosion Processes . . . . .	439
1.1. Surface Runoff . . . . .	440
1.2. Upland Erosion . . . . .	442
1.3. Soil Erosion Relationships . . . . .	443
1.4. Overland Sediment Transport Capacity Relationships . . . . .	444
1.5. Channel Transport Capacity Relationships . . . . .	445
1.6. Deposition . . . . .	446
2. Watershed Modeling . . . . .	448
2.1. CASC2D . . . . .	448
2.2. TREX . . . . .	448
3. Watershed Model Application . . . . .	450
3.1. Naesung Stream Site Description and Database . . . . .	450
3.2. Naesung Stream Model Setup . . . . .	451
3.3. Model Calibration Results . . . . .	456
3.4. Design Storm Application . . . . .	457
Acknowledgements . . . . .	462
References . . . . .	462

10. Advances in Water Resources Systems Engineering: Applications of Machine Learning <i>John W. Labadie</i> . . . . .	<b>467</b>
1. Introduction and Overview . . . . .	468
2. Stochastic Optimization of Multireservoir Systems via Reinforcement Learning . . . . .	470
2.1. Introduction . . . . .	470
2.2. Reinforcement Learning . . . . .	472
2.3. Bellman Equation . . . . .	473
2.4. Q-Learning Method . . . . .	475
2.5. $\epsilon$ -Greedy Actions . . . . .	476
2.6. Temporal-Difference Learning . . . . .	477
2.7. Discounting Scheme for Optimal Average Returns . . . . .	478
2.8. Case Study: Geum River Basin, South Korea . . . . .	478
3. Machine Learning Approach to Real-Time Control of Combined Sewer Overflows . . . . .	485
3.1. Introduction . . . . .	485
3.2. Optimal Control Module . . . . .	487
3.3. Neural Network Module . . . . .	492
3.4. Case Study: West Point Combined Sewer System, Seattle, Washington, USA . . . . .	496
4. Stormwater Management for Coastal Ecosystem Restoration: Learning Optimal Fuzzy Rules by Genetic Algorithms . . . . .	502
4.1. Introduction . . . . .	502
4.2. Integrated Reservoir Sizing and Operating Rule Optimization: OPTI6 . . . . .	504
4.3. Application of OPTI6 for Optimal Restoration Plan Development in St. Lucie Estuary . . . . .	512
5. Summary and Conclusions . . . . .	519
References . . . . .	521
11. Climate Change and Its Impact on Water Resources <i>Vijay P. Singh, Ashok K. Mishra, H. Chowdhary, and C. Prakash Khedun</i> . . . . .	<b>525</b>
1. Introduction . . . . .	526
2. Climate Change . . . . .	527
2.1. What Is Climate Change? . . . . .	527
2.2. Causes of Climate Change . . . . .	527
2.3. Debate on Climate Change . . . . .	529
3. Evidence of Climate Change . . . . .	530
3.1. Increases in Temperature . . . . .	530
3.2. Changes in Precipitation Patterns . . . . .	531
4. Impacts of Climate Change on Water Resources . . . . .	533
4.1. Runoff . . . . .	533
4.2. Floods . . . . .	534
4.3. Drought . . . . .	536
4.4. Snowmelt and Glacier Melt . . . . .	538
4.5. Water Quality . . . . .	539
4.6. Groundwater . . . . .	540
4.7. Transboundary Problems . . . . .	541
4.8. Agriculture . . . . .	543
4.9. Ecosystems . . . . .	544
5. Continental-Scale Impact of Projected Climate Changes on Water Resources . . . . .	545
5.1. Africa . . . . .	546
5.2. Europe . . . . .	547
5.3. Asia . . . . .	548
5.4. North America . . . . .	549

5.5. Central and South America (Latin America) . . . . .	550
5.6. Australia and New Zealand . . . . .	550
6. Adaptation to Climate Change . . . . .	551
6.1. Assessment of Adaptation Costs and Benefits . . . . .	552
6.2. Limitations in Adaptation to Climate Change . . . . .	553
7. Conclusions . . . . .	555
References . . . . .	556

12. Engineering Management of Agricultural Land Application for Watershed Protection

**Lawrence K. Wang, Nazih K. Shammis, Gregory K. Evanylo, and Mu-Hao Sung Wang . . . . .**

**571**

1. Introduction . . . . .	574
1.1. Biosolids . . . . .	574
1.2. Biosolids Production and Pretreatment Before Land Application . . . . .	574
1.3. Biosolids Characteristics . . . . .	575
1.4. Agricultural Land Application for Beneficial Use . . . . .	577
1.5. US Federal and State Regulations . . . . .	578
2. Agricultural Land Application . . . . .	584
2.1. Land Application Process . . . . .	584
2.2. Agricultural Land Application Concepts and Terminologies . . . . .	586
3. Planning and Management of Agricultural Land Application . . . . .	590
3.1. Planning . . . . .	590
3.2. Nutrient Management . . . . .	591
4. Design of Land Application Process . . . . .	593
4.1. Biosolids Application Rate Scenario . . . . .	593
4.2. Step-by-Step Procedures for Sludge Application Rate Determination . . . . .	595
5. Performance of Land Application . . . . .	600
6. Operation and Maintenance . . . . .	601
6.1. Process Monitoring . . . . .	601
6.2. Process O&M Considerations . . . . .	602
6.3. Process Control Considerations . . . . .	602
6.4. Maintenance Requirements and Safety Issues . . . . .	603
7. Normal Operating Procedures . . . . .	603
7.1. Startup Procedures . . . . .	603
7.2. Routine Land Application Procedures . . . . .	603
7.3. Shutdown Procedures . . . . .	603
8. Emergency Operating Procedures . . . . .	604
8.1. Loss of Power and/or Fuel . . . . .	604
8.2. Loss of Other Biosolids Treatment Units . . . . .	604
9. Environmental Impacts . . . . .	604
10. Land Application Costs . . . . .	605
11. Practical Applications and Design Examples . . . . .	606
11.1. Biosolids Treatment Before Agricultural Land Application . . . . .	606
11.2. Advantages and Disadvantages of Biosolids Land Application . . . . .	607
11.3. Design Worksheet for Determining the Agronomic Rate . . . . .	608
11.4. Calculation for Available Mineralized Organic Nitrogen . . . . .	608
11.5. Risk Assessment Approach versus Alternative Regulatory Approach to Land Application of Biosolids . . . . .	608
11.6. Tracking Cumulative Pollutant Loading Rates on Land Application Sites . . . . .	613
11.7. Management of Nitrogen in the Soils and Biosolids . . . . .	613
11.8. Converting Wet Weight Pollutant Concentrations to Dry Weight Basis . . . . .	616
11.9. Converting Dry Ton of Nutrient per Acre to Pound of Nutrient per Acre . . . . .	617



11.10. Converting Percent Content to Pound per Dry Ton . . . . .	618
11.11. Calculating Net Primary Nutrient Crop Need . . . . .	618
11.12. Calculating the Components of Plant-Available Nitrogen (PAN) in Biosolids . . . . .	619
11.13. Calculating the First-Year PAN <sub>0-1</sub> from Biosolids . . . . .	621
11.14. Calculating Biosolids Carryover PAN . . . . .	622
11.15. Calculating Nitrogen Based Agronomic Rate . . . . .	623
11.16. Calculating the Required Land for Biosolids Application . . . . .	625
11.17. Calculating the Nitrogen-Based and the Phosphorus-Based Agronomic Rates for Agricultural Land Application . . . . .	626
11.18. Calculating the Lime-Based Agronomic Rate for Agricultural Land Application . . . . .	628
11.19. Calculating Potassium Fertilizer Needs . . . . .	628
11.20. Land Application Inspection, Monitoring, Testing and Documentation . . . . .	629
12. Land Application, Crop Management and Watershed Management . . . . .	630
12.1. Nonpoint Source Pollution from Land Application . . . . .	630
12.2. Land Application Operation, Crop Management, and Watershed Protection . . . . .	630
12.3. Watershed Protection Act and Distressed Watershed Rules . . . . .	631
References . . . . .	640
<b>13. Wetlands for Wastewater Treatment and Water Reuse</b> <b><i>Azmi Idris, Abdul Ghani Liew Abdullah, Yung-Tse Hung,</i></b> <b><i>and Lawrence K. Wang</i></b> . . . . .	<b>643</b>
1. Introduction . . . . .	645
2. What Are Wetlands? . . . . .	646
2.1. Wetland Definition . . . . .	646
2.2. Wetland Functions and Values . . . . .	646
3. Natural Wetlands . . . . .	647
4. Constructed Wetlands . . . . .	648
4.1. Components of Constructed Wetlands . . . . .	649
4.2. Advantages of Constructed Wetlands for Wastewater Treatment . . . . .	649
4.3. Types of Constructed Wetlands . . . . .	650
5. Mechanisms of Treatment Processes for Constructed Wetlands . . . . .	652
5.1. Biodegradable Organic Matter Removal Mechanism . . . . .	652
5.2. Suspended Solids Removal Mechanism . . . . .	653
5.3. Nitrogen Removal Mechanism . . . . .	653
5.4. Heavy Metals Removal Mechanism . . . . .	654
5.5. Pathogenic Bacteria and Viruses Removal Mechanism . . . . .	654
5.6. Other Pollutants Removal Mechanism . . . . .	654
6. Selection of Wetland Plant . . . . .	655
6.1. Function of Wetland Plants . . . . .	655
6.2. Roles of Wetland Plants . . . . .	655
6.3. Types of Wetland Plants . . . . .	656
6.4. Selection of Wetland Plants . . . . .	657
7. Design of Constructed Wetland Systems . . . . .	662
7.1. Design Principles . . . . .	662
7.2. Hydraulics . . . . .	663
7.3. General Design Procedures . . . . .	663
8. Wetland Monitoring and Maintenance . . . . .	669
8.1. Water Quality Monitoring . . . . .	670
9. Case Study . . . . .	670
9.1. Putrajaya Wetlands, Malaysia . . . . .	670
9.2. Acle, Norfolk, United Kingdom . . . . .	673
9.3. Arcata, California . . . . .	673
10. Wetland: Identification, Creation, Utilization, Restoration, and Protection for Pollution Control and Water Conservation . . . . .	677
References . . . . .	678

<b>14. Living Machines for Bioremediation, Wastewater Treatment, and Water Conservation</b>	
<b><i>Yung-Tse Hung, Joseph F. Hawumba, and Lawrence K. Wang</i></b> . . . . .	<b>681</b>
1. Introduction . . . . .	682
1.1. Ecological Pollution . . . . .	682
1.2. Bioremediation Strategies and Advanced Ecologically Engineered Systems (AEES) . . . . .	684
2. Living Machines: As Concept in Bioremediation . . . . .	685
2.1. Advantages of Living Machines . . . . .	687
2.2. Limitations of Living Machines . . . . .	688
3. Components of the Living Machines . . . . .	688
3.1. Microbial Communities . . . . .	688
3.2. Macro-bio Communities (Animal Diversity) . . . . .	689
3.3. Photosynthetic Communities . . . . .	691
3.4. Nutrient and Micronutrient Reservoirs . . . . .	691
4. Types of Living Machines or Restorers . . . . .	692
4.1. Constructed Wetlands . . . . .	692
4.2. Lake Restorers . . . . .	694
4.3. Eco-Restorers . . . . .	694
4.4. Reedbeds . . . . .	696
5. Principle Underlying the Construction of Living Machines . . . . .	697
5.1. Living Machine Design to Be Consistent with Ecological Principles . . . . .	697
5.2. Living Machine Design to Deal with Site-Specific Situation . . . . .	698
5.3. Living Machine Design to Maintain the Independence of Its Functional Requirements . . . . .	698
5.4. Living Machine Design to Enhance Efficiency in Energy and Information . . . . .	699
5.5. Living Machine Design to Acknowledge and Retain Its Values and Purposes . . . . .	700
6. Operation of Living Machines . . . . .	700
7. Case Studies of Constructed Living Machine Systems for Bioremediation, Wastewater Treatment, and Water Reuse . . . . .	703
7.1. Sewage Treatment in Cold Climates: South Burlington, Vermont AEES, USA . . . . .	703
7.2. Environmental Restoration: Flax Pond, Harwich, Massachusetts, USA . . . . .	704
7.3. Organic Industrial Wastewater Treatment from a Poultry-Processing Waste in Coastal Maryland: Using Floating AEES Restorer . . . . .	705
7.4. Architectural Integration: Oberlin College, Ohio, USA . . . . .	706
7.5. Tyson Foods at Berlin, Maryland, USA . . . . .	707
7.6. Old Trail School, Bath, Ohio, USA . . . . .	707
7.7. US-Mexico Border, San Diego, California, USA . . . . .	707
7.8. US Marine Corps Recruit Depot, San Diego, California, USA . . . . .	708
7.9. San Francisco Public Utilities Commission Administration Building, California, USA . . . . .	708
7.10. Esalen Institute, Big Sur, California, USA . . . . .	708
7.11. Guilford County School District, California, USA . . . . .	708
7.12. Las Vegas Regional Animal Campus, Nevada, USA . . . . .	708
7.13. Port of Portland, Oregon, USA . . . . .	708
7.14. El Monte Sagrado Resort, Taos, New Mexico, USA . . . . .	709
8. Future Prospects of Living Machines . . . . .	709
8.1. Integration of Industrial and Agricultural Sectors: Proposed Eco-Park in Burlington, Vermont, USA . . . . .	709
8.2. Aquaculture . . . . .	710
References . . . . .	710

15. Aquaculture System Management and Water Conservation <i>Yung-Tse Hung, Hamidi A. Aziz, Mohd Erwan Sanik, Mohd Suffian Yusoff, and Lawrence K. Wang</i> . . . . .	<b>715</b>
1. Introduction . . . . .	716
1.1. Environmental Issues . . . . .	717
2. Regulations . . . . .	717
2.1. Agencies Regulating Aquaculture . . . . .	717
2.2. The Federal Clean Water Act . . . . .	718
2.3. National Pollutant Discharge Elimination System Permit Requirements . . . . .	718
2.4. General Criteria . . . . .	719
2.5. Beneficial Uses . . . . .	719
3. Waste Management of Aquaculture Operation . . . . .	720
3.1. Aquaculture Waste Management . . . . .	720
3.2. Water Supply . . . . .	721
3.3. Options in Waste Management . . . . .	721
3.4. Operational Practices . . . . .	722
3.5. Waste Management Plan . . . . .	722
3.6. Characterization of Waste, Waste Management Issues, and Quality of Water . . . . .	722
4. Design Criteria of Aquaculture System . . . . .	732
4.1. Criteria of Solids Removal . . . . .	733
4.2. System Components of Solids Removal . . . . .	737
5. Application of Aquaculture System for Wastewater Treatment and Water Conservation . . . . .	746
5.1. Aquaculture Wastewater Treatment: Water Hyacinth System . . . . .	746
5.2. Aquaculture Wastewater Treatment: Natural Wetland System . . . . .	746
5.3. Aquaculture Wastewater Treatment: Man-Made Living Machine System . . . . .	747
Appendix . . . . .	748
References . . . . .	757
16. Glossary and Conversion Factors for Water Resources Engineers <i>Mu-Hao Sung Wang and Lawrence K. Wang</i> . . . . .	<b>759</b>
Index . . . . .	<b>853</b>

## Contributors

ABDUL GHANI LIEW ABDULLAH, M.SC. • *Faculty of Engineering, Department of Chemical and Environmental Engineering, Universiti Putra Malaysia, Serdang, Selangor Darul Ehsan, Malaysia*

MICHAEL ANDERSON, PH.D., P.E. • *Division of Flood Management, California Department of Water Resources, Sacramento, CA, USA*

MAZDAK ARABI, PH.D. • *Department of Civil and Environmental Engineering, Colorado State University, Fort Collins, CO, USA*

HAMIDI A. AZIZ, PH.D. • *School of Civil Engineering, Engineering Campus, Universiti Sains Malaysia, Penang, Malaysia*

H. CHOWDHARY • *Department of Biological and Agricultural Engineering, Texas A&M University, College Station, TX, USA*

GREGORY K. EVANYLO, PH.D. • *Crop and Soil Environmental Sciences, Virginia Tech., Blacksburg, VA, USA*

FÉLIX FRANCÉS, PH.D. • *Department of Hydraulics and Environmental Engineering, Polytechnical University of Valencia, Valencia, Spain*

PATRICIA GOBER, PH.D. • *School of Geographical Sciences and Urban Planning, Arizona State University, Tempe, AZ, USA; Johnson-Shoyama Graduate School of Public Policy, University of Saskatchewan, Saskatoon, Canada*

RAO S. GOVINDARAJU, PH.D. • *School of Civil Engineering, Purdue University, West Lafayette, IN, USA*

TIMOTHY R. GREEN, PH.D. • *USDA Agricultural Research Service, Fort Collins, CO, USA; Department of Civil and Environmental Engineering, Colorado State University, Fort Collins, CO, USA*

JOSEPH F. HAWUMBA, PH.D. • *Department of Biochemistry and Sports Science, Makerere University, Kampala, Uganda*

YUNG-TSE HUNG, PH.D., P.E., D.EE, F-ASCE • *Department of Civil and Environmental Engineering, Cleveland State University, Cleveland, OH, USA*

AZNI IDRIS, PH.D. • *Faculty of Engineering, Department of Chemical and Environmental Engineering, Universiti Putra Malaysia, Serdang, Selangor Darul Ehsan, Malaysia*

UN JI, PH.D. • *River and Coastal Research, Korea Institute of Construction Technology, Goyang-si, Korea*

LYNN E. JOHNSON, PH.D., P.E. • *University of Colorado Denver, Denver, CO, USA*

PIERRE Y. JULIEN, PH.D., P.E. • *Department of Civil and Environmental Engineering, Colorado State University, Fort Collins, CO, USA*

C. PRAKASH KHEDUN, M.SC. • *Department of Biological and Agricultural Engineering, Texas A&M University, College Station, TX, USA*

- JAEHOON KIM, M. SC. • *Department of Civil and Environmental Engineering, Colorado State University, Fort Collins, CO, USA*
- JOHN W. LABADIE, PH.D, P.E. • *Department of Civil and Environmental Engineering, Colorado State University, Fort Collins, CO, USA*
- WALDO S. LAVADO-CASIMIRO, PH.D. • *National Service of Meteorology and Hydrology (SENAMHI), Lima, Peru; National Agrarian University at La Molina, Lima, Peru*
- XIAOFENG LIU, PH.D., P.E. • *Department of Civil and Environmental Engineering, Pennsylvania State University, State College, PA, USA*
- ASHOK K. MISHRA, PH.D. • *Department of Biological and Agricultural Engineering, Texas A&M University, College Station, TX, USA*
- GREGORY L. MORRIS, PH.D., P.E. • *GLM Engineering Corp., San Juan, PR, USA*
- BAO-ZHU PAN, PH.D. • *Changjiang River Scientific Research Institute, Wuhan, China*
- JOSE D. SALAS, PH.D. • *Department of Civil and Environmental Engineering, Colorado State University, Fort Collins, CO, USA*
- MOHD ERWAN SANIK, M.SC. • *Faculty of Civil and Environmental Engineering, Universiti Tun Hussein Onn Malaysia, Batu Pahat, Johore, Malaysia*
- NAZIH K. SHAMMAS, PH.D. • *Lenox Institute of Water Technology, Lenox, MA, USA; Krofta Engineering Corporation, Lenox, MA, USA*
- VIJAY P. SINGH, PH.D., D.SC., D. ENG. (HON.), PH.D. (HON.), P.E., P.H., HON. D. W.R.E • *Texas A&M University, College Station, TX, USA*
- WILSON SUAREZ, PH.D. • *National Service of Meteorology and Hydrology (SENAMHI), Lima, Peru; National Agrarian University at La Molina, Lima, Peru*
- MARK L. VELLEUX, PH.D., P.H., P.E. • *HDR HydroQual, Mahwah, NJ, USA*
- ZHAO-YIN WANG, PH.D. • *State Key Laboratory of Hydrosience and Engineering, Tsinghua University, Beijing, China*
- LAWRENCE K. WANG, PH.D., P.E., D.EE • *Lenox Institute of Water Technology, Newtonville, NY, USA; Krofta Engineering Corporation, Lenox, MA, USA; Zorex Corporation, Newtonville, NY, USA*
- MU-HAO SUNG WANG, PH.D., P.E., D.EE • *Lenox Institute of Water Technology, Newtonville, NY, USA*
- HYOSEOP WOO, PH.D., P.E. • *Korea Water Resources Association, Seoul, South Korea*
- CHIH TED YANG, PH.D., P.E., D. W.R.E. • *Department of Civil and Environmental Engineering, Colorado State University, Fort Collins, CO, USA*
- MOHD SUFFIAN YUSOFF, PH.D. • *School of Civil Engineering, Universiti Sains Malaysia, Penang, Malaysia*

# Introduction to Hydrology

---

Jose D. Salas, Rao S. Govindaraju, Michael Anderson, Mazdak Arabi,  
Félix Francés, Wilson Suarez, Waldo S. Lavado-Casimiro,  
and Timothy R. Green

## CONTENTS

INTRODUCTION

HYDROCLIMATOLOGY

SURFACE WATER HYDROLOGY

SOIL MOISTURE HYDROLOGY

HYDROLOGY OF GLACIERS

WATERSHED AND RIVER BASIN MODELING

RISK AND UNCERTAINTY ANALYSES IN HYDROLOGY

ADVANCES IN HYDROLOGIC DATA ACQUISITION AND INFORMATION SYSTEMS

ACKNOWLEDGEMENTS

REFERENCES

---

**Abstract** *Hydrology* deals with the occurrence, movement, and storage of water in the earth system. Hydrologic science comprises understanding the underlying physical and stochastic processes involved and estimating the quantity and quality of water in the various phases and stores. The study of hydrology also includes quantifying the effects of such human interventions on the natural system at watershed, river basin, regional, country, continental, and global scales. The process of water circulating from precipitation in the atmosphere falling to the ground, traveling through a river basin (or through the entire earth system), and then evaporating back to the atmosphere is known as the hydrologic cycle. This introductory chapter includes seven subjects, namely, hydroclimatology, surface water hydrology, soil hydrology, glacier hydrology, watershed and river basin modeling, risk and uncertainty analysis, and data acquisition and information systems. The emphasis is on recent developments particularly on the role that atmospheric and climatic processes play in hydrology, the

advances in hydrologic modeling of watersheds, the experiences in applying statistical concepts and laws for dealing with risk and uncertainty and the challenges encountered in dealing with nonstationarity, and the use of newer technology (particularly spaceborne sensors) for detecting and estimating the various components of the hydrologic cycle such as precipitation, soil moisture, and evapotranspiration.

**Key Words** Hydrologic cycle • Hydroclimatology • Precipitation • Streamflow • Soil moisture • Glaciology • Hydrologic statistics • Watershed modeling • Hydrologic data acquisition.

## 1. INTRODUCTION

*Hydrology* deals with the occurrence, movement, and storage of water in the earth system. Water occurs in liquid, solid, and vapor phases, and it is transported through the system in various pathways through the atmosphere, the land surface, and the subsurface and is stored temporarily in storages such as the vegetation cover, soil, wetlands, lakes, flood plains, aquifers, oceans, and the atmosphere. Thus, hydrology deals with understanding the underlying physical and stochastic processes involved and estimating the quantity and quality of water in the various phases and stores. For this purpose, a number of physical and statistical laws are applied, mathematical models are developed, and various state and input and output variables are measured at various points in time and space. In addition, natural systems are increasingly being affected by human intervention such as building of dams, river diversions, groundwater pumping, deforestation, irrigation systems, hydropower development, mining operations, and urbanization. Thus, the study of hydrology also includes quantifying the effects of such human interventions on the natural system (at watershed, river basin, regional, country, continent, and global scales). Water covers about 70 % of the earth surface, but only about 2.5 % of the total water on the earth is freshwater and the rest is saltwater (NASA Earth Observatory website). Of the total amount of the earth's freshwater, about 70 % is contained in rivers, lakes, and glaciers and about 30 % in aquifers as groundwater [1].

A related term/concept commonly utilized in hydrology is *hydrologic cycle*. It conveys the idea that as water occurs in nature, say in the form of rainfall, part of it may be temporarily stored on vegetation (e.g., trees), the remaining part reaches the ground surface, and in turn part of that amount may infiltrate and percolate into the subsurface, and another part may travel over the land surface eventually reaching the streams and the ocean. In addition, part of the water temporarily stored on the vegetation canopy, the soil, depression pools, the snow pack, the lakes, and the oceans evaporates back into the atmosphere. That process of water circulating from the start of the precipitation, traveling through the river basin (or through the entire earth system), and then evaporating back to the atmosphere is known as the hydrologic cycle.

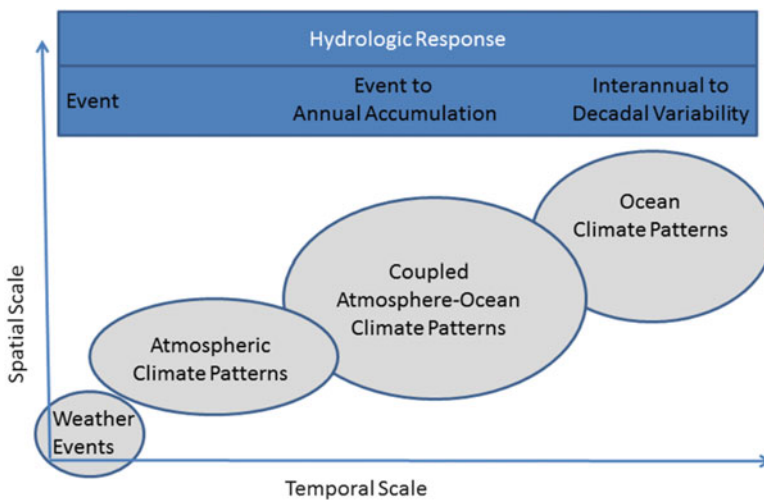
This introductory chapter includes seven subjects, namely, hydroclimatology, surface water hydrology, soil hydrology, glacier hydrology, watershed and river basin modeling, risk and uncertainty analysis, and data acquisition and information systems. The intent is to discuss some

basic concepts and methods for quantifying the amount of water in the various components of the hydrologic cycle. However, the chapter content cannot be comprehensive because of space limitations. Thus, the emphasis has been on recent developments particularly on the role that atmospheric and climatic processes play in hydrology, the advances in hydrologic modeling of watersheds, the experiences in applying statistical concepts and laws for dealing with risk and uncertainty and the challenges encountered in dealing with nonstationarity, and the use of newer equipment (particularly spaceborne sensors) for detecting and estimating the various components of the hydrologic cycle such as precipitation, soil moisture, and evapotranspiration. Current references have been included as feasible for most of the subjects.

## 2. HYDROCLIMATOLOGY

All years are not equal when it comes to hydrology and climate. The year-to-year response of the hydrologic system that results in floods or droughts is driven by the nonlinear interactions of the atmosphere, oceans, and land surface. While a deterministic understanding of the complex interactions of these systems may be near impossible, certain patterns have been identified that have been correlated to particular hydrologic response in different locations.

These identified patterns range in spatial and temporal scales as depicted in Fig. 1.1. At the lower left are the smaller spatial scale and relatively fast evolving atmospheric phenomena that can impact midlatitude weather systems resulting in different hydrologic outcomes. As the space and time scale expand, ocean processes start to play a role, and the patterns or relations are coupled ocean–atmosphere events that can span multiple years and play a role in spatial patterns of hydrologic response as well as magnitude. The largest spatial and longest time-scale processes come from the oceanic system and can play a role in decadal variability of hydrologic response.



**Fig. 1.1.** Schematic depicting the range of spatial and temporal scale of climate patterns and associated hydrologic response.



The strength of a given pattern and the interactions among multiple identified patterns across multiple scales play an important role in the type and level of hydrologic response (e.g., flood or drought). In addition, changes to the hydroclimatic system arising from natural and anthropogenic elements can impact the hydrology in a given location. This section presents an overview of the climate system and its potential impact on hydrology. Specified patterns in the ocean and atmospheric systems will be shown and related to hydrologic response in locations where a clear connection has been identified. Hydrologic response to climate change will also be reviewed noting some of the latest work completed in this area.

## 2.1. The Hydroclimatic System

The climate for a given location is a function of the nonlinear interactions of multiple physical processes occurring simultaneously in the atmosphere, ocean, and land surface systems. The atmosphere responds to changes in solar radiation, tilt and rotation of the earth, atmospheric constituents, and distribution of heat input from the ocean and land surface systems. The ocean system responds to changes in wind stresses from the atmosphere as well as from thermohaline currents at various depths that may be influenced by the bathymetry of the different ocean basins and relative positions of the continents. The land system is influenced by the temperature of both atmosphere and ocean and develops its own pattern of heating that is radiated back to the atmosphere as long-wave radiation. All of these elements play a role in the evolution of weather systems that result in different hydrologic outcomes.

While physical equations have been developed to describe the different time-evolving elements of these systems, using them directly to determine their impact on hydrology is extremely complex and filled with uncertainty. An alternative approach is to look for characteristic recurring patterns in the hydroclimatic system and examine their correlation with hydrologic time series to determine if there is a potential link. In some cases, the correlation may not be strong, but this may be due to the impact of other patterns or the combination of processes. Because of this, greater insight may be gained by examining hydrologic response through the use of probability distributions conditioned upon a given hydroclimatic patterns or collection of patterns. This can be limited by the available realizations provided by the observed record.

In the following sections, three scales of hydroclimate patterns identified in Fig. 1.1 are presented along with their potential impact on hydrologic response. Examples from observations or studies that have identified regions having significant correlative response will be highlighted. Additional factors that can impact extreme events also will be pointed out. Finally, a discussion of hydrologic response due to climate change will be provided in the context of scale and forcing of the hydroclimate system.

## 2.2. Hydroclimatic System Patterns: Atmospheric Patterns

*Atmospheric patterns* are the smallest in spatial scale and shortest in temporal scale. They are considered hydroclimatic patterns as they are larger than the scale of weather systems which is often referred to as the synoptic scale [2]. The synoptic scale has a spatial extent the

size of time-varying high- and low-pressure systems that form as part of the time evolution of the atmosphere. These systems are usually 500–1,000 km in spatial extent with extreme cases being larger. The life cycle of these events as they impact a given location results in a time scale on the order of 3 days. Patterns of atmospheric hydroclimate evolve on the order of weeks and have a spatial scale of several thousand kilometers. In addition, the pattern itself may result in the formation of planetary waves that can impact weather systems far removed from the pattern itself.

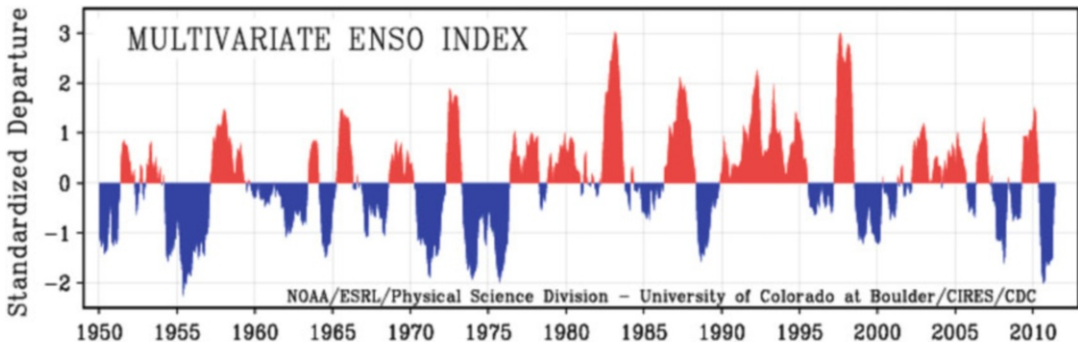
One of the most well-known atmospheric hydroclimate patterns is the *Madden-Julian Oscillation* [3]. This continent-sized cluster of convective activity migrates across the tropics with a periodicity ranging from 30 to 90 days. It is thought that the convective activity excites planetary scale waves that can interact with weather systems in the midlatitudes which can lead to enhanced precipitation for some locations. Maloney and Hartmann [4, 5] studied the influence of the Madden-Julian Oscillation and hurricane activity in the Gulf of Mexico.

A second pattern of atmospheric hydroclimate that can influence midlatitude weather systems and the resulting hydrologic response is the *Arctic Oscillation* [6]. This pressure pattern between the Northern Hemisphere polar region and northern midlatitudes has two phases called the positive phase and negative phase. In the positive phase, the higher pressures are in the northern midlatitudes which results in storm tracks shifting northward and confining arctic air masses to the polar region. As a result, places like Alaska, Scotland, and Scandinavia tend to be wetter and warmer, while the Mediterranean region and western United States tend to be drier. The negative phase is the opposite with more cold air movement to the northern midlatitudes and wetter conditions in the western United States and Mediterranean regions. The time frame for the oscillations is on the order of weeks. The oscillation does not directly cause storms but influences pressure tendencies in the midlatitudes that can facilitate the formation of storms in select regions. Additional information on this phenomenon can be found on the National Oceanographic and Atmospheric Administration's (NOAA) Climate Prediction Center's web pages (e.g., [http://www.cpc.ncep.noaa.gov/products/precip/CWlink/daily\\_ao\\_index/teleconnections.shtml](http://www.cpc.ncep.noaa.gov/products/precip/CWlink/daily_ao_index/teleconnections.shtml)).

### **2.3. Hydroclimatic System Patterns: Coupled Atmosphere-Ocean Patterns**

*Coupled atmosphere-ocean patterns* extend from the scale of atmospheric phenomena to the scale of select regions in ocean basins. These patterns can persist from months to years and can have significant influence on atmospheric circulation patterns that result in changes to storm tracks and observed hydrologic conditions at given locations.

The best-known phenomenon of this type is the *El Niño/Southern Oscillation* (ENSO). The ENSO pattern was discovered in pieces by different researchers in the late 1800s [7]. Subsequent studies showed that the variously observed pressure differences, changes in surface ocean currents, and changes in the equatorial sea surface temperatures in the eastern Pacific Ocean from the dateline to the coast of South America were all part of the ENSO pattern. There are three phases to ENSO: a warm (El Niño) phase, a cool (La Niña) phase, and a neutral phase. Transitions between phases occur in time periods ranging from 2 to 7 years. While this is a tropical phenomenon, hydrologic impacts occur across the globe as the global



**Fig. 1.2.** Plot of multivariate ENSO index from 1950 to present. *Blue regions* are associated with La Niña events and *red regions* are associated with El Niño events (source: NOAA, ESRL, <http://www.pmel.noaa.gov/co2/file/Multivariate+ENSO+Index>) (Color figure online).

atmosphere responds to the tropical ocean/atmosphere conditions that can persist for more than a year. Further information on ENSO can be found in Philander [7] and NOAA’s Climate Prediction Center web pages.

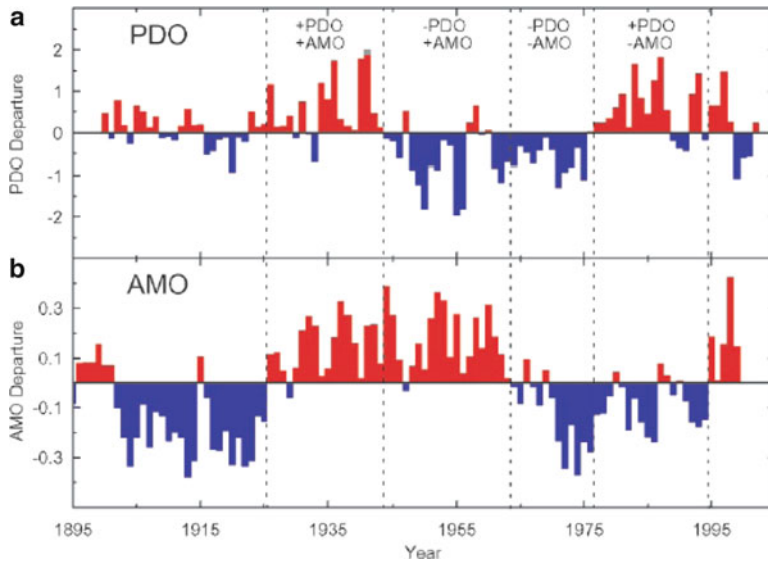
The United States has several regions that have seemingly well-defined hydrologic responses to the different phases of ENSO. The southeast tends to have colder drier winters during La Niña. In the west, the Pacific Northwest tends to be wetter (drier) than average during La Niña/El Niño, while the Southwest is drier (wetter) than average [8]. Cayan et al. [9] investigated the relationship of ENSO to hydrologic extremes in the western United States. Gray [10], Richards and O’Brien [11], and Bove et al. [12] have investigated links of Atlantic Basin hurricane activity to the state of ENSO which has a distinct impact on hydrologic condition in the Gulf States and Eastern seaboard.

It is important to realize that the ENSO phenomenon tends to impact the atmospheric circulation patterns. Variability in the positioning of the atmospheric circulation patterns relative to the land surface can have a significant influence on the observed hydrologic response for some locations. Figure 1.2 shows a plot of the Multivariate ENSO Index, an index based on multiple factors to determine the strength of the El Niño or La Niña event [13]. In Fig. 1.2, red regions are associated with El Niño events, and blue regions are associated with La Niña events.

#### 2.4. Hydroclimatic System Patterns: Ocean System Patterns

The oceanic component of the hydroclimate system has the longest time scale of evolution which can lead to interannual to decadal influences on hydrologic response. Ocean system patterns that influence the hydroclimate system are often tied to sea surface temperature patterns that are driven in part by ocean circulations due to heat content and salinity variations across the depth and breadth of the ocean basins.

One pattern of oceanic hydroclimate is the *Pacific Decadal Oscillation* (PDO). This sea surface temperature pattern spans the entire Pacific Ocean north of the equator ([14]; Minobe [15]). In the Atlantic basin, the *Atlantic Multidecadal Oscillation* (AMO) has been identified by Xie and Tanimoto [16]. Figure 1.3 shows a plot of the PDO and AMO.



**Fig. 1.3.** Time series of PDO and AMO (with permission from [17]).

For the PDO, there are two phases, a warm phase and a cold phase. In the warm phase of the PDO, a pool of warmer than average sea surface temperatures extends across the northeast Pacific. It is surrounded by a ring of cooler-than-normal water to the west. The cold phase has a cooler-than-average pool of water in the northeast Pacific with a ring of warmer water surrounding it to the west. The transition between a warm and cold phase occurs between 10 and 30 years. Its discovery was an outcome of a search for causal mechanisms of changes in fisheries patterns along the coast of North America [14, 18]. Due to ocean patterns' long time period of evolution, they tend to serve as a backdrop upon which the shorter time-scale processes occur. In that sense, impacts tend to relate more to decadal variability rather than specific event influence. Correlations with hydrologic conditions can be found in numerous studies and reviews (e.g., [19–21]).

Like the PDO, the AMO has a warm and cold phase defined primarily by SST patterns. For the North Atlantic and the AMO, any linear trends are removed from the SST time series prior to determining the phase of the AMO to take anthropogenic climate change into account. Variability in the AMO is associated with the ocean's thermohaline circulation. Correlations of the AMO to Northern Hemisphere precipitation and air temperature patterns are also numerous (e.g., [22–24]).

## 2.5. Interactions Across Scales and Extreme Events

The phenomena mentioned above do not evolve in isolation, and at any given time, multiple features can be influencing midlatitude weather patterns and their associated hydrologic response. In some cases, the interactions can mitigate the influence of one pattern and

may muddle the correlation with hydrologic response in a given location. On the other hand, there may be times when interactions between the processes occur in such a way that an unusually extreme event results. In these cases, there may be additional processes such as *atmospheric rivers* [25] that come into play.

Atmospheric rivers are narrow bands of high concentrations of atmospheric water vapor that extend from the tropics to the midlatitudes. When these water vapor bands interact with the right atmospheric dynamics, extreme precipitation events tend to occur. The relation of processes such as atmospheric rivers and other hydroclimate patterns and their associated impact on hydrologic response is an area of open research. NOAA's Climate Prediction Center tracks a large collection of these hydroclimate system patterns and has more information and references on their website.

## 2.6. Climate Change

Changes in atmospheric composition impacting the radiative balance of the atmosphere can have significant impacts on hydrologic processes. Increasing temperatures lead to higher freezing altitudes which lead to higher elevation snow lines. Higher snow lines mean greater watershed area contributing to runoff during a precipitation event which will result in more direct runoff and possible higher peak flows. Higher snow lines may result in smaller runoff volumes during the snowmelt period, changing the shape of the annual hydrograph. Higher snow lines may also change the local water balances resulting in changes to watershed yields for water supply purposes.

Methods for assessing hydrologic impacts of climate change are varied. Impacts to annual and monthly hydrology for water supply purposes have looked at scaled changes to monthly flow volumes using ratios (e.g., [26–28]). Hydrologic models have been used to determine changes to flows using temperature and precipitation change estimates from global climate model projections (e.g., [29–31]). However, these simulations assume that the model calibration for historical hydrologic conditions is also appropriate for future climate conditions. Such questions suggest that more research is needed into watershed processes and their potential change in relationship to each other with different climate conditions. Another option for expanding the hydrologic realizations of the observed record is to use paleoclimate estimates of hydrologic variables. For example, this has been done in the United States Bureau of Reclamation's Lower Colorado Study [32]. Other methodologies will likely be developed as more refined climate change projection information becomes available and more planning studies require consideration of climate change impacts.

## 2.7. Remarks

Climate plays a significant role in hydrologic response. Year-to-year variations in peak flows, low flows, or annual totals can be related to specific hydroclimatic patterns through a variety of correlative methods. Several hydroclimatic patterns have been identified with phases lasting from days to years to decades. Climate change may cause fundamental shifts in hydrologic processes at a given location that may impact the correlative relation between

the climate phenomena and local hydrologic response. Continued research and development is needed to move beyond correlative relations to a greater understanding of the physical processes that enable climate to impact weather that impacts hydrologic response. While a deterministic mapping of these processes may not be possible due to the complexity and interaction of the different phenomena, there should be opportunity for examining conditional probability distributions and their evolution based on the evolution of the climate system.

### 3. SURFACE WATER HYDROLOGY

#### 3.1. Precipitation

The lifting of moist air masses in the atmosphere leads to the cooling and condensation which results in precipitation of water vapor from the atmosphere in the form of rain, snow, hail, and sleet. Following the cooling of air masses, cloud droplets form on condensation nuclei consisting of dust particles or aerosols (typically  $< 1 \mu\text{m}$  diameter). When the condensed moisture droplet is larger than 0.1 mm, it falls as precipitation, and these drops grow as they collide and coalesce to form larger droplets. Raindrops falling to the ground are typically in the size range of 0.5–3 mm, while rain with droplet sizes less than 0.5 mm is called drizzle.

There are three main mechanisms that contribute to lifting of air masses. *Frontal lifting* occurs when warm air is lifted over cooler air by frontal passage resulting in *cyclonic* or *frontal* storms. The zone where the warm and cold air masses meet is called a *front*. In a *warm front*, warm air advances over a colder air mass with a relatively slow rate of ascent causing precipitation over a large area, typically 300–500 km ahead of the front. In a *cold front*, warm air is pushed upward at a relatively steep slope by the advancing cold air, leading to smaller precipitation areas in advance of the cold front. Precipitation rates are generally higher in advance of cold fronts than in advance of warm fronts. Oftentimes, warm air rises as it is forced over hills or mountains due to *orographic lifting* as it occurs in the northwestern United States, and the resulting precipitation events are called *orographic storms*. Orographic precipitation is a major factor in most mountainous areas and exhibits a high degree of spatial variability. In *convective lifting*, warm air rises by virtue of being less dense than the surrounding air, and the resulting precipitation events are called *convective storms* or, more commonly, *thunderstorms*.

Natural precipitation is hardly ever uniform in space, and spatially averaged rainfall (also called *mean areal precipitation*) is commonly utilized in hydrologic applications. Mean areal precipitation tends to be scale dependent and statistically nonhomogeneous in space. Precipitation at any location (measured or unmeasured) may be estimated using an interpolation scheme that employs linear weighting of point precipitation measurements at the individual rain gauges over a desired area as

$$\hat{P}(x) = \sum_{i=1}^N w_i P(x_i), \quad (1.1)$$

where  $\hat{P}(x)$  is the precipitation estimate at location  $x$ ;  $P(x_i)$  is the measured precipitation at rain gauge  $i$ , that is, located at  $x_i$ ;  $w_i$  is the weight associated with the point measurement at station  $i$ ; and  $N$  is the total number of measurements (gauges) being used in the interpolation.

Because of unbiasedness, the following condition  $\sum_{i=1}^N w_i = 1$  must be met.

There are a variety of ways to estimate the weights,  $w_i$ , depending on the underlying assumptions about the spatial distribution of the precipitation. Some of the more common methods are summarized briefly:

- (a) The precipitation is assumed to be uniformly distributed in space, and an equal weight is assigned to each station so that the estimated rainfall at any point is simply equal to the arithmetic average of the measured data, i.e.,

$$w_i = \frac{1}{N}, \quad i = 1, \dots, N. \quad (1.2)$$

- (b) The precipitation at any point is estimated to equal the precipitation at the nearest station. Under this assumption,  $w_i = 1$  for the nearest station, and  $w_i = 0$  for all other stations. This methodology is the discrete equivalent of the *Thiessen polygon method* [33] that has been widely used in hydrology.
- (c) The weight assigned to each measurement station is inversely proportional to the distance from the estimation point to the measurement station. This approach is frequently referred to as the *reciprocal-distance approach* (e.g., [34]). An example of the reciprocal-distance approach is the *inverse-distance-squared method* in which the station weights are given by

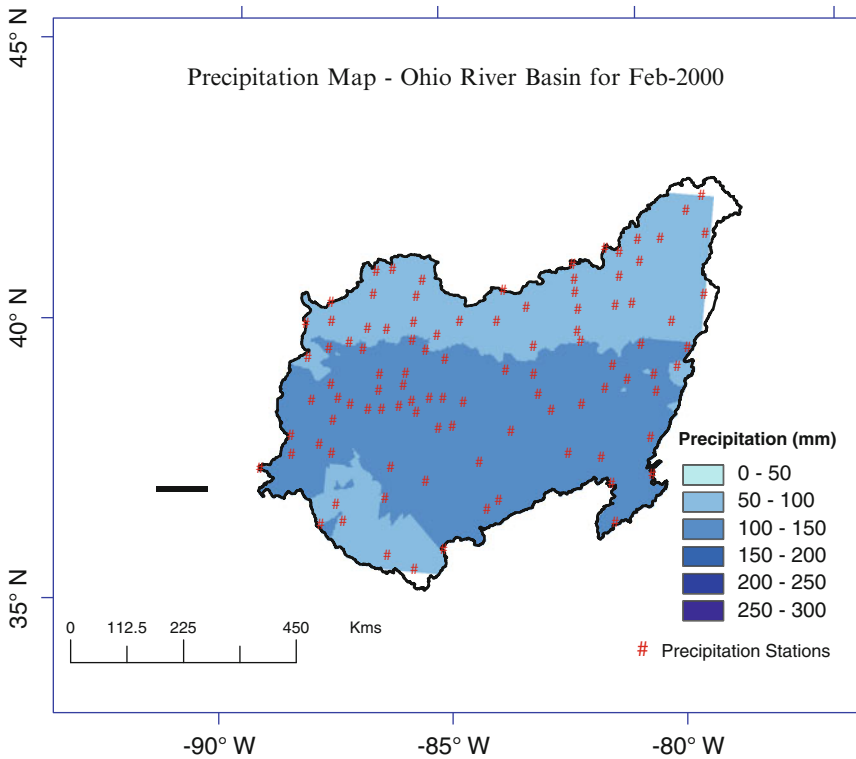
$$w_i = \frac{1/d_i^2}{\sum_{i=1}^N (1/d_i^2)}, \quad i = 1, \dots, N, \quad (1.3)$$

where  $d_i$  is the distance to station  $i$  and  $N$  is the number of stations within some defined radius where the precipitation is to be estimated.

- (d) The weights are calculated using geostatistical methods such as kriging using either the covariance or the variogram function of the precipitation (e.g., [35]). Because the kriging weights are dependent on spatial continuity of precipitation, kriging techniques are suitable for examining scale dependency of spatially averaged precipitation [36].

The methods above should not be used to estimate precipitation depths of mountainous watersheds where the spatial variability is very high. Nowadays, these computations are facilitated through the use of geographic information systems (GIS) that enable processing and visualization of data. Figure 1.4 is an example of spatial interpolation of precipitation over a watershed using kriging techniques.

After specifying the station weights in the precipitation interpolation formula, the next step is to numerically discretize the averaging area by placing an averaging grid. The definition of the averaging grid requires specification of the origin, discretization in the  $x$ - and  $y$ -directions, and the number of cells in each of the coordinate directions. The precipitation,  $\hat{P}(x_j)$ , at the



**Fig. 1.4.** Interpolated precipitation map over the Ohio River Basin using USHCN precipitation stations for February 2000.

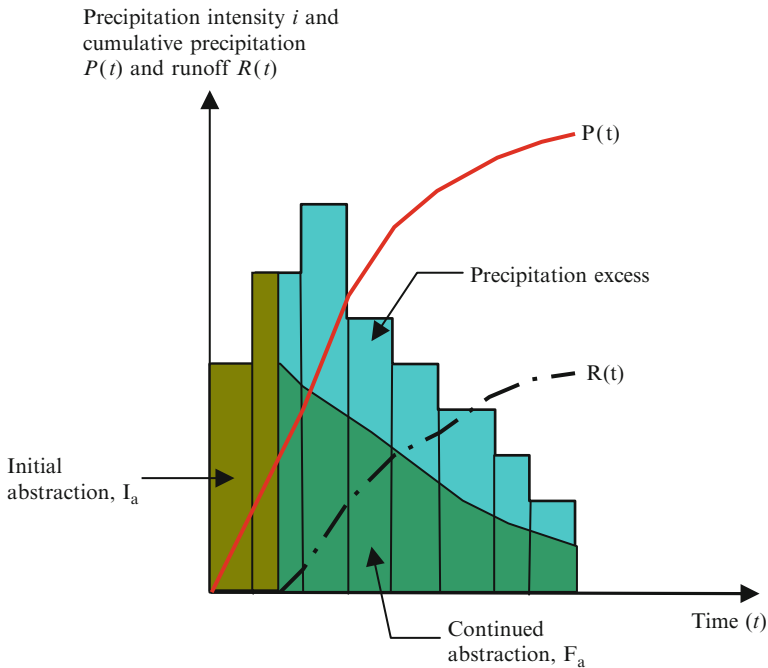
center,  $x_j$ , of each cell is then calculated using (1.1) with specified weights, and the average precipitation over the entire area,  $\bar{P}$ , is given by

$$\bar{P} = \frac{1}{A} \sum_{j=1}^J \hat{P}(x_j) A_j, \quad (1.4)$$

where  $A$  is the averaging area,  $A_j$  is the area contained in cell  $j$ , and  $J$  is the number of cells that contain a portion of the averaging area.

The fractions of precipitation that are trapped infiltrate into the ground and fill local depressions are called *abstractions* or *losses*, while the remainder is called *excess precipitation*, i.e., the fraction that generates runoff. The terms used in abstractions and runoff computations are illustrated in Fig. 1.5 where precipitation and loss rates are plotted versus time for a precipitation event. The total precipitation depth  $P(t)$  is the area under the plot of precipitation intensity  $i$ . The total precipitation is partitioned into *initial abstraction*  $I_a$ , *continued abstraction*  $F_a$ , and excess precipitation (which is assumed to be converted into surface runoff and its accumulation is called *cumulative runoff*  $R(t)$ ). The initial abstraction  $I_a$  is the area under the precipitation intensity curve at the beginning of the precipitation event





**Fig. 1.5.** Partitioning of the total precipitation hyetograph into excess precipitation and abstractions. The cumulative precipitation  $P(t)$  and cumulative runoff  $R(t)$  are also shown schematically.

when all the precipitation is lost through interception, surface storage, infiltration, and other abstractions. The continued abstraction  $F_a$  includes losses that occur after the initial abstraction has been met and primarily represents infiltration losses into the soil. Referring to Fig. 1.5, continued abstraction is the area under the loss rate curve after runoff is initiated, and the total abstraction  $S$  is the sum of  $I_a$  and  $F_a$ . The excess precipitation  $R(t)$  is the area under the precipitation intensity plot after subtracting the total losses. The ultimate abstraction  $S$  is an estimate of the total abstractions assuming that precipitation continues indefinitely.

### 3.2. Interception and Depression Storage

Interception is the part of precipitation that is stored on the earth's surface such as vegetation. Part of the intercepted water evaporates, but part of it may eventually filter through the vegetation and reach the soil surface as *throughfall* or creep down the branches as *stemflow*. Studies indicate that interception accounts for 10–30 % of the total rainfall in the Amazon rainforest depending on the season. Precipitation is also intercepted by buildings and other aboveground structures as in urban areas and industrial complexes. Methods used for estimating interception are mostly empirical, where the amount of interception is expressed either as a fraction of the amount of precipitation or as a function of the precipitation amount. Interception percentages over seasonal and annual time scales for several types of vegetation have been summarized by Woodall [37]. These data indicate that, on an annual basis,

interception ranges from 3 % for hardwood litter to 48 % for some conifers. Many interception formulas are similar to that originally suggested by Horton [38], where the interception,  $I$ , for a single storm, is related to the precipitation amount,  $P$ , by an equation of the form

$$I = a + bP^n, \quad (1.5)$$

where  $a$  and  $b$  are constants. When  $I$  is expressed in millimeters, typical values are  $n = 1$  (for most vegetative covers),  $a$  between 0.02 mm for shrubs and 0.05 mm for pine woods, and  $b$  between 0.18 and 0.20 for orchards and woods and 0.40 for shrubs. The interception storage capacity of surface vegetation may vary from less than 0.3 mm to 13 mm, with a typical value for turf grass of 1.3 mm.

Some interception models account for limited storage capacity of surface vegetation and evaporation during a storm (e.g., [39]) such as

$$I = S\left(1 - e^{-P/S}\right) + K'Et, \quad (1.6)$$

where  $S$  is the storage capacity of vegetation,  $P$  is the amount of precipitation during the storm,  $K'$  is the ratio of the surface area of one side of the leaves to the projection of the vegetation at the ground (called the *leaf area index*),  $E$  is the evaporation rate during the storm from plant surfaces, and  $t$  is the duration of the storm. The storage capacity,  $S$ , is typically in the range of 3–5 mm for fully developed pine trees; 7 mm for spruce, fir, and hemlock; 3 mm for leafed-out hardwoods; and 1 mm for bare hardwoods [40]. More sophisticated models of interception are described in Ramirez and Senarath [41] and Brutsaert [42].

Interception by forest litter is much smaller than canopy interception. The amount of litter interception is largely dependent on the thickness of the litter, water holding capacity, frequency of wetting, and evaporation rate. Studies have shown that it is only a few millimeters in depth in most cases [43] and, typically, about 1–5 % of annual precipitation and less than 50 mm/year are lost to litter interception [44].

Water that accumulates in surface depressions during a storm is called *depression storage* and can be a major part of the hydrologic budget in flat watersheds [45]. This portion of rainfall does not contribute to surface runoff. Depression storage is generally expressed as an average depth over the catchment area, and typical depths range from 0.5 to 7.5 mm.

### 3.3. Infiltration

The process by which water enters into the ground through the soil surface is called *infiltration* and is usually the dominant rainfall abstraction process. Bare-soil infiltration rates are considered high when they are greater than 25 mm/h and low when they are less than 2.5 mm/h [46]. The *infiltration rate*  $f$  expresses how fast water enters the soil at the surface. If water is ponded on the surface, the infiltration occurs at the *potential infiltration rate* (often called *infiltration capacity*) and is considered to be limited by soil properties. In case of rainfall over initially dry soils, the rate of supply of water at the surface (rainfall rate) is less than the potential infiltration rate, all the water enters the soil, and infiltration is limited

by rainfall rate. The *cumulative infiltration*  $F$  is the accumulated depth of water infiltrated over a given time and is related to infiltration rate as

$$f(t) = \frac{dF(t)}{dt} \quad (1.7a)$$

and

$$F(t) = \int_0^t f(t)dt. \quad (1.7b)$$

The simplest model for infiltration is the  $\phi$  index, which is a constant rate of abstraction such that the excess depth of rainfall equals the direct runoff depth; it has been commonly used in practice. Our current understanding of water movement through unsaturated soils is expressed by Richards' equation, and the infiltration process determines the boundary condition at the soil surface. Since Richards' equation is nonlinear, simpler empirical models for infiltration are commonly used. For example, Horton [47, 48] expressed potential infiltration rate as

$$f(t) = f_c + (f_0 - f_c)e^{-kt}, \quad (1.8)$$

where  $k$  is a decay constant and  $f_0$  is the initial infiltration rate at  $t = 0$  and decreases exponentially until it reaches a constant rate  $f_c$ . Philip [49, 50] expressed cumulative infiltration as

$$F(t) = St^{1/2} + Kt, \quad (1.9)$$

where  $S$  is soil *sorptivity* (a function of the *soil suction potential*) and  $K$  is the *saturated hydraulic conductivity*. Thus, the potential infiltration rate from this model when water supply is not limited is

$$f(t) = \frac{1}{2}St^{-1/2} + K. \quad (1.10)$$

The two terms in Philip's equation represent the effects of suction and gravity forces, respectively, in moving the water to deeper soil locations.

Green and Ampt [51] proposed a simplified infiltration model which approximated the water content profile in the soil as a sharp front, with the volumetric moisture content equal to the initially uniform value of  $\theta_i$  below the front and saturated soil with moisture content equal to porosity  $\eta$  above the front. The wetting front penetrates to a depth  $L$  in time  $t$  since the start of the infiltration process. Water is ponded to a small depth  $H_0$  on the soil surface, denoting an infinite supply of water at the surface. For a control volume extending from the soil surface to the wetting front of unit area, volumetric continuity yields

$$F(t) = L(\eta - \theta_i) = L\Delta\theta. \quad (1.11)$$

Denoting  $H$  as the total head (sum of gravity and suction heads), Darcy's law over this length of saturated soil is

$$-f = -K \frac{\partial H}{\partial z}. \quad (1.12)$$

Simplification yields

$$f = K \left[ \frac{\psi \Delta \theta + F}{F} \right] \quad (1.13)$$

and

$$F(t) = Kt + \psi \Delta \theta \ln \left( 1 + \frac{F(t)}{\psi \Delta \theta} \right), \quad (1.14)$$

where  $\psi$  is the suction head at the wetting front.

When the supply of water is limited as it normally occurs during rainfall events, water will pond on the surface only if the rainfall intensity exceeds the infiltration capacity of the soil. The *ponding time*  $t_p$  is the elapsed time between the time rainfall begins and the time water begins to pond on the soil surface. During pre-ponding times ( $t < t_p$ ), the rainfall intensity is less than the potential infiltration rate, and the soil surface is unsaturated. Ponding is initiated when the rainfall intensity exceeds the potential infiltration rate at  $t = t_p$  and the soil surface reaches saturation. With continued rainfall ( $t > t_p$ ), the saturated region extends deeper into the soil, and the ponded water is available on the soil surface to contribute to runoff. At incipient ponding conditions,  $F_p = i t_p$  and the infiltration rate equals the rainfall rate (i.e.,  $f = i$ ) so that

$$t_p = \frac{K \psi \Delta \theta}{i(i - K)}. \quad (1.15)$$

Post-ponding cumulative infiltration is given by

$$F - F_p - \psi \Delta \theta \ln \left( \frac{\psi \Delta \theta + F}{\psi \Delta \theta + F_p} \right) = K(t - t_p) \quad (1.16)$$

and the infiltration rate by (1.13). Pre- and post-ponding infiltration rates under supply-limiting conditions can be computed for the Horton and Philip models (e.g., [52]).

The Natural Resources Conservation Service (NRCS), formerly the Soil Conservation Service (SCS), developed the curve number method that is widely used in practice due to its simplicity and availability of empirical information (SCS, [53, 54]). The method relies on the use of a single parameter called the curve number  $CN$ . Following Fig. 1.5, consider the relationship below on intuitive grounds

$$\frac{F_a}{S} = \frac{R}{P - I_a}. \quad (1.17)$$

Note that at the beginning of the rainfall event, both  $F_a/S$  and  $R/(P - I_a)$  are zero. As time progresses, both  $F_a/S$  and  $R/(P - I_a)$  approach unity asymptotically. The continuity equation gives

$$P(t) = I_a + F_a(t) + R(t), P(t) > I_a. \quad (1.18)$$

Based on analyses of empirical data from numerous gauged watersheds, the NRCS proposed

$$I_a = 0.2S. \quad (1.19)$$

Combining (1.17)–(1.19) gives

$$\begin{aligned} R(t) &= \frac{[P(t) - 0.2S]^2}{P + 0.8S}, & \text{for } P(t) \geq I_a \\ R(t) &= 0, & \text{for } P(t) < I_a \end{aligned} \quad (1.20a)$$

with

$$\begin{aligned} S &= \frac{2,540}{CN} - 25.4 & \text{for } R, P, S \text{ in cm} \\ S &= \frac{1,000}{CN} - 10 & \text{for } R, P, S \text{ in inches} \end{aligned} \quad (1.20b)$$

where  $R(t)$  is the runoff volume (rainfall excess) expressed in the form of depth that results from precipitation  $P(t)$ ,  $S$  is the maximum potential abstraction after runoff begins,  $I_a$  is the initial abstraction before runoff begins, and  $CN$  is a curve number. Note that even though  $R$ ,  $P$ ,  $S$ , and  $I_a$  are essentially volumes, they have units of cm or inches, because these numbers are expressed over the watershed area. The theoretical justification of the foregoing method has been developed [55, 56].

The curve number  $CN$  depends on soil characteristics, land cover, and antecedent moisture conditions. Information on local soils is available from various sources, including published NRCS county soil surveys. The standard NRCS soil classification system consists of four groups (A, B, C, and D). *Group A* soils have low runoff potential and high infiltration rates (greater than 0.76 cm/h) and consist primarily of deep well-drained sands and gravel. *Group B* soils have moderate infiltration rates (0.38–0.76 cm/h) and consist primarily of moderately fine to moderately coarse textured soils, such as loess and sandy loam. *Group C* soils have low infiltration rates (0.127–0.38 cm/h) and consist of clay loam, shallow sandy loam, and clays. And *Group D* soils have high runoff potential and low

infiltration rates (less than 0.127 cm/h) and consist primarily of clays with a high swelling potential, soils with a permanent high water table, or shallow soils over nearly impervious material. Rather than estimating  $S$  for each watershed, NRCS recommends working with a dimensionless  $CN$  with  $0 \leq CN \leq 100$ . A  $CN$  of 100 corresponds to  $S = 0$ , implying that all precipitation is converted to runoff. For gauged watersheds, the parameters  $CN$  (or  $S$ ) and  $I_a$  may be determined by calibration. For ungauged watersheds,  $CN$  values may be estimated using tables (SCS, [57]).

### 3.4. Evaporation and Evapotranspiration

While precipitation brings water from the atmosphere down to the earth, *evaporation* does the opposite; it returns water from the earth back to the atmosphere. Evaporation generally occurs from all water storages such as interception and depression storages and surface water storages such as lakes and reservoirs. Also water may evaporate from the soil, snow, ice, and from all bodies that store and carry water. A related phenomenon is the water that is transported by plants from the root zone to the atmosphere, a process that is called *transpiration*. In this section, we will discuss the fundamental concepts behind the process of evaporation from liquid water bodies, soil, and solid water (ice and snow). In addition, we will discuss several methods for estimating lake evaporation and evapotranspiration from natural and irrigated fields and river basins. The study of evaporation is important in hydrologic and water resources engineering for several reasons. One important reason is in water balance studies of reservoirs and river basins. For example, in designing the capacity of a reservoir for municipal water supply, one must take into account the expected losses of water by evaporation from the planned reservoir. Also, (after the dam is built) during the real-time operation of the reservoir (to meet the expected water demands), one must consider that certain amount of water will be lost by evaporation. Another example is the problem of determining the expected water demands of irrigation systems. One must determine how much water will be lost by evaporation from the irrigated field plus the amount of water that will be needed by the plant to growth and to transpire.

Globally, about 62 % of the precipitation that falls on the continents is evapotranspired. About 97 % of this amount is evapotranspiration (ET) from land surface, while 3 % constitutes open-water evaporation. ET exceeds runoff in most river basins and is a major component of energy and water vapor exchange between land surfaces and the atmosphere.

#### 3.4.1. Concept of Evaporation

Evaporation denotes the conversion of water in the liquid or solid phase at or near the earth's land surface to atmospheric water vapor. In general the term includes evaporation of liquid water from rivers, lakes, oceans, and bare soil. Related terms include *evapotranspiration* from vegetative surfaces and *sublimation* from ice and snow surfaces.

Evaporation can be thought of as a diffusion process in which there exists transfer of water vapor. This water transfer is caused by a generating force which is the gradient of water vapor pressure existing in the interface liquid-air. Following Eagleson [58], let us consider a water body in which the temperature of the water surface is denoted by  $T_0$  and the air above the

water surface is still (no wind) and has temperature  $T$  and water vapor pressure equal to  $e$ . One could also assume that just above the water surface, there is a thin layer of saturated air with temperature equal to that of the water surface, i.e.,  $T_0$ , and saturated vapor pressure denoted by  $e_0$  (the thin layer becomes saturated as a result of a continuous exchange of water molecules due to vaporization and condensation).

Evaporation from the water body will exist as long as there is a gradient of water vapor pressure, i.e., whenever the saturated vapor pressure  $e_0$  (at temperature  $T_0$ ) is greater than the water vapor pressure  $e$  of the air above the thin layer. Therefore, one can write

$$E = -K \frac{\partial e}{\partial y}, \quad (1.21)$$

where  $E$  = evaporation rate,  $K$  = mass transfer coefficient,  $e$  = vapor pressure, and  $y$  = height. Naturally there must be many other factors besides water vapor pressure that influences evaporation rates. They may be categorized as (a) meteorological factors, (b) the nature of the evaporating surface, and (c) water quality. Meteorological factors include radiation, vapor pressure, humidity, temperature, wind, and pressure (elevation). Short- and long-wave radiations are main sources of energy that are necessary for liquid water to become water vapor. Water temperature at the water surface determines the water vapor pressure just above the (water) surface. Likewise, air temperature and air moisture determine the water vapor conditions (pressure) above the water surface. And both the water vapor near the water surface and that above the surface determine the rate of evaporation as (1.21) suggests. Also wind has a major effect; it enhances the rate of evaporation due to turbulent convection. Certainly the nature of the evaporating surface must have some effect on evaporation rates. For example, under all other conditions being the same, the evaporation rate per unit area from water must be different than that from ice. One difference is the temperatures at the surfaces of water and ice and the corresponding saturated water vapor pressures. Another difference is that the net radiation will vary for both surfaces because of the differences in albedo and reflectivity. Water quality is also important in determining evaporation rates. An example is the difference in evaporation rates per unit area of clean water versus water with a high concentration of sediments.

### 3.4.2. Lake Evaporation

Estimating evaporation rates from open-water bodies such as lakes and reservoirs has been an active area of study for water scientists and hydrologic engineers for many decades. Many theories and formulas have been developed for estimating lake evaporation. The various estimation methods can be classified as (a) use of pan coefficients, (b) water budget analysis (mass balance or continuity equation), (c) energy budget analysis (energy balance), (d) aerodynamic method (diffusion or mass transfer), and (e) combination method (Penman method).

### Estimating Lake Evaporation by Pan Coefficients

Measurements of evaporation in a pan or water tank are quite useful for predicting evaporation rates from any surface such as water and soil. For example, the standard US National Weather Service Class A pan is a common instrument utilized in the United States. It has 4 ft. diameter and is 10 in. deep. The pan is filled with water to a depth of 8 in. The water surface in the pan is measured by a hook gauge in a stilling well attached to the pan, and measurements are usually made daily. Water in the pan is filled back to the full depth of 8 in. each time a reading of the stilling basin is made. Evaporation readings are adjusted for any precipitation measured in a standard rain gauge. There are several other types of evaporimeters that are currently used in many parts of the world. The method (one of the simplest methods available) involves measuring pan evaporation at or near the lake and using a pan coefficient. The equation is

$$E_L = cE_p, \quad (1.22)$$

where  $E_L$  denotes lake evaporation,  $E_p$  is pan evaporation, and  $c$  is a pan coefficient. The coefficient  $c$  generally varies with the season, the type of pan, and the region. The average of the monthly (or seasonal) pan coefficients is smaller than one and about the same as the coefficient based on annual quantities. For example, for Class A pans, the annual  $c$  is of the order of 0.70. The coefficient 0.7 is generally used in formulas that calculate pan evaporation to obtain an estimate of lake evaporation. Extensive tables of  $c$  are available; see, for instance, Bras [59].

### Estimating Lake Evaporation by the Water Budget Equation

This is the most obvious approach and involves direct measurements of all water inputs, outputs, and change of water storage in the lake during the time interval  $\Delta t$  considered. Applying the mass balance (water budget) equation, we can determine the water storage in the lake at the end of the time interval  $\Delta t$  as  $S_2 = S_1 + I + P - E - O - O_g$  where  $I$  = surface inflow into the lake,  $P$  = precipitation on the lake surface,  $E$  = evaporation from the lake,  $O_g$  = subsurface seepage,  $O$  = surface outflow (lake outflow or releases), and  $S_1$  = lake storage at the beginning of the time interval. Solving for  $E$  gives

$$E = \Delta S + I + P - O - O_g, \quad (1.23)$$

where  $\Delta S = S_1 - S_2$ . This method may give reasonable estimates of lake evaporation as long as the measurements (and estimations) of the variables involved are accurate. This can be generally achieved regarding the terms  $\Delta S$  and  $O$ . However, the terms  $I$  and  $P$  may or may not be accurate depending of the particular case at hand. For example, the inflow  $I$  should be accurate if a stream gauging station is available upstream and near the lake entrance (it would be less accurate if the gauging station is located far from the dam site). Also estimates must be made of the runoff from the ungauged creeks surrounding the lake. Likewise estimates of  $P$  may be accurate or not depending on the size of the lake and the available network of precipitation gauges. On the other hand, the term  $O_g$  is generally inaccurate or unknown.



Estimates of  $O_g$  can be obtained by calibrating a loss function by taking appropriate measurements in the reservoir during certain periods of time. However, this may not be practical or possible in large lakes.

### Estimating Lake Evaporation by the Energy Budget Method

This approach involves direct measurements or estimation of all sources of energy inputs, outputs, and change of energy stored in the lake during the time interval  $\Delta t$  considered. Assuming a lake area unit of  $1 \text{ cm}^2$  and the time interval of 1 day, the energy budget equation for the lake in  $\text{cal}/(\text{cm}^2 \times \text{day})$  can be written as

$$Q_\theta = Q_s - Q_r - Q_\ell - Q_h - Q_E + Q_{\text{adv}}, \quad (1.24)$$

where  $Q_s$  = short-wave radiation input,  $Q_r$  = reflected short-wave radiation,  $Q_\ell$  = net long-wave radiation output (atmospheric long wave, reflected long wave, and emitted long wave from the lake),  $Q_h$  = sensible heat loss (heat conduction at the molecular level),  $Q_E$  = energy used for lake evaporation,  $Q_{\text{adv}}$  = net advected energy (due to inflow, outflow, precipitation, and seepage), and  $Q_\theta$  = change of energy stored during the time interval considered. One can simplify this equation by assuming that  $Q_h = BQ_E$  in which  $B$  is called the *Bowen's ratio*.  $B$  may be determined by

$$B = 0.61 \frac{p_a}{1,000} \frac{(T_0 - T_a)}{(e_0 - e_a)}, \quad (1.25)$$

where  $p_a$  = air pressure in mb,  $T_0$  = temperature of the water surface in  $^\circ\text{C}$ ,  $T_a$  = temperature of the air in  $^\circ\text{C}$ ,  $e_0$  = saturated water vapor pressure (in mb) at temperature  $T_0$ , and  $e_a$  = water vapor pressure of the air in mb. Then from (1.24), the energy used for lake evaporation is

$$Q_E = \frac{(Q_s - Q_r - Q_\ell) + (Q_{\text{adv}} - Q_\theta)}{(1 + B)}$$

Because  $Q_E = \rho L_v E$ , where  $\rho$  = density of water in  $\text{g}/\text{cm}^3$ ,  $L_v$  = latent heat of vaporization in  $\text{cal}/\text{g}$  (it can be determined accurately by  $L_v = 597.3 - 0.564 T$  for  $T \leq 40$   $^\circ\text{C}$ ), and  $E$  is the evaporation rate in  $\text{cm}/\text{day}$  (for a  $1 \text{ cm}^2$  area of the lake), the foregoing equation can be written as

$$E = \frac{Q_n + (Q_{\text{adv}} - Q_\theta)}{\rho L_v (1 + B)}, \quad (1.26)$$

where  $Q_n = Q_s - Q_r - Q_\ell$  = net radiation in  $\text{cal}/(\text{cm}^2 \times \text{day})$ . This term may be estimated from measurements in a pan (tank) as

$$Q_n = Q_{np} + \epsilon \sigma (T_{0p} - T_0)^4, \quad (1.27)$$

where  $Q_{np}$  = pan net all-wave radiation in  $\text{cal}/(\text{cm}^2 \times \text{day})$  (measured using a net pyrradiometer),  $T_{0p}$  = water surface temperature in the pan in  $^\circ\text{K}$ ,  $\sigma = 11.71 \times 10^{-8} \text{ cal}/(\text{cm}^2 \times ^\circ\text{K}^4 \times \text{day})$  (Stefan-Boltzmann constant), and  $\varepsilon$  = water surface emissivity  $\approx 0.97$ . Lastly the term  $Q_{adv} - Q_{\theta}$  can be determined by accounting the amount of energy contained in each term of the water budget equation (e.g., [60]).

In addition, pan evaporation may be estimated from (1.26) if the pertinent quantities involved are either measured or estimated for a pan. For instance, neglecting the term  $Q_{adv} - Q_{\theta}$ , an estimate of pan evaporation may be obtained by

$$E_p = Q'_{np} = Q_{np}/[\rho L_v(1 + B)], \quad (1.28)$$

where  $Q_{np}$  is the net radiation for the pan in  $\text{cal}/(\text{cm}^2 \times \text{day})$  and the symbol  $Q'_{np}$  is used to emphasize that the net radiation is computed in equivalent units of evaporation. Furthermore, formulas for estimating pan evaporation as a function of daily solar radiation and air temperature are available. For example, a formula to estimate pan evaporation developed based on Class A pan data is given by (e.g., [60])

$$E_p = Q'_{np} = 7.14 \times 10^{-3} Q_s + 5.26 \times 10^{-6} Q_s (T_a + 17.8)^{1.87} + 3.94 \times 10^{-6} Q_s^2 - 2.39 \times 10^{-9} Q_s^2 (T_a - 7.2)^2 - 1.02, \quad (1.29)$$

where  $E_p = Q'_{np}$  = pan evaporation in mm per day,  $Q_s$  = solar radiation in  $\text{cal}/(\text{cm}^2 \text{ day})$ , and  $T_a$  = air temperature in  $^\circ\text{C}$ . Then, lake evaporation may be determined approximately by  $E_L = c E_p$  where  $c$  is a pan coefficient. Often a value of  $c = 0.7$  is used for a Class A pan.

#### Estimating Lake Evaporation by the Mass Transfer Method (Aerodynamic or Diffusion)

From turbulent convection theory, the *vertical flux of water vapor* can be written as

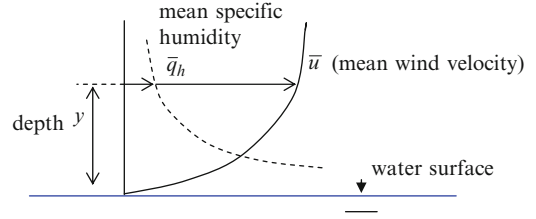
$$E = -\rho K_w \frac{\partial \bar{q}_h}{\partial y}, \quad (1.30)$$

where  $E$  = lake evaporation rate in  $\text{g}/(\text{cm}^2 \times \text{s})$  (flux),  $\rho$  = density ( $\text{g}/\text{cm}^3$ ),  $K_w$  = water eddy diffusivity ( $\text{cm}^2/\text{s}$ ),  $\bar{q}_h$  = mean specific humidity, and  $y$  = elevation above the lake water surface (cm). Likewise, from the equation of *momentum flux*, one can write

$$\tau = \rho K_m \frac{\partial \bar{u}}{\partial y}, \quad (1.31)$$

where  $\tau$  = momentum flux or shear stress in  $\text{g}/(\text{cm} \times \text{s}^2)$ ,  $K_m$  = kinematic eddy viscosity ( $\text{cm}^2/\text{s}$ ), and  $\bar{u}$  = mean wind velocity in the horizontal direction ( $\text{cm}/\text{s}$ ). The sketch shown in Fig. 1.6 summarizes the foregoing concepts.

**Fig. 1.6.** Variation of wind velocity and specific humidity with height above the lake surface.



Based on the foregoing concepts and equations, it may be shown that an expression for  $E$  can be written as (e.g., [61])

$$E = d\bar{u}(e_0 - e_a) \quad (1.32a)$$

which says that the evaporation rate is a function of both  $\bar{u}$  and  $e$  and  $d$  is a constant. But (1.32a) gives zero evaporation if  $\bar{u} = 0$ , which is not realistic. Therefore, a modified equation can be written as (e.g., [59])

$$E = (a + b\bar{u})(e_0 - e_a), \quad (1.32b)$$

where  $a$  and  $b$  are coefficients. Recall that  $e_0$  is the saturated vapor pressure at the lake surface temperature  $T_0$  and  $e_a$  is the vapor pressure of the air above the lake. However, in formulas of this type, the saturated vapor pressure  $e_s$  at the air temperature  $T_a$  is often used instead of  $e_0$ .

Several empirical formulas of the type of (1.32a) and (1.32b) have been developed (e.g., [62–65]). For example, Dunne's formula is

$$E = (0.013 + 0.00016\bar{u}_2)(1 - f)e_a, \quad (1.33)$$

where  $E$  = lake evaporation in cm/day,  $\bar{u}_2$  = wind speed at 2 m above the lake water surface in km/day,  $f$  = relative humidity of the air above the lake surface (fraction), and  $e_a$  = vapor pressure of the air above the lake surface in mb.

Furthermore, mass transfer-based formulas have been developed for estimating pan evaporation. For example, an empirical equation for a Class A pan evaporation is [46]

$$E_p = (0.42 + 0.0029\bar{u}_p)(e_s - e_a)^{0.88}, \quad (1.34)$$

where  $E_p$  = pan evaporation (mm/day),  $\bar{u}_p$  = wind speed (km/day) at 15 cm above the pan rim,  $e_s$  = saturated vapor pressure at air temperature 1.5 m above the ground surface (mb), and  $e_a$  = water vapor pressure of the air at 1.5 m above the ground surface (mb). Then, lake evaporation may be estimated as  $E_L = 0.7 E_p$ .

## Estimating Lake Evaporation by Penman's Equation (Combination Method)

Penman [66] combined the energy budget and the mass transfer methods for estimating lake evaporation. Essentially it involves combining (1.26) and (1.32) under certain assumptions. First of all, the term  $Q_{adv} - Q_{\theta}$  in (1.26) was neglected or assumed to be negligible; then in estimating the net all-wave radiation  $Q_n$ , the temperature of the lake water surface  $T_0$  was replaced by the air temperature above the lake,  $T_a$ ; and then in estimating the effect of turbulent convection as in (1.32),  $e_0$  was replaced by  $e_s$ . Under these conditions, Penman's equation is applicable to shallow lakes. Penman showed that the equation for estimating lake evaporation takes the form

$$E = \frac{\Delta Q'_n + \gamma E_a}{\Delta + \gamma}, \quad (1.35)$$

where  $E$  = lake evaporation in inches/day or cm/day;  $Q'_n$  = net all-wave radiation expressed in the same units as  $E$ , i.e., in/day or cm/day (i.e., if  $Q_n$  is known then  $Q'_n = Q_n/(\rho L_v)$ ); and  $E_a$  = evaporation term estimated by the mass transfer method, e.g., from (1.32b). The coefficient  $\gamma$  (mb/°C) is determined by  $\gamma = 0.00061 p_a$ , in which  $p_a$  is the air pressure in mb. Likewise, the coefficient  $\Delta$  is the derivative of  $e_s$  with respect to  $T$  evaluated at  $T_a$ . An approximate equation to estimate  $\Delta$  in units mb/°C is [60]

$$\Delta = \frac{de_s}{dT} = (0.00815T_a + 0.8912)^7, \quad T_a \geq -25^\circ\text{C}. \quad (1.36)$$

Therefore, (1.35) gives an estimate of daily lake evaporation if adequate climatological data are available for a shallow lake. However, to apply (1.35) for deep lakes, where significant energy transfer from deep layers of the lake to the evaporating surface (of the lake) may occur, in addition to advected energy, one must make an adjustment to the estimate provided by (1.35). Such an adjustment must include an estimate of the term  $Q_{adv} - Q_{\theta}$  plus an adjustment factor  $\alpha$ . Recall that (1.35) assumes that the energy advected into the lake is balanced by a change of heat storage, i.e.,  $Q_{adv} - Q_{\theta} \approx 0$ . This assumption may be reasonable for shallow lakes, but for deep lakes, further corrections may be necessary. For example, lake evaporation may be adjusted as

$$E'_L = E_L + \alpha(Q_{adv} - Q_{\theta}), \quad (1.37)$$

in which  $E'_L$  = adjusted lake evaporation,  $E_L$  is the lake evaporation from (1.35), and  $\alpha$  is an adjustment coefficient that can be estimated by (e.g., [60])

$$\alpha = \left[ 1 + \frac{0.00066p_a + (T_0 + 273)^3 \times 10^{-8} \times (0.177 + 0.00143v_4)^{-1}}{(0.00815T_0 + 0.8912)^7} \right]^{-1}, \quad (1.38)$$

where  $p_a$  = atmospheric pressure in mb,  $T_0$  = water temperature of the lake surface in °C, and  $v_4$  = 4 m wind speed (upwind from the lake) in km/day.

Also Penman's equation can be used to estimate pan evaporation if the variables involved in the right-hand side of (1.35) correspond to a pan. Thus, if  $Q'_n$  in (1.35) is obtained for a pan (for instance, using (1.28) or (1.29)) and  $E_a$  is given by (1.34), for example, then  $E$  of (1.35) is an estimate of pan evaporation. Therefore, Penman's equation for estimating pan evaporation can be written as

$$E_p = \frac{\Delta Q'_{np} + \gamma E_{ap}}{\Delta + \gamma}, \quad (1.39)$$

where the term  $E_a$  in Penman's equation (1.35) has been replaced by  $E_{ap}$  to emphasize that it refers to an estimate for a pan. Then lake evaporation can be obtained by  $E_L = cE_p$  in which  $c$  is the pan coefficient.

An equation that corrects for the sensible heat transfer through the pan is available. Assuming that pan evaporation  $E_p$  is estimated using Penman's equation (1.39), the corrected equation of pan evaporation (mm/day) becomes [60]

$$E'_p = E_p \pm 0.00064p_a\alpha_p(0.37 + 0.00255\bar{u}_p)|T_0 - T_a|^{0.88}, \quad (1.40)$$

where  $p_a$  = air pressure in mb,  $\alpha_p$  = correction factor,  $\bar{u}_p$  = wind speed in km/day at 150 mm above the pan rim,  $T_0$  = temperature of the water surface at the pan in °C, and  $T_a$  = air temperature in °C and the + sign after  $E_p$  is for  $T_0 > T_a$  and the – sign otherwise. And the correction factor  $\alpha_p$  can be approximated by [60]

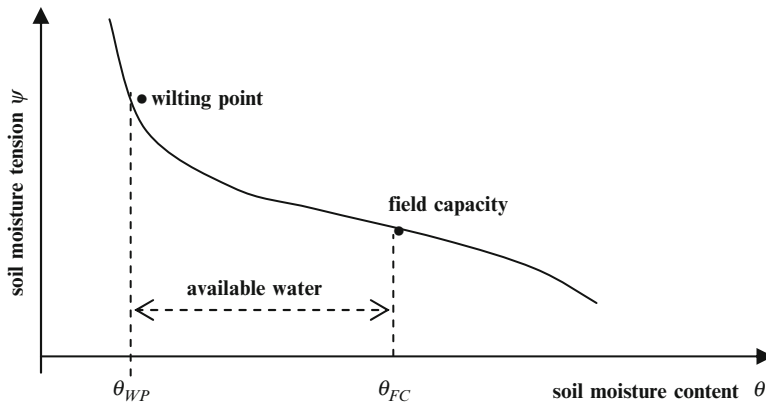
$$\alpha_p = 0.34 + 0.0117T_0 - 3.5 \times 10^{-7}(T_0 + 17.8)^3 + 0.0135\bar{u}_p^{0.36}. \quad (1.41)$$

No additional correction for advected energy is necessary because it is generally small for a pan. Then lake evaporation can be determined by multiplying  $E'_p$  by an appropriate pan coefficient.

### 3.4.3. Transpiration, Evapotranspiration, and Consumptive Use

*Transpiration* is the water vapor discharged to the atmosphere by plants through their stomatal pores. The factors affecting transpiration are (a) meteorological (e.g., radiation, temperature, and wind), (b) type of plant (e.g., shallow roots, long roots, and leaves) and stage of growth, (c) type of soil, and (d) available water. The role of meteorological factors is similar as for evaporation from free water surface discussed in Sects. 3.4.1 and 3.4.2. In fact, Penman's equation has been modified [67] to determine the evaporation rate from vegetation surfaces, and the resulting modified equation has been known as the Penman–Monteith equation.

*Evapotranspiration* is a widely used term in hydrology and irrigation engineering. Evapotranspiration is the amount of water evapotranspired by the soil and the plants of a given area of land. A related term, *consumptive use*, accounts for evapotranspiration and the amount of water utilized by plants for growing plant tissue. When the area considered is a watershed or a



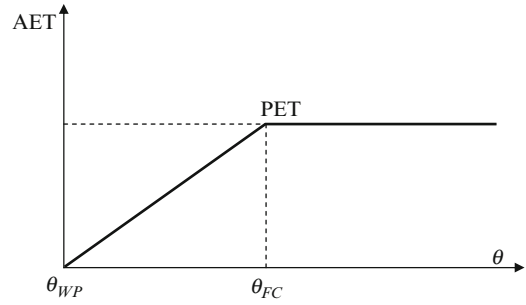
**Fig. 1.7.** Basic relationship between soil moisture tension  $\psi$  and soil moisture content  $\theta$ . The plot also shows the wilting point  $\theta_{WP}$ , the field capacity  $\theta_{FC}$ , and the available water  $AW = \theta_{FC} - \theta_{WP}$ .

river basin, evapotranspiration includes water evaporated from lakes and in general from all other sources. In addition, two other terms related to evapotranspiration are *potential evapotranspiration* (PET) and *actual evapotranspiration* (AET). Potential evapotranspiration is the expected evapotranspiration rate for the expected (normal) climatic conditions in the area, under plenty amount of water available in the soil and under complete (dense) vegetation coverage (i.e., potential evapotranspiration is a maximum evapotranspiration rate under unlimited water availability). On the other hand, actual evapotranspiration is less or equal to potential evapotranspiration because it depends on the water available in the soil. Also the term *reference-crop evapotranspiration* has been used as being equivalent to PET [66]. Furthermore, additional concepts related to PET such as Bouchet's complementary relationship and its advection-aridity interpretation have been suggested (e.g., [68–70]).

Soil moisture tension (refer to Sect. 4), which varies with soil moisture, plays an important role in the evaporation rate of the water that reaches the plant stomata. Figure 1.7 shows a schematic of the typical relationship between soil moisture tension and content, the *wilting point* (soil moisture level below which plants cannot extract water from the soil), the *field capacity* (soil moisture level above which water may percolate down below the root zone and eventually reach the aquifer), and the *available water* (amount of water that is available to the plant). Also Fig. 1.8 shows a schematic of an assumed relationship between potential and actual evapotranspiration as a function of soil moisture.

We illustrate some of the foregoing concepts with a simple example. Assume that at time  $t = 0$ , the soil moisture at a farm lot is at field capacity. If the expected precipitation rate is 12 mm/week and the consumptive use is 30 mm/week, how often and how much one must irrigate? Without any further information given for the problem, a simple approach could be to irrigate at a rate so as to make up for the deficit and to keep the soil moisture at the field capacity level. In this case, the irrigation rate would be  $30 - 12 = 18$  mm/week. However, one may like to take into account the water availability of the soil, the depth of the root zone, and the operating irrigation policy. For instance, suppose that the field capacity is 30 %

**Fig. 1.8.** Relationship between actual evapotranspiration (AET) and soil moisture  $\theta$ . It assumes that AET is equal to potential evapotranspiration PET for  $\theta \geq \theta_{FC}$ .



(in volume), the wilting point is 10 %, and the root zone depth is 300 mm. Then the corresponding amounts of water for the 300 mm root zone are  $\theta_{FC} = 0.30 \times 300 = 90$  mm (field capacity) and  $\theta_{WP} = 0.10 \times 300 = 30$  mm (wilting point), and the available water is  $AW = 90 - 30 = 60$  mm. In addition, suppose the operating policy is such that we would like to avoid drying up the soil beyond 50 mm. Since at the beginning of the week, the soil moisture is at field capacity, i.e.,  $\theta_0 = 90$  mm; after one week, the soil moisture will go down to  $\theta_1 = 90 + 12 - 30 = 72$  mm  $> 50$  mm. Similarly, at the end of the second week (without irrigation), the soil moisture becomes  $\theta_2 = 72 + 12 - 30 = 54$  mm, i.e., at the end of the second week, the soil moisture reaches the limiting threshold of 54 mm. Then, one may irrigate  $90 - 54 = 36$  mm every 2 weeks to comply with the operating policy.

#### Methods for Estimating Consumptive Use

There are several methods available for estimating consumptive use as a function of climatic factors such as temperature and radiation and type of vegetation (e.g., [71–73]). For example, the Blaney-Criddle empirical equation [74] gives the consumptive use as a function of temperature, the percentage of daytime hours, and a crop use coefficient. The consumptive use for a given month  $t$  can be determined by

$$u_t = (1/100)K_t T_t D_t, \quad (1.42)$$

where  $u_t$  = consumptive use for month  $t$  (inches),  $K_t$  = crop use coefficient for month  $t$ ,  $T_t$  = mean monthly air temperature °F, and  $D_t$  = % of the annual daytime hours occurring during month  $t$  (it varies with the latitude, the month, and the hemisphere). Table 1.1 provides values of  $D_t$  as a function of latitude and month of the year. Then, the total consumptive use  $U$  throughout the irrigation season is

$$U = \sum_{t=1}^N u_t = \sum_{t=1}^N K_t \frac{T_t D_t}{100}, \quad (1.43)$$

where  $N$  = number of months of the irrigation season. More generally available are crop coefficients for the whole irrigation season rather than monthly coefficients. Then, (1.43) can be written as

**Table 1.1**

**Monthly percentage of daytime hours  $D_t$  (relative to the year) for various latitudes of the north and south hemispheres (adapted from ref. 75)**

Latitude °north <sup>a</sup>	Jan.	Feb.	Mar.	Apr.	May	June	July	Aug.	Sept.	Oct.	Nov.	Dec.
0	8.49	7.67 (7.95 <sup>b</sup> )	8.49	8.22	8.49	8.22	8.49	8.49	8.22	8.49	8.22	8.49
10	8.15	7.48 (7.74 <sup>b</sup> )	8.46	8.37	8.80	8.61	8.84	8.71	8.25	8.34	7.92	8.09
20	7.75	7.25 (7.51 <sup>b</sup> )	8.40	8.52	9.15	9.03	9.24	8.96	8.28	8.15	7.59	7.66
30	7.32	7.03 (7.28 <sup>b</sup> )	8.37	8.70	9.55	9.48	9.67	9.21	8.34	8.00	7.20	7.16
40	6.76	6.72 (6.96 <sup>b</sup> )	8.31	8.94	10.01	10.08	10.23	9.55	8.40	7.75	6.72	6.54
50	5.98	6.33 (6.55 <sup>b</sup> )	8.25	9.24	10.70	10.92	11.01	9.98	8.46	7.44	6.09	5.64
60	4.71	5.68 (5.89 <sup>b</sup> )	8.12	9.69	11.78	12.42	12.31	10.70	8.55	6.94	5.01	4.15
Latitude °south <sup>a</sup>	Jan.	Feb.	Mar.	Apr.	May	June	July	Aug.	Sept.	Oct.	Nov.	Dec.
0	8.49	7.67 (7.95 <sup>b</sup> )	8.22	8.49	8.22	8.49	8.49	7.67	8.49	8.22	8.49	8.22
10	8.84	7.87 (8.15 <sup>b</sup> )	8.25	8.34	7.92	8.09	8.15	7.48	8.46	8.37	8.80	8.61
20	9.24	8.09 (8.38 <sup>b</sup> )	8.28	8.15	7.59	7.66	7.75	7.25	8.40	8.52	9.15	9.03
30	9.67	8.32 (8.61 <sup>b</sup> )	8.34	8.00	7.20	7.16	7.32	7.03	8.37	8.70	9.55	9.48
40	10.23	8.62 (8.93 <sup>b</sup> )	8.40	7.75	6.72	6.54	6.76	6.72	8.31	8.94	10.01	10.08
50	11.01	9.02 (9.34 <sup>b</sup> )	8.46	7.44	6.09	5.64	5.98	6.33	8.25	9.24	10.70	10.92
60	12.31	9.66 (10.01 <sup>b</sup> )	8.55	6.94	5.01	4.15	4.71	5.68	8.12	9.69	11.78	12.42

<sup>a</sup>Complete tables for finer resolution are available at “Irrigation Water Requirements,” Technical Release No. 21, USDA Soil Conservation Service, 1970.

<sup>b</sup>Values in parenthesis are for leap years.

$$U = K_s \sum_{t=1}^N \frac{T_t D_t}{100}, \quad (1.44)$$

where  $K_s$  = crop use coefficient for the irrigation season. Table 1.2 is a brief table that gives values of  $K_s$  for various crops.

We apply the Blaney-Criddle method to determine the total consumptive use and the net water required for an irrigation area located in eastern Colorado (with approximate latitude of 40°N). The irrigation area of 100 acres is planned where 20 % of the land will grow beans and 80 % potatoes. Consider the crop coefficients 0.65 and 0.70 for beans and potatoes, respectively, and the growing seasons June–August and May–September, respectively. The average monthly precipitation and temperature data for the referred months are shown in columns 2 and 3 of Table 1.3. We will apply (1.44) for each crop, and then, the total consumptive use for the 100-acre area in units of acre-ft can be determined by



**Table 1.2**

Values of  $K_s$  for various crops (data taken from "Irrigation Water Requirements", Tech. Release No. 21, USDA Soil Conservation Service, 1970)

Crop	Length of normal growing season	Consumptive use coefficient $K_s$
Alfalfa	Between frosts	0.80–0.90
Bananas	Full year	0.80–1.00
Beans	3 months	0.60–0.70
Corn	4 months	0.75–0.85
Potatoes	3–5 months	0.65–0.75
Sugar beets	6 months	0.65–0.75

**Table 1.3**

Computation of consumptive use for the example described in the text above

Month	Precip. (in)	Temp. (°F)	% daytime hours $D_t$	Crop coefficients		Consumptive use (in)	
				$K_s(b)$	$K_s(p)$	$U_t(b)$	$U_t(p)$
May	2.30	58.1	10.02		0.70		4.08
June	2.85	68.2	10.08	0.65	0.70	4.47	4.81
July	2.80	74.7	10.22	0.65	0.70	4.96	5.34
August	2.70	72.0	9.54	0.65	0.70	4.46	4.81
September	1.40	64.5	8.38		0.70		3.78
Total consumptive use for each crop						13.89	22.82

$$U = (1/12) \times 100 \times \left[ 0.2K_s(b) \sum_{t=1}^{N(b)} \frac{T_t D_t}{100} + 0.8K_s(p) \sum_{t=1}^{N(p)} \frac{T_t D_t}{100} \right],$$

where  $N(b)$  and  $N(p)$  are the number of months of the growing season for beans and potatoes, respectively, and  $K_s(b)$  and  $K_s(p)$  refer to the crop coefficients, respectively. The computations are carried out in Table 1.3. From the foregoing equation and the results of the table, we get: Consumptive use for the total area =  $(1/12) \times 100 (0.2 \times 13.89 + 0.8 \times 22.82) = 175.3$  acre-ft.

The Blaney-Criddle method has been quite popular in practice for several decades. It is still used because of its simplicity. However, Penman [66] and Monteith [67] laid the foundation for an energy-based method, which has been known in literature as the Penman–Monteith method. Perhaps the most recent manual on the subject published in the United States has been prepared by a task committee sponsored by the Environmental Water Resources Research Institute (EWRI) of the American Society of Civil Engineers (ASCE) [72]. The committee recommended a "standardized reference evapotranspiration equation" denoted as  $ET_{SZ}$  which may be applicable for a reference  $ET$  for a short crop (e.g., clipped grass with

about 0.12-m height) and a tall crop (e.g., full-cover alfalfa of about 0.50-m height). Thus, the recommended ASCE Penman–Monteith equation for daily short reference  $ET$  (mm/day) is [72]

$$ET_{SZ} = \frac{0.408\Delta(R_n - G) + 900\gamma u_2(e_s - e_a)(T + 273)^{-1}}{\Delta + \gamma(1 + 0.34u_2)}, \quad (1.45)$$

where  $\Delta$  = slope of the saturation vapor pressure-temperature curve ( $\text{kPa}/^\circ\text{C}$ ),  $R_n$  = net radiation at the crop surface ( $\text{MJ}/(\text{m}^2 \times \text{day})$ ),  $G$  = soil heat flux density at the soil surface ( $\text{MJ}/(\text{m}^2 \times \text{day})$ ),  $\gamma$  = psychrometric constant ( $\text{kPa}/^\circ\text{C}$ ),  $u_2$  = mean daily wind speed at 2-m height (m/s),  $e_s$  = saturation vapor pressure ( $\text{kPa}$ ) at 1.5–2.5-m height calculated as the average of the  $e_s$  obtained for maximum and minimum air temperature,  $e_a$  = mean actual vapor pressure at 1.5–2.5-m height ( $\text{kPa}$ ), and  $T$  = mean daily air temperature at 1.5–2.5-m height ( $^\circ\text{C}$ ). Note that the constants 900 (numerator) and 0.34 (denominator) must be changed to 1,600 and 0.38, respectively, for daily tall reference  $ET$ , and different sets of constants must be used for calculations of hourly  $ET$ . The referred manual [72] provides the needed equations for calculating the various terms in (1.45) along with explanatory appendices and examples. Equation (1.45) has been tested for 49 sites throughout the United States and found to be reliable.

Furthermore, the estimation of the crop evapotranspiration  $ET_c$  (i.e., consumptive use) requires an appropriate crop coefficient  $K_c$ , i.e.,  $ET_c = K_c ET_{SZ}$ , where  $K_c$  varies depending on whether  $ET_{SZ}$  is for short reference or long reference  $ET$ . Allen et al. [72] provides the various key references available in literature for determining the appropriate values of  $K_c$ . The crop coefficient varies with crop development stage and ranges from 0 to 1 (e.g., about 0.2 for young seedlings to 1.0 for crops at peak growing stage, although in some cases  $K_c$  may reach values greater than 1, depending on the crop and weather conditions). For illustration Table 1.4 gives values of  $K_c$  for commonly grown crops in the State of Colorado [76].

We include a hypothetical example, similar to the previous one, but with additional concepts and details. For this purpose, we consider a farm lot with a soil having field capacity equal to 30 % (in volume) and wilting point 10 %. The root zone depth is equal to 30 cm, the crop evapotranspiration  $ET_c$  (consumptive use) has been calculated as 30 mm/week, and the expected precipitation is 10 mm/week (for the sake of simplicity, we use weeks as the time frame; the calculations would be more realistic using a daily time step). It is also assumed that the actual evapotranspiration  $AET$  is equal to  $ET_c$  whenever the soil moisture is at field capacity or greater; otherwise the actual evapotranspiration decreases linearly from  $ET_c$  to zero at the wilting point (refer to Fig. 1.8). In addition, it is assumed that in the past several days, it has been raining so that at the time of planting the soil moisture is at field capacity (level). However, after planting supplementary irrigation may be needed to make up for the soil moisture deficit. Irrigation guidelines for the crop at the referred site suggest avoiding the soil moisture falling below 60 % of the field capacity level at any given time. The question is how much to irrigate and how often, to sustain the crop growth at the farm level.

**Table 1.4**

**Crop coefficients  $K_c$  for commonly grown crops for use with long reference  $ET$  (summarized from 76)**

Days from planting	Corn	Dry beans	Potatoes	Winter wheat	Sugar beets	Alfalfa	Pasture
10	0.25	0.30	0.21	0.33	0.20	0.43	0.33
20	0.27	0.44	0.33	0.52	0.21	0.82	0.56
30	0.29	0.71	0.50	0.74	0.27	1.00	0.79
40	0.41	1.00	0.70	0.89	0.33	1.00	0.79
50	0.58	1.00	0.81	1.00	0.38	1.00	0.79
60	0.73	1.00	0.94	1.00	0.50	0.33 <sup>a</sup>	0.79
70	0.86	1.00	0.95	1.00	0.60	0.77	
80	0.94	0.85	0.95	1.00	0.77	1.00	
90	1.00	0.73	0.95	0.85	0.92	1.00	
100	1.00	0.59	0.95	0.58	1.00	1.00	
110	0.96	0.45	0.95	0.35	1.00		
120	0.85		0.95	0.22	1.00		
130	0.69		0.95	0.22	1.00		
140	0.58		0.95	0.22	0.96		

<sup>a</sup>After cutting.

Summarizing, the following data are specified:  $\theta_{FC} = 30\%$ ,  $\theta_{WP} = 10\%$ ,  $y = 30$  cm,  $ET_c = 30$  mm/week,  $\theta_0 = \theta_{FC}$ , and  $\theta_t > 0.60 \theta_{FC}$  for any  $t$ . Then, for a soil depth of 300 mm, the field capacity (in mm) is equal to  $\theta_{FC} = 0.30 \times 300 = 90$  mm, the wilting point (in mm) is  $\theta_{WP} = 0.1 \times 300 = 30$  mm, the available water  $AW = 90 - 30 = 60$  mm, and  $\theta_t > 0.6 \times 90 = 54$  mm. In addition, from Fig. 1.8, the actual evapotranspiration can be determined as

$$\begin{aligned}
 AET_t &= \frac{ET_c}{\theta_{FC} - \theta_{WP}} (\theta_t - \theta_{WP}) & \text{for } \theta_{WP} \leq \theta_t < \theta_{FC} \\
 &= ET_c & \text{for } \theta_t \geq \theta_{FC}
 \end{aligned} \tag{1.46}$$

Since the initial soil moisture is  $\theta_0 = \theta_{FC} = 90$  mm, the actual evapotranspiration can be assumed to be equal to  $ET_c$  for the first week, i.e.,  $AET_1 = ET_c = 30$  mm, and assuming no irrigation in the first week, by the end of the week, the soil moisture depth becomes  $\theta_1 = \theta_0 + P - AET_1 = 90 + 10 - 30 = 70$  mm, which is bigger than 54 mm (the lower soil moisture limit specified). Then, from (1.46), the actual evapotranspiration for the second week becomes

$$AET_2 = \frac{ET_c}{\theta_{FC} - \theta_{WP}} (\theta_1 - \theta_{WP}) = \frac{30}{90 - 30} (70 - 30) = 20 \text{ mm}$$

**Table 1.5**  
**Calculations of actual evapotranspiration and soil moisture for the hypothetical example**

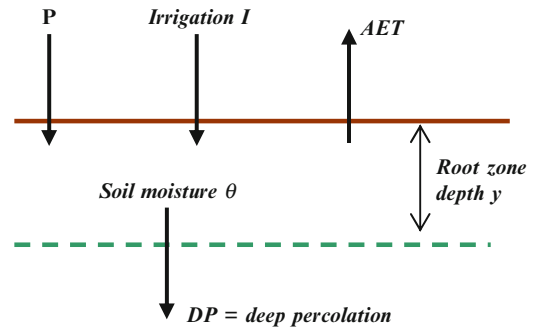
Time $t$ (weeks)	Precipitation $P_t$ (mm)	Actual evapotranspiration $AET_t$ (mm)	Irrigation $I_t$ (mm)	Soil moisture $\theta_t$ (mm)
0				90
1	10	30	0	70
2	10	20	0	60
3	10	15	0	55
4	10	12.50	10	62.5
5	10	16.25	0	56.25
6	10	13.13	10	63.12
7	10	16.60	0	56.50
8	10	13.30	10	63.20

Likewise, assuming no irrigation for the second week, the soil moisture by the end of the second week is  $\theta_2 = \theta_1 + P - AET_2 = 70 + 10 - 20 = 60 \text{ mm} > 54 \text{ mm}$ , and the actual evapotranspiration for the third week is  $AET_3 = 15 \text{ mm}$ . Further, if we continue the third week with no irrigation, the soil moisture by the end of the third week becomes  $\theta_3 = \theta_2 + P - AET_3 = 60 + 10 - 15 = 55 \text{ mm} > 54 \text{ mm}$ . If we let another week without irrigation, it may be shown that the soil moisture will fall below the threshold 54 mm; thus, it is apparent that we would need to irrigate in the following weeks. Table 1.5 gives the results of calculations following the procedure as shown above except that supplementary irrigation of 10 mm is considered every other week. Note that in the hypothetical example, we simply used the expected precipitation rate of 10 mm/week. In an actual situation, the weekly precipitation can be updated from measurements. The values in Table 1.5 suggests that irrigating more than 10 mm every other week will result in higher soil moisture levels and consequently higher values of  $AET$ . In fact, if we over-irrigate, it may cause the soil moisture to exceed the field capacity  $\theta_{FC}$  so that not only the  $AET$  will be at the maximum rate but also the excess water will percolate down to lower levels (in that case, the soil moisture balance must include the deep percolation term  $DP$  as shown in Fig. 1.9) and the irrigation water would not be used efficiently.

### 3.5. Runoff

*Runoff* is a term used to denote the excess water from precipitation that is available on the land surface after abstractions. Estimations of surface flows over a watershed are used for designing hydraulic structures such as bridges, spillways, dams, levees, storm sewers, culverts, and detention basins. They are also useful for flood management programs, especially for delineating flood plains. The influence of land use changes over time can also be represented in mathematical models of watershed runoff. Also runoff estimates are a

**Fig. 1.9.** Schematic depicting key variables influencing the soil moisture of the root zone.



prerequisite for computation of sediment transport and associated chemicals. There are numerous mechanisms of runoff generation that often occur in combination to produce streamflow.

*Hortonian overland flow* occurs from a catchment when rainfall exceeds the ability of the soil to infiltrate water and the excess water moves on the surface downslope. For Hortonian overland flow to occur, the rainfall intensity must be greater than the saturated hydraulic conductivity of the soil, and the duration of the rainfall event must be long enough to achieve surface saturation. Hortonian overland flow is prominent in (1) semiarid to arid regions where rainfalls tend to be intense and natural surface conductivities are low, (2) areas where surface conductivity has been reduced by compaction, and (3) impermeable areas. Horton's [47] view was modified by Betson [77], who proposed the partial-area concept according to which surface water may originate as Hortonian overland flow on a limited contributing area that varies from basin to basin.

In many forested catchments, rainfall intensity rarely exceeds the saturated conductivity of the surface soil, and *saturation-excess overland flow* develops because rain falls on temporarily or permanently saturated areas (wetlands) with no storage for water to infiltrate. Saturation overland flow is liable to be a dominant runoff mechanism in drainage basins with concave hillslope profiles and wide, flat valleys. When slowly moving subsurface water encounters saturated areas near the stream, some of the water reemerges onto the ground surface because the capacity of the soils to transmit all of the incoming water downslope is insufficient.

The areas of a catchment that are prone to saturation tend to be near the stream channels or where groundwater discharges to the surface. These areas grow in size during a storm and shrink during extended dry periods [65, 78, 79]. The areas on which saturation-excess overland flow develops expand and shrink during a storm in response to rainfall reflecting the overall wetness of the watershed. This mechanism of runoff generation is often referred to as the *variable source area concept* and was modeled by Govindaraju and Kavvas [80]. Variable source areas exert a very strong influence on the nature of the streamflow hydrograph for a storm event.

Most hydrologic models treat the overland flow process as fully turbulent, broad sheet flow, which may be satisfactory for computing runoff rates. However, overland flow can occur over

large parts of the landscape, and the depths and velocities of flow can be extremely variable. The microrelief of most natural soil surfaces is highly variable, resulting in nonuniform flow depths across the surface. The flow concentration is sometimes called *rills*, and the areas between rills are called interrill areas. The degree that flow concentrations occur on a surface depends on soil cover, tillage, natural roughness, and soil erodibility.

Further, the interaction of overland flow with infiltration is strongly modulated by spatial heterogeneity of soil hydraulic properties. Specifically, water running downstream may infiltrate into regions characterized by moisture deficit leading to the *runon* process that, in principle, should be represented through a coupled solution of overland flow and infiltration equations. The assumption of spatially uniform infiltration and rainfall excess is an important limitation in most current modeling approaches of surface flows over natural surfaces. Runon has been incorporated in analyzing infiltration and Hortonian surface runoff (e.g., [81–85]). Morbidelli et al. [85] presented a simple methodology that allows for an explicit representation of the runon process at the watershed scale.

Water that has infiltrated the soil surface and is impeded from downward movement due to stratification (abrupt or gradual) tends to move laterally in shallow soil horizons as subsurface storm flow or *interflow*. While this subsurface water generally moves slowly to the stream and contributes to baseflow, it may be energized by the presence of preferential flow pathways (e.g., soil cracks, old animal burrows, decayed root channels) leading to quickflow response in the stream. The response of interflow to rainfall events would be sluggish if it is not aided by the presence of *macropores* where Darcian flow through the soil matrix is largely short-circuited by water moving in conduits. Macropores are typically on the order of 3–100 mm in diameter and are interconnected to varying degrees; thus, they can allow water to bypass the soil matrix and move rapidly at speeds much greater than those predicted by Darcy's law. Stillman et al. [86] show that the effective conductivity of soils increased by several orders of magnitudes in the presence of macropores. The combination of macropores and tile drains was shown to generate Hortonian-like streamflow responses even when no surface flow was observed. It is generally difficult to assess the importance of macropores or to simulate their effects in catchment-scale models because their number, orientation, size, and interconnectedness are highly site-specific and macroscopic properties have to be obtained through calibration.

In general, groundwater flow results in the longest travel time (days, weeks, to years) for the water that fell on the soil surface to eventually reach the stream. Streamflows during the dry periods are comprised almost entirely of groundwater discharge or *baseflow*. Consequently, baseflow tends to vary slowly and over long time periods in response to changing inputs of water through net recharge. The unsaturated portion of the soil holds water at negative gauge pressures (i.e., water pressure is less than atmospheric pressure). The hydraulic resistance offered by the unsaturated soil is high, resulting in low flux rates (see Sect. 4.1). Flow through the unsaturated zone is one of the primary mechanisms of replenishing the aquifer through recharge. In special cases, unsaturated flow may contribute to baseflow in a stream [87].

## 4. SOIL MOISTURE HYDROLOGY

“Soils sustain life” [88]. Many factors are embedded in that statement. From the hydrologic perspective, the key is *soil moisture* (soil water), and the mechanism for storing soil water is capillarity. More fundamentally the answer to how soils sustain life is the surface tension of water. Soil moisture is commonly considered the water in the root zone that enables the interaction with atmospheric processes such as precipitation and air temperature; it recycles water back to the atmosphere through evapotranspiration and serves as the medium for infiltration and subsurface recharge.

### 4.1. Basic Concepts and Definitions

Some key concepts related to soil water are:

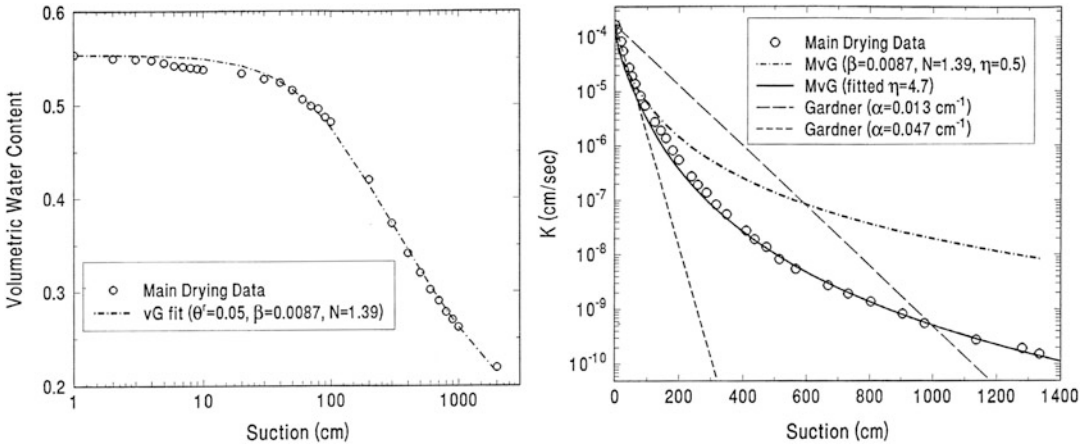
- Weak intermolecular attractions called *van der Waals forces* hold water together.  
Intermolecular forces are feeble; but without them, life as we know it would be impossible. Water would not condense from vapor into solid or liquid forms if its molecules didn't attract each other. [89]
- *Surface tension* is a force per unit area acting at air-water interfaces, because water molecules are attracted to themselves rather than to air. Where the air-water interface contacts a solid (i.e., soil particle), a contact angle forms to balance forces on the liquid water at the contact, which allows the curvature of an air-water interface to balance *capillary forces*. In this way, surface tension combines with the geometry of solids, or porous media, to cause *capillarity*.
- Capillarity holds water in small pores, while allowing pressure continuity and drainage of water from larger pores at a given water pressure or *matric potential*. Soil water can be retained or stored in the near-surface soils for extraction by plants at matric potentials up to a wilting point of approximately 15 bars or 15 atmospheres of negative pressure.

Water is stored in the near surface primarily due to capillary forces that counteract gravity. As soils drain and dewater, smaller pores hold the remaining water, and the resulting *hydraulic conductivity* decreases rapidly. Mualem [90] quantified the unsaturated hydraulic conductivity  $K$  using the concept of a bundle of capillary tubes with a distribution of diameters representing the pore throats in real porous media. As a result,  $K$  of a soil having complex geometry has been quantified using the relatively simple equation:

$$K_r(S_e) = \sqrt{S_e} \left[ \frac{\int_0^{S_e} \psi^{-1} dS_e}{\int_0^1 \psi^{-1} dS_e} \right]^2, \quad (1.47)$$

where  $K_r = K/K_s$ ,  $K_s$  is  $K$  at saturation with water [ $\text{m s}^{-1}$ ],  $\psi$  is matric potential [ $\text{m}$ ], and  $S_e$  is *effective saturation*:

$$S_e = \frac{\theta - \theta_r}{\theta - \theta_s}, \quad (1.48)$$



**Fig. 1.10.** Soil hydraulic property data [94] for left (water retention characteristic for Ida silt loam with the fit to (1.49)) and right (hydraulic conductivity as a function of matric suction (1,000 cm = 10 bar)) with model fits combining (1.49) and (1.50). Possible extreme fits using the exponential (log-linear) equation of Gardner [92] are shown for comparison (original figures taken from [95]). Notation: vG = van Genuchten's equation (1.49); MvG = Mualem-van Genuchten's equation (1.50); Gardner = Gardner's exponential model.

in which  $\theta$  is volumetric water content [ $\text{m}^3 \text{m}^{-3}$ ] with subscripts  $r$  and  $s$  denoting residual and saturated values. Mualem [90] derived (1.47) by assuming that an incremental change in soil water content is related to a *pore water distribution function* of the pore radii together with the *capillary law*, in which  $\psi$  is inversely proportional to the pore radius. Subsequently, van Genuchten [91] proposed the now commonly used analytical equation for *water retention*:

$$S_e(\psi) = [1 + (\psi/\psi_c)^\alpha]^{-\beta}, \quad (1.49)$$

where  $\alpha$ ,  $\beta$ , and  $\psi_c$  [m] are fitting parameters. Combining (1.49) with Mualem's model of (1.47) yields the predicted  $K_r(S_e)$  as

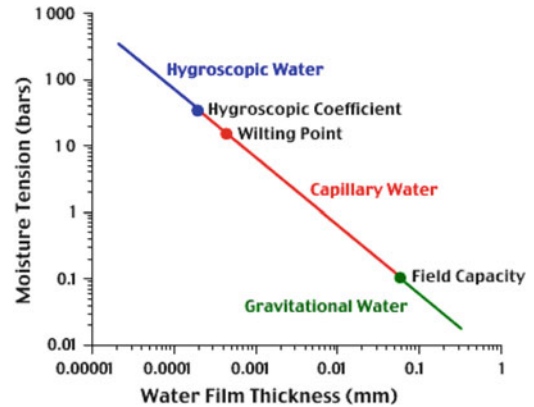
$$K(S_e) = S_e^\eta \left[ 1 - \left( 1 - S_e^{1/\beta} \right)^\beta \right]^2. \quad (1.50)$$

The parameter  $\beta$  comes from the fitted water retention curve of (1.49). Mualem [90] explored a range of  $\eta$  values ( $-1.0$  to  $2.5$ ) over a large data set (45 soils) and found that an average value of approximately  $\eta = 0.5$  was optimal.

How well do these (1.49) and (1.50) fit measured soil characteristics? Many studies have reported water retention (storage) data relevant to (1.49), but flux data relevant to estimating hydraulic conductivity (1.50) are rarely measured. A high-quality data set for a silt loam soil is shown in Fig. 1.10. The van Genuchten (vG) equation (1.49) fits the water retention data well over the range of measured soil water contents (left in Fig. 1.10). However, the default (predictive) Mualem-van Genuchten (MvG) equation (1.50) with  $\eta = 0.5$  overestimated



**Fig. 1.11.** Conceptual soil water retention modes (from [96]).



measured values of  $K$  at high values of soil water suction (right in Fig. 1.10). By fitting the  $\eta$  value ( $\eta = 4.7$ ), the fitted  $K$  is excellent over 6 orders of magnitude. Note that this value of the saturation exponent is greater than the upper limit explored by Mualem [90]. Figure 1.10 (right) also illustrates how poorly the Gardner (1958) equation fits the  $K$  data due to its exponential structure, and the fit cannot be improved further by parameter adjustment. Gardner's equation is commonly used for its quasi-linear mathematical convenience, but this example offers caution. More recently, Rucker et al. [93] presented a method for improved parameter equivalence between MvG and Gardner equations, given the utility of Gardner's exponential form.

This example soil (Ida silt loam is not an extreme example) allows us to illustrate some possible time scales associated with soil hydraulic properties at different moisture states. Six orders of magnitude in  $K$  from saturation ( $\theta = 0.55 \text{ m}^3 \text{ m}^{-3}$ ) to the assumed wilting point of plants (15 bar or approximately  $\theta = 0.20 \text{ m}^3 \text{ m}^{-3}$ ) are indicative of the potential range of temporal responses in soils (assuming a unit vertical gradient or *gravity drainage*). For example, 1 year =  $365 \times 86,400 \text{ s} = 31.5 \times 10^6 \text{ s}$ , such that the same amount of water draining in about half a minute at saturation would take a full year at 15 bar.

Perhaps as impressive a contrast is the change in  $K$  going from saturation to 100 cm of suction. In this example, very little water is drained ( $\Delta\theta \sim 0.05 \text{ m}^3 \text{ m}^{-3}$ ), but  $K$  decreases by a factor of approximately 20. At  $\theta \sim 0.5 \text{ m}^3 \text{ m}^{-3}$ ,  $K = 10^{-5} \text{ cm s}^{-1}$ , or less than  $9 \text{ mm day}^{-1}$ , water is being stored in the root zone for plant extraction at a maximum daily rate similar to the drainage rate. Subsequently, as the soil drains and dries further, root water uptake is the dominant sink.

Intermolecular forces in a soil water system may be depicted as shown in Fig. 1.11 [96], where *moisture tension* or *matric suction* is shown (in a log-log scale) to be a power function of water film thickness in soil. Here water film thickness is defined as a representative length of the water-solid interface to the air-water interface. *Hygroscopic water* is in very close proximity with the solid surface (within approximately  $0.2 \mu\text{m}$ ) and is considered immobile under subsurface environmental conditions. *Field capacity* is a commonly used term (see Sect. 3.4), but not well defined. Soils do drain under gravitational force (unit vertical gradient)

at rates determined by  $K(\psi)$ , such that *capillary water* drains at different rates. However, the drastically reduced rates of drainage (Fig. 1.10 right) allow soil water to be stored over a range of time scales (minutes to years).

#### 4.2. Soil Moisture Recycling

In addition to soils storing water for plant growth, water evaporated from soils and transpired by plants is recirculated into the atmosphere, thus promoting a positive feedback mechanism for precipitation. The importance of this feedback seems to depend on the scale of interest. At the global scale, circulation of water between the land, atmosphere, and ocean is obviously important. Simulation of such circulation patterns is the basis for projecting future climates in general circulation models (GCMs). Moving down in scale to individual continents, basins, and regional watersheds, the coupling of land-atmosphere interactions may become looser. For this reason, hydrologic models are typically run “off-line” (not coupled with an atmospheric model to capture these land-atmosphere feedbacks) and driven by measured precipitation without considering feedbacks. However, regional-scale feedback has been shown to account for a “weakly dependent” pattern of annual rainfall via “precipitation recycling” in central Sudan [97], the Amazon Basin [98], and other regions of the world (e.g., [99]). At linear scales of  $<300$  km (i.e., watershed areas  $<90,000$  km<sup>2</sup>), however, the recycling ratio (P/ET) of a watershed is expected to be less than 10 % based on simple scaling of annual precipitation in the Amazon Basin [100]. More recently, Koster et al. [101] described the Global Land–Atmosphere Coupling Experiment (GLACE) as a model intercomparison study addressing the effects of soil moisture anomalies that affect precipitation at the GCM grid cell resolution over the globe. The simulated strength of coupling between soil moisture and precipitation varied widely, but the ensemble multi-GCM results provided “hot spots” of relatively strong coupling based on a precipitation similarity metric. Koster et al. [101] discussed differences between their approach and the methods of estimating “recycling” above, but all studies indicate that the land’s effect on rainfall is relatively small, though significant in places, relative to other atmospheric processes.

#### 4.3. Variability of Soil Moisture

Soil moisture varies spatially (laterally and vertically) and temporally with characteristic periodicities (from infiltration events to diurnal, seasonal, annual cycles) and longer-term variability related to climatic variability (e.g., ENSO, PDO, and AMO) and projected climate change. As noted in Sect. 4.1, soil moisture response times are controlled primarily by moisture-dependent soil hydraulic properties. Generally, soils in humid climates respond much faster to a unit of infiltrated water than similar soils in more arid climates. This highlights an interaction between climate and soil physical characteristics (related to soil texture and structure). Delworth and Manabe [102] found global patterns of soil moisture in simulations, where the surface energy balance controlled soil moisture interactions with the atmosphere. The partitioning of sensible and latent (evaporative) heat fluxes were influenced strongly by soil moisture. This caused longer response times in soil moisture at high latitudes

(moving from the equator to the poles) associated with lower potential evaporation. Therefore, depending upon the scale of interest, one may need to consider coupled land (soil and vegetation)-atmosphere interactions to assess the spatial and temporal variability of soil moisture.

Profile soil moisture dynamics can also vary spatially by hillslope position in semiarid (e.g., [103]) and more humid environments [104, 105].

Spatial variability of soil moisture may be related to short-term hydrologic processes, land management, and weather patterns and to long-term soil development and terrain attributes. Spatial soil moisture has been correlated with terrain attributes, such as surface slope, aspect, curvature, potential upslope contributing area, and attributes derived from these quantities. The processes causing these correlations usually are not identified rigorously, but the inferred factors include short-term hydrometeorological fluxes and long-term pedologic and geomorphic processes.

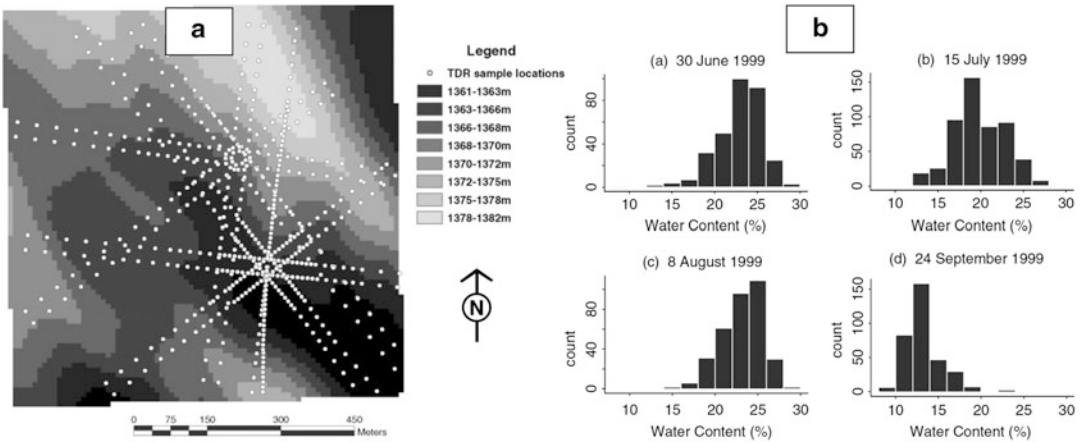
Zaslavsky and Sinai [106] related near-surface (0–0.4 m) soil moisture variation to topographic curvature (Laplacian of elevation) in Israel, citing processes of unsaturated lateral subsurface flow and raindrop splash affected by local surface curvature. Slope-oriented soil layering and the associated state-dependent anisotropy [107, 108], as well as lateral flow caused by transient wetting and drying [109], likely caused the observed soil moisture variability.

In a more humid environment in Australia [110], soil moisture variability has been related to topographic attributes, including  $\ln(a)$ , where  $a$  is the specific contributing area or a potential solar radiation index (PSRI) as a function of topographic slope, aspect, and solar inclination (latitude). More recently, data from Australia and other sites have been reanalyzed using empirical orthogonal functions (EOF's) for space-time interpolation of soil moisture [111], and the EOF parameters were correlated with the mean soil moisture state and topographic attributes [112, 113]. In this way, spatially explicit patterns of soil moisture are estimated rather than relating a lumped statistical distribution of soil moisture to the spatial mean, as previously inferred using the variable infiltration capacity (VIC) model [114].

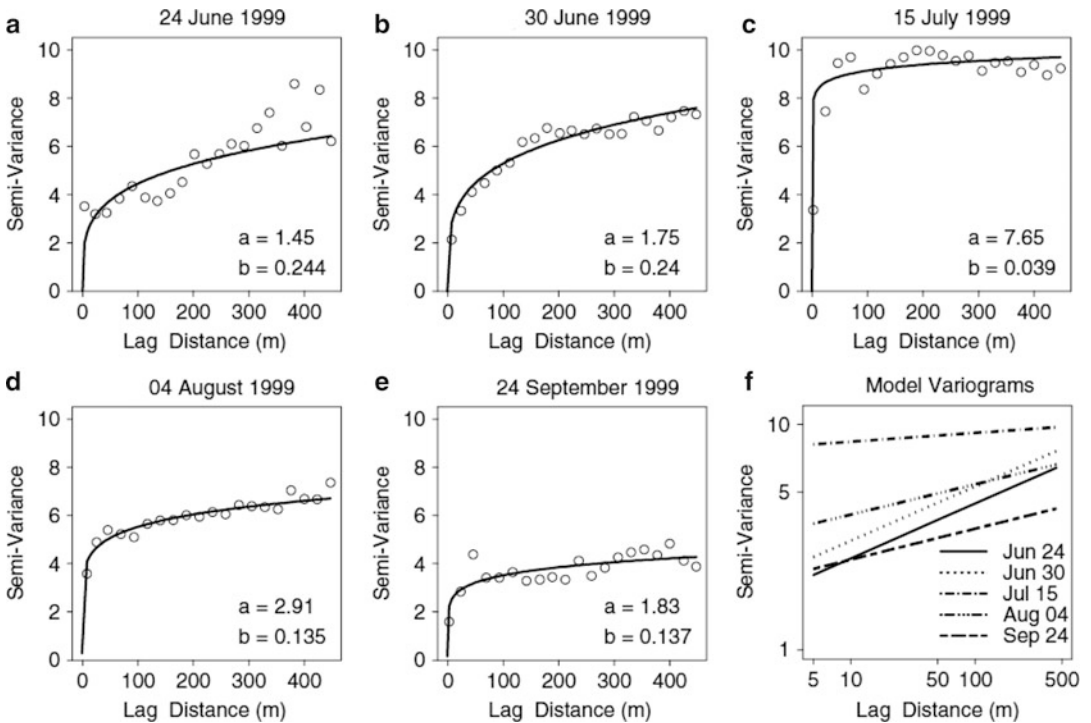
#### 4.4. *Scaling of Soil Moisture*

The variance of soil moisture within an area typically increases with the size or spatial extent of the area [115]. Green and Erskine [116] and Green et al. [117] conducted field-scale experiments to measure spatial attributes of soil moisture, soil hydraulic properties (water infiltration capacity), crop yield, and landscape topography for spatial scaling and modeling in rain-fed agricultural terrain. The spatial sampling design for soil water (Fig. 1.12a) provided a range of sample spacings, and these samples were used to estimate the lumped statistical distribution of water content for each sample date illustrated with histograms (Fig. 1.12b).

Fractal geometry was found to characterize the spatial autocorrelation structure of these spatial variables. “Simple” or monofractal geometry was inferred for soil moisture using power-law semi-variograms (Fig. 1.13a–e). The fitted power-law models plot as straight lines on a log-log scale (Fig. 1.13f), which shows the temporal variability of the spatial structure.



**Fig. 1.12.** (a) Spatial sampling pattern, using a time domain reflectometry (TDR) sensor to measure soil moisture in the top 0.3 m of soil and (b) soil moisture histograms of spatial measurements at 4 sampling dates (from [116]).



**Fig. 1.13.** Soil moisture experimental semi-variograms and power-law model fits used to estimate fractal geometry at different sampling dates. Model parameters  $a$  and  $b$  shown in (a)–(e) are the power-law multiplier and exponent, respectively, where  $b$  is related to the Hurst exponent or fractal dimension [116].

Steeper lines in June and their associated higher values of the model exponent correspond to greater spatial organization, which yields a higher Hurst exponent and lower fractal dimension [116].

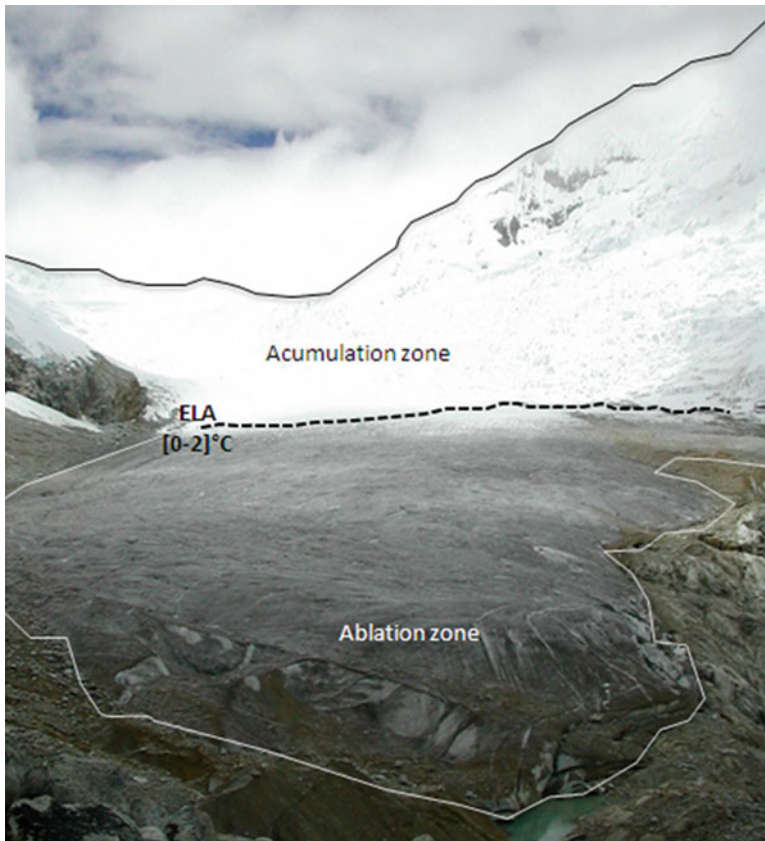
In a different agricultural field in Colorado, Green et al. [117] estimated steady infiltration rates from single-ring infiltrometer measurements at 150 nested sample locations spanning 10 hillslope positions (30-m by 30-m sites). Fractal behavior was analyzed using fractional moment analysis and power-law variogram fits to estimate the multifractal exponent or the monofractal Hurst exponent  $H$  as a function of the maximum lag distance  $h_{\max}$ . The spatial values of infiltration displayed persistence ( $H > 0.5$ ) up to a maximum  $H = 0.9$  at approximately 200 m, followed by a decline in  $H$  down to a value of  $H = 0.14$  for  $h_{\max} = 600$  m.

Because such “pre-asymptotic” behavior [118] in infiltration fractal behavior and persistence may be due to the sparseness of the measurements between landscape positions, terrain attributes computed from a 5-m grid DEM were used as surrogate spatial data. Terrain attributes (slope and contributing area) displayed similar variations in fractal behavior using the dense terrain data. Spatial persistence was identified at hillslope scales (approximately 200 m) with much lower values of  $H$  at smaller and larger scales. Green et al. [117] surmised that hillslope-scale processes affecting soil erosion, deposition, and development may account for the deviations from pure fractal behavior. Based on previous numerical simulations [119], areal infiltration capacity decreases with increasing values of  $H$ , for a given variance in saturated hydraulic conductivity. If  $H$  changes with the scale of analysis, as indicated here, pre-asymptotic persistence of infiltration rates at hillslope scales may be larger than expected at field to watershed scales.

Advances in hydrologic simulation and spatial quantification for precision agriculture and conservation require prediction of landscape-related variability and the transfer of information across spatial scales. The studies referenced here provided insights and methods for scaling infiltration, soil water content, and crop yield related to landscape topography.

## 5. HYDROLOGY OF GLACIERS

The *cryosphere* is an important component of the hydroclimate system, and the melt of snow and ice plays a vital role in the hydrologic cycle of river basins [120]. In recent decades, there has been a major concern of water resources specialists and policy makers regarding the accelerated decline of glaciers worldwide. It has been argued that such decline has been occurring due to global warming resulting from a number of factors such as the effects of increasing atmospheric concentration of  $\text{CO}_2$  and other greenhouse gases, the effect of land use changes, and other human activities. Regardless the loss of glacier cover may have a significant impact on the availability of water resources in various parts of the world, such as the Andean and Himalayan regions. For example, it has been estimated that glacier decline may have a significant impact on hydropower production in the Peruvian Andes Mountains [121]. This section describes briefly the methods commonly available for estimating ice melt/snowmelt. A more detailed discussion on the subject can be found in Singh et al. [122] and the references cited below.



**Fig. 1.14.** Andean Glacier where it can be seen as the accumulation and ablation zones separated by the glacier equilibrium line ELA (*line of segments*) (personal communication from Bernard Pouyaud).

### 5.1. Basic Concepts and Definitions

A glacier is a body of solid water in a perennial state that gains mass through solid precipitation (primarily snow) and loses it by melting and sublimation of ice. The relationship between the gain and loss of mass of water is known as *glacier mass balance*. The area where the accumulation of mass occurs is called the *accumulation zone* and is located at the top of the glacier, where, by the action of gravity, it moves downward towards the lower parts of the glacier. A glacier behaves as a viscoplastic body that becomes deformed because of its own weight [123]. Generally the solid precipitation (snow) that is subject to temperature below  $0\text{ }^{\circ}\text{C}$  is transformed into ice. In addition, the albedo is generally above 0.6 which avoids the exchange of energy with the surface of the glacier. At the lower part of the glacier, there is the *ablation zone* where the process of fusion takes place with more intensity and snow and ice are melted (Fig. 1.14). This mainly occurs on the surface, in part because of the temperature (above  $0\text{ }^{\circ}\text{C}$ ) and liquid precipitation that allows the albedo to be below 0.4. The ablation and the accumulation zones are separated by an imaginary line known as glacier equilibrium line

(ELA) where the glacier mass balance is zero (no gain or loss of mass) and is usually found close to the isotherm 0 °C. A related term is the line (elevation) of the *annual end-of-the summer snowline* (EOSS) which sometimes is used as a surrogate for glacier mass balance values [124]. The dynamics in the accumulation and ablation zones is mainly controlled by the energy balance and the topography of the area where the glacier is located.

The study of glaciers has a broad interest, ranging from paleoclimatology (isotopic dating of ice cores, reconstitution of moraines, etc.) to future scenarios of the evolution of the glacier coverage as time evolves. From a hydrologic perspective, the most relevant processes are the ice melting and the ensuing contribution of glacier meltwater to river discharge. The dynamics of glaciers are complex because of the physical processes involved, the topographic conditions, the geographical area where it is located, and the climatic conditions of the area. A simple conceptualization assumes that a glacier consists of a system of three components: snow, firn, and ice.

## 5.2. Glacial and Snow Fusion Methods

The processes of ice melt and snowmelt are driven by different factors such as energy exchange, albedo, temperature, slope, shading, and orientation. A number of methods have been proposed in literature for estimating the amount of ice melt and snowmelt (e.g., [125–127]). The methods are based on one or more of the several processes and variables involved. The modeling of ice and snow fusion in the midlatitude areas is similar as in the tropical regions, except for the difference of seasonal climatic conditions. Currently there are two types of methods used for estimating the glacial melting and snowmelting: the temperature-index (often called degree-day) method and the energy balance method. Also hybrid methods have been suggested. The details and experience of the various methods have been reviewed by Hock [126, 127].

### 5.2.1. Temperature-Index Methods

The temperature-index methods are based on conceptual models that are formulated as lumped (global) or semi-distributed levels. They are generally based on empirical relationships between the ice melt/snowmelt and the air temperature. This is because of the strong correlation that exists between these two variables. For example, Braithwaite and Olesen [128] found a correlation of 0.96 between annual ice melt and positive air temperature. Despite that several other factors besides air temperature influence the ice melt/snowmelt rate, the main reason why temperature-index-based models generally give quite satisfactory estimates of ice melt/snowmelt is because of the significant relationship between some of the key physical factors involved with temperature. For example, long-wave radiation and sensible heat flux generally are the largest source of heat for the melting of ice and snow. And both heat fluxes are strongly affected by air temperature (Ohmura [120]). A detailed review of the physical basis and the various factors involved in temperature-based models, their usefulness, limitations, and experience can be found in Ohmura [120] and Hock [126].

Hock [126] gave four reasons why temperature-index models have been popular in practice. They are summarized as follows: (1) wide availability of air temperature data,

**Table 1.6**  
**Values of DDF for snow and ice for different parts of the world (summarized from 126)**

Location	DDF snow	DDF ice	Latitude	Altitude (m.a.s.l.)	Period
Qamanarssup sermia	2.8	7.3	64° 28' N	370–1,410	1979–1987
Former European USSR	5.5	7.0		1,800–3,700	
Satujökull (Iceland)	5.6	7.7	65° N	800–1,800	1987–1992
Dokriani Glacier	5.9		31° 45'N	4,000	4–6 Jun 1995
Glacier AX010	7.3	8.1	27° 45'N	4,956	Jun–Aug 1978
Khumbu glacier		16.9	28° 00'N	5,350	21 May–1 Jun 1999
Rakhiot Glacier		6.6	35° 22'N	3,350	18 Jul–6 Aug 1986
Yala Glacier		9.3	28° 14'N	5,120	1 Jun–31 July 1996
Kronprins Christian land		9.8	79° 54'N	380	8 Jul–27 Jul 1999
Morenoglacier Argentina		7.1	50° 28'N	330	12 Nov 1993–1 Mar 1994

(2) simple interpolation and forecasting possibilities of air temperature, (3) generally good performance, and (4) ease of use. The temperature-index models can be used at different time scales such as daily, weekly, and monthly. The temperature data are easily available either from measurements or indirectly from reanalysis. Its wide application includes the prediction of ice melting/snowmelting for flow forecasts operations, modeling of glacier mass balance, and the evaluation of the snow and ice response applied to climate change predictions (e.g., [129, 130]).

The classical model for the ice melt and snowmelt for a given day may be expressed as

$$\begin{aligned}
 M_t &= \text{DDF} \times T_t, & T_t > 0 \\
 &= 0, & T_t \leq 0,
 \end{aligned}
 \tag{1.51}$$

where  $M_t$  = ice melt or snowmelt during a given day (mm/day),  $T_t$  = mean daily temperature ( $^{\circ}\text{C}$ ), and DDF = degree-day factor (mm/(day  $\times$   $^{\circ}\text{K}$ )). Naturally in order to calculate the total melt  $M$  during a given number of days  $n$  (e.g.,  $n = 30$  days), one will have to integrate the daily values so that  $M = \sum_1^n M_t$ .

The values of DDF may be determined by direct comparison using snow lysimeters or ablation stakes or from the melting estimated by the energy balance method (e.g., [131–133]). Field work investigations have shown that the term DDF exhibits significant temporal and spatial variability and it generally varies depending on the season, location, orientation of mountain slopes, humidity, wind, and other environmental factors. Hock [126] provides a table of average values of DDF for snow and ice (Table 1.6 above is a brief summary). Table 1.6 shows that the values of DDF for snow are lower than those for ice, which is mainly because of the higher albedo of snow compared to the albedo for ice.



### 5.2.2. Energy Balance Method

The energy balance is a physically based method where all sources of energy of the underlying system (e.g.,  $1 \text{ m}^2$  on the surface of a glacier) are considered and the excess of energy is assumed to be used for ice melt/snowmelt. It is mostly used for estimating melt for short time steps (e.g., daily or hourly) although it can be used for longer periods. The energy balance method analyzes the exchange of energy produced between the surface of the glacier and the air.

The energy balance equation may be written as [127]

$$Q_N + Q_H + Q_L + Q_G + Q_R + Q_M = 0, \quad (1.52)$$

where  $Q_N$  is the net radiation flux,  $Q_H$  is the sensible heat flux,  $Q_L$  is the latent heat flux,  $Q_G$  is the ground heat flux,  $Q_R$  is the heat flux brought by rainfall, and  $Q_M$  is the energy consumed by the ice melt/snowmelt (the units of all energy fluxes may be  $\text{W/m}^2$ ). Then the ice melt/snowmelt rates may be determined by

$$M = \frac{Q_M}{\rho_w L_f}, \quad (1.53)$$

where  $\rho_w$  is the density of water and  $L_f$  is the latent heat of fusion. Therefore, the energy balance method for estimating the melt rate  $M$  requires measuring all the heat fluxes involved in (1.52), i.e.,  $Q_N$ ,  $Q_H$ ,  $Q_L$ ,  $Q_G$ , and  $Q_R$ . However, this task is generally costly since it requires many especial equipment and instruments. Thus, alternative methods have been developed for estimating the various terms involved based on standard meteorological observations [127].

Energy balance models may be applied at a site (location of the equipment) or for an area (e.g., a square grid). Examples of energy balance studies at a site can be found in Table 2 of Hock [127]. For instance, Hay and Fitzharris [134] for the Ivory Glacier (1,500 m) in New Zealand gave the following estimates:  $Q_N = 76$ ,  $Q_H = 44$ ,  $Q_L = 23$ , and  $Q_R = 4$  ( $\text{W/m}^2$ ), which correspond to 52 %, 30 %, 16 %, and 2 %, respectively, of the total energy flux available for melt, i.e.,  $Q_M = 147 \text{ W/m}^2$  (these estimates were made for a period of 53 days during the summer). As expected, the relative contributions of the various components of the energy balance equation vary with the weather conditions so that they change during the melt season. Also the direct comparisons of the various estimates reported by different studies are restricted by the different uncertainties arising from the instruments and methods utilized. In addition, energy balance studies at spatial distributed scales are lacking; thus, a challenge for distributed studies is the extrapolation of input data and energy balance components for the entire grid [127].

### 5.2.3. Remarks

The temperature-index-based methods are much simpler to use than the energy balance methods. For this reason, the former methods have found wide acceptance in practice for a variety of problems such as flow forecasting (e.g., [135]) and assessment of basin response to potential climate change [136]. For basin studies requiring melt estimations at the monthly,

weekly, and daily time scales, simple temperature-index-based methods may be sufficient, but for smaller temporal scale (e.g., hourly) and spatial scale (e.g., small basins), more refined energy-based methods may be desirable.

In addition, over the years, there have been a number of studies oriented to improving the temperature-index-based methods by incorporating a radiation term in the equations (e.g., [131, 137, 138]) and adding other variables such as wind speed and vapor pressure (e.g., [139]). Likewise, the temperature-index-based and energy balance-based methods have been applied for the same basin but for different time periods, i.e., the temperature-index-based method for the dry periods and a simplified energy balance method during wet periods [140]. Also, software such as SRM has been developed and applied for a wide range of studies for estimating snowmelt and glacier melt worldwide [141].

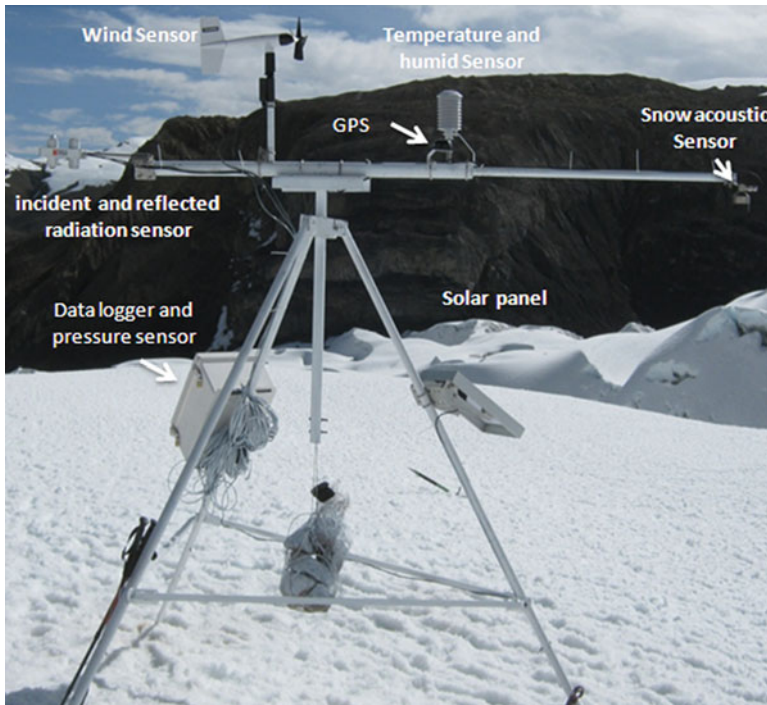
Furthermore, in some cases, estimations of glacier melt contributions to streamflows have been made using water balance equations for the basin where a glacier drains. For example, this method has been applied [142] to estimate that a significant amount (at least one-third) of annual streamflows of the Santa River in Peru arises from the melt of glaciers located at the Cordillera Blanca (Andes Mountains). Also a simple energy balance model with remotely sensed data of short-wave and long-wave radiations, DEM obtained from the Global Land One-Kilometer Base Elevation (GLOBE) and glacier areas derived from the Global Land Ice Measurements from Space (GLIMS) database have been utilized for estimating glacier contribution to streamflows worldwide [143].

### 5.3. Glacier Equipment

The energy balance method briefly summarized in Sect. 5.2.2 above requires specialized equipment and instrumentation to measure and estimate the various variables involved. The equipment installed at a selected site includes a number of sensors to measure the incident and diffuse solar radiation, both short- and long-wave radiation, air temperature at the glacier area, humidity, and speed and direction of the wind. In the case of applying the “temperature-index” methods, the equipment is simpler where the most important sensor is for air temperature at the glacial area. In both cases, it is important measuring precipitation data (at least of liquid precipitation) at the glacial area. Figure 1.15 shows a station located in the tropical Andes Mountains at 5,180 m.a.s.l in Peru. This station has sensors for radiation, speed and direction of the wind, temperature, pressure, humidity, an echo sounding (to measure variations of snow height), and a gyroscope system that keeps the radiation sensors in a vertical position on the ice surface.

## 6. WATERSHED AND RIVER BASIN MODELING

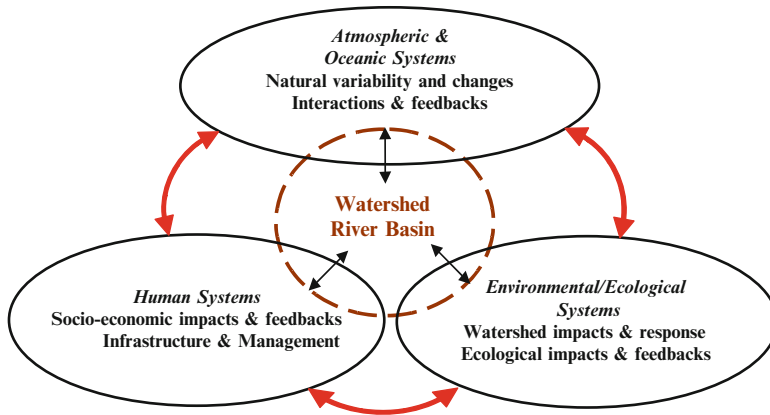
We have seen in previous sections a number of fundamental processes related to the hydrologic cycle, such as precipitation, interception, depression storage, infiltration, evaporation, soil moisture, and glacier melt/snowmelt. The main purpose of this section is to bring together many of the underlying concepts and mathematical formulations of the referred



**Fig. 1.15.** Climate station located at a tropical glacier in Peru.

processes for finding the relationships of precipitation and streamflow at various time scales, such as hours, days, weeks, seasons, and years. We will refer here to some of the foregoing concepts, mathematical formulations, and models to describe and interrelate the underlying physical processes so that one can estimate, for example, what fraction of the precipitation that falls on the basin is transformed into streamflow at the outlet of the basin. We will start by reviewing some needed concepts and then proceed with discussing some key features of such as concepts and definitions, types of models, temporal and spatial scales, model building and formulation, model calibration, and a brief example.

Hydrologic modeling of watersheds and river basins has a long history since the simple rational method for relating precipitation and runoff was established in the nineteenth century [144]. Thus, in about 160 years, a number of scientific and technological developments have occurred, which has led to a variety of models with various degrees of sophistication. Nowadays watershed models are increasingly adopted in the decision-making process to address a wide range of water resources and environmental issues. Models can represent the dynamic relationship between natural and human systems (Fig. 1.16) and have been applied to describe not only the transport of water and sediment but sources, fate, and transport of contaminants in watersheds and river basins. They can also help evaluate the response of fluxes of water, sediment, chemicals, and contaminants to the changing climate and land use. Efficient management of water and environmental systems requires integration of hydrologic, physical, geological, and biogeochemical processes. This has led to the



**Fig. 1.16.** Watershed and River Basin systems where processes interact with atmospheric and oceanic systems, environmental and ecological systems, and human systems.

development of complex models that can simulate an increasing number of state and output variables at various locations within the watershed and river basin. On the other hand, data availability and identifiability among other pragmatic considerations suggest adopting simple model structures that can solve the problem at hand. The development and application of watershed models must take into account the tradeoff between available data, model complexity, performance, and identifiability of the model structure.

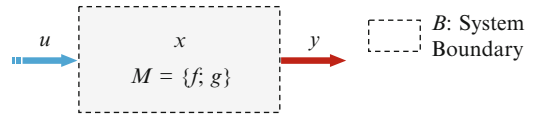
Over the years, a number of articles and books have been published on models for representing the hydrologic cycle of watersheds and river basins. For instance, detailed examples of a variety of models can be found in the books by Singh [145], Beven [146], Bowles [147], and Singh and Frevert [148, 149], and journal articles have been published describing critical issues involved in the modeling process such as parameter estimation, uncertainty, sensitivity analysis, performance, scaling, and applications and experiences thereof (e.g., [150–155]). Also literature abounds on classification and types of models such as deterministic or stochastic, conceptual or physically based (mechanistic), lumped or distributed, event or continuous, and some other types such as black box and parametric (e.g., [52, 60, 156–158], and other papers cited above).

### 6.1. Basic Concepts and Definitions

A model is a representation of a real system such as a watershed and a river basin. The model structure is developed on the basis of our understanding of the physical principles/rules that govern the system. A general distributed-parameter form of a model that can represent spatial heterogeneities inherent in the real system, as well as nonlinear interactions between system processes, can be expressed as [159]

$$\frac{dx(r, t)}{dt} = f(\nabla^2 x, \nabla x, x, u, \theta, t, r), \quad (1.54)$$

**Fig. 1.17.** Schematic of model components (adapted from ref. 160).



where  $f$  is a functional representation of the internal system processes;  $x$ ,  $u$ , and  $\theta$  are vectors of state variables, system inputs, and model parameters, respectively;  $t$  represents time; and  $r$  is a three-dimensional vector specifying spatial locations. State variables ( $x$ ) are quantities of mass stored within the system boundary ( $B$ ). Model inputs ( $u$ ) and outputs ( $y$ ) are fluxes of mass and energy into and out of the systems, respectively. Figure 1.17 illustrates a schematic of model components from a system perspective [160]. In the context of watershed modeling, examples of state variables may include mass of water, sediment, chemicals, organisms stored within surface and subsurface system compartments, vegetation biomass on the ground surface, and energy fluxes. Precipitation flux is a typical example of model input ( $u$ ) (although depending on the model input, variables may also include wind speed, air temperature, humidity, and radiation as needed). Fluxes of flow, sediment, and chemicals along the river network are examples of model outputs. Model parameters ( $\theta$ ) are assumed to be time invariant, but they may vary in space depending on the model; they are estimated by appropriate methods for solving the partial differential equation of (1.54).

A simpler lumped-parameter model in the form of an ordinary differential equation can be derived from (1.54) to describe changes in state variables as a function of time as

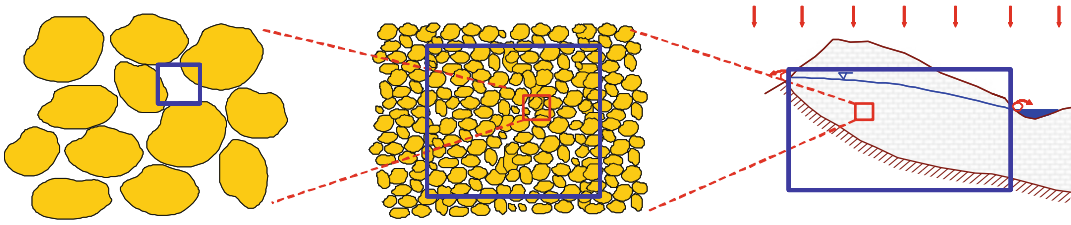
$$\frac{dx(t)}{dt} = f(x, u, \theta, t), \quad (1.55)$$

and model outputs are generated as

$$y(t) = g(x, \theta, t). \quad (1.56)$$

The vector functional relationships  $f$  and  $g$  constitute the model structure  $M$  and are typically treated as deterministic components. In reality, however, a model is only a mere approximation of the hydrologic system under study. Many important processes may be unknown during the development of the model, while some other processes may be considered to be insignificant and may be ignored. Thus, the structure of any watershed model will be generally incomplete and will contain uncertainty. Mathematical models are never perfect because of the errors in model conceptualization, input and output observations, physical characteristics of the system, temporal and spatial scales, and parameter estimation. In this scenario, model parameters may be understood as being *effective parameters* that compensate for these errors [161–163].

Depending on the physical basis of the model structure components  $f$  and  $g$ , watershed models may be classified into two main categories: *physically based models* and *empirical models*. Physically based models employ physical principles, i.e., conservation of mass, energy, and momentum, to describe the nonlinear system dynamics that control the movement



**Fig. 1.18.** Different equations may be needed for different scales in saturated flow in aquifer systems. From left to right in blue box: pore (1 mm), local (1 m), and whole aquifer (10 km) scales (color figure online).

of water, particles, chemicals, and organisms within various system compartments. Empirical models describe the relationships between system inputs and outputs based on statistical analysis of historical observations. Application of empirical models is limited to the conditions over which the observations were acquired. Most watershed models, however, contain both physically based equations and empirical relationships to represent the underlying processes of the watershed and may be referred to as *process-based models*.

Often, physically based models are divided into *conceptual models* and *pure physically based models*, where the latter ones presumably involve the proper equations for each process according to the current state of the knowledge. Freeze and Harlam [164] established the blueprint of this type of hydrologic models, proposing for the first time a representation of the underlying processes using the physical equations at the local scale. In principle, “pure” physically based models do not need calibration, and parameters can be estimated directly from the available information. However, the proper physical equations to be applied depend on the spatial scale. For example, consider the modeling of an aquifer (Fig. 1.18): generally applying the Darcy law at the local scale, one should use Boussinesq’s equations for solving the groundwater flow problem, but at pore scales, they must be substituted by the Navier–Stokes equations. Furthermore, at the aquifer scale, linear reservoir and water balance equations may give a good representation of the system.

Regardless of the degree of empiricism embedded in the model structure, the system of functional relationships can be resolved on various spatial and temporal scales. These equations may be solved for the entire watershed as a single unit where a unique set of state variables are defined and a single set of model parameters are estimated for the entire system. Models that use this approach are referred to as *lumped-parameter models*. On the other hand, the watershed may be divided into smaller rather homogeneous subunits or areas (e.g., grids, sub-watersheds, hydrologic response units) in order to better represent the heterogeneities of watershed characteristics such as soils, land use, land cover, and terrain as well as the spatial variability of the inputs such as precipitation and potential evapotranspiration. Thus, these models are referred to as *distributed-parameter models*, where the state variables and model parameters are different for each subunit. Then, as the number of subunits increases, the computational burden for solving the system equations may substantially increase.

In addition to the spatial scale, selection of appropriate temporal scales is an important consideration for building the models and solving the system equations. *Event-based models* are needed for analyzing the effect of design storms on the hydrologic system and usually require small time steps such as hours or even smaller, depending on the size of the catchment. Larger time steps (e.g., daily or even longer in some cases) may be sufficient for continuous models that are appropriate for long-term assessment of changes in the hydrologic system in response to the changes in climate, land use, and management drivers. Even in the case of distributed-parameter models with relatively small subunits for model computations, model parameters are aggregate measures of spatially and temporally heterogeneous properties of each unit. Thus, model parameters will always contain uncertainties that propagate forward into model predictions of state and output variables. Even “pure” physically based models involve effective parameters that must be also calibrated [165, 166].

## 6.2. Brief Example

For illustrative purposes, we describe some basic aspects of hydrologic modeling using a relatively simple distributed model known as TETIS model and its application to the Goodwin Creek basin for flood event simulation.

### 6.2.1. The Basin

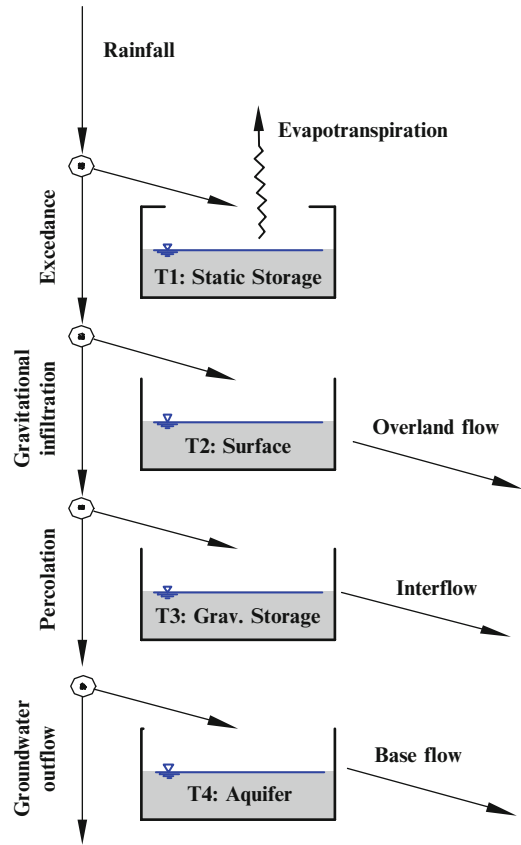
Goodwin Creek is a 21.3 km<sup>2</sup> experimental basin located in Panola County (Mississippi, USA). The watershed is fully instrumented with 14 flow gauges and 32 rain gauges, in order to continuously monitor precipitation, runoff, and sediment yield with a high spatial and temporal resolution [167]. The original hydrometeorological data has been sampled for this work at 5 min temporal resolution. Soils are mainly silt loams, and the topography is quite smooth, with elevation ranging from 67 to 121 m.a.s.l. and slope from 0 to 22 % (for a 30-m scale resolution). Major land uses are pasture, agriculture, and forest. The climate is humid, warm in the summer and temperate in the winter. The average annual precipitation is 1,440 mm, and convective rainfall events are common, especially in the summer. The watershed surface hydrology is largely Hortonian, with runoff almost entirely formed by overland flow and a little baseflow at the outlet (less than 0.05 m<sup>3</sup>/s). The main storm events of years 1981, 1982, and 1983, with peak flows at the outlet of 39.8, 37.8, and 106.3 m<sup>3</sup>/s, respectively, will be used in this example.

### 6.2.2. The Distributed Model

The TETIS model is a distributed hydrologic model, with physically based formulations and parameters, developed for continuous and event simulation of the hydrologic cycle at basin scale. The model has been satisfactorily tested in different climatic scenarios with a wide range of basin sizes, from a few hectares up to 60,000 km<sup>2</sup> [163, 168–172].

Version 8 of TETIS (free download at <http://luvia.dihma.upv.es>) represents the water cycle in each cell of the spatial grid using up to six interconnected vertical tanks. The example here (with no snow and no explicit representation of the vegetation interception) considers

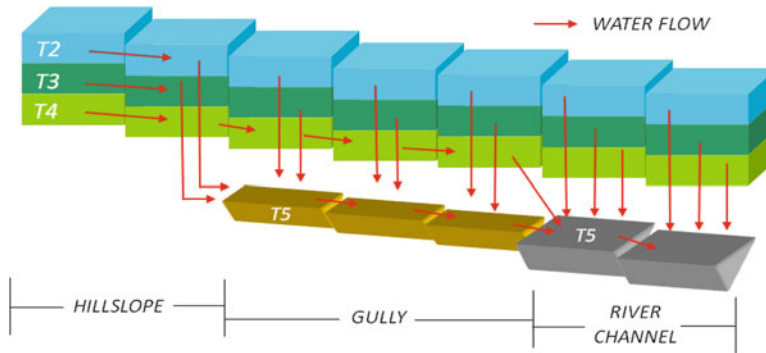
**Fig. 1.19.** Vertical conceptualization of TETIS model considering four tanks.



only four tanks as shown in Fig. 1.19. The relationships between tanks, representing the different hydrologic processes, are described by linear reservoirs and flow threshold schemes. The first tank (T1) represents the aggregation of vegetation interception, surface puddles, and upper soil capillary retention; water can leave this tank only by evapotranspiration and, for this reason, is called static tank (storage). The second tank (T2) corresponds to the surface storage, i.e., the water that does not infiltrate and generates overland flow. The third tank (T3) represents the gravitational soil storage; the percolation process is modeled according to both soil saturation conditions and vertical hydraulic conductivity, and the remaining water is available for interflow. The fourth tank (T4) represents the aquifer, which generates the baseflow and the groundwater outflow (underground losses in reference to the catchment outlet). The groundwater outflows are the aquifer flows that do not contribute to baseflow within the basin (generally they contribute to baseflows downstream or to the sea). Eight parameters are needed for the runoff production: static storage capacity, vegetation density, soil surface infiltration capacity, horizontal saturated permeability and percolation capacity, aquifer permeability, underground losses capacity, and overland flow velocity.

Basin stream network can be considered as an additional fifth tank, but it is not necessarily included in all cells. Two different types of channel networks can be defined: gullies (without





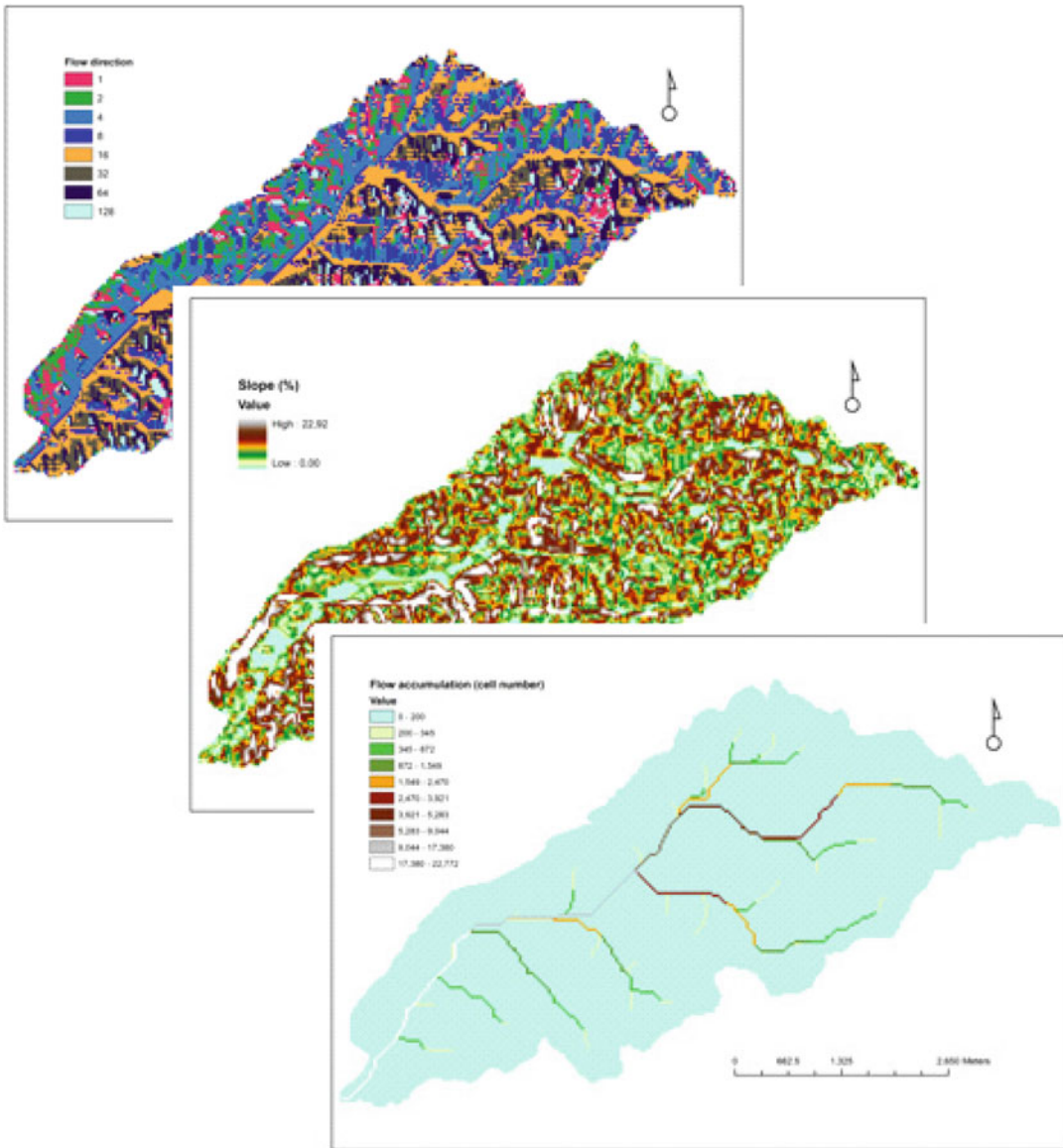
**Fig. 1.20.** Horizontal conceptualization of TETIS model.

permanent flow) and rivers (with permanent flow). The starting cells of these networks are defined by two drainage area thresholds. Every cell receives inflows from upstream and drains downstream following a 3D scheme generated from a digital elevation model (DEM), and the flow is routed towards the lowest of the eight contiguous cells. Figure 1.20 shows a 2D simplification of this scheme. The overland flow and the interflow are routed to the respective tanks (T2 and T3) of the downstream cell (Fig. 1.20); once both flows reach a cell whose drainage area is greater than the threshold drainage area corresponding to gullies, they move into T5. In the same way, baseflow is routed to T4 of the downstream cell until it reaches a second threshold drainage area (for river channels), and then it moves into T5. Therefore, this couple of threshold drainage areas divides the watershed into three classes of cells: pure hillslope cells (without the T5 tank), gully cells (with T5 tank and no connection between aquifer and gully), and river cells (with the T5 tank and connection between aquifer and channel). The flow routing along the stream channel network is carried out using the geomorphologic kinematic wave (GKW) methodology, where cross-section and roughness characteristics of the stream channel network are estimated with power laws of drainage area and slope for each cell [163].

The model effective parameters are organized following a split structure [163, 173]. Basically, each effective parameter  $i$  for cell  $j$ , ( $\theta_{ij}^*$ ), is the multiplication of a correction factor  $R_i$  that depends only on the type of the parameter and the prior parameter estimation  $\theta_{ij}$ , i.e., correction factors modify globally each parameter map, assuming the prior spatial structure and thus reducing drastically the number of parameters to be calibrated. In the referred TETIS configuration, there are a total of nine correction factors: eight affecting the runoff production parameter maps and one for the stream network velocity. Also, the split structure of model effective parameters facilitates the extrapolation to ungauged watersheds [171].

### 6.2.3. Initial Parameter Estimation

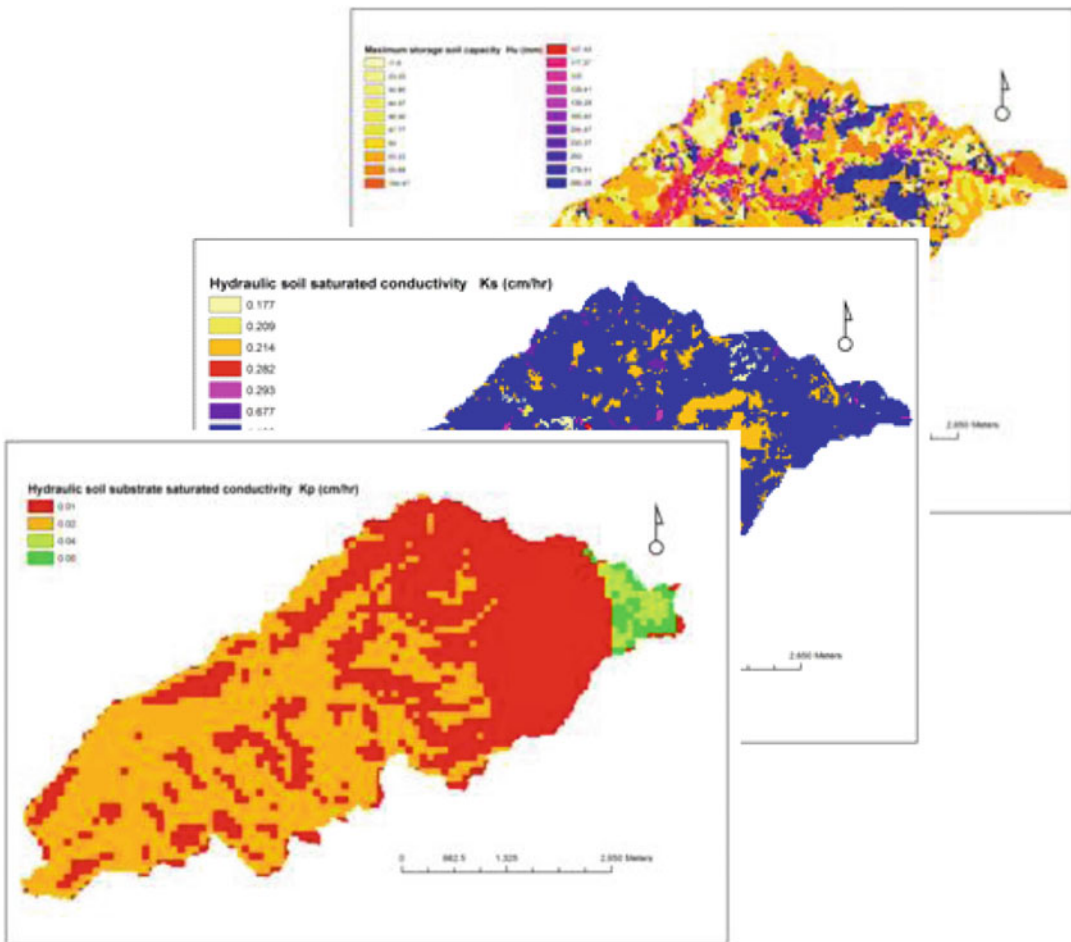
Concerning the initial parameter estimation in the model calibration, the best advice is to use all available information and experience. In this example, the basic information used to estimate the model parameters was taken from Blackmar [167]. This initial



**Fig. 1.21.** Parameter maps derived from the DEM: flow direction, slope, and accumulated area (color figure online).

parameter estimation is the prior parameter set in calibrating the effective parameters of TETIS model.

The DEM for the basin included  $30 \times 30$ -m square cells which were used to derive flow direction, slope, and flow accumulation maps (Fig. 1.21). The last one is needed for stream channel routing with TETIS, because hydraulic characteristics in the GWK are extrapolated using mainly the drainage area of each cell [163]. Drainage threshold areas were estimated as



**Fig. 1.22.** Main parameter maps derived from available landscape information: static storage capacity and upper and lower soil-saturated permeabilities (for the infiltration and percolation capacities, respectively) (color figure online).

0.01 km<sup>2</sup> (to differentiate between hillslopes and gullies) and 15.3 km<sup>2</sup> (for differentiating between gullies and river channels). The parameters of the GWK power laws have been taken from Molnár and Ramírez [174]. The overland flow velocity map was estimated from the slope map, assuming a representative uniform flow and a rough estimation of the roughness coefficient. Vegetation density was obtained from a simple reclassification of the land cover map. The static storage capacity and infiltration capacity were estimated using soil information (texture, soil classification, and soil profiles), the land cover map for effective root depth, and proper pedotransfer functions. Percolation capacity was derived from a geological map of the study area. These three important parameter maps are shown in Fig. 1.22. The estimated values are in fact modal values for the union of the three original cartographic units

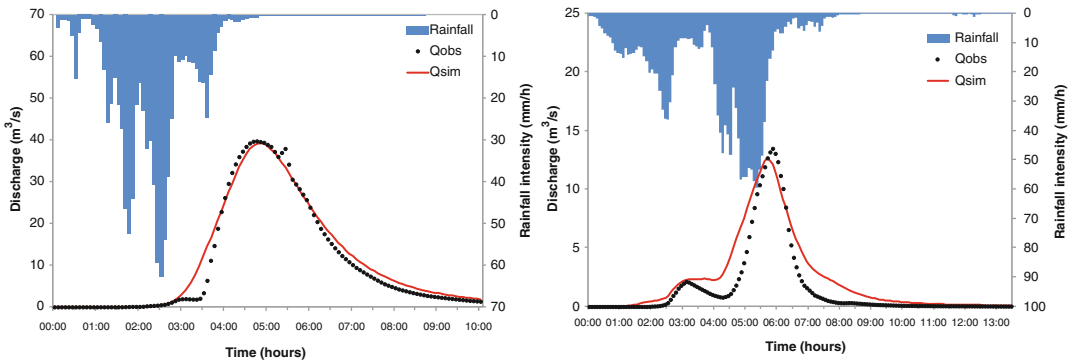
(vegetation, soil, and lithology). No specific estimation was done for horizontal saturated soil permeability, aquifer permeability, and underground loses capacity: for example, the infiltration capacity map was used also for the horizontal saturated soil permeability assuming a high correlation between them.

### 6.3. Model Calibration and Testing

Application of simulation models in research or water management decision making requires establishing credibility, i.e., “a sufficient degree of belief in the validity of the model” [175]. Beck et al. [176] describe attributes of a valid model as follows: (1) soundness of mathematical representation of processes, (2) sufficient correspondence between model outputs and observations, and (3) fulfillment of the designated task. Literature review is commonly practiced to deal with the first attribute, which often includes *model calibration*. Model calibration is the process of adjusting the model parameters ( $\theta$ ) manually or automatically for the system of interest until model outputs adequately match the observed data. The credibility of model simulations is further evaluated by investigating whether model predictions are satisfactory on different data sets, a procedure often referred to as validation, verification, or testing [177, 178].

One common calibration and testing strategy is to split observed data into two data sets: one data set for calibration and another one for testing. It is desirable that the calibration and testing data sets contain observed data of approximately the same lengths (although often this requirement is not met where data sets are small). It is also important that both calibration and testing data sets contain periods with high and low flows in order to increase the robustness of the model. Yapo et al. [179] demonstrated that approximately eight years of daily data were needed to appropriately adjust model parameters for calibration of a rainfall-runoff model for their watershed. Gan et al. [180] indicated that ideally, calibration of rainfall-runoff models should use 3–5 years of daily data that include average, wet, and dry years so that the data encompass a sufficient range of hydrologic events to activate all the model components during calibration. However, the required amount of calibration data is project specific. For example, in the case study referred to in Sect. 6.2, only one single flood event at the outlet of the basin was used for model calibration.

The classical calibration procedure aims at identifying a unique “best parameter set,” ( $\hat{\theta}$ ), that provides the closest match between model predictions and real-world observations of system outputs ( $y$ ). Several measures of information have been proposed for calibration of hydrologic models (Gupta et al. [181]), including Nash-Sutcliffe efficiency coefficient (E), root mean square error (RMSE), mean absolute error (MAE), maximum absolute deviation (MAD), bias (BIAS), and lag-1 autocorrelation ( $r_1$ ). Some studies have identified ranges for these measures that can be used to classify model simulations as poor, acceptable, good, and very good (e.g., [182, 183]). But other factors must be also taken into consideration such as the time step (i.e., more relaxed for smaller discretization), streamflow errors (especially when outputs are sediment and water quality), and input and prior parameter information uncertainties.



**Fig. 1.23.** Calibration of the TETIS model for Goodwin Creek at the outlet of the basin for a storm event in October 1981 (*left*) and validation for an upstream station for a storm event occurred in September 1983 (*right*).

Per illustration, considering our example, the TETIS model includes an automatic calibration module based on the SCE-UA algorithm [184, 185], which was used to calibrate all the correction factors (9) and the initial values of the state variables (4). The model calibration results using the RMSE as objective function for a flood event in October 1981 measured at the outlet of the basin (station Q01) are shown in Fig. 1.23 (left). It is worth noting that the referred basin shows a typical Hortonian behavior and the referred flood event occurred with a very dry initial condition. The resulting Nash-Sutcliffe efficiency coefficient was  $E = 0.98$ , which can be considered a very good performance [183]. As stated above, the calibrated model must be capable of reproducing properly the dominant process in the basin for events other than those used for calibration (temporal validation) and events occurring at other sites in the basin (spatial validation) or better both (temporal and spatial validation) for a more robust model testing. For example, Fig. 1.23 (right) shows the flood output estimated for an upstream site corresponding to a storm event occurred in September 1983 for which the efficiency coefficient is  $E = 0.87$ . As expected the value of  $E$  for validation is smaller than that for calibration (0.98), but a decrease smaller than 0.2 is generally judged to be acceptable.

The literature abounds with optimization procedures for automatic calibration of hydrologic and water quality models by means of minimizing appropriate objective functions that reflect the modeling error magnitude. While several studies have demonstrated the importance of choosing a formal and statistically correct objective function for proper calibration of hydrologic models (e.g., [186–188]), others have argued that there may not exist such measures (e.g., [151, 181, 189]). A major limitation of the classical calibration procedure is that it may not be possible to identify a unique set of model parameters that simultaneously minimize all objective functions corresponding to all model outputs. Thus, the use of multi-objective optimization algorithms has gained wide acceptance in the past years (e.g., [190–193]). Multi-objective approaches are particularly suitable for multisite multivariable calibration of watershed models, where minimization of all errors associated with estimated fluxes of water, sediments, and chemicals at multiple outlets within the watershed is desired.

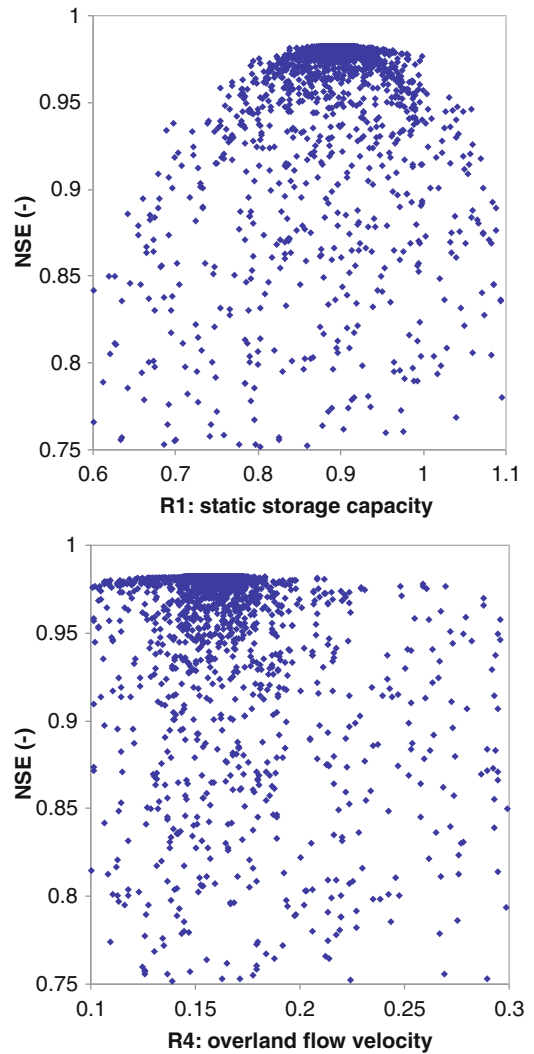
#### 6.4. Sensitivity Analysis

A model sensitivity analysis can be helpful in understanding which model inputs and initial conditions are most important or influential for understanding potential limitations of the model. Additional care must be taken when estimating model parameters that are the most influential. Data collection efforts that support the modeling study may focus on obtaining better data for these parameters. In order to eliminate the effect of an influential initial condition, one can do three things: to simulate a sufficiently long “warming” period (usually months for aquifer initial conditions, weeks for soil moisture, and days and hours for river channel discharges, depending on the size and the particular watershed at hand), use as initial state the state in a similar time within the simulated period, or calibrate the initial condition.

The sensitivity analysis can also identify potential limitations of the model. If a model is not sensitive to parameters that are to be varied in testing the project objectives or hypotheses, a different model may need to be selected. Or alternatively, improve the mathematical model by removing the non-influential parameters and the corresponding processes. As stated above, models are abstractions of the systems they simulate and therefore typically represent system components with varying levels of detail. For example, the scientific literature may indicate that differences in tillage practices influence pesticide losses in surface runoff. In such a case, the use of a model that is not sensitive to tillage to examine the impact of switching from conventional tillage to conservation tillage on pesticide losses in surface runoff would be inappropriate. Sensitivity analysis can be done by local sensitivity analysis (i.e., without interactions between the analyzed inputs, parameters, and initial conditions) or better by a general sensitivity analysis (GSA) using Monte Carlo simulations (see, e.g., [194]). Generally, it is worth selecting only the behavioral simulations [146, 151, 195, 196].

The literature and model documentation are often excellent sources of information on model sensitivity. For example, Muttiah and Wurbs [197] identified the sensitivity of SWAT (Soil and Water Assessment Tool) to various parameters. However, it may be necessary to conduct a sensitivity analysis for the study watershed if its conditions are significantly different than those for model sensitivity analyses reported in the literature, since model sensitivity may be specific to the model setup. Thus, limited data for parameterizing the model may need to be collected prior to conducting a sensitivity analysis. Generally, the sensitivity analysis should be completed using an un-calibrated model setup, since the influential parameters and those with the greatest uncertainty are typically used for model calibration. For example, Spruill et al. [198] conducted a SWAT sensitivity analysis to evaluate parameters that were thought to influence stream discharge predictions. During calibration, the average absolute deviation between observed and simulated streamflows was minimized and used to identify optimum values or ranges for each parameter. In our case study (Sect. 6.2), a GSA was made, and the most influential correction factors were detected using as behavioral threshold the Nash-Sutcliffe efficiency coefficient of 0.75. Figure 1.24 shows two extreme cases: the correction factors of the static tank (storage) capacity and overland flow velocity. The static tank, which is the sink (during a flood event) of the infiltration when soil moisture is

**Fig. 1.24.** Sensitivity analyses of two TETIS model correction factors for the Goodwin Creek basin. The behavioral parameter sets were detected where  $E > 0.75$ .



below field capacity, is a very influential component; on the other hand, the discharge at the basin outlet is not sensitive to the propagation of the overland flow within the hillslopes, i.e., maximum attention must be made to the estimation of the static tank storage capacity, whereas a rough estimation may be enough for the hillslope velocities.

### 6.5. Uncertainty Analysis

Any modeling process will necessarily entail a number of uncertainties arising from data, model abstractions, and natural heterogeneity of the watersheds. To this, we can add the uncertainty related to the decision-making process. The National Research Council report “Assessing the TMDL approach to water quality management” emphasizes that modeling

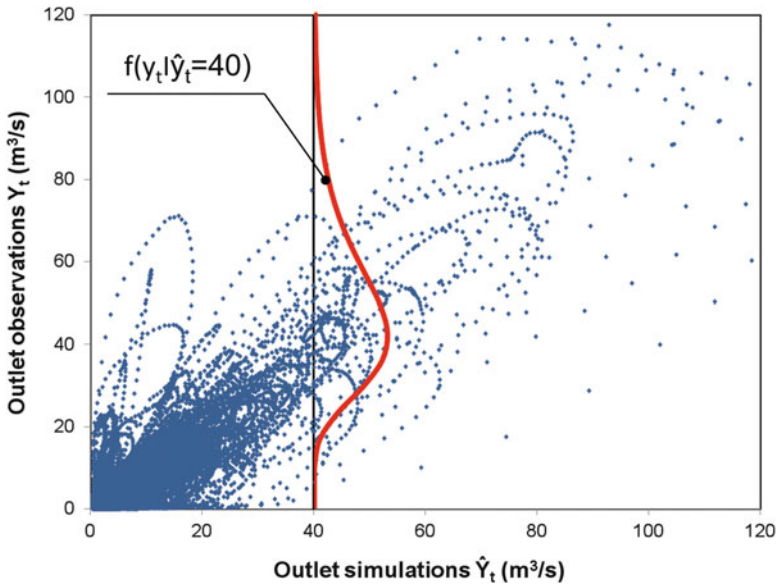
uncertainty should be rigorously and explicitly addressed in development and application of models for environmental management, especially when stakeholders are affected by the decisions contingent upon model-supported analyses [199].

Uncertainties from the various model components illustrated in Fig. 1.17 can propagate forward into model predictions for state and output variables. There are three primary types of uncertainties in watershed modeling: parameter uncertainty, structural uncertainty, and data uncertainty (e.g., [188, 200]). Parameter uncertainty arises from errors in estimating model parameters ( $\theta$ ). Structural uncertainties result from incomplete representation of the real system by the functional relationships  $f$  and  $g$ , or numerical schemes that are employed to solve the system equations [(1.55) and (1.56)]. Data uncertainties are associated with errors in the system inputs ( $u$ ) and outputs ( $y$ ) and may consist of random and systematic errors (e.g., instrumentation and human) and errors arising from the discrepancy between the scale of modeling outputs and observations.

Uncertainties associated with watershed modeling can be addressed using three types of methods: (1) behavioral, (2) analytic, and (3) sampling-based methods. Behavioral methods are based on human judgment and experience and are carried out by asking experts in the problem area to provide their best assessment of the probability of a particular outcome. This method should be the last resort for addressing the problem of model uncertainty and should only be used in the absence of statistical methods [201]. Unlike behavioral methods, analytical methods that are based on the method of moments provide a quantitative estimate of model uncertainty [202]. The output function of the model is expanded by series expansions (such as Taylor series), and first-order, quadratic, or higher-order terms of the series are selected for computation of the moments. For example, the first-order variance propagation method is based on the first-order approximation of the Taylor series, and the first two moments are used to compute the variance of the model output. First-order reliability method (FORM) and first-order second moment (FOSM) are among the popular analytical methods for determining model uncertainties (e.g., [203]). The prerequisite of analytical methods is that the solution of the differential equation  $f$  (1.55) must be obtained analytically. In the context of watershed modeling, this prerequisite is a formidable barrier for the wider use of analytical methods because analytical solutions to highly nonlinear system of equations are rarely available.

Sampling-based uncertainty analysis methods are commonly used in watershed modeling, where instead of analytical solutions a probability distribution function for the model output is generated from multiple realizations of the parameter space (e.g., [203]). Sample statistics are used to compute first and second moments. Also, the relative importance of model parameters with regard to variations of the model output can be determined. The most common sampling technique for deriving distributions for model outputs is Monte Carlo simulations [204], which has also been the basis for more sophisticated sampling methods. In particular, various Markov chain Monte Carlo (MCMC) methods have been developed to deal with input, parameter, and model structural uncertainties in hydrologic prediction (e.g., [188, 200, 205, 206]).

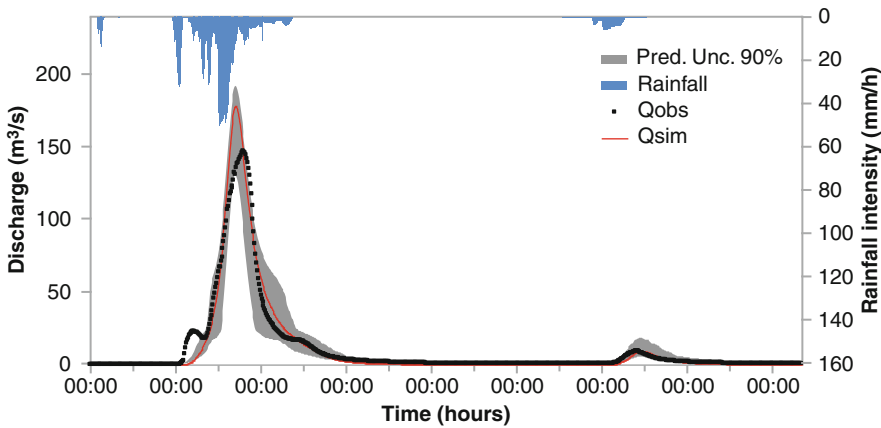




**Fig. 1.25.** Predictive uncertainty of the real output, i.e., the conditional probability given the simulations for the Goodwin Creek outlet (adapted from ref. 212).

In addition, from a decision maker point of view, it is necessary to integrate all sources of uncertainty in the context of *model predictive uncertainty* (PU). PU is the probability of any actual value (observed or not) conditioned to all available information and knowledge [207]. Figure 1.25 illustrates this important concept and shows the relationship between observations (real output) and simulations for the implemented model (i.e., fixed model and parameters), and PU is the conditional probability given the simulated output. From the model users' perspective, what we want is to understand the position of the reality (real output) given the simulations. Furthermore, additional PU algorithms have been developed such as the hydrologic uncertainty processor [207], the Bayesian model averaging [208, 209], the model conditional processor, MCP [210], and the quantile regression [211]. Moreover, all these techniques can be used for uncertainty reduction by combining more than one model.

We have applied the MCP for obtaining the PU of the simulations in our case study based on the TETIS model. MCP is a Bayesian method based on the estimation of the joint distribution function of observations and simulations. To estimate the PU statistical model parameters, a calibration period covering the maximum range of possible outcomes is needed, to reduce the extrapolation of the estimated distributions and correlation functions. Figure 1.26 shows the estimated 90 % band (i.e., the 5 and 95 % quantiles) obtained with the referred method for the simulations of two storm events that occurred in May 1983 (larger and a smaller storm events compared to that used for calibration). In this case, it is clear that the no flow is predicted with high reliability, flow peaks are predicted with acceptable reliability, and the larger PU is located around the 50 m<sup>3</sup>/s discharge.



**Fig. 1.26.** PU 90 % band for the simulations on May 1983 at the Goodwin Creek outlet flow gauge station.

## 7. RISK AND UNCERTAINTY ANALYSES IN HYDROLOGY

Statistical concepts and methods are routinely utilized for approaching a number of problems in hydrology and water resources. This is because most, if not all, hydrologic processes have some degree of randomness and uncertainty. For example, annual precipitation over a basin is a random occurrence that is generally described by probability laws. Another example is the random occurrence of annual maximum floods at a given cross section of a stream. Thus, concepts of risk and uncertainty are commonly utilized for planning and management of hydraulic structures such as spillways and dikes. This section starts with an elementary and brief review of some basic concepts of probability and statistics. Then frequency analysis of hydrologic variables is presented by using nonparametric and parametric methods and models. The concepts of risk, vulnerability, uncertainty, and regional analysis are discussed primarily in connection with flood-related structures. In addition, the concepts and applications of stochastic techniques, particularly streamflow simulation and forecasting, are discussed. The section ends with a summary of what has been done with the issue of nonstationarity.

### 7.1. Introduction

Many of the problems that we face in planning and management of water resources and environmental systems involve some degree of uncertainty. For example, the occurrences of multiyear droughts or the occurrences of yearly maximum floods are random events that must be approached using probability theory, statistics, and stochastic methods. Often in characterizing random events, the concept of random variables is utilized. For example, if  $X$  is a *random variable*, it means that it is governed by a certain *probability law* (we will also call it a *model*) which can be represented by a *probability density function* (PDF)  $f_X(x, \underline{\theta})$  or a

*cumulative distribution function* (CDF)  $F_X(x, \underline{\theta})$ , where  $\underline{\theta} = \{\theta_1, \dots, \theta_m\}$  is the parameter set (*population parameters*) and where  $m$  is the number of parameters of the model. For brevity we will also use the notation  $f_X(x)$  and  $F_X(x)$ , but it will be understood that they include the parameter set  $\underline{\theta}$ . It can be shown that the *population moments* of the random variable  $X$ , say the expected value  $E(X) = \mu_X$  or the variance  $Var(X) = \sigma_X^2$ , are functions of the parameter set  $\underline{\theta}$  and they are constant values (they are not random variables).

It is also convenient to remember the concept of a random sample. A *random sample* could be represented by  $X_1, \dots, X_N$  where all the  $X$ s have the same distribution  $f_X(x)$  (i.e., the same population mean  $\mu$  and variance  $\sigma^2$ ). *Sample moments* are functions of the random sample, for example, the sample mean  $\hat{\mu}_X = \bar{X} = (1/N) \sum_1^N X_i$  and the sample variance  $\hat{\sigma}_X^2 = S^2 = [1/(N-1)] \sum_1^N (X_i - \bar{X})^2$  are the first and the second sample moments. Since they are functions of the random sample, they are also random variables, and as such they also have moments. For instance, it may be shown that the expected values of  $\hat{\mu}_X$  and  $\hat{\sigma}_X^2$  are  $\mu$  and  $\sigma^2$ , respectively. Likewise, the variance of  $\hat{\mu}_X$  is equal to  $\sigma^2/N$ . In addition, we could also refer to a random sample as the set  $x_1, \dots, x_N$  where  $x_i$  represents a particular value of the random variable  $X$ . And we could also define the sample moments as above using the same equations (e.g.,  $\hat{\mu}_X = \bar{x} = (1/N) \sum_1^N x_i$ ), but the big difference is that  $\bar{x}$  is not a random variable but a given quantity that depends on the values  $x_1, \dots, x_N$  (while  $\bar{X}$  is a random variable as noted above).

Furthermore, assuming that we have a random sample  $X_1, \dots, X_N$  from a known model  $f_X(x, \underline{\theta})$  but unknown parameter set  $\underline{\theta}$ , one can estimate  $\underline{\theta}$  by using various estimation methods such as the method of moments, probability-weighted moments, and maximum likelihood (e.g., [213]). Regardless of the estimation method, the *estimator* say  $\hat{\underline{\theta}}$  will be a function of the random sample say  $\hat{\underline{\theta}} = g_1(X_1, \dots, X_N)$ . And the  $q$ th-quantile estimator  $\hat{X}_q$  will be a function of the parameter set, i.e.,  $\hat{X}_q = g_2(\hat{\theta}_1, \dots, \hat{\theta}_m)$ . Then  $\hat{\underline{\theta}}$  and consequently  $\hat{X}_q$  are random variables. Therefore, often in applying these concepts for problems such as flood frequency analysis, one would like to estimate the confidence limits of the population quantiles.

We can address some problems in engineering hydrology where probability laws and models can be directly applied for making risk-based design decisions. That is the case, for example, when we use probabilistic models for fitting the frequency distribution of annual floods and estimating the design flood to be used for designing the capacity of a spillway. We are able to do that because we assume that the sequence of annual floods is a random sample  $X_1, \dots, X_N$ , i.e., there is no correlation among the  $X$ s or they are *uncorrelated*. However, many data that we use in hydrology and water resources are *autocorrelated*, i.e., temporally dependent, and in such case, a direct application of a probability law  $f_X(x, \underline{\theta})$  may not be enough. For example, monthly and annual streamflow data (mean flow or total volume) or daily precipitation data are generally autocorrelated. In these cases, additional concepts and different types of models are needed in order to represent the temporal and spatial variability of the data. Such models incorporate one or more terms linking the underlying variable with

its past plus a random term, as is the case of single site or univariate models, and also linking it with other variables at other sites as is the case of multisite or multivariate models. These models fall in the category of *stochastic* models or *time series* models.

## 7.2. Frequency Analysis of Hydrologic Data

### 7.2.1. Empirical Frequency Analysis

Hydrologic data can be analyzed by using nonparametric methods for determining the PDF and CDF. Let us assume that we have a random sample denoted by  $x'_1, \dots, x'_i, \dots, x'_N$  where  $N$  is the sample size. For instance,  $x'_i, i = 1, \dots, N$  may be a sequence of maximum annual floods. The simplest procedure for estimating the empirical PDF is to arrange the data from the smallest to the largest one, say  $x_1, \dots, x_i, \dots, x_N$  such that  $x_1$  is the minimum and  $x_N$  is the maximum. Then the range of the data is subdivided into classes  $j = 1, \dots, N_c$  with  $N_c =$  the number of classes. Next assume that the class width is  $\Delta x$  and the number of observations that fall in class  $j$  is  $N_j$ . Then the relative frequency corresponding to class  $j$  is  $N_j/N$ . The plot of  $N_j/N$  against the class mark (the midpoint of the class) is the typical histogram, and the empirical PDF (estimate of the population PDF) is given by  $f(j) = N_j/(N\Delta x)$ . Additional details regarding the criteria for selecting  $N_c$  and  $\Delta x$  can be found in standard books (e.g., [214–216]). In addition, Kernel density estimates (KDE) may be useful in cases where a smooth density is needed across the range of the data set (rather than point estimates for classes). For example, KDE has been useful for identifying bimodality in the frequency distribution (e.g., [217]). Whether using  $f(j)$  or KDE, the empirical CDF  $F(j)$  can be found by integration.

Also the empirical CDF may be determined based on the so-called *plotting position* formulas as follows: (1) Arrange the data  $x'_1, \dots, x'_i, \dots, x'_N$  in either increasing or decreasing order of magnitude (for simplicity we will assume throughout this section that the data are arranged in increasing order of magnitude). As above denote the arranged sequence by  $x_1, \dots, x_i, \dots, x_N$  where  $x_1$  is the minimum and  $x_N$  is the maximum. (2) Assign a probability  $P(X \leq x_i)$  to each value  $x_i$  by using a plotting position formula. Several formulas have been suggested for this purpose (Table 1.7 gives some examples). The most widely used formula in practice is the Weibull plotting position formula, i.e.,  $F(x_i) = P(X \leq x_i) = i/(N + 1)$ . The formula gives a *non-exceedance probability* or the probability that the random variable  $X$  is less or equal to the value  $x_i$  (value that corresponds to the order  $i$  in the arranged sample). Then, the *exceedance probability* is  $P(x_i) = 1 - F(x_i) = P(X > x_i) = 1 - i/(N + 1)$ .

In addition, the concept of *return period* or *recurrence interval* has been widely used for many purposes in engineering practice. For events defined in the upper probability scale (generally events related to maximum quantities such as floods), the return period is equal to one divided by the exceedance probability, i.e., the empirical estimate of the return period is  $T(x_i) = 1/P(x_i)$ . On the other hand, in case that hydrologic events are defined in the lower probability scale (such as for minimum flows), the return period is given by  $T(x_i) = 1/F(x_i)$ . The empirical CDF is sometimes plotted on *probability papers*. A probability paper designed for a given model has the probability scale distorted so that the CDF of the model plots as a

**Table 1.7**  
**Examples of plotting**  
**position formulas**  
**typically used in**  
**hydrology [213]**

$F(x_i) = P(X \leq x_i)$
$\frac{i}{N + 1}$
$\frac{i - 0.4}{N + 0.2}$
$\frac{i - 0.31}{N + 0.38}$
$\frac{i - 0.25}{N + 0.5}$

straight line. The most popular and useful probability papers are the normal, lognormal, and Gumbel probability papers. The example below further illustrates the method.

The empirical CDF for the maximum annual floods of the St. Mary’s River at Stillwater, Canada, will be determined based on the flood data available for the period 1916–1939 as shown in the first two columns of Table 1.8. The original data have been ordered from the smallest (8,040) to the largest value (20,100) as shown in columns 4 and 5 of Table 1.8. Using the Weibull plotting position formula, the non-exceedance and the exceedance probabilities are calculated as shown in columns 6 and 7. And the return period is listed in column 8. The empirical CDF is plotted in Fig. 1.27. Based on the empirical distribution, one can make probability statements about the possible occurrences of certain flood events. For example, from Table 1.8 (columns 5 and 6), one can write  $P(X \leq 17,200) = 80\%$  which is the probability that annual floods at St. Mary’s River will be less or equal to 17,200. Conversely,  $P(X > 17,200) = 20\%$  is the exceedance probability, and  $T(17,200) = 5$  years is the corresponding return period. Obviously relevant probability information can be obtained from the empirical CDF. However, such information is rather limited because many design problems require estimating flood quantiles for specified return periods or estimating the return periods for given flood magnitudes that are beyond the values that can be found from the empirical frequency analysis such as that shown in Table 1.8. Section 7.3 below shows how using probabilistic models can enhance the frequency analysis of hydrologic data.

7.2.2. *Frequency Analysis Based on Probabilistic Models*

Probability models such as the normal, lognormal, gamma (Pearson), log-gamma (log-Pearson), and general extreme value (GEV) distributions have been widely used for fitting the distribution of hydrologic data. From experience the type of data may suggest applying or discarding one or more candidate models that may be considered for the data at hand. For example, extreme flood or extreme precipitation data are generally skewed, and for this reason, the normal distribution would not be a suitable distribution for such data. Generally more than one distribution may fit the empirical data reasonably well although, often, significant differences may result when extrapolating the fitted distribution beyond the

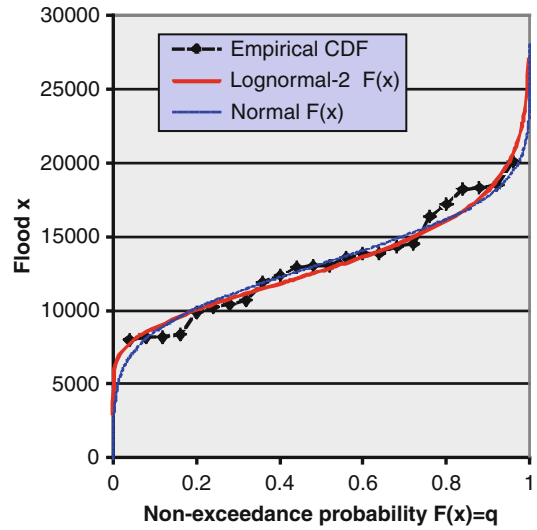
**Table 1.8**  
**Empirical CDF for the St. Mary's River annual flood data**

Years	Flood	Base-10	Order	Ordered flood	$F(x_i)$	$P(x_i)$	$T(x_i)$
	$x'_i$ (cfs)	$y = \log(x'_i)$	$i$	$x_i$ (cfs)	$i/(N + 1)$	$1 - F(x_i)$	$1/P(x_i)$
1916	10,400	4.0170	1	8,040	0.04	0.96	1.0
1917	10,700	4.0294	2	8,210	0.08	0.92	1.1
1918	20,100	4.3032	3	8,210	0.12	0.88	1.1
1919	8,210	3.9143	4	8,390	0.16	0.84	1.2
1920	14,300	4.1553	5	9,900	0.20	0.80	1.3
1921	8,040	3.9053	6	10,200	0.24	0.76	1.3
1922	8,210	3.9143	7	10,400	0.28	0.72	1.4
1923	13,900	4.1430	8	10,700	0.32	0.68	1.5
1924	8,390	3.9238	9	11,900	0.36	0.64	1.6
1925	18,500	4.2672	10	12,400	0.40	0.60	1.7
1926	13,000	4.1139	11	12,900	0.44	0.56	1.8
1927	16,400	4.2148	12	13,000	0.48	0.52	1.9
1928	14,500	4.1614	13	13,000	0.52	0.48	2.1
1929	13,000	4.1139	14	13,600	0.56	0.44	2.3
1930	17,200	4.2355	15	13,900	0.60	0.40	2.5
1931	13,900	4.1430	16	13,900	0.64	0.36	2.8
1932	11,900	4.0755	17	14,300	0.68	0.32	3.1
1933	13,600	4.1335	18	14,500	0.72	0.28	3.6
1934	12,400	4.0934	19	16,400	0.76	0.24	4.2
1935	18,300	4.2625	20	17,200	0.80	0.20	5.0
1936	12,900	4.1106	21	18,200	0.84	0.16	6.3
1937	18,200	4.2601	22	18,300	0.88	0.12	8.3
1938	9,900	3.9956	23	18,500	0.92	0.08	12.5
1939	10,200	4.0086	24	20,100	0.96	0.04	25.0
Mean	13,172	4.1040					
St. Dev.	3,569	0.1206					
Skew coef	0.271	-0.1739					

range of the empirical data. While fitting a particular model has become a simple task, the difficulty lies in selecting the model to be used for making design or management decisions [213]. However, in many countries and regions of the world, guidelines and manuals have been developed, suggesting a particular distribution for a certain type of hydrologic data. For example, Bulletin 17B [218] is a manual that suggests using the log-Pearson III distribution for flood frequency analysis in the United States of America.

In this section, we describe only four distributions, namely, the normal, lognormal, log-Pearson III, and the Gumbel distribution (which is a particular case of the GEV distribution). The fitting method, i.e., parameter estimation, will be illustrated using the method of

**Fig. 1.27.** Comparison of the empirical and fitted normal and lognormal CDFs for the annual flood data of the St. Mary's River.



moments only. The reader should be aware though that several alternative estimation methods exist in literature, some of them more efficient for certain distributions than the method of moments. Likewise, statistical tests such as the Smirnov-Kolmogorov test are available that help judging the goodness of fit of a particular model. For additional information on alternative probabilistic models, parameter estimation methods, testing techniques, and evaluating uncertainties, the reader is referred to well-known references (e.g., [213, 219]).

### Normal Distribution

The normal distribution is a benchmark distribution not only for hydrology but for many other fields as well. The PDF is given by

$$f_X(x) = \frac{1}{\sqrt{2\pi}\sigma} \exp\left[-\frac{1}{2}\left(\frac{x-\mu}{\sigma}\right)^2\right], \quad -\infty < x < \infty, \quad (1.57)$$

where  $\mu$  and  $\sigma$  are the model parameters. The plot of the PDF  $f(x)$  vs.  $x$  is centered around  $\mu$  and has a bell shape symmetric form. Certain properties of the normal distribution are useful. For instance, it may be shown that the population mean, variance, and skewness coefficient of the normal variable  $X$  are  $E(X) = \mu$ ,  $Var(X) = \sigma^2$ , and  $\gamma(X) = 0$ , respectively. The normal random variable  $X$  can be standardized as

$$Z = (X - \mu)/\sigma, \quad (1.58)$$

where  $Z$  is known as the *standard normal* and has mean 0 and variance 1. A typical problem of practical interest is determining the value of the cumulative probability for a specified value  $x$  (of the normal variable  $X$ ). This can be obtained from the cumulative distribution

function (CDF). The CDF of  $X$ , i.e.,  $F_X(x)$ , can be found by integrating the density function  $f(x)$  in (1.57) from  $-\infty$  to  $x$ . Mathematically this can be expressed as

$$F_X(x) = \int_{-\infty}^x f_X(x) dx = \int_{-\infty}^x \frac{1}{\sqrt{2\pi}\sigma} \exp\left[-\frac{1}{2}\left(\frac{x-\mu}{\sigma}\right)^2\right] dx$$

Unfortunately one cannot integrate the normal density in close form so numerical integration or tables must be used to find  $F_X(x)$ . Actually tables and numerical approximations are available in reference to the standardized variable  $Z$ . Thus, the following relationship is useful for practical applications of the normal distribution:

$$F_X(x) = F_Z(z) = \Phi(z), \quad (1.59)$$

in which  $z = (x - \mu)/\sigma$  and  $\Phi(z)$  denotes the CDF of the standard normal variable. In other words, the CDF of  $X$  can be found from the CDF of  $Z$ . Tables relating  $\Phi(z)$  versus  $z$  can be found in any standard statistical book (e.g., [220]). Likewise, another problem of interest is, given the value of the non-exceedance probability, i.e., given  $F_X(x_q) = q$ , we would like to find the  $q^{\text{th}}$ -quantile  $x_q$ . It may be shown that  $x_q$  can be obtained as a function of  $z_q$ , the  $q^{\text{th}}$  quantile of the standard normal distribution as

$$x_q = \mu + \sigma z_q. \quad (1.60)$$

Also note that both the estimation of the CDF  $F(x)$  and the quantile  $x_q$  can be made using statistical software packages and Excel.

The estimation of the parameters of the normal distribution can be made by the method of moments. They are

$$\hat{\mu}_X = \bar{x} = \frac{1}{N} \sum_{i=1}^N x_i \quad (1.61)$$

and

$$\hat{\sigma}_X = s_x = \sqrt{\frac{1}{N-1} \sum_{i=1}^N (x_i - \bar{x})^2}, \quad (1.62)$$

where  $\bar{x}$  and  $s_x$  are the sample mean and standard deviation, respectively.

### Lognormal Distribution

The lognormal distribution has been quite useful in the field of hydrology because it is a skewed distribution and is related to the normal distribution. Let us consider a lognormal distributed random variable  $X$  with parameters  $x_0$ ,  $\mu_Y$ , and  $\sigma_Y$ . It may be shown that if  $X$  is lognormal distributed with parameters  $x_0$ ,  $\mu_Y$ , and  $\sigma_Y$ , then  $Y = \log_a(X - x_0)$  (where  $x_0$  is a



lower bound) or  $Y = \log_a(x_0 - X)$  (where  $x_0$  is an upper bound) is normal with parameters  $\mu_Y$ , and  $\sigma_Y$  (note that  $a$  is the base of the logarithms and the bases  $e$  or  $10$  are commonly used). The PDF of the lognormal distribution with three parameters is defined as

$$f_X(x) = \frac{k}{\sqrt{2\pi}(x-x_0)\sigma_Y} \exp\left[-\frac{1}{2}\left(\frac{\log_a(x-x_0)-\mu_Y}{\sigma_Y}\right)^2\right], \quad \text{for } x_0 < x < \infty \quad (1.63a)$$

or

$$f_X(x) = \frac{k}{\sqrt{2\pi}(x_0-x)\sigma_Y} \exp\left[-\frac{1}{2}\left(\frac{\log_a(x_0-x)-\mu_Y}{\sigma_Y}\right)^2\right], \quad \text{for } -\infty < x < x_0, \quad (1.63b)$$

where  $k = 1$  if  $a = e$  and  $k = \log_{10}(e) = 0.4343$  if  $a = 10$ . In particular, if  $x_0 = 0$ , the model becomes the two-parameter lognormal distribution. As for the normal distribution, it is not possible to integrate the lognormal density in closed form. Therefore, the following relations are useful for computations:

$$F_X(x) = \Phi\left[\frac{\log_a(x-x_0)-\mu_Y}{\sigma_Y}\right], \quad \text{for } x_0 < x < \infty \quad (1.64a)$$

or

$$F_X(x) = 1 - \Phi\left[\frac{\log_a(x_0-x)-\mu_Y}{\sigma_Y}\right], \quad \text{for } -\infty < x < x_0 \quad (1.64b)$$

which give the CDF of  $X$  as a function of the CDF of the standardized normal. Likewise

$$x_q = x_0 + \exp_a(\mu_Y + \sigma_Y z_q), \quad \text{for } x_0 < x < \infty \quad (1.65a)$$

or

$$x_q = x_0 - \exp_a(\mu_Y + \sigma_Y z_{1-q}), \quad \text{for } -\infty < x < x_0 \quad (1.65b)$$

give the  $q^{\text{th}}$  quantile of  $X$  as a function of the  $q^{\text{th}}$  or  $(1-q)^{\text{th}}$  quantile of the standard normal.

Parameter estimation for the lognormal distribution can be made as follows. An efficient estimator of  $x_0$  is [213]

$$\hat{x}_0 = \frac{x_{\min}x_{\max} - x_{\text{med}}^2}{x_{\min} + x_{\max} - 2x_{\text{med}}} \quad (1.66)$$

where  $x_{\min}$ ,  $x_{\max}$ , and  $x_{\text{med}}$  are the sample minimum, maximum, and median, respectively. If  $x_{\min} + x_{\max} - 2x_{\text{med}} > 0$ ,  $\hat{x}_0$  is a lower bound, whereas if  $x_{\min} + x_{\max} - 2x_{\text{med}} < 0$ ,  $\hat{x}_0$  is an upper bound. Once  $x_0$  is estimated, the parameters  $\mu_Y$  and  $\sigma_Y$  may be estimated by

$$\hat{\mu}_Y = \bar{y} = \frac{1}{N} \sum_{i=1}^N \log_a(x_i - \hat{x}_0), \quad \text{for } x_0 < x < \infty \quad (1.67a)$$

or

$$\hat{\mu}_Y = \bar{y} = \frac{1}{N} \sum_{i=1}^N \log_a(\hat{x}_0 - x_i), \quad \text{for } -\infty < x < x_0 \quad (1.67b)$$

and

$$\hat{\sigma}_Y = s_y = \sqrt{\frac{1}{N-1} \sum_{i=1}^N [\log_a(x_i - \hat{x}_0) - \bar{y}]^2}, \quad \text{for } x_0 < x < \infty \quad (1.68a)$$

or

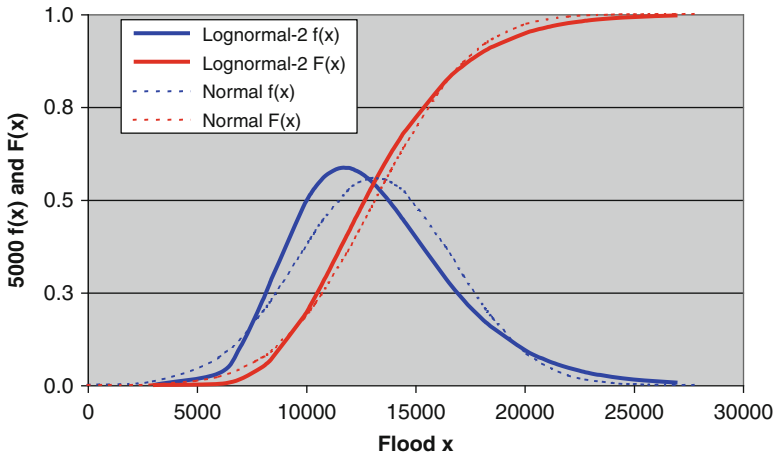
$$\hat{\sigma}_Y = s_y = \sqrt{\frac{1}{N-1} \sum_{i=1}^N [\log_a(\hat{x}_0 - x_i) - \bar{y}]^2}, \quad \text{for } -\infty < x < x_0 \quad (1.68b)$$

and  $\bar{y}$  and  $s_y$  are, respectively, the sample mean and standard deviation in the log domain.

For the same flood data of Table 1.8 above, the normal and lognormal models are fitted. Table 1.8 gives the sample mean, standard deviation, and skewness coefficient as  $\bar{x} = 13,172.9$ ,  $s_x = 3,569.3$ , and  $g_x = 0.271$ , respectively. Thus, from (1.61) and (1.62), the parameters of the normal distribution are  $\hat{\mu}_x = \bar{x} = 13,172.9$  and  $\hat{\sigma}_x = s_x = 3,569.3$ . The PDF and CDF are obtained from (1.57) and (1.59) using the mathematical functions available in Excel. Table 1.9 below shows a sample of the results obtained. In addition, Fig. 1.27 shows the comparison of the fitted normal and empirical CDFs, and Fig. 1.28 shows the fitted normal model PDF and CDF. Also a lognormal-2 model (i.e., with  $x_0 = 0$ ) is fitted. Table 1.8 (column 3) gives the base-10 logarithms of the data and the mean, standard deviation, and skewness coefficient of the logarithms as  $\bar{y} = 4.104$ ,  $s_y = 0.121$ , and  $g_y = -0.174$ , respectively. Then, the lognormal-2 model parameters are estimated from (1.67a) and (1.68a); they give  $\hat{\mu}_Y = \bar{y} = 4.104$  and  $\hat{\sigma}_Y = s_y = 0.121$ . The corresponding fitted lognormal PDF is obtained from (1.63a) in which  $k = 0.4343$  and  $x_0 = 0$ , and the fitted CDF is obtained from (1.64a) using the mathematical functions available in Excel. Table 1.9 shows the results obtained for a range of  $x$  values varying from 0 to 26,000. Figure 1.27 compares the normal, lognormal, and empirical CDFs. Because the skewness of the data is small, no major

**Table 1.9**  
**PDF and CDF for the**  
**normal and lognormal**  
**models fitted to the**  
**annual flood data of**  
**the St. Mary’s River**

Flood	Normal	Lognormal-2		
$x$	$5,000 f(x)$	$F(x)$	$5,000 f(x)$	$F(x)$
0	0.0006	0.0001	0	0
6,000	0.0742	0.0223	0.0318	0.0035
8,040	0.1988	0.0752	0.2312	0.0503
9,900	0.3671	0.1797	0.4844	0.1853
10,700	0.4397	0.2443	0.5533	0.2688
11,900	0.5245	0.3608	0.5853	0.4071
12,900	0.5572	0.4696	0.5542	0.5218
13,600	0.5549	0.5477	0.5110	0.5965
13,900	0.5473	0.5808	0.4889	0.6265
16,400	0.3713	0.8171	0.2869	0.8202
18,200	0.2072	0.9205	0.1712	0.9015
20,100	0.0850	0.9739	0.0918	0.9502
24,000	0.0056	0.9988	0.0220	0.9888
25,000	0.0023	0.9995	0.0150	0.9924
26,000	0.0009	0.9998	0.0101	0.9949



**Fig. 1.28.** PDF and CDF for the normal and lognormal models fitted to the annual flood data of the St. Mary’s River.

differences are seen between the CDFs. Also, Fig. 1.28 compares the lognormal-2 model PDF and CDF versus those of the normal model. One may observe that while the normal PDF is symmetric, that of the lognormal model is slightly skewed to the right (because of the positive skewness coefficient).

## Log-Pearson III Distribution

The log-Pearson type III distribution has been widely applied in hydrology, in particular for fitting the frequency distribution of extreme hydrologic data such as annual flood data. The US IACWD [218] recommended the use of the log-Pearson type III distribution as an attempt to promote a uniform and consistent approach for flood frequency studies. As a result, this distribution has become quite popular in the United States.

The probability density function of the log-Pearson type III distribution may be written as (e.g., [216, 221])

$$f_X(x) = \frac{k}{\alpha \Gamma(\beta)x} \left[ \frac{\log_a(x) - y_0}{\alpha} \right]^{\beta-1} \exp \left[ -\frac{\log_a(x) - y_0}{\alpha} \right], \quad (1.69)$$

where  $\alpha$ ,  $\beta$ , and  $y_0$  are the parameters and  $\Gamma(\beta)$  denotes the complete gamma function. The variable  $Y$  is a log-transform of  $X$ , i.e.,  $Y = \log_a(X)$ , and it implies that if  $X$  is log-Pearson III distributed with parameters  $\alpha$ ,  $\beta$ , and  $y_0$ , then  $Y$  is gamma distributed with the same parameter set. Thus, the parameters  $\alpha$  and  $y_0$  are expressed in the log domain. Also  $\beta > 0$  and  $\alpha$ , and  $y_0$  may be either positive or negative. If  $\alpha > 0$ ,  $f(x)$  is positively skewed and varies in the range  $\exp_a(y_0) \leq x < \infty$ . On the other hand, if  $\alpha < 0$ ,  $f(x)$  is either positively or negatively skewed depending on the values of  $\alpha$  and  $\beta$ , and  $f(x)$  varies in the range  $-\infty \leq x < \exp_a(y_0)$ . The CDF and the quantile (for a given non-exceedance probability) cannot be represented explicitly as is the case for the normal and lognormal models. Therefore, tables or numerical approximations are necessary for their computations.

The following relationships are important for parameter estimation. It may be shown that if  $X$  is log-Pearson III distributed with parameters  $\alpha$ ,  $\beta$ , and  $y_0$ , the first three population moments of  $Y = \log_a(X)$  are

$$E(Y) = \mu_Y = y_0 + \alpha\beta \quad (1.70)$$

$$\text{Var}(Y) = \sigma_Y^2 = \alpha^2\beta \quad (1.71)$$

and

$$\gamma_Y = \frac{2\alpha}{|\alpha|\sqrt{\beta}}. \quad (1.72)$$

Consider the random sample  $x_1, \dots, x_N$  where  $N =$  sample size. For fitting the log-Pearson III distribution, the original data were log-transformed, i.e.,  $y = \log_a(x)$ , and the new data set in the log domain is denoted as  $y_1, \dots, y_N$ . Then, based on the moment (1.70)–(1.72), the log-Pearson III parameters can be estimated as

$$\hat{\beta} = \left( 2/g_y \right)^2 \quad (1.73)$$

**Table 1.10**  
**Computations of flood quantiles using the log-Pearson III model fitted to the annual flood data of the St. Mary's River**

Exceedance probability	Non-exceed. probability	Return period (years)	Frequency factor	Equation (7.20)	Flood quantile
$p$	$q$	$T$	$K_T$	$y = \log(x_T)$	$x_T$
0.990	0.010	1.01	-2.4530	3.807187	6414.9
0.900	0.100	1.11	-1.2986	3.946869	8848.5
0.800	0.200	1.25	-0.8320	4.003329	10076.9
0.500	0.500	2	0.0289	4.107501	12808.6
0.200	0.800	5	0.8489	4.206714	16095.9
0.100	0.900	10	1.2614	4.256628	18056.3
0.050	0.950	20	1.5938	4.296850	20342.5
0.020	0.980	50	1.9592	4.341066	19808.4
0.010	0.990	100	2.1977	4.369920	23438.0
0.001	0.999	1,000	2.8444	4.448170	28065.3

$$\hat{\alpha} = \frac{s_y g_y}{2} \quad (1.74)$$

$$\hat{y}_0 = \bar{y} - \hat{\alpha} \hat{\beta}, \quad (1.75)$$

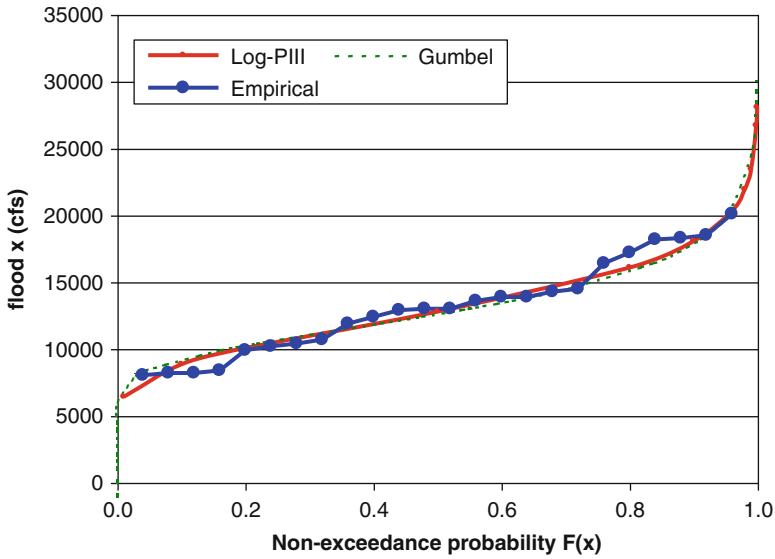
where  $\bar{y}$ ,  $s_y$ , and  $g_y$  are, respectively, the sample mean, standard deviation, and skewness coefficient of the logarithms of the data (the logs of the  $x$ 's).

The quantile (value of  $x$ ) for a return period of  $T$  years (or equivalently for an exceedance probability  $p$ ) can be obtained using the *frequency factor* of the gamma distribution as

$$\log_a(x_T) = \bar{y} + K_T s_y, \quad (1.76)$$

where  $K_T$  is the frequency factor for the gamma distribution and is a function of the skewness coefficient  $\gamma_Y$  and  $T$ . Appropriate tables that give  $K_T$  for a range of values of  $\gamma_Y$  and  $T$  can be found in literature (e.g., [218]).

For the same flood data used above, we fit the log-Pearson III distribution. The mean, standard deviation, and the skewness coefficient of the base-10 logarithms of the sample flood data are given in Table 1.8 (3rd column). They are  $\bar{y} = 4.104$ ,  $s_y = 0.121$ , and  $g_y = -0.174$ , respectively. The parameters are estimated from (1.73) through (1.75) which give  $\hat{\beta} = 132.1$ ,  $\hat{\alpha} = -0.0105$ , and  $\hat{y}_0 = 5.491$ , respectively. The flood quantiles are estimated from (1.76) using  $\bar{y} = 4.104$ ,  $s_y = 0.121$ ,  $g_y = -0.174$ , and 10 values of the frequency factor  $K_T$  that are taken from tables [218]. The results are shown in columns 1–6 of Table 1.10. For example,



**Fig. 1.29.** Comparison of the fitted Gumbel and log-Pearson III CDFs versus the empirical CDF for the annual floods of the St. Mary’s River.

referring to the 8th row, we observe that  $K_T = 1.9592$  for  $q = 0.98$  or  $T = 50$ . The value of  $K_T$  is obtained by interpolating between 1.94499 and 1.99973, values that correspond to  $T = 50$  and  $g_y = -0.20$  and  $-0.10$ , respectively. Then (1.76) gives  $\log(x_T) = 4.104 + 1.9592 \times 0.121 = 4.341$  so that  $x_T = 21,931.4$ . The values of  $x$  and  $q$  from Table 1.10 are plotted as shown in Fig. 1.29. Clearly the log-Pearson III model fits the empirical CDF reasonably well.

Gumbel Distribution

The Gumbel distribution is a particular case of the GEV distribution, i.e., the type I GEV. It has been a popular model for fitting the frequency distribution of extreme natural events such as extreme floods and winds. The model has two parameters and a fixed skewness coefficient. A nice feature of the Gumbel distribution is that both the CDF and the quantile can be written in explicit mathematical forms; hence, its application is simple and does not require numerical approximations or tables. Several parameter estimation techniques such as the method of moments, probability-weighted moments, and maximum likelihood have been developed for the Gumbel distribution (e.g., [213, 216]). In this section, we include only the moment estimates.

The PDF and CDF of the Gumbel model are given, respectively, as

$$f_X(x) = \frac{1}{\alpha} \exp\left\{-\frac{x - x_0}{\alpha} - \exp\left[-\frac{x - x_0}{\alpha}\right]\right\}, \quad -\infty < x < \infty \quad (1.77)$$

and

$$F_X(x) = \exp\left\{-\exp\left[-\frac{x-x_0}{\alpha}\right]\right\}, \quad -\infty < x < \infty, \quad (1.78)$$

where  $x_0$  is the location parameter (central value or mode) and  $\alpha$  is the scale parameter. Because of the nature of the CDF, the Gumbel model is also known as the double exponential distribution. By taking logarithms twice in (1.78), one can write  $x$  as a function of  $F(x) = q$  as

$$x = x_0 - \alpha \ln[-\ln q] \quad (1.79)$$

which can be used to obtain quantiles for specified values of the non-exceedance probability.

In addition, it may be shown that the first two population moments of the Gumbel distribution are

$$E(X) = \mu = x_0 + 0.5772\alpha \quad (1.80)$$

and

$$\text{Var}(X) = \sigma^2 = (\pi^2/6)\alpha^2 = 1.645\alpha^2. \quad (1.81)$$

Furthermore it may be shown that the skewness coefficient is  $\gamma = 1.1396$ . Equations (1.80) and (1.81) can be readily used to obtain the moment estimates of the parameters as

$$\hat{\alpha} = \frac{\sqrt{6}}{\pi} s_x = 0.78s_x \quad (1.82)$$

and

$$\hat{x}_0 = \bar{x} - 0.5772\hat{\alpha}, \quad (1.83)$$

in which  $\bar{x}$  and  $s_x$  are the sample mean and standard deviation.

For the same flood data used above, we fit the Gumbel model. The parameters are estimated from (1.82) and (1.83) based on the sample statistics  $\bar{x} = 13,172.9$  and  $s_x = 3,569.3$ . The results are  $\hat{\alpha} = 2,784$  and  $\hat{x}_0 = 11,566$ . Then (1.77) and (1.78) are used to calculate the PDF and CDF, respectively, for values of  $x$  ranging from 6,000 to 22,000 as shown in columns 1–3 in Table 1.11. Also flood quantiles are estimated from (1.79) for specified values of the non-exceedance probability  $q$  ranging from 0.1 to 0.9999 (i.e.,  $p$  ranging from 0.9 to 0.0001 or  $T$  ranging from 1.111 to 10,000 as shown in columns 4–7 in Table 1.11). The CDF is plotted in Fig. 1.29 next to the CDF of the log-Pearson III model and the empirical CDF.

**Table 1.11**  
**Gumbel model PDF and CDF for various values of the flood  $x$  and flood quantiles obtained for given values of non-exceeding probabilities**

Flood value	PDF	CDF	Non-exceed. prob.	Exceed. prob.	Return period	Flood quantile
$x$	10,000 $f(x)$	$F(x)$	$F(x) = q$	$p$	$T$	$x$
6,000	0.0165	0.0006	0.1000	0.9000	1.111	9,244
8,000	0.3534	0.0273	0.2500	0.7500	1.333	10,657
10,000	1.0900	0.1729	0.5000	0.5000	2	12,586
12,000	1.3062	0.4250	0.9000	0.1000	10	17,831
14,000	0.9873	0.6589	0.9500	0.0500	20	19,835
16,000	0.5961	0.8160	0.9750	0.0250	40	21,801
18,000	0.3225	0.9056	0.9800	0.0200	50	22,429
20,000	0.1654	0.9528	0.9900	0.0100	100	24,373
21,000	0.1172	0.9668	0.9990	0.0010	1,000	30,796
22,000	0.0827	0.9767	0.9999	0.0001	10,000	37,207

### 7.2.3. Risk and Reliability for Design

#### Design Flood and Design Life

We have seen in previous sections that annual floods are random variables that can be described by probability laws or probability distribution functions. Once a probability model is specified, one can determine a flood quantile for any non-exceedance (or exceedance) probability. Thus, for the models we have presented in Sect. 7.2.2 above, we have outlined the equations and procedures for estimating flood quantiles. For example, for the lognormal model, (1.65) can be used to determine the flood value  $x$  corresponding to a specified non-exceedance probability  $F(x) = q$ . Such flood value (flood quantile) was denoted as  $x_q$ . Also since  $T = 1/(1 - q) = 1/p$  is the return period, such flood quantile is commonly denoted as  $x_T$  and is called the  $T$ -year flood (note that sometimes the notation  $x_p$  is also used which means the flood with exceeding probability  $p = 1 - q$ ). For instance, referring to the lognormal model that was fitted to the annual flood data of the St. Mary's River, the model parameters were found to be  $\hat{\mu}_Y = 4.104$  and  $\hat{\sigma}_Y = 0.121$ . Then assuming  $q = 0.99$  (i.e.,  $p = 0.01$  or  $T = 100$ ), (1.65) for  $x_0 = 0$  gives

$$\hat{x}_{0.99} = \exp_{10}(4.104 + 0.121z_{0.99}) = \exp_{10}(4.104 + 0.121 \times 2.326) = 24,291.$$

Thus, 24,291 cfs is the flood with 99 % non-exceedance probability, or the flood with 1 % exceedance probability (i.e., there is 1 % of chance that floods in the referred river will exceed 24,291 in any given year), or is the 100-year flood.

In the context of designing hydraulic structures such as drainage systems and spillways, generally the return period  $T$  is specified depending on the type of structure to be designed

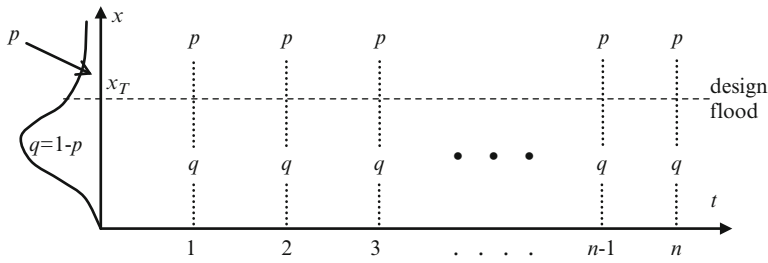


(e.g., [46]), and the design flood is determined from the frequency analysis of flood data as referred to in Sect. 7.2.2. The *design life* of a hydraulic structure has an economic connotation. For purposes of defining the concept, a simple example follows. Suppose the designer of a small bridge selects 25 years as the return period and after estimating the 25-year flood from frequency analysis, the estimated cost of the bridge is \$ 50,000. To pay for the construction of the bridge, the designer goes to the bank to borrow the money. The bank officer tells her that they can lend her the money if it is paid off in no more than 10 years. Then 10 years becomes the design life. The banker in fact may ask some other technical questions or requirements before processing the loan. For example, the bank may like to know “what is the risk that two floods exceeding the design flood may occur during the first five years after the construction of the bridge?” (perhaps the reasoning being that if one flood exceeding the design flood, say a 30-year flood, occurs in the five year period, the bridge may be repaired and continue functioning for the rest of the design life and that possibility may be acceptable to the bank, but if two floods exceeding the design flood occur within the first five years, then that possibility may not be acceptable to the bank especially if the risk of that event is beyond an acceptable level). The answer to the foregoing question and similar others concerning the risk of failure of a hydraulic structure are discussed in the sections below.

#### Probability of the Number of Floods Exceeding the Design Flood in a Given Time Period

Once a tentative design flood has been specified for a hydraulic structure, one of the first questions the designer may like to know is the probability that a certain number of floods exceeding the design flood may occur during a given number of years (e.g., during the design life of the structure). We will answer this and other related questions using the binomial probability law. For easy explanation in the following text, when referring to “floods that exceed the design flood,” we will use the term *exceeding floods*.

Firstly, let us consider a simple case. Assume that a  $T$ -year flood is the design flood, i.e., a flood with  $p = 1/T$  exceeding probability. This implies that  $p$  is the probability of exceeding floods and  $q = 1 - p$  is the probability of non-exceeding floods. In fact,  $p$  is the probability of exceeding floods in any given year, and we will assume that it remains constant throughout the future years considered, and also we will assume that floods are independent events. Figure 1.30 below illustrates this concept. Considering  $n = 2$ , we would like to answer the question: what is the probability that  $y$  exceeding floods will occur during the 2-year period? Clearly the only possible values that  $Y$  can take on are  $y = 0, 1, \text{ or } 2$ . Thus, we would like to find  $P(Y = 0)$ ,  $P(Y = 1)$ , and  $P(Y = 2)$ . Denoting by  $F$  the event of exceeding floods in any 1 year and by  $NF$  the opposite (non-exceeding floods), Table 1.12 summarizes the exceeding flood events that must occur in years 1 and 2 for the number of exceeding floods in the 2-year period to be either 0, 1, or 2. The last column gives the probability  $P(Y = y)$ ,  $y = 0, 1, 2$ . Following similar reasoning when  $n = 3$ , one can find that  $P(Y = 0) = (1 - p)^3$ ,  $P(Y = 1) = 3p(1 - p)^2$ ,  $P(Y = 2) = 3p^2(1 - p)$ , and  $P(Y = 3) = p^3$ . In general, for any  $n$ , it may be shown that



**Fig. 1.30.** Schematic depicting the design flood  $x_T$  and exceeding and non-exceeding probabilities throughout years 1 to  $n$  (adapted from ref. 216).

**Table 1.12**  
**Flood occurrence and probability of the number of exceeding floods in a 2-year period**

Number of exceeding floods in a 2-year period $y$	Flood occurrence year 1	Flood occurrence year 2	Probability of $y$ exceeding floods in a 2-year period $P(Y = y)$
0	NF*	NF	$(1 - p)(1 - p) = (1 - p)^2$
1	F or NF	NF or F	$p(1 - p) + (1 - p)p = 2p(1 - p)$
2	F	F	$p p = p^2$

\*NF no flood exceeding the design flood, F flood exceeding the design flood.

$$\begin{aligned}
 P(Y = y) &= \binom{n}{y} p^y (1 - p)^{n-y}, \quad y = 0, 1, \dots, n \\
 &= \frac{n!}{y!(n - y)!} p^y (1 - p)^{n-y}, \quad y = 0, 1, \dots, n
 \end{aligned}
 \tag{1.84}$$

which is the well-known binomial probability model. For example, for  $n = 3$ , (1.84) gives

$$P(Y = 2) = \frac{3!}{2!(3 - 2)!} p^2 (1 - p)^{3-2} = 3p^2(1 - p).$$

**First Occurrence Probability of a Flood Exceeding the Design Flood and Return Period**

We have already stated above that return period  $T$  is equal to  $1/p$ . However, it is useful examining the fundamental concepts behind this definition. Let us consider again the same flood problem as before where we selected a given value of  $T$  and determine the corresponding design flood (i.e., flood quantile) from frequency analysis. We would like to answer the following question: what is the probability that an exceeding flood (a flood exceeding the design flood) will occur for the first time in year  $w$ ? Clearly that first time

could be in year 1, or 2, or 3, etc., or perhaps it will never occur. Obviously the waiting time for an exceeding flood to occur for the first time is a random variable that we will denote by  $W$ . For an exceeding flood to occur for the first time at year  $W = w$ , the following event must occur:

Year:	1	2	3	...	$w - 1$	$w$
Event:	NF	NF	NF	...	NF	F
Probability:	$1 - p$	$1 - p$	$1 - p$	...	$1 - p$	$p$

As usual considering that floods are independent the referred event has probability  $(1 - p)^{w-1} p$  or

$$P(W = w) = (1 - p)^{w-1} p, \quad w = 1, 2, \dots \quad (1.85)$$

which is the geometric probability law. It may be shown that  $E(W) = 1/p$ , i.e., the expected waiting time or the mean number of years that will take for an exceeding flood to occur is  $1/p$  and that has become known as return period, i.e.,  $T = 1/p$ .

### Risk of Failure and Reliability

Risk and reliability are important concepts for designing hydraulic structures. In the previous examples on designing flood-related structures such as a bridge, we assumed that the return period  $T$  was selected from design tables or manuals and that the actual design flood magnitude is found from flood frequency analysis. In this section, we are interested on the risk of failure of the referred structure. However, we must specify a time frame such as one year and two years where the possibility of failure of the referred structure may occur. Also we will define as failure as that situation in which a flood exceeding the design flood occurs. Then we can ask the question: “what is the *risk of failure* of the structure in a period of  $n$  years?” (The value of  $n$  could be in fact the design life that we referred to in Sect. 7.2.3 above.) For instance, for  $n = 1$ , the *reliability* is  $R_\ell = q = 1 - p$  and conversely the risk is  $R = 1 - R_\ell = p$ . When  $n = 2$  the reliability of the structure can be calculated by the event that no exceeding floods will occur in the 2-year period, i.e., NF in the first year and NF in the second year. Thus, the probability of such 2-year event is  $(1 - p)(1 - p) = (1 - p)^2$  so that the reliability of the structure is  $R_\ell = (1 - p)^2$  and consequently the risk of failure becomes  $R = 1 - (1 - p)^2$ . Likewise, in general for an  $n$ -year period, the reliability is  $(1 - p)^n$  and the risk of failure becomes  $R = 1 - (1 - p)^n$ .

Actually with the foregoing background, we can now define reliability and risk using the binomial law previously described in Sect. 7.2.3. We define reliability as the probability that no exceeding floods will occur in an  $n$ -year period, i.e.,  $R_\ell = P(Y = 0)$  where  $Y =$  random variable denoting the number of exceeding floods in an  $n$ -year period. Likewise, risk is defined as the probability that one or more exceeding floods will occur in an  $n$ -year period, i.e.,  $R = P(Y > 0) = 1 - P(Y = 0)$ . These probabilities can be readily obtained from (1.84). Summarizing

$$R_\ell = P(Y = 0) = (1 - p)^n, \quad (1.86)$$

$$R = P(Y > 0) = 1 - (1 - p)^n. \quad (1.87)$$

Consider the data and results of the log-Pearson III model which was fitted to the annual flood data of the St. Mary's River (Sect. 7.2.2). Assume that a large bridge will be designed to cross the river. From design tables (e.g., [46]), the return period for designing a large bridge is taken as 50 years, and the 50-year flood using the log-Pearson III model gives  $\hat{x}_{50} = 21,931.4$  cfs. Then, for  $p = 0.02$  and  $n = 10$  (design life), (1.86) gives  $R_\ell = (1 - 0.02)^{10} = 81.7\%$  and  $R = 1 - (1 - 0.02)^{10} = 18.3\%$ . To lower the risk of failure, one may have to increase the design flood. For instance, if  $T = 100$  and  $p = 0.01$ , then the risk becomes 9.6 %.

### Expected Damage, Vulnerability, and Risk

In the previous section, we defined the term risk in the sense of *hydrologic risk*. However, in actual practice, the term risk also has other connotations. For example, continuing with the previous reference to flood events, let us assume that for a given reach of a river, it is known that the relationship between the flood level  $H$  and the damage  $D$ , i.e.,  $D = g_1(H)$  and  $D$ , can be expressed in monetary terms. Likewise, we assume a relationship between the flood level  $H$  and the flood discharge  $X$ , i.e.,  $H = g_2(X)$ . Because the probability distribution of  $X$  is known (Sect. 7.3), then conceptually we can find the distribution  $f_H(h)$  of the flood level  $H$  and consequently the distribution  $f_D(d)$  of the flood damage  $D$ . Then the expected value of the flood damage  $E(D)$  can be found by integration, i.e.,  $E(D) = \int_{-\infty}^{\infty} df_D(d)dd$ . Such expected damage (expected cost) has been also called risk, i.e.,  $R = E(D)$ . A practical reference on this subject is USACE [222].

However, an alternative way at looking at the problem may be finding a relationship (function) linking directly the damage  $D$  and the flood  $X$ , e.g.,  $d(X)$ . In this case, the expected damage (risk) can be found as  $R = E(D) = \int_{-\infty}^{\infty} d(x)f_X(x)dx$ . More realistically, since the damage begins to occur after the flood has reached some threshold, say  $x_0$ , and the damage after the flood reaches and exceeds some maximum threshold,  $x_m$  is likely to be a total or maximum damage  $d_m$  (e.g., total loss of a farmhouse, thus the cost of replacing the property), then the expected damage must be determined as  $R = E(D) = \int_{-x_0}^{x_m} d(x)f_X(x)dx + [1 - F_X(x_m)] \times d_m$  where  $F_X(x_m)$  is the CDF of the flood  $X$  evaluated at the value  $x_m$ .

Furthermore, we may add the concept of *vulnerability*. Assume a simple case where a flood wall is built to protect the flood plain so that  $d(x) = 0$  if  $x \leq x_d$  and  $d(x) = d_m$  if  $x > x_d$ , where  $x_d$  is the design flood of the flood wall. Then the risk is given by  $R = P(X > x_d)d_m$ . In addition, assume that the property owners in the floodplain have the option of building additional protection for their property. For example, if they do nothing, then the damage is  $d_m$  when the flood exceeds  $x_d$ , and in that case, the vulnerability ( $V$ ) of the property is 100 %. While if property owners build say a wall surrounding their property, we

may estimate the vulnerability as say 75 %, and if, in addition, they protect the doors and windows, then the estimated vulnerability may be reduced to 60 %. Thus, the risk is now given by  $R = P(X > x_d)d_m V$ . Therefore, in general assuming that vulnerability is also a function of the flood magnitude,  $V(x)$ , the expected damage (risk) may be determined as  $R = E(D) = E(D) = \int_{x_d}^{\infty} d(x)V(x)f_X(x)dx$ . Further details on the concept of vulnerability in connection to flood analysis may be found in Platte [223].

#### 7.2.4. Regional Frequency Analysis

In general, regional frequency analysis is a procedure for estimating quantiles of a probability distribution of the variable of interest (e.g., floods, low flows, or maximum precipitation) which is applicable to a given region (or area). Commonly this is done where the particular site (e.g., a stream cross section) lacks enough data so that a reliable estimate of a given quantile (e.g., the 100-year flood) can be made or the site is ungauged. Thus, alternative methods have been developed in literature depending on the type of variable, although some of the methods may be equally applicable regardless of the type of variable.

A widely used method for regional flood frequency analysis is based on a multiple regression model such as  $Y = aX_1^{b_1}X_2^{b_2} \dots X_m^{b_m}$ , where the dependent variable  $Y$  may represent a particular flood quantile (e.g., the  $T$ -year flood say  $Q_T$ ) and the  $X$ s are the independent variables (predictors), which generally involve physiographic (e.g., area of the basin, slope, and drainage density) and climatic (e.g., index of precipitation, temperature, and wind) characteristics. Literature abounds on applying this technique (e.g., [213, 224–228]). For example, Mc Cain and Jarrett [226] found the regression equation  $Q_{100} = 1.88A^{0.787}P^{0.932}$  for the mountains of the State of Colorado, USA, where  $A$  and  $P$  represent the drainage area and the mean annual precipitation, respectively. Selecting a particular quantile (say  $Q_T$ ) as the dependent variable has the disadvantage that multiple regression equations may be needed, i.e., one for every  $T$ . Instead two alternatives may be (1) regionalizing the sample moments such as  $\bar{Q}$ ,  $S_Q$ , and  $g_Q$  (i.e., the sample mean, standard deviation, and skewness coefficient, respectively) from which the estimates of the parameters  $\underline{\theta}$  of the flood frequency distribution  $f_Q(q, \underline{\theta})$  can be determined based on the method of moments and (2) regionalizing the parameters of a particular model. The two alternatives have the advantage that only two or three regressions are needed (depending on the model) and any flood quantile may be derived from the regionalized parameters (e.g., [227, 229]).

Another alternative, which is applicable for regionalizing flood quantiles and extreme precipitation quantiles, is the so-called *index-flood method* (IFM). This method, originally suggested by Dalrymple [230], involves three key assumptions: (1) observations at any given site are independent and identically distributed, (2) observations at different sites are independent, and (3) frequency distributions at different sites are identical except for a scale factor. The first assumption is a basic assumption for most methods of frequency analysis of extreme events, but the last two assumptions are unlikely to be met by hydrometeorological data [231]. The third assumption may be mathematically characterized as  $y_q^{(i)} = \mu^{(i)}y_q^R$ ,

$i = 1, \dots, n$  where  $y_q^{(i)} = q$ th quantile for site  $i$ ,  $\mu^{(i)} =$  index flood for site  $i$ ,  $y_q^R =$  regional  $q^{\text{th}}$  quantile, and  $n =$  number of sites in the region. The index flood  $\mu^{(i)}$  is usually taken to be the at-site population mean for site  $i$ , which is estimated by the at-site sample mean, i.e.,  $\hat{\mu}^{(i)} = \bar{y}^{(i)}$ . To estimate the regional  $q^{\text{th}}$  quantile, a model is assumed, and the parameter estimation may be based on the method of moments, probability-weighted moments, or maximum likelihood, depending on the selected model. Details on the applicability of this method for flood and extreme precipitation frequency analysis can be found in many published papers and books (e.g., [231–236]). An apparent flaw of the method resulting from using the sample mean as the index flood (as noted above) has been discussed by Stedinger [237] and Sveinsson et al. [238], and an index-flood method that avoids such a flaw (called the population index flood) has been developed [238]. In addition, Burn et al. [239] discussed approaches for regionalizing catchments for regional flood frequency analysis, Cunnane [240] reviewed the various methods and merits of regional flood frequency analysis, and also a worldwide comparison of regional flood estimation methods has been done [241].

Furthermore, regionalization and estimation of low-flow variables (e.g., [242–247]) and droughts (e.g., [248–250]) have been suggested in literature.

### 7.2.5. Uncertainty Considerations in Frequency Analysis

In the examples in Sect. 7.2.2, we illustrated how one can estimate the parameters  $\underline{\theta}$  of a specified distribution  $f_X(x; \underline{\theta})$  given that we have observations  $x_1, \dots, x_N$  of say flood, extreme precipitation, or low flows. However, since the parameters are estimated from a limited sample, they are uncertain quantities, i.e.,  $\hat{\underline{\theta}} = g_1(x_1, \dots, x_N)$ , and consequently since the  $q$ th quantile  $x_q$  is a function of the parameters, then it is also an uncertain quantity, i.e.,  $\hat{x}_q = g_2(\hat{\underline{\theta}})$ . Thus, for the common distributions that are generally applied in hydrology and water resources and for the various estimation methods, procedures have been developed for estimating the confidence limits for the population parameters and confidence limits for the population quantiles (e.g., [213, 216, 218, 251]). Obviously those confidence limits depend on the sample size  $N$ , and as the sample size becomes larger, the confidence interval becomes narrower and conversely.

There is the additional uncertainty regarding the distribution model, although often the model may be suggested by manuals or standards and they vary with the region or country. For example, for flood frequency analysis, the log-Pearson III is the preferred model in the United States, while the logistic model is the recommended model in Great Britain. Regardless there are also statistical procedures for testing the goodness of fit of the models although often more than one candidate model may not be rejected by the tests [219]. Likewise, simulation studies can be made for comparing the applicability of alternative models for estimating quantiles that are beyond the length of the historical sample. Also when the sample size for a given site is small, one may apply statistical models to extend the short records if longer records are available at nearby basins, and in some cases, rainfall-runoff models may be useful for record extension. And as indicated above, regional frequency analysis may be

also applied particularly for ungauged basins, but also regional parameters or quantile estimates can be combined with at-site estimates (e.g., [226]).

Furthermore, in designing flood-related hydraulic structures, it is a common practice to specify a return period and derive the corresponding design flood of the structure from the frequency distribution of the historical annual floods. Thus, the return period  $T = 1/(1 - q)$  is specified and the design flood  $x_q$  obtained from the selected CDF  $F(x; \theta)$ . Another case that arises in practice relates to projects that have been operating for some time, and it may be desirable reevaluating the capacity of the structure. This may be desirable because of several reasons such as the occurrence of extreme floods, the additional years of flood records, the modification of design manuals and procedures, and perhaps changes in the hydrologic regime as a result of climate variability and change, or changes in the landscape and land use, etc. [216]. In any case, reevaluating the capacity of the structure means that the flood magnitude is known and one may like to recalculate the structure's performance, such as the return period and the risk of failure. Thus, in this second situation, the design flood magnitude  $x_q$  is known, and the problem is estimating the non-exceedance probability  $q$ . Thus,  $q$  is the uncertain quantity (and consequently  $p$ ,  $T$ , and  $R$ ). A method that accounts for the uncertainty in estimating the non-exceedance probability  $q$ , the return period  $T$ , and the risk of failure  $R$  has been suggested by Salas and Heo [252], Salas et al., [253], and Salas et al. [254].

### 7.3. Stochastic Methods in Hydrology and Water Resources

#### 7.3.1. Introduction

Generally stochastic (time series) models may be used for two main purposes, namely, for *stochastic simulation* or *data generation* and for *forecasting*. In stochastic simulation, we use a stochastic model to generate artificial records of the variable at hand, e.g., streamflows, for a specified period of time, e.g., 50 years. Depending on the problem, one can simulate many *equally likely* samples of streamflows, each 50 years long or simulate one very long sample (e.g., 100,000 years long). On the other hand, in forecasting, we make the best estimate of the value of streamflow that may occur say in the period April–July given the observed streamflows in the past and many other predictors as needed. Typically, stochastic simulation is used for planning purposes, e.g., for estimating the capacity of a reservoir to supply water for an irrigation system, for testing operating rules and procedures under uncertain hydrologic scenarios, for estimating the return period of severe droughts, and for many other purposes (e.g., [255, 256]). On the other hand, short-term, medium-term, and long-range forecasting are needed in practice for a number of applications such as operating water supply systems, hydropower network systems, flood warning systems, irrigation scheduling, water releases from reservoirs, and tracking the dynamics of ongoing droughts.

The field of stochastic hydrology has been developed since the early work of Hurst [257], Thomas and Fiering [258], Yevjevich [259], Matalas [260], and Mandelbrot and Wallis [261] in the 1950s and 1960s who inspired the work and contributions of many others along several directions and books, chapters of books, papers, manuals, and software have been developed. Perhaps a broad classification of the various methods proposed may be as parametric and

nonparametric methods, and in each (category) well-known models and approaches became popular such as autoregressive (AR) and autoregressive and moving average (ARMA) for parametric (e.g., [255, 256, 262–264]) and bootstrap, kernel density estimates (KDE), K-nearest neighbor (KNN), and variations thereof for nonparametric (e.g., [217, 265–269]). Also the methods and names of models depend on the type of hydrologic processes to be analyzed, such as precipitation or streamflows, on the time scale, i.e., hourly, daily, seasonal, and yearly, and the number of sites involved (single or multiple sites). For example, contemporaneous ARMA (CARMA) has been widely used for modeling multisite streamflows (e.g., [256, 264]). Also modeling and simulation of complex systems can be simplified using temporal and spatial disaggregation and aggregation approaches (e.g., [256, 262, 270–276]). In this section, we introduce the subject with some concepts and definitions, describe how to characterize a hydrologic time series at yearly and monthly time scales, and apply a simple AR model along with an example to illustrate how to simulate streamflows. Subsequently we briefly discuss additional concepts regarding forecasting followed by a section on uncertainty issues. The issue of nonstationarity is covered in Sect. 7.4.

### 7.3.2. Main Concepts and Definitions

Most hydrologic series of practical interest are *discrete time series* defined on hourly, daily, weekly, monthly, and annual time intervals. The term *seasonal time series* is often used for series with time intervals that are fractions of a year (e.g., a month). Also seasonal time series are often called *periodic-stochastic* series because although being stochastic, they evolve in a periodic fashion from year to year. Hydrologic time series may be single or *univariate* series (e.g., the monthly precipitation series at a given gauge) and multiple or *multivariate* series (e.g., the monthly precipitation series obtained from several gauges). A time series is said to be *stationary* if the statistical properties such as the mean, variance, and skewness do not vary through time. Conversely if the statistical properties vary through time, then the time series is *nonstationary*.

Hydrologic time series are generally *autocorrelated*. Autocorrelation in some series such as streamflow usually arises from the effects of surface, soil, and groundwater storages [256]. Conversely, annual precipitation and annual maximum flows (flood peaks) are usually uncorrelated. Sometimes autocorrelation may be the result of trends and/or shifts in the series [97, 277]. In addition, multiple hydrologic series may be *cross-correlated*. For example, the streamflow series at two nearby gauging stations in a river basin are expected to be cross-correlated because the sites are subject to similar climatic and hydrologic events, and as the sites considered become farther apart, their cross-correlation decreases. However, because of the effect of some large-scale atmospheric-oceanic phenomena such as ENSO (El Niño Southern Oscillation), significant cross-correlation between SST (sea surface temperature) and streamflow between sites that may be thousands of miles apart can be found [278]. Furthermore, hydrologic time series may be *intermittent* when the variable under consideration takes on nonzero and zero values throughout the length of the record. For instance, hourly and daily rainfalls are typically intermittent series, while monthly and annual rainfalls are usually



non-intermittent. However, in arid regions, even monthly and annual precipitation and runoff may be intermittent as well.

Traditionally, certain annual hydrologic series have been considered to be stationary, although this assumption may be incorrect because of the effect of large-scale climatic variability, natural disruptions like a volcanic eruption, anthropogenic changes such as the effect of reservoir construction on downstream flow, and the effect of landscape changes on some components of the hydrologic cycle [279]. Also, hydrologic series defined at time intervals smaller than a year such as months generally exhibit distinct *seasonal (periodic)* patterns due to the annual revolution of the earth around the sun. Likewise, summer hourly rainfall series or certain water quality constituents related to temperature may also exhibit distinct diurnal patterns due to the daily rotation of the earth [280, 281]. Cyclic patterns of hydrologic series translate into statistical characteristics that vary within the year or within a week or a day as the case may be, such as seasonal or periodic variations in the mean, variance, covariance, and skewness. Thus, series with periodic variations in their statistical properties are nonstationary.

In addition of seasonality (periodicity), hydrologic time series may exhibit trends, shifts or jumps, autocorrelation, and non-normality. In general, natural and human-induced factors may produce gradual and instantaneous trends and shifts (jumps) in hydroclimatic series. For example, a large forest fire in a river basin can immediately affect the runoff, producing a shift in the runoff series. A large volcanic explosion or a large landslide can produce sudden changes in the sediment transport series of a stream. Trends in nonpoint source water quality series may be the result of long-term changes in agricultural practices and agricultural land development, and changes in land use and the development of reservoirs and diversion structures may also cause trends and shifts in streamflow series. The concern about the effects of global warming and those from low-frequency components in the atmospheric and ocean system (e.g., the Pacific Decadal Oscillation and the Atlantic Multidecadal Oscillation) is making hydrologists more aware of the occurrence of trends and shifts in hydrologic time series and the ensuing effects on water resources, the environment, and society (e.g., [279, 282], and also refer to Sect. 7.4).

### 7.3.3. Stochastic Characteristics of Hydrologic Data

The stochastic characterization of the underlying hydrologic processes is important in constructing stochastic models. In general, the stochastic characteristics of hydrologic series depend on the type of data at hand, e.g., data of precipitation and streamflow, and the time scale, e.g., yearly and monthly. The most commonly used statistical properties for analyzing hydrologic time series are the sample mean  $\bar{y}$ , variance  $s^2$ , coefficient of variation  $C_v$ , skewness coefficient  $g$ , and lag- $k$  autocorrelation coefficient  $r_k$ . Coefficients of variation of annual flows are typically smaller than one, although they may be close to one or greater in streams in arid and semiarid regions. The coefficients of skewness  $g$  of annual flows are typically greater than zero. In some streams, small values of  $g$  are found suggesting that annual flows may be approximately normally distributed. On the other hand, in streams of arid and semiarid regions,  $g$  can be greater than one.

The sample mean, variance, and skewness coefficient may be calculated, respectively, as

$$\bar{y} = \frac{1}{N} \sum_{t=1}^N y_t \quad (1.88)$$

$$s_y^2 = \frac{1}{N-1} \sum_{t=1}^N (y_t - \bar{y})^2 \quad (1.89)$$

and

$$g_y = \frac{N \sum_{t=1}^N (y_t - \bar{y})^3}{(N-1)(N-2)s_y^3}. \quad (1.90)$$

And the sample lag-1 autocorrelation coefficient  $r_1$  may be determined by

$$r_1 = \frac{c_1}{c_0}, \quad (1.91a)$$

$$c_k = \frac{1}{N} \sum_{t=1}^{N-k} (y_{t+k} - \bar{y})(y_t - \bar{y}), \quad k = 0, 1, \dots, \quad (1.91b)$$

where  $N$  = sample size and  $k$  = time lag. The lag-1 autocorrelation coefficient  $r_1$  (also called serial correlation coefficient) is a simple measure of the degree of time dependence of a series. Generally  $r_1$  for annual flows is small but positive, although negative  $r_1$ s may occur because of sample variability. Large values of  $r_1$  for annual flows can be found for a number of reasons including the effect of natural or man-made surface storage such as lakes, reservoirs, or glaciers, the effect of groundwater storage, the effect of errors in naturalizing streamflow data, and the effect of low-frequency components of the climate system. The estimators  $s_y^2$ ,  $g_y$ , and  $r_1$  are biased downward relative to the corresponding population statistics. Corrections for bias for these estimators have been suggested (e.g., [283–285]). In addition, when analyzing several time series jointly, cross-correlations may be important (e.g., [256]).

While the overall stochastic properties of hydrologic time series, such as those defined above, may be determined either from annual series or for seasonal series as a whole, specific seasonal (periodic) properties may provide a better picture of the stochastic characteristics of hydrologic time series that are defined at time intervals smaller than a year such as monthly streamflow data. Let the seasonal time series be represented by  $y_{\nu,\tau}$ ,  $\nu = 1, \dots, N$ ;  $\tau = 1, \dots, \omega$  in which  $\nu$  = year,  $\tau$  = season,  $N$  = number of years of record, and  $\omega$  = the number of seasons per year (e.g.,  $\omega = 12$  for monthly data). Then, for each season  $\tau$ , one can determine the mean  $\bar{y}_\tau$ , variance  $s_\tau^2$ , coefficient of variation  $Cv_\tau$ , and skewness coefficient

$g_\tau$  (these statistics are denoted as seasonal or periodic statistics). For example, the sample seasonal mean, variance, and skewness coefficient may be determined, respectively, as

$$\bar{y}_\tau = \frac{1}{N} \sum_{\nu=1}^N y_{\nu,\tau}, \dots \tau = 1, \dots, \omega \quad (1.92)$$

$$s_\tau^2 = \frac{1}{N-1} \sum_{\nu=1}^N (y_{\nu,\tau} - \bar{y}_\tau)^2, \dots \tau = 1, \dots, \omega \quad (1.93)$$

and

$$g_\tau = \frac{N \sum_{\nu=1}^N (y_{\nu,\tau} - \bar{y}_\tau)^3}{(N-1)(N-2)s_\tau^3}, \dots \tau = 1, \dots, \omega. \quad (1.94)$$

Furthermore, the sample season-to-season correlation coefficient  $r_{1,\tau}$  may be estimated by

$$r_{1,\tau} = \frac{c_{1,\tau}}{(c_{0,\tau-1}c_{0,\tau})^{1/2}}, \quad \tau = 1, \dots, \omega \quad (1.95a)$$

$$c_{k,\tau} = \frac{1}{N} \sum_{\nu=1}^N (y_{\nu,\tau} - \bar{y}_\tau)(y_{\nu,\tau-k} - \bar{y}_{\tau-k}), \quad k = 0, 1; \quad \tau = 1, \dots, \omega \quad (1.95b)$$

For instance, for monthly streamflows,  $r_{1,4}$  represents the correlation between the flows of the fourth month with those of the third month. Note that for  $\tau = 1$ ,  $c_{0,\tau-1}$  in (1.95a) must be replaced by  $c_{0,\omega}$ , and for  $\tau = 1$  and  $k = 1$ ,  $y_{\nu,\tau-1}$  and  $\bar{y}_{\tau-1}$  in (1.95b) must be replaced by  $y_{\nu-1,\omega}$  and  $\bar{y}_\omega$ , respectively. Likewise, for multiple seasonal time series, the sample lag-1 seasonal cross-correlation coefficient  $r_{i,\tau}^{ij}$  between the seasonal time series  $y_{\nu,\tau}^{(i)}$  and  $y_{\nu,\tau-1}^{(j)}$  for sites  $i$  and  $j$  may be determined.

The statistics  $\bar{y}_\tau$ ,  $s_\tau$ ,  $g_\tau$ , and  $r_{1,\tau}$  may be plotted versus time  $\tau = 1, \dots, \omega$  to observe whether they exhibit a seasonal pattern. Fitting these statistics by Fourier series is especially effective for weekly and daily data [262]. Generally, for seasonal streamflow series,  $\bar{y}_\tau > s_\tau$  although for some streams  $\bar{y}_\tau$  may be smaller than  $s_\tau$  especially during the “low-flow” season. Furthermore, for streamflow series in dry areas, the mean may be smaller than the standard deviation, i.e.,  $\bar{y}_\tau < s_\tau$  throughout the year [279]. Likewise, values of the skewness coefficient  $g_\tau$  for the dry season are generally larger than those for the wet season indicating that data in the dry season depart more from normality than data in the wet season. Values of the skewness for intermittent hydrologic series are usually larger than skewness for similar non-intermittent series. Seasonal correlations  $r_{1,\tau}$  for streamflow during the dry season are generally larger than

**Table 1.13**  
**Statistical analysis of the annual streamflows (acre-ft) of the Poudre River for the period 1971–1990**

1	2	3	4	5	6	7	(5) × (7)
$t$	$x_t$	$y_t = \log(x_t)$	$(y_t - \bar{y})^2$	$y_t - \bar{y}$	$y_{t-1}$	$y_{t-1} - \bar{y}$	
1971	367,000	5.56467	0.0100				
1972	238,000	5.37658	0.0078	-0.0882	5.56467	0.09994	-0.00881
1973	377,000	5.57634	0.0125	0.1116	5.37658	-0.08815	-0.00984
1974	329,000	5.51720	0.0028	0.0525	5.57634	0.11161	0.00586
1975	278,000	5.44404	0.0004	-0.0207	5.51720	0.05247	-0.00109
1976	206,000	5.31387	0.0228	-0.1509	5.44404	-0.02069	0.00312
1977	129,000	5.11059	0.1254	-0.3541	5.31387	-0.15086	0.05343
1978	330,000	5.51851	0.0029	0.0538	5.11059	-0.35414	-0.01905
1979	372,000	5.57054	0.0112	0.1058	5.51851	0.05378	0.00569
1980	471,000	5.67302	0.0434	0.2083	5.57054	0.10581	0.02204
1981	193,000	5.28556	0.0321	-0.1792	5.67302	0.20829	-0.03732
1982	298,000	5.47422	0.0001	0.0095	5.28556	-0.17917	-0.00170
1983	702,000	5.84634	0.1456	0.3816	5.47422	0.00949	0.00362
1984	440,000	5.64345	0.0319	0.1787	5.84634	0.38161	0.06820
1985	261,000	5.41664	0.0023	-0.0481	5.64345	0.17872	-0.00859
1986	368,000	5.56585	0.0102	0.1011	5.41664	-0.04809	-0.00486
1987	169,000	5.22789	0.0561	-0.2368	5.56585	0.10112	-0.02395
1988	287,000	5.45788	0.0000	-0.0068	5.22789	-0.23684	0.00162
1989	192,000	5.28330	0.0329	-0.1814	5.45788	-0.00685	0.00124
1990	268,000	5.42813	0.0013	-0.0366	5.28330	-0.18143	0.00664
Mean	313,750	$\bar{y} = 5.46473$					
Var		$s_y^2 = 0.02904$	$c_0 = 0.0276$				$c_1 = 0.00296$
S. dev.	128,560	$s_y = 0.1704$					
Skew	1.384	$g_y = 0.018$					$r_1 = 0.107$

those for the wet season, and they are significantly different than zero for most of the months. On the other hand, month-to-month correlations for monthly precipitation are generally low or not significantly different from zero for most of the months [286], while lag-1 correlations are generally greater than zero for weekly, daily, and hourly precipitation.

For illustration consider the time series of annual streamflows for the Poudre River at Mouth of the Canyon for the period 1971–1990 (as shown in Table 1.13, column 2). We would like to calculate the main stochastic characteristics of the annual flow data. We apply (1.88)–(1.90) to get the mean, standard deviation, and skewness coefficient, respectively, of the original data denoted as  $x_t$ . They are shown at the bottom of column 2 in Table 1.13. It gives a coefficient of variation of about 0.41. Note that the skewness coefficient is about 1.4, which suggests that the data are skewed to the right and departs from the normal distribution.

We apply the logarithmic transformation to try bringing the skewness down to zero (and close to the normal distribution). The log-transformed flows are shown in column 3, and the resulting statistics are given at the bottom. In this case, the skewness coefficient is 0.018, i.e., near zero. Thus, we can assume that the log-transformed flows are close to be normal distributed. In addition, we calculate the lag-1 serial correlation coefficient  $r_1$  of the transformed flows  $y_t$ . For this purpose, we apply (1.91a) and (1.91b) and get  $r_1 = 0.107$ . This low value is typical of small rivers (by the way, the  $r_1$  obtained for the same river based on a 120-year data set gives a value of  $r_1$  of about 0.15).

### 7.3.4. Stochastic Modeling and Simulation of Hydrologic Data

A number of stochastic models have been developed for simulating hydrologic processes such as streamflows. Some of the models are conceptually (physically) based, some others are empirical or transformed or adapted from existing models developed in other fields, while some others have arisen specifically to address some particular features of the process under consideration. In general models for short time scales such as daily are more complex than models for larger time scales such as monthly and annual. Also some of the models have been developed specifically for precipitation while some others for streamflow. Yet many of them are useful for both and for many other hydrologic processes. We will illustrate here a simple model that may be useful for data generation of annual data at one site (single variable). In some cases, the model may be also useful for data generation of monthly data after standardizing the data seasonally (i.e., season by season) although periodic-stochastic models may be better to apply for seasonal data. For further description of alternative models that are available for annual and seasonal data for both single site and multisite systems including models for intermittent data, the reader is referred to Salas et al. [262], Loucks et al. [255], Salas [256], and Hipel and McLeod [264].

We will use the lag-1 autoregressive or AR(1) model, which is given by

$$y_t = \mu_y + \phi(y_{t-1} - \mu_y) + \varepsilon_t, \quad (1.96)$$

where  $\varepsilon_t$  is a random noise term which is normally distributed with mean zero and variance  $\sigma_\varepsilon^2$  and is uncorrelated with  $y_{t-1}$ . In addition it may be shown that because  $\varepsilon_t$  is normally distributed, also  $y_t$  is normal with mean  $\mu_y$  and variance  $\sigma_y^2 = \sigma_\varepsilon^2/(1 - \phi^2)$ . To generate synthetic records of the variable  $y_t$ , one can use model (1.96) if the model parameters are known or estimated. The parameters of the model may be estimated by using the method of moments (although other methods are available). They are

$$\hat{\mu}_y = \bar{y}, \quad (1.97)$$

$$\hat{\phi} = r_1, \quad (1.98)$$

and

$$\hat{\sigma}_e^2 = (1 - r_1^2)s_y^2. \quad (1.99)$$

Substituting the estimated parameters of (1.97)–(1.99) into (1.96), we have

$$y_t = \bar{y} + r_1(y_{t-1} - \bar{y}) + \sqrt{1 - r_1^2}s_y\xi_t \quad (1.100a)$$

or

$$y_t = (1 - r_1)\bar{y} + r_1y_{t-1} + \sqrt{1 - r_1^2}s_y\xi_t, \quad (1.100b)$$

where in this case,  $\xi_t$  is a normal random variable with mean zero and variance one. Thus, to generate the variable  $y_t$ , one needs to generate the normal random number  $\xi_t$ . The standard normal random number  $\xi_t$  can be found from tables or from numerical algorithms available to generate standard normal random numbers (e.g., [256, 287]). Also the function NORMINV of Excel can be used to generate standard normal random numbers. One may observe from (1.100a) that it is also necessary to know the previous value of  $y$ , i.e.,  $y_{t-1}$ . For example, to generate the first value  $y_1$ , (1.100b) gives

$$y_1 = (1 - r_1)\bar{y} + r_1y_0 + \sqrt{1 - r_1^2}s_y\xi_1$$

which says that in addition to  $\xi_1$ , we need to know the initial value  $y_0$ . The initial value  $y_0$  may be taken to be equal to the mean  $\bar{y}$ , but in order to remove the effect of such arbitrary initial condition, one should warm up the generation as suggested by Fiering and Jackson [288]. For example, if we want to generate a sample of 100 values of  $y_t$ , one could generate 150 values, drop the first 50, and use the remaining 100 values. Alternatively,  $y_0$  can be taken randomly from a normal distribution with mean  $\bar{y}$  and standard deviation  $s_y$ . This way there is no need for a warm up generation. We will illustrate the approach by generating a few values of  $y_t$  as shown in the example below.

We use the data of the annual flows of the Poudre River shown in Table 1.13 and the AR (1) model (1.100) to generate synthetic annual flows for the Poudre. Firstly, we will build a model in the logarithmic domain because the data analysis in Sect. 7.3.3 showed that the original data were skewed and that the logarithmic transformation was able to bring the skewness down to nearly zero. Recall from Table 1.13 that the basic statistics of the log-transformed flows are  $\bar{y} = 5.46473$ ,  $s_y = 0.1704$ , and  $r_1 = 0.107$ . To start the generation, we must generate the initial value  $y_0$ . For this purpose, we obtain the standard normal random number  $-0.0898$  so that

$$y_0 = \bar{y} + s_y\xi_0 = 5.46473 + 0.1704 \times (-0.0898) = 5.449428.$$

**Table 1.14**  
**Generated annual**  
**streamflows based on**  
**the AR(1) model for a**  
**10-year period**

Time $t$	Noise $\xi_t$	$y(t)$	$x(t)$
0	-0.0898	5.449428	
1	-0.4987	5.378600	239,111.3
2	1.2471	5.666799	464,300.7
3	-0.1379	5.462981	290,389.3
4	-1.7221	5.172783	148,861.8
5	1.2136	5.639090	435,602.4
6	-0.3732	5.420160	263,123.8
7	1.1782	5.659566	456,632.0
8	1.8405	5.797395	627,184.0
9	0.5522	5.593876	392,532.8
10	-0.9957	5.309851	204,103.8

Then for  $t \geq 1$ , we will use (1.100b) as

$$y_t = (1 - 0.107) \times 5.46473 + 0.107y_{t-1} + \sqrt{1 - 0.107^2} \times 0.1704\xi_t \quad (1.101)$$

$$= 4.88 + 0.107y_{t-1} + 0.169422\xi_t.$$

Then values of  $y_t$  are obtained by successively applying (1.101). For example, we get  $\xi_1 = -0.4987$  and  $\xi_2 = 1.2471$  and (1.101) gives

$$y_1 = 4.88 + 0.107y_0 + 0.169422\xi_1 = 4.88 + 0.107 \times 5.449428 + 0.169422 \times (-0.4987)$$

$$= 5.37860$$

$$y_2 = 4.88 + 0.107y_1 + 0.169422\xi_2 = 4.88 + 0.107 \times 5.37860 + 0.169422 \times (1.2471)$$

$$= 5.666799$$

and so on. Furthermore, since the original flow data  $x_t$  has been transformed into a normal variable  $y_t$  by using the logarithmic transformation, we need to invert the data generated (in the normal domain) back to the original flow domain. Taking the antilog can do this, i.e.,  $x_t = 10^{y_t}$ . Thus, inverting the generated values  $y_1 = 5.37860$  and  $y_2 = 5.666799$ , we get

$$x_1 = 10^{5.37860} = 239, 111.3 \text{ acre-ft and } x_2 = 10^{5.666799} = 464, 300.7 \text{ acre-ft.}$$

The rest of the example can be seen in Table 1.14 below where ten values of synthetic streamflows have been generated.

Generally one must generate many samples (e.g., 100) each of length equal to the historical sample to make comparisons and verifications in order to see whether the model is capable of “reproducing” in the statistical sense the historical statistics that are relevant to the problem at hand (e.g., basic statistics, storage capacity, drought duration, and magnitude). For this purpose, one may use box plots and software packages such as SPIGOT [289] and SAMS-2010 [290]. In general, the length of generation depends on the particular planning and management problem at hand (e.g., [255, 256]).

### 7.3.5. Stochastic Forecasting

Stochastic forecasting techniques have been used in hydrology and water resources for a long time. Some of the stochastic techniques that are applied for short-, medium-, and long-term forecasting of hydrologic variables such as streamflows include regression models, principal components-based regression models, autoregressive integrated moving average (ARIMA) models, autoregressive moving average with exogenous variables (ARMAX), and transfer function noise (TFN) models. The advantage of using well-structured models is that model identification and parameter estimation techniques are widely available in statistical software packages. In addition, Kalman filtering techniques can be included to allow for model parameters to vary through time. Examples of applying many of these models including nonparametric techniques and extended streamflow prediction can be found in a number of papers and books published in literature (e.g., [264, 291–295]). In addition, because short-term rainfall is an intermittent process, often Markov chains and point process models are applied for forecasting rainfall (e.g., [296–298]).

Furthermore, since about 1990, artificial neural networks (ANN) have become popular for a number of applications such as streamflow and precipitation forecasting. The *ASCE J. Hydrol. Engr.* Vol.5, No.2, 2000 is a dedicated issue on the subject, and the book *Artificial Neural Networks in Hydrology* [299] includes some chapters specifically on streamflow forecasting (e.g., [300, 301]). Also French et al. [302] used ANN to forecast rainfall intensity fields, and ANN was applied for forecasting rainfall for 6-h lead time based on observations of rainfall and wind at a number of gauges [303]. Other forecasting applications of ANN can be found in [304] and [305].

Also since about the 1990s, a variety of stochastic forecasting approaches have been developed based on hydrologic, oceanic, and atmospheric predictors. It has demonstrated the significant effects of climatic signals such as SST, ENSO, PDO, AMO, and NAO and other atmospheric variables such as pressure and wind on precipitation and streamflow variations (e.g., [14, 306–310]) and that seasonal and longer-term streamflow forecasts can be improved using climatic factors (e.g., [307, 311–315]).

For example, Stone et al. [316] developed a probabilistic rainfall forecast using the Southern Oscillation Index (SOI) as a predictor. Also Sharma [317] applied a nonparametric model to forecast rainfall with 3–24 months of lead times. Another example is the forecasting of the Blue Nile River seasonal streamflows based on sea surface temperature (SST) for lead times of several months and up to 24 months based on multiple linear regression and principal component analysis [312]. And Grantz et al. [313] developed a forecast model using SST, GH, and SWE as predictors for forecasting April–July streamflows at the Truckee and Carson rivers in Nevada. They found that forecast skills are significant for up to 5-month lead time based on SST and GH. Also Regonda et al. [318] reported April–July streamflow forecasts in the Gunnison River using various climatic factors. And more recently, Salas et al. [315] reported successful forecasting results of seasonal and yearly streamflows in several rivers with headwaters in the State of Colorado based on hydrologic, oceanic, and atmospheric predictors.



### 7.3.6. Uncertainty Issues in Stochastic Generation and Forecasting

Uncertainties in hydrologic stochastic simulation may arise from various sources which include model uncertainty and parameter uncertainty. Model uncertainty can be minimized by applying well-known models, testing them with appropriate procedures, and relying on the experience and judgment of the modeler. Thus, we will center our attention here on the uncertainty that arises from the limited data that may be available for analysis. Stochastic models are often applied for simulating possible hydrologic scenarios that may occur in the future. But since the parameters of the underlying models are estimated using limited records, the parameter estimates are uncertain quantities, and consequently the decision variables that may be used for planning and management of water resources systems, such as the storage capacity of a reservoir or the critical drought that may occur in a given number of years, are also uncertain quantities.

The effect of parameter uncertainty using stochastic models can be quantified based on asymptotic analysis and Bayesian inference. In the asymptotic analysis, the approximate distributions of parameter estimators are derived based upon large sample theory. For example, Box and Jenkins [319] derived the large sample variance-covariance matrix of parameter estimators for univariate autoregressive moving average (ARMA) models, which enables one defining an approximate distribution of parameter estimators for sufficient large sample size. Also Camacho et al. [320] studied the large sample properties of parameter estimators of the contemporaneous autoregressive moving average (CARMA) model. In the Bayesian framework, the posterior distributions of parameter estimators describe the uncertainty of the parameters. Vicens et al. [321] determined the Bayesian posterior distribution of the parameters of the lag-1 autoregressive model, and Valdes et al. [322] expanded the Bayesian approach to the multivariate AR(1) model. Their application with diffuse prior distribution showed that the model produces synthetic flows with higher standard deviations than the historical sample when the historical records are short. Also McLeod and Hipel [323] suggested simulation procedures for streamflow generation with parameter uncertainty based on the ARMA model. In addition, Stedinger and Taylor [324] also applied the Bayesian framework to examine the effect of parameter uncertainty of annual streamflow generation for determining the reservoir system capacity and suggested that incorporating parameter uncertainty into the streamflow generation would increase the variability of the generated storage capacity.

Although the issue of parameter uncertainty based on parametric models such as ARMA has been well recognized in the past and some procedures have been suggested (e.g., [262, 289, 321–323, 325–328]), unfortunately the conventional approaches, i.e., simulation with no consideration of parameter uncertainty, are still being applied in practice generally leading to underdesign of hydraulic structures. This issue has been reexamined by Lee et al. [329] and suggests that neglecting parameter uncertainty in stochastic simulation may have serious consequences for determining the storage capacity of reservoirs or estimating critical droughts.

Furthermore, forecasts based on any type of ARMA, ARMAX, and TFN models can include the estimation of confidence limits (e.g., [264]). Also in conjunction with Kalman

filter techniques, previous forecast errors can be used to improve forecasts for subsequent time steps (e.g., [291]). Likewise, confidence limits on forecasts based on multiple regression models are also well known in literature (e.g., [215, 330]).

#### 7.4. Nonstationarity

Over the past decades, there have been a number of studies documenting that hydrologic records exhibit some type of nonstationarity in the form of increasing or decreasing trends (e.g., [331–335]), upward and downward shifts (e.g., [277, 336–339]), or a combination of trends and shifts. Perhaps the most obvious cases of human intervention leading to changes in the flow characteristics in part of the basin is the construction of diversion dams and dams for water regulation (which cause significant changes in the water regime downstream of the dam site but also changes in sediment transport and water quality). Also, it has been argued that streamflow records may be changing because of the effect of land use changes in the basin such as increasing urbanization (e.g., [340]), the effect of deforestation, and the conversion of arid and semiarid lands in large-scale irrigated fields (e.g., [279]).

The changes resulting from human intervention, some of which have been referred to above, are quite clear, and water resources engineers have developed methods to quantify them. In fact, a key step in many hydrologic studies is to “naturalize” the gauged flow records where upstream human intervention has taken place (although in complex systems, it is not an easy problem). However, in the last few years, it has been apparent that some part of the “changes” that we may be observing in hydrologic records may be due to the effect of climatic variability, particularly resulting from low-frequency components such as ENSO (El Niño Southern Oscillation) but more importantly from large-scale decadal and multidecadal oscillations such as the PDO and AMO. And these large-scale forcing factors have been shown to exert in-phase and out-of-phase oscillations in the magnitude of floods, mean flows, and droughts (e.g., [338, 339, 341–343]). To tackle the various types of nonstationarities, several stochastic approaches have been proposed in the literature such as using flood frequency distributions with mixed components (e.g., [344–347]), flood frequency models imbedded with trend components (e.g., [333, 348–350]), flood frequency modeling considering shifting patterns (e.g., [351, 352]), and flood frequency modeling considering covariates (e.g., [348, 349, 353, 354]).

In addition, stochastic approaches have been developed to deal with nonstationarities to simulate, for example, monthly and yearly hydrologic processes such as streamflows (e.g., for drought studies and design of reservoirs) using both short-memory models, such as shifting mean models and regime switching models that have features of nonstationarity (e.g., [277, 339, 343, 355–357]), and long-memory models such as FARMA (e.g., [358–360]) and fractional Gaussian noise models (e.g., [361, 362]). Thus, the field of stochastic hydrology has been enriched in the past decades to accommodate both stationary and nonstationary features of hydrologic regimes. However, a word of caution is that as more features of the hydroclimate regimes are involved and considered, it has become necessary to develop more sophisticated models and procedures, some of which require a very good understanding of stochastic processes and hydroclimatic variability. On the other hand, the availability of

computational tools, databases, and software have made it possible to develop and, in some cases, to apply some of the complex models referred to above in actual cases of planning and management of water resources systems.

## 8. ADVANCES IN HYDROLOGIC DATA ACQUISITION AND INFORMATION SYSTEMS

In order to have a good understanding of the dynamics of the hydrologic cycle, it has been necessary to make observations of the key variables involved such as precipitation, air temperature, humidity, evaporation, infiltration, soil moisture, groundwater levels, and streamflow. While field measurements are still being made with traditional equipment and devices, such as the conventional rain gauges and current flow meters, over the years, measurement equipment has become more sophisticated taking advantage of technological developments in materials, electronics, software, hardware, remote sensing, image processing, and computational algorithms. As a result, data have become more plentiful, often accessible in real time depending on the case and needs. Automated data screening may also make certain data sources more reliable.

Among the various developments, perhaps the most prominent ones are those obtained from spaceborne sensors that help gather information useful for hydrologic investigations. Thus, in this section, we summarize the main products that are being developed based on remote sensing from space. Also we include advances made for hydrologic measurements in large rivers and developing data information systems to make data gathering and applications more efficient.

### 8.1. *Satellite Precipitation Estimation*

Precipitation is one of the most important variables for studying the hydrologic cycle and for basic hydrologic studies in river basins. However, in many parts of the world, particularly in remote places such as the oceans and the arctic regions where the accessibility is difficult, surface precipitation measurements are lacking. Likewise, in developing countries, precipitation measurements based on the conventional rain gauges are insufficient, and weather-related radars may not even be available mainly because of the high cost of establishing and maintaining the monitoring stations (e.g., [363–365]). Furthermore, for a variety of reasons also in the developed world, there has been a trend of decreasing some of the existing measurement network (e.g., [366]).

On the other hand, over the past decades, several satellite precipitation products (SPP) with high spatial resolution (e.g.,  $1^\circ$ ,  $0.5^\circ$ ,  $0.25^\circ$ ) and temporal scales such as 1 h, 3 h, daily, and monthly have been developed. These products enable estimating precipitation over much of the world (e.g., [364]). The use of satellites for this purpose already has several decades of history starting with the launch of the low earth orbit (LEO) satellite by the United States in 1960. In addition, another type of meteorological satellite, the geostationary earth orbit satellite (GEOS), was launched in 1974 by the United States. Since then, several similar LEO and GEOS satellites were launched by several countries.

The sensors aboard the LEO satellites are for detecting the visible and infrared (IR) bands of the spectrum and over time have been developed to include advanced very high-resolution radiometers (AVHRR) and passive microwave (PMW) radiometers. And the Tropical Rainfall Measuring Mission (TRMM) satellite launched in 1997 further increased the PMW capabilities along with active microwave precipitation radar (PR) capable of capturing information on horizontal and vertical variability of rainfall. The various radiometers aboard the LEO satellites have provided spatial resolution of 1 km and 6-h temporal sampling [363]. Likewise the GEOS meteorological satellites carry aboard visible and IR sensors, and the various satellites are capable of detecting the visible and IR radiation at a finer temporal resolution (a minimum of 3 h) although at a coarser spatial resolution of 4 km. The combined precipitation information from multiple sensors and algorithms produces estimates of precipitation over almost the entire globe. Thus, the SPP provide additional precipitation data beyond what may be available from conventional surface-based equipment such as rain gauges and radars.

TRMM satellite uses both active and passive microwave instruments for measuring primarily heavy to moderate rainfall over tropical and subtropical regions of the world. Building on the success of TRMM a Global Precipitation Measurement (GPM) mission, an international network of satellites has been planned to provide the next generation of global observations of rain and snow (<http://pmm.nasa.gov/GPM>). The advantage of GPM over TRMM will be its capability of measuring light rain and snow. GPM will give global measurements of precipitation with improved accuracy and temporal and spatial resolutions. The GPM core observatory is scheduled to be launched in 2014.

Several SPP exist that may be useful for hydrologic applications such as the TRMM, Multi-satellite Precipitation Analysis (TMPA, 367), NOAA-CPC morphing technique (CMORPH, 368), and Precipitation Estimation from Remotely Sensed Information using Artificial Neural Network (PERSIANN, 369). These products are available at a minimum of 3-h temporal scale and spatial resolution of 0.25° latitude/longitude. These SPP generally combine data from PMW and thermal IR sensors, and some also include surface rain gauge observations. The main differences among them are the manner in which the individual data inputs are combined. These differences may affect the accuracy of precipitation estimates over different regions of the world [370]. Thus, a number of studies have been undertaken to validate and compare them against precipitation data observed at surface rain gauges in various regions of the world such as the United States (e.g., [368, 369, 371]), Africa (e.g., [372–375]), South America [370, 376], and worldwide [367, 377]. For example, Dinku et al. [370] evaluated the TMPA, CMORPH, PERSIANN, NRLB, and the GSMaP products at daily and 10-daily temporal scales and spatial resolution of 0.25° latitude/longitude against surface precipitation observed at 600 rain gauges in Colombia. Based on a number of validation techniques, the authors concluded that the performance of the tested SPP are reasonably good for detecting the occurrence of precipitation but are poor in estimating the amount of daily precipitation. But the products have good skill at the 10-day time frame. Although the performances varied over the various geographical regions in Colombia, the best performance was found for the eastern region and that CMORPH and GSMaP gave the best results. In addition, assessments

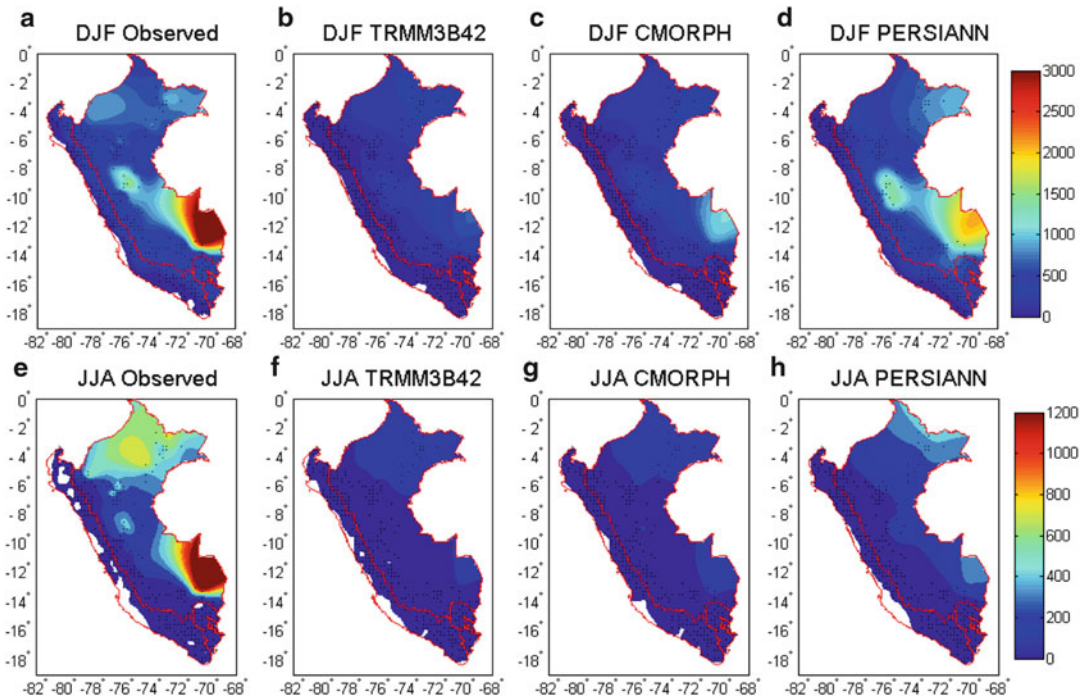
of some SPP have been made against estimated flood hydrographs (e.g., [365, 378]). For example, the TMPA precipitation estimates were used in conjunction with the variable infiltration capacity (VIC) hydrologic model to estimate streamflow hydrographs for the La Plata basin (Argentina) for the period 1998–2006 [365]. A good agreement of the TMPA-driven simulated seasonal and interannual variability of streamflows was obtained. Also the timing of the daily flood events and low flows were reproduced well although the peak flows were overestimated.

Furthermore, evaluations of the uncertainty of satellite-based precipitation estimates and the associated surface-based data obtained from rain gauges and radars have been made (e.g., [379, 380]), and a global map of uncertainties in satellite-based precipitation estimates has been developed [381]. They used CMORPH, GSMaP, PERSIANN, 3B42, 3B42RT, and NRL satellite precipitation products and estimated the ensemble mean and coefficient of variation (uncertainty) of precipitation over the globe. The ensemble mean reproduced the major features of precipitation consistent with surface observations. The uncertainty among the various estimates varied in the range 40–60 % over the oceans (especially in the tropics) and over the lower latitude of South America. However, the uncertainty varied in the range 100–140 % over high latitudes ( $>40^\circ$  in both hemispheres) especially during the cold season. As expected, large uncertainties across the year were found over complex geographic regions such as the Rocky Mountains, the Andes Mountains, and the Tibetan Plateau [381].

The applicability of some of the SPP is currently being studied in Peru. Figure 1.31 shows a comparison of the seasonal precipitation obtained from surface rain gauges (observed) versus the precipitation estimates obtained from TRMM3B42, CMORPH, and PERSIANN products for seasons December–February (DJF, top) and June–August (JJA, down). One may observe the complex precipitation distribution across the country for the two selected seasons. It appears that PERSIANN more closely resembles the spatial variability of precipitation for the DJF (summer) season, but for the JJA (winter) season, none of the SPP gives good results particularly for the mideastern region where the precipitation may reach about 1,200 mm. The referred comparison is simply graphical, but validation statistics will be determined to identify the specific strengths and weaknesses of the different SPP (Lavado, personal communication).

## **8.2. Spaceborne Methods for Estimating Surface Waters: *Rivers, Wetlands, and Lakes***

While conventional systems for measuring surface and subsurface waters in river systems are well established (Sect. 8.4), unfortunately in some remote regions of the world and particularly in developing countries, ground-based measurements and estimations of streamflows are insufficient especially because of the high cost of establishing and maintaining the gauging stations. In addition, there are some quite large river basins having complex geomorphology and hydrodynamics with meanders and not well-defined channels where the conventional gauging procedures are inappropriate (e.g., [382]). The applications of spaceborne remote sensing methods have opened newer possibilities for expanding the coverage of surface water in the world.



**Fig. 1.31.** Observed and satellite precipitation estimates for the summer (DJF) and winter (JJA) periods in Peru using TRMM3B42, CMORPH, and PERSIANN products (source: W. Lavado, article in preparation) (color figure online).

For example, one of the most promising new methods is based on the radar altimetry, which has been used since the 1990s for measuring surface elevations in the oceans. The various satellites having such devices include the ERS1 launched in 1991, TOPEX/Poseidon (T/P) launched in 1992, the ICESat launched in 2003, and the satellites launched by Japan and Europe (refer to 382 for details of available satellites and websites for measuring surface waters). The satellites include the radar altimeters that have become useful for measuring river surfaces particularly for large rivers and wetlands (a radar altimeter emits microwave pulses to the surface and registers the travel time between the emitted pulse and the received echo, which allows estimating the distance between the altimeter antenna and the water surface).

Among the first studies to apply satellite altimetry for measuring river level variations were those by Cudlip [383], Guzkowska et al. [384], and Koblinsky et al. [385] with applications to the Amazon River. The latter study was based on the Geosat altimeter, and the results showed the potential of using altimeter data, but the Geosat radar did not give sufficient accuracy or coverage. On the other hand, Birkett [386] used the NASA radar altimeter (NRA) on board of the T/P satellite and investigated their application for measuring surface water at large rivers and wetlands in various places of the world. And the results obtained were quite good in terms of accuracy and the capability of tracking the seasonal and interannual variations of the

Amazon River water levels. This initial application of the T/P altimetry was followed by other studies by Birkett et al. [387] for studying the surface water dynamics in the Amazon Basin using data of 7.5 years of the T/P and on a wider spatial scale across the Amazon Basin. The results obtained demonstrated not only the capability of monitoring the variations of the water surface height but also the water surface gradient. Also Coe and Birkett [388] extended the previous studies to investigate the variations of Lake Chad levels using T/P altimetry in conjunction with ground-based data to estimate not only lake levels but also river discharges at a major tributary of Lake Chad basin. Thus, they were able to predict Lake Chad level changes by observations of the changes at a station more than 600 km upstream. Additional studies with applications to the Amazon River and the Rio Negro (a major tributary of the Amazon) can be found in Zakharova et al. [389], Leon et al. [390], and Getirana et al. [391].

Alsdorf et al. [382] in reviewing the various applications of spaceborne sensors for estimating surface water suggested that the advances made in remote sensing using satellites have demonstrated that the elevation of the water surface ( $h$ ), its slope ( $\partial h/\partial x$ ), and its temporal change  $\partial h/\partial t$  can be estimated using the technology from spaceborne sensors. They also discussed the limitations and challenges ahead for measuring velocity, bathymetry, and other hydraulic/hydrologic properties. In fact, recently Kääb and Prowse [392] have been able to estimate the two-dimensional surface water velocity field for the St. Lawrence and MaKenzie rivers. Also recent applications of T/P altimetry have been made to forecast transboundary river water elevations [393].

### ***8.3. Spaceborne Methods for Estimating Soil Moisture, Evaporation, Vegetation, Snow, Glaciers, and Groundwater***

Microwave radiometers have been used for estimating soil moisture for the past several decades, and such experience has been extended to using satellite-borne sensors. The interest on this technology has been energized in this century with the launch of the Soil Moisture and Ocean Salinity (SMOS) satellite by the European Space Agency (ESA) in 2008 and the expected launching of NASA's satellite in 2014 that will carry aboard Soil Moisture Active Passive (SMAP) instruments. SMOS satellite carries a microwave radiometer that captures images of "brightness temperature" that correspond to microwave radiation emitted from the soil and ocean surfaces, which are then related to soil moisture held in the surface layer and ocean salinity. Estimates of surface soil moisture can be made with an accuracy of about 4 % (ESA website Dec. 2011) which is approximately twice the error of in situ electronic sensors. Recently SMOS has been used to keep track the soil moisture levels in Europe during the autumn of 2011, which has been very warm and dry. Likewise, the new SMAP satellite is expected to provide soil moisture information on a global scale and should be useful for a variety of applications in agriculture, weather forecasting, drought monitoring, and watershed modeling and should be also helpful in global circulation modeling. A number of studies have been made in developing the scientific and technical bases of spaceborne soil moisture estimation and its applications (e.g., [394–402]).

Evaporation cannot be measured directly from spaceborne sensors, but it can be estimated using the remote sensing data based on mathematical relationships that represent the soil and

air exchanges of water and energy fluxes. Estimates based on remote sensing data can be made with different approaches such as direct methods using thermal infrared (TIR) sensors and indirect methods using assimilation procedures combining different wavelengths to get various input parameters. Some methods are based on the spatial variability present in remote sensed images and no additional meteorological data to estimate evapotranspiration for routine applications (e.g., Courault et al. [403]). Detailed reviews of the various methods available for estimating evaporation using remote sensing have been made by several investigators [403–411]. A comprehensive summary table of the various methods and validation results and sources is included in Kalma et al. [411].

Also the Advanced Spaceborne Thermal Emission and Reflection (ASTER) radiometer has enabled the estimation of a number of surface fluxes such as heat and water vapor. For example, Ma et al. [412] suggested a method for deriving surface temperature, normalized difference vegetation index (NDVI), modified soil-adjusted vegetation index, net radiation flux, soil heat flux, and latent heat flux based on ASTER images and tested it on an experimental site located on the Tibetan Plateau. The results showed that the derived evaporation estimates based on ASTER were within 10 % of the corresponding ground measurements. However, the vegetation-derived estimates were not validated because of the lack of data in the study site. While the proposed method is still in development, the results obtained have been encouraging.

Forest degradation has become a major concern in the past decades because of the deterioration of the ecosystem, sustainable biodiversity, disruption of its natural functioning, and the effects on the water cycle. In addition to the regular field observations, the application of remote sensing technology has become attractive for detecting forest degradation by measuring differences in the biophysical/biochemical attributes of the canopy surfaces between healthy and degraded forests [413]. Several vegetation-related indices have been proposed for monitoring the state of vegetation using remote sensing techniques such as NDVI [414]; the photochemical reflectance index [415]; the normalized difference water index, NDWI [416]; the water index, WI [417]; the land surface water index, LSWI [418]; and the land surface temperature, LST [419, 420]. For example, the WI and NDWI indices correlate well with vegetation water concentration [417], and sparse or short vegetation shows a higher LST value than dense or tall vegetation [419]. Matsushita et al. [413] investigated the degree of forest degradation in Kochi, Japan, using Terra/ASTER satellite sensors and concluded that the use of water content based (e.g., LSWI) and the pigment content based (e.g., NDVI) obtained from satellite data were not effective for detecting forest degradation in the study area, but in contrast the thermal IR bands of the Terra/ASTER data were effective. However, the coarse spatial resolution of the satellite images still limits their application and suggests that the use of higher resolution may have large potential in mapping forest degradation [413].

In addition, various modeling tools have been suggested for mapping soil moisture, evapotranspiration, and moisture stresses based on thermal remote sensing data. For example, Anderson et al. [421, 422] investigated using TIR remote sensing to monitor evapotranspiration and moisture stress fields at continental scales based on improvements of the Atmosphere-Land



Exchange Inverse (ALEXI) model [423]. Also, mapping of evapotranspiration, moisture stresses, and drought identification at continental, regional, and local scales can be accomplished by properly utilizing a suite of TIR sensors available from the Geostationary Operational Environmental Satellites (GOES) and the Landsat series of satellites [424, 425]. By combining a number of TIR images retrieved from instruments such as the Moderate Resolution Imaging Spectrometer (MODIS) on board the Terra and Aqua satellites, AVHRR, and ASTER, and models such as ALEXI (for coarser spatial scales) and DisALEXI (a disaggregation algorithm to obtain a finer spatial resolution), useful products for mapping evapotranspiration at the ~100-m scale have been developed [424, 425].

Snowmelt and glacier melt are important sources of water for many parts of the world. Snow cover, depth, and density can be estimated by satellite remote sensing. For example, optical remote sensing of snow cover has been made since the 1970s using Landsat series of sensors, and more recently NASA's instrument MODIS on Terra (since 1999) and Aqua (since 2002) satellites and NOAA's Interactive Multisensor Snow and Ice Mapping System (IMS) provide 500-m resolution snow cover products that are available at National Snow and Ice Data Center (NSIDC, <http://nsidc.org>). Although differencing between snow and clouds is still a concern (e.g., [426]), some validation studies (e.g., [427, 428]) suggest a good potential for hydrologic applications. Likewise, glacier dynamics have been widely studied by airborne and spaceborne sensors. Table 1 in Gao and Liu [429] gives details of remote sensors that may be useful in glaciology. Both aerial photography and satellite images are used to map the areal extent of glaciers and monitor their temporal evolution [429]. For example, Kääh [430] used ASTER and Shuttle Radar Topographic Mission (SRTM) data to estimate the glacier dynamics at East Himalaya. The use of SRTM and SPOT satellite images have been also used for mass balance studies of some glaciers in India [431].

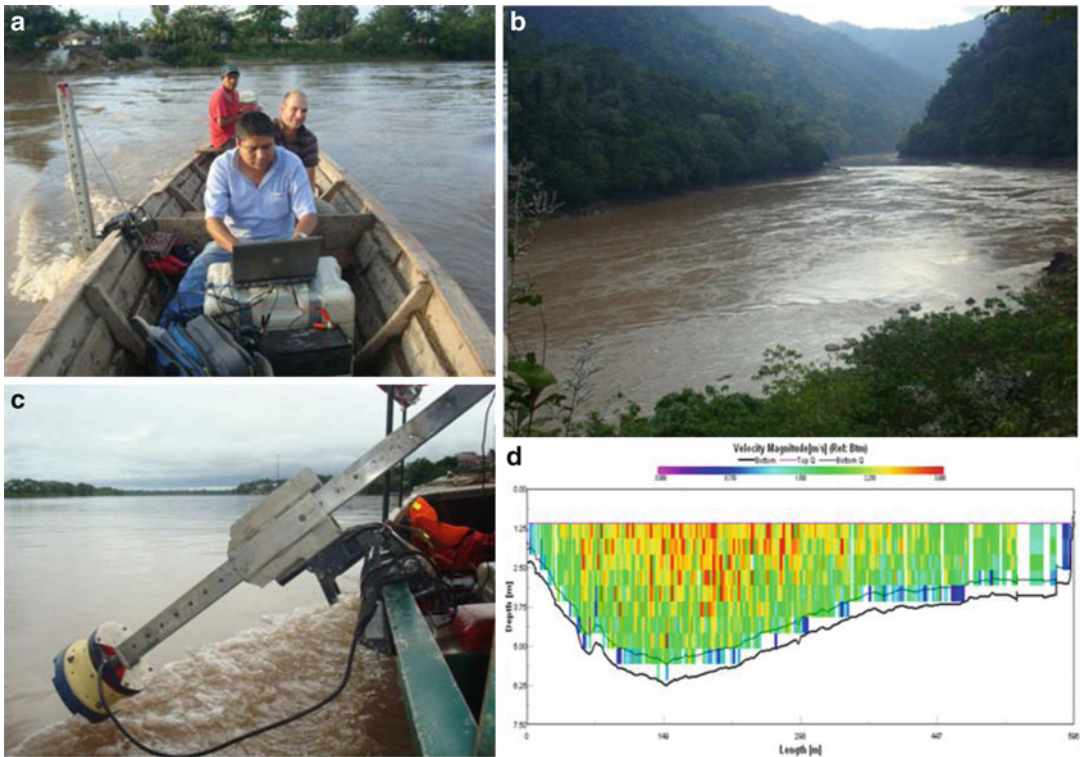
In addition, passive and active microwave radiation have been useful for determining snow extent, depth and density, and consequently snow water equivalent (SWE) (e.g., [432]). For example, the scanning multichannel microwave radiometer (SMMR) launched in 1978 has been used for retrieving SWE at the global scale [433]. Microwave radiation is related to various properties of the snow such as the number of snow grains and the packing of the grains [434], so is a function of snow depth and density. SWE algorithms (e.g., simple linear regression equations) have been developed using spaceborne microwave radiometer data for both open spaces and areas with forest cover. However, high-resolution (~100-m scales) SWE data are not available from current space systems, and radar technologies are being developed to fill such gap so that data retrieval will be able to capture the effects of topographic features and variations of wind [435]. Several uncertainties are involved in estimating SWE from space sensors. Dong et al. [433] examined satellite-derived SWE errors associated with several factors such as snow pack mass, distance to significant open-water bodies, forest cover, and topographical factors using SMMR data. Also the use of data assimilation for estimating snowpack properties based on Kalman filter has been suggested [436]. Furthermore, it has been reported that signals transmitted from global positioning system (GPS) satellites can be utilized for retrieving SWE [437].

Furthermore, spaceborne technology has been developed aimed at measuring (estimating) the total amount of water in the earth system particularly the surface water (soil moisture and snow) and the subsurface water (groundwater) based on the Gravity Recovery and Climate Experiment (GRACE) satellites (e.g., [438–440]). The joint use of Global Land Data Assimilation System (GLDAS) that gives estimates of surface waters and GRACE enables the estimation of groundwater storage (NASA website, 2011). For example, these techniques have been applied to estimate the variations of the total water storage for Texas river basins that drain to the Gulf of Mexico, the Rio Grande, Arkansas, and Red rivers, and California's Central Valley systems. Also this technology has been applied to quantify the current rates of groundwater depletion in northwestern India, in the Middle East, and in Africa (e.g., [441, 442]) and has been included as an additional input to identify drought severity (Drought Monitor website). Green et al. [443] reviewed additional applications and the history of GRACE.

#### ***8.4. Advances in Measuring Large River Systems***

Conventional methods for measuring and estimating surface waters are well known (e.g., [52, 444]). For estimating surface waters in streams, for example, hydrometric stations are located at an appropriate cross section to register water levels ( $H$ ) using recording or non-recording gauges, which are then converted into water discharge ( $Q$ ) by using appropriate relationships between  $Q$  and  $H$  (rating curves). Such relationships are developed by measuring stream water velocities and depths at a number of points across the stream cross section, which allows estimating the water discharge. Likewise, the hydrometric station can be used to measure sediment concentrations and other water quality parameters as the case may be. Thus, hydrologic services of the countries worldwide generally have a network of hydrometric gauging stations to make systematic observations to quantify the streamflow variations through time.

However, for measuring streamflows and other properties such as sediment transport in large river systems such as the Amazon River, such conventional methods are quite limited. Thus, for the past decades, the interest on developing especial equipment and methods for measuring large rivers has grown (e.g., [445–449]). In the 1990s, a number of studies were made to improve measuring discharges of the Amazon River, and a joint effort of Brazilians and French hydrologists introduced the Doppler technology with good results (e.g., [450, 451]). The study by Filizola and Guyot [452] describes the use of the Acoustic Doppler Current Profiler (ADCP) for streamflow measurement in the Amazon at a gauging station near Obidos, Brazil (the ADCP uses the Doppler effect by transmitting sound at a fixed frequency and receiving the echoes returning from sound scatters in the water). For example, they reported that the water discharge and suspended sediment in March 24, 1995 were  $172,400 \text{ m}^3/\text{s}$  and  $3.15 \times 10^6 \text{ Ton/day}$ , respectively. Details of the equipment and methods used for measuring and estimating the river discharge and suspended sediment can be found in Filizola and Guyot [452]. More recently Laraque et al. [453] reported additional studies of mixing processes at the confluence of a major tributary of the Amazon River (near Manaus) using also ADCP. Also the ADCP technology is being used for measuring river discharges



**Fig. 1.32.** (a) Staff of SENAMHI-Peru and IRD-France measuring discharge in the Huallaga River (Peru) using ADCP, (b) Huallaga River, (c) ADCP installed in the boat, and (d) transect of the ADCP, velocity grids, and measuring sections (source: Jorge Carranza SENAMHI-Peru).

and suspended sediment in major rivers in the Andean countries (Peru, Ecuador, and Bolivia). Per illustration Fig. 1.32 shows personal of SENAMHI (Peru) and IRD (France) with ADCP equipment for streamflow measurements in the Huallaga River, Peru.

### 8.5. Using Dendrohydrology for Extending Hydrologic Data

Dendrohydrology is the analysis and application of tree-ring records for hydrologic studies [454]. Trees are useful for reconstructing streamflows because they are sensitive recorders of natural climate variability. Tree-ring growth is affected by the same set of climatic factors (e.g., precipitation and evapotranspiration) that affect streamflows [455]. Dendrohydrology started in western North America primarily using ring-width time series to extend gauge records of streamflows [456]. Tree-ring records have been used to extend the short records of a number of hydrologic processes such as streamflows [457], precipitation [458], soil moisture [459], and SWE [460]. An extensive review of dendrohydrology was made by Loaiciga et al. [461]. The reconstructed streamflow records enable one observing a wider range of flow scenarios that may be obtainable from the historical records alone. For example, Woodhouse [462] observed that the reconstructed streamflows of the Middle Boulder Creek showed that

the low-flow events that occurred in the past were more persistent than those found from the analysis of the historical records. Similar other studies of tree-ring reconstructed flows indicate that droughts of more severe magnitude and longer durations had occurred in the past compared to droughts occurred during the historical period (e.g., [455, 457, 463–465]).

Several record extension models have been employed in literature to extend streamflow records using tree-ring indices data. Among them is the traditional multiple linear regression model (e.g., [457, 462, 466, 467]), principal component analysis (e.g., [457, 463, 467]), and transfer function models (e.g., [468]). For example, Woodhouse [462] used multiple linear regression models and the stepwise regression technique to select the tree-ring indices to be used for reconstructing the streamflows of the Middle Boulder Creek, Colorado. Furthermore, Tarawneh and Salas [464] developed a record extension technique, which is based on multiple linear regression with noise and spatial disaggregation to reconstruct the annual streamflows of the Colorado River for the entire 29 flow sites.

### ***8.6. Developments in Hydrologic Information Systems***

Hydrologic information has been collected by many entities and national and international organizations worldwide for a variety of purposes such as for evaluating water resources availability in various regions and countries, for water resources developments in river basins, for geo-environmental investigations in river basins, for detecting the effect of human interventions on hydro-environmental systems, and for studying the impact of climate variability and change on the water resources and the environment of river basins. Several years ago, the US National Science Foundation supported the creation of the Consortium of Universities for the Advancement of Hydrologic Sciences (CUAHSI) and also funded the Hydrologic Information System (HIS) project for sharing hydrologic data. It will consist of databases that will be integrated and connected through the Internet and web services for data finding, accessibility, and publication [469–471]. An example is HydroServer, a computer server that includes a collection of databases, web services, tools, and software applications that allows data producers to store, publish, and manage from a project site (Tarboton et al. [471]). Current efforts in various directions have been summarized in a CUAHSI Conference on Hydrologic Data and Information Systems convened at Utah State University on June 22–24, 2011. For example, a framework is currently being developed through which hydrologic and atmospheric science data can be shared, managed, discovered, and distributed (e.g., [472]).

### **ACKNOWLEDGEMENTS**

We would like to acknowledge the collaboration received from Dr. Jose L. Chavez, Assistant Professor of Colorado State University, and the peer review made by Dr. Wade Crow. Their suggestions and comments improved the final content of the chapter. In addition the main author acknowledges the continuous support from the NSF, particularly the ongoing project P2C2: Multi-Century Streamflow Records Derived from Watershed Modeling and Tree Ring Data (ATM-0823480).

## REFERENCES

1. Gleick PH (1996) Water resources. In: Schneider SH (ed) *Encyclopedia of climate and weather*, vol 2. Oxford University Press, New York, pp 817–823
2. Cushman-Roisin B (1994) *Introduction to geophysical fluid dynamics*. Prentice Hall, p 320
3. Zhang C (2005) Madden-Julian oscillation. *Rev Geophys* 43 RG2003/2005
4. Maloney E, Hartmann DL (2000) Modulation of hurricane activity in the Gulf of Mexico by the Madden-Julian oscillation. *Science* 287(5460):2002–2004
5. Maloney E, Hartmann DL (2000) Modulation of eastern north Pacific hurricanes by the Madden-Julian oscillation. *J Climate* 13:1451–1460
6. Thompson DWJ, Wallace JM (1998) The Arctic oscillation signature in the wintertime geopotential height and temperature fields. *Geophys Res Lett* 25(9):1297–1300
7. Philander SG (1990) El Niño, La Niña, and the southern oscillation. *Academic*, p 293
8. Piechota TC, Dracup JA (1996) Drought and regional hydrologic variation in the United States: associations with El Niño-southern oscillation. *Water Resour Res* 32(5):1359–1373
9. Cayan DR, Redmond KT, Riddle LG (1999) ENSO and hydrologic extremes in the western United States. *J Climate* 12:2881–2893
10. Gray WM (1984) Atlantic seasonal hurricane frequency. Part I: El Niño and the 30 mb quasi-biennial oscillation influences. *Mon Weather Rev* 112:1649–1668
11. Richards TS, O'Brien JJ (1996) The effect of El Niño on U.S. landfalling hurricanes. *Bull Am Meteorol Soc* 77:773–774
12. Bove MC, Elsner JB, Landsea CW, Niu X, O'Brien JJ (1998) Effects of El Niño on U.S. landfalling hurricanes, revisited. *Bull Am Meteorol Soc* 79:2477–2482
13. Wolter K, Timlin MS (1993) Monitoring ENSO in COADS with a seasonally adjusted principal component index. In: *Proceedings of the 17th climate diagnostics workshop*, Norman, OK, NOAA/NMC/CAC, NSSL, Oklahoma Clim. Survey, CIMMS and the School of Meteor., Univ. of Oklahoma, pp 52–57
14. Mantua NJ, Hare SR, Zhang Y, Wallace JM, Francis RC (1997) A Pacific decadal climate oscillation with impacts on salmon. *Bull Am Meteorol Soc* 78:1069–1079
15. Minobe S (1997) A 50-70 year climatic oscillation over the North Pacific and North America. *Geophys Res Lett* 24:683–686
16. Xie S-P, Tanimoto Y (1998) A pan-Atlantic decadal climate oscillation. *Geophys Res Lett* 25:2185–2188
17. McCabe GJ, Palecki MA, Betancourt JL (2004) Pacific and Atlantic Oceans influences on multidecadal drought frequency in the United States. *Proc Natl Acad Sci U S A* 101(12):4136–4141
18. Hare SR, Francis RC (1995) Climate change and salmon production in the Northeast Pacific Ocean. In: Beamish RJ (ed) *Ocean climate and northern fish populations*. Canadian special publication of fisheries and aquatic science, vol 121, pp 357–372
19. Bond NA, Harrison DE (2000) The Pacific decadal oscillation, air-sea interaction and central north Pacific winter atmospheric regimes. *Geophys Res Lett* 27(5):731–734
20. Hessler AE, McKenzie D, Schellhaas R (2004) Drought and Pacific decadal oscillation linked to fire occurrence in the inland Pacific northwest. *Ecol Appl* 14(2):425–442
21. Whitfield PH, Moore RD, Fleming S, Zawadzki A (2010) Pacific decadal oscillation and the hydroclimatology of western Canada: review and prospects. *Can Water Resour J* 35(1):1–28
22. Sutton RT, Hodson LR (2005) Atlantic forcing of north American and European summer climate. *Science* 309:115–118

23. Zhang R, Delworth TL (2006) Impact of Atlantic multidecadal oscillations on India/Sahel rainfall and Atlantic hurricanes. *Geophys Res Lett* 33 (no. L17712)
24. Shanahan TM, Overpeck JT, Anchukaitis KJ, Beck JW, Cole JE, Dettman DL, Peck JA, Scholz CA, King JW (2009) Atlantic forcing of persistent drought in west Africa. *Science* 324 (5925):377–380
25. Bao J-W, Michelson SA, Nieman PJ, Ralph FM, Wilczak JM (2006) Interpretation of enhanced integrated water vapor bands associated with extratropical cyclones: their formation and connection with tropical moisture. *Mon Weather Rev* 134:1063–1080
26. Miller NL, Kim J, Hartman RK, Farrara J (1999) Downscaled climate and streamflow study of the Southwestern United States. *J Am Water Resour Assoc* 35:1525–1537
27. DWR (2006) Progress on incorporating climate change into management of California's Water Resources, Technical memorandum report, California Department of Water Resources
28. DWR (2009) Using future climate projections to support water resources decision making in California, California climate change center report CEC-500-2009-052-F
29. Miller NL, Bashford KE, Strem E (2003) Potential impacts of climate change of California hydrology. *J Am Water Resour Assoc* 39:771–784
30. Mote PW, Clark M, Hamlet AF (2004) Variability and trends in mountain snowpack in western North America. In: Proceedings of the 16th symposium on global climate change. 85th Annual AMS meeting, Seattle, WA, January
31. Stewart IT, Cayan DR, Dettlinger MD (2004) Changes in snowmelt runoff timing in western North America under a 'business as usual' climate change scenario. *Clim Change* 62:217–232
32. USBR (2007) Reclamation final environmental impact statement Colorado River interim guidelines for lower basin shortages and coordinated operations for lakes Powell and Mead, Appendix N analysis of hydrologic variability sensitivity, p 70
33. Thiessen AH (1911) Precipitation for large areas. *Mon Weather Rev* 39:1082–1084
34. Simanton JR, Osborn HB (1980) Reciprocal-distance estimate of point rainfall. *ASCE J Hydraul Eng* 106(HY7):1242–1246
35. Tabios G, Salas JD (1985) A comparative analysis of techniques for spatial interpolation of precipitation. *Water Resour Bull* 21(3):365–380
36. Goovaerts P (1997) *Geostatistics for natural resources evaluation*. Oxford University Press, New York
37. Woodall SL (1984) Rainfall interception losses from melaleuca forest in Florida. Research note SE-323. USDA Southeastern Forest Experimental Station Forest Resources Laboratory, Lehigh Acres, FL
38. Horton RE (1919) Rainfall interception. *Mon Weather Rev* 47:603–623
39. Brooks PN, Folliott PF, Gregersen HM, Thames JL (1991) *Hydrology and management of watersheds*. Iowa State University Press, Ames, IA
40. Helvey JD (1971) A summary of rainfall interception in certain conifers of North America. In: *Biological effects in the hydrologic cycle*. Proceedings of third inter. seminar for hydrology professors, West Lafayette, IN, Purdue University Agricultural Experiment Station, pp 103–113
41. Ramirez JA, Senarath SUS (2000) A statistical-dynamical parameterization of interception and land surface-atmosphere interactions. *J Climate* 13:4050–4063
42. Brutsaert W (2005) *Hydrology—an introduction*. Cambridge University Press, New York
43. Chang M (2002) *Forest hydrology: an introduction to water and forests*. CRC Press, Boca Raton, FL

44. Helvey JD, Patrick JH (1965) Canopy and litter interception of rainfall by hardwoods of eastern United States. *Water Resour Res* 1:193–206
45. Sophocleous MA, Koelliker JK, Govindaraju RS, Birdie T, Ramireddygari SR, Perkins SP (1999) Integrated numerical modeling for basin-wide water management: the case of the Rattlesnake Creek Basin in south-central Kansas. *J Hydrol* 214:179–196
46. Viessman W, Lewis GL (2003) Introduction to hydrology, 5th edn. Prentice Hall, Upper Saddle River, NJ, p 612
47. Horton RE (1933) The role of infiltration in the hydrological cycle. *Trans Am Geophys Union* 14:446–460
48. Horton RE (1939) Analysis of runoff-plot experiments with varying infiltration capacity. *Trans Am Geophys Union* 20:693–711
49. Philip JR (1957) The theory of infiltration. Sorptivity and algebraic infiltration equations. *Soil Sci* 84:257–264
50. Philip JR (1969) The theory of infiltration. *Adv Hydrosoci* 5:215–290
51. Green WH, Ampt GA (1911) Studies on soil physics, 1: the flow of air and water through soils. *J Agric Sci* 4:1–24
52. Chow VT, Maidment DR, Mays LW (1988) Applied hydrology. McGraw-Hill, New York, p 572
53. SCS (Soil Conservation Service) (1985) SCS national engineering handbook. U.S. Department of Agriculture, Washington, DC
54. SCS (Soil Conservation Service) (1986) Urban hydrology for small watersheds, technical release 55. U.S. Department of Agriculture, Washington, DC
55. Schaake JC, Koren VI, Duan QY (1996) Simple water balance model for estimating runoff at different spatial and temporal scales. *J Geophys Res* 101(D3):7461–7475
56. Yu B (1998) Theoretical justification of SCS method for runoff estimation. *ASCE J Irrigat Drain Eng* 124(6):306–310
57. SCS (Soil Conservation Service) (1993) SCS national engineering handbook, section 4, hydrology. U.S. Department of Agriculture, Washington, DC
58. Eagleson P (1970) Dynamic hydrology. McGraw Hill Book, New York
59. Bras RE (1990) Hydrology: an introduction to hydrologic science. Addison and Wesley Publishing, Reading, MA, pp 197–198
60. Linsley RK, Kohler MA, Paulhus JLH (1986) Hydrology for engineers. McGraw Hill Book, New York
61. Anderson ER, Anderson LJ, Marciano JJ (1950) A review of evaporation theory and development of instrumentation, Lake Mead water loss investigation; interim report, Navy Electronics Lab. Rept. no. 159, February
62. Meyer AF (1944) Evaporation from lakes and reservoirs. Minnesota Resources Commission, St. Paul
63. Harbeck GE (1958) Water loss investigations: lake mead studies. U.S. Geological Survey professional paper 298, pp 29–37
64. Phillips DW (1978) Evaluation of evaporation from Lake Ontario during IFYGL by a modified mass transfer equations. *Water Resour Res* 14(2):196–205
65. Dunne T (1978) Field studies of hillslope flow processes. In: Kirkby MJ (ed) Hillslope hydrology. Wiley-Interscience, New York, pp 227–293
66. Penman HL (1956) Estimating evaporation. *Trans Am Geophys Union* 37(1):43–50
67. Monteith JL (1965) Evaporation and environment. In: Proceedings of the 19th symp. of the society for experimental biology, Cambridge University Press, New York, pp 205–233

68. Brutsaert W, Stricker H (1979) An advection-aridity approach to estimate actual regional evapotranspiration. *Water Resour Res* 15:443–450
69. Parlange MB, Katul GG (1992) An advection-aridity evaporation model. *Water Resour Res* 28:127–132
70. Ramirez JA, Hobbins MT, Brown TC (2005) Observational evidence of the complementary relationship in regional evaporation lends strong support for Bouchet's hypothesis. *Geophys Res Lett* 32(L15401):4
71. Haan CT, Johnson HP, Brakensiek DC (1982) Hydrologic modeling of small watersheds. *Am Soc Agricult Eng Monograph* no. 5
72. Allen RG, Walter IA, Elliott RL, Howell TA, Itenfisu D, Jensen ME, Snyder RL (2005) The ASCE standardized reference evapotranspiration equation. Task Committee of the EWRI, ASCE, Virginia
73. Allen RG (2011) REF-ET: reference evapotranspiration calculation software for FAO and ASCE standardized equations, version 3.1 for windows. University of Idaho, Kimberly, ID
74. Blaney HF, Criddle WD (1950) Determining water requirements in irrigated areas from climatological and irrigation data. U.S.D.A. soil conservation service, technical document no. 96, p 44
75. Allen RG, Pruitt WO (1985) Rational use of the FAO Blaney-Criddle formula. *ASCE J Irrigat Drain Eng* 112(2):139–155
76. Andales AA, Chavez JL, Bauder TA (2011) Irrigation scheduling: the water balance approach, Fact Sheet N. 4.707, Colorado State University Extension
77. Betson RP (1964) What is watershed runoff? *J Geophys Res* 69:1541–1551
78. Dunne T, Black RD (1970) Partial area contributions to storm runoff in a small New England watershed. *Water Resour Res* 6:1296–1311
79. Beven K (1978) The hydrological response of headwater and sideslope areas. *Hydrol Sci Bull* 23:419–437
80. Govindaraju RS, Kavvas ML (1991) Dynamics of moving boundary overland flows over infiltrating surfaces at hillslopes. *Water Resour Res* 27(8):1885–1898
81. Smith RE, Hebbert RHB (1979) A Monte Carlo analysis of the hydrologic effects of spatial variability of infiltration. *Water Resour Res* 15(2):419–429
82. Corradini C, Morbidelli R, Melone F (1998) On the interaction between infiltration and Hortonian runoff. *J Hydrol* 204:52–67
83. Nahar N, Govindaraju RS, Corradini C, Morbidelli R (2004) Role of run-on for describing field-scale infiltration and overland flow over spatially variable soils. *J Hydrol* 286:36–51
84. Govindaraju RS, Corradini C, Morbidelli R, Nahar N (2006) Infiltration and runoff under spatially variable hydrologic properties. In: Delleur JW (ed) *The handbook of groundwater engineering*. CRC Press, pp 8.1–8.16
85. Morbidelli R, Govindaraju RS, Corradini C, Flammini A (2008) A simplified model for simulating basin-scale surface runoff hydrographs. *ASCE J Hydrolog Eng* 13(3):164–170
86. Stillman JS, Haws NW, Govindaraju RS, Rao PSC (2006) A model for transient flow to a subsurface tile drain under macropore-dominated flow conditions. *J Hydrol* 317:49–62
87. Hewlett JD, Hibbert AR (1963) Moisture and energy conditions within a sloping soil mass during drainage. *J Geophys Res* 68(4):1081–1087
88. SSSA (2009) Soils sustain life. <https://www.agronomy.org/files/membership/ambassadors/ssa-brochure-2009.pdf>
89. Senese FA (2010) Frostburg State University. <http://antoine.frostburg.edu/chem/senese/101/liquids/faq/print-h-bonding-vs-london-forces.shtml>



90. Mualem Y (1976) New model for predicting hydraulic conductivity of unsaturated porous-media. *Water Resour Res* 12(3):513–522
91. van Genuchten MT (1980) A closed-form equation for predicting the hydraulic conductivity of unsaturated soils. *Soil Sci Soc Am J* 44:892–898
92. Gardner WR (1958) Some steady state solutions of unsaturated moisture flow equations with application to evaporation from a water table. *Soil Sci* 85:228–232
93. Rucker DF, Warrick AW, Ferre TPA (2005) Parameter equivalence for the Gardner and van Genuchten soil hydraulic conductivity functions for steady vertical flow with inclusions. *Adv Water Resour* 28:689–699
94. Green RE, Hanks RJ, Larson WE (1964) Estimates of field infiltration by numerical solution of the moisture flow equation. *Soil Sci Soc Am J* 28:15–19
95. Green TR (1994) The roles of moisture-dependent anisotropy and landscape topography in soil-water flow and groundwater recharge. Ph.D. dissertation, Stanford University, p 304
96. Pidwirny M (2006) Infiltration and soil water storage. In: *Fundamentals of physical geography*, 2nd edn. <http://www.physicalgeography.net/fundamentals/81.html>. Accessed 3 Oct 2011
97. Eltahir EAB (1989) A feedback mechanism in annual rainfall in Central Sudan. *J Hydrol* 110:323–334
98. Eltahir EAB, Bras RL (1994) Precipitation recycling in the Amazon basin. *Q J Roy Meteorol Soc* 120:861–880
99. Eltahir EAB, Bras RL (1996) Precipitation recycling. *AGU Rev Geophys* 34(3):367–378
100. Eltahir EAB (1993) Interactions of hydrology and climate in the Amazon basin. Doctorate thesis, Mass. Inst. of Technol., Cambridge, p 188
101. Koster RD et al (2006) GLACE: the global land–atmosphere coupling experiment. Part I: overview. *J Hydrometeorol* 7:590–610
102. Delworth TL, Manabe S (1988) The influence of potential evaporation on the variabilities of simulated soil wetness and climate. *J Climate* 1:523–547
103. Green TR, Erskine RH (2011) Measurement and inference of profile soil-water dynamics at different hill-slope positions in a semi-arid agricultural watershed. *Water Resour Res* 47(12): W00H15. doi:10.1029/2010WR010074
104. De Lannoy GJM, Verhoest NEC, Houser PR, Gish TJ, Van Meirvenne M (2006) Spatial and temporal characteristics of soil moisture in an intensively monitored agricultural field (OPE3). *J Hydrol* 331:719–730
105. Lin HS, Kogelmann W, Walker C, Bruns MA (2006) Soil moisture patterns in a forested catchment: a hydrogeological perspective. *Geoderma* 131:345–368
106. Zaslavsky D, Sinai G (1981) Surface hydrology: I—explanation of phenomena. *ASCE J Hydraul Div* 107(HY1):1–16
107. McCord JT, Stephens DB (1987) Lateral moisture flow beneath a sandy hillslope without an apparent impeding layer. *Hydrol Process* 1:225–238
108. Green TR, Freyberg DL (1995) State-dependent anisotropy—comparisons of quasi-analytical solutions with stochastic results for steady gravity drainage. *Water Resour Res* 31:2201–2211
109. Sinai G, Dirksen C (2006) Experimental evidence of lateral flow in unsaturated homogeneous isotropic sloping soil due to rainfall. *Water Resour Res* 42(W12402):12
110. Western AW, Grayson RB, Blöschl G, Willgoose GR, McMahon TA (1999) Observed spatial organization of soil moisture and its relation to terrain indices. *Water Resour Res* 35:797–810
111. Perry MA, Niemann JD (2007) Analysis and estimation of soil moisture at the catchment scale using EOFs. *J Hydrol* 334:388–404

112. Busch FA, Niemann JD, Coleman ML (2012) Evaluation of an EOF-based method to downscale soil moisture patterns based on topographical attributes. *Hydrolog Process* 26(18):2696–2709
113. Coleman ML, Niemann JD (2012) An evaluation of nonlinear methods for estimating catchment-scale soil moisture patterns based on topographic attributes. *J Hydroinform* 14(3):800–814
114. Western AW, Grayson RB, Green TR (1999) The Tarrawarra project: high resolution spatial measurement, modelling and analysis of soil moisture and hydrological response. *Hydrol Process* 13:633–652
115. Famiglietti JS, Ryu D, Berg AA, Rodell M, Jackson TJ (2008) Field observations of soil moisture variability across scales. *Water Resour Res* 44(1), W01423. doi:[10.1029/2006wr005804](https://doi.org/10.1029/2006wr005804)
116. Green TR, Erskine RH (2004) Measurement, scaling, and topographic analyses of spatial crop yield and soil water content. *Hydrol Process* 18(8):1447–1465
117. Green TR, Dunn GH, Erskine RH, Salas JD, Ahuja LR (2009) Fractal analyses of steady infiltration and terrain on an undulating agricultural field. *Vadose Zone J* 8(2):310–320
118. Salas JD, Boes DC, Yevjevich V, Pegram GGS (1979) Hurst phenomenon as a pre-asymptotic behavior. *J Hydrol* 44:1–15
119. Meng H, Salas JD, Green TR, Ahuja LR (2006) Scaling analysis of space-time infiltration based on the universal multifractal model. *J Hydrol* 322:220–235
120. Ohmura A (2001) Physical basis for the temperature-based melt index method. *J Appl Meteorol* 40:753–761
121. Vergara W, Deeb AM, Valencia AM, Bradley RS, Francou B, Zarzar A, Grunwaldt A, Haeussling SM (2007) Economic impacts of rapid glacier retreat in the Andes. *EOS Trans Am Geophys Union* 88(25):261–264
122. Singh VP, Singh P, Haritashya UK (2011) *Encyclopedia of snow, ice, and glaciers*. Springer, Dordrecht, p 1400
123. Hooke R (2005) *Principles of glacier mechanics*, 2nd edn. Cambridge University Press, UK
124. Clare GR, Fitzharris BB, Chin TSH, Salinger MJ (2002) Interannual variation in end-of-summer snowlines of the southern Alps of New Zealand, and relationships with southern hemisphere atmospheric circulation and sea surface temperature patterns. *Int J Climatol* 22:107–120
125. Martinec J, Rango A (1986) Parameter values for snowmelt runoff modeling. *J Hydrol* 84:197–219
126. Hock R (2003) Temperature index melt modeling in mountain areas. *J Hydrol* 282(1–4):104–115
127. Hock R (2005) Glacier melt: a review of processes and their modelling. *Prog Phys Geograph* 29:362–391
128. Braithwaitwe RJ, Olesen OB (1989) Calculation of glacier ablation from air temperature, West Greenland. In: Oerlemans J (ed) *Glacier fluctuations and climate change*. *Glaciol Quatern Geol*, Dordrecht, pp 219–233
129. Oerlemans J, Anderson B, Hubbard A, Huybrechts P, Johannesson T, Knap WH, Schmeits M (1998) Modeling the response of glaciers to climate warming. *Climate Dynam* 14:267–274
130. Schaeffli B, Hingray B, Niggli IM, Musy A (2005) A conceptual glacio-hydrological model for high mountainous catchments. *Hydrol Earth Syst Sci* 9:95–109
131. Kustas WP, Rango A (1994) A simple energy budget algorithm for the snowmelt runoff model. *Water Resour Res* 30:1515–1527
132. Braithwaitwe RJ, Konzelmann T, Marty C, Olesen OB (1998) Errors in daily ablation measurements in northern Greenland, 1993–94, and their implications for glacier climate studies. *J Glaciol* 44(148):583–588

133. Arendt A, Sharp M (1999) Energy balance measurements on a Canadian high arctic glacier and their implications for mass balance modeling. In: Tranter M et al (eds) Interactions between the cryosphere, climate, and greenhouse gases. Proceedings of the IUGG symp., Birmingham 1999, IAHS publ. no. 256, pp 165–172
134. Hay JE, Fitzharris BB (1988) A comparison of the energy-balance and bulk-aerodynamic approaches for estimating glacier melt. *J Glaciol* 4:145–153
135. WMO (World Meteorological Organization) (1986) Intercomparison of models for snowmelt runoff. Operational hydrology report 23, no 646
136. Braithwaite RJ, Zhang Y (1999) Modeling changes in glacier mass balance that may occur as a result of climate changes. *Geogr Ann* 81A:489–496
137. Martinec J (1989) Hour-to hour snowmelt rates and lysimeter outflow during an entire ablation period. In: Colbeck SC (ed) Glacier and snow cover variations. Proc. Baltimore Symp., Maryland, Wallingford: IAHS publication 183, pp 19–28
138. Pellicciotti F, Brock B, Strasser U, Burlando P, Funk M, Corripio J (2005) An enhanced temperature-index glacier melt model including the shortwave radiation balance: development and testing for Haut Glacier d’Arolla, Switzerland. *J Glaciol* 51(175):573–587
139. Willis IC, Sharp MJ, Richards KS (1993) Studies of the water balance of Midtdalsbreen, Hardangerjøkulen, Norway. I. The calculation of surface water inputs from basic meteorological data. *Zeitschrift für Gletscherkunde und Glazialgeologie* 27/28:97–115
140. Anderson EA (1973) National weather service river forecast system/snow accumulation and ablation model, NOAA Tech, Memorandum NWS HYDRO-17. U.S. Department of Commerce, Silver Springs, MD, p 217
141. Martinec J, Rango A, Roberts R (2008) Snowmelt runoff model (SRM) user’s manual, agricultural experiment station special report 100. New Mexico State University, Las Cruces, New Mexico
142. Mark BG, Seltzer GO (2003) Tropical glacier meltwater contribution to stream discharge: a case study in the Cordillera Blanca, Peru. *J Glaciol* 49(165):271–281
143. Schaner N, Voisin N, Nijssen B, Lettenmaier DP (2012) The contribution of glacier melt to streamflow. *Environ Res Lett* 7, 034029 (8pp). doi:[10.1088/1748-9326/7/3/034029](https://doi.org/10.1088/1748-9326/7/3/034029)
144. Mulvaney TJ (1851) On the use of self-registering rain and flood gauges in making observations of the relations of rainfall and flood discharges in a given catchment. *Trans Inst Civ Eng Ireland* 4(2):18–33
145. Singh VP (1995) Computer models of watershed hydrology. Water Resources Publications, Highlands Ranch, CO, 1144 pp
146. Beven KJ (2000) Rainfall-runoff modelling. The primer. Wiley, New York
147. Bowles DS (2001) Recent advances in the modeling of hydrologic systems, NATO Advanced Study Institute. Kluwer Academic Publishers, Sintra, Portugal
148. Singh VP, Frevert DK (2002) Mathematical models of small watershed hydrology and applications. Water Resources Publications, Littleton, CO, p 950
149. Singh VP, Frevert DK (2002) Mathematical models of large watershed hydrology. Water Resources Publications, Littleton, CO, p 891
150. Todini E (1988) Rainfall-runoff modeling—past, present and future. *J Hydrol* 100(1):341–352
151. Beven KJ, Binley A (1992) The future of distributed models: model calibration and uncertainty prediction. *Hydrol Process* 6(3):279–298
152. Blöschl G, Sivapalan M (1995) Scale issues in hydrological modelling: a review. In: Kalma JD, Sivapalan M (eds) Scale issues in hydrological modelling. Wiley, Chichester, UK, pp 9–48

153. Todini E (2007) Hydrological catchment modelling: past, present and future. *Hydrol Earth Syst Sci* 11(1):468–482
154. Moradkhani H, Sorooshian S (2008) General review of rainfall-runoff modeling: model calibration, data assimilation and uncertainty analysis. In: Sorooshian S, Hsu K-L, Coppola E, Tomassetti B, Verdecchia M, Visconti G (eds) *Hydrological modelling and the water cycle*. Springer, Berlin Heidelberg
155. Todini E (2011) History and perspectives of hydrological catchment modeling. *Hydrol Research* 42:73–85. doi: [10.2166/nh.2011.096](https://doi.org/10.2166/nh.2011.096)
156. Clarke RT (1973) A review of some mathematical models used in hydrology, with observations on their calibration and use. *J Hydrol* 19(1):1–20
157. Wheater HS, Jakeman AJ, Beven KJ (1993) Progress and directions in rainfall-runoff modeling. In: Jakeman AJ, Beck MB, McAleer MJ (eds) *Modelling change in environmental systems*. Wiley, Chichester, pp 101–132
158. Wagener T, Wheater HS, Gupta HV (2004) *Rainfall-runoff modelling in gauged and ungauged catchments*. Imperial College Press, London, UK, p 306
159. Beck MB (1987) Water quality modeling: review of the analysis uncertainty. *Water Resour Res* 23:1393–1442
160. Liu Y, Gupta HV (2007) Uncertainty in hydrologic modeling: toward an integrated data assimilation framework. *Water Resour Res* 43 (W07401). doi:[10.1029/2006WR005756](https://doi.org/10.1029/2006WR005756)
161. Beven KJ (2001) Spatially distributed modelling: conceptual approach to runoff prediction. In: Bowles DS (ed) *Recent advances in the modelling of hydrologic systems*. Kluwer, Dordrecht, pp 191–219
162. Mertens J, Madsen H, Kristensen M, Jacques D, Feyen J (2005) Sensitivity of soil parameters in unsaturated zone modelling and the relation between effective, laboratory and in situ estimates. *Hydrol Process* 19:1611–1633
163. Francés F, Vélez JI, Vélez JJ (2007) Split-parameter structure for the automatic calibration of distributed hydrological models. *J Hydrol* 332(1):226–240
164. Freeze RA, Harlan RL (1969) Blueprint for a physically-based, digitally-simulated hydrologic response model. *J Hydrol* 9:237–258
165. Beven KJ (1989) Changing ideas in hydrology—the case of physically-based models. *J Hydrol* 105:157–172. doi:[10.1016/0022-1694\(89\)90101-7](https://doi.org/10.1016/0022-1694(89)90101-7)
166. Beven K (2002) Towards an alternative blueprint for a physically based digitally simulated hydrologic response modelling system. *Hydrol Process* 16:189–206
167. Blackmarr WA (1995) Documentation of hydrologic, geomorphic, and sediment transport measurements on the Goodwin creek experimental watershed, northern Mississippi, for the period 1982–1993. Preliminary release, U.S. Department of Agriculture, National Sedimentation Laboratory, Oxford, MS, p 41
168. Vélez JI, Francés F, Lavabre J, Puricelli M (1999) Adaptación del Modelo GR3 a un Modelo Distribuido por Isocronas para Simulación de Crecidas. Aplicación a la Cuenca del Réal Collobrier. *Avances en Recursos Hidráulicos* 6:23–36 (in Spanish)
169. Francés F, Vélez JJ, Vélez JI, Puricelli M (2002) Distributed modelling of large basins for a real time flood forecasting system in Spain. In: *Proceedings second federal interagency hydrologic modelling conference*, Las Vegas, USA, July, CD Format, pp 3513–3524
170. Morales-de la Cruz M, Francés F (2008) Hydrological modelling of the Sierra de las Minas in Guatemala, by using a conceptual distributed model and considering the lack of data.

- In: Mander U, Brebbia CA, Martín-Duque JF (eds) Environment and landscape evolution III. WIT Press, Southampton, UK, pp 97–108
171. Vélez JJ, Puricelli M, López Unzu F, Francés F (2009) Parameter extrapolation to ungauged basins with a hydrological distributed model in a regional framework. *Hydrol Earth Syst Sci* 13 (2):229–246
  172. Guichard Romero D, García Bartual R, Francés Garcia F, Domínguez Mora R (2009) Análisis de la densidad de estaciones en zonas de lluvias convectivas. Caso del Mediterráneo español. *Ingeniería Hidráulica de México* 24(3):35–49
  173. Francés F, Benito G (1995) La modelación distribuida con pocos parámetros de las crecidas. *Ingeniería del Agua* 2(4):7–24 (in Spanish)
  174. Molnár P, Ramírez JA (1998) An analysis of energy expenditure in Goodwin Creek. *Water Resour Res* 34(7):1819–1829
  175. Rykiel EJ (1996) Testing ecological models: the meaning of validation. *Ecol Model* 90:229–244
  176. Beck MB, Ravetz JR, Mulkey LA, Barnwell TO (1997) On the problem of model validation for predictive exposure assessments. *Stoch Hydrol Hydraul* 11(3):229–254
  177. Konikow LF, Bredehoeft JD (1992) Ground-water models cannot be validated. *Adv Water Resour* 15:75–83
  178. Oreskes N, Shrader-Frechette K, Belitz K (1994) Verification, validation, and confirmation of numerical models in the earth sciences. *Science* 263:641–646
  179. Yapo PO, Gupta HV, Sorooshian S (1996) Automatic calibration of conceptual rainfall-runoff models: sensitivity to calibration data. *J Hydrol* 181:23–48
  180. Gan TY, Dlamini EM, Biftu GF (1997) Effects of model complexity and structure, data quality, and objective functions on hydrologic modeling. *J Hydrol* 192:81–103
  181. Gupta VH, Sorooshian S, Yapo PO (1998) Toward improved calibration of hydrologic models: multiple and noncommensurable measures of information. *Water Resour Res* 34(4):751–763
  182. Santhi C, Arnold JG, Williams JR, Dugas WA, Srinivasan R, Hauck LM (2001) Validation of the SWAT model on a large river basin with point and nonpoint sources. *J Am Water Resour Assoc* 37(5):1169–1188
  183. Moriasi DN, Arnold JG, Van Liew MW, Bingner RL, Harmel RD, Veith TL (2007) Model evaluation guidelines for systematic quantification of accuracy in watershed simulations. *Trans Am Soc Agricult Biol Eng* 50(3):885–900
  184. Duan Q, Gupta VK, Sorooshian S (1992) Effective and efficient global optimization for conceptual rainfall-runoff models. *Water Resour Res* 28(4):1015–1031
  185. Duan Q, Gupta VK, Sorooshian S (1993) A shuffled complex evolution approach for effective and efficient global minimization. *J Optim Theor Appl* 76(3):501–521
  186. Mantovan P, Todini E (2006) Hydrological forecasting uncertainty assessment: incoherence of the GLUE methodology. *J Hydrol* 330:368–381. doi:[10.1016/j.jhydrol.2006.04.046](https://doi.org/10.1016/j.jhydrol.2006.04.046)
  187. Stedinger JR, Vogel RM, Lee SU, Batchelder R (2008) Appraisal of the generalized likelihood uncertainty estimation (GLUE) method. *Water Resour Res* 44(W00B06). doi:[10.1029/2008WR006822](https://doi.org/10.1029/2008WR006822)
  188. Vrugt JA, ter Braak CJF, Gupta HV, Robinson BA (2009) Equifinality of formal (DREAM) and informal (GLUE) Bayesian approaches in hydrologic modeling? *Stoch Environ Res Risk Assess* 23(7):1011–1026
  189. Klepper O, Scholten H, van de Kamer JPG (1991) Prediction uncertainty in an ecological model of the Oosterschelde estuary. *Water Res* 10:191–209

190. Yapo PO, Gupta HV, Sorooshian S (1998) Multi-objective global optimization for hydrologic models. *J Hydrol* 204:83–97
191. Madsen H (2000) Automatic calibration of a conceptual rainfall-runoff model using multiple objectives. *J Hydrol* 235:276–288
192. Madsen H (2003) Parameter estimation in distributed hydrological catchment modelling using automatic calibration with multiple objectives. *Adv Water Resour* 26:205–216
193. van Griensven A, Bauwens W (2003) Multiobjective autocalibration for semidistributed water quality models. *Water Resour Res* 39(12):1348. doi:[10.1029/2003WR002284](https://doi.org/10.1029/2003WR002284)
194. Hornberger GM, Spear RC (1980) Eutrophication in Peel Inlet, I, The problem-defining behaviour and a mathematical model for the phosphorus scenario. *Water Res* 14(1):29–42
195. Beven KJ, Freer J (2001) Equifinality, data assimilation, and uncertainty estimation in mechanistic modelling of complex environmental systems using the GLUE methodology. *J Hydrol* 249 (1–4):11–29
196. Beven KJ (2009) *Environmental modelling: an uncertain future?* Routledge, London
197. Muttiah RS, Wurbs RA (2002) Scale-dependent soil and climate variability effects on watershed water balance of the SWAT model. *J Hydrol* 256:264–285
198. Spruill CA, Workman SR, Taraba JL (2000) Simulation of daily and monthly stream discharge from small watersheds using the SWAT model. *Trans Am Soc Agric Eng* 43(6):1431–1439
199. NRC (National Research Council) (2001) *Assessing the TMDL approach to water quality management*. National Academy Press, Washington, DC
200. Kavetski D, Kuczera G, Franks SW (2006) Bayesian analysis of input uncertainty in hydrological modeling: theory. *Water Resour Res* 42(W03407). doi:[10.1029/2005WR004368](https://doi.org/10.1029/2005WR004368)
201. Morgan MG, Keith D (1995) Subjective judgments by climate experts. *Environ Sci Tech* 29 (10):468–476
202. Morgan MG, Henrion M (1990) *Uncertainty: a guide to dealing with uncertainty in quantitative risk and policy analysis*. Cambridge University Press, Cambridge, UK
203. Saltelli A, Chan K, Scott EM (2000) *Sensitivity analysis*. Wiley, New York
204. Benjamin JR, Cornell CA (1970) *Probability, statistics, and decision for civil engineers*. McGraw-Hill, New York
205. Marshall L, Nott D, Sharma A (2004) A comparative study of Markov chain Monte Carlo methods for conceptual rainfall-runoff modeling. *Water Resour Res* 40(W02501). doi:[10.1029/2003WR002378](https://doi.org/10.1029/2003WR002378)
206. Ajami NK, Duan Q, Sorooshian S (2007) An integrated hydrologic Bayesian multimodel combination framework: confronting input, parameter, and model structural uncertainty in hydrologic prediction. *Water Resour Res* 43(W01403). doi:[10.1029/2005WR004745](https://doi.org/10.1029/2005WR004745)
207. Krzysztofowicz R (1999) Bayesian theory of probabilistic forecasting via deterministic hydrologic model. *Water Resour Res* 35:2739–2750
208. Raftery AE (1993) Bayesian model selection in structural equation models. In: Bollen KA, Long JS (eds) *Testing structural equation models*. Newbury Park, CA, pp 163–180
209. Vrugt JA, Robinson BA (2007) Treatment of uncertainty using ensemble methods: comparison of sequential data assimilation and Bayesian model averaging. *Water Resour Res* 43(W01411). doi:[10.1029/2005WR004838](https://doi.org/10.1029/2005WR004838)
210. Todini E (2008) A model conditional processor to assess predictive uncertainty in flood forecasting. *Int J River Basin Manag* 6(2):123–137

211. Weerts AH, Winsemius HC, Verkade JS (2010) Estimation of predictive hydrological uncertainty using quantile regression: examples from the national flood forecasting system (England and Wales). *Hydrol Earth Syst Sci* 7:5547–5575. doi:[10.5194/hessd-7-5547-2010](https://doi.org/10.5194/hessd-7-5547-2010)
212. Todini E (2011) History and perspectives of hydrological catchment modeling. *Hydrol Res* 42:73–85. doi:[10.2166/nh.2011.096](https://doi.org/10.2166/nh.2011.096)
213. Stedinger JR, Vogel RM, Foufoula-Georgiou E (1993) Frequency analysis of extreme events. In: Maidment DR (ed) *The handbook of hydrology*. McGraw Hill Book, New York
214. Yevjevich V (1972) *Probability and statistics in hydrology*. Water Resources Publications, Littleton, CO
215. Haan CT (2002) *Statistical methods in hydrology*. Blackwell Publisher, Ames, Iowa, p 496
216. Salas JD, Heo JH, Smith RA (2013) *Probability and statistics for water resources and environmental systems*. Colorado State University, Fort Collins (forthcoming book)
217. Rajagopalan B, Salas JD, Lall U (2010) Stochastic methods for modeling precipitation and streamflows. In: Berndtsson R, Sivakumar B (eds) *Advances in data-based approaches for hydrologic modeling and forecasting*. World Scientific, London, UK
218. IACWD (Interagency Committee on Water Data) (1982) Guidelines for determining flood flow frequency, bulletin 17B. Office of Water Data Coordination, U.S. Geological Survey, Reston, VA
219. Cunnane C (1989) *Statistical distributions for flood frequency analysis*, WMO Operational Hydrology report no. 33, Geneva, Switzerland
220. Mood AM, Graybill FA, Boes DC (1974) *Introduction to the theory of statistics*, 3rd edn. McGraw Hill Book, New York, p 564
221. Bobee B (1975) The log-Pearson type 3 distribution and its applications in hydrology. *Water Resour Res* 11(5):681–689
222. USACE (U.S. Army Corps of Engineers) (1996) Risk based analysis of flood damage reduction studies, manual, EM 1110-2-1619. USACE (US Army Corps of Engineers), Washington, DC
223. Platte EJ (2001) Risk management for hydraulic systems under hydrologic loads. In: Bogardi JJ, Kundzewicz ZW (eds) *Risk, reliability, uncertainty, and robustness of water resources systems*. Cambridge University Press, New York
224. Benson MA (1962) Evolution of methods for evaluating the occurrence of floods, water supply paper 1580-A. U.S. Geological Survey, Washington DC
225. Thomas DM, Benson MA (1970) Generalization of streamflow characteristics from drainage-basin characteristics, water supply paper 1975. US Geological Survey, Washington, DC
226. Mc Cain JF, Jarrett RD (1976) *Manual for estimating flood characteristics on natural-flow streams in Colorado*, technical manual no. 1, Colorado Water Conservation Board in Cooperation with the U.S. Geological Survey
227. Salas JD (1980) Use of multiple regression analysis to determine flood characteristics of small catchments. In: Sanders TG (ed) *Hydrology for transportation engineers*. U.S. Dept. of Transportation, Washington DC, HDV-21
228. Latraverse M, Rasmussen PF, Bobee B (2002) Regional estimation of flood quantiles: parametric versus nonparametric regression models. *Water Resour Res* 38(6):11
229. Saah AD (1975) *Basic hydrology methodology, summary and exhibit B, revision and updating of regional flood frequency analysis and computations*, Santa Clara Valley Water District
230. Dalrymple T (1960) *Flood frequency analysis*, water supply paper 1543-A. US Geological Survey, Washington, DC
231. Sveinsson OGB, Salas JD, Boes DC (2002) Regional frequency analysis of extreme precipitation in Northeastern Colorado and Fort Collins Flood of 1997. *ASCE J Hydrolog Eng* 7(1):49–63

232. Fill HD, Stedinger JR (1995) Homogeneity tests based upon Gumbel distribution and a critical appraisal of Dalrymple's test. *J Hydrol* 166(1–2):81–105
233. Lu LH, Stedinger JR (1992) Sampling variance of normalized GEV/PWM quantile estimators and a regional homogeneity test. *J Hydrol* 138(1–2):223–245
234. Naghavi B, Yu FX (1995) Regional frequency analysis of extreme precipitation in Louisiana. *J Hydraul Eng* 121(11):819–827
235. Rao AR, Hamed KH (1997) Regional frequency analysis of Wabash River flood data by L-moments. *J Hydrolog Eng* 2(4):169–179
236. Hosking JRM, Wallis JR (1997) *Regional frequency analysis: an approach based on L-moments*, 1st edn. Cambridge University Press, New York
237. Stedinger JR (1983) Estimating a regional flood frequency distribution. *Water Resour Res* 19(2):503–510
238. Sveinsson OGB, Boes DC, Salas JD (2003) Population index flood method for regional frequency analysis. *Water Resour Res* 37(11):2733–2748
239. Burn DH, Zrinji Z, Kowalchuk M (1997) Regionalization of catchments for regional flood frequency analysis. *ASCE J Hydrolog Eng* 2(2):76–82
240. Cunnane C (1988) Methods and merits of regional flood frequency analysis. *J Hydrol* 100(1–3):269–290
241. Meigh JR, Farquharson FAK, Sutcliffe JV (1997) A worldwide comparison of regional flood estimation methods and climate. *Hydrolog Sci J* 42(2):225–244
242. Gustard A, Roald LA, Demuth S, Lumadjeng HS, Gross R (1989) *Flow regimes from experimental and network data (FRIEND)*, 2 volumes, vol I. Hydrological studies. UNESCO, IHP III, project 6.1. Institute of Hydrology, Wallingford, UK
243. Vogel RM, Kroll CN (1992) Regional geo-hydrologic-geomorphic relationships for the estimation of low-flow statistics. *Water Resour Res* 28(9):2451–2458
244. Nathan RJ, McMahon TA (1992) Estimating low flow characteristics at ungaged catchments. *Water Resour Manag* 6:85–100
245. Kroll CN, Luz JG, Allen TB, Vogel RM (2004) Developing a watershed characteristics database to improve low streamflow prediction. *ASCE J Hydrolog Eng* 9(2):116–125
246. Laaha G, Blöschl G (2007) A national low flow estimation procedure for Austria. *Hydrolog Sci J* 52(4):625–644
247. Zhang Z, Kroll CN (2007) The base flow correlation method with multiple gaged sites. *J Hydrol* 347(3–4):371–380
248. Tase N (1976) *Area-deficit-intensity characteristics of droughts*. Ph.D. dissertation, Colorado State University, Fort Collins, CO
249. Santos M (1983) *Regional drought: a stochastic characterization*. *J Hydrol* 66(1–4):183–211
250. Rossi G, Cancelliere A (2003) At site and regional identification by REDIM model. In: Rossi G, Cancelliere A, Pereira LS, Oweis T, Shatanawi M, Zairi A (eds) *Tools for drought mitigation in Mediterranean regions*. Kluwer Academic Publishers, Dordrecht, The Netherlands, pp 37–54
251. De Michele C, Rosso R (2001) Uncertainty assessment of regionalized flood frequency estimates. *ASCE J Hydrolog Eng* 6(6):453–459
252. Salas JD, Heo JH (1997) On the uncertainty of risk of failure of hydraulic structures, managing water: coping with scarcity and abundance. *IAHR Congress*, San Francisco, pp 506–511
253. Salas JD, Burlando P, Heo JH, Lee DJ (2003) *The axis of risk and uncertainty in hydrologic design*, hydrology days 2003. Colorado State University, Fort Collins, CO



254. Salas JD, Heo JH, Lee DJ, Burlando P (2013) Quantifying the uncertainty of return period and risk in hydrologic design. *ASCE J Hydrolog Eng* 18(5):518–526
255. Loucks DP, Stedinger JR, Haith DA (1981) *Water resources planning and analysis*. Prentice Hall, Englewood Cliffs, NJ
256. Salas JD (1993) Analysis and modeling of hydrologic time series. In: Maidment DR (ed) *The handbook of hydrology*. McGraw Hill Book, New York
257. Hurst HE (1951) Long-term storage capacity of reservoirs. *Trans Am Soc Civ Eng* 116:770–799
258. Thomas HA, Fiering MB (1962) Mathematical synthesis of streamflow sequences for analysis of river basins by simulation. In: Maas A et al (eds) *The design of water resources systems*. Harvard University Press, Cambridge, MA, pp 459–493
259. Yevjevich V (1963) Fluctuations of wet and dry years—part I, research data assembly and mathematical models. *Hydrology papers 1*. Colorado State University, Fort Collins, CO
260. Matalas NC (1967) Mathematical assessment of synthetic hydrology. *Water Resour Res* 3(4):937–945
261. Mandelbrot BB, Wallis JR (1969) Computer experiments with fractional Gaussian noises: part 1, averages and variances. *Water Resour Res* 5(1):228–241
262. Salas JD, Delleur JW, Yevjevich V, Lane WL (1980) *Applied modeling of hydrologic time series*. Water Resources Publications, Littleton, CO, p 484 (2nd Printing 1985, 3rd Printing, 1988)
263. Bras R, Rodriguez-Iturbe I (1985) *Random functions and hydrology*. Addison-Wesley, Reading, MA, USA
264. Hipel K, McLeod AI (1994) *Time series modeling of water resources and environmental systems*. Elsevier, Amsterdam, p 1013
265. Lall U, Sharma A (1996) A nearest neighbor bootstrap for resampling hydrologic time series. *Water Resour Res* 32(3):679–693
266. Vogel RM, Shallcross AL (1996) The moving blocks bootstrap versus parametric time series models. *Water Resour Res* 32(6):1875–1882
267. Sharma A, O’Neill R (2002) A nonparametric approach for representing interannual dependence in monthly streamflow sequences. *Water Resour Res* 38(7):1100, 5-1/5-10
268. Srinivas VV, Srinivasan K (2005) Hybrid matched-block bootstrap for stochastic simulation of multiseason streamflows. *J Hydrol* 329(1–2):1–15
269. Salas JD, Lee TS (2009) Nonparametric simulation of single site seasonal streamflows. *ASCE J Hydrolog Eng* 15(4) April
270. Valencia D, Schaake JC (1973) Disaggregation processes in stochastic hydrology. *Water Resour Res* 9(3):580–585
271. Lane W (1979) *Applied stochastic techniques (last computer package) user manual*. Div. Planning Tech. Services, U.S. Bureau of Reclamation, Denver, CO
272. Stedinger JR, Vogel RM (1984) Disaggregation procedures for generating serially correlated flow vectors. *Water Resour Res* 20(1):47–56
273. Stedinger JR, Pei D, Cohn TA (1985) A condensed disaggregation model for incorporating parameter uncertainty into monthly reservoir simulations. *Water Resour Res* 21(5):665–675
274. Santos E, Salas JD (1992) Stepwise disaggregation scheme for synthetic hydrology. *ASCE J Hydraul Eng* 118(5):765–784
275. Tarboton DG, Sharma A, Lall U (1998) Disaggregation procedures for stochastic hydrology based on nonparametric density estimation. *Water Resour Res* 34(1):107–119

276. Lee TS, Salas JD, Prairie J (2010) Nonparametric streamflow disaggregation modeling. *Water Resour Res* 46(W08545):1–14
277. Salas JD, Boes DC (1980) Shifting level modeling of hydrologic series. *Adv Water Resour* 3:59–63
278. Eltahir EAB (1996) El Niño and the natural variability in the flow of the Nile River. *Water Resour Res* 32(1):131–137
279. Salas JD, Pielke RA (2003) Stochastic characteristics and modeling of hydroclimatic processes. In: Potter TD, Colman BR (eds) *Handbook of weather, climate and water: atmospheric chemistry, hydrology, and societal impacts*. Wiley, New York
280. Obeysekera JTB, Tabios G, Salas JD (1987) On parameter estimation of temporal rainfall models. *Water Resour Res* 23(10):1837–1850
281. Katz R, Parlange M (1995) Generalizations of chain-dependent processes: applications to hourly precipitation. *Water Resour Res* 31(5):1331–1341
282. Kerr RA (1992) Unmasking a shifty climate system. *Res News* 255:1508–1510
283. Bobbee B, Robitaille R (1975) Correction of bias in the estimation of the coefficient of skewness. *Water Resour Res* 11(6):851–854
284. Wallis JR, O’Connell PE (1972) Small sample estimation of  $\rho_1$ . *Water Resour Res* 8(3):707–712
285. Fernandez B, Salas JD (1990) Gamma-autoregressive models for streamflow simulation. *ASCE J Hydraul Eng* 116(11):1403–1414
286. Roesner LA, Yevjevich V (1966) *Mathematical models for time series of monthly precipitation and monthly runoff*, hydrology papers 15. Colorado State University, Fort Collins, CO
287. Press WH, Flannery BP, Teukolsky SA, Vetterling WV (1986) *Numerical recipes: the art of scientific computing*. Cambridge University Press, New York, NY
288. Fiering MB, Jackson BB (1971) *Synthetic streamflows*. Water resources monograph 1, American Geophysical Union, Washington DC, p 98
289. Grygier JC, Stedinger JR (1990) SPIGOT, a synthetic streamflow generation software package, technical description, version 2.5. School of Civil and Environmental Engineering, Cornell University, Ithaca, NY
290. Sveinsson OGB, Lee TS, Salas JD, Lane WL, Frevert DK (2010) *Stochastic analysis, modeling, and simulation (SAMS) version 2010*. Colorado State University, Fort Collins, CO
291. Wood EF, O’Connell PE (1985) Real-time forecasting. In: Anderson MG, Burt TP (eds) *Hydrological forecasting*. Wiley, New York, pp 505–558
292. Haltiner JP, Salas JD (1988) Short-term forecasting of snowmelt runoff using ARMAX models. *Water Resour Bull* 24(5):1083–1089
293. Burlando P, Rosso R, Cadavid L, Salas JD (1993) Forecasting of short-term rainfall using ARMA models. *J Hydrol* 144:193–211
294. Lettenmaier DP, Wood EF (1993) Hydrologic forecasting. In: Maidment DR (ed) *Handbook of hydrology*. McGraw Hill Book, New York
295. Ribeiro J, Lauzon N, Rousselle J, Trung HT, Salas JD (1998) Comparaison de deux modeles pour la prevision journaliere en temps reel des apports naturels. *Can J Civ Eng* 25:291–304
296. Ramirez JA, Bras RL (1985) Conditional distributions of Neyman-Scott models for storm arrivals and their use in irrigation control. *Water Resour Res* 21:317–330
297. Bertoni JC, Tucci CE, Clarke RT (1992) Rainfall-based real-time flood forecasting. *J Hydrol* 131:313–339
298. French MN, Bras RL, Krajewski WF (1992) A Monte-Carlo study of rainfall forecasting with a stochastic model. *Stoch Hydrol Hydraul* 6(1):27–45

299. Govindaraju RS, Rao AR (2000) Artificial neural networks in hydrology. Kluwer Academic Publishers, Dordrecht
300. Gupta HV, Hsu K, Sorooshian S (2000) Effective and efficient modeling for streamflow forecasting. In: Govindaraju RS, Rao AR (eds) Artificial neural networks in hydrology. Kluwer Academic Publishers, Dordrecht, pp 7–22
301. Salas JD, Markus M, Tokar AS (2000) Streamflow forecasting based on artificial neural networks. In: Rao AR, Rao G (eds) Artificial neural networks in hydrology. Kluwer Academic Publishers, London, pp 23–51
302. French MN, Krajewski WF, Cuykendall RR (1992) Rainfall forecasting in space and time using a neural network. *J Hydrol* 137:1–31
303. Kuligowski RJ, Barros AP (1998) Experiments in short-term precipitation forecasting using artificial neural networks. *Mon Weather Rev* 126:470–482
304. Luk KC, Ball JE, Sharma A (2000) A study of optimal model lag and spatial inputs to artificial neural network for rainfall forecasting. *J Hydrol* 227(1–4):56–65
305. Toth E, Brath A, Montanari A (2000) Comparison of short-term rainfall prediction models for real-time flood forecasting. *J Hydrol* 239(1–4):132–147
306. Cayan DR, Webb RH (1992) El Niño/southern oscillation and streamflow in the western United States. In: Diaz HF, Markgraf V (eds) Historical and paleoclimate aspects of the southern oscillation. Cambridge University Press, UK, pp 29–68
307. Clark MP, Serreze MC, McCabe GJ (2001) Historical effects of El Niño and La Niña events on seasonal evolution of the montane snowpack in the Columbia and Colorado river basins. *Water Resour Res* 37(3):741–757
308. Hidalgo HG, Dracup JA (2003) ENSO and PDO effects on hydroclimate variations of the Upper Colorado River basin. *J Hydrometeorol* 4:5–23
309. Tootle GA, Piechota TC (2006) Relationships between Pacific and Atlantic ocean sea surface temperatures and U.S. streamflow variability. *Water Resour Res* 42(W07411):14
310. Sveinsson OGB, Lall U, Gaudel J, Kushnir Y, Zebiak S, Fortin V (2008) Analysis of climatic states and atmospheric circulation patterns that influence Quebec spring streamflows. *ASCE J Hydrolog Eng* 13(6):411–424
311. Hamlet AF, Lettenmaier DP (1999) Columbia river streamflow forecasting based on ENSO and PDO climate signals. *ASCE J Water Resour Plann Manag* 125(6):333–341
312. Eldaw AK, Salas JD, Garcia LA (2003) Long range forecasting of the Nile River flow using large scale oceanic atmospheric forcing. *J Appl Meteorol* 42:890–904
313. Grantz K, Rajagopalan B, Clark M, Zagona E (2005) A technique for incorporating large-scale climate information in basin-scale ensemble streamflow forecasts. *Water Resour Res* 41. doi:10.1029/2004WR003467
314. Tootle GA, Singh AK, Piechota TC, Farnham I (2007) Long-lead time forecasting of U.S. streamflows using partial least squares regression. *ASCE J Hydrolog Eng* 12(5):442–451
315. Salas JD, Fu CJ, Rajagopalan B (2011) Long range forecasting of Colorado streamflows based on hydrologic, atmospheric, and oceanic data. *ASCE J Hydrolog Eng* 16(6):508–520
316. Stone RC, Hammer GL, Marcussen T (1996) Prediction of global rainfall using phases of the Southern Oscillation Index. *Nature* 384:252–255
317. Sharma A (2000) Seasonal to interannual rainfall probabilistic forecasts for improved water supply management: Part 3—a non parametric probabilistic forecast model. *J Hydrol* 239(1–4):249–258

318. Regonda SK, Rajagopalan B, Clark M, Zagona E (2006) A multimodel ensemble forecast framework: application to spring seasonal flows in the Gunnison River basin. *Water Resour Res* 42(W09404):14
319. Box GEP, Jenkins GW (1976) *Time series analysis forecasting and control*, revised edition. Holden-Day, San Francisco
320. Camacho F, McLeod AI, Hipel KW (1987) Multivariate contemporaneous ARMA model with hydrological applications. *Stoch Hydrol Hydraul* 1:141–154
321. Vicens GJ, Rodriguez-Iturbe I, Schaake JC (1975) Bayesian generation of synthetic streamflows. *Water Resour Res* 11(6):827–838
322. Valdes JB, Rodriguez-Iturbe I, Vicens GJ (1977) Bayesian generation of synthetic streamflows; 2. The multivariate case. *Water Resour Res* 13(2):291–295
323. McLeod AI, Hipel KW (1978) Simulation procedures for Box-Jenkins models. *Water Resour Res* 14(5):969–975
324. Stedinger JR, Taylor MR (1982) Synthetic streamflow generation, Part 2. Parameter uncertainty. *Water Resour Res* 18(4):919–924
325. Wood EF (1978) Analyzing hydrologic uncertainty and its impact upon decision making in water resources. *Adv Water Resour* 1(5):299–305
326. Klemes VR, Srikanthan R, McMahon TA (1981) Long-memory flow models in reservoir analysis: what is their practical value. *Water Resour Res* 17(3):737–751
327. Cover KA, Unny TE (1986) Application of computer intensive statistics to parameter uncertainty in streamflow synthesis. *Water Resour Bull* 22(3):495–507
328. Tasker GD, Dunne P (1997) Bootstrap position analysis for forecasting low flow frequency. *ASCE J Water Resour Plann Manag* 123(6):359–367
329. Lee DJ, Salas JD, Boes DC (2007) Uncertainty analysis for synthetic streamflow generation. In: *Proceedings of the ASCE/EWRI World Congress, Tampa, Florida, May*
330. Draper N, Smith H (1981) *Applied regression analysis*, 2nd edn. Wiley, New York, USA
331. Olsen JR, Stedinger JR, Matalas NC, Stakhiv EZ (1999) Climate variability and flood frequency estimation for the Upper Mississippi and Lower Missouri rivers. *J Am Water Resour Assoc* 35(6):1509–1523
332. Lins HF, Slack JR (1999) Streamflow trends in the United States. *Geophys Res Lett* 26(2):227–230
333. Strupczewski WG, Singh VP, Mitosek HT (2001) Non-stationary approach to at-site flood frequency modeling. III. Flood frequency analysis of Polish rivers. *J Hydrol* 248:152–167
334. Douglas EM, Vogel RM, Kroll CN (2000) Trends in floods in the United States: impact of spatial correlation. *J Hydrol* 240:90–105
335. Milly PCD, Dunne KA, Vecchia AV (2005) Global pattern of trends in streamflow and water availability in a changing climate. *Nat Lett* 438:347–350
336. Potter KW (1976) Evidence for nonstationarity as a physical explanation of the Hurst phenomenon. *Water Resour Res* 12(5):1047–1052
337. McCabe GJ, Wolock DM (2002) A step increase in streamflow in the conterminous United States. *Geophys Res Lett* 29(24):2185, 38(1–4)
338. Franks SW, Kuczera G (2002) Flood frequency analysis: evidence and implications of secular climate variability, New South Wales. *Water Resour Res* 38(5):20 (1–7)
339. Sveinsson OGB, Salas JD, Boes DC, Pielke RA (2003) Modeling the dynamics of long term variability of hydroclimatic processes. *J Hydrometeorol* 4:489–505

340. Hejazi MI, Markus M (2009) Impacts of urbanization and climate variability on floods in Northeastern Illinois. *ASCE J Hydrolog Eng* 14(6):606–616
341. Jain S, Lall U (2000) Magnitude and timing of annual maximum floods: trends and large-scale climatic associations for the Blacksmith Fork River, Utah. *Water Resour Res* 36(12):3641–3651
342. Jain S, Lall U (2001) Floods in a changing climate: does the past represent the future? *Water Resour Res* 37(12):3193–3205
343. Fortin V, Perreault L, Salas JD (2004) Retrospective analysis and forecasting of streamflows using a shifting level model. *J Hydrol* 296:135–163
344. Waylen PR, Woo MK (1982) Prediction of annual floods generated by mixed processes. *Water Resour Res* 18(4):1283–1286
345. Rossi F, Fiorentino M, Versace P (1984) Two-component extreme value distribution for flood frequency analysis. *Water Resour Res* 20(7):847–856
346. Jarrett RD (1987) Flood hydrology of foothill and mountain streams in Colorado. Ph.D. dissertation, Department of Civil Engineering, Colorado State University, Fort Collins, CO
347. Salas JD, Boes DC, Cunnane C, Guo X, Cadavid LG (1990) Improved methods for regional flood frequency analysis, final report submitted to the U.S. Geological Survey, Washington, DC, March, p 113
348. Clarke RT (2002) Estimating trends in data from the Weibull and a generalized extreme value distribution. *Water Resour Res* 38(6):25 (1–10)
349. Clarke RT (2002) Estimating time trends in Gumbel-distributed data by means of generalized linear models. *Water Resour Res* 38(7):16 (1–11)
350. El Adlouni A, Ouarda TBM, Zhang X, Roy R, Bobee B (2007) Generalized maximum likelihood estimators for the nonstationary generalized extreme value model. *Water Resour Res* 43 (W03410):1–13
351. Kiem AS, Franks SW, Kuczera G (2003) Multi-decadal variability of flood risk. *Geophys Res Lett* 30(2):1035, 7(1–4)
352. Sveinsson OGB, Salas JD, Boes DC (2005) Prediction of extreme events in hydrologic processes that exhibit abrupt shifting patterns. *ASCE J Hydrolog Eng* 10(4):315–326
353. Katz RW, Parlange MB, Naveau P (2002) Statistics of extremes in hydrology. *Adv Water Resour* 25:1287–1304
354. Griffis V, Stedinger JR (2007) Incorporating climate change and variability into Bulletin 17B LP3 model. *ASCE World Environmental and Water Resources Congress 2007*
355. Boes DC, Salas JD (1978) Nonstationarity in the mean and the Hurst phenomenon. *Water Resour Res* 14(1):135–143
356. Thyer M, Kuczera G (2000) Modeling long-term persistence in hydroclimatic time series using a hidden state Markov model. *Water Resour Res* 36(11):3301–3310
357. Akintug B, Rasmussen PF (2005) A Markov switching model for annual hydrologic time series. *Water Resour Res* 41, W09424 (1-10)
358. Hosking JRM (1984) Modeling persistence in hydrological time series using fractional differencing. *Water Resour Res* 20(12):1898–1908
359. Beran J (1994) *Statistics for long-memory processes*, monographs on statistics and applied probability, vol 61. Chapman & Hall, New York, USA
360. Montanari A, Rosso R, Taquu MS (1997) Fractionally differenced ARIMA models applied to hydrologic time series. *Water Resour Res* 33(5):1035–1044
361. Mandelbrot BB (1971) A fast fractional Gaussian noise generator. *Water Resour Res* 7 (3):543–553

362. Koutsoyiannis D (2002) The Hurst phenomenon and fractional Gaussian noise made easy. *Hydrolog Sci J* 47(4):573–595
363. Kidd CK (2001) Satellite rainfall climatology: a review. *Int J Climatol* 21:1041–1066
364. Huffman GF (2005) Satellite-based estimation of precipitation using microwave sensors. In: Anderson MG (ed) *Encyclopedia of hydrologic sciences*, chapter 64
365. Su FG, Hong Y, Lettenmaier DP (2008) Evaluation of TRMM multisatellite precipitation analysis (TMPA) and its utility in hydrologic prediction in the La Plata Basin. *J Hydrometeorol* 9(4):622–640
366. Vorosmarty C et al (2001) Global water data: a newly endangered species. *EOS Trans Am Geophys Union* 82(5):56–58
367. Huffman GJ, Adler RF, Bolvin DT, Gu G, Nelkin EJ, Bowman KP, Hong Y, Stocker EF, Wolff DB (2007) The TRMM multisatellite precipitation analysis (TMPA): quasi-global, multiyear, combined-sensor precipitation estimates at fine scales. *J Hydrometeorol* 8:38–55
368. Joyce RJ, Janowiak JE, Arkin PA, Xie P (2004) CMORPH: a method that produces global precipitation estimates from passive microwave and infrared data at high spatial and temporal resolution. *J Hydrometeorol* 5:487–503
369. Hsu KL, Gao X, Sorooshian S, Gupta HV (1997) Precipitation estimation from remotely sensed information using artificial neural networks. *J Appl Meteorol* 36:1176–1190
370. Dinku T, Ruiz F, Connor SJ, Ceccato P (2010) Validation and intercomparison of satellite rainfall estimates over Colombia. *J Appl Meteorol Climatol* 49(5):1004–1014
371. Krajewski WF, Ciach GJ, McCollum JR, Bacotiu C (2000) Initial validation of the Global Precipitation Climatology Project monthly rainfall over the United States. *J Appl Meteorol* 39:1071–1086
372. Nicholson SE, Some B, McCollum J, Nelkin E, Klotter D, Berte Y, Diallo BM, Gaye I, Kpabeba G, Ndiaye O (2003) Validation of TRMM and other rainfall estimates with a high-density gauge data set for West Africa. Part I: validation of GPCC rainfall product and pre-TRMM satellite and blended products. *J Appl Meteorol* 42:1337–1354
373. Nicholson SE, Some B, McCollum J, Nelkin E, Klotter D, Berte Y, Diallo BM, Gaye I, Kpabeba G, Ndiaye O (2003) Validation of TRMM and other rainfall estimates with a high-density gauge data set for West Africa. Part II: validation of TRMM rainfall products. *J Appl Meteorol* 42:1355–1368
374. Dinku T, Ceccato P, Kopec EG, Lemma M, Connor SJ, Ropelewski CF (2007) Validation of satellite rainfall products over East Africa's complex topography. *Int J Remote Sens* 28(7):1503–1526
375. Dinku T, Chidzambwa S, Ceccato P, Connor SJ, Ropelewski CF (2008) Validation of high resolution satellite rainfall products over complex terrain. *Int J Remote Sens* 29(14):4097–4110
376. Goncalves de Goncalves GL, Shuttleworth WJ, Nijssen B, Burke EJ, Marengo JA, Chou SC, Houser P, Toll DL (2006) Evaluation of model-derived and remotely sensed precipitation products for continental South America. *J Geophys Res* 111(D16113):13
377. Huffman GF, Adler RF, Morrissey M, Bolvin DT, Curtis S, Joyce R, McGavock B, Susskind J (2001) Global precipitation at one-degree daily resolution from multisatellite observations. *J Hydrometeorol* 2:36–50
378. Hossain F, Anagnostou EN (2004) Assessment of current passive microwave and infra-red based satellite rainfall remote sensing for flood prediction. *J Geophys Res* 109(D07102):14

379. Grebremichael M, Krajewski WF, Morrissey M, Langerud D, Huffman GF, Adler R (2003) Error uncertainty analysis of GPCP monthly rainfall products: a data-based simulation study. *J Appl Meteorol* 42:1837–1848
380. Steiner M, Bell TL, Zhang Y, Wood EF (2003) Comparison of two methods for estimating the sampling-related uncertainty of satellite rainfall averages based on a large radar dataset. *J Climate* 16:3759–3778
381. Tian YD, Peters-Lidard CD (2010) A global map of uncertainties in satellite-based precipitation measurements. *Geophys Res Lett* 37(L24407):6p
382. Alsdorf DE, Rodriguez E, Lettenmaier DP (2007) Measuring surface water from space. *Rev Geophys AGU*, 2006RG000197: 24
383. Cudlip W, Ridley JK, Rapley CG (1990) The use of satellite radar altimetry for monitoring wetlands. In: *Remote sensing and global change. Proceedings of the 16th annual conference of the remote sensing society*, Swansea, Dep. of Geogr., Univ. of Nottingham, UK, pp 207–216
384. Guzkowska MAJ, Rapley CG, Ridley JK, Cudlip W, Birkett CM, Scott RF (1990) Developments in inland water and land altimetry, ESA Contract, CR-7839/88/F/FL
385. Kobalinsky CJ, Clarke RT, Brenner AC, Frey H (1993) Measurement of river level variations with satellite altimetry. *Water Resour Res* 29(6):1839–1848
386. Birkett CM (1998) Contribution of the Topex NASA radar altimeter to the global monitoring of large rivers and wetlands. *Water Resour Res* 34(5):1223–1239
387. Birkett CM, Mertes LAK, Dunne T, Costa M, Jasinski J (2002) Surface water dynamics in the Amazon basin: application of satellite radar altimetry. *J Geophys Res* 107, No. D20-8059. doi:[10.1029/2001JD000609](https://doi.org/10.1029/2001JD000609)
388. Coe MT, Birkett CM (2004) Calculation of river discharge and prediction of lake height from satellite radar altimetry: example for the Lake Chad basin. *Water Resour Res* 40, No. W10205. doi:[10.1029/2003WR002543](https://doi.org/10.1029/2003WR002543)
389. Zakharova E, Kouraev A, Cazenave A, Seyler F (2006) Amazon river discharge estimated from the TOPEX/Poseidon altimetry. *Comput Geosci* 338:188–196
390. Leon JG, Calmant S, Seyler F, Bonnet MP, Cauhopé M, Frappart F, Filizola N, Fraizy P (2006) Rating curves and estimation of average depth at the Upper Negro River based on satellite altimeter data and modeled discharges. *J Hydrol* 328(3–4):481–496
391. Getirana ACV, Bonnet M-P, Rotunno OC, Collischonn W, Guyot J-L, Seyler F, Mansur WJ (2010) Hydrological modelling and water balance of the Negro River basin: evaluation based on in situ and spatial altimetry data. *Hydrol Process* 24:3219–3236
392. Kääb A, Prowse T (2011) Cold-regions river flow observed from space. *Geophys Res Lett* 38 (L08403):5
393. Biancamaria S, Hossain F, Lettenmaier DP (2011) Forecasting transboundary river water elevations from space. *Geophys Res Lett* 38(L11401):5
394. Owe M, Van de Griend AA, Chang ATC (1992) Surface moisture and satellite microwave observations in semiarid southern Africa. *Water Resour Res* 28:829–839
395. Njoku EG, Entekhabi D (1996) Passive microwave remote sensing of soil moisture. *J Hydrol* 184:101–129
396. Owe M, de Jeu R, Walker J (2001) A methodology for surface soil moisture and vegetation optical depth retrieval using the microwave polarization difference index. *IEEE Trans Geosci Rem Sens* 39(8):1643–1654
397. Jackson TJ (2001) Multiple resolution analysis of L-band brightness temperature for soil moisture. *IEEE Trans Geosci Rem Sens* 39(1):151–164

398. Wigneron J-P, Calvet J-C, Pellarin T, Van de Griend AA, Berger M, Ferrazzoli P (2003) Retrieving near-surface soil moisture from microwave radiometric observations: current status and future plans. *Remote Sens Environ* 85:489–506
399. Wagner W, Verhoest NEC, Ludwig R, Tedesco M (2007) Remote sensing in hydrological sciences. *Hydrol Earth Syst Sci* 13:813–881, <http://www.hydrol-earth-syst-sci.net/13/813/>
400. Crow WT, Ryu D (2009) A new data assimilation approach for improving runoff prediction using remotely-sensed soil moisture retrievals. *Hydrol Earth Syst Sci* 13:1–16
401. Albergel C, Rüdiger C, Carrer D, Calvet J-C, Fritz N, Naeimi V, Bartalis Z, Hasenauer S (2009) An evaluation of ASCAT surface soil moisture products with in-situ observations in Southern France. *Hydrol Earth Syst Sci* 13:115–124
402. Mattia F, Satalino G, Pauwels VRN, Loew A (2009) Soil moisture retrieval through a merging of multi-temporal L-band SAR data and hydrologic modeling. *Hydrol Earth Syst Sci* 13:343–356
403. Courault D, Seguin B, Olioso A (2005) Review on estimation of evapotranspiration from remote sensing data: from empirical to numerical modeling approaches. *J Irrigat Drain Syst* 19 (3):223–249
404. Moran MS, Jackson RD (1991) Assessing the spatial distribution of evapotranspiration using remotely sensed inputs. *J Environ Qual* 20(4):725–737
405. Kustas WP, Norman JM (1996) Use of remote sensing for evapotranspiration monitoring over land surfaces. *Hydrolog Sci J* 41(4):495–516
406. Quattrochi DA, Luval FJC (1999) Thermal infrared remote sensing for analysis of landscape ecological processes: methods and applications. *Landsc Ecol* 14:577–598. doi:[10.1023/A:1008168910634](https://doi.org/10.1023/A:1008168910634)
407. Overgaard J, Rosbjerg D, Butts MB (2006) Land-surface modeling in hydrologic perspective—a review. *Biogeosciences* 3:229–241
408. Gowda PH, Chavez JL, Colaizzi PD, Evett SR, Howell TA, Tolk JA (2007) Remote sensing based energy balance algorithms for mapping ET: current status and future challenges. *Trans Am Soc Agricult Biol Eng* 50(5):1639–1644
409. Glenn EP, Huete AR, Nagler PL, Hirschboeck KK, Brown P (2007) Integrating remote sensing and ground methods to estimate evapotranspiration. *Crit Rev Plant Sci* 26:139–168. doi:[10.1080/07352680701402503](https://doi.org/10.1080/07352680701402503)
410. Verstraeten WW, Veroustraete F, Feyen J (2008) Assessment of evapotranspiration and soil moisture content across different scales of observation. *Sensors* 8:70–117
411. Kalma JD, McVicar TR, McCabe MF (2008) Estimating land surface evaporation: a review of methods using remotely sensed surface temperature data. *Surv Geophys* 29:421–469
412. Ma W, Ma Y, Li M, Hu Z, Zhong L, Su Z, Ishikawa H, Wang J (2009) Estimating surface fluxes over the north Tibetan Plateau area with ASTER imagery. *Hydrol Earth Syst Sci* 13:57–67, <http://www.hydrol-earth-syst-sci.net/13/57/2009/>
413. Matsushita B, Xu M, Onda Y, Otsuki Y, Toyota M (2010) Detecting forest degradation in Kochi, Japan: ground-based measurements versus satellite (Terra/ASTER) remote sensing. *Hydrol Process* 24:588–595
414. Rouse J, Haas R, Schell J, Deering D (1974) Monitoring vegetation systems in the great plains with ERTS. In: *Proceedings of third earth resources technology satellite-1 symposium, Greenbelt, NASA SP-351*, pp 3010–3017
415. Gamon J, Penuelas J, Field CV (1992) A narrow-waveband spectral index that tracks diurnal changes in photosynthetic efficiency. *Remote Sens Environ* 41(1):35–44



416. Gao BC (1996) NDWI-A normalized difference water index for remote sensing of vegetation liquid water from space. *Remote Sens Environ* 58(3):257–266
417. Peñuelas J, Pinol J, Ogaya R, Filella I (1997) Estimation of plant water concentration by the reflectance water index WI (R900/R970). *Int J Remote Sens* 18:2869–2875
418. Xiao X, Hollinger D, Aber J, Goltz M, Davidson E, Zhang Q, Moore BIII (2004) Satellite-based modeling of gross primary production in an evergreen needleleaf forest. *Remote Sens Environ* 89:519–534
419. Nemani R, Running S (1997) Land cover characterization using multitemporal red, near-IR, and thermal-IR data from NOAA/AVHRR. *Ecol Appl* 7(1):79–90
420. Nemani R, Pierce LL, Runing SW, Goward SN (1993) Developing satellite derived estimates of surface moisture status. *J Appl Meteorol* 32:548–557
421. Anderson MC, Norman JM, Mecikalski JR, Otkin JA, Kustas WP (2007) A climatological study of evapotranspiration and moisture stress across the continental United States based on thermal remote sensing: 1. Model formulation. *J Geophys Res* 112(D10117):17
422. Anderson MC, Norman JM, Mecikalski JR, Otkin JA, Kustas WP (2007) A climatological study of evapotranspiration and moisture stress across the continental United States based on thermal remote sensing: 2. Soil moisture climatology. *J Geophys Res* 112(D11112):13
423. Anderson MC, Norman JM, Disk GR, Kustas WP, Mecikalski JR (1997) A two-source time-integrated model for estimating surface fluxes using thermal infrared remote sensing. *Remote Sens Environ* 60:195–216
424. Anderson MC, Kustas WP, Norman JM, Hain CR, Mecikalski JR, Schultz L, Gonzales-Dugo MP, Cammalleri C, d’Urso G, Pimstein A, Gao F (2011) Mapping daily evapotranspiration at field to continental scales using geostationary and polar orbiting satellite imagery. *Hydrol Earth Syst Sci* 15:223–239
425. Anderson MC, Allen RG, Morse A, Kustas WP (2012) Use of Landsat thermal imagery in monitoring evapotranspiration and managing water resources. *Remote Sens Environ*. doi:10.1016/j.rse.2011.08.025
426. Dozier J, Painter TH, Rittger K, Frew JE (2008) Time-space continuity of daily maps of fractional snow cover and albedo from MODIS. *Adv Water Resour* 31:1515–1526
427. Parajka J, Blosch G (2006) Validation of MODIS snow cover images over Austria. *Hydrol Earth Syst Sci* 10:679–689
428. Gafurov A, Bardossy A (2009) Snow cover data derived from MODIS for water balance applications. *Hydrol Earth Syst Sci* 6:791–841
429. Gao J, Liu Y (2011) Applications of remote sensing, GIS and GPS in glaciology: a review. *Prog Phys Geograph* 25(4):520–540
430. Kääb A (2005) Combination of SRTM3 and repeat ASTER data for deriving alpine glacier velocities in the Bhutan Himalaya. *Remote Sens Environ* 94(4):463–474
431. Berthier E, Arnaud Y, Kumar R, Ahmad S, Wagnon P, Chevallier P (2007) Remote sensing estimates of glacier mass balances in the Himachal Pradesh (Western Himalaya, India). *Remote Sens Environ* 108(3):327–338
432. Ulaby FT, Stiles WH (1980) The active and passive microwave response to snow parameters 2. Water equivalent of dry snow. *J Geophys Res* 85(C2):1045–1049
433. Dong J, Walker JP, Houser PR (2005) Factors affecting remotely sensed snow water equivalent uncertainty. *Remote Sens Environ* 97:68–82
434. Hall DK, Kelly RE, Foster JL, Chang AT (2005) Estimation of snow extent and snow properties. In: Anderson MG (ed) *Encyclopedia of hydrologic sciences*. Wiley, New York

435. Yueh S (2009) Remote sensing applications for snow cover and snow water equivalent. In: Water information management symposium, Western States Water Council, San Diego, CA
436. Durand M, Margulis SA (2006) Feasibility test of multifrequency radiometric data assimilation to estimate snow water equivalent. *J Hydrometeorol* 7:443–457
437. Jacobson MD (2010) Inferring snow water equivalent for a snow-covered ground reflector using GPS multipath signals. *Remote Sens* 2:2426–2441
438. Wahr J, Molenaar M, Bryan F (1998) Time-variability of the Earth's gravity field: hydrological and oceanic effects and their possible detection using GRACE. *J Geophys Res* 103(30):205–230
439. Rodell M, Famiglietti JS (1999) Detectability of variations in continental water storage from satellite observations of the time dependent gravity field. *Water Resour Res* 35(9):2705–2723
440. Tapley BD, Bettadpur S, Ries JC, Thompson PF, Watkins MM (2004) GRACE measurements of mass variability in the Earth system. *Science* 305:503–505
441. Rodell M, Velicogna I, Famiglietti JS (2009) Satellite-based estimates of groundwater depletion in India. *Nature* 460(20):999–1003
442. Scanlon BR, Longuevergne L, Wilson C, Favreau G (2011) Use of GRACE satellite to assess groundwater resources in semiarid regions. [http://www.un-igrac.org/dynamics/modules/SFIL0100/view.php?fil\\_Id=145](http://www.un-igrac.org/dynamics/modules/SFIL0100/view.php?fil_Id=145)
443. Green TR, Taniguchi M, Kooi H, Gurdak JJ, Allen DM, Hiscock KM, Treidel H, Aureli A (2011) Beneath the surface of global change: impacts of climate change on groundwater. *J Hydrol* 405 (3–4):532–560
444. Dingman SL (2002) *Physical hydrology*, 2nd edn. Prentice Hall, Upper Saddle River, NJ
445. Oltman RE, Stenberg HOR, Ames FC, Davis LC Jr (1964) Amazon river investigations reconnaissance measurements of July 1963, U.S.G.S. circular 486, Washington USA
446. Oltman RE (1968) Reconnaissance investigations of the discharge and water quality of the Amazon. U.S.G.S. circular 552, Washington USA
447. Meade RH, Nordin CF, Curtis WF (1979) Sediment in Rio Amazonas and some of its principal tributaries during the high water seasons of 1976 and 1977. In: *Proceedings of III simposio Brasileiro de Hidrologia (Brasilia, Brasil)*, 2, pp 472–485, April
448. Meade RH (1985) Suspended sediment in the Amazon river and its tributaries in Brazil during 1982–1984, USGS open file report 85-492, Denver, CO, USA
449. Richey JE, Meade RH, Salati E, Devol AH, Nordin CF, dos Santos U (1986) Water discharge and suspended sediment concentrations in the Amazon River. *Water Resour Res* 22(5):756–764
450. Guyot JL, Filizola N, Guimarães V (1998) Amazon suspended sediment yield measurements using an Acoustic Doppler Current Profiler (ADCP): first results. In: Johnson AI, Fernandez-Jauregui CA (eds) *Hydrology in the humid tropic environment*. Proc. Symp. Kingston, Jamaica, Nov., IAHS Publ. No. 253, pp 109–115
451. Callède J, Kosuth P, Guyot JL, Guimarães V (2000) Discharge determination by Acoustic Doppler Current Profilers (ADCP): a moving bottom error correction method and its application on the River Amazon at ODIBOS. *Hydrolog Sci J* 45(6):911–924
452. Filizola N, Guyot JL (2004) The use of Doppler technology for suspended sediment discharge determination in the River Amazon. *Hydrolog Sci J* 49(1):143–153
453. Laraque A, Guyot JL, Filizola N (2009) Mixing processes in the Amazon River at the confluences of the Negro and Solimoes Rivers. *Encontro das Aguas, Manaus, Brazil. Hydrol Process* 23:3131–3140

454. Biondi F, Strachan S (2011) Dendrohydrology in 2050: challenges and opportunities. In: Grayman WM, Loucks DP, Saito L (eds) *Toward a sustainable water future, visions for 2050*. American Society of Civil Engineers, New York
455. Meko D, Stockton CW, Boggess WR (1995) The tree-ring record of severe sustained drought. *Water Resour Bull* 31(5):789–801
456. Shulman E (1946) *Tree-ring hydrology of the Colorado river basin*. University of Arizona Bulletin. vol 16, no 4
457. Meko D, Therrell M, Baisan C, Hughes M (2001) Sacramento river flow reconstructed to AD 869 from tree rings. *J Am Water Resour Assoc* 37(4):1029–1039
458. Gray ST, Fastie CL, Jackson ST, Betancourt JL (2004) Tree ring-based reconstruction of precipitation in the Bighorn basin, Wyoming since 1260 A.D. *J Climate* 17(19):3855–3865
459. Yin ZY, Shao X, Qin N, Laing E (2008) Reconstruction of a 1436-year soil moisture and vegetation water use history based on tree-ring widths from Qilian junipers in northeastern Qaidam basin, northwestern China. *Int J Climatol* 28:37–53
460. Woodhouse CA (2003) A 431-yr reconstruction of western Colorado snowpack from tree rings. *J Climate* 16:1551–1561
461. Loaiciga HA, Haston L, Michaelsen J (1993) Dendrohydrology and long-term hydrological phenomena. *Rev Geophys* 31(2):151–171
462. Woodhouse CA (2001) A tree-ring reconstruction of streamflow for the Colorado front range. *J Am Water Resour Assoc* 37(3):561–569
463. Gedalof Z, Peterson DL, Mantua NJ (2004) Columbia river flow and drought since 1750. *J Am Water Resour Assoc* 40(6):1579–1592
464. Tarawneh ZS, Salas JD (2008) Extending the streamflows of the Colorado river using tree ring indices and drought analysis. Project report submitted to the U.S. Bureau of Reclamation, Colorado State University, August, p 83
465. Biondi F, Kozubowski TJ, Panorska AK, Saito L (2008) A new stochastic model of episode peak and duration for eco-hydro-climatic applications. *Ecolog Model* 211:383–395
466. Cleveland MK (2000) A 963-year reconstruction of Summer (JJA) streamflows in the White River, Arkansas, USA, from tree-rings. *The Holocene* 10(1):33–41
467. Hidalgo HG, Piechota TC, Dracup JA (2000) Alternative principal components regression procedures for dendrohydrologic reconstructions. *Water Resour Res* 36(11):3241–3249
468. Gonzalez J, Valdes JB (2003) Bivariate drought analysis using tree ring reconstruction. *ASCE J Hydrolog Eng* 8(4):247–257
469. Maidment DR (2011) The CUAHSI hydrologic information system. CUAHSI conference on hydrologic data and information systems, Abstracts, Utah State University, Logan, June 22–24
470. Zaslavsky I, Maidment DR, Tarboton DG, Piasecki M, Goodall J, Valentine D, Whitenack T, Horsburgh JS, Whiteaker T (2011) CUAHSI HIS service oriented architecture. CUAHSI conference on hydrologic data and information systems, Abstracts, Utah State University, Logan, June 22–24
471. Tarboton DG, Horsburgh JS, Schreuders KAT, Maidment DR, Zaslavsky I, Valentine D (2011) The HydroServer platform for sharing hydrologic data, CUAHSI conference on hydrologic data and information systems, Abstracts, Utah State University, Logan, June 22–24
472. Salas FR, Boldrini E, Maidment DR, Nativi S, Domenico B (2011) A federated approach to crossing the digital divide, CUAHSI conference on hydrologic data and information systems, Abstracts, Utah State University, Logan, June 22–24

# Open-Channel Hydraulics: From Then to Now and Beyond

---

Xiaofeng Liu

## CONTENTS

INTRODUCTION

NUMERICAL MODELING OF OPEN-CHANNEL HYDRAULICS

MODERN AND FUTURE CHALLENGES

REFERENCES

---

**Abstract** As a subdiscipline of water resources engineering, open-channel hydraulics is of critical importance to human history. This chapter starts with a brief history of open-channel hydraulics. Then the fundamental concepts in open-channel hydraulics (specific energy, momentum, and resistance) are introduced. The new development on the subject of open-channel flow modeling is discussed at some length. A general introduction on 1D, 2D, and 3D computer modeling and examples will be given. Despite the tremendous progress made in the past, modern and future challenges include revisiting past projects which were designed using less than ideal standards, effect of climate variability, and natural open channels in the arid environment. The chapter concludes with a discussion of potential future directions.

**Key Words** Open-channel hydraulics • Numerical modeling • Turbulence • Sediment transport.

## 1. INTRODUCTION

Open-channel hydraulics is a critical subdiscipline in the area of water resources engineering that has been practiced successfully throughout the settled parts of the world long before recorded history. Functional systems of open channels, of course, also predate modern theory and those modern essentials for design and analysis such as the computer.

An appropriate beginning of this very brief review of the importance of open channels in prehistory and history is to quote Hunter Rouse [1] who wrote in 1957, “A major task in dealing with modern times is . . . to separate the vast amount of chaff from the essential grain.” The advent of the information age has only added validity to this statement. However, it is worth briefly reflecting on the essential role water resources engineering, in general, and open channels, in specific, have played in human development. In c. 4000 BC, the Egyptians dammed the Nile in the vicinity of Memphis (a short distance south of Cairo) in part to divert flood waters to prehistoric Lake Moeris which could store vast quantities of water for irrigation. In c. 2300 BC the canal connecting the Nile and Lake Moeris was deepened and widened to form what is now known as *Bahr Yussef*. The purposes of this open-channel-reservoir system were to control the flooding of the Nile, regulate the water level of the Nile during dry seasons, and irrigate the surrounding area [1]. In c. 1800 BC, Egyptians also built a canal connecting the Nile River and Red Sea. The existence of this canal was quoted by Aristotle, Strabo, and Pliny the Elder. It should be observed that apparently the Red Sea then tended further north than it does today. The history of what today is known as the Middle East is replete with systems of dams and open-channel systems that sustained agriculture and allowed the development and growth of urban areas. Similar major systems also were undertaken in China, India, and Pakistan.

Certainly the best known contribution of the Romans, from the viewpoint of open-channel hydraulics, was the aqueduct. Throughout the Roman world, water was collected at springs and/or wells and transmitted by open channels to urban areas where it was distributed to consumers often by pressurized pipes. The Roman consumer was charged for the use of the resource so the system could be sustained. Although it cannot be known with certainty, Roman water resources engineers and their equally skilled predecessors likely had very little theoretical knowledge. However, they knew a slight slope was required for water to flow and that water will not rise above its initial elevation without the addition of energy.

After the fall of the Roman Empire, the “Dark Ages” descended in the west during which there was minimal recorded scientific and engineering progress. The Dark Ages were followed by the Renaissance and the rise of observational science. It was during this period that individuals of the stature of Leonardo da Vinci (1452–1519) made direct and critical contributions to hydraulic engineering. Regarding Leonardo’s discussion of continuity in the riverine environment Hunter Rouse said,

...he did it with such originality and clarity that the principle might justifiably bear his name. ([1], p. 49)

Following the major contributions of Newton to mechanics in the seventeenth century, Daniel Bernoulli, Leonhard Euler, and Jean le Rond d’Alembert made notable theoretical contributions in the field of hydrodynamics, which are well known. During the same period, Antoine Chezy and Robert Manning, as discussed in a subsequent section, made critical and lasting contributions to open-channel hydraulics.

In what was to become the United States, the planning of major water resources projects involving open channels began in Colonial times. In the eighteenth century, waterways were the most efficient means of transport and, hence, essential to commerce. In 1763, George Washington suggested draining the Great Dismal Swamp and connecting Chesapeake Bay in

Virginia with Albemarle Sound in North Carolina by a canal obviating the need to transport goods along the dangerous Carolina coast. In 1784, the Dismal Swamp Canal Company was formed and work on the canal began in 1793. The canal was dug completely by hand since this was before the age of steam power, and most of labor force was slaves. The 22 mile (35 km) long canal finally opened in 1805, and the canal, operated by the US Army Corps of Engineers, is still used.

Construction of the Erie Canal began on July 4, 1817, and the men who planned and oversaw its construction (James Geddes, Benjamin Wright, Canvass White, and Nathan Roberts to name just a few) were talented novices rather than trained civil engineers. Yet these individuals planned, designed, and constructed a project that contained hydraulic engineering structures that remain notable today such as the structure carrying the canal over the Niagara Escarpment at Lockport, New York. The canal, 363 miles (584 km) long, was completed in October 1826 without the benefit of power equipment. Many of the laborers on this project were newly arrived Scots-Irish immigrants. The canal was enlarged between 1834 and 1865 and was replaced by the New York State Barge Canal in 1918. It is pertinent to observe that the Erie Canal resulted in the building of competing transportation systems including the Baltimore and Ohio Railroad, the Mohawk and Hudson Railroad to name just two.

The Dismal Swamp and Erie Canals are only the best known of the many canals built in the United States in the late eighteenth and early nineteenth centuries as they were the interstate highways of the time. Agricultural and urban development west of the Rocky Mountains in semiarid and arid environments required canals convey water from the mountains where water is abundant to where it was needed for crops and people. Certainly one of the best known American water resources projects of the twentieth century is Los Angeles Aqueduct that conveys water by gravity from the Owens Valley in the Sierra Nevada Mountains to Los Angeles. This project led to what are known as the California water wars. Conceptually, the project began in 1898 when Frederick Eaton appointed William Mulholland as head of the Los Angeles Department of Water and Power. The Los Angeles envisioned by Eaton and Mulholland bore no relationship to the small coastal community it was at the turn of the twentieth century. In the early 1900s, the Owens Valley was a rich agricultural region with the needed irrigation water being provided by a number of small irrigation districts rather than a large district as had been recommended by John Wesley Powell. Eaton, Mulholland, and other Los Angeles visionaries (or scoundrels depending on your viewpoint) recognized the opportunity that was available for the taking. By 1905, Los Angeles using bribery, intimidation, subterfuge, and political influence up as high as President Theodore Roosevelt owned sufficient land and water rights in the Valley to justify the construction of the aqueduct.

From 1905 through 1913 Mulholland directed the construction of the 233 mile (375 km) aqueduct. By 1920s so much water was being exported from the Owens Valley that “the Switzerland of California” was becoming a desert, and the Valley residents took up armed rebellion. The rebellion was for naught because by 1928 Los Angeles owned most of the water in the Valley and only minimal agriculture was left. The reader is encouraged to consult refs.

[2, 3] for more details of this critical and controversial water resources project which was part of the plot in the Academy Award winning movie *Chinatown*.

In 1970, Los Angeles completed a second aqueduct to export even more water from the Valley. In response to various lawsuits, Los Angeles has put forth various plans to “rewater” the lower Owens River and bar all future development on its holding in the Owens Valley. Thus, the controversy over a simple gravity-driven system of open channels and pipes has spanned a full century and will continue into the future.

By the beginning of the twentieth century, most of the critical analytic tools required to design and build effective and fully operational open-channel systems for transportation and water supply were available. One of the best known and respected engineers involved in early twentieth-century open-channel hydraulics was Boris A. Bakhmeteff. Bakhmeteff was a civil engineering educator and consultant in St. Petersburg, Russia, before he became the Kerensky government’s ambassador to the United States. After the fall of the Kerensky government, he remained in the United States. Bakhmeteff in 1912 published in Russian a book on open channels and subsequently published a much enlarged version in English.

Many mark the beginning of modern open-channel hydraulics with the publication of Bakhmeteff’s *Hydraulics of Open Channel Flow*. In the following sections of this chapter, the fundamentals (specific energy, momentum, and resistance) are briefly discussed, and then the subject of modeling of open-channel flow is discussed at some length. The chapter concludes with a discussion of potential future directions.

### 1.1. Specific Energy

If the longitudinal slope of the channel is small, energy in an open channel is given by

$$H = z + y + \frac{u^2}{2g} \quad (2.1)$$

where  $H$  = total energy,  $z$  = elevation of the channel bottom above a datum,  $y$  = depth of flow, and  $u$  = cross-sectional average velocity. It is pertinent to note the modifications required if the slope is not small and development and use of the energy correction factor as the flow departs from being adequately described as one-dimensional. If the channel bottom slope is less than 1:10 ( $5.75^\circ$ ), the pressure in the flow is hydrostatic and corrections to the computed depths of flow are not required [4]. Channels with longitudinal slopes greater than 1:10 are rare, but the engineer needs to be aware that when modeling such channels the estimated depth may require adjustment [4].

As flow cross sections depart from simple geometric shapes such as rectangular and trapezoidal to include overbank flow areas, average velocity becomes less valid as a descriptor of the kinetic energy of the flow. The kinetic energy correction factor (also known as the velocity weighting coefficient) is intended to allow the one-dimensional energy equation to be used in situations that depart from being one-dimensional. Setting the actual kinetic energy of a flow equal to the kinetic energy of the one-dimensional idealization

$$\alpha \gamma \frac{\bar{u}^3}{2g} A = \iint_A \gamma \frac{u^3}{2g} dA \quad (2.2)$$

$$\alpha = \frac{\iint_A \gamma u^3 dA}{\gamma \bar{u}^3 A} \quad (2.3)$$

where  $\alpha$  = kinetic energy correction factor,  $\bar{u}$  = cross-sectional average velocity,  $A$  = area, and  $u$  = velocity. In an analogous fashion, a momentum correction factor,  $\beta$ , can be derived or

$$\beta = \frac{\iint_A \rho u^2 dA}{\rho \bar{u}^2 A} \quad (2.4)$$

With regard to  $\alpha$  and  $\beta$ , the following observations are pertinent. First, for uniform flow,  $\alpha = \beta = 1$ . Second, for a given channel section and velocity distribution,  $\alpha$  is more sensitive to variations in velocity than  $\beta$ . Third, as noted previously,  $\alpha$  and  $\beta$  are of importance when the channel consists of a primary channel and sub-channels and/or berms and floodplains. In such cases judgment must be used to decide if two-dimensional modeling should be used.

By definition, specific energy is

$$E = y + \frac{u^2}{2g}. \quad (2.5)$$

And for a rectangular channel of width  $b$  and a flow per unit width  $q$ , the specific energy equation becomes

$$E = y + \frac{q^2}{2gy^2} \quad (2.6)$$

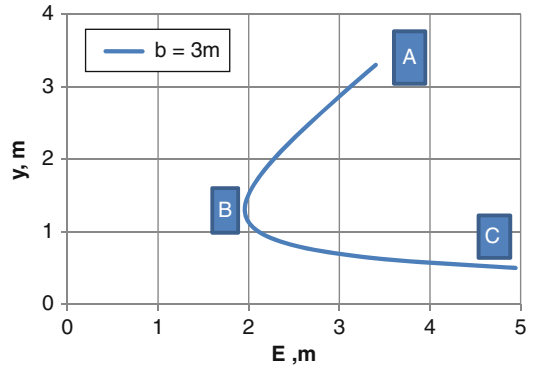
$$E - y = \frac{q^2}{2gy^2} \quad (2.7)$$

$$(E - y)y^2 = \frac{q^2}{2g} \quad (2.8)$$

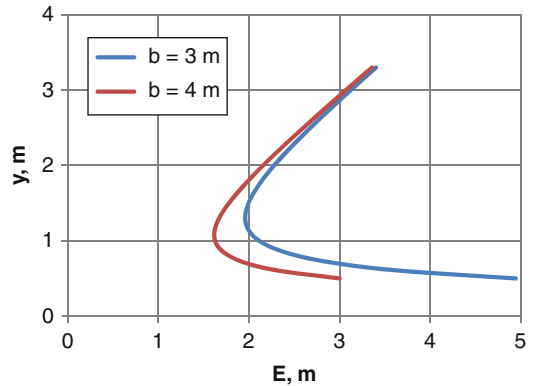
For a specified flow rate and channel width, the right-hand side of the equation is constant and the curve has asymptotes



**Fig. 2.1.** Specific energy as a function of depth for a rectangular channel with  $Q = 14 \text{ m}^3/\text{s}$  and  $b = 3 \text{ m}$ .



**Fig. 2.2.** Specific energy as a function of depth for a rectangular channel with  $Q = 14 \text{ m}^3/\text{s}$ ,  $b = 3 \text{ m}$ , and  $b = 4 \text{ m}$ .



$$y = 0 \tag{2.9}$$

$$(E - y) = 0. \tag{2.10}$$

It is also noted the equation has valid solutions in the first and third quadrants with only those in the first quadrant being of practical interest. Figure 2.1 is a plot of  $y$  vs.  $E$  for a flow of  $14 \text{ m}^3/\text{s}$  in a rectangular with a bottom width of 3 m. With regard to this figure, the following observations are pertinent. First, Pt. B is the only point where for a given value of  $E$ , there is a single depth of flow. At Pt. B the depth of flow is critical and the Froude number has a value of 1. Second, depths and velocities of flow associated with branch “BA” are subcritical, Froude number less than 1. Third, depths and velocities of flow associated with branch “BC” are supercritical, Froude number greater than 1. Fourth, for a given flow rate, there is a different  $E - y$  for each channel width, see Fig. 2.2. Fifth, from a design viewpoint, flows that are either strongly sub- or supercritical are desirable because near the critical point a change in flow regime can lead to a large change in depth.

Specific energy provides the basis for estimating the variation of channel shape and longitudinal slope on the depth of flow. Taking the derivative of (2.1) with respect to

longitudinal distance  $\times$  yields

$$\frac{dH}{dx} = \frac{dy}{dx} + \frac{dz}{dx} + \frac{d\left(\frac{u^2}{2g}\right)}{dx} \quad (2.11)$$

and recognizing

$$\frac{dH}{dx} = -S_f$$

and

$$\frac{dz}{dx} = -S_o.$$

For a given flow rate  $Q$ ,

$$\frac{d\left(\frac{u^2}{2g}\right)}{dx} = -\frac{Q^2}{gA^3} \frac{dA}{dy} \frac{dy}{dx} = -\frac{Q^2 T}{gA^3} \frac{dy}{dx} = -F^2 \frac{dy}{dx}.$$

Then substituting in (2.11) and simplifying yields

$$\frac{dy}{dx} = \frac{S_o - s_f}{1 - F^2} \quad (2.12)$$

Equation (2.12) describes the variation of the depth of flow with distance in steady open-channel flow.

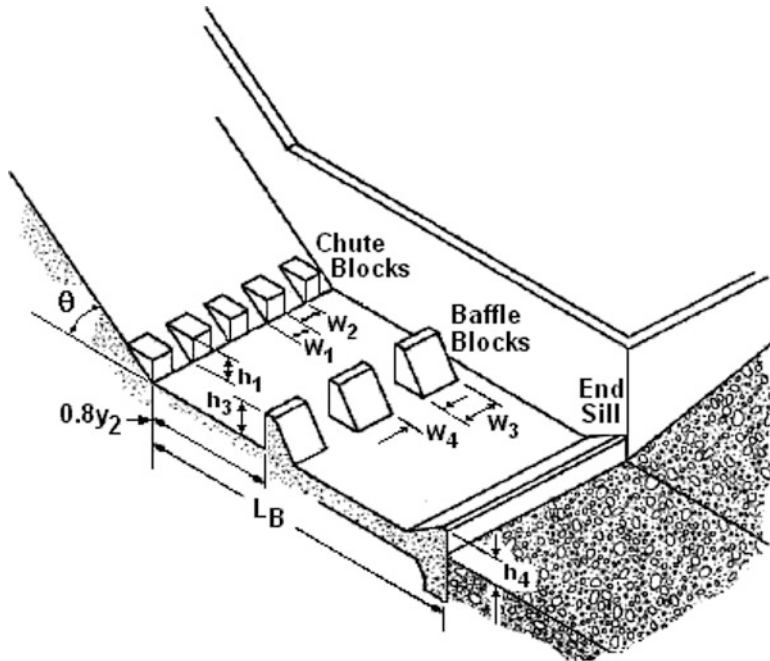
## 1.2. Specific Momentum (Specific Force)

In considering the application of Newton's second law of motion to steady open-channel flow, it is convenient to define specific momentum (specific force) or

$$M_i = \bar{z}_i A_i + \frac{Q^2}{gA_i}$$

where  $i$  = section identification,  $\bar{z}_i$  = distance to the centroid of flow area  $A$ , and  $Q$  = flow rate. Then for a control volume where Station 1 is upstream and Station 2 downstream, Newton's second law can be written as

$$\frac{F}{\gamma} = M_1 - M_2$$



**Fig. 2.3.** United States Bureau of Reclamation (USBR) Type III stilling basin [5].

where  $F$  = unknown force or forces acting in the control volume. At this point, three possibilities must be considered

$$\Delta E = 0$$

e.g., a sluice gate

$$F \neq 0$$

$$\Delta E \neq 0$$

e.g., simple hydraulic jump, Fig. 2.3

$$F = 0$$

$$\Delta E \neq 0$$

e.g., hydraulic jump assisted by stilling basin, Fig. 2.4

$$F \neq 0$$

For simplicity, the following discussion will be limited to results for rectangular channels. The widest used results of specific momentum analysis are the results for hydraulic jumps. The applications of hydraulic jumps in open-channel hydraulics are many and include:

- Dissipation of energy in flows over dams, weirs, and other hydraulic structures;
- Maintenance of high water levels in channels for water distribution;
- Increase the discharge of a sluice gate by repelling the downstream tailwater;
- Reduction of the uplift pressure under a structure by raising the water depth on the apron;
- Hydraulic mixing of chemicals for water purification or treatment; and
- Aeration and dechlorination of flows.



**Fig. 2.4.** Simple hydraulic jump occurring in a flood mitigation channel in Albuquerque, New Mexico, USA (Photo courtesy of Albuquerque Metropolitan Arroyo Flood Control Authority).

If the jump occurs in a horizontal, rectangular channel without the assistance structural appurtenances such as chute blocks or sills, then

$$M_1 = M_2$$

and the classic equation for sequent depth results or

$$\frac{y_2}{y_1} = 0.5 \left( \sqrt{1 + 8F_1^2} - 1 \right)$$

where  $y_1$  and  $y_2$  = depths of flow at upstream Station 1 and downstream Station 2, respectively, and  $F_1$  = Froude number at Station 1. The sequent depth equation is often interpreted in a much too simple fashion; that is, if the supercritical conditions of flow at Station 1 are as described by  $y_1$  and  $F_1$ , then the depth of flow after the hydraulic jump will be  $y_2$  tacitly assuming a hydraulic jump occurs. In point of fact, a hydraulic jump will not occur unless the engineer causes depth  $y_2$  to exist. Controlling the location of a hydraulic jump is a critical engineering and often requires the use of hydraulic structures such as the US Bureau of Reclamation Type III stilling basin shown in Fig. 2.3. Guidance regarding the design of stilling basins is available in agency design manuals (e.g., [5]) and standard engineering handbooks (e.g., [6]).

### 1.3. Resistance

From the viewpoint of water resources engineering and open-channel hydraulics, the latter eighteenth and early nineteenth centuries were an age of achievement yielding fundamental

equations produced by men whose names are familiar to every hydraulic engineer—in particular, Chezy and Manning.

Antoine Chezy was born in 1718 at Chalon-sur-Marne, France, and died in 1797. In 1760, the City of Paris was experiencing a water supply problem apparently related to the poor operation of its pumps. Seeking a solution, the City approached the *Academie des Sciences* which recommended, among other alternatives, water be brought to the City by a gravity canal from the nearby Yvette River. In 1768, the City moved forward, and Chezy was tasked to design the cross section of the canal and determine its discharge. As would be today, this was a critical engineering task since if the section was too small, the water required would not be delivered, and if it was too large, the right of way required would be too large. Public works projects then had critics, just as they do today. Chezy's review of the literature apparently found nothing that adequately addressed the issue; and therefore, he initiated his own investigation. It is relevant to note that there had been discussions regarding the relationship between the velocity and slope and the effect of the bed on velocity [1]. The report containing his recommendations was lost, but the files of the agency, Ponts et Chaussees, contain the original manuscript [1] and it is there that the Chezy Equation is put forward. The final report on the Yvette Project only contained the results of Chezy's computations and made no mention of the method used.

It is appropriate to mention that the French Revolution halted the Yvette River project. Chezy's simple, elegant approach to calculating uniform flow went unrecognized by his peers, and Chezy himself would have died in poverty except for the intercession of one of his students, Baron Riche de Prony which led to Chezy's appointment as the director of the Ecole Ponts et Chaussees. According to refs. [1, 7], the Chezy Equation was not widely used until it was published at the end of the nineteenth century by the well-known American hydraulic engineer Clemens Herschel [8]. However, Herschel seems to contradict this stating "... called the Chezy formula and well known in the engineering literature of Germany, France, England, and the United States."

Robert Manning was born in Normandy, France, the year following Waterloo, 1816, and died in 1897. In 1889, Manning, a professor at the Royal College of Dublin (Ireland) and chief engineer of the Office of Public Works responsible for various drainage, inland navigation, and harbor projects, presented a paper entitled "On the Flow of Water in Open Channels and Pipes" to the Institution of Civil Engineers in Ireland; and in this paper, the Manning equation was presented which Manning believed corrected defects in previous resistance models. It is pertinent to note that Manning was a self-taught hydraulic engineer with no formal training in engineering. Manning was apparently not aware that a French engineer, Philippe Gaspard Gauckler, had put forward essentially the same model in c. 1868 [7]. The popularity and widespread use of the Manning resistance formulation has been ascribed to its publication in a popular late nineteenth-century textbook by Flamant [7, 9].

The Manning Equation has always had its detractors, but none was any more critical than Robert Manning himself. According to [1], Manning had the following in his original paper:

... if modern formulae are empirical with scarcely an exception, and are not homogeneous, or even dimensional, then it is obvious that the truth of any such equation must altogether depend on that of the observations themselves, and it cannot in strictness be applied to a single case outside them.

Thus, Manning was quite aware of the limitations of his formulation which was in better agreement with data available than any other approach. Manning's second objection to his formulation was the need to extract a cubic root which was not easily done before the electronic age. In fact, Fischenich [10] pointed to the publication of King's *Handbook* [11] in 1918 with tabulation of the two-thirds power of numbers between 0.01 and 10 to firmly establishing the Manning resistance model preferred approach in American engineering practice.

It is pertinent to observe that Manning then abandoned the approach that bears his name and developed a dimensionally homogeneous equation which was apparently never widely used [1].

### ***1.4. Rise of the Computer***

The effort and time required to correctly plan, analyze, and design complex systems of open channels prior to the advent and widespread availability of digital computers was staggering. Given the scale, scope, and success of the projects discussed in the introduction, the resourcefulness and ingenuity of those involved in those projects must be recognized. Certainly, the most notable and significant advances in open-channel hydraulics since the 1960s have been due to the widespread availability of relatively inexpensive and increasing powerful computers and software. The models discussed in the next section, and the insights they provide for effective analysis and design of open channels would not be possible without the modern computer. However, these computational advances have also been accompanied by concerns, and two of the most notable are the following. First, other than knowing the effect of gravity on water, many modern hydraulic engineers have no inherent understanding of flow in open channels. That is, for these engineers, critical physical processes have been reduced to abstract algorithms, and they have no basis for judging the reasonableness of the digital output. Second, many modern engineers are unable to effectively function without sophisticated calculators and computers. Thus, as is the case with any significant technical leap forward, there are unanticipated problems that must be addressed.

## **2. NUMERICAL MODELING OF OPEN-CHANNEL HYDRAULICS**

### ***2.1. Review of Numerical Modeling of Open-Channel Flows***

With the widespread availability of powerful personal computers and the development of high-performance computers (HPC), numerical models for hydraulic engineering have gained popularity during the last several decades. This popularity is also propelled by the development of new numerical methods and efficient numerical schemes where hydraulic phenomena and processes with more complexity can be modeled. Along with theoretical and experimental research, computational models have grown to an important branch of hydraulics.

Numerical modeling of open channels has progressed from the original one-dimensional open-channel flow equations to three-dimensional free surface flows. The following is a brief overview of the achievements in the computer modeling of open-channel flow.

To perform numerical modeling for open-channel flows, as well as in other areas of fluid mechanics, the basic process includes preprocessing, computation, and post-processing. At the preprocessing stage, the majority of the work is to prepare the data in the format required by the specific numerical code. In the case of three-dimensional modeling, the preprocessing stage can be a major portion of the whole process. One of the difficulties during this stage is to generate a reasonable mesh that represents the domain of interest and has a good quality. Most of the commercial codes have their own preprocessing and mesh generation tools. There are also some independent meshing tools available which specialize in making high-quality meshes and are easy to use. Since there are many numerical models and each employs different numerical schemes, they require different mesh formats and vary on the tolerance on mesh quality; it is impossible to list each of them. Readers should refer to the documentations of these codes. One general suggestion is to make a mesh with good quality and at affordable resolution.

Depending on the dimensionality of the numerical models for open-channel flows, they can be classified into different categories, i.e., one-, two-, and three-dimensional models. Examples include the HEC series of pseudo-1D models, FESWMS-2DH from Federal Highway Administration (FHWA), and open-source HydroSed2D based on 2D depth-averaged shallow-water equations. The examples of fully three-dimensional computational fluid dynamics (CFD) models include commercial codes such as Fluent, Flow3D, Phoenix, CD-adapco, and the popular OpenFOAM from the open-source community.

Despite the variety and availability of different computer codes, there still exist challenges, as well as opportunities, for the numerical modeling of open-channel flows: (1) uncertainties in input data such as bathymetry, resistance law and roughness, vegetation, and flow measurement data; (2) computational domain and temporal span are large, which dictates that computational demand is high, especially for 3D modeling; (3) multiple scales needs to be resolved (in open-channel flow, it is often required or at least desirable to capture the global mean flow and the local variations); and (4) model calibration needs extensive data which are not always available.

In the following, numerical models (1D, 2D, and 3D) and their example applications are introduced. Depending on the physical scales, each category of models has its applications. For large-scale (such as river reach) modeling, 1D and 2D modes may be the right choice since they are faster and require less data input and yet reveal the overall hydraulic behavior. For localized, small-scale flow phenomenon, such as open-channel flow around hydraulic structures, flow over bedforms, and sediment elements, a fully 3D model is necessary and affordable.

## ***2.2. One-Dimensional Modeling of Open-Channel Flows***

### *2.2.1. Governing Equations for One-Dimensional Open-Channel Flow*

The general equations for unsteady nonuniform open-channel flows are the Saint-Venant equations or the dynamic wave equations. The derivation of the Saint-Venant equations is based on the shallow-water approximation where the vertical pressure distribution is hydrostatic and the vertical acceleration is small. It is also assumed that the channel bottom slope is

small such that  $S = \sin \theta$ , where  $\theta$  is the angle of the channel bed relative to the horizontal. It is also important to note that the resistance law used for the unsteady flow is assumed to be the same for steady flow; and therefore, the Manning and Chezy equations can be used.

The continuity equation which describes the water mass balance has the form

$$\frac{\partial A}{\partial t} + \frac{\partial Q}{\partial x} - q_l = 0 \quad (2.13)$$

and the momentum equation which describes the force balance of a control volume has the form

$$\frac{\partial Q}{\partial t} + \frac{\partial}{\partial x}(QV) = gA(S_0 - S_f) \quad (2.14)$$

where  $A$  is the cross-sectional area of the flow which depends of the geometry of the channel cross section and the flow depth,  $V$  is the average velocity perpendicular to the cross section, and  $Q = AV$  is the flow rate.  $q_l$  in the continuity equations is the lateral inflow rate per unit channel length. In the momentum equations,  $S_0 = -\partial z/\partial x$  is the water surface slope and  $z$  is the free surface elevation.  $S_f$  is the friction slope which is a function of flow and stage. The friction slope is determined by the resistance equation, such as Manning and Chezy equations. In derivation of (2.14), it is assumed the momentum associated with the lateral inflow can be neglected.

### 2.2.2. Numerical Solutions

Due to its simplicity and one dimensionality, the finite-difference method can be used to approximate the derivatives (both spatial and temporal) in the Saint-Venant equations. The spatial discretization for derivatives and source terms can be evaluated at the beginning of a time step (explicit) or the end of a time step (implicit). Different temporal discretization schemes can be used on different terms in the governing equations giving the mixed explicit-implicit formulations. The second mostly used scheme for the derivatives is the so-called method of characteristics (MOC) where the derivatives are calculated along the characteristic grid lines. The governing equations, which are partial differential equations (PDEs), need to be transformed along the characteristic curves [11]. The transformed equations are ordinary differential equations (ODE) which are readily solved. Once the ODEs are solved, the solution to the original PDEs for the 1D unsteady flow equations can be obtained. MOC is used in special cases where the transient is important, for example, dam-break flows. Since the governing equations are PDEs in general, other discretization schemes (such as finite element, finite volume, and spectral methods) could also be used. However, they are not used as often as the finite-difference method and MOC.

Instead of solving the full continuity and momentum equations, simplified versions can be solved without losing the dominant mechanisms. In the simplified versions, some of the terms have been omitted from the full equations or one of the equations is not used. When only the continuity equation is used (with the momentum equation ignored), it is called hydrologic



routing. When both equations are solved, it is called hydraulic routing [12]. In hydraulic routing, there are three sub-routing schemes, i.e., kinematic, diffusion, and dynamic routings. The kinematic routing considers only the balance between gravity and flow resistance, and diffusion routing ignores the inertia terms (temporal and convective accelerations). The dynamic routing includes all terms. When applying these different routing schemes, it is important to keep in mind the assumption that the neglected terms are relatively small comparing to others. If this assumption is not satisfied, the results will not capture the physical process.

To fully describe the details of finite difference and the MOC that needs a lengthy derivation, interested readers could consult references which are devoted to this topic.

There are many commercial and public domain codes available for the simulation of 1D open-channel flows which implement the various numerical schemes mentioned before. One of the most widely used models is HEC-RAS [4], which uses the finite-difference method. It has three basic hydraulic analysis components which comprise steady flow computations, unsteady flow computations, and movable boundary sediment transport computations. The software integrates the graphical user interface (GUI) with the three components as well as the data management system to facilitate the ease of use.

### 2.2.3. Examples

Due to its simplicity and efficiency, 1D open-channel flow models have been used widely for engineering design and flood risk analysis. The most popular 1D model, HEC-RAS, has been used by the industry and government agencies for open-channel design. The typical outputs of the model would be river stage, flow, and resistance (Figs. 2.5 and 2.6).

In flood prediction and mapping, it is very convenient to combine the hydraulic model results with geographic information system (GIS). For example, in [14], HEC-RAS model was integrated in GIS to predict the areal coverage of the flood over real terrains. It used high-resolution elevation data in the stream and the relatively low-resolution data in the floodplain. The resulting model was used for the Waller Creek in Austin, Texas.

## 2.3. Two-Dimensional Modeling of Open-Channel Flows

Two-dimensional modeling of open-channel flows usually uses the depth-averaged shallow-water equations (SWEs) where the vertical acceleration of the fluid is ignored. The governing equations for the one-dimensional modeling in the previous section can be viewed as a special case of SWEs where one spatial derivative vanishes. Both 1D and 2D modeling equations belong to the broad category of hyperbolic partial differential equations which has a natural connection with conservation laws.

It is noted that there are also two-dimensional models with one dimension being the vertical and the other one being along the river. This modeling methodology is applicable when the variation across the river is small and the emphasis is to model the vertical motion and transport. Although equally important, this vertical 2D modeling will not be introduced and this section will only treat two-dimensional depth-averaged modeling using shallow-water equations.

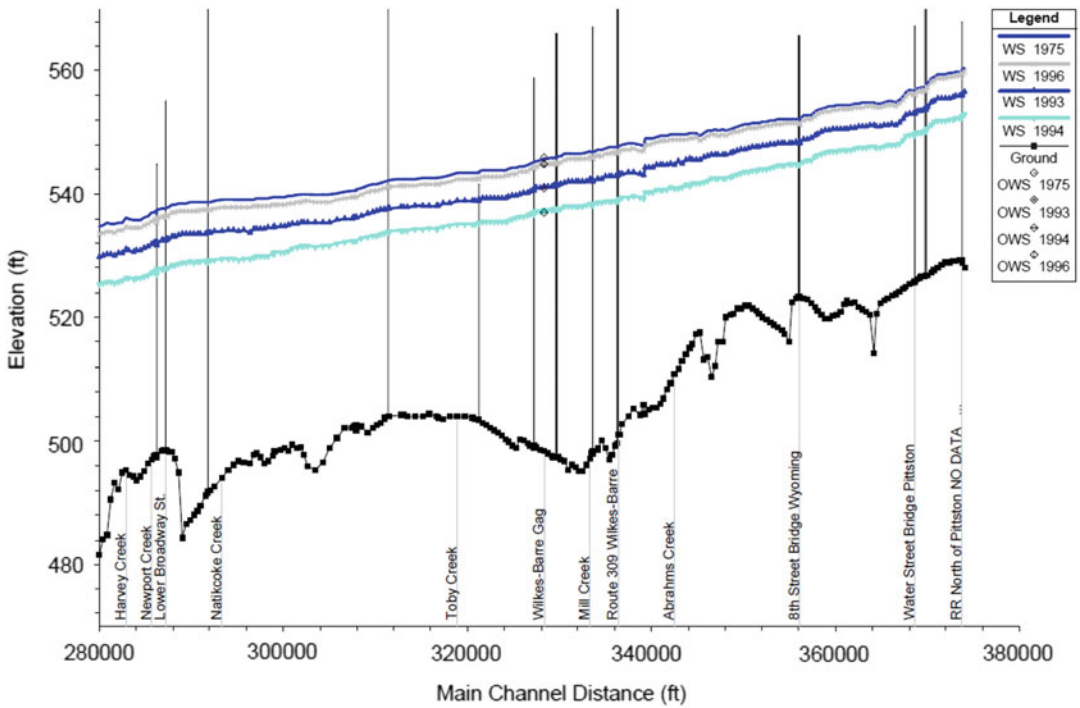


Fig. 2.5. Example outputs of water surface profiles for different flood events [13].

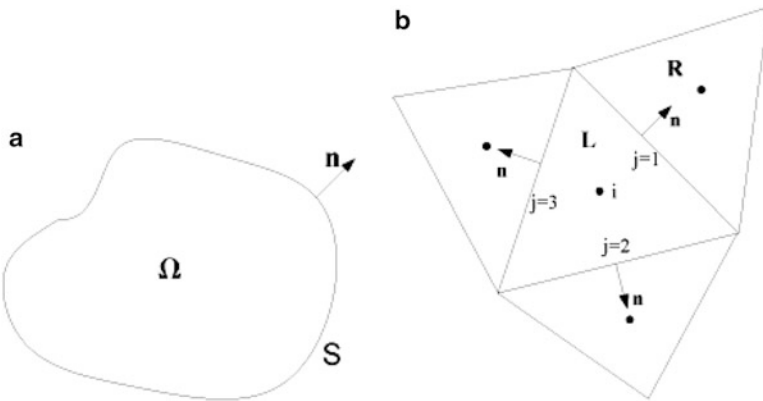


Fig. 2.6. Numerical schemes for 2D SWEs: (a) Control volume for the finite volume method. (b) Unstructured mesh topology.

As for general partial differential equations, numerical schemes (such as finite difference, finite volume, finite element methods) have been used to discretize the governing equations (e.g., [15–19]). Finite volume and finite element methods are more popular in solving SWEs since they use unstructured mesh which is ideal for complex domains. On the other hand, regular two-dimensional Cartesian grid can be used to model rectangular domains or the

governing equations can be transformed into curvilinear orthogonal coordinate systems for irregular domains (e.g., [20]). Other novel techniques for the meshing and representation of the computational domain have been proposed and successfully used. For example, an adaptive quadtree meshing and modeling method was proposed in [21] where any two-dimensional boundary topology can be approximated with the capability of enriching and coarsening dynamically.

Available codes for two-dimensional depth-averaged modeling include TELEMAC [22], TUFLOW [23], and HydroSed2D [18]. For the purpose of illustration, in the following, the shallow-water equations will be introduced and the finite volume method used for discretization will be elaborated. The scheme is exactly the one used in HydroSed2D and is similar to the ones used by others.

### 2.3.1. Governing Equations of Depth-Averaged Shallow-Water Equations

Two-dimensional shallow-water equations can be written in normal conservation law form as

$$\frac{\partial h}{\partial t} + \frac{\partial(uh)}{\partial x} + \frac{\partial(vh)}{\partial y} = 0 \quad (2.15)$$

$$\frac{\partial(uh)}{\partial t} + \frac{\partial(u^2h + \frac{1}{2}gh^2)}{\partial x} + \frac{\partial(uvh)}{\partial y} = ghS_{ox} - ghS_{fx} + \frac{\tau_{wx}}{\rho} + hfu \quad (2.16)$$

$$\frac{\partial(vh)}{\partial t} + \frac{\partial(uvh)}{\partial x} + \frac{\partial(v^2h + \frac{1}{2}gh^2)}{\partial y} = ghS_{oy} - ghS_{fy} + \frac{\tau_{wy}}{\rho} - hfv \quad (2.17)$$

where  $h$  is the water depth,  $u$  and  $v$  are the depth-averaged velocities in  $x$  and  $y$  directions respectively,  $g$  is the gravity constant,  $\rho$  is the water density,  $\tau_{wx}$  and  $\tau_{wy}$  are surface wind shear stresses,  $f$  is the Coriolis parameter, and  $\nu$  is the kinematic eddy viscosity.  $S_{ox}$  and  $S_{oy}$  are the bed slopes in the  $x$  and  $y$  directions;  $S_{fx}$  and  $S_{fy}$  are the friction slopes in the  $x$  and  $y$  directions, respectively, which can be estimated using Manning's formula

$$S_{fx} = n^2 u \sqrt{u^2 + v^2} \quad (2.18)$$

$$S_{fy} = n^2 v \sqrt{u^2 + v^2} \quad (2.19)$$

where  $n$  is Manning's roughness coefficient.

The 2D SWEs can be written in compact integral form as

$$\frac{\partial}{\partial t} \int_{\Omega} q d\Omega + \int_{\Omega} \left( \frac{\partial f}{\partial x} + \frac{\partial g}{\partial y} \right) d\Omega = \int_{\Omega} R d\Omega \quad (2.20)$$

where

$$\mathbf{q} = \begin{pmatrix} h \\ uh \\ vh \end{pmatrix}, \quad \mathbf{f} = \begin{pmatrix} u^2h + \frac{1}{2}gh^2 - \nu h \frac{\partial u}{\partial x} \\ uvh - \nu h \frac{\partial v}{\partial x} \end{pmatrix}, \quad \mathbf{g} = \begin{pmatrix} vh \\ uvh - \nu h \frac{\partial v}{\partial x} \\ u^2h + \frac{1}{2}gh^2 - \nu h \frac{\partial u}{\partial x} \end{pmatrix}$$

$$\mathbf{R} = \left[ 0 \quad ghS_{ox} - ghS_{fx} + \frac{\tau_{wx}}{\rho} + hfv \quad ghS_{oy} - ghS_{fy} + \frac{\tau_{wy}}{\rho} - hfu \right]^T$$

### 2.3.2. Numerical Schemes

The Godunov scheme is used to solve the conservative variables as defined in the previous section [24]. The basic idea of Godunov scheme is to assume the piecewise constant distribution of these conservative variables over each mesh cell and the time evolution is achieved by solving the Riemann problem at the cell–cell interfaces [25]. To improve the accuracy, the piecewise constant distribution can be replaced by high-order interpolations leading to higher spatial accuracy. Higher order schemes are important to capture transcritical flows and discontinuities such as dam-break/levee-breach flows.

Using Green’s theorem, the divergence term of (2.20) can be transformed into line integral and the vector form of the governing equations becomes

$$\frac{\partial}{\partial t} \int_{\Omega} \mathbf{q} d\Omega + \oint_S \hat{\mathbf{f}} dS = \int_{\Omega} \mathbf{R} d\Omega \tag{2.21}$$

where  $S$  is the boundary of the control volume  $\Omega$  and  $\hat{\mathbf{f}}$  is the flux vector given by

$$\hat{\mathbf{f}} = [f \quad g] \cdot \mathbf{n} = fn_x + gn_y \tag{2.22}$$

Here,  $\mathbf{n}$  is the unit outward normal vector which has the Cartesian components  $n_x$  and  $n_y$ . The flux vector  $\hat{\mathbf{f}}$  can be further split into inviscid and viscous fluxes as

$$\hat{\mathbf{f}} = \mathbf{f}^I - \nu \mathbf{f}^V \tag{2.23}$$

$$\mathbf{f}^I = \begin{pmatrix} uhn_x + vhn_y \\ \left( u^2h + \frac{1}{2}gh^2 \right) n_x + uvhn_y \\ uvhn_x + \left( v^2h + \frac{1}{2}gh^2 \right) n_y \end{pmatrix}, \quad \mathbf{f}^V = \begin{pmatrix} 0 \\ h \frac{\partial u}{\partial x} n_x + h \frac{\partial u}{\partial y} n_y \\ h \frac{\partial v}{\partial x} n_x + h \frac{\partial v}{\partial y} n_y \end{pmatrix} \tag{2.24}$$

Using standard finite volume method, (2.21) can be written as

$$\left. \frac{\partial Vq}{\partial t} \right|_i = \oint_S \hat{f} \, dS + V_i R_i, \text{ where } \oint_S \hat{f} \, dS = \sum_j \hat{f}_{i,j} \Delta l_j \quad (2.25)$$

where  $V$  is the area of the control volume and variables with subscript  $i$  represent the values stored at the center of the cell.  $\hat{f}_{i,j}$  is the interfacial flux between current cell  $i$ , and the neighbor  $j$ ,  $\Delta l_j$  is the length of the side sharing with cell  $j$ .

The representation of the different values across a boundary between two adjacent cells leads to the Riemann problem. There are many solvers (exact and approximate) to solve the Riemann problem. As an example, Roe's Riemann solver [26] is introduced to evaluate the interfacial inviscid fluxes

$$\hat{f}_{i,j} = \frac{1}{2} \left[ f^l(q_{i,j}^+) + f^l(q_{i,j}^-) - |A|(q_{i,j}^+ - q_{i,j}^-) \right], \quad (2.26)$$

Here  $|A| = R|A|L$  with  $R$  and  $L$  be the right and left eigenvector matrices of the flux Jacobian matrix  $A$ , which is defined as

$$A = \frac{\partial f^l}{\partial q} = \begin{pmatrix} 0 & n_x & n_y \\ (c^2 - u^2)n_x - uvn_y & 2un_x + vn_y & un_y \\ -uvn_x - (c^2 - u^2)n_y & vn_x & un_x + 2vn_y \end{pmatrix}. \quad (2.27)$$

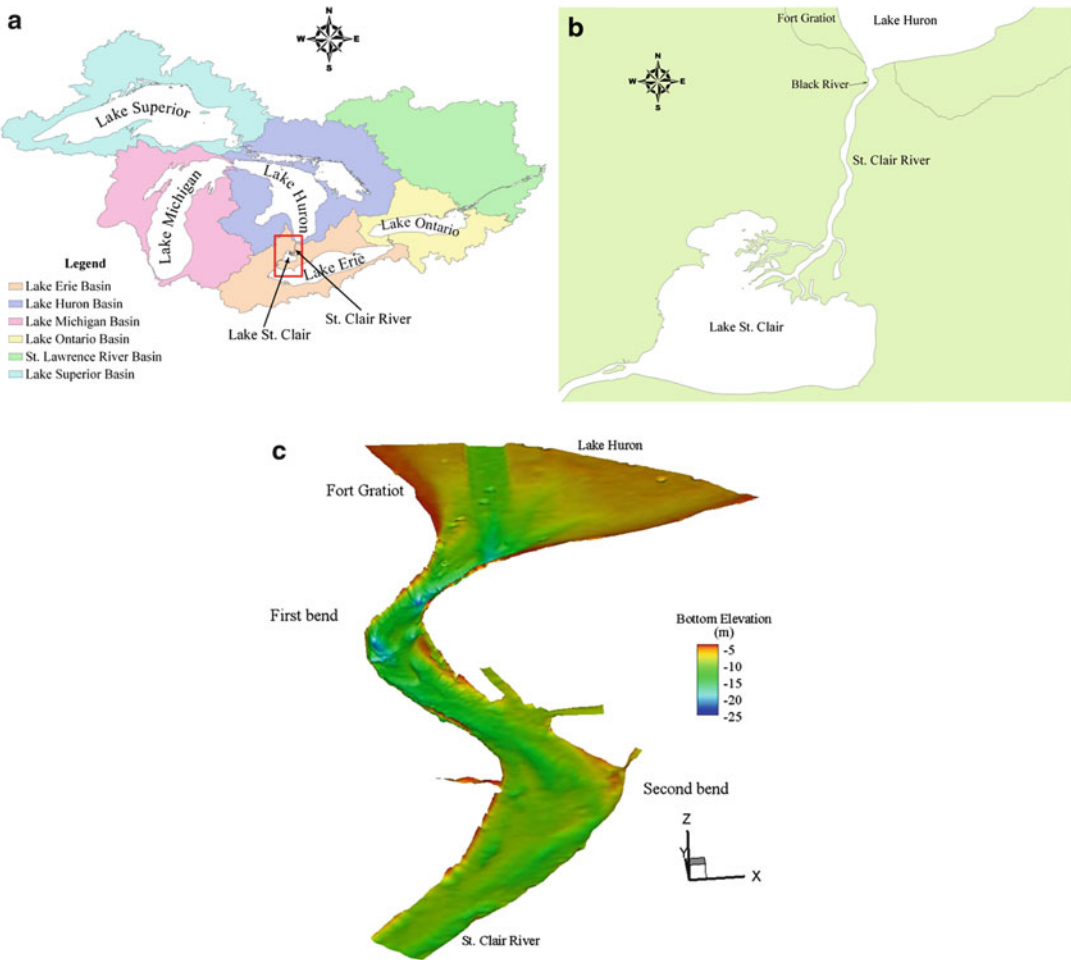
This Jacobian matrix has three distinct real eigenvalues. The eigenvalues can be derived analytically. The source term due to the bed slope is dealt with via a revised divergent form method. It has been proved that this method will give physical results even for steady state over complex terrain.

### 2.3.3. Examples

In this section, an example is shown to demonstrate the application of 2D models. This example is the St. Clair River sediment mobility study [19]. Corresponding 3D modeling has also been done to investigate the local flow field and will be introduced in the next section. In the context of this section, only 2D simulation results will be shown.

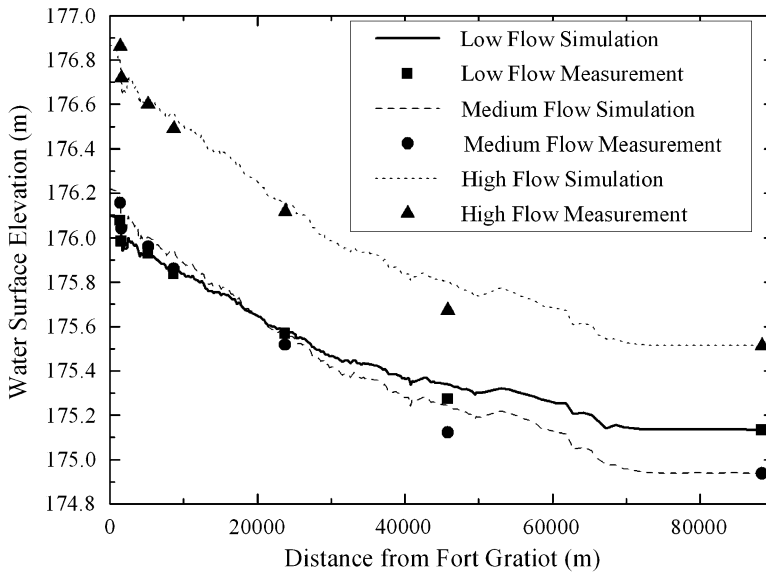
The St. Clair River is the connecting channel between Lake Michigan-Huron and the downstream Lake St. Clair (Fig. 2.7a, b). Despite the small recovery in year 2009, the head difference between the Michigan-Huron system and Lake Erie has declined by about 0.6 m between 1860 and 2006, with 0.23 m occurring between 1963 and 2006. The level of Lake Erie has remained relatively constant. Among many other hypotheses, the erosion in the St. Clair River and the increased conveyance have been postulated as one of the reasons for the dropping of the water level in Lake Michigan-Huron.

An open-source numerical code, *HydroSed2D*, was applied to the St. Clair River through the reach. *HydroSed2D* is a two-dimensional depth-averaged code that provided detailed



**Fig. 2.7.** Location and bathymetry of the St. Clair River: (a) The Great Lakes region and the St. Clair River. (b) The St. Clair River as the connecting channel between Lake Huron and Lake St. Clair. (c) Detailed bathymetry of the first two river bends from the multi-beam echo sounding survey.

hydrodynamic predictions (i.e., flow velocity and depth) within the channel [18]. These predictions were then used to calculate sediment transport rates and analyze armoring effects using surface-based gravel bed transport equations based upon the *Acronym* routine [27]. The boundary conditions of the model were based upon detailed field measurements that were conducted on July 21–25, 2008, and combined a multi-beam echo sounder (MBES) bathymetric survey (Fig. 2.7c) and Acoustic Doppler Current Profiler (ADCP) flow velocity surveys [28]. The numerical flow model was also calibrated and validated using these field measurements. The sediment characteristics within the reach (such as size and composition) were obtained through underwater video/image analysis. The bottom shear stresses predicted by *HydroSed2D* and these sediment size distributions were then subsequently used as an input

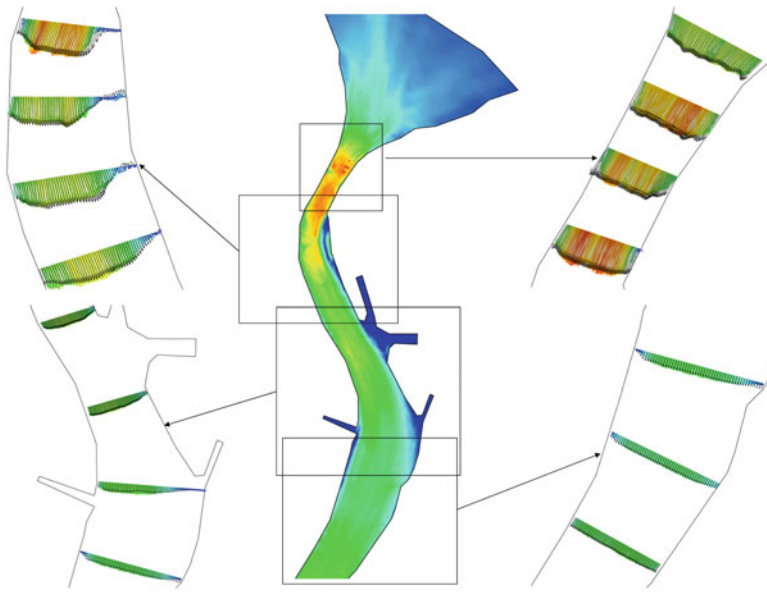


**Fig. 2.8.** Results for calibrated roughness for the low ( $Q = 4,645 \text{ m}^3/\text{s}$ ), medium ( $Q = 5,282 \text{ m}^3/\text{s}$ ), and high ( $Q = 4,645 \text{ m}^3/\text{s}$ ) flow scenarios.

to *Acronym*. This section demonstrates the integrated modeling approach and presents the results of the analysis, including the distribution of bed shear within the channel, and its implications for the changing water conveyance and lake levels of Lake Michigan-Huron.

All numerical models need extensive calibration before being applied to produce credible results. In this example, the roughness along the river bottom was chosen as one of the calibration parameters. Due to its importance of hydraulic resistance, many other studies have also used it as the calibration parameter. Some researchers lump the hydraulic resistance into one representative value for the whole domain. However, due to the change of the bed material from upstream to downstream in the St. Clair River, the whole river reach was divided into several subdomains and each of them with a different roughness. The initial estimation of these roughness values are derived from the mean bed material sizes. Different combination of the roughness values for each subdomain constitutes the roughness calibration sets. To cover a wide range of hydraulic conditions, three representative discharges (low, medium, and high) were chosen as the inflow into the river. The simulation results for river stages were compared with the measured results and the best set of roughness were chosen as the calibration result. In Fig. 2.8, the river stages along the St. Clair River with the calibrated roughness are plotted against the measurement. It is clear that the calibrated model can capture the overall hydraulics of the river.

The 2D simulation results were also compared with the ADCP measurement around the first two bends of the river inlet from Lake Huron. In Fig. 2.9, the depth-averaged velocity vectors along several river cross sections are plotted against those from the measurement. The flow discharges during the field measurement and for the simulation are similar. This comparison reveals that the numerical model captured most of the important flow features,

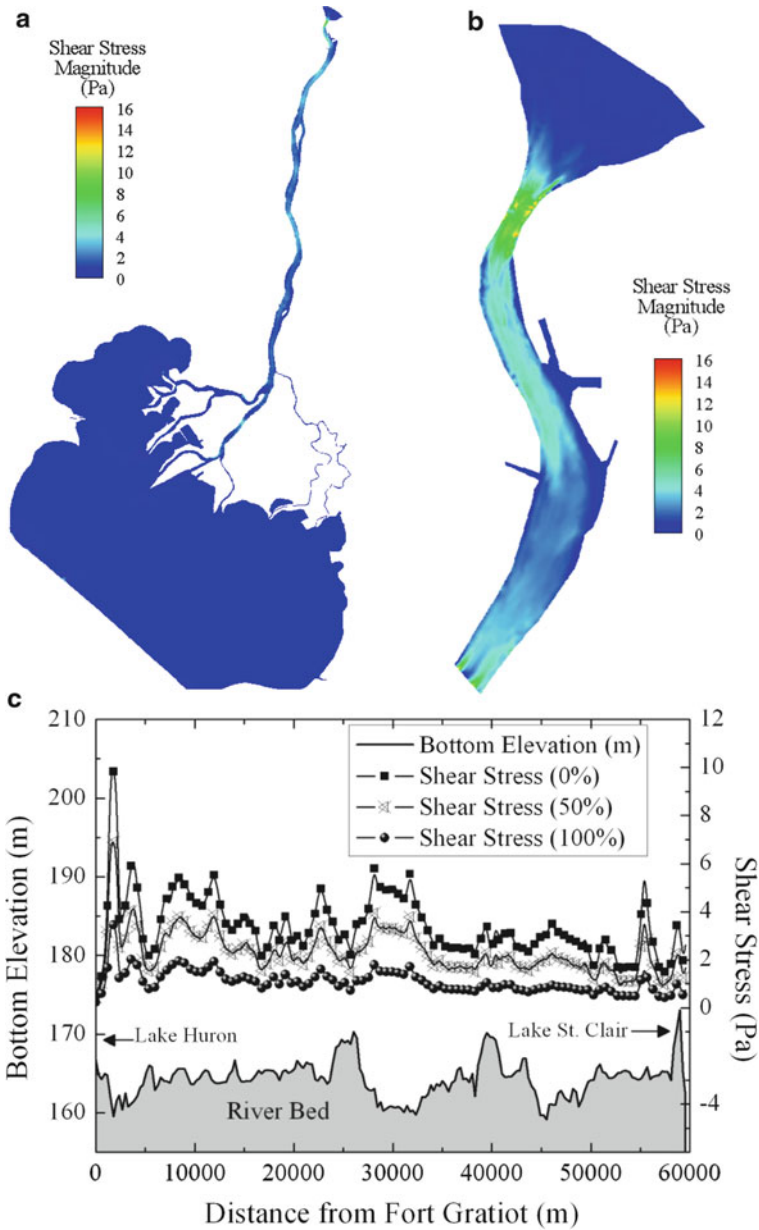


**Fig. 2.9.** Comparison of depth-averaged velocity vectors between HydroSed2D numerical results and ADCP measurements. The velocity vectors in black are numerical results and those in color are from ADCP measurements.

including the flow constriction and acceleration near the Lake Huron inlet area into the upper river channel and the subsequent large recirculation zone, which extends across approximately a third of the channel width, at the first bend downstream of the constriction. Any morphological change is probably most active within this region, particularly as the downstream flow velocity is accelerated to its maximum within the channel by the influence of both the width constriction and the recirculation zone.

For the purpose of this study, the shear stress exerted on the bed by the flow is the driving force of the sediment motion and is an important parameter to investigate the possible erosion in the river. As a typical flow condition, the case which corresponds to the 50 % exceedance discharge in the flow duration curve is shown in Fig. 2.10. Higher shear stresses are only observed in the St. Clair River channel, with the velocity and shear stresses declining on entry to Lake St. Clair. In the St. Clair River, the highest shear stresses are located in the upper river channel close to Lake Huron outlet. In this area, the bed shear stresses are predicted at about 8–10 Pa. Based upon Shields diagram, this value of shear stress is not capable of moving sediment coarser than 20 mm diameter. However, the shear stresses are high enough to transport finer sediment, with likely deposition in the lee of the first bend of the upper channel, where there are a large outer bank scour and two large lobate bars with shear stresses below 5 Pa through this zone. At this lower value of shear stress, the flow is only able to move sediment finer than 10 mm. The two bars might be historical features from initial water scour. They could still be evolving because of the episodic high shear stresses events such as ship passages and ice jam breakups.





**Fig. 2.10.** Shear stresses distribution: (a) Shear stresses for the whole St. Clair River (50 % flow discharge on the duration curve). (b) Shear stresses for the Upper St. Clair River (50 % exceedance flow discharge on the duration curve). (c) Shear stresses distributions along the center line of the river (0, 50, and 100 % exceedance flow discharges on the duration curve).

The shear stress distributions corresponding to 0, 50, and 100 % exceedance discharges along the center line of the river (Fig. 2.10c) show that the bed shear stresses decrease downstream from peaks near the Lake Huron outlet, at the location of constriction. However, it is notable that, in general, the bed shear stresses along most of the length of the river are globally low, ranging in mean values from 1 to 3 Pa. It is concluded from the 2D numerical simulation results that the St. Clair River itself can not cause enough erosion to dramatically change the conveyance of the river. Other factors, such as navigation and dredging activities, may play a more important role.

## 2.4. Three-Dimensional CFD Modeling of Open-Channel Flows

### 2.4.1. Governing Equations of 3D Navier–Stokes Equations

To do fully three-dimensional modeling of open-channel flows, there are several questions need to be answered regarding to the important physical processes involved.

The first question is the turbulence. Since the Reynolds number, which is a dimensionless number measuring the ratio between the inertial and viscous force, is usually very high due to the large spatial scales in open channels, the flow is dominated by inertial force and turbulent. To directly resolve all the scales in the turbulent flow without modeling is a tremendous challenge and is only possible for relatively moderate Reynolds numbers and simple geometries. Instead, the governing equations are usually averaged/filtered over time and/or space. Most numerical methods used to solve the averaged/filtered equations can only resolve the turbulence up to the scales comparable to the mesh size. Turbulence models are needed to represent the scales which are not resolved. Interested readers could refer to the abundant literatures on this topic, for example, [29–31], among many others.

The second question is the modeling of the free surface in the open channel. For open-channel flows, either the traditional river flows, coastal flows, or the flows through hydraulic structures, part of the flow boundary directly contacts with the atmosphere and is free to move. Under some circumstances, the whole domain occupied by the water and air could be confined in a limited space, for example, partially filled sewage pipe flows where air, though compressible, could retard the free motion of the water surface. In any case, the interface between water and air evolves with time and is part of the solution. The resolution of the free surface introduces extra computational complexity into the problem [32], although mature numerical schemes are available to track or capture the free surface, such as volume of fluid (VOF, [33]) and level set method (LSM, [34]). In practice, unless absolutely necessary, free water surface is usually replaced by a rigid lid where the surface is replaced by a shear-free boundary. This is a good approximation when the free surface does not change dramatically. For rapidly changing water surface (e.g., waves and hydraulic jumps), the rigid lid approximation will introduce errors and should not be used.

Based on the specific problem to be solved, the best strategy is to identify the most important fluid dynamics processes and choose the modeling approach accordingly. The aim is to reduce the unnecessary computational demand while capturing the physical phenomenon. In the following part of this section, the governing equations with the most commonly used turbulence model will be introduced. And then the numerical methods and

codes available will be briefly described. At the end of this section, examples of 3D CFD modeling of the open-channel flows will be shown.

To be general, we assume the resolution of the free surface is important and use the VOF method as an example. In the VOF method, a scalar transport equation is solved as an indicator for the water and air where a value of 1 represents water and 0 represents air. If the free surface is not as important, the VOF scheme could be easily turned off by not solving the scalar transport equation and fill the whole domain by a value of 1. The interface between water and air could be replaced by a rigid lid. The governing equations for the fluid are the Reynolds-averaged Navier–Stokes equations:

$$\frac{\partial \rho}{\partial t} + \nabla \cdot (\rho u) = 0, \quad (2.28)$$

$$\frac{\partial \rho u}{\partial t} + \nabla \cdot (\rho u u) - \nabla \cdot [(\mu + \mu_t) \overline{\sigma}] = -\nabla p + \rho g \quad (2.29)$$

where  $u$  is the fluid velocity vector field,  $p$  is the pressure field,  $\mu$  is the molecular viscosity,  $\mu_t$  is the turbulent eddy viscosity,  $\overline{\sigma}$  is the strain rate tensor, and  $g$  is the gravity force vector. The density  $\rho$  in the domain is given by

$$\rho = \alpha \rho_w + (1 - \alpha) \rho_a, \quad (2.30)$$

where  $\alpha$  is the volume fraction of water and  $\rho_w$  and  $\rho_a$  are densities of water and air, respectively.

The volume fraction scalar,  $\alpha$ , is governed by the transport equation which has the form

$$\frac{\partial \alpha}{\partial t} + \nabla \cdot (\alpha u) = \mu \nabla^2 \alpha. \quad (2.31)$$

To solve the turbulent eddy viscosity  $\mu_t$ , turbulence models need to be used. As an example, equations for fluid model are closed by the conventional  $k$ - $\varepsilon$  turbulence model [35], which is most popular in engineering practice,

$$\mu_t = C_\mu \rho \frac{k^2}{\varepsilon}, \quad (2.32)$$

$$\frac{\partial k}{\partial t} + \nabla \cdot [uk] = \frac{1}{\rho} \nabla \cdot \left( \frac{\mu_t}{\sigma_k} \nabla k \right) + 2 \frac{\mu_t}{\rho} |\nabla u|^2 - \varepsilon, \quad (2.33)$$

$$\frac{\partial \varepsilon}{\partial t} + \nabla \cdot [u\varepsilon] = \frac{1}{\rho} \nabla \cdot \left( \frac{\mu_t}{\sigma_k} \nabla \varepsilon \right) + 2 \frac{C_1 \mu_t}{\rho} |\nabla u|^2 \frac{\varepsilon}{k} - C_2 \frac{\varepsilon^2}{k}, \quad (2.34)$$

where  $k$  is turbulence kinetic energy and  $\varepsilon$  is turbulence energy dissipation rate and  $\sigma_k$  and  $\sigma_\varepsilon$  are the Schmidt numbers. The constants appear in (2.20)–(2.22) take the values of  $C_\mu = 0.09$ ,  $C_1 = 1.44$ , and  $C_2 = 1.92$  [35]. The Schmidt numbers have the values of  $\sigma_k = 1.0$  and  $\sigma_\varepsilon = 1.0$ . More turbulence models can be found in the literature.

#### 2.4.2. Numerical Solutions and Available Codes

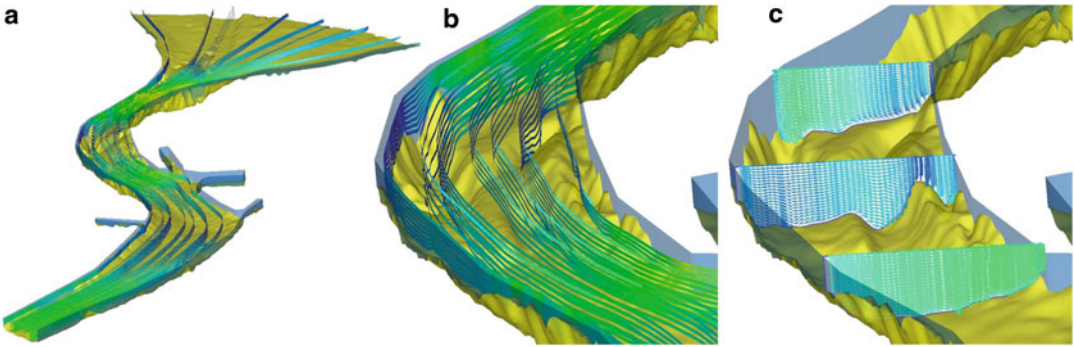
The partial differential equations (PDEs) of the 3D CFD models can be solved using any numerical schemes (e.g., finite-difference, finite element, and finite volume methods) introduced in the previous sections. Whatever the schemes chosen, the PDEs are discretized and the physical variables (velocity, pressure, etc.) are solved at finite number of grid points. As mentioned in the introduction, in general, the process includes preprocessing, simulation, and post-processing. A very important step in the preprocessing stage is to prepare a good quality mesh which can determine the overall quality of simulation results and sometimes even the success or failure of the simulation.

There are a number of commercially available programs such as Fluent, Flow3D, Phoenics, and CD-adapco which are used widely in practice because of their ease of use and good support. In recent years, with the growth of the open-source movement (from operating systems to applications), several CFD codes are released under various open-source license agreements. Instead of compiled binary executables as is the case with most of the commercial codes, the whole source code is available. This is very appealing to people who wish to have the freedom to modify the code according to his or her particular application. The drawback of open-source CFD codes is that the learning curve is steep and it needs more background and experience in computer programming.

One of the popular open-source CFD code is OpenFOAM [36], which has been used extensively by the author for various applications. OpenFOAM is primarily designed for problems in continuum mechanics. It uses the tensorial approach and object-oriented techniques [37]. OpenFOAM provides a fundamental platform to write new solvers for different problems as long as the problem can be written in tensorial partial differential equation form. It comes with a large number of turbulence models for both incompressible and compressible fluids. The core of this code is the finite volume discretization of the governing equations. Differential operators in a partial differential equation, such as temporal derivative, divergence, Laplacian operator, and curl, can be discretized in the code. A numerical solver which solves the partial differential equations can be written at high programming level with great efficiency. Researchers and engineers can be liberated from the burden of tedious coding and focus on the physical problem. In the next section, an example of 3D CFD simulation using OpenFOAM will be introduced.

#### 2.4.3. Examples

Three-dimensional computational models have been used in many applications involving almost all aspects of traditional and emerging open-channel hydraulics problems. Some of the examples include secondary flows in meandering channels, turbulent coherent structures over complex bed forms and rough elements such as gravels, and free surface flow through/around



**Fig. 2.11.** Streamlines and velocity vector plots around the first two bends of the St. Clair River: (a) Streamlines around the first two bends from Lake Huron to the St. Clair River. (b) Streamlines over the bedforms in the first bend. (c) Secondary flow in the first bend over the bedforms.

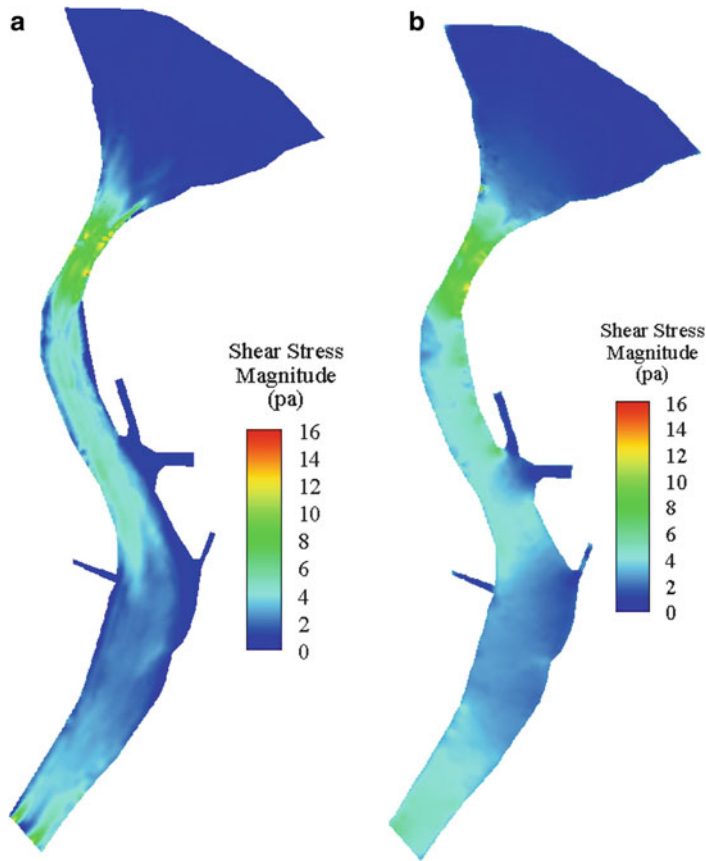
hydraulic structures such as spillways and fish passages. If the channel is built with a mobile bed, sediment transport and channel evolution can also be modeled together with the fluid flows. In this section, an example will be shown to demonstrate the application of three-dimensional numerical modeling of open-channel flows. This example is the 3D sediment mobility analysis in the St. Clair River, whose 2D analysis has been introduced in the previous section.

As we have seen in the previous section of 2D depth-averaged models, St. Clair River was modeled using finite volume shallow-water equations. To further understand the hydraulics of the river, especially at the river inlet from Lake Huron where it could be most active morphologically, 3D CFD simulation was performed. The 3D simulation results could also be used to cross-check the 2D model.

Due to the limitation of computational resource, only the Lake Huron inlet area and the first two bends are modeled in the 3D simulations. The bathymetry is from the multi-beam scan and the 3D view of the 2008 bathymetry is shown in Fig. 2.7. The domain is about 8 km long and it has a mesh of about 1.5 million cells. The turbulence is modeled by the  $k-\epsilon$  model. Although surface waves in the lake inlet area present, the river surface elevations of the majority of the domain only changes slightly. Thus, a rigid lid is placed on the top of domain. It takes more than 24 h for the model to reach steady state in an eight nodes computer cluster.

The flow pattern from the 3D model is shown in Fig. 2.11. The stream traces in Fig. 2.11a, b help visualize the flow field. In the first bend, the velocity vectors in several cross sections are shown in Fig. 2.11c. The secondary flow feature is evident. This may cause the further scour of the deep hole on the outer bend and deposit sediment on the two sandbars in the inner bend. The flow field from the numerical model with 3D ADCP measurement can be used to give a clear picture of what is happening around the bend.

The comparison of the bed shear stress between the 2D and 3D models is shown in Fig. 2.12. Although exact match of the shear stresses is not possible, the basic patterns of the shear distribution from both models agree well. For both models, the maximum shear stress is located at the Lake Huron inlet area, and in the second bend, low shear stress is



**Fig. 2.12.** Comparison on the bed shear stress between 2D modeling (HydroSed2D) and 3D modeling (OpenFOAM) around the first two bends of the St. Clair River: (a) Results from HydroSed2D. (b) Results from OpenFOAM.

observed. The magnitude of the shear stress also agrees well indicating the roughness coefficient selected and the velocity magnitudes the model computed are in the right range. With these, it is reasonable to conclude that the HydroSed2D model gives reasonable results.

### 3. MODERN AND FUTURE CHALLENGES

As has been the case with most engineering disciplines, the major advances in open-channel hydraulics in the past five decades have been in areas digital computing and software development. To assert there were no advances in theory and understanding of the governing processes would be wrong; but those advancements have not had the impact that the advances in computing have had. The advances in computing power and software are now permitting water resource engineers to examine complex, multidisciplinary problems that could previously only be considered qualitatively. Among the problems involving open-channel

hydraulics problems are the following, and it is pertinent to observe that they require multidisciplinary approaches which synthesize the skills and knowledge of professionals in diverse fields to develop solutions. Or to paraphrase the old adage, the solution is greater than the sum of its components.

### *3.1. Revisiting Past Projects*

Throughout the 1950s and 1960s in the United States, many natural channels were straightened and lined to increase their hydraulic efficiency in conveying flood flows. While these improvements maximized conveyance, they often resulted in channels that are by current standards less than ideal for a number of reasons and among them are the following. Many improved channels are aesthetically unappealing; that is, they are usually prismatic, straight, functionally lined with concrete or a similar artificial material, and protected with chain-link fence. The channel pictured in Fig. 2.4 is an example of a functional but is not aesthetically pleasing nor was it intended to be. In 1954, the US Army Corps of Engineers undertook the San Antonio Channel Improvements Project, and during the early stages of this project in the 1950s and 1960s, the San Antonio River below the downtown was straightened to efficiently convey flood flows through densely populated areas. In the twenty-first century portions of that reach of the San Antonio River are being restored to achieve better aesthetics, restore riparian areas, and provide for recreation while maintaining hydraulic conveyance.

In discussing preserving natural channels while mitigating flood flows, Indian Bend Wash in Scottsdale, AZ, must be mentioned. Indian Bend Wash is an ephemeral channel that bisects the City of Scottsdale. Before 1960, Scottsdale was a rural agricultural community that could not afford to bridge a channel that rarely conveyed flow. However, during the 1960s, there were a series of severe floods and Federal tax dollars were allocated for US Army Corps of Engineers to remedy the problem. The proposed remedy was to build a prismatic concrete canal instead of a system of parks and golf courses the community wanted. Grass was an untried lining for channels conveying episodic flows and high maintenance costs were anticipated. The City, in a controversial and bold move, voted for flood mitigation by the aesthetically attractive system of parks and golf courses which today is known as Scottsdale Greenbelt. This project, built against the Corps of Engineers judgment, has proved to be a success from the viewpoints of flood mitigation, aesthetics, and recreation.

Restoring or maintaining channels to mitigate flood flows and achieve other design objectives is a challenging problem that requires a multidisciplinary approach. In restoring a channel, a stable section must be designed and constructed that behaves under many flow regimes as a natural channel that took decades to form. It is pertinent to observe that the approaches to this challenge can, generally, be divided into two groups: qualitative and quantitative. The quantitative approaches derive from the theory of sediment transport and river mechanics. This is the preferred approach of professionals who have backgrounds in deterministic Newtonian mechanics. The qualitative approach is generally favored by people whose background is not mechanics and views watershed management holistically; see, for

example, [38]. The proponents of the two approaches both dismiss the merits and validity of other approach while asserting theirs is valid. Restoring a disturbed system to a “natural” condition that is in equilibrium is a challenge for which there is not yet a sufficient or adequate understanding of the processes involved.

Managing a natural floodway in an urban environment is also a multidisciplinary challenge. That is, melding the needs to maintain conveyance and riparian habitat while enhancing recreation and preventing the spread of nonnative invasive species is a complex technical and social issue. A technical issue that remains a challenge is estimating the Manning resistance coefficient for naturally vegetated areas with diverse ground cover and vegetation. Although progress has been made in this area, see, for example, [39, 40], more work is needed. A second and equally important issue is balancing the hydraulic conveyance needed with maintaining health and diverse riparian areas; see, for example, [41]. Finally, other uses of the channel and its floodplain must often be considered such as recreation, that is, hiking and biking trails, parks, and playing fields.

### *3.2. Effects of Climate Variability*

Without entering into a discussion of whether there will be significant climate change in the near future or not, the water resource engineers treat the variability of climate and weather in designing and maintaining open-channel systems. One of the most important sources of year-to-year climate variation throughout the world is the El Niño/La Niña phenomena of the tropical Pacific Ocean. Under normal conditions, the tropical trade winds blow from the east to west resulting in the concentration of warm water in the western Pacific Ocean. In the eastern Pacific Ocean, the effect of the trade winds is to upwell cold, deep nutrient waters along the Equator from the coast of Ecuador to the Central Pacific. During an El Niño episode, the trade winds weaken and the upwelling of the cool waters in the Eastern Pacific is reduced. In turn, this allows the warm water in the Western Pacific to drift eastward towards South America. As the central and eastern Pacific warms, atmospheric pressure gradients along the Equator weaken and the trade winds are further diminished. These changes are the defining factors of an El Niño episode and were first noted by Gilbert Walker in the early decades of the twentieth century who termed this the “Southern Oscillation.” From the viewpoint of water resources engineering in the United States, the importance of this cycle is that during El Niño periods, the Southwest tends to be wet and the Northwest dry and vice versa for La Niña periods. The implications of the El Niño/La Niña phenomena on water supply are known and have been studied; see, for example, [42]. However, the implications of these phenomena on flood mitigation projects, in general, and open channels, in particular, have not been studied in any detail.

From the viewpoints of designing and maintaining open-channel systems, whether the climate is changing on an engineering timescale is less important than whether climate and weather variability have been properly taken into account. This is again an area where the water resources engineer can form productive partnerships with professionals in the geosciences, statistics, and atmospheric sciences to reduce both cost and risk.



### ***3.3. Challenges of Natural Open Channels in the Arid Environment***

Flow in open channels in the arid environment present a unique challenge since the flows are often episodic and flood hazard is often less related to magnitude than to quickness and ferocity. In addition, non-Newtonian flows of mud and debris are common in some areas and unconfined flows are common. The dominant landform in semiarid and arid environments is the alluvial fan. For example, in the southwestern United States, alluvial fans and bajadas occupy approximately 31.3 % of the area [43]. From the viewpoint of water resources engineering, an appropriate definition is that of the US Federal Emergency Management Agency (FEMA) [44] or

Alluvial fans are geomorphic features characterized by cone-or fan shaped deposits of boulders, gravel, sand, and fine sediments that have been eroded from mountain watersheds, and then deposited on the adjacent valley floor. . . Flooding that occurs on active alluvial fans is characterized by fast-moving debris and sediment laden shallow flows. The paths followed by these flows are prone to lateral migration and sudden relocation to other portions of the fan. In addition, these fast moving flows present hazards associated with erosion, debris flow, and sediment transport.

The FEMA definition itemizes the hydraulic processes expected to occur on a generic, regulatory alluvial fan from an engineering viewpoint; and this definition makes clear that hazards on alluvial fans are due to a wide range of hydraulic processes that involve sediment movement and transport; and many of these processes are not yet well understood.

While hydraulic processes on alluvial fans have interested those in the geosciences for many years, the interest of the engineering community began when development on alluvial fans rose to a level where the hazards of flooding on these landforms could not be ignored. The seminal paper treating open channels conveying floods on alluvial fans was [45] which proposed a probabilistic approach to flood hazard identification and mitigation on alluvial fans. Since 1979, a vigorous debate, often acrimonious, over modeling open-channel flow on alluvial fans has taken place. Although sophisticated two-dimensional models, see [46] for example, a consensus, either technical or regulatory, has been reached. Again this is a problem involving both the engineering and geoscience communities and should be addressed jointly.

### ***3.4. Discovering and Implementing New Synergies***

The foregoing sections have suggested critical topics involving open channels where the knowledge available is not sufficient to address critical problems that require solutions. In almost all cases these problems are at the interface between engineering and one or more of the sciences: geology, geomorphology, ecology, or hydrometeorology to name just a few. The advancements in modeling over the past several decades have reached the point that synergistic considerations covering multiple disciplines are possible and necessary. In this aspect, model integration becomes important and inter-model communication should be standardized to ensure smooth flow of data and information. Future generations of computational hydraulics modeling tools should also incorporate the emerging technologies such as cloud computing and big data processing to improve efficiency and accuracy. The boundary between model and data will probably be blurred furthermore which requires the adaptation of our modeling philosophy.

**REFERENCES**

1. Rouse H, Ince S (1957) *History of hydraulics*. Dover Publications, New York
2. Reisner M (1986) *Cadillac Desert*. Viking Penguin, Inc., New York
3. Kahrl WL (1982) *Water and power: the conflict over Los Angeles water supply in the Owens Valley*. University of California Press, Berkeley, CA
4. USACE (2010) *HEC-RAS river analysis system, hydraulic reference manual*. US Army Corps of Engineers Hydrologic Engineering Center, Davis, CA
5. FHA (2000) Chapter 8: *stilling basins*. Hydraulic design of energy dissipators for culverts and channels, hydraulic engineering circular no. 14, 3rd edn 2. Federal Highway Administration, Washington DC
6. Wei CY, Lindell JE (1999) Chapter 18: *hydraulic design of stilling basins and energy dissipators*. In: Mays LW (ed) *Hydraulic design handbook*. McGraw-Hill, New York, NY
7. Levi E (1995) *The science of water: the foundation of modern hydraulics*. American Society of Civil Engineers, New York, NY
8. Herschel C (1897) *115 Experiments on the carrying capacity of large, Riveted Metal Conduits* (Google books). Robert Drummond, Electrotyper and Printer, New York
9. Flamant A (1900) *Hydraulique* (Google books), 2nd edn. Beranger, Paris
10. Fischenich C (2000) *Robert manning (a historical perspective)*, ERDC TN-EMRRP-SR-10. U.S. Army Engineer Research and Development Center, Environmental Laboratory, Vicksburg, MS
11. King HW (1918) *Handbook of hydraulics for the solution of hydraulic problems*. McGraw-Hill, New York
12. Sturm TW (2010) *Open channel hydraulics*, 2nd edn. McGraw Hill Higher Education, Burr Ridge, IL
13. Mays LW (2005) *Water resources engineering*. Wiley, Berlin
14. U.S. Army Corps of Engineers (2003) *Subquehanna River flood warning and response system*. Project report PR-56. U.S. Army Corps of Engineers, Hydrologic Engineering Center, Davis, CA
15. Tate EC, Maidment DR, Olivera F, Anderson DJ (2002) *Creating a terrain model for floodplain mapping*. *J Hydrol Eng* 7(2):100–108
16. Bermúdez A, Rodríguez C, Vilar MA (1991) *Solving shallow water equations by a mixed implicit finite element method*. *IMA J Numer Anal* 11(1):79–97
17. Bradford SF, Sanders BF (2002) *Finite-volume model for shallow-water flooding of arbitrary topography*. *J Hydraul Eng* 128(3):289–298
18. Weiming W (2004) *Depth-averaged 2-D numerical modeling of unsteady flow and nonuniform sediment transport in open channels*. *J Hydraul Eng* 130(10):1013–1024
19. Liu X, García MH (2008) *Coupled two-dimensional model for scour based on shallow water equations with unstructured mesh*. *Coast Eng* 55(10):800–810
20. Liu X, Parker G, Czuba J, Oberg K, Mier JM, Best JL, Parsons DR, Ashmore P, Garcia MH (2011) *Sediment Mobility and Bed Armoring in the St. Clair River: insights from hydrodynamic modeling*. *Earth Surface Processes and Landform* 37(9):957–970
21. Fujihara M, Borthwick AGL (2000) *Godunov-type solution of curvilinear shallow-water equations*. *J Hydraul Eng* 126(11):827–836
22. Borthwick AGL, León SC, Józsa J (2001) *Adaptive quadtree model of shallow-water hydrodynamics*. *J Hydraul Res* 39(4):413–424
23. Galland JC, Goutal N, Hervouet JM (1991) *TELEMAC—a new numerical model for solving shallow-water equations*. *Adv Water Resour* 14(3):138–148
24. TUFLOW (2008) *TUFLOW user manual, GIS based 2D/1D hydrodynamic modelling*, TUFLOW

25. Godunov SK (1959) A difference scheme for numerical solution of discontinuous solution of hydrodynamic equations. *Math Sbornik* 47:271–306, translated US Joint Publ. Res. Service, JPRS 7226, 1969
26. Hirsch C (1990) Numerical computation of internal and external flows. Computational methods for inviscid and viscous flows, vol 2, Wiley series in numerical method in engineering. Wiley, Berlin
27. Roe PL (1981) Approximate Riemann solvers, parameter vectors, and difference schemes. *J Comput Phys* 43:357–372
28. Parker G (1990) Surface-based bedload transport relation for gravel rivers. *J Hydraul Res* 28(4):417–436
29. Czuba JA, Oberg KA, Best J, Parsons DR (2009) The effect of channel shape, bed morphology, and shipwrecks on flow velocities in the Upper St. Clair River. Proceedings of 33rd IAHR congress, Vancouver, BC, Canada
30. Tennekes H, Lumley JL (1972) A first course in turbulence. MIT Press, Cambridge, MA
31. Sagaut P (2001) Large eddy simulation for incompressible flows: an introduction. Springer, Berlin
32. Wilcox DC (2006) Turbulence modeling for CFD, 3rd edn. DCW Industries, La Canada, CA
33. Liu X, García MH (2008) A 3D numerical model with free water surface and mesh deformation for local sediment scour. *J Waterw Port Coast Ocean Eng* 134(4):203–217
34. Hirt CW, Nichols BD (1981) Volume of fluid (vof) method for dynamics of free boundaries. *J Comput Phys* 39(1):201–225
35. Sethian JA (1996) Level set methods: evolving interfaces in geometry, fluid mechanics, computer vision, and material science, Cambridge monographs on applied and computational mathematics. Cambridge University Press, Cambridge
36. Rodi W (1980) Turbulence models and their applications in hydraulics. IAHR monograph series. Rotterdam, Brookfield, A.A. Balkema
37. OpenCFD (2010) Openfoam: the open source computational fluid dynamics (CFD) toolbox. <http://www.OpenFoam.org>
38. Weller HG, Tabor G, Jasak H, Fureby C (1998) A tensorial approach to computational continuum mechanics using object-oriented techniques. *Comput Phys* 12(6):620–631
39. Rosgen DL, Silvey HL (1996) Applied river morphology. Wildland Hydrology Books, Fort Collins, CO
40. Flippin-Dudley SJ, Abt SR, Bonham CD, Watson CC, Fischenich JC (1997) A point quadrant method of vegetation measurement for estimating flow resistance. Technical Report EL-97-XX. U.S. Army Waterways Experiment Station, Vicksburg, MS
41. Kouwen N, Fathi-Moghadam M (2000) Friction factors for coniferous trees along rivers. *J Hydraul Eng ASCE* 126(10):732–740
42. Murray KE, Bush JK, Haschenburger JK, French RH (2008) Technical and field guide: management practices for natural waterways. Center for Water Research, University of Texas at San Antonio, San Antonio, TX
43. Cayan DR, Peterson DH (1989) The influence of North Pacific circulation on streamflow in the West. Aspects of climate variability in the Pacific and Western Americas. *Geophys Monogr* 55:375–398
44. Anstey RL (1965) Physical characteristics of alluvial fans, Technical Report ES-20. US Army Natick Laboratories, Natick, MA
45. Federal Register (1989) 54(156)
46. Dawdy DR (1979) Flood frequency estimates on alluvial fans. *J Hydraul Div Proc Am Soc Civil Eng* 105(HY11):1047

---

Zhao-Yin Wang and Bao-Zhu Pan

*CONTENTS*

RIVER ECOSYSTEMS  
ECOLOGICAL STRESSES TO RIVERS  
ASSESSMENT OF RIVER ECOSYSTEMS  
REFERENCES

---

**Abstract** Rivers have many service functions such as water supply, food production, sightseeing, and shipping, hence playing an important role in people's living and agricultural production. During the last decades, intensive human activities have been threatening river ecosystem. A better understanding of ecological stresses and assessments of river ecosystem is of great significance to river conservation and management. This chapter discusses river ecology, disturbances to the ecology, and assessments of river ecosystem.

**Key Words** River ecology • Ecological stresses • Ecological assessments • Biodiversity • Habitat.

## 1. RIVER ECOSYSTEMS

### 1.1. *Background Information of Rivers*

Rivers are such an integral part of the land, and they are much more than merely water flowing to the sea. Rivers carry downhill not just water, but just as importantly sediments, dissolved minerals, and the nutrient-rich detritus of plants and animals. The main functions of rivers are draining floods, supplying drinking water, maintaining ecology, irrigating farmland, transporting sediment, supplying power, providing habitat for fishes, assimilating wastewater, and providing navigation. Humans exploit the resources of rivers by constructing dams and water-diverting channels, developing navigation channels, and harvesting fishes, which result

in changes in the river hydrology, runoff, sediment transport, riparian and stream habitats, and water quality.

Rivers can be recognized as mountain rivers, alluvial rivers, and estuaries. A mountain river is the most upstream part of the river, including the river source and the upstream tributaries of the river, where the river system flows through mountainous areas and the flow is confined by mountains. Erosion control and vegetation development over the watershed, landslides and debris flows, and control of channel bed incision are major topics of mountain river studies. An alluvial river is defined as a river with its boundary composed of the sediment previously deposited in the valley, or a river with erodible boundaries flowing in self-formed channels. Sediment transportation, water resources development, and flood defense are the most important issues in the alluvial river management. The estuary is the connection part of a river with the water body (lake, sea, or ocean) into which it flows, including the river mouth, a river section affected by the tide, and the water body area affected by the river flow. Delta and coastal processes, eutrophication, and algal blooms are the major challenges for the management of estuaries.

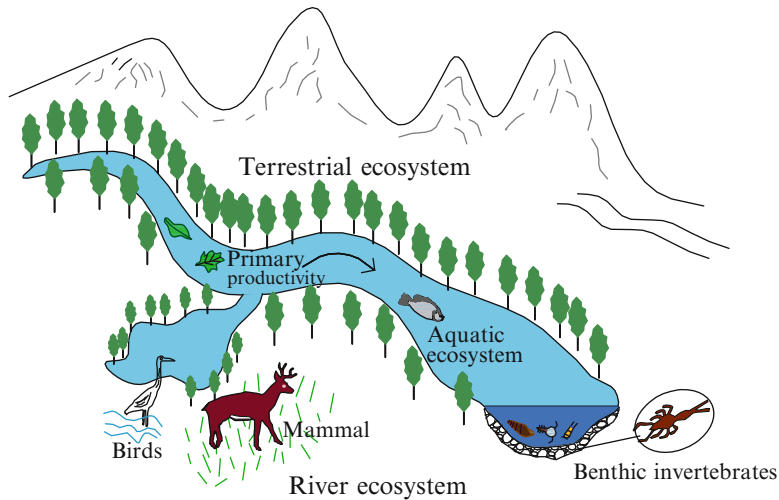
River ecology is the science of studying the relations among different organisms and the relations between organisms and their environment in rivers. In recent years, river ecosystems have been facing the threat of eutrophication and the destruction of natural hydrologic regime. The former is due to the discharge of sewage, while the latter mainly due to the construction of hydraulic engineering. At present, in the world, over 40,000 large dams (>15 m high) impound the rivers, and about 300 new large dams are currently built every year, particularly in the developing countries [1, 2]. The construction of hydraulic engineering can affect water temperature, water chemistry, sediment transport, and vegetation assemblages, thereby threatening the ecological functions of the rivers. Therefore, it is vital to assess ecological status of river systems and to put forward river strategies of conservation and restoration.

## ***1.2. Spatial Elements of River Ecosystems***

Ecosystems of rivers vary greatly in size. Taking a deeper look into these ecosystems can help to explain the functions of landscapes, watersheds, floodplains, and streams, as shown in Fig. 3.1. In ecosystems movement between internal and external environments is common. This may involve movement of materials (e.g., sediment and storm water runoff), organisms (e.g., mammals, fish, and insects), and also energy (e.g., heating and cooling of stream waters).

Many sub-ecosystems form a river ecosystem which, in turn, can also be part of a larger-scale landscape ecosystem. The structure and functions of the landscape ecosystem are in part determined by the structure and functions of the river ecosystem. The river ecosystem may have input or output relations with the landscape ecosystem; thus, the two are related. In order to plan and design a river ecosystem restoration, it is vital to first investigate the relations between the ecosystems. Landscape ecologists use four basic terms to define spatial structure at a particular scale:

1. **Matrix**—the land cover that is dominant and interconnected over the majority of the land surface. Theoretically the matrix can be any land cover type but often it is forest or agriculture.



**Fig. 3.1.** A river ecosystem consists of the terrestrial ecosystem and the aquatic ecosystem, which is affected by and impacts on the landscape ecosystem through input and output (after FISRWG 1997).

2. Patch—a nonlinear area (polygon) that is less abundant than, and different from, the matrix.
3. Corridor—a special type of patch that links other patches in the matrix. Usually, a corridor is linear or elongated in shape, such as a stream corridor.
4. Mosaic—a collection of patches, none of which are dominant enough to be interconnected throughout the landscape.

Figure 3.2 shows examples of a forest matrix, a city patch, a stream corridor, and a mosaic consisting of a lake, island, forest, and hills. One may see a matrix of mature forest, cropland, pasture, clear-cuts, lakes, and wetlands on a landscape scale. However, on a river reach scale, in a matrix of less desirable shallow waters, a trout may perceive pools and well-sheltered, cool pockets of water as preferred patches, and in order to travel safely among these habitat patches, the stream channel may be its only alternative. The matrix-patch-corridor-mosaic model is a very useful, basic way of describing structure in the environment at all levels. When planning and designing ecosystem restoration, it is very important to always consider multiple scales.

The stream corridor is an ecosystem with an internal and external environment (its surrounding landscape). Stream corridors often serve as a primary pathway for the aforementioned movement of energy, materials, and organisms in, through, and out of the system. This may be accomplished by connecting patches and functioning as a conduit between ecosystems and their external environment. Movement in, through, and out of the ecosystem may be dictated by spatial structure, especially in corridors; conversely, this movement also serves to change the structure over time. Thus, the end result of past movement is the spatial structure, as it appears at any point in time. In order to work with ecosystems at any scale, it is paramount to understand the feedback loop between movement and structure.

Many of the functions of the stream corridor are strongly interlinked with drainage patterns. So, many people commonly use the term “watershed scale,” and it will also be



**Fig. 3.2.** (a) Forest matrix in the suburbs of Beijing, China; (b) A township patch and a surrounding stream corridor in Wasserburg, Germany; (c) Stream corridor (the Leinbach River in Germany) and riparian forest matrix; and (d) Mosaic consisting of forest, lake, island, and hills (Banff, Canada).

used in this chapter. A *watershed* is defined as an area of land that drains water, sediment, and dissolved materials to a common outlet at some point along a stream channel [3]. Watersheds, therefore, occur at many different scales, ranging from the watersheds of very small streams that measure only a few  $\text{km}^2$  in size to the largest river basins, such as the Yangtze River watershed. The matrix, patch, corridor, and mosaic terms can still be used to describe the ecological structure within watersheds. However, one could further describe the watershed structure more meaningfully by also focusing on elements such as upper, middle, and lower watershed zones; drainage divides; upper and lower hill slopes; terraces; floodplains; estuaries and lagoons; and river mouths and deltas. Figure 3.3 displays examples of (a) the upper watershed (the Yangtze River at the Shennongjia Mountain), (b) a mountain stream (the Qingjiang River is a tributary of the Weihe River in the Yellow River basin), (c) an alluvial river (the Blue Nile at the confluence with the White Nile River), and (d) an estuary (the Venice Lagoon at the Po River mouth).

The river corridor is a spatial element (a corridor) at the watershed and landscape scales. Common matrices in stream corridors include riparian forest or shrub cover or alternatively herbaceous vegetation. Examples of patches at the stream corridor scale are wetlands, forest, shrub land, grassland patches, oxbow lakes, residential or commercial development, islands in



**Fig. 3.3.** (a) Upper watershed of the Yangtze River at the Shennongjia Mountain; (b) the Qingjiang River in the Yellow River basin; (c) the Blue Nile at the confluence with the White Nile in Sudan; and (d) the Venice Lagoon at the Po River mouth in Italy.

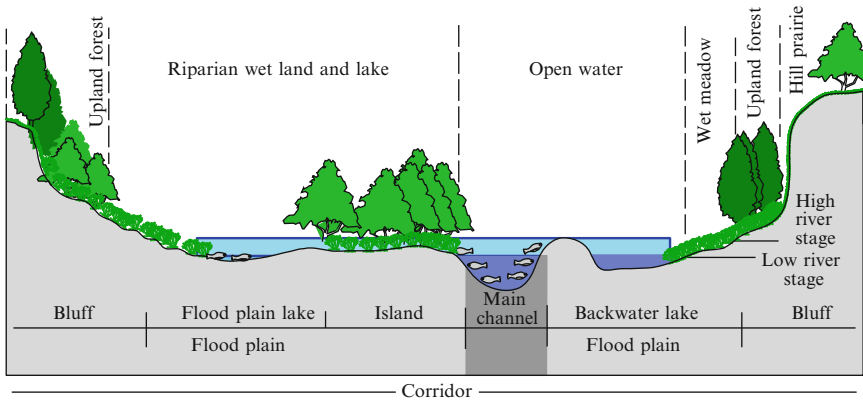
the channel, and passive recreation areas such as picnic grounds. Figure 3.4 shows a cross section of a river corridor. The river corridor can be subdivided by structural features and plant communities. Riparian areas have one or both of the following characteristics: (a) vegetative species clearly different from nearby areas and (b) species similar to adjacent areas but exhibiting more vigorous or robust growth forms. Riparian areas are usually transitional between wetland and upland.

### 1.3. Ecological Conditions

#### 1.3.1. Flow

Streams are distinguished from other ecosystems by a flow of water from upstream to downstream. The micro- and macro-distribution patterns of many stream species are affected by the spatial and temporal characteristics of stream flow, such as fast versus slow, deep versus shallow, turbulent versus laminar, and flooding versus low flows [4–6]. Flow velocity affects the deliverance of food and nutrients to organisms; however, it can also dislodge them





**Fig. 3.4.** A cross section of a river corridor, in which the river corridor is subdivided by structural features and plant communities (after FIRSWG 1997).

and prevent them from remaining at a certain site. When a stream has a very slow flow, the fauna on the banks and the bed are similar in composition and configuration to those present in stagnant waters [7]. High flows are cues for timing migration and spawning of some fish. When fish detect high flows, some will migrate and some will spawn.

### 1.3.2. Temperature

Water temperature can vary markedly in a stream system and between different stream systems. It is a very important factor for cold-blooded aquatic organisms for it affects many of their physiological and biochemical processes. Stream insects, for example, often grow and develop more rapidly in warmer portions of a stream or during warmer seasons. Some species may complete two or more generations per year at warmer sites yet only one or fewer at cooler sites [6, 8]. This can also be applied to algae and fish for their growth rates increase with increased water temperature [5, 9]. Some species are only found in certain areas due to the correlation between temperature and growth, development, and behavior.

### 1.3.3. Riparian Vegetation

Decreased light and temperature in streams can be a result of riparian vegetation [10]. When the flow of water is slow, direct sunlight can significantly warm up the water, especially in the summer. In Pennsylvania, the average daily stream temperatures increased by 12 °C when flowing through an open area in direct sunlight but then decreased significantly during flow through 500 m of forest [11]. However, during the winter, a lack of cover has the opposite effect and causes a decrease in temperature. Sweeney (1992) found that temperature changes of 2–6 °C usually altered key life-history characteristics of some species [12]. It has been observed that riparian forest buffers help to prevent changes in natural temperature patterns and also to mitigate the increases in temperature following deforestation.

#### 1.3.4. Oxygen

Oxygen enters the water by absorption directly from the atmosphere and by plant photosynthesis [13]. Mountain streams that do not receive a lot of waste discharges are generally saturated with oxygen due to their shallow depth, constant motion, and large surface area exposed to the air. Aquatic organisms only survive because of the dissolved oxygen which, at appropriate concentrations, enables them to reproduce and develop and gives them vigor. When oxygen levels are low, organisms experience stress and become less competitive in sustaining the species [13]. Dissolved oxygen concentrations of 3 mg/L or less have been shown to interfere with fish populations for a number of reasons [13]. When the oxygen needed for chemical and biological processes exceeds the oxygen provided by reaeration and photosynthesis, the fish will die. Dissolved oxygen concentrations will decrease and may even be depleted by slow currents, high temperatures, extensive growth of rooted aquatic plants, algal blooms, or high concentrations of aquatic matter [14].

Pollution that depletes the stream of oxygen has a marked effect on stream communities [15]. Major factors determining the amount of oxygen found in water are temperature, pressure, salinity, abundance of aquatic plants, and the amount of natural aeration from contact with the atmosphere [14]. A level of 5 mg/L or higher of dissolved oxygen in water is the level associated with normal activity of most fish [16]. In streams filled with trout, the dissolved oxygen concentration has been shown, by analysis, to be between 4.5 and 9.5 mg/L [14].

#### 1.3.5. pH Value




































































Aquatic biota survive best when the water has a pH of 7, i.e., nearly neutral hydrogen ion activity. If the pH changes, either becoming more acidic or more alkaline, the stress levels increase and eventually species diversity and abundance decrease. In streams under the stresses of various human activities, the pH often becomes more acidic and many species suffer, as shown in Table 3.1 (revised based on FISRWG 1997). One of the main causes for changes in the pH of aquatic environments is the increase in the acidity of rainfall [17]. Some soils have the ability to buffer pH changes; however, those which cannot neutralize acid inputs cause environmental concerns.

#### 1.3.6. Substrate

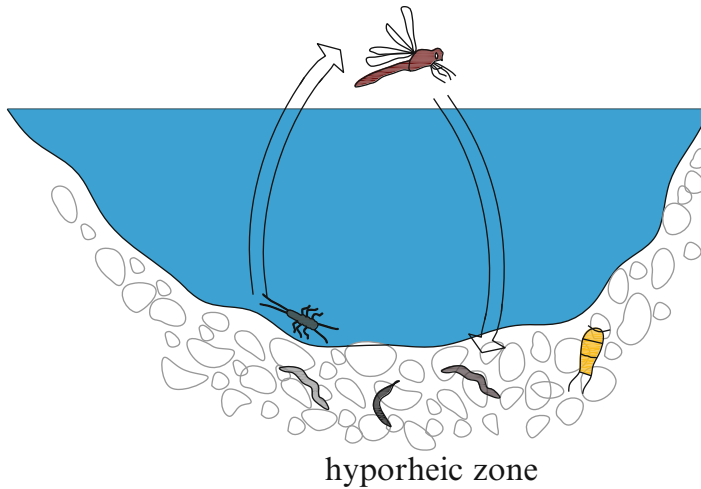
Substrate influences stream biota. Within one reach of a stream, different species and different numbers of species can be seen among microinvertebrate aggregations found in snags, sand, bedrock, and cobbles [18–20]. The hyporheic zone is the area of substrate which is under the substrate-water boundary and is the main area for most benthic invertebrate species to live and reproduce. It may be only one centimeter thick in some cases or one meter thick in other cases. The hyporheic zone may form a large subsurface environment, as shown in Fig. 3.5.

Stream substrates are composed of various materials, including clay, sand, gravel, cobbles, boulders, organic matter, and woody debris. Substrates form solid structures that modify surface and interstitial flow patterns, influence the accumulation of organic materials, and

**Table 3.1**  
**Effects of acid rain on some aquatic species**

pH	6.5	6.0	5.5	5.0	4.5	4.0	3.5	3.0
Grass carp ( <i>Ctenopharyngodon idellus</i> )								
Chinese sturgeon ( <i>Acipenser sinensis</i> )								
Chinese river dolphin ( <i>Lipotes vexillifer</i> )								
Rainbow trout ( <i>Oncorhynchus mykiss</i> )								
Brown trout ( <i>Salmo trutta</i> )								
Brook trout ( <i>Salvelinus fontinalis</i> )								
Smallmouth bass ( <i>Micropterus dolomieu</i> )								
Fathead minnow ( <i>Pimephales promelas</i> )								
Pumpkinseed sunfish ( <i>Lepomis gibbosus</i> )								
Yellow perch ( <i>Perca flavescens</i> )								
Bullfrog ( <i>Rana catesbeiana</i> )								
Wood frog ( <i>R. sylvatica</i> )								
American toad ( <i>Bufo americanus</i> )								
Spotted salamander ( <i>Ambystoma maculatum</i> )								
Clam								
Crayfish								
Snail								
Mayfly								

As acidity increases (pH decreases) in lakes and streams, some species are lost as indicated by the lighter colors (revised on the basis of FISRWG 1997).



**Fig. 3.5.** Schematic diagram of hyporheic zone.

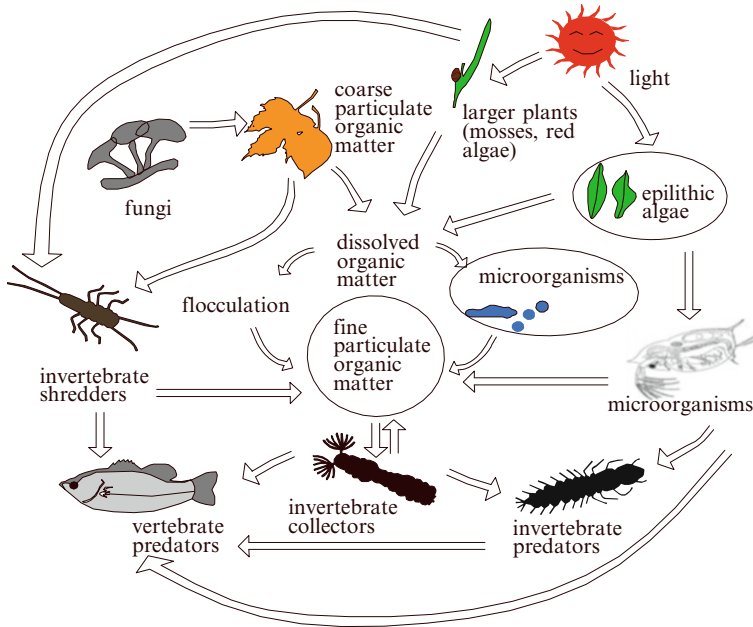
provide for production, decomposition, and other processes [21]. Sand and silt are considered to be the least suitable substrates for supporting aquatic organisms and provide for the fewest species and individuals. Rubble substrates have the highest densities and the most organisms [15]. If woody debris, from nearby trees in forests and riparian areas, fall into the stream, the quantity and diversity of aquatic habitats are increased [22, 23].

#### 1.3.7. Nutrients and Eutrophication

Nitrogen, phosphorus, potassium, selenium, and silica are needed for plant growth. However, nitrogen and phosphorus, if found in surplus, may cause an increase in the rate of growth of algae and aquatic flora in a stream. This process is called eutrophication. Eutrophication has been an environmental and ecological problem in China since the 1980s when the economy began to rapidly grow. If the excess organic matter is decomposed, it can result in oxygen depletion of the water; it also can have terrible aesthetic consequences, the worst of which is the death of fish. Eutrophication in lakes and reservoirs is indirectly measured as standing crops of phytoplankton biomass, usually represented by planktonic chlorophyll-a concentration. However, phytoplankton biomass is not generally the main component of plant biomass in smaller streams because the growth of periphyton and macrophytes, which live on the streambed, is promoted by high substrate to volume ratios and periods of energetic flow. When there are decreased flows and high temperatures, excessive algal mats develop and oxygen is depleted due to eutrophication.

### 1.4. Biological Assemblages

Stream biota are often classified into seven groups—bacteria, algae, macrophytes (higher plants), protists (amoebas, flagellates, ciliates), microinvertebrates (invertebrates less than 0.5 mm in length, such as rotifers, copepods, ostracods, and nematodes), macroinvertebrates



**Fig. 3.6.** Stream ecosystem and bio-community (after FISRWG 1997).

(invertebrates greater than 0.5 mm in length, such as mayflies, stoneflies, caddis flies, crayfish, worms, clams, and snails), and vertebrates (fish, amphibians, reptiles, and mammals) as shown in Fig. 3.6. Undisturbed streams can contain a remarkable number of species. For example, more than 1,300 species were found in a 2-km reach of a small German stream, the Breitenbach, when a comprehensive inventory of stream biota was taken.

The most important elements of the aquatic ecosystem for river management are aquatic plants, benthic invertebrates, and vertebrates (fish, reptiles, and amphibians). Aquatic plants usually consist of mosses attached to permanent stream substrates and macrophytes including floating plants, such as *Eichornia crassipes*; submerged plants, such as *Potamogeton* sp.; and emergent plants, such as *Phragmites communis* Trin (reed). These plants provide primary productivity for the faunal community and play an important role in decontaminating the river water and providing multiple habitats for fish and invertebrates. Bedrock or boulders and cobbles are often covered by mosses and algae. Figure 3.7 shows microhabitats with moss on cobbles, submerged macrophytes species *Potamogeton* sp., floating plants species *Lemna minor*, and emergent plants species *Phragmites communis* Trin (reed). Rooted aquatic vegetation may occur where substrates are suitable and high currents do not scour the stream bottom. Luxuriant vascular plants may occur in some areas where water clarity, stable substrates, high nutrients, and slow water velocities are present.

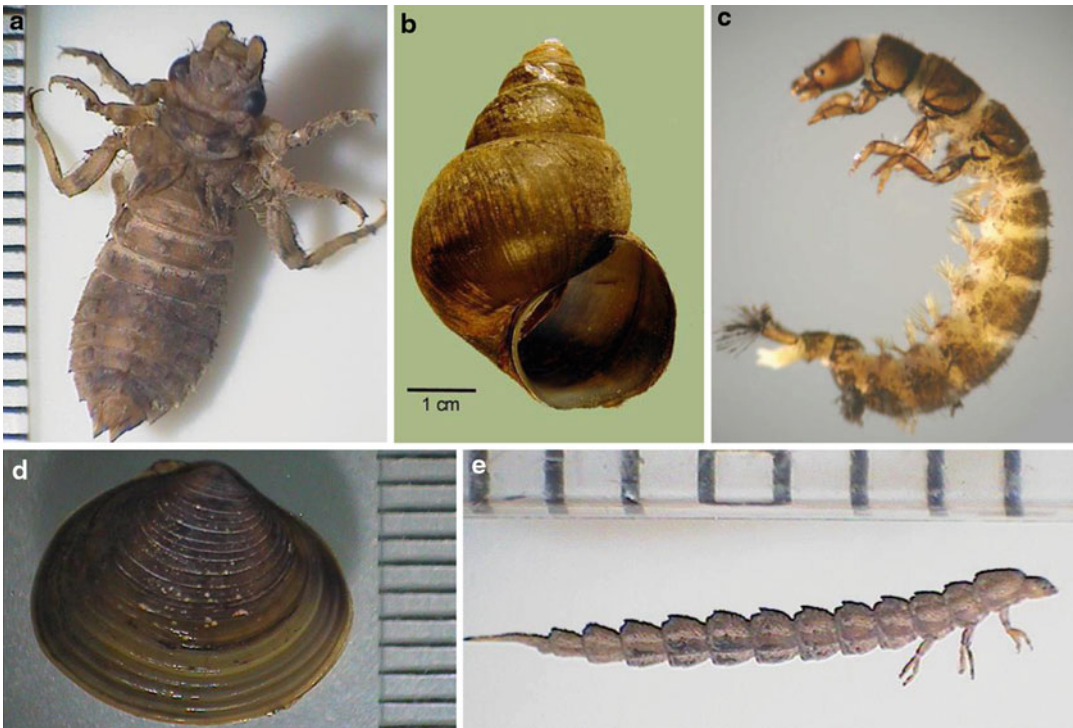
Benthic invertebrates collectively facilitate the breakdown of organic material, such as leaf litter, that enters the stream from external sources. Larger leaf litter is broken down into smaller particles by the feeding activities of invertebrates known as shredders (insect larvae



**Fig. 3.7.** Aquatic plants: (a) moss on cobbles; (b) *Potamogeton* sp.; (c) *Lemna minor*; and (d) *Phragmites communis* Trin.

and amphipods). Other invertebrates filter smaller organic material from the water, known as filterers (blackfly larvae, some mayfly nymphs, and some caddis fly larvae); scrape material off the surfaces of bedrock, boulders, and cobbles, known as scrapers (snails, limpets, and some caddis fly and mayfly nymphs); or feed on material deposited on the substrate, known as collectors (dipteran larvae and some mayfly nymphs) [24]. Some macroinvertebrates are predatory, known as predators, such as dragonfly, which prey on small vertebrates. Figure 3.8 shows typical species of the five groups with different ecological functions.

Fish are the apex predator in the aquatic system. Many restoration projects aim at restoration of fish habitat. From the headwaters to the estuaries, the composition of fish species varies considerably due to changes in many hydrologic and geomorphic factors which control temperature, dissolved oxygen, gradient, current velocity, and substrate. The amount of different habitats in a given stream section is determined by a combination of these factors. Fish species richness (diversity) tends to increase downstream as gradient decreases and stream size increases. For small headwater streams, the gradient tends to be very steep and



**Fig. 3.8.** Typical species of the five groups of benthic invertebrates with different functions in the food chain: (a) Gomphidae (dragonfly-predator); (b) Viviparidae (scraper); (c) Hydropsychidae (collector-filterer); (d) Corbiculidae (collector-filterer); and (e) Haliplidae (shredder).

the stream is small, and environmental fluctuations occur with a greater intensity and frequency; therefore, species richness is lowest [9].

Some fish species are migratory and travel long distances to return to a certain site to spawn. They have to swim against currents and go up over waterfalls, thus, showing great strength and endurance. When migrating they move between saltwater and freshwater, therefore, need to be able to osmoregulate efficiently [25, 26]. According to their temperature requirements, species may also generally be referred to as cold water or warm water and gradations between. Salmonid fish prefer cold and highly oxygenated water and, therefore, can generally be found at high altitudes or northern climes. Salmonid populations are very sensitive to change or deterioration of their habitat, including alteration of flows, temperature, and substrate quality. They tolerate only very small fluctuations in temperature and only reproduce under certain conditions. Their reproductive behavior and movements are affected by almost undetectable changes in temperature. Usually a salmonid spawns by depositing eggs over or between clean gravel, which remain oxygenated and silt-free due to upwelling of currents between the interstitial spaces. Salmonid populations, therefore, are highly susceptible to many forms of habitat degradation, including alteration of flows, temperature, and substrate quality.

The general concern and interest in restoring habitats for fish by improving both quality and quantity is due to the widespread decrease in numbers of native fish species. With ecological, economic, and recreational considerations in mind, the importance given to the restoration of fish communities is increasing. In 1996 approximately 35 million Americans went fishing for recreational purposes resulting in over \$36 billion in expenditures [27].

Since most recreational fishing is in streams, it is important to restore stream corridors. Restoration activities have often been focused on improving local habitats, such as fencing or removing livestock from streams, constructing fish passages, or installing instream physical habitat. However, the success of these activities, demonstrated by research, has been very small or questionable. Over its life span, a species needs many resources and has a great range of habitat requirements which were not considered during the restoration.

Although the public are most interested in fish stocks, another goal of the stream restoration is to preserve other aquatic biota. Of particular concern are freshwater mussels, many species of which are threatened and endangered. Mussels are highly sensitive to habitat disturbances. Some of the major threats faced by mussels are dams, which lead to direct habitat loss and fragmentation of the remaining habitats, persistent sedimentation, pesticides, and exotic species like fish and other mussel species which are introduced into the habitat.

### 1.5. Ecological Functions of Rivers

The main ecological functions of rivers are habitat, conduit, filter, barrier, source, and sink. Ecological restoration is done in order to enable river corridor functions to be effectively restored. However, the goals of restoration are not only to reestablish the structure or to restore a particular physical or biological process. Ecological functions can be summarized as a set of basic, common themes that reappear in an ongoing range of situations.

Two characteristics are particularly important to the operation of stream corridor functions:

1. **Connectivity**—This is a measure of the dimensions of a stream corridor and how far it continues [28]. This attribute is affected by breaks in the corridor and between the stream and adjacent land uses. Transport of materials and energy and movement of flora and fauna are valuable functions promoted by a high degree of connectivity in a stream between its natural communities.
2. **Width**—In stream corridors, this refers to the distance across the stream and its zone of adjacent vegetation cover. Width is affected by edges, community composition, environmental gradients, and disturbances/disruptions in adjacent ecosystems, including those with human activity. Average dimension and variance, number of narrows, and varying habitat requirements are some example measures of width [29].

#### 1.5.1. Habitat Function

Habitat is a term used to describe an area where plants or animals (including people) normally live, grow, feed, reproduce, and otherwise exist for any portion of their life cycle. The important factors needed for survival such as space, food, water, and shelter are provided by the habitat. As long as the conditions are suitable, many species use river corridors to live, find food and water, reproduce, and establish viable populations. Population size, number of species, and genetic variation are a few measures of a stable biological community, which





**Fig. 3.9.** The Fazi River, an urban stream in Taichung City, provides habitats for benthic invertebrates, fish and birds.

vary within known boundaries over time. Streams may positively affect these measures at different levels. Since corridors are linked to small habitat patches, they have a great value as habitats because they create large, more complex habitats with greater wildlife populations and higher biodiversity. In general, stream corridors are habitats for plants, fish, invertebrates, and amphibians. For instance, the Fazi River is an urban stream in Taichung City, as shown in Fig. 3.9. The river has gravel bed with alternative lentic and lotic waters. Although the river is seriously polluted in the upstream reaches, several tens of species of macroinvertebrates, fish, and birds are found in the river.

Habitat functions differ at various scales, and an appreciation of the scales at which different habitat functions occur will help a restoration initiative succeed. The evaluation of a habitat at larger scales, for example, may make note of a biotic community's size, composition, connectivity, and shape. To help describe habitat over large areas at the landscape scale, the concepts of matrix, patches, mosaics, and corridors can be used. Migrating species can be provided with their favorite resting and feeding habitats during migration stopovers by stream corridors with naturally occurring vegetation. Some patches are too small for large mammals like the black bear which need great, unbroken areas to live in. However, these patches may be linked by wide stream corridors to create a large enough territory for bears.

Assessing habitat function at small scales can also be viewed in terms of patches and corridors. It is also at local scales that transitions among the various habitats within the river can become more important. Two basic types of habitat structure, interior and edge habitat, can be found in stream corridors. Connectivity and width greatly influence the functions of habitats at the corridor scale. A stream corridor provides a better habitat if it is wide and if it has greater connectivity. Changes in plant and animal communities can be caused by river valley morphology and environmental gradients, such as gradual changes in soil wetness, solar radiation, and precipitation. Species usually find ideal habitats in broad, unfractured, and diverse streams, rather than narrow and homogenous ones.



**Fig. 3.10.** A stream is a flow pathway for heat, water, and other materials, and organisms as shown for a small tributary of the Songhua River in northeast China.

Factors such as climate, microclimate, elevation, topography, soils, hydrology, vegetation, and human uses cause the habitat conditions within a river to vary. When planning to restore a stream, its width is of great importance to wildlife. The size and shape of a stream corridor must be sufficiently wide for a species to populate. This must be considered when trying to maintain a certain wildlife species. If the corridor is too narrow, from the point of view of the species, it is as if there is a piece of the corridor missing.

Riparian forests provide diversity not only in their edge and interior habitats, but also offer vertical habitat diversity in their canopy, sub-canopy, shrub, and herb layers. Within the channel itself, riffles, pools, glides, rapids, and backwaters all provide different habitat conditions in both the water column and the streambed. These examples, all described in terms of physical structure, yet again show that there is a strong correlation between structure and habitat function.

### 1.5.2. Conduit Function

To act as a route for the flow of energy, materials, and organisms is known as the conduit function, as shown in Fig. 3.10. A stream is foremost a conduit that was formed by and for collecting and transporting water and sediment. As well as water and sediment, aquatic fauna and other materials use the stream corridor as a conduit. Since there is movement across as well as along the stream and in many other directions, the corridor can be considered to have lateral and longitudinal conduit functions. If the stream corridor is covered by a closed canopy, then birds and mammals may cross over the stream through the vegetation. The food supply for fish and invertebrates may be enriched or increased by the movement of organic debris and nutrients from higher to lower floodplains.

Corridors can act as pathways and habitats at the same time for migratory or highly mobile wildlife. The migration of songbirds from their wintering habitat in the neotropics to a summer habitat further north is made possible by rivers together with other, useful habitats. After all, birds can only fly a certain distance before they need to eat and rest. For rivers to function effectively as conduits for these birds, they must be sufficiently connected and be broad enough to provide the habitat required for migratory birds.

The migration of salmon upstream for spawning has been extensively investigated and is a well-known example of the movement of aquatic organisms and interactions with the habitat. A conduit to their upstream spawning grounds is very important to the salmon which mature in a saltwater environment. In the case of the Pacific salmon species, the stream corridor depends on the nutrient input and biomass of dying fish and plentiful spawning in the upstream reaches. So, not only are conduits important for the movement of aquatic biota, but also for the transport of nutrients from ocean waters upstream.

Stream corridors are also conduits for the movement of energy, which occurs in many forms. Heat is transported with flowing water along a stream, as shown in Fig. 3.10. The potential energy of the stream is provided by gravity, which alters and carves the landscape. The corridor modifies heat and energy from sunlight as it remains cooler in spring and summer and warmer in the fall. Stream valleys move cool air from high to low altitudes in the evening and, therefore, are effective airsheds. The energy built up by the productivity of plants in a corridor is stored as living plant material, and it moves into other systems by leaf fall and detritus.

Seeds may be carried for long distances by flowing water and then deposited. Whole plants may be uprooted, transported, and then deposited, still living, in a new area by strong floods. Plants are also transported when animals eat and transport their seeds throughout different parts of the river. Some riparian habitats depend on a continuous supply and transport of sediment, although many fish and invertebrates can be harmed by excess fine sediment.

### 1.5.3. Filter and Barrier Functions

Stream corridors may act as filters, allowing selective penetration of energy, materials, and organisms; they may also act as a barrier to movement. In many ways, the entire stream corridor serves beneficially as a filter or barrier that reduces water pollution, minimizes sediment transport, and often provides a natural boundary to land uses, plant communities, and some less mobile wildlife species as shown in Fig. 3.11.

Movement of materials, energy, and organisms perpendicular to the flow of the stream is most effectively filtered or barred; however, elements moving parallel to the stream corridor, along the edge, may also be selectively filtered. The movement of nutrients, sediment, and water over land is filtered by the riparian vegetation. Dissolved substances, such as nitrogen, phosphorus, and other nutrients, entering a vegetated river valley, are restricted from entering the channel by friction, root absorption, clay, and soil organic matter.

Edges at the boundaries of stream corridors begin the process of filtering. Initial filtering functions are concentrated into a tight area by sudden edges. These edges tend to be caused by disruptions and usually encourage movement along boundaries while opposing movement



**Fig. 3.11.** A stream functions as a boundary of land uses, plant communities, and some less mobile wildlife species.

between ecosystems. On the other hand, gradual edges promote movement between ecosystems and increase filtering and spread it across a wider ecological gradient. Gradual edges are found in natural settings and are more diverse [30].

#### 1.5.4. Source and Sink Functions

Organisms, energy, and materials are supplied to the bordering area by rivers. Areas that function as sinks absorb organisms, energy, or materials from the surrounding landscape. A stream can act as both a source and a sink, as shown in Fig. 3.12. However, this is affected by the location of the stream and the time of year. Although they may sometimes function as a sink, when flooding deposits new sediment there, stream banks tend to act as a source, for example, of sediment to the stream. Genetic material throughout the landscape is supplied by and moves through corridors, which at the landscape scale, act as conduits or connectors to many different patches of habitats.

Surface water, groundwater, nutrients, energy, and sediment can be stored in stream corridors, which then act as a sink and allow materials to be temporarily stored in the corridor. Friction, root absorption, clay, and soil organic matter prevent the entry of dissolved substances such as nitrogen, phosphorus, and other nutrients into a vegetated stream corridor. Forman (1995) offers three sources and sink functions resulting from floodplain vegetation: (a) decreased downstream flooding through floodwater moderation and/or uptake, (b) containment of sediments and other materials during flood stage, and (c) source of soil organic matter and waterborne organic matter [31].



**Fig. 3.12.** A stream functions as a source providing organisms, energy, or materials to the surrounding landscape and also as a sink absorbing organisms, energy, or materials from the surrounding landscape.

## 2. ECOLOGICAL STRESSES TO RIVERS

Ecological stresses are defined as the disturbances that bring changes to river ecosystems. The ecological stresses are natural events or human-induced activities that occur separately or simultaneously. The structure of a system and its capability of carrying out important ecological functions may be changed by stresses, regardless of whether they act individually or in combination. One or more characteristics of a stable system may be permanently changed by a causal chain of events produced by a stress present in a river. For instance, land-use change may cause changes of hydrologic and hydraulic features of the river, and these changes may cause changes in sediment transportation, habitat, and ecology [32].

Disturbances are not all of equal frequency, duration, and intensity, and they may occur anywhere within the stream corridor and associated ecosystems. A large number of disturbances of different frequency, duration, intensity, and location may be caused by one single disturbance. Once people understand the evolution of what disturbances are stressing the system, and how the system reacts to those stresses, people can decide which actions are needed to restore the function and structure of the stream corridor.

Disturbance occurs within variations of scale and time. Changes brought about by land use, for example, may occur within a single year at the stream or reach scale (crop rotation), a decade within the stream scale (urbanization), and even over decades within the landscape scale (long-term forest management). Despite the fact that wildlife populations, such as the monarch butterfly, remain stable over long periods of time, they may fluctuate greatly in short periods of time in a certain area. Similarly, while weather fluctuates daily, geomorphic or climatic changes may occur over hundreds to thousands of years.

Although it is not observed by humans, tectonic motion changes the landscape over periods of millions of years. The slope of the land and the elevation of the earth surface are affected by tectonics, such as earthquakes and mountain-creating forces like folding and faulting. Streams may alter their cross section or plan form in response to changes brought on by tectonics. Great changes in the patterns of vegetation, soils, and runoff in a landscape are caused by the quantity, timing, and distribution of precipitation. As runoff and sediment loads vary, the stream corridor may change.

## 2.1. Natural Stresses

Climatic change, desertification, floods, hurricanes, tornadoes, erosion and sedimentation, fire, lightning, volcanic eruptions, earthquakes, landslides, temperature extremes, and drought are among the many natural events that have a negative impact on the structure and functions of a river ecosystem. The relative stability, resistance, and resilience of an ecosystem determine their response to a disturbance.

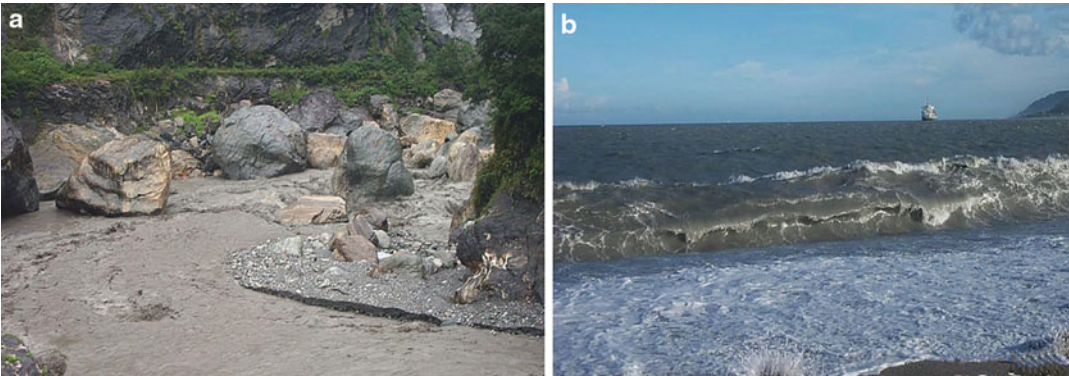
Climate change may be illustrated with climate diagrams at meteorological stations. The climate diagram was suggested by Walter [33]. In the diagram, temperature is plotted on the left vertical axis and average total monthly precipitation on the right vertical axis. Temperature and precipitation are plotted on different scales. Walter (1985) used 20 mm/month as equivalent to 10 °C for the USA and Europe, but 100 mm/month is used as equivalent to 10 °C for a tropical rain forest [33]. In this book, 30 mm/month is equivalent to 10 °C for China. Very useful information, such as the seasonal fluctuation of temperature and precipitation, the duration and intensity of wet and dry seasons, and the percentage of the year in which the average monthly temperature is above and below 0 °C, is summarized in this climate diagram. When the precipitation line lies above the temperature line, then, in theory, there should be enough moisture for plants to grow. The potential evapotranspiration rate will exceed the precipitation if the temperature line lies above the precipitation line. The more the temperature line moves up and away from the precipitation line, the drier the climate will be.

A huge landslide may totally destroy the terrestrial and aquatic ecosystem of a river. Figure 3.13 shows the Wenjiagou Landslide in Mianzhu City, Sichuan, China, which was induced by the Wenchuan Earthquake on May 12, 2008. The total volume of the sliding body was 81 million m<sup>3</sup>. The stream and vegetation on slopes were buried underneath the 180-m-thick landslide. Both faunal and floral communities have been totally destroyed and the restoration needs a long period of time.

Erosion and sedimentation often are the direct cause of ecology impairment. Figure 3.14a shows the high sediment concentration in a stream in Taiwan, southeast China, which causes a strong stress on the aquatic bio-community. The sediment results from intensive soil erosion caused by a rainstorm. The high concentration results in low transparency, low dissolved oxygen, and sediment coating the substrate. Benthic animals and fish may be killed during the high concentration event. Figure 3.14b shows the turbid seawater with a high concentration of sediment on the east coast of Taiwan. The sediment is transported into the ocean by debris flows and hyperconcentrated flows. Tidal current and waves bring the sediment onto the shore and bays, which impacts on fish and invertebrate communities.



**Fig. 3.13.** Wenjiagou Landslide in Mianzhu City buried the stream and vegetation.



**Fig. 3.14.** (a) High sediment concentration in a stream in Taiwan, southeast China, which results in low transparency, low dissolved oxygen, and sediment coating the substrate; (b) Turbid seawater with high concentration of sediment impacts on fish and invertebrate communities.

Stream ecology is influenced by certain animal activities. For example, beavers build dams that cause ponds to form within a stream channel or in the floodplain. Figure 3.15a shows that a couple of beavers skillfully use nature's building materials and construct a wood dam with tree branches on the Spring Pond in Pennsylvania, and Fig. 3.15b shows the 3-m-high beaver dam forms a pond, which provides a good habitat for fish and birds. Without any machines the beavers transported so much building materials and built the dam within several months. The landlord of the Spring Pond, Mr. R. Devries, pronounced that there is no way for humans



**Fig. 3.15.** (a) A couple of beavers began to construct a dam with tree branches on the Spring Pond in Pennsylvania, USA; (b) The 3-m-high beaver dam forms a pond, which provides a good habitat for fish and birds.

“could ever match their dam skills, their dam resourcefulness, their dam ingenuity, their dam persistence, their dam determination, and their dam work ethic.”

Of course the dam construction by beavers disturbs the stream ecology. The pond kills much of the existing vegetation. Moreover, if appropriate woody plants in the floodplain are scarce, beavers extend their cutting activities into the uplands and can significantly alter the riparian and stream corridors. The sequence of beaver dams along a stream corridor may have major effects on hydrology, sedimentation, and mineral nutrients. Silts and other fine sediments accumulate in the pond rather than being washed downstream. On the other hand the aquatic ecological conditions are improved by the beaver dams. Water from storm flow is held back, thereby affording some measure of flood control. Wetland areas usually form, and the water table rises upstream of the dam. The ponds combine slow flow, near-constant water levels, and low turbidity that support fish and other aquatic organisms. Birds may use beaver ponds extensively.

Although the Pennsylvania Department of Environmental Quality found that “dams of this nature are inherently hazardous and cannot be permitted.” The Department therefore orders “to restore the stream to a free-flow condition by removing all wood and brush forming the dams from the stream channel.” The beaver dam and the life of beavers on fish in their “reservoir” are a part of the ecology, which increases the diversity of habitats. The landlord Mr. R. Devries pronounced on behalf of the beavers that “the Spring Pond Beavers have a right to build their unauthorized dams as long as the sky is blue, the grass is green and water flows downstream. They have more dam rights than humans do to live and enjoy Spring Pond. If the Department of Natural Resources and Environmental Protection lives up to its name, it should protect the natural resources (Beavers) and the environment (Beavers’ Dams).

Riparian vegetation, in general, tends to be resilient. Despite the fact that a flood may destroy a mature cottonwood forest, the conditions it leaves behind are usually those of a nursery, so a new forest can be established, and, thus, the riparian ecosystem is increased



[34]. Having developed characteristics such as high biomass and deep established root systems, the riparian forest systems have adapted to many types of natural stresses. Due to this adaptation, small and frequent droughts, floods, and other natural disruptions are of little consequence to the systems. When an unexpected serious stress occurs like fire, then the effect is only local and does not affect the community on a larger scale. However, the resilience of the system can be disrupted by widespread effects such as acid rain and indiscriminate logging and associated road building. Soil moisture, soil nutrients, and soil temperature can be critically changed by these and other disturbances, as well as other factors. Several tens of years are needed for the recovery of a system affected by widespread disturbance.

## 2.2. Human-Induced Stresses

Human-induced stresses undoubtedly have the greatest potential for introducing enduring changes to the ecological structure and functions of stream corridors. Physical disturbance effects occur at any scale from landscape and stream corridor to stream and reach, where they can cause impacts locally or at locations far removed from the site of origin. Activities such as flood control, road building and maintenance, agricultural tillage, and irrigation, as well as urban encroachment, can have dramatic effects on the geomorphology and hydrology of a watershed and the stream corridor morphology within it. The modification of stream hydraulics directly affects the system, causing an increase in the intensity of disturbances caused by floods. Chemically defined disturbance effects, for example, can be introduced through many activities including discharging sewage and wastewater (acid mine drainage and heavy metals) into the stream. Ecological disturbance effects are mainly to the result of the introduction of exotic species. The introduction of exotic species, whether intentional or not, can cause disruptions such as predation, hybridization, and the introduction of diseases. For instance, bullfrogs have been introduced into the western USA. They reproduce prodigiously and prey on numerous native amphibians, reptiles, fish, and small mammals and cause biological problems in the ecosystem. Altering the structure of plant communities can affect the infiltration and movement of water, thereby altering the timing and magnitude of runoff events.

### 2.2.1. Dams

Ranging from small temporary structures to huge multipurpose structures, human-constructed barriers can have profound and varying impacts on stream corridors. Barriers affect resident and migratory organisms in stream channels. Power plants may kill fish when they swim through the turbines. Figure 3.16a shows that many birds are searching for dead fish at the outlets of a hydropower plant in Korea, which were killed when they swam through the turbine; Fig. 3.16b shows that the Baozhusi Dam on the Bailong River in Sichuan Province has cut off the river flow. The stream ecology of the lower reaches has been greatly affected. The dam blocks or slows the passage and migration of aquatic organisms, which in turn affects food chains associated with stream ecological functions.

The Colorado River watershed is a 627,000-km<sup>2</sup> mosaic of mountains, deserts, and canyons. The watershed begins at over 4,000 m in the Rocky Mountains and ends at the



**Fig. 3.16.** (a) Birds are searching for dead fish at the outlets of a hydropower plant at which fish are killed when they swim through the turbine; (b) The Baozhushi Dam on the Bailong River has cut off the flow and greatly affects the stream ecology in the lower reaches.

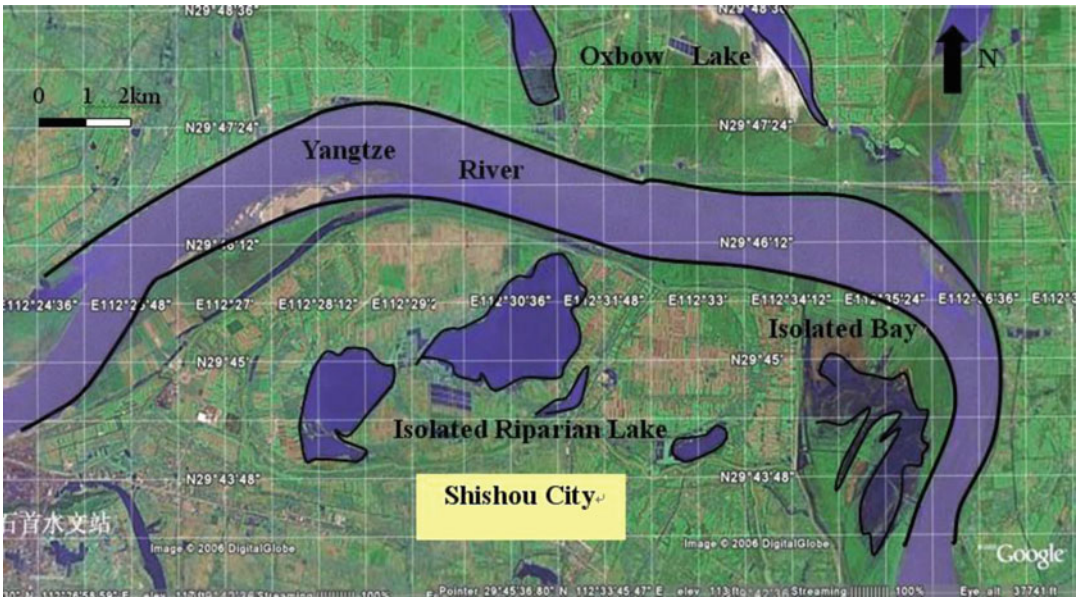
Sea of Cortez. Many native species require very specific environments and ecosystem processes to survive. Under natural conditions, the basin's rivers and streams were characterized by a large stochastic variability in the annual and seasonal flow levels. This hydrologic variability was a key factor in the evolution of the basin's ecosystems. Today over 40 dams and diversion structures control the river system and result in extensive fragmentation of the watershed and riverine ecosystem.

### 2.2.2. Channelization and Water Diversions

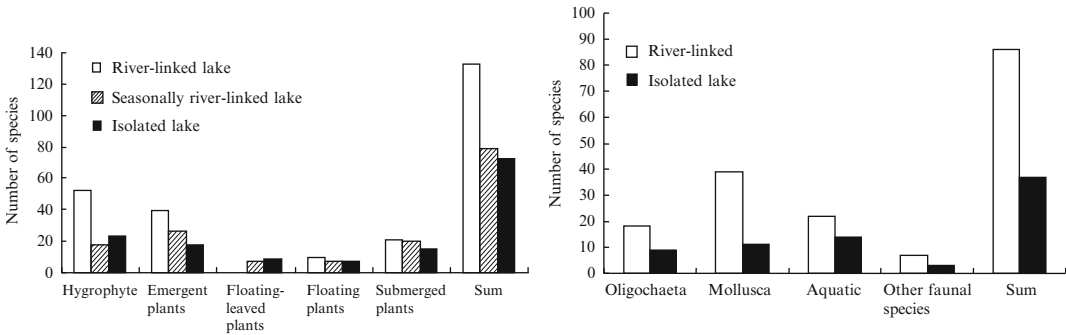
Like dams, channelization disturbs the stream ecology, by disrupting riffle and pool complexes needed at different times in the life cycle of certain aquatic organisms. The flood conveyance benefits of channelization and diversions are often offset by ecological losses resulting from increased stream velocities and reduced habitat diversity. Levees along rivers and diversion channels tend to replace riparian vegetation. The reduction in trees and other riparian vegetation along levees result in changes in shading, temperature, and nutrients. Hardened banks result in decreased habitat for organisms that live in stream sediments, banks, and riparian plants. Water diversion from rivers impacts the stream ecology, depending on the timing and amount of water diverted, as well as the location, design, and operation of the diversion structure.

### 2.2.3. Fragmentation of Habitat

Some river training works result in the fragmentation and isolation of habitats. Figure 3.17 shows the Yangtze River and numerous riparian lakes with different sizes. Naturally these lakes connected with the Yangtze River and formed a huge habitat in the past. Humans cut the



**Fig. 3.17.** Isolation of riparian lakes along the Yangtze River results in fragmentation of habitat (Satellite image from the web <http://earth.google.com>).



**Fig. 3.18.** Comparison of species richness of aquatic plants and benthic invertebrates in isolated lakes and river-linked lakes in the middle and lower Yangtze River basin (after Wang and Wang 2008).

connection for flood defense and aquatic farming, thus, fragmenting the habitat. The fragmentation of habitat has resulted in deterioration of the ecology and extinction of some species.

Cutoff of riparian lakes from the Yangtze River stressed the complex ecosystem in the lakes and the river. Figure 3.18 shows a comparison of species richness of aquatic plants and benthic invertebrates in isolated lakes and river-linked lakes in the middle and lower Yangtze River basin [35]. The connection of the isolated lakes with the Yangtze River was cut off in



**Fig. 3.19.** (a) Gold placer mining in the Bailong River, a tributary of the Jialing River in Sichuan; (b) Gravel mining for building materials from the Qingjiang River, a tributary of the Yangtze River.

the past decades, which has resulted in continuous reduction of species. The cutoff also caused reduction of fish species. There are 101 fish species in the river-linked Poyang Lake but only 57 and 47 fish species in the isolated Honghu Lake and Zhangdu Lake.

#### 2.2.4. Mining

Gold placer mining in rivers has become an extreme intensive disturbance to the stream ecology in southwest China. Figure 3.19a shows placer mining in the Bailong River, which is a tributary of the Jialing River in Sichuan Province. People are removing bed gravel from the river for placer mining. The benthic invertebrate community is completely disturbed. Moreover, mercury is used in the process, which has also resulted in water pollution. Compared with gold mining, gravel mining is much more widespread. Since the 1980s, gravel mining has become a serious ecological stress in many rivers throughout China, as shown in Fig. 3.19b. Gravel and coarse sand are mined for building materials. Gravel mining causes loss of habitat for benthic bio-communities and loss of spawning ground for many fish species. Lacking laws for controlling river sediment mining and attracted by great economic benefit, sediment mining has developed so quickly that almost all streams are stressed.

Surface mining also causes stresses on the river ecosystem. Exploration, extraction, processing, and transportation of coal, minerals, and other materials have had and continue to have a profound effect on stream corridors. Many river ecosystems remain in a degraded condition as a result of mining activities. Such mining activity frequently resulted in total destruction of the stream corridor. In some cases today, mining operations still disturb most or all of entire watersheds. Mercury was used to separate gold from the ore; therefore, mercury was also lost into streams. Present-day miners using suction dredges often find considerable quantities of mercury still resident in streambeds. Current heap-leaching methods use cyanide to extract gold from low-quality ores. This poses a special risk if operations are not carefully managed.

#### 2.2.5. *Pollution*

Point source pollution from industry and diffuse pollution from agriculture (pesticides and nutrients) have the potential to disturb natural chemical cycles in streams and, thus, to degrade water quality and impact the ecosystem. Toxic runoff or precipitates can kill streamside vegetation or can cause a shift to species more tolerant of polluted conditions. Chemical disturbances from agriculture are usually widespread, nonpoint sources. Municipal and industrial waste contaminants are typically point sources and often chronic in duration. Secondary effects, such as agricultural chemicals attached to sediments, frequently occur as a result of physical activities (irrigation or heavy application of herbicides). In these cases, it is better to control the physical activity at its source than to treat the symptoms within a stream corridor.

Toxic runoff or precipitates can kill streamside vegetation or can cause a shift to species more tolerant of polluted conditions. This affects habitat required by many species for cover, food, and reproduction. Aquatic habitat suffers from several factors. Acid mine drainage can coat stream bottoms with iron precipitates, thereby affecting the habitat for bottom-dwelling and bottom-feeding organisms. Precipitates coating the stream bottom can eliminate places for egg survival. Fish that do hatch may face hostile stream conditions due to poor water quality.

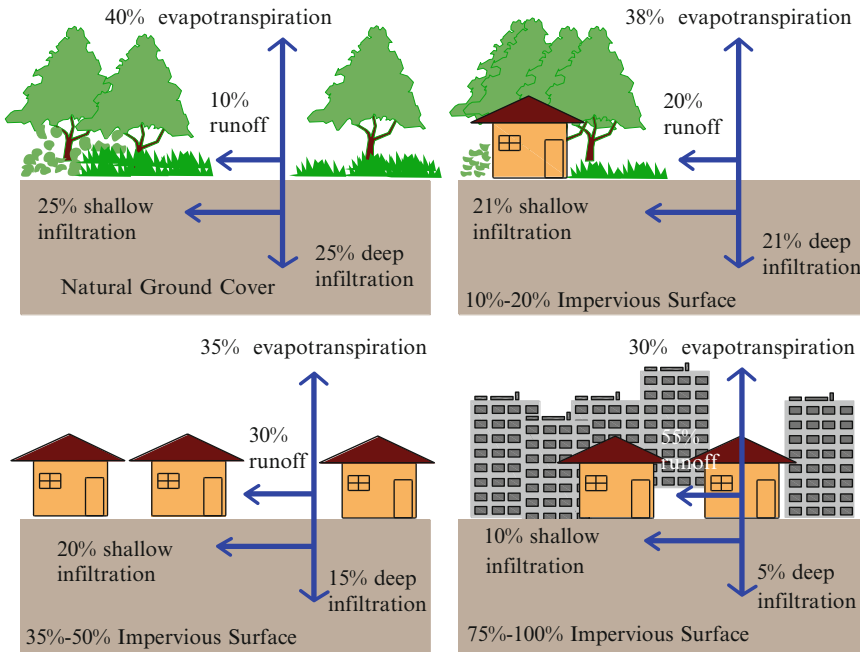
Chemical disturbances from agriculture are usually widespread, nonpoint sources. Municipal and industrial waste contaminants are typically point sources and often chronic in duration. Secondary effects, such as agricultural chemicals attached to sediments, frequently occur as a result of physical activities (irrigation or heavy application of herbicides). In these cases, it is better to control the physical activity at its source than to treat the symptoms within a stream corridor.

#### 2.2.6. *Urbanization*

Urbanization in watersheds poses special challenges for stream ecological management. Recent research has shown that streams in urban watersheds have a character fundamentally different from that of streams in forested, rural, or even agricultural watersheds. Impervious cover directly influences urban streams by dramatically increasing surface runoff during storm events by 2–16 times, with proportional reductions in groundwater recharge [36]. Figure 3.20 conceptually shows the effects of different amounts of impervious cover on the water balance for a watershed.

#### 2.2.7. *Agriculture and Land-Use Change*

Land-use change is the most common human-induced stress on the ecosystem. Agricultural activities have generally resulted in encroachment on stream corridors. Producers often crop as much productive land as possible to enhance economic returns; therefore, native vegetation is sacrificed to increase arable areas. As the composition and distribution of vegetation are altered, the interactions between ecosystem structure and function become fragmented. Vegetation removal from stream banks, floodplains, and uplands often conflicts with the hydrologic and geomorphic functions of stream corridors. These disturbances can result in



**Fig. 3.20.** Effects of different amounts of impervious cover on the water balance for a watershed (after FISRWG 1997).

sheet erosion, rill erosion, and gully erosion, reduced infiltration, increased upland surface runoff and transport of contaminants, increased bank erosion, unstable stream channels, and impaired habitat.

Tillage and soil compaction interfere with the soil’s capacity to partition and regulate the flow of water in the landscape, increase surface runoff, and decrease the water-holding capacity of soils. Tillage also often aids in the development of a hard pan, a layer of increased soil density and decreased permeability that restricts the movement of water into the subsurface. Disturbance of soil associated with agriculture generates runoff polluted with sediment, a major nonpoint source pollutant in the world. Pesticides and nutrients (mainly nitrogen, phosphorous, and potassium) applied during the growing season can leach into groundwater or flow in surface water to stream corridors, either dissolved or adsorbed to soil particles. Improper storage and application of animal waste from concentrated animal production facilities are potential sources of chemical and bacterial contaminants to stream corridors.

Tree removal decreases the quantity of nutrients in the watershed since approximately one-half of the nutrients in trees are in the trunks. Nutrient levels can increase if large limbs fall into streams during harvesting and decompose. Conversely, when tree cover is removed, there is a short-term increase in nutrient release followed by long-term reduction in nutrient levels. Removal of trees can affect the quality, quantity, and timing of stream flows. If trees are removed, from a large portion of a watershed, flow quantity can increase accordingly, and water temperature can increase during summer and decrease in winter.



**Fig. 3.21.** (a) Grazing pressure has been increased due to development of husbandry in the Tibet-Qinghai Plateau; (b) Livestock swimming in a stream can result in extensive physical disturbance and bacteriological contamination.

Many of the potential effects of land-use change are cumulative or synergistic. Restoration might not remove all disturbance factors; however, addressing one or two disturbance activities can dramatically reduce the impact of those remaining. Simple changes in management, such as the use of conservation buffer strips in cropland or managed livestock access to riparian areas, can substantially overcome undesired cumulative effects or synergistic interactions.

#### 2.2.8. Domestic Livestock

Stream corridors are particularly attractive to livestock for many reasons. They are generally highly productive and provide ample forage. Husbandry development in a watershed has applied a unique stress on the ecosystem. For instance, the riparian vegetation succession from herbaceous to shrubs has been delayed or even stopped by grazing of livestock along the Ake River on the Qinghai-Tibet Plateau, as shown in Fig. 3.21a. On the other hand, the activities of livestock have become an important element of the river ecology. Excrement of cattle provides the main nutrient for the grassland. The positive and negative effects of grazing of domestic livestock must be considered in any restoration strategy. In many cases livestock swimming in a stream can result in extensive physical disturbance and bacteriological contamination, as shown in Fig. 3.21b.

#### 2.2.9. Recreation and Tourism

The amount of impacts caused by the recreation and tourism industry depends on stream hydrology, soil type, vegetation cover, topography, and intensity of use. Various forms of foot and vehicular traffic associated with recreational activities can damage riparian vegetation and soil structure. All-terrain vehicles, for example, can cause increased erosion and habitat reduction. At locations, reduced infiltration due to soil compaction and subsequent surface

runoff can result in increased sediment loading to the stream [37]. In areas where the stream can support recreational boating, the system is vulnerable to additional impacts.

#### 2.2.10. Forestry

In addition to the changes in water, sediment, and nutrient loads to streams because of logging practices (i.e., land-use change), forestry may have other impacts of river ecosystems. Forest roads are constructed to move loaded logs to higher-quality roads and then to a manufacturing facility. Mechanical means to move logs to a loading area (landing) produce “skid trails.” Stream crossings are necessary along some skid trails, and most forest road systems are in especially sensitive areas. Removal of topsoil, soil compaction, and logging equipment and log skidding can result in long-term loss of productivity, decreased porosity, decreased soil infiltration, and increased runoff and erosion. Spills of petroleum products can contaminate soils. Trails, roads, and landings can intercept groundwater flow and cause it to become surface runoff.

### 2.3. Introduction of Exotic Species

Biologically defined disturbance effects occur within species (competition, cannibalism, etc.) and among species (competition, predation, etc.). These are natural interactions that are important determinants of population size and community organization in many ecosystems. Biological disturbances due to improper grazing management or recreational activities are frequently encountered. The introduction of exotic flora and fauna species can introduce widespread, intense, and continuous stress on native biological communities. There are numerous examples worldwide of introduced species bringing about the extinction of native organisms. The most dramatic have involved predators. An extreme example is the deliberate introduction of the fish-eating Nile perch (*Lates niloticus*) to Lake Victoria, in East Africa, causing the extinction of dozens of species of small endemic cichlid fish.

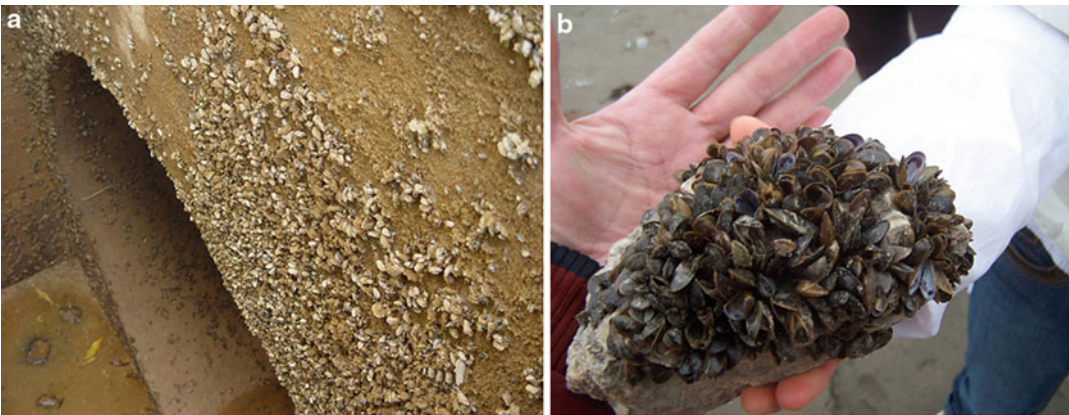
Exotic animals are a common problem in many areas in the USA and China. Species such as *Cambarus clarkaij* have been introduced in many waters in south China. Without the normal checks and balances found in their native habitat in North America and Japan, *Cambarus clarkaij* reproduces prodigiously and causes disturbance to the ecosystem. Figure 3.22 shows *Cambarus clarkaij*. The species burrow in river levees and have caused many breaches and flooding disasters. The rapid spreading of the species has caused rice harvest reduction because the animals eat the rice paddies’ root. In some places *Cambarus clarkaij* has also caused prevalence of a disease.

Similarly introduction of the zebra mussel and bullfrog has imposed an intense stress on native biological communities in the western USA. Without the normal checks and balances found in their native habitat in the eastern USA, bullfrogs reproduce prodigiously and prey on numerous native amphibians, reptiles, fish, and small mammals.

Golden mussel (*Limnoperna fortunei*) is an invasive filterer species of macroinvertebrate. Originally the species comes from south China, which has spread to various regions, including Japan, Australia, Argentina, Thailand, India, Brazil, and Europe [38]. The species colonizes habitats with water temperature between 8 and 35 °C, flow velocity less than 2 m/s, water



**Fig. 3.22.** *Cambarus clarkii* has been introduced in many waters in south China, resulting in ecological problems.



**Fig. 3.23.** Colonization of golden mussel on concrete walls in a water transfer tunnel and attachment of golden mussel on a concrete fragment with high density.

depth less than 10 m with or without sunlight, dissolved oxygen higher than 1.0 mg/L, and pH higher than 6.4 [39–41]. Golden mussels have unprimitive byssus threads, which allow them to attach onto solid walls, especially human-constructed water transfer tunnels and pipelines. Dense attachment of golden mussels in drinking water transfer tunnels and pipelines results in macro-fouling [42] and causes high resistance to water flow and damage to pipeline walls. This along with dead mussels decay harms the surrounding water quality [43, 44]. Figure 3.23 shows colonization of golden mussel in the water transfer tunnels in Shenzhen, southern China, and attachment of golden mussel on the surface of a concrete fragment. The density of golden mussel individuals is as high as to 20,000/m<sup>2</sup>. Golden mussel invasion causes a serious challenge to water transfer projects that seek to solve issues such as the uneven distribution of water resources and the problem of water shortages in northern China. The presence of golden mussels results in quick and uncontrolled spread of the species.

Introduction of exotic species has inevitably occurred worldwide, and this is accelerating following economic and ecological globalization. Compared with faunal species, introduction of floral species is quicker and more intensive because humans pay less attention to the negative impacts of the introduction. The introduction of exotic species, whether intentional or not, can cause disruptions such as hybridization and the introduction of diseases. Nonnative species compete with native species for moisture, nutrients, sunlight, and space and can adversely influence establishment rates for new plantings, foods, and habitat. In some cases, exotic plant species can even detract from the recreational value of streams by creating a dense, impenetrable thicket along the stream bank.

Many exotic species have been introduced as consequences of human activities. For instance, at least 708 floral species and about 40 faunal species have been successfully introduced into China in the past century; among them several tens of species have caused ecological problems. A lot of money has been spent to remove these species. The most harmful species are *Eupatorium adenophorum*, *Eichoimia crassips*, *Ambrosia artemisia* L., and *Spartina alterniflora*.

*Spartina alterniflora* was introduced from the USA in 1980 to control coastal erosion and accelerate land creation in estuaries. The species may grow in salt marsh, because they tolerate periodical tidal inundation and resist wave erosion. The species colonize silt coasts very quickly and stabilize the coast with its dense roots. Nevertheless, the species dominate silt coasts and estuaries, resulting in a great reduction in biodiversity. Many invertebrates and fish cannot live in the shallow waters with *Spartina alterniflora*. The species has over to spread the neighboring coastal areas. Coastal areas and estuaries dominated by reed (*Phragmites communis* Trin) have been colonized and occupied by *Spartina alterniflora*. The fishery harvest has been significantly reduced. Figure 3.24a shows *Spartina alterniflora* in the Yangtze River estuary.

Alien invasive species *Eupatorium adenophorum* originates from Mexico and was introduced into south China from South Asia in the 1940s. The species has spread quickly in southwest China and eliminated local species. The species is toxic and many cattle and sheep have been killed. The area occupied by the species has increased to about 30 million ha. To remove the species from grassland is very difficult. Millions of dollars have been lost due to husbandry loss and control of spreading of the species in Sichuan and Yunnan Provinces. Figure 3.24b shows the *Eupatorium adenophorum* in Yunnan Province in southwest China.

*Eichoimia crassips* was introduced to control eutrophication in streams and lakes. The species adsorb pollutants and nutrients in the water and may enhance the purification capacity of the stream or lake. Nevertheless, the species spread too fast and fishery and water surface recreation have been affected. Humans have to remove them from waters, which has caused economic losses up to several tens of millions of dollars. Figure 3.24c shows *Eichoimia crassips* spreading quickly in a polluted stream in Beijing.

*Ambrosia artemisia* L. and *Ambrosia trifida* L. entered China in the 1930s and spread quickly since the 1980s and 1990s. The species produce a lot of pollen. In Shenyang in northeast China, the density of pollen in air in 1987 was 38 times of that in 1983 because of



**Fig. 3.24.** (a) *Spartina alterniflora* in the Yangtze River estuary; (b) *Eupatorium adenophorum* in Yunnan Province in southwest China; (c) *Eichoimia crassipes* spreading quickly in polluted waters; (d) *Ambrosia artemisia* L. in northeast China.

introduction of the species. About 1.5 % of the local people suffer from pollinosis. Millions of dollars have been lost due to introduction of the species. Figure 3.24d shows the *Ambrosia artemisia* L. in northeast China.

Introduction of exotic species is not always bad for the ecosystem. Hong Kong has become a paradise of exotic species and most of these species have been naturalized in the island. Hong Kong and the island of Dominica, in the Caribbean, probably had no inland plant species in common 500 years ago. Today they share more than a hundred weeds of human-dominated open habitats. The term “alien” is used to refer to species that originated elsewhere but have become established in Hong Kong. Although people have introduced many alien species by accident, others have been brought to a location deliberately, as crops,

ornamentals, livestock, or pets. Not all introduced species are aliens. In fact, reintroduction of species to parts of their former range is an important conservation tool. Hong Kong's total vascular plant flora of approximately 2,100 species includes at least 150 naturalized aliens, that is, species introduced from other parts of the world which have run wild in Hong Kong [45]. For faunal species, most of these aliens were brought to Hong Kong by people, but some have spread on their own. Some of these have established wild populations when they escaped or were abandoned or released.

In Hong Kong the majority of introduced species are confined to those areas where human influence is strongest and most persistent. Indeed, in most residential and industrial areas, as well as the few sites still used for intensive farming, alien species dominate the biota. In contrast, recognizable aliens are rare or absent in most upland streams and hillside communities. Thus, the majority of aliens are found in those places where the native flora and fauna has already suffered most as a result of human activities. At present, the impact of the numerous alien plant and animal species established in Hong Kong is, in most cases, hard to distinguish from the direct impact of human activities on the habitats they occupy [45].

The introduction of alien species into Hong Kong has increased the biodiversity and has resulted in no serious impacts on the local ecology. However, invasions by alien species are a potential conservation management problem that has received almost no attention in Hong Kong. Even if we ignore the risk posed by aliens to the ecology of Hong Kong, we have an obligation to ensure that the territory does not become a stepping-stone for invasion elsewhere.

### 3. ASSESSMENT OF RIVER ECOSYSTEMS

#### 3.1. *Indicator Species*

Complete measurement of the state of a river ecosystem, or even a complete census of all of the species present, is not feasible. Thus, good indicators of the system conditions are efficient in the sense that they summarize the health of the overall system. The current value of an indicator for an impaired river ecosystem can be compared to a previously measured, pre-impact value, a desired future value, an observed value at an "unimpaired" reference site, or a normative value for that class of river ecosystems. For example, an index of species composition based on the presence or absence of a set of sensitive species might be generally correlated with water quality. If a river is polluted, some species may be absent and the number of species may be less than that before the pollution. An index of indicator species itself provides no information on how water quality should be improved. However, the success of management actions in improving water quality could be tracked and evaluated through iterative measurement of the index.

An indicator species group is defined as a set of organisms whose characteristics (e.g., number of species, presence or absence, population density, dispersion, reproductive success) are used as an index of attributes or environmental conditions of interest, which are too difficult, inconvenient, or expensive to measure for other species [46]. The 1970s–1980s is a

peak interest period using aquatic and terrestrial indicator species for assessment of ecosystems. During that time, Habitat Evaluation Procedures (HEP) were developed by the US Fish and Wildlife Service, and the use of management indicator species was mandated by law with passage of the National Forest Management Act in 1976. Since that time, numerous authors have expressed concern about the ability of indicator species to meet the expectations expressed in the above definition. Landres et al. (1988) critically evaluated the use of vertebrate species as ecological indicators and suggested that rigorous justification and evaluation are needed before the concept is used [46].

Indicator species have been used to predict environmental contamination, population trends, and habitat quality. The assumptions implicit in using indicators are that if the habitat is suitable for the indicator, it is also suitable for other species and that wildlife populations reflect habitat conditions. However, because each species has unique life requisites, the relationship between the indicator and its guild may not be completely reliable. It is also difficult to include all the factors that might limit a population when selecting a group of species that an indicator is expected to represent.

### 3.1.1. Selection of Indicator Species

Several factors are important to consider in the selection process of indicator species [30]:

1. Sensitivity of the species to the environmental attribute being evaluated. When possible, data that suggest a cause-and-effect relation are preferred to mere correlation (to ensure the indicator reflects the variable of interest).
2. Indicator accurately and precisely responds to the measured effect. High variation statistically limits the ability to detect effects. Generalist species do not reflect change as well as more sensitive endemics. However, because specialists usually have lower populations, they might not be the best for cost-effective sampling. When the goal of monitoring is to evaluate on-site conditions, using indicators that occur only within the site makes sense. However, although permanent residents may better reflect local conditions, the goal of many riparian restoration efforts is to provide habitat for migratory birds. In this case, residents such as cardinals or woodpeckers might not serve as good indicators for migrating warblers.
3. Size of the species home range. If possible, the home range should be larger than that of other species in the evaluation area. Game species are often poor indicators simply because their populations are highly influenced by hunting mortality, which can mask environmental effects. Species with low populations or restrictions on sampling methods, such as threatened and endangered species, are also poor indicators because they are difficult to sample adequately.
4. Response uniformity in different geographic locations. Response of an indicator species to an environmental stress cannot be expected to be consistent across varying geographic locations or habitats. If possible, the response to a stress should be more uniform than that of other species in different geographic locations.

In summary, a good indicator species should be in the middle on the food chain to respond quickly and have relatively high stability, should have a narrow tolerance to stresses, and should be a native species [47]. The selection of indicator species should be done through corroborative research.

### 3.1.2. Aquatic Macroinvertebrates

Aquatic macroinvertebrates have been used as indicators of stream and riparian health for many years. Perhaps more than other taxa, they are closely tied to both aquatic and riparian habitat. Their life cycles usually include periods in and out of the water, with ties to riparian vegetation for feeding, pupation, emergence, mating, and egg laying [47]. It is often important to look at the entire assemblage of aquatic invertebrates as an indicator group. Impacts of stresses to a stream often decrease biodiversity but might increase the abundance of some species [48]. Using benthic macroinvertebrates is advantageous for the following reasons: (a) they are good indicators of localized conditions, (b) they integrate the effects of short-term environmental variables, (c) degraded conditions are easily detected, (d) sampling is relatively easy, (e) they are in the middle of the food chain and provide food for many fish of commercial or recreational importance, and (f) macroinvertebrates are generally abundant [49–51].

Field sampling of macroinvertebrates usually requires a combination of quantitative and qualitative collection methods. The sampling may be performed for one site in a 100-m stretch with representative areas of flow velocity, water depth, substrata composition, and hydrophyte growth. For a segment of an investigated stream, collections were made in areas with different current velocity, water depth, and different substrate sizes. At least three replicate samples were collected at each sampling site at appropriate depths of 0.15 m of the substrate with a kick-net (1 m × 1 m area, 420- $\mu$ m mesh) if the water depth is less than 0.7 m. A D-frame dip net may be used to sample along stone surfaces and in plant clusters. If the water depth is greater than 0.7 m, samples may be collected with a Peterson grab sampler with an open area of 1/16 m<sup>2</sup>. Replicate samples for each site are combined to form a composite sample, amounting to at least a minimum area of 1 m<sup>2</sup> [52]. The cobbles sampled are generally scrubbed by hand to remove invertebrates and then discarded. The debris and invertebrates are rinsed vigorously through a fine sieve with a 300- $\mu$ m mesh. Then the macroinvertebrates are taken from the debris and are placed in plastic sample containers and preserved in 10 % formaldehyde in the field.

Environmental parameters, including substrate composition, water depth, water temperature, average current velocity, and dissolved oxygen concentration, are usually measured and recorded in situ. Growth and cover proportion of aquatic hydrophytes are also described. All macroinvertebrates are picked out of the samples and then identified and counted under a stereoscopic microscope in the laboratory. Macroinvertebrates are identified most to family or genus level except early-instar insects [53], and each species is assigned to an FFG based on the literature [49, 54].

### 3.1.3. Fish

Fish are also used as indicator species. Some management agencies use fish species as indicators to track changes in habitat condition or to assess the influence of habitat alteration on selected species. Habitat suitability indices and other habitat models are often used for this purpose, though the metric chosen to measure a species' response to its habitat can influence the outcome of the investigation. As van Horne (1983) pointed out, density or number of fish

may be misleading indicators of habitat quality. Fish response guilds as indicators of restoration success in riparian ecosystems may be a valuable monitoring tool [55].

Hocutt (1981) states “perhaps the most compelling ecological factor is that structurally and functionally diverse fish communities both directly and indirectly provide evidence of water quality in that they incorporate all the local environmental perturbations into the stability of the communities themselves.” The advantages of using fish as indicators are as follows: (a) they are good indicators of long-term effects and broad habitat conditions, (b) fish communities represent a variety of trophic levels, (c) fish are at the top of the aquatic food chain and are consumed by humans, (d) fish are relatively easy to identify, and (e) water quality standards are often characterized in terms of fisheries. However, using fish as indicators is inconvenient because (a) the cost of collection is high, (b) long-term monitoring and a large number of samplings are needed to have reliable results and statistical validity may be hard to attain, and (c) the process of sampling may disturb the fish community [56].

Electrofishing is the most commonly used field technique. Each collecting station should be representative of the study reach and similar to other reaches sampled; effort between reaches should be equal. All fish species, not just game species, should be collected for the fish community assessment. Karr et al. (1986) used 12 biological metrics to assess biotic integrity using taxonomic and trophic composition and condition and abundance of fish [57]. The assessment method using fish as indicator has been studied and applied in many large rivers [49].

#### 3.1.4. *Birds and Mammals*

Birds and mammals are used as indicator species for both terrestrial and aquatic ecosystems. Croonquist et al. (1991) evaluated the effects of anthropogenic disturbances on small mammals and birds along Pennsylvania waterways [58]. They evaluated species in five different response guilds, including wetland dependency, trophic level, species status (endangered, recreational, native, exotic), habitat specificity, and seasonality. The habitat specificity and seasonality response guilds for birds were best able to distinguish those species sensitive to disturbance from those which were not affected or benefited. Edge and exotic species were greater in abundance in the disturbed habitats and might serve as good indicators there. Seasonality analysis showed migrant breeders were more common in undisturbed areas, which, as suggested by Verner (1984), indicate the ability of guild analysis to distinguish local impacts [59].

In general the advantages of using birds and mammals as indicator species are that (a) they are good indicators of long-term effects and broad habitat conditions, including terrestrial and aquatic ecosystems; (b) they are at the top of the food chain; (c) they are relatively easy to identify; and (d) some restoration projects aim at restoration of endangered birds and mammals. The disadvantages are that (a) the cost of collection is high, (b) long-term monitoring is needed to have reliable results, and (c) they are not sensitive to aquatic habitat conditions (e.g., hydrologic changes or water pollution). Birds have been used as indicator species for ecological assessment of wetlands.

### 3.1.5. Algae

Algae communities are also useful for bioassessment. Algae generally have short life spans and rapid reproduction rates, making them useful for evaluating short-term impacts. Sampling impacts are minimal to resident biota, and collection requires little effort. Primary productivity of algae is affected by physical and chemical impairments. Algal communities are sensitive to some pollutants that might not visibly affect other aquatic communities. Algal communities can be examined for species, diversity indices, species richness, community respiration, and colonization rates. A variety of nontaxonomic evaluations, such as biomass and chlorophyll, may be used and are summarized in Weitzel [60]. Rodgers et al. (1979) describe functional measurements of algal communities, such as primary productivity and community respiration, to evaluate the effects of nutrient enrichment [61].

Although collecting algae in streams requires little effort, identifying for metrics, such as diversity indices and species richness, may require considerable effort. A great deal of effort may be expended to document diurnal and seasonal variations in productivity.

## 3.2. Metrics of Biodiversity

### 3.2.1. Richness and Abundance

If an indicator species group is selected, the ecosystem can be assessed by monitoring some variables of the indicator species group, including the species richness,  $S$ ; the number density (or abundance),  $N$ , which is the total number of individuals per area; the biomass (the total weight of all individuals) per area; and the number of individuals per area for each species. Many parameters representing biodiversity of river ecosystems have been proposed. The species richness,  $S$ , is the most widely used index [62] and the most important characteristic of biodiversity:

$$S = \text{total number of species in the samples from a sampling site.} \quad (3.1)$$

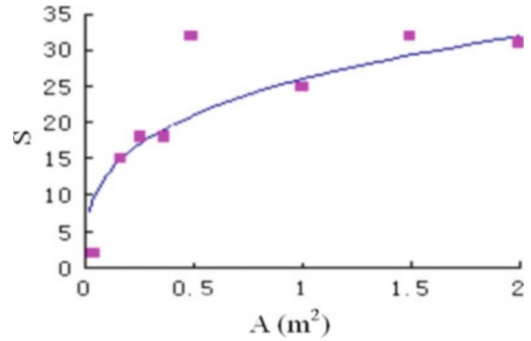
The ecological assessment and habitat conditions of streams may be mainly represented by the species richness. In general, the samples should be identified to species level for all species. Nevertheless, it is often not possible because to identify some species special instruments and experienced biologists are needed. In this case these species may be identified to genus level or family level. This does not affect the ecosystem assessment if the samples before and after the disturbance are examined by the same biologist and to the same level. A simple measure of richness is most often used in conservation biology studies because the many rare species that characterize most systems are generally of greater interest than the common species that dominate in diversity indices and because accurate population density estimates are often not available [63].

In general there are more species within large areas than within small areas. The relation between species richness,  $S$ , and habitat area,  $A$ , follows a power function formula [64]:

$$S = cA^z \quad (3.2)$$



**Fig. 3.25.** Relation between the species richness in a sample and the sampling area at each site.



where  $c$  and  $z$  are constants fitted to data. Analysis of species-area relations revealed that most values of  $z$  fall within the range 0.20–0.35 for birds and fish and within the range 0.05–0.2 for benthic macroinvertebrates. For example, for the land-bird fauna of the West Indies, species richness increases from only 16 within an area of 10 km<sup>2</sup> to about 100 within an area of about 100,000 km<sup>2</sup>. The relation between  $S$  and  $A$  is then [64]:

$$S = 10A^{0.24} \quad (3.3)$$

The species richness increases with habitat area because habitat heterogeneity increases with the size of the area (and resulting topographic heterogeneity) of islands in the west Indies, and larger islands make better targets for potential immigrants from mainland sources of colonization. In addition, the larger populations on larger islands probably persist longer, being endowed with greater genetic diversity, broader distributions over area and habitat, and numbers large enough to prevent chance extinction.

The fish community, like birds, also occurs in a large area of habitat, and the sampling area must be large enough to have a reliable value of  $S$ . As a comparison, the macroinvertebrate community is more localized and needs much less sampling area for assessment of local ecosystems. If a river ecosystem with high heterogeneity of habitat is assessed with macroinvertebrates as indicator species, numerous sampling sites should be selected to represent different habitat conditions. For each sampling site the sampling area may be one or several m<sup>2</sup>. The workload increases with the sampling area; therefore, ecologists prefer small sampling areas as long as a sufficient number of species can be sampled. Figure 3.25 shows the relation between the number of species in a sample and the sampling area at each site [52]. The sampling area at each site should be at least 1 m<sup>2</sup> for a relatively reliable value of richness.

The number density of individuals (abundance),  $N$ , is generally dynamic. If a bio-community colonizes a habitat at time  $t_0$ , the number density increases with time  $t$  and finally reaches equilibrium after a period of time. A differential equation describing the dynamic process of the number density growth is suggested [64]:

$$\frac{dN}{dt} = rN \left( 1 - \frac{N}{K} \right) \quad (3.4)$$

in which  $r$  represents the intrinsic exponential growth rate of the population when its size is very small (i.e., close to 0), and  $K$  is the carrying capacity of the environment, which represents the number of individuals that the environment can support. This equation is called the logistic equation. So long as  $N$  does not exceed the carrying capacity  $K$ , that is,  $N/K$  is less than 1, the number density continues to increase, albeit at a slowing rate. When  $N$  exceeds the value of  $K$ , the ratio  $N/K$  exceeds 1,  $dN/dt$  becomes negative, and the density decreases.  $K$  is the eventual equilibrium size of number density growing according to the logistic equation. Integration of the logistic equation yields

$$N = \frac{K}{1 + \frac{K-N_0}{N_0} e^{-rt}} \quad (3.5)$$

where  $N_0$  is the number density of individuals at time  $t = 0$ . The logistic equation may be used for a species, e.g., black carp in Dongting Lake, or for a bio-community, e.g., benthic macroinvertebrates at a section of a stream.

The abundance (density number) of a particular species reflects the balance between a large number of factors and processes, variations in each of which result in small increments or decrements in abundance. Population distribution models account for the evenness (equitability) of distribution of species, which fit various distributions to known models, such as the geometric series, log series, lognormal, or broken stick. In a large sample of individuals, species often distribute themselves normally over the logarithmic abundance categories.

### 3.2.2. Diversity Indices

Not all species should contribute equally to the estimate of total diversity, because their functional roles in the community vary, to some degree, in proportion to their overall abundance. Ecologists have formulated several diversity indices in which the contribution of each species is weighted by its relative abundance. Three such indices are widely used in ecology: Simpson's index, Margalef index, and the Shannon-Weaver index. Simpson's index is

$$D = \left[ \sum_{i=1}^S \left( \frac{n_i^2}{N^2} \right) \right]^{-1} \quad (3.6)$$

in which  $n_i$  is the number of individuals of the  $i$ -th species and  $N$  is the total number of individuals in the sample.

For any particular number of species in a sample ( $S$ ), the value of  $D$  can vary from 1 to  $S$ , depending on the evenness of species abundances.

The Margalef index is defined as the total number of species present and the abundance or total number of individuals. The higher is the index, the greater the diversity. The Margalef index  $M$  is given [65]:

$$M = (S - 1) / \log_e^N \quad (3.7)$$

The Shannon-Weaver index, developed from information theory and integrating the species richness and evenness of the abundance distribution, is given [66]:

$$H = -\sum_{i=1}^S \frac{n_i}{N} \ln \frac{n_i}{N} \quad (3.8)$$

The Shannon-Weaver index provides no information on the total abundance of the bio-community. For instance, samples from two sites have the same number of species, the distributions are also the same, but the density of individuals for site one is 10 ind/m<sup>2</sup> and for site two is 100 ind/m<sup>2</sup>. Equation (3.8) gives the same values of  $H$ . The difference in population density for the two cases is large, but it is not reflected by the values of  $H$ . Considering both the abundance and biodiversity, the following bio-community index is suggested [67]:

$$B = H \ln N = -\ln N \sum_{i=1}^S \frac{n_i}{N} \ln \frac{n_i}{N} \quad (3.9)$$

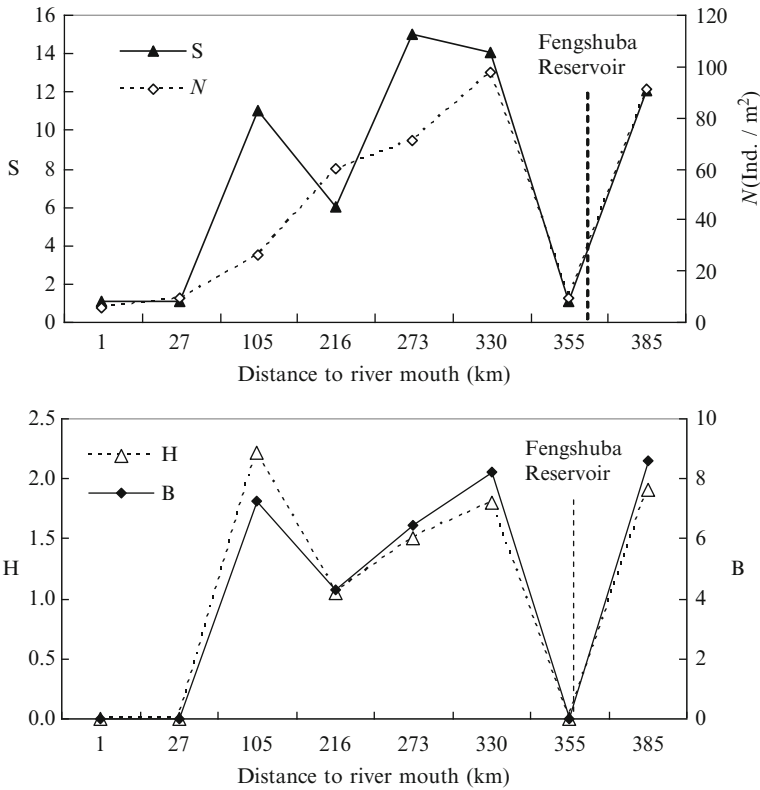
Macroinvertebrates census data from nine sites along the East River in south China can be used to illustrate these different methods of presentation, as listed in Table 3.2 [68]. The East River is 562 km long and has a drainage area of 35,340 km<sup>2</sup>. The river is one of the three major rivers of the Pearl River system—the largest system in south China. The Fenshuba Dam is a hydropower project on the river dividing the upper and middle reaches of the river and is 382 km from the river mouth. Figure 3.26 shows the variation of the species richness,  $S$ ; number density of individual invertebrates,  $N$ ; Shannon-Weaver index,  $H$ ; and the bio-community index,  $B$ , from upper to lower reaches along the course. In general the richness,  $S$ ; the density,  $N$ ; Shannon-Weaver index,  $H$ ; and the bio-community index,  $B$ , of benthic invertebrates reduce from the upper to the lower reaches. The Fenshuba Dam causes instantaneous fluctuation in flow discharge and velocity, which strongly impacts the invertebrates. Therefore, only one species, Palaemonidae, which may survive the fluctuation, was found at the site downstream of the dam. The impact of velocity fluctuation becomes weak further downstream from the dam and exhibits no influence on the benthic invertebrates at a distance of 80 km from the dam.

In the lower reaches the channel has been regulated with relatively uniform width, and the banks have been hardened with concrete and stones. Flow velocity in the channel is more uniform than the upper reaches, and the substrate consists of only sand. The sand bed is compact, which provides no space for benthic animals to live and no shelter for the animals to escape current. The richness, number density, and biodiversity and bio-community indices in the lower reaches are very low or zero. Humans have reclaimed river bays, riparian lakes and wetlands, and sluggish and backwater zones, which caused loss of habitat and made formerly diversified habitats very uniform and unitary. In general, the biodiversity and bio-community indices are proportional to the diversity of habitats. The habitat loss and low diversity of habitats result in low biodiversity and bio-community.

**Table 3.2**  
**Species of benthic macroinvertebrates at the sampling sites along the East River**

Sampling site	Species and the number of animals of each species per area (figure within the parentheses is the number of individual animals of each species per square meter)
Shang-Pingshui	Baetidae (30); Melaniidae, <i>S. libertine</i> (23); Chironomidae (two species 16); <i>Ceratopsyche</i> sp. (7); <i>Aphropsyche</i> sp. (5); Elmidae (3); Corydalidae, <i>Protohermes</i> (3); Corbiculidae, <i>Corbicula nitens</i> (2); Polycentropodidae, <i>Neureclipsis</i> (2); Caenidae (1); <i>Helobdella</i> (1)
Feng-Shuba Dam	Palaemonidae (9)
Yidu	Leptophlebiidae, <i>Paraleptophlebia</i> (42); Chironomidae (21); Gomphidae (5); Siphonuridae (4); Hydropsychidae (4); Leptophlebiidae, <i>Leptophlebia</i> (2); <i>Decapoda</i> (2); Hydrobiidae (2); <i>Semisulcospira</i> (1); Tipulidae, <i>Hexatoma</i> (1); Naucoridae (1); Corydalidae (1); Caenidae (1)
Wuxing	<i>Natantia</i> (44); <i>Bellamya</i> (10); <i>Branchiura</i> (3); <i>Radix</i> (2); <i>Melanoides</i> (2); Nepidae (1); <i>Limnodrilus</i> (1); Coenagrionidae, <i>Pseudagrion</i> (1); Leptophlebiidae, <i>Traverella</i> (1); Heptageniidae (1); Leptophlebiidae, <i>Paraleptophlebia</i> (1); Corbiculidae, <i>Corbicula nitens</i> (1); Noteridae (1); <i>Whitmania</i> (1); <i>Hirudinea</i> sp. (1)
Baipuhe	Palaemonidae (40); Palaemonidae, <i>Palaemon modestus</i> (12); Gomphidae (2); Macromiidae (2); <i>Semisulcospira</i> (2); <i>Branchiura</i> (2)
Huizhou	Chironomidae (3 species 11); Coenagrionidae (two species 6); <i>Branchiura</i> (4); Paratelphusidae (1); <i>Ilydrolus</i> (1); Gomphidae (1); Platycnemididae (1); Ampullariidae (1)
Yuanzhou	0 (first sampling); Palaemonidae (9) (second sampling)
Dasheng	0 (first sampling); Palaemonidae (5) (second sampling)
Yequ Creek	Chironomidae (386); Simuliidae (18); Herpodellidae (4); Dytiscidae (3); <i>Branchiura</i> (3); Lumbriculidae (1); Psychodidae (1); Corduliidae, <i>Epitheca marginata</i> (1); Baetidae (1)

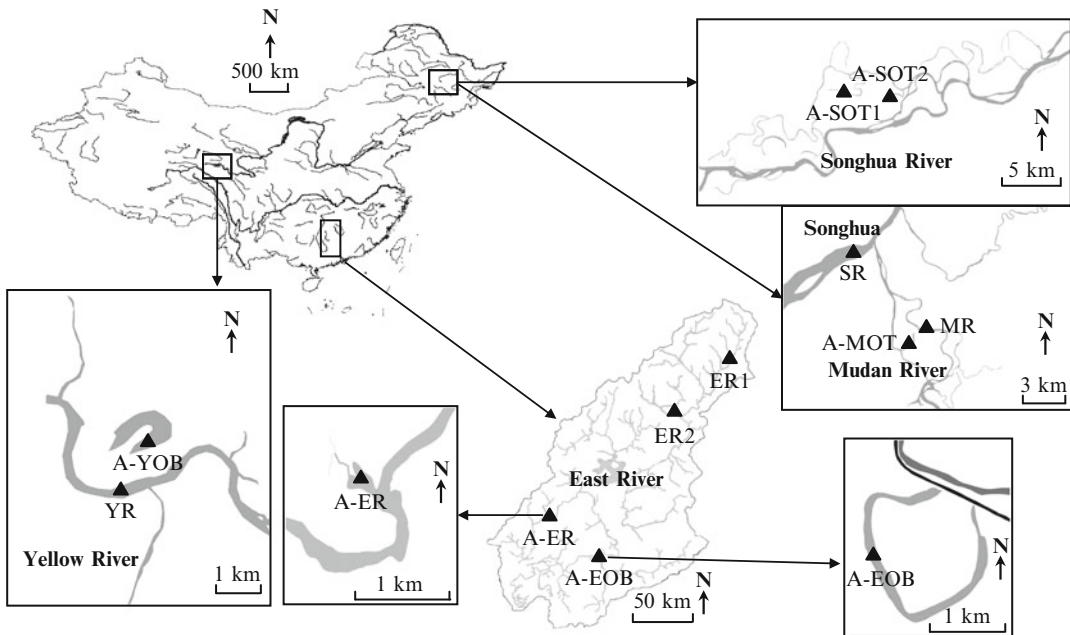
Biodiversity of macroinvertebrates in different types of abandoned channels was different, which is also due to different riverbed habitats. There are four types of abandoned channels: old river courses, oxbow lakes, oxtail lakes, and riparian wetlands, which result from avulsions, meander cutoffs, ice-jam floods, and stem-channel shifts, respectively. These posterior three types belong to freshwater ecosystems. Oxbow lakes result from the natural cutoff of meanders. In meandering rivers, a continuing increase in the amplitude and tightness of bends may result in a threshold sinuosity at which the river can no longer maintain its shape and a cutoff develops. Oxbow lakes may also result from artificial cutoffs. In general, artificial cutoffs cause intensive erosion in the new channel in the first several years of formation. The new channel is not stable during the intensive fluvial process. Oxtail lakes are generated from the fluvial process of anastomosing rivers. In northeast China, some rivers flow from south to north. When the northern section of the river freezes, the water will



**Fig. 3.26.** Species richness,  $S$ ; number density of individual invertebrates per area,  $N$ ; Shannon-Weaver index,  $H$ ; and the bio-community index,  $B$ , as functions of distance to the river mouth.

still flow upstream to the north. This forms anastomosing rivers, which are not very stable. If one of the parallel channels is scoured deeper than the others, all available water may flow into this channel and abandon the others. The lower part of the abandoned channel remains connected with the main channel and becomes a channel-shaped lake. These lakes are different from the oxbow lakes in shape and origin and are named as such because they look like oxtails. Many riparian wetlands result from the shifting of channels. Sediment is then deposited in wide river sections and forms bars. Under some circumstances, one channel of braided river develops into the main channel, and the other channels and the bars become a wetland.

Field investigations were carried out in the Yellow River, Songhua River basin, and East River. The locations of the study areas and sampling sites are shown in Fig. 3.27. Environmental conditions of the sampling sites and macroinvertebrate biodiversity are given in Table 3.3. It can be found that East River that is freely connected with the mainstream was characterized by the highest biodiversity. Species diversity can also be assessed using K-dominant curves, which combines the two aspects of diversity-species richness and evenness. Using this method, dominance patterns can be represented by plotting the accumulative



**Fig. 3.27.** Locations of study areas and sampling sites. The site abbreviations are the same as defined in Table 3.3. *Filled triangle* represents the sampling site.

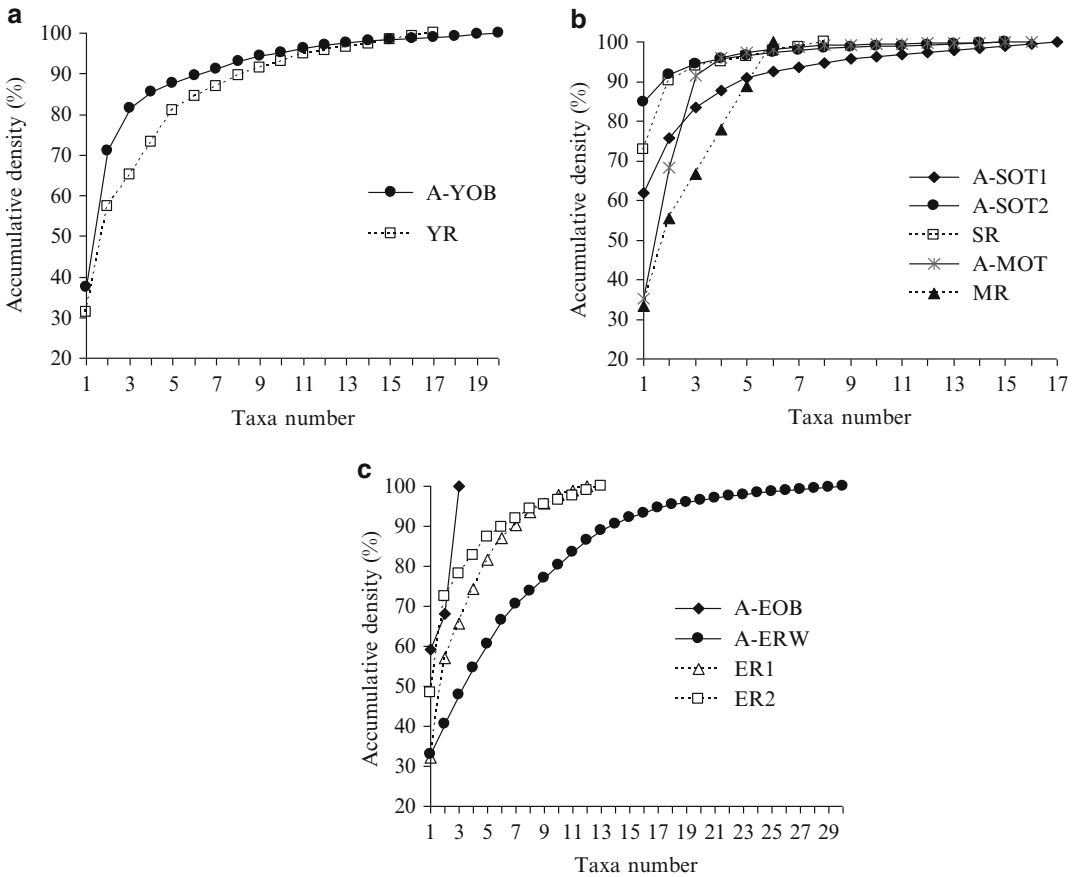
abundance of each species (%) ranked in decreasing order of dominance. The lower curve indicates even individual distribution and higher biodiversity. Figure 3.28 shows K-dominant curves of macroinvertebrates in abandoned channels and their adjoining rivers. Figure 3.28 reports similar results as shown in Table 3.3. The different biodiversity of these channels was ascribed to different habitat conditions.

As indicated in the previous section, biological diversity refers mainly to the number of species in an area or region and includes a measure of the variety of species in a community that takes into account the relative abundance of each species [69]. When measuring diversity, it is important to clearly define the biological objectives, stating exactly what attributes of the system are of concern and why [70]. Different measures of diversity can be applied at various levels of complexity, to different taxonomic groups, and at distinct spatial scales.

Overall diversity within any given level of complexity may be of less concern than diversity of a particular subset of species or habitats. Measures of overall diversity include all of the elements of concern and do not provide information about the occurrence of specific elements. For example, measures of overall species diversity do not provide information about the presence of individual species, such as Chinese sturgeon, or species groups of management concern. Thus, for a specific ecological restoration project, measurement of diversity may be limited to a target group of special concern.

**Table 3.3**  
**Environmental conditions of the sampling sites and macroinvertebrates biodiversity**

Site	Code	Location	Connection frequency (/year)	Substrate	Velocity (m/s)	Water depth (m)	H	B
Yellow River	A-YOB	N 34°12'4" E 101°33'40"	0.3	Clay and silt, dense emerged and submerged plants (cover: 1/3)	0.0–0.3	0.3–1.0	1.74	11.86
	YR	N 34°12'3" E 101°33'39"		Silt, sand and cobbles	0.1–1.0	0.1–1.0	2.08	9.86
Songhua River	A-SOT1	N 45°47'1" E 126°23'25"	1.0	Silt and fine sand, aquatic plant (cover: 1/3)	0.0–0.2	0.1–1.5	1.45	7.58
	A-SOT2	N 45°47'58" E 126°32'18"	0.1	Silt and fine sand	0.0–0.2	0.1–1.5	0.71	4.26
	SR	N 45°47'5" E 126°36'37"		Sand and gravel	0.1–0.8	0.1–3.0	0.93	4.08
Mudan River	A-MOT	N 45°49'5" E 126°44'4"	1.0	Clay and silt	0.0–0.2	0.1–0.6	1.42	9.93
	MR	N 45°49'4" E 126°43'59"		Sand and gravel	0.3–0.8	0.1–1.5	1.68	3.68
East River	A-EOB	N 23°3'23" E 114°25'34"	0.0	Fine sand	0.0	0.0–3.0	0.89	2.76
	A-ERW	N 23°27'1" E 113°54'8"	Always connected	Clay, silt and sand, dense submerged plants (cover: 1/2)	0.0–0.5	0.0–3.0	2.57	15.02
	ER1	N 24°34'15" E 115°29'46"		Cobbles and boulders, aquatic plants (cover: 1/4)	0.2–1.0	0.1–0.5	1.97	8.92
	ER2	N 24°17'36" E 115°7'49"		Cobbles	0.2–1.5	0.2–1.0	1.66	7.41



**Fig. 3.28.** K-dominant curves of macroinvertebrates in abandoned channels (*solid line*) and their adjoining rivers (*dashed line*). The site abbreviations are the same as defined in Table 3.3.

3.2.3. *Alpha and Beta Diversities*

Diversity can be measured within the bounds of a single community, across community boundaries, or in large areas encompassing many communities. Diversity within a relatively homogeneous community is known as alpha diversity, or local diversity. Usually the diversity indices obtained by examining the samples taken from one site are referred to as alpha diversity. Diversity between communities in a region, described as the amount of differentiation along habitat gradients, is termed beta diversity, or regional diversity. For instance, the total number of species from numerous sites along a stream is the regional diversity of the stream. Beta diversity may be large in river-lake connected habitats with high heterogeneity, because some species colonize stream habitat and very different species may live in the riparian lakes.

Noss and Harris (1986) note that management for alpha diversity may increase local species richness, while the regional landscape (gamma diversity) may become more



homogeneous and less diverse overall [71]. They recommend a goal of maintaining the regional species pool in an approximately natural relative abundance pattern. The specific size of the area of concern should be defined when diversity objectives are established.

A beta diversity index is given by the following formula:

$$\beta = \frac{M}{\frac{1}{S} \sum_{i=1}^S m_i} \quad (3.10)$$

in which  $M$  is the number of sampled habitats in a region, e.g., the middle reaches of the Yangtze River;  $m_i$  is the number of habitats, in which the  $i$ -th species is found; and  $S$  is the total number of species found at all sampling sites in the region. If the species in all sites are the same, or  $m_i = M$ , the beta diversity index is 1. If all species occur at only one site,  $m_i = 1$ , the beta diversity index equals  $M$ . The total number of species,  $S$ , in the region is then the product of the average species richness by the beta diversity index.

The ecological implication of beta diversity may be seen from the example of preliminary assessment of aquatic ecology of the source region of the Yellow River. The benthic macroinvertebrates were sampled at 8 sites with different environmental conditions in the source region of the Yellow River from Aug. 7 to Aug. 15, 2009. Figure 3.29 shows the location of 8 sampling sites. Samples were taken from five sites from the Yellow River and riparian waters. In addition, samples were taken from a small stream on the plateau, the Eling Lake, and the Qinghai Lake. The sampling method is as follows: (1) in mountain streams with gravel beds, the gravels were washed and sieved with a kick-net with holes of 0.5 mm and organic and inorganic detritus with macroinvertebrates collected. The detritus was subsequently placed on a white tray, and the invertebrates were collected. Invertebrate species were thereafter examined and identified to family or genus level under a microscope. The sampled area was 1.5 m<sup>2</sup> consists of three subsampling areas in order to reflect diversified ecological conditions. After sampling, macroinvertebrates and associated material were immediately preserved in ethanol and were subsequently processed and identified in the laboratory. There is little pollution and the water quality is very good.

In general, the community of benthic invertebrates is different if the environmental conditions are different. The main environmental factors for benthic invertebrates are stream substrate, water depth, flow velocity, and water quality [72]. At the site ① the Zequ River is a tributary of the Yellow River with meandering channel. In its drainage area there are numerous swamps and rivulets with small but stable flow. The rivulets wriggle on vast meadows with grass coverage almost 100 %. The site of streamlet represents the habitat type. Near the Yellow River by Kesheng town (site ②), there is an oxbow lake (site ③), which is an abandoned channel of the Yellow River and has been cut off from the river for a very long period of time. The site ④ is a riparian lake, which may connect with the Yellow River during high floods. The Dari bay ⑤ is a riparian wetland where the Yellow River flows from a normal channel to a very wide valley with shallow water. The main water flow has a deep channel, but plume of low sediment concentration drifts into the bay. The site ⑥ is a



Fig. 3.29. Location of the 8 sampling sites in the source region of the Yellow River.

wetland by the Yellow River. The Eling Lake ⑦ is the source of the Yellow River with a capacity of 10 billion m<sup>3</sup>. The pool level in the lake is not stable depending on the incoming water and operation of a hydropower station just below it. The water level had been rising since a month before the field investigation. The Qinghai Lake has brackish water with low concentration of salt. It is near by the source of the Yellow River and represents a type of habitat in the region.

Table 3.4 lists the species of macroinvertebrates identified from the samples of each site with the number density (ind/m<sup>2</sup>) of each species in the parentheses. The taxa richness, or the number of species at each site, *S*, and the calculated biodiversity index *B* are listed in the table. Altogether 48 species of macroinvertebrates belonging to 24 families and 44 genera were identified. The average density and wet biomass of macroinvertebrates in the eight sampling stations were 360 ind/m<sup>2</sup> and 2.3934 g/m<sup>2</sup>, respectively. Insects were predominant group, being 77.1 % of the total in taxa number, 82.7 % in density, and 88.6 % in wet biomass. Figure 3.30 shows the representative species of macroinvertebrate in the sampling sites, which are dominant species or typical species at each site.

**Table 3.4**  
**Species composition of macroinvertebrates with densities (ind/m<sup>2</sup>) in the parentheses**

No.	Site	Species composition	S	B
1	Streamlet	<i>Limnodrilus grandisetosus</i> (2); Amphipoda (488); <i>Baetis</i> sp. (53); <i>Setodes</i> sp. (5); Tipulidae (1); <i>Eukiefferiella</i> sp. (9)	6	3.04
2	YR channel	Amphipoda (9); Acarina (2); <i>Baetis</i> sp. (3); <i>Cinygmula</i> sp. (4); <i>Ephemerella</i> sp. (30); <i>Leptonema</i> sp. (36); <i>Brachycentrus</i> sp. (3); Naucoridae (1); <i>Simulium</i> sp. (1); Culicidae (3); <i>Clinotanytus</i> sp. (1); <i>Eukiefferiella</i> sp. (9); <i>Orthocladius</i> sp. (2); <i>Cladotanytarsus</i> sp. (1); <i>Dicrotendipes</i> sp. (1); <i>Parachironomus</i> sp. (4); <i>Polypedilum</i> sp. (2)	17	9.86
3	Oxbow lake	Nematoda (300); <i>Aulodrilus plurisetus</i> (6); <i>Radix lagotis</i> (3); <i>Radix swinhoei</i> (12); <i>Hippeutis cantori</i> (9); <i>Hippeutis umbilicalis</i> (36); Amphipoda (93); Acarina (3); <i>Caenis</i> sp. (6); Dytiscidae (18); Elmidae (3); Corixidae (15); Pyralidae (336); <i>Procladius</i> sp. (15); <i>Chironomus</i> sp. (18); <i>Cryptochironomus</i> sp. (3); <i>Microchironomus</i> sp. (3); <i>Paratanytarsus</i> sp. (3); <i>Polypedilum braseniae</i> (3); <i>Xenochironomus</i> sp. (9)	20	11.84
4	Riparian lake	<i>Stylaria</i> sp. (1); <i>Limnodrilus</i> sp. (2); <i>Branchiura sowerbyi</i> (2); <i>Radix ovata</i> (4); Dytiscidae (8); Tipulidae (2); Culicidae (1); <i>Procladius</i> sp. (2); <i>Parametriocnemus</i> sp. (2); <i>Chironomus</i> sp. (10); <i>Cryptochironomus</i> sp. (1); <i>Endochironomus</i> sp. (1); <i>Paratanytarsus</i> sp. (17)	13	8.48
5	Dari bay	<i>Limnodrilus</i> sp. (3); Amphipoda (12); Tipulidae (1); <i>Psectrocladius</i> sp. (17); <i>Tvetenia</i> sp. (8); <i>Chironomus</i> sp. (10); <i>Polypedilum</i> sp. (13)	7	6.72
6	Eling Lake	No benthic animals	0	–
7	Riparian wetland	<i>Limnodrilus</i> sp. (1); Amphipoda (464); Culicidae (4); <i>Procladius</i> sp. (1); <i>Cricotopus</i> sp. (10); <i>Microchironomus</i> sp. (3); <i>Rheotanytarsus</i> sp. (75)	7	3.68
8	Qinghai Lake	Amphipoda (210); Culicidae (2); Ephydriidae (2); <i>Cricotopus</i> sp. (105); <i>Eukiefferiella</i> sp. (19); <i>Chironomus</i> sp. (2)	6	5.32

The taxa richness *S* and the index *B* at each site are not high. In other words, the biodiversity of the sampling sites is not high. The streamlet and Qinghai Lake have only 6 species and both dominated by Amphipoda. The oxbow lake has the highest biodiversity, with 20 species and bio-community index about 12. In general, cobble, gravel, and aquatic plants are the best substrates for benthic invertebrates. The oxbow lake, the isolated riparian lake at Dari, and the Yellow River channel at meanders have relatively stable environment and have multiple habitats with different substrates; therefore, they have high biodiversity. The Dari bay is an open shallow water connecting the Yellow River, its substrate consists of only fluid mud, and the sediment from the river drifting into the bay may change the fluid mud surface layer; thus, it has relatively low biodiversity. Moreover, the species composition in the oxbow lake and riparian lake is quite different from the river and bay. These riparian waters are important in aquatic biodiversity.



**Fig. 3.30.** Representative species of macroinvertebrate from the sites 1, 2, 3, 4, 5, and 8.

The value of beta diversity was calculated for the source region of the Yellow River. The total number of sampled habitats is 8, so the value of  $M$  is 8 in (3.10). Calculation with the sampled species from the 8 habitats yields the beta diversity equal to 5.33, which is 66.7 % of the maximum value. As a comparison, field investigations were paid to the Juma River in the

suburbs of Beijing from Shidu to Yesanpo with a length of about 70 km. The river is a mountain stream with beautiful landscapes and good aquatic ecology. The river reach from Shidu to Yesanpo is a main tourist attraction for Beijing people. Samples of benthic invertebrates were taken from eight sites with different habitats, including gravel bed with turbulent flow, riparian wetland with lentic water, branch channel with low velocity flow, and pool behind weir. The substrates at the sampling sites were different, varying from gravel, cobbles, sand, and macrophytes. The average taxa richness for the 8 different habitats was 19.4, and the highest taxa richness was 28. The total number of species was 54. The average value of index  $B$  for the 8 habitats was 10 and the highest value of  $B$  was 16. All the 8 habitats have high local biodiversity (alpha biodiversity). Nevertheless, the species compositions at different sites were rather similar. The beta diversity for the Juma River was only 2.7. The beta diversity for the source region of the Yellow River is two times of the Juma River. Ecological management or restoration in the region must base on an overall consideration of various habitats in the region.

#### 3.2.4. Indices of Biotic Integrity

##### Karr's IBI

Fish represent the top of the aquatic food chain, and, thus, the quality and composition of the fish community comprise the best measure of the overall health of the aquatic community. This is because the fish community integrates the effects of the entire suite of physical, chemical, and biological stresses on the ecosystem. A fish community index should include at least one metric for each of the five attributes of fish assemblages [73]: species richness and condition, indicator species, trophic function, reproduction function, and individual abundance and condition.

Considering the foregoing considerations, Karr (1981) proposed and revised the Index of Biotic Integrity (IBI) to evaluate stream quality at the fish community level [74]. The Karr's IBI is comprised of 12 metrics to define fish community structure. The index accounts for changes in fish community richness and allows for comparison of fish community composition with values for similar-sized streams. The applicability of the IBI concept has been demonstrated in a wide variety of stream types [75]. As recommended by Karr et al. [57], IBI metrics require adjustment for the region to which the index is applied. The basic components of Karr's index are listed in Table 3.5. It is recognized that stream size is an important factor when refining the IBI to a geographic region.

The definitions of the 12 metrics are described as follows [57, 76]:

*Total number of species*—The total number of species collected at a site, excluding hybrids and subspecies. The number of fish species supported by streams of a given size in a given region decreases with environmental degradation, if other features are similar.

*Number of darter species*—The total number of darter species (family Percidae) collected, excluding hybrids. Darters are small benthic species that tend to be intolerant of many types of environmental degradation. They are mainly insectivorous, and for many of them riffles or runs are preferred habitats. These species are sensitive to degradation, particularly as a result

**Table 3.5**  
**Karr's Index of Biological Integrity (IBI) (after Karr et al. 1986)**

Category	Metrics	Scoring criteria		
		5	3	1
Species richness and composition	1. Total number of fish species	Expectations for metrics		
	2. Number and identity of darter species	1–5 vary with stream		
	3. Number and identity of sunfish species	size and region		
	4. Number and identity of sucker species			
	5. Number and identity of intolerant species			
Trophic composition	6. Proportion of individuals as green sunfish	<5 %	5–20 %	>20 %
	7. Proportion of individuals as omnivores	<20 %	20–45 %	>45 %
	8. Proportion of individuals as insectivorous Cyprinids	>45 %	45–20 %	<20 %
	9. Proportion of individuals as piscivores (top carnivores)	>5 %	5–1 %	<1 %
Fish abundance and condition	10. Number of individuals in sample	Expectations vary with stream size and region		
	11. Proportion of individuals as hybrids	0 %	0–1 %	>1 %
	12. Proportion of individuals with disease, tumors, fin damage, skeletal anomalies (DELT)	0–2 %	2–5 %	>5 %

of their need to reproduce and feed in benthic habitats. Such habitats are degraded by channelization, siltation, and reduction in oxygen content.

*Number of sunfish species*—The total of sunfish species (family Centrarchidae), including rock bass (*Ambloplites rupestris*) and crappies (*Pomoxis* species), but excluding hybrids and black basses (*Micropterus salmoides*). Sunfish are medium sized, mid-water species, which tend to occur in pools or other shallow-moving water. Most, but not all, are tolerant of environmental degradation. All feed on a variety of invertebrates, although some larger adults may eat fish. Sunfish are included in the index because they are particularly responsive to the degradation of pool habitats and to other aspects of habitat such as instream cover.

*Number of sucker species*—The total number of sucker species (family Catostomidae) collected, excluding hybrids. Suckers are large benthic species that generally live in pools or runs, although a few species are common in riffles. Some species are intolerant of environmental degradation, whereas others are tolerant. Most species feed on insects, although a few also eat large quantities of detritus or plankton. Suckers are included in the index because many of these species are intolerant to degradation of habitat or chemical quality. Also, the longevity of suckers provides a multiyear integrative perspective.

*Number of intolerant species*—The total number of species, excluding hybrids, which are intolerant of environmental degradation, particularly poor water quality, siltation and increased turbidity, and reduced heterogeneity (e.g., channelization). Intolerant species are

among the first to be decimated after perturbation to habitat or water quality, and the species identified in metrics 2–4 may be included in this group.

*Proportion of individuals as green sunfish*—In the Midwestern USA, the green sunfish (*Lepomis cyanellus*) increases in relative abundance in degraded streams and may increase from an incidental to the dominant species. Thus, this metric evaluates the degree to which typically tolerant species dominate the community. In many other IBIs, tolerant species in the sample are listed and the proportion of tolerant individuals in the sample is computed and used as the metric in place of green sunfish.

*Proportion of individuals as omnivores*—The number of individuals that belong to species with an adult diet consisting of at least 25 % (by volume) plant material or detritus and at least 25 % live animal matter, expressed as a percentage of the total number of fish captured. By definition, omnivores can subsist on a broad range of food items, and they are relatively insensitive to the change in the food base of a stream caused by environmental degradation. Hybrids are included in this metric if both of the parental species are considered omnivores. The dominance of omnivores occurs as specific components of the food base become less reliable, and the opportunistic foraging habits of omnivores make them more successful than specialized foragers.

*Proportion of individuals as insectivorous cyprinids*—Cyprinids that belong to species with an adult diet normally dominated by aquatic or terrestrial insects, expressed as a percentage of the total number of fish captured. Although insectivorous cyprinids are a dominant trophic group in streams in the Midwestern USA, their relative abundance decreases with degradation, probably in response to variability in the insect supply, which in turn reflects alterations of water quality, energy sources, or instream habitat. In other regions the proportion of total insectivores to total individuals may provide better information for this metric with a resetting of the scoring criteria.

*Proportion of individuals as piscivores (top carnivores)*—The number of individuals that belong to species with an adult diet dominated by vertebrates (especially fish) or decapod crustacea (e.g., crayfish, shrimp), expressed as a percentage of the total number of fish captured. Some species feed on invertebrates and fish as fry and juveniles. Hybrids are included in this metric only if both of the parental species are carnivores. Viable and healthy populations of top carnivores indicate a healthy, trophically diverse community.

*Number of individuals in a sample*—This metric evaluates populations and is expressed as catch per unit of sampling effort. Effort may be expressed per unit area sampled, per length of reach sampled, or per unit of time spent. In streams of a given size and with the same sampling method and efficiency of effort, poorer sites are generally expected to yield fewer individuals than sites of higher quality.

*Proportion of individuals as hybrids*—This metric is difficult to determine from historic data and is sometimes omitted for lack of data. Its primary purpose is to assess the extent to which degradation has altered reproductive isolation among species. Hybridization may be common among cyprinids after channelization, although difficulties in recognizing hybrids may

**Table 3.6**  
**Index of Biological Integrity (IBI) for Taiwan (after Hu et al. 2005)**

Category	Metrics	Scoring criteria		
		5	3	1
Species richness and composition	1. Total number of fish species	≥10	4–9	0–3
	2. Number of darter species	≥3	1–2	0
	3. Number of sunfish species	≥2	1	0
	4. Number of suckers species	≥2	1	0
	5. Number of intolerant species	≥3	1–2	0
Trophic composition	6. Proportion of individuals as omnivores	<60 %	60–80 %	>80 %
	7. Proportion of individuals as insectivores	>45 %	45–20 %	<20 %
Fish abundance and condition	8. Number of individuals in sample	≥101	51–100	0–50
	9. Number of hybrids or exotic species	0	1	≥2

preclude using this criterion with darters in addition to cyprinids. Sunfish also hybridize quite readily, and the frequency of their hybridization appears to increase with stream modifications.

*Proportion of individuals with disease, tumors, fin damage, and skeletal anomalies (DELT)*—The number of individual fish with skeletal or scale deformities, heavily frayed or eroded fins, open skin lesions, or tumors that are apparent from external examination, expressed as a percentage of the total number of fish captured. DELT fish are normally rare except at highly degraded sites.

Sampling of fish to determine these metrics is done on a reach basis. In Wisconsin, for example, a stream reach is defined as a minimum of 35 times the mean stream width based on at least 10 field measurements per site [76]. The results of the reach sampling are combined to define a sampling site.

### IBI Examples

Karr's IBI concept has been adapted and modified from its Midwestern USA beginnings for application throughout the world. Some IBIs simply adjust the scoring criteria as appropriate for their region of application, whereas other IBIs have combined new metrics with Karr's metrics. More than 40 fish metrics have been utilized in the various IBIs used in the USA [77].

The IBI developed for Taiwan [78] is an example, where the majority of Karr's original metrics (with slight modifications) were applied, but the scoring criteria were modified (Table 3.6). Other than the scoring criteria modifications, the main differences in the Taiwan IBI versus Karr's IBI are the use of all insectivores and consideration of numbers of hybrids or exotic species rather than the proportion of hybrids. Exotic species are species that are present in a region through introduction by man or have recent invasions that would not have been



**Table 3.7**  
**Index of Biological Integrity (IBI) for large rivers in southern Wisconsin (after Lyons et al. 2001)**

Metrics	Scoring criteria		
	10	5	0
1. Weight of fish per unit effort	>25 kg	10–25 kg	0–9.9 kg
2. Total number of native fish species	>15	12–15	0–11
3. Number of suckers species	>4	3–4	0–2
4. Number of intolerant species	>2	2	0–1
5. Number of riverine species	>6	5–6	0–4
6. Proportion of individuals with disease, tumors fin damage, skeletal anomalies (DELT)	<0.5 %	0.5–3 %	>3 %
7. Percent of individuals as riverine species	>20 %	11–20 %	0–10 %
8. Percent of individuals as simple lithophilous spawners	>40 %	26–40 %	0–25 %
9. Percent of insectivores by weight	>39 %	21–39 %	0–20 %
10. Percent of round suckers by weight	>25 %	11–25 %	0–10 %

possible without human intervention. The total IBI scores then yield the following biological conditions categories: non-impaired = 35–45, slightly impaired = 23–34, moderately impaired = 15–22, and severely impaired = 0–14.

Karr's IBI and its many regional modifications for areas throughout the USA and around the world have generally been well calibrated to small "wadable" streams, but applications in larger rivers are less common [79]. Lyons et al. (2001) identified 7 IBIs developed for use in large rivers and then developed IBIs for use in large rivers in Wisconsin. In this case large rivers are defined as having at least 3 km of contiguous river channel too deep to be effectively sampled by wading. Lyons et al. (2001) used fish assemblage data from 155 main-channel-border sites on 30 large warmwater rivers in Wisconsin (including 19 sites on the Mississippi River) to construct, test, and apply large river IBIs. Fourteen sites were sampled more than once for a total of 187 samples. Watershed drainage areas for these sites ranged from 349 to 218,890 km<sup>2</sup>. Lyons et al. (2001) used some of Karr's original metrics while adding several different metrics. A main difference is that instead of just considering the proportion of individuals (i.e., numbers-based metrics), the large river IBI also considers the proportion of fish by weight (i.e., biomass-based metrics). Such biomass-based metrics best reflect the amount of energy flow across trophic levels and functional groups, whereas number-based metrics indicate the diversity of pathways that energy could follow and the potential for intra- and interspecific interactions [79].

The large river IBI for southern Wisconsin is listed in Table 3.7. Definitions of some of the "new" metrics are given as follows [76, 79]:

*Weight per unit effort*—Weight (biomass) to the nearest 0.1 kg of fish collected per 1,600 m of shoreline, excluding tolerant species.

*Total number of native species*—The total number of species collected at a site, excluding hybrids (which are common among sunfish and certain minnow species) and exotic species.

*Total number of riverine species*—Number of species that are obligate stream or river dwellers not normally found in lentic habitats.

*Percent of individuals as simple lithophilous spawners*—The number of individuals that belong to species that lay their eggs on clean gravel or cobble and do not build a nest or provide parental care, expressed as a percentage of the total number of fish captured. Simple lithophilous species need clean substrates for spawning and are particularly sensitive to sedimentation (embeddedness) of rocky substrates. Hybrids are included in this metric only if both of the parental species are simple lithophilous species.

The total IBI scores then yield the following biological conditions categories: excellent = >80, good = 60–79, fair = 40–69, poor = 20–39, and very poor  $\leq 20$ . Lyons et al. (2001) found that the Wisconsin large river IBI was comparable to IBIs developed for use in large rivers in Ohio (including data for the Ohio River) and Indiana [79]. The fact that the IBI metrics in Table 3.7 reflect conditions on the Mississippi River and Ohio River indicates that these metrics might be a good beginning point for developing IBIs for the other large rivers of the world.

## Uses of the IBI

IBIs provide a valuable framework for assessing the status and evaluating the restoration of aquatic communities. IBIs encompass the structure, composition, and functional organization of the biological community. IBIs can be viewed as quantitative empirical models for rating the health of an aquatic ecosystem, providing a single, defensible, easily understood measure of the overall health of a river reach in question [79]. For example, IBIs can be used to quickly identify both high-quality reaches for protection and degraded sites for rehabilitation.

While total IBI scores can provide the user with an indication that a stream fish community is potentially degraded by environmental stressors, the total score cannot provide the ability to identify which individual stressors are causing the response. The same total IBI score can be reached by an infinite combination of individual metric scores, each with its own environmental stressor. Thus, several researchers have focused not on the final IBI score, but rather on how the individual metrics can be used to describe the effects of anthropogenic stresses on the fish community [80–83]. If relations between stresses and the fish community can be found, ways to reduce these stresses and efficiently improve the fish community can be derived.

### 3.3. Bioassessment

#### 3.3.1. Rapid Bioassessment

Rapid bioassessment techniques are most appropriate when restoration goals are nonspecific and broad, such as improving the overall aquatic community or establishing a more balanced and diverse community in the river ecosystem [30]. Bioassessment often refers to use of biotic indices or composite analyses, such as those used by the Ohio Environmental Protection Agency [84], and rapid bioassessment protocols (RBP), such as those documented

**Table 3.8**  
**Five tiers of the rapid bioassessment protocols (after Plafkin et al. 1989)**

Level or tier	Organism group	Relative level of effort	Level of taxonomy/where performed	Level of expertise required
I	Benthic invertebrates	Low; 1–2 h per site (no standardized sampling)	Order, family/field	One highly trained biologist
II	Benthic invertebrates	Intermediate; 1.5–2.5 h per site (all taxonomy performed in the field)	Family/field	One highly trained biologist and one technician
III	Benthic invertebrates	Most rigorous; 3–5 h per site (2–3 h of total are for lab taxonomy)	Genus or species/laboratory	One highly trained biologist and one technician
V	Fish	Low; 1–3 h per site (no fieldwork involved)	Not applicable	One highly trained biologist
VI	Fish	Most rigorous; 2–7 h per site (1–2 h are for data analysis)	Species/field	One highly trained biologist and 1–2 technicians

by Plafkin et al. [49]. The Ohio EPA evaluates biotic integrity by using an invertebrate community index that emphasizes structural attributes of invertebrate communities and compares the sample community with a reference or control community. The invertebrate community index is based on 10 metrics that describe different taxonomic and pollution tolerance relations within the macroinvertebrate community. The rapid bioassessment protocols established by the US Environmental Protection Agency were developed to provide states with the technical information necessary for conducting cost-effective biological assessments [49]. The RBP are divided into five sets of protocols, three for macroinvertebrates and two for fish, as shown in Table 3.8.

The rapid bioassessment protocols RBP I to RBP III are for macroinvertebrates. RBP I is a “screening” or reconnaissance-level analysis used to discriminate obviously impaired and unimpaired sites from potentially affected areas requiring further investigation. RBP II and III use a set of metrics based on taxon tolerance and community structure similar to the invertebrate community index used by the State of Ohio. Both are more labor intensive than RBP I and incorporate field sampling. RBP II uses family-level taxonomy to determine the following set of metrics used in describing the biotic integrity of a stream: (a) species richness, (b) Hilsenhoff biotic index [85], (c) ratio of scrapers to filtering collectors, (d) ratio of Ephemeroptera/Plecoptera/Trichoptera (EPT) and chironomid abundances, (e) percent contribution of dominant taxa, (f) EPT index, (g) community similarity index, and (h) ratio of shredders to total number of individuals. RBP III further defines the level of biotic impairment and is essentially an intensified version of RBP II that uses species-level taxonomy. As with the invertebrate community index, the RBP metrics for a site are compared to metrics from a control or reference site.

### 3.3.2. Comparison Standard

With stream restoration activities, it is important to select a desired end condition for the proposed management action. A predetermined standard of comparison provides a benchmark against which to measure progress. For example, if the chosen diversity measure is native species richness, the standard of comparison might be the maximum expected native species richness for a defined geographic area and time period. Historical conditions in the region should be considered when establishing a standard of comparison. If current conditions in a river are degraded, it may be best to establish the standard for a period in the past that represented more natural or desired conditions. In some cases historical diversity might have been less than current diversity due to changes in hydrology and encroachment of native and exotic riparian vegetation in the floodplain [86]. Thus, it is important to agree on what conditions are desired prior to establishing the standard of comparison.

For a hypothetical stream restoration initiative, the following biological diversity objective might be developed. Assume that a primary concern in an area is conserving native amphibian species and that 30 native species of amphibians have been known to occur historically in the watershed. The objective could be to manage the river ecosystem to provide and maintain suitable habitat for the 30 native amphibian species. River ecosystem restoration efforts must be directed toward those factors that can be managed to increase diversity to the desired level. Those factors might be the physical and structural features of the river ecosystem. Diversity can be measured directly or predicted from other information. Direct measurement requires an actual inventory of the element of diversity, such as counting the amphibian species in the study area.

Direct measures of diversity are most helpful when baseline information is available for comparing different sites. It is not possible, however, to directly measure certain attributes, such as species richness or the population level of various species, for various future conditions. Predicting diversity with a model is generally more rapid than directly measuring diversity. In addition, predictive methods provide a means to analyze alternative future conditions before implementing specific restoration plans. The reliability and accuracy of diversity models should be established before their use.

### 3.3.3. Classification Systems

The common goal of classification systems is to organize variation. Classification systems include [30]:

1. Geographic domain. The range of sites being classified varies from rivers of the world to local differences in the composition and characteristics of patches within one reach of a single river.
2. Variables considered. Some classifications are restricted to hydrology, geomorphology, and aquatic chemistry. Other community classifications are restricted to biotic variables of species composition and abundance of a limited number of taxa. Many classifications include both abiotic and biotic variables. Even purely abiotic classification systems are relevant to biological evaluations because of the important correlations (e.g., the whole concept of physical habitat) between abiotic structure and community composition.
3. Incorporation of temporal relations. Some classifications focus on describing correlations and similarities across sites at one, perhaps idealized, point in time. Other classifications identify

explicit temporal transitions among classes, for example, succession of biotic communities or evolution of geomorphic landforms.

4. Focus on structural variation or functional behavior. Some classifications emphasize a parsimonious description of observed variation in the classification variables. Others use classification variables to identify types with different behaviors. For example, a vegetation classification can be based primarily on patterns of species co-occurrence, or it can be based on similarities in functional effect of vegetation on habitat value.
5. The extent to which management alternatives or human actions are explicitly considered as classification variables. To the extent that these variables are part of the classification itself, the classification system can directly predict the result of a management action. For example, a vegetation classification based on grazing intensity would predict a change from one class of vegetation to another class based on a change in grazing management.

Comparison of the degraded system to an actual unimpacted reference site, to the ideal type in a classification system, or to a range of similar systems can provide a framework for articulating the desired state of the degraded system. However, the desired state of the system is a management objective that ultimately comes from outside the classification of system variability.

#### 3.3.4. *Analyses of Species Requirements*

Analyses of species requirements involve explicit statements of how variables interact to determine habitat or how well a system provides for the life requisites of fish and wildlife species. Complete specification of relations between all relevant variables and all species in a river system is not possible. Thus, analyses based on species requirements focus on one or more target species or groups of species. In a simple case, this type of analysis may be based on an explicit statement of the physical factors that distinguish good habitat for a species (places where it is most likely to be found or where it best reproduces) from poor habitat (places where it is unlikely to be found or reproduces poorly). In more complicated cases, such approaches incorporate variables beyond those of purely physical habitat, including other species that provide food or biotic structure, other species as competitors or predators, or spatial or temporal patterns of resource availability.

Analyses based on species requirements differ from synthetic measures of system condition in that they explicitly incorporate relations between “causal” variables and desired biological attributes. Such analyses can be used directly to decide what restoration actions will achieve a desired result and to evaluate the likely consequences of a proposed restoration action. For example, an analysis using the habitat evaluation procedures might identify mast production (the accumulation of nuts from a productive fruiting season which serves as a food source for animals) as a factor limiting squirrel populations. If squirrels are a species of concern, at least some parts of the stream restoration effort should be directed toward increasing mast production. In practice, this logical power is often compromised by incomplete knowledge of the species habitat requirements.

The complexity of these methods varies along a number of important dimensions, including prediction of habitat suitability versus population numbers, analysis for a single place and single time versus a temporal sequence of spatially complex requirements, and analysis for a

single target species versus a set of target species involving trade-offs. Each of these dimensions must be carefully considered in selecting an analysis procedure appropriate to the problem at hand.

### 3.4. Habitat Evaluation and Modeling

#### 3.4.1. Habitat Diversity

Habitat evaluation is an important aspect of bioassessment. Habitat has a definable carrying capacity, or suitability, to support or produce wildlife populations [87]. The capacity depends, to a great extent, on the habitat diversity. A habitat diversity index is needed to represent this characteristic. The physical conditions of stream habitat are mainly (1) the substrate, (2) water depth, and (3) flow velocity [88]. Different physical conditions support different bio-communities and diversified physical conditions may support diversified bio-communities. A habitat diversity index,  $H_D$ , is proposed as follows [67]:

$$H_D = N_h N_v \sum_i \alpha_i \quad (3.11)$$

where  $N_h$  and  $N_v$  are numbers for water depth diversity and velocity diversity, and  $\alpha$  is the substrate diversity, which is different for different substrates. For water depth less than 0.1 m, the habitat is colonized by species that like high concentrations of dissolved oxygen and plenty of light. For water depth larger than 0.5 m, the habitat is colonized by species that like low light and dissolved oxygen. Many species may live in water with depths between 0.1 and 0.5 m. If a stream has three water areas, (a) shallow water, in which the water depth is in the range of 0–0.1 m; (b) mid-depth water, in which the water depth is in the range of 0.1–0.5 m; and (c) deep water, in which water depth is larger than 0.5 m, and each of the three areas is larger than 10 % of the stream water surface area,  $N_h = 3$ . If a stream has only shallow water and mid-depth water, and each of them is larger than 10 % of the stream water surface area,  $N_h = 2$ . The value of  $N_h$  for other cases can be analogously obtained. For flow velocity less than 0.3 m/s, the habitat is colonized by species that swim slowly. For velocity higher than 1 m/s, the habitat is colonized by species that like high velocities. Many species live in the current between 0.3 and 1 m/s. If a stream has three water areas, (a) lentic area, in which the flow velocity is smaller than 0.3 m/s; (b) mid-velocity area, in which the flow velocity is in the range of 0.3–1 m/s; and (c) lotic area, in which the velocity is larger than 1 m/s, and each of the three areas is larger than 10 % of the stream water surface area,  $N_v = 3$ . If a stream has only lentic and mid-velocity areas, and each of them is larger than 10 % of stream water,  $N_v = 2$ . The value of  $N_v$  for other cases can be analogously obtained.

The selection of the critical values of water depth and velocity is determined by studying the habits of species, mainly of macroinvertebrates. It is found from field investigations that in the Yangtze River basin some species in the water depth between 0.1 and 0.5 m are different from those in shallower or deeper water. Similarly, some species living in the current range of 0.3–1 m/s are different from those in currents lower than 0.3 m/s or higher than 1 m/s. Beauger et al. (2006) reported that the highest species richness and density were found in various

substrates where the velocity ranged between 0.3 and 1.2 m/s and depths ranged from 0.16 to 0.5 m. Below 0.3 m/s the riverbed tends to be filled and not very productive, whereas above 1.2 m/s the current velocity acts as a constraint for most living material. Undoubtedly, at lower depths, vegetation and animals are disturbed by light; conversely at higher depths in which the primary productivity decreases, the bio-community is disturbed due to light attenuation. At lower and higher depths and velocities, only those species tolerant to the constraints may colonize the habitat [89].

Streambeds consisting of cobbles and boulders are very stable and provide the benthic macroinvertebrates diversified living spaces. Therefore, cobbles and boulders are associated with high habitat diversity. Stream flow over aquatic grasses has high velocity, but the aquatic grasses generate a low velocity canopy; moreover, the aquatic grasses themselves are also habitat for some species. Thus, streams with aquatic grasses exhibit high habitat diversity. Some species may move and live within the fluid mud layer and consume the organic materials in the mud layer. The interstices in a fine gravel bed are small but sufficient for some species. A sand bed is compact, and the interstices between sand particles are too small for big benthic macroinvertebrates to move and live within them. If sand particles are moving as bed load, the bed provides no stable habitat for animals. Therefore, moving sand is the worst habitat for benthic macroinvertebrates. Based on this discussion and field investigations of 16 streams, the  $\alpha$ -values for various substrates are listed in Table 3.9. It is well known that large woody debris can substantially contribute to habitat quality in streams [90, 91], and, thus, a more generally applicable listing of  $\alpha$ -values should also include a value for stream substrates with large woody debris. However, large woody debris does not often occur in Chinese streams; therefore, a rating for large woody debris has not been determined and is not listed in Table 3.9.

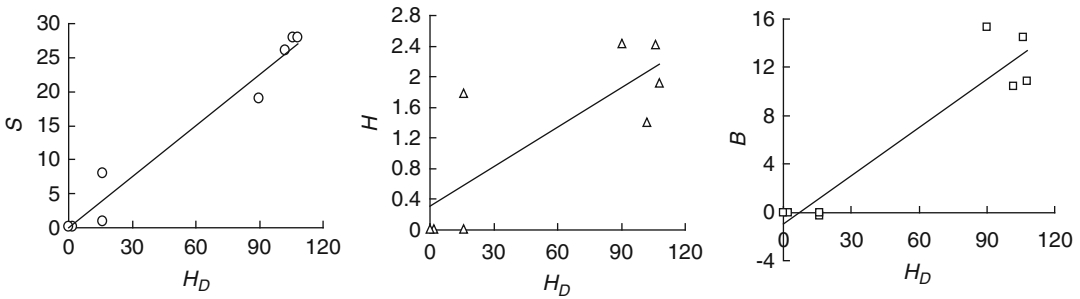
If a part of the streambed consists of one substrate and another part consists of another substrate and both parts have areas larger than one-tenth of the stream surface, the two  $\alpha$ -values for the two kinds of substrates should be summed. However, if sand or silt fills the interstices of gravel, the  $\alpha$ -value should be taken as for the substrate of sand or silt. If a streambed has three parts with different substrates, boulders and cobbles, aquatic grasses, and fluid clay mud, and each of the three parts is larger than one-tenth of the total stream area, the sum of the  $\alpha$ -values for the stream is  $\sum_i \alpha_i = 6 + 5 + 3 = 14$ . If the streambed is covered by moving sand and gravel or the bed is very unstable,  $\sum_i \alpha_i = 0$ .

Gorman and Karr (1978) also developed a habitat diversity index combining the effects of substrate, velocity, and depth [88]. They showed that fish species diversity and richness were strongly related to a combination of the effects of substrate, velocity, and depth. Their substrate classification is similar to that proposed here with the main differences being in the divisions of sediment sizes into the various classes, but a similar ordinal ranking is applied to the substrate material. They also developed class ranges for velocity and depth throughout a reach determined by a weighting of point measurements. The index applied here takes a simpler approach to considering the diversity of velocity and depth.

**Table 3.9**  
**Substrate diversity,  $\alpha$ , values for different substrates (after Wang et al. 2008a)**

Substrate	Boulders and cobbles (D>200 mm)	Aquatic grass	Gravel (2–200 mm)	Fluid clay mud (D < 0.02 mm)	Silt (0.02–0.2 mm)	Sand (0.2–2 mm)	Unstable sand, gravel, and silt bed (0.02–20 mm)
$\alpha$	6	5	4	3	2	1	0





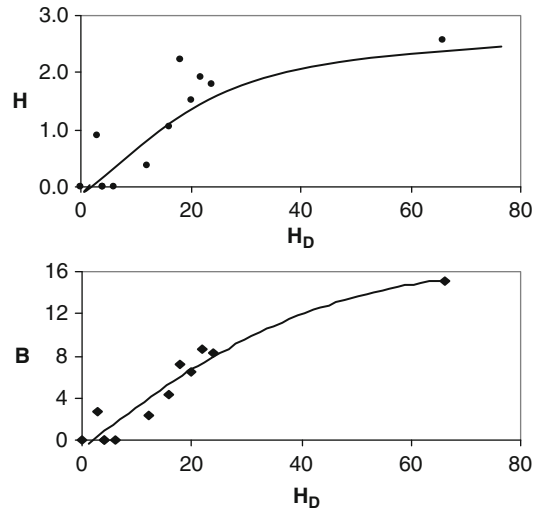
**Fig. 3.31.** Species richness,  $S$ ; Shannon-Weaver index,  $H$ ; and the bio-community index,  $B$ , as functions of the habitat diversity index,  $H_D$ .

The biodiversity of streams depends not only on the physical conditions, but also is affected by food availability and water quality. Food availability is very different for different species and should be studied separately. Generally speaking, water pollution reduces the number of species but may not reduce the density of pollution-tolerant species. Water quality is not an inherent feature of a habitat and depends on human disturbances. Therefore, water quality is not taken in the habitat diversity index. Water temperature also is an important factor for stream ecology. However, the temperature does not vary much in a reach of a stream unless a thermal discharge is present, and it is not necessary to consider it in the analysis of local habitat diversity. When habitat across different zones with great temperature differences is studied, then temperature difference has to be considered in the analysis.

High diversity of habitat supports high diversity of bio-community, which may be illustrated with the sampling results of macroinvertebrates in several mountain streams in the Xiaojiang River basin in Yunnan Province in southwestern China. Figure 3.31 shows the relations between the habitat diversity,  $H_D$ , and the species richness,  $S$ ; the Shannon Weaver index,  $H$ ; and the bio-community index,  $B$ , for these streams. In general, the higher the habitat diversity, the higher are the species richness, the biodiversity, and the bio-community index. However, the species richness,  $S$ , has the best relation with the habitat diversity clearly showing an increasing trend with habitat diversity. The bio-community index,  $B$ , also linearly increases with the habitat diversity. The Shannon-Weaver index,  $H$ , increases with the habitat diversity, but the points around the  $H_D$ - $H$  curve are rather scattered. The results suggest that the species richness,  $S$ , and bio-community index,  $B$ , are suitable ecological indicators for good habitat in streams that are not impaired by poor water quality. Similar results also were obtained from a study on the East River basin in Guangdong Province. Figure 3.32 shows the relations of the habitat diversity,  $H_D$ , with the Shannon-Weaver index,  $H$ , and bio-community index,  $B$ , for the East River. The higher is the habitat diversity, the higher are the biodiversity and bio-community indices. The bio-community index,  $B$ , increases with habitat diversity,  $H_D$ , and the points of  $B$ - $H_D$  relation are much closer to the curve than the relation of  $H$ - $H_D$ .

High habitat diversity means various habitat conditions. Certainly, influencing variables of macroinvertebrate communities are different under different river habitat conditions. Three Chinese rivers (the Songhua River, the Yongding River, and the West River) with different

**Fig. 3.32.** Relation between habitat diversity,  $H_D$ , and Shannon-Weaver index,  $H$  (upper), and the relation between habitat diversity,  $H_D$ , and bio-community index,  $B$  (lower).



latitudes were surveyed May–August of 2009 (high water level) and September–December of 2009 (low water level). Based on canonical correspondence analysis (CCA), water physico-chemical variables (total phosphorus and conductivity) played a key role in structuring macroinvertebrate assemblages in silt substrate, while hydrologic variables (median grain size of substrate and water velocity) mainly affected macroinvertebrate assemblages in stone substrate (Fig. 3.33).

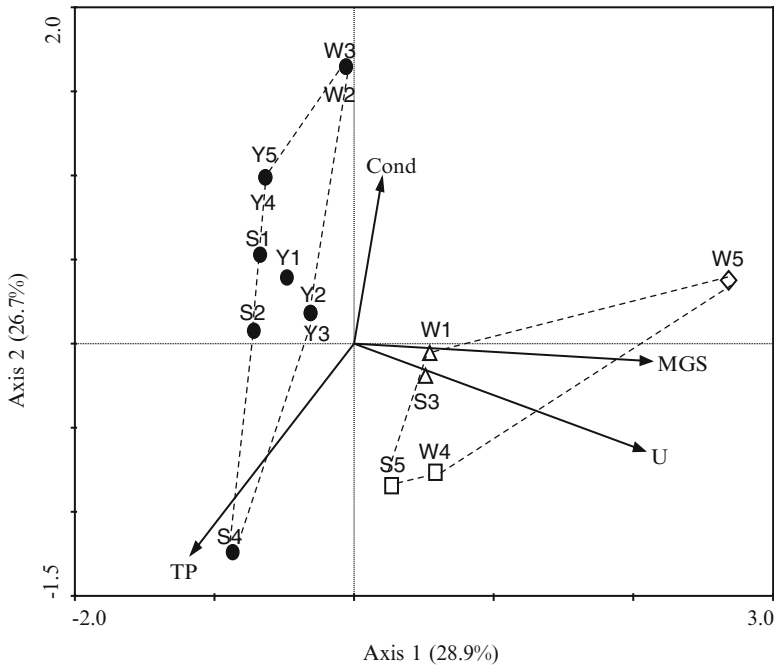
### 3.4.2. Habitat Evaluation Procedure

The Habitat Evaluation Procedures (HEP) can be used for several different types of habitat studies, including impact assessment, mitigation, and habitat management. The HEP provides information for two general types of habitat comparisons—the relative value of different areas at the same point in time and the relative value of the same area at different points in time.

The HEP is based on two fundamental ecological principles—habitat has a definable carrying capacity to support wildlife populations, and the suitability of habitat for a given wildlife species can be estimated using measurements of vegetative, physical, and chemical characteristics of the habitat. The suitability of a habitat for a given species is described by a Habitat Suitability Index (HSI) constrained between 0 (unsuitable habitat) and 1 (optimum habitat). HSI models have been developed and published [92]; the US Fish and Wildlife Service [93] also provides guidelines for use in developing HSI models for specific projects. HSI models can be developed for many of the previously described metrics, including species, guilds, and communities [94].

The fundamental unit of measure in the HEP is the Habitat Unit, computed as follows:

$$HU = \text{AREA} \times \text{HSI} \quad (3.12)$$



**Fig. 3.33.** CCA biplots of sites/environments. Major environmental variables influencing abundance and distribution of macroinvertebrates are presented. Environmental variables: *TP* total phosphorus concentration of water ( $\text{mg}/\text{m}^3$ ), *MGS* median grain size (mm), *U* water velocity (m/s); *Cond* conductivity ( $\mu\text{S}/\text{cm}$ ). Abbreviated river codes: *S* Songhua River, *Y* Yongding River, *W* West River. Substrate types: *filled circle*, silt; *open triangle*, gravel; *open square*, cobble; *open diamond*, bedrock.

where HU is the number of habitat units (units of area), AREA is the areal extent of the habitat being described (in  $\text{km}^2$ ), and HSI is the index of suitability of the habitat (dimensionless). Conceptually, an HU integrates the quantity and quality of habitat into a single measure, and one HU is equivalent to one unit of optimal habitat. The HEP provides an assessment of the net change in the number of HUs attributable to a proposed future action, such as a stream restoration initiative. A HEP application is essentially a two-step process—calculating future HUs for a particular project alternative and calculating the net change as compared to a base condition.

### 3.4.3. Habitat Modeling

Many habitat evaluation models have been developed. The *Physical Habitat Simulation Model* was designed by the US Fish and Wildlife Service primarily for instream flow analysis [95]. The model allows evaluation of available habitat within a study reach for various life stages of different fish species. The first component of the model is hydraulic simulation for predicting water surface elevations and velocities at unmeasured discharges (e.g., stage vs. discharge relations, Manning's equation, step-backwater computations). The second

component of the model-habitat simulation integrates species and life stage-specific habitat suitability curves for water depth, velocity, and substrate with the hydraulic data. Output is a plot of weighted usable area against discharge for the species and life stages of interest.

*Riverine Community Habitat Assessment and Restoration Concept Model* is based on the assumption that aquatic habitat in a restored stream reach will best mimic natural conditions if the frequency distribution of depth and velocity in the subject channel is similar to a reference reach with good aquatic habitat. Study site and reference site data can be measured or calculated using a computer model. The similarity of the proposed design and reference reach is expressed with three-dimensional graphs and statistics [96, 97]. The model has been used as the primary tool for environmental analysis on studies of flow management for the Missouri River and the Alabama basin.

*SALMOD* (Salmonid Population Model) is a conceptual and mathematical model for the salmonid population for Chinook salmon in concert with a 12-year flow evaluation study in the Trinity River of California using experts on the local river system and fish species in workshop settings [98, 99]. The structure of the model is a middle ground between a highly aggregated classical population model that tracks cohorts/size groups for a generally large area without spatial resolution and an individual-based model that tracks individuals at a great level of detail for a generally small area. The conceptual model states that fish growth, movement, and mortality are directly related to physical hydraulic habitat and water temperature, which in turn relate to the timing and amount of regulated stream flow. Habitat capacity is characterized by the hydraulic and thermal properties, which are the model's spatial computational units. Model processes include spawning, growth (including maturation), movement (freshet induced, habitat induced, and seasonal), and mortality (base, movement related, and temperature related). The model is limited to freshwater habitat for the first 9 months of life; estuarine and ocean habitats are not included.

#### 3.4.4. Suitability Indices

Suitability Indices are the core for habitat modeling, which may be illustrated for the Chinese sturgeon [100]. The life cycle of the Chinese sturgeon in the Yangtze River mainly comprises spawning, hatching, and growth of 1-year juvenile sturgeon. Brood fish seek suitable spawning sites; fertilized eggs adhere to stone and hatch after about 120–150 h. Whelp sturgeons drift with the current and grow slowly in the lower reaches of the Yangtze River and river mouth. Juvenile sturgeons swim to the East China Sea and stay there until they reach maturity. Therefore, analysis for the habitat quality of the Chinese sturgeon is based on basic requirements of spawning, hatching, and juvenile and adult sturgeon growth.

In habitat modeling variables which have been shown to affect growth, survival, abundance, or other measures of well-being of the Chinese sturgeon are placed in the appropriate component. Ten aquatic eco-factors, which mainly influence the habitat of the Chinese sturgeon, are selected for the modeling as follows: (a) water temperatures for adults and juveniles ( $V_1$ , °C), (b) water depth for adults ( $V_2$ , m), (c) substrate for adults ( $V_3$ ), (d) water temperature for spawning ( $V_4$ , °C), (e) water depth for spawning ( $V_5$ , m), (f) substrate for spawning and hatching ( $V_6$ ), (g) water temperature during hatching ( $V_7$ , °C), (h) flow velocity

during spawning ( $V_8$ , m/s), (i) suspended sediment concentration during spawning ( $V_9$ , mg/l), and (j) the amount of eggs-predating fish in the studied year in comparison to a standard year ( $V_{10}$ ). The suitable ranges and the Suitability Index ( $SI$ ) curves of the ten main eco-factors are determined based on biological research. By analyzing these eco-factors, a habitat assessment model is developed which combines these factors and can be used for assessing habitat changes caused by human activities and hydraulic processes. The habitat suitability function for the Chinese sturgeon mainly considered the suitability for juvenile and adult fish growth, spawning, and hatching.

Habitat Suitability Index:

$$HSI = \min(C_{Ad}, C_{Sp}, C_{Ha}) \quad (3.13)$$

in which  $C_{Ad}$  represents the suitability for juvenile and adult growth, given by

$$C_{Ad} = \min(V_1, V_2, V_3) \quad (3.14)$$

$C_{Sp}$  represents the suitability for spawning

$$C_{Sp} = \min(V_4, V_5, V_6) \quad (3.15)$$

$C_{Ha}$  represents the suitability for hatching

$$C_{Ha} = V_{10} \bullet \min(V_6, V_7, V_8, V_9) \quad (3.16)$$

where  $V_1$ – $V_{10}$  are the ten factors. The  $SI$  curve quantifies physical habitat such as water temperature, flow velocity, and suspended sediment concentration. The habitat suitability ranges from unsuitable (0) to optimal habitat suitability (1). The intermediate values represent the suitability range based on a specified hydraulic variable.

Biological studies discovered that adult sturgeon distribution, spawning time, and spawning site selection by brood fish are mainly influenced by water temperature ( $V_1$ ,  $V_4$ ), water depth ( $V_2$ ,  $V_5$ ), and substrate ( $V_3$ ,  $V_6$ ). The main eco-factors which influence hatching are water temperature ( $V_7$ ), flow velocity ( $V_8$ ), substrate ( $V_6$ ), suspended sediment concentration ( $V_9$ ), and the amount of the eggs-predating fish ( $V_{10}$ ). Water temperature is an essential factor for hatching; flow velocity influences the distribution of eggs and their cohesiveness on the riverbed. Excessive suspended sediment concentration may cause sturgeon eggs to debond, which then affects fertilization and hatching. According to Chang [101], 90 % of sturgeon eggs suffer predation. The data sources used to develop the SIS are listed in Table 3.10, and the  $SI$  curves are shown in Fig. 3.34. The value of  $V_{10}$  (the ratio of estimated brood sturgeon to eggs-predatory fish) is not shown in the figure, because it depends on the physical conditions and the number of the eggs-predatory fish in the previous year. In the modeling the value of  $V_{10}$  is assumed equal to 1.0, i.e., the amount of eggs-predatory fish is the lowest in the record.

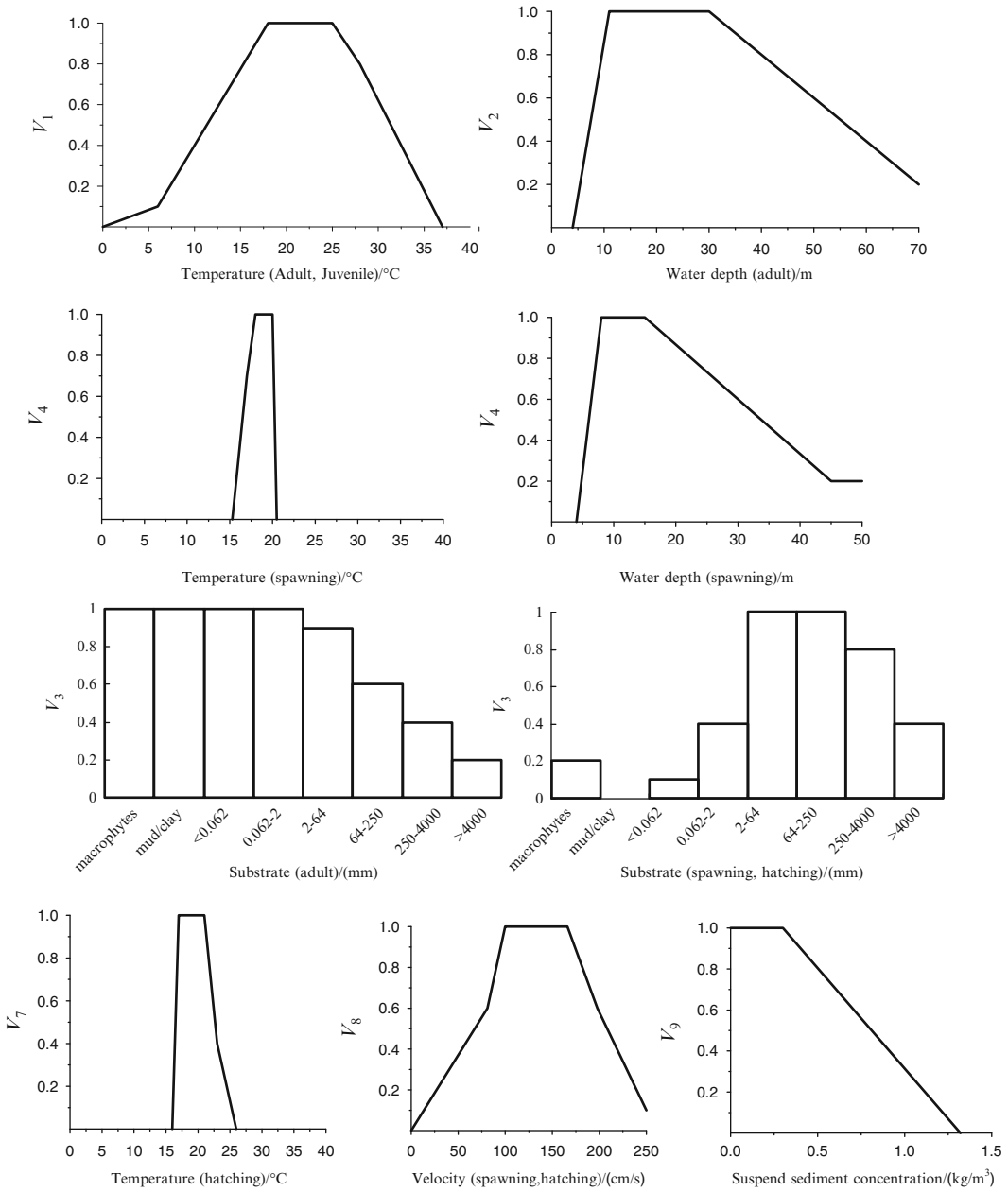
**Table 3.10**  
**Eco-factors for Chinese sturgeon (after Yi et al. 2007)**

Variables	Eco-factors	Results of previous research
$V_1$	Water temperature (adults and juveniles)	The Chinese sturgeon can survive temperatures between 0 and 37 °C; 13–25 °C is suitable for growth, and 20–22 °C is optimum. The sturgeon becomes anorexic and stops growing when temperatures fall to 9–6 °C [102]. Research results indicate that the Chinese sturgeon grows well under a wide range of temperatures; feeding has been recorded from 8 to 29.1 °C [103]. Yan (2003) found that Chinese sturgeons prefer tepid water; anorexia results and growth almost stops when temperatures are <6 °C and >28 °C; growth rate slows when temperatures are near 10 °C. 18–25 °C is an optimum range for growth; sturgeon will die when temperature is >35 °C [104]. The optimum temperature for juvenile sturgeon is 22–25 °C [105]
$V_2$	Water depth (adults)	The Chinese sturgeon is distributed in areas with 9.3–40-m water depth; 90 % of individuals are distributed at depths from 11 to 30 m; 11 Chinese sturgeons detected in the Yanzhiba to Gulaobei reach were distributed at depths from 9 to 19 m [105]
$V_3$	Substrate (adults)	Juvenile and adult Chinese sturgeons have similar substrate choices as with shortnose sturgeon in the USA. Experiments show that juvenile shortnose sturgeons prefer habitat in sand-mud substrate or gravel substrate [106]. Chinese sturgeons prefer to cruise along river channels with deep trenches and sandy dunes and are fond of resting in pools, backwaters, and places varied terrain [103]
$V_4$	Water temperature (spawning)	The spawning temperature for sturgeon is 17.0–20.0 °C; spawning will stop when temperature <16.5 °C [107]. The average temperature in the reaches downstream of the Gezhouba Dam during the sturgeon spawning period is 15.8–20.7 °C. About 79.31 % of fish are spread in the range of 17.5–19.5 °C; the average temperature of the original spawning sites in the upper reaches of the Yangtze River is 17.0–20.2 °C. Therefore, the suitable spawning temperature for Chinese sturgeon is 17.0–20.0 °C [105]. Spawning occurs when temperature is 15.3–20.5 °C; the suitable range is 17.0–20.0 °C, and the optimum is 18.0–20.0 °C [108]
$V_5$	Water depth (spawning)	More than 20 years of monitoring indicates that the length of new spawning sites is about 30 km from the tail water area of Gezhouba Dam to Gulaobei, with 10–15-m water depth [103]. The “stable spawning site of Chinese sturgeon” determined by Deng et al. (1991) has a water depth in a range from 4 to 10 m [109]

(Continued)

**Table 3.10**  
(Continued)

Variables	Eco-factors	Results of previous research
$V_6$	Substrate (spawning and hatching)	Gravel and pebbles are present in Chinese sturgeon spawning sites of [110]. The substrate of new spawning sites is composed of sand, gravel with sand, gravel, and stone and gradually coarsens from left to right bank [107]. The substrate of the original centralized spawning sites of Chinese sturgeon was mainly composed of stones and gravels [111]
$V_7$	Water temperature (hatching)	The suitable temperature for hatching is 16–22 °C; the optimum is 17–21 °C. The hatching rate decreases when at temperature <16 °C; deformity rate increases at temperature >23 °C. The temperature should be stable when zoosperms are hatching; abnormal fetation or death will occur with even small fluctuations in temperature of 3–5 °C [112]. Water temperature for cultivating fries should be between 12 and 29 °C; the most suitable temperature is 16–24 °C [113]
$V_8$	Flow velocity (spawning)	Sturgeons prefer spawning areas with flow velocity of 0.08–0.14 m/s at the bottom, 0.43–0.58 m/s in the middle, and 1.15–1.70 m/s at the surface [114]. The surface flow velocity at spawning areas is 1.1–1.7 m/s [110]. The flow velocity of spawning areas during spawning season ranges from 0.82 to 2.01 m/s; 57.69 % of fish are distributed between 1.2 and 1.5 m/s. When spawning occurs during periods when water levels are falling, the daily fluctuation range of flow velocity is 0.82–1.86 m/s, with an average of 1.24 m/s. The daily maximum fluctuation range is 1.20–2.33 m/s, with an average of 1.56 m/s. When spawning activity occurs during periods when water levels are rising, the daily fluctuation range of flow velocity is 1.17–2.01 m/s, with an average of 1.55 m/s [105]. According to 31 records from 1983 to 2000, the average flow velocity on spawning day was between 0.81 and 1.98 m/s, and 81 % took place in the range of 1.00–1.66 m/s [108]
$V_9$	Suspended sediment concentration (spawning)	The suspended sediment concentration in reaches downstream from the Gezhouba Dam is between 0.073 and 1.290 kg/m <sup>3</sup> , with an average of 0.508 kg/m <sup>3</sup> . About 66.67 % of fish are distributed between 0.3 and 0.7 kg/m <sup>3</sup> . When spawning activity occurs during periods of falling water level, the daily average suspended sediment concentration varies between 0.17 and 1.29 kg/m <sup>3</sup> , with an average of 0.52 kg/m <sup>3</sup> . When spawning activity occurs during periods of rising water levels, the daily average suspended sediment concentration varies between 0.41 and 1.02 kg/m <sup>3</sup> , with an average of 0.61 kg/m <sup>3</sup> [107]. The suitable range of suspended sediment concentration for Chinese sturgeon is 0.10–1.32 kg/m <sup>3</sup> . From 1983 to 2000, 15 of 31 spawning events were in the range of 0.2–0.3 kg/m <sup>3</sup> [108]



**Fig. 3.34.** Suitability Index curves for habitat of Chinese sturgeon.

3.4.5. Vegetation-Hydroperiod Modeling

Vegetation-hydroperiod modeling is a very useful tool for habitat evaluation. Hydroperiod is defined as the depth, duration, and frequency of inundation and is a powerful determinant of what plants are likely to be found in various positions in the riparian zone, as





**Fig. 3.35.** Soil moisture conditions determine the plant communities in riparian areas of the Nile River in Sudan.

shown in Fig. 3.35. In most cases, the dominant factor that makes the riparian zone distinct from the surrounding uplands, and the most important gradient in structuring variation within the riparian zone, is site moisture conditions or hydroperiod. Formalizing this relation as a vegetation-hydroperiod model can provide a powerful tool for analyzing existing distributions of riparian vegetation, casting forward or backward in time to alternative distributions, and designing new distributions. The suitability of site conditions for various species of plants can be described with the same conceptual approach used to model habitat suitability for animals. The basic logic of a vegetation-hydroperiod model is straightforward. It is possible to measure how wet a site is and, more importantly, to predict how wet a site will be. From this, it is possible to estimate what vegetation is likely to occur on the site.

The two basic elements of the vegetation-hydroperiod relation are the physical conditions of site moisture at various locations and the suitability of those sites for various plant species. In the simplest case of describing existing patterns, site moisture and vegetation can be directly measured at a number of locations. However, to use the vegetation-hydroperiod model to predict or design new situations, it is necessary to predict new site moisture conditions. The most useful vegetation-hydroperiod models have the following three components [30]:

1. Characterization of the hydrology or pattern of stream flow—This can take the form of a specific sequence of flows, a summary of how often different flows occur, such as a flow duration or flood frequency curve, or a representative flow value, such as bankfull discharge or mean annual discharge.
2. A relation between stream flow and moisture conditions at sites in the riparian zone—This relation can be measured as the water surface elevation at a variety of discharges and summarized as a stage versus discharge curve. It can also be calculated by a number of hydraulic models that relate water surface elevations to discharge, taking into account variables of channel geometry and

roughness or resistance to flow. In some cases, differences in simple elevation above the channel bottom may serve as a reasonable approximation of differences in inundating discharge.

3. A relation between site moisture conditions and the actual or potential vegetation distribution— This relation expresses the suitability of a site for a plant species or cover type based on the moisture conditions at the site. It can be determined by sampling the distribution of vegetation at a variety of sites with known moisture conditions and then deriving probability distributions of the likelihood of finding a plant on a site given the moisture conditions at the site. General relations are also available from the literature for many species.

In altered or degraded stream systems, current moisture conditions in the riparian zone may be dramatically unsuitable for the current, historical, or desired riparian vegetation. Several conditions can be relatively easily identified by comparing the distribution of vegetation to the distribution of vegetation suitabilities.

The hydrology of the stream has been altered, for example, if stream flow has diminished by diversion or flood attenuation; sites in the riparian zone may be drier and no longer suitable for the historic vegetation or for current long-lived vegetation that was established under a previous hydrologic regime. The inundating discharges of plots in the riparian zone have been altered so that stream flow no longer has the same relation to site moisture conditions; for example, levees, channel modifications, and bank treatments may have either increased or decreased the discharge required to inundate plots in the riparian zone. The vegetation of the riparian zone has been directly altered, for example, by clearing or planting so that the vegetation on plots no longer corresponds to the natural vegetation for which the plots are suitable.

Temporal variability is a particularly important characteristic of many stream ecosystems. Regular seasonal differences in biological requirements are examples of temporal variability that are often incorporated into biological analyses based on habitat suitability and time series simulations. The need for episodic extreme events is easy to ignore because these are as widely perceived as destructive both to biota and constructed river features. In reality, however, these extreme events seem to be essential to physical channel maintenance and to the long-term suitability of the riverine ecosystem for disturbance-dependent species.

Cottonwood in riparian systems in the western USA is one well-understood case of a disturbance-dependent species. Cottonwood regeneration from seed is generally restricted to bare, moist sites. Creating these sites depends heavily on channel movement (meandering, narrowing, and avulsion) or new flood deposits at high elevations. In some riparian systems, channel movement and sediment deposition on flood plains tend to occur infrequently in association with floods. The same events are also responsible for destroying stands of trees. Thus, maintaining good conditions for existing stands, or fixing the location of a stream's banks with structural measures, tends to reduce the regeneration potential and the long-term importance of this disturbance-dependent species in the system as a whole.

There is a large body of information on the flooding tolerances of various plant species. Summaries of this literature include Whitlow and Harris [115] and the multivolume *Impact of Water Level Changes on Woody Riparian and Wetland Communities* [116, 117]. This type of information can be coupled to site moisture conditions predicted by applying discharge estimates or flood frequency analyses to the inundating discharges of sites in the riparian

zone. The resulting relation can be used to describe the suitability of sites for various plant species, e.g., relatively flood-prone sites will likely have relatively flood-tolerant plants. Inundating discharge is strongly related to relative elevation within the floodplain. Other things being equal (i.e., within a limited geographic area and with roughly equivalent hydrologic regimes), elevation relative to a representative water surface line, such as bankfull discharge or the stage at mean annual flow, can, thus, provide a reasonable surrogate for site moisture conditions. Locally determined vegetation suitability can then be used to determine the likely vegetation in various elevation zones.

## REFERENCES

1. Shiklomanov IA (1998) Assessment of water resources and water availability in the world, Report for the Comprehensive Assessment of Freshwater Resources of the World, New York, United Nations, USA
2. Ittekkot V, Humborg C, Schaefer P (2000) Hydrological alterations and marine biogeochemistry: a silicate issue? *Bioscience* 50:776–782
3. Dunne T, Leopold LB (1978) *Water in environmental planning*. Freeman, San Francisco, CA
4. Bayley PB, Li HW (1992) Riverine fish. In: Calow P, Petts GE (eds) *The rivers handbook*. Blackwell, Oxford, pp 251–281
5. Reynolds CS, Calow P, Petts GE (1992) Chapter 9: algae. In: *The rivers handbook*. Blackwell, Oxford, pp 195–215
6. Ward JV (ed) (1992) *Aquatic insect ecology: biology and habitat*. Wiley, New York, NY
7. Ruttner F (ed) (1963) *Fundamentals of limnology*. University of Toronto Press, Toronto
8. Sweeney BW (1984) Factors influencing life-history patterns of aquatic insects. In: Resh VH, Rosenberg DM (eds) *The ecology of aquatic insects*. Praeger, New York, NY, pp 56–100
9. Hynes HBN (ed) (1970) *The ecology of running waters*. University of Liverpool Press, Liverpool
10. Cole GA (ed) (1994) *Textbook of limnology*, 4th edn. Waveland Press, Prospect Heights, IL
11. Lynch JA, Corbett ES, Sopper WE (1980) Evaluation of management practices on the biological and chemical characteristics of streamflow from forested watersheds. Technical Completion Report A- 041-PA. Institute for Research on Land and Water Resources, The Pennsylvania State University, State College
12. Sweeney BW (1992) Streamside forests and the physical, chemical, and trophic characteristics of piedmont streams in eastern North America. *Water Sci Technol* 26(12):2653–2673
13. Mackenthun KM (1969) *The practice of water pollution biology*. U.S. Department of the Interior, Federal Water Pollution Control Administration, Washington, DC: Division of Technical Support. U.S. Government Printing Office
14. Needham PR (ed) (1969) *Trout streams: conditions that determine their productivity and suggestions for stream and lake management* (revised by Bond, C. F.). Holden-Day, San Francisco
15. Odum EP (ed) (1971) *Fundamentals of ecology*, 3rd edn. Saunders, Philadelphia, PA
16. Walburg CH (1971) Zip code H<sub>2</sub>O. In: Saults D, Walker M, Hines B, Schmidt RG (eds) *Sport fishing USA*. U.S. Government Printing Office, U.S. Department of the Interior, Bureau of Sport Fisheries and Wildlife, Fish and Wildlife Service, Washington, DC, p 464
17. Schreiber K (1995) Acidic deposition (“acid rain”). In: LaRoe T, Ferris GS, Puckett CE, Doran PD, Mac MJ (eds) *Our living resources: a report to the nation on the distribution, abundance, and*

- health of U.S. plants, animals, and ecosystems. U.S. Department of the Interior, National Biological Service, Washington, DC, pp 418–420
18. Benke AC, Van Arsdall JR, Gillespie DM, Parrish FK (1984) Invertebrate productivity in a subtropical blackwater river: The importance of habitat and life history. *Ecol Monogr* 54 (1):25–63
  19. Smock LA, Gilinsky E, Stoneburner DL (1985) Macroinvertebrate production in a southeastern United States blackwater stream. *Ecology* 66(5):1491–1503
  20. Huryn AD, Wallace JB (1987) Local geomorphology as a determinant of macrofaunal production in a mountain stream. *Ecology* 68(6):1932–1942
  21. Minshall GW (1984) Aquatic insect-substratum relationships. In: Resh VH, Rosenberg DM (eds) *The ecology of aquatic insects*. Praeger, New York, pp 358–400
  22. Bisson RA, Bilby RE, Bryant MD, Dolloff CA, Grette GB, House RA, Murphy MJ, Koski KV, Sedell JR (1987) Large woody debris in forested streams in the Pacific Northwest: past, present, and future. In: Salo EO, Cundy TW (eds) *Streamside management: forestry and fishery interactions*. Institute of Forest Resources, University of Washington, Seattle, pp 143–190
  23. Dolloff CA, Flebbe PA, Owen MD (1994) Fish habitat and fish populations in a southern Appalachian watershed before and after hurricane Hugo. *Trans Am Fish Soc* 123(4):668–678
  24. Moss B (ed) (1988) *Ecology of fresh waters: man and medium*. Blackwell, Boston
  25. McKeown BA (1984) *Fish migration*. Timber, Beaverton, OR
  26. B-18 Stream Corridor McLaughlin Water Engineers, Ltd (1986) Evaluation of and design recommendations for drop structures in the Denver Metropolitan Area. A report prepared for the Denver Urban Drainage and Flood Control District by McLaughlin Water Engineers, Ltd
  27. Brouha P (1997) Good news for U.S. fisheries. *Fisheries* 22:4
  28. Forman RTT, Godron M (eds) (1986) *Landscape ecology*. Wiley, New York
  29. Dramstad WE, Olson JD, Gorman RT (eds) (1996) *Landscape ecology principles in landscape architecture and land-use planning*. Island, Washington, DC
  30. FISRWG (the Federal Interagency Stream Restoration Working Group) (ed) (1997) *Stream corridor restoration*. The National Technical Information Service, Washington, DC
  31. Forman RTT (ed) (1995) *Land mosaics: the ecology of landscapes and regions*. Cambridge Univ. Press, Cambridge
  32. Wesche TA (1985) Stream channel modifications and reclamation structures to enhance fish habitat (Chapter 5). In: Gore JA (ed) *The restoration of rivers and streams*. Butterworth, Boston, pp 103–159
  33. Walter H (ed) (1985) *Vegetation of the earth*, 3rd edn. Springer, New York
  34. Brady W, Patton DR, Paxson, J (1985) The development of southwestern riparian gallery forests. In: *Riparian Ecosystems and Their Management: Reconciling Conflicting Uses*, Johnson RR, Ziebell CD, Patton DR, Ffolloitt PF, Hamre RH, (eds) Service General Technical Report RM-120, Rocky Mountain Forest and Range Experiment Station, Fort Collins, USDA Forest, Colorado. p. 39–43
  35. Wang HZ, Wang HJ (2008) Ecological impacts of cut-off of the connection of lakes with the Yangtze River and restoration strategies. In: Wang ZY (ed) *Yangtze river ecology and optional operation of hydraulic engineering*. Science, Beijing, pp 379–396 (in Chinese)
  36. Schueler T (1995) The importance of imperviousness. *Watershed Protect Tech* 1(3):100–111
  37. Cole DN, Marion JL (1988) Recreation impacts in some riparian forests of the eastern United States. *Environ Manage* 12(1):99–107

38. Darrigran G, Damborenea C, Penchaszadeh P (2003) Reproductive stabilization *limnoperna fortunei* (Bivalvia Mytilidae) after ten years of invasion in the Americas. *J Shellfish Res* 22 (1):1–6
39. Morton B (1982) The reproductive cycle in *Limnoperna fortunei* (Dunker 1857) (Bivalvia: Mytilidae) fouling Hong Kong's raw water supply system. *Oceanologia et Limnologia Sinica* 13(4):312–324
40. Darrigran G, Damborenea C (eds) (2006) Bio-invasión del mejillón dorado en el continente americano. Univ de La Plata, La Plata (in Spanish)
41. Márcia D (2006) The limnological characteristics of aquatic environments which support the golden mussel (*Limnoperna Fortunei*, Dunker, 1857) and the potential of the golden mussel to further spread within the Paraguay River Basin, Brazil. 14th International Conference on Aquatic Invasive Species, Florida
42. Yamada Y, Kurita K, Kawauchi N (1997) Countermeasures for *Limnoperna fortunei* in Isojima Intake facilities. In: Proceedings of the 24th Conference of Construction Technology, Japan Water Works Association, Osaka. pp 230–234
43. Darrigran G (2002) Potential impact of filter-feeding invaders on temperate inland freshwater environments. *Biol Invasions* 4(1–2):145–156
44. Guan F, Zhang XH (2005) Research on the oxygen consumption and ammonia excretion of invasive mussel *Limnoperna fortunei* in raw water transport pipeline. *Water Wastewater Eng* 31 (11):23–26 (in Chinese)
45. Dudgeon D, Corlett R (eds) (2004) The ecology and biodiversity in Hong Kong. Friends of the Country Park and Joint Publishing (HK) Company Ltd, Hong Kong
46. Landres PB, Verner J, Thomas JW (1988) Ecological uses of vertebrate indicator species: a critique. *Conserv Biol* 2:316–328
47. Erman NA (1991) Aquatic invertebrates as indicators of biodiversity. In: Proceedings of a Symposium on Biodiversity of Northwestern California, Santa Rosa, California, University of California, Berkeley
48. Wallace JB, Gurtz ME (1986) Response of *Baetis* mayflies (Ephemeroptera) to catchment logging. *Am Midl Nat* 115:25–41
49. Plafkin JL, Barbour MT, Porter KD, Gross SK, Hughes RM (eds) (1989) Rapid bioassessment protocols for Use in streams and rivers, EPA444/4-89-001. U.S. Environmental Protection Agency, Washington, DC
50. Demars BOL, Kemp JL, Friberg N, Usseglio-Polatera P, Harper DM (2012) Linking biotopes to invertebrates in rivers: biological traits, taxonomic composition and diversity. *Ecol Indic* 23:301–311
51. Kail J, Arle J, Jähnig SC (2012) Limiting factors and thresholds for macroinvertebrate assemblages in European rivers: empirical evidence from three datasets on water quality, catchment urbanization, and river restoration. *Ecol Indic* 18:63–72
52. Duan XH, Wang ZY, Cheng DS (2007) Benthic macroinvertebrates communities and biodiversity in various stream substrata. *Acta Ecol Sin* 27(4):1664–1672 (in Chinese)
53. Liu YY, Zhang WZ, Wang X (eds) (1979) Economic fauna of china: freshwater mollusk. Science, Beijing (in Chinese)
54. Barbour MT, Gerritsen BD, Snyder BD, Stribling JB (1999) Benthic macroinvertebrate protocols. In: Barbour MT, Gerritsen BD, Snyder BD, Stribling JB (eds) Rapid bioassessment protocols for Use in streams and wadeable rivers, volume 7, periphyton, benthic

- macroinvertebrates and fish. U.S. Environmental Protection Agency, Office of Water, Washington, DC, EPA 841-B-99-002
55. Van Horne B (1983) Density as a misleading indicator of habitat quality. *J Wildl Manag* 47:893–901
  56. Hocutt CH (1981) Fish as indicators of biological integrity. *Fisheries* 6(6):28–31
  57. Karr JR, Fausch KD, Angermeier PL, Yant PR, Schlosser IJ (eds) (1986) Assessing biological integrity in running waters: A method and its rationale. Illinois Natural History Survey Special Publication, Champaign, IL, p 28, No 5
  58. Croonquist MJ Brooks RP, Bellis ED, Keener CS, Croonquist MJ, Arnold DE (1991) A methodology for biological monitoring of cumulative impacts on wetland, stream, and riparian components of watershed. In: Kusler JA, Daly S (eds) *Proceedings of an International Symposium: Wetlands and River Corridor Management*, Charleston, South Carolina. pp 387–398
  59. Verner J (1984) The guild concept applied to management of bird populations. *Environ Manage* 8:1–14
  60. Weitzel RL (1979) Periphyton measurements and applications. In: Weitzel RL (ed) *Methods and Measurements of Periphyton Communities: A Review*. Special publication 690, American Society for Testing and Materials. pp 3–33
  61. Rodgers JH, Jr, Dickson KL Cairns J, Jr. (1979) A review and analysis of some methods used to measure functional aspects of periphyton. In: Weitzel RL (ed) *Methods and Measurements of Periphyton Communities: A Review*. Special publication 690, American Society for Testing and Materials. pp 142–167
  62. Magurran AE (ed) (1988) *Ecological diversity and its measurement*. Princeton University Press, Princeton, NJ
  63. Meffe GK, Carroll CR, and contributors (eds) (1994). *Principles of conservation biology*. Sinauer Associates, Inc., Sunderland, MA
  64. Ricklefs RE (ed) (2001) *The economy of nature*. Freeman, New York
  65. Margalef R (1957) La teoria de la informacion en ecologia. *Mem. Real Acad. Ciencias Artes Barcelona* 32:373–499
  66. Krebs CJ (ed) (1978) *Ecology: the experimental analysis of distribution and abundance*, 2nd edn. Harper and Row, New York
  67. Wang ZY, Melching CS, Duan XH, Yu GA (2009) Ecological and hydraulic studies of step-pool systems. *J Hydraul Eng* 135(9):705–717
  68. Wang ZY, Lee JHW, Cheng DS, Duan XH (2008) Benthic invertebrates investigation in the East River and habitat restoration strategies. *J Hydro Environ Res* 2(1):19–27
  69. Ricklefs RE (ed) (1990) *Ecology*. Freeman, New York
  70. Schroeder RL, Keller ME (1990) Setting objectives: a prerequisite of ecosystem management. *N Y State Museum Bull* 471:1–4
  71. Noss RF, Harris LD (1986) Nodes, networks, and MUMs: Preserving diversity at all scales. *Environ Manage* 10(3):299–309
  72. Wang ZY, Melching CS, Duan XH, Yu GA (2009) Ecological and hydraulic studies of step-pool systems. *ASCE J Hydraulic Eng* 134(9):705–717
  73. Simon TP, Lyons J (1995) Application of the index of biotic integrity to evaluate water resources integrity in freshwater ecosystems. In: Davis WS, Simon TP (eds) *Biological assessment and criteria: tools for water resources planning and decision making*. Lewis, Boca Raton, FL, pp 245–262
  74. Karr JR (1981) Assessment of biotic integrity using fish communities. *Fisheries* 6(6):21–27

75. Miller DL, Hughes RM, Karr JR, Leonard PM, Moyle PB, Schrader LH, Thompson BA, Daniels RA, Fausch KD, Fitzhugh GA, Gammon JR, Halliwell DB, Angermeier PL, Orth DJ (1988) Regional applications of an index of biotic integrity for use in water resource management. *Fisheries* 13(5):12–20
76. Lyons J (1992) Using The Index of Biotic Integrity (IBI) to Measure Environmental Quality in Warmwater Streams of Wisconsin. U.S. Department of Agriculture, Forest Service, North Central Forest Experiment Station, General Technical Report NC-149, St. Paul, MN, p 48
77. Limnotech (2009) Review and selection of fish metrics for the Chicago Area Waterway System habitat evaluation and improvement study, Report Prepared for the Metropolitan Water Reclamation District of Greater Chicago, Ann Arbor, MI, p 37
78. Hu TJ, Wang HW, Lee HY (2005) Environmental and ecological measures of river corridor on Nan-Shih Stream in Taiwan, Proceedings (CD-ROM), XXXI Congress of the International Association for Hydraulic Engineering and Research, Seoul, Korea, 11–16 September 2005
79. Lyons J, Piette RR, Niermeyer KW (2001) Development, validation, and application of a fish-based index of biotic integrity for Wisconsin's large warmwater rivers. *Trans Am Fish Soc* 130:1077–1094
80. Manolakos E, Virani H, Novotny V (2007) Extracting knowledge on the links between water body stressors and biotic integrity. *Water Res* 41:4041–4050
81. O'Reilly N (2007) The development and evaluation of methods for quantifying environmental stress to fish in warm-water streams of Wisconsin using self-organized maps: Influences of watershed and habitat stressors, Ph.D. Dissertation, Marquette University, Milwaukee, WI
82. Novotny V, Bedoya D, Virani H, Manolakos E (2008) Linking indices of biotic integrity to environmental and land use variables—Multimetric clustering and predictive models, Proceedings, IWA World Water Congress, Vienna, Sept. 2008, p 8
83. Bedoya D, Novotny V, Manolakos E (2009) Instream and offstream environmental conditions and stream biotic integrity. *Ecol Modeling* 220(19):2393–2406
84. Ohio Environmental Protection Agency (EPA) (1990) Use of biocriteria in the Ohio EPA surface water monitoring and assessment program. Ohio Environmental Protection Agency, Division of Water Quality Planning and Assessment, Columbus, OH
85. Hilsenhoff WL (1982) Using a biotic index to evaluate water quality in streams. Department of Natural Resources, Madison, WI
86. Knopf FL (1986) Changing landscapes and the cosmopolitanism of the eastern Colorado avifauna. *Wildl Soc Bull* 14:132–142
87. Fretwell SD, Lucas HL (1970) On territorial behavior and other factors influencing habitat distribution in birds. I. Theoretical development. *Acta Biotheor* 19:16–36
88. Gorman OT, Karr JR (1978) Habitat structure and stream fish communities. *Ecology* 59:507–515
89. Beauger A, Lair N, Reyes-Marchant P, Peiry JL (2006) The distribution of macro-invertebrate assemblages in a reach of the River Allier (France), in relation to riverbed characteristics. *Hydrobiologia* 571:63–76
90. Gippel CJ (1995) Environmental hydraulics of large woody debris in streams and rivers. *J Environ Eng* 121:388–395
91. Abbe TB, Montgomery DR (1996) Large woody debris jams, channel hydraulics and habitat formation in large rivers. *Regul Rivers Res Manag* 12:201–221
92. Schamberger M, Farmer AH, Terrell JW (1982) Habitat Suitability Index Models: Introduction, FWS/OBS-82/10. U.S. Department of the Interior, U.S. Fish and Wildlife Service, Washington, DC

93. USFWS (United States Fish and Wildlife Service) (1981) Standards for the Development of Habitat Suitability Index Models, ESM 103. U.S. Department of the Interior, Fish and Wildlife Service, Washington, DC
94. Schroeder RL, Haire SL (1993) Guidelines for the development of community-level habitat evaluation models. Biological Report 8. U.S. Department of the Interior, U.S. Fish and Wildlife Service, Washington, DC
95. Bovee KD (ed) (1982) A guide to stream habitat analysis using the instream flow incremental methodology. U.S. Fish and Wildlife Service, Washington, DC
96. Nestler J, Schneider T, Latka D (1993) RCHARC: A new method for physical habitat analysis. *Eng Hydrol* 294–299
97. Abt SR (1995) Settlement and submergence adjustments for Parshall flume. *J Irrig Drain Eng* 121 (5):317–321
98. Bartholow JM, Laake JL, Stalnaker CB, Williamson SC (1993) A salmonid population model with emphasis on habitat limitations. *Rivers* 4:265–279
99. Williamson SC, Bartholow JM, Stalnaker CB (1993) Conceptual model for quantifying pre-smolt production from flow-dependent physical habitat and water temperature. *Regul Rivers Res Manag* 8:15–28
100. Yi YJ, Wang ZY, Lu YJ (2007) Habitat suitability index model of Chinese sturgeon in the Yangtze River. *Adv Water Sci* 18(4):538–543 (in Chinese)
101. Chang JB (1999) Change trend of composition characteristic and number of Chinese sturgeon propagation colony, Ph.D. dissertation, Institute of Hydrobiology, Chinese Academy of Sciences, Wuhan. (in Chinese)
102. NERCITA (National Engineering Research Center for Information Technology in Agriculture) (2004a) Culture Technology of Chinese Sturgeon. [http://www.nercita.org.cn/sturgeon\\_zzxt/](http://www.nercita.org.cn/sturgeon_zzxt/) (in Chinese)
103. Guo ZD, Lian CP (2001) Experiment of Chinese sturgeon breed aquatics in small water body. *Fishery Sci* 20(2):15–16 (in Chinese)
104. Yan YY (2003) Biological characteristic and culture methods for Chinese sturgeon. *Fishery Sci* 5:14–16 (in Chinese)
105. Wei QW (ed) (2005) Reproductive behavioral ecology of Chinese sturgeon with its stock assessment [D], institute of hydrobiology. Chinese Academy of Sciences, Wuhan (in Chinese)
106. Zhang J (1998) Technical points on sturgeon breed aquatics. *Beijing Fishery* 1:18–20 (in Chinese)
107. Hu DG, Ke FE, Zhang GL et al (1992) Investigation of Chinese sturgeon spawning sites in downstream of the Gezhouba Dam. *Freshwater Fishery* 5:6–10 (in Chinese)
108. Yang DG, Wei QW, Chen XH et al (2007) Hydraulic status and on the spawning grounds of Chinese sturgeon below the Gezhouba Dam and its relation to the spawning run. *Acta Ecol Sin* 27(3):862–869 (in Chinese)
109. Deng ZL, Xu YG, Zhao Y (eds) (1991) Analysis on *Acipenser sinensis* spawning ground and spawning scales below the Gezhouba Dam by means of examining the digestive contents of benthic fish. CEMAGREF, Bordeaux, p 243 (in Chinese)
110. Li AP (1999) Protection of sturgeon in the Yangtze river. *J Taiyuan Normal Collage* 4:46–47 (in Chinese)
111. Xing XC (2003) Rare Chinese sturgeon and paddlefish in china. *Bull Biol* 38(9):10–11 (in Chinese)



112. NERCITA (National Engineering Research Center for Information Technology in Agriculture) (2004b) Artificial Propagation of Chinese sturgeon. [http://www.nercita.org.cn/sturgeon\\_zzxt/](http://www.nercita.org.cn/sturgeon_zzxt/) (in Chinese)
113. Wang CL, Teng Y, Liu CL (2002) Propagation characteristic and development utilization of Chinese sturgeon. *Fishery Sci Technol Informat* 29(4):174–176 (in Chinese)
114. Li SF (ed) (2001) A Study on biodiversity and its conservation of major fish in the Yangtze River, Shanghai Science & Technology, Publication. (in Chinese)
115. Whitlow TH, Harris RW (1979) Flood tolerance in plants: A state-of-the-art review. Environmental and Water Quality Operational Studies. Technical Report E-79-2. U.S. Army Corps of Engineers Waterways Experiment Station, Vicksburg, MS
116. Chapman RJ, Hinckley TM, Lee LC, Teskey RO (eds) (1982). Impact of Water Level Changes on Woody Riparian and Wetland Communities, Vol. X. FWS/OBS-82/23. U.S. Department of Agriculture, Fish and Wildlife Service
117. Teskey RO, Hinckley TM (eds) (1978). Impact of Water Level Changes on Woody Riparian and Wetland Communities, Vols. I, II, and III. FWS/OBS-77/58,—77/59, and -77/60, U.S. Department of Agriculture, Fish and Wildlife Service

Hyoseop Woo

*CONTENTS*

INTRODUCTION

OVERVIEW OF RIVER AND DISTURBANCES AFFECTING RIVER

RIVER RESTORATION PLANNING AND DESIGN

RESTORATION IMPLEMENTATION, MONITORING, AND ADAPTIVE MANAGEMENT

APPENDIX: GUIDELINES AND HANDBOOKS OF RIVER RESTORATION (WRITTEN  
IN ENGLISH) (IN CHRONOLOGICAL ORDER)

REFERENCES

**Abstract** River restoration is to regain the ecological integrity and enhance the human well-being by reestablishing the natural hydrologic, geomorphic, and ecological processes, in a self-sustainable manner by possibly, but not necessarily, referring to a pre-disturbance state. This chapter starts with an introductory part of the basic concepts and definitions of river restoration. Following, this chapter introduces an overview of a river in terms of the physical, chemical, and biological characteristics in conjunction with river restoration. Disturbances affecting the river and problems caused by such are briefly explained. For river restoration planning, the goals and objectives of river restoration, planning process, site assessment, and investigations are explained. For river restoration design, channel design, in-stream habitat structures, riverbank restoration, channel–floodplain connectivity, and riparian restoration are explained. Finally, the restoration implementation, monitoring, and adaptive management are then explained. This chapter mainly focuses on an ecological river restoration, excluding enhancements of the amenities or the aesthetic values of such a restoration. It also does not relate to the restoration of the river water quality, which is equally as important as the restoration of river itself.

**Key Words** River restoration • River disturbances • Planning and design • Monitoring • Adaptive management.

## 1. INTRODUCTION

### 1.1. Scope

This chapter has the purpose and aims to describe the definition and basic concepts of river restoration, followed by an overview of a river and disturbances affecting a river, river restoration planning and design, and the implementation/monitoring/management of river restoration projects.

Explained further, this chapter starts with an introductory part of the scope of this handbook, the basic concepts, and definitions of river restoration including, among others, the restoration and rehabilitation. Following, this chapter introduces an overview of a river such as the physical, chemical, and biological characteristics in conjunction with river restoration including, among others, the ecological structures and the functions of a river habitat. Also, disturbances affecting the river and problems caused by such are briefly explained. From the next parts, the core contents of this chapter are then introduced, such as river restoration planning and design. For river restoration planning, the goals and objectives of river restoration, planning process, site assessment, and investigations are explained. For river restoration design, channel design, in-stream habitat structures, riverbank restoration, channel–floodplain connectivity, and riparian restoration are fully explained. Finally, the restoration implementation, monitoring, and adaptive management are then explained.

This chapter focuses on an ecological river restoration, excluding any enhancement of the amenities or the aesthetic values of such a restoration, which may be practically important especially to the urban rivers. Readers who are interested in such topics may refer to the literature of URBEM [1].

This chapter also does not relate to the restoration of the river water quality, which is equally as important as the restoration of river itself. That topic will be dealt with in a separate chapter in the handbook. Readers who want to know the water quality restoration can refer to the Volume 4, *Water Resources and Natural Control Processes*, of Handbook of Environmental Engineering [2] or the corresponding chapter of this handbook.

This chapter focuses mainly on the technical aspects of a river restoration project, excluding the decision-making processes and public participation of such a restoration project, which are especially important to the “watershed approach” [3]. Watershed usually covers multiple land ownerships, and often complex patchworks of private and public lands latticed with the transportation infrastructure networks and utility easements. Planning river restoration, therefore, requires some level of participation by the many stakeholders in the watershed, leading to the general public consensus and support for the works, of which dramatically increases the likelihood of the success and positive long-term outcomes. Readers who are interested in the decision-making processes and the stakeholders’ participation in the planning and design of a restoration project can refer to other documents on river restoration as such listed in [Appendix](#).

This chapter is based mainly on the existing manuals or texts for river restoration published in the USA, including the Federal Interagency Stream Corridor Restoration Handbook [4],

Stream Restoration Design of NRCS [5], and Chap. 9 *Stream Restoration* of Sedimentation Engineering of ASCE [6].

[Appendix](#) of this chapter lists some well-documented (in English) guidelines, manuals, and handbooks for river restoration in the world and their relevant URL addresses.

## 1.2. Backgrounds and Basic Concepts

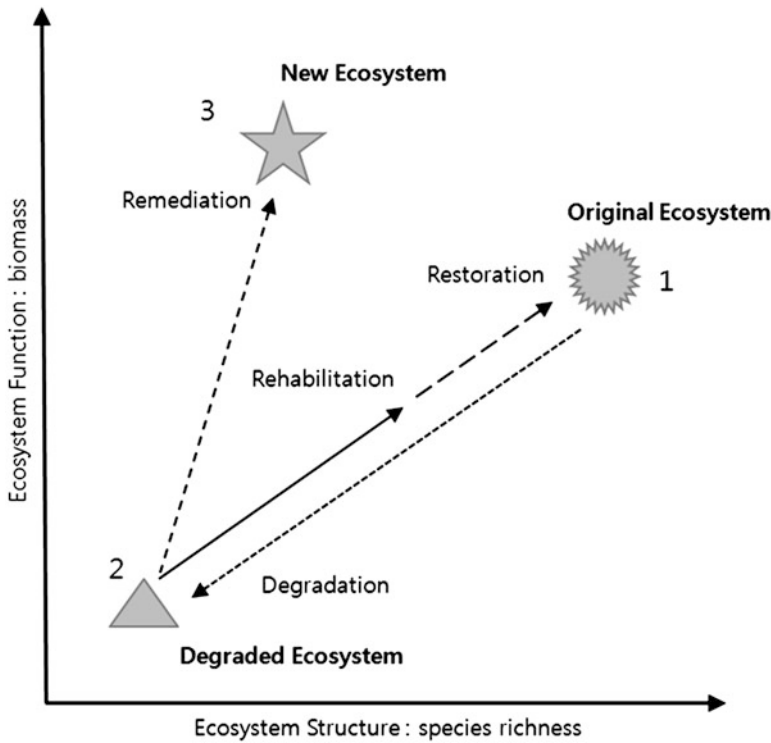
The Clean River Act of 1972, or the Federal Water Pollution Control Act as it is officially known, is for the restoration and maintenance of the chemical, physical, and biological integrity of the nation's waters in the USA. It may be a starting point of river restoration in a broad sense. One of the two main goals of the law is to achieve water quality levels that create a fishable and swimmable habitat.

Since then, during the 1980s and 1990s, river restoration has been based generally on a pre-disturbance state [7]. Here, the desired conditions are usually defined as a pre-major impacted state, for example, preindustrial or presettlement states in a long-term sense or pre-dam or preflood control river works in a short-term sense. A similar definition for river (or stream) restoration and the related terms are found in the manual of river restoration [4]. In that manual, the following three terms are defined:

- *Restoration*: a reestablishment of the structure and function of ecosystems. Ecological restoration is the process of returning an ecosystem as closely as possible to pre-disturbance conditions and functions.
- *Rehabilitation*: making the land useful again after a disturbance, mainly involving the recovery of the ecosystem functions and processes in a degraded habitat. It does not necessarily reestablish the pre-disturbance condition, but does involve establishing geological and hydrologically stable landscapes that support the natural ecosystem mosaic.
- *Reclamation*: a series of activities intended to change the biophysical capacity of an ecosystem. It has implied the process of adapting wild or natural resources to serve a utilitarian human purpose such as the conversion of riparian or wetland ecosystems to agricultural, industrial, or urban uses.

Meanwhile, the first two terms are used for the remaking of the land and ecosystem after a disturbance, while the third one is used mainly for the changing of the land use for human purposes regardless of the disturbance. This chapter, therefore, is concerned with only the first two categories.

On the other hand, an Australian manual for stream restoration [8] introduces *remediation* in addition to restoration and rehabilitation, which is based on Bradshaw's work on the principle of restoration [9]. Also, that manual differentiates between restoration and rehabilitation differently from the literature [4]. According to that manual, restoration involves only returning the stream to the original, for example, pre-European condition, while rehabilitation involves fixing only some aspects of the stream, but generally returning the degraded stream closer to the original condition. Remediation, on the other hand, recognizes that the stream has changed so much that the original condition is no longer relevant and aims for some entirely new condition. Figure 4.1 shows the relative positions of the three definitions. A question can arise from the Bradshaw's definition of rehabilitation and restoration [9] as shown in Fig. 4.1. Strictly speaking, in most cases of river restoration projects, there is no practical way of



**Fig. 4.1.** Relative positions of restoration, rehabilitation, and remediation [8] (with permission from NRC Research Press).

measuring how close a restored stream is to their original states. The ecological closeness of before and after the restoration works, unlike geomorphologic or hydrologic closeness, may not be obtained due to the dynamic nature of ecosystems once an ecological system is disturbed and changed for a long time. In this sense, differentiation between the two definitions is hardly possible in most practical cases. Rather, the two definitions of *restoration* and *rehabilitation* in Fig. 4.1 can be combined into the definition of *restoration* by the literature [4]. Then, *remediation* in Fig. 4.1 can be equivalent to *rehabilitation* by the literature [4].

Another question of the restoration to a pre-disturbance state had been raised in the 1990s based on the fact that humans have interfered with the river and its floodplain since the dawn of civilization, especially since the industrialization and urbanization in the nineteenth and twentieth centuries depending on the regions. Moreover, the ecological state is not usually static but dynamic for the structure and functioning of the ecosystems are continuously evolving. A pre-disturbance state may be hardly determined in this situation.

More plausible goals of river restoration may be to pursue the ecosystem goods and services rather than to try to restore them to the completely original state, which may be useless [10]. Therefore, a goal of river restoration should be to reestablish the ecological integrity and the human well-being in the degraded rivers. In this sense, reference condition is just the model, or a guiding image for the planning of an ecological restoration project [11].

**Table 4.1**  
**Definitions of (river) restoration (adopted from the literature [10])**

River restoration is the process of recovery enhancement. Recovery enhancement should establish a return to an ecosystem which closely resembles unstressed surrounding areas	Gore (1985) cited by Brookes and Shields (1996)
River restoration is the complete structural and functional return to a pre-disturbance state	Cairns (1991) cited by Brookes and Shields (1996)
Ecological restoration is the process of returning an ecosystem as closely as possible to pre-disturbance conditions and functions. The restoration process reestablishes the general structure, function, and dynamic but self-sustaining behavior of the ecosystem	NRC (1992) cited by FISRWG (1998)
Rehabilitation involves the recovery of ecosystem functions and processes in a degraded habitat. It does not necessarily reestablish the pre-disturbance conditions	Dunster and Dunster (1996) cited by FISRWG (1998)
Restoration is a planned process that aims to regain ecological integrity and enhance human well-being in deforested or degraded forest landscapes	WWF/IIUNC (2005)
Assisting the recovery of ecological integrity in a degraded watershed system by reestablishing natural hydrologic, geomorphic, and ecological processes and by replacing lost, damaged, or compromised biological elements	Wohl et al. (2005)

Since goals of river restoration have progressed from a strict expression of the restoration to a pre-disturbance state in a dynamic state of the ecosystem to a more practical way of reestablishing the ecological integrity and human well-being, the definition of river restoration also has been expressed in a wide variety. Table 4.1 shows a variety of concepts and terminologies on river restoration.

Based on the backgrounds of the progress of concepts of river restoration, river restoration can be defined in this chapter, as WWF/IUCN [11] once did for a forest, as a planned process that aims to regain the ecological integrity and enhance the human well-being in a degraded river corridor. It does not necessarily reestablish the pre-disturbance conditions as indicated by the literature [12], but still needs the reestablishment of natural hydrologic, geomorphic, and ecological processes, and replacing lost, damaged, or compromised biological elements as indicated by the literature [13].

On the other hand, river rehabilitation involves establishing geologically and hydrologically stable landscapes that supports the natural ecosystem mosaic. Although still useful to be delineated separately from river restoration, it does not need to reestablish the natural processes as close to as to a pre-disturbance state.

To summarize, river restoration is to regain the ecological integrity and enhance the human well-being by reestablishing the natural hydrologic, geomorphic, and ecological processes, in a self-sustainable manner by possibly referring to a pre-disturbance state. River restoration,

however, can be conducted without reference to a pre-disturbance state. Delineating the concept of river restoration from other ones such as that of river rehabilitation may, therefore, not be practically important.

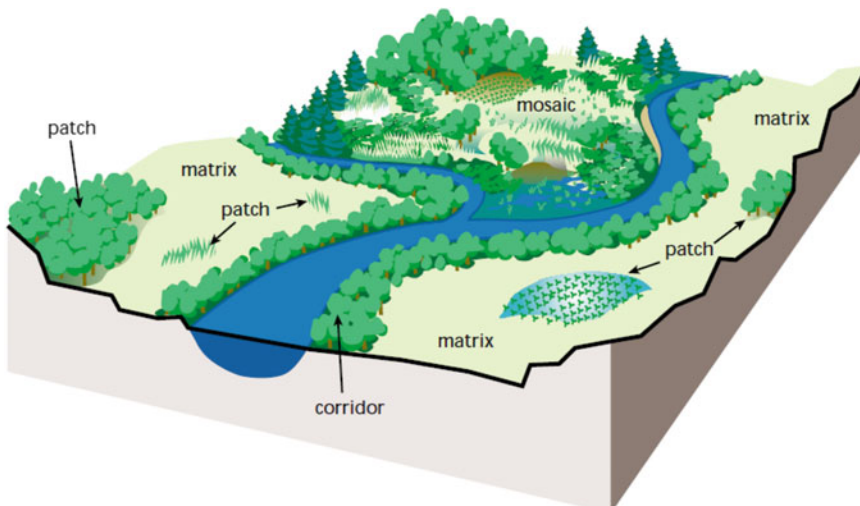
## 2. OVERVIEW OF RIVER AND DISTURBANCES AFFECTING RIVER

### 2.1. Overview of River in Terms of Restoration

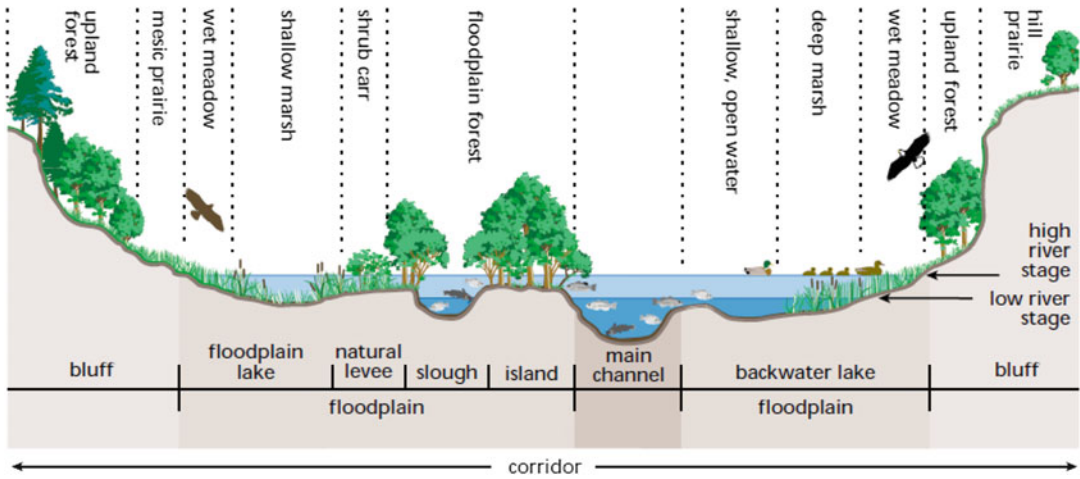
River restoration usually encompasses, in a spatial scale, the floodplain and transitional upland fringe as well as the channel itself, which forms a river corridor. Understanding the physical, chemical, and biological characteristics of the components of the river corridor and their scale and structure, therefore, is essential to river restoration planning and design.

In general, the landscape, including the river corridor, can be viewed as different space and time scales. As for river restoration, the watershed scale, river corridor scale, and reach scale are most relevant to the movement of material, energy, and organisms. The spatial structure of the landscape and river corridor is viewed as shown in Fig. 4.2, which includes a matrix, patch, corridor, and mosaic.

In Fig. 4.2, the matrix is defined as the land cover that is dominant and interconnected over the majority of the land surface (forest or agriculture). The patch is a polygon that is less dominant than and smaller than that from the matrix. The corridor is a special type of patch that links to other patches in the matrix. It is linear or elongated in shape. The mosaic is a collection of patches, none of which is dominant enough to be interconnected throughout the landscape [4].



**Fig. 4.2.** Spatial structure of landscape encompassing river corridor (cited from Fig. 1.4 in the literature [4]).



**Fig. 4.3.** A cross-sectional view of a river corridor (cited from Fig. 1.11 in the literature [4]).

Examples of a patch in the river corridor scale are wetlands, shrubland patch in a grass mosaic, oxbow lakes, and islands in the channel, while examples of a patch in the reach scale are riffles and pools, small islands and point bars, and woody debris.

River restoration works are usually done on the river corridor that is focused mostly on channel and floodplain, but sometimes includes the upland fringe. The ecological functions of a river corridor, however, are directly interconnected to the neighboring patch and matrix, and it is essential to the planning and design of a river restoration to investigate the interconnectivity of both landscape structures.

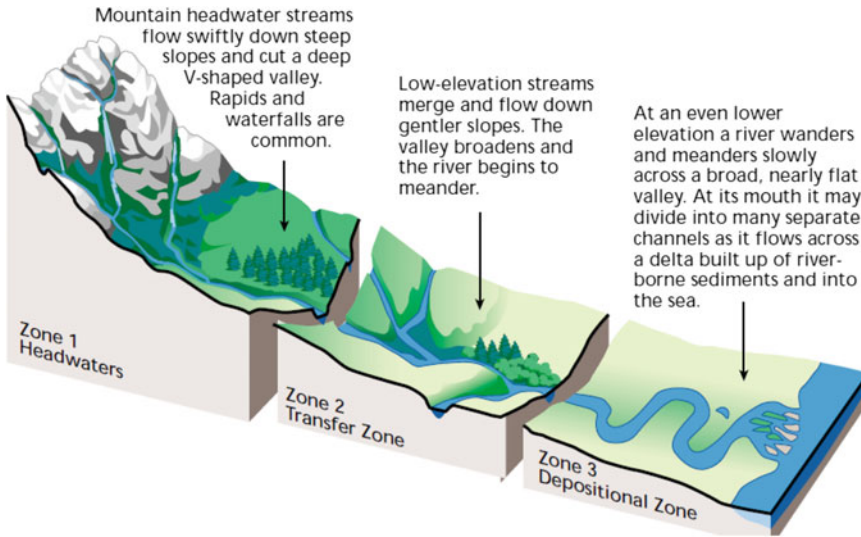
Focusing in detail on the physical structures in the river corridor itself, two views are conceived: a cross-sectional view and a longitudinal view of a river corridor. Figure 4.3 shows a cross-sectional view of a typical natural river corridor. Prominent features in this figure are the river channels and flows, main and sides, floodplain, transitional upland fringe, and flora and fauna which inhabit the river corridor.

Figure 4.4 shows a longitudinal view of a typical river corridor and variations in the transport features as it travels from headwater to the mouth. Schumm [14] divided the longitudinal profile of a river into three parts: headwaters, transfer zone, and depositional zone. According to his classification, the headwaters often have the steepest gradient, where the sediment erodes from slopes of the watershed and moves downstream. The transfer zone receives sediment and then transfers it downstream. It is often characterized by a wide floodplain and meander channels. The depositional zone is characterized by a flattened gradient with sediment deposits.

The river ecosystem also changes along the river corridor, which may be best viewed by the River Continuum Concept [15] as shown in Fig. 4.5.

The River Continuum Concept lies on the dependence of energy and material coming inside or outside of channel for the life of aquatic biota. Accordingly, the number of species in the river corridor increases to the downstream direction, while it rather decreases slightly at





**Fig. 4.4.** A longitudinal view of a typical river corridor and variations in transport features (cited from Fig. 1.27 in the literature [4]).

the river mouth. This conceptual model not only helps to identify the connection between the watershed, floodplain, and stream systems, but it also describes how biological communities develop and change from the headwaters to the mouth.

#### 2.1.1. River Corridor Processes: Hydrologic and Hydraulic Processes

In the spatial dimension of a watershed and channel, hydrologic and hydraulic processes are considered in the three dimensions of watershed (land), ocean, and atmosphere, while they are considered in the cross-sectional dimensions across the channel. They are also considered in the longitudinal dimensions as water flows downstream in the channel.

The hydrologic cycle, or water cycle, describes the continuous transfer of water from precipitation to surface water, to storage and runoff, and to the eventual return to the atmosphere by evapotranspiration. The various hydrologic terminologies related to the hydrologic cycle are self-explained by the schematic picture of Fig. 4.6. They are precipitation, transpiration, evaporation, interception, infiltration, soil moisture, and groundwater and surface runoff, each of which are well understood from any standard hydrology textbook.

Among these various processes of water flow in the atmosphere, on the land surface, and underground, a concentrated flow into the river corridor would be of the most importance. Yearly-based variations in river water flows are usually barely predictable, since they depend heavily on variations in precipitation and other hydrologic processes. On the other hand, seasonable variations in the river water flow are more predictable. Several important formats are especially useful for the planning and design of a river restoration as well as ordinary river works and management. They are flow duration, the probability that a given river flow will

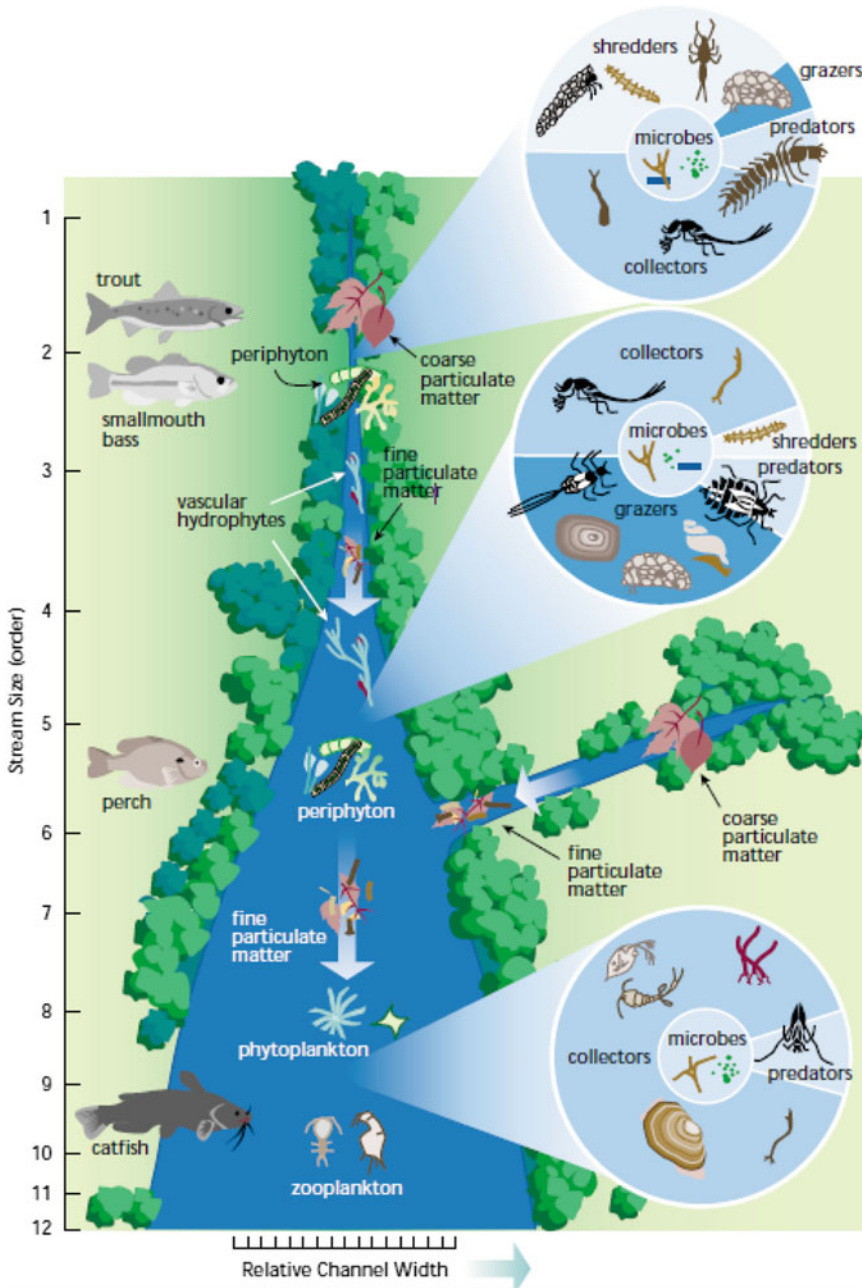


Fig. 4.5. The River Continuum Concept ([15], with permission from NRC Research Press).

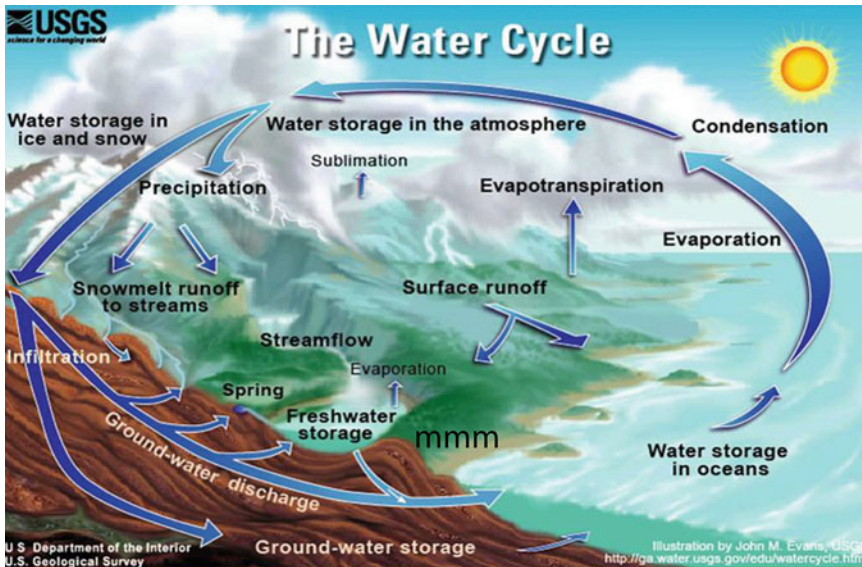


Fig. 4.6. The water cycle [16].

exceed or be equal over a period of time; flow frequency, the probability a given river flow will be exceeded in a year; and the flow duration curve, the percentage of time a given river flow is exceeded over a given period.

### 2.1.2. River Corridor Processes: Geomorphic Processes

The geomorphic processes are the primary mechanisms for the formation of the drainage patterns, channel, floodplain, terraces, and other watershed and stream corridor features. Erosion, sediment transport, and sediment deposition are the three primary processes that are involved with flowing waters.

Similar to the hydrologic and hydraulic processes, two aspects of considerations are possible on the geomorphic processes in the watershed: the geomorphic processes across the river corridor and along the river corridor. Soil erosion can occur gradually over long periods, or it can be episodic, accelerating during a certain rainfall event.

Stream flow dictates the erosion in a river corridor, transport, and deposition of sediment and eventually forms channels, floodplains, terraces, and other features along the river corridor. Stream competence describes the largest particle size that a stream can transport under a given hydraulic condition. Various terminologies and relations that are related to sediment transport in a river are easily found in any standard textbook of sedimentation engineering.

River channels and their floodplains are constantly adjusting to the water and sediment supplied by the watershed. Successful restoration of degraded rivers requires an understanding of watershed history, including the adjustment processes that are active in channel evolution. River channel responses to changes in flow and sediment load have been described

qualitatively in a number of ways. One of the oldest and simplest relations is Lane's relation [17], which explains a relation of equilibrium between the flow and sediment as follows:

$$Q_s D_{50} \approx QS \quad (4.1)$$

In which  $Q_s$  is the sediment discharge,  $D_{50}$  is the median particle size,  $Q$  is the water discharge, and  $S$  is the channel slope. When one or two variables in the relation are changed, the other variables are changed to create a new equilibrium, accordingly.

Yang [18] proposed a quantitative equation to replace Lane's qualitative relationship based on Yang's unit stream power concept to compute and predict river morphologic changes. His equation is as follows:

$$\frac{Q_t D_{50}}{K} = \frac{Q^2 S}{A} \quad (4.2)$$

In which  $Q_t$  is the total bed load discharge,  $K$  is the parameter specific to site, and  $A$  is the cross-sectional area of the channel. Readers who are interested in the above equation can review the reference of [18].

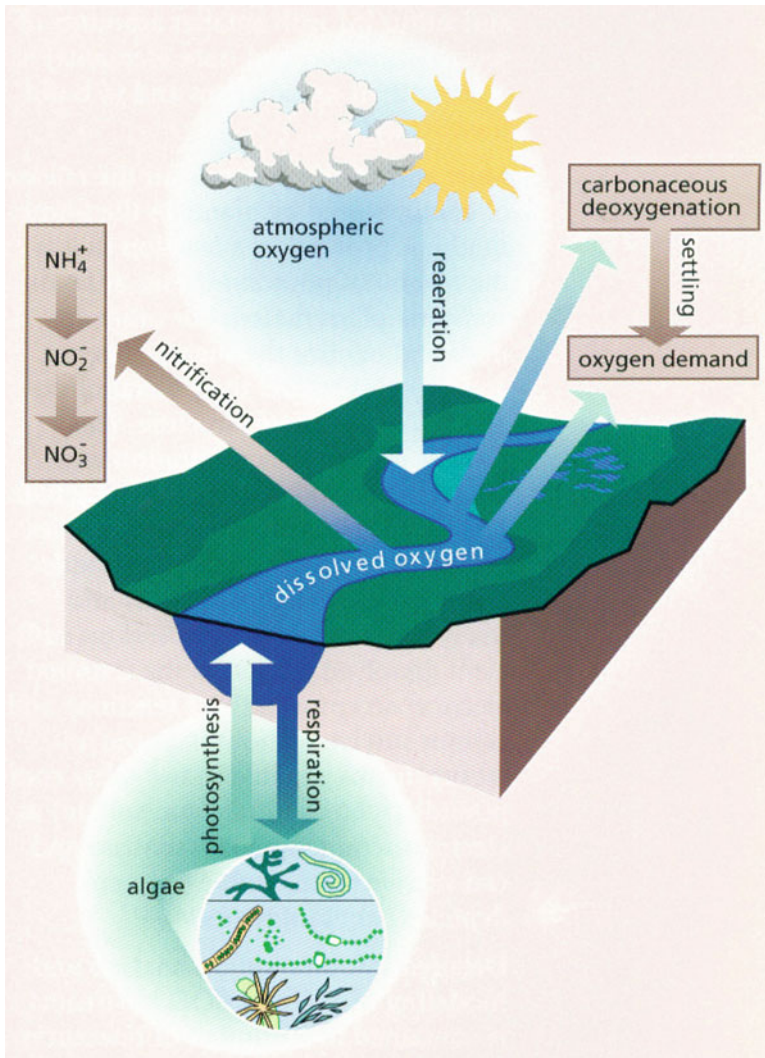
### 2.1.3. River Corridor Processes: Physical/Chemical

Water quality issues are an essential part of understanding the characteristics and processes of a river and a river corridor, if the restoration of water quality is not covered in this handbook. This section, therefore, just briefly surveys some of the key physical and chemical characteristics of flowing waters.

In a river, sediment moves as well as water flows. The negative impacts of changes in sediment characteristics from natural conditions are well known and explained in Sect. 2.2. The water temperature is a crucial factor in the river corridor restoration for dissolved oxygen solubility, biochemical and physiological processes, aquatic species' tolerance of limited temperature range, and the effect on the abiotic chemical processes. Other important constituents include pH, alkalinity, and acidity, which affect the suitability for biota and influence chemical reactions in the water. The characteristics of sediment, temperature, and other constituents, either across the river corridor or along the river, are well documented in any standard textbooks on this topic.

Dissolved oxygen (DO) is a basic requirement for a healthy aquatic ecosystem. Major processes affecting the DO balance within a river are depicted in Fig. 4.7. Major components in the processes are carbonaceous deoxygenation, nitrogenous deoxygenation, re-aeration, sediment oxygen demand, and photosynthesis and respiration of plants.

Aquatic plants can produce organic matters, such as sugars, through photosynthesis using sunlight, carbon dioxide, and water. In addition, plants require a variety of elements to support their bodily structures and metabolisms, such as nitrogen and phosphorus. These important nutrients can be characterized both across the river and along the river.



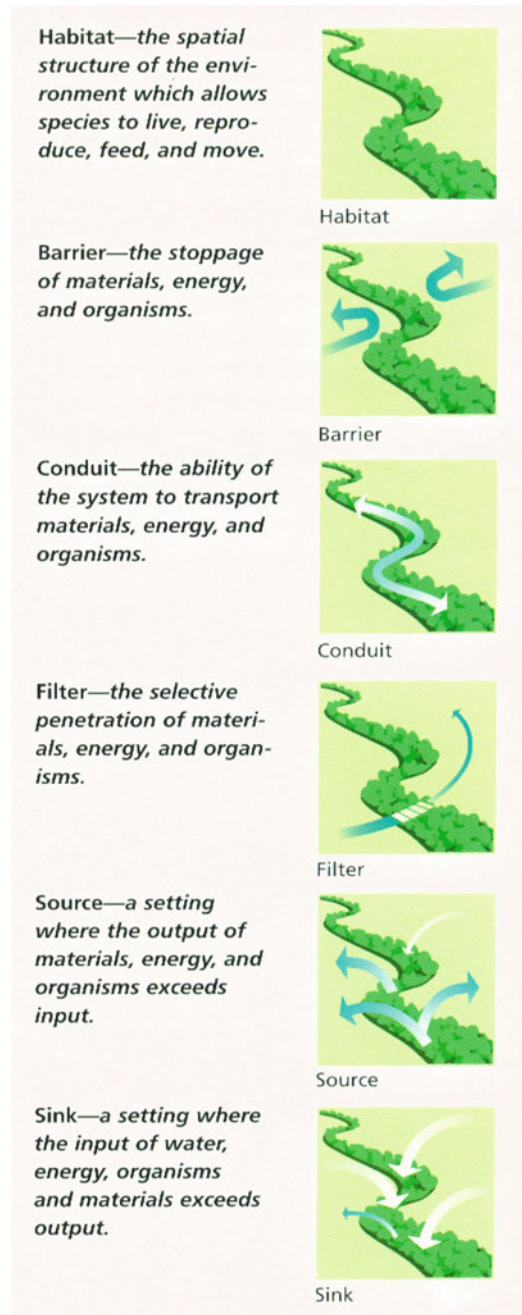
**Fig. 4.7.** Major processes for BOD and DO in river (cited from Fig. 2.20 in the literature [4]).

#### 2.1.4. River Corridor Processes: Biological Community

River corridor processes are characterized by the physical, chemical, and biological characteristics, and thus understanding of the interactions among these three processes at a varying time scale is essential to a successful river restoration. Two ecosystems, terrestrial and aquatic, are characterized by the physical, chemical, and biological processes, and habitats formed inherently by those characteristics themselves.

Ecosystems, in corridor forms, have some inherent functions of which a river corridor restoration project usually determines as goals of the project. They are the functions of the

**Fig. 4.8.** Critical ecosystem functions (cited from Fig. 2.37 in the literature [4]).



habitat, barrier, conduit, filter, source, and sink, which are depicted in Fig. 4.8. The habitat function means many species can use the corridor to live and to seek food and water. The conduit function is the ability to serve as a flow pathway for energy, materials, and organisms, activating laterally as well as longitudinally. The other functions are self-depicted in Fig. 4.8.

## 2.2. Overview of Disturbances Affecting Rivers

A disturbance naturally induced or human induced, affecting a river corridor, usually results in a chain of alterations to the river corridor structure and functions, which is obvious in the aspect of the River Continuum Concept as well as the flow and sediment continuity. The literature [4] depicts a chain of events due to a disturbance in a river corridor, starting from changes in the land and river corridor use, to changes in the geomorphology and hydrology; to changes in functions of habitat, sediment transport and storage; and eventually to changes in population, composition, and distribution in the system.

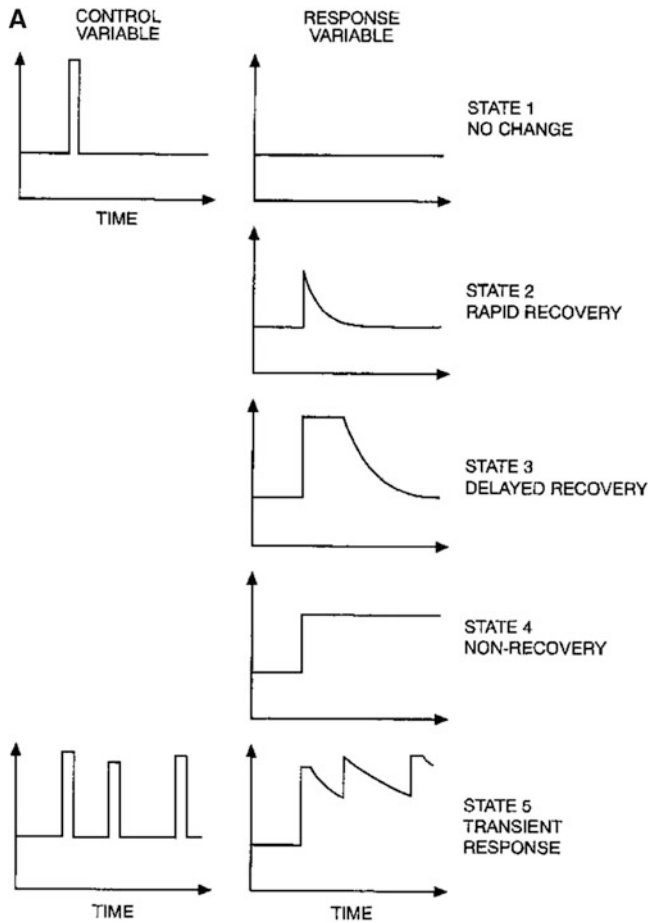
Any disturbances, natural or man-made, can be characterized by three factors, the intensity, frequency, and extent of the disturbances. In order to plan and design a river restoration project, therefore, it is essential to understand what the changes of which disturbances are stressing the ecological system of a river corridor, and how the system responds to those stresses. For the sake of convenience, two types of stresses are delineated, as natural disturbance and man-induced disturbance, both of which can affect the river ecosystem as well as the river hydraulics and morphology.

Among the various natural events affecting the system such as floods and droughts, fire, and storms, floods are the most frequently occurring and severely affecting ones. The energy inherent in high flows performs the work of shaping the channel and floodplain, maintaining the channel capacity, and transporting and depositing of sediment. Flooding serves as the principal mechanism for the creating, maintaining, and destroying of channels and floodplain features, such as pools, islands, bars, oxbows, side channels, and off-channel ponds [3].

The variation in channel response, such as river widening, straightening, and steepening from floods, can be represented diagrammatically in Fig. 4.9 [19]: from no response at one event to transient behavior at the other extreme, with various intermediate states involving different styles of recovery and non-recovery. In spite of this dramatic variation of river geomorphology, however, the river corridor ecosystem is basically resilient.

A range of human activities has the potential to alter the disturbance regimes of the river systems. Alterations to the storage and delivery of water, sediment, or large wood from the uplands tend to occur synergistically rather than independently and result in substantial cumulative effects. For instance, widespread soil compaction and changes to the vegetative community can affect the hydrologic process and thus the biological process in the region [3].

Human-induced disturbances, such as dams, channelization and diversions, land use agricultural activities, and mining activities all profoundly affect river ecosystems. For example, dams ranging from a small temporary structure to a huge multipurpose dam can have profound impacts both on upstream and downstream rivers. These disturbances, however, cannot be eliminated or alleviated easily without a physical restoration of river, i.e., a dam removal, which is plausible at present only for a small, out-functioned one. The literature [4] depicts common disturbances such as dams, channelization and diversion, introduction of alien species, and widespread disturbances, such as land use activities for agriculture, forestry, mining, recreation, and urbanization. Dams also affect downstream



**Fig. 4.9.** Diagrammatic representation of potential channel response to large floods (cited from Fig. 6.9a in the literature [19]).

floodplain geomorphology and accelerate and decelerate the vegetation recruitment on the floodplain. Since an investigation on this problem was first reported in 1984 in the USA [20], many similar results have been reported worldwide. Recently, restorations of floodplain or sand/gravel bars, on which vegetation was established after dam construction, to the original bare condition have been tried [21].

Finally, the disturbances of sediment load and particle size from a natural condition can have negative impacts. Fine sediment can severely alter aquatic communities in the way that it may clog and abrade fish gills, suffocate eggs and aquatic insect larvae on the bottom, and fill in the pore space between the bottom cobbles where fish lay eggs. Sediment may also carry other pollutants into water bodies, such as nutrients and toxic chemicals attached to the surfaces of sediment particles [4].



### 3. RIVER RESTORATION PLANNING AND DESIGN

#### 3.1. River Restoration Planning

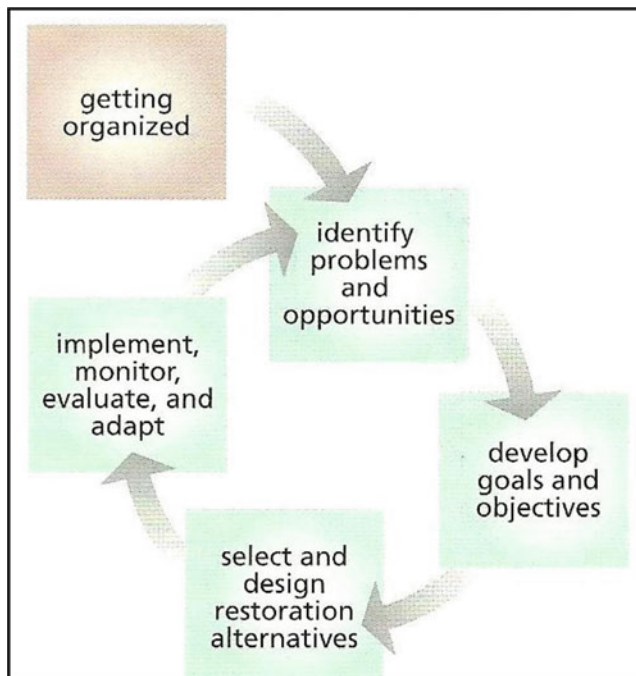
##### 3.1.1. Planning Process

Basically, there are two major purposes of a restoration plan for any river restoration effort: (1) problem-solving framework for addressing critical river corridor restoration issues and requirements and (2) documentation for the results of the restoration process [4]. Figure 4.10 shows the process of a river restoration plan development starting from *getting organized*.

Similarly, NRCS [5] has proposed the nine-step planning process of river restoration as shown in Table 4.2. Among the many steps in the table, the determination of goals and objectives at Step 2 may be critically important to guide the restoration project to the right direction. Three types of approaches for the determination of the goals for river restoration design are suggested in NRCS [5], namely, the historical, geomorphic, and ecosystem approaches.

A desire to recover the lost conditions in the river (*Historical Approach*) is frequently a motivation for a river restoration. For example:

- What did a river look like before the preindustrial or pre-European settlement state [22]?
- What did a river look like before the land use became what it is today?
- What did a river look like before the major river works was made?
- What did a river look like before river was incised due to bad watershed management?



**Fig. 4.10.** Planning process of river restoration work (cited from the figure on p. II-ii in the literature [4]).

**Table 4.2**  
**Stream restoration planning process (cited from table 2.1 in the literature [5])**

Step no.	Description	Generalized stream restoration planning steps	Detailed stream restoration planning steps
<i>Phase I: Collection and analysis (understanding the problems and opportunities)</i>			
1	Identify problems and opportunity	Decide what stream characteristics need to be changed	Project identification: identify all: – Stakeholders – Goals and objectives – Risks – Local vs. system-wide instabilities
2	Determine objectives	Describe desired physical, chemical, and biological changes in the system	Assessment: assess the following at the watershed scale and at the site of reach scale: – Geomorphic conditions (stream type) – Existing ecological conditions (riparian and in-stream)
3	Inventory resources	Study stream to understand its primary physical processes, dominant impacts on water quality, and abundance and different biological populations	– Ecological and physical thresholds – Dominant physical and biological processes and constraints
4	Analyze resource data	Examine collected information and decide what are the most important factors or processes that impact and influence the desired conditions in the stream	– Sediment budget and stability of existing conditions Acquire hydrologic data (watershed scale) Acquire hydraulic data (stream reach scale) Determine: – Why is the stream in its current conditions – What is the ideal condition – What keeps it from naturally adjusting to the ideal condition

(Continued)

**Table 4.2  
(Continued)**

Step no.	Description	Generalized stream restoration planning steps	Detailed stream restoration planning steps
<i>Phase II: Decision support (understanding the solutions)</i>			
5	Formulate alternatives	Determine which processes and factors can be changed, and decide if these changes are sustainable and self-reinforcing	Conduct the stability design
6	Evaluate alternatives		Select techniques and practices for RMSs
7	Make decisions		Select and design appropriate stabilization techniques: <ul style="list-style-type: none"> <li>– Cross section</li> <li>– Planform</li> <li>– Stabilization, soil bioengineering, and integrated techniques</li> <li>– Profile, grade</li> <li>– Conduct a sediment budget and stability assessment on the selected design, appropriate to design the practice, so it can be implemented</li> </ul>
<i>Phase III: Application and evaluation (understanding the results)</i>			
8	Implement the plan	Implement the selected changes to the stream system	Identify construction issues and impacts on design to fine-tune design and implementation
9	Evaluate the plan	Modify the course of action as new information is collected and analyzed	Document maintenance and monitoring requirements: <ul style="list-style-type: none"> <li>– Perform ongoing maintenance</li> <li>– Evaluate success and practice adaptive management</li> </ul>

The reestablishment of an original state of a river, however, was criticized ([23, 24], and recently [10]) by the reasoning that a river system follows complex trajectories, frequently making it impossible to return it to a previous state. Instead, they suggest that an objective-based strategy that reflects the practical limitations of the development of sustainable landscapes and the emerging importance of accounting for human services of the target ecosystem. Human services, here, represent the environmental functions of a river system, such as physiological needs (fresh air, water, food, health) and psychological needs (opportunities for cognitive and spiritual development, recreation, and safety) [25].

NRCS [5] also explains the geomorphic approaches for determining the goals for a river restoration design, which encompasses a number of different activities, such as the stabilization of unstable stream banks and channels, reconfiguring the channelized or aggraded/degraded rivers, and restoration natural substrates and other habitat features.

An analog reach of a river, called a *reference river*, can also be used in establishing the goals of a river restoration. A reach of the project river or a neighboring river, which is considered to function in a desired manner, is identified. The reference reach is then investigated for physical and biological characteristics, which can be a goal for the restoration of the project river.

The ecosystem approaches to river restoration include the remediation or compensations of, among others, fish migration blockages, diversion of water flow for irrigation or municipal water supply, upstream migrating head cut, and streams confined by concrete. These are artificial disturbances which are detrimental to the ecosystem of the river concerned. Therefore, this approach to river restoration starts first by identifying the ecological problems on the river or river reach concerned and the sources of disturbances and finally remediating them with the removal or correction of the stressors.

Regardless of the approaches to be selected, there are some general ways to determine the goals and objectives of a river restoration, which is explained in detail as follows:

### 3.1.2. Goals and Objectives

The goals and objectives of a river restoration are to identify, usually in a short but clear sentence, the desired outcome or results of any action to restore the river. This is a critical step in the overall planning process in order to avoid failed or poorly performing restoration as well as to evaluate the restoration project after the completion of the project.

General and broad scopes and expressions of the objectives can make the project team lose focus and how well to perform for the restoration. Narrowing the objectives reduces any ambiguity for the project team. The objectives of river restoration should be [5]:

- Specific
- Realistic
- Achievable
- Measurable

Goals for river restoration focuses generally on the three major management targets of the river: value of water and river use, management target of river flooding, and the

environmental (or natural) function of river such as habitat, self-purification of the water quality, and aesthetics of the river.

Typical goals for river restoration that focuses on the management of river flood are:

- Preventing stream-bank erosion on residential properties and protect infrastructure
- Protecting valuable agricultural land
- Protecting municipal water supply

Typical goals for river restoration that focuses on the environmental function of river are:

- Restoring fish habitat
- Restoring water quality
- Restoring overall environmental quality

Examples of goals and objectives for river restoration that focuses on the environmental function of river are to maintain or rehabilitate the environmental quality by designing and constructing river restoration projects that [5]:

- Look natural
- Function naturally with channels connected to floodplains
- Provide desirable river and riparian habitat, including overhanging root cover and large woody debris
- Reduce bank erosion
- Maintain water quality
- Are economical to design and build

Meanwhile, the literature of WSAHGP [3] suggests several common restoration goals based on the processes of a river and river corridor that determine abundance, diversity, form, and quality of river habitat. Here the processes are the flows of water, sediment, solutes, organic matter, and energy. WSAHGP's suggestions for common restoration goals include:

- Restoring sediment supply
- Restoring stream flow regime
- Restoring energy inputs to the stream
- Restoring water quality

In addition, WSAHGP [3] suggests, for more site- and species-specific restoration goals:

- Restoring incised channels
- Restoring aggrading channels
- Restoring salmonid-spawning habitat
- Restoring salmonid-rearing habitat

### 3.1.3. Site Assessment and Investigation

Two useful references are available for the site assessment and investigation for a river restoration: [4] and [5]. The literature of FISRWG [4] introduces the “analysis of corridor condition” for the site investigation. It contains four major components: hydrologic and geomorphic processes and chemical and biological characteristics. The hydrologic processes

include flow analysis and stage–discharge relationships; the geomorphic processes include stream classification, proper functioning condition [26], hydraulic geometry, stream system dynamic, and determining stream instability; the chemical characteristics include data collection and sampling techniques; and the biological characteristics include synthetic measures of a system condition and analysis of species requirements. Each subcomponent includes relevant analysis methods and/or tools as follows:

- Flow analysis: flow duration and flow frequency analysis
- Stage–discharge relationships: continuity equation, Manning’s equation, energy equation, analyzing composite and compound cross sections, reach selection, and field procedures
- Stream classification: advantages and limitations of stream classification, stream classification systems, channel evolution models, advantages and limitations of channel evolution models, and application of geomorphic models
- Hydraulic geometry: hydraulic geometry and stability assessment
- Determining stream instability: system-wide instability, local instability, bed instability, sediment transport processes, numerical analyses and models to protect aggradation and degradation, and bank instability
- Data collection: constituent selection, sampling frequency, and site selection
- Sampling techniques: sampling protocol for water and sediment, field analysis of water quality samples, water quality sample preparation and handling for laboratory analysis, collecting and handling water quality samples, data management, and quality assurance and quality control
- Synthetic measures of system condition: indicator species, diversity and related indices, and classification system
- Analysis of species requirement: Habitat Evaluation Procedure [27], physical habitat simulation, riverine community assessment and restoration, time series simulation, vegetation–hydroperiod modeling, and extreme events and disturbance requirements

NRCS [5] rather simply introduces on the site assessment and investigation for a river restoration. It starts with an introductory for a stream system assessment, flow duration, and stream orders. Then, it introduces the preliminary investigation, reconnaissance, and detailed field investigations of geologic and biologic assessment. Finally, it introduces stream classification systems, starting with overview, a USDA guide, channel evolution model [28], Montgomery and Buffington classification system [29], and Rosgen classification system [30].

Among the many items described in the two references, the readers may select proper items that are required for the specific sites concerned. For example, they may select models of geomorphic evolution and stream stability to assess the site concerned that are incised and degraded.

### 3.2. River Restoration Design

This section describes the design procedures to restore, or rehabilitate at least, the river corridor and its habitat in a concerned river. Problems that are localized may be designed relatively easily. Problems that are widely and diversely spread in a concerned reach or watershed and involve multiple stakeholders require a systematic, integrated approach considering the environmental and ecological factors as well as the physical factors.

Various texts and guidelines are available for assistance on how to design a river restoration after the goals and objectives are adequately formulated and relevant planning processes are delineated. Readers who are interested in the design of a river restoration focused on the sediment transport and channel morphology can refer to Chap. 9 *Stream Restoration* in *Sedimentation Engineering of ASCE* [6]. Readers who are interested in relatively small streams that flow across farmlands, which have the problems of such as accelerated erosion, sediment, and site instability; unsuited or insufficient habitat and biodiversity; and unsuited or insufficient production/land use, can refer to Chap. 4 *Stream Restoration Design Process*, Part 654 *Stream Restoration Design*, *National Engineering Handbook of NRCS* [5]. Readers who are interested especially in the aquatic and riparian habitat restoration such as stream-bank protection, fish passage and fishway, and “ecological” in-stream structures can refer to the *Stream Habitat Restoration Guidelines* prepared for the Washington State Aquatic Habitat Guidelines Program [3]. Readers who are interested in any large-scale influences on stream corridor ecosystems and need design guidance primarily at the stream corridor and stream scales can refer to Chap. 8 *Restoration Design*, *Stream Corridor Restoration* [4].

This chapter briefly introduces the methods and techniques for river restoration design in a transverse direction from the main channel and bank to the floodplain and upland fringe, including (1) channel design, (2) in-stream habitat structures, (3) riverbank restoration, (4) channel–floodplain connectivity, (5) riparian restoration, and finally (6) “Room for the River”—a Dutch practice. “Channel design and in-stream habitat structures” primarily follow the literature of ASCE [6], “riverbank protection” follows the *Stream Corridor Restoration* [4], and “channel–floodplain connectivity and riparian restoration” primarily follow Washington State’s Guidelines [3]. “Channel–floodplain connectivity” also includes a levee removal and side-channel/off-channel restorations. “Room for the River,” which is a Dutch river management practice mainly for flood control along the rivers, is briefly introduced in this section that focuses on the aspect of floodplain restoration.

### 3.2.1. Channel Design

Channel design for restoration projects is required in the case that the concerned river is unstable or channel modification is needed in order to meet the overall project objectives, such as restoring in-stream habitat structures. In many parts of the world, natural channels were artificially straightened or modified mainly for flood control or other river-use purposes. Special concerns should be given to restoring this kind of artificially modified and channelized rivers close to their original features.

Restoration projects often seek to enhance the dynamic behavior of fluvial systems, often by relaxing constraints when past activities have led to highly regulated flows or uniform, fixed boundaries. System restoration may involve the restoration of processes such as flooding, meandering migration, channel avulsion, the formation and destruction of large woody debris jams, and backwater sedimentation. Restoration of the natural fluvial processes, however, presents challenges to engineers because it requires changing rivers from an understood present condition, to an uncertain, more dynamic future situation. Channel

stability analysis, such as bed and bank stability and sediment budgets, of each channel design scenario, therefore, is essential to a successful river restoration.

Proper approaches should be used to select the channel width, depth, and slope required for an acceptable level of stability given the water and sediment inflows that are anticipated for the future conditions of the project. The present analytical approaches usually are for perennial, moderate-to-low energy, single-thread, meandering channels. For the channels beyond these limitations, therefore, empirical approaches obtained with data sets, similar to the concerned river condition, or simply a reference reach, may be more plausible to estimate the design channel geometry.

Proper channel design means a so-called channel in equilibrium, i.e., an incoming sediment load would pass the designed channel without any significant aggradation or degradation of channel bed and bank scours. Channel design variables, such as the channel width, depth, slope, hydraulic roughness, and layout of the channel plan form, are usually dependent upon water discharge, sediment inflow, and the river bed and bank characteristics at least for the engineering time span of about 100 years, not beyond the geologic time span of a thousand or more years.

In the aspect of sedimentation engineering, two approaches are available: threshold methods and active-bed methods, depending upon if a channel boundary is mobile or not at the design discharge [6]. If not, the former method may be used, while if yes, the latter method should be used. The followings are based on the reference of ASCE [6], pp. 486–491.

### 3.2.2. Threshold Method

This method is useful and relatively simple where sediment inflow is negligible and the channel boundary is immobile at the design flow. Often, these are the cases of a very coarse-material bed channel. In these channels, silt/clay and even sand/gravel particles move as a wash load over the immobile bed material [31]. Selection of the design bed material size, therefore, is important. Refer to Sect. 9.3.2 *Bed Material Size Distribution* at Chap. 9 of *Sedimentation Engineering* of ASCE [6] for the guidance for sampling bed material. The problem of this method is that it does not provide unique solutions for the channel geometry and geomorphic principles may be used for the selection of proper design variables. Two slightly different methods are available for this approach, namely, “allowable velocity” and “tractive force” approaches.

A commonly used method for the concept of the threshold method is the allowable velocity approach of the NRCS [5]. This empirical approach is based on experience and field observations. Readers can refer to Fig. 9.9 at Chap. 9 of *Stream Restoration, Sedimentation Engineering* of ASCE [6], for the estimation of allowable velocities for unprotected earth channels.

A more scientific, but still empirical approach may be the tractive-force approach where the channel cross sections and slopes are uniform, the beds are flat, and bed material transport is negligible, which may be not the usual case for a river restoration. An example of this approach is shown in Table 4.3 where some values are surveyed and some are calculated using the various empirical and semiempirical equations. In this table, the first four quantities are



**Table 4.3**

**Example of preliminary channel design using threshold approach (cited from table 9.9 in the literature [6], with permission from ASCE)**

Quantity	Relationship	Source	Value
Valley slope		Survey or topographic map	0.007
Downvalley distance [km]		Survey or topographic map	1.5
$D_{50}$ of bed material [mm]		Samples and sieve analysis	45
$D_{84}$ of bed material [mm]		Samples and sieve analysis	60
Design discharge [ $\text{m}^3/\text{s}$ ]	$Q_{1.5\text{yr}}$	Flood-frequency curve	6.7
Width, $B$ [m]	$2.73 Q^{0.5}$	Hey and Thorne (1986)	7.1
Shields constant, $\theta$	Appropriate value or relationship <sup>a</sup>	Buffington and Montgomery (1997)	0.042
Depth-slope product, $RS$ [ $\text{m}^2$ ] <sup>b</sup>	$1.65 D_s \theta$		0.0031
Variation in depth at a section	$R/H_{\text{max}}$	Assumed based on reference reach	0.75
Channel shape coefficient, $a$	$11.1 [R/H_{\text{max}}]^{-0.314}$	Hey (1979)	12.15
Darcy-Weisbach flow resistance coefficient, $f^c$	$\frac{8}{\left[5.75 \log \left(\frac{aR}{3.5D_{84}}\right)\right]^2}$	Hey (1979)	0.10
Hydraulic radius, $R$ [ $\text{m}$ ] <sup>d</sup>	$\sqrt{\frac{fQ^2}{8gP^2(RS)}}$	Simultaneous solution of continuity and uniform flow equations for depth	0.6
Bed slope, $S$	$RS/R$		0.005
Sinuosity	Valley slope/channel slope		1.3
Channel length [km]	Sinuosity $\times$ downvalley distance		2.0

<sup>a</sup>Many of the relations tabulated by Buffington and Montgomery (1997) require an entire gradation curve for both surface (armor) and subsurface bed sediments.

<sup>b</sup>Assumes that average flow depth = hydraulic radius.

<sup>c</sup>Assumes a trial value for  $R$ . Numerous other relationships are available. For example, the equation due to Limerinos (1970) leads to a Manning's  $n$  of 0.032, which is equivalent to a Darcy-Weisbach's  $f$  of 0.10.

<sup>d</sup>Assumes the wetted perimeter  $P =$  width,  $B$ . Check  $R$  computed with this formula against the trial value assumed for the computation of Darcy  $f$ . Iterate as required.

obtained directly from field observations or maps. Design discharge for the tractive-force approach is usually less than the effective discharge which transports most of the sediment load over time, since the boundary is immobile under the design discharge condition. In this example, a return period of 1.5 years is used for the estimation of the design discharge  $Q_{1.5\text{yr}}$  using the flood-frequency curve. The width of the channel  $B$  is obtained from Hey and Thorne's formula. The Shields constant  $\theta$  is the value for the dimensionless critical tractive stress in the Shields diagram, which is obtained from an appropriate relationship. In this example, the values of the Shields constant are suggested to be 10, 1.0, and 0.04 for the

suspended load, mixed load, and bed load regimes, respectively. The depth–slope product  $RS$ , where  $S$  is the bed slope and the average depth  $d$  is assumed to be equal to the hydraulic radius  $R$ , is obtained from the following relation of the critical shear stress  $\tau_c$  and the Shields constant  $\theta$ :

$$\frac{RS}{\gamma_w} = \tau_c = \frac{\theta(\gamma_s - \gamma_w)}{\gamma_w D_s} \quad (4.3)$$

where  $\gamma_s$  and  $\gamma_w$  are the unit weights of sediment particle and water, respectively, and  $D_s$  is the size of the particle concerned and where the value for  $(\gamma_s - \gamma_w)/\gamma_w$  is equal to 1.65. Variation in depth at a section can be obtained from a reference reach. Channel shape coefficient  $a$  can be obtained from the literature [32], while Darcy–Weisbach flow resistance coefficient  $f$  can be obtained also from the same literature with a trial value for  $R$ . Now, the hydraulic radius  $R$  can be obtained from the simultaneous solution of continuity and mean velocity equations. The computed value for  $R$  is checked against the trial value assumed for the computation of Darcy  $f$ . Now, the bed slope is calculated from  $RS/R$ , and the sinuosity of channel is calculated from the valley slope/channel slope, and channel length is from downvalley distance.

### 3.2.3. Active-Bed Method

This method should be used for channels with beds that are mobile during high flow events. This method is more sensitive to the channel geometry relationships and sediment inflows than the threshold method, and needs much attention for proper application. This method is only applicable for the hydraulic design of channels for single-thread rivers. This method requires a complicated hydraulic computation, which usually needs sophisticated hydraulic models in order to simulate the 2- or 3-D nature of river flows. So far, however, only 1-D models such as SAM [33] or HEC-RAS 3.1 are frequently used for the hydraulic computation for channel design.

In order to design a channel that flows over a floodplain for river restoration, at least the width, depth, and slope should be determined using any reasonable methods followed by the design of channel alignment. Channel width can be determined using the average of the measured channel widths from a reference reach, which must be in a state of dynamic equilibrium and having the same channel-forming discharge. Hydraulic geometry formulas, based preferably on the analyses of the field data that were collected from the river reach with similar geomorphic and hydraulic conditions, can be used for the determination of the channel width. Finally, analytical methods using the hydraulic models can be used if a reliable relationship between width and channel-forming discharge relationship is not available.

Table 4.4 is the example of an active-bed approach for preliminary channel design. The first four quantities are obtained from a field survey, topographic map, samples, and sieve analysis. The design discharge can be obtained using an effective discharge analysis. The sediment load at design discharge can be obtained using a proper sediment transport equation such as Brownlie [34] shown in this example and channel geometry at upstream reach. Channel side slope can be assumed as 1V:1.5H. Manning's  $n$  value for side slopes can be estimated through actual experiences. The top width  $B$  may be obtained from hydraulic

**Table 4.4**

**Example of preliminary channel design using active-bed approach (cited from table 9.10 in the literature [6], with permission from ASCE)**

Quantity	Relationship	Source	Value
Valley slope		Survey or topographic map	0.001
Downvalley distance [km]		Survey or topographic map	10
Median bed material size [mm]		Samples and sieve analysis	0.6
$D_{84}$ of bed material [mm]		Samples and sieve analysis	1.0
Design discharge [ $\text{m}^3/\text{s}$ ]		Effective discharge analysis	68
Sediment load at design discharge [kg/s]	Sediment transport equation and channel geometry from upstream reach	Brownlie (1981)	25
Channel side slope		Assumed	1V:1.5H
Manning $n$ value for side slopes		Estimated	0.05
Top width $B$ [m]	$3.6 Q^{0.5}$	Developed from stable reaches within watershed	30
Depth [m] and bed slope	Simultaneous solution of sediment transport and uniform flow equations Bed resistance composited with assumed Manning $n$ value for side slope	Brownlie (1983) for bed resistance Equal-velocity approach (Chow 1959) for compositing	2.4 (depth) 0.00061 (slope)
Sinuosity	Valley slope/channel slope		1.6
Channel length [km]	Sinuosity $\times$ downvalley distance		1.6

geometry formulas based on the data collected from reference reaches. In this example, the relation of  $B = 3.6 Q^{0.5}$  is used. Depth and bed slope can be obtained from the simultaneous solution of sediment transport and uniform flow equations. Brownlie's friction equation for bed resistance can be used for the uniform flow equation. Sinuosity can be obtained from a valley slope/channel slope, and then the channel length is obtained from the calculated sinuosity multiplied by the downvalley distance.

### 3.2.4. In-Stream Habitat Structures

In an ideal case of a river restoration, the natural fluvial forms and processes such as flow dynamics and sediment transport would guide choices for actions, making any artificial structural elements for in-channel habitats unnecessary. In many cases, however, river

restoration may not be complete only with fluvial forms and processes being restored, and artificial structural measures are required to help in-channel habitats function properly. River restoration or making a close-to-nature (*Naturnaher* in a German word) river work is based usually on two basic concepts: close-to-nature forms of river and the use of native material for river works.

Designers of a river restoration should be careful when using the habitat structures of the followings [4]:

- Structures should never be viewed as a substitute for good riparian and upland management.
- Defining the ecological purposes of a structure and site selection is as important as the construction technique.
- Scour and deposition are natural stream processes necessary to create habitat. Over stabilization, therefore, limits habitat potential, whereas properly designed and sited structures can speed ecological recovery.
- Use of native materials (stones and wood) is strongly encouraged.
- Periodic maintenance of structures will be necessary and must be incorporated into project planning.

Design of in-channel habitat structures may basically proceed following the steps below [35]:

- Plan layout.
- Select types of structures.
- Size the structures.
- Investigate hydraulic effects.
- Consider effects on sediment transport.
- Select materials and design structures.

A plan layout includes the location of each structure, the frequency of structures, spacing of structures, and avoidance of certain places. As shown in Table 4.5, four major types of habitat structures are basically available: sills (weirs), deflectors (dikes), random rocks (boulders), and bank covers (lunkers). In addition, substrate reinstatement (artificial riffle), fish passage, and off-channel ponds and coves are widely employed. Fact sheets on several of these structures are available in the Techniques Appendix of the literature [4]. The flow duration curves and information on extreme high and low flows are needed for sizing the structures ensuring the proper functioning of each structure installed. Hydraulic conditions at designed flow should provide the desired habitat. In many cases, the channel conveyance is important, and the effect of the proposed structure on stages at high flow should be investigated. Conversely, the vulnerability of the proposed structure to high flow, such as over-scours and over-depositions around the structure and an eventual collapse and washout of the structure, should be checked carefully with model tests or 2-D/3-D hydraulic computations, if necessary. Also, efforts should be made to predict the locations and the magnitude of local scours and depositions. Materials used for aquatic habitat structures include stones, fencing wire, posts, and felled trees. Logs can provide a long service in the channel.

In some cases and places, reintroduction of a specific fauna to stream and restoration of in-stream habitat structure for a specific fauna can be considered. One example for the former case is beaver reintroduction to forested headwaters, and another example for the latter case is

**Table 4.5**  
**Typical characteristic of in-channel habitat structures (cited from table 9.11 in the literature [6], with permission from ASCE)**

Structure type	Intended effects	Typical location	Materials	Common problems	Design guidance
Sills (weirs)	Increase scour away from banks	Extending across channel from bank to bank	Stone, gabion, or log weirs with uniform, sloping, or notched crests	Flanking Fish passage Undetermined by downstream scour hole Erosion of crest Abrasion and failure of gabion wire	Klingeman et al. (1984). “Simple bed control structures.” in Biedenham et al. (1998). Artificial riffles described by Newbury and Gaboury (1993)
Deflectors (dikes)	Increase surface flow disturbance along banks; deflect flow away from banks	Along banks Extending out from riverbank	Irregularly shaped revetments, intermittently spaced short spurs or groins, boulders, or root wads Cabled (anchored) trees; longer spur dikes, groins, or jetties	Erosion of crest Structure subsidence in fine-bed channels Erosion of opposite bank Scour holes too small Covered by deposition	Klingeman et al. (1984). “Dikes and retards,” in Biedenham et al. (1998). Kuhntle et al. (1999b; 2002), Thompson (2002a)
Random rocks (boulders)	Induce scours, create zones of low velocity in wake	Isolated midchannel flow obstructions	Boulders, boulder clusters (groups), root wads, vanes, or sills detached from banks	Flanking Fall or roll into downstream scour hole	
Covers (lunkers)	Little impact on flow or sediment; primarily intended to provide shade and hiding places	Along undercut banks	Lumber piers, trees, brush, rafts, and features that cause local turbulence and thus reduce water transparency	Habitat protected by cover may be eliminated by sedimentation	

the salmonid-spawning gravel cleaning and placement, both of which are especially important in the Northwest region of the USA. Technical guidelines for those restoration are well described in the literature of WSAHGP [3], and more information on the beaver reintroduction can be found in recent literature [36, 37].

### 3.2.5. Riverbank Restoration

In natural rivers, riverbanks are usually flexible and are frequently eroded by floods thus river channels are changed, which is of a dynamic nature of rivers. In some cases, however, riverbanks are required to be fixed either temporarily or permanently [4], pp. 8–61. The first case corresponds to the so-called bondage effect, that is, riverbanks being protected against erosion until the floodplain restoration is complete. In these situations, the initial bank protection may be provided primarily with vegetation, wood, and rock as necessary.

The second case corresponds to ensuring permanent river stability for land development or modified flow, and vegetation is used primarily to address the specific ecological deficiencies such as a lack of channel shading.

Soil bioengineering, a method that uses live plants and other natural material for the control of soil slope and banks, is frequently used for both temporarily or permanently stabilizing riverbanks. Any particular site must be evaluated to determine how vegetation can or cannot be used. Soil cohesiveness, the presence of gravel lenses, ice accumulation patterns, the amount of sunlight that reaches the bank, and the ability to ensure that grazing would be precluded are all considerations in assessing the suitability of vegetation to achieve bank stabilization.

Existing riverbank stabilization techniques can be categorized into three types: armor with rocks and stones, armor combined with plants, and vegetative methods. Vegetative methods alone are sufficient on some rivers and streams or some bank zones, but as erosive forces increase, they can be combined with other materials, such as rocks, logs or brush, and natural fabrics. The literature [4] introduces, in its appendices, the various techniques for riverbank stabilization, which can be categorized into the above three types. They are:

- Type of armor: riprap, stone toe protection, and dead tree revetment
- Type of vegetative methods: live stakes, live fascine, dormant and post plantings, and brush mattresses
- Type of mixed methods: coconut fiber roll, vegetated gabions, joint planting, live cribwalls, log/rootward/boulder revetments, and vegetated geogrids

### 3.2.6. Channel–Floodplain Connectivity

Past river-engineering activities focused primarily on the protection of floodplains against floods, which have caused degradation of the ecosystems of the floodplains. Hydrologic interaction between a floodplain and channel is ecologically important, and the reestablishment of the floodplain functions by frequent inundations is sometimes a goal of river restoration works.

Several types of channel–floodplain connections can be identified: a levee breaching, a levee setback, a levee removal, and a direct reconnection by side-/off-channel restorations. Levee breaching allows pastures or gravel pits to flood during high-water periods. It can be an excellent option where a levee removal or setback is unfeasible because there is no large equipment or well-established vegetation. Levee breaching still allows for some level of inundation of the floodplain, floodwater storage, sediment deposition, and refuge areas for terrestrial and aquatic species, although not to the same extent as a levee removal or setback.

A levee setback is a good option for areas where levee overtopping is common and where significant land uses are unlikely to occur. It requires the same construction components as removal, in addition to rebuilding the levee itself. One of the greatest advantages of a levee setback is that it allows for the seasonal use of land within the newly established floodway and greater flood protection.

Levee removal can be well adopted in the case of relatively low and/or short levees denuded of vegetation, if the costs of removal and disposal of levee materials is given. The cost usually includes those for the removal and disposal of the levee material (sediment).

A direct reconnection of a channel and a floodplain can be considered particularly where major floodplain development occurs. It can provide two physical and biological effects: side- and/or off-channel restoration as well as the floodplain restoration itself. Side- and/or off-channel habitats are generally small watered remnants of major river meanders across the floodplain. They are naturally abandoned river channels, oxbows, flood swales, and sometimes the lower ends of terrace tributaries flowing out onto the floodplains. They also include constructed channels and connecting ponds that could have been built specifically for an aquatic habitat or indirectly for other purposes such as gravel mining. Side- and/or off-channel restoration works usually include the construction, restoration, and reconnection of side channels to the main channel and protection of these areas by controlling the river and flood flow from the main river and capitalizing on the availability of floodplain groundwater.

There are two types of side-channel restoration [3]: a new side channel that focuses on the creation of self-sustaining side channels, which are maintained through natural processes, and the reconnection of an existing side-channel habitat that focuses on the restoration of fish access and habitat-forming processes.

### 3.2.7. *Riparian Restoration*

Riparian zones are defined as the land adjacent to streams, rivers, ponds, lakes, and some wetlands, whose soils and vegetation are influenced by the presence of the ponded or channelized water. Riparian zones include both the active floodplain and the adjacent plant communities that directly influence the stream system by providing shade, fine or large woody material, nutrients, organic and inorganic debris, terrestrial insects, and a habitat for riparian-associated wildlife.

Riparian habitats may consist of side channels, off-channel ponds and wetlands, perennial or intermittent streams and springs, and periodically flooded grasslands and forests. These habitats offer feeding, reproduction, and refuge habitats for invertebrates, fish, waterfowl, amphibians, birds, and mammals.

Large-scale riparian restoration projects may require the acquisition and procurement of large amounts of plant materials. Local stocks of native plants would be best suited to the site conditions. Some of the required plant material can be transplanted or cut from an adjacent healthy donor or sites near the project area.

Riparian restoration may be employed as a stand-alone technique or used in conjunction with other stream restoration and enhancement efforts. Riparian restoration and management may be undertaken on sites ranging from narrow stream fringes characterized by sharp transitions to an upland habitat to wide riparian corridors with gradual transitions to adjacent uplands.

In addition, a riparian buffer or corridor, a narrow, long patch along the stream, can buffer a stream from adjacent land uses in the ecological as well as the physical aspects and promote channel stability. As previously mentioned in Sect. 2.1, a natural riparian corridor has various ecological functions of a habitat, barrier, conduit, filter, source, and sink. Removal of riparian vegetation for agricultural or urban developmental purposes, therefore, decreases or completely destroys those valuable ecological functions of a habitat of wildlife or filtering of nonpoint pollutants that are incoming to rivers.

Table 4.6 shows a general guideline of a riparian buffer strip width for the riparian restoration and management [38]. Ranges of the widths shown in this table is a synopsis of the values as reported in the literature. Figure 4.11 shows a sketch of a riparian buffer strip. The width of the buffer to be restored or enhanced will be site specific, dictated by budget constraints, land ownership, infrastructure, and valley width.

For river corridor restoration and management, the followings are recommended (cited from the literature [38]):

- Think at a watershed scale when planning for or managing corridors. Many species that primarily use upland habitats may, at some stage of their life cycle, need to use corridors or a habitat, movements, or dispersal.
- Corridors that maintain or restore natural connectivity are better than those that link areas that were historically unconnected.
- Continuous corridors are better than fragmented corridors.
- Wider corridors are better than narrow corridors.
- Riparian corridors are more valuable than other types of corridors because of habitat heterogeneity and the availability of food and water.
- Several corridor connections are better than a single connection.
- Structurally diverse corridors are better than structurally simple corridors.
- Native vegetation in corridors is better than nonnative vegetation.
- Practice ecological management of corridors, burn, flood, open canopy, etc., if it mimics naturally occurring historical disturbance processes.
- Manage the matrix with wildlife in mind; apply principles relative to the native plant and animal communities in the area.

### 3.2.8. Room for the River: Dutch Practice

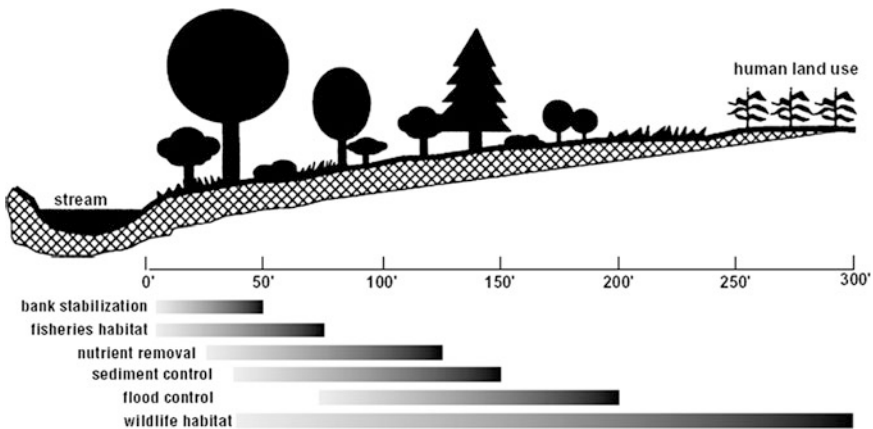
This catchphrase was not originally intended for restoration planning or design methods, but mainly as a flood control method in the Netherlands in the mid-2000s. Since the 1953 flood which claimed more than 1,800 lives and hundreds of thousands of evacuees, the Dutch



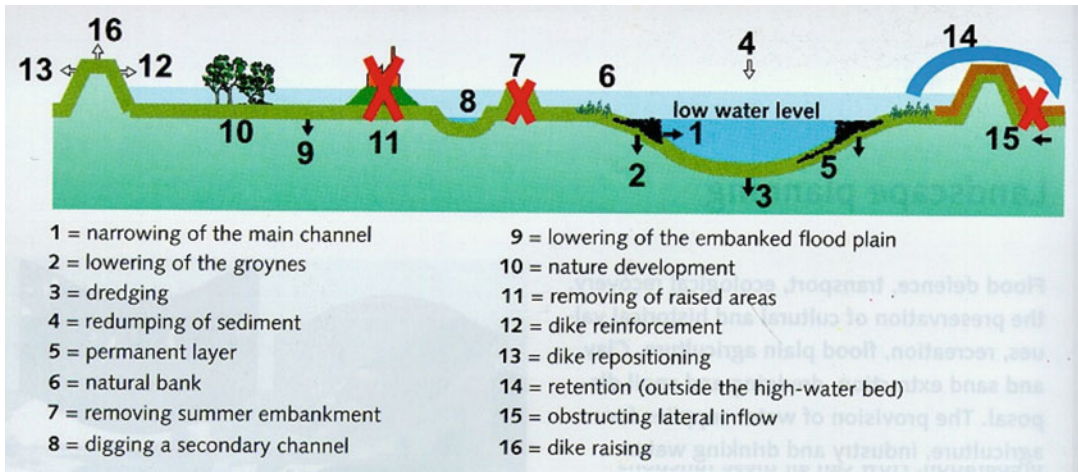
**Table 4.6**  
**A general guideline of riparian buffer strip width [38]**

Function	Description	Recommended width <sup>a</sup>
Water quality protection	Buffers, especially dense grassy or herbaceous buffers on gradual slopes, intercept overland runoff, trap sediments, remove pollutants, and promote groundwater recharge. For low to moderate slopes, most filtering occurs within the first 10 m, but greater widths are necessary for steeper slopes, buffers comprised of mainly of shrubs and trees, where soils have low permeability or where NPSP loads are particularly high	5–30 m
Riparian habitat	Buffers, particularly diverse stands of shrubs and trees, provide food and shelter for a wide variety of riparian and aquatic wildlife	30–500+ m
Stream stabilization	Riparian vegetation moderates soil moisture conditions in-stream banks, and roots provide tensile strength to the soil matrix, enhancing bank stability. Good erosion control may only require that the width of the bank be protected, unless there is active bank erosion, which will require a wider buffer. Excessive bank erosion may require additional bioengineering techniques (see Allen and Leach 1997)	10–20
Flood attenuation	Riparian buffers promote floodplain storage due to backwater effects; they intercept overland flow and increase travel time, resulting in reduced flood peaks	20–150
Detrital input	Leaves, twigs, and branches that fall from riparian forest canopies into the stream are an important source of nutrients and habitat	3–10 m

<sup>a</sup>Synopsis of values reported in the literature, a few wildlife species require much wider riparian corridors.



**Fig. 4.11.** Widths of riparian buffer strip by restoration goals [39].



**Fig. 4.12.** Schematic view of the Dutch practice of “Room for the River” [40].

government have built and reinforced numerous dikes along the rivers for flood control purposes. With the 1993 and 1995 floods, however, they have recognized that sea levels rise and higher river discharges due to the forecast of climate change would nullify the present measures of flood control and therefore decided in 2007 to adopt a new paradigm of river management, *Room for the River*. This means to provide more space to a river for increasing the flood conveyance capacity of the river.

Figure 4.12 shows the various types of measures, under the catchphrase of “Room for the River,” to secure more spaces for the river. In this figure, no. 7 of “removing summer bank” corresponds to a levee removal in the “channel–floodplain connectivity”; no. 8 of “digging secondary channel” corresponds to the side-channel restoration; no. 9 of “lowering of the embanked floodplain,” which may be done only at the silted and aggraded floodplains, corresponds to a riparian restoration since the development of riparian plants such as *Salix* and *Populus* are expected with the reestablishment of frequently flooded areas; no. 10 of “nature development” may correspond to a part of riparian restoration; and no. 13 of “dike repositioning” corresponds to a levee setback in a “channel–floodplain connectivity.” With these flood control measures, the possibilities of successful ecological restoration of the river can be high.

#### 4. RESTORATION IMPLEMENTATION, MONITORING, AND ADAPTIVE MANAGEMENT

This section describes how to implement a planned and designed restoration project for a site-specific fitting, how to monitor the outcome of the restoration effort, and how to activate an adaptive management for the completion of a restoration project.

#### 4.1. Restoration Implementation

In order to implement a restoration project, the technical aspects of site preparation, site clearing, construction, inspection, and maintenance should all be considered. There are some major elements of restoration implementation, starting from a review of the restoration implementation plan, site preparation, site clearing, installation and construction, site reclamation/cleanup, inspection, and finally on to maintenance. The followings are based on the literature [4], pp. 9–3 ~ 9–29.

Implementation of river restoration project can be preceded by careful planning such as:

- Determining a schedule
- Obtaining necessary permits
- Conducting a pre-implementation meeting
- Informing and involving property owners
- Securing site access and easements
- Locating existing facilities
- Confirming sources of materials and ensuring standards of materials

Site preparation requires several actions including, among others, the delineation of work zones, preparation for access and staging areas, taking precautions to minimize any disturbances, and obtaining the appropriate equipment. Several methods for taking precautions to minimize disturbance can be conceivable, such as protecting the existing vegetation and sensitive habitats, soil erosion, water and air qualities, cultural resources, noise and solid waste disposal, and worksite sanitation.

The next step is site clearing, involving the marking of geographic limits, removal of undesirable plant species, addressing site drainage issues, and protecting and managing desirable existing vegetation.

The third step regards the activities of the installation and construction such as earthmoving, diversion of flow, and the installation of plant materials. Earthmoving activities include fill placement and disposal, contouring, and final grading. Installation of plant material is an important part of most restoration initiatives that require active restoration. The timing of the installation of plant material is most important, as it varies by species and regions. Transportation and storage also vary, according to the types of planting, such as seeds, live cutting, and rooted stock. Planting should be based on some principles, which in general rely on the types of soils and planting methods. Other considerations on the installation of plant material include the treatment of competing plants, use of chemicals, use of mulches, irrigation, and fencing.

The fourth step is the inspection, periodic ones during implementation and a final one after installation, and thus is a critical process for the success of restoration works. Finally, maintenance is the repairing work based on any problems noted in annual inspections. Two types of maintenance are identified: remedial maintenance and scheduled maintenance. The former is the results of the annual inspection, while the latter is performed at intervals that are preestablished during the design phase or based on project-specific needs.

## 4.2. Monitoring Techniques

Appropriate monitoring techniques should be considered for the evaluation of restoration efforts. The monitoring of restoration works may be conducted for a number of different purposes including [4]:

- Performance evaluation, which assesses in terms of project implementation and ecological effectiveness
- Trend assessment, which includes longer term sampling to evaluate changing ecological conditions at various spatial and temporal scales
- Risk assessment, which is used to identify causes and sources of impairment within an ecosystem
- Baseline characterization, which is used to quantify ecological processes operating in a particular area

Performance evaluation monitoring usually includes three different types of monitoring, depending upon the purpose of monitoring, i.e., implementation monitoring, effectiveness monitoring, and validation monitoring. The first type concerns if the restoration works are implemented correctly and properly according to the plan and design of the restoration project. The second type concerns if the restoration works achieve the desired results or goals of the project. This type of monitoring requires a systematic work of monitoring with proper indicators, closely linked with the project goals, to measure the performance of the project. The third type is to check if the assumptions and hypothesis used for the design of a restoration project are correct. This type of monitoring is usually used when restoration work are out of the intended scope or goals, even if implementation work was proven to have been correctly performed by the implementation monitoring.

The monitoring program should be carefully planned along with the time when a restoration project is planned. In New Zealand practice [41], appropriate indicators (or parameters) are set for each project goal, such as the natural habitat, water quality, ecosystem functioning, aquatic biodiversity, terrestrial biodiversity, downstream health, recreation, cultural, aesthetics, and fisheries. The key step in designing a monitoring program begins with identifying project goals and catchment constraints, understating the restoration site, and having a clear image of the project goal or reference site. Appropriate indicators to measure goals of a restoration project should be carefully chosen. Then, identification of the criteria to judge success for each indicator should be followed and, finally, the appropriate methods and time scales, such as when to measure should be determined.

Various types of physical and biological parameters (or indicators) are considered for the evaluation of restoration works. Table 4.7 shows physical parameters in the establishment of evaluation criteria for the measurement of physical performance and stability.

When water quality is an important goal of a restoration project, chemical parameters should be collected and monitored. Important chemical and physical parameters for that might have a significant influence on the aquatic habitat are as follows [4]:

- Temperature
- Turbidity
- Dissolved oxygen

- pH
- Natural and manufactured toxics
- Flow
- Nutrients
- Organic loading (BOD, TOC, etc.)
- Alkalinity/acidity
- Hardness
- Dissolved and suspended solids
- Channel characteristics
- Spawning gravel
- In-stream cover
- Shade
- Pool/riffle ratio
- Springs and groundwater seeps
- Bed material load
- Amount and size distribution of large woody debris (LWD)

**Table 4.7**

**Physical parameters for monitoring of restoration works (cited from table 9.3 in the literature [4])**

Plan view	Sinuosity, width, bars, riffles, pools, boulders, and logs
Cross-sectional profiles by reach and features	Sketch of full cross section, bank response angle, depth bankfull, width, width/depth ratio
Longitudinal profile	Bed particle size distribution, water surface slope, bed slope Pool size/shape/profile, riffle size/shape/profile Bar features
Classification of existing streams (all reaches)	Varies with classification system
Assessment of hydrologic flow regimes through monitoring	2-, 5-, and 10-year storm hydrographs Discharge and velocity of base flow
Channel evolutionary track determination	Decreased or increased runoff, flash flood flows Incisement/degradation, overwidening/aggradation Sinuosity trend-evolutionary state, lateral migration Increasing or decreasing sinuosity Bank erosion patterns
Corresponding riparian conditions	Saturated or ponded riparian terraces Alluvium terraces and fluvial levees Upland/well-drained/sloped, or terraced geomorphology Riparian vegetation composition, community patterns, and successional changes
Corresponding watershed trends—past 20 years and future 20 years	Land use/land cover, land management, soil types, and topography Regional climate/weather

**Table 4.8****Biological attributes and corresponding parameters for performance evaluation (cited from table 9.4 in the literature [4])**

Biological attribute	Parameter
Primary productivity	Periphyton, plankton Vascular and nonvascular macrophytes
<i>Zooplankton/diatoms</i>	
Invertebrate community	Species, numbers, diversity, biomass, macro/micro-aquatic/terrestrial
Fish community	Anadromous and resident species Specific populations or life stages Number of outmigrating smolts Number of returning adults
Riparian wildlife/terrestrial community	Amphibians/reptiles, mammals, birds
Riparian vegetation	Structure, composition, condition, function Changes in time (succession, colonization, extirpation, etc.)

Biological monitoring can cover a broad range of organisms, riparian conditions, and sampling techniques. Table 4.8 shows the biological attributes of a stream ecosystem that may be related to restoration goals.

Chemical monitoring can be conducted in conjunction with biological monitoring. Important chemical and physical parameters that may have a significant influence on biological systems include the following [4]:

- Temperature, turbidity, dissolved oxygen, pH, natural toxics (mercury), and manufactured toxins
- Flow, nutrients, organic loading (BOD, TOC), alkalinity/acidity, and hardness
- Dissolved and suspended solids, channel characteristics, spawning gravel, stream cover, shade, pool/riffle ratio, springs and groundwater seeps, bed material load, and amount and size distribution of large woody debris

### 4.3. Adaptive Management

Adaptive management is the process for establishing checkpoints to determine whether proper actions have been taken and are effective in providing the desired results. It is not a trial and error approach. It is the flexibility to detect when changes are needed to achieve success and to be able to make the necessary midcourse or short-term corrections. The necessity of adaptive management can be determined through the implementation, effectiveness, and validation components of the performance monitoring. Through these monitoring processes, a restoration project can be tested if the hypothesis that the restoration planning and design is based on a good understanding of the watershed processes and appropriately addresses adverse changes in these processes and related ecological functions.

Adaptive management provides an alternative approach to traditional planning procedures for the design and implementation of programs and projects that seek to manage and/or restore natural systems [42]. It replaces the current dependencies on numerical models and traditional planning guidelines by applying a focused “learning-by-doing” approach to decision-making. The “learning-by-doing” approach is proactive—it is an iterative and deliberate process of applying principles of scientific investigation to the design and implementation of restoration projects to better understand the ecosystem and to reduce the key uncertainties, as a basis for continuously refining the project design and operation. New information that can guide a project plan can include results gained from scientific research and monitoring, new or updated modeling information gleaned from iterative project implementation, and as an input from managers and the public.

A useful review and analysis of the applications of adaptive management in some river restoration projects in the USA is available from the Water Resources Collections and Archives, University of California [43], which focuses on (1) how adaptive management is being applied in river restoration, (2) why practitioners are using adaptive management, and (3) how well the adaptive management is working.

An idealized cycle of adaptive management includes the following sequence of steps, which are continually repeated [43]:

1. Establish a stakeholder adaptive management team.
2. Define the problem(s) to be addressed.
3. Establish goals and objectives.
4. Specify a conceptual model that expresses the collective understanding of how the system in question functions, highlighting any key uncertainties and acknowledging factors that are outside of the system.
5. Develop hypotheses about the effects of different management actions that address the uncertainties.
6. Design management experiments/interventions to test hypotheses while meeting management goals.
7. Design a monitoring plan to measure the impact(s) of management interventions.
8. Implement management interventions.
9. Monitor.
10. Evaluate the impacts in terms of management goals and hypotheses.
11. Reassess and adjust the problem statement, goals, conceptual model, interventions, and the monitoring plan.

In the above, steps of 1 through 3 correspond to the planning stage, while steps 4 through 6 differ from the conventional way of designing a restoration project, since in the adaptive management concept, uncertainties in the planning and design of a project are assessed and different management actions are considered to compare their performances with each other. Step 7 corresponds to designing the monitoring plan, while step 8 corresponds to the implementing stage according to the plan and the design of the project. Finally, step 9 corresponds to the monitoring stage of the project after implementation, step 10 corresponds to the evaluation stage of the performance of the project, and step 11 is to reassess, if necessary, and adjust the project plan in the contexts of the project goals.

## APPENDIX: GUIDELINES AND HANDBOOKS OF RIVER RESTORATION (WRITTEN IN ENGLISH) (IN CHRONOLOGICAL ORDER)

1. *Stream Corridor Restoration Design: Principles, Processes, and Practices*; Federal Interagency Stream Corridor Restoration Handbook, Federal Interagency Stream Corridor Restoration Working Group (FISRWG), first published in 1998 and revised in 2001. [http://www.nrcs.usda.gov/technical/stream\\_restoration/](http://www.nrcs.usda.gov/technical/stream_restoration/).
2. *A Rehabilitation Manual for Australian Streams*, Vol. 1 and 2, authored by I. D. Rutherford, Kathryn Jerie, and Nicholas, Marsh, published by Land and Water Resources Development Corporation, 2000. <http://lwa.gov.au/products/pr000324>.
3. *Guidelines for Rehabilitation and Management of Floodplains Ecology and Safety Combined*, published by Netherlands Centre for River Studies and sponsored by International Rhine-Meuse Activities, 2001. [http://www.ecrr.org/publication/restgeom\\_doc6.pdf](http://www.ecrr.org/publication/restgeom_doc6.pdf).
4. *Manual of River Restoration Techniques*, The River Restoration Centre, Silsoe, UK; First edited in 1999 and first updated in 2002. [http://www.therrc.co.uk/rrc\\_manual.php](http://www.therrc.co.uk/rrc_manual.php).
5. *Urban River Basin Enhancement Methods (URBEM)*, funded by the EC under the 5th Framework, 2004. <http://www.urbem.net/index.html>
6. *Stream Habitat Restoration Guidelines* (Final Draft), Prepared for Washington State Aquatic Habitat Guidelines Program, and co-published by the Washington Departments of Fish and Wildlife and Ecology and U.S. Fish and Wildlife Service, 2004. <http://wdfw.wa.gov/publications/00043/wdfw00043.pdf>.
7. *Stream Restoration Design*, Part 654 National Engineering Handbook, US Department of Agriculture, National Resources Conservation Center, 2007. <http://policy.nrcs.usda.gov/viewerFS.aspx?id=3491>.
8. *California Riparian Habitat Restoration Handbook, Second Edition*, F. Thomas Griggs and River Partners, July 2009. [http://www.riverpartners.org/reports-and-articles/Restoration\\_Handbook\\_July\\_Final4Web.pdf](http://www.riverpartners.org/reports-and-articles/Restoration_Handbook_July_Final4Web.pdf).

## REFERENCES

1. URBEM (2004) Urban river basin enhancement methods, funded by the EC under the 5th Framework, HR Wallingford et al participated
2. Wang LK, Pereira NC (eds) (1986) Handbook of environmental engineering, vol 4, water resources and natural control processes. Humana Press, Totowa, NJ, p 496
3. WSAHGP (2004) Stream habitat restoration guidelines (final draft). Prepared for Washington State Aquatic Habitat Guidelines Program, and co-published by the Washington Departments of Fish and Wildlife and Ecology and U.S. Fish and Wildlife Service
4. FISRWG (1998) Stream corridor restoration design: principles, processes, and practices, federal interagency stream corridor restoration handbook. Federal Interagency Stream Corridor Restoration Working Group
5. NRCS (2007) Stream restoration design, part 654 national engineering handbook. US Department of Agriculture, National Resources Conservation Center
6. ASCE (2007) Sedimentation engineering. ASCE manuals and reports on engineering practice no. 110 Garcia MH (ed), pp 461–503
7. Cairns J (1991) The status of the theoretical and applied science of restoration ecology. Environ Prof 13:186–194



8. Rutherford ID, Jerie K, Marsh N (2000) A rehabilitation manual for Australian streams, vols 1 and 2. Published by Cooperative Research Center for Catchment Hydrology and Land and Water Resources and Development Corporation
9. Bradshaw AD (1996) Underlying principles of restoration. *Can J Fish Aquat Sci* 53(suppl 1):3–9
10. Dufour S, Piegay H (2009) From the myth of a lost paradise to targeted river restoration: forget natural references and focus on human benefits. *River Res Appl* 25:568–581
11. WWF/IUCN (2000) Forest landscape restoration. WWF/IUCN first international workshop on forest restoration initiative “Forest Reborn”, Segovia, Spain, 3–5 July
12. Dunster J, Dunster K (1996) Dictionary of natural resources management. University of British Columbia, Vancouver, BC, p 363
13. Wohl EE, Angermeier PL, Bledsoe B, Kondolf GM, McDonell L, Merritt DM, Palmer MA, Poff NL, Tarboton D (2005) River restoration. *Water Resour Res* 41(10), AW10301
14. Schumm SA (1977) The fluvial system. John Wiley & Sons, New York, p 338
15. Vannote RL, Minshall GW, Cummins KW, Sedell JR, Cushing CE (1980) The river continuum concept. *Can J Fish Aquat Sci* 37(1):130–137
16. USGS. <http://ga.water.usgs.gov/edu/watercycle.html>
17. Lane EW (1955) The importance of fluvial morphology in hydraulic engineering. *Proc Am Soc Civil Eng* 81(745):1–17
18. Yang CT (1996, 2003) Sediment transport theory and practice, 1st edn by McGraw-Hill (1996) and 2nd edn by Krieger Publishing Company (2003), pp 303–312
19. Knighton D (1998) Fluvial forms and processes a new perspective. Department of Geography, University of Sheffield, Arnold Press, Sheffield, p 299
20. Williams GP, Wolman MG (1984) Downstream effects of dams on alluvial channels. USGS Professional Paper 1286, Department of the Interior, USA
21. Maenor S, Watanabe S (2008) Field experiment to restore a gravel bar and control growth of trees in the Asahi River. *J River Basin Manage* 6(3):225–232
22. NRC (1992) Restoration of aquatic ecosystem. National Research Council, National Academy Press, Washington, DC, p 576
23. Stanford JA, Ward JV, Liss WJ, Frissell CA, Williams RN, Lichatowich JA, Coutant CC (1996) A general protocol for restoration of regulated rivers. *Regul River Res Manage* 12(4–5):319–413
24. Palmer MA et al (2005) Standards for ecologically successful restoration. *J Appl Ecol* 42:208–217
25. De Groot RS (1992) Functions of nature: evaluation of nature in environmental planning, management and decision making. Unpublished thesis, Wolters and Noordhoff, Groningen
26. Prichard et al (1993) Process for assessing proper conditions. Technical reference 1737-9, US Department of the Interior, Bureau of Land Management Service Center, Denver, Colo., rev. in 1995
27. USFWS (1980) Habitat evaluation procedure (HEP), ESM 102. US Department of the Interior, Fish and Wildlife Service, Washington, DC
28. Simon A (1989) A model of channel response in distributed alluvial channels. *Earth Surf Process Landf* 14(1):11–26
29. Montgomery DR, Buffington JM (1993) Channel classification, prediction of channel response and assessment of channel condition, report TFW-SH10-002. Department of Geological Sciences and Quaternary Research Center, Univ. of Washington, Seattle, WA
30. Rosgen DL (1994) A classification of natural rivers. *Catena* 22:169–199
31. Woo H, Julien PY, Richardson EV (1986) Wash load and fine sediment load. Technical note of *J Hydraul Eng ASCE* vol 112, June

32. Hey RD (1979) Flow resistance in gravel-bed rivers. *J Hydraul Div ASCE* vol 105, no. 4
33. SAM (2005) Hydraulics design package for channels. US Army Engineering Research and Development Center. [http://www.erd.c.usace.army.mil/pls/erdcpub/www\\_fact\\_sheet.PRODUCT\\_PAGE?ps\\_product\\_num=18758&tmp\\_Main\\_Topic=&page=All](http://www.erd.c.usace.army.mil/pls/erdcpub/www_fact_sheet.PRODUCT_PAGE?ps_product_num=18758&tmp_Main_Topic=&page=All)
34. Brownlie WR (1981) Prediction of flow depth and sediment discharge in open channels. W. M. Keck Laboratory of Hydraulics and Water Resources, Report no. KH-R-43A, California Institute of Technology, Pasadena, CA, Nov
35. Shields FD Jr (1983) Design of habitat structures for open channels. *J Water Res Plan Manage ASCE* 109(4):331–344
36. Burchsted D, Daniels M, Thorson R, Vokoun V (2010) The river discontinuum: applying beaver modifications to baseline conditions for restoration of forested headwaters. *Bioscience* 60(11):908
37. Daniels M (2011) The ecosystem engineer: research looks at Beaver's role in river restoration. *Science Daily*, Jan 4. [www.sciencedaily.com/release/2011/01/110103110331.htm](http://www.sciencedaily.com/release/2011/01/110103110331.htm)
38. Fisher RA, Fischenich JC (2000) Design recommendation for riparian corridors and vegetated buffer strips, ERDC TN-EMRRP-SR-24. Technical Note of US Army Corps of Engineers Ecosystem Management and Restoration Research Program, April
39. CRJC (2000) Connecticut River Joint Commission. <http://www.crjc.org/buffers/Introduction'.pdf#search='riparian%20buffer%20zone'>
40. Middelkoop H, van Haselen COG (eds) (1999) Twice a river; Rhine and Meuse in the Netherlands, RIZA report 99.003, The Netherlands
41. Parkyn S et al NIWA (2010) The restoration indicator toolkit indicators for monitoring the ecological success of stream restoration. National Institute of Water and Atmospheric Research, New Zealand
42. CERP (2006) Adaptive management strategy. Comprehensive everglades restoration plan, April. Also see the official site of Comprehensive Everglades Restoration Plan, Executive Summary of Adaptive Management
43. Levine J (2004) Adaptive management in river restoration: theory and practice in western North America, Restoration of rivers and streams, Water resources collection and archives. University of California Water Resources Center, UC Berkeley, Berkeley, CA

# Sediment Management and Sustainable Use of Reservoirs

---

Gregory L. Morris

## *CONTENTS*

INTRODUCTION  
RESERVOIR CONSTRUCTION AND SEDIMENTATION  
RESERVOIRS AND SUSTAINABILITY  
SEDIMENTATION PROCESSES AND IMPACTS  
PREDICTING FUTURE CONDITIONS  
CLASSIFICATION OF SEDIMENT MANAGEMENT STRATEGIES  
REDUCE SEDIMENT INFLOW FROM UPSTREAM  
ROUTE SEDIMENTS  
RECOVER, INCREASE, OR REALLOCATE STORAGE VOLUME  
TOWARD ACHIEVING SUSTAINABLE USE  
REFERENCES

---

**Abstract** Reservoirs have traditionally been designed to operate for periods of 50–100 years without impairment by sedimentation. However, aging reservoirs are now experiencing sedimentation problems that were ignored by the original designers, and to sustain their utilization, it is now necessary to redefine operations and modify structures to manage sediment. This chapter outlines the basic concepts and strategies to consider in predicting and evaluating reservoir sedimentation, in determining the time frame and severity of the problem, and in selecting an appropriate course of action. Strategies from the watershed to the dam are described which can contribute to the achievement of long-term sustainable use.

**Key Words** Reservoir sedimentation • Sustainability • Sediment management • Reservoir flushing • Offstream reservoir.

## 1. INTRODUCTION

Dams and reservoirs interrupt the transport of sediment along a river, trapping sediment in the low-velocity reach above the dam while the reach below the dam, which no longer receives coarse suspended or bed material, tends to erode. The fluvial system will eventually restore the sediment balance across the impounded reach by completely filling the reservoir and reestablishing sediment discharge below the dam. As an alternative, the impounded river reach can be managed to improve the balance between sediment inflow and discharge to sustain beneficial storage. The ultimate objective of sediment management in reservoirs is to retard storage loss and to achieve a sediment balance in an economical and environmentally responsible manner while maximizing sustained long-term benefits from the reservoir.

Ours is, above all, a hydraulic society, particularly from the standpoint of food production. Of global consumptive water use, consisting of water evaporated, incorporated into products or polluted, 86 % is appropriated by agriculture, with only 9 % and 5 % respectively attributed to industrial and domestic use [1]. Flow regulation by reservoirs adds about 460 km<sup>3</sup>/year to the world's irrigation supply, a 40 % increase above naturally available supplies [2]. Additionally, about 20 % of the world's electricity is produced by hydropower, a non-consumptive use, but which also depends on reservoir storage to sustain hydropower production through the dry season. Even run-of-river plants need to maintain a limited volume of storage to supply power during daily periods of peak demand.

Reservoirs have traditionally been designed based on the "life of reservoir" concept. Under this paradigm, the designer estimates the rate of sediment inflow and provides storage capacity for 50–100 years of sediment accumulation, thus postponing the sedimentation problem. Not only does this approach ignore the long-term problem of storage loss, but at many sites sedimentation problems are occurring much earlier than anticipated because sediment yield was underestimated or, due to increased sediment yield resulting from changed land use. This traditional approach may also fail to anticipate rapid sedimentation in areas which interfere with recreational uses, intake function, etc. In multipurpose reservoirs, the normally empty flood control pool may receive little sediment, while the conservation pool at the bottom of the reservoir loses capacity rapidly. But most importantly, many reservoirs have now seen more than 50 years of operation and are now beginning to experience sedimentation problems that were "pushed into the future" by the original designers.

Reservoir operation is not sustainable unless sedimentation can be controlled, and in our hydraulic society reservoirs may represent the most important class of non-sustainable infrastructure. Yet, despite increased knowledge of sedimentation processes and control methods, and the acknowledged need for sustainable design, most reservoirs continue to be designed and operated based on the traditional concept of a finite reservoir life, giving little consideration to maintaining long-term storage [3]. This chapter introduces strategies for managing sediments to maintain long-term reservoir capacity. This is a complex topic and only basic concepts are provided here. More comprehensive sources of information are listed at the end of this chapter.

## 2. RESERVOIR CONSTRUCTION AND SEDIMENTATION

The history of ancient dams has been reported by Schnitter [4], who listed over 12 dams which have seen over 2,000 years of service. The record for most years in operation appears to be held by Egypt's Mala'a reservoir constructed by King Amenemhet III (1842–1798/95 BCE) in the Faiyum depression about 90 km southwest of Cairo and reconstructed in the third century BCE with a dam 8 km long and 7 m high. This 275 Mm<sup>3</sup> off-channel impoundment stored water diverted from the Nile and remained in operation until the eighteenth century, a span of 3,600 years. The largest number of ancient structures was built by the Romans, and other long-lived ancient structures are reported in Greece, Sri Lanka, and China. If properly maintained, the life of a dam can be virtually unlimited. For example, the Proserpina reservoir at Mérida, Spain, constructed by the Romans in the second century, continues in use today. Reservoirs are the longest lived of all functional engineering works. Pyramids may be older, but they are monuments rather than functional engineering infrastructure.

Most dam construction has been undertaken during the last half of the twentieth century, which saw the worldwide increase in inventory of large dams (>15 m tall) from 5,000 to 40,000. During this same period in China, which is heavily dependent on irrigation supplies from reservoirs, the number of large dams increased from under a dozen to 22,000 [5]. China today has about half the world's large dams. However, the rate of dam construction declined dramatically worldwide toward the end of the twentieth century as many of the best available reservoir sites in developed regions were consumed, and resistance to dam construction grew from the increased competition for land resources inundated by reservoirs and in response to adverse social and environmental impacts.

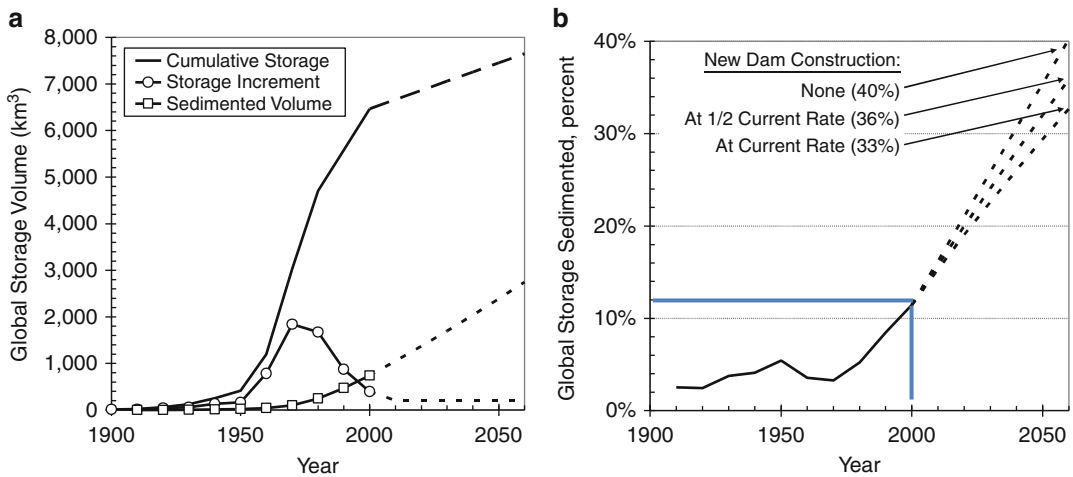
In contrast to the decline in the rate of new dam construction, the rate of storage loss from sedimentation has been steadily increasing. Estimates of average global rate of storage loss worldwide vary from Mahmood's [6] estimate of 1 % to White's [7] estimate of 0.5 %. Sedimentation is now estimated to reduce global reservoir capacity at the rate of 40 km<sup>3</sup>/year, or about 0.6 % annually based on the current global reservoir capacity of approximately 7,000 km<sup>3</sup> [8]. Using the International Commission on Large Dams (ICOLD) database, Basson [8] estimated that about 1,400 km<sup>3</sup> of capacity has already been lost to sedimentation, equivalent to 20 % of total original storage capacity (Table 5.1). Reservoir storage is now being lost much faster than it is being created.

Rates of storage loss are highly variable, ranging from about 0.1 % per year in Great Britain to 2.3 % per year in China [7]. Within a given country or region, there is also a wide variation in the rates of storage loss; some reservoirs already have serious problems while centuries of unimpaired operation remain at others. Average rates of storage loss in different regions of South Africa, for example, range from <0.2 % to 3 % per year [9], and the variation in loss rates for individual dams is far greater.

New reservoir construction to offset sedimentation is frequently not a viable option once reservoirs have been developed within a region. There are relatively few locations both topographically and geologically suitable for reservoir construction, lands both upstream and downstream have often become occupied, and heightening of the dam to add storage

**Table 5.1**  
**Summary of worldwide reservoir capacity and sedimentation, 2010 [8]**

Type of use	Original reservoir volume, km <sup>3</sup>	Percent of total storage volume
Water supply (irrigation, municipal, industrial)	1,000	14 %
Hydropower dead storage	3,000	43 %
Hydropower live storage	3,000	43 %
Total reservoir storage	7,000	100 %
Storage lost to sedimentation by year 2010	1,400	20 %
Annual storage loss	40	0.6 %



**Fig. 5.1.** (a) Cumulative reservoir storage, rate of reservoir construction, and cumulative volume loss due to sedimentation, assuming new dam construction at half the present rate. (b) Projected loss of global reservoir volume due to sedimentation under three different scenarios of new dam and reservoir construction rates. Percentage of global storage which is sedimented declines when the rate of new dam construction exceeds the rate of storage loss.

may not be viable due to both structural and upstream land use limitations. Development of a new reservoir at a distant site may not be economically viable, and water is costly to transport long distances, even if the political and environmental conditions allow such development and water transfers.

Due to the lack of available undeveloped sites, the problem of storage loss by sedimentation cannot be solved by new reservoir construction. This can be appreciated by viewing the global data [10] summarized in Fig. 5.1. Storage volume increases rapidly during the initial period of rapid dam construction. During this period, the rate of storage loss by sedimentation increases slowly. However, once the new construction rate declines, storage

loss by sedimentation will exceed the rate that volume is added by new construction and declining capacity becomes the predominate trend. Similar patterns also result from plotting regional or national data. Two additional trends worsen the impact of the stagnation and subsequent decline in reservoir capacity. First, population is increasing, which means that the storage capacity on a per capita basis will decline much more rapidly than total storage capacity. Because of population increase, the volume of storage on a per capita basis began declining even before overall storage capacity began to decline. Second, climate change is ushering a period of more extreme weather, particularly drought severity. This means that the yield available from reservoirs will decline, not only because of storage loss, but also as a result of increased climatic variability. The developed world cannot return to high rates of new reservoir construction because a large inventory of undeveloped dam sites no longer exists. With new construction constrained, to sustain long-term capacity requires that existing reservoirs be actively managed to reduce the rate of storage loss.

Most dams are relatively young, and engineering experience to date has focused primarily on structures not yet experiencing significant sedimentation problems. However, this situation is changing as sediment accumulates, and the twenty-first century will see water resource engineers increasingly focus on the management of existing dams and reservoirs to achieve sustainable operation.

### 3. RESERVOIRS AND SUSTAINABILITY

#### 3.1. Economic Analysis and Sustainable Use

Although economic analysis has long been the basis for decision-making in the water resources sector, it has important well-known limitations in counting impacts to affected third parties, including future generations, and to nonmarket values such as the environment. Financial analysis discounts future cash flows as compared to current income or expense, logically representing our preference for immediate rather than future income by expressing future value as a time-discounted present value. The present value (PV) for an income or expense amount  $A$ , which occurs  $N$  years in the future, may be computed for an annual discount rate,  $i$ , expressed as a decimal value (i.e., 7 % = 0.07) by

$$PV = A/(1 + i)^N \quad (5.1)$$

Use of discounting helps focus development activity on projects with near-term benefits as opposed to projects with less-certain distant future benefits. However, discounting removes economic incentives to incur costs today for actions to sustain long-term operation. This will be illustrated by an example.

Consider the two cash flows shown in Fig. 5.2 which compares Project #1 with benefits initially at \$100/year but declining to zero at year 30, against Project #2 with a sustainable benefit of \$90/year which extends indefinitely into the future. Using a 30-year horizon for financial planning and a 7 % discount rate, the present value of Project #1 is higher than

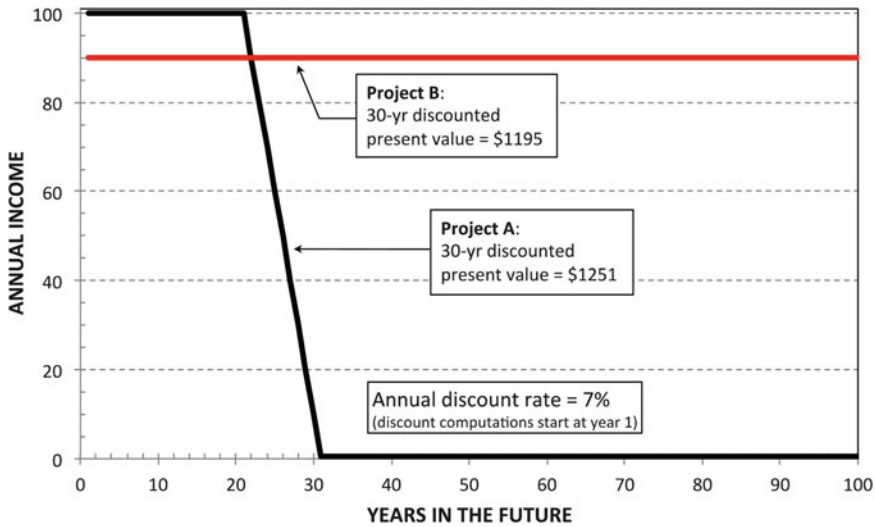


Fig. 5.2. Present values of two future income streams with a 7 % annual discount rate.

Project #2, and from a financial standpoint Project #1 is preferred over the sustainable option. This illustrates the effect that financial analysis can have in directing investment toward measures with near-term benefits but lacking long-term sustainability.

### 3.2. Sustainability Criteria

Public policy in the form of legislation and regulations is used to protect third parties and the environment from failings of the economic marketplace. The concept of sustainable development attempts to establish a more holistic framework for project decision-making and specifically includes issues of intergenerational equity, those long-term consequences of today's actions that will affect our children and grandchildren but which may be discounted out of project financing decisions.

The 1987 report to the United Nations by World Commission on Environment and Development titled "Our Common Future" [11] explicitly brought the rights of and our obligations to future generations, stating: "Humanity has the ability to make development sustainable—to ensure that it meets the needs of the present without compromising the ability of future generations to meet their own needs." An international team of experts reviewed the implications of sustainability to water resources projects, stating that "Most definitions of sustainable development include three broad notions: justice to nature, justice to future generations, justice within our generation" [12]. Economic performance is not excluded from the sustainability equation, but is recognized as one of several complementary factors which, together, result in sustainable activities. Despite widespread agreement on the general form of sustainability goals, it has been most difficult to establish specific project criteria. The issue of sustainability associated with dam construction has been addressed by the World Commission on Dams (WCD) [5] and the International Hydropower Association (IHA) in its



Hydropower Sustainability Assessment Protocol [13]. While the WCD gives greater emphasis to social and equity issues, the IHA's approach is more closely aligned with achieving economic performance and efficiency. However, neither the WCD nor IHA explicitly focuses on long-term sustainable use. For example, the IHA defines "long term" as "the planned life of the hydropower project."

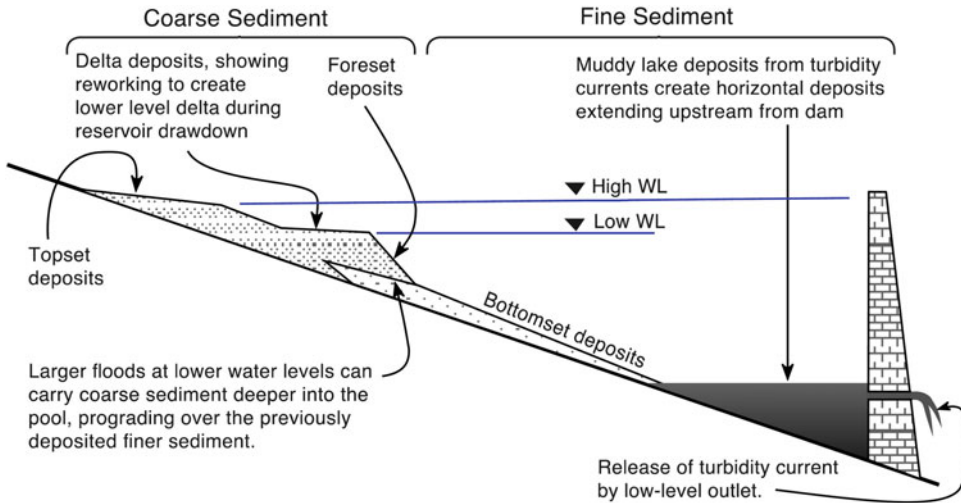
Reservoirs are expected to serve not only the present but the future as well, and cities and societies are built using water from reservoirs based on this assumption. A sustainable approach to reservoir design and management does not accept as inevitable obsolescence by sedimentation, but rather seeks to design and actively manage reservoirs to sustain long-term beneficial use, even though the long-term benefits may differ in both magnitude and character from the original design purpose. Nevertheless, it is not always appropriate to sustain the operation of every reservoir, as benefits may not always justify the cost of sediment management. Facility retirement and removal should always be considered as a management option. Sediment management also plays a major role in the abandonment and removal of dams, since dam removal can release large volumes of sediment with significant downstream consequences. For example, retirement of the small San Clemente dam on the Carmel River, impounding less than 2 Mm<sup>3</sup> of volume, is expected to cost over \$75 M, with the largest cost component associated with management of the 1.9 Mm<sup>3</sup> of sediment that now occupies most of the original reservoir storage volume [14].

## 4. SEDIMENTATION PROCESSES AND IMPACTS

### 4.1. Longitudinal Sedimentation Patterns

A definition diagram showing the idealized configuration of sediment deposits in reservoirs is presented as Fig. 5.3. Based on analysis of data from hundreds of reservoir surveys, Ferrari [15] noted that most sediment inflow tends to deposit either in the delta or along the reservoir thalweg. Deltaic deposits consisting of coarser sediment dominate in some reservoirs, while in others delta deposits may be essentially absent and most volume loss will consist of finer sediment, often transported by turbid density currents. More typically reservoirs will exhibit some combination of these two patterns. This general pattern can be complicated by the effect of sediment inputs from multiple tributaries and the reworking of sediment as reservoir level varies, plus the effect of extreme floods and reservoir drawdown which may carry coarser sediment deeper into the reservoir. It is important to determine where sediment is being deposited since even a small percentage of capacity loss can be problematic if deposited in front of outlet works, in navigation channels, and in the delta creating backwater flooding. In multipurpose reservoirs sedimentation will affect different beneficial pools to varying degrees.

Longitudinal profiles characteristically show a rapid initial change in the bottom configuration in the delta and also near the dam when turbidity currents are important. This initial rapid change in the reservoir profile corresponds to the deposition of material in zones of the reservoir with only limited storage capacity. Thus, if 30 m of sediment depth has been



**Fig. 5.3.** Generalized pattern of reservoir sedimentation showing development of delta containing coarse sediment at two different levels corresponding to periods of two different water levels, and the accumulation of fine-grained deposits downstream of the delta.

deposited in front of the dam in the first 20 years of operation, the top of the sediment bed will not rise an additional 30 m during the next 20 years; the rate of rise will decline over time because each depth increment requires more volume to fill. Compaction of fine sediment can also reduce the subsequent rate of volume loss.

#### 4.2. Reservoir Deltas

When a river enters a reservoir the velocity rapidly diminishes. Bed material transport stops and the coarsest fraction of the suspended load settles rapidly, creating a deltaic depositional pattern which begins at the upstream end of the reservoir and advances downstream. Gravels and cobbles may dominate delta deposits in steep mountain streams, but deltas may consist of fine sand and coarse silts in reservoirs impounding low-gradient streams. The downstream limit of the delta deposit is delimited by a change in grain size and also by its geomorphic expression as a slope change, although the characteristic delta shape is not always evident in reservoirs with limited bed material transport or wide variations in water level [16]. Delta deposits can be extensively reworked and coarse material moved further into the pool by reservoir drawdown or large floods. The topset slope of reservoir deltas is frequently about half the original channel slope [17]. Deltas can also advance upstream, raising backwater levels and causing deposition to occur above the maximum pool level.

An example of deltaic type deposition is illustrated in the sedimentation study of Peligre hydropower and irrigation reservoir in Haiti [18]. At this reservoir, the predominant grain size outside of the river channel is classed as silt based on sedimentation velocity in native water and without using a dispersant to deflocculate clays. Constructed in 1956, the reservoir had lost 50 % of its total capacity by 2008. The longitudinal pattern of sediment deposition is

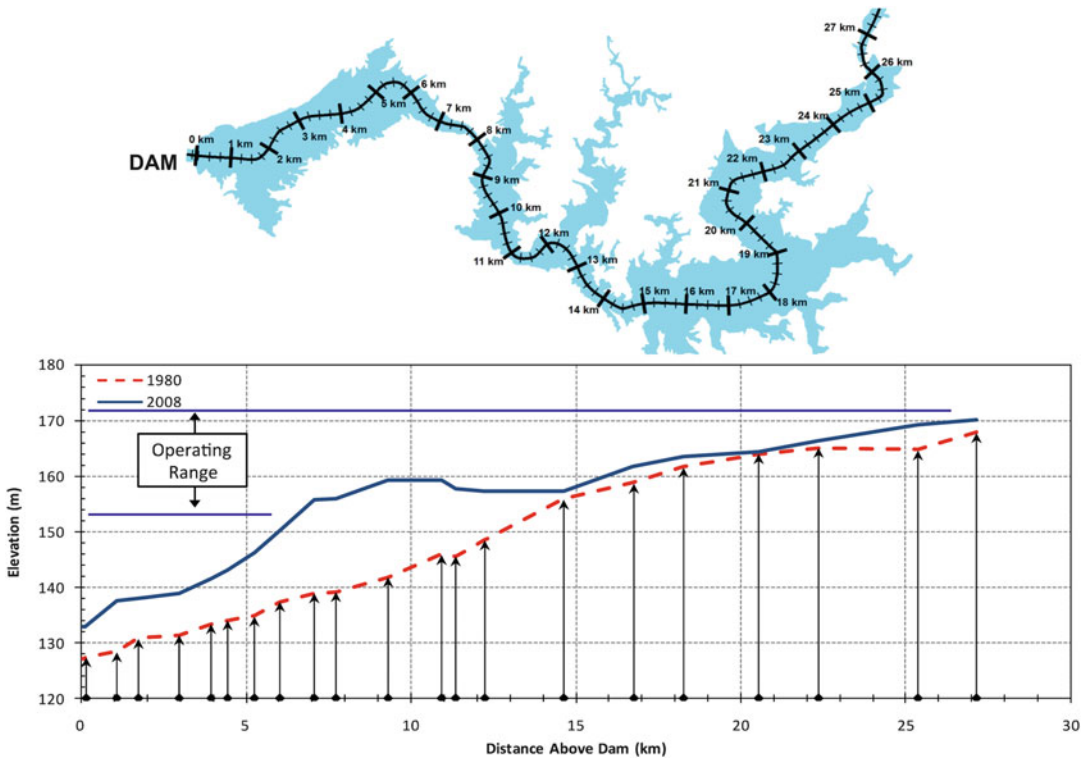


Fig. 5.4. Longitudinal profile of Peligre reservoir, Haiti, showing advance of delta-type deposition [18].

observed in Fig. 5.4, showing deposits advancing toward the dam, but the top of the delta deposit is well below the maximum pool level. A photograph of the reservoir bed during a seasonal drawdown (Fig. 5.5) shows the following: (1) seasonal utilization of exposed sediment for agriculture, (2) river channel meandering across seasonally submerged sediment deposits, and (3) focusing of sediment along the banks of the channel with less deposition along the margins of the reservoir. The concentration of sediment deposits along the main flow path, with less deposition in the reservoir branches, may also be observed in other heavily sedimented reservoirs.

### 4.3. Turbid Density Currents

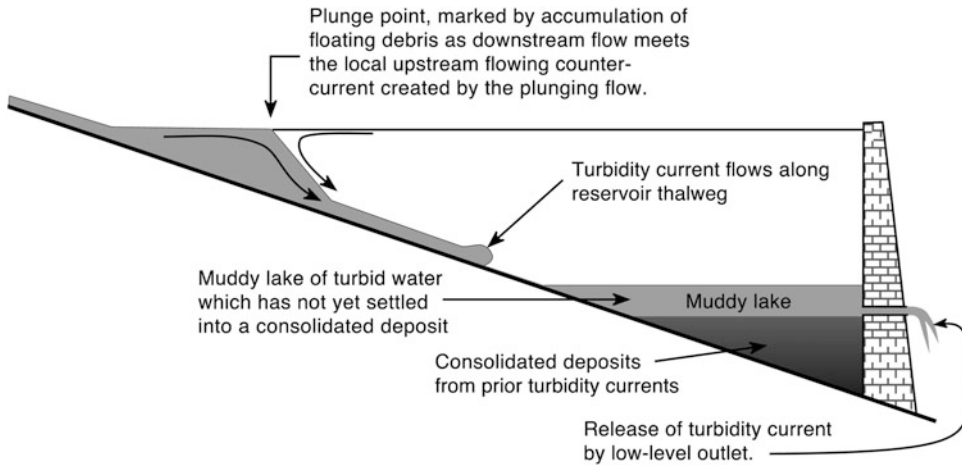
In many reservoirs the coarse sediment which deposits into the delta comprises less than 10 % of the inflowing load, and most inflowing sediments consist of fines smaller than 0.062 mm (smaller than sand) which can be transported along the floor of the reservoir by turbid density currents. Turbidity currents are created by the density difference between the sediment-laden inflowing load and the clear water in the reservoir. Suspended sediment can easily create density differences much greater than those resulting from temperature differences, and the resulting gravity-driven current can carry sediment long distances along the



**Fig. 5.5.** Photograph of deposits in Peligre reservoir during seasonal drawdown for power production (photo: G. Morris).

bottom of the reservoir. For example, turbid density currents were documented to carry sediment-laden water 129 km along the bottom of Lake Mead prior to construction of Glen Canyon dam upstream [19]. Turbid density currents are particularly important in explaining both the mode of transport and the observed deposition patterns for fine sediment, and high-velocity turbidity currents can also redistribute fine sediment within reservoirs by scouring submerged material and transporting it closer to the dam. For example, scouring of submerged deposits by turbidity currents having velocities as high as 2.5 m/s has been documented at the Luzzone reservoir in Switzerland [20].

Several characteristics and indicators of turbid density currents are illustrated in Fig. 5.6. When turbid flow enters a reservoir and plunges this underflow pulls along with it part of the clear water impounded in the reservoir, thereby inducing a surface countercurrent of clear water at the plunge point. The downstream river flow and the induced upstream flow converge at the plunge point and floating debris carried into the reservoir will be trapped at this point of flow convergence. Floating material such as woody debris and logs can accumulate as massive debris dams blocking the entire width of the reservoir at the plunge point. Muddy surface water will be observed upstream of the plunge point, but surface water will be clear downstream of this point. The release of turbid water from low-level outlets, such as deep power intakes, while water on the surface of the reservoir at the dam remains clear, is a visual indicator that turbid density currents are reaching the dam. Another indicator is given by bathymetric data. If horizontal sediment beds extend upstream from the dam, this indicates that turbid currents are transporting a significant sediment load to the dam to create a

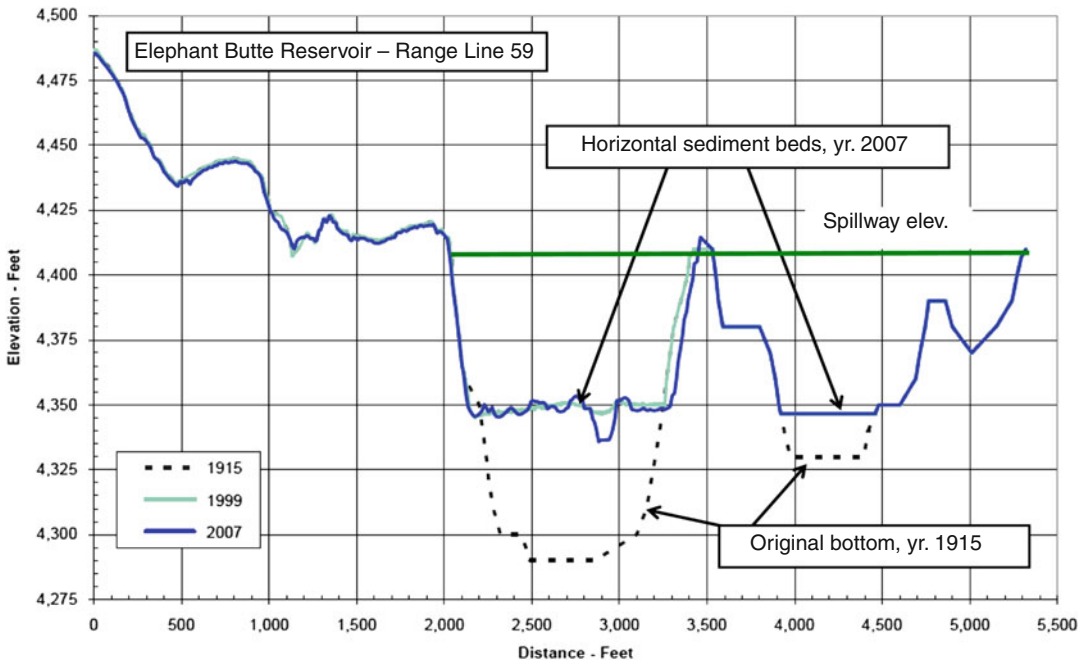


**Fig. 5.6.** Generalized pattern of turbidity current flow through a reservoir and accumulation as horizontal deposits extending upstream from the dam. Because of turbidity currents, it is not uncommon for muddy water to pass through low-level outlets although the surface water in the reservoir is clear.

submerged muddy lake from which the sediments have settled to create horizontal deposits (see Fig. 5.6). Turbid density currents can also be responsible for sedimentation near the dam even when the deposition pattern does not create horizontal beds. Turbid may not form if the reservoir is not deep enough or has insufficient concentration of fine sediment. In reservoirs with cold deep water, turbid inflows may be much warmer and lack sufficient suspended sediment to plunge beneath the cold bottom water. In this case, the turbid water may stay on the surface or may plunge only to the level of the thermocline separating warm surface water from deeper cold water.

The gravity-driven forward motion of the turbidity current creates turbulence which sustains sediment in suspension, but as sediment settles out the density difference and gravitational force driving the current diminish causing it to slow down. This allows more sediments to settle, further diminishing the density difference and the forces driving the current forward. By this means, the current may dissipate before reaching the dam while delivering sediment along the bottom of the reservoir. Sediment deposited by these currents as they flow along the reservoir thalweg infills the cross section from the bottom up to create flat-bottomed cross sections (Fig. 5.7). Flood discharge, suspended sediment grain size, and concentration all vary over the duration of a flood, and consequently turbid density currents are unsteady with respect to discharge, sediment concentration, grain size distribution, velocity, and thickness.

Turbidity current velocities vary with changes in both sediment concentration (density of the turbid flow) and bottom slope. The propagation of turbidity currents along the bottom of the reservoir is dependent on the submerged geometry, and their behavior can be greatly modified by changes in subsurface geometry through sedimentation or modification of sediment deposits by reservoir flushing or dredging. When the reservoir is newly impounded,

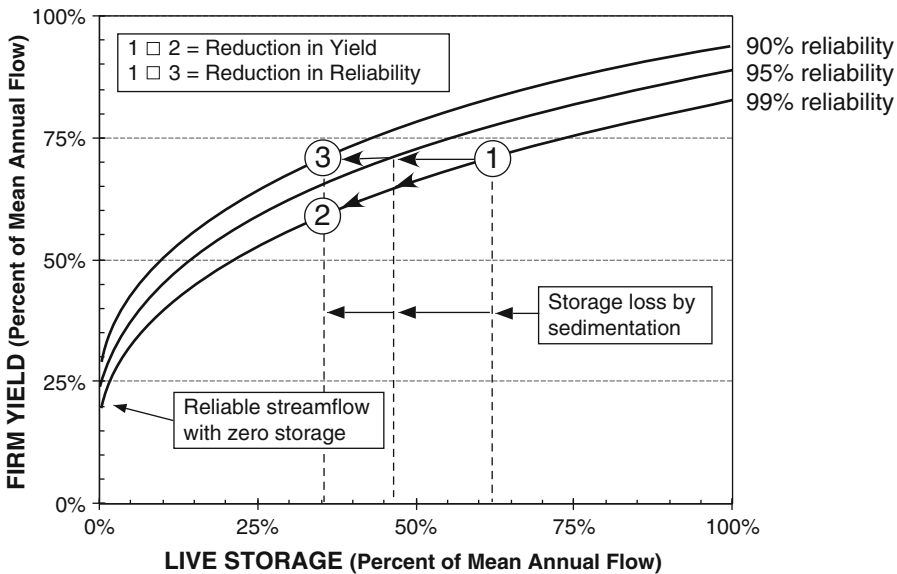


**Fig. 5.7.** Sediment deposited in horizontal beds in the bottom of Elephant Butte reservoir despite complex subsurface geometry [21].

the turbidity current can flow along the original river channel, producing a thick and compact current with a low wetted perimeter. However, as the original channel is filled, the reservoir bottom becomes wide and flat, and the turbidity current itself becomes wide and shallow, greatly increasing the frictional effects on both the top and bottom of the current, retarding its motion. This effect was noted as early as 1954 by Lane [22], who observed that turbidity currents reached Elephant Butte dam on the Río Grande in New Mexico during the initial years of impounding but thereafter dissipated before reaching the dam. Turbidity currents can also overflow submerged barriers such as a submerged cofferdam.

#### 4.4. Reservoir Volume Loss and Reservoir Half-Life

The loss of reservoir volume by sedimentation can reduce water supply yield or flood control benefits. Sediment accumulation can also cause coarse sediment to be delivered to or clog intakes, obstruct navigational channels and access to marinas or other shoreside facilities, reduce recreational value, and modify reservoir ecology including loss of fish habitat and conversion of open water first into wetlands and then to uplands. When the reservoir is drawn down, fine sediment deposits dried and exposed to wind can produce noxious dust storms. Reservoirs with turbid density currents have experienced operational problems at intakes near the dam due to sedimentation after losing only a few percentage of their capacity. Because the original design purpose of the reservoir will become seriously affected once half the original



**Fig. 5.8.** Characteristic pattern of a reservoir storage-yield curve. Initial volume loss due to sedimentation has much less impact on firm yield than an equivalent volume loss when the reservoir capacity is diminished. Volume loss by sedimentation results in either a reduction in reliability, firm yield, or some combination of the two, depending on reservoir operation.

capacity is lost (if not much earlier), reservoir *half-life* (1/2 of original volume filled with sediment) is a much better indicator of the period of operational utility than is “reservoir life” based on 100 % storage loss.

Absent flow regulation by reservoirs, firm yield is limited to the natural minimum streamflow, which in arid regions may seasonally decline to zero. On a given stream, and at a given level of water supply reliability, an increase in storage volume will produce an increment in yield. The relationship between storage volume and water supply yield can be expressed by a storage–yield relationship. These curves exhibit diminishing marginal yield increments as reservoir volume increases, resulting in curves having the shape shown in Fig. 5.8. Reliability may be expressed as the percentage of days that the water supply is available at the stated yield. Different curves can be computed for different levels of reliability. As illustrated in Fig. 5.8, loss of storage by sedimentation will result in a decline in reliability if the normal withdrawal rate is sustained, or a reduction in firm yield if the withdrawal rate is reduced to sustain a given level of reliability. Reliability will also decline as climate variability increases, which adversely affects the ability of a given reservoir storage volume to either provide a sustained water supply yield or to provide the design level of flood control. Increased climatic variability will produce a new lower curve in Fig. 5.8, with diminished benefits at all storage volumes.

The impact of storage loss on reservoir function will vary widely from one site to another. High hydropower dams constructed primarily to produce hydraulic head may see little impairment until much of the storage volume has been lost, whereas at other sites functional

impairment will occur much earlier. For instance, data reported by the US Army Corps of Engineers in 2010 revealed that in dams reporting operational impairment up to 10 % of the time due to sedimentation, 80 % of these had experienced less than a 25 % capacity loss [23]. In reservoirs with multiple uses, such as water supply, hydropower, and flood control, each use will be affected to a different degree by sedimentation. For example, because the flood control volume necessarily occupies the top portion of the reservoir pool which is normally empty, it will typically experience a low sedimentation rate, while more sediments will be deposited into the conservation pool. Pool reallocation will need to be performed at regular intervals if the impact of volume loss is to be apportioned equally among the different beneficial pools.

#### ***4.5. Sedimentation Impacts Above Pool Elevation***

Delta deposits will cause flood levels to rise above the backwater profile computed in the absence of sedimentation, and sediment deposits can extend well upstream of the reservoir's normal pool level. This can produce upstream flooding and waterlogging of adjacent agricultural soils, bury upstream intakes and stream diversions beneath sediment, increase tailwater elevation at upstream hydropower plants, reduce freeboard beneath bridges affecting both flood hazard and navigational clearance, and promote avulsion of the upstream channel. Sedimentation of the main channel will also affect tributaries. In the case of Niobrara, Nebraska, for example, aggradation of the delta created by the sand-laden Niobrara River where it discharges into Lewis & Clark reservoir on the Missouri River increased flood levels to the extent that it became necessary to relocate the entire town to higher ground [24]. Recreational facilities and marinas in areas affected by delta deposition may become seriously affected very early in the sedimentation process.

#### ***4.6. Sedimentation Impacts Below the Dam***

The river channel below the dam is impacted by elimination of the coarse suspended and bed material sediment supply due to trapping in the reservoir, and also by the diminished flood peaks which reduces sediment transport capacity below the dam. These factors tend to counteract one another. The first factor usually predominates, resulting in downstream channel incision and armoring. However, when a large reservoir greatly diminishes downstream transport capacity, and tributaries below the dam supply a heavy sediment load, the downstream channel can aggrade, as occurs along the Río Grande downstream of Elephant Butte reservoir in New Mexico [25]. The remainder of this section describes the more common situation, channel degradation.

Reservoirs trap virtually all coarse sediment, cutting off the supply of new bed material to the channel below the dam. Because discharges from the dam will continue to transport bed material downstream, and because smaller grains are transported at a higher rate than the larger material, the channel bed below the dam will progressively coarsen, incise, and may become armored. Armoring can reduce or eliminate habitat. Channel incision will accelerate bank failure and streambank erosion, and downcutting of the main channel can trigger



incision of its tributaries due to the lowered base level. Hydropower peaking operations which produce large fluctuations in streamflow can further destabilize channel banks. These impacts are lessened by the reduction in peak discharges caused by flood detention in the impoundment, which occurs even in reservoirs not designed for flood control. Downstream impacts can extend from the dam to the sea and can affect coastal erosion. For example, a study in California [26] estimated 10 Mm<sup>3</sup>/year of sand reached the coast prior to dam building, but dams on coastal rivers have reduced this by 23 %. The impacts are greatest in southern California where 50 % of the sand flux is now trapped by dams.

#### **4.7. Sedimentation Impact Thresholds**

Sedimentation impacts do not occur in a linear manner. Impacts to intakes, navigation, and recreational uses will typically have critical thresholds. While reservoir storage–yield relationships do not have specific thresholds, they are characterized by a nonlinear relationship as illustrated in Fig. 5.8. As reservoir capacity declines, the firm yield (or reliability at a fixed yield) also declines, but in a nonlinear manner, and the yield reduction per unit of storage loss (the yield elasticity) will increase as storage volume declines. When sedimentation is focused in the bottom of the reservoir, without reducing surface area, the surface-to-volume ratio will change thereby increasing the relative importance of evaporative losses, and in dry climates this can further increase the impact of sedimentation on yield loss [27]. While exact threshold values may be difficult to define, it is important to realize that thresholds do exist and to incorporate them into decision-making related to sediment management.

## **5. PREDICTING FUTURE CONDITIONS**

Beneficial uses of reservoirs become increasingly constrained as sedimentation progresses, making it prudent to determine the time frame over which different beneficial uses may be impacted or when significant impact thresholds may be encountered. Sedimentation rates and future reservoir capacity may be predicted for individual reservoirs or at the regional or national level based on aggregate data.

### **5.1. Reservoir Surveys to Measure Sedimentation**

Successive bathymetric reservoir surveys provide information on the historical rate and pattern of sediment accumulation at a reservoir, information needed to answer questions concerning the timing, characteristics, and magnitude of sedimentation impacts. Data from reservoir surveys are used to update the storage–elevation and storage–area relationships. Changes in the storage–elevation relationship over time will indicate the extent to which sedimentation affects different storage-dependent uses. These surveys also provide the data required to calibrate models to predict future sedimentation patterns and analyze management alternatives. Data on the volume of sediment trapped can also be used to estimate watershed sediment yield following correction for sediment bulk density and reservoir trap efficiency. Examples of bathymetric surveys and procedural guidelines can be downloaded from the US

Bureau of Reclamation website (<http://www.usbr.gov/pmts/sediment/>) and in Chap. 9 of the bureau's *Erosion and Sedimentation Manual* [28].

The interval between reservoir surveys should be established to track the rate and pattern of deposition, and at sites where the annual rate of storage loss is low the survey interval will be longer than at a reservoir with a high sedimentation rate or where deposition creates a significant problem. A survey interval corresponding to each 5–10 % increment in volume loss may be adequate, but more frequent surveys may be appropriate at critical sites and in smaller reservoirs following an extreme flood that transports a large sediment volume.

Volume surveys are subject to errors, especially when measurement techniques change. The pre-impoundment reservoir volume may have been computed from topographic mapping or by a photogrammetric survey biased by errors in estimating vegetation height. Cross-sectional surveys made during impounding may estimate volume from a very limited geometric dataset. Survey errors become evident when a detailed post-impoundment survey volume is larger than the initial volume, despite decades of impounding. Errors in the other direction can also occur but their detection is not so obvious. To minimize these problems, a detailed bathymetric survey should be performed soon after initial impounding to establish a baseline volume to be compared against future surveys.

Reservoir capacity surveys are best performed with the reservoir full using sonar connected to a GPS, mounted in a boat which then conducts multiple traverses to obtain the data density required to construct a contour map and compute capacity. If the reservoir is drawn down, part of the area may be traversed by vehicle or on foot or mapped by aerial methods such as LIDAR. In delta areas sediment can be deposited above the pool elevation, and it is important to survey the upstream delta growth to complement data from within the reservoir pool.

Large datasets can now be processed easily by computer, and the cost of the reservoir survey is primarily determined by the field data collection effort. Boat speed during bathymetric survey is normally limited to less than about 8 km/h, as higher velocities can induce cavitation on the sonar transducer and also increase the spacing of data points. At this speed, significant field effort will be required for complete mapping at large reservoirs, even when multi-beam sonar is used. Because sediment tends to accumulate in two areas, in the delta or along the submerged thalweg, once the depositional patterns are documented, the reconnaissance technique described by the US Bureau of Reclamation [15] can be used to remap large reservoirs, limiting data collection to those areas where most sediment accumulates. This technique requires prior survey data of the entire reservoir to confirm sediment deposition patterns and to plan the survey navigational tracks.

The range line method was used in older reservoir surveys, prior to the availability of automated GPS survey techniques. It continues to be used today in larger reservoirs when the budget does not allow the density of field data required for a contour survey or as a cost-effective method to monitor sedimentation rates at selected ranges. The range line method involves measurement of a series of representative cross sections and computing the volume change between adjacent range lines by formulas based on cross-sectional areas and surface area. Range line techniques are described by Strand and Pemberton [17] and by Morris and Fan [29]. As a word of caution, different survey methodologies and computational algorithms

(pre-impounding vs. post-impounding, range line vs. contour) will produce different results. For example, a study of comparative measurement techniques at the Kremasta reservoir in Greece [30] found that at this site the range line method underestimated the volume of deposited sediment by 18–32 % as compared to a digital terrain model, depending on the number of range lines used. Different algorithms used to compute range line data also affect accuracy, and methods such as the surface area – average end area method [29] are expected to be more accurate than the end area method. When changing computational algorithms, or from range line to contour methods, computations from the same dataset should be made by both methods to document the volume change attributed to changed methodology. Small errors in volume estimate can produce very large errors in the estimated rate of volume loss by sedimentation.

## **5.2. Future Sedimentation Rate and Pattern**

Future reservoir volume can be estimated by extrapolating the trend of volume depletion documented by successive reservoir surveys and incorporating any corrections as appropriate for the future compaction of fine sediment and change in trap efficiency as volume declines. However, the rate of sediment delivery to the reservoir is often not constant over time, being influenced by factors such as upstream dam construction plus changes in land use and climate. For proposed reservoirs, or existing reservoirs without survey data, future sedimentation rate must be predicted from secondary data. The rate of volume loss can be estimated from three parameters: sediment yield, sediment-trapping efficiency, and dry bulk density of the trapped sediment. These are each briefly described in subsequent sections.

Information on the future sediment deposition pattern will indicate the timing and severity of impacts to beneficial uses and reservoir infrastructure such as intakes. Prediction of depositional patterns is best performed by sediment transport modeling using tools such as the Bureau of Reclamation's SRH-1D model, the sediment transport component of the HEC-RAS model available from the US Army Corps of Engineers, or others. A sediment transport model requires, as a minimum, the following: initial pool geometry, a long-term inflow hydrograph, inflow sediment rating curve, sediment grain size distribution (hydraulic size of fines determined by sedimentation velocity), and the reservoir operating rule. When determining the grain size distribution of sediment containing clays, it is important to determine the sedimentation velocity using native water and without the aid of a deflocculant. Use of standard geotechnical laboratory techniques (deflocculant and distilled water) will determine the clay fraction of the sample, but not the true sedimentation velocity, since clays frequently experience flocculation in natural waters and may settle at velocities characteristic of silts. However, differentiation between silt and clay must be known for the purpose of evaluating cohesion in the sediment deposits and the potential for sediment compaction.

The empirical area-reduction method estimates the sedimentation pattern by predicting the future form of the elevation-volume curve. It is an approximate method to estimate the distribution of sediment within a reservoir based on the allocation of inflowing sediment at different depth increments within the reservoir [17]. It does not take into account the grain size distribution of the inflowing sediment and should not be used as the basis for design of a

new reservoir. It is best used at existing reservoirs to project future conditions once the sediment distribution pattern has already been documented by bathymetric studies and when resources do not allow the use of modeling techniques.

### 5.3. Sediment Yield

*Sediment yield* is the mass of sediment delivered to a particular point in the stream network over a stated period of time and is always less than total erosion. Because there are relatively few long-term suspended sediment gaging stations, the long-term mean daily suspended sediment concentration or load is typically computed by a sediment rating equation which correlates either concentration or load to discharge. This empirical rating equation is derived from operation of a suspended sediment gage station for several years of representative flows. Given the importance of the rating equations in computing variations in suspended sediment discharge over time, and given the many potential sources of error, several concepts relating to collection and analysis of suspended sediment data are presented in this section.

*Erosion* refers to the process of soil detachment and initiation of particle motion. Erosion rates are measured on small plots, and these data are used to calibrate erosion models such as the Revised Universal Soil Loss Equation (RUSLE) and the Water Erosion Prediction Project (WEPP) model. These models are then used to estimate erosion rates on larger land areas ranging from individual farms to entire catchments based on factors including soil type, soil slope, slope length, rainfall intensity, and type of soil cover or management treatment. The *sediment delivery ratio* expresses the ratio of sediment yield to erosion. Sediment yield is typically an order of magnitude less than the erosion rate because most soil particles are redeposited close to the point of dislodgement, at the base of the slope, in an aggrading channel, or on a floodplain, before exiting the catchment [31]. In practice, sediment yield is measured by gaging stations or reservoir surveys, but the erosion rate is estimated by modeling, and the sediment delivery ratio compares the modeled erosion rate to measured sediment yield. Erosion, sediment yield, and the sediment delivery ratio all vary greatly from one runoff event to another, and long-term average values obscure the wide variability that exists among the individual events. Floods are of primary interest in sedimentation management as they are responsible for much of the sediment delivery to reservoirs. Erosion models can be used to determine the erosion potential of different soil and land use combinations, thereby identifying areas to focus erosion control practices to yield the greatest benefit. However, lacking reliable methods to determine the sediment delivery ratio, erosion rates are of limited utility in estimating sediment yield [32, 33].

Sediment yield may be expressed in units of T/year, and the specific sediment yield per unit area may be expressed as T/km<sup>2</sup>/year. Long-term sediment yield within a region may be best quantified by bathymetric surveys of reservoirs to document the cumulative sediment volume captured, following adjustment to account for trap efficiency and sediment bulk density. Reservoir data are particularly useful because reservoirs capture sediment from all events following dam closure, including extreme events which may be inadequately sampled or absent from gage station records.

**Table 5.2**  
**Factors evaluated in the PSIAC model [29]**

Parameter	Characteristics considered
Geology	Durability and weathering of parent material
Soils	Erodibility and extent of soil cover
Climate	Rainfall intensity (storm types) and frequency of convective storms
Runoff	Runoff volume and peak discharge per unit of watershed area
Topography	Slope and extent of floodplain deposits
Ground cover	Extent of ground cover and soil litter
Land use	Percentage of disturbed land, especially row crops, overgrazing and fire
Upland erosion	Extent of rill, gully, and landside erosion
Channel erosion and sediment	Amount and frequency of channel bank erosion

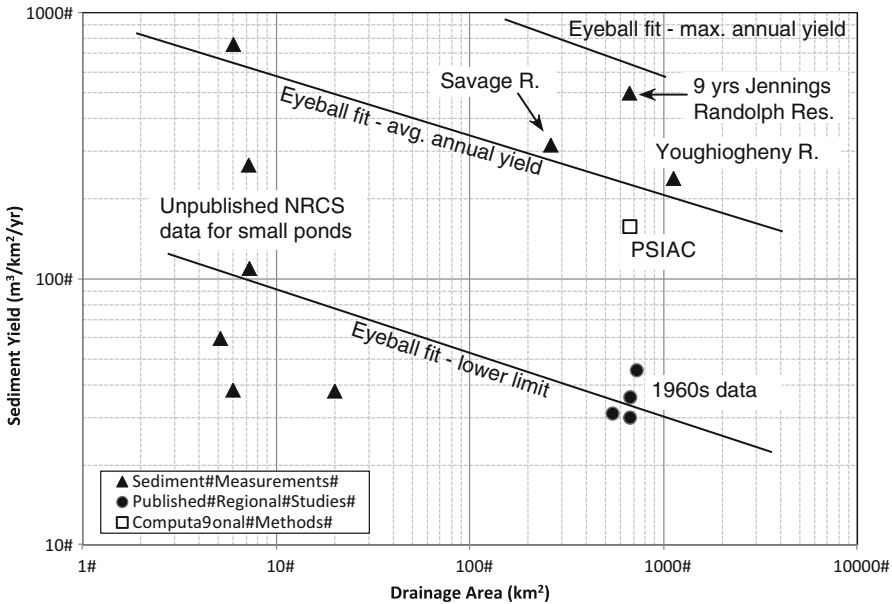
To document timewise variations in sediment yield requires suspended sediment gaging and employing transport equations or empirical methods to correct for the unsampled bed load. It is important to insure the dataset includes adequate sampling of large events which are responsible for a disproportionate amount of sediment yield, since datasets lacking such events can seriously underreport yield. The potential for error is particularly large in mountainous watersheds and smaller watersheds where sediment delivery is dominated by large events of short duration and extreme events (e.g., hurricanes) may be difficult or impossible to sample accurately.

Sediment yield data are usually sparse, particularly in less developed areas, making it necessary to estimate yield by other techniques. In areas of low rainfall or Mediterranean-type climates, the PSIAC and similar methods which evaluate the factors responsible for the generation and delivery of sediment at the watershed scale (Table 5.2) have been found to give good indicators of sediment yield when evaluated across an entire watershed within a GIS framework. Application of this approach has been reported by several authors [34–38].

In analyzing sediment yield data it may be useful to prepare a plot of yield vs. drainage area from multiple sources within the same physiographic environment to help provide a range of reasonable sediment yield values (Fig. 5.9). Yield estimates which fall significantly outside of other regional values should be closely evaluated. Although it has been generally accepted that specific yield declines as watershed area increases [17], this is not always true. In plotting sediment yield data it should not be automatically assumed that specific yield will decrease as watershed area increases, as in some regions there is no clear relationship between these two parameters [38].

#### **5.4. Climate Change and Sediment Yield**

Long-term changes in sediment yield can occur due to construction of upstream dams; modification in soil cover resulting from land use changes; exhaustion of the supply of available sediment by soil denudation; climate change which can modify temperature,



**Fig. 5.9.** Plotting data from multiple sources to better understand the range of estimates of sediment yield within a region. Redrawn from Burns and MacArthur [39].

precipitation, and evaporation and promote glacial retreat; and changes in erosional power from modification in rainfall intensity and runoff volume. The overall effects of climate change on sediment yield are complex, and it may be difficult to separate out climate effect from other factors. For example, increasing aridity of itself will reduce vegetative cover and make the soil more susceptible to erosion, but the reduced precipitation reduces runoff and thus sediment transport capacity, other factors remaining equal. However, a decrease in vegetative cover due to increased temperatures, coupled with increased rainstorm intensity, also related to climate warming, may significantly increase sediment yield. Walling [40] provides an overview of current knowledge on climate change and its potential impact on erosion and sediment transport by rivers. Evidence from around the world indicates that the principal factors affecting sediment yield have been land clearing, which increases sediment yield, and dam construction and flow abstraction which decreases yield, all modified by the impact of instream mining. Walling concluded that, “In most rivers, it is likely to prove difficult to disentangle the impacts of climate change or variability from changes resulting from other human impacts and existing evidence suggests that, in most cases, these human impacts are at present most likely to be more significant.”

Erosion rates can change as a consequence of both climate and management techniques. For example, studies of the Midwestern USA indicate that a combination of increased precipitation coupled with a bias toward more intense storms, anticipated climatic trends already being observed, will increase both runoff volume and soil erosion [41]. About half of the increased precipitation is associated with the most intense 10 % of storms, causing both

rainfall erosivity and erosion rate to increase more rapidly than total precipitation [42]. However, farmers are expected to respond to climate modification by changing cropping patterns and management techniques, which will itself effect erosion rates. Modeling studies for 11 regions within five Midwestern states of the USA by O'Neal and coworkers [43] took these factors into consideration and concluded that soil loss might increase by a factor ranging from 33 % to 274 % in ten of the regions and would decrease slightly in the eleventh. However, as pointed out by Walling [40], a relatively small percentage of the erosion may actually find its way into downstream reservoirs due to redeposition near the point of erosion, at the base of slopes, in upstream impoundments, in channels and wetlands, or on floodplains. Although it will be difficult to quantify future changes in sediment yield associated with climate change, the combination of climate change plus land use impacts from continued population increase is expected to sustain or increase sediment yields over time, especially in regions undergoing development and deforestation. Finally, it is worth noting that climate models generally agree that the climate will become more variable, with more intense floods and droughts. Reservoir storage exists to smooth out this hydrologic variability. An increase in hydrologic variability produces an impact on reservoir yield or flood protection similar to reducing storage volume and will further reduce reservoir benefits beyond that due to sedimentation alone.

### 5.5. Reservoir Trap Efficiency

*Trap efficiency* refers to the percentage of the inflowing sediment load retained within a reservoir. Trap efficiency varies greatly from one event to another. All sediment from a small inflow event may be captured, while a large inflow event producing a short hydraulic residence time in the reservoir may transport much of the finer sediment through the impoundment and beyond the dam with a low trap efficiency. The average long-term trap efficiency may be estimated from a reservoir's hydrologic size, expressed as ratio of total reservoir capacity to mean annual inflow (the capacity:inflow or C:I ratio), based on the empirical Brune relationship shown in Fig. 5.10 [44]. The three curves represent an envelope of conditions ranging from reservoirs having a lower average trap efficiency (reservoir emptied annually, slowly settling sediment) to reservoirs having a higher average trap efficiency (continuously impounding, coarser sediment inflow). A significant decline in trap efficiency does not occur until a reservoir's C:I ratio becomes quite small. The following equation can be used to plot the Brune curve for the case of "normal ponded reservoirs" [45]:

$$T_e = (R)/(0.012 + 1.02 \times R) \quad (5.2)$$

where  $T_e$  = trap efficiency and  $R$  = capacity:inflow ratio. Brune's curves should be used only for normally ponded reservoirs, not for floodwater-retarding structures, debris basins, semidry reservoirs, or reservoirs where sediment-release techniques are employed. Heinemann [46] modified Brune's relationship for smaller agricultural impoundments, using data for 20 normally ponded surface discharge reservoirs with catchment areas ranging from 0.8 to 36.3 km<sup>2</sup>

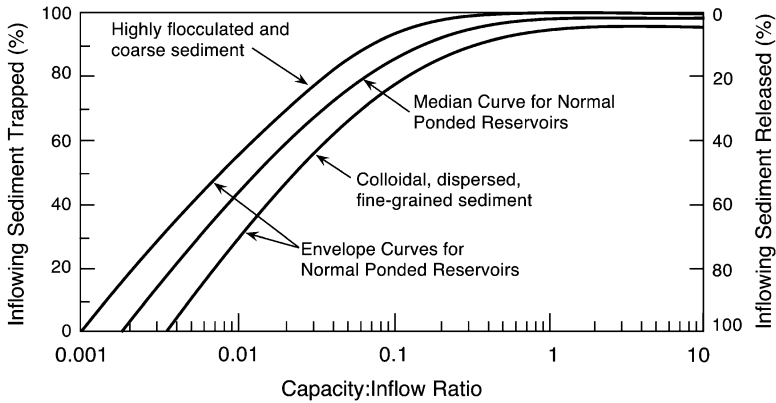


Fig. 5.10. Trap efficiency as a function of reservoir capacity:inflow ratio as proposed by Brune [44].

and volumes from 0.031 to 4.1 Mm<sup>3</sup>. The Heinemann curve can be expressed by the following equation:

$$T_e = -22 + 119.6 (R)/(0.012 + 1.02 \times (R)) \quad (5.3)$$

For this size range, his curve predicted a lower trap efficiency than the Brune relationship.

The Brune curve is widely used due to its limited data requirements. However, the best tool for examining sedimentation history and predicting future sedimentation behavior is by mathematical modeling. A properly validated model can simulate the contribution of each discharge event to the sedimentation process, as well as the sediment management benefits of alternative operational measures such as routing of sediment-laden floods through the reservoir.

### 5.6. Sediment Bulk Density

Dry weight per unit of submerged sediment volume may be termed either *specific weight* or *dry bulk density* (g/cm<sup>3</sup>, T/m<sup>3</sup>). To determine sediment yield from reservoir surveys it is necessary to convert sediment volume to sediment mass. This can be determined by analysis of sediment cores, being careful not to compact soft sediment during the sampling. Because sediment composition varies from one point to another in a reservoir, sampling should be spaced so each core represents a known fraction of the total deposit volume, to enable the volume-weighted dry bulk density to be computed. The volume-to-mass conversion can also be estimated by empirical methods. Lara and Pemberton [47] presented a method to compute initial bulk density, and the Lane and Koelzer [48] method adjusts for compaction of fine sediment over time. These methods are described in Morris and Fan [29] and Strand and Pemberton [17]. Representative values of bulk density are summarized in Table 5.3.



**Table 5.3**  
**Representative values specific weight for reservoir sediments in T/m<sup>3</sup> or g/cm<sup>3</sup>**

Dominant grain size	Always submerged	Aerated
Clay	0.64–0.96	0.96–1.28
Silt	0.88–1.20	1.20–1.36
Clay–silt mixture	0.64–1.04	1.04–1.36
Sand–silt mixture	1.20–1.52	1.52–1.76
Sand	1.36–1.60	1.36–1.60
Gravel	1.36–2.00	1.36–2.00
Poorly sorted sand and gravel	1.52–2.08	1.52–2.08

Source: Geiger [49].

### 5.7. Preliminary Sedimentation Assessment for a Single Reservoir

A preliminary assessment of sedimentation rate and potential future impacts can be undertaken by following the approach outlined below. This approach will help identify the types and timing of possible impacts, help determine when sedimentation will become problematic, and identify the appropriate data collection and management strategies.

1. Compile available bathymetric data, plot reservoir storage volume over time, and estimate annual rate of storage loss. Several surveys are required to reliably define the overall pattern of storage loss. Comparison of the reported pre-impoundment volume against a single bathymetric survey data point is not a reliable measure of sedimentation rate due to errors inherent in the use of two measurement methodologies.
2. Predict future rate of storage loss considering any variation in trap efficiency due to loss in reservoir volume or any upstream reservoir construction which may affect sediment yield.
3. Plot longitudinal thalweg profiles and superimpose the location of intakes or other critical structures. Also plot representative cross sections giving particular attention to locations near potentially affected infrastructure or properties.
4. A preliminary estimate of the shift in the stage-storage curve can be made by the empirical area-reduction method based on data from prior sedimentation surveys. Sediment transport modeling is recommended to achieve more reliable results.
5. Determine the extent to which beneficial users may be affected in the future. In a storage reservoir, for example, this would entail projecting future loss in firm yield based on storage–yield relationship or by simulation modeling of supply reliability or power production under scenarios of declining volume.

These data should provide the type of information needed to determine the nature and timetable of beneficial uses to be affected by sedimentation and form the basis for identifying and scheduling the next actions to be taken. Next actions may range from a continuation of reservoir surveys in the future to the execution of more detailed sustainability analysis to better define and address any sedimentation issues revealed by the preliminary assessment

**Table 5.4**  
**Corps of engineers reservoirs with operations reportedly affected by sedimentation, by authorized purpose [23]**

Authorized use	Percent of reservoirs affected	Notes
Water supply	<10 %	Most of these in Tulsa District
Fisheries	10 %	Most in Tulsa and Omaha Districts
Navigation	2 %	1/3 of reservoirs are authorized for navigation
Hydropower	2 %	
Recreation	15 %	
Flood control	11 %	
Water quality	6 %	Over half of these in Tulsa District

### 5.8. Regional Analysis

A national, regional, or institution-wide analysis of sedimentation at multiple reservoirs can help determine the extent of existing problems and identify priority sites for sediment management. However, regional analysis is often constrained by sparse sedimentation data, and the available data may be geographically scattered and in inconsistent reporting formats. Two strategies may be used to assess and prioritize regional sedimentation issues: data-call and regional sediment balance model.

*Data-call.* The data-call method consists of querying each dam operator for information on sedimentation data and to identify existing or anticipated sediment-related problems. This approach was used by the US Army Corps of Engineers [23] to compile sedimentation information on the 609 dams under corps jurisdiction nationwide. It revealed that less than 5 % of their reservoirs had lost more than 25 % of their capacity by sedimentation. Nevertheless, a significant percentage of the sites reported one or more authorized purposes were experiencing “moderate” restrictions due to sedimentation, defined as “sedimentation limits a specific purpose up to 10 % of the time” (see Table 5.4). Not all reservoirs are authorized for all types of use, and some reservoirs report impacts in multiple authorized uses. Data collected will feed into a larger national database hosted by the USGS which contains data on over 6,000 sites [50].

Data-call results may be biased by differences in data availability and by differing interpretations and levels of interest by the respondents. The data-call approach can also include questions about problems which may exist below the dam resulting from cutoff of the sediment supply, although these may be of less concern to dam operators. A serious deficiency in the data-call approach is the nonuniformity of response quality.

*Regional reservoir sediment balances.* Many watersheds have multiple dams, and sediment accumulation is affected both by sediment trapping in upstream dams plus the change in trap efficiency over time as each impoundment loses storage. To obtain an accurate regional

**Table 5.5****Cumulative loss of existing reservoir volume computed by alternative methodologies (adapted from Minear and Kondolf, 51)**

Methodology to estimate sedimentation	Cumulative percent storage loss	
	Year 2000	Year 2100
Using total basin area and 100 % trap efficiency	16 %	70 %
Correcting for trap efficiency and upstream dams	4 %	15 %

picture of long-term sedimentation impacts and trends requires evaluation of these parameters for all reservoirs within the studied watersheds. For example, California's state database lists 57 dams above Folsom Dam on the American River, and to predict future sedimentation at Folsom requires that all of these upstream sites be considered.

A spreadsheet model for prediction of sedimentation rates at all reservoirs within a region considering these factors was described by Minear and Kondolf [51], who analyzed 1,382 reservoirs in California. This methodology requires the following: (1) estimates of specific sediment yield by physiographic region; (2) location of each reservoir and its watershed limits overlain on the physiographic regions to estimate sediment load from the unregulated watershed above each dam; (3) hierarchy of reservoirs within each watershed and construction dates and volume for each site to account for changes in sediment trapping over time; and (4) a procedure to estimate sediment-trapping efficiency at each reservoir, since trap efficiency declines as reservoir capacity diminishes. A GIS database which locates each dam on a digital elevation map with an overlay for physiographic regions was used to facilitate computation of watershed areas and sediment loads. Brown's equation was used to estimate trap efficiency based on watershed area:

$$T_{a,t} = 1 - 1/[1 + 0.00021 \times K_{a,t-1}/A] \quad (5.4)$$

where  $T_{a,t}$  = decimal trap efficiency of reservoir  $a$  at time step  $t$ ,  $A$  = watershed area, and  $K_{a,t-1}$  is capacity of reservoir  $a$  at time step  $t - 1$ . The Brune relationship based on the capacity:inflow ratio could not be used because data on mean annual inflow were not available at about 80 % of the sites. The results of this analysis (Table 5.5) showed the critical importance of accounting for both trap efficiency and upstream dams when assessing long-term sedimentation impacts.

## 6. CLASSIFICATION OF SEDIMENT MANAGEMENT STRATEGIES

Strategies for sediment management in reservoirs may be broadly classified as follows: (1) methods to reduce sediment inflow from upstream, (2) methods to pass sediment through or around the impoundment to minimize sediment trapping, and (3) methods to recover, increase, or reallocate storage or to modify intakes or other structures, after sediment has been deposited. Specific techniques available under each strategy are shown in Fig. 5.11 and

Classification of Sediment Management Strategies

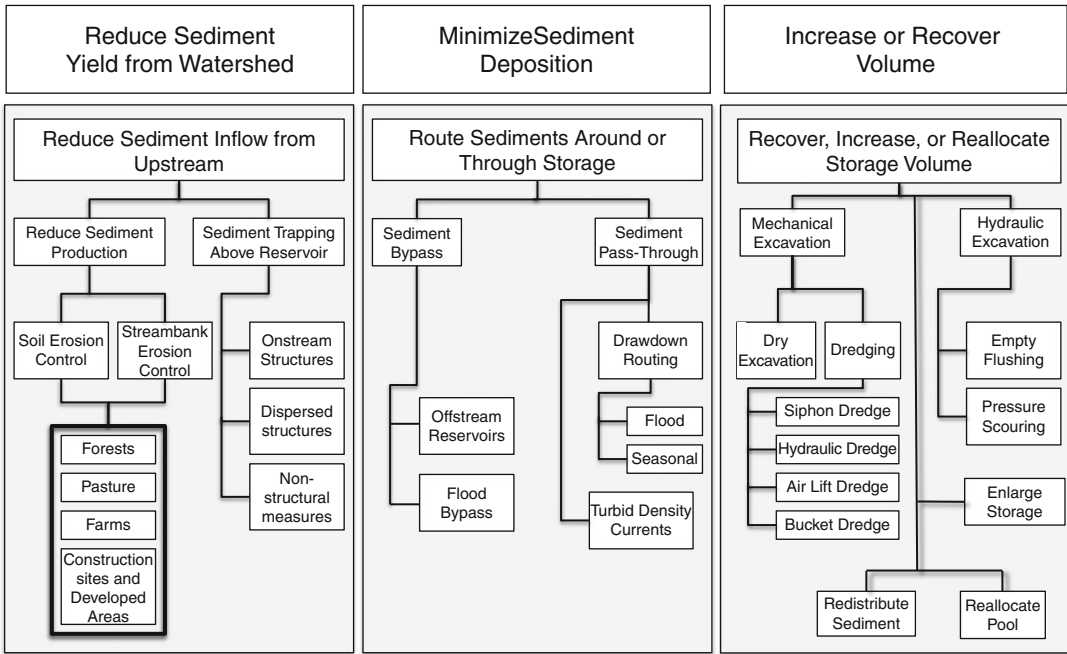


Fig. 5.11. Classification of sediment management alternatives.

Table 5.6. These can be used as a preliminary checklist to confirm that the gamut of control strategies has been considered. Some authors have classified management techniques based on management location rather than process [52, 53]. A combination of management strategies will typically be employed, and the techniques suitable for implementation will change over time. For example, the venting of turbidity currents may be the only feasible technique to pass sediment through a hydrologically large reservoir, but this method may no longer work and other routing approaches become feasible when reservoir volume has been diminished by sedimentation. A long-term sediment management strategy may consist of a sequence of different techniques to be applied sequentially as volume diminishes.

**7. REDUCE SEDIMENT INFLOW FROM UPSTREAM**

All watersheds export sediment, but the natural sediment yield can be greatly accelerated by land use changes which remove vegetative cover, destroy soil structure, concentrate the hydraulic energy of flowing water, initiate stream incision, and accelerate streambank erosion. For example, isotope analysis of sediment deposits in a Mississippi oxbow lake documented a 50-fold increase in sediment yield initiated by land clearing in the late nineteenth century and sustained to the present day [54]. In developing areas, land use often changes after dam construction as extension of the road network enables farmers to

**Table 5.6**  
**Classification of sediment management strategies**

Strategy	Description
Reduce sediment inflow from upstream	<ul style="list-style-type: none"> <li>• <i>Erosion control</i> to reduce sediment yield</li> <li>• <i>Upstream trapping</i> of eroded sediment in structures ranging from small check dams and farm ponds to major reservoirs</li> </ul>
Route sediments around or through storage	<ul style="list-style-type: none"> <li>• <i>Bypass sediment</i>, sediment is passed around the storage zone, for example, by constructing an offstream reservoir or sediment bypass tunnel</li> <li>• <i>Sediment pass-through</i>, routing sediment through the impounded reach by venting turbidity currents or reservoir drawdown. The lowered water level accelerates flow velocity, transporting sediment beyond the dam</li> </ul>
Recover, increase, or reallocate storage volume	<ul style="list-style-type: none"> <li>• <i>Flushing</i>, use hydraulic action to scour out previously deposited sediment. Flushing requires full reservoir drawdown to be effective. Pressure scouring occurs with water ponded in the reservoir and only removes a scour cone in front of the flushing outlet</li> <li>• <i>Dredging</i>, removal of sediment from underwater by mechanical means</li> <li>• <i>Dry excavation</i>, removal of sediment from an empty reservoir by conventional earthmoving equipment</li> <li>• <i>Increase storage</i> by raising the dam or constructing additional storage reservoirs</li> <li>• <i>Modify structures</i>, modify intakes or other structures to avoid areas of sediment deposit</li> <li>• <i>Redistribute sediments</i>, manipulate water levels to deposit sediment in areas of the pool where impacts are reduced</li> <li>• <i>Reallocate available storage</i>, distribute sedimentation impacts among the beneficial uses to maximize the utility of the remaining volume</li> </ul>

move into previously unpopulated areas above the dam, producing rates of erosion and sediment yield much higher than originally anticipated. Two broad strategies can be used to reduce the sediment load reaching a reservoir: reduce the erosion rate from the land surface or stream channels, or provide upstream storage to trap eroded sediment.

### 7.1. Reduce Sediment Production

Soils are held in place primarily by vegetation and the associated soil ecosystem, and the principal objective in the control of soil erosion is to maximize vegetation coverage. Vegetation and leaf litter physically protect soil from the direct impact of raindrops which can dislodge particles from the soil matrix. Organic materials produced by fungi and bacteria in the soil ecosystem act as a binding agent that causes fine particles to agglomerate, thereby resisting dislodgement and retaining soil structure which enhances infiltration. Roots, worms,

**Table 5.7**  
**Median erosion rates as function of land use, Río Guadiana Basin, Puerto Rico (modified from ref. 54)**

Land use	Median erosion rate, T/km <sup>2</sup> /year	Percent of surface area in the watershed	Percent of total erosion
Bare soil	53,400	0.6	21
Dense urban (impervious)	100	1.7	0.1
Rural residential	1,500	9.4	9.2
Agriculture	2,200	0.3	0.4
Pasture	1,700	16.6	18
Open canopy forest	2,600	14.5	25
Closed canopy forest	700	56.9	26

Note: Forests occupy lands having higher slopes.

and burrowing insects all loosen the soil, enhancing infiltration and reducing erosive overland flow. Vegetation, soil litter such as leaves and twigs, and minor soil surface irregularities all retard the velocity of surface flow, reducing erosive energy and trapping sediment eroded from upslope. Interventions which disrupt or destroy these natural processes at and beneath the soil surface can accelerate soil erosion rates by two orders of magnitude, as illustrated by the data in Table 5.7 from a 22 km<sup>2</sup> moist mountainous tropical watershed. Modeling showed that conversion of 5 % of the most-erosive land use to forest would produce a 20 % reduction in erosion rate. The average sediment delivery ratio in this watershed was computed as 17 % [55].

Soil erosion control is typically recommended to control reservoir sedimentation. Erosion control success depends on identifying the areas of accelerated soil loss, implementing effective erosion control measures, and then sustaining these controls or land use changes indefinitely. Nevertheless, some areas have experienced sustained high rates of sediment yield despite substantial reductions in soil erosion. In practice, a significant reduction in sediment yield may not be seen in a river system for years or decades following erosion control treatment because much eroded sediment will become trapped at the base of slopes as colluvial fill or may accumulate in channel bars or on floodplains, creating a large reservoir of sediment to be transported downstream for many years after soil erosion is reduced at the source [56, 57]. This should not be interpreted to minimize the long-term benefits of erosion control, which also include enhanced soil fertility and moisture retention, environmental recovery, and other benefits which exist independent of reservoirs. Rather, it is to point out that while erosion control is an excellent long-term strategy, it will not necessarily produce an immediate and measurable reduction in sediment yield.

Erosion modeling in a GIS environment can be used to determine erosion rates for the purpose of focusing erosion control efforts and to better understand the possible sources of sediment entering a reservoir. For example, the European Environment Agency applied the Revised Universal Soil Loss Equation (RUSLE) to the entire Alpine area, including parts of

6 different countries, to estimate soil erosion rates on a 100 m grid, mapping soil erosion rates in eight classes from  $<50$  to  $>5,000$  T/km<sup>2</sup>/year [58]. Modeling can also be used to estimate the benefits of management measures.

In agricultural areas, erosion control strategies can include minimizing soil disturbance (no-till), maximizing soil cover by vegetation and mulch, sediment trapping by vegetated buffer strips, management of runoff water with grassed waterways, and construction of farm ponds. In general, maximize vegetation and mulch coverage while keeping runoff flows as dispersed as possible, thereby maximizing the potential for infiltration and reducing the erosive energy of concentrated flows. Vegetated swales and hardened structures can be used to carry concentrated flows across slopes without gullyng. In promoting the implementation of erosion control measures by farmers, it is essential that they see on-farm benefits from soil conservation activities; otherwise, these activities will not be self-sustaining. On-farm benefits may include enhanced infiltration and retention of water leading to higher yield and income, reduced fertilizer inputs, etc. Effective erosion control typically requires effective and sustained intervention with hundreds to thousands of landowners and users, an undertaking not likely to be successful absent a strong organizational presence. For example, in the USA, the Natural Resource Conservation Service and local soil and water conservation districts provide both technical services and directed incentives to land users. There is an abundance of literature and technical guidance concerning soil erosion and its mitigation on agricultural soils available from the US Natural Resources Conservation Service website (<http://www.nrcs.usda.gov/>), the Soil and Water Conservation Society (<http://www.swcs.org>), and many other organizations.

In forested areas a dense network of roads and skid trails may be constructed for logging. Erosion and slope failures associated with the construction and use of unpaved roads are typically the most important long-term contributors of sediment from logged areas. After logging ends these roads may fall into disrepair while simultaneously experiencing increased traffic for which they were not originally constructed. For example, the US Forest Service has more kilometers of roads than the US Interstate Highway System and has seen use of its forest roads increase 18-fold over 50 years, and timber harvest now accounts for only 0.5 % of forest road use [59]. Whereas sediment yield from the forest floor can quickly diminish after logging, road erosion will remain as a long-term source of sediment which can potentially increase over time, especially if hydraulic structures fall into disrepair. The US Forest Service's Treesearch online library (<http://www.treesearch.fs.fed.us/>) has an extensive research library relating to sediment yield and erosion control, and numerous region-specific best management practice (BMP) guidelines for timber harvesting, logging roads, and related topics are available on the Internet from local extension services and national forestry services.

Urban development will dramatically increase onsite erosion and sediment yield as vegetation is removed and earth movement destroys soil structure and exposes destabilized soils to erosive energy. However, sediment yield declines dramatically after construction is completed, as soils become vegetated or covered with impervious surfaces, and drainage is routed through hard structures. For example, Warrick and Rubin [60] analyzed 34 years of data from the semiarid Santa Ana River watershed in California and found that conversion to urban land use produced a 20-fold reduction in suspended sediment concentration with respect to

discharge and a sixfold increase in discharge. However, when the increased peak discharge reaches a downstream natural channel, the increased erosive energy will accelerate channel incision and bank erosion. Thus, urbanization moves the problem of accelerated erosion into the channels downstream of the impervious areas. Urban erosion control typically focuses on implementing best management practices (BMPs) for erosion control on construction sites through combined local and federal regulatory frameworks.

Urban stormwater detention basins have been used to compensate for the increase in peak discharge due to impervious surfaces, but these structures have traditionally focused on treating only the larger and more infrequent “design storms,” while the smaller and frequent events responsible for the great majority of runoff pass through the basins with little attenuation. The current emphasis in the management of post-construction runoff from urban areas is to mimic, insofar as possible, pre-construction hydrologic behavior. This strategy of Low Impact Development (LID) focuses on maximizing opportunities for evaporating, detaining, and infiltrating water, trapping sediment and other contaminants as far upstream as possible within the catchment and before entering drainage structures with concentrated high-velocity flow. This is reminiscent of the 1930s motto of the Civilian Conservation Corps: “Stop the water where it falls.” Online documentation and links are available from the Low Impact Development Center (<http://www.lowimpactdevelopment.org>).

Alluvial stream channels naturally meander across their floodplain, eroding the exterior of channel bends while simultaneously depositing sediment on point bars located opposite the eroding banks. However, natural streambank erosion rates may be greatly accelerated as a result of human intervention and become an important contributor to increased sediment yield. Causes of accelerated channel erosion include increased peak runoff due to upstream deforestation, overgrazing, and urbanization; removal of streambank vegetation; channel straightening which increases channel slope and erosion rate; and channel incision induced by activities such as upstream dam construction or removal of channel sediment by instream aggregate mining. In built-up environments, even natural stream meandering is usually the object of control since any lateral movement will quickly threaten property and infrastructure. Traditional approaches for the treatment of bank erosion have focused on the extensive use of rip rap. A more environmentally sustainable and potentially less costly channel management approach focuses on developing an understanding of the geomorphically stable stream form, and to establish this form along the stream channel, rather than using patch-in-place channel bank hardening which can itself contribute to further stream destabilization [61]. More comprehensive information is given in the Stream Restoration Design Handbook compiled by the US Natural Resources Conservation Service which incorporates inputs from multiple federal agencies and the private sector and is available on the Internet [62].

In summary, several factors are critical to successfully reduce sediment yield from an impacted watershed.

- *High erosion areas.* Identify priority areas or priority land uses to be treated. Determine the types of soils and corresponding land use practices which create high rates of erosion over sufficient land surface to significantly influence sediment yield and which can be expected to be amenable to



treatment. In unstable streams, identify treatment strategies which lead to long-term channel stability.

- *High sediment delivery ratio.* Focus treatments on areas which have the highest potential to deliver sediment to the reservoir. While it is difficult to assess the sediment delivery ratio, the following factors will tend to increase the delivery ratio from a catchment: close proximity to the reservoir, high soil and channel slopes, small alluvial floodplains or wetlands to trap sediment, mostly fine sediment, few farm ponds or other impoundments, high drainage density, and gullyng.
- *Sustained community participation.* Identify erosion control practices suitable to the local technical, economic, and institutional environment, and which can be expected to be sustained because they generate visible benefits to the local community. Identify and partner with local grassroots organizations or institutions having presence and credibility within the watershed. Reduction of erosion and sediment production within a watershed can generate substantial and sustained benefits to many members of the community including farmers who retain their soil, recreational users who have cleaner water, and environmentalists.

Although land use changes are not easy to achieve, the benefits can be both broad based and long lasting. The realization of tangible benefit by the local community is essential for both initiating and sustaining changed land use practices.

## 7.2. Sediment Trapping Above the Reservoir

Sediment inflow into a reservoir can be reduced by the construction of upstream sediment-trapping storage facilities. It is relatively rare to construct an upstream reservoir for the sole purpose of trapping sediment, other than the construction of debris basins designed to trap coarse sediment that would otherwise collect in and impair the operation of a downstream flood channel. However, upstream impoundments of all sizes can act as efficient sediment-trapping structures, and the presence of upstream dams is one of the most important factors modifying sediment loads downstream. In considering the effect of upstream dams, not only are large dams important, but numerous small structures, including those as small as stock watering ponds, can also act as efficient sediment traps. For example, in the conterminous USA, Renwick et al. [63] estimated that there are at least 2.6 million, and possibly as many as 8 or 9 million, small impoundments capturing runoff from about 21 % of the total drainage area in the lower 48 states. Total sediment capture in these ponds was estimated to equal between 25 % and 100 % of the total sedimentation in the 43,000 reservoirs listed in the U. S. National Inventory of Dams.

## 8. ROUTE SEDIMENTS

Sediment discharge is highly concentrated in time, and *sediment routing* refers to a family of techniques that take advantage of this timewise variation in sediment discharge, managing flows during periods of highest sediment yield to minimize sediment trapping in the reservoir. These strategies include the following: (1) selectively diverting clear water to an offstream impoundment and excluding sediment-laden flood flows, (2) sediment bypass around an onstream reservoir, (3) reservoir drawdown to pass sediment-laden floods through the

impoundment at a high velocity to minimize deposition, and (4) release of turbid density currents through a bottom outlet. In all cases, the objective is to release sediment-laden water and impound clear water.

### 8.1. *Timewise Variation in Sediment Yield*

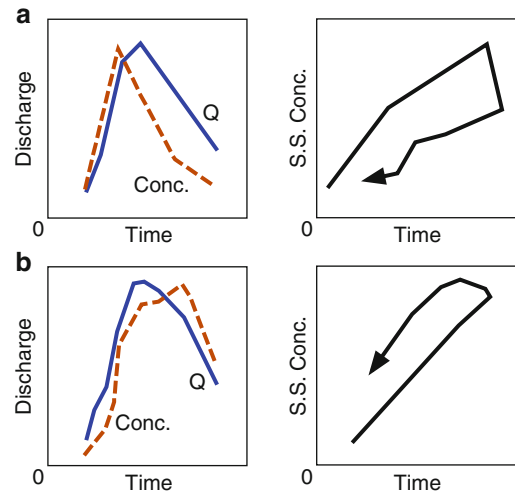
Sediment yield is highly variable over all time frames. It is necessary to understand this variability to properly interpret sediment data and devise efficient management strategies. These strategies take advantage of the timewise variation in suspended sediment concentration to capture and impound flows having relatively low suspended load while passing high-concentration flows through or around the impoundment.

Most sediment is transported by floods, and the intervening period of normal or low flows typically transports relatively little sediment. Using data from the USA, Meade and Parker [64] showed that for many rivers in the USA about two percent of the days account for about half the annual sediment load. In smaller watersheds and mountainous areas sediment discharge can be even more concentrated in time. Because so much sediment can be discharged by large floods, sediment yield can vary dramatically from year to year, reflecting variation in hydrologic conditions and timewise variations in sediment availability within the watershed. In mountainous areas landslides can contribute over half the sediment load during extreme events, and the onset of widespread landslide activity may be associated with an intensity-duration threshold [65]. In mountainous watersheds the role of extreme events can be particularly important, and a single catastrophically large event can generate sediment loads, including debris flows, equivalent to many decades of “normal” events. Such events may not be reflected even in decades of gage record [66].

The finer fraction of the total sediment load, the *wash load*, consists of sediment smaller than the smallest 10 % contained in the stream bed material. This finer material is “washed” through the system without appreciable interaction with the stream bed because the hydraulic energy is large enough to transport all the fine sediment delivered to the stream. It is delivered to the stream primarily by soil erosion in the watershed, and delivery rate to the stream is dependent on rainfall-runoff processes. However, transport of the coarser material that composes the predominate fraction of the stream bed, the *bed material load*, is driven primarily by stream hydraulics rather than the delivery rate from the watershed. Thus, in a sand or gravel bed stream, a storm early in the flood season may have a high total suspended load with a high component of fine wash load, while a late-season storm having the same discharge may have a much lower suspended sediment concentration of fines, while the rate of bed material transport remains unaltered. The late-season suspended sediment yield from watershed erosion may be reduced by factors such as increased ground cover as vegetative grows, plus the seasonal exhaustion of readily mobilized sediment. Where a consistent timewise sediment delivery pattern exists, it may be possible to route sediment-laden water through or around the reservoir at the start of the season and to fill the reservoir with late-season discharge having a lower sediment concentration.

Suspended sediment concentration will also typically exhibit a systematic variation within the duration of a single runoff event, producing hysteresis effects in concentration–discharge

**Fig. 5.12.** Conceptual hysteresis loop in concentration–discharge data from flood events showing (a) clockwise loop with the concentration preceding the discharge peak and (b) counterclockwise loop.



(C–Q) graphs. If multiple samples are collected over the duration of a flood event, a graph of sediment concentration vs. discharge rarely produces a straight line relationship [67]. The more common pattern is for sediment concentration to peak before discharge peaks, producing a clockwise concentration–discharge (C–Q) hysteresis loop (Fig. 5.12). This can occur when the first part of the flood washes out readily mobilized sediment, leaving the latter portion of the hydrograph relatively deficient in sediment. Counterclockwise loops can occur when more distant areas of the watershed have more erodible soils or when landslides develop as soils become oversaturated as the storm progresses. The hysteresis pattern is not necessarily a fixed watershed characteristic, and different storms can produce different timewise patterns in the same watershed.

## 8.2. Sediment Rating Relationships

Sediment yield can be measured by suspended sediment gaging stations operated for a sufficient number of years to obtain suspended sediment concentration and discharge data over a wide range of flows. These data may be used to define a *sediment rating curve* which correlates discharge to suspended sediment concentration, and by applying this rating curve to a longer streamflow record, the sediment discharge may be estimated over the entire period of stream gage record. It is critical that floods be adequately sampled because they have both high sediment concentration and flow rates, and thus discharge a disproportionate amount of the total load. Bed load is infrequently measured and is instead computed by a transport equation or estimated as a fixed percentage of suspended load.

Sediment rating relationships are characteristically developed as a power function having the form

$$SSC = bQ^c \quad (5.5)$$

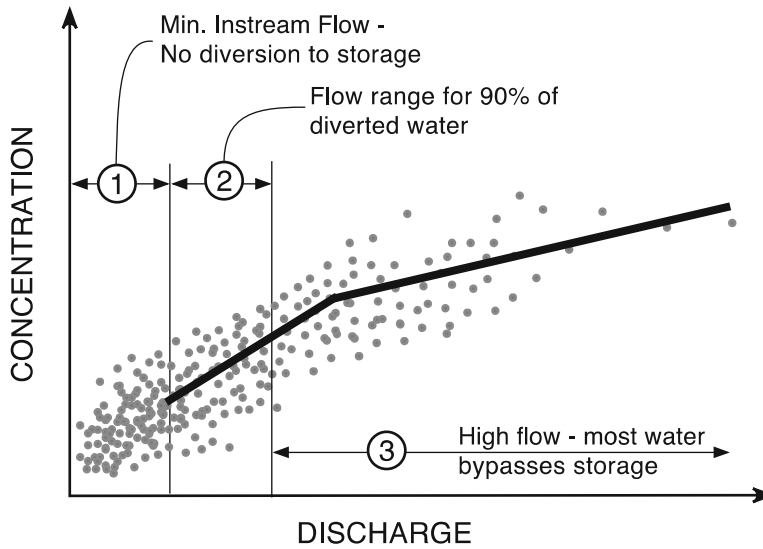
where  $SSC$  = concentration (mg/L),  $Q$  = discharge ( $m^3/s$ ),  $b$  = coefficient value, and  $c$  = exponent which is often in the vicinity of 1.5. While this equation implies an intercept of zero concentration at zero discharge, use of a nonzero intercept may be appropriate in some datasets to better represent the flow range of interest.

There is typically considerable scatter in a graph of sediment concentration vs. discharge due to variations in watershed and sediment delivery processes over time, and it is quite common for sediment concentration to vary by more than an order of magnitude at a given discharge. Horowitz [68] noted that “The key to a good rating-curve-derived flux estimate appears to be how well the regression averages out the ‘scatter’ in the data, rather than how well the curve actually fits all the data points.” When a regression equation is used to fit a curve to the logged discharge and concentration data, the resulting regression can underestimate the true rating curve by as much as 50 % [69, 70]. Comparative analysis of data from Europe by Asselman [70] indicates that curve fitting by nonlinear least squares produces the best overall fit. To check that the rating curve accurately averages out the scatter, perform a period-of-record *total load comparison* in which the total sediment load computed by the rating equation is compared to the measured total load in the original sediment dataset. The rating equation should be adjusted if these two loads do not match closely. Considerations for constructing rating curves are discussed by Glysson [71].

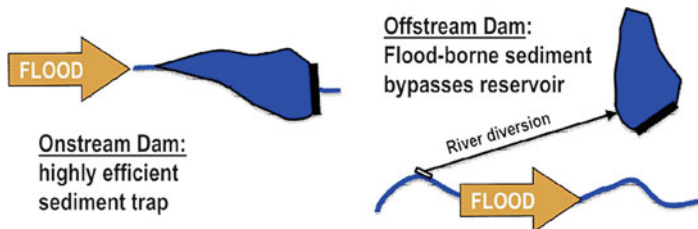
When analyzing reservoir management techniques such as sediment bypass, in which only the lower-discharge events are diverted into the reservoir, it is critical that the rating curve reflect as accurately as possible the concentration–discharge relationship for the range of flows to be diverted. An equation that reproduces the total load in the original dataset will not necessarily produce an unbiased fit over the range of flows that contribute most of the diverted water volume. To protect against this error, a total load comparison (computed vs. dataset load) should be performed over discrete discharge intervals to insure against rating equation bias in any critical flow range (Fig. 5.13). Similarly, the rating curve may produce concentrations too high when extrapolated to large discharges beyond the range of the original dataset. In these cases, it is appropriate to use a multisegment rating curve incorporating more than one equation, as also shown in Fig. 5.13. Manual preparation and adjustment of rating curves should be performed to achieve a good overall fit to the data when mathematical equations do not adequately represent the dataset.

### 8.3. Sediment Bypass by Offstream Reservoir

Sediment bypass may be accomplished by constructing an *offstream* or *off-channel reservoir*, diverting water having low sediment concentration into storage by either gravity or pumping while allowing large sediment-laden floods to bypass the storage pool (Fig. 5.14). Water supply reservoirs fed by gravity have been constructed specifically for sediment management in Taiwan [72] and Puerto Rico [73]. Offstream reservoirs provide other benefits in addition to sediment control. Exclusion of floods greatly diminishes spillway size, offsetting the cost of the intake and diversion works. Offstream reservoirs also avoid environmental problems associated with the construction of onstream dams by minimizing impacts to aquatic species and riparian wetlands, by maintaining the transport of bed material along



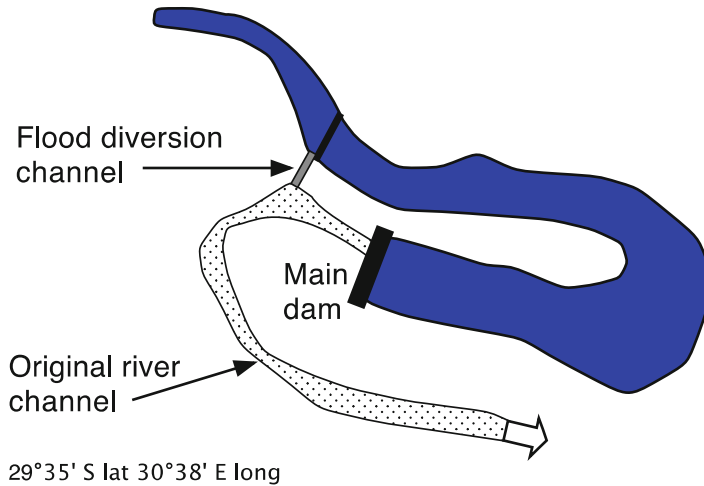
**Fig. 5.13.** Conceptual diagram showing adjustments in a sediment rating curve to produce an unbiased estimate of the discharge–concentration relationship for the ranges of flows to be diverted into off-channel storage. In computations for sediment bypass, it is critical to insure that the rating curve accurately reflects sediment concentration in the flow range “2” which contributes most of the diverted water and sediment inflow into the impoundment.



**Fig. 5.14.** Schematic of offstream reservoir supplied by a diversion dam, which allows sediment-laden floodwaters and bed material load to continue downstream without entering the impoundment.

the natural stream channel, and it also improves the quality of water delivered to users such as hydropower and water filtration plants. The ability to sustain bed material transport along the stream is particularly important as it avoids the problem of channel incision, accelerated bank erosion, and riverine habitat loss that plagues river reaches below instream dams.

Sediment enters an offstream reservoir either as suspended inflow from the diverted stream or by erosion from the watershed tributary to the dam. Simulations for the gravity-fed Río Fajardo offstream reservoir in Puerto Rico showed that 26 % of the total streamflow can be diverted into the reservoir with only 6 % of the suspended sediment load. Additionally, the intake design excludes 100 % of the bed material load. However, sediment eroding from the small watershed tributary to the dam will be trapped with essentially 100 % efficiency, since the reservoir is operated to avoid spills. For this reason, in developing



**Fig. 5.15.** Configuration of Nagle dam and reservoir in South Africa showing the flood bypass channel.

offstream reservoir sites, it is important to minimize the catchment area above the dam and to undertake strict land use controls or convert the catchment to permanent forest to minimize long-term sediment yield. At both offstream reservoirs in Puerto Rico the entire catchment area tributary to the dam was acquired and dedicated to natural forest, generating reservoir half-lives in excess of 1,000 years [73] despite naturally high sediment yields. The firm yield of an offstream reservoir is related to both storage volume and diversion capacity. In moist areas of Puerto Rico where rainfall is rather well distributed throughout the year, it is possible to achieve a firm yield almost equal to that possible from an onstream reservoir of the same volume with a diversion capacity equal to 140 % of mean annual flow [73]. Under other hydrologic settings, with more episodic runoff events, the required diversion capacity may become too large to make offstream storage economically attractive.

#### 8.4. Sediment Bypass at Onstream Reservoirs

Under favorable conditions it is possible to divert sediment around an onstream reservoir, bypassing sediment-laden flows using a channel or tunnel which discharges below the dam. Taking advantage of river meanders, the Nagle reservoir in South Africa (Fig. 5.15) was designed to pass sediment-laden floods around the main pool using a flood-diversion dam and a flood bypass channel upstream of the storage pool [74]. In mountainous areas of Japan, several bypass tunnels have been constructed to pass gravel-sized bed material from the upstream limit of the reservoir to below the dam with the objective of maintaining the continuity of coarse bed material flow along the river to prevent stream incision and maintain gravel beds for environmental purposes. The Japanese systems have a small diversion dam at the upstream limit of the pool which directs bed material into the bypass tunnel (Fig. 5.16). To date, bypass tunnels have been used primarily on mountain reservoirs which allow for tunnel slopes of at least 1 %, and the maximum tunnel length reported to date is 4.3 km. When the



**Fig. 5.16.** Upstream area of Asahi reservoir, Japan, showing entrance to gravel bypass tunnel on the right and cofferdam which directs flood flows into the tunnel (photo G. Morris).

tunnel entrance is located at the upstream limit of the reservoir pool, the tunnel's entrance sill is set slightly below the riverbed elevation, followed by a short steep entrance reach to accelerate flow before transitioning to a long reach at constant slope. If the tunnel is located within the reservoir pool, the entrance may be set below the normal reservoir level and water is diverted during a sediment-bypassing flood event by opening a normally closed gate. These tunnels are characteristically designed to achieve supercritical flow to maximize the discharge per unit area, but the resulting combination of coarse sediment and high velocity can produce substantial scour damage to the floor of the tunnel [75]. At the Solis reservoir in Switzerland, a physical model study was used to support the design of a 900 m bypass tunnel which included a skimming barrier at the tunnel entrance to exclude floating logs [76].

### 8.5. Turbid Density Currents

A turbid density current occurs when sediment-laden water enters an impoundment, plunges beneath the clear water, and travels downstream along the submerged thalweg toward the dam. Figure 5.6 illustrates characteristics of a turbidity current passing through a reservoir showing the plunging flow, movement through the impoundment, accumulation as a submerged "muddy lake," and release through a low-level outlet at the dam. As the current travels downstream it will deposit the coarser part of its sediment load, and if enough sediment is deposited the current will dissipate before reaching the dam.

Turbidity current forward motion is facilitated where a thick current can flow along a defined channel, but as the submerged channel is infilled with sediment the geometry of the

**Table 5.8****Sediment balance for Cachi reservoir, Costa Rica, during an average hydrologic year [29, 77]**

Sediment distribution	Tons/year	Percent of total
Throughflow, turbidity currents through turbines and spills	148,000	18
Deposited on submerged terraces	167,000	21
Bed load trapped in reservoir	60,000	7
Turbidity current deposits removed by flushing	432,000	54
Total	807,000	100

reservoir bottom becomes flat and wide. This causes the turbidity current to spread out, becoming wide and shallow, increasing frictional resistance along both the top and the bottom of the current. This lowers the velocity and results in the deposition of transported sediment. For this reason, turbidity currents which reach the dam after initial impoundment may dissipate after the bottom configuration is modified by sedimentation. Regular flushing can maintain a submerged channel conducive to the propagation of turbidity currents to the area of the dam. The impact of turbidity current release on the sediment balance in a reservoir is illustrated by data from the Cachi hydroelectric reservoir in Costa Rica (Table 5.8). This reservoir was being flushed each year, thereby maintaining a normally submerged channel along the reservoir which facilitated the flow of turbidity currents to the low-level power intake at the dam where the turbid water was vented with the turbine flow.

Under the most favorable conditions some reservoirs in China's Yellow River basin have reported that turbidity currents transporting silts have discharged more sediments than the inflow, a result of scouring and then transporting unconsolidated bed sediments. For example, at the narrow 40 km long Liujiaxia hydropower and flood control reservoir on China's upper Yellow River, a major sediment-laden tributary named the Tao River (Taohe), discharges only 1.5 km above the dam. This tributary contributes 30 % of the inflowing sediment load, consisting primarily of silt, but provides only 2 % of the reservoir's storage capacity. Partial drawdown during floods allows inflow along the Taohe to scour sediment from the bed, transporting it to the outlet at the dam in the form of a turbid density current. By entraining additional sediment by scour, it was possible to release over 100 % of the inflowing sediment load during 13 of 25 density current release events during 1995. Over a 10-year period, 37 % of the inflowing Taohe sediment was released [78].

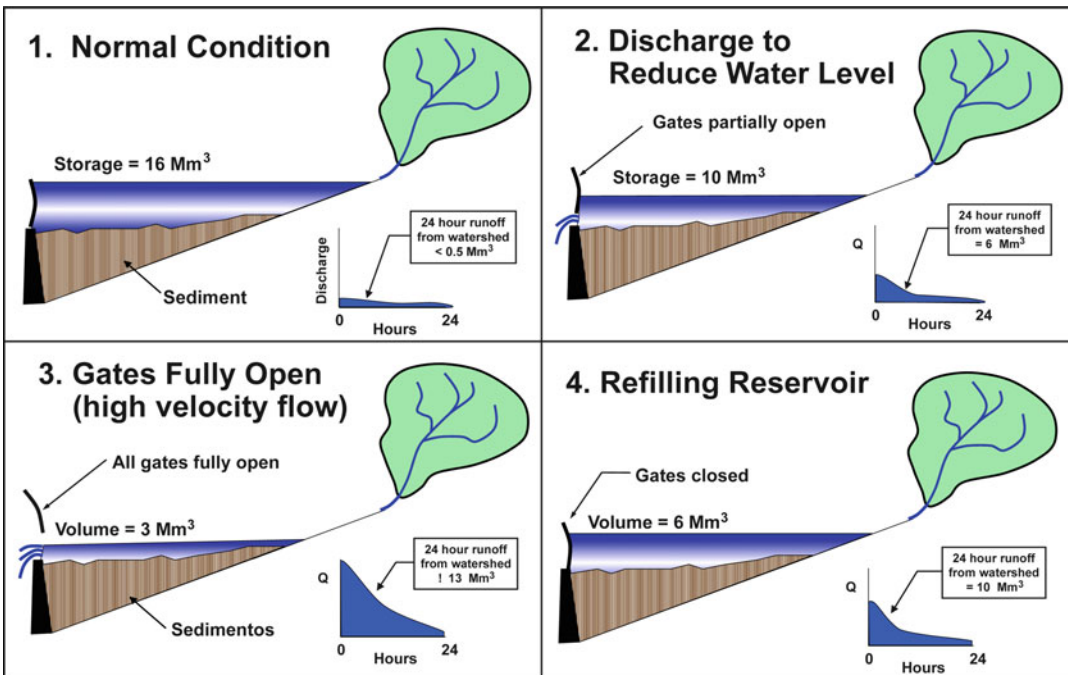
The release of turbidity currents is dependent on successfully predicting the arrival time at the dam and operating outlets to minimize the settling period in the muddy lake. Hydropower facilities with low-level power intakes may be well suited to release these currents if the dispatch schedule adopts sediment managed operation to allow continuous power production during sediment-laden inflow events when only fine sediments reach the dam, since these will not normally abrade hydraulic machinery.



### 8.6. Sediment Routing by Reservoir Drawdown

The strategy for drawdown pass-through (often termed sluicing) is to route sediment-laden inflows through the impounded reach at the highest velocity possible, maintaining sediment in suspension and minimizing deposition in the reservoir. High-velocity flows are achieved by reservoir drawdown, and the reservoir is refilled with water having lower sediment concentration toward the end of the inflow event. Because this strategy entails substantial drawdown and refilling of the reservoir, it is only suitable for reservoirs with a small storage capacity in relation to annual streamflow. It also requires large-capacity low-level outlets.

Sediment pass-through was first employed in a large reservoir at the Sanmenxia dam on China's Yellow River, where serious sedimentation problems required reconstruction of the outlet works to permit seasonal emptying at the beginning of the flood season to generate riverine flow along the length of the reservoir, not only passing inflowing sediment but also scouring out sediment accumulated from the prior year's impounding [29, 79]. The best-known example of this strategy is the Three Gorges Reservoir in China, which also employs a seasonal drawdown [29]. At smaller reservoirs the drawdown may be performed for individual flood events, instead of seasonally, refilling the reservoir's storage pool at the end of each pass-through event. A sediment routing operation of this type in a reservoir with a smaller watershed is schematically illustrated in Fig. 5.17. The management system consists of real-time rain and stream gage stations with attendant software to monitor and predict inflow rate



**Fig. 5.17.** Conceptual operation of a reservoir for sediment pass-through. (1) Normal operation, (2) initiation of drawdown as precipitation is received in the watershed, (3) gates fully open and high-velocity flow developed through the length of the reservoir, and (4) when precipitation diminishes gates are closed to refill the reservoir.

and volume. This operation may be described in a sequence of four steps. (1) During periods of normal weather the reservoir maintains storage for water supply and the hydrologic forecast system continuously updates flood forecast parameters such as antecedent soil moisture. (2) At the onset of a large rainfall event, reservoir gates are opened to draw down the storage pool at a rate not exceeding the accumulation of runoff volume in the watershed as determined by hydrologic modeling based on received rainfall and corroborated by discharge measurements at upper watershed stream gages. The total volume in the system, consisting of the volume in the reservoir plus the predicted 24-h inflow volume from the watershed, is never allowed to drop below the reservoir capacity, thereby ensuring the storage pool can always be refilled. (3) During a large volume flood, reservoir gates are fully opened and high-velocity riverine flow occurs through the impoundment, transporting flood-laden sediment beyond the dam. (4) When the hydrologic model indicates that the runoff volume under the predicted hydrograph has declined to that required to refill the reservoir, gates are closed and the reservoir is refilled. While this method may mobilize and remove some of the previously deposited sediment, its main focus is to minimize deposition, particularly since the velocity required to maintain cohesive sediment in suspension is much less than that required to scour sediments which have already been deposited. Maintaining sediment transport through the impounded river reach during floods avoids the environmental impacts that accompany strategies such as flushing, which releases high-concentration flows with limited discharge, and thus requires particular attention to environmental mitigation. A key feature of sediment pass-through is that it maintains the natural flood hydrograph and its associated sediment transport along the river system.

## 9. RECOVER, INCREASE, OR REALLOCATE STORAGE VOLUME

Sediment removal can be undertaken by opening a low-level outlet to produce hydraulic scour and remove sediments, a process termed *flushing*. There are two basic types of flushing operations: *pressure flushing* occurs when a low-level outlet is opened while the reservoir pool is held at a high level, and *drawdown flushing*, *empty flushing*, or more commonly simply *flushing*, occurs when the reservoir is completely emptied and riverine flow runs along the entire length of the reservoir and out the bottom outlet [79].

The term *sluicing* refers to any method which removes sediment through a low-level outlet (a *sluice gate*), and the term *sluicing* has been used by different authors to refer to sluicing (venting) of turbidity currents, sluicing by partial drawdown (sediment pass-through), sluicing through a tunnel (sediment bypass), and sluicing by reservoir emptying (flushing). Given its multiple interpretations, use of this term is not recommended.

Sediment can also be removed mechanically from beneath the water while the reservoir is inundated (dredging) or with the reservoir empty (dry excavation). Mechanical methods to excavate sediment are well known and are invariably suggested to “solve” sedimentation problems. However, to rely solely on mechanical equipment and fuel to sustain a sediment balance across a reservoir can rarely be considered a sustainable strategy, and the mechanical management of sediment should normally be evaluated as a complement to other measures rather than as a stand-alone practice.

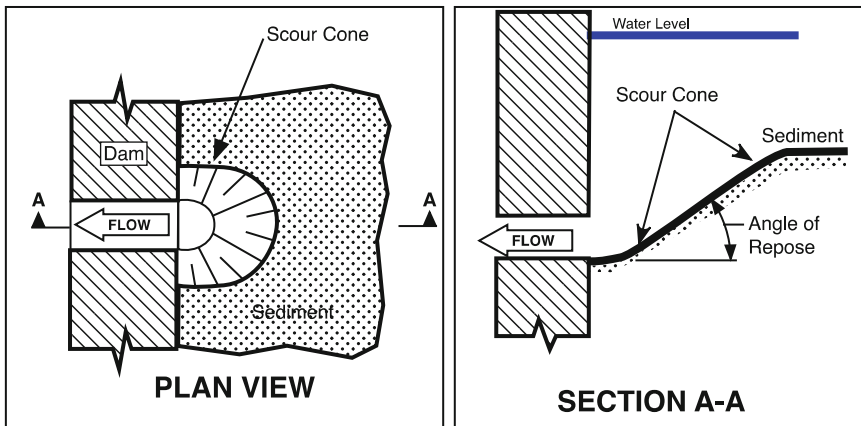


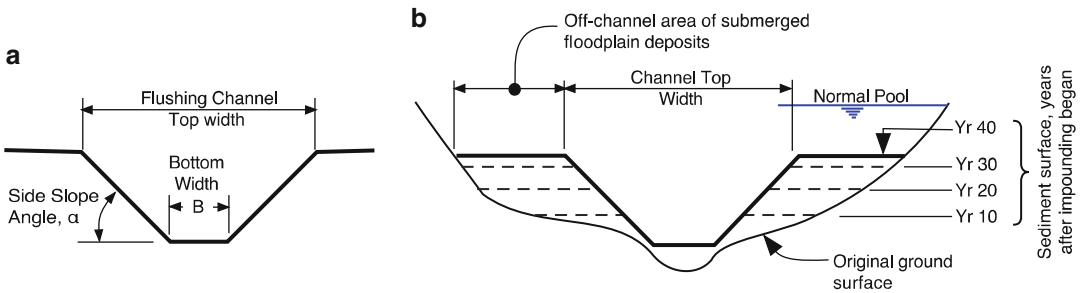
Fig. 5.18. Definition sketch for pressure scouring.

### 9.1. Pressure Flushing for Localized Sediment Removal

Pressure flushing will release only a relatively small volume of sediment in the immediate vicinity of the flushing outlet. If an intake is located immediately above or adjacent to a low-level outlet operated for pressure flushing, it will be possible to maintain the intake area free of sediment. With reference to the definition sketch in Fig. 5.18, in granular sediment, the angle of repose of the scour cone under continuously submerged conditions will approximate the submerged angle of repose of the sediment, on the order of approximately  $30^\circ$ . In the case of cohesive sediment this angle can be much steeper, and operators at some sites have found it necessary to dredge cohesive sediment in front of the intake to reduce clogging despite continuous hydropower releases. Based on laboratory experiments on scour cone formation using cohesionless sediment [80], it was reported that the half cone created centered on the outlet at the wall of the dam was nearly symmetrical and that the volume of the scour cone is increased (angle of repose decreased) by increased discharge, increased outlet diameter, or decreased water depth over the sediment deposit. When a reservoir is emptied, sediments will normally slump and the dewatered angle of repose can be less than half of the submerged value. When an outlet is buried in sediment it may be necessary to sink a small shaft (e.g., by water jet) to create a piping channel to initiate flow through the outlet.

### 9.2. Empty Flushing

Empty flushing entails opening a low-level outlet to completely drain the reservoir and scour out sediment. Flushing of this type inevitably occurs as a consequence of reservoir emptying for any reason, such as emptying to repair a low-level intake. The removal of sediment by flushing is an old technique dating to Moorish Spain over 500 years ago when emptying and flushing of irrigation reservoirs was scheduled at intervals of 4 years [81]. Today flushing is frequently undertaken on an annual basis and the flushing duration may vary from a few days to a few weeks, but its utilization is limited due to adverse downstream impacts. Empty flushing has primarily been practiced in hydrologically small



**Fig. 5.19.** Effect of flushing on reservoir geometry showing (a) definitional cross section of flushing channel in reservoir deposits, and (b) conceptual sequence of deposit configuration over time. This geometry is applicable only to deposits of fine sediment below the area of the reservoir delta.

reservoirs (low capacity:inflow ratio) on streams in mountainous areas. Maximum flushing effectiveness is achieved using the highest discharge that can be passed through the bottom outlet without backwater.

When the river is allowed to run through the impoundment and exit through a low-level outlet it will scour a channel across the deposits, typically following the original river channel. The volume within the reservoir that can be sustained by flushing can be defined based on the width of the flushing channel and the side slope angle (Fig. 5.19). In narrow reservoirs flushing has been used to sustain most of the original reservoir capacity, but in wider reservoirs sediments deposited on either side of the flushing channel during impounding will not be removed and will create a submerged floodplain that continues to accumulate sediment and increase in elevation over time. Sediment removal during flushing can be increased by using mechanical equipment to push sediment into the flushing channel or by diverting smaller flows laterally across erodible floodplain deposits. This lateral erosion procedure has been used successfully in Chinese reservoirs where sediments are predominately erodible silts [82]. Where a significant clay content is present, consolidation of the cohesive sediment can impair erosion.

Regular flushing which sustains a defined channel along the length of the reservoir will facilitate the passage of turbidity currents to the dam where they can be released through low-level outlets. Also, turbidity currents will deposit their sediment into the submerged flushing channel from whence they can be readily removed during subsequent flushing events. The data previously presented for Cachí reservoir in Table 5.8 which showed high rates of sediment removal reflects the beneficial effects of the flushing channel which conducts turbidity currents to the power intake at the dam and which also focuses deposition of fine sediment from turbidity currents into the submerged flushing channel from which it is easily removed during the subsequent flushing event.

Flushing is much less efficient in removing coarse sediment from a reservoir. Bed material sediment is transported and deposited on the reservoir delta by floods with high hydraulic transport capacity, but flushing flows are typically limited by bottom outlet size and cannot generate the transport capacity required to remove the volume of bed material delivered to the delta area by natural inflows. Thus, while flushing may achieve a sediment balance for the fine

fraction of the inflowing load, the coarse fraction may continue to accumulate in the reservoir (as occurs at Cachí reservoir per Table 5.8). For example, Sumi and Kantoush [83] reported that flushing at the Unazuki dam in Japan was effective in removing 73 % of the total sediment inflow but removed only 10 % of the annual load of coarse sediment >2 mm in diameter. Thus, the geometry of the flushing channel defined in Figure 5.19 may not be sustainable in the very long term because it does not represent the behavior of the continuously accumulating coarse sediment.

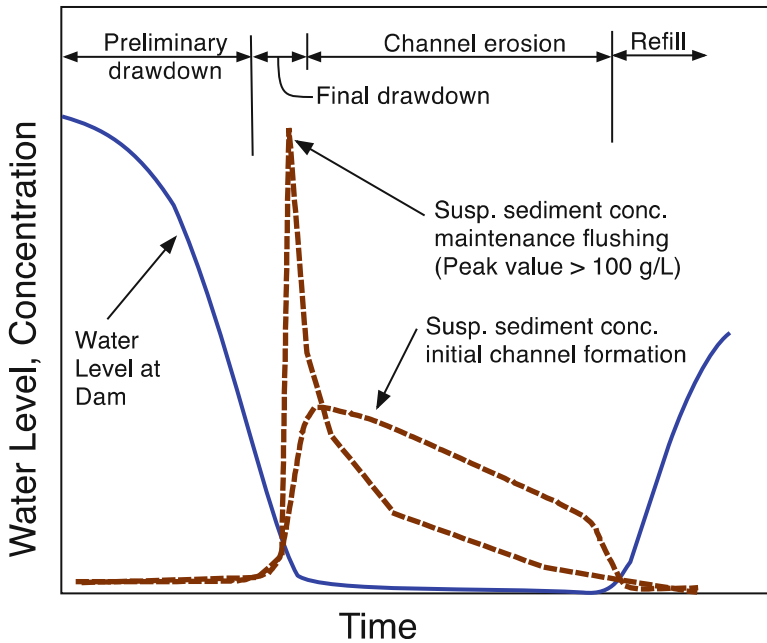
### 9.3. Downstream Impacts of Flushing

Flushing releases high sediment loads with limited water volumes, potentially producing downstream environmental impacts including reduced dissolved oxygen, high sediment concentrations that interfere with the function of gills and smother stream benthos, reduction in visibility and light penetration, and channel morphological impacts such as infilling of pools and clogging of river gravels with fine sediment, thereby eliminating spawning sites and habitat. Social and economic impacts include the interference with water treatment processes for municipal or other users, sedimentation within irrigation canals if not designed to transport sediment, accumulation in heat exchangers which draw water from the river, reduction of recreational quality, impacts to fisheries of economic importance, accumulation in flood control and navigational channels, and impacts to coastal areas. While the total amount of sediment released is not different from that which would have been transported downstream absent the dam, the combination of high sediment concentrations during flushing, changed downstream hydrology due to the dam, and the potential to release sediment-laden water out of sync with natural biological cycles, can produce large adverse impacts.

The downstream impacts associated with flushing are related primarily to the release of high-concentration flows. Early in the process of reservoir drawdown for flushing much of the sediment scoured from the upper part of the impoundment will be redeposited before reaching the dam. Sediment eroded from within the impoundment is discharged as a high-concentration mud flow only as the reservoir approaches full drawdown. This causes the suspended sediment concentration in the released water to rapidly spike to a very high level, often in the range of 100,000–400,000 mg/L, if not otherwise controlled by limiting the release rate to match dilution flows. Typical variations in hydraulic parameters and suspended sediment concentration during flushing are illustrated in Fig. 5.20. The highest concentrations associated with flushing events occur in reservoirs with annual maintenance flushing because recent poorly consolidated sediments in the flushing channel can be readily mobilized as a thick mud flow as soon as free flow is established along the bottom of the reservoir.

Based on the experience at alpine reservoirs in Europe which are flushed to maintain capacity, the following measures have been identified as minimizing the adverse environmental impacts of reservoir flushing [84, 85]:

- *Timing of release.* The most important criterion for minimizing flushing impacts is the proper timing of the release. Flushing releases should be timed to coincide with natural high-flow events or releases from other reservoirs to provide dilution, and particularly flows from tributaries downstream of the dam. Also, if flushing coincides with the beginning of the wet season, there is



**Fig. 5.20.** Typical pattern of variation in suspended sediment concentration during flushing events. When a reservoir is flushed for the first time and a flushing channel is gradually eroded, peak suspended sediment concentrations are lower than when a reservoir flushed on a regular basis. With regular maintenance flushing, suspended sediments that accumulate in the flushing channel do not consolidate between flushing events and are discharged as highly concentrated mud.

the opportunity for subsequent floods to cleanse the river channel and gravel beds of fine sediment deposited by the flushing release. If flushing releases sediment when fish are using gravels for spawning or the recently emerged weak-swimming larvae are using gravels for refuge, the juvenile population may be decimated, making it important to use biological as well as hydrologic criteria in selecting flushing dates. Because natural populations of juvenile fish can experience significant cyclic fluctuations, it is important to understand and document population fluctuations due to natural or other impacts and separate them from the impact of reservoir management.

- *Duration of release.* At a number of sites, the volume required to flush sediment from a reservoir is significantly less than the volume required to transport the released sediment downstream in a manner which minimizes localized sediment accumulation [29]. The availability of tributary inflow and the ability to release clear water downstream to further transport the released sediment soon after the low-level outlet is closed are important mitigation factors.
- *Frequency of release.* More frequent releases can result in smaller sediment releases during each event, which would normally be considered favorable. For example, a review of data from flushing at the Dashidaira and Unazuki dams on the Kurobe River in Japan indicated that adverse downstream impacts to the river channel were limited because of frequent flushing, high stream slope which facilitated transport of the released sediment, and the short distance (<30 km) to the sea. To minimize water quality problems, the reservoirs were flushed as frequently as possible during periods of high flow to provide high dilution volumes, thereby reducing the peak suspended

sediment concentration and sustaining higher oxygen levels in the stream below the dam [83]. Studies of flushing impacts in Italy [84] also emphasized the positive effect of frequent (annual) flushing which minimizes the amount of sediment release during any single event, in combination with the adequate release of clear water for dilution and cleaning the bed after the sediment release. Fish were impacted by both the high discharge and elevated sediment concentration, with juveniles being particularly susceptible.

Flushing has not been feasible in many areas of the world due to downstream water quality impacts, and only in recently years has significant attention been directed at developing flushing strategies to minimize these impacts.

#### 9.4. Flushing Equations

A rough preliminary idea of flushing channel geometry can be defined by two equations, one to estimate the width of the flushing channel and the other to estimate the slope angle of channel banks [85], as previously defined in Figure 5.19. Channel bottom width can be estimated by

$$B = 12.8Q_f^{0.5} \quad (5.6)$$

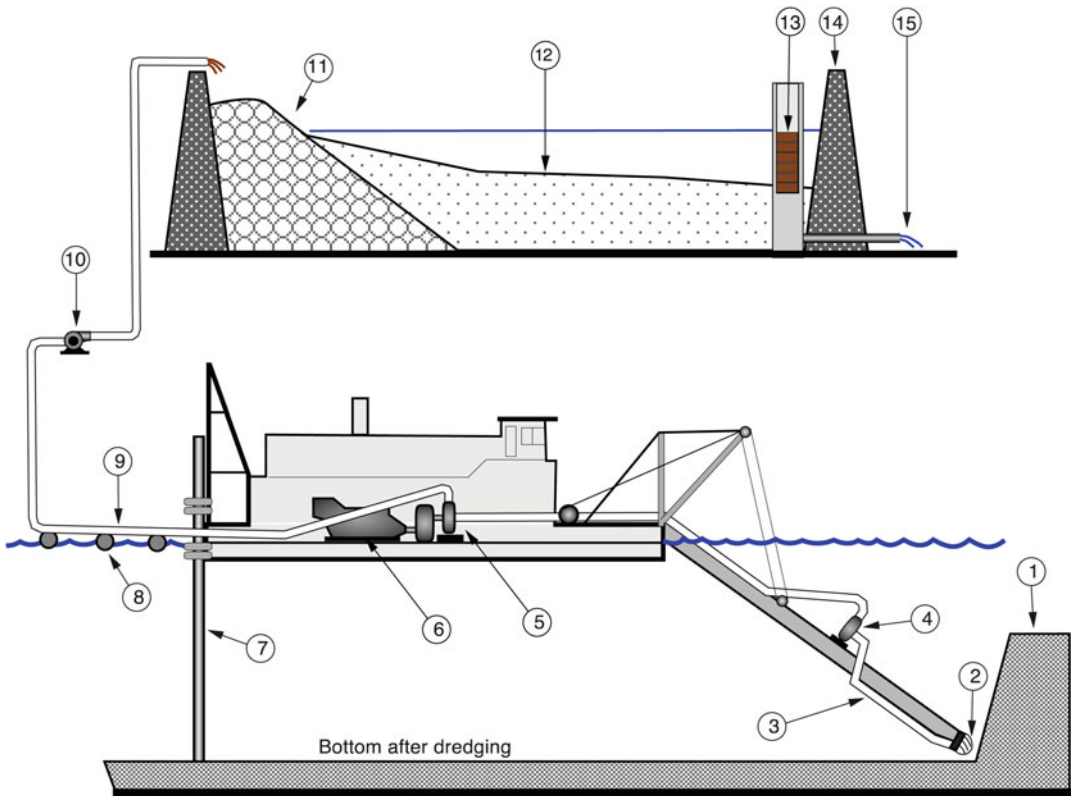
and the bank angle can be estimated by

$$\tan \alpha = \frac{31.5}{5} \gamma_d^{4.7} \quad (5.7)$$

The rate of sediment discharge during flushing based on data from Chinese reservoirs can be roughly estimated by the Tsinghua University equation [29]:

$$Q_s = \Psi \frac{Q_f^{1.6} S^{1.2}}{B^{0.6}} \quad (5.8)$$

where  $Q_s$  is sediment transporting capacity (T/s),  $Q_f$  is flushing discharge ( $\text{m}^3/\text{s}$ ),  $S$  is bed slope,  $B$  is channel width (m), and  $\Psi$  is a constant determined by sediment type: 1,600 for loess sediments, 650 for other sediments with median size  $<0.1$  mm, 300 for sediments with median size  $>0.1$  mm, and 180 for flushing with a “low” discharge. These equations provide only a rough approximation of flushing performance, but they do show the importance of maximizing the discharge during flushing events. A tenfold increase in discharge increases the rate of sediment discharge by a factor of 20 and increases the channel width by a factor of 3, while cutting in half the volume of water needed to remove a fixed sediment volume. Reservoir flushing in China is frequently performed annually, meaning that the flushing channel refills with sediments which do not have time to consolidate before the next flushing event and making flushing very efficient in terms of water use. Atkinson [85] suggests that equation may overestimate the rate of sediment discharge by a factor of approximately three when flushing sediments that have had many years to consolidate or when flushing from a reservoir with sediments coarser than 0.1 mm diameter.



**Fig. 5.21.** Schematic of components of dredging system: (1) sediment to be dredged; (2) rotating cutterhead to cut and suspend sediment; (3) suction line connected to the ladder; (4) ladder pump; (5) main pump; (6) main drive, either diesel or electric; (7) spud; (8) pontoons to support discharge pipe; (9) discharge pipeline; (10) booster pump; (11) coarser material deposited near the discharge point; (12) fine sediment; (13) discharge weir with flashboards to allow elevation to be raised as the containment area is filled; (14) containment area dike; and (15) discharge of clarified water back to the reservoir or to other receiving body.

### 9.5. Dredging

Dredging refers to the excavation of material from beneath the water. There are broadly two types of dredging: mechanical dredging in which the dredged material is removed by buckets such as a clamshell, dragline, or bucket ladder dredge or hydraulic dredging in which sediment is excavated and transported as a slurry. Mechanical dredging is generally used in low-volume applications which focus on dredging of smaller areas and the removal of woody debris, such as the area around an intake, or for the removal of gravels and cobbles from the delta as this coarse material is inefficient to dredge hydraulically. Mechanical dredging in reservoirs typically entails haulage of the material to a disposal site by truck.

Volume-wise, most sediment is removed from reservoirs by hydraulic cutterhead dredges. The principal components of a hydraulic dredging system are illustrated in Fig. 5.21. Hydraulic dredges can achieve high rates of production, can handle a wide range of grain sizes, do not



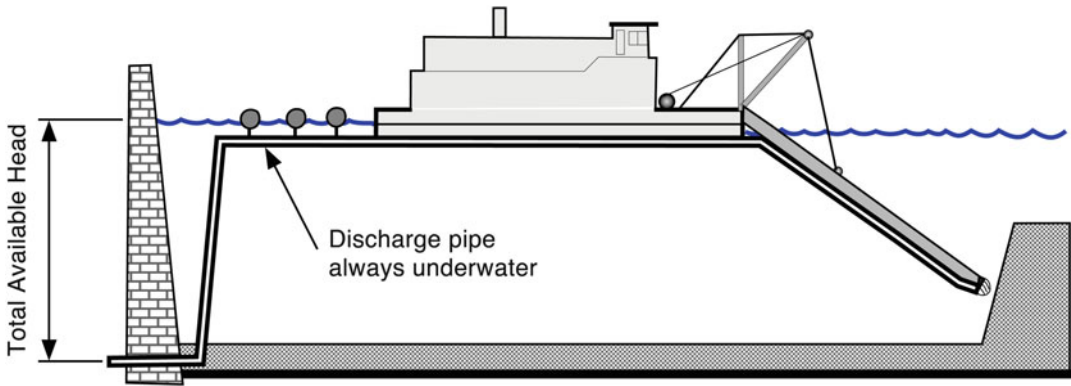


Fig. 5.22. Siphon or hydrosuction dredging configuration.

interfere with normal reservoir operation, and the slurry pipeline is a clean and low-impact means to convey dredged material to the disposal site.

A special type of hydraulic dredging developed only for reservoirs is the *siphon* or *hydrosuction* dredge [86], which does not use a pump but instead uses the difference in head between the reservoir water surface and a discharge point at the base of the dam as the energy source for slurry transport, as illustrated in Fig. 5.22. Because the amount of hydraulic energy available is fixed by the reservoir level, which may vary, high friction losses in the slurry pipeline typically limit the use of siphon dredges to the removal of sediment within about 2 km of the dam. A slurry pipeline must be designed to transport the largest grain sizes in the material to be dredged. The high velocity required to sustain sand or coarser material in suspension generates high friction loss, making it infeasible to transport coarse material over significant distances without energy input by pumping. Longer transport distances are feasible with uniformly fine material because they can be transported at lower velocities without sedimentation in the pipeline. The hydraulics of slurry pipeline transport of coarse materials for siphon dredging in reservoirs has been outlined by Eftekharzadeh [87].

Dredging is expensive and is typically much more costly than creating storage volume by dam construction. Dredging costs include engineering and permitting, costs associated with acquisition, and management of the dredged material placement site, plus the cost of dredging itself. Dredging costs vary widely, and 2013 reservoir dredging costs can be expected to run in the general range of \$5 to \$15/m<sup>3</sup>, provided there are no unusual conditions such as contaminated sediments. The unit cost of reservoir dredging is typically higher than navigational dredging because dredges must be transported to the reservoir by land and are typically smaller than the equipment available for navigational dredging. Upland dredged material containment area costs may also be higher than in navigational dredging.

The availability of land for the disposal of dredged material is an important impediment to sustaining long-term reservoir capacity by dredging. Material removed by hydraulic dredging is subject to bulking, and if fines are present the volume of containment area must be proportionally larger than the in situ volume of the material to be dredged, as computed by the dimensionless *bulking factor*:

$$B = \frac{V_c}{V_i} = \frac{\gamma_c}{\gamma_i} \quad (5.9)$$

where  $V$  = volume,  $\gamma$  = dry unit weight, and subscripts  $c$  and  $i$  refer, respectively, to containment area and in situ values. The value of the bulking factors is 1.0 for pure sands, in the range of 1.3 for silts, but can exceed 1.5 for clays. Their value depends on the amount of consolidation in the area being dredged as well as the settling characteristic of the material. Thus, the bulking factor for older consolidated clay deposits may be larger than for recent clay deposits having a lower in situ dry unit weight. Column settling tests should be run for at least 15 days to better determine the anticipated settling characteristics of the material to be dredged. Over time the dredged material will dewater and consolidate, particularly when the material is dewatered and provided with good surface drainage and plant roots penetrate the material [88].

In some instances, it is permissible to discharge dredged material to the river channel downstream of the dam. Discharge below the dam is advantageous in that it sustains the flow of sediment along the channel, with the principal problem being that sediment is released continuously rather than being timed to coincide with natural discharge events. Nevertheless, at smaller dams in mountainous areas with frequent downstream releases, sediment discharge to the river below the dam can represent a good alternative, especially when coarse bed material can be placed below the dam to replenish the cutoff of sediment supply due to the dam. Small-scale downstream sediment replenishment in the Isa River, Germany, is described in Hartmann [90] and in the Nunome River, Japan, is described by Kantoush and Sumi [89]. When downstream discharge is not feasible, dredging can be sustained only as long as there is space available in containment areas which are sufficiently close to the reservoir to be economically feasible.

### 9.6. Dry Excavation

Dry excavation has been used in some instances to remove sediment from reservoirs. Unlike dredging, it requires that reservoir level be lowered or emptied to allow access to deposits by earthmoving equipment. At some sites with predictable seasonal water-level variation, dry excavation can be undertaken on a seasonal basis. Disposal area limitations similar to those associated with dredging apply, the difference being that sediment transport is typically by truck haulage with attendant damage to roads, public disturbance from traffic and dust, etc. Dry excavation can easily remove coarse material from the delta, but removal of deep deposits of poorly consolidated fine sediment presents significant difficulties absent a period for dewatering and consolidation.

### 9.7. Raise the Dam

Raising the dam to increase storage capacity can, in some cases, provide a volume increase sufficient to substantially delay sediment problems. Due to reservoir geometry, each height increment provides more volume than the prior increment, making even relatively small

height increases potentially important. However, raising the dam is neither a simple nor inexpensive undertaking. In addition to structural and hydraulic considerations, raising the dam may entail additional land acquisition, upstream flood levels will increase, delta deposition will move further upstream, evaporative surface will be enlarged, etc. Raising the dam in combination with improvements to gates to facilitate sediment release may improve the long-term sediment balance. However, if the dam is raised to increase storage capacity without other sediment management measures, it may not contribute to a long-term solution.

### **9.8. Structural Modifications**

Sedimentation can interfere with intake operation and can result in the entrainment of coarse sediment. For example, at the glacial-fed Gebidem hydropower reservoir in Switzerland, which maintains storage capacity by annual flushing, fine sands were being carried into the area of the low-level outlet and causing turbine abrasion. In this case a new intake tower was installed and provided with multiple-level inlets at higher elevations in the pool to avoid the entrainment of sand (290). When fine sediment accumulates in front of the dam that does not practice sediment removal, the intake may be raised to avoid the accumulating sediment. The disadvantage of this approach is that it will tend to maintain a high reservoir trap efficiency. In general, turbid density currents should be released insofar as possible, and passage of turbidity currents through turbines will typically not cause abrasion problems due to the small grain size of the transported sediment.

To minimize interference by sedimentation, intakes should be placed above or adjacent to a low-level outlet, so that operation of the outlet for either pressure or empty flushing will clean out the area in front of the intake. However, many reservoirs have intakes located at the side of a reservoir, a significant distance from either the low-level outlet or the channel which is created by flushing through a low-level outlet. In such cases it may be necessary to construct a normally submerged pipe or other conveyance structure from the intake to an area of the dam which can be maintained sediment-free by pressure flushing or to the location of the flushing channel. This conveyance structure should be sized to generate the velocities required to avoid sedimentation within the conveyance structure, based on the largest sediment size likely to be entrained. Relocation of the intake entrance by this method may increase the frequency with which turbid density currents are diverted into the intake.

### **9.9. Reuse of Reservoir Sediments**

Reservoir sediments will reflect conditions in the upstream watershed, including the contaminants generated by upstream activities. If there is extensive upstream agricultural activity including the historical application of persistent pesticides, these may be found in the reservoir sediments and should be evaluated when considering reuse options. Similarly, upstream mining or industrial activity can result in sediment contamination. However, in general reservoir sediments do not present special hazards and can be readily reused for activities such as agriculture, fill, or construction materials if sediments are sufficiently coarse. Testing protocols to insure compatibility with intended uses will vary by jurisdiction and by intended use.

## 10. TOWARD ACHIEVING SUSTAINABLE USE

### 10.1. *Modeling of Sediment Management Activities*

Future sedimentation patterns and alternative sediment management activities can be best examined by simulation modeling. Depending on the situation, the appropriate tool may be a physical model, a numerical model, or both. Physical modeling is typically used to simulate the detailed behavior of 3-dimensional flow patterns, deposition, scour and the movement of floating debris in the vicinity of structures such as intakes, gates, and spillways. Numerical sediment transport models are currently used for both single-event and longer-term (e.g., 100-year) simulations focusing on larger-scale scour and deposition phenomena. Fundamental aspects of sediment transport are covered by Yang [91], and the mathematical basis for numerical models has been summarized by Simões and Yang [92]; this section will focus on several practical aspects of numerical modeling.

Numerical models may solve flow problems in one, two, or three dimensions. One-dimensional models have been in use for many years, and two-dimensional models are increasingly being used as computational capacity expands. Three-dimensional models remain, at this moment, more in the purview of academic research. Inasmuch as river-reservoir systems can frequently be simulated as one-dimensional systems, 1-D models have been employed in many situations to predict the timing and patterns of sediment deposition and scour. One-dimensional models available from US government agencies include SRH-1D available from the US Bureau of Reclamation and HEC-RAS (successor to the HEC-6 sediment transport model) available from the US Army Corps of Engineers. Both models can simulate the behavior of both coarse and cohesive sediment.

One-dimensional models are used to simulate the changes in bed profiles and the longitudinal variation in grain size as a result of changes in discharge, sediment load, and the influence of hydraulic structures which raise or lower water levels and sediment transport capacity. They cannot simulate situations involving secondary currents and transverse sediment movement, changes in stream morphology such as meandering, point bar formation, pool-riffle formation, and many plan form changes. They also cannot simulate the details of local deposition and erosion resulting from intakes, bridges, and other instream structures. Several types of reservoir sedimentation questions are commonly addressed using one-dimensional models. One question is to predict the future sedimentation pattern and particularly the evolution of the reservoir delta into the pool as well as deltaic aggradation upstream above the pool. A second question involves the extent to which the sedimentation rate and patterns will be modified by changes in factors such as sediment input or reservoir operation. A third question involves the effectiveness of sediment removal and the reservoir profiles resulting from reservoir flushing. A fourth question involves the response of the channel below the dam as affected by reduced sediment inflow from reservoir construction or from an increase in sediment inflow due to reservoir flushing, dam removal, or other management. Models may be run to examine the effects of a single flood event, multiple events, or long-term (>100 year) behavior, depending on the nature of the question to be addressed. Because most sediment is transported by floods, simulations frequently focus on these large events.

Input data required for numerical modeling include geometry, hydraulics, sediment, and operating rules. Model geometry is established using cross sections of the river-reservoir system. Hydraulic parameters include the inflow time series at the upstream boundary plus any tributaries, the downstream water surface boundary (subcritical flow), plus rating curves for any internal boundaries such as gates or weirs. Sediment data includes specification of the bed material size distribution, depth to bedrock at each cross section, sediment deposit density, and the inflowing load for each grain size as a function of discharge and density of sediment deposits. It is also necessary to select the appropriate sediment transport equation from the several that are available. Operating rules involve the management of water levels during inflow events, which directly influences the flow velocity and trap efficiency in the reservoir and which may also entail periods of reservoir drawdown for sediment flushing.

The simulation of sediment transport is usually undertaken with very limited data. For example, many locations will not have a suspended sediment gage station to provide data to construct a sediment rating curve, and bed material transport data are virtually never available. Furthermore, selection of one or another transport equation can change the transport rate by more than an order of magnitude. This makes model verification essential. When simulating sedimentation within an existing reservoir, the model can be exercised over the historical period and parameters adjusted until a reasonable fit is made to the observed depositional pattern and grain size distribution within the reservoir.

Calibration of a sediment transport model should start with the hydraulic elements, adjusting hydraulic roughness or other parameters until a reasonable match is achieved against any available hydraulic profile data. Calibration of a sediment transport model for an existing reservoir requires bathymetric data from at least two points in time, plus data on the grain size of deposited sediments as a function of location along the reservoir. Grain size samples should be taken using a sediment core, since grab samples from the surface of the sediment deposits will reflect only the most recent period of sedimentation rather than average conditions. The model is calibrated by starting with the pre-impoundment condition, and then run to simulate the documented post-impoundment geometry and grain size along the reservoir, while insuring that the resulting value of reservoir trap efficiency is reasonable. This may require adjustment of the amount and grain size in the inflowing sediment load and a change in the transport function. If simulating sedimentation in a proposed reservoir, the model may be run for a period of decades using the existing stream geometry to insure that it properly simulates the existing profile and grain size distribution along the river while transporting anticipated amounts of sediment through the system. However, this will verify only the coarse fraction of the load as represented in the bed material, but most reservoir sediments consist of fines which behave as wash load. This makes it important to have a good estimate of the suspended sediment rating curve, and lacking this the inflowing load will need to be approximated from other suspended sediment gages which may exist in the area, or based on volume of sediment trapped. Modeling cannot overcome errors in the estimate of the inflowing suspended sediment load.

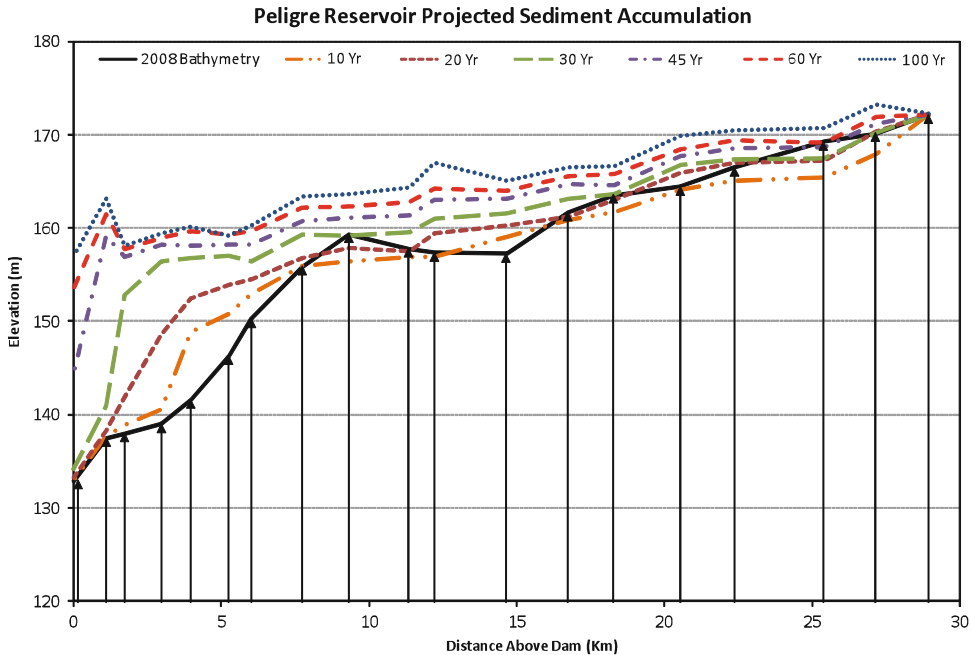
An important factor limiting the reliability of sediment transport models is the availability of data for model calibration. Grain size will exhibit significant variation within a reservoir

and may be locally influenced by the lateral inflows from minor tributaries. It is important that the modeler understand the sampling procedures that were used, obtain samples at multiple locations, and should ideally be personally involved in at least some sediment field work. It is also necessary to interpret results from transport models for overall reasonableness, since sediment calibration data are not themselves always consistent. The future conditions which are simulated should always be interpreted as a general guide rather than a precise prediction, taking into consideration limitations that exist in the calibration data, the uncertainty of future hydrologic conditions, and the limitations inherent in using a simplified model to study a complex process.

An example of the use of the SRH-1D model was given by simulations performed at the Peligre reservoir in Haiti [18], which had lost 50 % of its capacity after 50 years of operation. This reservoir produces hydropower and also delivers water to irrigators downstream in the Artibonite Valley. The configuration of this reservoir was previously shown in Figures 5.4 and 5.5. A study was undertaken for the Inter-American Development Bank to determine whether or not coarse sediments would enter the hydropower intake within the next 20 years. To address this question, the reservoir was surveyed to determine the existing (2008) configuration of sediment deposits, and sediment samples were collected to determine the longitudinal grain size distribution. The SRH-1D model was started with the 1980 bathymetry (the original reservoir configuration was not available) and calibrated against the 2008 bathymetry. Because there are no data on inflowing grain size data, the inflowing grain size distribution was adjusted to produce the grain size distribution observed in the reservoir from field samples. The calibrated model was then run 100 years into the future under the existing and alternative operating rules, including a rule which included periodic flushing using the existing outlets. Simulation results for the recommended operating rule are illustrated in Fig. 5.23 showing the simulation of delta advancement toward the dam. These results indicated that coarse sediment would not enter the intakes during the next 20 years. Furthermore, it was shown that by both raising the power intake level and using the recommended operating rule, it would be possible to sustain hydropower operations during the next 100 years with no reduction in energy production, although the reduction in storage would significantly impair the reliability of irrigation supplies. It also showed that absent a large low-level outlet to discharge large floods with significant reservoir drawdown, it will not be possible to flush a significant part of the delta sediment from the reservoir. However, when the reservoir capacity is greatly reduced, and by operating at the lowest possible level during flood events (sediment pass-through), the trap efficiency is reduced from 95 % to 50 % over the 100-year simulation period.

## **10.2. Implementation Steps**

Reservoir operation becomes sustainable once a program is implemented to bring sediment inflow and outflow into long-term balance in a manner that produces significant net benefits to society while sustaining the integrity of ecological systems. Sustainable operation at a specific reservoir site may be achieved through a sequence of actions such as those listed below:



**Fig. 5.23.** Advancement of reservoir delta toward the dam over a 100-year simulation period, Peligre dam, Haiti [18].

1. *Data collection.* Perform bathymetric studies at regular intervals to document the pattern and trend of sediment accumulation and to identify those beneficial uses most threatened by sedimentation. Operate one or more sediment monitoring gage stations upstream of the reservoir to collect data for construction of a sediment rating curve including grain size distribution of the inflowing load, giving particular attention to monitoring flood events. The sediment rating curve is an important input for numerical modeling.
2. *Predict sedimentation patterns and impacts.* Use sediment transport modeling to predict long-term sedimentation patterns, identifying the benefits to be impacted and approximate time frames when sediment will interfere with specific operations.
3. *Adaptive measures.* Identify and implement measures to adapt to sedimentation. This may include measures at the reservoir such as pool reallocation, modification, or optimization of operating rules or offsite measures such as development of an alternative water supply and increased efficiency of resource use through water conservation, reuse, or loss reduction.
4. *Select long-term sediment management strategy.* Identify feasible strategies to manage sediment, assign action priorities based on the urgency and consequences of sedimentation, and establish an implementation timetable. The sedimentation impacts at some sites may be very large as loss of an essential water supply or flood protection may eliminate the livelihood of entire communities, and large consequences can justify aggressive sediment management actions. If sedimentation will lead to decommissioning of the dam, those implications and potential liabilities should also be considered.

The most appropriate strategies may change over time as the reservoir loses capacity; management measures such as sediment routing by drawdown may not be technically feasible early in the reservoir life, but will become feasible as storage volume diminishes. Conversely, the ability to

release turbid density currents may diminish over time. If heightening or a new dam is selected as an alternative, land should be acquired or otherwise reserved for this eventual use.

5. *Implementation.* Initiate those activities required to support the long-term strategy. At sites without a significant near-term problem or mitigation opportunities, implementation may be limited to the data collection program. At sites with more proximate problems or immediate sediment management opportunities, implementation may include detailed analysis, design, environmental permitting, operational modifications, and construction activities. Even though some types of control measures may be delayed until sedimentation is more advanced, these should be identified and scheduled. The objective is to outline the path to sustainable operation and insure that all future activities are coincident with this path.
6. *Monitoring.* Monitor the impacts of implementation measures, and adjust sediment management activities as needed to maximize long-term benefits.

In summary, long-term sustainable use requires that project design and operation look beyond the traditional planning horizons associated with project financing. It requires that owners and engineers actively pursue measures to establish a sediment balance across the impounded reach. In the same manner that dams are designed and managed to comply with dam safety and environmental criteria, sustainability should also be considered an essential component of the project, implementing to the greatest extent possible those elements that lead to a long-term sediment balance.

### 10.3. Additional Resources

This section lists several online resources which provide information and software, at no cost unless otherwise noted.

---

Intl. Assn. for Hydrological Research (many open access publications)	<a href="http://www.iahs.info/press.htm">http://www.iahs.info/press.htm</a>
Intl. Commission on Large Dams. ICOLD (publications, some free)	<a href="http://www.icold-cigb.net/">http://www.icold-cigb.net/</a>
<i>Reservoir Sedimentation Handbook</i> (PDF download)	<a href="http://www.reservoirsedimentation.com">http://www.reservoirsedimentation.com</a>
<i>Erosion and Sedimentation Manual</i> (PDF download)	<a href="http://www.usbr.gov/pmts/sediment/">http://www.usbr.gov/pmts/sediment/</a>
US Army Corps of Engineers (publications and software)	<a href="http://www.hec.usace.army.mil/">http://www.hec.usace.army.mil/</a>
US Bureau of Reclamation (publications and software)	<a href="http://www.usbr.gov/pmts/sediment/">http://www.usbr.gov/pmts/sediment/</a>
USDA Natural Resources Conservation Services (publications, software, local offices)	<a href="http://www.nrcs.usda.gov/">http://www.nrcs.usda.gov/</a>
US Environmental Protection Agency (water quality regulations)	<a href="http://www.epa.gov">http://www.epa.gov</a>
US Geological Survey (online water data and publications)	<a href="http://www.usgs.gov/water/">http://www.usgs.gov/water/</a>
US Geological Survey, reservoir/fluvial sedimentation website	<a href="http://ida.water.usgs.gov/ressed/">http://ida.water.usgs.gov/ressed/</a>

---



## REFERENCES

1. Hoekstra AY, Chapagain AK (2007) Water footprints of nations: water use by people as a function of their consumption pattern. *Water Resour Manag* 21:35–48. doi:10.1007/s11269-006-9039-x
2. Blemans H et al (2011) Impact of reservoirs on river discharge and irrigation supply during the 20th century. *Water Resour Res* 47:1–15. doi:10.1029/2009WR008929
3. Palmieri A, Shah F, Dinar A (2001) Economics of reservoir sedimentation and sustainable management of dams. *J Environ Manag* 61:149–163
4. Schnitter NJ (1994) A history of dams: the useful pyramids. A.A. Balkema, Rotterdam
5. World Commission on Dams (2000) Dams and development: a new framework for decision-making. Earthscan Publications Ltd, London and Sterling, VA
6. Mahmood K (1987) Reservoir sedimentation impact, extent, and mitigation. World Bank technical paper 1971. Washington, DC
7. White R (2001) Excavation of sediments from reservoirs. Thomas Telford Ltd, London
8. Basson G (2010) Tackling the growing sedimentation problem. *Int Water Power Dam Construct* August 9
9. Sawadogo G (2008) Analysis of observed reservoir sedimentation rates in South Africa. Postgraduate thesis, University of Stellenbosch
10. Morris GL (2003) Reservoir sedimentation management: worldwide status and prospects. In: Proceedings of world water forum. March 31, Japan
11. Brundtland Commission (1987) Our common future. Report of world commission on environment and development. <http://www.un-documents.net/wced-ocf.htm>. Accessed 8 Dec 2011
12. Loucks DP, Gladwell JS (eds) (1999) Sustainability criteria for water resource systems. Cambridge University Press, Cambridge
13. International Hydropower Association (2010) Hydropower sustainability assessment protocol: background document. <http://hydrosustainability.org/>. Accessed 8 Sept 2011
14. Klein J, Iso-Ahola V, Pratt J, Wade D (2007) San Clemente Dam: an example of funding barriers in dam removal. In: Proc. ASCE World Environmental and Water Resources Congress
15. Ferrari RL (2006) Reconnaissance techniques for reservoir surveys. US Department of the Interior. Bureau of Reclamation. Technical Service Center, Denver, CO
16. Fan J, Morris GL (1992) Reservoir sedimentation. I: delta and density current deposits. *J Hydraul Eng ASCE* 118(3):354–369
17. Strand RI, Pemberton EL (1987) Reservoir sedimentation. In: Design of small dams, US Bureau of Reclamation, Denver. [http://www.usbr.gov/prints/hydraulics\\_lab/pubs/index.cfm](http://www.usbr.gov/prints/hydraulics_lab/pubs/index.cfm)
18. Gregory L. Morris Engineering (2008) Sedimentation study Peligre reservoir, Haiti. Report to Inter American Development Bank, Washington, DC
19. Grover NC, Howard CS (1938) The passage of turbid water through Lake Mead. *Trans ASCE* 103:720–790
20. Althaus JJ, De Cesare G (2006) Reservoir sedimentation. Vol 3. In: Sustainable sediment management of alpine reservoir considering ecological and economical aspects. Institut für Wasserwesen, Neubiberg
21. Ferrari RL (2008) Elephant butte reservoir 2007 sedimentation survey. Tech. report no SRH-2008-4. U.S. Bureau of Reclamation, Denver
22. Lane EW (1954) Some hydraulic engineering aspects of density currents. Hydraulic laboratory report no Hyd-373. U.S. Bureau of Reclamation, Denver

23. Jonas M, Pinkard F, Remus J (2010) USACE reservoir sedimentation: data, assessment and guidance. In: Proceedings of 2nd joint federal interagency conference, June 27–July 1, Las Vegas, Nevada
24. Carter JE (1991) Niobrara, Nebraska: the town too tough to stay put! *Nebraska History* 72(1991):144–149
25. Collier M, Webb RH, Schmidt JC (1995) Dams and rivers: a primer on the downstream effects of dams. USGS circular 1126, Denver
26. Slagel M, Griggs G (2006) Cumulative loss of sand to the California coast by dam impoundment. Report to Calif. Dept. of Boating and Waterways, by Inst. of Marine Sciences, Univ. of Calif, Santa Cruz
27. Araújo D, Carlos J, Güntner A, Bronstert A (2006) Loss of reservoir volume by sediment deposition and its impact on water availability in semiarid Brazil. *Hydrol Sci J* 51(1):157–170
28. Ferrari R, Collins K (2006) Reservoir survey and data analysis. Ch 6. In: Yang CT (ed) *Erosion and sedimentation manual*. U.S. Bureau of Reclamation, Denver
29. Morris GL, Fan J (1998) *Reservoir sedimentation handbook: design and management of dams, reservoirs and watersheds for sustainable use*. McGraw-Hill Book Co, New York. <http://www.reservoirsedimentation.com>. Accessed 8 Sept 2011
30. Zarris D, Lykoudi E (2003) Comparative analysis of different reservoir surveying methodologies for the optimum volumetric computation of fluvial sediment deposits. In: 7th Hellenic symposium on oceanography and fisheries, 6–9 May, Hersonissos, Crete
31. Trimble SW, Crosson P (2000) U.S. Soil erosion rates: myth and reality. *Science* 289(5477):248–250
32. Walling DE (1983) The sediment delivery problem. *J Hydrol* 65:209–237
33. De Vente J, Poesen J, Arabkhedri M, Verstraeten G (2007) The sediment delivery problem revisited. *Progr Phys Geogr* 31(2):155–178
34. Safamanesh R, Sulaiman WNA, Firuz Ramli M (2006) Erosion risk assessment using an empirical model of Pacific South West inter-agency committee method for Zargeh Watershed, Iran. *J Spatial Hydrol* 6(2):105–120
35. De Vente J, Poesen J, Van Rompaey A, Gorers G (2008) Spatially distributed modeling of soil erosion and sediment yield at regional scales in Spain. *Global Planet Change* 60:393–415
36. Haregeweyn N, Poesen J, Jean N, Jan V, Gerty DV, Joris G, Gerard D, Seppe M (2005) Specific sediment yield in Tigray-Northern Ethiopia: assessment and semi-quantitative modeling. *Geomorphology* 69:315–331
37. Tangestani MH (2006) Comparison of EPM and PSIAC models in GIS for erosion and sediment yield assessment in a semi-arid environment: Afzar catchment, Fars Province, Iran. *J Asian Earth Sci* 17:585–597
38. De Vente J, Poesen J (2005) Predicting soil erosion and sediment yield at the basin scale: scale issues and semi-quantitative models. *Earth Sci Rev* 71:95–125
39. Burns M, MacArthur R (1996) Sediment deposition in Jennings Randolph Reservoir, Maryland and West Virginia. In: Proceedings of 6th federal inter-agency sedimentation conference, Las Vegas, pp 10.16–10.21
40. Walling DE (2009) The impact of global change on erosion and sediment transport by rivers: current progress and future challenges. UNESCO. <http://unesdoc.unesco.org/images/0018/001850/185078e.pdf>. Accessed 8 Sept 2011
41. Soil and Water Conservation Society (2003) Conservation implications of climate change: soil erosion and runoff from cropland. Ankeny, Iowa. <http://www.swcs.org>

42. Nearing MA, Jetten V, Baffaut C, Cerdan O, Couturier A, Hernandez M, Le Bissonnais Y, Nichols MH, Nunes JP, Renschler CS, Souchère V, van Oost K (2005) Modeling response of soil erosion and runoff to changes in precipitation and cover. *Catena* 61:131–154
43. O’Neal MR, Nearing MA, Vining RC, Southworth J, Pfeifer RA (2005) Climate change impacts on soil erosion in Midwest United States with changes in crop management. *Catena* 61:165–184
44. Brune GM (1953) Trap efficiency of reservoirs. *Trans Am Geophys Union* 34(3):407–418
45. Gill MA (1979) Sedimentation and useful life of reservoirs. *J Hydrol* 44:89–95
46. Heinemann HG (1981) A new sediment trap efficiency curve for small reservoirs. *Water Resour Bull* 17:825–830
47. Lara JM, Pemberton EL (1963) Initial unit weight of deposited sediments. In: Proceedings of federal interagency sedimentation conference, USDA-ARS Misc. Publ. 970. Washington DC, pp 818–845
48. Lane EW, Koelzer VA (1953) Density of sediments deposited in reservoirs. Report no. 9. In: A study of methods used in measurement and analysis of sediment loads in streams. Hydraulic Lab., University of Iowa
49. Geiger AF (1963) Developing sediment storage requirements for upstream retarding reservoirs. In: Proceedings of federal interagency sedimentation conference, USDA-ARS Misc. Pub. 970. pp 881–885
50. Gray JR, Bernard JM, Stewart DW, McFaul EJ, Laurent KW, Schwartz GE, Stinson JT, Jonas MM, Randle TJ, Webb JW (2010) Development of a national, dynamic reservoir-sedimentation database. In: Proceedings of 2nd joint federal interagency conference, June 27–July 1, Las Vegas, Nevada
51. Minear JT, Kondolf GM (2009) Estimating reservoir sedimentation rates at large spatial and temporal scales: a case study of California. *Water Resour Res* 45, W12502. doi:[10.1029/2007WR006703](https://doi.org/10.1029/2007WR006703)
52. Boillat J-L, Oehy CD, Schleiss AJ (2003) Reservoir management in Switzerland. In: Proceedings of 3rd world water forum, Osaka, Japan
53. Sumi T (2003) Reservoir sedimentation management in Japan. In: Proceedings of 3rd world water forum, Osaka, Japan
54. Wrem DG, Davidson GR, Walker WG, Galicki SJ (2008) The evolution of an oxbow lake in the Mississippi alluvial floodplain. *J Soil Water Conserv* 63(3):129–135. doi:[10.2489/jswc.63.3.129](https://doi.org/10.2489/jswc.63.3.129)
55. López T d M, Aide TM, Scatena FN (1998) The effect of land use on soil erosion in the Guadiana watershed in Puerto Rico. *Caribbean J Sci* 34(3–4):298–307
56. Trimble SW (1974) Man-induced soil erosion on the Southern Piedmont, 1700–1970. Soil Conservation Society of America. Ankeny, Iowa
57. Brooks ES, Boll J, Snyder AJ, Ostrowski KM, Kane SL, Wulfhorst JD, Van Tassell LW, Mahler R (2010) Long-term sediment loading trends in Paradise Creek watershed. *J Soil Water Conserv* 65 (6):332–342. doi:[10.2489/jswc.65.6.331](https://doi.org/10.2489/jswc.65.6.331)
58. European Environment Agency (2010) Erosion rate in the Alps. <http://www.eea.europa.eu/data-and-maps/figures/erosion-rate-in-the-alps>. Accessed 8 Dec 2011
59. Grace JM, Clinton BD (2007) Protecting soil and water in forest road management. *Trans Am Soc Agricult Biol Eng* 50(5):1579–1584, <http://digitalcommons.unl.edu/usdafsfacpub/58>
60. Warrick JA, Rubin DM (2007) Suspended-sediment rating curve response to urbanization and wildfire, Santa Ana River, California. *J Geophys Res* 112 (FO2018). doi:[10.1029/2006JF000662](https://doi.org/10.1029/2006JF000662)
61. Rosgen D, Silvey L (1996) Applied river morphology. <http://www.wildandhydrology.com>

62. USDA, Natural Resources Conservation Service (2007) Stream restoration design handbook. <http://directives.sc.egov.usda.gov/viewerFS.aspx?id=3491>
63. Renwick WH, Smith SV, Bartley JD, Buddemeier RW (2005) The role of impoundments in the sediment budget of the conterminous United States. *Geomorphology* 71:99–111
64. Meade RH, Parker RS (1984) Sediment in the rivers of the US. In: National water summary. USGS, Reston, VA
65. Larsen MC, Simon A (1993) Rainfall intensity-duration threshold for landslides in a humid-tropical environment, Puerto Rico. *Geogr Ann A* 75(1–2):13–21
66. Kirchner JW, Finkel RC, Riebe CS, Granger DE, Clayton JL, King JG, Meghan WF (2001) Mountain erosion over 10 yr, 10 k.y., and 10 m.y. time scales. *Geology* 29(7):591–594
67. Williams GP (1989) Sediment concentration versus water discharge during single hydrologic events in rivers. *J Hydrol* 111:89–106
68. Horowitz AJ (2003) An evaluation of sediment rating curves for estimating suspended sediment concentrations for subsequent flux calculations. *Hydrol Process* 17:3387–3409
69. Ferguson RI (1986) River loads underestimated by rating curves. *Water Resour Res* 22(1):74–76
70. Asselman NEM (2000) Fitting and interpretation of sediment rating curves. *J Hydrol* 234 (2000):224–248
71. Glysson GD (1987) “Sediment transport curves,” USGS open-file report 87-218, Reston, VA
72. Wu CM (1991) Reservoir capacity preserving practice in Taiwan. In: Proceedings of 5th federal interagency sedimentation conference, Las Vegas, pp 10.75–10.81
73. Morris GL (2010) Offstream reservoirs for sustainable water supply in Puerto Rico. In: Am. Water Resource Assn., Summer Specialty Conf. Aug 30–Sept 1, San Juan
74. Annandale GW (1987) Reservoir sedimentation. Elsevier Science Publishers, New York
75. Sumi T, Okano M, Takata Y (2004) Reservoir sedimentation management with bypass tunnels in Japan. In: Proceedings of 9th Intl. Symp. on River Sedimentation, Oct 18–21, Yichang, China
76. Auel C, Berchtold T, Boes R (2010) Sediment management in the Solis reservoir using a bypass tunnel. In: 8th ICOLD European club symposium, 22–23 Sept, Innsbruck
77. Sundborg A, Jansson MB (1992) Present and future conditions of reservoir sedimentation. In: Jansson MB, Rodríguez A (eds) Sedimentological studies on the Cachí Reservoir, Costa Rica. UNGI Report No. 81. Department of Physical Geography, Uppsala University, Sweden
78. International Research & Training Center on Erosion & Sedimentation (2005) Case study on the yellow river sedimentation. UNESCO-IHP International Sedimentation Initiative, Beijing
79. Fan J (1985) Methods of preserving reservoir capacity. In: Bruk S (ed) Methods of computing sedimentation in lakes and reservoirs. UNESCO, Paris, pp 65–164. <http://unesdoc.unesco.org/images/0011/001121/112133eo.pdf>. Accessed 8 Sept 2011
80. Meshkati Shahmirzadi ME, Dehghani AA, Sumi T, Naser Gh, Ahadpour A (2010) Experimental investigation of half-cone scouring against dam. In: Dittrich A, Koll K, Aberle J, Geisenhainer P (eds) River flow 2010. Bundesanstalt für Wasserbau ISBN 978-3-939230-00-7
81. Brown CB (1943) The control of reservoir silting. USDA Misc. Pub. 521. U.S. Govt. Printing Office, Washington, DC
82. Xia M (1989) Lateral erosion, a storage recovery technique for silted-up reservoirs. In: Proceedings of 4th Intl. Symp. river sedimentation, Beijing, pp 1143–1149
83. Sumi T, Kantoush SA (2010) Integrated management of reservoir sediment routing by flushing, replenishing, and bypassing sediments in Japanese river basins. In: International Symposium on Ecohydrology, Kyoto. pp 831–838

84. Crosa G, Castelli E, Gentili G, Espa P (2010) Effects of suspended sediments from reservoir flushing on fish and macroinvertebrates in an alpine stream. *Aquat Sci* 72:85–95. doi:[10.1007/s00027-009-0117-z](https://doi.org/10.1007/s00027-009-0117-z)
85. Atkinson E (1996) The feasibility of flushing sediment from reservoirs. Report OD-137. HR Wallingford, Wallingford
86. Hotchkiss RH, Huang X (1995) Hydrosuction sediment-removal systems (HSRS): principles and field test. *ASCE J Hyd Eng* 121(6):479–489
87. Eftekharzadeh S (1987) Sediment bypass system for impounding reservoirs. PhD dissertation, University of Arizona
88. U.S. Army Corps of Engineers (1987) Confined disposal of dredged material. EM 1110-2-5027, Washington, DC
89. Kantoush S, Sumi T (2010) River morphology and sediment management strategies for sustainable reservoir in Japan and European Alps. *Ann Disas Prev Res Inst Kyoto Univ* 53(B):821–839
90. Hartmann S (2009) Sediment management in alpine reservoirs—recommendations and best practice guide. Institut für Wasserwesen, Univ. der Bundeswehr München. <http://www.alpreserv.eu>
91. Yang CT (1996) Sediment transport: theory and practice. McGraw-Hill Book Co, New York (reprint by Krieger Publishing Co., 2003)
92. Simões FJM, Yang CT (2006) Sediment modeling for rivers and reservoirs. Ch 5. In: Yang CT (ed) *Erosion and sedimentation manual*. US Bureau of Reclamation, Denver

# Sediment Transport, River Morphology, and River Engineering

---

Chih Ted Yang

## CONTENTS

INTRODUCTION
SEDIMENT TRANSPORT
MINIMUM ENERGY DISSIPATION RATE THEORY
GENERALIZED SEDIMENT TRANSPORT MODEL FOR ALLUVIAL RIVER SIMULATION (GSTARS)
RIVER MORPHOLOGY AND HYDRAULIC ENGINEERING
HYDRAULIC ENGINEERING CASE STUDIES USING GSTARS
SUMMARY AND CONCLUSIONS
REFERENCES

---

**Abstract** Unit stream power is the most important and dominant parameter for the determination of transport rate of sand, gravel, and hyper-concentrated sediment with wash load. The unit stream power theory can also be applied to the study of surface erosion. The unit stream power theory can be derived from the basic theories in turbulence and fluid mechanics. Minimum energy dissipation rate theory, or its simplified minimum unit stream power and minimum stream power theories, can be derived from the basic thermodynamic law based on the analogy between a thermo system and a river system. It can also be derived directly from mathematical argument for a dissipative system under dynamic equilibrium condition. The minimum energy dissipation rate theory and its simplified theories of minimum unit stream power and minimum stream power can provide engineers the needed theoretical basis for river morphology and hydraulic engineering studies. The Generalized Sediment Transport model for Alluvial River Simulation computer model series have been developed based on the above theories. The computer model series have been successfully applied in many countries for solving hydraulic engineering and reservoir sedimentation problems. Examples will be

used to illustrate the applications of the computer models to solving a wide range of river morphology, river engineering, and reservoir sedimentation problems.

**Key Words** Computer model • Hydraulic engineering • Minimum energy dissipation rate • River engineering • River morphology • Sediment transport • Unit stream power.

## 1. INTRODUCTION

Thorough understandings of basic theories of sediment transport and surface erosion are important to river erosion and sedimentation, river morphology, reservoir sedimentation and operation, and river engineering studies. In spite of centuries of effort by river engineers, most of the tools used by river engineers still rely heavily on engineering experiences and judgments. Equations used by engineers are often based on simplified assumptions with limited tests and verifications of the validity of their application to field conditions. Different and often conflicting assumptions are used in the derivation of equations. These conflicting assumptions often become the source of inconsistency among the results using different equations and theories.

This chapter will summarize the theory of unit stream power and formulas for sediment transport and surface erosion derived from that theory. From theoretical point of view, river hydraulics is indeterminate because there are more unknowns than independent equations available for solving them. River engineers often use site-specific empirical relations to obtain some ad hoc solutions. The theory of minimum energy dissipation rate and its simplified minimum stream power and minimum unit stream power theories can provide river engineers the needed theoretical basis changing river hydraulics from indeterminate to determinate.

The Generalized Sediment Transport model for Alluvial River Simulation (GSTARS) computer model series have been used by engineers and geologists around the world for solving river engineering and reservoir sedimentation problems based on unit stream power and minimum stream power theories. The use of stream tube concept allows the GSTARS models solving river engineering and reservoir sedimentation problems with a semi-two-dimensional hydraulic computation and a semi-three-dimensional solution for river and reservoir studies along each stream tube. Examples of application of GSTARS will be used to illustrate the applicability of the computer model for solving a wide range of river engineering and reservoir sedimentation problems.

## 2. SEDIMENT TRANSPORT

### 2.1. *Basic Approaches*

Sediment transport is a subject of interest to river engineers for centuries. More than 100 sediment transport formulas have been published in the literature. Most of the formulas assumed that sediment transport rate or concentration can be determined by a dominant parameter, such as water discharge, average flow velocity, water surface or energy slope, shear stress, stream power, or unit stream power. Yang [1–6] made detailed evaluation of the validity of these assumptions.

The basic assumption in a deterministic approach is the existence of one-to-one relationship between independent and dependent variables. Conventional dominant independent variables used in sediment transport studies are water discharge, average flow velocity, shear stress, and energy or water surface slope. More recently, the use of stream power and unit stream power has gained increasing acceptance as important parameters for the determination of sediment transport rate or concentration. Other independent parameters used in sediment transport functions are sediment particle diameter or sediment fall velocity, water temperature, or kinematic viscosity. The accuracy of a deterministic sediment transport formula depends on the generality and validity of the assumption of whether a unique relationship between dependent and independent variables exists. Deterministic sediment transport formulas can be expressed by one of the following forms:

$$q_s = A_1(Q - Q_c)^{B_1} \quad (6.1)$$

$$q_s = A_2(V - V_c)^{B_2} \quad (6.2)$$

$$q_s = A_3(S - S_c)^{B_3} \quad (6.3)$$

$$q_s = A_4(\tau - \tau_c)^{B_4} \quad (6.4)$$

$$q_s = A_5(\tau V - \tau_c V_c)^{B_5} \quad (6.5)$$

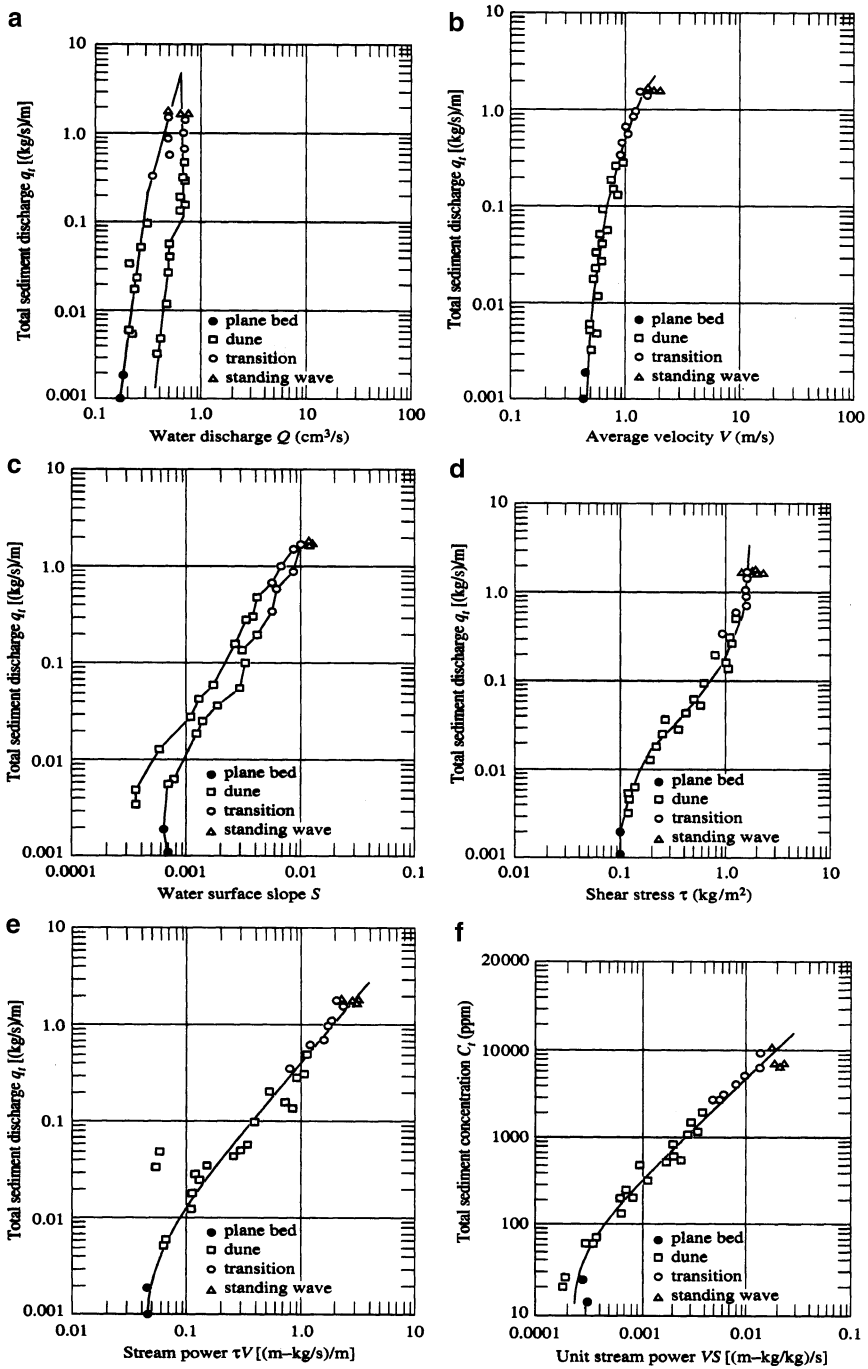
$$q_s = A_6(VS - V_c S_c)^{B_6} \quad (6.6)$$

where  $q_s$  = sediment discharge per unit width of channel,  $Q$  = water discharge,  $V$  = average flow velocity,  $S$  = energy or water surface slope,  $\tau$  = shear stress,  $\tau V$  = stream power per unit bed area,  $VS$  = unit stream power or rate of potential energy expenditure per unit weight of water,  $A_1, A_2, A_3, A_4, A_5, A_6, B_1, B_2, B_3, B_4, B_5, B_6$  = parameters related to flow and sediment conditions, and  $c$  = subscript denoting the critical condition at incipient motion.

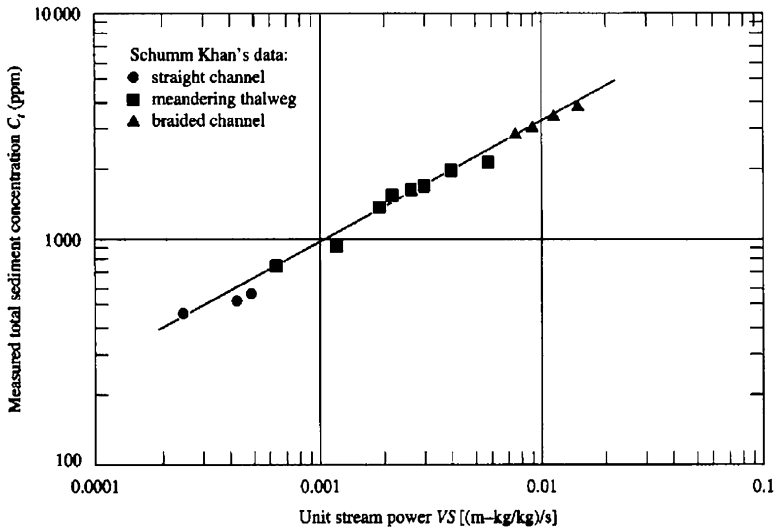
Yang [1, 2] used laboratory data collected by Guy et al. [7] from a laboratory flume with 0.93 mm sand, as shown in Fig. 6.1, as an example to examine the validity of these assumptions.

Figure 6.1 shows comparison among six parameters to determine which one has the best one-to-one correlation between sediment discharge and the suggested dominant parameters. Figure 6.1a shows that dual relationship exists between sediment discharge and water discharge. Figure 6.1b shows that a good part of the curve between sediment discharge and velocity can be approximated by a vertical line. This means that there is no strong correlation between sediment discharge and average flow velocity for a good portion of the data compared. Figure 6.1c shows that a sediment discharge can be obtained at two different water surface or energy slopes. Figure 6.1d shows that the relationship between sediment discharge and shear stress can be approximated by two vertical lines with a transition between





**Fig. 6.1.** Relationships between total sediment discharge and (a) water discharge, (b) velocity, (c) slope, (d) shear stress, (e) stream power, and (f) unit stream power, for 0.93 mm sand in an 8 ft wide flume [2, 5, 6].



**Fig. 6.2.** Relationship between total concentration and unit stream power during the process of channel pattern development from straight to meandering and to braided [5, 6].

the two vertical lines. Figure 6.1e shows that the relationship between sediment discharge and stream power is better than other parameters just mentioned except two points. Figure 6.1f shows that the correlation between sediment discharge and unit stream power is the strongest one among all dominant parameters compared. Figure 6.2 shows that the strong correlation between sediment concentration and unit stream power exists in spite of channel pattern change from a straight to meandering and to a braided channel.

Some engineers believe that sediment transport rate or concentration can be determined by the combined use of relative depth, Froude number, and bed form. Figure 6.3 shows an example of the attempt to develop this type of equation [8, 9]. Figure 6.3 shows a family of curves without any well-defined pattern among relative depth, Froude number, and bed form. When the same data are used in Fig. 6.4, there is a near-perfect correlation between dimensionless unit stream power and sediment concentration regardless of the existence of different flow regimes and bed forms. The superiority of using dimensionless unit stream power over other parameters for the determination of sediment concentration is apparent.

## 2.2. Unit Stream Power Formulas for Rivers and Reservoirs

Sediment transport mainly occurs in turbulent flows. Yang and Molins [11] made detailed step-by-step derivations of the relationship between sediment concentration and unit stream power from the basic theories in turbulent flows. They have shown that bed load, suspended load, and total bed-material load of sediment can all be determined by unit stream power from theoretical point of view. Their theoretical results have been confirmed by laboratory data.

A summary of the theoretical derivation of the unit stream power formula is given below. The rate of energy per unit weight of water available for transporting water and sediment in an open channel with reach length  $x$  and total drop of  $Y$  is

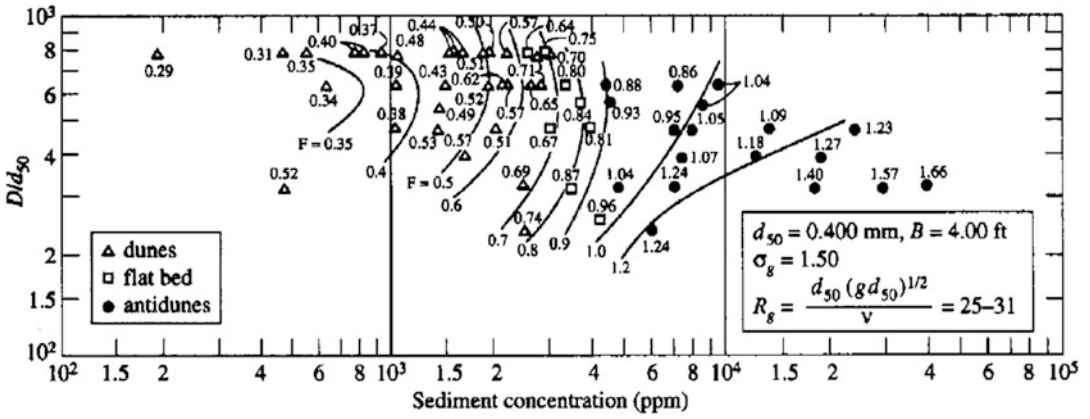


Fig. 6.3. Plot of Stein's [8] data as sediment discharge concentration against Froude number  $F_r$  (indicated by the number next to each data point) and the ratio of flow depth  $D$  to bed-sediment size  $d_{50}$  [9].

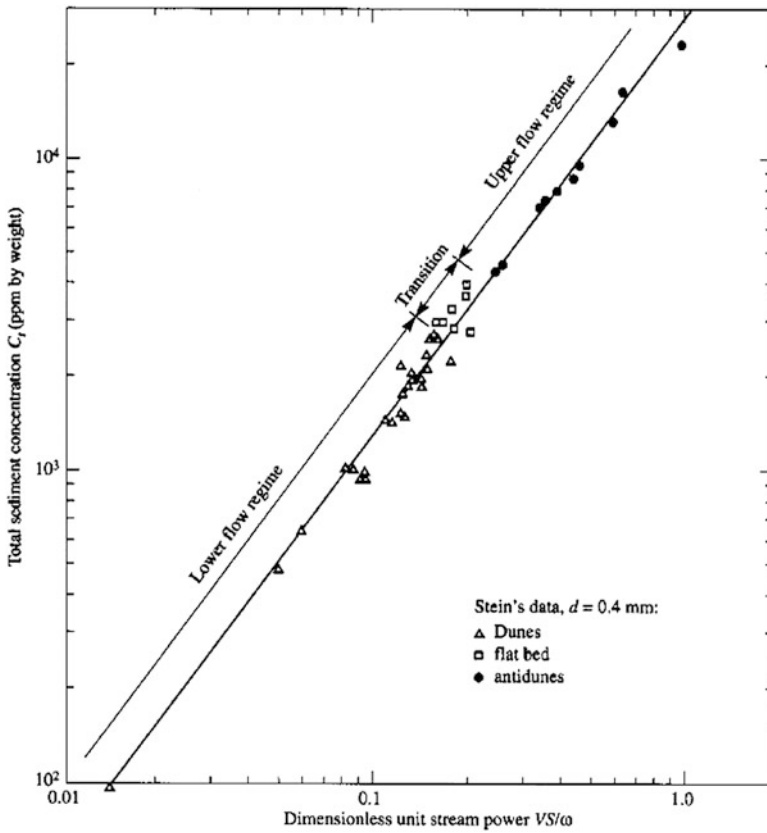


Fig. 6.4. Relationship between sediment concentration and dimensionless unit stream power [10].

$$\frac{dY}{dt} = \frac{dx}{dt} \frac{dY}{dx} = VS \tag{6.7}$$

where  $V$  = average flow velocity and  $S$  = energy or water surface slope.

Yang [1] defined unit stream power as the velocity-slope product shown in (6.7). The rate of work being done by a unit weight of water in transporting sediment must be directly related to the rate of work available to a unit weight of water. Thus, total sediment concentration or total bed-material load must be directly related to unit stream power. While Bagnold [12] emphasized the power applies to a unit bed area, Yang [1, 2] emphasized the power available per unit weight of water to transport sediments.

To determine total sediment concentration, Yang [2] considered a relation among relevant variables of the form:

$$\Phi(C_t, VS, U_*, \nu, \omega, d) = 0 \tag{6.8}$$

where  $C_t$  = total sediment concentration, with wash load excluded (in ppm by weight),  $VS$  = unit stream power,  $U_*$  = shear velocity,  $\nu$  = kinematic viscosity,  $\omega$  = fall velocity of sediment, and  $d$  = median particle diameter.

Using Buckingham’s  $\pi$  theorem and the analysis of laboratory data,  $C_t$  in (6.8) can be expressed in the following dimensionless form:

$$\log C_t = I + J \log \left( \frac{VS}{\omega} - \frac{V_{cr}S}{\omega} \right) \tag{6.9}$$

where  $V_{cr}S/\omega$  = critical dimensionless unit stream power at incipient motion.

$I$  and  $J$  in (6.9) are dimensionless parameters reflecting the flow and sediment characteristics, that is,

$$I = a_1 + a_2 \log \frac{\omega d}{\nu} + a_3 \log \frac{U_*}{\omega} \tag{6.10}$$

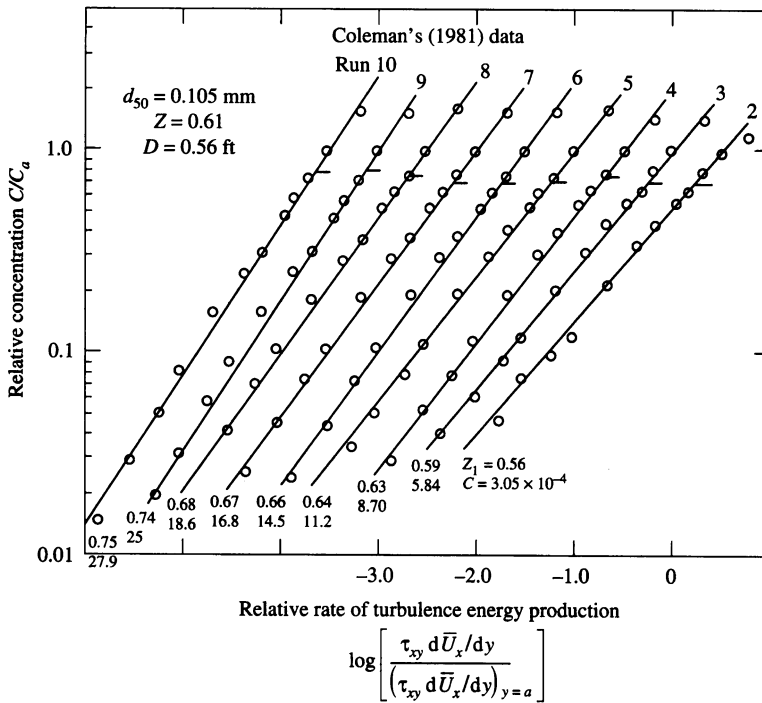
$$J = b_1 + b_2 \log \frac{\omega d}{\nu} + b_3 \log \frac{U_*}{\omega} \tag{6.11}$$

where  $a_1, a_2, a_3, b_1, b_2, b_3$  = coefficients.

Yang [2] used 463 sets of laboratory data for the determination of coefficients in (6.10) and (6.11).

Yang and Molinas [11] made step-by-step derivations to show that sediment concentration is directly related to unit stream power, based on basic theories in fluid mechanics and turbulence. They also showed that the vertical sediment concentration distribution is directly related to the vertical distribution of turbulence energy production rate, that is,

$$\frac{\bar{C}}{\bar{C}_a} = \left[ \frac{\tau_{xy} d\bar{U}_x/dy}{(\tau_{xy} d\bar{U}_x/dy)_{y=a}} \right]^{Z_1} \tag{6.12}$$



**Fig. 6.5.** Comparison between theoretical and measured suspended sediment concentration distribution [13].

where  $\bar{C}$ ,  $\bar{C}_a$  = time-averaged sediment concentration at a given cross section and at a depth  $a$  above the bed, respectively,  $\tau_{xy}$  = turbulence shear stress,  $dU_x/dy$  = velocity gradient,  $\tau_{xy} dU_x/dy$  = turbulence energy production rate,  $Z_1 = \omega/k\beta U_*$ ,  $\omega$  = sediment particle fall velocity,  $\beta$  = coefficient,  $k$  = von Karman constant, and  $U_*$  = shear velocity.

It can be shown that the basic equation shown in (6.9) can be obtained by the integration of sediment concentration shown in (6.12) (Fig. 6.5).

Yang published the following unit stream power formulas for sediment transport.

Yang's 1973 [2] sand transport formula with incipient motion criteria is

$$\log C_s = 5.435 - 0.286 \log \frac{\omega d}{\nu} - 0.457 \log \frac{U_*}{\omega} + \left( 1.799 - 0.409 \log \frac{\omega d}{\nu} - 0.314 \log \frac{U_*}{\omega} \right) \log \left( \frac{VS}{\omega} - \frac{V_{cr} S}{\omega} \right) \tag{6.13}$$

The incipient motion criteria are

$$\frac{V_{cr}}{\omega} = \frac{2.5}{\log(U_* d/\nu) - 0.06} + 0.66 \text{ for } 1.2 \leq \frac{U_* d}{\nu} < 70 \tag{6.14}$$

$$\frac{V_{cr}}{\omega} = 2.05 \text{ for } 70 \leq \frac{U_*}{v} \quad (6.15)$$

Yang's 1979 [3] sand transport formula without the incipient motion criteria for concentration greater than 100 ppm by weight is

$$\begin{aligned} \log C_s = & 5.165 - 0.153 \log \frac{\omega d}{v} - 0.297 \log \frac{U_*}{\omega} \\ & + \left( 1.780 - 0.360 \log \frac{\omega d}{v} - 0.480 \log \frac{U_*}{\omega} \right) \log \frac{VS}{\omega} \end{aligned} \quad (6.16)$$

Yang's 1984 gravel transport formula is

$$\begin{aligned} \log C_g = & 6.681 - 0.633 \log \frac{\omega d}{v} - 4.816 \log \frac{U_*}{\omega} \\ & + \left( 2.784 - 0.305 \log \frac{\omega d}{v} - 0.282 \log \frac{U_*}{\omega} \right) \log \left( \frac{VS}{\omega} - \frac{V_{cr} S}{\omega} \right) \end{aligned} \quad (6.17)$$

where  $C_s$ ,  $C_g$  = sediment concentration in ppm by weight for sand and gravel, respectively,  $V$  = average flow velocity,  $S$  = water surface or energy slope,  $VS$  = unit stream power,  $\omega$  = sediment particle fall velocity,  $d$  = sediment particle diameter,  $U_*$  = shear velocity, and  $v$  = kinematic viscosity of water.

It should be noted that every term in the above equations is dimensionless and can be applied to laboratory flumes and natural rivers without any scale problem.

Yang and Wan [14] made detailed and systematic evaluation of the accuracy of Yang's 1973 formula using reliable laboratory and field data independently collected by other researchers. These studies indicate that the accuracy of Yang's 1973 formula is not sensitive to the variation of Froude number and sediment concentration, while other formulas cannot be applied to super critical flows with accuracy.

A recent study on sediment transport using ANN technique [15] showed that Yang's 1973 unit stream power formula for sediment transport [2] is more accurate than other commonly used formulas based on 24 sets of river data collected in the United States. The US Department of Agriculture National Sedimentation Laboratory [16] made detailed comparisons of the accuracy of commonly used sediment transport formulas with laboratory and field data. Alonso [16] concluded that Yang's 1973 sand transport formula is the most accurate one. The ASCE Sedimentation Committee [17] also concluded that Yang's 1973 formula can provide the "best overall predictions" for sediment transport in laboratory flumes and natural rivers. The ASCE conclusions are shown in Table 6.1. Mengis of the US Geological Survey [18] and the German Association for Water Resources and Land Improvement [19] made independent comparisons of the accuracy of sediment transport formulas and reached similar conclusions.

**Table 6.1**  
**Summary of rating of selected sediment transport formulas (17)**

Formula number (1)	Reference (2)	Type (3)	Comments (4)
1	Ackers and White (1973)	Total load	Rank <sup>a</sup> = 3
2	Engelund and Hansen (1967)	Total load	Rank = 4
3	Laursen (1958)	Total load	Rank = 2
4	MPME	Total load	Rank = 6
5	Yang (1973)	Total load	Rank = 1, best overall predictions
6	Bagnold (1966)	Bed load	Rank = 5
7	Meyer-Peter and Müller (1948)	Bed load	Rank = 7
8	Yalin (1963)	Bed load	Rank = 8

<sup>a</sup>Based on mean discrepancy ratio (calculated over observed transport rate) from 40 tests using field data and 165 tests using flume data.

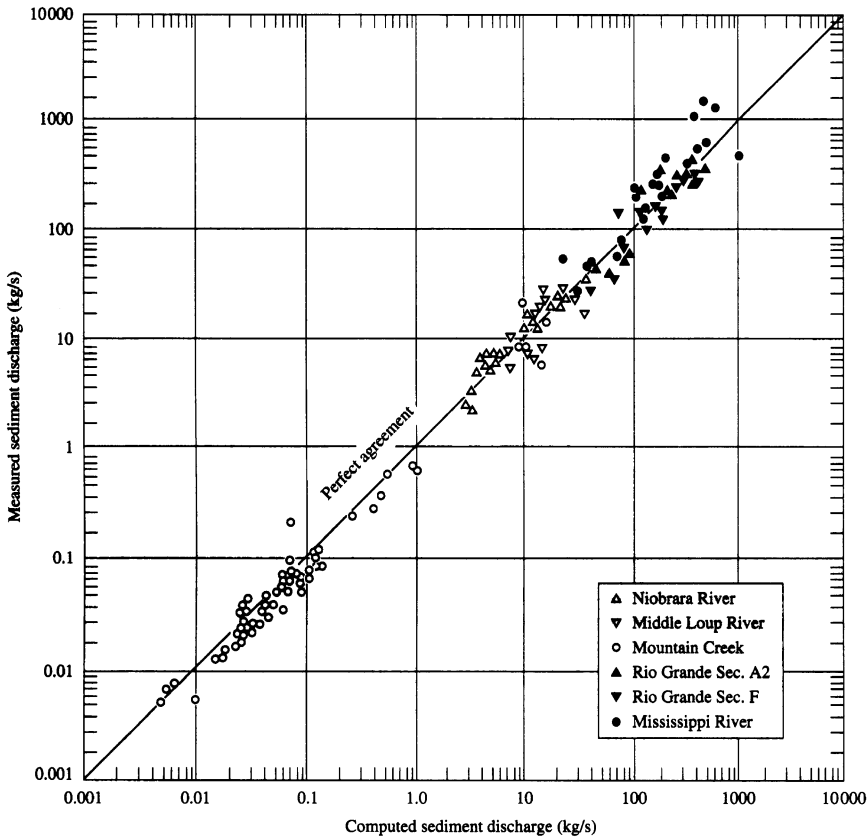
Direct comparisons between measured and computed results from different sediment transport equations indicate that, on the average, Yang's 1973 dimensionless unit stream power equation [2] is more accurate than others for sediment transport in the sand-size range. Figure 6.6 shows a summary comparison between measured and computed bed-material discharges from rivers.

Most sediment transport formulas do not consider the impact of wash load in rivers. Yang et al. [22] developed the following unit stream power formula for the Yellow River with hyper-concentrated sediment, including wash load:

$$\log C_{sl} = 5.165 - 0.153 \log \frac{\omega_m d}{\nu_m} - 0.297 \log \frac{U_*}{\omega_m} + \left( 1.780 - 0.360 \log \frac{\omega_m d}{\nu_m} - 0.480 \log \frac{U_*}{\omega_m} \right) \log \left( \frac{\gamma_m}{\gamma_s - \gamma_m} \frac{VS}{\omega_m} \right) \quad (6.18)$$

where  $C_{sl}$  = sediment concentration in ppm by weight of sediment laden flow with wish-load,  $\omega_m$  = sediment particle fall velocity in water and sediment mixture with wish-load,  $\nu_m$  = kinematic viscosity of water and sediment mixture with wish-load, and  $\gamma_m, \gamma_s$  = specific weight of water and sediment mixture with wash load and specific weight of sediment, respectively.

It should be noted that all the coefficients in (6.16) and (6.18) are identical to each other. However, Yang et al. [22] changed the physical meaning of each parameter from sediment transport in clear water in (6.16) to that in hyper-concentrated flows with high concentration of wash load in (6.18). The consistent pattern of all the dimensionless unit stream power formulas is an indication of the robustness of the unit stream power theory and its applicability to a wide range of flow and sediment conditions.



**Fig. 6.6.** Comparison between measured total bed-material discharge from six river stations and computed results from Yang’s (1973) equation [20, 21].

### 2.3. Unit Stream Power Formula for Surface Erosion

Shih and Yang [23] proposed the following unit stream power formulas for surface erosion.

According to the unit stream power theory, unit stream power  $U = VS$  is the most significant and dominant variable for erosion and sediment transport. The relationship between sediment concentration due to surface erosion and unit stream power can be expressed as

$$C_{mgl} = 1,922,000 \cdot \left(1 - e^{-MU^N}\right) \tag{6.19}$$

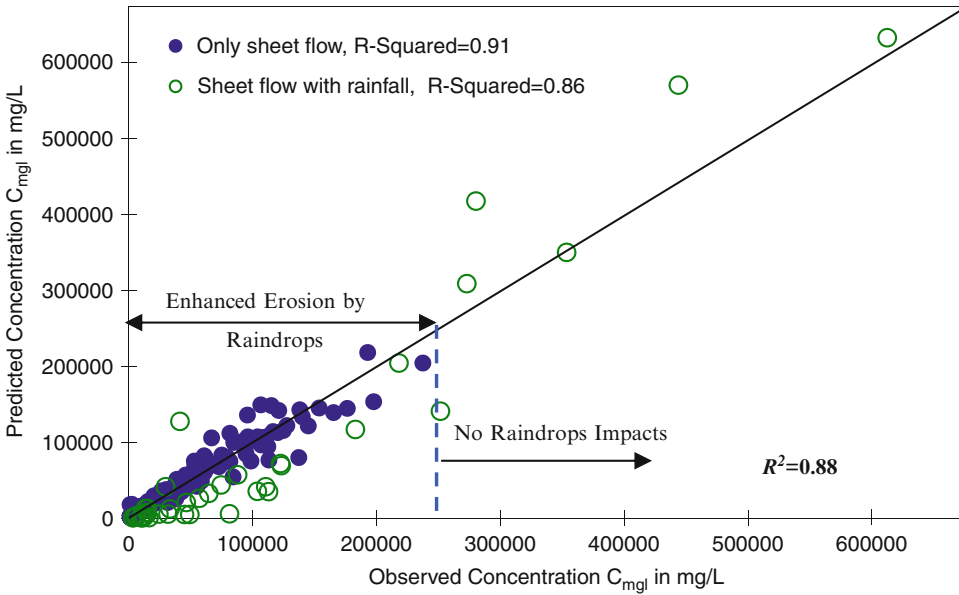
where  $M$  and  $N =$  functions of physical parameters. Gilbert [24] showed that  $M$  always increases linearly with increasing value of  $N$ . Hence,  $M$  and  $N$  can be expressed as

$$M = m_1 \cdot S + m_2 \cdot V + m_3 \cdot Fr + m_4 \tag{6.20}$$

$$N = n_1 \cdot S + n_2 \cdot V + n_3 \cdot Fr + n_4 \tag{6.21}$$

where  $m_i$  and  $n_i =$  coefficients and  $Fr =$  Froude number.





**Fig. 6.7.** Agreements between computed surface erosion concentration by (6.19) and observation [23].

Nonlinear regression analysis was used to determine coefficients  $M$  and  $N$  of the proposed soil erosion formulas. The regression equations obtained by using surface flow data excluding those with rainfall data are

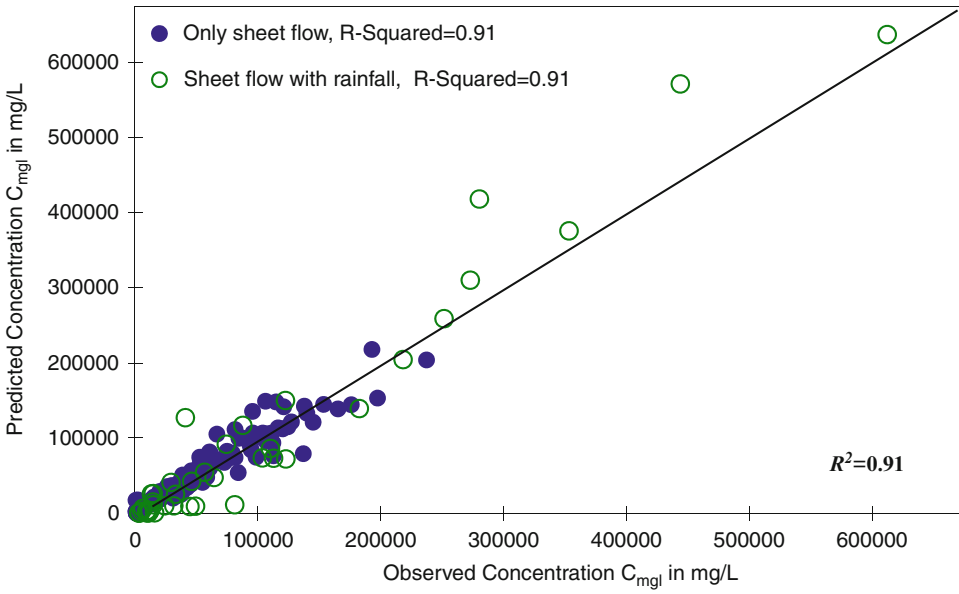
$$M = -0.654 \cdot S - 3.848 \cdot V + 0.227 \cdot Fr + 2.657 \tag{6.22}$$

$$N = -1.692 \cdot S - 1.170 \cdot V + 0.071 \cdot Fr + 1.532 \tag{6.23}$$

with a  $R^2 = 0.91$  for sediment data excluding those with rainfall data and a  $R^2 = 0.88$  for all 158 data sets used in this study. Flow velocity  $V$  is in m/s. The comparison between computed values and observed data is shown in Fig. 6.7.

Rainfall events can complicate the relationship between surface erosion rate and unit stream power. In Fig. 6.7, the comparison shows under estimations when the observed concentration of simulation rainfall events is less than about 260,000 mg/l. It is resulted from the raindrop erosion enhancement. This shows a need to modify (6.19) to consider the impact due to raindrops. Guy and Dickinson [25] and Julien and Simons [26] suggested to add a rainfall enhancement term in the overland flow erosion equation. An erosion enhancement term  $l$  is used in this study to represent the rainfall impact on overland flow erosion. The regression equation is expressed as

$$C_{mgl} = 1,922,000 \cdot \left(1 - e^{-(MU^N)l}\right) \tag{6.24}$$



**Fig. 6.8.** Agreements between computed concentration by (6.24) and observation [23].

where

$$M = -0.654 \cdot S - 3.848 \cdot V + 0.227 \cdot Fr + 2.657 \tag{6.25}$$

$$N = -1.692 \cdot S - 1.170 \cdot V + 0.071 \cdot Fr + 1.532 \tag{6.26}$$

$$l = \left[ 1 + 1.141 \cdot \left( 1 - e^{-0.005 \left( 10^4 \cdot \frac{1}{v} \right)^{23.012}} \right) \right] \tag{6.27}$$

with a  $R^2 = 0.91$  for all data with and without the rainfall events. Rainfall intensity  $i$  is in m/s.

Figures 6.7 and 6.8 show good agreements between computed and observed sediment concentrations. Comparison between Figs. 6.7 and 6.8 shows that the rainfall erosion enhancement term  $l$  can represent the rainfall impact of overland flow erosion very well.

### 3. MINIMUM ENERGY DISSIPATION RATE THEORY

The minimum energy dissipation rate theory can be derived from the use of entropy concept in thermodynamics or from mathematical argument. The entropy in a thermal system is defined as

$$\varphi = \int \frac{dE}{T} \tag{6.28}$$

where  $E$  = thermal energy per unit mass and  $T$  = absolute temperature used to measure the variation of  $E$ . For a river system, the only available energy is potential energy per unit mass of water  $H$ , and elevation  $Z$  is used to measure the variation of potential energy.

The entropy for a river system can then be defined as

$$\psi = \int \frac{dH}{Z} \quad (6.29)$$

where  $H$  = potential energy per unit mass of water in a river system and  $Z$  = elevation. Both  $T$  and  $Z$  are positive.

According to Prigogine [27], during the evolution toward a stationary state, the rate of production of entropy per unit mass should be a minimum compatible with external constraints. Yang [28] has shown that this should lead to the conclusion that the potential energy dissipation rate per unit mass or weight of water in a river system should be a minimum. The minimum value depends on the constraints applied to the system.

Once the analogy between a thermo system and a river system is established, all thermodynamic laws and theories can be applied directly to river systems without further derivation and modification. Yang [28] used this analogy to obtain the law of least rate of energy expenditure, or the theory of minimum energy dissipation rate as more commonly referred in the literature later.

The theory of minimum energy dissipation rate can also be derived from mathematical argument without the use of thermodynamic laws and theories under equilibrium conditions. For a reach of open channel or pipe, the only way to maintain an equilibrium condition is to maintain a constant head between two end stations of the study reach. One can envision that this condition can be reached if the study reach or pipe is connected with two reservoirs of infinite volumes such the flow between the reservoirs will not change the head difference. In other words, a seemingly open system of open channel or pipe with inflow and outflow can be approximated by a closed system including two large reservoirs with an open channel or pipe connecting them to maintain a state of steady flow under equilibrium condition.

Yang and Song [29] and Yang [30] used the following mathematical arguments to deriviate the theory of minimum energy and minimum energy dissipation rate theories.

For a closed dynamic system, energy will be dissipated during the process of evolution to the final state of static equilibrium. For a dissipative system, its energy  $E$  must decrease with respect to time, i.e.,

$$\frac{dE}{dt} < 0 \quad (6.30)$$

When the system reaches its stable static equilibrium condition, the energy must be at its minimum value subject to the constraint applied to the system. This is called the theory of minimum energy. Let the energy dissipation rate  $P$  be defined as

$$P = -\frac{dE}{dt} > 0 \quad (6.31)$$

Because static equilibrium is a state of minimum energy, a dynamic state that is not too far from the static state should have

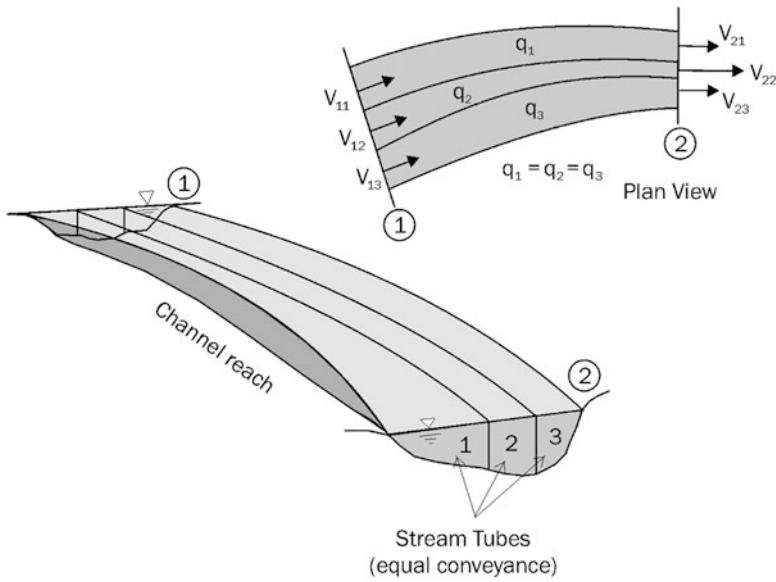
$$\frac{dP}{dt} = -\frac{d^2E}{dt^2} \leq 0 \quad (6.32)$$

Equation (6.32) states that during the evaluation process of a dynamic system, its energy dissipation rate should decrease with respect to time. When the system reaches its dynamic equilibrium condition, its energy dissipation rate must be at a minimum value. The minimum value depends on the constraints applied to the system. This is the theory of minimum energy dissipation rate. Conventional fluid mechanics using Newton's equation of motion to solve a system of equations based on a set of initial and boundary conditions. This approach is effective and appropriate if the boundary conditions are constant and will not change with respect to time. For river morphology and river engineering studies, the boundary condition varies with flow and sediment conditions and should not be treated as constant. The boundary conditions are the answers river engineers try to obtain. Consequently, it is not appropriate to assume that the boundary conditions would not change.

The classical mechanics of the variational principle is based on the use of energy or energy dissipation rate. The mathematical tools are the objective and constraint functions. This approach, which is independent of the use of Newton's law of motion, can give river engineers the needed additional independent equation to change indeterminate hydraulics to determinate hydraulics. This approach was used by Yang and Song [29] and Yang [30] to solve a wide range of fluid mechanics and river engineering problems. Yang [31, 32] also used the theory of minimum energy dissipation rate to explain the basic reason of river meander and the formation of riffles and pools.

#### 4. GENERALIZED SEDIMENT TRANSPORT MODEL FOR ALLUVIAL RIVER SIMULATION (GSTARS)

GSTARS is a series of computer models developed by the US Bureau of Reclamation for alluvial river and reservoir sedimentation studies. The original GSTARS was released in 1986 [33], and GSTARS2.0 and GSTARS2.1 were released in 1998 [34] and 2000 [35], respectively. The most widely used version is GSTARS3 [36], and the most recent version is GSTARS4 [37] for steady and unsteady flow simulations. Common to all GSTARS models is the use of stream tube concept as shown in Fig. 6.9. The total water discharge is divided equally among stream tubes based on equal conveyance. By doing so, semi-two-dimensional flow problems can be solved with one-dimensional equations along each stream tube. The change of channel geometry and longitudinal profile is governed by the use of minimum stream power theory. The change of channel width and depth at each time step of computation depends on whether width or depth change can produce less stream power in accordance with the theory of minimum stream power.



**Fig. 6.9.** Schematic representation illustrating the use of stream tube between two cross sections, numbered 1 (upstream) and 2 (downstream).

The flow equations used in GSTARS models are:

Continuity equation

$$\frac{\partial A}{\partial t} + \frac{\partial Q}{\partial x} = q_l \tag{6.33}$$

Momentum equation

$$\frac{\partial Q}{\partial t} + \frac{\partial}{\partial x} \left( \beta \frac{Q^2}{A} \right) + gA \frac{\partial \eta}{\partial x} + gA(S_f - S_0) = 0 \tag{6.34}$$

The friction slope can be computed by

$$S_f = \frac{Q|Q|}{K^2} \tag{6.35}$$

The conservation of energy equation is

$$\frac{F_p}{\gamma} + \frac{V^2}{2g} + D = H_t = \text{a constant} \tag{6.36}$$

where  $A$  = channel cross-sectional area of the flow;  $Q$  = water discharge;  $q_l$  = lateral inflow per unit channel length;  $t$  = time;  $x$  = distance;  $S_f, S_0$  = friction and bed slope, respectively;

$\beta$  = momentum correction coefficient ( $\beta \cong 1$ );  $g$  = gravitational acceleration;  $K$  = conveyance, which can be calculated using a resistance function such as the Manning's equation;  $F_p$  = pressure acting on the cross section;  $\gamma$  = unit weight of water;  $D$  = hydraulic head or depth; and  $V$  = average flow velocity.

Sediment conservation equation is

$$\frac{\partial Q_s}{\partial x} + \eta \frac{\partial A_d}{\partial t} + \frac{\partial A_s}{\partial t} - q_{\text{lat}} = 0 \quad (6.37)$$

where  $Q_s$  = volumetric sediment discharge,  $\eta$  = volume of sediment in a unit bed layer volume (one minus porosity),  $A_d$ ,  $A_s$  = sediment volume in bed and in suspension, respectively, and  $q_{\text{lat}}$  = lateral sediment inflow. If the change of suspended sediment concentration in a cross section is much smaller than the change of river bed, and if the parameters in the sediment transport function for a cross section can be assumed to remain constant during a time step, Equation (6.37) can be simplified to

$$\eta \frac{\partial A_d}{\partial t} + \frac{dQ_s}{dx} = q_{\text{lat}} \quad (6.38)$$

The total minimum stream power can be expressed by

$$\varphi_T = \int QSdx = \text{a minimum} \quad (6.39)$$

The minimum value depends on natural and man-made constraints applied to the study reach. Detailed derivations and explanations of the theories and equations used in GSTARS3 are given in the GSTARS3 User's Manual [36], and the papers by Yang and Ahn [37], Yang and Simões [38] and Simões and Yang [39].

## 5. RIVER MORPHOLOGY AND HYDRAULIC ENGINEERING

River morphological changes of channel cross sections, longitudinal profiles, and patterns have been studied by river morphologists and river engineers for centuries. River morphologists emphasize their studies on long-term dynamic adjustments of a long river reach. River engineers emphasize their studies on a short river reach for a relatively short duration. The interaction and exchange of ideas between river morphologists and river engineers are less than desirable. It is highly desirable for them to work together and learn from each other. Due to the differences of assumptions and approaches used by river morphologists and river engineers, different and often conflicting results can be obtained. There is a need to have some common theories and equations applicable to both disciplines. In view of the theoretical strength and wide range of applications, the theory of minimum energy dissipation rate, or its simplified minimum unit stream power or minimum stream power theory, can be a powerful and independent tool for solving complicated river morphology and river engineering problems.

Some commonly observed phenomena in nature will be used to illustrate the application of these theories.

River meandering and the formation of riffles and pools are two commonly observed phenomena in nature. Different hypotheses and theories have been used to explain these phenomena. They include, but are not limited to, the rotation of the earth, maximization or minimization of energy loss, local disturbances, and bank erosion. A detailed and systematic review [31, 32] concluded that none of the above theories and hypotheses can explain the basic reason for river meandering and the formation of the pool and riffle sequence. The only consistent reason for river meandering and formation of the pool and riffle sequence is to reduce a river's energy dissipation rate in accordance with the theory of minimum energy dissipation rate. Laboratory data by Friedkin [40] and field data by Leopold and Wolman [41] also confirmed that river meandering and the formation of riffles and pools are two sides of the same coin to reduce a river's energy dissipation rate.

As the water discharge increases in the downstream direction in a river system, the longitudinal slope actually decreases. For a water distribution system, water discharge decreases in the downstream direction, and the longitudinal or energy slope must increase. This seemingly paradox observation can be explained by the use of minimum stream power theory expressed by the following equation:

$$\frac{d(QS)}{dx} = S \frac{dQ}{dx} + Q \frac{dS}{dx} = 0 \quad (6.40)$$

For a river system,  $dQ/dx$  is positive and  $dS/dx$  must be negative, and the longitudinal river bed profile is concave. For an irrigation or pipe water distribution system,  $dQ/dx$  is negative; the energy gradient  $dS/dx$  must be positive so water can be delivered to the end of the distribution system in accordance with (6.40). According to the Manning's formula, an increase of water discharge should have an increase of energy slope. This is due to the fact that the use of Manning's formula assumes that the roughness coefficient is a constant applicable to a very short reach of river. For a river system of a long reach, sediment size and Manning's roughness usually decrease in the downstream direction. Consequently, Manning's formula cannot be applied to a river system unless the variation of roughness is given along the course of flow.

River engineers have the temptation to shorten the length of a meandering reach with cutoffs to straighten its course. This type of engineering action may reduce the navigation distance and time between two stations and reduce the flood stage for a give discharge for a short duration. However, this action is against the theory of minimum energy dissipation rate and often causing undesirable long-term results.

The US Army Corps of Engineers has made many cutoffs of the Lower Mississippi River to shorten the navigation time and distance as shown in Fig. 6.10. The 1933 Greenville Reach of the Mississippi River was a stable meandering reach with well-defined location of riffles or crossings. After the cutoffs were completed, the river became highly unstable. Numerous dikes and levees were constructed along the straightened reach to control the lateral movement of the river. Long-term observations of the behavior of the river indicate that the water

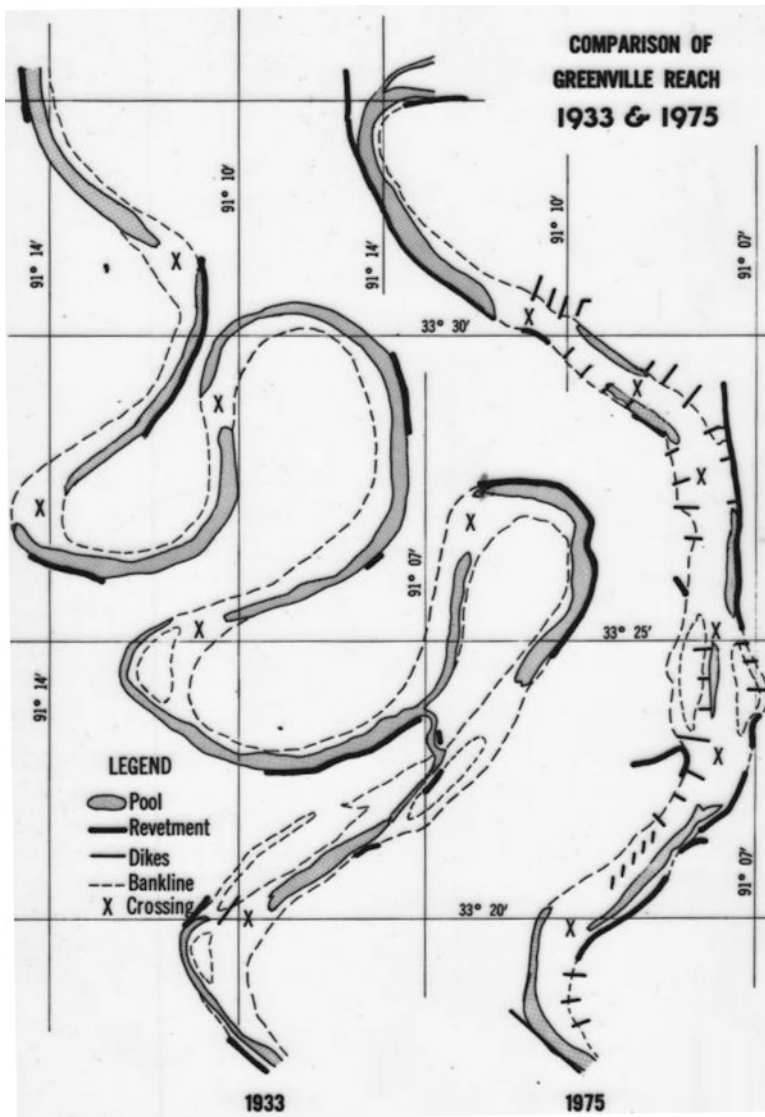


Fig. 6.10. Comparison of Greenville Reach of the Mississippi River between 1933 and 1875.

stage for a given flood is actually higher after some initial drop of water stage immediately after the cutoffs. The theory of minimum energy dissipation rate states that a river will adjust itself to minimize its energy dissipation rate or energy slope. The minimum value depends on the constraints applied to the river. One important constraint is water discharge or its associate water stage. Higher water discharge or higher water stage should be associated with higher energy slope. Figure 6.11 shows that the relationship between water stage and energy slope of meandering reaches follows the theory of minimum energy dissipation rate, while straight reaches do not follow the theory. Figure 6.12 shows the relationship between



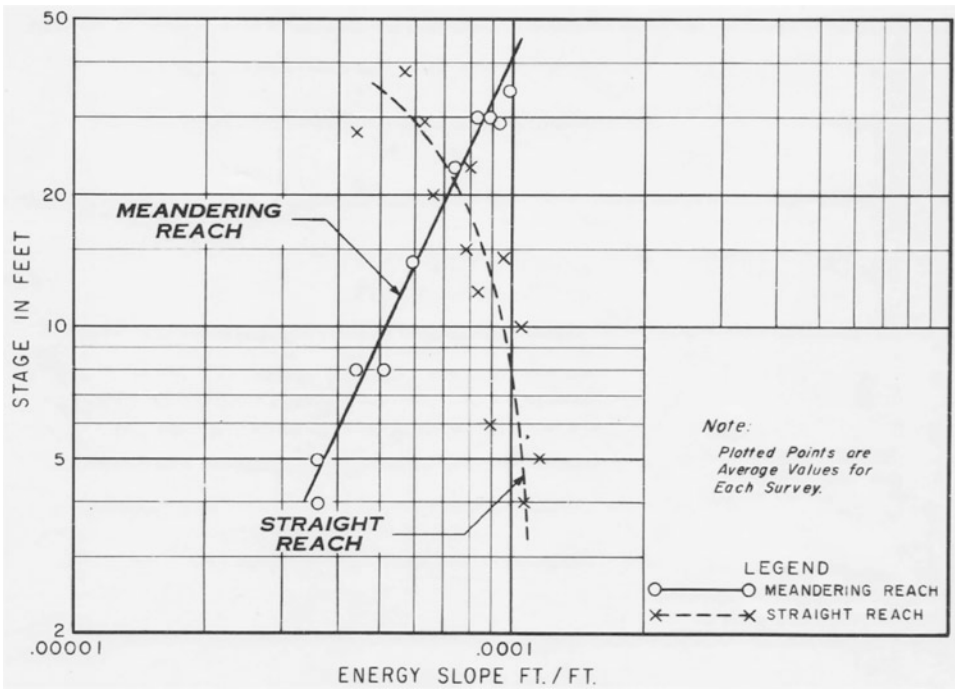


Fig. 6.11. Comparison of energy slopes between the straight and meandering reaches of the Mississippi River.

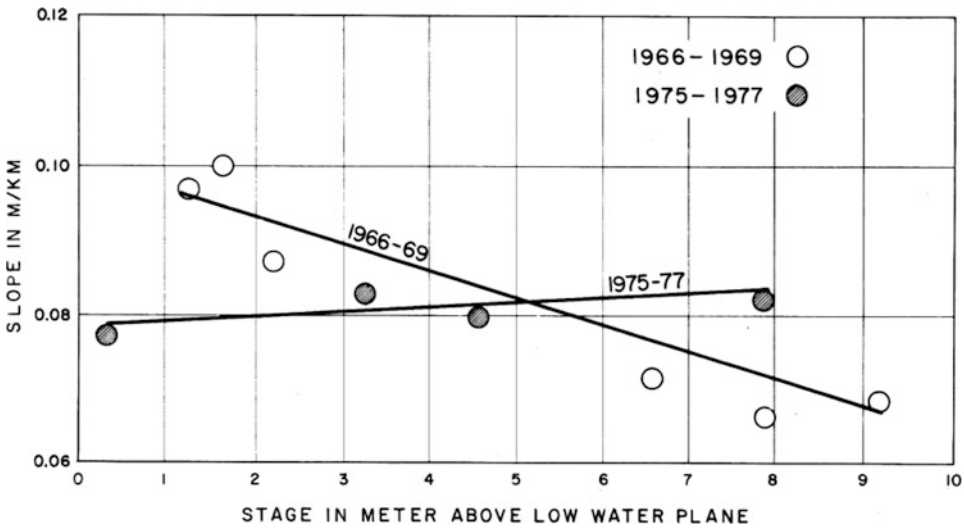


Fig. 6.12. Relationship between water stage and energy slope of the Kentucky Bend-Mayersville Reach of the Mississippi River.

energy slope and water stage of the Kentucky Bend-Mayersville Reach. The 1966–1969 relationship was obtained right after the cutoffs, which is against the theory of minimum energy dissipation rate. After the cutoffs, the US Army Corps of Engineers recognized that the Lower Mississippi River became highly unstable and restored some of the meandering reaches. The 1975–1977 relationship obtained after the meandering pattern was reestablished; the relationship between energy slope and water stage became consistent with the theory of minimum energy dissipation rate and the reach became stable again. River engineers should learn from this historical lesson to work with a river, not against a river, in accordance with the theory of minimum energy dissipation rate. Yang [42] provided more detailed explanations of the dynamic adjustment of rivers according to the theory of minimum energy dissipation rate.

A meandering river has well-defined thalweg connecting pools with a crossing between the two. This type of river has a well-defined course for navigation and requires minimum amount of dredging. Once a meandering river is straightened, there is no well-defined thalweg. Irregularly distributed and shifting sand bars are formed due to the deposit of sediment after a flood. This can create navigation problems and causes higher river roughness and higher water stage for a given water discharge.

## 6. HYDRAULIC ENGINEERING CASE STUDIES USING GSTARS

The following case studies are used to illustrate the application of GSTARS computer models to hydraulic engineering.

### 6.1. *Mississippi River Lock and Dam No. 26 Replacement Project*

At the request of the US Army Corps of Engineers, GSTARS [33] was applied to simulate and predict local scour at the Mississippi River Lock and Dam No. 26 Replacement Project site near St. Louis, Missouri. Study results were published by Yang et al. [43]. Figure 6.13 is an aerial view of the coffer dam at the construction site. The measured scour pattern is shown in Fig. 6.14a. Because GSTARS cannot be used for the prediction of local scour due to secondary current, the project site was simplified by cutting off the area of secondary current as shown in Fig. 6.14b. Yang's 1973 sand and 1984 gravel transport formulas were used in the study.

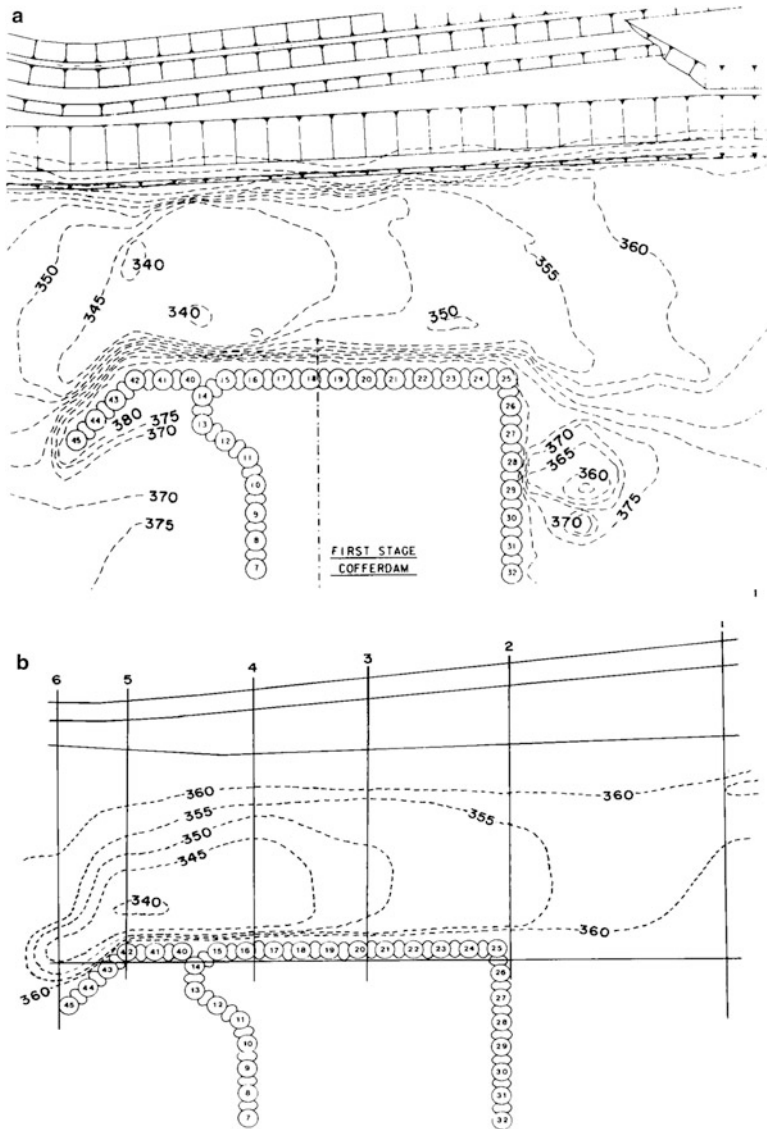
In spite of this simplification, the predicted scour pattern shown in Fig. 6.14b is very close to the measure pattern shown in Fig. 6.14a. On the average, the predicted scour depths are within 1 ft from the measurements. Figure 6.15 shows the three-dimensional plots of the predicted channel geometry changes at 4, 36, and 72 days of simulation using only three stream tubes. The ability for GSTARS to simulate and predict detailed channel geometry changes is due to the fact that each stream tube can adjust its width, depth, and location during the simulation process. In most cases, three tubes are adequate for river engineering purpose. It should be noted that the minimization option was not applied in this study because the width was fixed by levee and cofferdam at the construction site.



**Fig. 6.13.** Aerial view of the Mississippi River Lock and Dam No. 26 Replacement Project construction site near St. Louis, Missouri.

## 6.2. Lake Mescalero Unlined Emergency Spillway

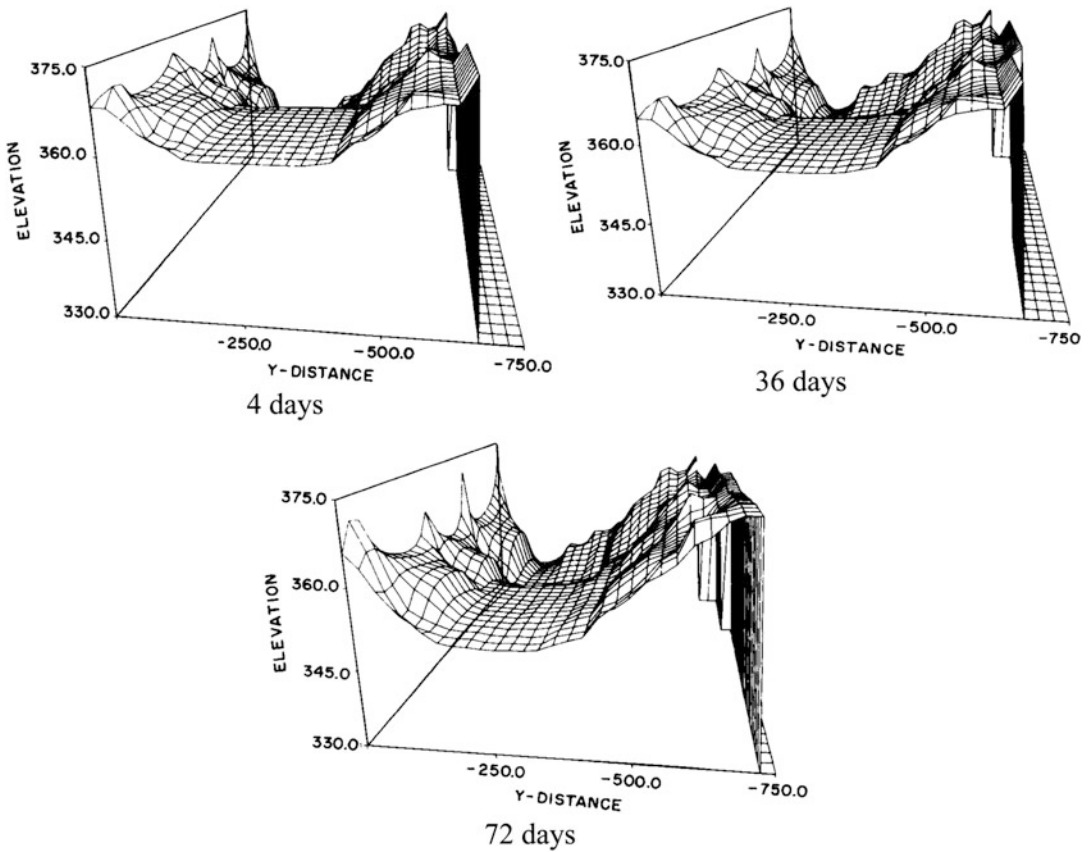
The US Bureau of Reclamation gave the University of Minnesota a contract to independently test the ability of using GSTARS [33] to predict river morphological changes of an alluvial channel based on the application of minimum stream power theory. During the period of December 20 to 31, 1984, floodwater passed the concrete spillway crest of Lake Mescalero in New Mexico and eroded the downstream unlined spillway as shown in Fig. 6.16a. The spillway flood hydrograph for the December 1984 flood, shown in Fig. 6.16b, and some cross-sectional surveys made prior to the flood were given to the University of Minnesota. In order to estimate the roughness and angle of repose of channel bank materials, the contractor was allowed to take a field trip and collect some bed-material samples and measured the angle of repose of materials on the channel bank after the flood. The bed-material size varies from 0.06 mm to 20 mm with a mean size of 2.5 mm. An average value of Manning's roughness coefficient of 0.06 was used for hydraulic routing. Yang's 1973 formula for sand and 1984 formula for gravel transport were used for sediment routing.



**Fig. 6.14.** (a) Measured and (b) predicted scour pattern at the Mississippi River Lock and Dam No. 26 Replacement Project construction site.

The study result was first published by Song et al. [44]. GSTARS 2.0, 2.1, and 3 were later used to retest the predicted results.

Figure 6.17 shows the initial and measured cross sections after the flood at Station 0 + 60 along the emergency spillway. The predicted results using GSTARS3 [36] with and without using the stream power minimization are also shown in Fig. 6.17. It is apparent that the result obtained by using the minimization option more realistically predicts channel

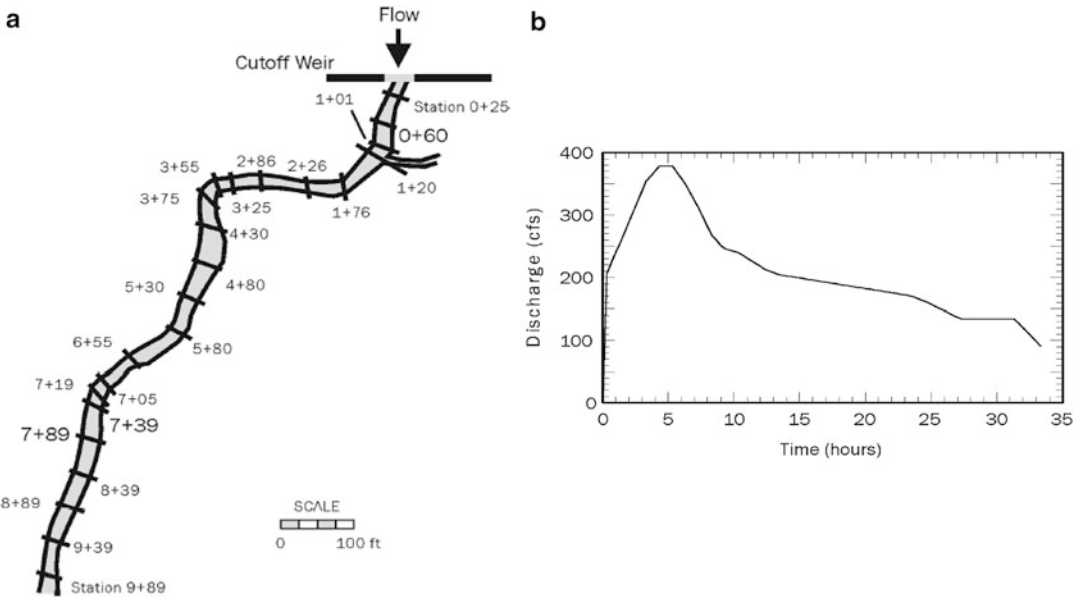


**Fig. 6.15.** Simulated and predicted semi-three-dimensional scour patterns after 4, 36, and 72 days of simulation at the Mississippi River Lock and Dam No. 26 Replacement Project site.

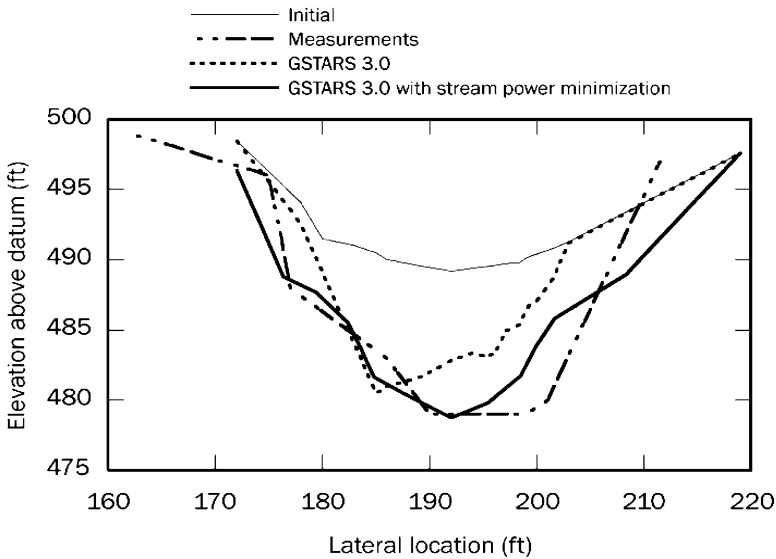
width and depth adjustments. Three stream tubes, Yang's 1973 sand transport and 1984 gravel transport formulas, and a Manning's roughness coefficient of 0.06 were used by Song et al. [44]. Same input data and formulas were also used in the GSTARS3 study with the same results.

### 6.3. Tarbela Reservoir Sedimentation Study

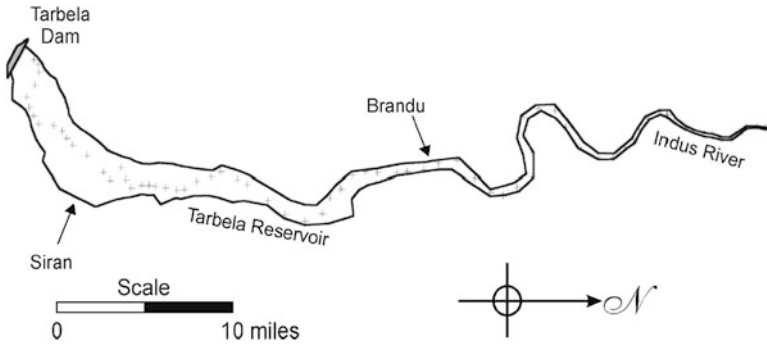
Tarbela Dam and Reservoir is located in northern Pakistan along the Indus River. The reservoir's storage capacity has been continuously depleted since the dam has been built in 1974, with an annual inflow rate of 265 million tons of sediment. GSTARS3 was used by Yang and Simões [36] to simulate 22 years of reservoir sedimentation (from 1974 to 1996) for a reach that spans nearly 58 miles upstream from the dam as shown in Fig. 6.18. The hydrology and dam operation records for the Tarbela Reservoir in the period of 1974 and 1996 are shown in Fig. 6.19.



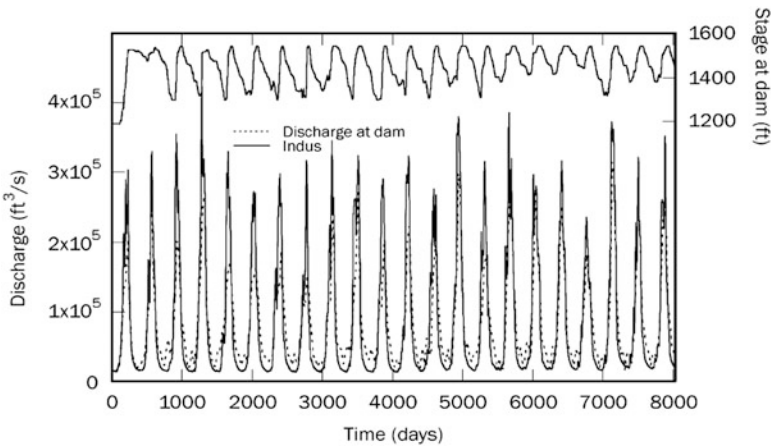
**Fig. 6.16.** (a) Plain view of the channel below the Lake Mescalero emergency spillway and (b) spillway hydrograph for the December 1984 flood.



**Fig. 6.17.** Comparison of results produced by GSTARS3 and surveyed data with and without the stream power minimization at Section 0 + 60 along the Lake Mescalero emergency spillway [36].

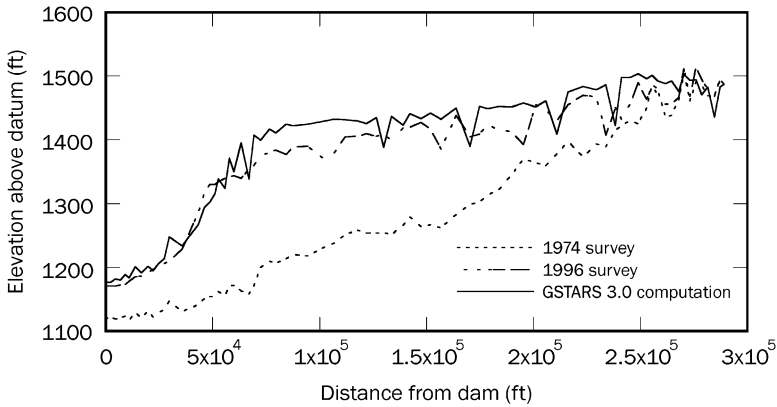


**Fig. 6.18.** Tarbela Dam and Reservoir. The points (+) mark the thalweg and the locations of the cross sections used in the study.

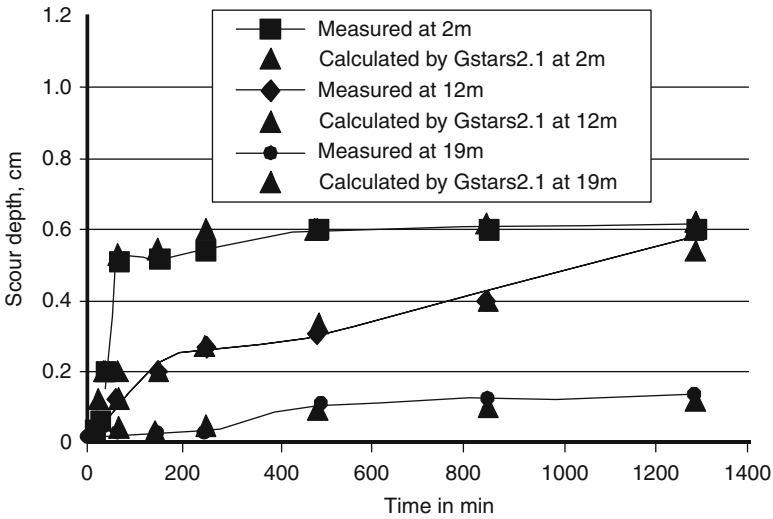


**Fig. 6.19.** Hydrology and dam operation for Tarbela in the period of 1974–1996.

Sediments in the Tarbela Reservoir are mainly sand and silt, and Yang’s 1973 formula and Han’s 1980 nonequilibrium transport function [45] were used in the simulation. Only one stream tube was used without using the minimization option because the emphasis of the study was to simulate the longitudinal profile of the delta along the thalweg, especially the location of the front set of the delta and its slope. Figure 6.20 shows that the simulated delta longitudinal profile agrees with the 1996 survey result very well, especially the front set of the delta. GSTARS3’s ability to simulate and predict the reservoir delta formation process can be used to determine a reservoir’s loss of capacity, the useful life of a reservoir, and the impact that dam operations have on the reservoir’s deposition pattern.



**Fig. 6.20.** Comparison between the measured and simulated longitudinal profiles of the delta in the Tarbela Reservoir [36].



**Fig. 6.21.** Comparison between measured and calculated scour depth along the Tigris River.

**6.4. Channel Degradation Downstream of the Mosul Dam in Iraq and Sediment Deposition in the Upper Rhone River in Switzerland**

Othman and Wang [46] applied GSTARS 2.1 [35] to simulate the degradation and armoring processes of the Tigris River below the Mosul Dam in Iraq. Yang’s 1973 sand [2] and 1984 gravel [4] formulas and Han’s 1980 nonequilibrium sediment transport function [45] were used in the simulation. Four stream tubes were used, and stream power minimization option was activated. Figure 6.21 shows that calculated scour depths agree with measured



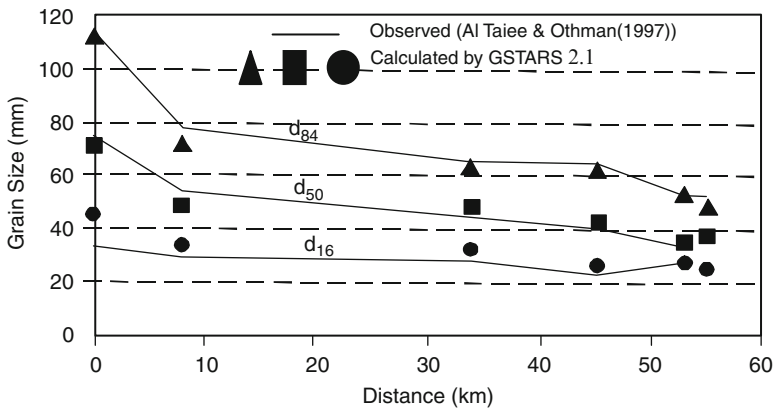


Fig. 6.22. Calculated and observed grain size distribution along the Tigris River.

results from three stations along the Tigris River very well. Figure 6.22 shows that the calculated sediment grain size distributions obtained from GSTARS 2.1 agree with the observations along the Tigris River very well.

GSTARS 2.0 [34] was applied by Cellino and Essyad [47] for the development of possible engineering solutions to reduce sediment deposition in the Dranse River, which is a tributary of the Upper Rhone River, near Martigny, Switzerland, after the October 10, 2000 flood. GSTARS 2.0 was first used for the analysis of flood. The same model was then used to test several solutions focusing the attention on the erosion and deposition induced by the flood. The GSTARS 2.0 simulation results were used to guide physical model investigation. Physical model of the study reach was constructed at the Polytechnique School of Lausanne in Switzerland to test different engineering solutions.

The bed materials in the study reach are mainly gravels with nominal diameters between 149.7 mm and 349.9 mm. The computed and measured depth-averaged depositions at the Bathiaz Bridge site are both 7 cm. The numerical computation was performed by using only two stream tubes because of the simplified channel shape.

GSTARS 2.1 was more recently applied by Banchuen et al. [48] to simulate and predict the longitudinal and lateral morphological processes downstream of the Pa Sak Jolasid Dam in Thailand. Laursen's [49] formula was used in the simulation. The predicted results from using GSTARS 2.1 are in good agreement with field observations.

### 6.5. Bed Sorting and Armoring Downstream from a Dam

Ashida and Michiue [50] conducted laboratory experiments in a small laboratory channel with 0.8 m in width and 20 m in length. Figure 6.23 illustrates the test condition for their Run#1. Figure 6.24 shows the comparisons between the computed results from GSTARS3 and the measurements at the initial and final stage of the tests. The computed bed degradation agrees with the measurements very well.

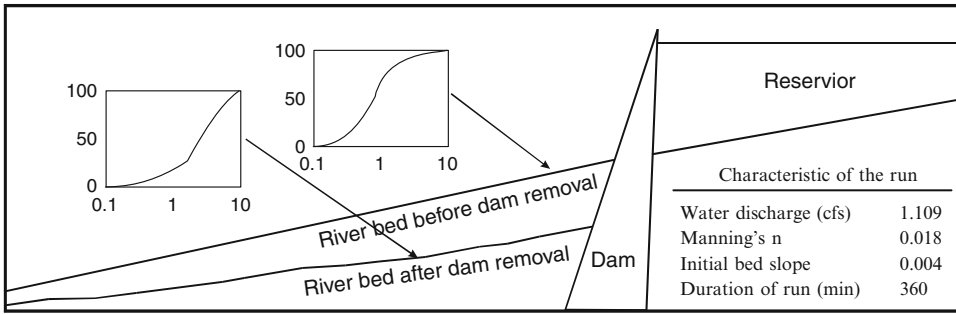


Fig. 6.23. Schematic diagram of bed sorting and armoring laboratory tests [50].

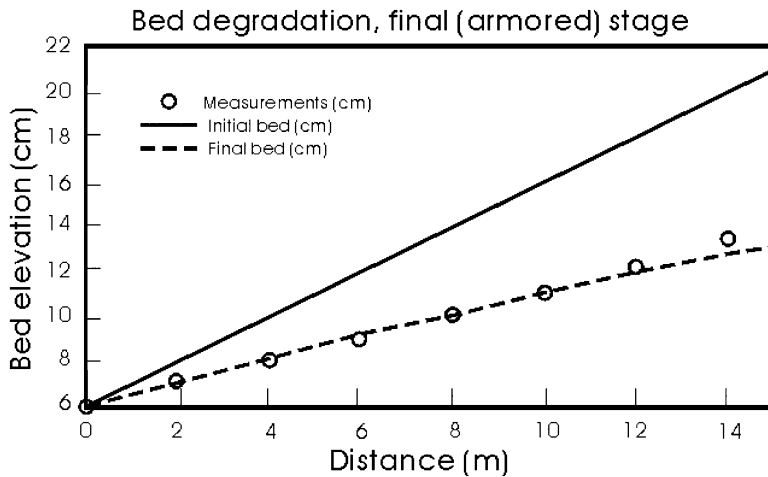
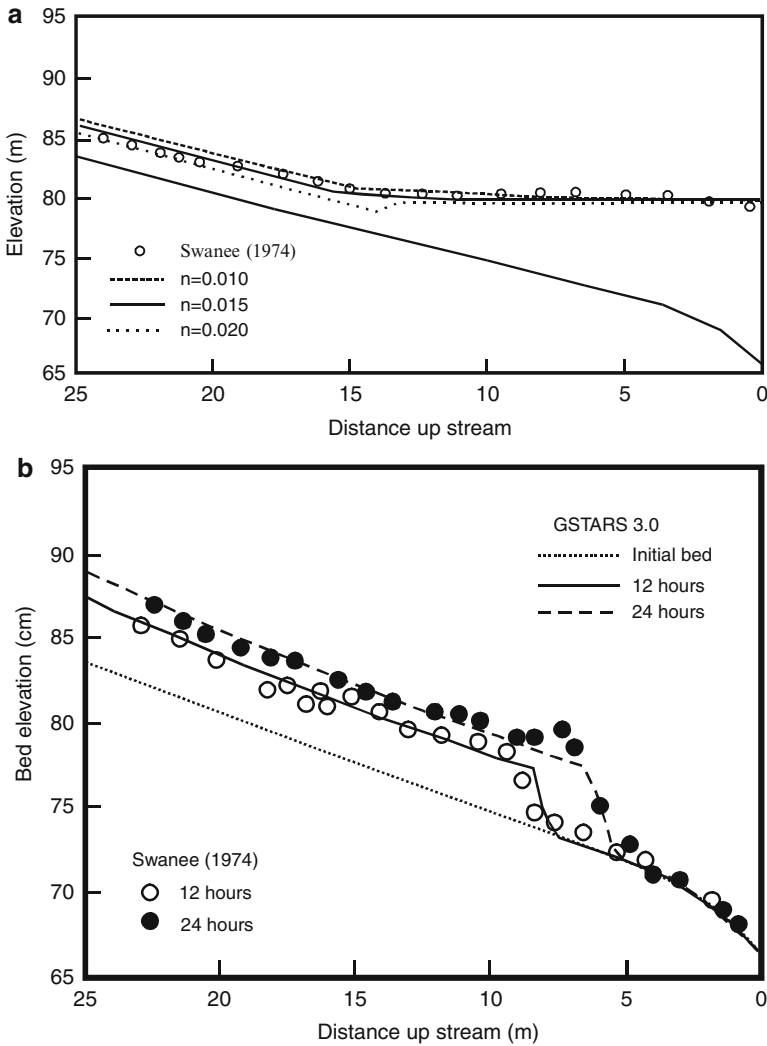


Fig. 6.24. Comparisons between measured [50] and computed results using GSTARS3.

### 6.6. Reservoir Delta Formation

Swamee [51] conducted laboratory tests for the development of reservoir delta. Figure 6.25a shows comparisons between measured and computer profiles from GSTARS3 with three different values of roughness coefficient. Figure 6.25b shows that predicted delta development agrees with laboratory test results very well. The minor local differences between the computed and measured results shown in Fig. 6.25b are due to the presence of the movement of dune bed forms in the laboratory flume.



**Fig. 6.25.** Comparisons between laboratory tests by Swamee [51] and predicted results from GSTARS3. (a) Water surface profile. (b) Delta development.

## 7. SUMMARY AND CONCLUSIONS

This chapter provides a summary of some basic theories, concepts, and computer models useful to our sediment transport, river morphology, and river engineering studies. Important conclusions are:

- (a) The unit stream power theory for sediment transport can be derived from basic turbulent flow theories.
- (b) The unit stream power theory was applied to the derivation of formulas for sand and gravel transport as well as to sediment transport with high concentration of wash load with accuracy.

- (c) The unit stream power theory can be applied to the estimation of surface erosion rate with accuracy.
- (d) The theory of minimum energy dissipation rate can be derived from thermodynamic principles using the analogy between a thermo system and a river system. The theory can also be derived from mathematical argument.
- (e) The minimum energy dissipation rate theory and its simplified minimum stream power and minimum unit stream power theories can be applied to river morphology and river engineering studies.
- (f) The GSTARS computer models based on the minimum stream power theory and stream tube concept have been applied to solving a wide range of river and reservoir problems with success.

## REFERENCES

1. Yang CT (1972) Unit stream power and sediment transport. *ASCE J Hydraul Div* 98(No. HY10):1805–1826
2. Yang CT (1973) Incipient motion and sediment transport. *ASCE J Hydraul Div* 99(No. HY10):1679–1704
3. Yang CT (1979) Unit stream power equations for total load. *J Hydrol* 40:123–138
4. Yang CT (1984) Unit stream power equation for gravel. *ASCE J Hydraul Eng* 110(No. HY12):1783–1797
5. Yang CT (1996) *Sediment transport theory and practice*. McGraw-Hill, New York, NY
6. Yang CT (2003) *Sediment transport theory and practice*. Krieger Publishing Company, Malabar, FL
7. Guy HP, Simons DB, Richardson EV (1966) Summary of alluvial channel data from experiments, 1956–1961. U.S. Geological Survey Professional Paper 462—J
8. Stein RA (1965) Laboratory studies of total load and apparent bed-load. *J Geophys Res* 70(8):1831–1842
9. Vanoni VA (1978) *Predicting sediment discharge in alluvial channels, water supply and management*. Pergamon, Oxford, pp 399–417
10. Yang CT, Kong X (1991) Energy dissipation rate and sediment transport. *J Hydraul Res* 29(4):457–474
11. Yang CT, Molinas A (1982) Sediment transport and unit stream power function. *ASCE J Hydraul Div* 108(No. HY6):776–793
12. Bagnold RA (1966) An approach to sediment transport problem from general physics, U.S. Geological survey Professional Paper 422—J
13. Yang CT (1985) Mechanics of suspended sediment transport. In: Bechteler W (ed) *Proceedings of Euromech 192: Transport of suspended solids in open channels*. Institute of Hydromechanics, University of the Armed Forces, Munich/Neubiberg, Germany, pp 87–91
14. Yang CT, Wan S (1991) Comparisons of selected bed-material load formulas. *ASCE J Hydraul Eng* 117(8):973–989
15. Yang CT, Marsooli R, Aalami MT (2009) Evaluation of total load sediment transport formulas using ANN. *Int J Sediment Res* 24(3):274–286
16. Alonso CV (1980) Selecting a formula to estimate sediment transport capacity in nonvegetated channels, CREAMS (A Field Scale Model for Chemicals, Runoff, and Erosion from Agricultural Management System), Knisel WG (ed) U.S. Department of Agriculture Conservation Research Report No. 26, Chapter 5, pp 426–439

17. ASCE Task Committee on Relations between Morphology of Small Streams and Sediment Yield of the Committee on Sedimentation of the Hydraulics Division (1982) Relationships between morphology of small stream and sediment yield. *ASCE J Hydraul Div* 108(No. NY11):1328–1365
18. Mengis RC (1981) Modeling of a transient streambed in the Rio Grande, Cochiti Dam to near Albuquerque, New Mexico, U.S. Geological Survey Open File Report 82–106, Denver, Colorado
19. German Association for Water Resources and Land Improvement (DVWK) (1990) *Sediment Transport in Open Channels—Calculation Procedures for Engineering Practice*, Bulletin No. 17, Verlag, Paul Parey, Hamburg/Berlin
20. Yang CT (1980) Sediment transport and river engineering. *Proceedings of the International Symposium on River Sedimentation*, Vol. 1, pp 350–386, Beijing, China
21. Yang CT (1977) The movement of sediment in rivers, *Geophysical Survey* 3. D. Reidel, Dordrecht, pp 39–68
22. Yang CT, Molinas A, Wu B (1996) Sediment transport in the Yellow River. *ASCE J Hydraul Eng* 122(5):237–244
23. Shih H-M, Yang CT (2009) Estimating overland flow erosion capacity using unit stream power. *Int J Sediment Res* 24(1):46–62
24. Gilbert KG (1914) The transportation of debris by running water, U.S. Geological Survey Professional Paper 86, p 263
25. Guy BT, Dickinson WT (1990) Inception of sediment transport in shallow overland flow. In: Bryan RB (ed) *Soil erosion-experiment and models*. Springer-Verlag, Cremlingen, pp 91–109, Catena Supplement 17
26. Julien PY, Simons DB (1985) Sediment transport capacity of overland flow. *Am Soc Agric Eng* 28(3):755–762
27. Prigogine I (1967) *Introduction to thermodynamics of irreversible processes*, 3rd edn. Wiley, New York, NY
28. Yang CT (1971) Potential energy and stream morphology, *American Geophysical Union. Water Resour Res* 7(2):311–322
29. Yang CT, Song CCS (1986) Theory of minimum energy and energy dissipation rate, *Encyclopedia of Fluid Mechanics* Vol. 1, Cheremisinoff (ed), Gulf publishing company book division, Chapter 11, Houston, London, Paris, Tokyo: 353–399
30. Yang CT (1987) Energy dissipation rate approach in river mechanics. In: Thorne CR, Bathurst JC, Hey RD (eds) *Sediment transport in gravel-bed rivers*. Wiley, New York, pp 753–766
31. Yang CT (1971) On river meanders. *J Hydrol* 13:231–235
32. Yang CT (1971) Formation of riffles and pools. *Am Geophys Union Water Resour Res* 7(6):1567–1573
33. Molinas A, Yang CT (1986) *Computer program User's manual for GSTARS (generalized stream tube model for alluvial river simulation)*. U.S. Bureau of Reclamation Engineering and Research Center, Denver, CO
34. Yang CT, Treviño MA, Simões FJM (1998) *Program User's manual for GSRARS 2.0 (Generalized stream tube model for alluvial river simulation version 2.0)*. U.S. Bureau of Reclamation Technical Service Center, Denver, CO
35. Yang CT, Simões FJM (2000) *User's Manual for GSTARS 2.1 (Generalized sediment transport model for alluvial river simulation version 2.1)*. U.S. Bureau of Reclamation Technical Service Center, Denver, CO

36. Yang CT, Simões FJM (2002) User's Manual for GSTARS3 (generalized sediment transport model for alluvial river simulation version 3.0). U.S. Bureau of Reclamation Technical Service Center, Denver, CO
37. Yang CT, Ahn J (2011) User's Manual for GSTARS4 (generalized sediment transport model for alluvial river simulation version 4.0). Colorado State University Hydroscience and Training Center, Fort Collins, CO
38. Yang CT, Simões FJM (2008) GSTARS computer models and their applications, part I: theoretical development. *Int J Sediment Res* 23(3):197–211
39. Simões FJM, Yang CT (2008) GSTARS computer models and their applications, part II: applications. *Int J Sediment Res* 23(4):299–315
40. Friedkin JF (1945) A laboratory study of the meandering of alluvial river, plate 9, waterways experiment station. U.S. Army Corps of Engineers, Vicksburg, MS
41. Leopold LB, Wolman MG (1957) River patterns: braided, meandering, and straight. U.S. Geological Survey Professional Paper 282—B
42. Yang CT (1986) Dynamic adjustment of rivers. Proceedings of the 3rd International Symposium on River Sedimentation, Jackson, MS, pp 118–132
43. Yang CT, Molinas A, Song CCS (1988) GSTARS—Generalized Stream Tube model for Alluvial River Simulation, Twelve Selected Computer Stream Sedimentation Models Developed in the United States, Subcommittee on Sedimentation, Interagency Advisory Committee on Water Data, Interagency Ad Hoc Sedimentation Work Group, (Fan SS ed), Federal Energy Regulatory Commission. Washington, DC, USA
44. Song CCS, Zheng Y, Yang CT (1995) Modeling of river morphologic changes. *Int J Sediment Res* 10(2):1–20
45. Han Q (1980) A study on non-equilibrium transportation of suspended load. In: Proceedings of the International Symposium on River Sedimentation, Beijing, China, pp 793–802 (in Chinese)
46. Othman KI, Wang D (2004) Application of GSTARS 2.1 model for degradation in alluvial channels. In: Proceedings of the Ninth International Symposium on River Sedimentation, Yichang, China, Vol. III, 1532–1537
47. Cellino M, Essyad K (2002) Reduction of sediment deposition by introducing an artificial stony bank. A practical example in Upper Rhone River, Switzerland. In: Bousmar D, Zech Y (eds) Proceedings of the international conference on Fluvial Hydraulics, Louvain-La-Neuve, Belgium, River Flow 2002. A. A. Balkema Publishers, Lisse/Abingdon/Exton (PA)/Tokyo, pp 951–959
48. Banchuen S, Tingsanchali T, Chinnarasri C (2008) Comparison between GSTARS 2.1 and HTC-6 river morphological models. *IAHR Int J Hydrol Sci*
49. Laursen EM (1958) The total sediment load of streams. *ASCE J Hydraul Div* 84 (No. HY1):1530-1–1530-36
50. Ashida K, Michiue M (1971) An investigation of river bed degradation downstream of a dam. Proceedings of the IAHR XIV Congress, 3
51. Swanee PK (1974) Analytic and experimental investigation of streambed variation of a dam, Ph.D. thesis, Department of Civil Engineering, University of Roorkee, India

# GIS and Remote Sensing Applications in Modern Water Resources Engineering

---

Lynn E. Johnson

## CONTENTS

SELECTED ABBREVIATIONS

INTRODUCTION

OVERVIEW OF GEOGRAPHIC INFORMATION SYSTEMS AND REMOTE SENSING

GIS FOR SURFACE WATER HYDROLOGY

GIS FOR FLOODPLAIN MANAGEMENT

GIS FOR WATER SUPPLY SYSTEMS

GIS FOR GROUNDWATER HYDROLOGY

REFERENCES

---

**Abstract** Geographic information system (GIS) and remote sensing (RS) concepts and technologies are used extensively in modern water resources engineering planning, design, and operations practice and are changing the way these activities are accomplished. GIS has become an increasingly important means for understanding and dealing with the pressing problems of water and related resources management in our world. GIS concepts and technologies help us collect and organize the data about such problems and understand their spatial relationships. GIS analysis capabilities provide ways for modeling and synthesizing information that contribute to supporting decisions for resource management across a large range of scales, from local to global. And GIS provides a means for visualizing resource characteristics and thereby enhancing understanding in support of decision-making. This chapter introduces GIS and RS and their application to water resources systems. A general overview of GIS is presented which is followed by summary review of GIS applications for modern water resources engineering.

**Key Words** Geographic information system • Remote sensing • Geodesy • Global positioning systems • Digital elevation model • Digital orthophoto • Geodetic control • Triangular integrated network • Feature dataset • Geodatabase • Geocoding • Attributes • Vector • Raster • Networks • Topology • Pfasseter code • Overlays • Map algebra • Spatial statistics • Graphical user interface • Unit hydrograph • Spatial decision support system.

## SELECTED ABBREVIATIONS

ABR	Average basin rainfall
AMBER	Areal mean basin effective rainfall
API	Application program interface
ALERT	Automated local evaluation in real time
AML	Arc macro language
AMSR	Advanced Microwave Scanning Radiometer
CAD	Computer-aided design
CAPPI	Constant altitude plan position indicator
CASE	Computer-aided software engineering
CDSS	Colorado Decision Support System
CERL	Construction Engineering Research Lab (US Army Corps of Engineers)
CRWR	Center for Research in Water Resources (Univ. Texas, Austin)
CU	Consumptive use
CUAHSI	Consortium of Universities for the Advancement of Hydrologic Science
CWCB	Colorado Water Conservation Board
DBMS	Database management system
DCIA	Directly connected impervious area
DCP	Data collection platform
DCS	Data Capture Standards (FEMA)
DEM	Digital elevation model
DFIRM	Digital flood insurance rate map
DLG	Digital line graph
DMI	Data management interface
DOQQ	Digital Orthoimagery Quarter Quadrangles
DPA	Digital precipitation array
DSS	Decision Support System
DTM	Digital terrain model
EDNA	Elevation derivatives for national applications
EOS	Earth observation satellite
EPA	Environmental Protection Agency
ESRI	Environmental Systems Research Institute, Inc.
ET	Evapotranspiration
ETM+	Enhanced Thematic Mapper Plus
F2D	Flood two-dimensional rainfall-runoff model



FDA	Flood damage analysis
FEMA	Federal Emergency Management Agency
FFG	Flash flood guidance
FIRM	Flood insurance rate map
FIS	Flood Insurance Studies
FWPP	Flood warning and preparedness program
Geo-MODSIM	GIS-based MODSIM (Modular Simulation program)
GeoRAS	Geospatial River Analysis System
GIS	Geographical Information System
GLEAMS	Groundwater Loading Effects of Agricultural Management Systems
GNIS	Geographic Names Information System
GOES	Geostationary operational environmental satellite
GPS	Global positioning system
GRASS	Geographic Resources Analysis Support System
GUI	Graphical user interface
HAS	Hydrologic analysis and support
HEC	Hydrologic Engineering Center (US Army Corps of Engineers)
HEC-RAS	HEC River Analysis System
HIS	Hydrologic Information System
HL-RMS	Hydrology Lab—Research Modeling System (NWS)
HMS	Hydrologic Modeling System (HEC)
HMT	Hydrometeorological Testbed (NOAA)
HRAP	Hydrologic Rainfall Analysis Project
HTML	Hypertext markup language
HTTP	Hypertext transfer protocol
HUC	Hydrologic unit code
LIDAR	LIght detection and ranging
LSM	Land Surface Model
LULC	Land use–land cover
MAP	Mean areal precipitation
MD	Maximum day demand
MH	Maximum hour demand
MODFLOW	Modular Finite-Difference Groundwater Flow Model
MPE	Multisensor precipitation estimator
MRLC	Multi-resolution Land Characteristics Consortium
MSS	Multispectral scanner
NAIP	National Agricultural Imagery Program
NASA	National Aeronautics and Space Administration (USA)
NASIS	National Soil Information System
NDVI	Normalized Difference Vegetation Index
NED	National Elevation Dataset
NFIP	National Flood Insurance Program
NESDIS	National Environmental Satellite Data Information Service

NEXRAD	Next Generation Weather Radar
NHD	National Hydrography Dataset
NLCD	National Land Cover Dataset
NLDAS	North American Land Data Assimilation System
NOAA	National Oceanic and Atmospheric Administration
NOHRSC	National Operational Hydrologic Remote Sensing Center
NRCS	Natural Resources Conservation Service
NRC	National Research Council
NSA	National Snow Analyses
NWS	National Weather Service
NWIS	National Water Information System (USGS)
OSD	Official Soil Series Description
PDSI	Palmer Drought Severity Index
PPS	Precipitation processing system (radar)
PRISM	Parameter-Elevation Regressions on Slope Model
QPE	Quantitative precipitation estimate
QPF	Quantitative precipitation forecast
RDBMS	Relational Database Management System
RFC	River Forecast Center (NWS)
RGDSS	Rio Grande Decision Support System
SAC-SMA	Sacramento Soil Moisture Accounting
SCADA	Supervisory Control and Data Acquisition
SDMS	Spatial Data Management System
SDSS	Spatial Decision Support Systems
SLAR	Side-Looking Airborne Radar
SMA	Soil Moisture Accounting
SQL	Structured Query Language
SSM/I	Special Sensor Microwave/Imager
SSURGO	Soil Survey Geographic Database
STATSCO	State Soil Geographic Database
STORET	STORage and RETrieval
STP	Storm total precipitation
TIGER	Topologically Integrated Geographic Encoding and Referencing
TIN	Triangulated Irregular Network
TM	Thematic Mapper
UH	Unit hydrograph
UML	Universal Modeling Language
USBR	United States Bureau of Reclamation
USDA	US Department of Agriculture
USGS	United States Geologic Survey
UZFWM	Upper-zone free water maximum
WADISO	Water Distribution System Analysis and Optimization
WADSOP	Water Distribution System Optimization
XML	Extensible Markup Language

## 1. INTRODUCTION

Information about water resources and the environment is inherently geographic. Maps, whether on paper or in digital GIS formats, continue to be the medium for expression of engineering plans and designs. We are concerned about the spatial distribution and character of the land and its waters. Weather patterns, rainfall and other precipitation, and resultant water runoff are primary driving forces for land development, water supplies, and environmental impacts and pollution. Our water resources systems are comprised of dams and reservoirs, irrigated lands and canals, water supply collection and distribution systems, sewers and stormwater systems, and floodplains. These systems are tailored in response to a complex mix of topography and drainage patterns, population and land use, sources of water, and related environmental factors.

A geographic information system (GIS) presents information in the form of maps and feature symbols and is integrated with databases containing attribute data on the features. A GIS is a computer-based information system that supports capture, manipulation, retrieval, modeling, analysis, and presentation of spatial data. This is a standard definition that does not highlight the uses of GIS as an integrator of data management operations and decision support in an organization. Looking at a GIS map gives knowledge of where things are, what they are, and how they are related. A GIS can also provide tabular reports on the map features, create a list of all things connected in a network, and support simulations of river flows, travel time, or dispersal of pollutants. A more expansive view is that the purpose of a GIS is to provide a framework to support decisions for the intelligent use of earth's resources and to manage the built and natural environment. Purposes and concepts of GIS are a key to the understanding and successful application of this technology.

A GIS provides an integrating data and modeling environment for the conduct of these activities. A GIS provides a means to collect and archive data on the environment. Measurements of location, distance, and flow by various devices are typically handled in digital formats and quickly integrated into a spatial database. Data processing, synthesis, and modeling activities can draw on these data using the GIS, and analysis results can be archived as well. The GIS spatial and attribute database can then be used to generate reports and maps, often interactively, to support decision-making on which alternatives are best and the impacts of these. Further, maps are a powerful communication medium; thus, this information can be presented in public forums so that citizens concerned with planning and design choices can better understand and be more involved.

Planning and design in water resources engineering typically involve the use of maps at various scales and the development of documents in map formats. For example, in a river basin study, the map scale often covers a portion of a state and includes several counties and other jurisdictions. The river drains a certain geography having topographic, geologic and soil, vegetation, and hydrological characteristics. Cities and human-built facilities are located along the river and across the basin, and transportation and pipeline networks link these together. It is required that all of these datasets be established in a common geo-reference framework so that overlays of themes can be made and the coincidence of features identified in the planning and design phase.

A GIS is applied to manage all of these data. It provides a comprehensive means for handling the data that could not be accomplished manually. The large amount of data involved requires a GIS—there may be many thousands of features having a location, associated attributes, and relationships with other features. The GIS provides a means to capture and archive these data and to browse and review the data in color-coded map formats. This data review capability supports quality control as errors can be more readily identified. Also, through visualization, the user can gain a better understanding of patterns and trends in the data in a manner not possible if the data were only in tabular format. The GIS provides an analysis capability as well; new information can be obtained by the wide variety of spatial analysis functions and linked mathematical models. The database can be accessed by the computer software and used as input to various modeling procedures to generate derived products.

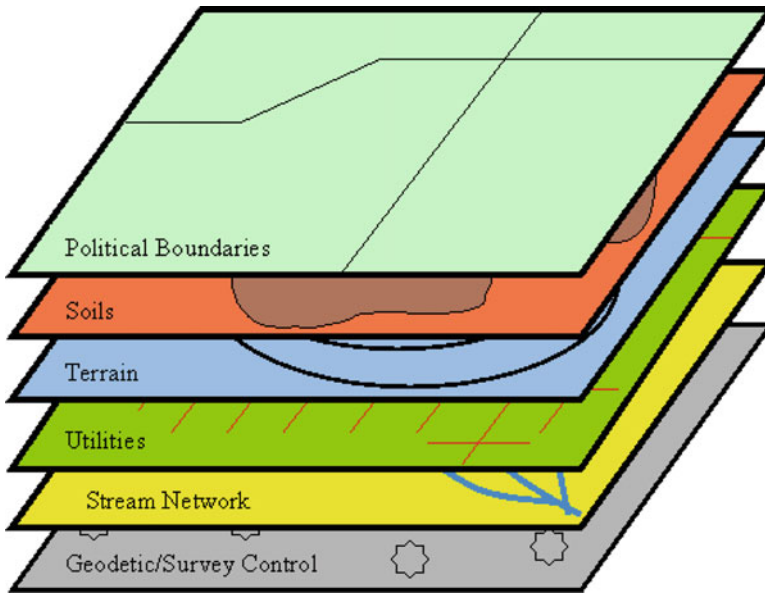
A comprehensive review of GIS for water resources engineering was presented by Johnson [1]. That book addressed fundamental concepts of GIS database development and applications of GIS for surface and groundwater hydrology, flood plains, water supply and wastewater systems, water quality, and river basin decision support systems. This chapter presents a summary review of GIS concepts and water resources engineering applications. It is intended to inform the reader on the role that GIS plays in modern water resources engineering in concert with the other topics presented in this book.

## **2. OVERVIEW OF GEOGRAPHIC INFORMATION SYSTEMS AND REMOTE SENSING**

### **2.1. GIS Basics**

GIS concepts and technologies arise from a wide variety of fields, and GIS has become a generic term referring to all automated systems used primarily for the management of maps and geographic data. The development of GIS has relied on innovations made in many disciplines: civil engineering, geography, photogrammetry, remote sensing, surveying, geodesy, statistics, computer science, operations research, demography, and many other branches of engineering and the natural and social sciences. Indeed, an outstanding characteristic of GIS is its interdisciplinary character in its development as a collection of tools as well as the wide variety of applications.

GIS cartographic concepts originated with the maps created by early explorers and extended by modern geographers to portray locations and characteristics of the earth's features. Engineering measurement theories and practices of surveyors and geodesists provided the means to describe property boundaries and locate features accurately. Civil engineers have migrated to digital formats for land development plans which include parcel boundaries as well as elements for water and sewer pipes, roads and streets, and other infrastructure. Satellite and airborne remote sensing technologies have advanced to become a primary data source for high-resolution mapping of land characteristics; these apply for base mapping, in real time, and for assessing changes over time.



**Fig. 7.1.** Map layers address multiple themes.

It has become common to think of GIS databases as a collection of map layers that are geographically referenced and registered to a common coordinate projection. Most GIS organizes data by layers, each of which contains a theme of map information that is logically related by its location (Fig. 7.1). Each of these separate thematic maps is referred to as a layer, coverage, or feature dataset. And each layer has been precisely overlaid on the others so that every location is matched to its corresponding locations on all the other maps. The geodetic control layer of this diagram is quite important; it represents the coordinate location reference system to which all the maps have been accurately registered. Once these maps have been registered within a standardized reference system, information displayed on the different layers can be compared and analyzed in combination.

## 2.2. GIS Data Development and Maintenance

Input or capture of data comes from a variety of sources. The data may be converted from existing paper (or mylar) plans and records, as well as data residing in digital databases (e.g., property records). These conversions may involve tablet digitizing and scanning to images. Over the past several decades, there has been a convergence of GIS with the technologies of engineering measurement that record field data in digital formats and can be ported directly into a GIS spatial database (e.g., surveying total stations and global positioning systems (GPS)). Data capture technologies include remote sensing by satellites and airborne platforms (photogrammetry). Satellite imagery is received in various wavelengths so that particular aspects of the land surface can be characterized through image processing procedures. Imagery from airplane overflights is most often of the photographic type, particularly for

development of high-resolution topographic maps of urban areas and identification of urban features such as building footprints, street centerlines, manholes, and water distribution valves. Increasingly, Light Detection and Ranging (LIDAR) is being used to provide high-resolution topographic mapping required for detailed site planning and floodplain hydraulic studies. Regardless of the source, there is a requirement that spatial data be developed in some coordinate reference system.

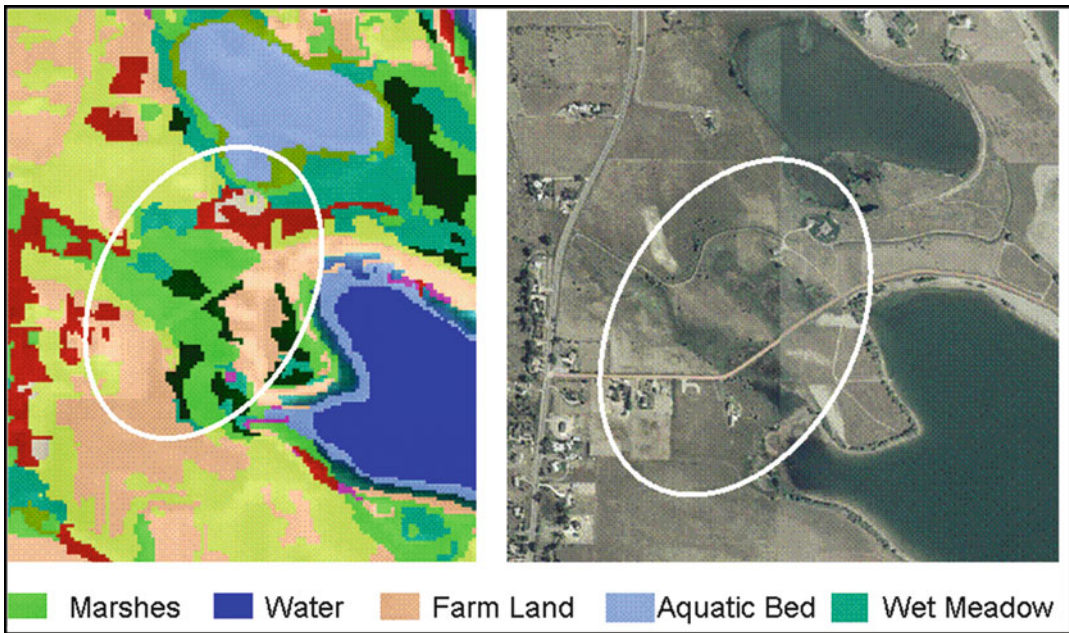
GIS functions for spatial data capture include the numerous technologies for data capture as well as the many ways for conversion of source data into GIS compatible formats. These functions include:

- Tablet digitizing and scanning
- Format conversion
- Surveying and coordinate geometry (COGO)
- Global positioning systems
- Photogrammetric data development
- Image processing
- Geometric transformations and projection conversions
- Attribute entry and editing
- Metadata

### 2.3. Remote Sensing

Satellite remote sensing can provide various sources of data for water resources applications ranging from basic land use characteristics (and changes over time) to terrain and to meteorological event tracking. Satellites using the visible and near-infrared regions of the spectrum can provide detailed information of the land characteristics, and SPOT with its stereo capability can even provide topographic information [2]. Side-Looking Airborne Radar (SLAR) and satellite SLARs can produce very detailed maps of basin characteristics, even in traditionally cloudy areas and areas with heavy vegetation growth. Interferometric SLAR can also provide quantitative measures of topography.

Image processing functions have been developed to extract information from satellite imagery, although many of the procedures may be applied to other grid datasets as well. Jensen [3] describes image processing functions and techniques in some detail. Image classification is accomplished using multispectral classification methods that transform raw reflectivity data into information on land cover classes. There are a variety of classification algorithms including (1) hard classification using supervised or unsupervised approaches, classification using fuzzy logic, and/or (2) hybrid approaches using ancillary (collateral) information. Supervised classification involves a priori identification and location of land cover types, such as urban, agriculture, or wetland, through a combination of field work, aerial photography, and other mapping. Specific sites, called training sites, having known spectral characteristics are located in the image and are used to train the classification algorithm for application to the remainder of the image. This is a hard classification scheme since each pixel is assigned to only one class. In unsupervised classification, the identities of land cover types are not known a priori, and training site



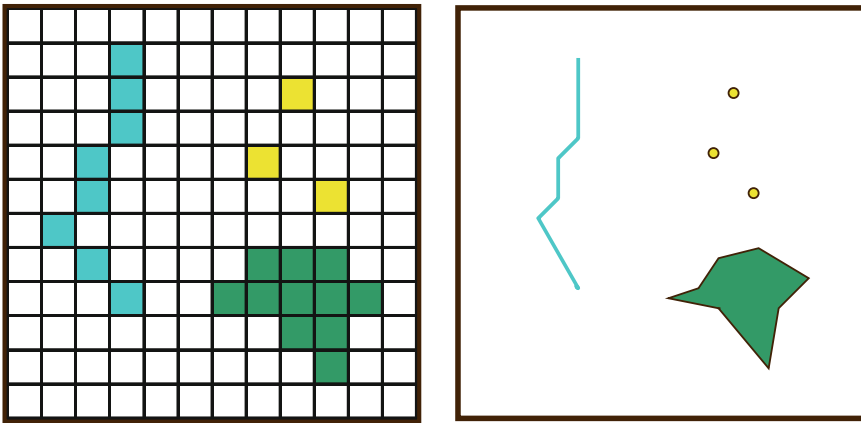
**Fig. 7.2.** Image processing techniques are used to classify land characteristics. Example shown identifies wetland areas in mixed agricultural landscape [4].

data are not collected or are unavailable. Figure 7.2 illustrates an example of image classification for wetland identification.

#### 2.4. GIS Data Models and Geodatabases

GIS databases incorporate two distinct branches: the spatial database and the associated attribute database. Many GIS software maintain this distinction; the spatial data is characterized as having a “vector” structure comprised of features represented as points, lines, and polygons. Other GIS spatial data are handled as images, or “rasters,” having simple row and column formats. Figure 7.3 illustrates the difference between the raster and vector data structures. Attribute data are handled in relational database software comprised of records and fields, and the power of the relational model is applied for these data. These feature data are “tagged” to the spatial database to facilitate tabular data retrievals.

Database management systems (DBMS) are computer programs for storing and managing large amounts of data. Required functions of a DBMS include (1) consistency with little or no redundancy, (2) maintenance of data quality including updating, (3) self-descriptive with metadata, (4) a database language for query retrievals and report generation, (5) security including access control, and (6) shareable between users. Most DBMS are designed to handle attribute data. A special characteristic of a geodatabase is the join between spatial and attribute data for water resources system features.



**Fig. 7.3.** Raster (grid) and vector data structures provide complementary means for representing location and character of map features.

## 2.5. GIS Analysis Functions

GIS analysis capabilities are specifically keyed to the spatial realm. An analysis function unique to GIS is the overlay operation whereby multiple data themes can be overlain and the incidence of line and polygon intersections are derived. This graphical and logical procedure is used in many ways to identify the correspondence between multiple data layers. Other GIS functions include networks and connectivity operations, terrain analyses, statistical interpolation, and other neighborhood procedures, as well as functions for spatial database development and maintenance.

The nature of the data representation has a strong influence on the analysis that can be applied. Spatial data in GIS are most often organized into vector and raster (or surface) data structures (Fig. 7.3). In the vector structure, geographic features or objects are represented by points, lines, and polygons that are precisely positioned in a continuous map space, similar to traditional hard copy maps that identify landmarks, buildings, roads, streams, water bodies, and other features by points, lines, and shaded areas. In addition, each object in the vector structure includes topologic information that describes its spatial relation to neighboring objects, in particular its connectivity and adjacency. This explicit and unambiguous definition of and linkage between objects makes vector structures attractive and allows for the automated analysis and interpretation of spatial data in GIS environments [5].

On the other hand, surface, or raster (from display technology), data structures divide space into a two-dimensional grid of cells where each cell contains a value representing the attribute being mapped. A raster is an  $x, y$  matrix of spatially ordered numbers. Each grid cell is referenced by a row and column number with the boundary of the grid being registered in space to known coordinates. Raster structures arise from imaging sources such as satellite imagery and assume that the geographical space can be treated as though it was a flat Cartesian surface [6]. A point is represented by a single grid cell, a line by a string of



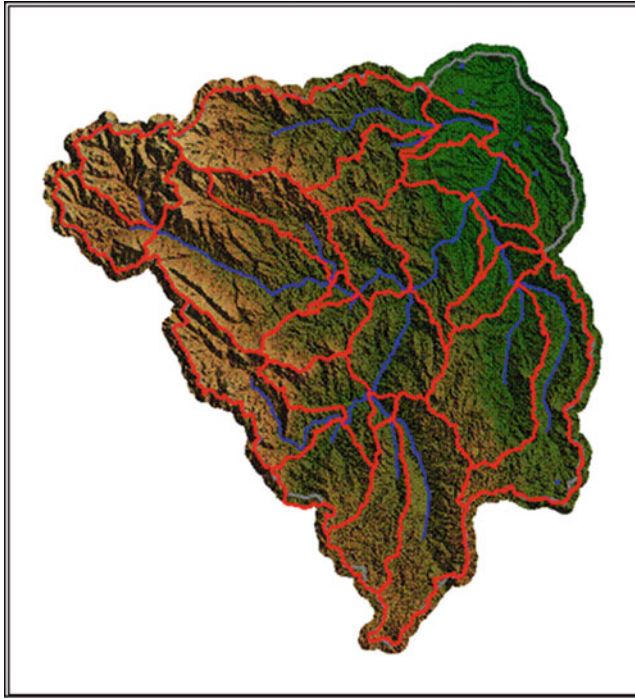
connected cells and an area by a group of adjacent cells. When different attributes are considered such as soil and land use, each is represented by separate raster layers. Operations on multiple layers involve the retrieval and processing of the data from corresponding cell positions in the different layers. This overlay concept is like stacking layers (two-dimensional grids) and then analyzing each cell location [5]. The simplicity of data processing in raster structures has contributed to its popularity. Both vector and raster structures are valid representations of spatial data. The complementary characteristics of both structures have long been recognized, and modern GIS can process both structures, including conversion between structures and overlays of both structures.

GIS provides a rich suite of intrinsic functions that perform analyses using attributes of spatial data. In many respects, these intrinsic functions provide unprecedented capabilities (i. e., no historical manual equivalent) that are difficult and time consuming if performed manually. Terrain processing for watershed delineation is but one example of GIS functions that can be conducted much easier and better than can be done manually. As will be shown in subsequent chapters, the range and sophistication of spatial analyses applied to water resources problems are extensive. Moreover, integration of conventional water resources analysis procedures into the GIS sphere has extended the realm of GIS to include advanced surface modeling, simulation, and optimization functions heretofore not often recognized by GIS practitioners. Also, the water resources field now includes a wide range of decision support systems for planning and operations that involve a dominant spatial dimension; these are called spatial decision support systems (SDSS).

The art and science of using a GIS entails combining the available analysis functions with the appropriate data to generate the desired information. GIS practice therefore requires some schema of design to ensure that the effort is focused on answering the appropriate questions. Here, the GIS database, modeling, and visualization tools provide enhancements to the traditional engineering design process. The GIS provides a powerful means to manage data, conduct analyses, and communicate planning and design outcomes to the various “publics” concerned with these outcomes. This communication dimension of GIS is particularly important in environmental and water resources engineering because much of our work concerns public resources having significant impacts over extensive areas on a large number of interest groups.

General categories of analysis functions include the following:

1. Data capture and maintenance
2. Geometrics and measurements
3. Spatial and aspatial queries; classifications
4. Neighborhood operations
5. Spatial arrangement, connectivity functions, and networks
6. Surface operations
7. Overlays and map algebra
8. Spatial statistics
9. Display, interfaces, integration
10. Management models



**Fig. 7.4.** DEM processing routines are applied to extract stream networks and watershed.

Automated extraction of watersheds or surface drainage, channel networks, drainage divides, and other hydrographic features from DEMs is a standard surface processing routine in modern GIS (Fig. 7.4). The eight-direction, or D-8, method is the most common approach to identifying the direction of flow from a grid cell. Using an iterative approach similar to the spread and seek functions, the D-8 defines the drainage network from raster DEMs based on an overland flow analogue. The method identifies the steepest downslope flow path between each cell of a raster DEM and its eight neighbors and defines this path as the only flow path leaving the raster cell. The method also accumulates the catchment area downslope along the flow paths connecting adjacent cells. The drainage network is identified by selecting a threshold catchment area at the bottom of which a source channel originates and classifying all cells with a greater catchment area as part of the drainage network. This drainage network identification approach is simple and directly generates connected networks.

## **2.6. User Interfaces and Interaction Modes**

A primary attraction of modern GIS is the user-friendliness of the computer system interface provided by the various software vendors. Efficient retrieval of data depends not only on properly structured data in the database and speed of retrieval but also on well-designed interfaces and query languages. The human-computer interface provides the environment that enhances human interaction with the GIS. It makes it easy for the user to access

data and analysis results and to display these data in understandable formats. Most traditional information systems provide limited presentation formats, usually as text, tables, and graphs. While these formats are still useful, the spatial character of geodata allows additional possibilities, including map formats and visualization techniques.

To achieve usability, GIS software has progressed from command entry modes to menu and forms modes to graphical user interfaces (GUI) [7]. A GUI enables a user to interact with the computer system by pointing to pictorial representations (icons) and lists of menu items on the screen using the mouse. Using the icons provides a means for the primary functionality of data selection, data presentation, and data manipulation.

Visualization is an extension of the traditional data retrieval and display concepts. It includes techniques that aid in the interpretation of spatial datasets. Since GIS is concerned with analysis and interpretation, it is the graphics-based nature of GIS that allows perception of spatial patterns and features of the information, extraction of parameters, and discrimination of classes of objects [8].

## ***2.7. GIS System Planning and Implementation***

Consideration of organizational factors is important to successful GIS implementation and management because of the critical role that information plays in an organization's role and purpose. In most cases, the design and implementation of a GIS and is a long-term effort that involves changes in the way an organization does its work. Experience has shown that, as important as technical issues of software, hardware, and database design are, it is the people problems arising from access to the information and its use that determine whether a GIS will succeed or fail [9].

During the planning of a major GIS acquisition and/or development, it is important to consider certain organizational attributes that will impact the chosen approach. These attributes, generally addressed in a Needs Assessment, should be evaluated in the broadest possible sense. In this way, the goals, equipment, costs, etc., of all impacted departments will be included in the implementation planning. Only after careful consideration of these attributes can the best possible implementation strategy be chosen. Some attributes to consider:

- Overall organization function and goals.
- Sources of data available as input to the GIS system.
- GIS hardware/software/databases and products that are currently and planned to be utilized.
- Management approaches that will guide and have guided the GIS program to date.
- Costs of implementation, both historic and planned.
- Benefits of implementation, both tangible and intangible.
- Procedure to be used in evaluating and comparing the costs and benefits.
- Review generation procedures: internal, external, current, and potential.
- Quality Assurance/Quality Control Procedures (QA/QC) and any applicable data standards.
- End-user interactions and training consider how the GIS group will communicate with its "clients."
- Evaluation/assessment procedures to be used to review the GIS implementation.
- Legal issues pertaining to data distribution and ownership.

Although it is difficult to quantify many of these attributes, it is a useful exercise to at least estimate the worth of each one. For instance, many organizations consider a formal cost/benefit analysis to be based on highly speculative information, although it is possible to measure the relative “goodness” of intangible benefits on a relative scale. Further, as these types of organizational issues are discussed during planning, a broader and more realistic picture of the resulting GIS implementation becomes available.

## 2.8. GIS Software

There are a large number of GIS software options which are available as open source or commercial products. A large listing of GIS software can be found at: [http://en.wikipedia.org/wiki/GIS\\_software](http://en.wikipedia.org/wiki/GIS_software).

## 3. GIS FOR SURFACE WATER HYDROLOGY

### 3.1. GIS Data for Surface Water Hydrology

The watershed runoff processes are inherently spatial in character so there is a strong motivation to use GIS tools to organize the data and formulate hydrologic models. Surface water hydrology is perhaps the area for which GIS has been most applied in the water resources and environmental field. The advent of digital data products and software for processing spatial data has prompted a change in the way we look at hydrologic systems and made it possible to more precisely describe watershed characteristics and runoff response to precipitation inputs. There is a movement away from the so-called “lumped parameter” models to more spatially distinct or “distributed” modeling approaches that represent fundamental physical processes.

The general availability of DEMs, TINs, DLGs, digital soil and land use data, radar-rainfall and satellite imagery, real-time gage reporting, and the GIS software to process these has contributed to an increased awareness of the spatial distribution of hydrologic processes. Most surface water hydrologic applications begin with raster data of the terrain due to the wide availability of DEMs and intrinsic GIS software functions to conduct digital terrain processing. For highly detailed terrain mapping, such as required to define floodplain details, there is increasingly wide use of Light Detection and Ranging (LIDAR) data.

Hydrographic vector data of surface water systems are also common and may have been developed as features in the original map making process or derived from DEM processing. A primary dataset on stream vectors is the National Hydrography Dataset (NHD; Fig. 7.5). The NHD is designed to combine spatial accuracy with detailed features, attributes, and values to provide information on flow paths, permanent reach IDs, and hydrologic ordering for use in modeling [10].

Soil data are available from the soil-mapping agencies, typically those dealing with the agriculture sector. In the USA, soil survey data are available in digital formats from the Natural Resources Conservation Service (NRCS), including the State Soil Geographic (STATSGO) and Soil Survey Geographic (SSURGO) databases. The mapping scale for

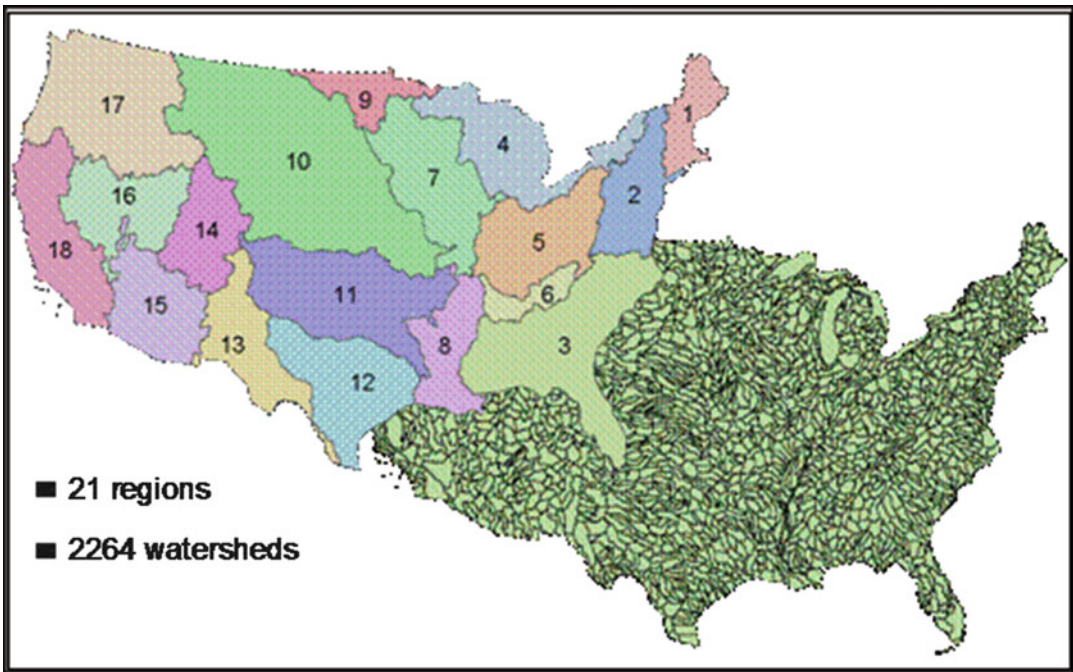
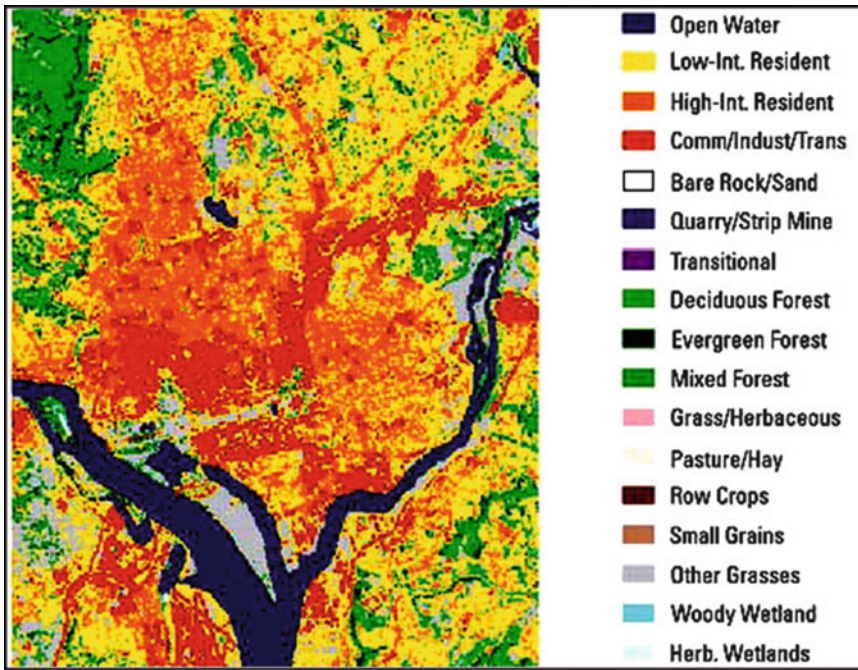


Fig. 7.5. NHD watersheds are organized in a hierarchical manner for the various levels of scale [11].

STATSGO map is 1:250,000 and was created by generalizing more detailed soil survey maps. The SSURGO digitizing duplicates the original soil survey maps at mapping scales ranging from 1:12,000 to 1:63,360. SSURGO is linked to the National Soil Information System (NASIS) attribute database. The attribute database gives the proportionate extent of the component soils and their properties for each map unit. Recent advances in remote sensing technology have shown that soil moisture can be quantitatively estimated using microwave technology under a variety of topographic and vegetation cover conditions. A summary assessment of the state of the art of remote sensing of soil moisture was presented by the National Research Council [11].

Land use and land cover information is used in hydrologic modeling to estimate surface roughness or friction values since it affects the velocity of the overland flow of water. Sources of land use data include the USGS-EPA National Land Cover Dataset (NLCD) which has been developed with time stamps for 1992 and 2001 and is appropriate for most watersheds modeling (Fig. 7.6). The most recent release includes an impervious surface coverage. Interpretation of land use information from satellite imagery or aerial photography is another means of obtaining land use and land cover data. The techniques of supervised and unsupervised classification of satellite imagery yield clusters of different spectral classes that are assigned into different land use types. The same technique can be used with aerial photos that are digitally scanned. Research by Ragan and Jackson [12] and Bondelid et al. [13] has shown that the degree of urban land use or various categories of agriculture or forest can

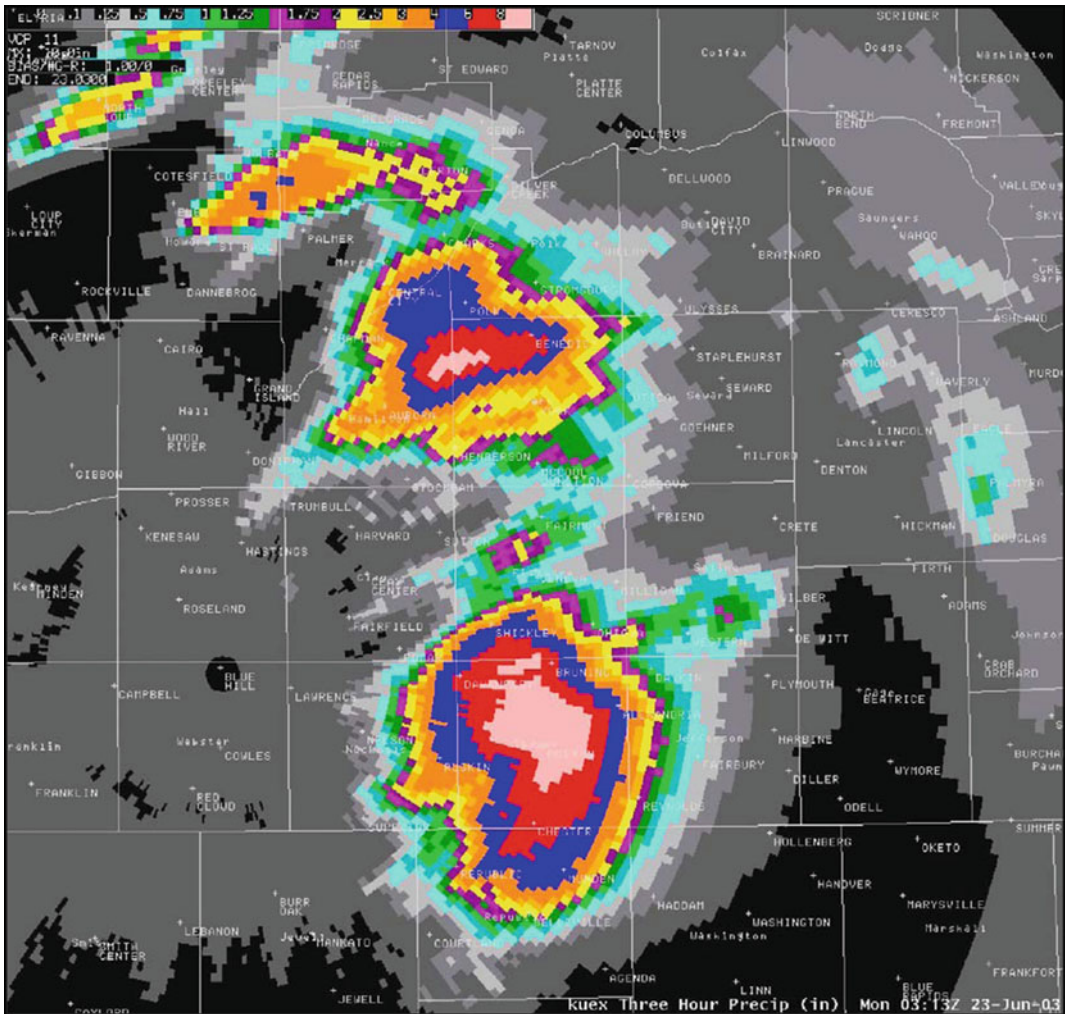


**Fig. 7.6.** National Land Cover Dataset is available nationwide and is widely used for watershed modeling studies.

be determined accurately through remote sensing and used as variables in urban runoff models or the SCS runoff curve number method.

Precipitation and climate data of various types are routinely collected by the National Weather Service, other agencies, and citizen volunteers at specific locations. The primary data archive for climate and other meteorological data is the National Climatic Data Center (NCDC). Land-based observations archived by the NCDC contain various meteorological elements that over time describe the climate of a location or region. These elements include temperature, dew point, relative humidity, precipitation, snowfall, snow depth, wind speed, wind direction, cloudiness, visibility, atmospheric pressure, evaporation, and soil temperatures.

Weather radars have become a primary source of rainfall data (Fig. 7.7). Weather radar data are available from the National Weather Service (NWS) Weather Surveillance Radar Doppler units (WSR-88D) throughout the USA. The WSR-88D radar transmits horizontal pulses, which give a measure of the horizontal dimension of the cloud (cloud water and cloud ice) and precipitation (snow, ice pellets, hail and rain particles). Over a 5- to 10-min period, successive scans are made with  $0.5^\circ$  increments in elevation. The reflectivity observations from these scans are integrated over time and space to yield estimates of particle size and density in an atmospheric column over a particular location. To simplify data management, display, and analysis, the NWS digitizes and reports reflectivity for cells in a Hydrologic Rainfall Analysis Project (HRAP) grid. Cells of the grid are approximately 4 km by 4 km.



**Fig. 7.7.** Radar-rainfall data are being collected nationwide by the WSR-88D system. Image displays example of 3-h rainfall accumulation product [14].

Satellite imagery can provide useful information on rainfall distribution over large areas and inaccessible regions. However, direct measurement of rainfall from satellites for operational purposes has not been generally feasible because the presence of clouds prevents direct observation of precipitation with visible, near-infrared, and thermal infrared sensors. The visible and infrared images from the polar-orbiting satellites, including the NOAA N series and the Defense Meteorological Satellite Program, and geostationary satellites such as GOES, GMS, and Meteosat provide information only about the cloud tops rather than cloud bases or interiors. These satellites provide frequent observations (even at night with thermal sensors), and the characteristics of potentially precipitating clouds and the rates of changes in

cloud area and shape can be observed. From these observations, estimates of rainfall can be made which relate cloud characteristics to instantaneous rainfall rates and cumulative rainfall over time. Improved analysis of rainfall can be achieved by combining satellite and conventional gage data.

Snow is another hydrologic variable that has been successfully measured for large regions using aerial and satellite remote sensors. Ground-based snow surveys are also routinely collected at sites by the Natural Resources Conservation Service (NRCS). The National Operational Hydrologic Remote Sensing Center (NOHRSC) ingests daily ground-based, airborne, and satellite snow observations from all available electronic sources for the coterminous USA. These data are used along with estimates of snowpack characteristics generated by a physically based snow model to generate the operational, daily NOAA National Snow Analyses (NSA) for the coterminous USA. Extent of snow cover can be determined with satellite visible and near-infrared (VIS/NIR) data and can be observed in remote regions that are generally inaccessible during the winter months.

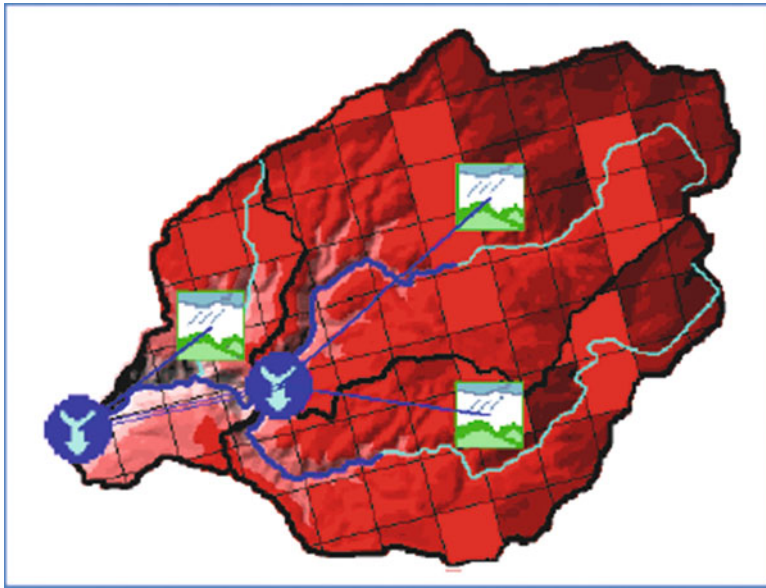
### ***3.2. GIS for Surface Water Hydrology Modeling***

GIS analysis and database functions provide extensive means for developing surface water hydrologic models datasets and modeling operations. A primary area of application is processing of digital terrain data to derive landscape features pertinent to hydrology such stream paths and drainage divides. GIS databases are created to help organize the multitude of spatial and nonspatial attribute data needed for surface water hydrologic studies. Intrinsic GIS surface and network analysis functions provide fundamental capabilities for deriving surface water modeling products.

Digital representations of landscape topography as digital elevation models (DEM) or digital terrain models (DTM) incorporate arrays of elevation values so that terrain features can be evaluated using specialized numerical algorithms and GIS visualizations rendered. Landscape features such as slope, aspect, flow length, contributing areas, drainage divides, and channel network can be rapidly and reliably determined from DEMs even for large watersheds [15]. A concise review of digital terrain processing methods was presented in DeBarry [16]. Automated extraction of surface drainage, channel networks, drainage divides, drainage networks and associated topologic information, and other hydrography data from DEMs has advanced considerably over the past decade and is now routinely a part of most GIS software packages.

The common problem of obtaining rainfall data for the watershed of interest using point rain gages is addressed using spatial interpolation procedures. Interpolation methods are appropriate when an attribute measured at sample points is a spatially continuous field variable. Usually, the interpolation process involves estimating the rainfall values onto a regular grid. Alternately, contours may be fitted to the grid and the data represented as vector objects with labels or as polygon objects having the contours as boundaries. The interpolated surface may also be represented as a TIN. There are a wide variety of procedures for interpolation and supporting literature (e.g., [17, 18]). For this discussion, five methods are described: (1) nearest neighbor, (2) isohyetal, (3) triangulation, (4) distance weighting, and





**Fig. 7.8.** HEC-GeoHMS provides an integrated GIS work environment for watershed modeling.

(5) kriging. A concern with interpolation with sparse network data is that different interpolation methods may yield differing results; an independent verification dataset is commonly used to determine the best method.

GIS procedures for computing evaporation and evapotranspiration (ET) include interpolation of the input meteorological data from weather stations to the location of interest. These spatial interpolations may be accomplished in a manner similar to those used for rain gage data. Computations may be accomplished using map algebra techniques for regular grid structures across the landscape taking account of differences in temperature, precipitation, elevation, soils, vegetative cover, and other variables as required.

Runoff is generated from excess precipitation that has not infiltrated or been stored on the land surface. This direct runoff is translated from its location on the ground to the nearest stream channel (overland flow) of to the watershed outlet. The unit hydrograph is a well-known, commonly used empirical model of the relationship of direct runoff to excess precipitation [18]. Various versions of the UH have been developed, including (1) user-specified UH and (2) Clark's UH, Snyder's UH, the SCS UH, and ModClark UH. These are options incorporated into the HEC-HMS software package (Fig. 7.8; [18]). The Geospatial Hydrologic Modeling Extension (HEC-GeoHMS; [19]) is a software package for use with the ArcView<sup>®</sup> GIS. GeoHMS uses ArcView and Spatial Analyst to develop a number of hydrologic modeling inputs. Analyzing digital terrain information, HEC-GeoHMS transforms the drainage paths and watershed boundaries into a hydrologic data structure that represents the watershed response to precipitation. In addition to the hydrologic data structure, capabilities include the development of grid-based data for linear quasi-distributed runoff transformation



Fig. 7.9. Watersheds with Pfafstetter index numbering [20].

(ModClark), the HEC-HMS basin model, physical watershed and stream characteristics, and a background map file.

Flow routing through the channel network is accomplished using a variety of mathematical representations of the fundamental equations of channel flow hydraulics. For example, The HEC-RAS system contains four one-dimensional river analysis components for (1) steady flow water surface profile computations, (2) unsteady flow simulation, (3) movable boundary sediment transport computations, and (4) water quality analysis. A key element is that all four components use a common geometric data representation and common geometric and hydraulic computation routines [18]. Regardless of the channel routing method, GIS representations of the network as a binary tree collection of reaches and junctions are central to coordinating the logical sequencing of computations from an upstream to downstream direction. The network database includes the topological relations to identify upstream and downstream nodes and junction characteristics. Sometimes the indexing code generated by the stream network derivation (e.g., Pfafstetter code) is used to schedule the sequencing of computations (Fig. 7.9).

Increasing availability of high-resolution DEMs and land surface data provides a foundation for distributed models of the watershed. The ModClark time-area method mentioned above is an example of a semi-distributed model. Also, a large basin may be represented as a collection of sub-basins; the overall system representation can be considered distributed. For fully distributed

models, the excess precipitation amounts computed for various locations in the watershed, usually on a grid structure, are routed overland and through channels to the basin outlet. The distributed approach allows flow predictions at many points internal to the watershed.

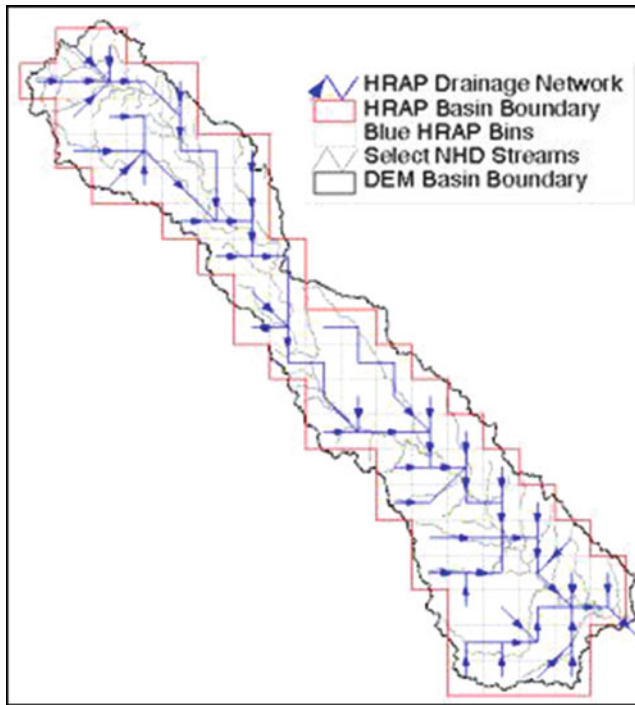
The NWS Research Modeling System (HL-RMS) is an example of a fully distributed approach [21]. The HL-RMS has been developed to support proof of concept research comparing distributed modeling approaches with the more traditional lumped models based on the UH. Some of the main features of the current HL-RMS are:

- Ingests gridded NEXRAD-based products.
- Basic modeling unit is the NEXRAD grid cell (~4 km).
- Rainfall-runoff calculations are done independently for each grid cell.
- Runoff is routed over hillslopes within a model cell.
- Channel routing is done from cell to cell.
- Rainfall-runoff calculations can be done using lumped or distributed rainfall and lumped or distributed parameters.
- Uses the Sacramento Soil Moisture Accounting Model (SAC-SMA).
- Uses the kinematic method for both hillslope and channel routing.
- Writes output parameter, state, or forcing grids that can be displayed in ArcView GIS.

In HL-RMS, the impervious, surface, and direct runoff components are routed over conceptual hillslopes within each NEXRAD cell to a conceptual channel. Because of the relatively large size of the 4-km model cells, the cells are subdivided into conceptual hillslopes to make overland flow distances physically realistic. A drainage density parameter in the model is used to subdivide a cell into equally sized overland flow planes. These hillslopes drain to a conceptual channel segment within the same cell. Cell-to-cell channel routing is done using flow direction networks like that illustrated in Fig. 7.10. Three parameters are defined in each cell for kinematic overland flow routing: hillslope slope, hillslope roughness, and drainage density. Representative hillslope slopes are estimated using DEM data (initially with 30-m DEM data for basin-scale applications and 400-m DEM data for regional-scale applications) by first computing the local slope of each DEM cell in the study domain using the Arc/Info slope function and then averaging all of the DEM cell slopes in each 4-km model cell. A kinematic routing scheme is applied for the channels; parameters are based on stage-discharge, channel cross section, and other geomorphic data.

There are a number of surface water hydrologic models having integrated GIS interfaces and databases. A large listing of hydrologic models can be found at the Hydrologic Modeling Inventory Website (<http://hydrologicmodels.tamu.edu/>).

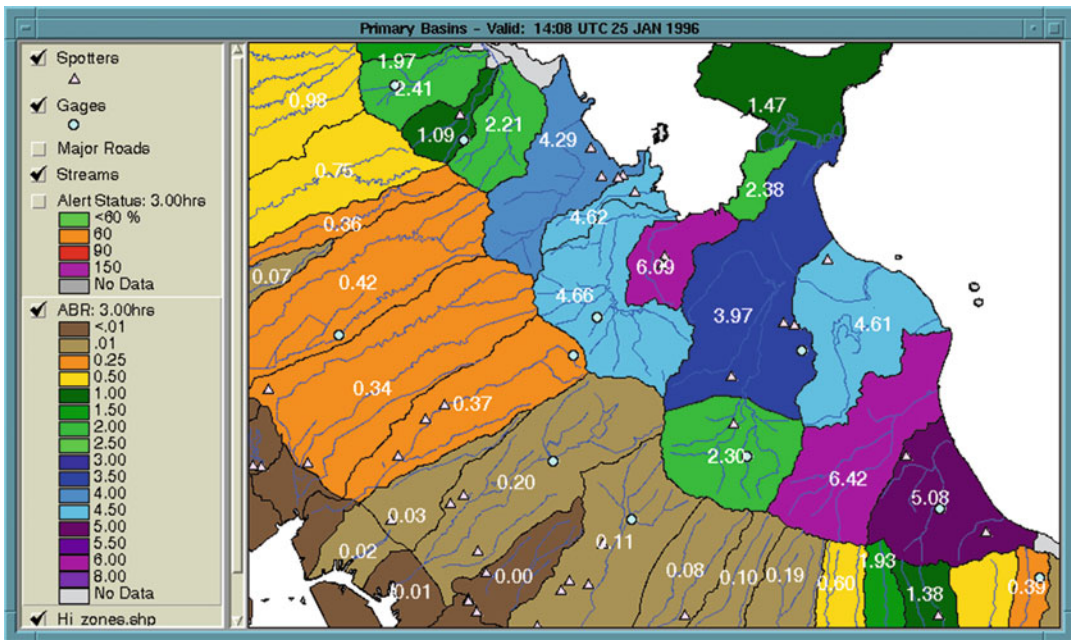
The National Weather Service has developed various methods for assessing the threat of flash floods for local forecast regions. The AMBER algorithm was developed at the Pittsburgh NWS Forecast Office in the early 1990s. The AMBER program provides the field forecaster direct guidance for issuance of flash flood warnings. AMBER directly links WSR-88D radar-rainfall estimates with all defined watersheds, down to a 2-square mile area (3 sq. km). AMBER computes average basin rainfall (ABR) in each watershed for direct comparison with flash flood guidance or other thresholds set by the forecasters. AMBER also computes



**Fig. 7.10.** HL-RMS distributed model represents conceptual hillslopes within a 4-km HRAP grid cell-to-cell drainage network [21].

the “rate” or intensity of each watershed ABR every 5–6 min. Scan-to-scan accumulation for all bins in a basin is summed using area of bin as weighting factor to compute ABR. The database saves the ABR for each basin for each scan-to-scan accumulation time period. Also, the ABR from scan-to-scan periods is summed to produce accumulation over longer time periods.

Basin delineations for AMBER were derived nationwide using GIS terrain processing procedures. A basin was defined for each segment of a stream network, and basins were defined for various thresholds of basin scale including (1) headwaters (e.g., less than 50 square miles); (2) streams (less than 200 square miles); (3) rivers (greater than 200 square miles); (4) urban areas, any area known to be prone to flooding; and (5) rain gages (single bin over rain gage location for gage) and radar comparison. Figure 7.11 shows an example AMBER display. As implemented for flash flood monitoring, the interface provides access to the various levels of basin scale. It can be difficult to monitor 5,000–10,000 small basins so only those basins which exceed rainfall and rainfall thresholds can be displayed. Also, a database on results for all basins can be sorted and the ABR, FFG, Alert Status, and Basin Rate of Accumulation (BRA) output for each basin for each Alert Time Period.



**Fig. 7.11.** Sample ArcView<sup>®</sup> GIS AMBER basin display. Basins are color coded by the 3-h ABR value for the basin. Streams and gage and spotter locations also are displayed. Numbers are the actual ABR in inches for the basin.

## 4. GIS FOR FLOODPLAIN MANAGEMENT

### 4.1. Floodplain Mapping Requirements

Extensions of surface water hydrologic modeling apply to floodplain mapping and GIS tools play an important role in accomplishing these activities. Given the regulatory authority of the Federal Emergency Management Agency (FEMA), it is their standards that establish primary mapping requirements for floodplains [22]. FEMA defines technical requirements, product specifications for Flood Hazard Maps and related National Flood Insurance Program (NFIP) products, and associated coordination and documentation activities.

Data required for floodplain mapping and management purposes are comprised of three general categories: (1) floodplain and watershed topography data to support hydrologic and hydraulic modeling, (2) physical data on built facilities for drainage control and buildings, and (3) administrative data on jurisdiction boundaries. These data are developed from a variety of sources using various GIS procedures and technologies and are ultimately collected into a comprehensive dataset supportive to project needs and longer-term multiple purpose management purposes. GIS tools for floodplain map updates have become standard practice. Floodplain maps and information prepared using traditional methods during the 1970s and 1980s are the basis for most current regulatory programs. Programs for map modernization are progressing, and GIS standards are promulgated for these.

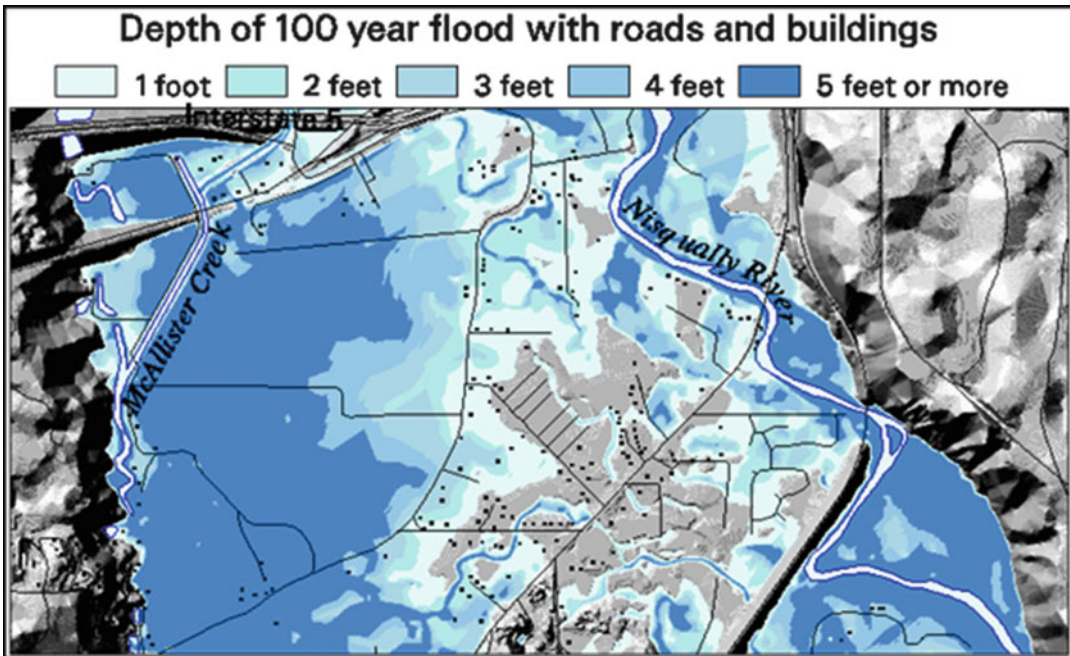


Fig. 7.12. Flood depth map with locations of roads and buildings [23].

A study by the USGS for the Nisqually River near Puget Sound, Washington [23], demonstrated the effectiveness of modern elevation data and GIS for updating flood maps. Existing floodplain maps were shown to have a number of shortcomings as follows: (1) based on out-of-date flood probability estimates, (2) hand drawn and difficult to manage, (3) have limited vertical accuracy, and (4) are expensive and time consuming to update. The GIS approach was shown to be (1) relatively inexpensive (10–20 % of traditional methods), (2) equally accurate and more detailed, (3) provided depth-of-flood details, (4) able to identify areas of uncertainty, and (5) digital, so analyses could be extended to other themes (e.g., roads and buildings) in support of risk assessments. GIS was used to create and manipulate digital elevation models representing the land surface and the flood surface. Determining the inundated area is a simple calculation: the flood surface elevation model is subtracted from the land surface elevation model at each location, resulting in negative values wherever the flood elevation is greater than the land elevation. A by-product of this calculation is flood depth which is important for damage and insurance assessments when intersected with building floor elevations (Fig. 7.12).

#### 4.2. Floodplain Geodatabase

Given the extensive and disparate data sources required for floodplain mapping, there is a strong motivation to integrate the data into a comprehensive geodatabase. Doing so would provide advantages that a geodatabase provides in terms of standardization, removal of

redundancy, concurrency control, and transferability, to name a few. FEMA has developed various data collection and reporting standards for floodplain studies as part of their nationwide program of map modernization. The two principle documents relevant to the design of a geodatabase for FEMA flood hazard mapping are (1) Appendix L of the Guidelines and Specifications for Flood Hazard Mapping Partners: Guidance for Preparing Draft Digital Data and DFIRM Database [24] and (2) Appendix N of the Guidelines and Specifications for Flood Hazard Mapping Partners: Data Capture Standards (DCS) [22]. These standards specify the current GIS databases used for archiving flood hazard models and results. Figure 7.13 presents the DCS relationship diagram for hydraulics.

### 4.3. Floodplain Hydraulic Modeling with GIS

The technical core of floodplain studies is the hydrologic and hydraulic modeling activities that lead to delineation of the floodplain boundary. GIS has become central to the conduct of such modeling studies, providing the means for integration of the various data involved, coordinating the various models, and providing high-resolution maps required for supporting flood management strategies.

There are a number of floodplain hydrologic and hydraulic (H&H) modeling packages that have been developed by the public and private sectors. H&H software varies in their capabilities for representing floodplain hydraulics and the level of GIS integration. In the 1-D approach, water flow is assumed to occur in one dominant spatial dimension aligned with the center line of the main river channel. The geometry of the problem is represented in the model by channel and floodplain cross sections perpendicular to the channel centerline. Two-dimensional approaches solve for water level and depth-averaged velocities in two spatial dimensions using finite difference, finite element, or finite volume computational grid approaches [25]. The 2-D models are appropriate for situations where there is opportunity for flood waters to spill out primary channels and flow overland, such as alluvial fans.

A popular public domain floodplain software package is the HEC-RAS, HEC-GeoRAS software package developed by the US Army Corps of Engineers. HEC-GeoRAS is a set of procedures, tools, and utilities for processing geospatial data in ArcGIS<sup>®</sup> using a graphical user interface (GUI) [19]. Figure 7.14 illustrates the type of display obtainable from HEC's GeoRAS [26].

An example of 2-D hydraulic modeling was demonstrated for the South Boulder Creek floodplain study. The MIKE FLOOD<sup>®</sup> model used in the study combines the traditional channelized one-dimensional (or 1-D) flow analysis model with a more physically based two-dimensional (or 2-D) model that analyzes distributed flow patterns away from the channel and across the floodplain. Due to the complexity of flow paths, the city updated the older 2-ft mapping with detailed 1-ft contour interval maps. These topographic data were developed using LIDAR technology which provided a DEM having 1-m grid spacing and a

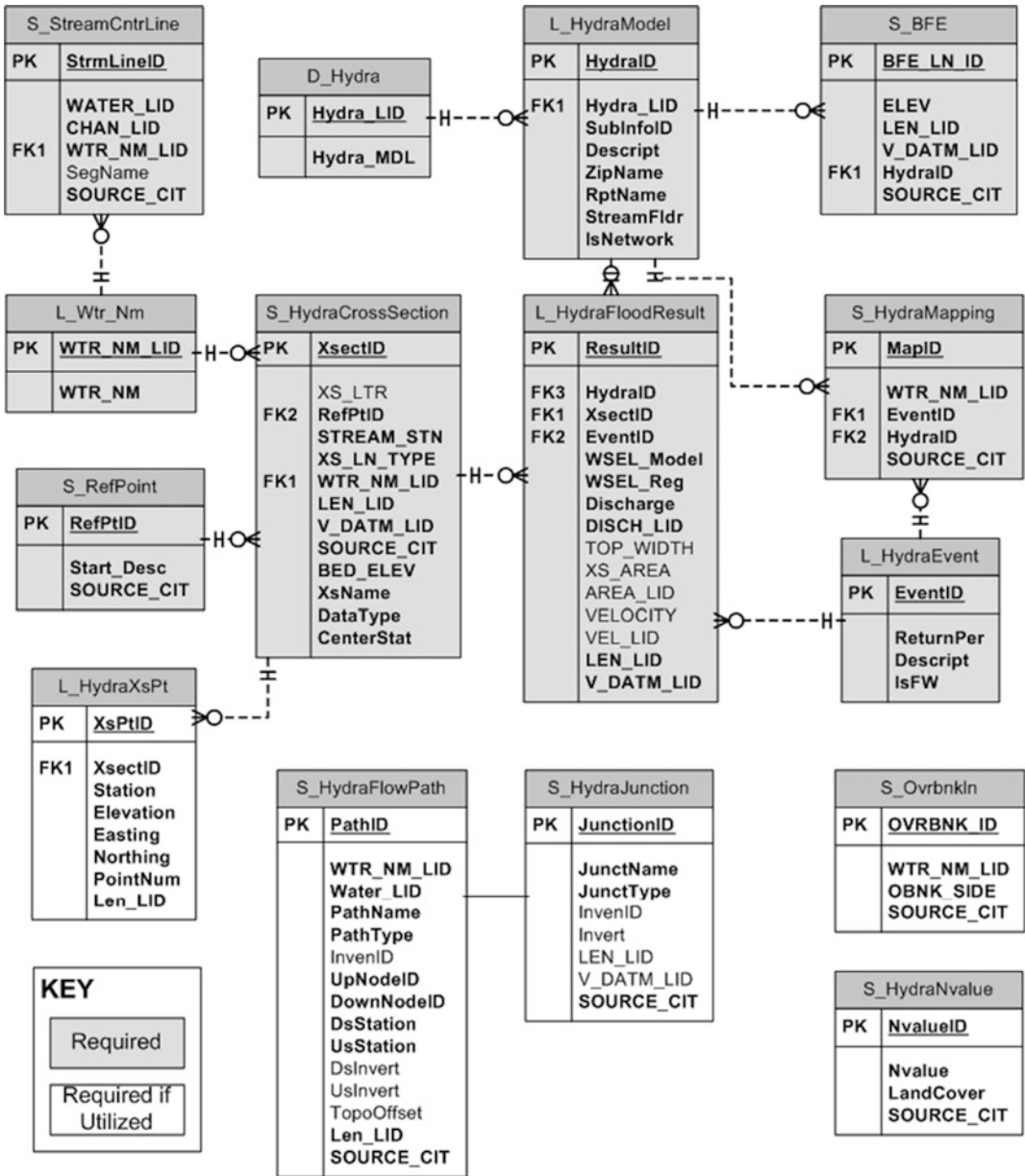


Fig. 7.13. Data Capture Standards relationship diagram for hydraulics [22].

vertical resolution of 15 cm. This allowed representation of the ground and structures in greater detail. Figure 7.15a shows the definition of one-dimensional channel and canal segments on a high-resolution digital orthophoto. Figure 7.15b shows a segment of the LIDAR DEM used as the land base for the two-dimensional model.



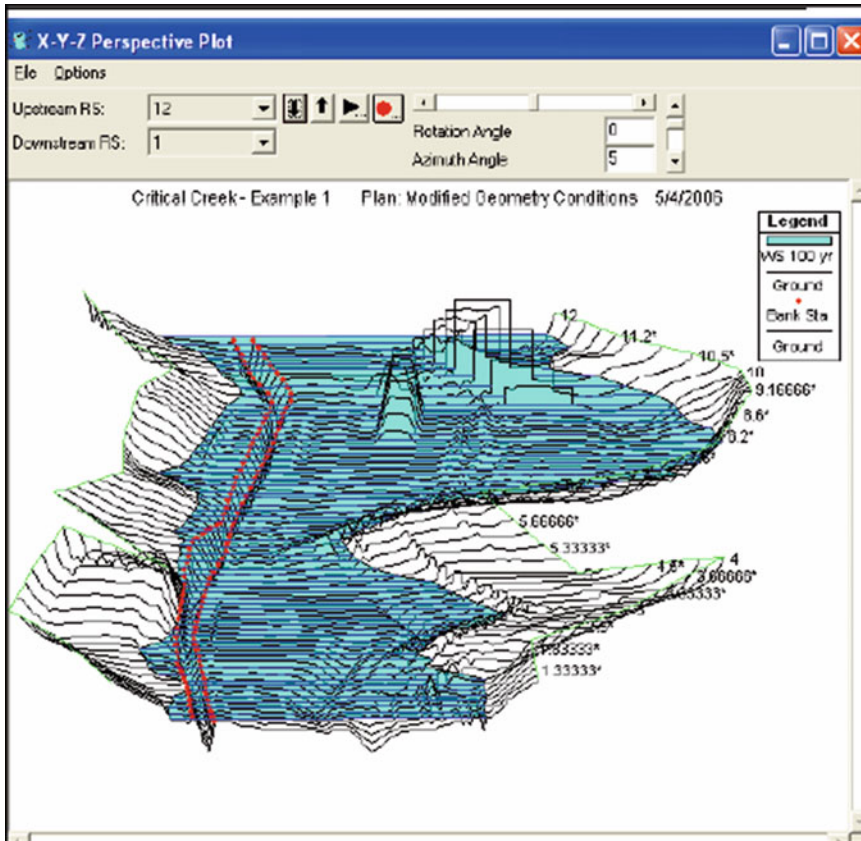


Fig. 7.14. HEC-GeoRAS perspective plot of river reach with a bridge [19].

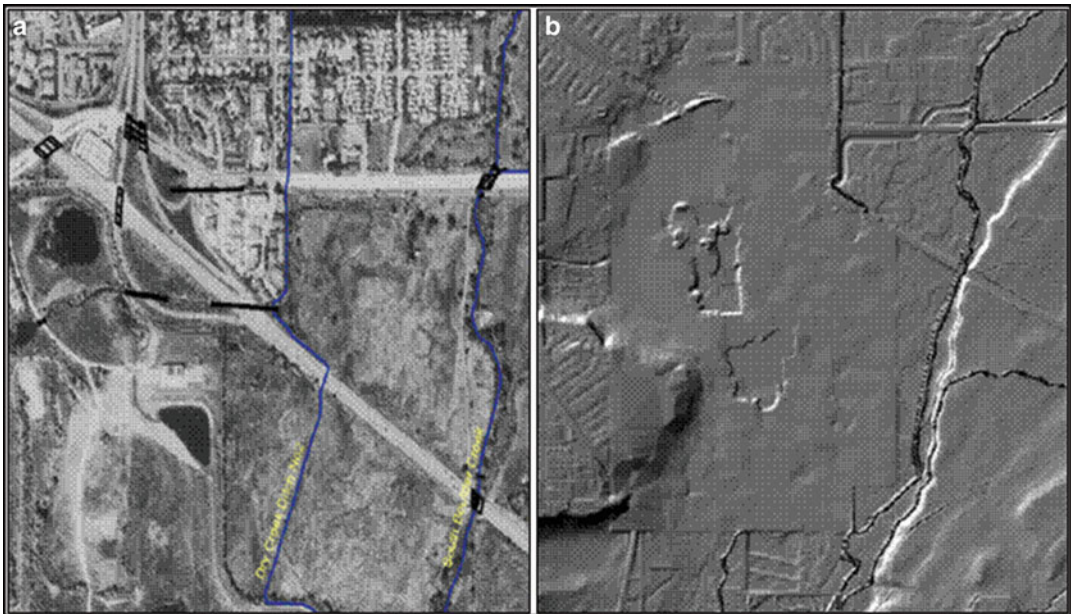


Fig. 7.15. Channel and floodplain hydraulic features were defined by (a) digital orthophotos and (b) LIDAR DEM for South Boulder Creek floodplain study. Courtesy of City of Boulder, CO.

## 5. GIS FOR WATER SUPPLY SYSTEMS

### 5.1. Overview

Water supply systems are fundamental infrastructure components sustaining community public health and economic productivity. This paper reviews water supply distribution systems and components, aspects of their design and operation, and GIS concepts and tools which support these activities. GIS tools are applied for demand estimations, network design, and system operations. GIS spatial data management and analysis tools enable these functions. Without GIS, required system parameters are often generalized. Spatial details on pipe connections are often reduced to a single value expressing average tendency over a group of connections which may introduce significant error. A GIS provides functions for development and preparation of accurate spatial information for input to network design simulation models and operations control.

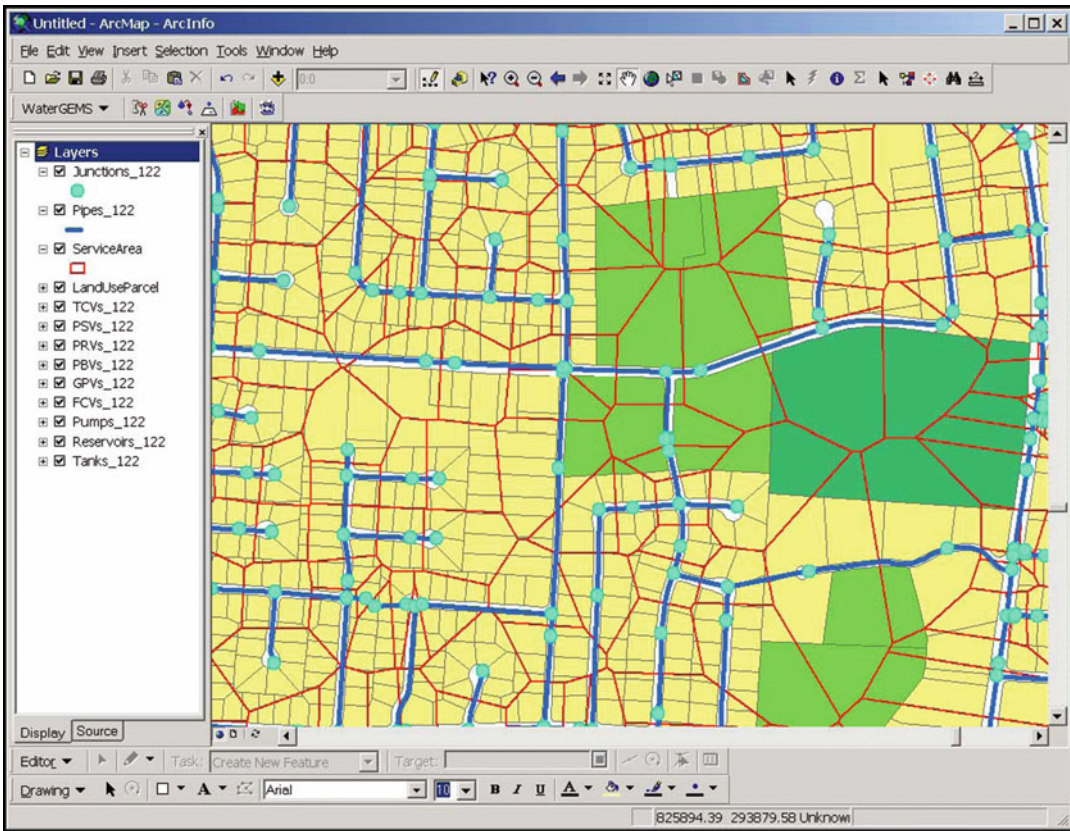
### 5.2. GIS-Based Water Supply Demand Forecasting

Procedures for generating water demands for pipe network modeling using GIS were described by Wu et al. [27] and Prins and Bodeaux [28]. In general, water demands are based on land use maps augmented by a relational database, or geodatabase, which incorporates attribute data such as customer ID, land use category, water use records, and per unit planning factors. Customer billing records can be used to determine water demands given historic records. Geocoding, a standard GIS process to establish the location of customers based on their address, can be used to assign customer demands to a model using (a) nearest node, (b) nearest pipe, or (c) meter aggregation [27]. Figure 7.16 illustrates an example of nodal demand assignments by land use.

### 5.3. Pipe Network Design with GIS

Water supply distribution system design is accomplished using pipe network hydraulic models to simulate performance of the network under various design scenarios, typically for forecast maximum hour and maximum day plus fire flow demands. The pipe network design process is iterative in character involving specification of a pipe network layout having pipes of certain types and sizes. For reliability, it is desirable that the network be a looped system so that water can be delivered to all services even if a certain pipe is shut off for repairs. Topography can be a primary determinant of system layout to take advantage of gravity distribution that is more reliable and cheaper than pumping. Distribution storage tanks may be placed at strategic locations in the system to provide storage to meet fluctuations in use, provide water for fire-fighting use, and stabilize pressures in the distribution system. Also, pumps may be required to move water to high storage areas. It is necessary to calibrate the hydraulic model to ensure an accurate representation of the actual distribution system hydraulics.

Pipe network models are based on hydraulic flow and network theory and use the principles of conservation of mass and energy to represent flows and friction losses throughout a network. Pipe networks create relatively complex problems, particularly if the network



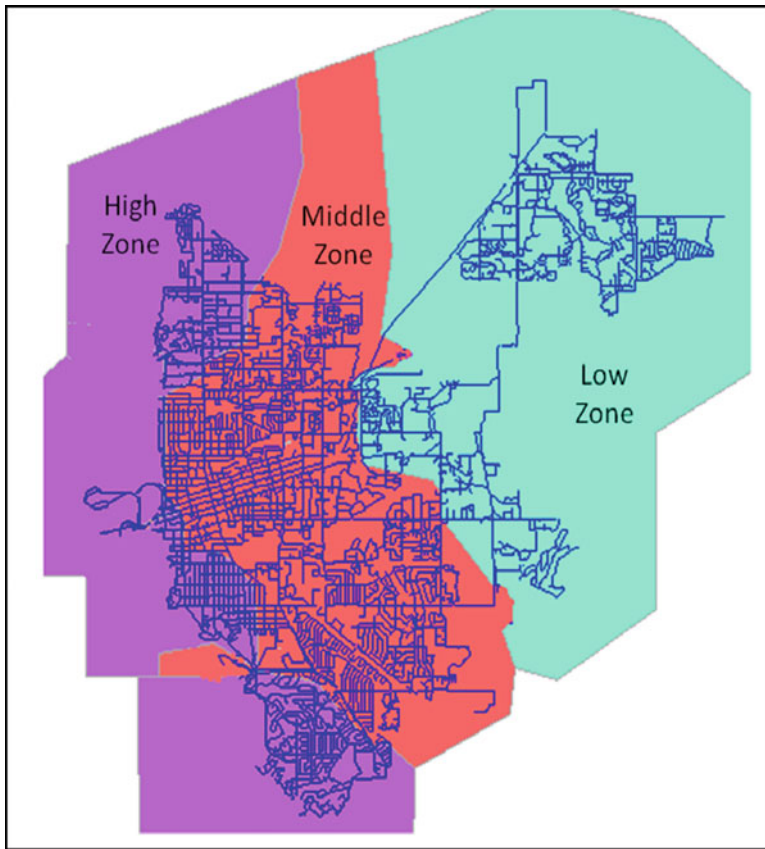
**Fig. 7.16.** Example of nodal demand assignments by land use [27].

consists of a large number of pipes, and solutions of these problems require sophisticated computerized mathematical procedures. Jeppson [29] and Walski [30] provide reviews of numerical solution procedures.

There are a number of modeling packages for simulating pipe networks that are integrated with GIS. The most common is the public domain EPANET model [31]. Other commercial pipe network software includes WaterCad<sup>®</sup> and InfoWater/H2Onet<sup>®</sup>.

GIS provides functions for development and preparation of accurate spatial information for input into the network design modeling process, which include network layout, connectivity, pipe characteristics, pressure gradients, demand patterns, cost analysis, network routing and allocation, and effective color graphic display of results. The GIS accomplishes database management operations for both spatial and attribute data, user-friendly dialog interfaces for data manipulation and output display, and models subsystem including both simulation and optimization.

An application of EPANET and InfoWater<sup>®</sup> GIS pipe network modeling capabilities was conducted by Szana [32]. The process used to create an all-pipes hydraulic model from GIS



**Fig. 7.17.** Pipe network model completed with assignments to pressure zones [32].

data included (a) processing of initial GIS datasets, (b) importing data into the GIS, (c) formulating the initial hydraulic model based on the GIS pipe data, (d) error-checking for network connectivity, (e) assignment of node elevations based on the digital elevation model (DEM), (f) assignment of node demands (current and future), (g) calibration of the model for current conditions, and (h) simulations of alternative scenarios.

Processing of initial GIS datasets involved importing the ArcInfo<sup>®</sup> data from the city GIS department. The all-pipes model was created from the GIS pipes dataset which contained fields for all information useful to perform hydraulic and system analysis. A digital elevation model was imported and geo-registered to the other spatial datasets; elevation is a fundamental attribute of the hydraulic model, and all nodes, reservoirs, pumps, and tanks must have assigned elevations. A parcels dataset was imported to support land use demand factors and customer notification for maintenance and emergency conditions. Other GIS data were added, including the street network, parks, and other land features; these were for general map identification purposes and were not used for the hydraulic analyses. The final pipe network was completed and available for nodal demand assignments and simulations (Fig. 7.17).

Water use data from the billing system was used to represent the minimum and maximum demands. Demands were allocated to the model using a meter-closest pipe method. Demands for future growth or rezoning were estimated from the zoning designations where the system will serve in the future.

Model calibration was accomplished by adjusting parameters until model outputs matched field data collected with the utility's Supervisory Control and Data Acquisition (SCADA) system. This procedure involved two main processes. First, model parameters and attributes that can be physically tested and/or measured are adjusted to attain model results that more closely match actual results in the field. Secondly, pipe roughness, which changes over time and is very difficult to measure, can be optimized to minimize the difference between the model and field results. The initial model calibration was accomplished by trial and error, running model simulations and then viewing pressures, flow rates, tank levels, and water age. The process is aided by the GIS-based visual displays of pressures, velocities, and differences between monitored and simulated values.

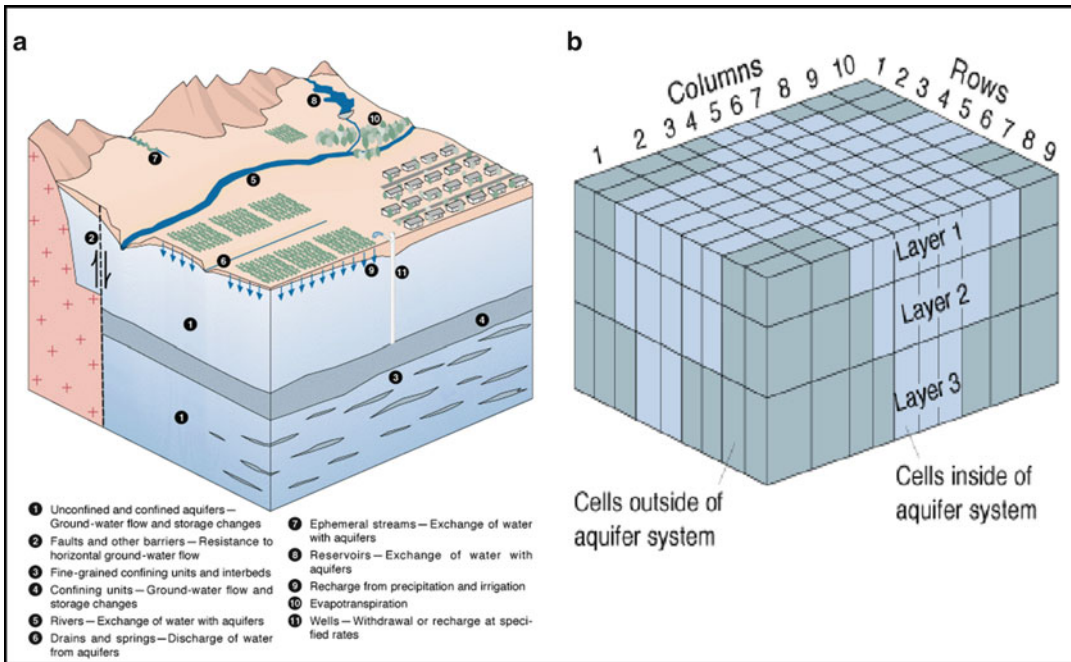
## 6. GIS FOR GROUNDWATER HYDROLOGY

### 6.1. Overview

GIS has found extensive application for groundwater assessments as there are many types and large amounts of data involved. Proper evaluation of groundwater resources requires thorough hydrologic, geologic, and hydraulic investigations. The spatial scope may be quite local for a specific pumping well or range in size from a few hundred hectares to entire basins and even countries. Use of simulation and management models is widespread in such studies, and GIS has become a primary technology for coordinating the data management and providing the interface for groundwater model development.

### 6.2. GIS for Groundwater Modeling

Groundwater modeling tools are used to represent an approximation of the field data and to assess the behavior of the groundwater system under varying climatic conditions (drought conditions) or changes in water consumption, population growth, or changes in land use. The most popular computer model of the numerical type is the modular finite-difference groundwater flow model (MODFLOW) developed by the US Geological Survey [33]. MODFLOW simulates groundwater flow in aquifer systems using the finite-difference method. A variety of features and processes such as rivers, streams, drains, springs, reservoirs, wells, evapotranspiration, and recharge from precipitation and irrigation also can be simulated (Fig. 7.18a). In this method, an aquifer system is divided into rectangular blocks by a grid (Fig. 7.18b). The grid of blocks is organized by rows, columns, and layers, and each block is commonly called a "cell." For each cell within the volume of the aquifer system, the user must specify aquifer properties. Also, the user specifies information relating to wells, rivers, and other inflow and outflow features for cells corresponding to the location of the features.



**Fig. 7.18.** (a) Features of an aquifer that can be simulated by MODFLOW. (b) The features are represented in a three-dimensional finite-difference grid [33].

Groundwater models require a number of disparate and large datasets which are difficult to manage. GIS can help with the modeling process by coordinating data collection, providing comprehensive database operations, supporting systematic model parameter assignments, conducting spatial analysis (e.g., spatial statistics) functions, and displaying model results in understandable color map formats. Groundwater systems are often represented using gridded data; grids are used to efficiently create and visualize spatial distributions for pre- and post-processing of the model [34]. Grid functions make it easy to compare and modify input data. Identifying attribute values of concern in large data files is made easier with GIS when they can be visualized in map formats. Most data is gathered at points, which are then interpolated using geo-statistical techniques into surfaces of elevations (land surface, piezometric). GIS grids, coverages, and shapefiles are used to create the majority of the input datasets for MODFLOW, including hydrogeology and stratigraphy, hydrogeologic parameters, boundary conditions, and initial conditions. Coverages and shapefiles are used to represent rivers, drains, and wells. Geoprocessing is used to create polygons with unique soils, precipitation, evapotranspiration, and land use, which can then be combined to generate recharge and evapotranspiration arrays.

In concert with the surface water domain, there has been a movement toward a geodatabase approach for groundwater data and modeling support. Zeiler [35] described the ESRI geodatabase data model as an object-oriented model introduced with the ArcGIS<sup>®</sup> software.

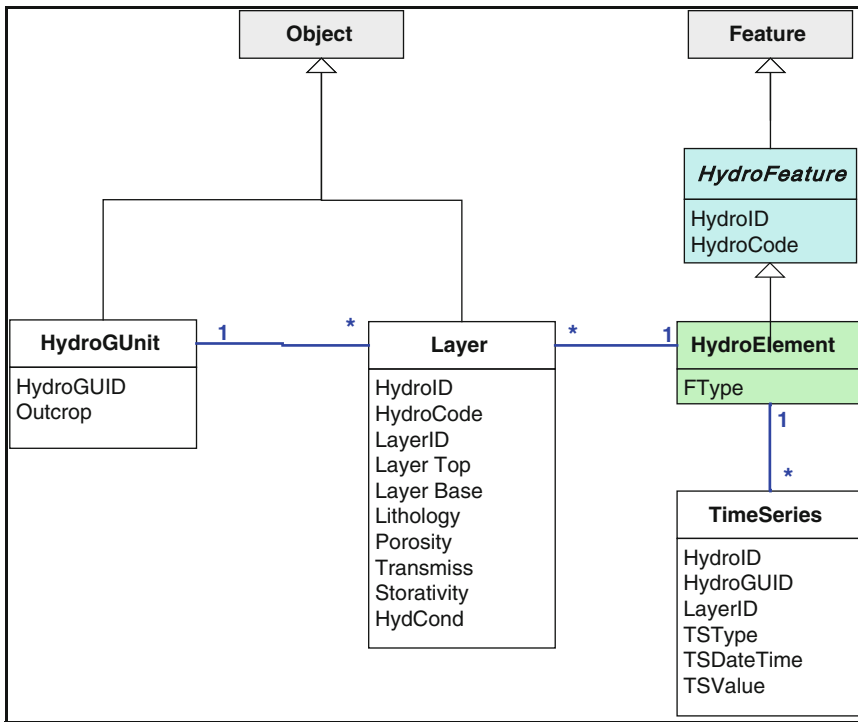


Fig. 7.19. Classes and relationship of the three-dimensional data model [36].

The basic form of the model contains a geodatabase, feature datasets, feature classes, and object classes. An example of a feature dataset would be a group of monitoring stations, where a feature class would be the observation well locations and the object class the water level data collected at all the stations. The model is packaged in a geodatabase, which contains the feature datasets. Feature datasets in turn contain all the feature classes in a model and the relationships among them within a common coordinate system. An object class is a nonspatial entity like a data table, and feature classes are objects plus spatial coordinates. Maidment et al. [36] extended the ArcHydro geodatabase concepts to include groundwater. Groundwater applications range from regional studies, which usually describe the flow in aquifers as two-dimensional, to site investigations that model the three-dimensional nature of the flow through the aquifer architecture. Figure 7.19 illustrates the classes and relationships of the three-dimensional data model.

### 6.3. Case Example: MODFLOW for Rio Grande Valley

The Rio Grande basin within Colorado is located in south-central Colorado and encompasses approximately 7,500 square miles. The primary feature of the basin is an open, almost treeless, relatively flat valley floor (known as the San Luis Valley) surrounded by mountains. Agricultural activities account for more than 85 % of basin water consumption with an

estimated 638,000 acres under irrigation. The primary crops are potatoes, carrots, small grains, and alfalfa.

The basin has been the focus of a major groundwater modeling effort directed to assessing the amount of recoverable water [37]. The Rio Grande Decision Support System [38] program has been developed to provide the tools and information appropriate for water management of the region. The RGDSS was directed to addressing these groundwater issues by activities for groundwater modeling, consumptive use modeling, new data collection, and DSS integration. The groundwater simulation modeling effort required new data on streamflows, piezometric pressures, consumptive uses, stratigraphy, topography, and wells. GIS databases and tools of various types provided a primary means for accomplishing the project. The coverages developed for the RGDSS groundwater model included rivers/streams, canals, drains, surface irrigated lands, groundwater irrigated lands, wells, nonirrigated lands, soils, rim inflows, diversion locations, and gage locations. All GIS coverages were developed on a common datum and consistent units.

The groundwater computer modeling package MODFLOW was used as the primary simulation tool to analyze the movement and impact of pumping wells on the surface water system in the Rio Grande basin. Procedures for developing input files for MODFLOW were described by Rindahl and Bennett [39]. The groundwater modeling interface system (GMS) involved integration of GIS coverages, relational databases, and consumptive use model results into a coordinated package for generating input files required by the following MODFLOW packages: (1) basic package (2) block-centered flow package, (3) general head boundary package, (4) stream or river package, (5) output control, (6) solver package, and (7) drain package. GMS also exports the model cell grid system so that it can be processed by the ArcView<sup>®</sup> data analysis.

Calibration of the Rio Grande basin groundwater model was performed for steady-state (1990–1998) and average monthly (1970–2002) study periods [38]. It was determined to be adequate when the difference between observed and simulated flow values and heads was minimized while maintaining aquifer parameters within a reasonable range. Calibration included evaluation of (1) groundwater budget, (2) change in storage, (3) streamflow, diversions and gain-loss, (4) observation wells, (5) total evapotranspiration, and (6) other non-numeric data (e.g., dry cells, flooded cells). Figure 7.20 presents a residuals plot that shows the difference between simulated head and observed head for the 903 wells where observed data was compared to simulated values; the map display is for layer 1 of the model (the top most layer of the four-layer model). The residual plots indicate the model reproduces observation wells fairly accurately with better results in the center of the valley than the boundaries.



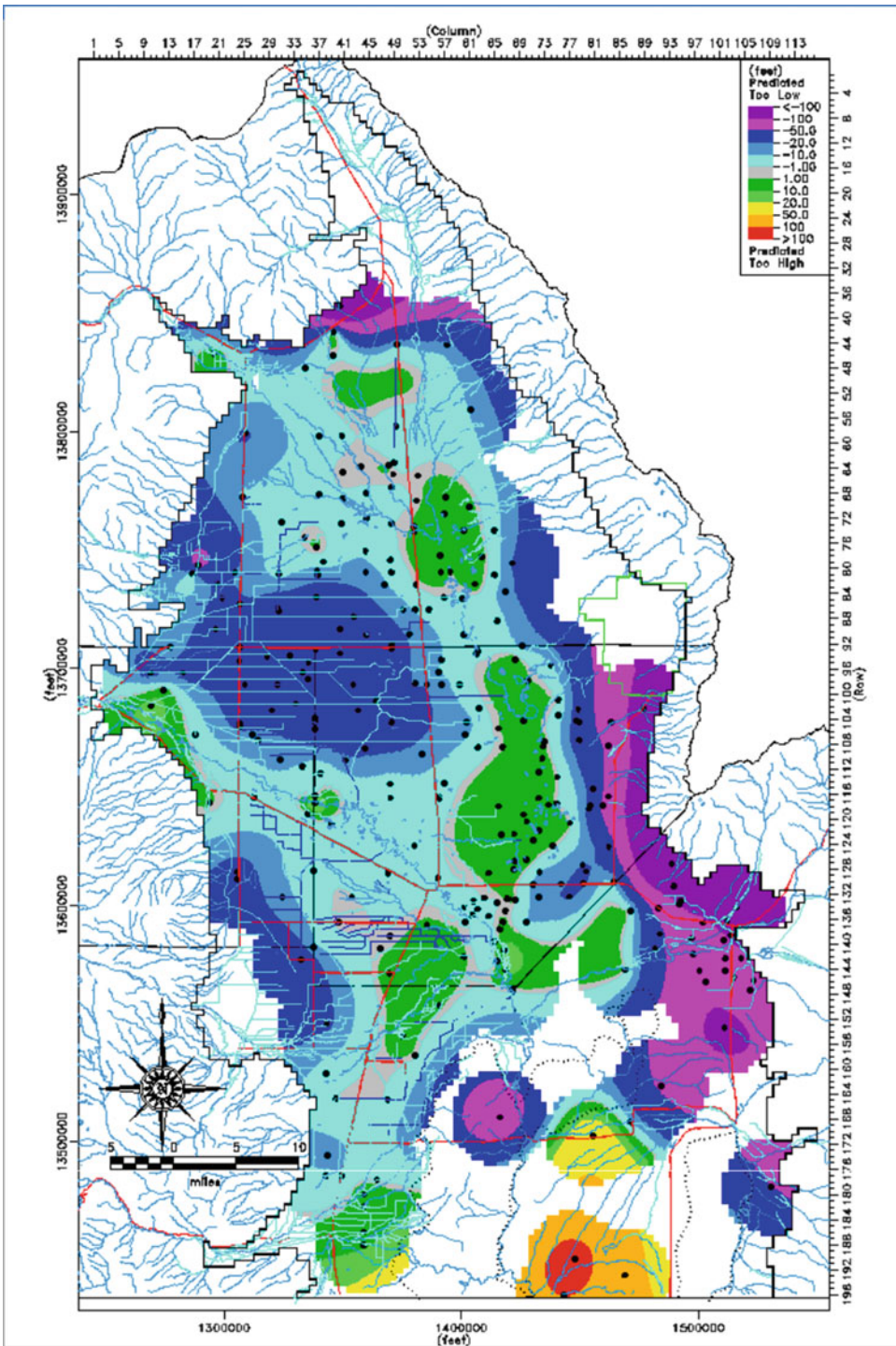


Fig. 7.20. Residual head for steady-state simulation for layer 1 of the Rio Grande groundwater model [38].

## REFERENCES

1. Johnson LE (2009) Geographic information systems in water resources engineering. Taylor-Francis Group, CRC Press, Boca Raton, FL. ISBN 978-1-4200-6913-6
2. Gagan DJ, Dowman IJ (1988) Accuracy and completeness of topographic mapping from SPOT imagery. *Photogrammetric Record* 12(72):787–796
3. Jensen JR (1996) *Introductory digital image processing: a remote sensing perspective*, 2nd edn. Prentice-Hall, Inc., Upper Saddle River, NJ. ISBN 0-13-205840-5
4. Hsu C, Johnson LE (2007) Multi-criteria wetlands mapping using an integrated pixel-based and object-based classification approach (with C. Hsu). Proceedings AWRA annual conference, Albuquerque, N.M., 12 Nov
5. Meijerink AMJ, Brouwe HAM, Mannaert CM, Valenzuel CR (1994) Introduction to the use of geographic information systems for practical hydrology. UNESCO international hydrological programme, Publication Number 23, 243 p
6. Burrough PA, McDonnell RA (1998) *Principles of geographical information systems*. Oxford University Press, Oxford
7. Martin PH, LeBoeuf EJ, Dobbins JP, Daniel EB, Abkowitz MD (2005) Interfacing GIS with water resource models: a state-of-the-art review. *J American Water Resources Assoc* 41(6):1471
8. Worboys MF, Duckham M (2004) *GIS: a computing perspective*, 2nd edn. CRC Press, Boca Raton, FL. ISBN 0415283752
9. Aronoff S (1991) *GIS—a management perspective*. WDL Publications, Ottawa. ISBN 0-921804-91-1
10. Perdue D (2006) National Hydrography Dataset—concepts and contents. US Geological Survey (<http://nhd.usgs.gov/techref.html>)
11. National Research Council (NRC) (2007) Integrating multiscale observations of U.S. Waters. Committee on integrated observations for hydrologic and related sciences. ISBN: 0-309-11455-1. <http://www.nap.edu/catalog/12060.html>
12. Ragan RM, Jackson TJ (1980) Runoff synthesis using Landsat and the SCS model. *J Hydraulics Div ASCE* 106:3–14
13. Bondelid TR, McCuen RH, Jackson TJ (1982) Sensitivity of SCS models to curve number variation. American Water Resources Association. *Water Resources Bulletin* 18(1):111–116
14. Office of the Federal Coordinator for Meteorological Services and Supporting Research (OFCM) (2006) Meteorological handbook No. 11—Doppler Radar Meteorological Observations, Part C, WSR-88D Products and Algorithms. FCM-H11C-2006. <http://www.ncdc.noaa.gov/oa/radar/radarresources.html>
15. Garbrecht J, Martz LW (1999) TOPAZ: an automated digital landscape analysis tool for topographic evaluation, drainage identification, watershed segmentation and subcatchment parameterization; TOPAZ overview. U.S. Department of Agriculture, Agricultural Research Service, Grazinglands Research Laboratory, El Reno, Oklahoma, USA, ARS Publication No. GRL 99-1, April 1999, 26 pp
16. DeBerry P (ed) (1999) GIS modules and distributed models of the watershed. A report from the ASCE Task Committee. ASCE, Reston, VA. ISBN 0-7844-0443-7
17. Issacs EH, Srivastava RM (1989) *Applied geostatistics*. Oxford University Press, Oxford (pbk). ISBN 0-19-505013-4
18. Hydrologic Engineering Center (HEC) (2000) HEC-HMS hydrologic modeling system, technical reference manual. U.S. Army Corps of Engineers, USACE-HEC, Davis, CA, Mar. (<http://www.hec.usace.army.mil/software/hec-hms/>)

19. Hydrologic Engineering Center (HEC) (2003) Geospatial hydrologic modeling extension (HEC-GeoHMS). U.S. Army Corps of Engineers, USACE-HEC, Davis, CA, Dec. (<http://www.hec.usace.army.mil/software/hec-geohms/>)
20. Kost JR, Kelly GG (2002) Watershed delineation using the National Elevation Dataset and semiautomated techniques. USGS Paper 0421. (<http://edna.usgs.gov/Edna/pubs/p0421/p0421.html>)
21. Smith M, Koren V, Zhang Z, Reed S, Seo DJ, Moreda F, Kuzmin V, Cui Z, Anderson R (2004) NOAA NWS distributed hydrologic modeling research and development. NOAA Technical Report NWS 45, April, 62 pp
22. Federal Emergency Management Agency (FEMA) (2005) Appendix N: data capture standards and guidelines. Guidelines and specifications for floodplain mapping partners. [http://www.fema.gov/pdf/fhm/frm\\_gsana.pdf](http://www.fema.gov/pdf/fhm/frm_gsana.pdf)
23. Jones JL, Haluska TJ, Williamson AK, Erwin ML (1998) Updating flood maps efficiently: building on existing hydraulic information and modern elevation data with a GIS. U.S. Geological Survey Open-File Report 98-200. <http://www.dwatcm.wr.usgs.gov/reports/floodgis/>
24. Federal Emergency Management Agency (FEMA) (2003) Appendix L of the guidelines and specifications for flood floodplain mapping partners. [http://www.fema.gov/pdf/fhm/frm\\_gsana.pdf](http://www.fema.gov/pdf/fhm/frm_gsana.pdf)
25. Pender G, Neelz S (2007) Use of computer models of flood inundation to facilitate communication in flood risk management. *Environmental Hazards* 7:106–114
26. Ackerman CT, Evans TA, Brunner GA (2000) HEC-GeoRAS: linking GIS to hydraulic analysis using ARC/INFO and HEC-RAS. In: Maidment DR, Djokic D (eds) *Hydrologic and hydraulic modeling support with geographic information systems*. ESRI Press, Redlands, CA. ISBN 1-879102-80-3
27. Wu ZY, Wang RH, Diaz D, Walski T (2003) Mining water consumption and GIS-based data for loading water distribution models. *ASCE World Water Congress* 118:23
28. Prins JG, Bodeaux M (2000) Building land use plans for water master plans: a case study. ESRI User's Conference, San Diego, CA
29. Jeppson RW (1982) *Analysis of flow in pipe networks*. Ann Arbor Science Inc, Ann Arbor, MI. ISBN 0-250-40119-3
30. Walski T (1984) *Analysis of water distribution systems*. Van Nostrand-Reinhold, New York
31. Rossman LA (2000) *EPANET 2 users manual*. U.S. Environmental Protection Agency. Water Supply and Water Resources Division, National Risk Management Research Laboratory, Cincinnati, OH, 45268 Report EPA/600/R-00/057, Sep. <http://www.epa.gov/nrmrl/wswrd/dw/epanet.html>
32. Szana K (2006) *Water distribution systems modeling and optimization in a GIS environment*. Master's project report, Department of Civil Engineering, University of Colorado at Denver, Denver, CO, May
33. McDonald MG, Harbaugh AW (1988) A modular three-dimensional finite-difference groundwater flow model. *Techniques of Water Resources Investigations of the U.S. Geological Survey (USGS)*, Book 6, Chapter A1, Denver, Colorado
34. Radin HA (2006) Using ArcGIS for preprocessing and postprocessing a Modflow-96 groundwater model. GIS and Water Resources IV, AWWRA Spring Specialty Conference, May
35. Zeiler M (1999) *Modeling our world—the ESRI guide to geodatabase design*. ESRI Press, Redlands, CA. ISBN 1-879102-62-5

36. Maidment DR, Jones NL, Strassberg G (2004) Arc hydro groundwater geodatabase. Center for Research in Water Resources, University of Texas, Austin, TX, <https://webspace.utexas.edu/gstras/MyWebsite/publications/ArcHydroGWGeoDBFinalForReview.doc>
37. Colorado Water Conservation Board (CWCB) (2005) Rio Grande decision support system. <http://cdss.state.co.us/DNN/>
38. Rio Grande Decision Support System (RGDSS) (2005) Calibration of the Rio Grande Basin Groundwater Model. Report to the Colorado Water Conservation Board, Denver, CO
39. Rindahl B, Bennett R (2013) Design and implementation of a data-centered groundwater modeling system. Proceedings ESRI annual users conference. San Diego, CA. <http://gis.esri.com/library/userconf/proc00/professional/papers/PAP443/p443.htm>

# Decision Making Under Uncertainty: A New Paradigm for Water Resources Planning and Management

---

Patricia Gober

## CONTENTS

INTRODUCTION  
CLIMATE UNCERTAINTY AND VULNERABILITY  
DECISION MAKING UNDER UNCERTAINTY  
HUMAN FACTORS IN THE WATER SECTOR  
SUSTAINABLE WATER SYSTEMS  
REFERENCES

---

**Abstract** Climate change challenges water managers to make decisions about future infrastructure and the adequacy of current supplies before the uncertainties of the climate models and their hydrological impacts are resolved. Water managers thus face the classic problem of decision making under uncertainty (DMUU). The aim of DMUU is not to be paralyzed by uncertainty, but to highlight and use it to better manage risk. Strategies for DMUU include scenario planning, exploratory simulation modeling, robust decision making, and anticipatory planning and governance. These tools imply a new role for social scientists in the fields of water science and engineering and a new relationship between water science and the practitioner community. Examples are drawn from Phoenix, Arizona, and the US Southwest for DMUU support tools and strategies for science-policy engagement. Simulation experiments for Phoenix reveal challenging, but feasible, strategies for climate adaptation in the water sector for all but the most dire future climate conditions.

**Key Words** Decision making under uncertainty • Simulation modeling • Climate change • Scenario planning • Anticipatory governance • Robust decision making.

## 1. INTRODUCTION

The growing uncertainties of climate change present formidable challenges for water engineering and planning, as presently practiced. Systems for managing water traditionally have been designed and operated assuming the principle of stationarity—the notion that natural systems function within a known envelope of variability [1]. This principle implies that relevant hydrological variables such as stream flow and annual flood peak vary according to probability-density functions based on the instrumented record. These functions are, in turn, the basis for managing risk to water supplies and building infrastructure. Anthropogenic changes in Earth's climate are altering the means and extremes of temperature, precipitation, evapotranspiration, and rates of river discharge [2]. These changes imply that the instrumented historical record may no longer be a valid basis for predicting the future and managing risk.

Climate change belongs to a class of problems characterized by “deep uncertainty.” These are situations about which there is fundamental disagreement about the driving forces that will shape the future, the probability distributions used to represent uncertainty, and how to value alternative outcomes [3]. Water managers, facing long lead times to plan and implement new water infrastructure, often are required to make decisions before the uncertainties about climate models and their hydrological impacts will be resolved. They are prime candidates for *decision making under uncertainty* (DMUU). DMUU approaches reframe the climate-change question from how we can reduce uncertainty in the climate models and their application to how we can better decisions in the face of inevitable uncertainty about the climate. The idea is not to be paralyzed by uncertainty, but to draw attention to it and use it for better decision making.

DMUU approaches move away from the idea that there is a single optimal or most likely future and take into account multiple possible futures expressed as scenarios. They clarify stakeholder priorities and goals and use them as the basis for presenting choices about the future. These choices often involve critical tradeoffs, for example, between the risk of shortage and the cost of redundant infrastructure, system efficiency and distributional fairness, short-term economic growth and long-term sustainability, and water for farmers to grow food and water for city dwellers to grow decorative lawns. Societal decisions about these tradeoffs require us to ask: what is the risk, what is safe, is it fair, and who is responsible? These questions inherently involve human values, social organization, governance, participatory processes, and decision making and thus engage social scientists in research about the water system.

This chapter will focus on climate models and water resource management from a DMUU perspective. Tools for DMUU include scenario planning, exploratory simulation modeling, robust decision making, and anticipatory governance. These tools imply a new role for social scientists in the fields of water science and engineering and a new relationship between water science and engineering and water policy. I use examples from Phoenix, Arizona, and the southwestern US to show the growing risk of climate-induced water scarcity, new methods of water planning and decision making, and the application of DMUU tools in the water sector.

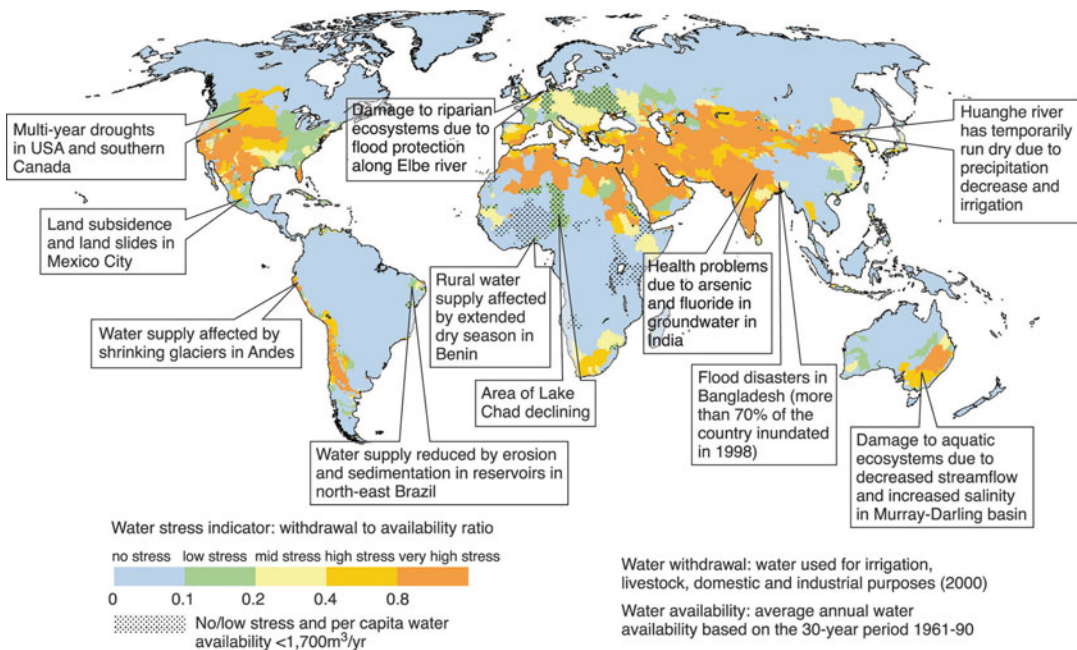
The chapter concludes with a discussion of the newly emerging field of sustainability science and the insight it offers for the practice of integrated water management in an age of deep uncertainty.

## 2. CLIMATE UNCERTAINTY AND VULNERABILITY

### 2.1. Sources of Climate Uncertainty

The Intergovernmental Panel on Climate Change's (IPCC) Fourth Assessment Report in 2007 expressed high to very high confidence about climate-change impacts on freshwater systems and their management via increasing temperatures (e.g., effects of increased evaporation on water demand and decreased stream flows), sea level rise (e.g., contamination of freshwater estuaries and groundwater resources), and increasing precipitation variability (e.g., frequency and duration of droughts, floods, and severe climate events). Semiarid and arid regions are particularly prone to a variety of climate-change impacts; a warmer planet means more intense convection and precipitation at the equator which, in turn, reduces the amount of rainfall available to arid and semiarid regions at  $\sim 30^\circ$  north and south latitude. Changing climate will create a host of water-related problems including droughts, floods, subsidence, shrinking glaciers, and damage to aquatic ecosystems (Fig. 8.1).

Efforts to quantify the global and regional effects of climate change use atmosphere-ocean general circulation models (AOGCMs) to simulate future (and past) climate conditions. These



**Fig. 8.1.** IPCC's Fourth Assessment Report shows the range of vulnerabilities that may be affected by future climate change, superimposed on a map of water stress (*Source: IPCC [4], Fig. 3.2*).

computer models are based on differential equations that describe basic laws of physics, fluid motion, and atmospheric chemistry; the equations are solved for three-dimensional grid cells with the goal of accurately replicating atmospheric, oceanic, and land-surface processes through time. They are the primary tools for estimating future changes in temperature, precipitation, humidity, and solar radiation resulting from changes in atmospheric composition (e.g., increasing greenhouse gas emissions) and land-surface properties (e.g., increasing urbanization).

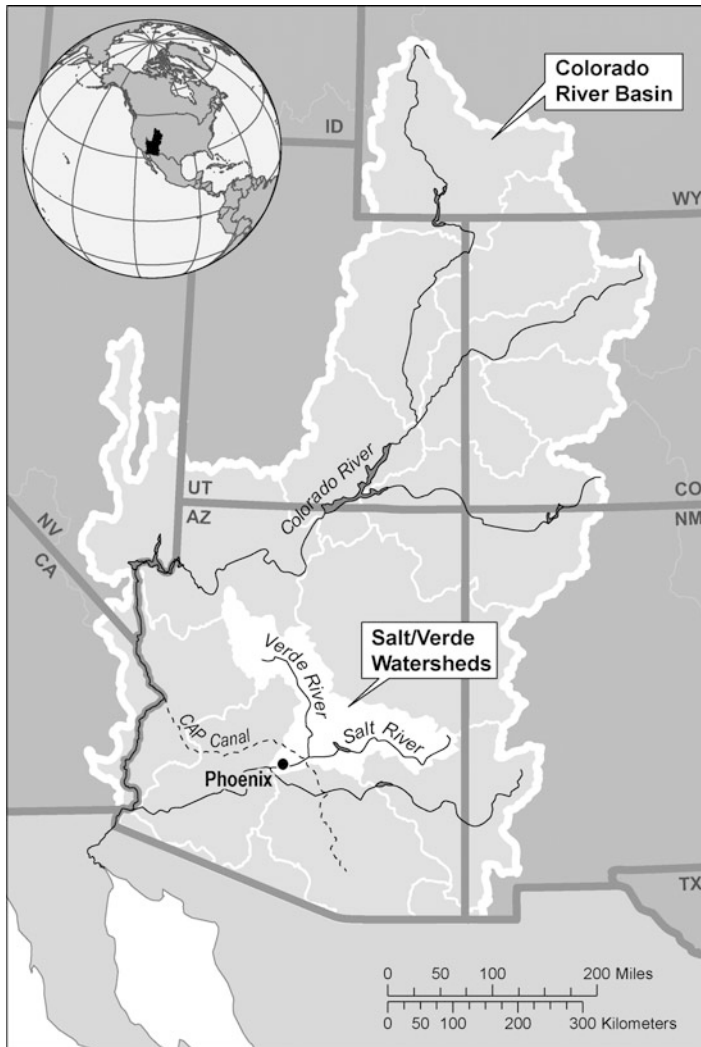
Significant uncertainties are associated with forecasts from the most widely used AOGCMs [2, 5]. These models have different resolutions in time and space, they are constructed with varying emphases on different processes, and they contain different statistical parameterizations to represent unresolved physical processes such as the formation of clouds and precipitation, ocean mixing due to wave processes, sea–ice interactions, and land-surface processes. The IPCC states “Uncertainty in parameterizations is the primary reason why climate projections differ between different AOGCMs” [2]. The inherently chaotic nature of the climate system also guarantees some level of uncertainty in model predictions.

Uncertainties about human activities further complicate modeling of the global atmospheric system. Modelers struggle with how to address human behavior with respect to fossil fuel use, development and adoption of renewable energy sources, population growth, economic development, technological innovation, and human alteration of land cover. The IPCC considers a range of storyline and scenario families and is careful to avoid statements about the relative likelihood of scenarios. Instead, they pronounce scenarios as “equally sound,” without explicitly defining what this means [6].

Additional sources of uncertainty are introduced when moving from global and hemispheric to regional and local scales where climate impacts are experienced by human populations and where water decisions are made. Researchers have developed statistical and dynamical modeling approaches to “downscale” AOGCM output to higher resolutions at regional scales such as drainage basins. Uncertainties at these scales are particularly large for precipitation, given the models’ problems with simulating clouds and other processes that produce precipitation. Uncertainties in model predictions appear to increase in areas of complex terrain, creating special problems in the mountainous western US [2, 7, 8].

The National Research Council reported that the US Southwest will become warmer and drier in this century, reducing snowpack, Colorado River flows, and urban water supplies [9]. Results from 24 climate models from the Intergovernmental Panel on Climate Change Fourth Assessment Report (AR4) point to drier conditions in the Southwest, but there is substantial uncertainty about the extent, causal mechanisms, and geographic pattern of increased aridity [10]. A set of downscaled model/scenario combinations from the AR4 for the Salt/Verde River Basins, immediately upstream from Phoenix and major sources of Phoenix’s surface water (Fig. 8.2), revealed that future (2030) stream flow could range from 19 to 123 % of historical averages [11]. Similar results from the AR3 model/scenario combinations showed a range of 50–127 % [12]. Uncertainty about the physical systems that deliver surface water to Phoenix actually *increased* from the AR3 (2001) to the AR4 (2007) results as additional AOGCMs were developed and as climate models were linked to more and new land-use and hydrological models.

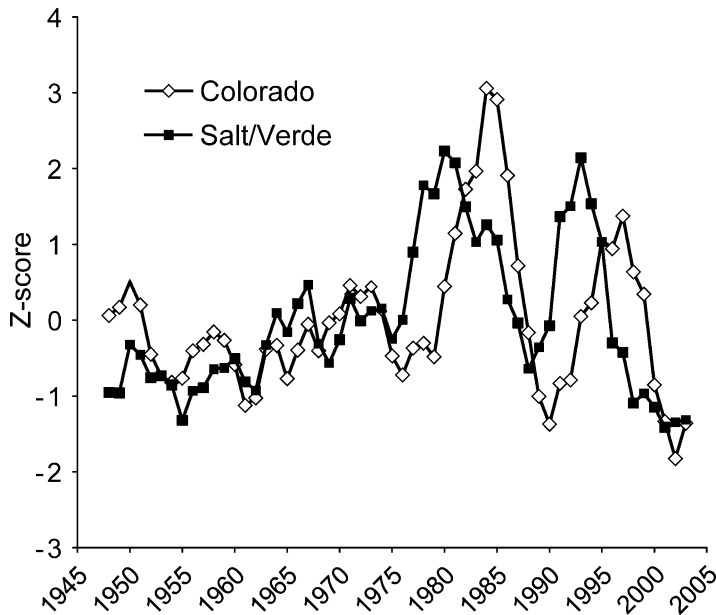




**Fig. 8.2.** Phoenix obtains surface water from the Colorado River Basin and Salt/Verde Watersheds.

## 2.2. Stationarity Assumption

Water systems throughout the world are designed and operated using the assumption of stationarity—the idea that natural systems operate within a known envelope of variability (Fig. 8.3). This envelope of variability is used to build and operate water infrastructure, such as dams and reservoirs, storm-water runoff systems, and wastewater treatment plants. In a seminal 2008 article in *Science*, Milly et al. declared that “stationarity is dead” [1]. There is now solid evidence in support of structural change in Earth’s climate system, including a poleward expansion of the subtropical dry zone. The hydroclimate appears to have exited the known envelope of variability in some regions. And yet, records of historical variability



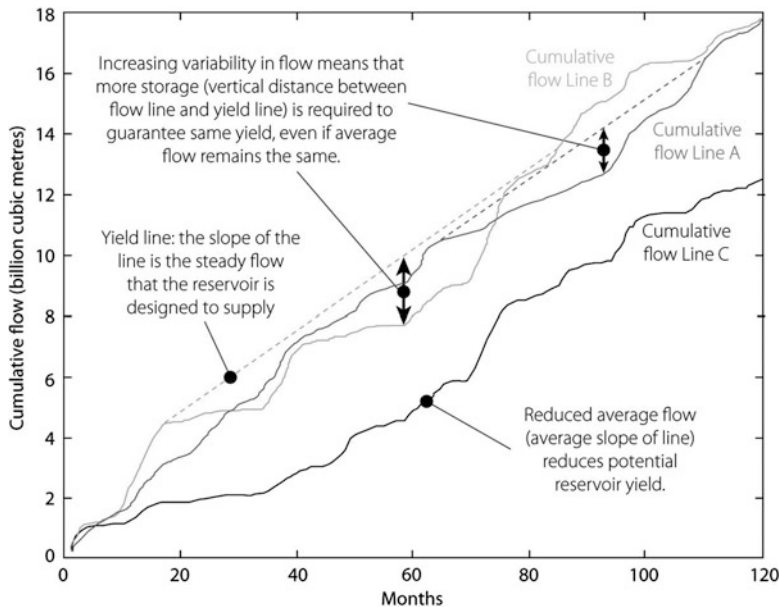
**Fig. 8.3.** Normalized annual flow on the Colorado and Salt/Verde River systems in Z scores, the number of standard deviation units from the mean annual flow.

remain the primary basis for establishing the risk of shortage, flooding, soil erosion, lake sedimentation, and ecosystem damage in water systems.

Nonstationary conditions pose significant challenges for reservoir construction and management. Reservoirs store water to account for natural variability (both seasonal and interannual) in river flows. Figure 8.4 shows the typical cumulative flow over a 10-year period in Line A. The maximum supply that the reservoir can provide in any given year is the average slope of the cumulative curve. If the flow becomes more variable, as it does in Line B, the reservoir will have to be enlarged to guarantee a given yield. This is the case even if average flows remain constant. Long periods of low flows, where the cumulative curve flattens (Line C), result in reduced yield no matter how large the reservoir. This example demonstrates the sensitivity of physical infrastructure to assumptions about future climate and the formidable challenge of infrastructure planning in an era of uncertainty. While it is possible to optimize reservoir design based on projections from a single climate model, this design will not account for all future possibilities. Rather than optimize on the basis of climate models that are still improving, water resource managers alternatively can seek solutions such as demand management that are less sensitive to any one or any one set of climate predictions [13].

### 2.3. *Extremes Matter!*

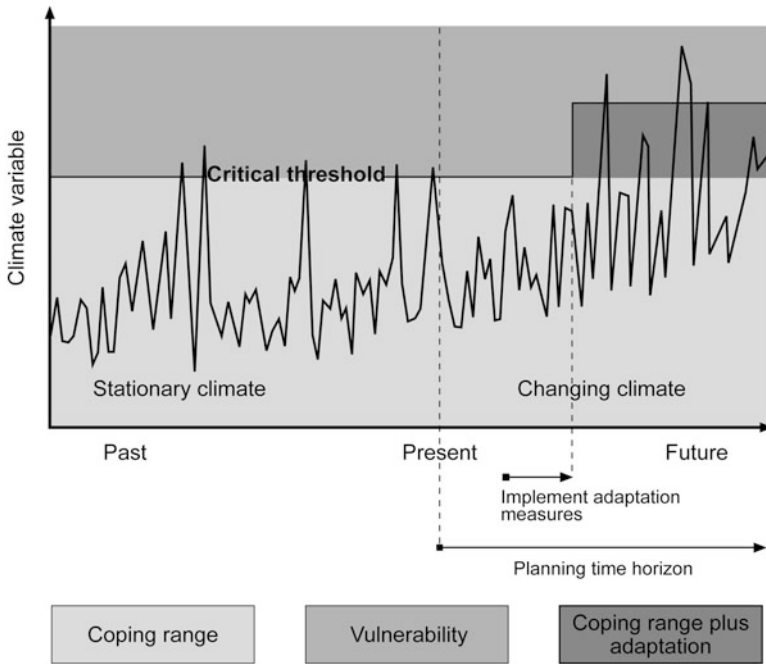
Extreme events that fall outside the envelope of historical variability expose individuals and communities to the risk of harm. Modern societies have adapted to the historical range of climate extremes through engineering works, building codes and floodplain maps, warning



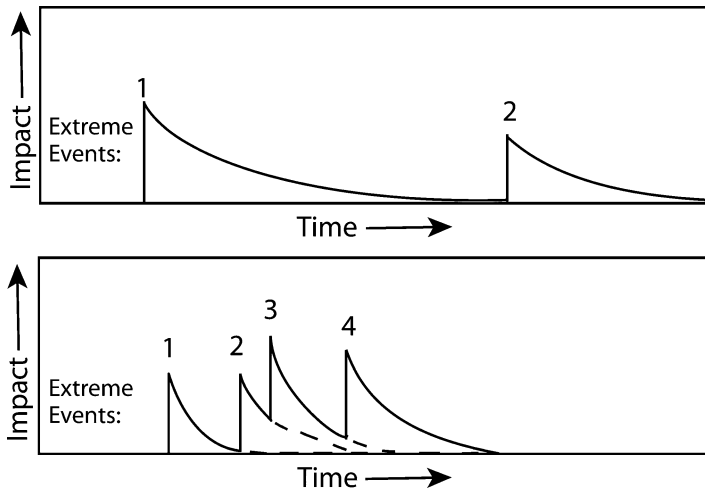
**Fig. 8.4.** Reservoir management in a nonstationary climate (Source: Krebs and Hall [13], Fig. 3).

systems, and financial instruments such as insurance programs and contingency funds. The problem is that these historical ranges are, in many cases, changing as a result of global warming. Droughts and heat waves have, over the past 40–50 years, become more intense and frequent in the US [14]. This means that many communities are experiencing climate conditions that are outside their “coping range” (Fig. 8.5). The core of the coping range contains beneficial outcomes. Approaching the critical threshold, outcomes are negative but tolerable to human societies because they have adapted to accommodate them. Beyond the critical threshold, damages and losses can no longer be tolerated, raising the risk of harm to individuals and communities. Theoretically, societies can extend coping ranges through further adaptive behaviors, but building new infrastructures, remapping floodplains, and changing human perceptions of risk take time and cost money. In an era of climate change, society will be more vulnerable to environmental harm until these adaptive behaviors are accomplished.

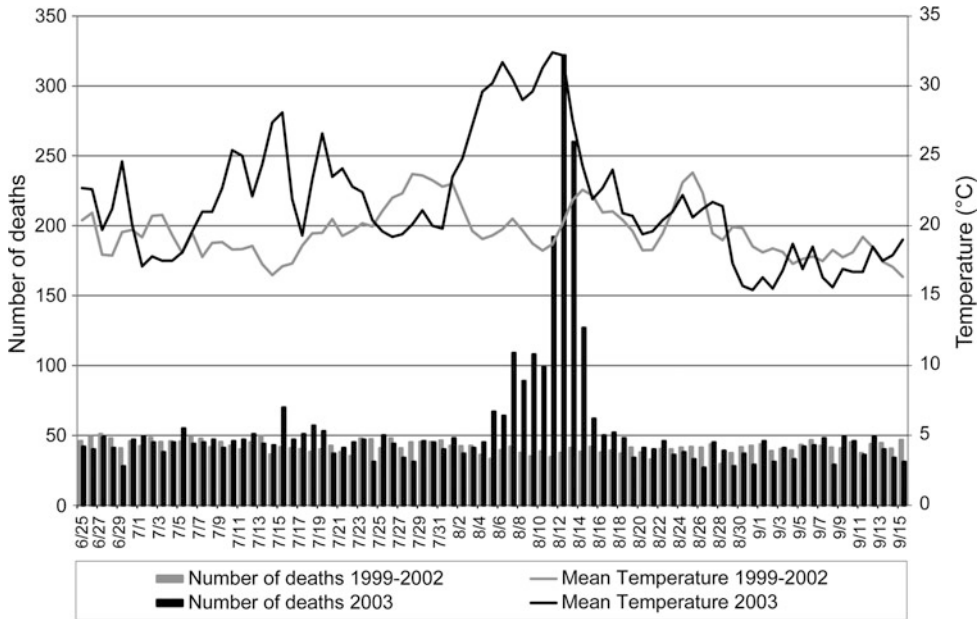
Ability to cope depends not only on the intensity of events but also on their frequencies (Fig. 8.6). In the upper diagram, two events of similar magnitude take place, but after the first one, new adaptation measures, such as changes in building codes, are undertaken. The second event thus has a lessened impact. In the bottom diagram, a second extreme event occurs before an area has completely recovered from and adapted to the previous one. It has a total impact in excess of what would have occurred in isolation. That is what happened during the 2003 heat wave in Europe. Anomalous hot and dry conditions affected southern and central Europe between June and mid-August 2003, raising temperatures by 3–5 °C. The warm conditions in



**Fig. 8.5.** Extreme conditions in a changed climate will fall outside of society’s ability to cope (Source: UKCIP [15], Fig. 3.1).



**Fig. 8.6.** Extreme events result in greater impact as they increase in both frequency and intensity (Source: USCCSP [16], Fig. 1.8).



**Fig. 8.7.** Heat-related deaths in Paris during the 2003 European heat wave (Source: Vandentorren and Empeur-Bissonnet [17], Fig. 2).

June lasted throughout the month, but did not cause excess mortality until the second episode between August 1 and 13 when temperatures were more than 7 °C above normal (Fig. 8.7).

Extreme events are also the primary mechanism by which nonhuman biological species will experience the impacts of climate change. Van Vliet and Leemans have documented that “the unexpected rapid appearance of ecological responses through the world” can be explained largely by observed changes in extremes for the past several decades [18]. These climate-induced biological changes affect humanity indirectly through ecosystem services, such as water provisioning, temperature regulation, nutrient cycling, recreation, and spiritual benefits.

## 2.4. Vulnerability to Extreme Events

Study of the vulnerability of complex human and social systems to extreme events has evolved over the past several decades from one focused on physical hazards (floods, droughts, fires, earthquakes, etc.) to one that considers both physical exposure and the human ability to cope with extreme events [19]. Social scientists became more active in this field as attention turned from the physical event itself to the structure of social systems and personal characteristics that put people at risk to extreme events. A lack of coordination among public agencies, conflicts in responsibilities and mandates, political and financial priorities, and awareness of, and confidence in, available information affect the adaptive capacity of local governments [20, 21]. On a personal level, coping capacity is affected by poverty, racial and

ethnic status, age (young children and the elderly are least able to cope), migration status (newcomers have less understanding of the local environment and risk than long-term residents), and housing tenure (owners have a greater stake in local outcomes than renters). Populations lacking in economic assets and access to public support systems, with diminished physical or cognitive capacities to respond to warnings, and missing strong and enduring social support systems are least able to adapt to and thus more vulnerable to physical hazards [16].

### 3. DECISION MAKING UNDER UNCERTAINTY

#### 3.1. *Problems of Deep Uncertainty*

Standard methods of risk analysis from a variety of disciplines, including game theory, economics, operations research, and statistical decision theory, have been successfully applied to policy problems for many decades. These methods are adequate for problems in which system behavior is predictable—situations in which probability functions are known and widely used and accepted as the basis to assess risk. Increasingly, however, society is confronted with problems such as climate change, sustainable development, and the introduction of new technologies where inherent uncertainties can lead to surprising and catastrophic outcomes. Classical methods of uncertainty analysis using probabilities, statistics, and statistical decision theory are inadequate for these types of problems [22].

Deep uncertainty characterizes situations (e.g., prospects of a particular business, introduction of a new technology, water planning in the face of climate change) in which analysts do not know or cannot agree upon the key drivers that will shape the future, probability functions that represent uncertainty, and how to value who gains and who loses from key outcomes [3]. When making their arguments about deep uncertainty, decision scientists use the physical principle of nonstationarity to argue that the past is not an adequate guide for predicting the future.

DMUU methods can be used in the water sector for planning and decision making. These methods account for the fact that uncertainty will not be resolved before near-term decisions must be made about whether to build water infrastructure, acquire backup supplies, and alter urban growth patterns. They further acknowledge that water is but one component in a complex system of supply and demand, and water managers thus face multiple sources of uncertainty. Even without climate change, the Southwest would be vulnerable to water shortage due to rapid population growth and urbanization, fierce competition between urban and agricultural interests, cultural practices that rely on heavy water use to maintain oasis-type landscape treatments, and highly fragmented and rigid institutions that were set up to manage interannual variability of the twentieth century rather than twenty-first-century climate change. When queried about other sources of uncertainty, Phoenix-area water managers mention aspects of their policy setting, such as the legal status of Indian water rights, endangered-species designations, and the environmental permitting process [23].

### 3.2. Scenario Planning

Scenario planning is designed to cope with the uncertainty and unpredictability of the future. Scenario planners conduct group exercises and create narratives or storylines about the long-term future. These exercises often construct a small number of stories from qualitative discussions. Even quantitative analyses that produce hundreds and thousands of computer runs typically are reduced to a small number (three to four) of plausible and logically consistent stories about the future. It is important that each scenario be theoretically possible, even though some participants in the exercise believe it to be undesirable or unlikely [3]. Avoiding these rare but sometimes catastrophic outcomes is often a major concern in real-world policy situations.

Planning exercises involve a series of steps by which a set of scenarios are developed and evaluated [24]. The first step defines the decisions these scenarios are designed to inform. In the water sector, long-term planning and policy decisions include the design and construction of new water-supply infrastructure, agricultural planting patterns, water markets that allow temporary transfers of water, allocations and rate structures, and reservoir operating rules. The second step is to identify the most important and uncertain driving factors that will affect these decisions. The scenario planning group is then asked to rank key driving forces and their uncertainties. It is common for stakeholders to have differing views of the future; one goal of scenario planning is to bring these differences into the open and for stakeholders to acknowledge that a range of alternative futures is possible.

Table 8.1 lists the concerns or priorities of water stakeholders in Phoenix. Respondents to an online survey included representatives from federal and state entities, Indian tribes, local and regional water providers, private sector providers and users, and environmental organizations. They were asked to apportion 100 points across categories to reflect their level of concern about the following: (a) social and economic impacts, (b) financial and technical requirements, (c) health and safety, (d) natural and biophysical impacts, (e) political impacts and governance, (f) supply sufficiency, and (g) other legal and institutional issues. The most highly rated concern for managers in the desert city of Phoenix was the sufficiency of supply, accounting for 32 % of the total points, followed by impacts on the natural environment (16 %), health and safety (13 %), political impacts and governance (12 %), and financial and technical requirements (12 %). The overall results mask important differences across stakeholder groups, however. Representatives from local water departments and regional agencies expressed more concern for water sufficiency and safety than environmental groups who emphasized impacts on the natural/biophysical environment [25]. These results expose a critical tradeoff in urban water decisions—how to balance instream flows and biodiversity with the need to provide an adequate and reliable supply 24/7 for an ever-growing urban population.

After bringing the priorities and views of divergent groups into the open, a third step involves crafting three to four scenarios for in-depth discussion and analysis. The fourth step investigates how alternative policies and decisions work across these scenarios. This testing and evaluation process can be done qualitatively through discussion and consensus or quantitatively through simulation experiments. Scenarios are examined to determine the

**Table 8.1**

**Concerns or priorities of water stakeholders in Phoenix, Arizona, US (adapted from Keller et al. [25])**

---

1. Central Arizona socio-economic impacts
    - (a) Costs to the user
      - Affordability for the user
      - Informing public about costs of water
      - Investigate pricing options
      - Household versus industry pricing differences
    - (b) Impacts on the economy
      - Impact to jobs
      - Development impacts
  2. Financial and technical requirements
    - (a) Costs
      - Costs of distribution and transportation
      - Other, indirect costs
      - Litigation
    - (b) Performance of the system
      - Reliability of system infrastructure
      - Infrastructure maintenance and expansion
  3. Health and safety
    - (a) Meet existing standards: maintaining sampling and testing standard
    - (b) Meet existing standards: enforcing existing regulations
    - (c) Meet existing standards: planning for new threats to the supply
  4. Impacts on the natural/biophysical environment
    - (a) Local environment effects on the climate (impact to local climate)
    - (b) Regional environment's natural habitat concerns
      - Riparian use of water
      - Identifying non-urban uses of water
  5. Indirect/external impacts (broader impacts)
    - (a) Planning impacts: identify planning related issues
    - (b) Planning impacts: collaboration with other stakeholders
  6. Political impacts and governance
    - (a) Quality of the political process (inclusion of all stakeholder concerns)
    - (b) Policy development
      - To have a collaborative process
      - Meet federal requirements
  7. Sufficiency of water supplies
    - (a) Resilience of the water supply to drought and other climatic impacts
    - (b) Material requirements
      - Water supply availability
      - Acquisition of water for future supplies
      - Exchange of knowledge about water data
    - (c) Mid and long-term availability of the water supply
      - Future supply
      - Portfolio diversification
-



most critical outcomes and to identify “branching points” relating to the issues and policies that have the greatest impact (potentially generating crisis) on the future. Planning from scenarios involves searching for policies that are robust, that is, they will perform reasonably well across a wide range of plausible future scenarios. The goal is to minimize downside risk, given that we do not know what the future will hold.

Scenario planning processes have been criticized for their reluctance to explore rare events, failure to consider a full range of future conditions, and tendency to focus too early on one particular scenario for implementation purposes [26]. In principle, the goal of scenario planning is to open discussion to a wide range of future conditions; in practice, the process often limits community response to a single view of the future [26].

### 3.3. Simulation/Exploratory Modeling

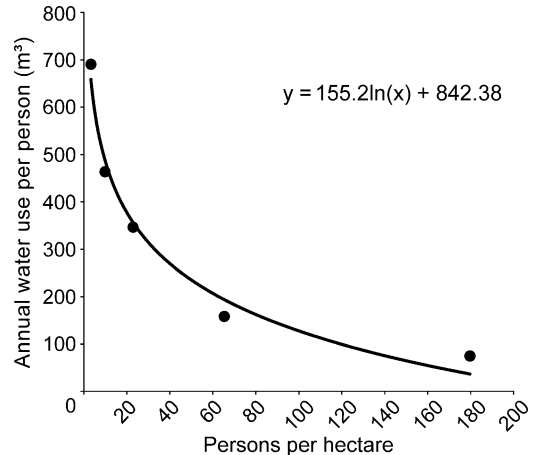
Many, but not all, scenario planning processes use simulation models to represent complex human-natural coupled systems and to anticipate how they respond to various biophysical changes and policy decisions. Bankes makes a useful distinction between *consolidative* modeling which uses known facts to replicate an actual system and *exploratory* modeling which investigates the consequences of varying assumptions and hypotheses about the system and its future dynamics [27]. The former is useful in optimization and prediction, while the latter acknowledges that not all relevant and important information is available. Exploratory modeling is appropriate for situations in which there is a high level of system complexity—where nonlinear behaviors and feedbacks can result in unintended consequences and potentially catastrophic events. The search for an optimum solution may not reveal the unlikely but real possibility for catastrophic consequences nor will it necessarily reveal a path that would avoid such consequences. There has been considerable development of agent-based modeling as an exploratory simulation approach to deal with problems that are characterized by complexity and deep uncertainty [22, 28].

Exploratory models can be both scientific tools to investigate system behavior and communication devices to promote social learning about the system at hand. Ideally, they evolve iteratively as new information is gained and integrated into modeling activities. Robust decision making acknowledges that a range of long-term conditions are possible and that near-term strategies will be revisited as our knowledge about complex systems improves.

### 3.4. Elements of Robust Decision Making

Robust adaptive strategies are “comprised of *shaping actions* intended to influence the future, *hedging actions* intended to reduce vulnerability if adverse futures come to pass, and *signposts*, which are observations that warn of the need to change strategies” [29]. Hedging actions in the water sector have traditionally involved building redundancies into the water system with additional infrastructure or supply sources. Shaping actions involve conservation programs aimed at reducing demand or altering the built environment to reduce water use. In Phoenix, there is a strong relationship between urban residential densities and per capita water use (Fig. 8.8). Urban densities of 37–74 housing units per hectare require around 75 m<sup>3</sup> of water per person annually, compared to large-lot semirural developments where per capita

**Fig. 8.8.** Estimated water use needed to support residential developments of varying densities (*Source:* Gober and Kirkwood [30], Fig. 2).



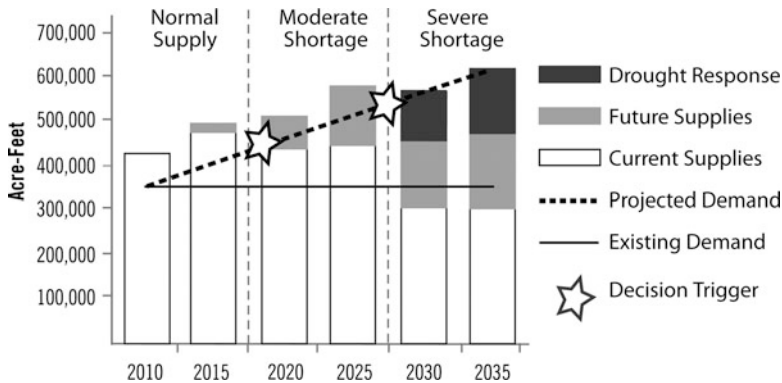
water use is almost ten times higher. Adding compact residential developments would lower per capita water requirements and shape demand. Signposts involve predetermined thresholds that automatically trigger policy action. Policy change might involve an increase in price or use of block pricing, implementation of a water education program, incentives to replace turf grass with native plants, step-up in water reuse, or fixing leaks and improving water efficiency.

### 3.5. Anticipatory Governance

The planning profession has developed the idea of anticipatory governance to address problems of deep uncertainty. Guston distinguished between precaution and anticipation in dealing with complex problems of deep uncertainty [31]. Precaution is a way of acting that avoids predicted but uncertain risks; anticipation implies building capacity to respond to unpredictable and uncertain risks. Anderson argued for the need to move from prediction and prevention toward more anticipatory modes of practice [32]. Rather than trying to avoid the unknown, he urges that we anticipate surprise and plan systems that are able to accommodate a wide range of future conditions.

Fourth defines anticipatory governance as “a system of institutions, rules, and norms that provide a way to use foresight for the purpose of reducing risk, and to increase capacity to respond to events at early rather than later stages of their development” [33]. Employing the principles of anticipatory governance, the City of Phoenix utilizes a range of scenarios in its water planning process, including the possibility of moderate-to-severe water shortage, varying levels of conservation, and different development patterns (e.g., high versus low density). Over the next 8–10 years, supplies are adequate to meet even the most dire drought conditions, but action is needed to address the gap between projected demand and current supplies and thus prevent shortage beyond 2025 (Fig. 8.9). As a result of this exercise, the City is now taking steps to develop backup supplies in the form of recharged groundwater credits (excess supplies can now be banked underground and credited for use later), additional surface water from the Colorado River via the Central Arizona Project, and reclaimed water [34].

Anticipatory governance entails three steps: (a) anticipation and futures analysis, (b) flexible adaptation strategies, and (c) monitoring and action [26]. The anticipation and



**Fig. 8.9.** Current projections indicate that Phoenix will be unable to meet expected demands in 2020 under shortage conditions without augmenting current supplies. Adapted from *Water Resources Plan 2005 Update* [34] based on personal communication with Steve Rossi.

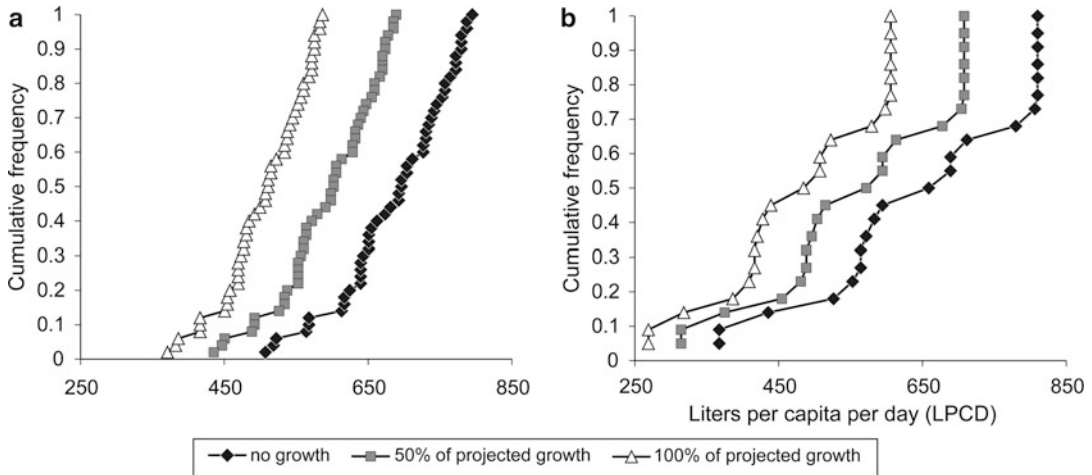
futures analysis phase is quite close to robust decision making in the sense that it uses advanced computation methods to produce a large number of scenarios. Outcome spaces are then examined for robust policies; worst-case or unacceptable outcomes are identified; and sensitivity analyses of various factors are conducted. Using the range of possible futures identified in the first step, adaptive strategies are developed in the second step. Ideally, these strategies are broken into modules so that they can be implemented separately as funding becomes available and knowledge about the climate and other relevant systems increases. Critical to any adaptive strategies is the monitoring and action required in the third step. Phoenix, Denver, and New York were evaluated for their anticipatory governance procedures, but none had yet developed a structured monitoring program for long-term water planning [26].

Camacho notes that effective climate adaptation “necessitates a fundamental reformation of natural resource governance” [35]. This reformation would ask different questions about the water system. Rather than focus on the physical aspects of water systems, relevant questions would address why governance systems are unable to cope with uncertainty, why they lack capacity for cooperative behavior, why they are unable to learn from mistakes, and why information sharing is limited. More coordinated and adaptive governance systems consist of:

1. Proactive strategies that take effect before the impacts of climate change are felt rather than reactive strategies that respond to a problem at hand or seek to prevent it from reoccurring,
2. No-regret strategies that provide a net benefit irrespective of the effects of climate change,
3. Procedural strategies focused on the regulatory environment itself and how decisions about natural resource management are made [35].

### 3.6. *WaterSim: An Example of DMUU*

We constructed *WaterSim*, an integrated simulation model, to investigate the long-term consequences of climate change and policies to manage groundwater, growth, and urban development in metropolitan Phoenix [36]. *WaterSim* represents water consumption and



**Fig. 8.10.** Cumulative frequency distributions from WaterSim for LPCD in 2030—LPCD available for residential use assuming no growth, 50 % of projected growth, and 100 % of projected growth for the (a) Salt/Verde and (b) Colorado River systems (*Source:* Gober and Kirkwood [30], Fig. 3).

availability in Central Arizona from the present until 2030 and uses the XLRM framework which contains four types of components:

1. Exogenous uncertainties (X) are factors that decision makers cannot control; these are primarily associated with climate and water supply,
2. Policy levers (L) are actions that decision makers could take, such as groundwater policy, land-use planning, and population growth management,
3. Relationships (R) are mathematical or algorithmic associations among variables,
4. Outcome measures (M) summarize outcome metrics for decision- and policy-making purposes [3].

Model users can consider the consequences of policies related to population growth, while assuming that consumption is restricted to available surface-water supply plus natural recharge (Fig. 8.10). Groundwater is used sustainably in this set of model runs, assuming that withdrawal equals natural recharge. This assumption does not account for instream flows and assumes that 40 % of indoor water use is recycled. The left diagram (Fig. 8.10a) shows the effects of population-growth scenarios under varying climate-change conditions on the Salt/Verde system. The right diagram (Fig. 8.10b) shows outcomes across climate-change conditions on the Colorado River. Under the expected unconstrained growth conditions (“100 % of projected growth”), liters per capita per day (LPCD) range from 371 to 587 for the Salt/Verde system and from 269 to 606 for the Colorado system. Any of these outcomes would require reductions from today’s consumption levels of 875 LPCD on a regional basis. The midpoint for the Salt/Verde system would translate into consumption levels of 511 LPCD, while the Colorado midpoint would mean consumption levels of 496 LPCD. These average conditions impose challenging but feasible restrictions on current growth patterns and lifestyles, as Tucson’s 2005 LPCD was 431 and, in Albuquerque, it was 416 [37]. Limited growth would reduce the need for lifestyle sacrifices, and in the no-growth cases, modest reductions would accommodate all but the worst-case climate-model results.

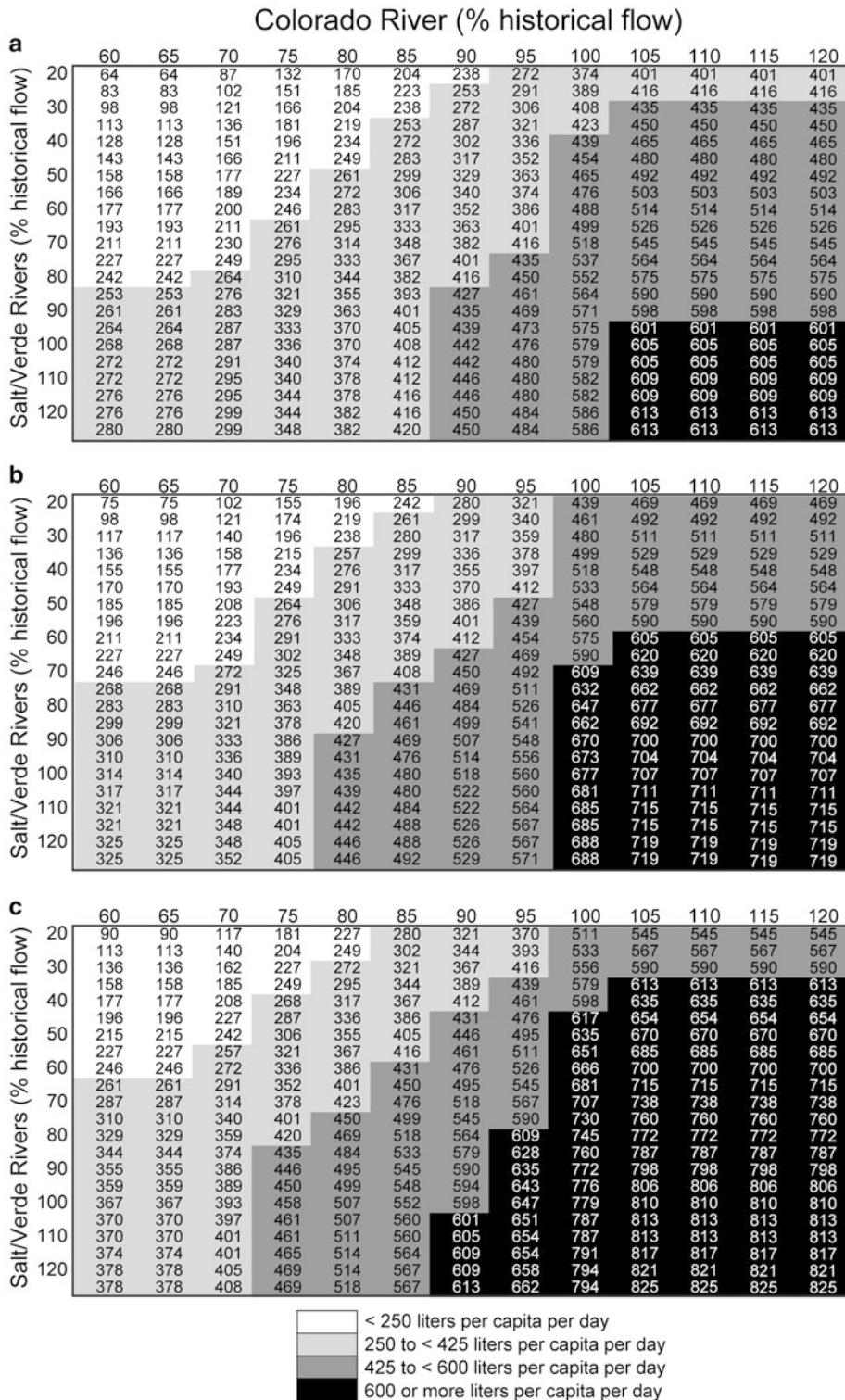


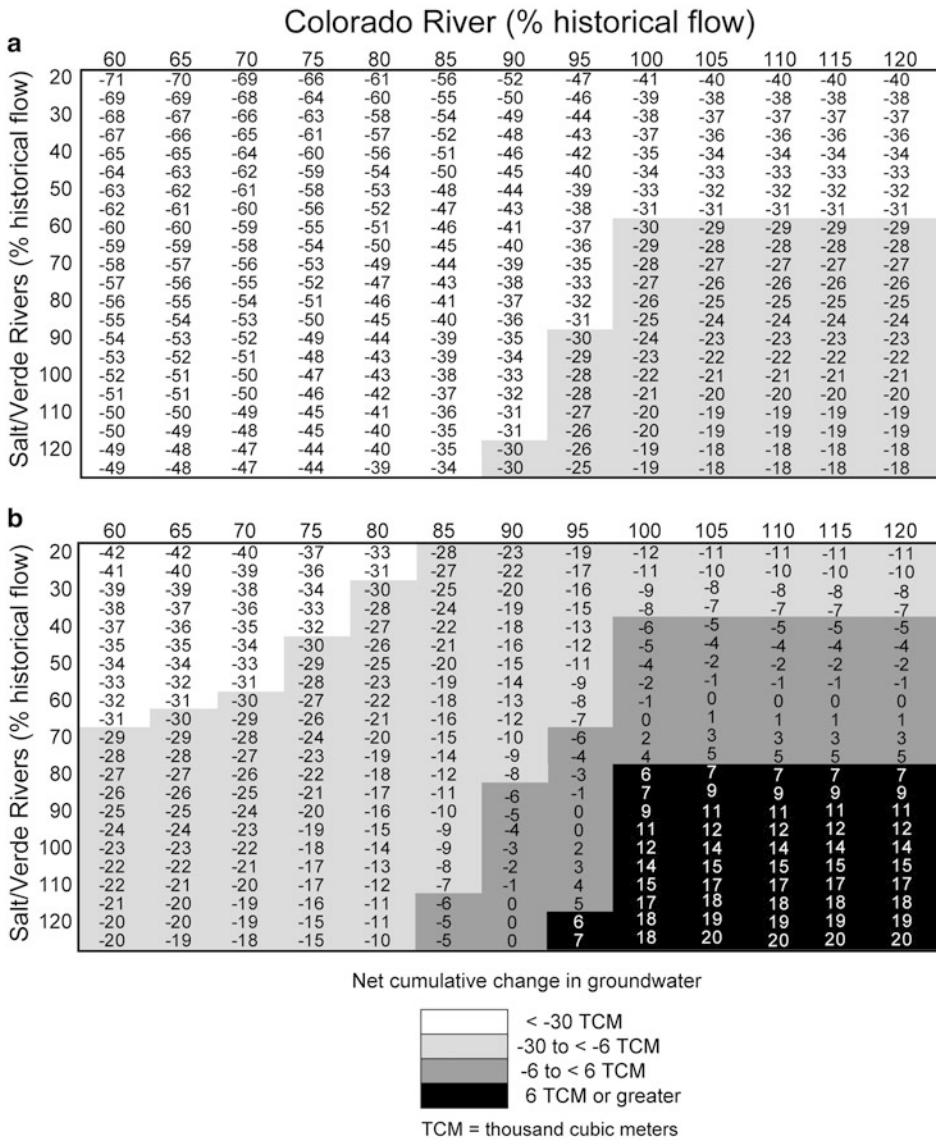
**Fig. 8.11.** Lake Mead water levels: 1935–2010 (Data source <http://www.usbr.gov/lc/region/g4000/hourly/mead-elv.html>).

Central Arizona is especially sensitive to climate-change conditions on the Colorado River system because of a 1968 agreement put into place when federal funding was secured for the Central Arizona Project (CAP). In exchange for support from the California congressional delegation for a federal loan to build the CAP, regional advocates agreed to give California senior rights to Lower Colorado River allocations [38]. The consequences of this agreement have appeared only recently with persistent drought on the Colorado River Basin. In 2010, levels in Lake Mead sat at 1,082 ft above sea level [39]. These were dangerously close to the 1,075-foot mark at which the first cutbacks in delivery to CAP would be triggered (Fig. 8.11). Long-term drought would reduce Central Arizona’s allocation quickly and lead to the steeply sloping lines in Fig. 8.10b. The region would more gradually lose its supply from the Salt/Verde system as shown in Fig. 8.10a. These figures and these types of analyses allow policy makers and stakeholders to explore best, worst, and mean-case climate-change conditions and then explore the effects of managing growth on output metrics (in this case LPCD). The process also highlights tradeoffs between continued growth and maintaining oasis-type lifestyles and landscape treatments (reflected in LPCD).

We used WaterSim to examine water availability under all possible runoff conditions for both systems. We considered the effect of policies related to population growth, assuming that consumption is restricted to available surface-water supply plus recharge. Under the expected unconstrained growth conditions (100 % of projected growth, Fig. 8.12a), there are future climate conditions that would require substantial reductions in consumption below 425 LPCD and many to below 250 LPCD, which is slightly below what is now used for indoor purposes. Lowering the growth rate to 50 % of the projected unconstrained level would allow the region to sustain current levels of indoor use under all but the most severe future climate conditions (Fig. 8.12b). A no-growth policy would further reduce the risk that current levels of indoor use could not be sustained (Fig. 8.12c).

We also investigated how groundwater drawdown would be affected by climate-change conditions if we assume a policy with current levels of residential water demand.





**Fig. 8.13.** Scenario ensembles from WaterSim for groundwater drawdown, assuming (a) 100 % of projected growth and current levels of pools, irrigated landscaping, and urban densities and (b) 50 % of projected growth, no pools, no irrigated landscaping, and higher densities (Source: Gober and Kirkwood [30], Fig. 5).

Groundwater has been the historical bank account from which providers tap when surface supplies are in deficit. Under currently projected population growth conditions and unconstrained water usage, it is not possible to achieve groundwater sustainability in 2030 under any climate scenario (Fig. 8.13a). At current consumption levels, drawdown would become quite severe if the pessimistic climate scenarios were to occur. At current drawdown

rates of between 250 million m<sup>3</sup>/year and 600 million m<sup>3</sup>/year, cumulative drawdown ranges from 6 billion to 14 billion m<sup>3</sup> over the course of the simulation. Current growth patterns produce more extreme drawdown situations; the more pessimistic the climate-change conditions, the more severe drawdown levels are. Policy action of some kind is necessary to achieve long-term groundwater sustainability, although it is possible to justify some overdraft while society learns to cope with new climate conditions.

Figure 8.13b shows the impacts on cumulative groundwater drawdown of restricting population growth to 50 % of projected levels and eliminating irrigated outdoor landscaping and private backyard pools. These policies would achieve groundwater sustainability under normal (100 %) surface flows and would substantially reduce drawdown for all but the most severe climate futures.

## 4. HUMAN FACTORS IN THE WATER SECTOR

### 4.1. *Water Planning as a Social Process*

The predict-and-plan model of water management in which well-defined problems are solved with technological solutions, such as wastewater treatment and water-supply augmentation, has tended to treat human actors as separate from the environmental and technical problem at hand [40]. The socioeconomic system is typically seen as an external boundary condition—the number of people to be served, the nature of their land uses, rules that govern reservoir management, etc. The complexities, feedbacks, and uncertainties in modern water systems require that humans and their social organizations and political institutions be fully integrated into water science. The use of DMUU strategies, the search for robust solutions in water planning, and analysis of system vulnerabilities recognize that humans and nature are elements of an inherently coupled system. Critical vulnerabilities often occur in the intersection points of the human and physical system, for example, when governance systems are incapable of dealing with climate-induced changes in water supply.

While climate mitigation efforts such as emission standards, carbon markets, and incentives for renewable energy are within the purview of federal authority, climate adaptation often occurs at the local and regional level where climate impacts will be felt and relevant decision making occurs. Adaptation efforts require participatory processes that reveal the needs of diverse stakeholders for climate and hydrological information and decision support and consensus building among these diverse stakeholders. Social scientists, particularly decision scientists, have played a mediating role in translating the products of water science into tools to support decision making in the water sector.

Jacobs et al. conducted an information-gathering workshop with water stakeholders and found that the availability of more information is often not the major impediment of good decisions [41]. The more relevant question is how much information is enough and how to develop and sustain participatory networks that reveal the answer to this question. Workshop participants noted that effective knowledge systems mine both practical experience and scientific knowledge to focus on common solutions to reduce the risk from climate change. Stakeholders emphasized robust solutions—those that reduce risk, no matter what the future climate conditions.



## 4.2. Boundary Science

Scholars in the field of science and technology policy studies have systematically examined the process of science-policy engagement, now known as “boundary science,” for best practices. Cash et al. have identified the attributes of knowledge systems that support decision making in the environmental realm [42]. They note the emergence of boundary organizations that sit at the interface of science and policy and are responsible to both. In-depth analysis from case studies of boundary organizations reveals that efforts to use science to support policy and decision making are more likely to be effective when they manage the boundary between science and policy in ways that balance credibility, salience, and legitimacy. Credibility embodies the adequacy of technical advice and scientific arguments. Salience deals with the relevance of the assessment to the needs of decision makers, and legitimacy speaks to the perception that scientific and technological experts have been respectful of stakeholders’ divergent values and beliefs, unbiased, and fair in their treatment of opposing views. Water managers in Central Arizona gave high marks to WaterSim for its legitimacy, believing that it was produced from unbiased and objective data, modeling efforts, and scientific relationships, but lower marks for credibility and salience. The model had not yet included all relevant components of the regional water budget and thus was not yet deemed useful for decision making [43].

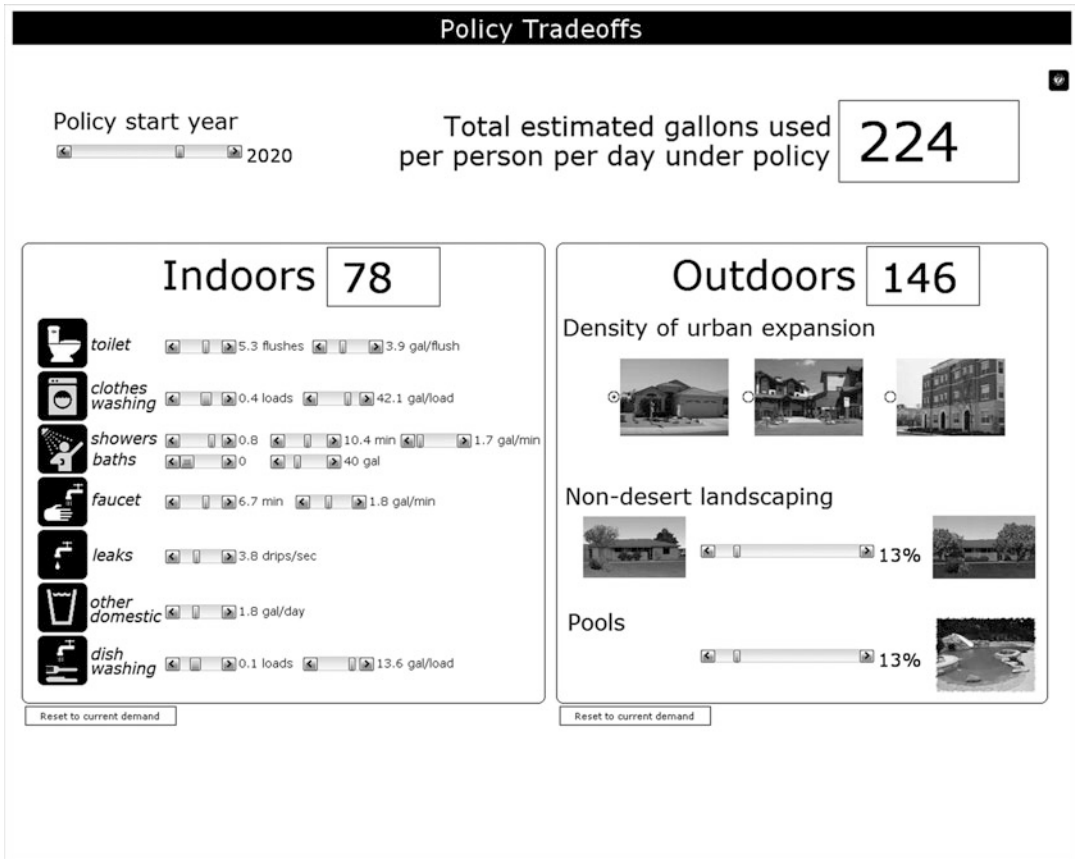
Participatory environments for science-policy engagement are hampered by differing perceptions of the relevant problem and its solutions. Scientists, water professionals, and the public at large have fundamentally different views of the problem of potential water shortage in Phoenix [44]. Survey results show that scientists viewed the possibility of climate-induced water shortage as a demand management problem—the key issue is how water is used, not supply constraints. The city can solve its water problems through conservation and urban design. Water managers tended to emphasize supply-side constraints and focused on how to obtain additional supplies from farmers, desalination, and infrastructure augmentation. The general public saw potential shortage as someone else’s problem—why should today’s households conserve water to protect the profits from new development on the urban fringe? These differing perceptions present profound challenges for participatory processes that aspire to link science with decision making for climate adaptation in the water sector and beyond.

## 4.3. Decision Theater

Visualization is increasingly used to facilitate social learning and decision making. Visualization caves and decision theaters create an immersive experience in which participants feel part of the model development and scientific process. Arizona State University’s 3-D, immersive Decision Theater enables WaterSim to be seen, experienced, and manipulated by water stakeholders and the public at large (Fig. 8.14). The model and its user interface have evolved as an iterative process (WaterSim 5.0 is now in development) in response to user criticism and suggestions. Users requested less emphasis on the climate conditions that are outside of their control and more opportunity to manipulate policy conditions that are within their purview (Fig. 8.15).



**Fig. 8.14.** The author leads an interactive session of WaterSim in Arizona State University’s Decision Theater. Photo credit: Dustin Hampton.



**Fig. 8.15.** Policy screen for WaterSim interactive display in Decision Theater.

## 5. SUSTAINABLE WATER SYSTEMS

The seminal and enduring definition of sustainability comes from the Brundtland Commission Report in 1987: “Sustainable development is development that meets the needs of the present without compromising the ability of future generations to meet their own needs” [45]. While it has been easier to define sustainability as an intellectual concept than as an operational tool, there is growing agreement that a sustainability perspective includes an awareness of complex systems thinking, foresight analysis, decision making under uncertainty, stakeholder engagement, and interdisciplinary approaches to real-world problem solving.

When these ideas are applied to the water sector, it is clear that the current practice of water management and water science will need to evolve to meet the challenges of water sustainability. Not only do we need to treat the water sector as a complex human-natural coupled system, include water professionals in the coproduction of knowledge, and incorporate DMUU support tools, but also consider the fact that water is not a stand-alone resource. It is connected to land (low-density development encourages high per capita water use), food production (virtual water is exported via food crops), and energy (the so-called energy-water nexus). Water and energy, particularly in arid regions, are linked resources. Energy is used to pump, move, and treat water. Water is used to turn turbines, wash inputs, and cool equipment. It is anticipated that as climate changes, water resources will be altered; potentially reducing their quality, quantity, and accessibility. This in turn will require increased energy inputs to purify water of lower quality or pump water from greater depths or distances. Thus, the effects of climate change for the water sector may appear indirectly in the amount of energy it will take to deliver and treat water and keep the city cool.

The concept of sustainability challenges us to look at water holistically, to consider the hidden vulnerabilities that occur because water is linked to other resources such as energy, land, and food production. This new approach to water science is interdisciplinary; it requires analysis of how complex human and biophysical systems function at a range of scales and new tools for risk assessment and decision support that incorporate notions of decision making under uncertainty.

## REFERENCES

1. Milly PCD, Betancourt J, Falkenmark M, Hirsch RM, Kundzewicz ZW, Lettenmaier DP, Stouffer RJ (2008) Stationarity is dead: whither water management? *Science* 319(5863):573–574
2. Intergovernmental Panel on Climate Change: Solomon S, Qin D, Manning M, Chen Z, Marquis M, Averyt KB, Tignor M, Miller HL (eds) (2007) *Climate change 2007: the physical science basis. Contribution of Working Group I to the Fourth Assessment Report of the Intergovernmental Panel on Climate Change*, Cambridge University Press, Cambridge, UK
3. Lempert RJ, Popper SW, Bankes SC (2003) *Shaping the next one hundred years: new methods for quantitative, long-term policy analysis*. RAND Corporation, Santa Monica, CA
4. Intergovernmental Panel on Climate Change: Parry ML, Canziani OF, Palutikof JP, van der Linden PJ, Hanson CE (eds) (2007) *Climate change 2007: Impacts, Adaptation and Vulnerability*.

- Contribution of Working Group II of the Fourth Assessment Report of the Intergovernmental Panel on Climate Change, Cambridge University Press, Cambridge, UK
5. Knutti R, Allen MR, Friedlingstein P, Gregory JM, Hegerl GC, Meehl GA, Meinshausen M, Murphy JM, Plattner GK, Raper SCB, Stocker TF, Stott PA, Teng H, Wigley TML (2008) A review of uncertainties in global temperature projections over the twenty-first century. *J Climate* 21(11):2651–2663
  6. Intergovernmental Panel on Climate Change (2000) IPCC Special Report: Emissions scenarios. Summary for policymakers. A special report of Working Group III of the Intergovernmental Panel on Climate Change, Geneva, Switzerland
  7. Fowler HJ, Blenkinsop S, Tebaldi C (2007) Linking climate change modelling to impacts studies: recent advances in downscaling techniques for hydrological modelling. *Int J Climatol* 27(12):1547–1578
  8. Salathe EP, Mote PW, Wiley MW (2007) Review of scenario selection and downscaling methods for the assessment of climate change impacts on hydrology in the United States Pacific Northwest. *Int J Climatol* 27(12):1611–1621
  9. National Research Council (2007) Colorado river basin water management: evaluating and adjusting to hydroclimatic variability. The National Academies Press, Washington, DC, p 222
  10. Seager R, Vecchi GA (2010) Greenhouse warming and the 21st century hydroclimate of southwestern North America. *Proc Natl Acad Sci U S A* 107(50):21277–21282
  11. Gober P, Kirkwood CW, Balling RC Jr, Ellis AW, Deitrick S (2010) Water planning under climatic uncertainty in Phoenix: why we need a new paradigm. *Ann Assoc Am Geogr* 100(2):356–372
  12. Ellis AW, Hawkins TW, Balling RC Jr, Gober P (2008) Estimating future runoff levels for a semi-arid fluvial system in central Arizona. *Climate Res* 35(3):227–239
  13. Krebs J, Hall J (2010) Adapting infrastructure to a changing climate. *Ingenia* 42:20–25
  14. United States Global Change Research Program (2010) National climate change. Available at <http://downloads.globalchange.gov/usimpacts/pdfs/National.pdf>
  15. Willows RI, Connell RK (eds) (2003). Climate adaptation: risk, uncertainty and decision-making. UKCIP technical report, UKCIP, Oxford
  16. Peterson TC, Anderson DM, Cohen SJ, Cortez-Vázquez M, Murnane RJ, Parmesan C, Phillips D, Pulwarty RS, Stone JMR (2008) Why weather and climate extremes matter. In: Karl TR, Meehl GA, Miller CD, Hassol SJ, Waple AM, Murray WL (eds) *Weather and climate extremes in a changing climate. Regions of focus: North America, Hawaii, Caribbean, and U.S. Pacific Islands*. A report by the U.S. climate change science program and the subcommittee on global change research, Washington, DC, pp 11–34
  17. Vandentorren S, Empereur-Bissonnet P (2005) Health impact of the 2003 heat-wave in France. In: Kirch W, Menne B, Bertollini R (eds) *Extreme weather events and public health responses*. Springer, Berlin, Germany, pp 81–88
  18. van Vliet A, Leemans R (2006) Rapid species' responses to changes in climate require stringent climate protection targets. In: Schellnhuber HJ (ed) *Avoiding dangerous climate change*. Cambridge University Press, Cambridge, UK, pp 135–141
  19. Wisner B, Blaikie P, Cannon T, Davis I (2004) *At risk: natural hazards, people's vulnerability and disasters*, 2nd edn. Routledge, London, UK, pp 49–86
  20. Crabbé P, Robin M (2004) Institutional adaptation of water resource infrastructures to climate change in Eastern Ontario. *Clim Change* 78(1):103–133

21. Ivey J, Smithers J, de Loe RC (2004) Community capacity for adaptation to climate-induced water shortages: linking institutional complexity and local actors. *Environ Manage* 33(1):36–47
22. Bankes S (2002) Tools and techniques for developing policies for complex and uncertain systems. *Proc Natl Acad Sci U S A* 99(Suppl 3):7263–7266
23. White DD, Corley EA, White MS (2008) Water managers' perceptions of the science-policy interface in Phoenix, Arizona: implications for an emerging boundary organization. *Soc Nat Resour* 21(3):230–243
24. Schwartz P (1996) *The art of the long view: planning for the future in an uncertain world*. Currency Doubleday, New York, p 288
25. Keller LR, Kirkwood CW, Jones NS (2010) Assessing stakeholder evaluation concerns: an application to the Central Arizona water resources system. *Syst Eng* 13(1):58–71
26. Quay R (2010) Anticipatory governance: a tool for climate change adaptation. *J Am Plann Assoc* 76(4):496–511
27. Bankes SC (1993) Exploratory modeling for policy analysis. *Oper Res* 41(3):435–449
28. Zellner ML (2008) Embracing complexity and uncertainty: the potential of agent-based modeling for environmental planning and policy. *Plan Theory Pract* 9(4):437–457
29. Lempert RJ, Schlesinger ME (2000) Robust strategies for abating climate change. *Clim Change* 45(3–4):387–401
30. Gober P, Kirkwood CW (2010) Vulnerability assessment of climate-induced water shortage in Phoenix. *Proc Natl Acad Sci U S A* 107(50):21295–21299
31. Guston DH (2008) Innovation policy: not just a jumbo shrimp. *Nature* 454(7207):940–941
32. Anderson B (2007) Hope for nanotechnology: anticipatory knowledge and the governance of affect. *Area* 39(2):156–165
33. Fuerth LS (2009) Foresight and anticipatory governance. *Foresight* 11(4):14–32
34. City of Phoenix Water Services Department (2005) *Water resources plan 2005 update*. City of Phoenix Water Services Department, Phoenix, AZ, p 136
35. Camacho AE (2009) Adapting governance to climate change: managing uncertainty through a learning infrastructure. *Emory Law J* 59(1):1–77. Notre Dame Legal Studies Paper No. 09-06. Available at SSRN: <http://ssrn.com/abstract=1352693>
36. Gober P, Wentz EA, Lant T, Tschudi MK, Kirkwood CW (2011) WaterSim: a simulation model for urban water planning in Phoenix, Arizona, USA. *Environ Plan B* 38(2):197–215
37. Hutchins-Cabibi T, Miller B, Schwartz A (2006) Water in the urban southwest: an updated analysis of water use in Albuquerque, Las Vegas Valley, and Tucson. *Western Resource Advocates*, Boulder, CO, p 57
38. Hirt P, Gustafson A, Larson K (2008) The mirage in the Valley of the Sun. *Environ Hist* 13(3):482–514
39. Bureau of Reclamation (2013) Lower Colorado River daily report. Available at <http://www.usbr.gov/lc/region/g4000/hourly/hourly.html>
40. Pahl-Wostl C (2002) Towards sustainability in the water sector: the importance of human actors and processes of social learning. *Aquat Sci* 64(4):394–411
41. Jacobs K, Garfin G, Buizer J (2009) The science–policy interface: experience of a workshop for climate change researchers and water managers. *Sci Public Policy* 36(10):791–798
42. Cash DW, Clark WC, Alcock F, Dickson NM, Eckley N, Guston DH, Jaeger J, Mitchell RB (2003) Knowledge systems for sustainable development. *Proc Natl Acad Sci U S A* 100(14):8086–8091

43. White DD, Wutich A, Larson KL, Gober P, Lant T, Senneville C (2010) Credibility, salience, and legitimacy of boundary objects: water managers' assessment of a simulation model in an immersive decision theater. *Sci Public Policy* 37(3):219–232
44. Larson KL, White DD, Gober P, Harlan S, Wutich A (2009) Divergent perspectives on water resource sustainability in a public-policy-science context. *Environ Sci Policy* 12(7):1012–1023
45. World Commission on Environment and Development (1987) *Our common future*. Oxford University Press, Oxford, UK

Pierre Y. Julien, Mark L. Velleux, Un Ji, and Jaehoon Kim

## *CONTENTS*

UPLAND EROSION PROCESSES  
WATERSHED MODELING  
WATERSHED MODEL APPLICATION  
ACKNOWLEDGEMENTS  
REFERENCES

---

**Abstract** Significant advances in upland erosion modeling have been achieved in the past decade. The TREX (Two-dimensional Runoff, Erosion, and Export) watershed model has been developed at Colorado State University for the simulation of surface runoff from spatially and temporally distributed rainstorms on watersheds. The model has been applied in several countries with different climatic conditions. TREX can calculate surface infiltration, surface runoff, sediment transport, and the partition of metals in dissolved, adsorbed, and particulate form. The focus of this chapter is on the calculation of surface flows and total suspended solids at the watershed scale. The chapter is comprised of three parts: (a) a description of the main processes and governing equations, (b) a description of the model components and algorithms, and (c) an application example on a large watershed. The application example for Naesung Stream in South Korea provides powerful visual evidence of upland erosion processes at the watershed scale during large rainstorms (300 mm of rainfall). Model calibration was successful and overall model performance is acceptable. Hydrologic simulation results were in good to very good agreement with measured flow volume, peak flow, and time to peak at the watershed outlet as well as several stations within the watershed. Sediment transport simulation results were also in reasonable agreement with the measured suspended solids concentration.

**Key Words** Upland erosion • Distributed model • Extreme events • Sediment transport.

## LIST OF SYMBOLS

$a$	Experimentally determined constant for flocculation
$A$	USLE (annual) average soil loss (tons/acre/year) [ $M L^{-2} T^{-1}$ ]
$A_c$	Cross-sectional area of flow [ $L^2$ ]
$B_e$	Width of eroding surface in flow direction [ $L$ ]
$B_x, B_y$	Flow width in the $x$ - or $y$ -direction [ $L$ ]
$\hat{C}$	USLE soil cover factor [dimensionless]
$C_s$	Concentration of sediment particles in the water column [ $M L^{-3}$ ]
$C_{sb}$	Concentration of sediment particles in the soil or sediment bed [ $M L^{-3}$ ]
$C_t$	Concentration of entrained sediment at the transport capacity [ $M L^{-3}$ ]
$C_w$	Concentration of entrained sediment particles by weight at the transport capacity [dimensionless]
$d_f$	Median floc diameter ( $\mu m$ ) [ $L$ ]
$d_p$	Particle diameter [ $L$ ]
$d^*$	Dimensionless particle diameter [dimensionless]
$f$	Infiltration rate [ $L T^{-1}$ ]
$g$	Gravitation acceleration [ $L T^{-2}$ ]
$G$	Particle specific gravity [dimensionless]
$h$	Surface water depth (flow depth of water column) [ $L$ ]
$H_c$	Capillary pressure (suction) head at the wetting front [ $L$ ]
$i_e$	Excess precipitation rate [ $L T^{-1}$ ]
$i_n$	Net (effective) rainfall rate at the surface [ $L T^{-1}$ ]
$J_c$	Sediment transport capacity areal flux [ $M L^{-2} T^{-1}$ ]
$J_d$	Deposition flux [ $M L^{-2} T^{-1}$ ]
$J_e$	Erosion flux [ $M L^{-2} T^{-1}$ ]
$k$	Empirically or theoretically derived coefficient for sediment transport capacity [ $M L^{-1} T^{-1}$ ]
$\hat{K}$	USLE soil erodibility factor [dimensionless]
$K_h$	Effective hydraulic conductivity [ $L T^{-1}$ ]
$LS$	Slope length-gradient factor normalized to a field with a standard length of 23.2 m (76.2 ft) and a slope of 9 % [dimensionless]
$m$	Experimentally determined constant for flocculation
$n$	Manning roughness coefficient [ $T L^{-1/3}$ ]
$P_c$	Wetted perimeter of channel flow [ $L$ ]
$\hat{p}$	USLE soil management practice factor [dimensionless]
$P_{dep}$	Probability of deposition [dimensionless]
$q$	Unit flow rate of water = $v_a h$ [ $L^2 T^{-1}$ ]
$q_c$	Critical unit flow for erosion (for the aggregate soil matrix) [ $L^2 T^{-1}$ ]
$q_l$	Lateral unit flow from overland plane to channel (floodplain) [ $L^2 T^{-1}$ ]



$q_p$	Peak runoff rate ( $\text{m}^3/\text{s}$ ) [ $\text{L}^3 \text{T}^{-1}$ ]
$q_s$	Total sediment transport capacity ( $\text{kg}/\text{m s}$ ) [ $\text{M L}^{-1} \text{T}^{-1}$ ]
$q_x, q_y$	Unit discharge in the $x$ - or $y$ -direction = $Q_x/B_x, Q_y/B_y$ [ $\text{L}^2 \text{T}^{-1}$ ]
$Q$	Total discharge [ $\text{L}^3 \text{T}^{-1}$ ]
$Q_v$	Storm runoff volume ( $\text{m}^3$ ) [ $\text{L}^3$ ]
$Q_x, Q_y$	Flow in the $x$ - or $y$ -direction [ $\text{L}^3 \text{T}^{-1}$ ]
$R$	Rainfall erosivity factor [dimensionless]
$R_h$	Hydraulic radius of flow = $A_c/P$ [L]
$S_f$	Friction slope [dimensionless]
$S_{fx}, S_{fy}$	Friction slope (energy grade line) in the $x$ - or $y$ -direction [dimensionless]
$S_{0x}, S_{0y}$	Ground surface slope in the $x$ - or $y$ -direction [dimensionless]
$t$	Time [T]
$v_a$	Advective (flow) velocity (in the $x$ - or $y$ -direction) [ $\text{L T}^{-1}$ ]
$v_c$	Critical velocity for soil or sediment erosion [ $\text{L T}^{-1}$ ]
$v_r$	Resuspension (erosion) velocity [ $\text{L T}^{-1}$ ]
$v_s$	Quiescent settling velocity [ $\text{L T}^{-1}$ ]
$v_{se}$	Effective settling (deposition) velocity [ $\text{L T}^{-1}$ ]
$v_{sf}$	Floc settling velocity ( $\text{cm}/\text{s}$ ) [ $\text{L T}^{-1}$ ]
$Y_e$	MUSLE sediment yield from an individual storm [M]
$\alpha_c$	Empirical soil erosion coefficient = 11.8
$\alpha_x, \alpha_y$	Resistance coefficient for flow in the $x$ - or $y$ -direction [ $\text{L}^{1/3} \text{T}^{-1}$ ]
$\beta$	Resistance exponent = $5/3$ (assuming Manning resistance) [dimensionless]
$\beta_e$	Empirical soil erosion exponent = 0.56 [dimensionless]
$\beta_s$	Empirically or theoretically derived exponent for discharge [dimensionless]
$\gamma_s$	Empirical or theoretically derived exponent for local energy gradient [dimensionless]
$\theta$	Initial soil moisture deficit [dimensionless]
$\rho_b$	Bulk density of sediments [ $\text{M L}^{-3}$ ]
$\nu$	Kinematic viscosity of water [ $\text{L}^2 \text{T}^{-1}$ ]

## 1. UPLAND EROSION PROCESSES

A brief review of upland hydrologic and sediment transport processes is first presented. The main hydrologic processes include: (a) rainfall precipitation and interception, (b) snowmelt, (c) infiltration and transmission losses, (d) depression storage, and (e) overland and channel flow. Rainfall precipitation is usually determined from a network of point rain gage measurements or remotely sensed from radars. Rain gage measurements are usually more reliable, but radars usually provide a better spatial distribution of the rainfall patterns which may change with time as storms move through the watershed area. Snowmelt can be determined from radiative energy balance formulations or from empirical formulas based on daily temperature.

Infiltration is the downward transport of water from the surface to the subsurface. The rate at which infiltration occurs may be affected by several factors including hydraulic

conductivity, capillary action, and gravity (percolation) as the soil matrix reaches saturation. Many relationships [1–4] have been used to describe infiltration. The Green and Ampt relationship is often used because of its ease of application. For single storm events, the recovery of infiltration capacity by evapotranspiration and percolation can be neglected. Similarly, the loss to evaporation or other processes can also be neglected for single storm events.

Water may be stored in depressions on the land surface as small, discontinuous surface pools. In effect, the depression storage depth represents a threshold limiting the occurrence of overland flow. Note that water in depression storage is still subject to infiltration and evaporation.

### 1.1. Surface Runoff

Overland flow occurs when the water depth on the overland plane exceeds the depression storage threshold. Overland flow is governed by conservation of mass (continuity) and conservation of momentum. The two-dimensional (vertically integrated) continuity equation for gradually varied flow [5, 6] over a plane in rectangular ( $x, y$ ) coordinates is:

$$\frac{\partial h}{\partial t} + \frac{\partial q_x}{\partial x} + \frac{\partial q_y}{\partial y} = i_n - f = i_e \quad (9.1)$$

where  $h$  = surface water depth [L]

$q_x, q_y$  = unit discharge in the  $x$ - or  $y$ -direction =  $Q_x/B_x, Q_y/B_y$  [ $L^2 T^{-1}$ ]

$Q_x, Q_y$  = flow in the  $x$ - or  $y$ -direction [ $L^3 T^{-1}$ ]

$B_x, B_y$  = flow width in the  $x$ - or  $y$ -direction [L]

$i_n$  = net (effective) rainfall rate at the surface [ $L T^{-1}$ ]

$f$  = infiltration rate [ $L T^{-1}$ ]

$i_e$  = excess precipitation rate [ $L T^{-1}$ ]

Momentum equations for the  $x$ - and  $y$ -directions may be derived by relating the net forces per unit mass to flow acceleration [5, 6]. In full form, with all terms retained, these equations can be expressed in dimensionless form as the friction slope and are known as the Saint-Venant equations. The full dynamic wave formulation of the Saint-Venant equations can normally be simplified to the diffusive wave approximation (of the friction slope) for the  $x$ - and  $y$ -directions:

$$S_{fx} = S_{0x} - \frac{\partial h}{\partial x} \quad (9.2)$$

$$S_{fy} = S_{0y} - \frac{\partial h}{\partial y} \quad (9.3)$$

where

$S_{fx}, S_{fy}$  = friction slope (energy grade line) in the  $x$ - or  $y$ -direction [dimensionless]

$S_{0x}, S_{0y}$  = ground surface slope in the  $x$ - or  $y$ -direction [dimensionless]

To solve the overland flow equations for continuity and momentum, the hydraulic variables must be defined in terms of a depth-discharge relationship to describe flow resistance. Assuming that flow is turbulent and resistance can be described using the Manning formulation (in S.I. units), the depth-discharge relationships are:

$$q_x = \alpha_x h^\beta \quad (9.4)$$

$$q_y = \alpha_y h^\beta \quad (9.5)$$

$$\alpha_x = \frac{S_{fx}^{1/2}}{n} \quad (9.6)$$

$$\alpha_y = \frac{S_{fy}^{1/2}}{n} \quad (9.7)$$

where

$\alpha_x, \alpha_y$  = resistance coefficient for flow in the  $x$ - or  $y$ -direction [ $L^{1/3} T^{-1}$ ]

$\beta$  = resistance exponent = 5/3 [dimensionless]

$n$  = Manning roughness coefficient [ $T L^{-1/3}$ ]

Similarly, channel flow can occur when the water depth in the channel exceeds the dead storage threshold. Channel flow is also governed by conservation of mass (continuity) and conservation of momentum. At the watershed scale, it is convenient to represent channel flows in a watershed as one-dimensional (along the channel in the down-gradient direction). The one-dimensional (laterally and vertically integrated) continuity equation for gradually varied flow along a channel is

$$\frac{\partial A_c}{\partial t} + \frac{\partial Q}{\partial x} = q_l \quad (9.8)$$

where

$A_c$  = cross-sectional area of flow [ $L^2$ ]

$Q$  = total discharge [ $L^3 T^{-1}$ ]

$q_l$  = lateral unit flow (into or out of the channel) [ $L^2 T^{-1}$ ]

Based on the momentum equation for the down-gradient direction and again neglecting terms for local and convective acceleration, the diffusive wave approximation may be used for the friction slope (see (9.2)). To solve the channel flow equations for continuity and momentum [5, 6], the Manning relationship may be used to describe flow resistance:

$$Q = \frac{1}{n} A_c R_h^{2/3} S_f^{1/2} \quad (9.9)$$

where

$R_h$  = hydraulic radius of flow =  $A_c/P_c$  [L]

$P_c$  = wetted perimeter of channel flow [L]

## 1.2. Upland Erosion

Erosion is the entrainment (gain) of material from a bottom boundary into surface flow by the action of water. The erosion flux may be expressed as a mass rate of particle removal from the boundary over time and the concentration (bulk density) of particles at the boundary:

$$J_e = v_r C_{sb} \quad (9.10)$$

where

$J_e$  = erosion flux [ $M L^{-2} T^{-1}$ ]

$v_r$  = resuspension (erosion) velocity [ $L T^{-1}$ ]

$C_{sb}$  = concentration of sediment at the bottom boundary (in the bed) [ $M L^{-3}$ ]

Entrained material may be transported as either bedload or suspended load. However, for overland sheet and rill flows, bedload transport by rolling and sliding may predominate as the occurrence of saltation and full suspension may be limited [7]. Entrainment rates may be estimated from site-specific erosion rate studies or, in general, from the difference between sediment transport capacity and advective fluxes:

$$v_r = \begin{cases} \frac{J_c - v_a C_s}{\rho_b} & \text{for } J_c > v_a C_s \\ 0 & \text{for } J_c \leq v_a C_s \end{cases} \quad (9.11)$$

where

$v_r$  = resuspension (erosion) velocity [ $L T^{-1}$ ]

$J_c$  = sediment transport capacity areal flux [ $M L^{-2} T^{-1}$ ]

$v_a$  = advective (flow) velocity (in the  $x$ - or  $y$ -direction) [ $L T^{-1}$ ]

$C_s$  = concentration of sediment entrained in the flow [ $M L^{-3}$ ]

$\rho_b$  = bulk density of bed sediments [ $M L^{-3}$ ]

In the overland plane, particles can be detached from the bulk soil matrix by raindrop (splash) impact and entrained into the flow by hydraulic action when the exerted shear stress exceeds the stress required to initiate particle motion [7, 8]. The overland erosion process is influenced by many factors including precipitation (rainfall) intensity and duration, runoff length, surface slope, soil characteristics, vegetative cover, exerted shear stress, and particle size. Raindrop impact may generally be neglected when flow depths are greater than three times the average raindrop diameter [6].

### 1.3. Soil Erosion Relationships

Extensive review of hillslope and watershed-scale soil erosion models is presented by [9, 10]. Soil erosion relationships range in complexity from simple empirical equations to physically based models that are applicable over different spatial and temporal scales. Common soil erosion relationships include the Universal Soil Loss Equation (USLE) and its variants. The USLE [11] is an empirical based on a large database of field plot measurements. It was developed to predict soil losses from agriculture and is designed to estimate long-term average annual soil loss associated with sheet and rill erosion using six factors that are associated with climate, soil, topography, vegetation, and land use management:

$$A = R\hat{K}LS\hat{C}\hat{P} \quad (9.12)$$

where

$A$  = average annual soil loss due to sheet and rill erosion (tons/acre/year) [ $\text{M L}^{-2} \text{T}^{-1}$ ]

$R$  = rainfall erosivity factor [dimensionless]

$\hat{K}$  = soil erodibility factor (tons/acre) [dimensionless]

$LS$  = slope length-gradient factor normalized to a field with a standard length of 23.2 m (76.2 ft) and a slope of 9 % [dimensionless]

$\hat{C}$  = cropping-management factor normalized to a tilled area that is continuously fallow [dimensionless]

$\hat{P}$  = conservation practice factor normalized to straight-row farming up and down the slope [dimensionless]

The Revised Universal Soil Loss Equation (RUSLE) and later versions of the RUSLE framework [12–14] have the same basic form as the original USLE but use extended methods to calculate how soil erosion factors are determined. In particular, a subfactor approach to determine crop management factors enables RUSLE to be applied to crops and management systems that were not examined in the original experiments used to develop the USLE. RUSLE is applicable to one-dimensional hillslopes that do not produce deposition as a result of changes in slope gradient. RUSLE2 [15] provides an approach that estimates erosion on a daily basis and accounts for deposition resulting from slope gradient changes on hillslopes.

The Modified Universal Soil Loss Equation (MUSLE) [16] estimates soil erosion loss (yield) for a single storm event by replacing the rainfall erosivity factor with a runoff energy factor determined by flow:

$$Y_e = \alpha_c (Q_v q_p)^{\beta_e} \hat{K} LS \hat{C} \hat{P} \quad (9.13)$$

where

$Y_e$  = sediment yield from an individual storm (tons/acre) [ $\text{M L}^{-2}$ ]

$Q_v$  = storm runoff volume ( $\text{m}^3$ ) [ $\text{L}^3$ ]

$q_p$  = peak runoff rate ( $\text{m}^3/\text{s}$ ) [ $\text{L}^3 \text{T}^{-1}$ ]

$\alpha_c$  = empirical soil erosion coefficient = 11.8

$\beta_e$  = empirical soil erosion exponent = 0.56 [dimensionless]

More detailed review of the USLE family of soil erosion relationships is presented by [17].

#### 1.4. Overland Sediment Transport Capacity Relationships

Building on the initial work of [7], Prosser and Rustomji [18] summarized relationships to describe the sediment transport capacity of overland flow. A generalized overland flow sediment transport capacity equation is

$$q_s = k q^{\beta_s} S_f^{\gamma_s} \quad (9.14)$$

where

$q_s$  = total sediment transport capacity [ $M L^{-1} T^{-1}$ ]

$k$  = empirically or theoretically derived coefficient for sediment transport capacity [ $M L^{-1} T^{-1}$ ]

$q$  = unit flow (discharge) of water [ $L^2 T^{-1}$ ]

$\beta_s$  = empirically or theoretically derived exponent for discharge [dimensionless]

$S_f$  = friction slope (local energy gradient) [dimensionless]

$\gamma_s$  = empirical or theoretically derived exponent for local energy gradient [dimensionless]

The sediment transport capacity coefficient ( $k$ ) represents the combined influence that rainfall intensity, overland flow, and landscape and particle characteristics such as soil erodibility, infiltration, surface roughness, and vegetative cover have on sediment transport. Extending the review of discharge ( $\beta_s$ ) and local energy gradient ( $\gamma_s$ ) exponent values presented by [7], more recent research by [18] concluded that values of  $1.0 \leq \beta_s \leq 1.8$  and  $0.9 \leq \gamma_s \leq 1.8$  are generally applicable for use in soil erosion modeling.

Julien [6, 19] recommends a modified form of the Kilinc and Richardson relationship [20] that includes soil erodibility, cover, and management practice terms from the Universal Soil Loss Equation (USLE) [21] to estimate the total overland sediment transport capacity (for both the  $x$ - and  $y$ -directions):

$$q_s = 1.542 \times 10^8 q^{2.035} S_f^{1.66} \hat{K} \hat{C} \hat{P} \quad (9.15)$$

$$J_c = \frac{q_s}{B_e} \quad (9.16)$$

where

$q_s$  = total sediment transport capacity ( $kg/m s$ ) [ $M L^{-1} T^{-1}$ ]

$q$  = unit flow rate of water =  $v_a h$  [ $L^2 T^{-1}$ ]

$S_f$  = friction slope [dimensionless]

$\hat{K}$  = USLE soil erodibility factor [dimensionless]

$\hat{C}$  = USLE soil cover factor [dimensionless]

$\hat{P}$  = USLE soil management practice factor [dimensionless]

$B_e$  = width of eroding surface in flow direction [L]

### 1.5. Channel Transport Capacity Relationships

In channels, sediment particles can be entrained into the flow when the exerted shear stress exceeds the stress required to initiate particle motion. For non-cohesive particles, the channel erosion process is influenced by factors such as particle size, particle density, and bed forms. For cohesive particles, the erosion process is significantly influenced by interparticle forces (such as surface charges that hold grains together and form cohesive bonds) and consolidation. Total (bed material) load transport capacity relationships account for the both bedload and suspended load components of sediment transport. Yang and Julien [19, 22] provide summaries of numerous total load transport relationships. The Engelund and Hansen relationship [23] is considered a reasonable estimator of the total load:

$$C_w = 0.05 \left( \frac{G}{G-1} \right) \frac{v_a S_f}{[(G-1)g d_p]^{0.5}} \left[ \frac{R_h S_f}{(G-1)d_p} \right]^{0.5} \quad (9.17)$$

$$J_c = \frac{v_a C_t}{A_c} \quad (9.18)$$

where

$C_w$  = concentration of entrained sediment particles by weight at the transport capacity [dimensionless]

$G$  = particle specific gravity [dimensionless]

$v_a$  = advective (flow) velocity (in the down-gradient direction) [ $L T^{-1}$ ]

$S_f$  = friction slope [dimensionless]

$R_h$  = hydraulic radius of flow [L]

$g$  = gravitation acceleration [ $L T^{-2}$ ]

$d_p$  = particle diameter [L]

$J_c$  = advection flux [ $M L^{-2} T^{-1}$ ]

$A_c$  = cross-sectional area of flow [ $L^2$ ]

$C_t$  = concentration of entrained sediment particles at the transport capacity =  $10^6 G C_w / [G + (1 - G)C_w]$  ( $g/m^3$ ) [ $M L^{-3}$ ]

It is worth noting that one feature common to both (9.15) and (9.17) is that the implicit threshold for incipient motion is zero. This means that the transport capacity of any particle will always be greater than zero, regardless of particle size or the exerted shear stress, as long as the unit flow or flow velocity and friction slope are nonzero. This can lead to inconsistent results when erosion rates are computed from sediment transport capacities. The inferred erosion rate will almost always be greater than zero because the difference between the

transport capacity and advective flux will nearly always be greater than zero. Consequently, a nonzero erosion rate can be computed even when the exerted shear stress is far less than the incipient motion threshold for the material. To address this limitation, an incipient motion threshold can be added to the modified relationships [20, 23]:

$$q_s = 1.542 \times 10^8 (q - q_c)^{2.035} S_f^{1.66} \hat{K} \hat{C} \hat{P} \quad (9.19)$$

$$C_w = 0.05 \left( \frac{G}{G-1} \right) \frac{(v_a - v_c) S_f}{[(G-1)g d_p]^{0.5}} \left[ \frac{R_h S_f}{(G-1)d_p} \right]^{0.5} \quad (9.20)$$

where

$q_c$  = critical unit flow for erosion (for aggregate the soil matrix) =  $v_c h$  [ $L^2 T^{-1}$ ]

$v_c$  = critical velocity for erosion [ $L T^{-1}$ ]

$h$  = surface water depth [ $L$ ]

### 1.6. Deposition

Deposition is the sedimentation (loss) of material entrained in a flow to a bottom boundary by gravity. The deposition process is influenced by many factors including particle density, diameter and shape, and fluid turbulence. The deposition flux may be expressed as a mass rate of particle removal from the water column over time and the concentration of sediment particles that are entrained in the flow:

$$J_d = v_{se} C_s \quad (9.21)$$

where

$J_d$  = deposition flux [ $M L^{-2} T^{-1}$ ]

$v_{se}$  = effective settling (deposition) velocity [ $L T^{-1}$ ]

$C_s$  = concentration of sediment particles in the flow [ $M L^{-3}$ ]

Coarse particles ( $>62 \mu m$ ) are typically inorganic and non-cohesive and generally have large settling velocities under quiescent conditions. Numerous empirical relationships to describe the non-cohesive particle settling velocities are available. Summaries of relationships and settling velocities are presented by [19, 22]. For non-cohesive (fine sand) particles with diameters from 62 to 500  $\mu m$ , the settling velocity [24] can be computed as

$$v_s = \frac{\nu}{d_p} \left[ (25 + 1.2d_*^2)^{0.5} - 5 \right]^{1.5} \quad (9.22)$$

$$d_* = d_p \left[ \frac{(G-1)g}{\nu^2} \right]^{1/3} \quad (9.23)$$



where

$v_s$  = quiescent settling velocity [ $L T^{-1}$ ]

$\nu$  = kinematic viscosity of water [ $L^2 T^{-1}$ ]

$d_*$  = dimensionless particle diameter [dimensionless]

$d_p$  = particle diameter [L]

Medium particles ( $10 \mu\text{m} < d_p < 62 \mu\text{m}$ ) can vary in character. Inorganic particles may behave in a non-cohesive manner. In contrast, organic particles (potentially including particles with organic coatings) may behave in a cohesive manner. Fine particles ( $< 10 \mu\text{m}$ ) often behave in a cohesive manner. If behavior is largely non-cohesive, settling velocities may be estimated as described by Julien [19]. If the behavior is cohesive, flocculation may occur. Floc size and settling velocity depend on the conditions under which the floc was formed [25–27]. When flocculation occurs, settling velocities of cohesive particles can be approximated by relationship of the form [25]:

$$v_{sf} = a d_f^m \quad (9.24)$$

where

$v_{sf}$  = floc settling velocity (cm/s) [ $L T^{-1}$ ]

$a$  = experimentally determined constant =  $8.4 \times 10^{-3}$

$d_f$  = median floc diameter ( $\mu\text{m}$ ) [L]

$m$  = experimentally determined constant = 0.024

However, depending on fluid shear, particle surface charge, and other conditions, fine particles may not flocculate. Under conditions that limit floc formation, fine particles can have very small, near zero settling velocities.

As a result of turbulence and other factors, not all particles settling through a column of flowing water will necessarily reach the sediment-water interface or be incorporated into the sediment bed [28]. Beuselinck [29] suggests that this process also occurs for the overland plane. As a result, effective settling velocities in flowing water can be much less than quiescent settling velocities. The effective settling velocity of a particle can be described as a reduction in the quiescent settling velocity by the probability of deposition [28, 30]:

$$v_{se} = P_{\text{dep}} v_s \quad (9.25)$$

where

$v_{se}$  = effective settling velocity [ $L T^{-1}$ ]

$v_s$  = quiescent settling velocity [ $L T^{-1}$ ]

$P_{\text{dep}}$  = probability of deposition [dimensionless]

## 2. WATERSHED MODELING

A range of watershed modeling methods and frameworks exist. Methods include unit hydrograph/lumped parameter, advanced lumped parameter/semi-distributed, and fully distributed, physically based approaches. Singh [31] presents descriptions of numerous watershed models. Each approach has characteristic strengths and limitations, and there are trade-offs between the spatial and temporal detail used to represent physical processes and model performance. Although methods used differ, all model frameworks reviewed have the ability to simulate runoff. Some frameworks can simulate soil erosion. A few models can also simulate stream sediment transport (erosion and deposition) processes. Even fewer have the specialized capabilities to simulate chemical transport.

Key milestones in the development of fully distributed, physically based watershed models include CASC2D (and CASC2D-SED) [5, 32–35], GSSHA [36], the SHE series of models [37–40], and TREX [41, 42]. The starting point for TREX development was CASC2D. Like CASC2D, the TREX framework is an event-based model that simulates overland flow, surface soil erosion and deposition, stream flow, and sediment transport through streams. As part of the TREX development, hydrologic and sediment transport components of CASC2D were expanded to support chemical transport. A complete review of hydrologic, sediment transport (and chemical transport) processes to describe the physics behind the model is provided by [41] and [43]. Further descriptions of CASC2D and TREX follow.

### 2.1. CASC2D

CASC2D (including CASC2D-SED) is a fully distributed, physically based, event-oriented model that simulates rainfall, interception, infiltration, overland flow, channel flow, as well as sediment erosion and deposition [5, 32–35, 44]. For surface waters, flow routing is performed using the diffusive wave approximation and is two-dimensional overland and one-dimensional in channels. CASC2D does not include groundwater flow processes other than infiltration and Hortonian overland flow. However, it can be directly coupled with GIS-based site characterization data obtained from remote sensing sources.

CASC2D has been applied at a wide variety of spatial scales from large river basins (12,000 km<sup>2</sup>) to moderate watersheds (560 km<sup>2</sup>) [45] to small watersheds (20–30 km<sup>2</sup>) [44]. Overland and channel erosion are computed using the modified form of the Kilinc-Richardson [20, 23, 33]. Up to three solids classes can be simulated [44]. Chemical transport and fate is not simulated. The CASC2D source code is publicly available.

### 2.2. TREX

A generalized conceptual framework for the TREX watershed model is presented in Fig. 9.1. TREX (Two-dimensional Runoff, Erosion, and Export) is a spatially distributed, physically based model that can be used to simulate precipitation, overland runoff, channel flow, soil erosion, stream sediment transport, and chemical transport and fate at the watershed scale [41–43, 46]. TREX combines surface hydrology and sediment transport features from

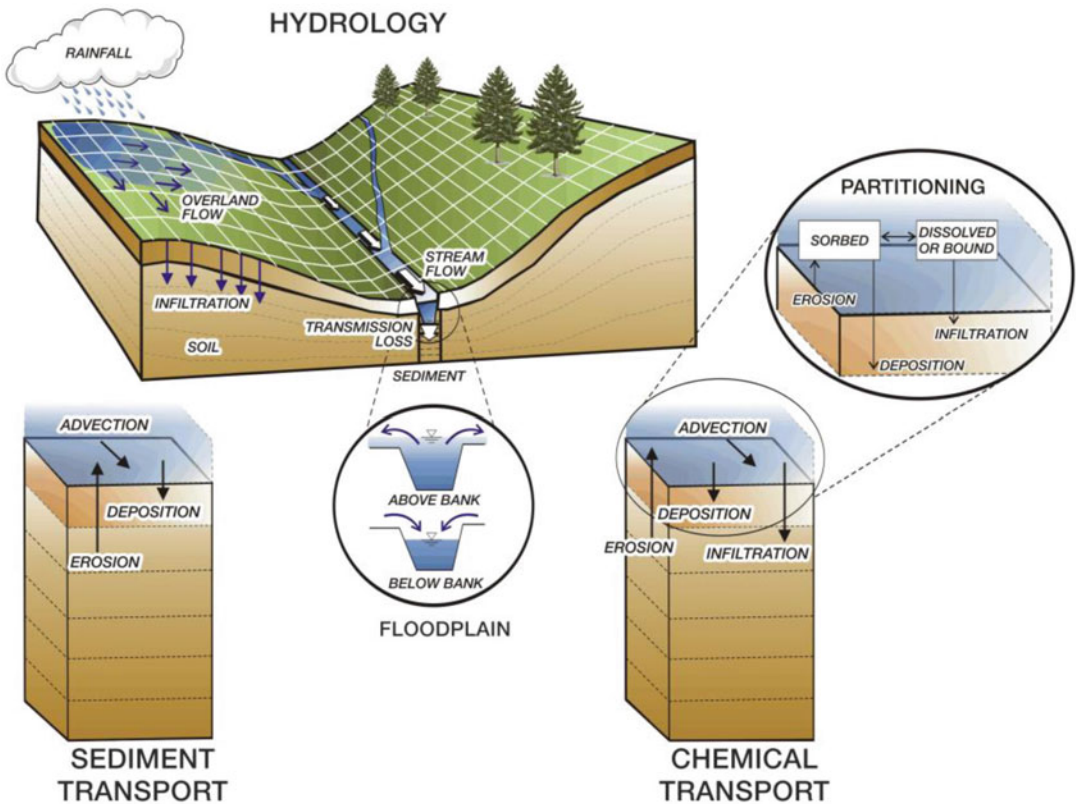
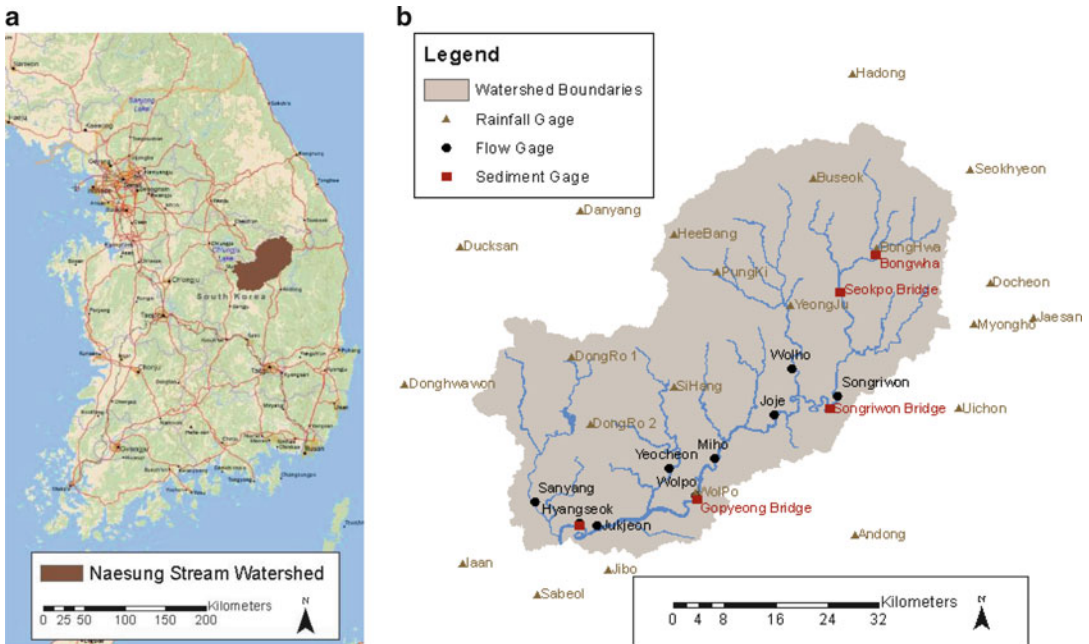


Fig. 9.1. TREX conceptual model framework.

the CASC2D watershed model [33, 35, 44] with chemical transport features from the WASP/IPX series of water quality models [47, 48].

Hydrologic processes simulated are (a) rainfall and snowfall (precipitation), interception, snowmelt, and surface storage; (b) infiltration and transmission loss; and (c) overland and channel flow. Model state variables are water depth in the overland plane and stream channels. Precipitation can be uniform or distributed in both time and space and can also be specified using several grid-based formats to facilitate radar precipitation data use. When spatially distributed precipitation is simulated, areal estimates are interpolated from point gage data using an inverse distance weighting approach. Interception and surface storage are simulated as equivalent depths. Infiltration and transmission loss rates are simulated using the Green and Ampt relationship [1]. Overland flow is two-dimensional and simulated using the diffusive wave approximation. Channel flow is one-dimensional and is also simulated using the diffusive wave approximation.

Sediment transport processes simulated are (a) advection-diffusion, (b) erosion and deposition, and (c) bed elevation adjustment. All processes are simulated in the overland plane and stream channels. Model state variables are solid concentrations in overland runoff, soil, stream flow, and stream bed sediment. Any number of particle size classes can be simulated.



**Fig. 9.2.** Naesung Stream watershed and monitoring station locations. (a) Watershed location, Korea. (b) Rainfall, flow, and sediment monitoring stations.

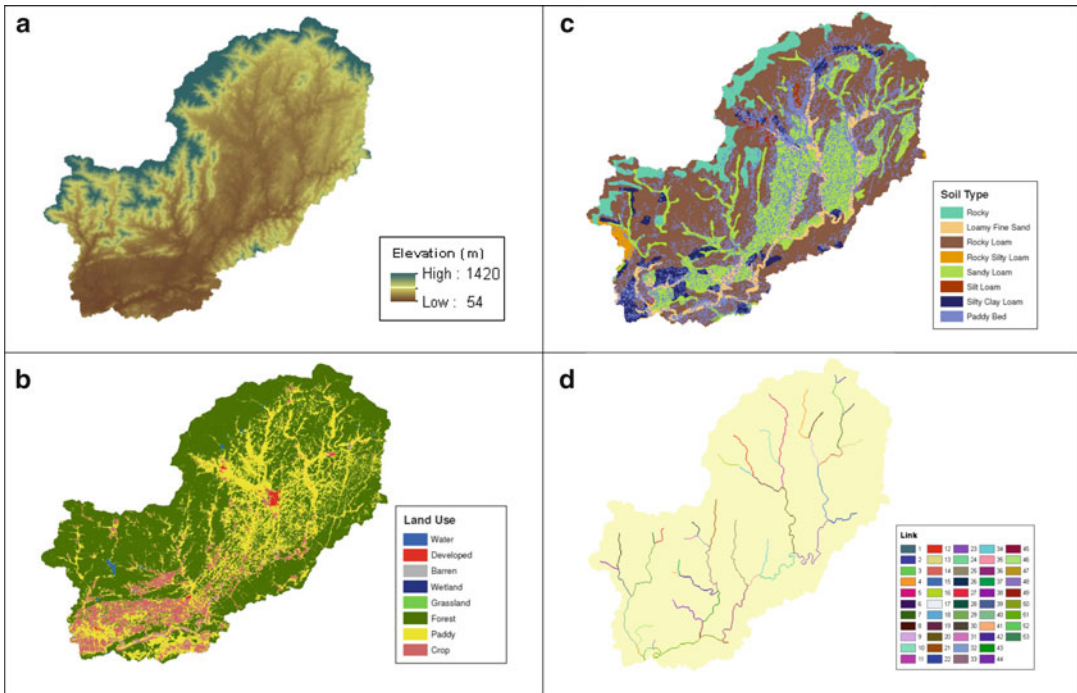
In floodplain areas, water and transported constituents are transferred between the overland plane and channel network based on the difference in water surface elevations. Floodplain transfers are bidirectional. Water and transported sediments and chemicals move into stream channels by overland flow and can return to the overland plane when water levels in the stream exceed bank height. Similarly, materials can be moved from the sediment bed and can be delivered to the land surface by floodwaters. TREX source code, a user manual, reference material, and example files are freely available on the web.

### 3. WATERSHED MODEL APPLICATION

To demonstrate watershed modeling concepts, a case study application using TREX [41–43, 46] is presented. TREX was applied to the Naesung Stream watershed in Korea and was used to simulate hydrology and sediment transport. Soil erosion results from the model were used to identify erosion-prone areas.

#### 3.1. Naesung Stream Site Description and Database

The Naesung Stream watershed is located in North Gyeongsang Province (Gyeongsangbuk-do), Korea, and drains an area of approximately 1,815 km<sup>2</sup> within the Nakdong River basin. Land surface elevations range from 54 to 1,420 m above mean sea



**Fig. 9.3.** Raster maps of (a) watershed elevations, (b) land uses, (c) soil types, and (d) the stream channel network (flow path links) at the 150-m scale.

level. The average channel slope of the stream is 0.009 m/m. The database for this watershed includes rainfall measurements reported at 22 monitoring stations, stream flows reported at 9 stations, suspended solids data at 11 stations, sediment discharges at 3 stations, and sediment yields estimated at 4 stations. Rainfall and flow data were reported on an hourly basis and were available for 2008 and 2009 as well as other periods. Maps displaying locations of the Naesung Stream watershed, stream network, and monitoring stations are presented in Fig. 9.2. Stations at Hyangseok, Miho, Wolho, and Yecheon provide stream flow measurements for subbasins within the watershed as well as near the watershed outlet. Stations at Hyangseok and Songriwon provide sediment discharge and yield estimates.

### 3.2. Naesung Stream Model Setup

The model requires data to describe watershed boundaries, the stream channel network, land surface elevations, soils, land use, and related information describing physical processes that control runoff and soil and sediment transport for any given rainfall event. All data were detailed in the Naesung Stream Watershed Data Collection [49] and Naesung Stream Watershed Bank Erosion [50] reports. Data included geographic information system (GIS) files for ArcGIS 9.3 [51], HEC-RAS hydraulic model files [52], as well as additional data such as stage-discharge relationships and sediment-discharge information.

Watershed land surface elevations were defined using digital elevation model (DEM) data. Soil types, land uses, and their spatial distributions were defined according to the associations and classes that occur within the watershed. DEM, soil, and land use data were provided at a 30-m resolution (1 arc s) and subsequently processed for model use at a 150-m grid scale (i.e., where each model cell is 150 m by 150 m). The 150-m grid scale was selected to improve model execution speed and reduce time required for simulations. Model grid scale affects accuracy of hydrology and sediment transport simulations [53]. Compared to higher resolution configurations (e.g., 30 or 90 m), use of a 150-m grid scale permits reasonable simulation of both hydrology and soil erosion. At the 150-m scale, the Naesung Stream watershed is comprised of 80,690 grid cells. The watershed DEM was also smoothed using a custom computer program created to reduce effects of anomalous elevations that resulted in deep pits in isolated areas of the watershed. Raster maps of watershed elevations, soil types, land uses, and the stream channel network at the 150-m scale are presented in Fig. 9.3.

Watershed boundaries and the stream channel network were delineated using TauDEM 4.0 [54]. For consistency with the Naesung Stream hydrography layer provided by Myongji University, the hydrography layer was converted from polygons to polylines in ArcGIS and then used to “burn” stream locations into the DEM prior to delineating the channel network. Using this approach, the stream network was defined as 53 links comprised of 2,135 nodes, yielding a total stream length of approximately 34.8 km and a drainage density of 0.2 km of stream length per square kilometer of watershed ( $0.2 \text{ km/km}^2$ ). Physical dimensions of the channel network (e.g., width, bank height, side slope) were determined from data contained in HEC-RAS geometry files for Naesung Stream.

Soil types and land use classes were defined based on major associations and classifications present in the watershed as described in the GIS files. In the “simple” GIS files, soil types and land use classes with similar characteristics were combined to simplify model setup. Soil types in the model were also modified to include rice paddy fields as a distinct soil type. Inclusion of paddy fields as a soil type was based on research indicating that paddy fields are often underlain by soil layers with lower hydraulic conductivities and higher clay contents [55].

Interception depths and depression storage depths for each land use class were assigned based on expected land use characteristics described in the literature [56–58]. For simplicity, depression storage depths for all land use classes other than paddy fields were set to zero. The paddy fields land use was specified to have 6 cm of depression storage to account for berms surrounding paddy fields [55]. Initial values for overland and channel flow resistance (Manning  $n$ ) values were determined by land use and substrate [59, 60]. Manning  $n$  values for stream channels were regularized by assigning values into two classes: (1) rocky substrate streams (higher flow resistance) and (2) wider, sand bed streams (lower flow resistance). Final flow resistance values were determined by calibration.

Size distributions of particles comprising soils and sediments of the site vary with the strata from which they originate. Surface soils are typically dominated by silts with considerable fractions of sands and clays as well as gravel and other rock fragments. Bed sediments are

**Table 9.1**  
**Particle classes and properties**

Particle class name	Representative size range (mm)	Effective diameter ( $d_p$ ) (mm)	Specific gravity ( $G$ ) (dimensionless)	Fall velocity ( $v_s$ ) (m/s)	Critical shear stress for deposition (Pa)	Critical erosion velocity ( $v_c$ ) (m/s)
Gravel-cobble	>16	32	2.65	0.678	26	1.39
Gravel	4–16	8	2.65	0.338	5.7	0.693
Sand	0.125–4	0.5	2.65	0.066	0.27	0.268
Silt/clay	>0.125	0.016	2.65	0.000167	0.065	0.022

dominated by sands and finer gravel. Overall, particles sizes range from coarse gravels and cobbles to silts and clays. There is a trade-off between the number of particle state variables (classes) used to represent solids and computational time needed for a simulation. Processing time increases as the number of state variables increases. Given the range of particle types present in the watershed, solids were simulated as four classes: (a) coarse gravels and coarser (“gravel-cobble”); (b) fine to coarse gravel (“gravel”); (c) coarse sands to fine gravels (“sands”); and (d) finer sands, silts, and smaller particles (“silt/clay”).

Properties of each particle class, soils, and sediments were defined from values tabulated in the Myongji University database and supplemented by other literature as noted below. Properties specified include (a) effective particle diameter  $d_p$ , (b) particle specific gravity  $G$ , (c) particle fall velocity  $v_s$ , (d) soil and sediment porosity, (e) soil effective hydraulic conductivity  $K_h$ , (f) soil capillary suction head  $H_c$ , (g) soil erodibility  $\hat{K}$ , (h) erosion (incipient motion) thresholds for soil and sediment expressed as critical velocities  $v_c$ , and (i) grain size distributions for soils and sediments. Summaries of these properties, including physical characteristics of the channel network, are presented in Tables 9.1, 9.2, and 9.3.

Effective hydraulic conductivities and capillary suction heads were determined from soil types [61]. Final effective hydraulic conductivity values were determined by calibration. Soil erodibility  $\hat{K}$ , cover factor  $\hat{C}$ , and practice factor  $\hat{P}$  values were estimated based on literature values summarized by [11, 19]. Soil effective porosities were estimated from maximum moisture content and field moisture content values for each soil type. Sediment porosity was assumed to be 0.5 uniformly in the riverbed.

In the overland plane, the soil column was defined as two layers with a total thickness of 15 cm (a 5-cm surface layer and a 10-cm subsurface layer). This total soil thickness is reasonable because a single event is not expected to completely denude the land surface of erodible, unconsolidated soils. In the channel network, the sediment bed was also defined as two layers with a total thickness of 20 cm (two 10-cm layers) underlain by non-erodible hardpan. This bed configuration was selected to represent conditions where particles from the streambed may have limited availability and that supply limited sediment transport occurs. Representation of the bed as two relatively thin layers over hardpan is reasonable because it is possible that large storm events could cause transport sufficient to erode all unconsolidated

**Table 9.2**  
**Soil classes and properties**

Soil type	Critical erosion velocity $v_c$ (m/s)	Effective porosity	$K_h$ (m/s)	Initial soil moisture deficit ( $\theta$ )	$H_c$ (m)	$\hat{K}$ (tons/acre/year)	Soil grain size distribution			
							Gravel-cobble	Gravel	Sand	Silt/clay
Rocky	0.0071	0.44	8.35E-07	0.051-0.409	0.05	0.1	0.50	0.20	0.15	0.15
Loamy fine sand	0.0278	0.40	1.66E-07	0.047-0.387	0.061	0.44	0.00	0.05	0.75	0.20
Rocky loam	0.0118	0.43	4.18E-07	0.035-0.400	0.069	0.1	0.05	0.15	0.30	0.50
Rocky silty loam	0.0120	0.49	6.05E-08	0.037-0.371	0.137	0.16	0.10	0.15	0.15	0.60
Sandy loam	0.0238	0.41	3.33E-09	0.033-0.363	0.11	0.27	0.00	0.00	0.55	0.45
Silt loam	0.0339	0.49	1.89E-08	0.031-0.351	0.167	0.48	0.00	0.00	0.25	0.75
Silty clay loam	0.0244	0.43	5.55E-09	0.001-0.231	0.273	0.37	0.00	0.00	0.15	0.85
Paddy field	0.0244	0.43	4.68E-09	0.000	0.000	0.37	0.00	0.00	0.15	0.85

*Notes:* Lower soil moisture deficit values represent wet initial conditions for July 2008 and larger values represent drier conditions for July 2009.



**Table 9.3**  
**Land use classes and properties**

Land use	Manning $n$	Interception depth (mm)	$\hat{C}$	$\hat{P}$
Wetland	0.100	0.00	0.000	1.00
Water	0.050	0.00	0.000	1.00
Developed	0.010	0.10	0.008	1.00
Barren	0.200	0.00	0.050	1.00
Grassland	0.300	1.00	0.013	1.00
Forest	0.400	2.00	0.002	1.00
Paddy	0.500	1.00	0.050	1.00
Crop	0.300	1.00	0.013	1.00

material from the bed in some locations. However, the maximum depth of bed scour (degradation) that can occur will be limited by the total thickness of bed sediment at the start of the simulation (i.e., 20 cm for this model setup).

It should be noted that several parameters summarized in Tables 9.1, 9.2, and 9.3 were subject to calibration (e.g., effective hydraulic conductivity, Manning  $n$ , soil moisture deficit). Values reported in these tables represent model setup from calibration to the July 24–26, 2008, and July 8–10, 2009, storm events. Model initial conditions that must be specified include baseflow and initial water depths, initial soil moisture deficit, depth of infiltrated water (soil moisture conditions), and suspended solids concentrations for each particle class. Soil moisture conditions were estimated based on review of rainfall records preceding the July 2008 and July 2009 storms. Conditions preceding the July 2008 storm were relatively wet as there was appreciable rain (i.e., more than 100 mm) in the days before the event. Conditions preceding the July 2009 storm were relatively dry as there was little rain (i.e., less than 10 mm) before the event. Soil moisture deficit values were refined by calibration. For simplicity, the initial depth of infiltrated water was assumed to be zero. Initial water depths on the overland plain were assumed to be zero except for rice paddy areas. For rice paddies, the initial water depth was assumed to be 3 cm for the July 2008 storm and 1 cm for the July 2009 storm. Initial water depths for paddy fields were refined by calibration. Initial suspended solids concentrations for the “silt/clay” particle class ranged from 1 g/m<sup>3</sup> (mg/L) to 10 g/m<sup>3</sup> and were zero for the remaining three particle classes.

Baseflow (i.e., stream flow for periods preceding storm events) was estimated by reviewing flow records at monitoring gages throughout the watershed. Flow conditions for the July 24–26, 2008, and July 8–10, 2009, storms appeared to be similar, so the same values were used for both events. The channel network includes 21 headwater branches (i.e., branches that are upstream of all other portions of the channel network). Baseflow was represented as a flow point source to the head of each headwater link in the channel network. Baseflow at Hyangseok was estimated to be 40 m<sup>3</sup>/s based on flow monitoring data at Hyangseok.

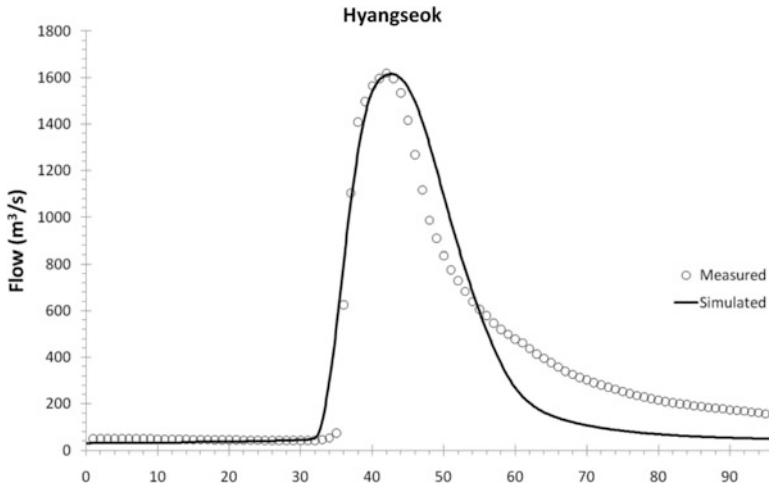


Fig. 9.4. Simulated and measured flows at Hyangseok: July 24–26, 2008, storm.

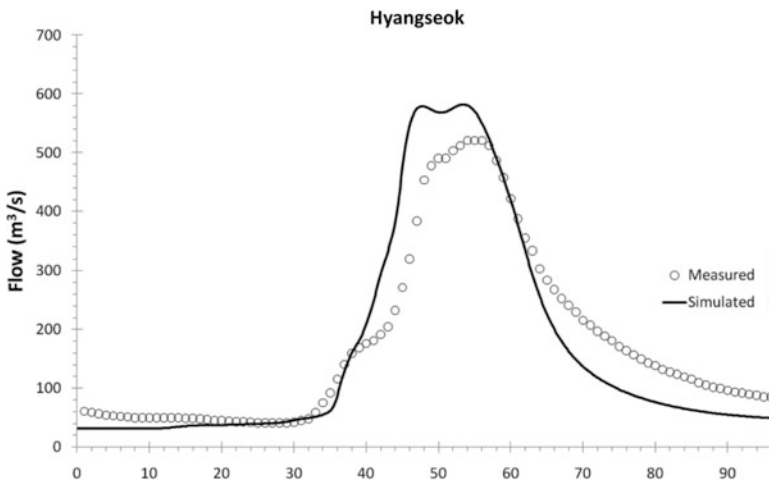


Fig. 9.5. Simulated and measured flows at Hyangseok: July 08–10, 2009, storm.

### 3.3. Model Calibration Results

#### 3.3.1. Hydrology

The watershed model was calibrated by simulating rainfall, runoff, and sediment transport for two storms: (a) July 24–26, 2008, and (b) July 8–10, 2009. Rainfall for these events was defined by hourly measurements at 22 gages across the watershed. All simulations were 96 h in duration and included each storm's rainfall period (up to 48 h) and an additional 48 h to allow simulation of the recession limb of the hydrograph and return to baseflow conditions. As part of calibration, model parameters were iteratively varied until simulation results were in rough agreement with measured flows and sediment concentrations. Agreement between model results and measurements was assessed by graphical and statistical comparisons.

The hydrologic calibration was performed by varying the following parameters: effective hydraulic conductivity  $K_h$ , channel and overland flow resistance (Manning  $n$ ), and initial soil moisture deficit  $\theta$ . Effective hydraulic conductivity affects the total volume of runoff generated. Flow resistance influences the timing and magnitude of flow. Soil moisture conditions also affect runoff volume and the timing of flow through the system. As part of hydrologic calibration efforts, 12–18 individual model simulations were completed for each storm.

Calibrated hydrologic simulation results and measurements for the July 2008 and July 2009 storms are presented in Figs. 9.4 and 9.5 respectively. Statistical summaries comparing simulated and measured values for total flow volume, peak flow, and time to peak flow metrics are presented in Table 9.4. Statistical analyses include relative percent difference (RPD), Nash-Sutcliffe efficiency coefficient (NSE), and root mean square error (RMSE). Model performance was generally good.

### 3.3.2. Sediment

Calibrated sediment transport simulation results and measurements for the July 2008 and July 2009 storms are presented as functions of flow in Figs. 9.6 and 9.7. Simulated and estimated values are presented for the Hyangseok station. Estimated values presented on these graphs represent values estimated from flow using reported sediment-discharge relationships at these stations. Tabular summaries comparing simulated, measured, and estimated values for suspended solids concentration and sediment yield rates are presented in Tables 9.5 and 9.6, respectively.

Simulated suspended solids concentrations are roughly within a factor of 2 to 3 of values estimated from flow and sediment-discharge relationships at Hyangseok. However, simulated suspended solids concentrations appear to be much smaller than estimated concentrations across the ranges of flows at Songriwon. Some of the differences between simulated values and concentrations estimated from sediment-discharge relationships may be attributable to uncertainty introduced by extrapolating discharge relationships beyond the flow ranges for which they were developed. Some differences between simulated and estimated concentrations may also be attributable to hydrologic model overestimation and underestimation errors at Songriwon as well as Hyangseok.

In Table 9.6, reported sediment yields and estimated yields represent values calculated using flow and sediment-discharge relationships for each station and normalized by drainage area. Similarly, simulated sediment yields were calculated using simulated flow and simulated suspended solids concentrations and normalized by drainage area. As a broad generality, simulated sediment yields are within the range of reported and estimated yields. However, differences between reported and estimated sediment yield values are large, suggesting large uncertainties in the underlying database used for model development. Given these potential uncertainties in measurements, sediment transport model performance was considered to be reasonable.

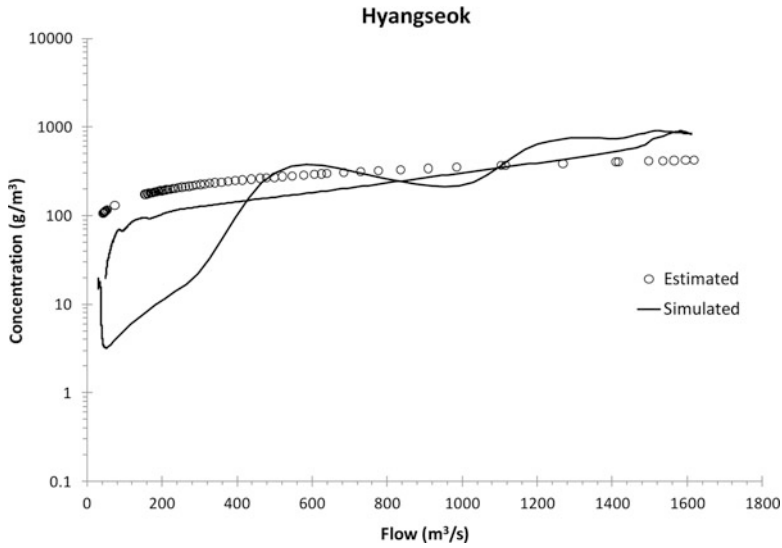
## 3.4. Design Storm Application

The calibrated model was applied to design storm rainfall to simulate runoff and sediment transport that would occur for a very large storm event. As specified by Myongji University,

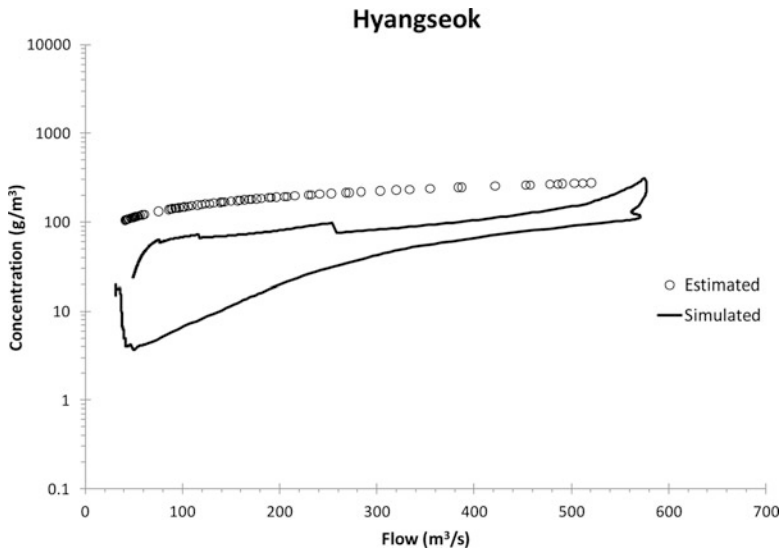
**Table 9.4**  
**Summary statistics for hydrologic model performance**

Event	Station	Metric	Total flow volume (m <sup>3</sup> )			Peak flow (m <sup>3</sup> /s)			Time to peak flow (h)			Flow time series			
			Measured	Simulated	RPD (%)	Measured	Simulated	RPD (%)	Measured	Simulated	RPD (%)	Measured	Simulated	RPD (%)	NSEC
July 24–26, 2008	Hwangseok	8.21E + 07	9.09E + 07	10.72	1,619	1,615	-0.25	42.0	42.8	1.79	0.94	25.0			
			8.45E + 07	-1.07	1,569	1,457	-7.14	34.0	41.9	23.09	0.62	61.6			
			3.27E + 07	-4.89	638	617	-3.30	30.0	34.8	16.00	0.84	38.0			
			4.69E + 06	98.08	92	270	193.85	36.0	36.5	1.25	-4.47	199.2			
July 8–10, 2009	Hwangseok	3.56E + 07	4.07E + 07	14.33	520	582	11.79	54.0	53.4	-1.11	0.80	42.5			
			2.93E + 07	22.18	452	519	14.76	50.0	51.5	2.90	0.93	26.4			
			9.23E + 06	49.51	196	250	27.59	45.0	46.1	2.33	0.43	71.9			
			4.35E + 06	66.67	90	188	107.45	44.0	43.7	-0.79	-1.02	133.6			

Notes: (1) RPD = relative percent difference. RPD values were calculated as (Simulated - Measured)/Measured; (2) NSEC = Nash-Sutcliffe efficiency coefficient. NSEC values range from 1 to  $-\infty$ , with a value of 1 representing perfect agreement; (3) RMSE = root mean square error.



**Fig. 9.6.** Simulated and estimated total suspended solids concentrations at Hyangseok: July 24–26, 2008, storm.



**Fig. 9.7.** Simulated and estimated total suspended solids concentrations at Hyangseok: July 8–10, 2009, storm.

this design storm delivers 300 mm of rain that is uniformly distributed over the entire watershed and which falls at a rate of 50 mm/h for 6 h. Initial moisture and water conditions for the design storm were assumed to be the same as those that occurred for the July 2009 rainfall event.

**Table 9.5**  
**Summary of measured, estimated, and simulated suspended solids concentrations**

Station	Measured (g/m <sup>3</sup> )		Estimated (g/m <sup>3</sup> )		Simulated (g/m <sup>3</sup> )		Storm
	Geometric mean	Range	Geometric mean	Range	Geometric mean	Range	
Hyangseok	30	7–210	187	106–423	48	3–901	July 2008
			159	105–275	31	4–308	July 2009
Gopyeong Bridge	15	6–30			63	5–1,040	July 2008
					43	7–326	July 2009
Songriwon	6	0.4–52	797	290–21,700	40	0.7–1,940	July 2008
			11	0.05–1,720	17	0.5–250	July 2009
Seokpo	4	0.4–22			4	5–1,950	July 2008
					4	3–260	July 2009

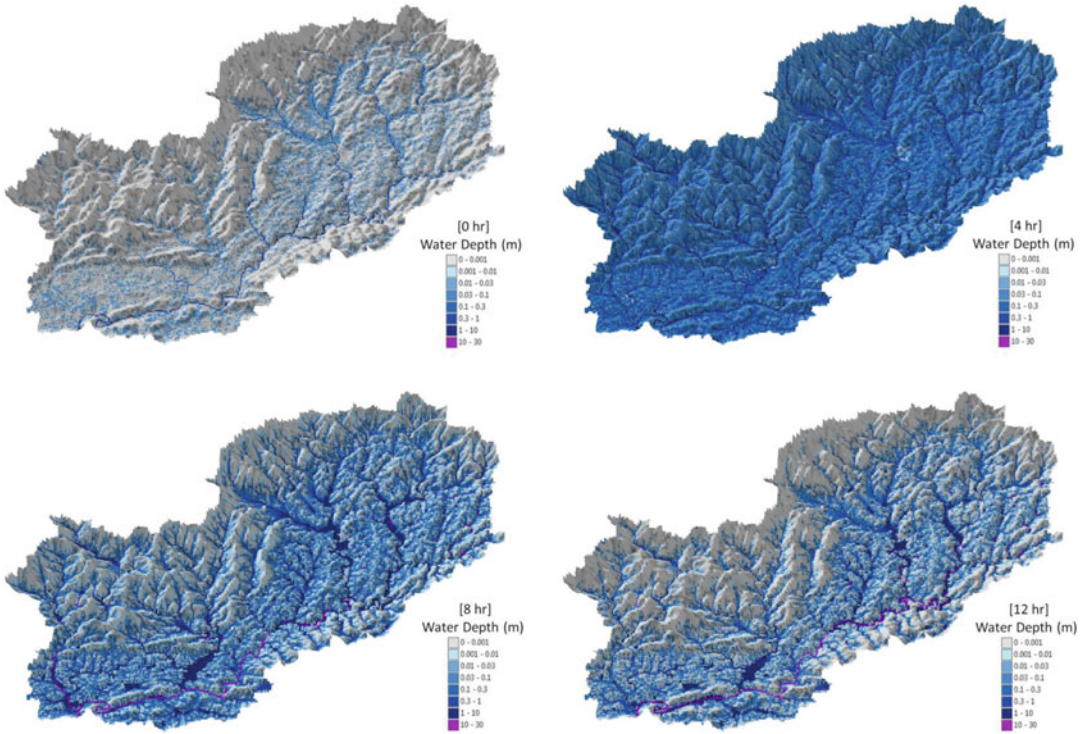
Notes: (1) Measured values were determined from samples collected at six stations within the watershed as part of monthly monitoring efforts during the month of July in 2003, 2006, 2008, and 2009 as detailed in the Myongji University database. For Hyangseok, the Naesung Stream 3, 3-1, and 3A stations were used to determine measured concentrations. For Gopyeong Bridge, the Naesung Stream 1 station was used. For Songriwon, the Yeongjuseo Stream 2 station was used. For Seokpo, the Naesung Stream 4 station was used; (2) estimated values were determined from flow and sediment-discharge relationships for each station.

**Table 9.6**  
**Summary of reported, estimated, and simulated sediment yield rates**

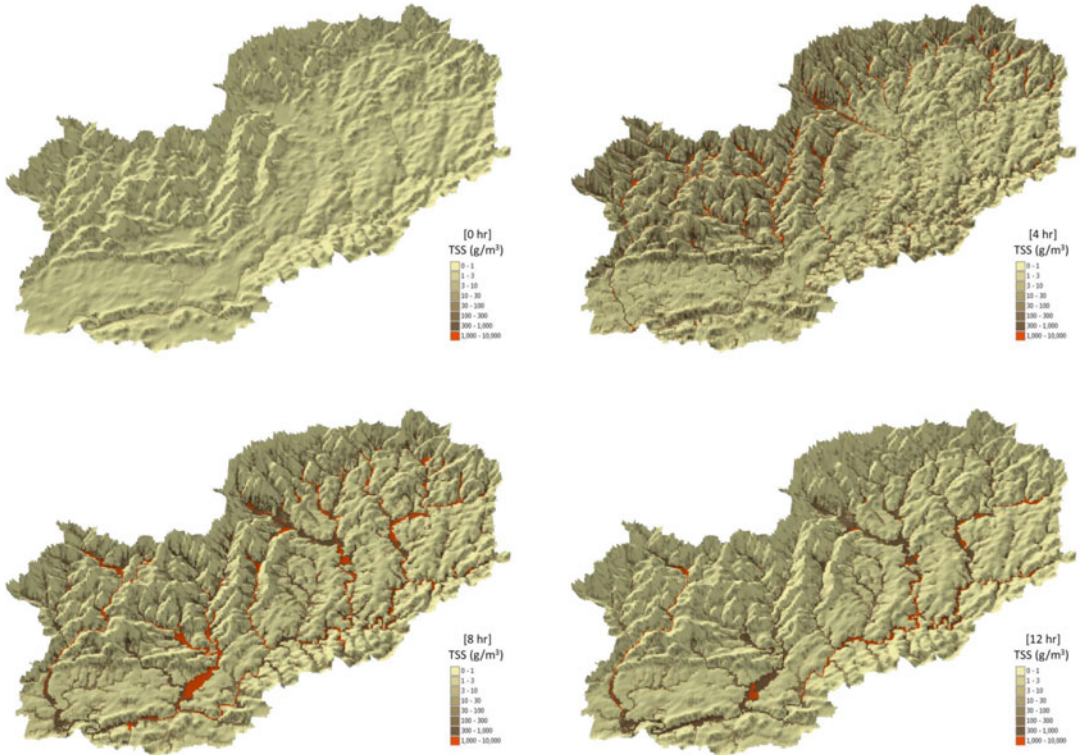
Station	Drainage area (km <sup>2</sup> )	Sediment yield rate (metric tons/km <sup>2</sup> /year)		
		Reported	Estimated	Simulated
Hyangseok	1,630 (estimated)		660–2,100	345–3,110
Gopyeong Bridge	1,153	320		355–3,880
Songriwon Bridge	491	453	1,100–67,000	451–5,970
Seokpo Bridge	299	501		637–3,030
Bongwha	157	624		502–13,830

Notes: (1) Reported values were obtained from the Myongji University database; (2) estimated values were determined by calculating computing sediment loads using reported flows and sediment-discharge relationships where available; (3) simulated values for the July 2008 storm represent high values for the tabulated ranges. Simulated values for the July 2009 storm represent low values for tabulated ranges.

Visualizations of water depth and total suspended solids at Naesung Stream are presented in Figs. 9.8 and 9.9. Surface runoff in the main channel can be observed at 4 h and is dominant at 8 h after the beginning of the storm. Upland erosion losses are clearly visible from the mountain areas 4 h after the beginning of the storm. High sediment concentrations then reach the valleys after 8 h and sediment settling takes place after 8 h.



**Fig. 9.8.** Visualization of Naesung Stream design storm water depths: 0, 4, 8, and 12 h after storm starts.



**Fig. 9.9.** Visualization of Naesung Stream design storm total suspended solids (TSS): 0, 4, 8, and 12 h after storm starts.

## ACKNOWLEDGEMENTS

The TREX model development has been developed by P. Julien's research group at Colorado State University, with funding from the Center for Geosciences/Atmospheric Research under Cooperative Agreement DAAD19-02-2-0005. The application at Naesung Stream has been the result of collaboration between HDR|HydroQual, Colorado State University, and Myongji University. These applications were supported by a grant for the project "Sediment Management Plan Development for Channel Stabilization" from K-Water (Korea Water Resources Corporation) funded by Ministry of Land, Transport and Maritime Affairs of the Korean government. We are grateful to Masatsugu (Masa) Takamatsu, Lihong (Lucy) Yang, Daniel Schwartz, Christopher Fanelli, and James Hallden at HDR|HydroQual and Jazuri Abdullah, James Halgren, and Andy Steininger at Colorado State University and Eunkyung Jang at Myongji University.

## REFERENCES

1. Green WH, Ampt GA (1911) Studies on soil physics. 1: The flow of air and water through soils. *J Agric Sci* 4(1):11–24
2. Richards LA (1931) Capillary conduction of liquids in porous mediums. *Physics* 1:318–333
3. Philip JR (1957) The theory of infiltration: 1. The infiltration equation and its solution. *Soil Sci* 83:345–357
4. Smith RE, Parlange J-Y (1978) A parameter efficient hydrologic infiltrations model. *Water Resour Res* 14(3):533–538
5. Julien PY, Saghafian B, Ogden FL (1995) Raster-based hydrologic modeling of spatially-varied surface runoff. *J Am Water Resour Assoc* 31(3):523–536
6. Julien PY (2002) *River mechanics*. Cambridge University Press, Cambridge, UK, p 434
7. Julien PY, Simons DB (1985) Sediment transport capacity of overland flow. *Trans Am Soc Agric Eng* 28(3):755–762
8. Julien PY, Frenette M (1985) Modeling of rainfall erosion. *J Hydraul Eng* 11(10):1344–1359
9. Aksoy H, Kavvas ML (2005) A review of hillslope and watershed scale erosion and sediment transport models. *Catena* 64(2–3):247–271
10. Merritt WS, Letcher RA, Jakeman AJ (2003) A review of erosion and sediment transport models. *Environ Model Softw* 18(8–9):761–799
11. Wischmeier WH, Smith DD (1978) Predicting soil erosion losses: a guide to conservation planning, vol 537, *Agricultural handbook*. U.S. Department of Agriculture, Washington, DC, p 58
12. Renard KG, Foster GR, Weesies GA, Porter JP (1991) RUSLE: revised universal soil loss equation. *J Soil Water Conserv* 46(1):30–33
13. Renard KG, Foster GR, Yoder DC, McCool DK (1994) RUSLE revisited: status, questions, answers, and the future. *J Soil Water Conserv* 49(3):213–220
14. Renard KG, Foster GR, Weesies GA, McCool DK, Yoder DC (1997) Predicting soil erosion by water: a guide to conservation planning with the revised universal soil loss equation (RUSLE), vol 703, *Agricultural handbook*. U.S. Department of Agriculture, Washington, DC, p 407
15. Foster GR, Toy TE, Renard KG (2003) Comparison of the USLE, RUSLE1.06 and RUSLE2 for application to highly disturbed lands. In: Renard KG, McIlroy SA, Gburek WJ, Cranfield HE,



- Scott RL (eds) First interagency conference on research in watersheds. U.S. Department of Agriculture, Washington, DC
16. Williams JR (1975) Sediment routing for agricultural watersheds. *Water Resour Bull* 11(5):965–974
  17. Kinnell PIA (2010) Event soil loss, runoff and the Universal Soil Loss Equation family of models: a review. *J Hydrol* 385(1–4):384–397
  18. Prosser IP, Rustomji P (2000) Sediment transport capacity relations for overland flow. *Prog Phys Geogr* 24(2):179–193
  19. Julien PY (2010) *Erosion and sedimentation*, 2nd edn. Cambridge University Press, Cambridge, UK, p 371
  20. Kilinc MY, Richardson EV (1973) Mechanics of soil erosion from overland flow generated by simulated rainfall, vol 63, Hydrology papers. Colorado State University, Fort Collins, CO
  21. Meyer LD, Wischmeier WH (1969) Mathematical simulation of the process of soil erosion by water. *Trans Am Soc Agric Eng* 12(6):754–762
  22. Yang CT (1996) *Sediment transport: theory and practice*. McGraw-Hill Inc., New York, p 396
  23. Engelund F, Hansen E (1967) A monograph on sediment transport in alluvial streams. Teknisk Vorlag, Copenhagen, Denmark, p 62
  24. Cheng NS (1997) Simplified settling velocity formula for sediment particle. *J Hydraul Eng* 123(2):149–152
  25. Burbank PY, Xu Y, McNeil J, Lick W (1990) Settling speeds of flocs in fresh and sea waters. *J Geophys Res C Oceans* 95(C10):18213–18220
  26. Krishnappan BG (2000) In situ distribution of suspended particles in the Frasier River. *J Hydraul Eng* 126(8):561–569
  27. Haralampides K, McCorquodale JA, Krishnappan BG (2003) Deposition properties of fine sediment. *J Hydraul Eng* 129(3):230–234
  28. Krone RB (1962) Flume studies of the transport of sediments in estuarial shoaling processes. Final Report, Hydraulic Engineering Laboratory and Sanitary Engineering Research Laboratory, University of California, Berkeley, California
  29. Beuselinck L, Govers G, Steegen A, Quine TA (1999) Sediment transport by overland flow over an area of net deposition. *Hydrol Process* 13(17):2769–2782
  30. Mehta A, McAnally W, Hayter E, Teeter A, Heltzel S, Carey W (1989) Cohesive sediment transport. II: Application. *J Hydraul Eng* 115(8):1094–1112
  31. Singh VP (1995) Computer models of watershed hydrology. Water Resources Publications, Highlands Ranch, CO, p 1144
  32. Julien PY, Saghafian B (1991) CASC2D user's manual—A two dimensional watershed rainfall-runoff model. Report CER90-91PYJ-BS-12. Department of Civil Engineering, Colorado State University, Fort Collins, Colorado, p 66
  33. Johnson BE, Julien PY, Molnar DK, Watson CC (2000) The two-dimensional upland erosion model CASC2D-SED. *J Am Water Resour Assoc* 36(1):31–42
  34. Ogden FL, Julien PY (2002) CASC2D: a two-dimensional, physically-based, hortonian hydrologic model. In: Singh VP, Frevert D (eds) *Mathematical models of small watershed hydrology and applications*. Water Resources Publications, Littleton, CO, pp 69–112
  35. Julien PY, Rojas R (2002) Upland erosion modeling with CASC2D-SED. *Int J Sediment Res* 17(4):265–274
  36. Downer CW, Ogden FL (2004) GSSHA: model to simulate diverse stream flow producing processes. *J Hydrol Eng* 9(3):161–174

37. Abbott MB, Bathurst JC, Cunge JA, O'Connell PE, Rasmussen J (1986) An introduction to the European Hydrological System—Système Hydrologique Européen, SHE.1: History and philosophy of a physically-based, distributed modelling system. *J Hydrol* 87(1–2):45–59
38. Wicks JM, Bathurst JC (1996) SHESED: a physically based, distributed erosion and sediment yield component for the SHE hydrological modeling system. *J Hydrol* 175(1–4):213–238
39. Ewen J, Parkin G, O'Connell PE (2000) SHETRAN: distributed river basin flow and transport modeling system. *J Hydrol Eng* 5(3):250–258
40. Abbott MB, Bathurst JC, Cunge JA, O'Connell PE, Rasmussen J (1986) An introduction to the European Hydrological System—Système Hydrologique Européen, SHE. 2: Structure of a physically-based, distributed modelling system. *J Hydrol* 87(1–2):61–77
41. Velleux M, England J, Julien P (2008) TREX: spatially distributed model to assess watershed contaminant transport and fate. *Sci Total Environ* 404(1):113–128
42. England J, Velleux M, Julien P (2007) Two-dimensional simulations of extreme floods on a large watershed. *J Hydrol* 347(1):229–241
43. Velleux M (2005) Spatially distributed model to assess watershed contaminant transport and fate. Ph.D. dissertation, Department of Civil Engineering, Colorado State University, Fort Collins, Colorado, p 261
44. Rojas R (2002) GIS-based upland erosion modeling, geovisualization and grid size effects on erosion simulations with CASC2D-SED. Ph.D. dissertation, Department of Civil Engineering, Colorado State University, Fort Collins, Colorado
45. Molnár DK, Julien PY (2000) Grid size effects on surface runoff modeling. *J Hydrol Eng* 5(1):8–16
46. Velleux M, Julien P, Rojas-Sanchez R, Clements W, England J (2006) Simulation of metals transport and toxicity at a mine-impacted watershed: California Gulch, Colorado. *Environ Sci Technol* 40(22):6996–7004
47. Ambrose RB, Martin JL, Wool TA (1993) WASP5, a hydrodynamic and water quality model—model theory, user's manual, and programmer's guide. U.S. Environmental Protection Agency, Office of Research and Development, Environmental Research Laboratory, Athens, GA
48. Velleux M, Westenbroek S, Ruppel J, Settles M, Endicott D (2001) A user's guide to IPX, the in-place pollutant export water quality modeling framework, Ver. 2.7.4. EPA/600/R-01/079. U.S. Environmental Protection Agency, Office of Research and Development, National Health and Environmental Effects Research Laboratory, Mid-Continent Ecology Division, Large Lakes Research Station, Grosse Ile, Michigan, p 179
49. MJU (2010) Naesung stream watershed data collection. Prepared by Myongji University, Yongin, South Korea
50. MJU (2011) Naesung stream watershed bank erosion. Prepared by Myongji University, Yongin, South Korea
51. ESRI (2008) ArcGIS 9.3. Environmental Systems Research Institute, Redlands, CA
52. USACE (2008) HEC-RAS, river analysis system user's manual, version 4.0. U.S. Army Corps of Engineers, Hydrologic Engineering Center (HEC), Davis, CA
53. Rojas R, Velleux M, Julien P, Johnson B (2008) Grid scale effects on watershed soil erosion models. *J Hydrol Eng* 13(9):793–802
54. Tarboton D (1997) A new method for the determination of flow directions and upslope areas in grid digital elevation models. *Water Resour Res* 33(2):309–319

55. Jia Y, Kinouchi T, Yoshitani J (2005) Distributed hydrologic modeling in a partially urbanized agricultural watershed using water and energy transfer process model. *J Hydrol Eng* 10(4):253–263
56. Linsley RK, Kohler MA, Paulhus JLH (1982) *Hydrology for engineers*, 3rd edn. McGraw-Hill Book Company, New York, p 508
57. Woolhiser DA, Smith RE, Goodrich DC (1990) KINEROS, a kinematic runoff and erosion model: documentation and user manual. U.S. Department of Agriculture, Agriculture Research Service, ARS-77, Mar 1990
58. Bras RL (1990) *Hydrology: an introduction to hydrologic science*. Addison-Wesley Publishing Company, Reading, MA, p 643
59. USACE (1998) HEC-1 flood hydrograph package user's manual. Report: CPD-1A. U.S. Army Corps of Engineers, Hydraulic Engineering Center, Davis, CA, June 1998
60. Chow VT (1959) *Open-channel hydraulics*. McGraw-Hill, New York, p 680, Reissued 1988
61. Rawls WJ, Ahuja LR, Brakensiek DL, Shirmohammadi A (1993) Infiltration and soil movement. In: Maidment DR (ed) *Handbook of hydrology*. McGraw-Hill, Inc., New York, pp 5.1–5.51

# Advances in Water Resources Systems Engineering: Applications of Machine Learning

---

John W. Labadie

## CONTENTS

INTRODUCTION AND OVERVIEW
STOCHASTIC OPTIMIZATION OF MULTIRESERVOIR SYSTEMS VIA REINFORCEMENT LEARNING
MACHINE LEARNING APPROACH TO REAL-TIME CONTROL OF COMBINED SEWER OVERFLOWS
STORMWATER MANAGEMENT FOR COASTAL ECOSYSTEM RESTORATION: LEARNING OPTIMAL FUZZY RULES BY GENETIC ALGORITHMS
SUMMARY AND CONCLUSIONS
REFERENCES

---

**Abstract** There has long existed a dichotomy in the field of water resources systems engineering between simulation and optimization modeling, with each approach having its own advantages and disadvantages. Simulation models provide a means of accurately representing the complex physiochemical, socioeconomic, and legal-administrative behavior of complex water resources systems, but lack the capability of systematically determining optimal water planning and management decisions. Optimization models, on the other hand, excel at automatic determination of optima, while often sacrificing the accurate representation of the underlying water system behavior. Various means of effectively establishing a synergy between simulation and optimization models that accentuates their advantages while minimizing their shortcomings have evolved from the field of artificial intelligence within the province of computer science. Artificial intelligence was defined by John McCarthy in 1955 as “the science and engineering of making intelligent decisions.” Machine learning, as a

---

John W. Labadie is former Senior Editor of the ASCE *Journal of Water Resources Planning and Management*.

From: *Handbook of Environmental Engineering, Volume 15: Modern Water Resources Engineering*  
Edited by: L.K. Wang and C.T. Yang, DOI 10.1007/978-1-62703-595-8\_10, © Springer Science+Business Media New York 2014

branch of artificial intelligence, focuses on the development of specific algorithms that allow computerized agents to learn optimal behaviors through interaction with a real or simulated environment. Although there are many aspects of machine learning, the focus here is on agent-based modeling tools for learning optimal decisions and management rule structures for water resources systems under conflicting goals and complex stochastic environments. A wide variety of machine learning tools such as reinforcement learning, artificial neural networks, fuzzy rule-based systems, and evolutionary algorithms are applied herein to complex decision problems in integrated management of multipurpose river-reservoir systems, real-time control of combined sewer systems for pollution reduction, and integrated design and operation of stormwater control systems for sustaining and remediating coastal aquatic ecosystems damaged by intensified urbanization and development.

**Key Words** Artificial intelligence • Coastal environment • Detention reservoirs • Ecology • Estuaries • Fuzzy sets • Genetic algorithms • Hydraulic sewer models • Markov decision processes • Multireservoir systems • Neural networks • Optimal real-time control • Reinforcement learning • Stochastic dynamic programming • Urban stormwater management.

## 1. INTRODUCTION AND OVERVIEW

The focus of water resources systems engineering is treating the natural environment, the built infrastructure, and regulatory institutions associated with water resources planning and management as an integrated, highly interactive system. The goals are to provide reliable, clean, and inexpensive water supply for municipalities, industry, and irrigated agriculture through conjunctive use of surface and groundwater resources; mitigate the impacts of extreme flood and drought events, preserve and enhance aquatic ecosystems, and produce clean, efficient, and renewable energy through hydropower generation; enhance commerce through maintenance of navigable waters; and provide important recreational opportunities while preserving and maintaining natural habitats and the environment. The need for applying systems engineering to structural and nonstructural measures for achievement of these goals arises since water in its unregulated state is rarely available in the preferred quantity, acceptable quality, at the appropriate place, and at the desired time.

Challenges arise when considering that these goals are often in competition and highly conflicting, compounded by stochastic hydrology, long-term climate-change impacts, uncertain future demands, and unpredictable economic and sociopolitical conditions. Further, appropriate application of systems engineering greatly expands the scale and scope of water planning and management to consider integrated modeling of entire river basins and even interconnected multi-basin systems. The long-term sustainability of water resources development projects and management plans is contingent on multidisciplinary consideration of all the important physical, hydrologic, environmental, institutional, legal, sociopolitical, and economic impacts. Decision support systems [1] and shared vision modeling approaches [2]

attempt to consider these multidimensional impacts and encourage stakeholder involvement in model development as a means of establishing compromise and consensus.

As reviewed by Labadie [3], traditional water resources systems engineering has emphasized the application of simulation and optimization models in water resources planning and management, but rarely with full integration of the two modeling approaches. Physically based simulation models, also known as descriptive models, are able to accurately represent complex spatially distributed, dynamic processes governing hydrologic and hydraulic surface water flows; hydroelectric energy production, groundwater and stream-aquifer interaction; contaminant transport, aquatic habitat conditions, and ecosystem health, as long as an adequate database for model calibration and verification is available.

Simulation models help answer *what if* questions regarding performance of water resources planning and management alternatives and are useful for examining the long-term reliability, vulnerability, and resilience [4] of proposed strategies through Monte Carlo analysis. Simulation models, however, are incapable of directly *prescribing* the best or optimum strategies, whereas prescriptive optimization models systematically select optimal solutions, or families of solutions, under agreed-upon objectives and constraints. Unfortunately, traditional optimization methods applied in water resources systems engineering often impose simplifying assumptions and approximations regarding the intrinsic behavior of the modeled system, such as the requirement of linear relations in the formulation of linear programming problems. Since these assumptions may represent sizable departures from the real-world behavior, the ideal is to somehow combine the best attributes of simulation with the prescriptive advantages of optimization.

Machine learning [5] is a branch of artificial intelligence with the capability of providing the desired linkage of simulation and optimization in water resources systems engineering so as to combine the most desirable characteristics of both modeling approaches. Although there are many aspects of machine learning, the focus here is on agent-based modeling tools for learning optimal decisions and management rule structures under conflicting goals through interaction with a simulated, dynamically changing process environment.

Reinforcement learning [6] is a machine learning technique for solving sequential decision problems that combines concepts from artificial intelligence, cognitive science, and operations research. With a mathematical foundation similar to dynamic programming and Markov decision processes, reinforcement learning acquires knowledge of the optimal policies that maximize the long-term reward or returns as conditioned on the state of the system environment and the immediate reward obtained from operational and management decisions. Unlike traditional methods of stochastic dynamic programming, transition probabilities and rewards are not assumed to be explicitly known a priori, but rather are learned through (simulated) long-term interaction with the stochastic environment. The Q-Learning method of reinforcement learning is applied to the Geum River basin located in South Korea through linkage with a well-calibrated simulation model of the river basin network.

Artificial neural networks provide another means of applying machine learning for linking realistic simulation and optimization models. Optimal real-time regulation of flows and in-line storage in combined sewer systems is challenging due to the need for complex optimization models integrated with accurate urban stormwater runoff prediction and fully dynamic hydraulic simulation of sewer flows over a citywide extent. For real-time control of in-system storage through regulation of control gates and pump stations, these models need to

be executed within short time increments as rainfall and sewer flow measurements/forecasts are updated during an ongoing storm event with the potential for surcharging combined sewers and spilling untreated raw sewage to adjacent receiving waters. Unfortunately, execution of the optimal control model as linked to a spatially distributed, fully dynamic hydraulic sewer simulation model, exceeds the limited time constraint for real-time regulation. An artificial neural network is therefore applied to *learning* optimal control strategies from training data sets generated through numerous off-line executions of the realistic optimization-simulation modeling system applied to a wide range of historical, overflow-producing storm events. Online implementation of the resulting neural-optimal control model provides rapid execution to facilitate adaptive real-time control through incorporation of updated rainfall and sewer flow conditions as provided by the SCADA system. The neural-optimal control algorithm is demonstrated in a simulated real-time control experiment for the King County combined sewer system, Seattle, Washington, USA.

A key element in water resources planning is the incorporation of simulated optimal operations of planned facilities within the broader project selection, sizing, and design problem. This effective linkage of planning and operations results in reduced facility sizing and costs of achieving the desired goals by incorporating the simulation of spatially distributed, real-time operational policies for the planned system. Machine learning is applied in this context by use of a genetic algorithm for optimizing the planned facilities, but which also *learns* the imbedded optimal fuzzy operational rule structures by simulating the long-term, risk-based performance of the planned system under stochastic hydrology.

Similar to many coastal ecosystems, the St. Lucie Estuary located on the east coast of South Florida has been adversely impacted by magnified stormwater runoff due to expanding urbanization. A suite of models dealing with watershed hydrology, reservoir optimization, and estuary salinity and ecology are applied for optimal sizing and operation of stormwater reservoirs. The multipurpose stormwater control facilities provide for hydrologic restoration to approximate natural hydrologic conditions for recovery of salinity-sensitive biota in the Estuary, as well as provide supplemental irrigation water supply and pollution control through connected stormwater treatment areas. Rather than simply attempting to control individual storm events, the goal is to match the long-term frequency distribution of mean monthly stormwater discharges to the desired probability distribution reflecting natural, predevelopment conditions. A genetic algorithm is coupled with a daily simulation model of the stormwater drainage network to minimize the sizing and learn the fuzzy operating rules of detention reservoirs for controlling stormwater discharges to the Estuary.

## 2. STOCHASTIC OPTIMIZATION OF MULTIRESERVOIR SYSTEMS VIA REINFORCEMENT LEARNING

### 2.1. Introduction

According to the World Commission on Dams [7], many large-scale water storage projects worldwide are failing to produce the expected benefits that provided the economic justification for their development. This is often due to an inordinate focus on project planning and construction, with inadequate attention placed on operational issues and

optimal coordinated management of new projects with existing reservoirs in the river basin. Performance of the project is also undermined when new unplanned uses arise not originally considered in the project authorization. Examples include retrofitting water supply reservoirs with hydropower generation plants to increase energy production, adding water supply uses to projects initially designed for flood control purposes only, and modifying reservoir operations for augmentation of streamflows to maintain and enhance downstream aquatic ecosystems.

The current moratorium on dam construction in the USA and many other countries has shifted the emphasis from development of expensive new water projects to improving the operational effectiveness and efficiency of existing systems for maximizing beneficial use [3]. In most cases, current reservoir operation policies fail to consider the need for integrated water resources management over an entire river basin. Although a system-wide focus has the potential for significantly improving operational effectiveness, the development of adaptive strategies for coordinated regulation of multiple reservoirs under complex stochastic hydrology continues to be a challenging problem in water resources systems modeling. Further complications arise from conflicting objectives, climate-change impacts, and uncertain demand forecasts.

Most methods of stochastic optimization of multireservoir systems can be categorized as implicit or explicit methods [3]. Implicit stochastic optimization (ISO) is essentially a Monte Carlo analysis procedure whereby deterministic optimization is performed over long historical or stochastically generated inflow sequences in order to infer general feedback reservoir operating rules. Although efficient optimization algorithms abound for use in ISO, the extraction of usable optimal policies from the results is not guaranteed. Explicit stochastic optimization (ESO) methods overcome this problem by operating directly on stochastic models of the hydrologic processes rather than historical sequences of hydrologic time series data. A Markov decision problem is formulated and solved without the presumption of perfect foreknowledge of future hydrologic events, and a posteriori regression analyses or inference methods on the optimization results are not required.

Stochastic dynamic programming (SDP) is one of the most popular explicit stochastic optimization methods for reservoir system analysis but suffers from several disadvantages. Discretization of the state variables (i.e., reservoir storage and/or reservoir inflow forecasts) and decision variables (i.e., reservoir releases) is generally required, and probability distributions of the underlying hydrologic processes must be known a priori or defined by Bayesian estimation methods. Because of this, the computational burden associated with SDP is significantly greater than the ISO approach, combined with the difficulty of explicitly identifying the underlying probability distributions governing the spatially and temporally correlated hydrologic inflows to multireservoir systems. In spite of these challenges, successful applications of SDP are described in Wang and Adams [8], Braga et al. [9], and Tejada-Guibert et al. [10].

Reinforcement learning (RL) from the field of artificial intelligence represents a body of methodologies with the potential for overcoming the computational challenges of stochastic optimization of multireservoir systems. RL employs a *depth-first* search strategy that



alleviates to some extent the *curse of dimensionality* problem that has long plagued applications of SDP, where visits to all reachable system states occur over many trials or episodes. This is in contrast with the *breadth-first* solution strategy of SDP requiring exhaustive calculation of the DP optimal value or cost-to-go function for all discrete combinations of system states, many of which may not be operationally attainable. In addition, a learning process embodied within RL acquires implicit knowledge of the underlying stochastic structure of river basin hydrologic inflows, rather than requiring known transition probability matrices.

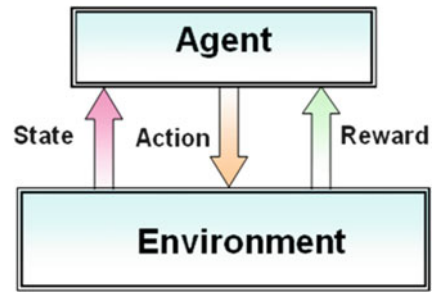
The advantages of reinforcement learning are demonstrated through application to the Geum River basin in South Korea, as described in Lee and Labadie [11]. A well-calibrated simulation model of the Geum River system is linked with a reinforcement learning algorithm for the development of accurate and realistic reservoir operating rules. Performance of the optimal operating rules developed by RL is compared with those developed through application of alternative approaches including implicit stochastic dynamic programming [3] and sampling stochastic dynamic programming [12]. The intense computational challenges of applying SDP to a complex multireservoir system prevented its inclusion in the comparative analysis.

## 2.2. Reinforcement Learning

Rather than presuming explicit knowledge of the stochastic processes governing hydrologic inflows, reinforcement learning attempts to implicitly learn the underlying stochastic behavior, which may be gained in an actual online environment or through simulated experience using a system dynamics model. Just as behavioral psychologists have attempted to model the ability of animals to learn appropriate actions in response to particular stimuli based on associated rewards or punishments, Kaelbling et al. [13] in the field of artificial intelligence created a framework for a computational agent to learn the best behavior through trial-and-error interactions with an environment. As stated by Sutton and Barto (6; p. 3–4), reinforcement learning is “. . . learning how to map situations to actions so as to maximize a numerical reward signal. The learner is not told which actions to take, as in most forms of machine learning, but instead must discover which actions yield the most reward by trying them. In the most interesting and challenging cases, actions may affect not only the immediate reward, but also the next situation and, through that, all subsequent rewards. These two characteristics—trial-and-error search and delayed reward—are the two most important distinguishing features of reinforcement learning.”

A reinforcement learning system consists of an agent, the environment, and their interactions (Fig. 10.1). In contrast with supervised learning, reinforcement learning requires the agent to discover from experience those actions resulting in optimal long-term reward. And unlike unsupervised learning, there is some feedback available as to the quality of the actions or decisions in RL. The agent initially has no understanding of the environment and is usually unable to observe all its aspects and intricacies. The agent therefore attempts to explore the environment so as to both *discover* new actions and *exploit* actions that have been found to be effective through past experience.

**Fig. 10.1.** Agent-based reinforcement learning system.



### 2.3. Bellman Equation

Stochastic optimization of multireservoir systems is achieved by determining optimal feedback release policies  $\mathbf{a}_t^*(\mathbf{s}_t, \mathbf{q}_t)$  conditioned on the current storage and inflow states  $\mathbf{s}_t, \mathbf{q}_t$  that maximize the expected total current and discounted future benefits under a stochastic hydrologic regime:

$$\max \mathbf{E} \left\{ \sum_{t=1}^T \gamma^{t-1} r_t(\mathbf{s}_t, \mathbf{s}_{t+1}, \mathbf{a}_t) \right\} \quad (10.1)$$

where  $\mathbf{E}\{\cdot\}$  is the statistical expectation operator;  $\mathbf{s}_t = (s_{1t}, s_{2t}, \dots, s_{Nt})$  is the system state vector representing discrete storage contents in  $N$  reservoirs at the beginning of period  $t$ ;  $\mathbf{a}_t = (a_{1t}, a_{2t}, \dots, a_{Nt})$  is the action or decision vector of controlled reservoir releases during period  $t$ ;  $r_t(\mathbf{s}_t, \mathbf{s}_{t+1}, \mathbf{a}_t)$  is the return or reward for period  $t$  from action  $\mathbf{a}_t$  performed in state  $\mathbf{s}_t$  and resulting in state  $\mathbf{s}_{t+1}$  based on random net inflow  $\mathbf{q}_t$  during period  $t$ , which is assumed to include evaporation and other losses;  $\gamma$  is the factor ( $<1$ ) for discounting future returns in relation to immediate returns; and  $T$  is the total number of time periods in the operational horizon. In this formulation, the immediate return  $r_t(\mathbf{s}_t, \mathbf{s}_{t+1}, \mathbf{a}_t)$  in period  $t$  is shown as a function of end-of-period storage  $\mathbf{s}_{t+1}$  since criteria such as hydropower production should be calculated based on average head over the period for accurate solution.

System state transitions are governed by a multidimensional state dynamics equation:

$$\mathbf{s}_{t+1} = \mathbf{s}_t + \mathbf{C} \cdot (\mathbf{a}_t + \mathbf{sp}_t) + \mathbf{q}_t - \mathbf{d}_t \quad (\text{for } t = 1, \dots, T) \quad (10.2)$$

where  $\mathbf{C}$  is the system connectivity matrix for routing upstream controlled releases and spills to downstream locations (connectivity matrix components  $c_{ij} = -1$  for all  $i = 1, \dots, N$  and  $c_{ij} = 1$  if reservoir  $i$  is directly upstream of reservoir  $j$ ; otherwise,  $c_{ij} = 0$  for  $i, j = 1, \dots, N$ );  $\mathbf{sp}_t$  is the vector of uncontrolled spills due to restrictions on reservoir storage space, discharge outlet capacity, and downstream channel capacity; and  $\mathbf{d}_t$  are required demands, diversions, or depletions from the system. In some formulations, demands can be treated as decision variables and included in the objective function as related to benefits of supplying water. Initial storage levels  $\mathbf{s}_1$  are assumed known, and all flow units in (10.2) are expressed in storage units per time interval.

Explicit lower and upper bound on conservation or active storage are represented as

$$s_{t+1,\min} \leq s_{t+1} \leq s_{t+1,\max} \quad (\text{for } t = 1, \dots, T) \tag{10.3}$$

where  $s_{t+1,\min}$  is assigned for purposes of providing recreation opportunities, sediment storage capacity, and minimum head levels for power plant operation; and  $s_{t+1,\max}$  is defined by available conservation storage capacity, allowing for maintenance of flood control space between the conservation pool and spill capacity of the reservoir. Likewise, maximum reservoir releases  $a_{t,\max}$  are defined by outlet capacity and downstream flood conditions, whereas minimum releases  $a_{t,\min}$  provide for water quality control and fish and wildlife maintenance:

$$a_{t,\min} \leq a_t \leq a_{t,\max} \quad (\text{for } t = 1, \dots, T) \tag{10.4}$$

This problem is solved through recursive calculation of the dynamic programming optimal value function  $V(s_t)$  using the Bellman equation [14], which is synonymous with the value iteration method for solving Markov decision problems:

$$\begin{aligned} V_k(s_t) &= \max_{a_t} \sum_{q_t} p(q_t) \cdot [r_t(s_t, s_{t+1}, a_t) + \gamma V_{k-1}(s_{t+1})] \quad \text{for } t = 1, \dots, 11 \\ V_k(s_{12}) &= \max_{a_{12}} \sum_{q_{12}} p(q_{12}) \cdot [r_{12}(s_{12}, s_1, a_{12}) + \gamma V_{k-1}(s_1)] \quad \text{for updates } k = 1, \dots, T \end{aligned} \tag{10.5}$$

where

$$\begin{aligned} \tau &= k \bmod(12) \\ t &= \tau \text{ for } \tau = 1, \dots, 11; t = 12 \text{ for } \tau = 0 \end{aligned}$$

where  $k \bmod(12)$  is the modulo operation on the remainder of  $k/12$ , assuming that seasonal inflows are defined for the 12 calendar months; initial value function  $V_0(s) = 0$ ; and  $p(q_t)$  is the independent joint probability distribution of inflow vector  $q_t$  in season  $t$ . More accurate conditional distributions can be used that consider lag- $n$  serial correlations of seasonal inflows, but each lag requires the addition of a state variable in (10.5) representing previous season inflows. Assuming  $T$  is sufficiently large, Ross [15] has proven that the value iteration process results in convergence to optimal seasonal (e.g., calendar month) stationary release policies, after a finite number of updates  $k$  for the discounted case, as feedback decision rules that maximize the total expected discounted return over a long-term operational horizon:

$$\begin{aligned} a_t^*(s_t) &= \arg \max_{a_t} \sum_{q_t} p(q_t) \cdot [r_t(s_t, s_{t+1}, a_t) + \gamma V_{k-1}(s_{t+1})] \quad \text{for } t = 1, \dots, 11 \\ a_{12}^*(s_{12}) &= \arg \max_{a_{12}} \sum_{q_{12}} p(q_{12}) \cdot [r_{12}(s_{12}, s_1, a_{12}) + \gamma V_{k-1}(s_1)] \end{aligned} \tag{10.6}$$

### 2.4. Q-Learning Method

As stated previously, the primary computational challenges of SDP are the combinatorially explosive number of evaluations of the dynamic programming optimal value function  $V(\mathbf{s}_t)$  for all possible discrete states  $\mathbf{s}_t$  at each stage of the iterative updating process, as well as the requirement for a priori specification of the inflow probability distributions  $p(\mathbf{q}_t)$  which may not be accurate representations of the complex underlying stochastic hydrologic processes. Although there are several reinforcement learning methods for solving Markov decision problems, the most popular is the *Q-Learning* method [6]. Q-Learning uses the *Q*-function version of the Bellman equation but updates the *Q*-function as a means of overcoming these problems:

$$\begin{aligned}
 Q_k(\mathbf{s}_t, \mathbf{a}_t) &= \sum_{\mathbf{q}_t} p(\mathbf{q}_t) \cdot [r_t(\mathbf{s}_t, \mathbf{s}_{t+1}, \mathbf{a}_t) + \gamma V_{k-1}(\mathbf{s}_{t+1})] \quad \text{for } t = 1, \dots, 11 \\
 Q_k(\mathbf{s}_{12}, \mathbf{a}_{12}) &= \sum_{\mathbf{q}_{12}} p(\mathbf{q}_{12}) \cdot [r_t(\mathbf{s}_{12}, \mathbf{s}_1, \mathbf{a}_{12}) + \gamma V_{k-1}(\mathbf{s}_1)] \quad \text{for updates } k = 1, \dots, T
 \end{aligned}
 \tag{10.7}$$

where

$$\begin{aligned}
 \tau &= k \bmod(12) \\
 t &= \tau \text{ for } \tau = 1, \dots, 11; t = 12 \text{ for } \tau = 0
 \end{aligned}$$

Note that by definition

$$V_k(\mathbf{s}_t) = \max_{\mathbf{a}_t} Q_k(\mathbf{s}_t, \mathbf{a}_t)
 \tag{10.8}$$

and

$$\mathbf{a}_t^*(\mathbf{s}_t) = \arg \max_{\mathbf{a}_t} Q_k(\mathbf{s}_t, \mathbf{a}_t)
 \tag{10.9}$$

Rather than performing the exhaustive optimization of (10.7), Q-Learning attempts to *learn by experience* what the best actions are based on a long sequence of historical or synthetically generated monthly inflow data sets  $\mathbf{q}_t, t = 1, \dots, K$ . Much like Monte Carlo analysis, this avoids the need for a priori definition of the underlying probability distributions. The *Q*-function is therefore updated according to:

$$Q_k(\mathbf{s}_t, \mathbf{a}_t) = r_t(\mathbf{s}_t, \mathbf{s}_{t+1}, \mathbf{a}_t) + \gamma \max_{\mathbf{a}_{t+1}} Q_{k-1}(\mathbf{s}_{t+1}, \mathbf{a}_{t+1})
 \tag{10.10}$$

over many long sequences of the inflow data sets  $\mathbf{q}_t, t = 1, \dots, K$ , rather than calculating the expected value as in (10.7).

Most often, actions obtained from the current policy from (10.9) after  $k$  updates are used, which is called *exploitation*. However, Q-Learning is an *off-policy* method, meaning that there is a small probability of a random action being selected that is not defined by (10.9), which is

referred to as *exploration*. This alleviates the need for evaluating the optimal value function for all possible combinations of storage states  $\mathbf{s}_t$ , many of which may not be physically attainable during long-term operation of the system. In contrast with the breadth-first search procedure of stochastic dynamic programming, Q-Learning performs a depth-first search process which helps alleviate the so-called curse of dimensionality associated with dynamic programming and Markov decision processes. After many updates, all possible reachable states are eventually visited during the Q-Learning search process.

**2.5.  $\epsilon$ -Greedy Actions**

Application of Q-Learning begins with initial policies that are assumed to be *greedy*. Using the first 12 months of the inflow data series  $\mathbf{q}_t, t = 1, \dots, 12$ , greedy policies are restricted to maximizing only the immediate returns and ignore future implications of those actions:

$$\begin{aligned}
 \mathbf{a}_t^*(\mathbf{s}_t) &= \arg \max_{\mathbf{a}_t} r_t(\mathbf{s}_t, \mathbf{s}_{t+1}, \mathbf{a}_t) \quad \text{for } t = 1, \dots, 11 \\
 &\text{subject to : Eqs. (10.2) - (10.4)} \\
 \mathbf{a}_{12}^*(\mathbf{s}_{12}) &= \arg \max_{\mathbf{a}_{12}} r_{12}(\mathbf{s}_{12}, \mathbf{s}_1, \mathbf{a}_{12}) \\
 &\text{subject to : Eqs. (10.2) - (10.4)}
 \end{aligned}
 \tag{10.11}$$

That is, greedy policies are restricted to maximizing only the expected immediate returns and ignore future implications of those actions.

The associated optimal value functions based on the greedy policies are also initialized:

$$\begin{aligned}
 V_t(\mathbf{s}_t) &= \max_{\mathbf{a}_t} r_t(\mathbf{s}_t, \mathbf{s}_{t+1}, \mathbf{a}_t) \quad \text{for } t = 1, \dots, 11 \\
 &\text{subject to : Eqs. (10.2) - (10.4)} \\
 V_t(\mathbf{s}_{12}) &= \max_{\mathbf{a}_{12}} r_{12}(\mathbf{s}_{12}, \mathbf{s}_1, \mathbf{a}_{12}) \\
 &\text{subject to : Eqs. (10.2) - (10.4)}
 \end{aligned}$$

During the update process, action  $\mathbf{a}_t$  for releases from each reservoir is selected randomly based on the following distribution:

$$\begin{aligned}
 &\text{For all } \mathbf{a}_t \in A(\mathbf{s}_t) : \\
 \pi(\mathbf{s}_t, \mathbf{a}_t) &= \begin{cases} 1 - \epsilon + \frac{\epsilon}{|A(\mathbf{s}_t)|} & \text{if } \mathbf{a}_t = \mathbf{a}_t^*(\mathbf{s}_t) \\ \frac{\epsilon}{|A(\mathbf{s}_t)|} & \text{if } \mathbf{a}_t \neq \mathbf{a}_t^*(\mathbf{s}_t) \end{cases}
 \end{aligned}
 \tag{10.12}$$

Loop end

where  $|A(\mathbf{s}_t)|$  is cardinality of the set of all feasible discrete actions  $\mathbf{a}_t$  from state  $\mathbf{s}_t$ . These are called  $\epsilon$ -greedy or *soft* policies whereby there is a small probability  $\frac{\epsilon}{|A(\mathbf{s}_t)|}$  that an action other

than *greedy* (i.e., defined by the current policy) will be selected. Without allowing some exploration of non-greedy policies, convergence to suboptimal policies may occur. In effect, the *exploitation* characteristics of greedy policies are *softened* by the *exploration* capabilities of  $\varepsilon$ -greedy policies. To encourage exploration of alternative actions in the early stages,  $\varepsilon$  is often set to higher values initially and then decreased in subsequent episodes as learning is strengthened.

Given initial state  $\mathbf{s}_1$ , sequences of monthly inflows  $\mathbf{q}_k$ ,  $k = 1, \dots, K$ , and initial  $Q_0(\mathbf{s}_1, \mathbf{a}_1)$ :

Repeat for episodes  $k = 1, \dots, K$  :

$$\tau = k \bmod(12)$$

$$t = \tau \quad \text{for } \tau = 1, \dots, 11; t = 12 \text{ for } \tau = 0$$

Randomly select action  $\mathbf{a}_t$  based on probability distribution  $\pi(\mathbf{s}_t, \mathbf{a}_t)$  and historical or synthetic inflow vector  $\mathbf{q}_k$  :

$$Q_k(\mathbf{s}_t, \mathbf{a}_t) = r_t(\mathbf{s}_t, \mathbf{s}_{t+1}, \mathbf{a}_t) + \gamma \max_{\mathbf{a}_{t+1}} Q_{k-1}(\mathbf{s}_{t+1}, \mathbf{a}_{t+1}) \quad (10.13)$$

$$\text{IF : } Q_k(\mathbf{s}_t, \mathbf{a}_t) > V_k(\mathbf{s}_t)$$

$$\text{THEN : } V_k(\mathbf{s}_t) = Q_k(\mathbf{s}_t, \mathbf{a}_t)$$

$$\mathbf{a}_t^*(\mathbf{s}_t) = \mathbf{a}_t$$

successor state  $\mathbf{s}_{t+1}$  calculated (if  $t = 12$ , successor state is  $\mathbf{s}_1$ )

End loop

The update process of (10.13) continues for  $K$  episodes, until optimal policies  $\mathbf{a}_t^*(\mathbf{s}_t)$  become stationary, or  $V_k(\mathbf{s}_t)$  (for  $t = 1, \dots, T$ ) has not improved after several episodes. Watkins and Dayan [16] proved that “Q-Learning converges to the optimum action values with probability 1 so long as all actions are repeatedly sampled in all states and the action values are represented discretely.” Although a large number of episodes may be required for convergence, computer CPU time only increases approximately linearly with the number of episodes.

## 2.6. Temporal-Difference Learning

An alternative Q-Learning update uses temporal difference (TD) learning to perform an incremental update, where (10.14) replaces (10.13):

$$Q_k(\mathbf{s}_t, \mathbf{a}_t) = Q(\mathbf{s}_t, \mathbf{a}_t) + \alpha \left( r_t(\mathbf{s}_t, \mathbf{s}_{t+1}, \mathbf{a}_t) + \gamma \max_{\mathbf{a}_{t+1}} Q_{k-1}(\mathbf{s}_{t+1}, \mathbf{a}_{t+1}) - Q(\mathbf{s}_t, \mathbf{a}_t) \right) \quad (10.14)$$

where  $Q(\mathbf{s}_t, \mathbf{a}_t)$  is the current Q-function value for state-action pair  $\mathbf{s}_t, \mathbf{a}_t$  and coefficient  $\alpha \in [0,1]$  is the *learning rate* parameter controlling the weight or importance given to the reward or return just experienced. With TD learning, the Q-function value is incrementally updated from its previous value, rather than performing a complete replacement, which has been found to produce more stable convergence in stochastic environments. Notice that if  $\alpha = 1$ , then (10.14) and (10.13) are equivalent. Generally,  $\alpha$  should decrease with the increasing number of episodes in order to slow the learning rate as the process converges.

In updating the  $Q$ -function of (10.14), a method of interpolating  $Q_{k-1}(s_{t+1}, \mathbf{a}_{t+1})$  is required since states calculated from (10.2) may not coincide with the discrete states over which  $Q_{k-1}(s_{t+1}, \mathbf{a}_{t+1})$  is stored. In this study, various function approximation techniques were applied including linear, polynomial, and spline approximations [17, 18]. It was found that the simple *nearest neighbor* methods provided more efficient and stable convergence of the Q-Learning algorithm since the optimal value function exhibited high degrees of discontinuity over certain ranges of the state variables.

## 2.7. Discounting Scheme for Optimal Average Returns

One of the problems in solving Markov decision processes, especially over possibly many thousands of stages as in Q-Learning, is the total expected discounted returns represented in the DP optimal value function can become extremely large, depending on the number of times a particular state is visited. Since this can lead to numerical instabilities, this problem is overcome by discounting immediate returns by  $(1 - \gamma)$  in relation to the discounted future returns:

$$Q_k(s_t, \mathbf{a}_t) = Q(s_t, \mathbf{a}_t) + \alpha \left( (1 - \gamma) r_t(s_t, s_{t+1}, \mathbf{a}_t) + \gamma \max_{\mathbf{a}_{t+1}} Q_{k-1}(s_{t+1}, \mathbf{a}_{t+1}) - Q(s_t, \mathbf{a}_t) \right) \quad (10.15)$$

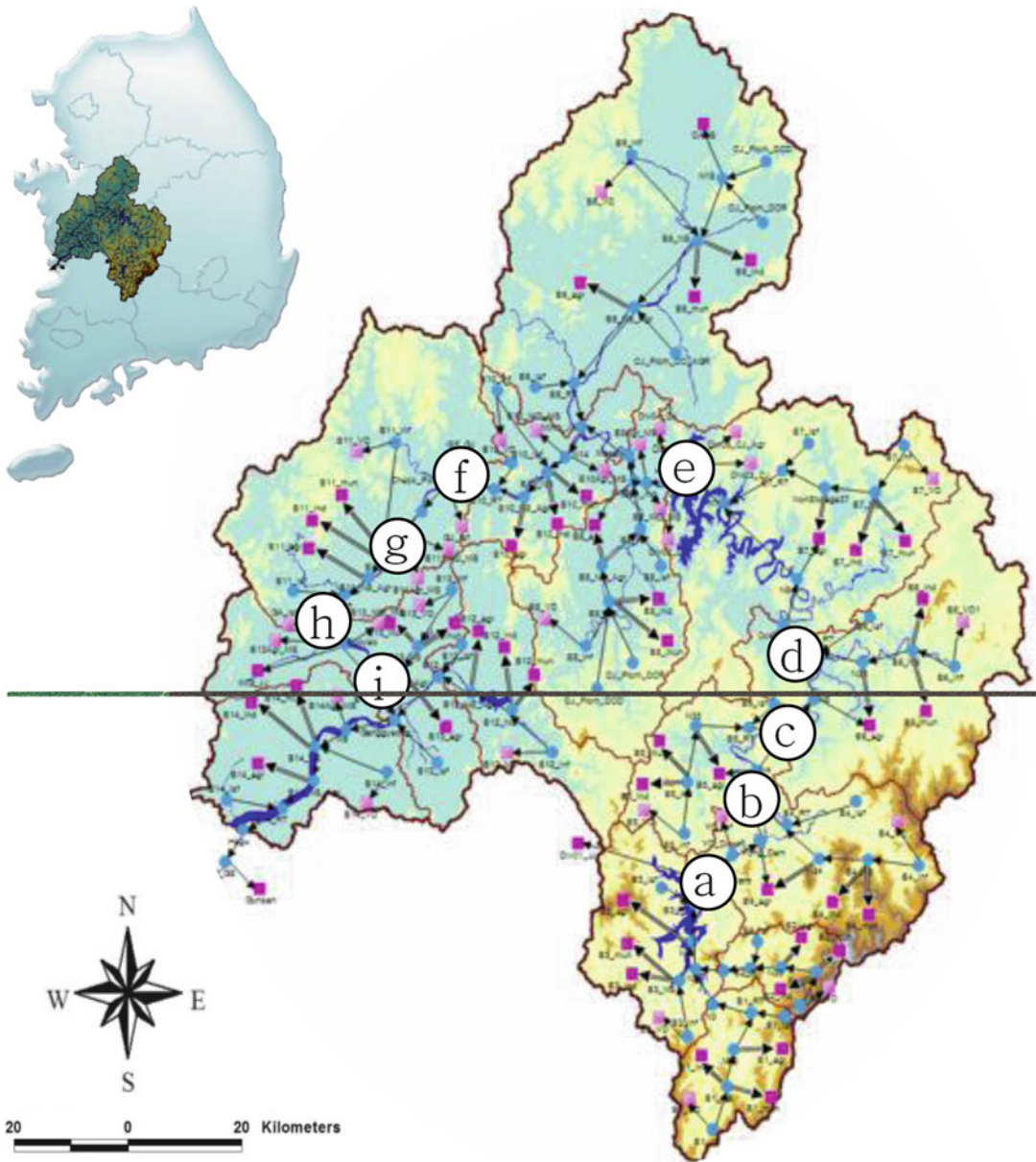
Lee and Labadie [11] prove that under this modified discounting scheme, the optimal value function converges to the optimal expected average return over all stages, instead of the expected total discounted returns.

## 2.8. Case Study: Geum River Basin, South Korea

### 2.8.1. Description

The Geum River basin, South Korea, is selected as a case study to demonstrate the applicability of the Q-Learning algorithm, as described by Lee and Labadie [11]. Figure 10.2 provides a location map and the major features of the network flow simulation model of the Geum River basin. Located in the southwestern portion of the Korean Peninsula, the Geum River basin is one of the four major river basins in South Korea with a total basin area of 9,810 km<sup>2</sup>, which is subdivided into 12 subbasins. With a main stem length of 396 km, the Geum River is impounded by the multipurpose Daechung and Yongdam Reservoirs, which benefit a population of almost five million in the region. Satisfaction of municipal, industrial, and agricultural water demands are the primary purposes of these two reservoirs, but flood control, hydropower generation, and maintaining instream flow requirements for water quality and ecological maintenance are also important.

Daechung Reservoir, located in the central portion of the Geum River basin, has an active storage capacity of 790 MCM, whereas the more recently constructed Yongdam Reservoir upstream of Daechung has a capacity of 684 MCM. The primary purpose of Yongdam Reservoir was to provide transbasin diversion of water supply to the Jun-Ju region to the west,



**Fig. 10.2.** Major features of network flow simulation model of the Geum River basin, South Korea [(a) Yongdam Reservoir, (b) Sutong Gage, (c) Hotan Gage, (d) Okcheon Gage, (e) Daechung Reservoir, (f) Gongju Gage, (g) Seokhwa Gage, (h) Gyuam Gage, and (i) Kangkyeong Gage].

which has given rise to regional conflicts between users in the downstream region of the Geum River basin and new users in the Jun-Ju region receiving transbasin water from Yongdam. Cities located in the Geum River basin depend primarily on Daechung Reservoir for water supply and are therefore concerned about the potential for both water shortages and water quality degradation



in the river as a result of flows diminished by the transbasin diversions. These concerns have heightened the need for coordinated, fully integrated water management in the Geum River basin.

### 2.8.2. Operational Guidelines

In decreasing order of priority, the primary water uses in the 12 subbasins are instream flow maintenance and domestic, industrial, and agricultural water supply. In order to protect preexisting water rights in the subbasins, these demands are distributed prior to any allocations to demands along the main stem of the river. The Korea Water Resources Corporation (K-water) has defined minimum streamflow requirements as flows at the 95 % exceedence percentile over the 19-year historical period for each subbasin [19].

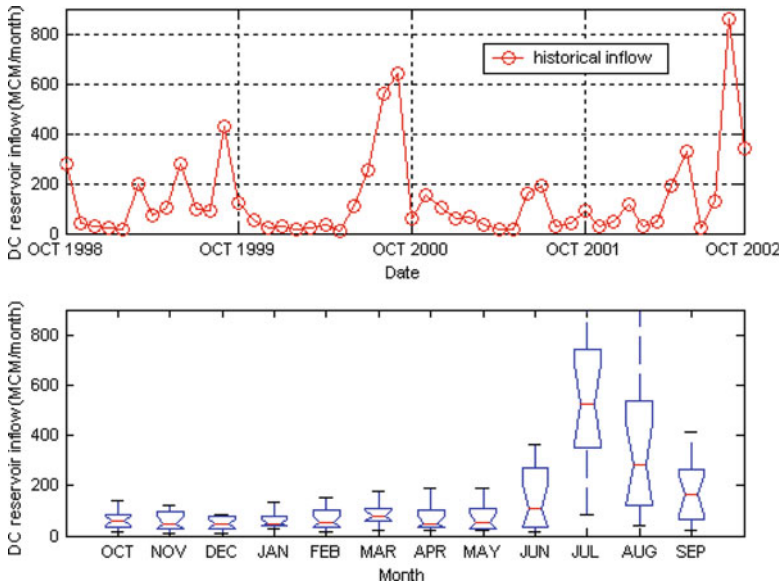
Although hydropower generation in the Geum River system is assigned the lowest priority in the basin, it is still considered an important objective by K-water. Yongdam Reservoir has two power plants, with a low-head plant operating on releases to the Geum River up to a discharge capacity of 22.6 cm and a high-head plant generating power at the Jun-Ju diversion with a capacity of 6.2 cm. Both power plants at Yongdam Reservoir operate 24 h per day with a combined annual generation of 207.8 GWh. The power plant at Daechung Reservoir operates for only 5 h of daily peak time during the non-flood season (October to June), with an annual energy generation of 238 GWh. During the flood season, generation hours vary according to inflow conditions. Flood control at Yongdam Reservoir requires maintaining the reservoir level at or below 261.5 m (672.84 MCM) during the flood season. However, the normal full storage level of 76.5 m (1242.7 MCM) at Daechung Reservoir is used as the flood control level since inflows to Daechung Reservoir were reduced following completion of the Yongdam Reservoir upstream [19].

### 2.8.3. Multiobjective Optimization Model

Minimizing prioritized water demand deficits and reservoir spills, while maximizing hydropower generation, constitute the primary operational objectives in the Geum River system. The weighting method of multiobjective optimization is applied to commensurating these objectives into a single performance measure as the reward function:

$$r_t(\mathbf{s}_t, \mathbf{s}_{t+1}, \mathbf{a}_t) = w_1 \left[ \sum_{i=1}^{NR} P_i(a_{it}, \bar{h}_{it}(s_{it}, s_{i,t+1})) + P_3(a_{3t}, \bar{h}_{2t}(s_{2t}, s_{2,t+1})) \right] - \sum_{j=1}^{ND} w_{2j} \left( 100 \cdot \frac{(d_{jt} - a_{j+3,t})}{d_{jt}} \right)^2 - w_3 \sum_{i=1}^{NR} sp_{it} \quad (10.16)$$

where  $w_1$ ,  $w_{2j}$ ,  $w_3$  are weighting factors for hydropower generation, diversion or instream flow requirements  $j$ , and reservoir spill, respectively; NR is the number of reservoirs (=2); ND is the number of diversion or instream flow demands (=25);  $P_i$  is energy generation at power plants  $i = 1, 2$  as a function of discharge  $a_{it}$  and average head  $\bar{h}_{it}(s_{it}, s_{i,t+1})$  over month  $t$ ;  $P_3$  is energy generation at the high-head power plant for the Jun-Ju diversion requirement  $d_{3t}$



**Fig. 10.3.** Time series and box and whisker plots for Daechung Reservoir inflows for performance evaluation data set.

from Yongdam Reservoir;  $sp_{it}$  is spill from reservoir  $i$  during month  $t$ ;  $d_{jt}$  is demand at diversion or instream flow point  $j$ ; and  $a_{j+2,t}$  is the actual flow delivered to the demand. Releases  $a_{1t}$  from Daechung and Yongdam releases  $a_{2t}$  and  $a_{3t}$  constitute the primary decision variables in the formulation. The remaining variables  $a_{j+3,t}$  for  $j = 1, \dots, ND$  representing flows to demands  $j$  are independent decision variables but are directly based on reservoir releases and simulation of the allocation to the various water use sectors based on the aforementioned priority scheme. Constraints on the optimization include mass balance equations for each reservoir, upper and lower bounds on reservoir storage, and simulation of optimal downstream distribution of reservoir releases to multiple demand points, including available return flows.

#### 2.8.4. Inflow and Demand Data Sets

Although the available data covers a 19-year period, only 15 years of monthly data from October 1983 to September 1998 were used for generating stationary optimal operational policies using Q-Learning. The remaining 4 years of data from October 1999 to October 2002 were applied to model verification and policy performance evaluation (Fig. 10.3). Rainfall-runoff simulation models were calibrated by K-water based on the US Army Corps of Engineers SSARR (Streamflow Synthesis and Reservoir Regulation) model [19] for estimating unregulated inflows in each of the subbasins where direct streamflow measurements were missing.

Historical estimated agricultural demands provided by K-water were based on the average of 19 years of data from 1983 to 2002. K-water estimated agricultural water requirements from a consumptive use model, with an assumed 0.35 return flow fraction. Municipal and industrial demands were derived by averaging demands for water years 2001 and 2002 to reflect current conditions in the Geum River basin. Return flows from domestic and industrial water usage were assumed as 65 % of diversion amount. All of these assumptions were incorporated by K-water into calibration of the SSARR model [19]. Instream flow requirements for the subbasins were estimated as the 95 % exceedence percentile of the 19 years of the historical monthly flows for each subbasin.

#### 2.8.5. Application of Q-Learning

For application of Q-Learning, reservoir storage states were discretized into 21 grid points for Yongdam reservoir and 24 grid points for Daechung reservoir, representing 34 MCM increments. Yongdam releases were evenly discretized into 10 MCM increments from 3 to 133 MCM (14 points), whereas Daechung releases were unevenly discretized into 27 points from 17 to 707 million cubic meters per month. Since the water allocation procedure for the deficit sharing policy and priority system for water deliveries in the basin require considerable computational time, it was decided to pre-calculate immediate benefit (reward) over the finite discretized grid points of state and decision spaces. This required substantial computer memory for storage of the large-scale benefit tables but saved considerable computational time in the Q-Learning model by replacing function calculation with simple table lookup.

Figure 10.4 shows convergence of the  $Q$ -function updates relating the absolute deviation between the current update value and the optimal value. Although over 3.5 million episodes were required for convergence for this case study, each update required little CPU time since only a single state transition is calculated at each episode. It can be seen that the discount factor influences the number of episodes required for convergence. Several values of the learning rate parameter  $\alpha$  and rates of its reduction with episode were evaluated, but simply setting  $\alpha = 1$  provided the best convergence behavior for this study.

An example stationary optimal operational rule for Daechung Reservoir for August and a discount factor of 0.95, conditioned on both Daechung and Yongdam storage levels, is shown in Fig. 10.5. The influence of Yongdam Reservoir storage is clearly seen in the release rules for Daechung reservoir. Optimal operational rules developed with different discount factors exhibited similar patterns.

#### 2.8.6. Comparative Evaluation of Optimal Operating Rules

Simulation analysis was used to evaluate and compare the optimal operating policies developed by Q-Learning with implicit stochastic dynamic programming and sampling stochastic dynamic programming (SSDP) [12]. As a variant of stochastic dynamic programming, SSDP which uses streamflow scenarios as ensembles to represent the stochastic inflow processes. Each of these methods is described in detail in Lee and Labadie [11]. The same performance measure used in the optimization models was also applied in the performance simulation.

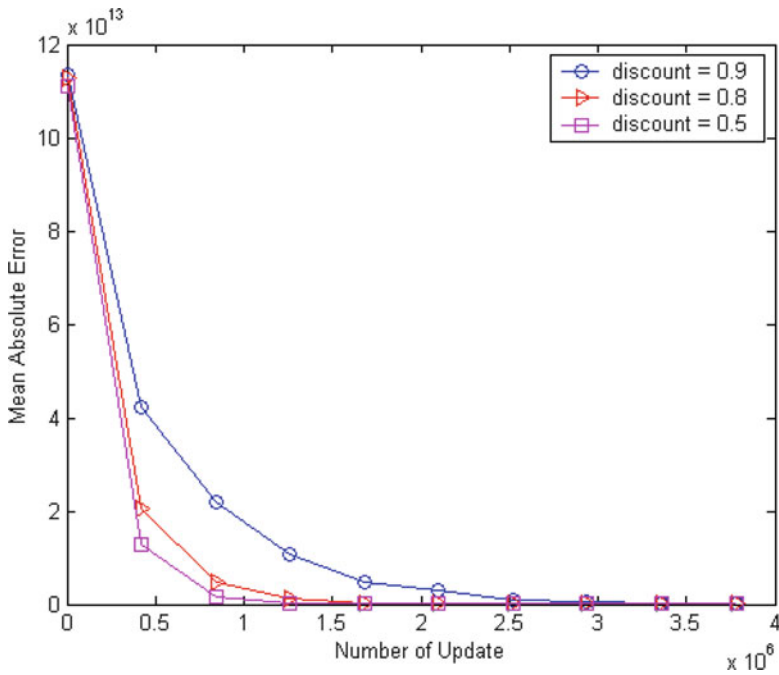


Fig. 10.4. Number of updates of Q-function versus mean absolute error from optimum value.

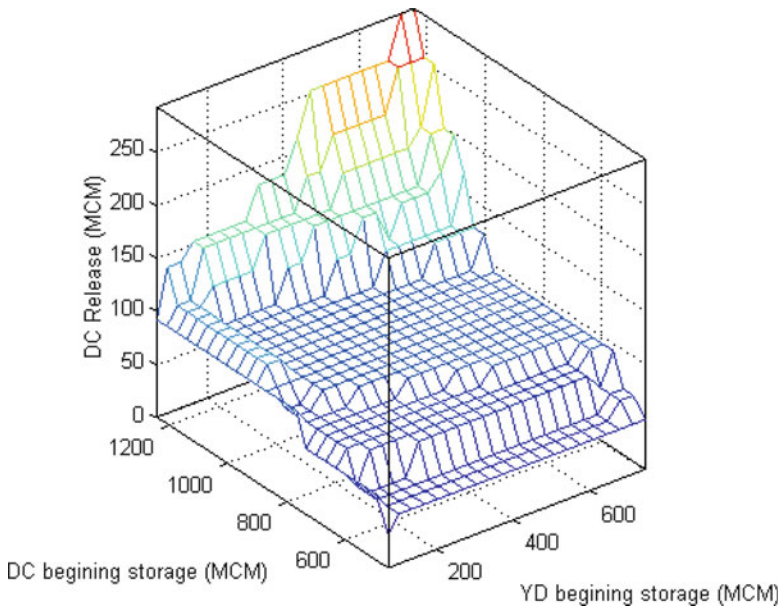
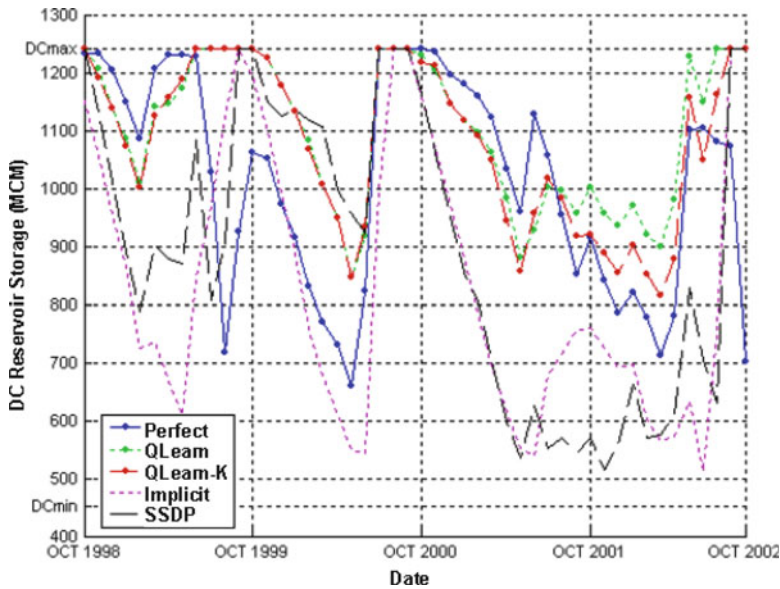


Fig. 10.5. Q-Learning optimal operation rules for Daechung Reservoir (August,  $\gamma = 0.8$ ).



**Fig. 10.6.** Simulated end-of-month storage levels for Daechung Reservoir under alternative operating policies.

The historical streamflow data set for the period October 1998 to September 2002 was used for performance testing and evaluation for all methods, but not included in the development of optimal operating rules for each method. This hydrologic period provides a valid basis for performance analysis since the time series data for Daechung and Yongdam Reservoirs includes average, high-flow, and extensive low-flow conditions. Initial storage conditions for Daechung Reservoir were set to the historical storage levels at the end of September 1998 (1074.8 MCM, representing approximately 80 % of normal full storage). Since Yongdam Reservoir was not yet completed at that time, the initial storage was assumed to be approximately 80 % of normal full storage (606.75 MCM).

The model options selected for evaluation include *Implicit* (implicit stochastic optimization), *SSDP* (sampling stochastic dynamic programming), *Q-Learn* (reinforcement learning using the Q-Learning model), *QLearn-K* (a Q-Learning model described in Lee and Labadie [11] that conditions the Q-function on hydrologic state forecasts based on K-means clustering), and *Perfect* (deterministic dynamic programming under perfect foreknowledge). The latter does not provide useable operating rules, but provides the upper bound on the maximum possible performance for comparison purposes. Alternative discount factors applied to SSDP and Q-Learning ranged from 0.7 to 0.95, but with  $\gamma = 0.95$  providing the best performance.

Reservoir storage results for Daechung Reservoir are shown in Fig. 10.6 under operating rules developed by each of the selected methods. It can be seen that operations under the *Implicit* rules reduce Daechung Reservoir releases in order to recover normal full reservoir storage at the end of the water year, resulting in higher releases during the dry season and lower releases during the flood season. These reduced releases during the flood season likely have little impact on the performance measures due to the abundant flow conditions during the

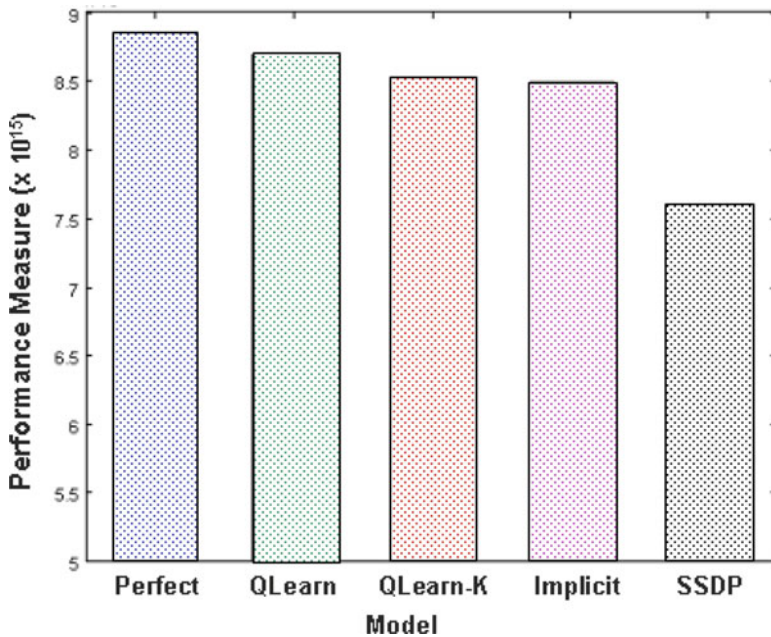


Fig. 10.7. Total performance measure for alternative operating rules.

flood season. More stable operations are evident under *Perfect*, *QLearn*, and *QLearn-K* during the dry seasons. The poor performance of the *SSDP* rules is revealed in Fig. 10.6, as well as with the operational results for Yongdam Reservoir, not shown here. It can be seen that all the models attempt to refill the reservoir by the end of the flood season (September), reflecting the realistic need in reservoir operations to prepare for the dry season. The ending reservoir storage for May by the *Perfect* model is close to minimum storage for Daechung Reservoir, which is only possible if there is perfect foresight of future streamflows.

Figure 10.7 compares the total performance measures, showing that the Q-Learning model (*QLearn*) provides the best overall performance. The Q-Learning model conditioned on hydrologic state (*QLearn-K*) is likely outperformed by *QLearn* since season-to-season inflow correlations in the basin were not statistically significant. It can be seen that *QLearn* and *QLearn-K* provide the most consistent monthly benefits, particularly during low-flow months, whereas *SSDP* exhibits the poorest performance.

### 3. MACHINE LEARNING APPROACH TO REAL-TIME CONTROL OF COMBINED SEWER OVERFLOWS

#### 3.1. Introduction

Combined sewer systems (CSS) for conveying both wet and dry weather flows create serious pollution problems in adjacent receiving waters when intense rainfall events produce discharges exceeding interceptor sewer and treatment plant capacities. Although combined

sewers are no longer constructed, they still exist in many large metropolitan areas. Replacement of combined sewers with separate conveyances for wastewater and stormwater is a possible solution, but sewer separation can actually increase pollution to adjacent water bodies since untreated stormwater discharges alone often carry high BOD loadings, heavy metals from industrial areas, hydrocarbons from automobiles, organic chemicals, and pathogens from plumbing misconnections. According to the AMSA [20], stormwater is often directly discharged into receiving waters in separated systems without requisite treatment. The US federal and state regulations now require assurance that stormwater runoff does not pollute adjacent rivers and streams [21].

Other options for reducing or eliminating combined sewer overflows is the construction of large underground retention basins. Examples such as the Deep Tunnel and Reservoir Project are yet to be completed "...after more than three decades and \$5 billion in public expense..." [22]. San Francisco's shoreline underground storage/transport system for controlling combined sewer overflows has been completed at costs exceeding \$1.5 billion, and yet "...during the storms that rained on the San Francisco Bay Area in January (2010), a total of 630,000 gallons of raw sewage spewed into the bay at 47 spots. Even worse, 170 million gallons of partially treated sewage was discharged from three East Bay Municipal Utility District "wet weather" overflow plants" [23].

The high cost and disruption to residences and businesses of converting to separated systems, or constructing large underground storage/transport facilities, has given impetus to the search for cost-effective methods for controlling combined sewer overflows (CSOs). Real-time regulation of in-sewer storage or off-line retention storage in both stormwater and combined sewer systems through control of gates, pumps, and weirs is an approach to reducing untreated overflows that has been successfully demonstrated in a few cities (e.g., Milwaukee, USA [24]; Quebec, Canada [25]; Saverne, France [26]; and Ense-Bremen, Germany [27]). Unfortunately, potential implementations have not been sustained due to concerns about the robustness and reliability of required computer control equipment, sensor, and communication devices, as well as inadequate software and modeling capabilities. Schutze et al. [28] claim, however, that incentives for consideration of real-time control technology have been renewed by current advances in hardware and software technologies at reasonable cost.

Relative to capital construction, the maximum utilization of spatially distributed in-line storage in a combined sewer system is an inexpensive approach to reducing the polluting effects of untreated stormwater and combined sewer spills to receiving waters [29]. The goal is to provide optimal regulation of control structures in the sewer network such that CSOs are minimized or even eliminated. The proper management over time and space of the aggregate in-sewer storage capacity and available off-line retention storage in a sewer network can help reduce pollution from untreated CSOs to adjacent water bodies. Even if elimination of CSOs is not possible under ideal control strategies, incorporation of real-time control into plans for constructing additional retention/detention storage facilities may reduce sizing requirements and associated costs by making optimum use of available storage.

According to Pleau et al. [25], most current RTC implementations employ local reactive or supervisory control. Although real-time control (RTC) is most effective if integrated over the entire sewer network, the result is a large-scale and complex spatially distributed optimal control problem. The optimization is highly nonlinear, requiring integration with models for accurately simulating stormwater runoff and sewer hydraulics, including fully dynamic unsteady flow modeling in the sewer network. The dynamic optimization is further complicated by the computational stress of repeatedly solving the optimal control problem within 5- to 15-min time intervals as rainfall forecasts and measured levels and flows are updated in real time.

The primary limitations in employing the accurate models necessary for effective real-time control are computational time and complexity. The use of machine learning approaches employing dynamic or recurrent artificial neural networks (ANN) may provide the analysis speed, generalization ability, and high fault tolerance needed for overcoming these limitations. The potential usefulness of dynamic artificial neural networks for real-time control of stormwater and combined sewer systems is explored, with a computationally time-consuming, optimal control model utilized to provide the training data set for a recurrent ANN under a wide range of sewer inflow conditions. Off-line performance evaluation of the trained ANN is compared with the optimal control module using a test data set not included in the ANN training. The neural-control algorithm is applied by Darsono and Labadie [30] to real-time control of the combined sewer system of the King County Wastewater Treatment Division, Washington, USA as a case study to demonstrate its viability.

### 3.2. Optimal Control Module

#### 3.2.1. Formulation

Reducing the occurrence and magnitude of stormwater and combined sewer overflows (CSOs), and thereby reducing pollution impacts on receiving waters, is the primary goal of the real-time control system. The primary objectives are to minimize overflows while maximizing through-flows to the wastewater treatment plant for a storm event occurring over  $T$  time intervals:

$$\underset{\mathbf{u}, \mathbf{x}}{\text{minimize}} \sum_{t=1}^T \sum_{i=m+n+1}^{2m+n} c_{it} u_{it}^2 + \sum_{i=1}^m w_i s_{i,T+1}^2 \tag{10.17}$$

subject to:

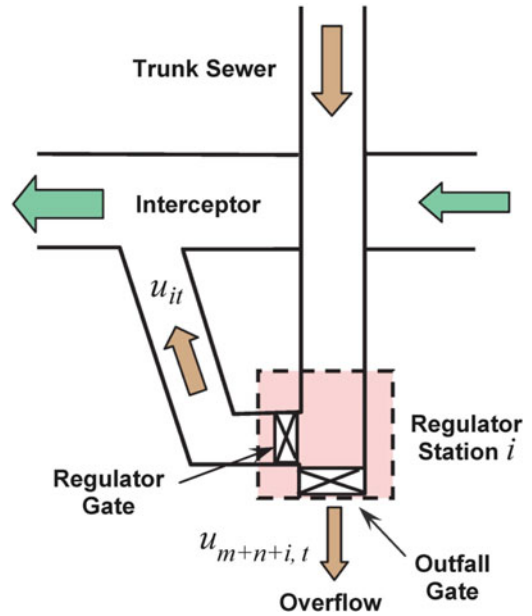
$$s_{t+1} = s_t + \left( 0.5 \left( \mathbf{B}_t^{(k)} \mathbf{u}_t + \mathbf{B}_{t-1}^{(k)} \mathbf{u}_{t-1} \right) + \mathbf{r}_t \right) \cdot \text{conv} \tag{10.18}$$

$$\mathbf{0} \leq s_{t+1} \leq \mathbf{s}_{\max} \left( \mathbf{q}^{(k)}, \mathbf{h}^{(k)} \right) \tag{10.19}$$

$$\mathbf{0} \leq \mathbf{u}_t \leq \mathbf{u}_{\max} \left( \mathbf{q}^{(k)}, \mathbf{h}^{(k)} \right) \tag{10.20}$$



**Fig. 10.8.** Typical regulator station with both regulator gate and outfall gate.



where  $\mathbf{u}_t = (u_{1t}, \dots, u_{mt}, u_{m+1,t}, \dots, u_{m+n,t}, u_{m+n+1,t}, \dots, u_{2m+n})^T$  is the vector of node discharge rates ( $\text{m}^3/\text{s}$ ) at the end of time interval  $t$  throughout the sewer network (initial release rates  $\mathbf{u}_0$  are assumed to be given), with  $m$  representing the number of control structures such as regulators, pump stations, weirs, and orifices in the system. It is assumed that state vector components  $(s_{1t}, \dots, s_{mt})$  represent temporary storage accumulated behind these structures located in the interceptor and lateral or trunk sewers ( $\text{m}^3$ ).

The interceptor sewer is divided into  $n$  sections corresponding to the location of each regulator controlling discharges from a lateral sewer. The portion of the state vector  $(s_{m+1,t}, \dots, s_{m+n,t})$  is zero-storage nodes within the interceptor sewer for the convenience of flow routing calculations. Control vector components  $(u_{1t}, \dots, u_{mt})$  are controlled discharges from each regulator or pump station into the interceptor sewer or downstream trunk sewer; the portion  $(u_{m+1,t}, \dots, u_{m+n,t})$  are flows at each section of the interceptor sewer; and  $(u_{m+n+1,t}, \dots, u_{2m+n,t})$  represents untreated overflows from the system at regulator stations and other control structures. A typical configuration for a regulator station is shown in Fig. 10.8.

The current estimates at iteration  $k$  of routing coefficients calculated from a fully dynamic sewer hydraulics model are incorporated into routing matrices  $\mathbf{B}_t^{(k)}$  in (10.18). Sewer discharges  $\mathbf{q}^{(k)}$  and heads  $\mathbf{h}^{(k)}$ , respectively, over each sewer section  $i$  and discrete time interval  $t$  are also simulated by the hydraulic model. Temporary storage capacities  $s_{\max}(\mathbf{q}^{(k)}, \mathbf{h}^{(k)})$  and node discharge  $\mathbf{u}_{\max}(\mathbf{q}^{(k)}, \mathbf{h}^{(k)})$  are dynamic functions of  $\mathbf{q}^{(k)}, \mathbf{h}^{(k)}$  due to dependence on hydraulic flows and heads throughout the sewer network. These iteratively adjusted restrictions on temporary in-line storage and discharges prevent the occurrence of upstream surcharge conditions in the lateral or trunk sewers sufficient to produce street flooding.

The objective function of (10.17) minimizes total weighted overflows (squared) from the CSS, where the weighting coefficients  $c_{it}$  can vary both spatially and temporally.

These coefficients allow consideration of receiving water impacts being more sensitive to overflows at certain locations than others, as well as temporal influences such as tidal conditions. In this formulation, the untreated spills are *squared* in the objective function, which has a *smoothing* effect on the solution, thereby avoiding oscillations and surges in the sewer system. This also ameliorates the impacts of the so-called *first-flush* shock on aquatic biota of untreated spills that has been observed in overflow-producing storm events due to the flushing out of catch basin litter accumulations with high BOD loadings [31].

Residual storage of stormwater and combined sewer flows in the sewer system at the end of the storm is minimized through inclusion of the final term in the objective function  $\sum_{i=1}^m w_i s_{i,T+1}^2$ , which also indirectly maximizes through-flow to the wastewater treatment plant. Weighting factors  $w_i$  act to trade-off this objective with the primary objective of minimizing untreated spills. If forecasts indicate that a storm event may be immediately followed by another, it may be necessary to increase this weighting factor to provide sufficient capacity for the imminent event.

Equation (10.18) maintains mass balance in each sewer reach, where  $\mathbf{r}_t$  are spatially distributed stormwater inflows to the CSS as predicted from an urban stormwater runoff model such as the RUNOFF module of the US EPA SWMM model [32]. As the storm event progresses and new rainfall forecasts are generated, these predictions are assumed to be updated in real time. Discharges  $\mathbf{u}_t$  are instantaneous flow rates, requiring averaging over the time interval and multiplication by conversion factor *conv* for conversion to storage units per time interval.

### 3.2.2. Discrete Time Optimal Control Algorithm (OPTCON)

The augmented Lagrangian algorithm, also called the method of multipliers [33], is applied to solving the nonlinear, dynamic optimal control problem of (10.17)–(10.20) over discrete time steps based on Pontryagin’s maximum principle. The Lagrangian function  $L(\mathbf{x}, \mathbf{u}, \boldsymbol{\lambda})$  is formed by adding the state dynamics (10.18) to the objective function using Lagrange multipliers  $\boldsymbol{\lambda}$  and then *augmenting* the Lagrangian function with penalty terms on the state-space constraints, or the constraints on the state variables (10.19), using estimated penalty weights  $p_1$  and  $p_2$ :

$$\begin{aligned}
 & \underset{\mathbf{0} \leq \mathbf{u}_t \leq \mathbf{u}_{\max}(\mathbf{q}^{(k)}, \mathbf{h}^{(k)}), \mathbf{s}, \boldsymbol{\lambda}}{\text{minimize}} && L(\mathbf{s}, \mathbf{u}, \boldsymbol{\lambda}) \\
 & = \sum_{t=1}^T \sum_{i=m+n}^{2m+n} c_{it} u_{it}^2 + \sum_{i=1}^m w_i s_{i,T+1}^2 \\
 & + \sum_{t=1}^T \boldsymbol{\lambda}_t^T \cdot \left( \mathbf{s}_t - \mathbf{s}_{t+1} + \left( 0.5 \left( \mathbf{B}_t^{(k)} \mathbf{u}_t + \mathbf{B}_{t-1}^{(k)} \mathbf{u}_{t-1} \right) + \mathbf{r}_t \right) \cdot \text{conv} \right) \\
 & + \sum_{t=1}^T p_1 \cdot \left[ \sum_{i=1}^m s_{i,t+1}^2 \text{ IF } s_{i,t+1} < 0 \right] \\
 & + \sum_{t=1}^T p_2 \cdot \left[ \sum_{i=1}^m \left( s_{i,t+1} - s_{i,\max}(\mathbf{q}^{(k)}, \mathbf{h}^{(k)}) \right)^2 \text{ IF } s_{i,t+1} > s_{i,\max}(\mathbf{q}^{(k)}, \mathbf{h}^{(k)}) \right]
 \end{aligned} \tag{10.21}$$

The steps in the OPTCON augmented Lagrangian algorithm are described as follows:

1. Given the initial system state  $\mathbf{s}_0$ , start with initial guesses  $\mathbf{u}_t^{(0)}$  for the control variables; set iteration counter  $\ell = 0$ .
2. Using current controls  $\mathbf{u}_t^{(\ell)}$ , solve the system state dynamics (10.18) *forward* in time to calculate states  $\mathbf{s}_{t+1}^{(\ell)}$ .
3. Evaluate the adjoint equations based on the stationarity conditions,  $\partial L / \partial s_{i,t+1} = 0$ , and solve them *backwards* over time for the Lagrange multipliers  $\lambda_t^{(\ell)}$ .
4. If  $\|\nabla_{\mathbf{u}} L\| < \varepsilon$  for some given tolerance  $\varepsilon$ , STOP! Optimum found. Otherwise, apply efficient conjugate gradient or quasi-Newton search procedure for determining improved controls  $\mathbf{u}_t^{(\ell+1)}$  based on the current gradient estimate  $\nabla_{\mathbf{u}} L$ ;  $\ell \leftarrow \ell + 1$  GO TO Step 1.

### 3.2.3. Solution of the Saint Venant Equations (UNSTDY)

The fully dynamic unsteady flow module UNSTDY is applied to one-dimensional hydraulic routing in a stormwater or combined sewer network, including flows through junctions and control structures [34]. A fully implicit numerical scheme is applied to solving the Saint Venant equations of conservation of mass and momentum in UNSTDY:

$$\frac{\partial A}{\partial t} + \frac{\partial q}{\partial x} = q_\ell \quad (10.22)$$

$$\frac{\partial(\rho q)}{\partial t} + \frac{\partial(\rho q V)}{\partial x} + \rho g A \frac{\partial h}{\partial x} + \rho g A (S_0 - S_f) = 0 \quad (10.23)$$

where for each sewer section,  $A$  is flow cross-sectional area,  $q$  is discharge,  $h$  is depth of flow,  $V$  is mean velocity,  $q_\ell$  is lateral flow per unit length of the sewer section,  $x$  is longitudinal distance,  $t$  is time,  $S_0$  is bed slope,  $S_f$  friction slope,  $\rho$  is fluid mass density, and  $g$  is gravitational acceleration.

The fully implicit finite difference numerical scheme used in UNSTDY is unconditionally stable up to the Courant condition for temporal discretization. Calculation of transitions between subcritical and supercritical flow conditions is included in UNSTDY, with the kinematic wave equations applied to supercritical flow routing. Evaluation of unsteady flow in a storm sewer network under submerged conditions is based on the hypothetical Preissmann slot for attaining higher pressurized flow wave celerity. This allows the same set of unsteady flow equations to be applied to surcharge flow conditions, where the width of the slot in UNSTDY is assumed to be 0.1 % of the maximum width of a conduit under surcharge conditions. Stormwater inflow predictions from the RUNOFF module of the US EPA SWMM model [32] define the upstream boundary conditions, whereas discharge hydrographs, stage hydrographs, stage-discharge rating curves, or storage basins can be applied to the downstream boundary conditions.

Branched sewer networks can be modeled in UNSTDY, allowing up to three inflow branches and one outflow pipe in a dendritic structure. The hydraulic equations for sewer flows through confluence junctions are modeled using the continuity and energy equations

(10.22) and (10.23), respectively. UNSTDY allows specification of internal boundary conditions for inclusion of weirs, sluice gates, radial gates, siphons, in-line and side orifices, wet-well and dynamic head pump stations, and storage facilities for simulating real-time control of flow regulation facilities.

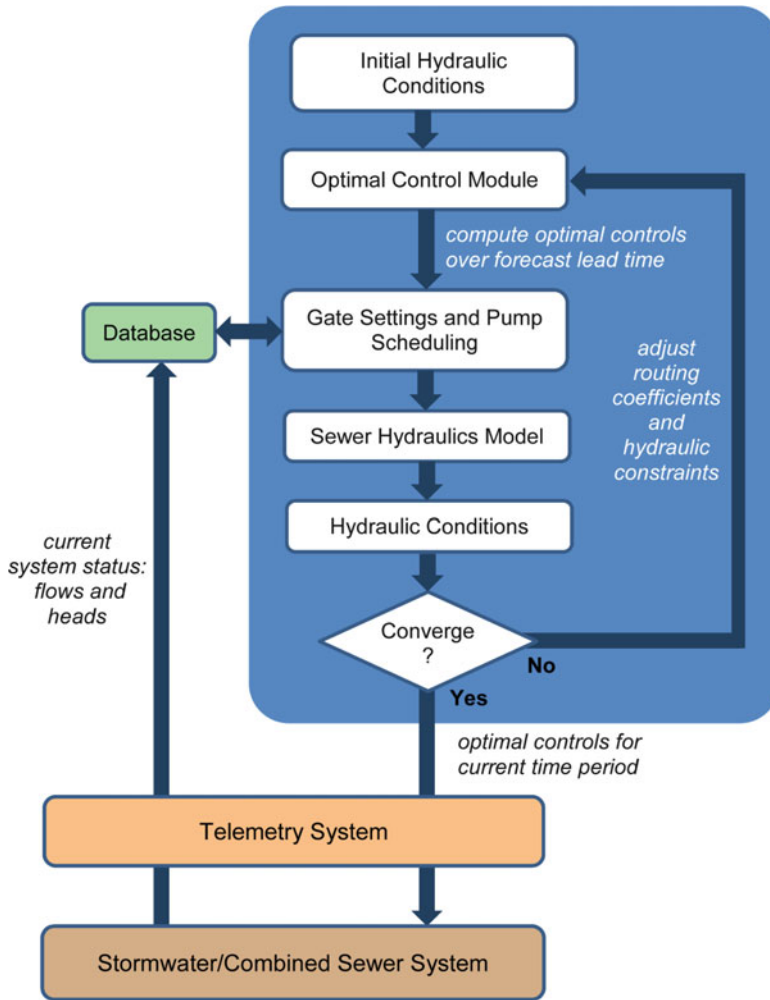
### 3.2.4. Iterative Calculation of Hydraulic Sewer Flows

The  $(m + n) \times (2m + n)$  routing matrices  $\mathbf{B}_t^{(k)}$  in (10.18) serve to account for attenuation and lagging of upstream releases to downstream nodes and system spills. Superscript  $(k)$  is an iteration index indicating that elements of  $\mathbf{B}_t^{(k)}$  are updated through successive solution of UNSTDY throughout the sewer network. Unver and Mays show that it is possible to directly incorporate numerical approximations of the linearized Saint Venant equations as constraints in a large-scale quadratic programming problem for application to an entire sewer network over a dynamic time horizon. Unfortunately, this approach requires linearization of important nonlinear terms in the full Saint Venant equations, thereby preventing accurate simulation of complex sewer hydraulic conditions such as transitions between supercritical and subcritical flow regimes.

An iterative approach originally proposed by Labadie [29] involves successive solution of the optimal control model OPTCON and the hydraulic sewer routing model UNSTDY (Fig. 10.9). OPTCON is first executed with current approximations of the routing coefficients (i.e., elements of matrix  $\mathbf{B}_t^{(k)}$ ), as well as initial estimates of bounds on temporary storage and discharge (i.e., (10.19) and (10.20)). Optimal node discharge control solutions  $\mathbf{u}_t^*$  are then converted into gate or pump settings, which are then simulated using the UNSTDY hydraulic model. Based on these results, coefficients  $\{b_{ij}\}_t^{(k+1)} = \frac{u_{jt}^{(k+1)}}{u_{it}^{(k+1)}}$  used in the optimal control model are updated, as shown in Fig. 10.10, where  $u_{it}^{(k+1)}$  are the simulated flows from the dynamic hydraulic routing model under the current optimal gate or pump settings. For any iteration  $k$ , the routing matrix elements  $\{b_{ij}\}_t^{(k)}$  are positive if node  $i$  receives outflow from node  $j$ , or 0 if the two nodes are unconnected. For spills and downstream releases from node  $i$ ,  $\{b_{ij}\}_t^{(k)} = 1$ .

Along with routing coefficients, limits on sewer reach storage  $\mathbf{s}_{\max}(\mathbf{q}^{(k+1)}, \mathbf{h}^{(k+1)})$  and discharge limits  $\mathbf{u}_{\max}(\mathbf{q}^{(k+1)}, \mathbf{h}^{(k+1)})$  are updated from the hydraulic sewer simulation model in the next iteration to assure hydraulic feasibility of solutions from the optimal control model.

Interactive simulation using the complete Saint Venant equations allows bounds on flows through gates and regulators to be adjusted based on levels calculated by the hydraulic simulation model that guarantee sufficient head for downstream releases. It is assumed that the iterative process has converged when successive calculations of routing coefficients agree to a desired error tolerance. The convergent routing coefficients in (10.18) represent solution of the complete Saint Venant equations without having to directly incorporate them into the optimization model.

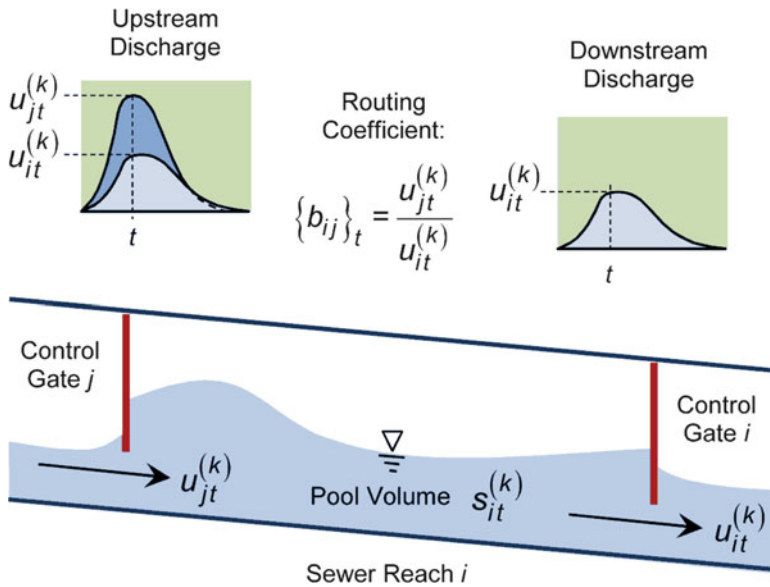


**Fig. 10.9.** Flowchart of successive, iterative solution of optimal control model OPTCON and hydraulic sewer model UNSTDY.

### 3.3. Neural Network Module

#### 3.3.1. Machine Learning of Optimal Regulator Control

In spite of the computational efficiency of indirect incorporation of the Saint Venant equations in the optimal control module through iterative calculation of routing coefficients, clock time limitations for real-time implementation may be exceeded due to required RUNOFF model calculations and multiple executions of UNSTDY at each control time step for large-scale stormwater or combined sewer networks. Several studies have shown that artificial neural networks (ANN) are an effective tool for controlling complex, nonlinear



**Fig. 10.10.** Calculation of routing coefficients used in optimal control model from flows simulated by numerical hydraulic model.

systems [36]. The goal is to employ a machine learning approach whereby an ANN is applied to learning how the optimal control module makes correct decisions in a real-time environment, but without perfect foreknowledge of stormwater inflows produced by the ongoing storm event.

Although the optimal control module with incorporation of the RUNOFF and UNSTDY simulation models may be limited by the need for calculations to be completed within the desired real-time increments for adjustment of control settings, off-line calculations of OPTCON for a wide range of historical storm events are under no such limitation. This allows off-line OPTCON calculations to be performed with complete foreknowledge of future inflows, thereby determining optimal strategies under a wide variety of inflow conditions. Attempting to directly solve OPTCON in real time would require successive runs using error-prone forecasts of future inflows, whereas a machine learning approach is applied here whereby the ANN is trained using rainfall input and OPTCON-based optimal control output exemplars. The trained and tested ANN neural-optimal control model can be efficiently implemented in real time as a replacement of OPTCON, hypothesizing that forecast information may not be required if the ANN is able to detect changing storm patterns as types of events included in the training, and adapt accordingly.

### 3.3.2. Jordan Recurrent ANN Architecture

Adaptive control of combined sewer systems in real time requires a recurrent ANN to model dynamic operational trajectories. Since the main purpose of the dynamic neural-control module is to compute optimal real-time gate controls based on current and previous rainfall

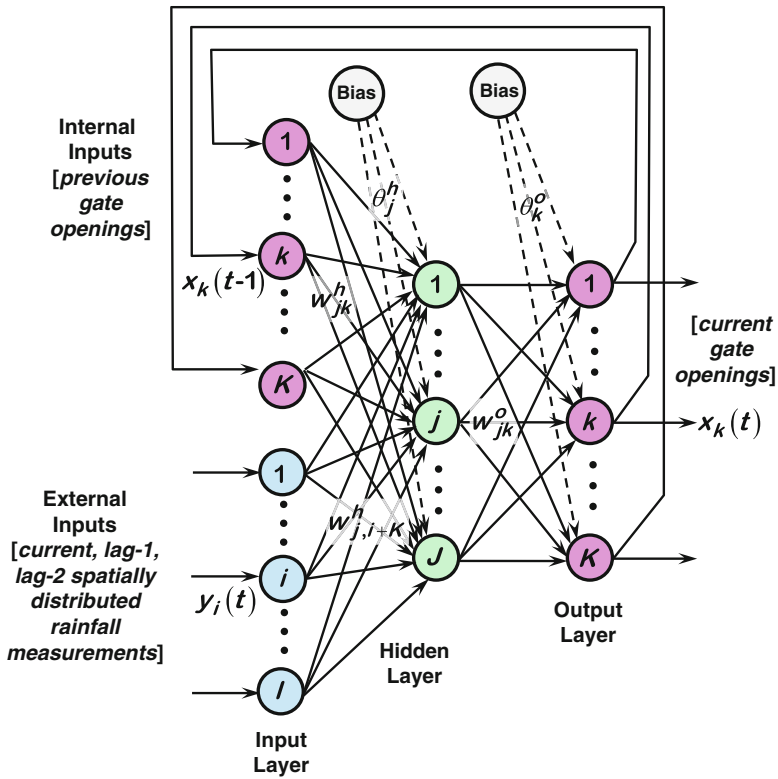


Fig. 10.11. Schematic of Jordan Architecture recurrent artificial neural network.

data and previous gate control decisions, the Jordan Architecture is selected as the desired structure (Fig. 10.11):

$$v_j^h(t) = \sum_{i=1}^I w_{j,i+K}^h y_i(t) + \sum_{k=1}^K w_{jk}^h x_k(t-1) + \theta_j^h \quad (10.24)$$

$$z_j(t) = h_j(v_j^h(t)); \quad j = 1, \dots, J \quad (10.25)$$

$$v_k^o(t) = \sum_{j=1}^J w_{kj}^o z_j(t) + \theta_k^o \quad (10.26)$$

$$x_k(t) = o_k(v_k^o(t)); \quad k = 1, \dots, K \quad (10.27)$$

where  $I$  is the total number of external inputs applied to neurons in the input layer;  $K$  is the total number of internal inputs originating from neurons of the output layer and applied to

$K$  neurons in the input layer in the next time step;  $J$  is the total number of neurons in the hidden layer;  $w_{ji}^h$  is the synaptic weight of connection of neuron  $i$  in the input layer to neuron  $j$  in the hidden layer;  $w_{kj}^o$  is the synaptic weight of connection of neuron  $j$  in the hidden layer to neuron  $k$  in the output layer;  $y_i(t)$  is the external input signal entering neuron  $i$  in the input layer at time  $t$ ;  $x_k(t)$  is the output from neuron  $k$  in the output layer, serving as internal input to the input layer in the next time step;  $\theta_j^h$  is the threshold or bias unit applied to neuron  $j$  in the hidden layer;  $\theta_k^o$  is the threshold or bias unit applied to neuron  $k$  in the output layer;  $v_j^h(t)$  is the net internal activity level of neuron  $j$  in the hidden layer;  $v_k^o(t)$  is the net internal activity level of neuron  $k$  in the output layer;  $z_j(t)$  is the output from neuron  $j$  in the hidden layer produced from operation of activation function  $h_j(v_j^h(t))$  on net internal activity  $v_j^h(t)$  for neuron  $j$ ; and  $o_k(v_k^o(t))$  is the activation function operating on net internal activity  $v_k^o(t)$  for neuron  $k$  in the output layer.

The *logistic* function is the commonly used activation function for multilayer perceptrons that guarantees output in the range  $0 \leq y_j(t) \leq 1$  [37]:

$$z_j(t) = h_j\left(v_j^h(t)\right) = \frac{1}{1 + e^{-v_j^h(t)}} \quad (10.28)$$

$$x_k(t) = o_k\left(v_k^o(t)\right) = \frac{1}{1 + e^{-v_k^o(t)}} \quad (10.29)$$

Recognizing the likely correlation of successive rainfall inputs over time and space, internal inputs to the recurrent ANN are current, lag-1, and lag-2 spatially distributed rainfall data. Gate opening controls from the previous time period serve as internal inputs to the ANN in order to facilitate smooth, dynamic operation of gates in the system. Since current period gate openings are the output of the ANN, the number of output neurons is the same as the number of gate controls in the system.

### 3.3.3. Training and Testing of Recurrent ANN

A supervised learning process is applied to determining the optimal connection weights  $w_{ji}^h$ ,  $w_{kj}^o$  and bias weights  $\theta_j^h$ ,  $\theta_k^o$  from the input–output training data set. The input data are rain gauge measurements for various historical storm events, and the output data set are the optimal gate controls calculated off-line by the optimal control module. The standard generalized delta rule [38] is applied to training the Jordan recurrent ANN, involving feed-forward and error back-propagation calculations. Standard normal transformations of the input–output training set data are applied since the activation function in the neural network can only produce outputs in the range between 0 and 1. Following training, actual gate control settings are then obtained by inverse transformation of neuron output values from neurons in the output layer. Initialization of the weighting matrices is carried out using random number generation, and the standard back-propagation, gradient-type optimization procedure is applied to adjusting the connection weights until the sum-of-squares error deviation between ANN outputs and training set outputs is minimized [37].



Optimal values of the learning parameter and momentum constant that are based on experimental procedures are applied to determining learning rate and momentum parameters that maximize convergence efficiency of the training algorithm. Training of recurrent neural networks is often plagued by slow convergence to local minima and must be conducted with great care [39]. An experimental procedure to evaluate the minimum square error (MSE) for determining the optimum number of neurons in the hidden layer is embedded in the learning process. Validating the recurrent ANN involves testing the performance using input and output data sets not included in the training data sets.

### **3.4. Case Study: West Point Combined Sewer System, Seattle, Washington, USA**

#### *3.4.1. Description of Case Study*

The capabilities of the neural-optimal control algorithm are demonstrated through application to the West Point Treatment Plant collection system of the King County Wastewater Treatment Division, Seattle, Washington, USA. The service area of the West Point Treatment Plant that is included in this study covers an area of over 26,000 ha with 160 km of gravity sewers with diameters up to 3.66 m, 11 pumping stations, and 17 regulator stations. Figure 10.12 shows the extent of the West Point combined sewer system as modeled in this study, but it should be noted that this configuration does not reflect recent expansions, upgrades, and improvements to the King County wastewater system designed to substantially reduce the volume and frequency of combined sewer overflows [40]. Although not up-to-date, this configuration was deemed acceptable for demonstrating the viability of the neural-optimal control algorithm. However, the recent expansion of the West Point Treatment plant capacity to handle wet weather peak flow rates up to 19.3 m<sup>3</sup>/s was included.

Metro Seattle, which merged with King County as a single agency in 1994, originally developed the CATAD (Computer Augmented Treatment and Disposal) system in the early 1970s, one of the first attempts to implement a supervisory control and data acquisition (SCADA) system for real-time regulation of in-line storage in a combined sewer system. With the main control center located at the West Point Treatment Plant, CATAD is designed to monitor and control pump and regulator stations, including telemetry of real-time data on water levels, gate positions, tide levels, and pump speed data [40]. Recent attempts have been made to upgrade CATAD to monitor rainfall and flow conditions in the major trunk sewers and interceptors for model prediction of sewer inflows and optimal control of selected regulator station gates in real time. Unfortunately, problems at the Interbay Pump Station and computer hardware limitations have prevented the use of the predictive control components in CATAD.

#### *3.4.2. RUNOFF Model Calibration and Validation*

RUNOFF model calibration was conducted by the staff of the King County Department of Natural Resources, Wastewater Treatment Division (formerly Metro Seattle). The West Point service area was portioned into 400 drainage subbasins, with average slope, overland flow lengths, roughness coefficients, percent imperviousness, and infiltration parameters evaluated



Fig. 10.12. Combined sewer collection system of the West Point Treatment Plant, King County Wastewater Treatment Division, Washington, USA.

in the calibration. Further validation studies comparing simulated inlet hydrographs with measured flows were based on storm events not included in the calibration. For the stormwater modeling, 10-min rainfall data were collected within the Seattle City limits at 17 locations, along with measurements at the National Weather Service station at Sea-Tac Airport and Sand Point in North Seattle. Flow data for model calibration were measured at more than 60 locations throughout the West Point service area using transportable flow meters.

### 3.4.3. UNSTDY Hydraulic Model Development

Storm water hydrographs generated from the RUNOFF model are routed into 22 inlet locations serving as upstream boundary conditions and lateral inflows to the combined sewer network (Fig. 10.12). UNSTDY modeling of the sewer network is restricted to only those portions with 1.22 m diameter pipe sizes and higher, with kinematic wave approximations applied to the smaller pipe sections. The sewer network was divided into 260 sections for numerical modeling with UNSTDY, with distances between sections ranging from 18.3 m to 91.4 m based on desired numerical accuracy, changes in slope or existence of a weir or other control structure. The hydraulic model was provided with pipe and gate sizes, slopes, roughness coefficients, and junction data, along with rating tables for downstream boundary conditions based on the normal flow approximation. Inlet stormwater hydrographs are routed through the sewer network, with dry weather flows provided as initial flow conditions. Optimal regulator station releases calculated by OPTCON are specified as interior boundary conditions in UNSTDY, with the required gate openings then calculated that produce those flows.

### 3.4.4. Optimal Control Module

Figure 10.13 shows the layout of regulator stations along Elliott Bay for simulated real-time control, with other uncontrollable regulator stations throughout the Seattle region modeled in UNSTDY as fixed weirs. Although the optimal control module is confined to optimization of the regulator stations along the Elliott Bay Interceptor, the UNSTDY hydraulic model calculates flows from the Duwamish pump station into the Elliott Bay Interceptor, as well as flows from the North Interceptor into the West Point Treatment Plant. These hydraulic calculations allow specification of treatment capacity available for flows in the Elliott Bay Interceptor.

For purposes of the modeling, storage variables in the interceptor sewer are defined as zero-storage dummy variables, which are necessary for the state-space formulation of the optimal control problem, in spite of the fact that there are no gates or other control structures within the interceptor since flows in the interceptor are indirectly controlled by regulator station gates. Weighting factors  $c_{it}$  in the objective function (10.17) were uniformly set to 125, with the penalty on final storage  $w_i$  set an order of magnitude smaller at 12.5. These weights are easily modified for prioritization of overflows as to location and time of day, such as for considering tidal influences on polluting impacts of combined sewer overflows.

Eleven diverse, spatially distributed storm events over the study area were defined based on 10-min rain gauge data from National Weather Service stations in the Seattle area. Rainfall data in 10-min time increments were obtained from National Weather Service stations in the area, Sea-Tac airport south of the study area, and Sand Point located north of the study area. The City of Seattle maintains other rain gauges in the Seattle area, but the NWS gauges provided the most complete data set at the desired time increment of 10 min. The first 10 events were utilized as training data sets for the neural-optimal control model, with Storm #11 reserved for testing and validation purposes. Figure 10.14 shows the inflow hydrographs for Storm #11 for the study area corresponding to the controllable regulators along the Elliott Bay

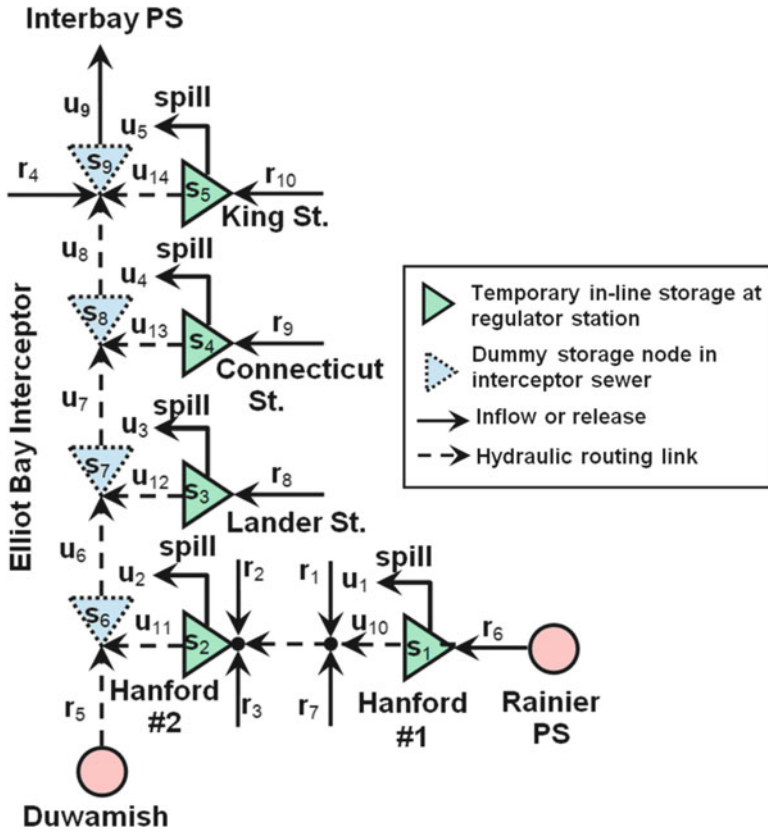


Fig. 10.13. Schematic of the Elliott Bay portion of the West Point Collection System modeled in OPTCON.

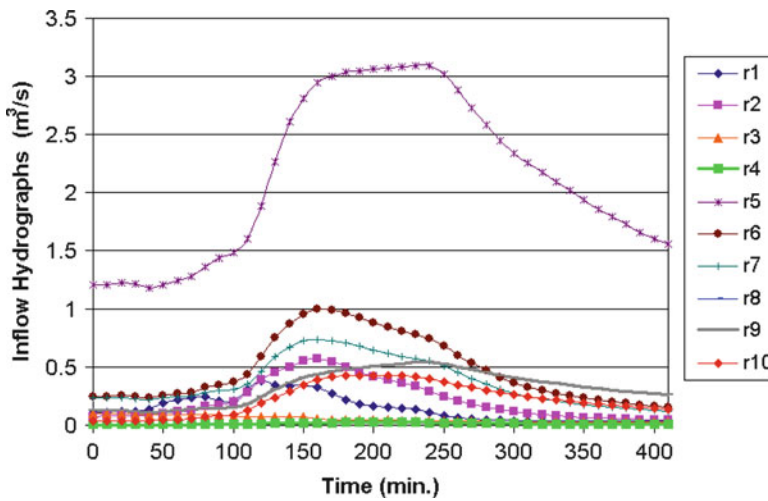
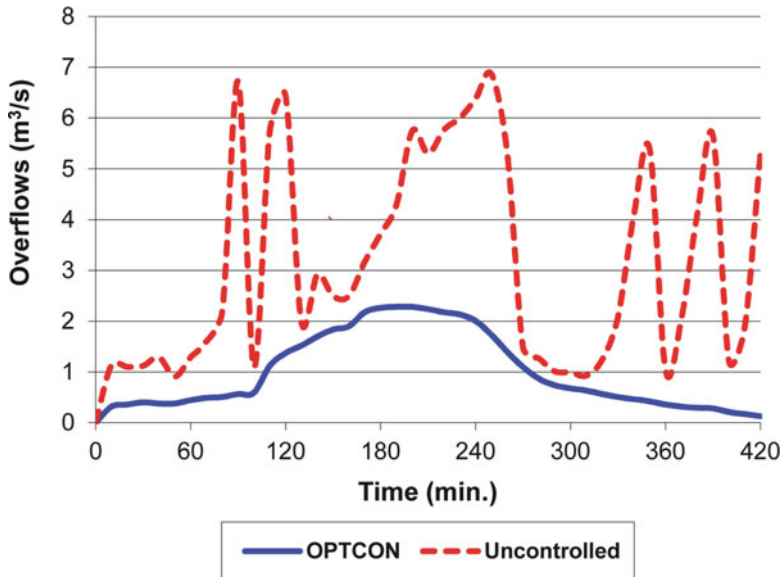


Fig. 10.14. Inflow hydrographs to the study area for Storm #11.



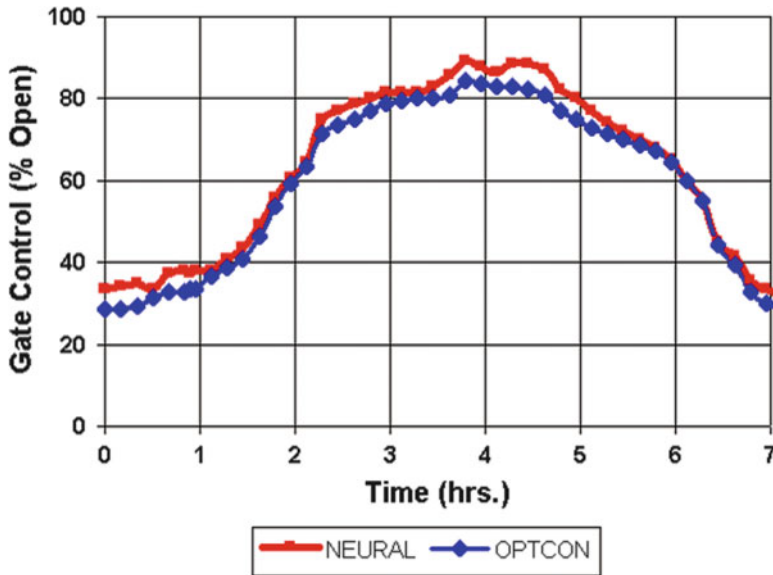
**Fig. 10.15.** Comparison of total overflows from OPTCON solution versus uncontrolled operation for Storm #11.

Interceptor, as depicted in Fig. 10.13. The RUNOFF model was applied to calculating stormwater inflows in the Southern Service Area, which were then routed using UNSTDY to the Duwamish Pump Station to provide inflows  $r_5$  entering the Elliott Bay Interceptor.

OPTCON was applied to computing optimal gate controls for each of the 11 storm events in 10-min time increments. In Fig. 10.15, application of OPTCON in reducing combined sewer overflows under fully integrated dynamic optimal control for Storm #11 is contrasted with the standard uncontrolled solution where diversions from the trunk sewers are allowed to enter the interceptor sewer until surcharging occurs at that location, resulting in spills or overflows at that regulator station. The magnitude of Storm #11 results in overflows in spite of the application of the optimal control strategy, but with substantially reduced total overflows and peak discharge rates. Although the viability of optimal use of in-line storage in the combined sewer system is clearly demonstrated, these controls are based on perfect foreknowledge of the storm event and therefore cannot be implemented for actual real-time control. OPTCON solutions for Storms 1–10 are utilized as training data sets for the recurrent neural network and then validated using results from Storm #11. This allows the demonstration of optimal real-time control without the presumption of perfect foreknowledge of the storm event.

### 3.4.5. Training the Recurrent ANN with Optimal Gate Controls

The optimal gate controls for the training data set comprising Storms 1–10 are calculated using the optimal control module, which then serve as desired outputs in the learning step of the recurrent ANN. Ten-minute rainfall hyetographs provide the external inputs to the



**Fig. 10.16.** Comparison of gate operations under neural control and OPTCON at Connecticut Street regulator station.

module, with gate control outputs as feedback from the previous time step comprising the internal inputs. Back-propagation is applied to optimal estimation of the synaptic weights  $w_{ji}^h$ ,  $w_{kj}^o$  and bias units  $\theta_j^h$ ,  $\theta_k^o$ . The gradient algorithm requires specification of learning parameter  $\eta$  and momentum constant  $\alpha$  which govern the convergence rate and stability of the learning process. Numerous experiments with these parameters resulted in specification of the optimal parameters  $\eta = 0.10$  and  $\alpha = 0.30$  as providing the minimum root mean square error (RMSE) in the learning process and requiring 100 epochs or iterations.

Although only used as an approximation of the hidden layer size, Masters [41] recommends the number of hidden neurons  $= \sqrt{mn}$  for networks with a single hidden layer, where  $n$  is the number of input neurons and  $m$  the number of output neurons. For this study, the optimal number of neurons in the hidden layer was determined from an experimental approach, with results indicating that 60 neurons gave the minimum value of RMSE.

#### 3.4.6. Testing the Neural-Optimal Control Model

Data sets for testing and validating the trained ANN should differ from training data sets. Since Storm #11 was excluded from the training data sets, it is selected for use in testing and validation. Figure 10.16 compares the gate controls produced by the neural-control model with OPTCON under perfect foreknowledge for the regulator gate at the Connecticut Street station for Storm #11. The neural-control model does not benefit from perfect foreknowledge, but rather generates decisions based only on current measured rainfall, past rainfall, and previous gate controls as inputs, and yet the gate controls are quite close to those produced by OPTCON.

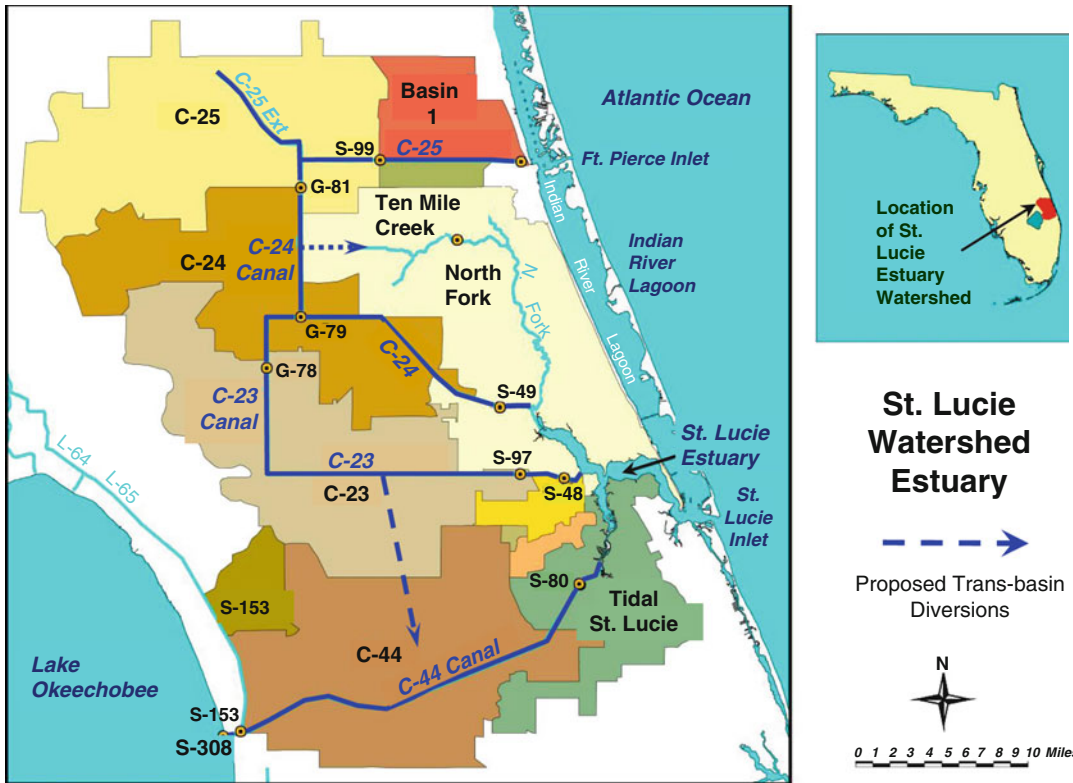
Similar results are found in comparing the neural-control and OPTCON gate controls for the other regulator stations in the study area. The neural-control model clearly displays a learning capability that adapts to the ongoing storm event as rainfall data are being collected. Although the event used for testing differs from all the storms used for training of the ANN, *portions* of this event are similar to *portions* of the events used in the training, indicating that the neural-control model exhibits a pattern-recognition capability that detects and exploits these similarities.

Total direct overflows from the combined sewer system as hydraulically simulated using gate controls from the neural-control model were 27, 224 m<sup>3</sup> vs. 25, 390 m<sup>3</sup> for the controls produced by OPTCON under perfect foreknowledge. This represents only a 7 % increase in total overflows using the neural-control algorithm without the benefit of perfect foreknowledge. Also, the neural-control gate operations exhibit a smoothness and stability that belies the high variability of the rainfall inputs. It was originally hypothesized that providing direct rainfall measurements as inputs to the ANN would be unsuccessful since rainfall data can be noisy and sporadic. If this were the case, it would have been necessary to preprocess the rainfall data through the RUNOFF model and provide the resulting sewer inflow predictions as input data sets for training the ANN. In fact, it is clear that rainfall data can indeed be provided as direct inputs, which is facilitated by the dynamic nature of the recurrent ANN and the use of time-lagged inputs. For this application, execution of the recurrent ANN at each time step required only 0.02 s. of CPU time on a 2 GHz Pentium 4 desktop workstation, indicating that the neural-optimal control model can be easily implemented for adaptive, real-time control of stormwater and combined sewer systems.

#### **4. STORMWATER MANAGEMENT FOR COASTAL ECOSYSTEM RESTORATION: LEARNING OPTIMAL FUZZY RULES BY GENETIC ALGORITHMS**

##### **4.1. Introduction**

Increased stormwater discharges and pollutant loadings due to expanded urban and agricultural development have adversely impacted shoreline ecosystems along many coastal areas. An example is the St. Lucie Estuary (SLE) within the Indian River Lagoon on the east coast of south Florida, where an elaborate drainage canal system constructed by the US Army Corps of Engineers over the last century has greatly altered the natural drainage patterns that historically maintained the important Everglades natural area. As shown in Fig. 10.17, the canals intercept and divert stormwater drainage to the east coast, along with emergency releases from Lake Okeechobee for protecting dykes surrounding the Lake. Drainage of the swamps and so-called overflow areas stimulated land development and the resulting population boom in Florida that continues today. These man-made alterations have contributed to decline of the Everglades ecosystem, along with increased freshwater inflows into coastal estuaries such as the SLE affecting the overall salinity regime supporting estuarine ecosystems. As a result, sea grasses, oysters, and other species once abundant in the SLE are virtually absent today [42].



**Fig. 10.17.** Location map of St. Lucie Estuary and major drainage canals in the watershed. Canals draining the basins are assigned the same name as the basin. Basin C-25 and Basin 1 discharge directly into the Indian River Lagoon.

The Comprehensive Everglades Restoration Plan (CERP) undertaken by the South Florida Water Management District (SFWMD) and the US Army Corps of Engineers (USCOE) includes restoration of the SLE ecosystem as a major component [43]. The proposed restoration plan includes construction of stormwater detention/retention reservoirs for modifying the long-term mean monthly frequency distribution of freshwater inflows into the SLE to be more consistent with natural, predevelopment conditions for recovery and protection of salinity-sensitive biota. In addition, constructed wetlands are attached to the reservoirs to serve as multicell stormwater treatment areas (STAs) for pollutant removal. Unfortunately, the relatively flat terrain of South Florida affords few natural sites for construction of reservoirs, requiring expensive land acquisition and excavation of diked containment areas for development of detention storage capacity. Since these are primarily off-stream facilities, pumping is required for diversion into the reservoirs and may also be needed for release back to the canals or streams.

According to Haunert and Konyha [44], biota in the SLE is more sensitive to the long-term frequency distribution of mean monthly inflows, rather than individual extreme hydrologic events. Sizing of the stormwater detention facilities is a particularly challenging stochastic



optimization problem since the objective is to locate, size, and operate in a fully integrated manner the constructed reservoir/STA systems such that mean monthly stormwater discharges to the SLE reasonably match the desired natural or pre-drained probability distribution. It is hypothesized that the key to minimizing the cost of the constructed facilities for achieving this goal is to fully incorporate real-time operational strategies within the design and capacity sizing problem. The integrated design/operational problem is further complicated by the need to consider stormwater as a multipurpose resource for augmenting water supplies available to agricultural areas according to specified reliability measures for water delivery. Further challenges arise in that the optimization procedure must be linked with existing, well-calibrated hydrologic simulation models of the drainage basin for accurately predicting system response to the stormwater management alternatives. The solution of this problem is achieved by linking a genetic algorithm to a hydrologic simulation model for learning the optimal fuzzy operational rules for real-time reservoir operation.

## 4.2. Integrated Reservoir Sizing and Operating Rule Optimization: OPTI6

### 4.2.1. Formulation

As presented by Wan et al. [45], the optimization model OPTI6 was developed to determine the optimal sizing and real-time operating rules for constructed reservoir/STA systems in the SLE watershed with the following objectives: (a) meet the target long-term frequency distribution of stormwater discharges to the SLE for ecological remediation, (b) provide supplemental irrigation water supply at acceptable risk levels, and (c) minimize the capacities, and hence cost, of the reservoir/STA system for satisfying objectives (a) and (b). The multiobjective optimization problem is formulated using the weighting method:

$$\begin{aligned} \text{minimize } & \sum_{c=1}^{nc} w_c (100F_c - 100T_c)^2 + \sum_{i=1}^{nb} \left[ w_I (100P_i - 100\alpha)^2 \text{ if } P_i > \alpha; 0 \text{ otherwise} \right] \\ & + \sum_{i=1}^{nb} w_S \cdot s_{i,\text{cap}}^2 \end{aligned} \quad (10.30)$$

where  $F_c$  is the frequency distribution of mean monthly stormwater discharges to the SLE within discrete flow ranges  $c$ ;  $T_c$  is the target probability of mean monthly stormwater runoff to the SLE for flow class  $c$ ;  $P_i$  is the risk of failure to satisfy the supplemental water supply requirements for irrigation associated with reservoir  $i$  in any year;  $\alpha$  is the acceptable risk level for water supply, which is assumed as the 1-in-10-year drought in the SLE watershed;  $w_c$  ( $c = 1, \dots, nc$ ) are weighting factors providing a subjective ranking of the relative priority of achieving each of the  $nc$  discrete flow frequency classes targets  $T_c$ ;  $w_I$  is penalty factor associated with risk target violation for irrigation water supply;  $w_S$  is a weighting factor associated with minimizing storage capacity requirements at each proposed reservoir/STA site;  $nb$  is the number of stormwater detention/retention reservoirs; and  $s_{i,\text{cap}}$  is the maximum storage capacity actually used in storage option  $i$  based on hydrologic simulation of the system.

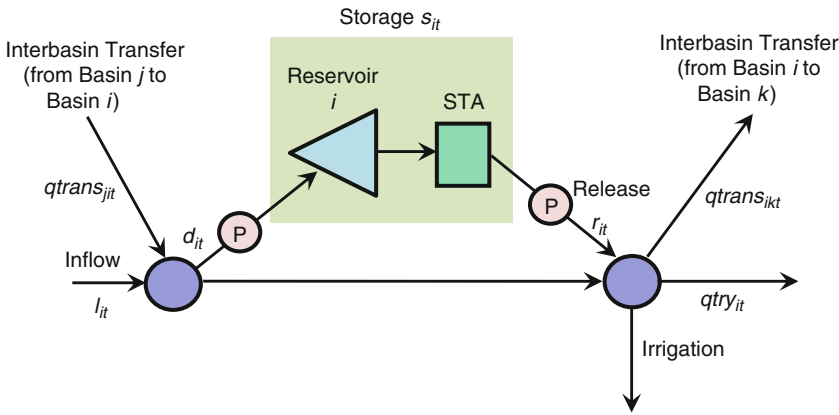


Fig. 10.18. Schematic of typical off-stream detention reservoir with connected STA.

Evaluation of (10.30) requires daily simulation of the watershed detention storage and network for calculation of mean monthly probabilities  $F_c$  for all frequency classes  $c$  of stormwater releases to the SLE. The drainage network simulation includes planned off-stream reservoirs requiring pumping facilities for diversion into the basins, as well as either gravity or pumped outflow, as depicted in Fig. 10.18. Pumping costs were excluded from the objective function for this study, with preeminence given to the major criteria represented in (10.30). It is also assumed that a multicell STA is connected to each detention reservoir for reducing loads of nutrients, pesticides, and other pollutants from stormwater runoff.

The mass balance equation for the reservoirs with connected STA is

$$s_{i,t+1} = s_{it} + d_{it} - r_{it} + (rain_{it} - evap_{it}) \cdot A(s_{it}) - seep_i \cdot s_{it} \quad (10.31)$$

$$(for i = 1, \dots, nb; t = 1, \dots, nd)$$

where  $s_{it}$  is the storage in basin  $i$  at the beginning of day  $t$ , combining both the reservoir and STA storage ( $10^3 \text{ m}^3$ );  $A(s_{it})$  is the surface area of basin  $i$  as a function of storage  $s_{it}$  ( $10^3 \text{ m}^2$ );  $d_{it}$  is pumped discharge diverted into basin  $i$  from the adjacent canal ( $10^3 \text{ m}^3/\text{d}$ );  $r_{it}$  is pumped release from the STA to the canal ( $10^3 \text{ m}^3/\text{d}$ );  $rain_{it}$  and  $evap_{it}$  are rainfall and evaporation rates, respectively, for basin  $i$  on day  $t$  ( $\text{m}/\text{d}$ );  $seep_i$  is the seepage fraction per unit storage for basin  $i$ ; and  $nd$  is the total number of days in the simulation. The simulation assumes that a portion of the reservoir/STA seepage can return as lagged flow to the canal and is added to the stormwater release to the SLE.

Additional constraints designed to maintain nonnegative flows include:

$$I_{it} + \sum_{j \in I_i} qtrans_{jit} - d_{it} \geq 0 \quad (10.32)$$

$$I_{it} + \sum_{j \in J_i} qtrans_{jit} - d_{it} + r_{it} - ws_{it} - \sum_{k \in O_i} qtrans_{jkt} \geq 0 \quad (10.33)$$

(for  $i = 1, \dots, nb; t = 1, \dots, nd$ )

where  $I_{it}$  is the unregulated stormwater inflow from basin  $i$ ;  $qtrans_{jit}$  is the portion of flow originating from basin  $j$  that is transferred to basin  $i$ ;  $J_i$  is the set of basins transferring flow into basin  $i$ ;  $O_i$  is the set of basins receiving flow transfers from basin  $i$ ;  $ws_{it}$  is the irrigation water delivery from basin  $i$ ; and  $qtry_{it}$  is the stormwater release from basin  $i$  to the Estuary.

The following bounds on the variables are imposed during solution of (10.30):

$$0 \leq s_{i,t+1} \leq s_{i,\max} \quad (10.34)$$

$$0 \leq d_{it} \leq d_{i,\max} \quad (10.35)$$

$$0 \leq r_{it} \leq r_{i,\max} \quad (10.36)$$

(for  $i = 1, \dots, nb; t = 1, \dots, nd$ )

However, the actual maximum capacity  $s_{i,\text{cap}}$  for each reservoir/STA  $i$  calculated during the simulation is

$$s_{i,\text{cap}} = \max_{t=1, \dots, nd} s_{i,t+1} \quad (10.37)$$

Although the scheduling of diversions  $d_{it}$  pumped into the reservoir/STA and discharges  $r_{it}$  pumped out are the designated decision variables, these are replaced by the net inflow to the reservoir  $q_{it} = [d_{it} - r_{it}]$ , where if  $q_{it} < 0$ ,  $r_{it} = |q_{it}|$  and  $d_{it} = 0$  and if  $q_{it} \geq 0$ ,  $r_{it} = 0$  and  $d_{it} = q_{it}$ . Although minimization of pumping costs is not directly included in the formulation, preventing both  $d_{it} > 0$  and  $r_{it} > 0$  to occur on any day  $t$  serves to indirectly minimizing pumping costs.

Attempts are first made to satisfy the water supply requirements for irrigation  $ws_{it}$  by removing water in storage in the reservoir at the beginning of each day. If there is insufficient basin storage to satisfy the irrigation demand, then the remainder is supplied from basin inflows and transbasin diversions to satisfy the irrigation demand for that day. Irrigation deliveries occur only if the demand can be entirely satisfied for that day. Insufficient available storage, inflows, and transbasin diversions for complete satisfaction of the daily irrigation demand constitute a water supply failure, and no deliveries are made on that day. That is,

$$\begin{aligned}
 &\text{IF : } I_{it} + \sum_{j \in J_i} qtrans_{jit} + s_{it} \geq ws_{it} \\
 &\text{THEN :} \\
 &\quad \text{IF : } I_{it} + \sum_{j \in J_i} qtrans_{jit} - ws_{it} > 0 \\
 &\quad \text{THEN : } qavail_{it} = I_{it} + \sum_{j \in J_i} qtrans_{jit} - ws_{it} \\
 &\quad \text{ELSE : } qavail_{it} = I_{it} + \sum_{j \in J_i} qtrans_{jit} + s_{it} - ws_{it} \\
 &\quad \quad s_{it} \leftarrow s_{it} - I_{it} - \sum_{j \in J_i} qtrans_{jit} + ws_{it} \\
 &\text{ELSE : } ws_{it} = 0 \\
 &\quad wsfail_i \leftarrow wsfail_i + 1 \\
 &\quad qavail_{it} = I_{it} + \sum_{j \in J_i} qtrans_{jit}
 \end{aligned} \tag{10.38}$$

where  $qavail_{it}$  is the remaining canal flow available for diversion to the reservoir/STA, with  $wsfail_i$  counting the number of days of water supply failure during each year of the simulation. Average annual risk of failure to satisfy the daily irrigation demand for each basin  $i$  is then calculated as:

$$P_i = \frac{\sum_{t=1}^{nd} wsfail_i}{nd} \quad (\text{for } i = 1, \dots, nb) \tag{10.39}$$

A high priority is given to transbasin diversions  $qtrans_{jit}$  whereby if sufficient inflow is available, they can occur up to the pumping capacity after satisfaction of irrigation demands. The ecological health of the Estuary is enhanced if stormwater releases are diverted from C-24 to the North Fork of the St. Lucie River, or south from C-23 to C-44, which enhances the salinity balance in the SLE by reducing stormwater releases to the middle of the Estuary. The hydrologic and drainage system simulation model allows any desired transbasin transfer configuration, with provision for transfers to be made to more than one basin. Transbasin diversion amounts are limited by available pumping capacity, as well as restrictions imposed if the potential exists for the transbasin diversion exacerbating flooding in the receiving basin during high-flow conditions. Rules governing the scheduling of releases from Lake Okeechobee for protection of the dykes surrounding the Lake are also incorporated, which prevents releases from the C-44 reservoir/STA system during high water level conditions in the Lake.

#### 4.2.2. Fuzzy Operating Rules

Optimal reservoir operating rules  $q_i^*(I_{it}, s_{it})$  are represented in OPTI6 as feedback policies whereby reservoir operational guidelines are conditioned on current-day measurements of inflows and reservoir storage, as well as the time of year. The optimal rules are defined by a

fuzzy rule-based system with the advantage of not requiring any a priori mathematical structure for the rules, such simplified linear decision rules.

The general structure of a fuzzy rule  $n$  is [46]

$$\begin{aligned} \text{IF : } a_1 \text{ is } A_{n1} \text{ AND } a_2 \text{ is } A_{n2} \text{ AND } \dots \text{ AND } a_K \text{ is } A_{nK} \\ \text{THEN : } B_n \end{aligned} \tag{10.40}$$

Arguments in the rule premises (IF portion) are assumed to belong to fuzzy sets, and the consequence (THEN portion) also belongs to a fuzzy set. A fuzzy set assigns a *membership value* or *degree-of-truth* to elements of the set, which is in contrast with Boolean logic defining *crisp* sets, which can be considered as a subset of fuzzy logic [47]. Membership values of 0 indicate no truth to the assertion that an element is a member of the set, values of 1 represent complete confidence in the assertion, and values between 0 and 1 signify partial membership in the fuzzy set. Current measurements of inflows  $I_{it}$  and storage  $s_{it}$  comprise the facts provided to each fuzzy rule  $n$ , requiring calculation of the degree of fulfillment (DOF)  $\nu_{in}(I_{it}, s_{it})$  for basin  $i$  at time  $t$ . For this study, the *product inference* method of calculating DOF is applied:

$$\nu_{in}(I_{it}, s_{it}) = (A_{in1} \text{ AND } A_{in2}) = \mu_{A_{in1}}(I_{it}) \cdot \mu_{A_{in2}}(s_{it}) \tag{10.41}$$

where  $\mu_{A_{ink}}(a_k)$  is the membership value (between 0 and 1) of argument  $a_k$  ( $k = 1$ : inflow  $I_{it}$ ;  $k = 2$ : storage  $s_{it}$ ) in fuzzy set  $A_{ink}$  of rule  $n$  for basin  $i$ . Fuzzy rule-based systems are characterized by the potential for several rules with DOF values  $>0$  for a given set of facts, requiring the need for combining the fuzzy consequences of each of these rules. The *normed weighted sum combination* method has the advantage of providing a convenient means of *defuzzifying* the fuzzy consequences [46]:

$$\mu_{B_i}(x) = \frac{\sum_{n=1}^{N_i} \nu_{in}(I_{it}, s_{it}) \cdot \beta_{in} \cdot \mu_{B_{in}}(x)}{\max_u \sum_{n=1}^{N_i} \nu_{in}(I_{it}, s_{it}) \cdot \beta_{in} \cdot \mu_{B_{in}}(u)} \tag{10.42}$$

where  $N_i$  is the total number of rules for basin  $i$  and  $\beta_{in}$  is the inverse of the area under the membership function for the  $n$ -th consequence.

$$\frac{1}{\beta_{in}} = \int_{-\infty}^{\infty} \mu_{B_{in}}(x) dx \tag{10.43}$$

This results in less weight being assigned to vague fuzzy consequences as characterized by larger areas under the membership function.

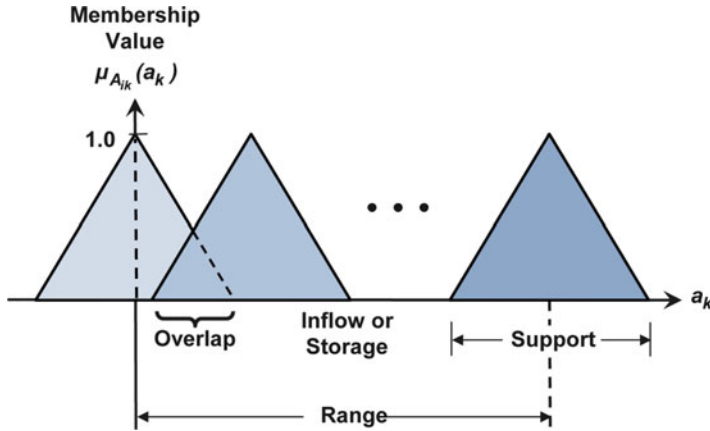


Fig. 10.19. Triangular fuzzy numbers for premises (inflow or storage) for fuzzy rule-based system.

The next step is to defuzzify the fuzzy combinations, where the most popular method is mean defuzzification:

$$q_t(I_{it}, S_{it}) = \frac{\sum_{n=1}^{N_i} \nu_{in}(I_{it}, S_{it}) \cdot \bar{q}_{in}}{\sum_{n=1}^{N_i} \nu_{in}(I_{it}, S_{it})} \tag{10.44}$$

where  $\bar{q}_{in}$  is the mean of the fuzzy consequence of rule  $n$  and  $q_t(I_{it}, S_{it})$  is the defuzzified operating rule conditioned on the current inflow  $I_{it}$  and storage measurements  $s_{it}$  provided as facts to the fuzzy rule-based system. The combination of product inference for degree of fulfillment of rule premises, normed weighted sum combination of fuzzy of consequences, and mean defuzzification avoids the need to explicitly characterize the structure of the fuzzy consequence membership function  $\mu_{B_{in}}(x)$ . Since only the means of the fuzzy consequences  $\bar{q}_{in}$  for each basin  $i$  and rule  $n$  are needed, they are regarded as the decision variables that are manipulated to determine the optimal fuzzy rules.

The fuzzy membership functions for the premises are assumed to be structured as symmetric, triangular fuzzy numbers, as depicted in Fig. 10.19. The *Range* for each type of argument is determined using the maximum potential storage capacity for each basin and the largest daily inflow occurring during simulation for the basin storage and expected inflow arguments, respectively. With specification of the desired number of arguments for each type of premise (i.e., storage or inflow), the model then calculates the *Support* for each fuzzy number based on the *Range* and the specified number of arguments. A desired degree of *Overlap* of the triangular fuzzy numbers (e.g., 0.25 represents an *Overlap* of 25 % of the calculated *Support* of each fuzzy number) can also be specified, where the recommended degree of *Overlap* is usually a value between 0.20 and 0.333 [46].

The number of arguments for the storage and inflow premises divides these values into discrete classes, with each class governed by a triangular membership function. As an example, 6 argument classes specified for storage and 7 argument classes for inflow result in a total of  $6 \times 7 = 42$  fuzzy rules generated by the model for each basin. Although increasing the number of argument classes may provide a more accurate representation of the storage and inflow amounts occurring in a basin, there is an increase in the number of rules and the corresponding number of variables to be optimized. Each of the fuzzy rules produces means of the fuzzy consequences  $\bar{q}_{in}(n = 1, \dots, N_i; i = 1, \dots, nb)$  as the variables to be optimized. The fuzzy means vary between  $-100$  and  $100$ , where  $\bar{q}_{in} \geq 0$  represents the percentage of total available flow actually diverted to the reservoir for that particular rule, whereas if  $\bar{q}_{in} < 0$ , then  $|\bar{q}_{in}|$  is the percentage of available storage that is pumped out if. Based on the fuzzy means, the feedback or conditional operating rules  $q_i(I_{it}, s_{it})$  are calculated from (10.42) using mean defuzzification, with daily diversion and release decisions calculated as follows:

$$\begin{aligned}
 &\text{IF : } q_i(I_{it}, s_{it}) > 0 \\
 &\quad \text{THEN : } d_{it} = \frac{\text{abs}(q_i(I_{it}, s_{it}))}{100} \cdot q_{avail_{it}} \\
 &\quad \text{AND : } r_{it} = 0 \\
 &\text{ELSE IF : } q_i(I_{it}, s_{it}) \leq 0 \\
 &\quad \text{THEN : } r_{it} = \frac{r_i(I_{it}, s_{it})}{100} \cdot s_{it} \\
 &\quad \text{AND : } d_{it} = 0
 \end{aligned}$$

Rainfall in South Florida varies by distinct wet and dry seasons, with the wet summer season rainfall events primarily convective and tropical storms, whereas dry winter season rainfall is governed by frontal systems. Distinct rules  $q_i^w(I_{it}, s_{it})$  and  $q_i^s(I_{it}, s_{it})$  are therefore developed for each season by optimizing the means of the fuzzy consequences  $\bar{q}_{in}^w$  and  $\bar{q}_{in}^s$  for the winter and summer seasons, respectively.

#### 4.2.3. Genetic Algorithm

Each evaluation of the objective function (10.30) requires simulation of the performance of the fuzzy operating rules using the daily hydrologic simulation model for the SLE watershed and drainage network. Each simulation run results in a mean monthly frequency distribution  $F_c$  for stormwater discharges to the SLE under the given sets of fuzzy operating rules. In addition, mean annual probabilities  $P_i$  of failing to satisfy irrigation demands for basin  $i$  are calculated from (10.39), as well as the highest daily storage requirement  $s_{i, \text{cap}}$  for each basin  $i$  occurring during simulation. A genetic algorithm (GA) is ideal for solution of (10.30) since no explicit analytical representation of the objective function and constraint sets is required, which is critical for linkage with complex simulation models. Furthermore, since GAs are not gradient-based techniques, they are capable of avoiding entrapment in local optima for highly nonconvex and discontinuous objective functions. A GA is therefore selected as the machine learning tool in OPTI6 for discovering the optimal fuzzy operating rules that solve (10.30).

Genetic algorithms (GAs) were first proposed by Holland [48] for modeling the evolutionary and adaptive processes of biological systems. Subsequently, Goldberg [49] was instrumental in introducing numerous researchers in wide-ranging fields to the learning capabilities of GAs for solving *np-hard* optimization problems. Since then, numerous variants of genetic and evolutionary algorithms have been applied for reliable and efficient solution of complex combinatorial problems, as well as serving as an ideal method of interfacing simulation and optimization. As heuristic procedures, mathematical proofs of convergence to global or even local optima are unavailable, although GAs have successfully solved numerous nonconvex test problems with known global optima [50].

GAs differ from traditional methods of mathematical programming by operating on a binary string coding of the variables (*genotype*) instead of direct manipulation of the real number values (*phenotype*). The length of the string depends on the size and precision of the real number being coded. The biological analogy is a *chromosome*, with each bit representing a *gene* in the chromosome with a particular *locus* or position in the string. Whereas traditional optimization methods perform sequential search over points in the solution space, GAs generate *populations* of solutions at each step (*generation*). GAs attempt to maximize the genetic *fitness* of the individuals (i.e., variables) in the population (i.e., solution set), corresponding to maximizing (or minimizing) the objective function, by combining *survival of the fittest* binary code representation with a structured yet randomized information exchange. Because of this, GAs have been mistakenly categorized as random search methods, but differ by utilizing historical information to probe regions of improved performance within the search space.

As illustrated in Fig. 10.20, the basic components of a GA are populations of binary strings, selection of the mating pool, genetic operators (i.e., crossover and mutation), replacement of the old generation, and stopping criteria. The GA applies genetic operators that create subsequent generations from the previous ones until the stopping criteria are satisfied, such as terminating when best solution of the population fails to improve. *Niching* methods based on *fitness sharing* have been applied in GAs to avoid genetic drift or premature convergence of the population to members with similar genetic structure. Fitness sharing involves diminishing the fitness of an individual proportion to the number of similar individuals in the population based on a *sharing function* measuring the degree of similarity of the individuals [51].

Figure 10.21 shows how the GA and drainage network simulation model are interconnected in OPTI6, where the GA selects populations of the means of the fuzzy consequences  $\bar{q}_{in}^w$  and  $\bar{q}_{in}^s$  from which fuzzy operating rules  $q_i^w(I_i, s_{ii})$  and  $q_i^s(I_i, s_{ii})$  are constructed by the fuzzy rule-based system. Performance of these fuzzy operating rules is then evaluated through execution of the daily hydrologic and drainage network simulation model, resulting in mean monthly frequency distributions  $F_c$  of stormwater discharges, mean annual water supply failure probabilities  $P_i$  for each basin  $i$ , and simulated maximum storage  $s_{i,cap}$  required in each basin  $i$ . These responses from the simulated environment are returned to GA, allowing an interactive learning process culminating in discovery of the best fuzzy operating rules that minimize the objective function in (10.30) (i.e., maximize the fitness).



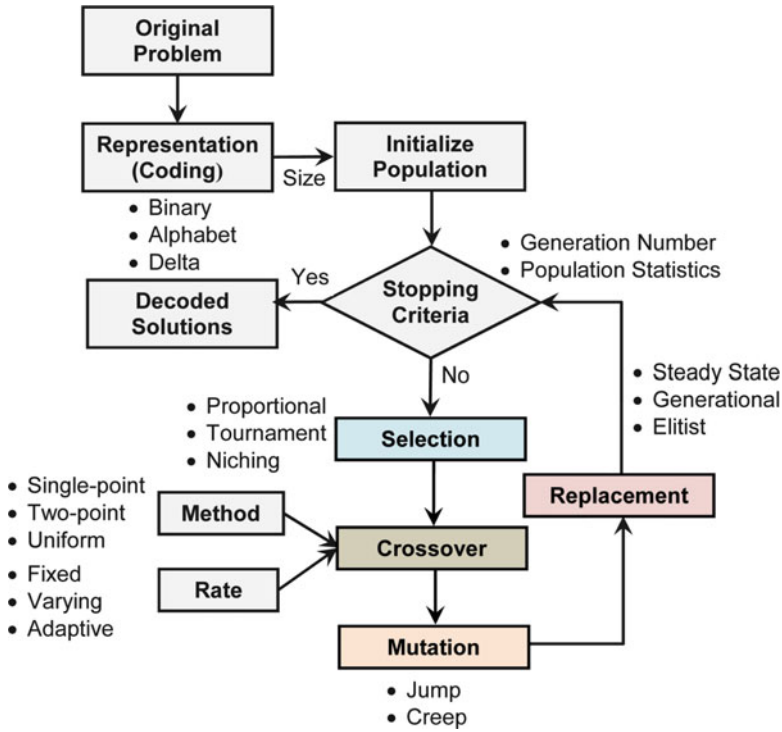
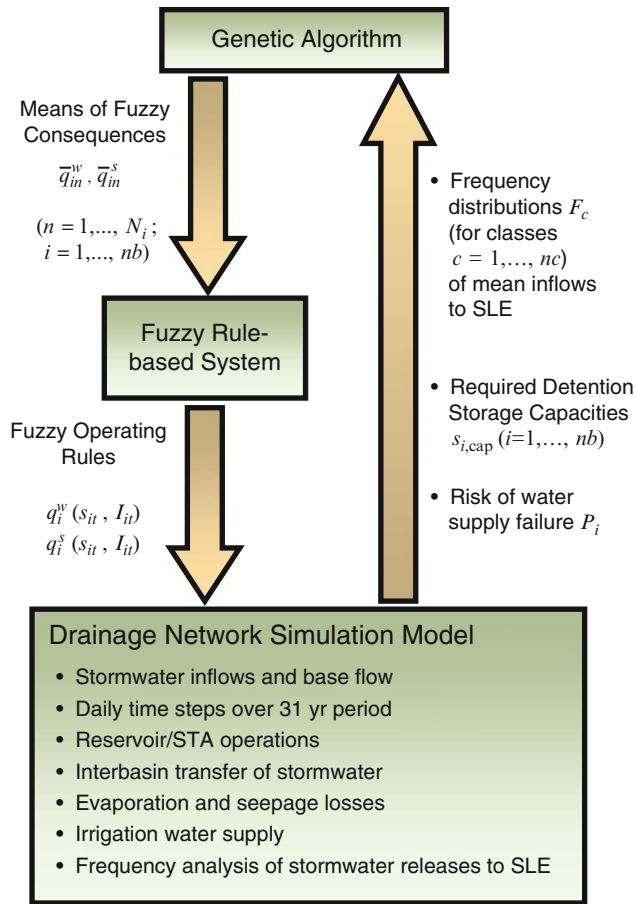


Fig. 10.20. Components of simple genetic algorithm.

### 4.3. Application of OPTI6 for Optimal Restoration Plan Development in St. Lucie Estuary

#### 4.3.1. Hydrologic Data and Irrigation Demands

The Hydrologic Simulation Program-FORTRAN (HSPF) [52] was applied to modeling daily hydrologic responses in the SLE watershed over the historical period 1965–1995. Enhancements to HSPF were incorporated prior to model calibration by Aqua Terra Consultants [53] for simulating high water table and wetland conditions that prevail in South Florida. The model was calibrated to the six major drainage basins within the SLE watershed, with further subdivision into subbasins, with each in turn divided into six land use types: irrigated agriculture (primarily citrus), nonirrigated pasture, forest, wetland, and urban lands. The 1995 land use coverage was used to represent current development conditions, with the resulting simulation under these conditions referred to as the 1995 base. Land use projections to 2050 represent the future development condition, with the associated simulation designated as the 2050 base. Although substantial expansion of urban development is expected by 2050, it is assumed that irrigated agriculture and wetlands will remain at current levels, but with decreases in forest and pasture areas. HSPF was applied to predicting how these changes in land use would impact the hydrology of the SLE watershed.

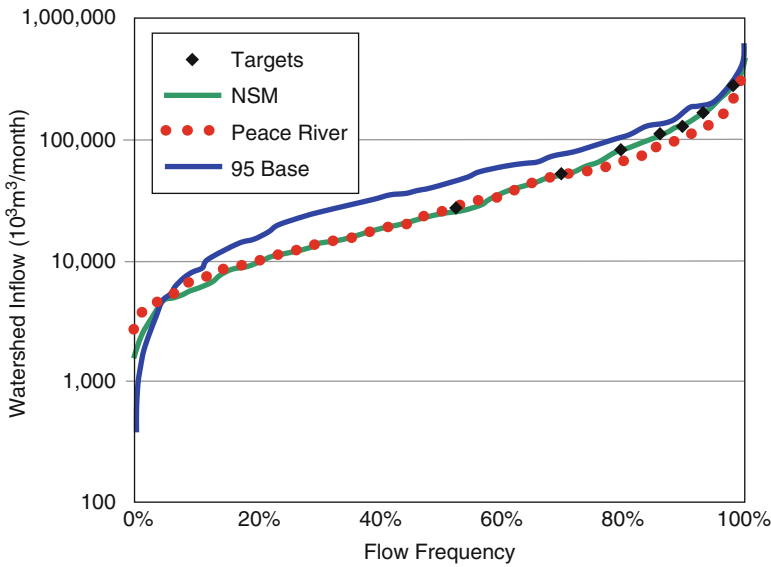


**Fig. 10.21.** OPTI6: interaction of genetic algorithm for optimizing fuzzy operating rules with drainage network simulation model.

The Floridian Aquifer is an artesian aquifer that constitutes the major water supply source for irrigated agriculture in the SLE watershed. Salinity concentrations in the aquifer have steadily increased to the point where during extended periods of drought, significant reductions in citrus yields can occur. Unfortunately, when the canals are dry during the winter season, saline groundwater pumpage cannot be mixed with better quality surface water, resulting in severe water shortages. Irrigation demands were estimated using the Agricultural Field-Scale Irrigation Requirements Simulation (AFSIRS) model [54] based on water availability and Floridian Aquifer withdrawals within the SLE watershed.

#### 4.3.2. Restoration Target: Flow Distribution

The target flow distribution  $T_c$  as expressed in (10.30) is based on a favorable range of stormwater discharges for salinity-sensitive biota in SLE called the *salinity envelope*. Hu [55] found from salinity modeling in the SLE that mean monthly inflows exceeding



**Fig. 10.22.** Flow distributions into St. Lucie Estuary: 1995 Base conditions and pre-drained conditions.

56.6 m<sup>3</sup>/s (2,000 ft<sup>3</sup>/s) to 85 m<sup>3</sup>/s (3,000 ft<sup>3</sup>/s) resulted in salinity levels that approached zero in the upper SLE. These results, combined with a biological understanding of salinity impacts on juvenile marine fish and shellfish, oysters, and submerged aquatic vegetation in the estuarine ecosystem, led to an estimated salinity envelope ranging from 10 m<sup>3</sup>/s (350 ft<sup>3</sup>/s) to 56.6 m<sup>3</sup>/s (2,000 ft<sup>3</sup>/s).

Hauert and Konyha [44] determined acceptable frequencies of mean monthly inflows within this range based on estimates of predevelopment drainage conditions in the SLE watershed using the Natural System Model (NSM). Verification of the NSM model results was based on comparison with long-term measured flow data from the Peace River basin located in southwest Florida, with landscape characteristics similar to the natural, predeveloped SLE watershed. Comparison of the cumulative probability distributions from the NSM model, the Peace River measured flow data, and post-development 1995 base conditions is seen in Fig. 10.22. Plotted on the NSM-derived cumulative probability distribution shown in Fig. 4.6 are selected discrete mean monthly inflow range classes  $c$  with associated frequencies  $T_c$  calculated as the difference in cumulative probability between the successive upper and lower limits of the flow range.

#### 4.3.3. GA for Multiobjective Optimization

The GA optimizer in OPTI6 is based on the freeware program *gafortran* written in FORTRAN 90 as obtained from Dr. David Carroll (<http://cuaerospace.com/carroll>). In order to maintain compatibility with other C/C++ software used in this study, *gafortran* was translated into the ANSI C code *gaopt.c*, which is compiled with the Gnu *gcc* compiler

using standard C libraries. A population size of 100 was selected for application of *gaopt.c*, with bounds on the fuzzy rule consequences maintained between  $-100$  and  $+100$ , where positive values indicate the percent of available flow to be diverted to the reservoirs (as constrained by available storage space) and negative values specify the percent (absolute value) of storage for release from the reservoirs.

Since *gaopt.c* is a binary coded GA, discretization of the fuzzy rule consequences is designed to maintain single decimal place precision of the fuzzy rule consequence variables, which is considered sufficient for this study. Selection of random pairs for mating was based on tournament selection with shuffling, and niching was invoked to enhance the diversity of successive generations. The recommended jump mutation rate of  $(1/npopsiz)$  was applied to the genotype representation, where *npopsiz* is the number of individuals in the population, with the creep mutation rate for the phenotype set at 0.02. Uniform crossover was found to outperform single-point crossover with the recommended crossover probability of 0.5. Superior results were also produced with inclusion of *elitism* in the generational replacement operation.

A multiobjective analysis was conducted with OPTI6 by varying the weighting factors in (10.30) until a suitable compromise solution was obtained between the three specified criteria: (a) matching the target frequency distribution of stormwater discharges to the SLE, (b) maintaining an acceptable risk of violation of water supply requirements, and (c) minimizing sizing requirements of the reservoir/STAs. In assigning penalty weighing factors  $w_c$  for monthly flow ranges  $c$  in (10.30), flows outside the favorable range  $10 \text{ m}^3/\text{s}$ – $56.6 \text{ m}^3/\text{s}$  ( $350$ – $2,000 \text{ ft}^3/\text{s}$ ) were assigned the most severe penalties, particularly for high-flow frequencies above  $56.6 \text{ m}^3/\text{s}$  ( $2,000 \text{ ft}^3/\text{s}$ ). Reduced penalties were given to flows in the range  $<10 \text{ m}^3/\text{s}$  ( $<350 \text{ ft}^3/\text{s}$ ), with the lowest penalty weights applied to the intermediate ranges. Penalty weights  $w_I$  on irrigation water supply failure and  $w_S$  for minimizing storage requirements were systematically manipulated until a desirable compromise solution was obtained.

#### 4.3.4. OPTI6 Results for Integrated Reservoir Sizing and Operations

Several alternatives were tested with locations and areal extents of stormwater detention/retention reservoirs with connected STAs during development of the optimal restoration plan. Figure 10.23 depicts the selected alternative consisting of four off-stream reservoir/STAs located in the C-23, C-24, North Fork (NF), and C-44 basins, including associated water control structures, pumps, levees, canals, and acquisition of approximately  $4,937 \text{ ha}$  ( $12,200 \text{ acres}$ ) of land. For this configuration of the optimal restoration plan, it is seen from Fig. 10.24 that the OPTI6 results provide an excellent match to the NSM-based targets for the most important high-flow frequency classes, with the lower flow frequency classes of less importance displaying acceptable agreement.

Although not shown here, comparison of the frequency distribution of flows in C-23 between OPTI6 results and the current uncontrolled conditions provides further evidence of the benefits of the optimal restoration plan due to the added flexibility of transfer of stormwater discharges between basins. Significant ecological improvement to the SLE is

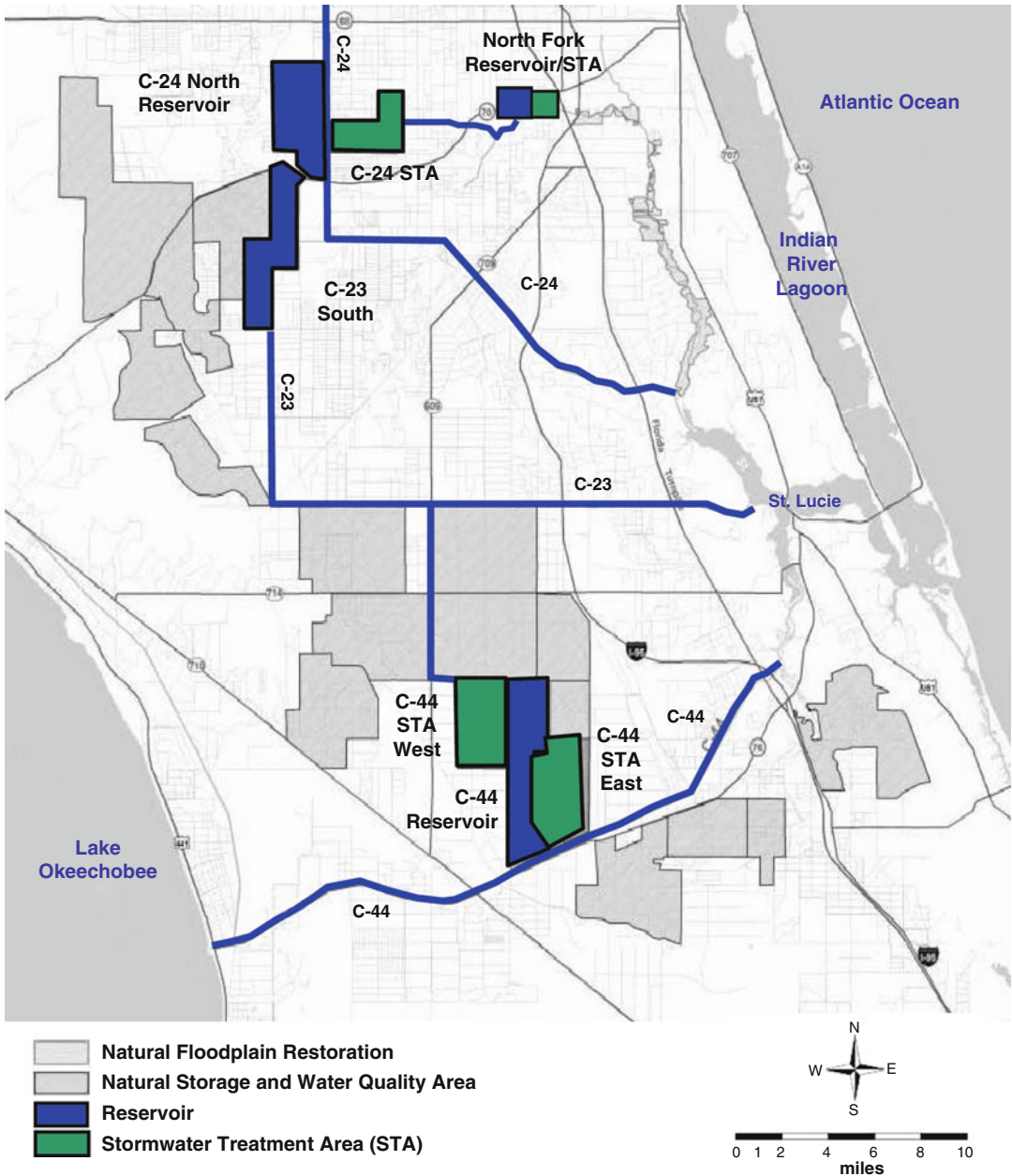
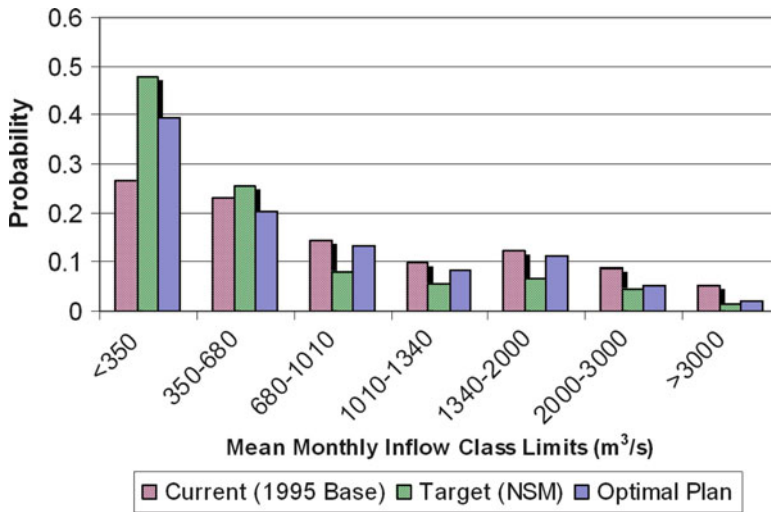
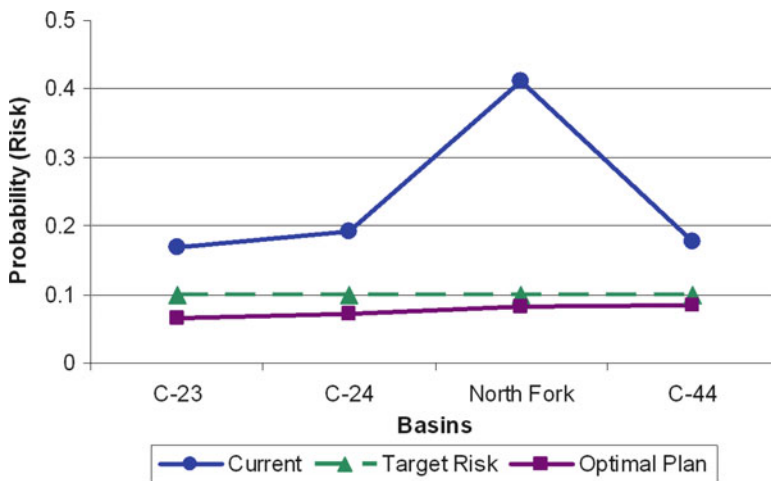


Fig. 10.23. Recommended plan for St. Lucie Estuary ecosystem restoration.

provided since the optimal plan shows substantial reduction in stormwater discharges to the middle SLE, which have the most direct impact on salinity imbalances in the SLE. In addition, OPTI6 results indicate reductions in pollutant loadings to the SLE with approximately 20 % of previously untreated stormwater inflows undergoing natural treatment in the STAs.



**Fig. 10.24.** Comparison of mean monthly frequency distributions of SLE inflows between current distribution (1995 Base), target (NSM Model), and optimal plan.



**Fig. 10.25.** Comparison of risk of water supply failure (base hydrology and 2050 land use) between current (uncontrolled) and optimal plan.

The multipurpose benefits of the detention reservoirs under fully integrated, real-time control policies as *learned* by OPTI6 are highlighted in Fig. 10.25 where, in stark contrast with current uncontrolled conditions, the 10 % risk target of violating water supply requirements is maintained. Based on actual storage capacity requirements determined from OPTI6 as calculated by (10.37), sizing requirements of the detention reservoir/STA system are reduced by 45,400 10<sup>3</sup> m<sup>3</sup> (36,800 acre-ft), representing a 30 % reduction in the original capacity estimates for restoration of the SLE, as shown in Fig. 10.26. According to USCOE

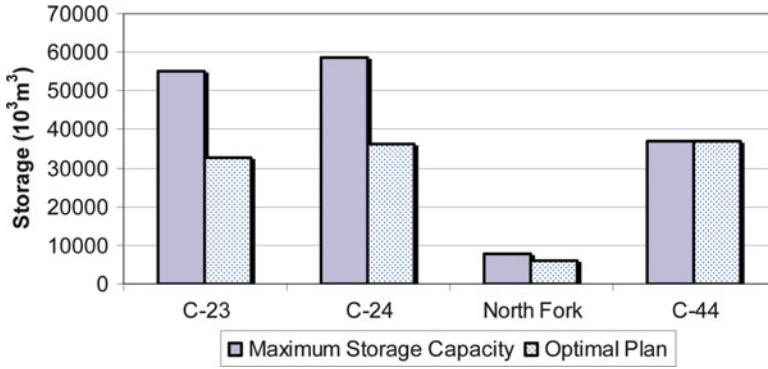


Fig. 10.26. Reduction in required storage capacity under optimal plan.

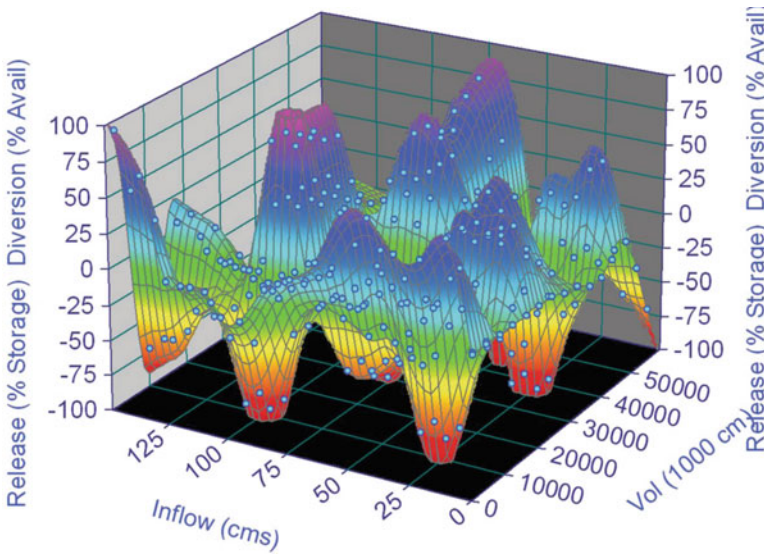


Fig. 10.27. Sample operating rules for C-23 basin from fuzzy rule-based system conditioned on current day storage volume and inflows (summer season).

and SFWMD (2004), total expected cost of the original recommended plan was \$1,207,288,000 based on initial estimates of necessary reservoir/STA storage capacities. Of this total, reservoir/STA construction and real estate acquisition costs were estimated as \$490,639,000. Assuming direct proportionality of these costs to capacity requirements, the reduced sizing requirements based on OPTI6 results amount to cost savings of approximately \$150,000,000, which are directly attributed to the machine learning approach of spatial and temporal integration fuzzy optimal operating rules into the system capacity planning and design.

Displayed in Fig. 10.27 are sample optimal fuzzy operating rules conditioned on current-day measured inflows and basin storage during the summer season as derived by OPTI6 for

the C-23 basin. These optimal fuzzy operating rules specify the optimal percent of available flow that should be diverted into the reservoir on a given day, where available flow is defined as the minimum of measured streamflows, unused capacity in the reservoir, and maximum pump capacity for diversion. Also specified in these conditional rules are recommended releases from the reservoir/STA as represented by the optimal percent of the smaller of current storage in the basin and available pump capacity or hydraulic capacity of gated outflow structures if pumping is not required for release.

The robustness of the fuzzy rule-based system is underscored by observing the highly multimodal rule structure as seen in Fig. 10.27 for the C-23 basin as typical of the operating rules derived for the other basins, suggesting that flexibility of the fuzzy rules could not be duplicated through the use of a priori defined rule structures such as a piecewise linear functions or even high-order polynomials. The high degree of nonlinearity of the fuzzy rule structure is related to the complexity of the objective function and the underlying stochastic hydrology of the SLE watershed. Unlike stochastic optimization approaches which attempt to minimize the expected value of the objective, or utilize some other type of statistical measure, the long-term frequency distribution of stormwater discharges to the St. Lucie Estuary is directly optimized in OPTI6 based on fuzzy optimal release policies *conditioned* on daily inflow and storage monitoring in the basin.

## 5. SUMMARY AND CONCLUSIONS

Machine learning methods within the field of artificial intelligence are opening opportunities for significant advances in water resources systems engineering. These powerful methodologies are providing a new means of effectively linking dynamic simulation and optimization models that fully exploits the benefits of each modeling approach without requiring adherence to simplifying assumptions and approximate mathematical structures for modeling the environment. In addition, the difficult problem of requiring explicit specification of underlying probabilistic models for solution of stochastic optimization problems is overcome through application of machine learning. As an agent-based modeling tool, machine learning provides a mechanism for interacting with the simulated environment as a means of learning optimal decision strategies in complex, stochastic environments under conflicting goals and objectives.

As a machine learning technique, reinforcement learning is applied to solving the challenging problem of stochastic optimization of multireservoir systems. The Q-Learning method of reinforcement learning is a simulation-based technique rooted in dynamic programming that circumvents the need for explicit knowledge of state transition probabilities. Rather, the underlying stochastic behavior is learned implicitly through direct use of historical hydrologic data and interaction with an accurate river basin simulation model. With Q-Learning, optimal policies are developed through a forward-looking *depth-first* procedure, rather than requiring exhaustive *breadth-first* evaluation of all possible combinations of system states that gives rise to infamous *curse of dimensionality* in dynamic programming and Markov decision processes. Reinforcement learning is applied to the Geum River basin,



South Korea, consisting of two major multipurpose reservoirs operated for water supply, flood control, hydropower generation, and instream flow requirements. Simulation analysis comparing the performance of operating rules developed by Q-Learning with traditional implicit stochastic optimization and sampling stochastic optimization methods clearly show the superiority of the Q-Learning policies.

Real-time control of available in-line storage in combined sewer systems is a cost-effective approach to reducing the adverse environmental impacts of sanitary sewage mixed with stormwater from untreated overflows. Unfortunately, incorporation of hydraulic realism in optimal control strategies requires computationally expensive iterative processes which violate the severe time constraints on repeated execution of the models under rapidly changing stormwater and sewer discharge conditions. A machine learning strategy is adopted whereby the linked optimal control—sewer hydraulics modeling system—is executed off-line for a wide range of spatially distributed historical storm events, with the resulting optimal gate controls, along with the rainfall data sets as inputs, providing training data for a recurrent artificial neural network (ANN). Once trained and tested, the recurrent ANN can be implemented for real-time control of combined sewer systems with full consideration of complex system hydraulics and integrated, spatially distributed system-wide control.

The neural-optimal control algorithm is demonstrated using the West Point Treatment Plant collection system of the King County Wastewater Treatment Division, Seattle, Washington, USA. Validation results indicate that the neural-optimal control algorithm closely tracks the optimal gate controls produced by the linked optimal control—sewer hydraulics model—despite the fact that the latter calculations assume perfect foreknowledge of rainfall amounts and distribution. This is significant considering that this storm event was excluded from the training data set for the recurrent ANN and that the neural-optimal control algorithm requires only inputs of current and past rainfall measurements and previous gate controls. The ability of the ANN to learn how to adapt the optimal controls to changes in rainfall intensity and distribution in the ongoing event is clearly evident in this demonstration.

The ecosystem recovery plan for the St. Lucie Estuary (SLE), located on the southeast coast of Florida, USA, has been developed based on coupling of a genetic algorithm with a daily drainage network simulation model for optimal sizing and operation of the planned reservoir-assisted stormwater treatment areas in the SLE watershed. Robust operating rules are obtained through a machine learning approach connecting a genetic algorithm with a simulation model of the stormwater drainage network. The genetic algorithm learns the optimal structure of a fuzzy rule-based system through interaction with the simulated environment to produce optimal real-time operating policies that achieve the target mean monthly frequency distribution of stormwater inflows for restoration of the SLE ecosystem. In addition, the multipurpose benefits of the detention reservoirs are clearly evident by maximizing the use of the attached storage-treatment areas (STAs) for pollutant load reductions as well as maintaining desirable risk targets for supplemental irrigation water supply from stormwater. Significant cost reductions were achieved under the optimal plan through reduction of total sizing requirements for the detentions basins by over 30 % from initial estimates based on trial-and-error simulation studies. Results indicate that the optimal restoration plan has the potential to restore and protect the mesohaline ecosystem in the SLE.

**REFERENCES**

1. Labadie JW, Brazil LE, Corbu I, Johnson LE (eds) (1989) Computerized decision support systems for water managers. American Society of Civil Engineers, Reston, VA
2. Keys AM, Palmer RN (1995) An assessment of shared vision model effectiveness in water resources planning, Proceedings of the 22nd annual water resources planning and management conference. American Society of Civil Engineers, Washington, DC, pp 532–535
3. Labadie JW (2004) Optimal operation of multi-reservoir systems: state-of-the-art review. *J Water Resour Plann Manage* 130(2):93–111
4. Hashimoto T, Stedinger JR, Loucks DP (1982) Reliability, resiliency, and vulnerability criteria for water resource system performance evaluation. *Water Resour Res* 18(3):489–498
5. Ao S-I, Rieger B, Amouzegar MA (eds) (2010) Machine learning and systems engineering, vol 68, Series: Lecture Notes in Electrical Engineering. Springer, Netherlands
6. Sutton RS, Barto AG (1998) Reinforcement learning: an introduction. MIT Press, Cambridge, MA
7. World Commission on Dams (WCD) (2000) Dams and development: a new framework for decision-making, report of the world commission on dams. Earthscan Publications Ltd., London
8. Wang D, Adams BJ (1986) Optimization of real-time reservoir operations with Markov decision processes. *Water Resour Res* 22(3):345–352
9. Braga BPF, Yeh WG, Becker L, Barros MTL (1991) Stochastic optimization of multiple reservoir system operation. *J Water Resour Plann Manage* 117(4):471–481
10. Tejada-Guibert JA, Johnson SA, Stedinger JR (1995) The value of hydrologic information in stochastic dynamic programming models of a multireservoir system. *Water Resour Res* 31(10):2571–2579
11. Lee, J-H, Labadie JW (2007) Stochastic optimization of multi-reservoir systems via reinforcement learning. *Water Resour Res* 43, No. W11408
12. Kelman J, Stedinger JR, Cooper LA, Hsu E, Yuan S-Q (1990) Sampling stochastic dynamic programming applied to reservoir operation. *Water Resour Res* 26(3):447–454
13. Kaelbling LP, Littman ML, Moore AW (1996) Reinforcement learning: a survey. *J Artif Intell Res* 4:237–285
14. Dreyfus SE, Law AM (1977) The art and theory of dynamic programming. Academic, New York, USA
15. Ross SM (1983) Introduction to stochastic dynamic programming. Academic Press, Inc., San Diego, CA
16. Watkins C, Dayan P (1992) Technical note: Q-Learning. *Mach Learn* 8:279–292
17. Foufoula-Georgiou E (1991) Convex interpolation for gradient dynamic-programming. *Water Resour Res* 27(1):31–36
18. Johnson SA, Stedinger JR, Shoemaker CA, Li Y, Tejada-Guibert JA (1993) Numerical-solution of continuous-state dynamic programs using linear and spline interpolation. *Oper Res* 41(3):484–500
19. K-water (2003) Geum river basin operational guidelines for MODSIM, technical report. Korea Water Resources Corporation, Daejeon
20. AMSA (1994) Approaches to combined sewer overflow program development. Association of Metropolitan Sewerage Agencies, Washington, DC
21. U.S. EPA (1999) Combined sewer overflow management fact sheet. EPA/832/R-99-005, U.S. Environmental Protection Agency, Washington, DC
22. McCarron J (2010) Chicago Sun Times. August 6
23. Water News Update (2010) Clean Water Council. <http://waternewsupdate.com>, December 29

24. Loucks ED, Locke EF, Heinz SR, Vitasovic ZC (2004) A real-time control strategy for operating the Milwaukee Metropolitan Sewerage District (MMSD) conveyance and storage system. *Proceedings of the 2004 World Water and Environmental Resources Congress: Critical Transitions in Water and Environmental Resources Management*, Environmental and Water Resources Institute and American Society of Civil Engineers, Reston, Virginia, USA
25. Pleau M, Colas H, Lavallée P, Pelletier G, Bonin R (2005) Global optimal real-time control of the Quebec urban drainage system. *Environ Model Software* 20:401–413
26. Vazquez J, François M, Gilbert D (2003) Real-time management of a sewage system: verification of the optimality and applicability of graphical linear programming compared to mixed linear programming. *J Water Sci* 16(4):425–442, article in French
27. Weyand M (2002) Real-time control in combined sewer systems in Germany—some case studies. *Urban Water* 4:347–354
28. Schutze M, Campisano A, Colas H, Schilling W, Vanrolleghem PA (2004) Real-time control of urban wastewater systems—Where do we stand today? *J Hydrol* 299(3):335–348
29. Labadie JW (1993) Optimal use of in-line storage for real-time urban stormwater control. In: Cao C, Yen BC, Benedini M (eds) *Urban storm drainage*. Water Resources Publications, Inc, Highlands Ranch, CO
30. Darsono S, Labadie JW (2007) Neural optimal control algorithm for real-time regulation of in-line storage in combined sewer systems. *Environ Model Software* 22:1349–1361
31. Kayhanian M, Stenstrom MK (2005) First flush pollutant mass loading: Treatment strategies. *Trans ResRecord (Hydrology, Hydraulics, and Water Quality)*, No. 1904, 133–143
32. Huber WC, Dickinson RE (1992) *Stormwater management model. Version 4: User's Manual*, EPA/600/3-88-001a, U.S. Environmental Protection Agency, Athens, Georgia, USA. October
33. Griva I, Nash SG, Sofer A (2010) *Linear and nonlinear optimization*. SIAM, Pennsylvania, PA
34. Chen Y-H, Chai S-Y (1991) *UNSTDY: combined sewer model user's manual*. Chen Engineering Technology, Inc, Ft. Collins, CO
35. Unver OL, Mays LW (1990) Model for real-time optimal flood control operation of a reservoir system. *Water Res Manage* 4:21–46
36. Parisini T, Zoppoli R (1994) Neural networks for feedback feed-forward nonlinear control systems. *IEEE Trans Neural Netw* 5(3):436–449
37. Haykin S (1994) *Neural networks: a comprehensive foundation*. IEEE Press, New York
38. Freeman J (1994) *Simulating neural networks with mathematica*. Addison Wesley Publishing Company, Inc, Reading, MA
39. Hassoum M (1995) *Fundamentals of artificial neural networks*. MIT Press, Cambridge, MA
40. County K (2004) 2003–2004 Annual combined sewer overflow report. King County Department of Natural Resources and Parks, Wastewater Treatment Division, Seattle
41. Masters T (1996) *Practical neural network recipes in C++*. Elsevier Science and Technology Books, Burlington, MA
42. Wilson C, Scotto L, Scarpa J, Volety A, Laramore S, Haunert D (2005) Survey of water quality, oyster reproduction and oyster health status in the St. Lucie Estuary. *J Shellfish Res* 24:157–165
43. USCOE and SFWMD (2004) Central and southern Florida project: Indian river lagoon—south: final integrated project implementation report and environmental impact statement. U.S. Army Corps of Engineers and South Florida Water Management District, Jacksonville, FL
44. Haunert D, Konyha K (2001) Establishing St. Lucie Estuary Watershed Inflow Targets to enhance Mesohaline Biota, Appendix E., Indian River Lagoon—South Feasibility Study, South Florida Water Management District, West Palm Beach, FL

45. Wan Y, Labadie J, Konya K, Conboy T (2006) Optimization of frequency distribution of freshwater inflows for coastal ecosystem restoration. *J Water Resour Plann Manage* 132 (5):320–329
46. Bárdossy A, Duckstein L (1995) Fuzzy rule-based modeling with applications to geophysical, biological, and engineering systems. CRC Press, Boca Raton, FL
47. Zimmermann H (2001) Fuzzy Set theory and its applications. Kluwer, Boston, MA
48. Holland J (1975) Adaptation in natural and artificial system. The University of Michigan Press, Ann Arbor, MI
49. Goldberg D (1989) Genetic algorithms in search, optimization and machine learning. Addison-Wesley Publishing Company Inc, Reading, MA
50. Michalewicz Z (1996) Genetic algorithms + data structures = evolution programs. Springer, Berlin
51. Sareni B, Krähenbühl L (1998) Fitness sharing and niching methods revisited. *IEEE Trans Evolut Comput* 2(3):97–106
52. Bicknell B, Imhoff J, Kittle J, Jobs T, Donigan A (2001) Hydrologic simulation program-FORTRAN, version 12, user's manual, national exposure research laboratory, office of research and development. U.S. Environmental Protection Agency, Athens, GA
53. Aqua Terra Consultants (1996) Modifications to HSPF for high water table and Wetlands conditions in South Florida. Report submitted to South Florida Water Management District, West Palm Beach, Florida
54. Smajstrla AG (1990) Agricultural field scale irrigation requirements simulation (AFSIRS) model, version 5.5. Technical manual. University of Florida, Gainesville, FL
55. Hu G (1999) Two-dimensional hydrodynamic model of St. Lucie estuary. Proceedings of the ASCE-CSCE national conference on environmental engineering. American Society of Civil Engineers, Reston, VA

# Climate Change and Its Impact on Water Resources

---

Vijay P. Singh, Ashok K. Mishra, H. Chowdhary,  
and C. Prakash Khedun

## CONTENTS

INTRODUCTION

CLIMATE CHANGE

EVIDENCE OF CLIMATE CHANGE

IMPACTS OF CLIMATE CHANGE ON WATER RESOURCES

CONTINENTAL-SCALE IMPACT OF PROJECTED CLIMATE CHANGES ON WATER RESOURCES

ADAPTATION TO CLIMATE CHANGE

CONCLUSIONS

REFERENCES

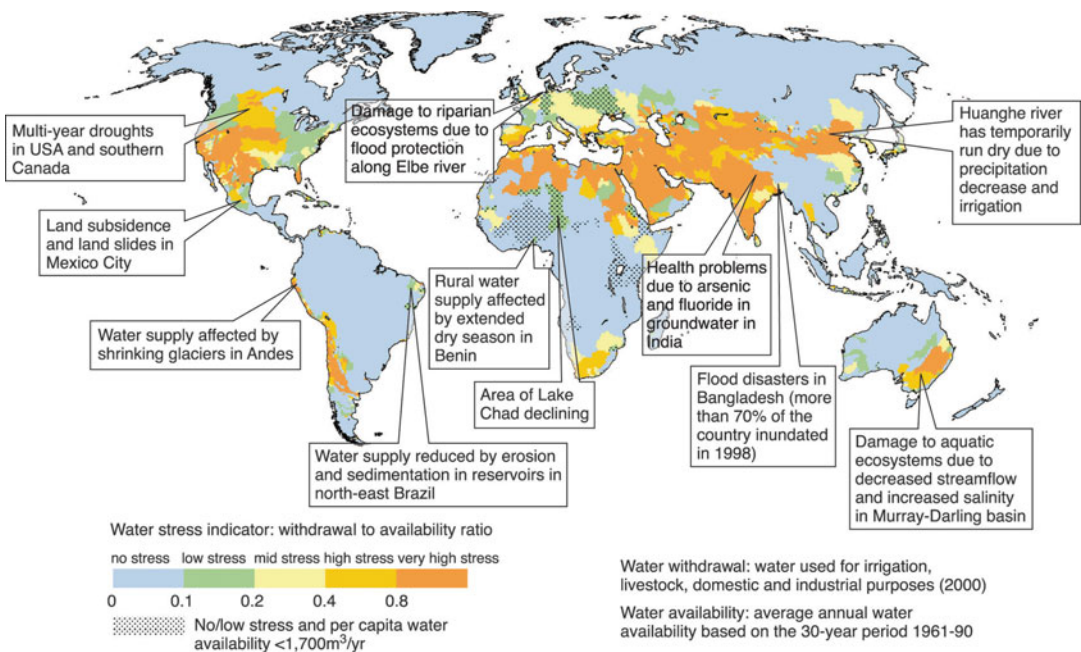
---

**Abstract** Recent years have witnessed an increase in global average air temperatures as well as ocean temperatures, as documented by the Intergovernmental Panel on Climate Change (IPCC). The rise in temperature is considered irrefutable evidence of climate change, and this has already started to have serious consequences for water resources and will have even more dire consequences in the future. Compounding these consequences are population growth, land-use changes and urbanization, increasing demands for water and energy, rising standards of living, changing dietary habits, changing agricultural practices, increasing industrial activities, increased pollution, and changing economic activities. All these will likely have adverse effects on water resources. This article briefly discusses climate change and its causes and impacts on water resources.

**Key Words** Climate change • Extreme events • Ecosystem • Water quality • Groundwater • Agriculture • Transboundary water problems • Adaptation to climate change.

## 1. INTRODUCTION

Water is vital for all forms of life and survival. Freshwater resources are limited, and therefore their protection and management are of utmost importance. Sustainable management of freshwater resources depends on an understanding of how climate, freshwater, and biophysical and socioeconomic systems are interconnected at different spatial scales: at watershed scales, at regional scales [1], and at a global scale [2]. Recently documented activities contributing to climate change can be a major challenge to the availability of freshwater quantity (too much or too less) or quality. These activities will play a critical role in sectorial and regional vulnerability to water resource mismanagement. Examples of vulnerabilities include multiyear drought in the USA and southern Canada, flood disasters in Bangladesh, ecosystem damage due to reduced stream flow in the Murray-Darling basin in Australia, and reduced water supply to reservoirs in northeastern Brazil. The use of water has increased manifold over recent decades due to the increase in population, industrialization, economic growth, energy production, changes in life style, and irrigation demand as global irrigated land has increased approximately from 140 million ha in 1961–1963 to 270 million ha in 1997–1999 [3]. On a global scale, basins are generally called water-stressed if they have a per-capita water availability below  $1,000 \text{ m}^3/\text{year}$  (based on long-term average runoff), and such water-stressed basins are located in Northern Africa, the Mediterranean region, the Middle East, the Near East, southern Asia, Northern China, Australia, the USA, Mexico, northeastern Brazil, and the west coast of South America [4, 5], as shown in Fig. 11.1.



**Fig. 11.1.** IPCC's Fourth Assessment Report shows the range of vulnerabilities that may be affected by future climate change, superimposed on a map of water stress (Source: IPCC [5], Fig. 3.2).

Therefore, the relationship between climate change and freshwater resources is of fundamental concern for the well-being of society.

Climate change leads to changes in the hydrologic cycle since different components of the climatic system, including the atmosphere, hydrosphere, cryosphere, land surface, and biosphere, are involved. Therefore, climate change affects water resources both directly and indirectly. The objective of this chapter is to highlight the impact of climate change on water resources. The chapter is organized as follows. Following a brief introduction to climate change in Sect. 2, Sect. 3 presents an overview of the evidence for climate change, followed by a discussion on the impact of climate change on different water resources sectors in Sect. 4. Section 5 reviews continental-scale impacts of projected climate change on water resources, and Sect. 6 discusses adaptation to climate change. The article is concluded in Sect. 7.

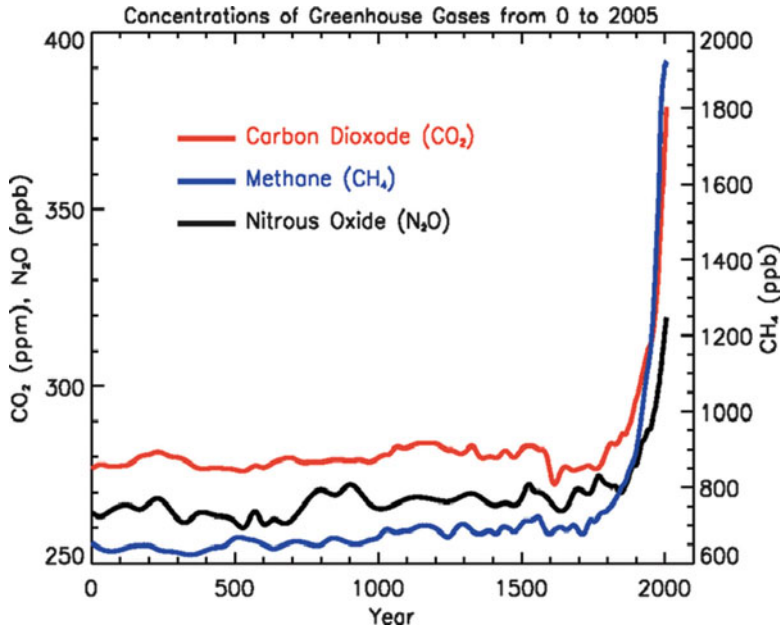
## **2. CLIMATE CHANGE**

### ***2.1. What Is Climate Change?***

Natural ecosystems are generally driven by climatic patterns of a region that can be quantified by understanding the patterns in hydrometeorological variables, such as temperature, precipitation, humidity, and wind. Climate change is defined by the Intergovernmental Panel on Climate Change (IPCC) as changes in the state of the climate that can be identified by changes in its properties and that persist for an extended period, typically decades or longer, due to natural internal processes or external forcing or to persistent anthropogenic changes in the composition of the atmosphere or in land use. Another definition, this one by the United Nations Framework Convention on Climate Change (UNFCCC), is as follows: “a change of climate which is attributed directly or indirectly to human activity that alters the composition of the global atmosphere and which is in addition to natural climate variability observed over comparable time periods.” The American Meteorological Society glossary (AMS Glossary) defines climate change as “any systematic change in the long-term statistics of climate elements (such as temperature, pressure, or winds) sustained over several decades or longer. Climate change may be due to natural external forcings, such as changes in solar emissions or slow changes in the Earth’s orbital elements; natural internal processes of the climate system; or anthropogenic forcing.”

### ***2.2. Causes of Climate Change***

The causes of climate change can be regarded as a complex interaction between Earth, atmosphere, ocean, and land systems; so the changes in any of these systems can be both natural and anthropogenic, based on changes in atmospheric concentrations of greenhouse gases (GHG), aerosol levels, land use and land cover, and solar radiation affecting the absorption, scattering, and emission of radiation within the atmosphere and at the Earth’s surface. Some of the important factors responsible for climate change are discussed in what follows.



**Fig. 11.2.** Atmospheric concentrations of important long-lived greenhouse gases over the last 2,000 years [7]. Concentration units are parts per million (ppm) and parts per billion (ppb).

### 2.2.1. Greenhouse Gases

One of the main causes of climate change are changes in Earth's atmosphere due to changes in the amounts of greenhouse gases, aerosols, and cloudiness. The anthropogenic increase in greenhouse gas emissions, not natural variability, is responsible for most of the warming in recent decades [6]. Since the start of the industrial era (ca. 1750), the overall effect of human activities on climate has been one of warming. The major greenhouse gases, for example, carbon dioxide (CO<sub>2</sub>), methane (CH<sub>4</sub>), nitrous oxide (N<sub>2</sub>O), and the halocarbons, are the result of human activities, and they accumulate in the atmosphere, and the concentration increases with time, as shown in Fig. 11.2 [7]. The major causes of the increase in CO<sub>2</sub> are the increased use of fossil fuel use in transportation, building heating and cooling, and the manufacture of cement and other goods. Human activities, such as agriculture, natural gas distribution, and landfills, result in increases in CH<sub>4</sub>, whereas the use of fertilizer and the burning of fossil fuels leads to increases in N<sub>2</sub>O. The increasing use of the principal halocarbons (chlorofluorocarbons) as refrigeration agents and in other industrial processes has been found to cause stratospheric ozone depletion.

### 2.2.2. Radiative Forcing

The energy balance of the Earth-atmosphere system can be measured based on radiative forcing, which is usually quantified as the rate of energy change per unit area of the globe as measured at the top of the atmosphere. The Earth-atmosphere system gets warmer when radiative forcing is positive; for negative radiative forcing, the energy will ultimately



decrease, leading to a cooling of the system. The major causes of forcing include increases in greenhouse gases; tropospheric ozone increases contributing to warming; stratospheric ozone decreases contributing to cooling; the influence of aerosol particles through reflection and absorption processes; the nature of land cover around the globe principally through changes in croplands, pastures, and forests; and persistent linear trails of condensation due to aircraft in regions that have suitably low temperatures and high humidity [7].

### 2.2.3. *Natural Processes*

The human impact on climate during this era greatly exceeds that due to known changes in natural processes, such as solar changes and volcanic eruptions. The original Milankovitch theory [8] identifies three types of orbital variation that could act as climate-forcing mechanisms: the obliquity or tilt of the Earth's axis (which affects the distribution of insolation in space and time), the precession of the equinoxes, and the eccentricity of the Earth's orbit around the Sun. The other natural processes are volcanic eruptions that release huge amounts of gases by reducing the amount of solar radiation reaching the Earth's surface, lower temperatures, and change atmospheric circulation patterns, whereas tectonic movements generate both atmospheric circulation changes and greenhouse feedback, directly or indirectly.

## 2.3. *Debate on Climate Change*

The increase in the average surface temperature by the end of the twentieth century due to emissions of anthropogenic greenhouse gases (GHGs) have already reached the critical threshold for many elements of the climate system [9]. Current climate policy emphasizes undertaking sustainable measures on long-term reductions of CO<sub>2</sub>, and even when CO<sub>2</sub> emissions end, climate change is largely irreversible for 1,000 years [10]. A number of forums and institutions have been established to develop actions for mitigating the adverse impact of climate change. For example, the UNFCCC was created in 1992 to provide a framework for policymaking to mitigate climate change by the stabilization of atmospheric greenhouse gases at a sufficiently low level to prevent dangerous anthropogenic effects on the climate. The countries that are parties to the Kyoto Protocol—excluding the countries of the former Soviet Union whose economies are in transition—had increased their emissions by 9.9 % above the 1990 levels by 2006 [11].

The Kyoto Protocol, formed in 1997 and considered to be a milestone document in international climate change policy, for the first time established legally binding limits for industrialized countries on emissions of carbon dioxide and other greenhouse gases [12]. For example, national targets range from 8 % reductions for the European Union and some others to 7 % for the USA, 6 % for Japan, and 0 % for Russia; it permits increases of 8 % for Australia and 10 % for Iceland. International initiatives where the threat of climate change is considered to be the greatest challenge facing humanity include the Montreal Protocol, considered to be the most successful environmental treaty, which calls for reducing almost 100 ozone-depleting chemicals by 97 % [13], and recent forums, including the Bali Road Map of 2007 and the 2009 Copenhagen Accord.

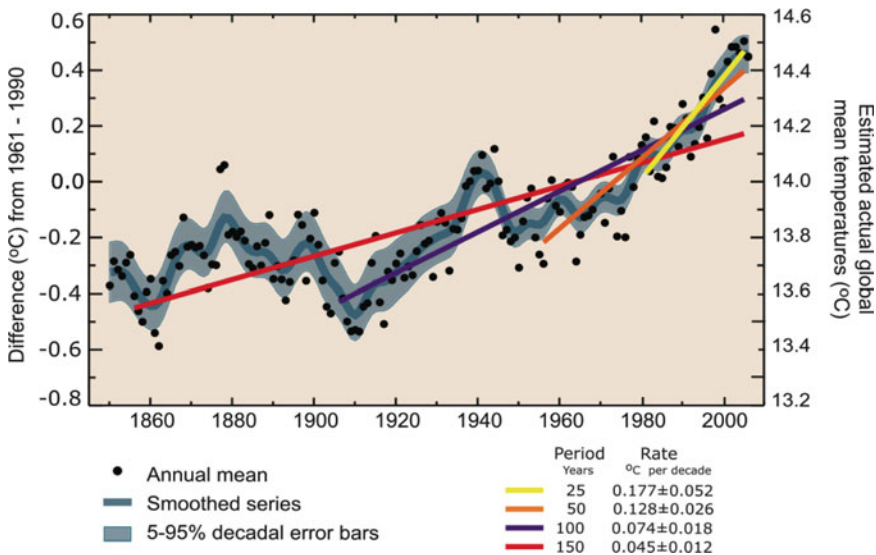
### 3. EVIDENCE OF CLIMATE CHANGE

The following section discusses the changing patterns of temperature and precipitation during the twentieth century as evidence of climate change.

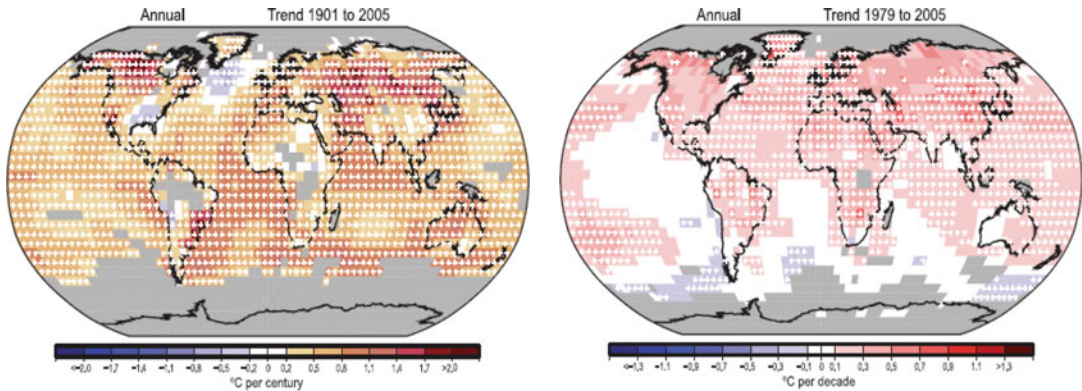
#### 3.1. Increases in Temperature

In its fourth assessment report, the IPCC unequivocally states that the Earth’s climate is warming [14]. During the last century, the Earth warmed by roughly 0.6 °C, with most of the warming occurring during the period 1920–1940 and during the last 30 years. An increase has been noted in the Earth’s surface and atmospheric temperature but this warming is not evenly distributed across the globe. Land masses are warming faster than oceans. Higher northern latitudes have seen larger increases, and the average temperature of the Arctic has risen by almost twice the global average rate in the past 100 years [14]. Several places, including mountaintops, have seen losses in ice cover. Expressed as a global average, surface temperatures have increased by approximately 0.74 °C over the past 100 years (between 1906 and 2005), with an increase (0.35 °C) occurring in the global average temperature from the 1910s to the 1940s, followed by a slight cooling (0.1 °C), and then a rapid warming (0.55 °C) up to the end of 2006 (Fig. 11.3) [15]. It is worth noting that for shorter recent periods, the slope is greater, indicating accelerated warming.

A number of research groups around the world have produced estimates of global-scale changes in surface temperature [16], for example, the retreat of mountain glaciers on every continent [17], reductions in the extent of snow cover, earlier blooming of plants in spring,



**Fig. 11.3.** Annual global mean observed temperatures (*black dots*) along with simple fits to the data; *left-hand axis*: anomalies relative to 1961–1990 average; *right-hand axis*: estimated actual temperature (°C) [15].



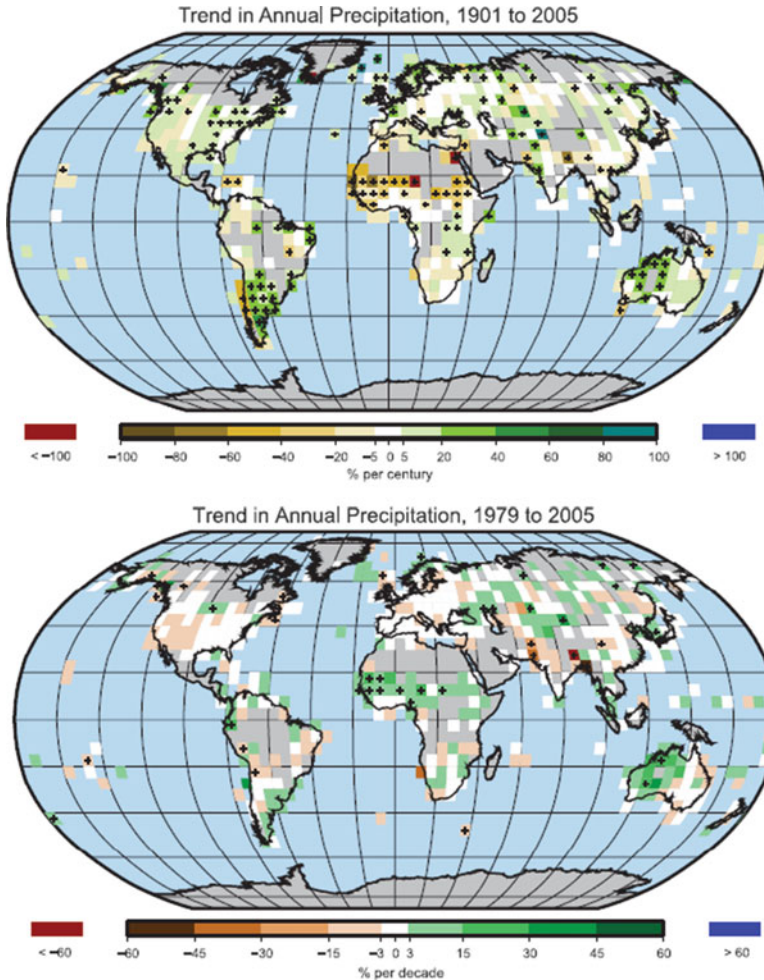
**Fig. 11.4.** Linear trend of annual temperatures for 1901–2005 (*left*) ( $^{\circ}\text{C}$  per century) and 1979–2005 (*right*) ( $^{\circ}\text{C}$  per decade) [15].

and increased melting of the Greenland and Antarctic ice sheets [18]. Many studies are in general agreement with long-term temperature variations [15], including the operational version of the Global Historical Climatology Network (GHCN), the National Climatic Data Center (NCDC) [19], the National Aeronautics and Space Administration's (NASA's) Goddard Institute for Space Studies (GISS) [20], and improved analysis of CRU/Hadley Centre gridded land-surface air temperature version 3 (CRUTEM3) [21, 22].

The spatial pattern of changes in the annual surface temperature for 1901–2005 and 1979–2005 is shown in Fig. 11.4 [15], where differences in trends between locations can be large, particularly for shorter time periods; based on the century-long period, warming is statistically significant over most of the Earth's surface. Based on data compiled from 20 sources, including Global Historical Climatology Network, and two editions of world weather records, from 1950 to 2004, the annual trends in minimum and maximum land-surface air temperature averaged over regions were  $0.20\text{ }^{\circ}\text{C}$  per decade and  $0.14\text{ }^{\circ}\text{C}$  per decade, respectively, with a trend in the diurnal temperature range of  $-0.07\text{ }^{\circ}\text{C}$  per decade [23]. Based on the reconstructed annual Northern Hemisphere mean temperature series, the warmth of the 1990s (3 years in particular: 1990, 1995, and 1997) was unprecedented in at least the past 600 years [24], taking into account the self-consistently estimated uncertainties in the reconstruction back to AD 1400.

### 3.2. Changes in Precipitation Patterns

The increase in evaporation due to the rise in temperature has led to more precipitation [7], which generally increased over land located north of  $30^{\circ}\text{N}$  from 1900 to 2005 but has mostly declined over the tropics since the 1970s, and globally there has been no statistically significant overall trend in precipitation over the past century, with a wide variability in patterns by region and over time. Spatial patterns of trends in annual precipitation (as a percentage per century or per decade) during the periods 1901–2005 and 1979–2005 are shown in Fig. 11.5 [15]; the observations include the following: (1) in most of North America,



**Fig. 11.5.** Trend of annual land precipitation amounts for 1901–2005 (*top*) (percentage per century) and 1979–2005 (*bottom*) (percentage per decade) [15].

and especially over high-latitude regions in Canada, annual precipitation has increased, and the primary exception is over the southwestern parts of the USA, northwestern Mexico, and the Baja Peninsula, where drought has prevailed in recent years; (2) across South America, increasingly wet conditions were observed over the Amazon Basin and southeastern South America, including Patagonia, while negative trends in annual precipitation were observed over Chile and parts of the western coast of the continent; and (3) the largest negative trends in annual precipitation were observed over West Africa and the Sahel.

Global annual mean precipitation is constrained by the energy budget of the troposphere, and extreme precipitation is constrained by the atmospheric moisture content [25]; changes in extreme precipitation are greater than those in mean precipitation. Similarly, based on the physical mechanisms governing changes in the dynamic and thermodynamic components of

mean and extreme precipitation, a greater percentage increase in extreme precipitation versus mean precipitation was observed in models [26]. Several other findings include the following: a higher increase in tropical precipitation intensity due to an increase in water vapor, while mid-latitude intensity increases are related to circulation changes that affect the distribution of increased water vapor [27]; the most intense precipitation occurring in warm regions [28]; higher temperatures leading to a greater proportion of total precipitation in heavy and very heavy precipitation events with no changes in total precipitation [29]; increases in total precipitation, with a greater proportion falling in heavy and very heavy events if the frequency remains constant, as demonstrated empirically [30] and theoretically [31]; rises in temperature that are likely to increase the moisture content faster than the total precipitation, which is likely to lead to an increase in the intensity of storms [32]; increases in observed extreme precipitation over the USA, where the increases are similar to changes expected under greenhouse warming (e.g., [33, 34]).

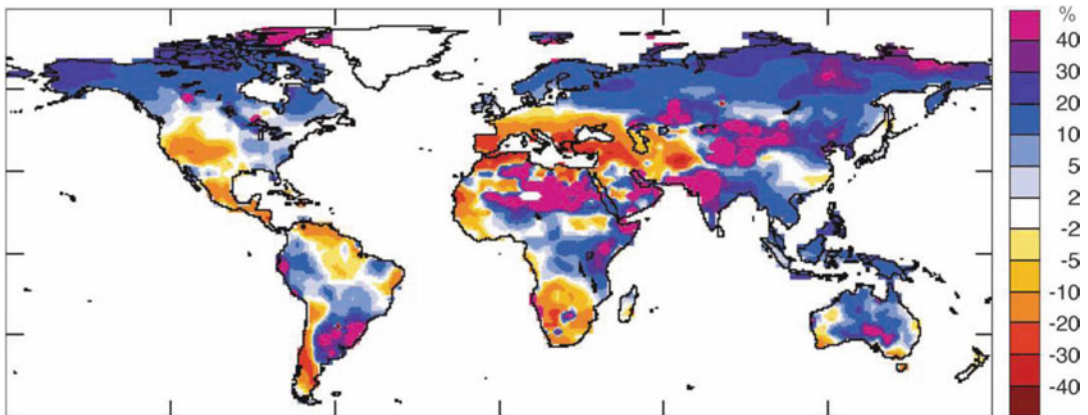
#### 4. IMPACTS OF CLIMATE CHANGE ON WATER RESOURCES

Water resources are sensitive to variations in climatic patterns. It is believed that there will be changes in the water resources sector due to climate change, which is discussed in the following section.

##### 4.1. Runoff

Current observations and climate projections suggest that one of the most significant impacts of climate change will likely be on the hydrological system and, hence, on river flows and regional water resources [5, 35]. Variability in climate causes flooding patterns in space and time. During the twentieth century several studies examined potential trends in measures of river discharge at different spatial scales, some detected significant trends in several indicators of flow, and some demonstrated statistically significant links with trends in temperature or precipitation [5]. In addition, human interventions have affected flow regimes in many catchments at the global scale, and there is evidence of a broadly coherent pattern of change in annual runoff, with some regions experiencing an increase in runoff (e.g., high latitudes and large parts of the USA) and others (such as parts of West Africa, southern Europe and southernmost South America) experiencing a decrease in runoff [5, 36].

Some of the changes in runoff described in studies during the twentieth century include widespread increases in runoff largely due to the suppression of evapotranspiration by increasing CO<sub>2</sub> concentrations [37]; in addition, based on a 30-year running averaged streamflow, a linearly increasing pattern in four major river basins in southeastern South America was observed after the mid-1960s, but not the same in all rivers [38]. Increasing streamflow has been observed in the USA since 1940, though these increases have not been uniform across the range of annual streamflows, nor have they been uniform geographically or seasonally, as reported by the USGS using a variety of approaches [39–41]. Regions that have experienced the most widespread increases are the Upper Mississippi, Ohio Valley, Texas-Gulf, and the Mid-Atlantic. Fewer trends were observed in the South Atlantic Gulf region,



**Fig. 11.6.** Change in annual runoff by 2041–2060 relative to 1900–1970, in percentage, under SRES A1B emissions scenario [36, 54].

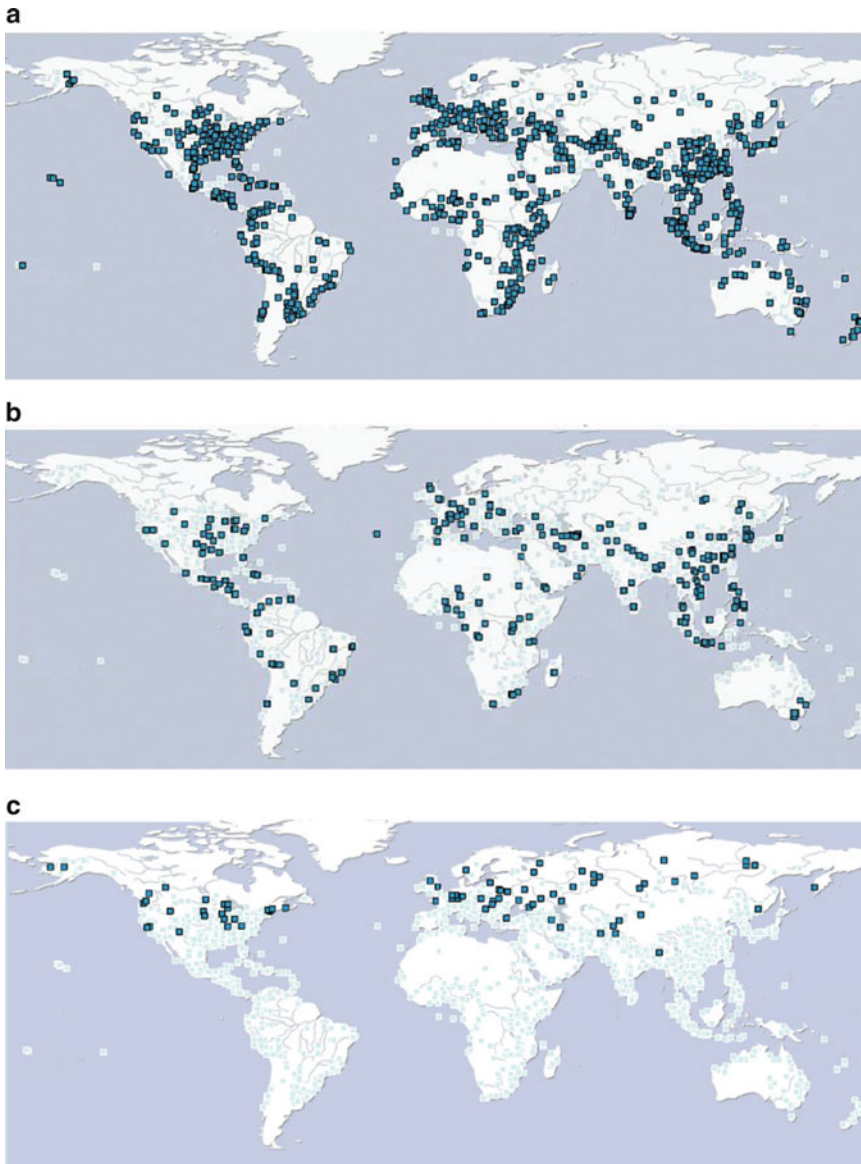
Missouri, and regions of the far West. The Pacific Northwest and the South Atlantic Gulf actually had a number of streamflow decreases, particularly in the lowest percentiles.

Long-term shifts in the timing of streamflow have been observed for snowmelt-dominated basins throughout western North America since the late 1940s [42, 43]. These shifts represent an advance to earlier streamflow timing by 1–4 weeks in recent decades relative to conditions that prevailed in the 1950s through the mid-1970s, and the evidence for the shift includes earlier snowmelt onsets and advances in the center of mass of the annual hydrograph, which is called center timing [44]. Several researchers have highlighted an increasing runoff trend, especially in winter and spring seasons, over the past several decades in most northern rivers, including the largest arctic rivers in Siberia [45–47]. The causes of spring discharge increase in Siberian regions are primarily due to earlier snowmelt associated with climate warming during the snowmelt period [47, 48], reduction in permafrost area extent, and an increase in active layer thickness under warming climatic conditions [48, 49].

Based on the IPCC Special Report on Emissions Scenario (SRES) A1B from an ensemble of 24 climate model runs, the mean runoff change until 2050 is shown in Fig. 11.6 [36]. Major observations include runoff change in the high latitudes of North America and Eurasia, with increases of 10–40 % and of decreasing runoff (by 10–30 %), and in the Mediterranean, southern Africa, and western USA/northern Mexico. In general, between the late twentieth century and 2050, the areas of decreased runoff will expand [36].

## 4.2. Floods

Floods cause significant damage to the economies of affected areas, and this is considered to be one of the commonly occurring natural hazards around many parts of the world due to the impact of climate change [50]. The causes of flooding are many and include heavy rainfall, torrential rain, and snowmelt; their spatial locations since 1985 are shown in Fig. 11.7. Severe floods from high rainfall (of long or short duration) have occurred in almost all humid regions of the world, as well as some semiarid zones. Tropical storms (known as hurricanes, cyclones,



**Fig. 11.7.** Spatial distribution of extreme floods from three different causes listed by Dartmouth Flood Observatory since 1985. (a) Heavy rain (b) Brief torrential rain (c) Snowmelt (Source: <http://www.dartmouth.edu/~floods/archiveatlas/floodcauselocation.htm>).

or typhoons) are more concentrated in distribution, with hotspots around the western Pacific coasts, the Caribbean, southeastern USA, and the Bay of Bengal. The common cause of flooding in India is the tremendous impact of monsoonal rain, which causes levy breaks. Intense rainfall of long duration induced extreme flooding in five countries of central and Eastern Europe in August 2002 [51].

Detecting anthropogenically forced changes in flooding is difficult due to the substantial natural variability; land-use changes on flow regime further complicate the issue. For example, changes in the risk of great floods, that is, floods with discharges exceeding a 100-year return period from basins larger than 200,000 km<sup>2</sup> using both streamflow measurements and numerical simulations of anthropogenic climate change, and the frequency of great floods increased substantially during the twentieth century [52]. On the global scale the number of great inland flood catastrophes during the last 10 years (between 1996 and 2005) is twice as large, per decade, as between 1950 and 1980, while economic losses have increased by a factor of 5 [53]. However, a warmer climate, with its increased climate variability, will increase the risk of flooding [54].

### 4.3. Drought

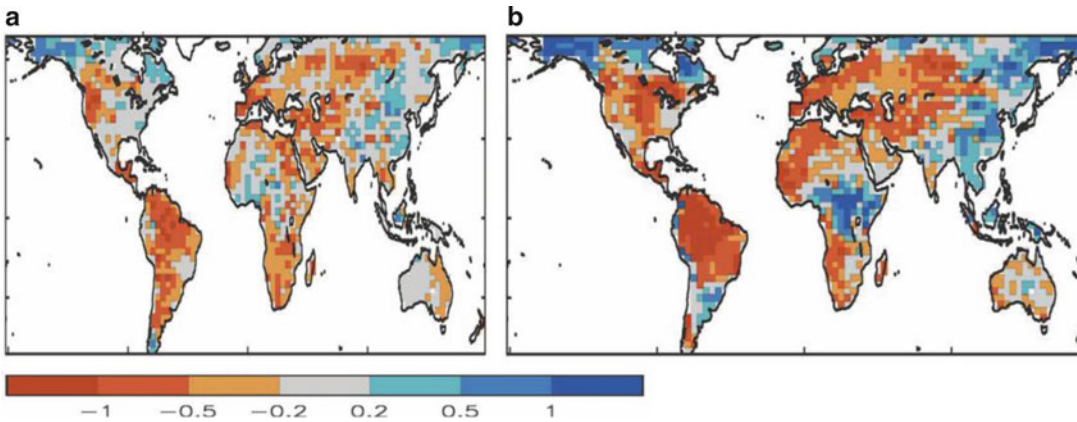
Of twentieth century natural hazards, droughts have had the greatest detrimental impact [55, 56], and large-scale intensive droughts have been observed on all continents in recent decades affecting large areas in Europe, Africa, Asia, Australia, South America, Central America, and North America [57].

During the past two centuries, at least 40 long-duration droughts have occurred in Western Canada. In southern regions of Alberta, Saskatchewan, and Manitoba, multiyear droughts were observed in the 1890s, 1930s, and 1980s [58]. The drought situation in many European regions has already become more severe [59]. It is observed that during the past 30 years, Europe has been affected by a number of major drought events, most notably in 1976 (Northern and Western Europe), 1989 (most of Europe), 1991 (most of Europe), and, more recently, the prolonged drought over large parts of Europe associated with the summer heat wave in 2003 [60]. The impacts of droughts in the USA has increased significantly with the increased number of droughts or increase in their severity [61, 62]. Based on the data available from the NCDC, USA (2002), nearly 10 % of the total land area of the United States experienced either severe or extreme drought at any given time during the last century.

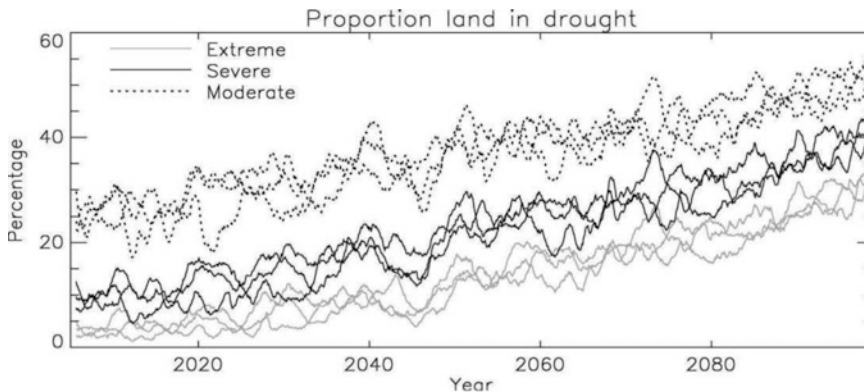
Frequent severe droughts during 1997, 1999, and 2002 in many areas of Northern China caused significant economic and societal losses [63]. The severe drought of 1997 in Northern China resulted in a period of 226 days with no streamflow in the Yellow River, which is the longest drying-up duration on record. There has also been an increased risk of droughts since the late 1970s as global warming progresses and produces both higher temperatures and increased drying [64]. In addition, drought is a recurring theme in Australia, with the most recent, the so-called millennium drought, now having lasted for almost a decade [65].

Several investigators have highlighted more drought episodes in the twenty-first century. Using 15 coupled models from the IPCC AR4 simulations under the SRES A1B scenario, the general drying over most of the planet's land, except parts of the northern mid- and high-latitude regions during the nongrowing season, points to a worldwide agricultural drought by the late twenty-first century [66]. All of the eight AR4 models show a decrease in soil moisture for all scenarios, with a doubling of both the spatial extent of severe soil moisture deficits and frequency of short-term (4–6 months in duration) droughts from the mid-twentieth century to the end of the twenty-first century, while long-term (>12 months)





**Fig. 11.8.** Trend in PDSI-PM per decade for (a) ensemble mean of first half of twenty-first century and (b) ensemble mean of second half of twenty-first century projected by SRES A2 [68].



**Fig. 11.9.** Proportion of land surface in drought for twenty-first century based on results from A2 emissions scenario [68].

droughts will become three times more common [67]. Based on the Palmer drought severity index calculated using the Penman–Monteith potential evapotranspiration (PDSI-PM) as the drought index, the spatial distribution of drought was obtained by calculating the trend in the PDSI-PM per decade at each point using the A2 ensemble (Fig. 11.8) [68]. The observation predicts drying over Amazonia, the United States, Northern Africa, Southern Europe, and Western Eurasia and wetting over Central Africa, Eastern Asia, and high northern latitudes. There is an overall drying trend with a decrease in the global average PDSI of 0.30/decade projected for the first half of the twenty-first century, while the rate of drying over the second half of the twenty-first century increases, with the PDSI-PM decreasing by 0.56/decade. There is a projected increase in the proportion of the land area under drought over the twenty-first century, and this increase continues throughout the twenty-first century (Fig. 11.9) [68]. The reader may consult [56] to gain a better understanding of drought concepts and [69] for drought under climate change scenarios.

#### 4.4. Snowmelt and Glacier Melt

Many major river systems around the world are fed by snowpack and melting glaciers, and global warming is likely to have an appreciable impact on snowmelt and associated runoff. Glaciers are sensitive to every hydrological variable, including precipitation, humidity, and wind speed, but mostly to temperature, and hence are a good indicator of global warming. There is clear evidence of glacier retreat on every continent, with global warming having a noticeable influence [70]. High-latitude and high-altitude rivers may experience an increase in discharge despite a decrease in precipitation resulting from the melting of glaciers [71, 72]. The change in volume and timing of discharge may cause significant fluvial geomorphological changes in rivers, including channel enlargement and incision, higher sinuosity, increased bank erosion, and faster channel migration [73].

The European Alps have lost between 30 and 40 % in surface area and around half of its volume since the Little Ice Age, and this loss has accelerated in the late twentieth century [70]. The Bolivian Andes lost two-thirds of their volume and 40 % in average thickness between 1992 and 1998 and may disappear within 15 years if the current trend persists [74]. In North America, varying gains and losses have been observed in three glaciers—South Cascade Glacier in the Pacific Northwest and Wolverine and Gulkana glaciers in Alaska [75]. In the Himalayas, depending on the location and time period, glaciers have been observed both retreating and advancing at varying rates. Nevertheless, the system has suffered a net overall decrease in glacier area and thickness during the last century [76]. The Gangotri Glacier, for example, which forms the headwaters of the Ganges River, has shrunk by 1.5 km over 69 years but is currently retreating at a slower rate [77].

The Alaskan glacier has been shrinking by  $52 \pm 15 \text{ km}^3/\text{year}$ , adding about  $0.14 \pm 0.04 \text{ mm/year}$  to sea level during the period from the mid-1950s to the mid-1990s [78]. For the period from the mid-1990s to 2000–2001 the Alaskan glaciers have been thinning at a faster rate, equating to a volume loss of  $96 \pm 35 \text{ km}^3/\text{year}$  and a sea level rise of  $0.27 \pm 0.10 \text{ mm/year}$ . Subpolar glaciers, for the period 1961–1997, have shrunk by 147 mm/year on average, representing a total volume of  $3.7 \times 10^3 \text{ km}^3$  [79]. Associated sea level rise has been estimated at 0.51 mm/year for the period 1961–2003, with the rate for 1994–2003 being 0.93 mm/year, signifying faster melting [80].

In the alpine regions, studies based on scenarios project further glacier retreat [81] and loss in thickness, while small glaciers may disappear in the near future [74]. A similar dreadful future has been predicted for the Rockies [82], Himalayas [83, 84], Andes [85], and Australian Alps [86]. A more recent study utilizing a global glacier model coupled with a land surface and hydrological model showed large-scale glacier mass loss in Asia, Europe, Canadian Arctic islands, and Svalbard [87], and the mass loss has increased dramatically since 1990, resulting in an increase in sea level by 0.76 mm/year.

The societal impacts of retreating glaciers are hard to quantify. Major rivers fed by glacial melt sustain agriculture, domestic water needs, and water stored in dams for hydroelectric production. If the appropriate infrastructure is not put in place, the additional water issuing from melting glaciers may lead to devastating floods, or droughts as the timing of the runoff changes. The costs for additional power capacity to cope with retreating glaciers in Peru are estimated to be around US\$1 billion per gigawatt [88].

#### 4.5. Water Quality

There has been an increase in temperature as observed in the past century, and climate change models also predict increasing temperatures. Warmer temperatures can affect water quality in several ways, including decreased dissolved oxygen levels, increased contaminant load to water bodies, reduced stream and river flows, increased algal blooms, and an increased likelihood of saltwater intrusion near coastal regions. Acid rain is one of the primary reasons for degrading water quality, and the principal cause of this is sulfuric and nitrogen compounds from human actions, and variations in streamflow characteristics will alter the transport of chemical loads in rivers. Due to low flows in rivers, the dilution process between water and waste will be affected, which can increase the mineralization of organic nitrogen in soil.

Warmer water holds less oxygen, so global warming would lead to lower dissolved oxygen contents. An increase in runoff and erosion due to greater precipitation intensity will result in increased pollutant transport. Several other factors influencing water quality include soil, geological formations and terrain in catchment areas (river basins), surrounding vegetation, human activities, precipitation and runoff from adjacent land, and biological, physical, and chemical processes in water.

Studies reveal a rise in surface water temperature since the 1960s in Europe, North America, and Asia of between 0.2 and 2 °C, which is mainly due to atmospheric warming in relation to solar radiation increases [5, 89]. For example, after the severe drought of 2003, there was an average increase in water temperature of around 2 °C, in the Rhine and Meuse Rivers causing a decrease in a decrease in dissolved oxygen (DO) [90]. The stratified period has lengthened by 2–3 weeks due to a rise in temperature of 0.2–1.5 °C in several lakes in Europe and Northern America, which affects thermal stratification and lake hydrodynamics [89].

Many factors that are influenced by climate change, including air temperature, rainfall intensity, atmospheric CO<sub>2</sub> (increase) and acid deposition (decrease) levels, have shown significant dissolved organic carbon (DOC) increases in Northern Europe [91–93], Central Europe [94], and North America [92].

Changes in weather patterns have a significant impact on nutrient loading [95]. A warmer climate affects water bodies, leading to increased nutrients loads in surface and groundwater [90]. Rainfall patterns, including seasonality and intensity, along with increased air temperatures, are the main drivers for changing the fate and behaviors of pesticides [96].

Several studies investigated the impact of climate change on water quality in future decades. An increase in water temperature of around 2 °C by 2070 in European lakes, depending on the lake characteristics and the season, would place shallow lakes at the highest risk of being adversely affected by climate change [97, 98]. In addition, the residence time of lakes would probably increase in summer by 92 % in 2050 for lakes with short residence times [97]. The deepest lakes are most sensitive to climate warming over a long period of time due to their greater heat storage capacity and will consequently show the highest winter temperatures [97]. An increase in water temperature would also affect lake chemical processes with

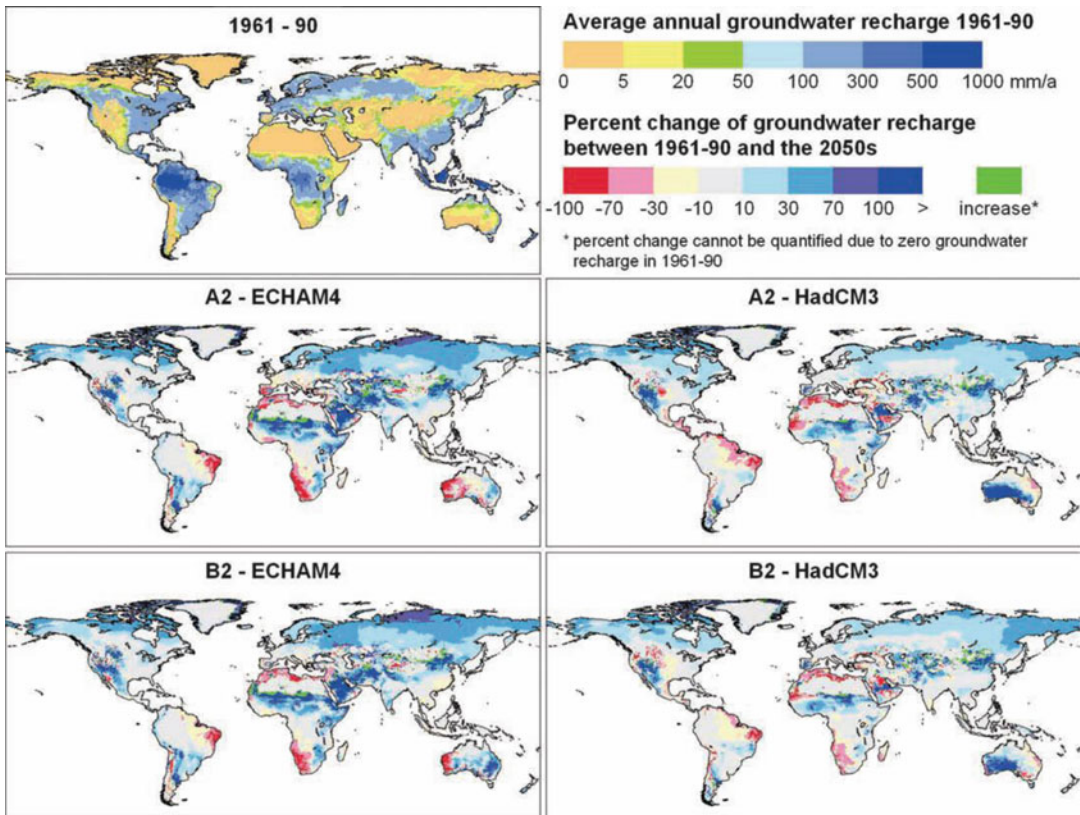
increases in pH and greater in-lake alkalinity generation [99]. Higher nitrate concentration in rivers can occur due to an increase in summertime frequency, which might lead to a gradual mobilization of nitrates in soils that would be flushed into streams at the beginning of the wet seasons [100]. Other studies have pointed to increases in nitrate concentration in the Seine basin aquifer layers for the years 2050 and 2100 due to an increase in precipitation and, consequently, in soil leaching [101] and a 40–50 % increase in nitrate flux by 2070–2100 in a Norwegian river basin due to an increase in precipitation and, consequently, in soil leaching [102].

#### 4.6. Groundwater

Global warming will likely affect groundwater resources by altering precipitation and temperature patterns, which will likely be further aggravated by overexploitation. Based on NASA's Gravity Recovery and Climate Experiment (GRACE) twin satellites [103], the groundwater in the states of Rajasthan, Punjab, and Haryana in India is declining at a rate of 33 cm/year. Similar studies in the United States showed that groundwater in the San Joaquin Valley in California has been dropping by 60–150 cm over the last 5 years [104]. Groundwater recharge is affected by land-use and land-cover change, urbanization, loss in forest cover, changes in cropping patterns and rotation, and changes in soil properties occurring over a long period of time that may affect infiltration capacity.

The recharge dynamics of the Edwards Balcones Fault Zone Aquifer in Texas, USA, based on climate change, coupled with water requirements for the year 2050, are such that climate change would result in an increase in the springflow for that area, but growing demand will be the major factor of concern for the aquifer [105]. A study on the effect and resulting change in the hydrological cycle in Bièvre-Valloire in Grenoble [106], due to a doubling in CO<sub>2</sub> and its ensuing effect on groundwater recharge, it was found that global warming would not cause a major change in rainfall patterns but may result in a large increase in evaporation and a decrease in recharge. Further, changes in land use land cover and changes in precipitation regimes (flash rainfall instead of drizzles) could alter runoff patterns and further reduce recharge.

Based on the four climate scenarios, the computed groundwater recharge decreases dramatically by more than 70 % in northeastern Brazil, southwest Africa, and along the southern rim of the Mediterranean Sea (Fig. 11.10) [54, 107]. Regions with groundwater recharge increases of more than 30 % by the 2050s include the Sahel, the Near East, Northern China, Siberia, and the western USA. Understanding the future concerns of groundwater resources, UNESCO-IHP (International Hydrological Programme) has established the Groundwater Resources Assessment under the Pressures of Humanity and Climate Changes (GRAPHIC) project to study the interaction between groundwater and the global water cycle, how it supports ecosystems and humankind, and the threats posed by a growing population and climate change [108]. The study will be carried out on every continent and will make use of various recent technologies in assessing and monitoring changes to groundwater, including GRACE.



**Fig. 11.10.** Simulated impact of climate change on long-term average annual diffuse groundwater recharge based on percentage changes of 30-year average groundwater recharge between present day (1961–1990) and 2050s (2041–2070) based on four different climate change scenarios [54, 107].

#### 4.7. Transboundary Problems

A remote sensing study showed that 261 river basins, covering 45.3 % of the land surface of the Earth (excluding Antarctica), extends beyond political boundaries and are shared by two or more countries [109]. These basins carry around 60 % of the surface water flows and are home to 40 % of the world's population. The sharing of a watercourse has, due to its sensitive nature, given rise to several instances for concern and has created opportunities for either conflict or cooperation. Several nations have conceded that it is not in their interest to wage war over water and have, even in the event of hostility associated with other issues, managed to successfully work toward agreements and treaties. There exist more than 300 treaties dealing with a wide array of nonnavigational uses of water in international basins [109]. In the last 50 years alone, no less than 157 treaties have been negotiated [110]. Nevertheless, the potential for conflict has not yet been eliminated.

Four general theories have inspired legislators in debates around the nonnavigational uses of international watercourses [111], namely, absolute territorial sovereignty, absolute

territorial integrity, limited territorial sovereignty, and the concept of community of interests. Global warming is perceived by many as a new threat to relations over transboundary basins because it interferes with the hydrological cycle, influencing the timing, quantity, and even quality of both surface and groundwater. The IPCC, in its Third Assessment Report [112], states that

...where there are disputes, the threat of climate change is likely to exacerbate, rather than ameliorate, matters because of uncertainty about the amount of future resources that it engenders. One major implication of climate change for agreements between competing users (within a region or upstream versus downstream) is that allocating rights in absolute terms may lead to further disputes in years to come when the total absolute amount of water available may be different.

The following section highlights some examples of the impact of climate change on transboundary rivers.

#### 4.7.1. Nile River Basin

The Nile is the world's longest river and is transboundary to 11 countries in Africa. It drains approximately 3.3 million km<sup>2</sup> and is home to 160 million people. The river has been subject to a number of treaties, some dating back to colonial times [113]. The Nile Basin Initiative (NBI), a relatively new effort among 9 of the 11 riparian countries, puts the concept of community of interests into action. The basin has been the subject of a number of papers on the effect of climate change. Based on a water balance model for 12 subcatchments of the Nile, the effect of climate change for five different General Circulation Model (GCMs) [114] highlights the higher flows in equatorial Africa and the expansion of the Sudd swamps, and, depending on the GCM used, the response on the Ethiopian highlands of the Blue Nile and Atbara basins varied.

#### 4.7.2. Danube River Basin

The Danube River Basin is the second longest river in Europe and is one of the most international river basins. It is shared among ten countries and is home to 85 million people. The basin is already threatened because it faces deteriorating water quality and ecological problems due to its heavy use of electricity generation [116]. With global warming, the flow in the Danube may decrease by 16 % toward the end of the century [117]. A reduction in flow will exacerbate the water quality problem. A Danube River Basin Management Plan has been formulated to address the impact of climate change and water quality issues in the river to ensure satisfactory socioeconomic development without further threatening the ecology of the river [118].

#### 4.7.3. Rio Grande Basin

The Rio Grande or Río Bravo del Norte is a transboundary river between three states within the United States and between the United States and Mexico. The river is fed by snow melt from the Rockies and runs through arid and semiarid areas. The water in the river is overallocated, and on several instances it has not made it to the Gulf of Mexico. By the

time the river reaches the Presidio, along the Texas Mexico border, the flow is almost negligible and is restored by water from the Río Conchos, a Mexican tributary. Predictions from climate models suggest that this region will become drier and droughts will be more frequent. The effect of climate change using five GCMs and two emission scenarios (A2 and A1B) on the Río Conchos will be a decrease in precipitation, which will result in a reduction in flow at the basin outlet in Ojinaga by approximately 18 % [119]. Winter and summer flows are expected to decrease by 25 % toward the end of the century.

#### **4.8. Agriculture**

The agricultural sector is a contributor to greenhouse gas emissions due to land conversion, including deforestation, tillage and burning practices, volatilization of organic and inorganic fertilizers, and methane emission from ruminant livestock and paddy rice cultivation. Globally, carbon dioxide emissions from land-use change (approximately 1,600 million tons C/year), largely driven by agricultural expansion, grew most rapidly in the period 1950–1970. Also, agriculture is the major anthropogenic source of methane, a gas with very high global warming potential [120, 121].

Approximately 70 % of the world's freshwater use goes to agriculture, and already some 30 developing countries are facing water shortages; by 2050 this number will increase to some 55 countries, the majority in the developing world [122]. This water scarcity, together with the degradation of arable land, could become the most serious obstacle to increasing food production. The vulnerability of agricultural sectors to climate change is mainly due to changes in precipitation and temperature, and, consequently, the likely impacts on the agricultural sector have prompted concern over the magnitude of future global food production [123]. Many countries are agriculture dependent; therefore, climate change could create a linkage between the agricultural sector and poverty and is likely to affect many developing countries. For example, in Africa, it is estimated that nearly 60–70 % of the population is dependent on the agricultural sector for employment, and this sector contributes on average nearly 34 % to the gross domestic product (GDP) per country, whereas in the case of the West African Sahel alone, more than 80 % of the population is involved in agriculture and stock farming in rural areas [124]. Findings of several investigations highlight that the degree of vulnerability of the agricultural sector depends on local biological conditions, moisture content, cropping patterns, extent of knowledge, and awareness of expected changes in the climate, and the increased uncertainty of climate effects represents an additional problem that farmers must address.

Human-induced climate change has the potential to substantially alter agricultural systems [125–127]. Climate change will affect agricultural productivity characterized mainly by five factors, including changes in precipitation, temperature, carbon dioxide (CO<sub>2</sub>) fertilization, climate variability, and surface water runoff [128]. However, precipitation and temperature will have direct effects as these combinations are useful for determining the availability of freshwater and the level of soil moisture, which are critical inputs for crop growth. Also, higher precipitation leads to a reduction in yield variability [129], and higher precipitation will reduce the yield gap between rainfed and irrigated agriculture, but it may also have a

negative impact if extreme precipitation causes flooding [130]. The combination of temperature and soil moisture determines the length of the growing season and controls crop development and water requirements; however, in arid and semiarid areas, higher temperatures will shorten the crop cycle and reduce crop yields [131].

Several studies have been carried out to assess crop yield based on climate change impacts. Based on a statistical model using 22 climate models and three IPCC global emissions scenarios (A1B, A2, and B1), temperature increases of  $\sim 1\text{--}3$  °C would reduce yields of three temperate-zone California perennials (almond, walnut, and table grapes) by 2050, even without consideration of possible impacts on irrigation water availability [132]. Similarly, climate-change-induced drought episodes affect agricultural productivity; for example, periodic drought in the Yakima basin will lead to substantial reductions in crop yields and increases in economic risk both in dry years under the current climate scenario and in a future climate with 2 °C warming and no change in annual precipitation [133].

Some studies have investigated crop productivity for Europe, where an overall increase in crop productivity is anticipated as a result of climate change and increased atmospheric carbon dioxide (CO<sub>2</sub>); however, because of technological developments, wheat yields will increase by 37–101 % by the 2050s, depending on the scenario [134]. However, air pollution could also reduce crop yields since tropospheric ozone has negative effects on biomass productivity [135, 136]. Also, annual temperature increases may lead to a longer crop (and grass) growing season and vegetative growth and cover, particularly in Northern Europe [137]. Negative impacts in Northern Europe could include increased pest and disease pressures and nutrient leaching and reduced soil organic matter (SOM) content [138]. There could be an increasing demand for water for crop irrigation (up to 10 %, depending on the crop type), especially in southern and Mediterranean regions [139], and for fruit and vegetable production in Northern Europe [140].

#### 4.9. Ecosystems

Physical processes and biological systems on many scales have been altered due to global climate change caused by the sudden increase in the energy balance of the planet, which affects ecosystems that support human society [7]. This may cause sudden, irreversible effects that fundamentally change the function and structure of the ecosystem, with potentially huge impacts on human society [141]. The global ecosystem is sensitive to many components [142], including large variability and extremes of CO<sub>2</sub> and climate throughout geological history [143]; anthropogenic changes, such as land use, nitrogen deposition, pollution, and invasive species [144]; natural disturbance regimes (e.g., wildfire); and subtle changes in management practices within a given land-use type, e.g., intensification of agricultural practices [145]. Land-use changes, habitat loss, and fragmentation have long been recognized as important causes of ecosystem change, particularly changes in biodiversity [146]. A regime shift occurs in ecosystems, such that even small changes in physical conditions can provoke a regime shift that may not be easily or symmetrically reversed [7, 147], and most initial ecosystem responses appear to dampen change [148], although ecosystems are likely to respond to increasing external forcing in a nonlinear manner.



Deserts, one of the largest terrestrial biomes, are likely to experience more episodic climate events, and interannual variability may increase in the future, although there is substantial disagreement among GCM projections and across different regions [149]. Vulnerability to desertification will likely be exacerbated due to increases in the incidence of severe drought globally [68]; for example, in the Americas, temperate deserts are projected to expand substantially under doubled CO<sub>2</sub> climate scenarios [150]. Further, desert biodiversity is likely to be affected by climate change [144]; for example, 2,800 plant species in the Succulent Karoo biome of South Africa as a bioclimatically suitable habitat could be reduced by 80 % with global warming of 1.5–2.7 °C above preindustrial levels [142]. Rainfall change and variability are very likely to affect vegetation in tropical grassland and savanna systems [151]. Changing amounts and variability of rainfall may also strongly control temperate grassland responses to future climate change [152]. The Mediterranean Basin regions, however, could see increased occurrence of fires [153], and doubled CO<sub>2</sub> climate scenarios could increase wildfire events by 40–50 % in California [154] and double the fire risk in Cape Fynbos [155].

Inland aquatic ecosystems will be affected by climate change directly with rises in temperature and CO<sub>2</sub> concentrations and indirectly through alterations in the hydrology resulting from changes in regional or global precipitation regimes [156]. Microorganisms, benthic invertebrates, and many species of fish will be negatively affected by higher temperatures [157]; invertebrates, waterfowl, and tropical invasive biota are likely to shift poleward [158] with some potentially going extinct [159]. Other major changes will likely occur in species composition, seasonality, and the production of planktonic communities and their food web interactions [160]. Enhanced UV-B radiation and increased summer precipitation will significantly increase dissolved organic carbon concentrations, altering major biogeochemical cycles [161]. Wetland plants and animals at different stages of their life cycle are affected by small increases in the variability of precipitation [162]. In monsoonal regions, increased variability risks that diminish wetland biodiversity and prolonged dry periods promote terrestrialization of wetlands, for example, in Keoladeo National Park, India [163]. There is evidence of riparian ecosystems among many rivers around the world experiencing additional pressure due to changes in climate and land-use practices [164], whereas the pattern of freshwater flows will affect coastal wetlands due to changes in salinity, sediment inputs, and nutrient loadings [165].

## **5. CONTINENTAL-SCALE IMPACT OF PROJECTED CLIMATE CHANGES ON WATER RESOURCES**

Future climate projections are made based on four IPCC SRES [166] storylines considering a range of plausible changes in population and economic activity over the twenty-first century. The scenarios include: A1 storyline and scenario family (a future world of very rapid economic growth, global population that peaks in mid-century and declines thereafter, and rapid introduction of new and more efficient technologies); A2 storyline and scenario family (a very heterogeneous world with continuously increasing global population and regionally oriented economic growth that is more fragmented and slower than in other storylines);

B1 storyline and scenario family (a convergent world with the same global population as in the A1 storyline but with rapid changes in economic structures toward a service and information economy); B2 storyline and scenario family (a world in which the emphasis is on local solutions to economic, social, and environmental sustainability, with continuously increasing population but lower than A2 and intermediate economic development).

Due to advances in modeling as well as in our understanding of the physical processes involved, it has been possible to make more reliable climate projections. The development of Atmosphere-Ocean General Circulation Models (AOGCMs) remains the foundation for projections, though they cannot provide information at scales finer than their computational grids. The climatic patterns are region-specific due to several reasons [167], which include an uneven distribution of solar heating; individual responses of the atmosphere, oceans, and land surface; interactions among these; and physical characteristics of the regions. Therefore, it will be useful to study the projected climate for different regions. The following region-specific discussions are based on the *IPCC Fourth Assessment Report: Climate Change 2007*, where the information is drawn from AOGCM simulations, downscaling of AOGCM-simulated data using techniques to enhance regional detail, physical understanding of the processes governing regional responses, and recent historical climate change [167].

### 5.1. Africa

During the twenty-first century all of Africa is very likely to warm, and the warming is very likely to be larger than the global, annual mean warming throughout the continent and in all seasons, with drier subtropical regions warming more than the moister tropics. Annual rainfall is likely to decrease in much of Mediterranean Africa, the northern Sahara, and southern Africa during winter, whereas there is likely to be an increase in annual mean rainfall in East Africa [167].

Climate change is expected to exacerbate critical water stress conditions before 2025 due to rises in water demand and in population. Based on the full range of SRES scenarios, the population to be affected is projected to be 75–250 million and 350–600 million people by the 2020s and 2050s, respectively [168]. Groundwater is the most common primary source of drinking water in Africa, particularly in rural areas, and its recharge is projected to decrease with decreased precipitation and runoff, resulting in increased water stress in those areas [5]. Similarly, projections of hydroelectric power generation, conducted based on projections of future runoff, indicate that hydropower generation would be negatively affected by climate change, particularly in river basins situated in subhumid regions [169].

Several studies have linked climate change with health issues on the continent. For example, results from the Mapping Malaria Risk in Africa project indicate changes in the distribution of climate-suitable areas for malaria by 2020, 2050, and 2080 [170]. From an agricultural perspective, the net crop revenues would likely fall by as much as 90 % based on the three scenarios [171]. The changes in freshwater flows and greater intrusion of saltwater into lagoons would affect species that form the basis of inland fisheries, which is considered to be an important source of revenue [172]. The reduction in soil moisture could affect natural systems in several ways [5], for example, significant extinctions in both plant and animal

species as over 5,000 plant species could be impacted by climate change, mainly due to the loss of suitable habitats. In addition, the Fynbos biome is projected to lose 51–61 % of its extent due to decreased winter precipitation.

## **5.2. Europe**

Overall, the annual mean temperature is likely to increase more than the global mean. Northern Europe is likely to experience the greatest warming during winter, whereas in summer the most dramatic warming will likely occur in the Mediterranean area. In addition, the increase is more likely in the lowest winter temperature in comparison to average temperature in northern Europe, and in southern and central Europe, the highest summer temperatures are likely to increase more than the average summer temperature. Annual precipitation is very likely to increase in most of northern Europe and decrease in most of the Mediterranean area. Based on seasons, precipitation will likely increase in winter and decrease in summer in central Europe, whereas the annual number of precipitation days is very likely to decrease in the Mediterranean area. The daily precipitation extremes are very likely to increase in northern Europe, and summer drought is likely to affect central Europe and the Mediterranean area more. The duration of the snow season and snow depth are likely to decrease in most of Europe [167].

European countries will face a range of impacts on water resources due to climate change [5]. These impacts are summarized in this section. Annual average runoff is projected to increase in northern Europe (north of 47°N) by approximately 5–15 % up to the 2020s and by 9–22 % up to the 2070s, under the A2 and B2 scenarios and climate scenarios from two different climate models [173], whereas in southern Europe (south of 47°N), runoff is projected to decrease by 0–23 % up to the 2020s and by 6–36 % up to the 2070s (for the same set of assumptions). There is a possibility of a reduction in groundwater recharge in central and eastern Europe [174], with a larger reduction in valleys [175] and lowlands, e.g., in the Hungarian steppes [176].

An increase in irrigation water demand will likely make regions more prone to the drought risk in the Mediterranean and some parts of central and eastern Europe [177]. Also, irrigation needs will substantially increase in countries where they hardly exist today [178]. The risk of flooding is projected to increase throughout the continent [5], and the regions most prone to increases in flood frequencies are eastern Europe, then northern Europe, the Atlantic coast, and central Europe, while projections for southern and southeastern Europe show significant increases in drought frequency. In some regions, the risks of both floods and droughts are projected to increase simultaneously. Increases in the intensity of daily precipitation events are likely to be observed even in areas with a decrease in the mean precipitation, such as central Europe and Mediterranean regions [179]. The Mediterranean regions and even much of eastern Europe may experience an increase in dry periods by the late twenty-first century [180]. The hydropower potential for all of Europe is expected to decline by 6 %, which translates into a 20–50 % decrease around the Mediterranean, a 15–30 % increase in northern and eastern Europe, and a stable hydropower pattern for western and central Europe [181]. Extreme rainfall and droughts can increase the total microbial loads in freshwater

and have implications for disease outbreaks and water-quality monitoring [5]. The predicted increase in extreme weather events is projected to increase yield variability [182] and reduce average yield [183].

### 5.3. Asia

It is very likely that Asia will warm during the twenty-first century, and warming could vary by region, for example, temperatures could be well above the global mean in central Asia, the Tibetan Plateau, and northern Asia be above the global mean in East and South Asia, and be similar to the global mean in Southeast Asia. Similarly, changes will likely be observed in precipitation patterns; boreal winter precipitation is very likely to increase in northern Asia and the Tibetan Plateau and likely to increase in eastern Asia and the southern parts of Southeast Asia; summer precipitation is likely to increase in northern Asia, East and South Asia, and most of Southeast Asia, but it is likely to decrease in central Asia.

Changes will likely be observed in extreme events, and the frequency of intense precipitation events in parts of South Asia and in East Asia will likely increase; summer heat waves/hot spells in East Asia will be of longer duration, more intense, and more frequent; and tropical cyclones are likely to increase in East, Southeast, and South Asia.

Several impacts are likely to be observed in the water resources sector in Asian countries [5]. One of the major changes is in seasonality and the amount of water flows in river systems. That could significantly alter the variability of river runoff such that extremely low runoff events might occur much more frequently in the crop-growing regions of the southwest parts of Russia [184]. The availability of surface water from major rivers, such as the Euphrates and Tigris, might be affected by the alteration in river flow. In comparison to 1961–1990, the maximum monthly flow of the Mekong River is projected to increase more in the basin in comparison to the delta, with a lower value estimated for the years 2010–2038 and a higher value for the years 2070–2099 [5].

The central part of Asia is expected to witness an increased probability of events such as mudflows and avalanches due to the rise in temperature [185]. There is likely to be a 27 % decline in glacier extent, a 10–15 % decline in frozen soil area, an increase in flood and debris flow, and more severe water shortages by 2050 compared with 1961–1990 in Northwest China [186]. There is likely to be a reduction of 20–40 % in runoff per capita in Ningxia, Xinjiang, and Qinghai Provinces by the end of the twenty-first century [187]. Based on the SRES A1B scenario, there is likely to be an increase of 1.1–1.2 times in flood risk in Tokyo (Japan) between 2050 and 2300 compared with present risk levels [188]. The gross per capita water availability in India is projected to decline from approximately 1,820 m<sup>3</sup>/year in 2001 to as little as 1,140 m<sup>3</sup>/year in 2050 as a result of population growth [189], which is likely to be affected by spatiotemporal precipitation variability. Severe water stress will be one of the most pressing environmental problems in South and Southeast Asia in the future. It is estimated that under the full range of SRES scenarios, from 120 million to 1.2 billion and from 185 to 981 million people will experience increased water stress by the 2020s and the 2050s, respectively [168]. The variability in runoff will have a significant effect on hydropower-generating countries, such as Tajikistan [190]. The increases in water demand

and soil-moisture deficit, along with a projected decline in precipitation, could lead to water-related challenges in future rainfed crops in the plains of northern and northeastern China [191]. In addition, in northern China, irrigation from surface water and groundwater sources is projected to meet only 70 % of the water requirement for agricultural production due to the effects of climate change and increasing demand [186].

#### 5.4. North America

The annual mean warming of all of North America is very likely to exceed the global mean warming in most areas, and the warming is likely to be greatest in winter in northern regions. Based on the lowest winter temperature, northern North America is likely to witness an increase in temperature that will be greater than the average winter temperature, whereas the highest summer temperatures are likely to increase more than the average summer temperature in the southwestern parts of the USA. The northeastern parts of the USA and Canada are very likely to witness an increase in annual precipitation, whereas the American Southwest is likely to witness a decrease in precipitation. Winter and spring precipitation is likely to increase in southern Canada but decrease in summer. The snow depth in the northernmost part of Canada will likely increase, whereas the snow season length and snow depth are very likely to decrease in most of North America [192].

Annual mean precipitation is projected to decrease in the southwestern USA but increase over most of the remainder of North America up to 2100, whereas increases in precipitation in Canada are projected to be in the range of +20 % for the annual mean and +30 % for winter, under the A1B scenario [5]. Some studies project widespread increases in extreme precipitation but also droughts associated with greater temporal variability in precipitation.

The variability in runoff affects hydropower production significantly; for example, the impact of lengthy droughts on the Great Lakes in 1999 significantly affected hydropower production [193]. With an increase of 2–3 °C in warming in the British Columbia Hydro service areas, the hydroelectric supply under worst-case water conditions for winter peak demand will likely increase; in addition, Colorado River hydropower yields will likely decrease significantly [194], as will Great Lakes hydropower [195].

Waterborne diseases and degraded water quality are very likely to increase with heavier precipitation. Waterborne diseases are likely to be clustered in key watersheds due to many factors, including heavy precipitation in the USA [196] and extreme precipitation and warmer temperatures in Canada [197]. Moreover, heavy runoff following severe rainfall can also contaminate recreational waters through higher bacterial count [198]. Several investigations highlighted that moderate climate change will likely increase yields of North American rainfed agriculture, but with smaller increases and more spatial variability than in earlier estimates [199]; however, many climate projections indicate decreasing yields (currently under climate threshold) in terms of quality, or both, with even modest warming [200]. In another example, water availability will be the major factor limiting agriculture in southeast Arizona [201]. The changes in rainfall patterns and drought regimes could lead to ecosystem disturbances [202] and cause the areal extent of drought-limited ecosystems to increase 11 % per 1 °C warming in the continental USA [203].

### 5.5. *Central and South America (Latin America)*

Central and South America will likely be warmer during the twenty-first century, and annual mean warming will be larger than the global mean warming in most of parts, whereas warming similar to that of the global mean is likely to be observed in southern South America. Annual precipitation is likely to decrease in most of Central America, with the relatively dry boreal spring becoming drier; in the southern Andes, relative precipitation changes will be greatest in summer. Increasing precipitation is likely in Tierra del Fuego during winter and in southeastern South America during summer.

According to different climate models, the projected mean temperature for Latin America ranges from 1 to 4 °C for the B2 emissions scenario and from 2 to 6 °C for the A2 scenario for 2100 [5]. In the absence of climate change, the number of people living in already water-stressed watersheds is estimated at 22.2 million (in 1995), whereas under the SRES scenarios, this number is estimated to increase to between 12 and 81 million in the 2020s and to between 79 and 178 million in the 2050s [168]. The potential vulnerabilities in many regions of Latin American countries are likely to increase as a result of rising populations and their concomitant increased demands on water supplies and irrigation and as a result of the expected drier conditions in many basins. Glacial retreat is projected to impact the generation of hydroelectricity in countries such as Colombia and Peru [204], whereas some small tropical glaciers have already disappeared, which is likely to affect hydropower generation [74].

Approximately 31 % of the Latin American population lives in areas at risk of malaria (i.e., tropical and subtropical regions) [205], and, based on SRES emissions scenarios and socioeconomic scenarios, some projections indicate that additional numbers of people will be at risk in areas around the southern limit of the disease distribution in South America [206]. The reason for this is the decrease in the length of the transmission season of malaria due to the reduction in precipitation, such as the Amazon and Central America. There is also the possibility of a substantial increase in the number of people at risk of dengue due to changes in the geographical limits of transmission in Mexico, Brazil, Peru, and Ecuador [207].

Based on several studies using crop simulation models, under climate change, for commercial crops, the number of people at risk of hunger under SRES emissions scenario A2 is projected to increase by one million in 2020, while it is projected that there will be no change for 2050 and that the number will decrease by four million in 2080 [5]. The biodiversity of the region is likely to be affected due to a complex set of alterations comprising modifications in rainfall and runoff, and a replacement of tropical forest by savannas is expected in eastern Amazonia and in the tropical forests of central and southern Mexico, along with replacement of semiarid by arid vegetation in parts of northeastern Brazil and most of central and northern Mexico due to the synergistic effects of both land-use and climate changes [5].

### 5.6. *Australia and New Zealand*

All of Australia and New Zealand are very likely to warm during this century, comparable overall to the global mean warming. Precipitation is likely to decrease in southern Australia in winter and spring and in southwestern Australia in winter, whereas there is likely to be an

increase in precipitation in the western part of the South Island of New Zealand. The extremes based on daily precipitation are very likely to increase; increased risk of drought in southern areas of Australia is also likely to occur.

Australia's largest river basin, Murray-Darling, accounts for approximately 70 % of irrigated crops and pastures [208], and according to the SRES A1 and B1 emissions scenarios and a wide range of GCMs, annual streamflow in the basin is projected to fall 10–25 % by 2050 and 16–48 % by 2100, with salinity changes of –8 to +19 % and –25 to +72 %, respectively [209]. Similarly, water security problems are very likely to increase by 2030 in southern and eastern Australia and in parts of eastern New Zealand that are far from major rivers [5]. The runoff in 29 Victorian catchments is projected to decline by 0–45 % [210].

Energy production is likely to be affected in Australia and New Zealand in regions where climate-induced reductions in water supplies lead to reductions in feed water for hydropower turbines and cooling water for thermal power plants. Cropping and other agricultural industries are likely to be threatened where irrigation water availability is reduced [211].

Heavier rainfall events are *likely* to affect mosquito breeding and increase the variability in annual rates of Ross River disease, particularly in temperate and semiarid areas [212]. Australia faces a threat from dengue, and outbreaks of dengue have occurred with increasing frequency and magnitude in far northern Australia over the past decade. Possible changes are likely to occur in a range of geographical regions and in the seasonality of some mosquito-borne infectious diseases, e.g., Ross River disease, dengue, and malaria. The other major problem in water quality is eutrophication [213], and toxic algal blooms could increase in frequency and be present for a longer time due to climate change. They can pose a threat to human health for both recreation and consumptive water use and can kill fish and livestock [214]. Alterations in the composition of species of freshwater habitats, with consequent impacts on estuarine and coastal fisheries, are likely to occur due to multiple factors, including saltwater intrusion as a result of sea-level rise, decreases in river flows, and increased drought frequency [215, 216].

## 6. ADAPTATION TO CLIMATE CHANGE

Climate change poses a new threat to adaptation policies, even though human being are known to adapt and survive and develop methodologies to overcome many water-related problems. The major problem of adaptation to climate change might be related to the multiple dimensions involved, which include [217], for example, various sectors (water resources, agriculture, industrial); the spatial scale (local, regional, national); type of action (physical, technological, investment, regulatory, market); and climatic zones (dryland, floodplains, mountains, and arctic regions). The major focus on climate adaptation has emerged since the third assessment report of IPCC highlighted several strategies, including adaptations to observed climate changes, planned adaptations to climate change in infrastructure design and coastal zone management, the variable nature of vulnerability, and adaptive capacity [218].

For several decades measures have been in place to reduce climate impacts by understanding their variability on decadal, annual, and seasonal scales so as to develop climate forecasting methods, risk analysis based on disasters, and crop and livelihood diversification.

Various types of adaptations have been implemented around the world [217], and what follows are some examples based on water-related sectors:

1. Drought: enhancing the use of traditional rainwater harvesting and water-conserving techniques, building of shelter belts and windbreaks to improve the resilience of rangelands and setting up of revolving credit funds (e.g., for Sudan, Africa) [219]; inclusion of drought-resistant plants, adjustment of planting dates and crop variety, accumulation of commodity stocks as economic reserves, creation of local financial pools (for Mexico and Argentina) [220]; creating employment program options following drought in national government programs and assistance to small subsistence farmers to increase crop production (e.g., in Botswana; [221]).
2. Sea-level rise: acquisition of land with a view to climate change to acquire coastal lands damaged/prone to damage by storms or buffering other lands (e.g., New Jersey Coastal Blue Acres land acquisition program in the USA) [222]. Installation of hard structures in areas vulnerable to coastal erosion and adoption of a national climate change action plan integrating climate change concerns into national policies (e.g., in Egypt) [223]. Introduction of participatory risk assessment, capacity building for shoreline defense system design, construction of cyclone-resistant housing units, and review of building codes (e.g., in Philippines) [224]. Adoption of Flooding Defense Act and Coastal Defense Policy as precautionary measures allowing for the incorporation of emerging trends in climate and building of a storm surge barrier taking a 50-cm sea-level rise into account (e.g., in the Netherlands) [225].

### **6.1. Assessment of Adaptation Costs and Benefits**

A few studies have investigated adaptation costs and benefits in the context of climate change [217] and some of the studies these issues as they pertain to Bangladesh [226], Fiji and Kiribati [227], and Canada [228]. Based on individual issues, some studies address sea-level rise [229], agriculture [129], and water resource management [230].

The greatest number of studies have been carried out for costs and benefits related to sea-level rise. Some of the important findings are as follows: (a) almost 100 % of coastal cities and harbors in the countries that make up the Organisation for Economic Cooperation and Development (OECD) should be protected, while the optimal protection for beaches and open coasts would vary between 50 and 80 % [231]; (b) the total cost of sea-level rise could be reduced by around 20–50 % for the US coastline if real estate market prices adjusted efficiently as land became submerged [232]; (c) based on the IPCC SRES [166] the A1FI, A2, B1, and B2 scenarios, with the exception of certain Pacific Small Island States, coastal protection investments comprise a very small percentage of gross domestic product (GDP) for the 15 most-affected countries by 2080 [217]; (d) based on a global-scale assessment, uncertainties surrounding endowment values could lead to a 17 % difference in coastal protection, a 36 % difference in the amount of land protected, and a 36 % difference in the direct cost globally [233].

Adaptation studies for the agricultural sector may be based on increases in yield or on the welfare of people at risk of hunger, which can be considered at the farm level or on the level of



international trade [234, 235]. For many countries located in tropical regions, low-cost adaptation measures, such as modifying crop mixes and changing planting dates, will likely be insufficient to offset the significant damages that will result from climate change [235, 236]. In another study, the benefits to the American economy from adaptation measures increased from US\$3.29 billion (2000 values) to US\$4.70 billion (2000 values) [234, 237, 238]. Adaptation measures could reduce the variability in welfare by up to 84 % in the case of Mali [235].

Only a few studies have investigated adaptation costs and benefits in water resource management; for example, the reliability of the water supply in the Boston metropolitan area under climate change scenarios is estimated to be 93 % by 2100 on account of the expected growth in water demand [230]. The costs of adaptation to climate change for storm water management by water utilities in Canada, where the potential adaptation strategies include building new treatment plants, improving the efficiency of existing plants, or increasing retention tanks, were considered, and the results indicated that the adaptation costs for Canadian cities could be as high as Canadian \$9,400 million for a city like Toronto if extreme events are considered [228]. The other major impact of climate change includes the increase in energy demand due to increases in temperature. In one study, the global energy costs related to heating and cooling would increase by US\$2 billion to US\$10 billion (1990 values) for a 2 °C increase in temperature by 2100 and by US\$51 billion to US\$89 billion (1990 values) for a 3.5 °C increase [239]. The other major impact is sea-level rise, whose associated global protection costs have been estimated at US\$1,055 billion for a 1-m sea-level rise [240].

## **6.2. Limitations in Adaptation to Climate Change**

To overcome the impact of climate change, systems need to adapt or respond successfully to climate variability and changes; therefore, the presence of an adaptive capacity has been shown to be a necessary condition for the design and implementation of effective adaptation strategies. Many factors that act as a limitation on adaptation to climate change [217] are discussed in the following sections.

### **6.2.1. Threshold Level of Ecosystem**

Several investigations lead to findings that the resilience of coupled socioecological systems to climate change will depend on the rate and magnitude of climate change, and when climate change persists beyond critical thresholds, some systems may not be able to adapt to changing climate conditions without radically altering their functional state and integrity [217]. The physical environment can change dramatically in response to changing climatic patterns, for example, the resilience of kelp forest ecosystems, coral reefs, rangelands, and lakes affected both by climate change and other pollutants beyond a certain threshold level [241, 242]. Persistent below-average rainfall and recurrent droughts in the late twentieth century in the Sudano-Sahel region of Africa, have led to constricted physical and ecological limits by contributing to land degradation, diminished livelihood opportunities, food insecurity, and internal displacement of people [243]. Loss of sea ice

in Arctic sea threatens the survival of polar bears [244]. Climate change also significantly affects the economy due to its impact on ecosystems, such as fisheries and agricultural systems. This leads to significant challenges with respect to resource management from ecosystem shifts, but such challenges are often outside the experience of institutions [245].

### 6.2.2. *Technological Limits*

Adapting to new technologies serves as a potential means of adapting to climate variability and changes, and the transfer of appropriate technologies to developing countries forms an important component of the UNFCCC [246]. There are also potential limits to technology as an adaptation response to climate change [217]; for example, technology is developed and applied in a social context, and decision making under uncertainty may inhibit adaptation to climate change [247], and although some adaptations may be technologically possible, they may not be economically feasible or culturally desirable [248]. New technology is unlikely to be equally transferable to all contexts and to all groups or individuals, regardless of the extent of country-to-country technology transfer [249], and adaptations that are effective in one location may be ineffective in other places.

### 6.2.3. *Financial Barriers*

The estimated total costs for the implementation of adaptation measures are quite high, and they face a number of financial barriers; for example, preliminary estimates are that climate proofing development could be as high as US\$10 billion to US\$40 billion/year [250]. Similarly, institutions at the local level and individuals can be similarly constrained by the lack of adequate financial resources; for example, farmers often cite the lack of adequate financial resources as an important factor that constrains the use of adaptation measures, such as irrigation systems, improved or new crop varieties, and diversification of farm operations [251]. The lack of resources is likely to reduce the ability of low-income groups to afford proposed adaptation mechanisms by raising the actuarial uncertainty in catastrophe risk assessment, placing upward pricing pressure on insurance premiums and possibly leading to reductions in risk coverage [252].

### 6.2.4. *Informational and Cognitive Barriers*

Risks associated with climate change are context specific [253], and adaptation responses to climate change can be limited by human cognition [254]. Therefore, knowledge of the factors responsible and their impacts and possible solutions do not necessarily lead to adaptation. Perceptions of climate change risks vary, and the psychological dimensions of evaluating long-term risk focus on changes in relation to climate change mitigation policies. Some studies have explored the behavioral foundations of adaptive responses [217, 255]. For example, thresholds of rapid climate change may induce different individual responses influenced by trust in others, resulting in adaptive and nonadaptive behaviors [256]. In another study [255] aimed at human cognition and adaptive capacity in populations living in

flood-prone areas in Germany and farmers struggling with drought in Zimbabwe, the authors note that divergence between perceived and actual adaptive capacity is a real barrier to adaptive actions.

#### 6.2.5. Social and Cultural Barriers

There are social and cultural limits to climate change adaptation where people and groups experience, interpret, and respond to impacts [217]. Differences in understanding and prioritizing climate change issues across different social and cultural groups can limit adaptive responses [256]. In addition, societies are responsible for changes to their environments, and they alter their own vulnerability to climate fluctuations, as illustrated, for example, by the development of the Colorado River Basin in the face of environmental uncertainty [257]. Several case studies have revealed that there exists a diversity of traditional practices for ecosystem management under environmental uncertainty based on social regulation, mechanisms for cultural internalization of traditional practices, and the development of appropriate worldviews and cultural values [258].

## 7. CONCLUSIONS

Various observations, including increases in global average air and ocean temperatures and the melting of snow and ice, confirm that the climatic system is getting warmer. Impacts of this warming have been observed on global and local scales in different water resource sectors. The following conclusions are drawn from this study:

1. Overall changes in large-scale hydrologic cycles are observed based on spatiotemporal scales. The noted observations include increased precipitation in high northern latitudes since the 1970s, increased frequency in heavy precipitation events, runoff patterns, reductions in snow cover, and shifts in the amplitude and timing of glacial runoff.
2. Based on global climate models, precipitation is likely to increase in high latitudes and decrease in lower mid-latitude regions during the twenty-first century. The risks of flooding and drought are likely to increase in many parts due to increases in precipitation intensity and variability. Water availability and annual river runoff are likely to increase at high latitudes by the middle of the twenty-first century, whereas many arid and semiarid areas are projected to suffer a decrease in water resources.
3. The basic food sector (i.e., availability, stability, and access), which will likely be affected by changes in the quantity and quality of water resources, will be vulnerable in the arid and semiarid tropics and Asian and African mega deltas.
4. Water quality, which will likely be affected by climate change due to higher water temperatures, precipitation extremes, flood and drought events, and pollution, will decrease because of imbalances in several factors, including sediments, nutrients, dissolved organic carbon, pathogens, pesticides, salt, and thermal pollution.
5. The quantity and quality of water resources will have a severe impact on ecosystems and human health, which will be further impacted by sea-level rise that will extend areas of salinization of groundwater and estuaries, resulting in a decrease in freshwater availability for humans and ecosystems in coastal areas.

6. Climate change can aggravate freshwater systems, which are already stressed due to increases in population and rising water demand in various sectors, changing economic activity, alterations in land use, and urbanization. The global population rise will have repercussion on the global scale, whereas demand in various affected sectors will impact regional water demand.
7. To ensure proper management of water resources, various strategies should be adopted based on water availability and water demand depending on the different needs at local, regional, and continental levels. Some of the strategies include water conservation, improved water use efficiency by recycling water, development of water markets and implementation of virtual water trade, and improved storage facilities to act as lifelines during drought periods. There is also a need to improve decision making based on the efficient modeling of climate change related to the hydrologic cycle through a better understanding of the uncertainties likely to exacerbate the impacts of climate change.

## REFERENCES

1. European Union (2000) EU water framework directive: Directive 2000/60/EC of the European Parliament and of the Council establishing a framework for the Community action in the field of water policy. EU Official Journal (OJ L 327, 22 December 2000)
2. United Nations (2006) World water development report 2: water, a shared responsibility. UNESCO, Paris, 601 pp
3. Bruinsma J (2003) World agriculture: towards 2015/2030. An FAO perspective. Earthscan, London, 444 pp
4. Alcamo J, Döll P, Henrichs T, Kaspar F, Lehner B, Rösch T, Siebert S (2003) Development and testing of the WaterGAP 2 global model of water use and availability. *Hydrol Sci J* 48:317–338
5. Bates BC, Kundzewicz ZW, Wu S, Palutikof JP (eds) (2008) Climate change and water. Technical paper of the intergovernmental panel on climate change. IPCC Secretariat, Geneva, 210 pp
6. Crowley TJ (2000) Causes of climate change over the past 1000 years. *Science* 289:270–277
7. Solomon S, Qin D, Manning M, Chen Z, Marquis M, Averyt KB, Tignor M, Miller HL (eds) (2007) Climate change: the physical science basis. Contribution of working group I to the fourth assessment report of the intergovernmental panel on climate change. Cambridge University Press, Cambridge, UK
8. Milankovitch M, Köppen W, Geiger R (eds) (1930) Mathematische Klimalehre und astronomische Theorie der Klimaschwankungen, vol 1, Handbuch der Klimatologie. Gebrüder Bornträger, Berlin, pp 1–176
9. Molina M, Zaelke D, Sarma KM, Andersen SO, Ramanathan V, Kaniaru D (2009) Reducing abrupt climate change risk using the Montreal Protocol and other regulatory actions to complement cuts in CO<sub>2</sub> emissions. *Proc Natl Acad Sci U S A* 106(49):20616–20621
10. Solomon S et al (2009) Irreversible climate change due to carbon dioxide emissions. *Proc Natl Acad Sci U S A* 106:1704–1709
11. UNFCCC (2009) Fact sheet: the need for mitigation. UNFCCC, Bonn, Germany
12. Breidenich C, Daniel M, Anne R, Rubin JW (1998) The Kyoto protocol to the United Nations framework convention on climate change. *Am J Int Law* 92(2):315–331
13. Andersen SO, Sarma KM, Taddonio KN (2007) Technology transfer for the ozone layer: lessons for climate change. Earthscan, London, UK

14. IPCC (2007) Summary for policymakers. In: Solomon S, Qin D, Manning M, Chen Z, Marquis M et al (eds) *Climate change 2007: the physical science basis. Working group I contribution to the intergovernmental panel on climate change fourth assessment report*. Cambridge University Press, Cambridge, UK, pp 1–18
15. Trenberth KE, Jones PD, Ambenje P, Bojariu R, Easterling D, Klein Tank A, Parker D, Rahimzadeh F, Renwick JA, Rusticucci M, Soden B, Zhai P (2007) Observations: surface and atmospheric climate change. In: Solomon S, Qin D, Manning M, Chen Z, Marquis M, Averyt KB, Tignor M, Miller HL (eds) *Climate change 2007: the physical science basis. Contribution of working group I to the fourth assessment report of the intergovernmental panel on climate change*. Cambridge University Press, Cambridge, UK
16. Karl TR, Melillo JM, Peterson TC (eds) (2009) *Global climate change impacts in the united states*. US global change research program. Cambridge University Press, New York
17. Meier MF, Dyurgerov MB, Rick UK, O’Neel S, Pfeffer WT, Anderson RS, Anderson SP, Glazovsky AF (2007) Glaciers dominate eustatic sea-level rise in the 21st century. *Science* 317(5841):1064–1067
18. Steffen K, Clark PU, Cogley JG, Holland D, Marshall S, Rignot E, Thomas R (2008) Rapid changes in glaciers and ice sheets and their impacts on sea level. In: U.S. Geological Survey (ed) *Abrupt climate change. Synthesis and assessment product 3.4*. U.S. Geological Survey, Reston, VA, pp 60–142
19. Smith TM, Reynolds RW (2005) A global merged land and sea surface temperature reconstruction based on historical observations (1880–1997). *J Clim* 18:2021–2036
20. Hansen J et al (2001) A closer look at United States and global surface temperature change. *J Geophys Res* 106:23947–23963
21. Brohan P, Kennedy JJ, Harris I, Tett SFB, Jones PD (2006) Uncertainty estimates in regional and global observed temperature changes: a new dataset from 1850. *J Geophys Res* 111, D12106. doi:[10.1029/2005JD006548](https://doi.org/10.1029/2005JD006548)
22. Lugina KM et al (2005) Monthly surface air temperature time series area-averaged over the 30-degree latitudinal belts of the globe, 1881–2004. In: *Trends: a compendium of data on global change*. Carbon Dioxide Information Analysis Center, Oak Ridge National Laboratory, US Department of Energy, Oak Ridge, TN
23. Vose RS, Easterling DR, Gleason B (2005) Maximum and minimum temperature trends for the globe: an update through 2004. *Geophys Res Lett* 32, L23822. doi:[10.1029/2005GL024379](https://doi.org/10.1029/2005GL024379)
24. Mann ME, Bradley RS, Hughes MK (1998) Global-scale temperature patterns and climate forcing over the past six centuries. *Nature* 392:779–787
25. Allen MR, Ingram WJ (2002) Constraints on future changes in climate and the hydrological cycle. *Nature* 419:2224–2232
26. Emori S, Brown SJ (2005) Dynamic and thermodynamic changes in mean and extreme precipitation under changed climate. *Geophys Res Lett* 32, L17706. doi:[10.1029/2005GL023272](https://doi.org/10.1029/2005GL023272)
27. Meehl GA, Arblaster JM, Tebaldi C (2005) Understanding future patterns of increased precipitation intensity in climate model simulations. *Geophys Res Lett* 32, L18719. doi:[10.1029/2005GL023680](https://doi.org/10.1029/2005GL023680)
28. Easterling DR et al (2000) Observed variability and trends in extreme climate events: a brief review. *Bull Am Meteorol Soc* 81:417–425
29. Karl TR, Trenberth KE (2003) Modern global climate change. *Science* 302:1719–1723
30. Groisman PY et al (1999) Changes in the probability of heavy precipitation: important indicators of climatic change. *Clim Change* 42:243–283

31. Katz RW (1999) Extreme value theory for precipitation: sensitivity analysis for climate change. *Adv Water Resour* 23:133–139
32. Trenberth KE, Shea DJ (2005) Relationships between precipitation and surface temperature. *Geophys Res Lett* 32, L14703. doi:[10.1029/2005GL022760](https://doi.org/10.1029/2005GL022760)
33. Karl TR, Knight RW (1998) Secular trends of precipitation amount, frequency, and intensity in the USA. *Bull Am Meteorol Soc* 79:231–241
34. Semenov VA, Bengtsson L (2002) Secular trends in daily precipitation characteristics: greenhouse gas simulation with a coupled AOGCM. *Clim Dyn* 19:123–140
35. Strzepek K, McCluskey A (2007) The impacts of climate change on regional water resources and agriculture in Africa policy research working paper 4290. World Bank, Washington, DC
36. Milly PCD, Dunne KA, Vecchia AV (2005) Global pattern of trends in streamflow and water availability in a changing climate. *Nature* 438:347–350
37. Gedney N, Cox PM, Betts RA, Boucher O, Huntingford C, Stott PA (2006) Detection of a direct carbon dioxide effect in continental river runoff records. *Nature* 439(7078):835–838
38. Genta JL, Perez-Iribarren G, Mechoso CR (1998) A recent increasing trend in the streamflow of rivers in southeastern South America. *J Clim* 11:2858–2862
39. Lins HF, Michaels PJ (1994) Increasing U.S. streamflow linked to greenhouse forcing. *Eos Trans Am Geophys Union* 75:281, 284–285
40. Lins HF, Slack JR (1999) Streamflow trends in the United States. *Geophys Res Lett* 26:227–230. doi:[10.1029/1998GL900291](https://doi.org/10.1029/1998GL900291)
41. McCabe GJ, Wolock DM (2002) A step increase in streamflow in the conterminous United States. *Geophys Res Lett* 29:2185–2188. doi:[10.1029/2002GL015999](https://doi.org/10.1029/2002GL015999)
42. Mote PW (2003) Trends in snow water equivalent in the Pacific Northwest and their climatic causes. *Geophys Res Lett* 30:1601. doi:[10.1029/2003GL017258](https://doi.org/10.1029/2003GL017258)
43. Regonda SK, Rajagopalan B, Clark M, Pitlick J (2005) Seasonal cycle shifts in hydroclimatology over the western United States. *J Clim* 18:372–384
44. Stewart IT, Cayan DR, Dettinger MD (2005) Changes towards earlier streamflow timing across western North America. *J Clim* 18:1136–1155
45. Zhang X, Harvey KD, Hogg WD, Yuzyk TR (2001) Trends in Canadian streamflow. *Water Resour Res* 37:987–998
46. Lammers R, Shiklomanov A, Vorosmarty C, Fekete B, Peterson B (2001) Assessment of contemporary arctic river runoff based on observational discharge records. *J Geophys Res* 106:3321–3334. doi:[10.1029/2000JD900444](https://doi.org/10.1029/2000JD900444)
47. Nijssen B, O'Donnell G, Lettenmaier DP, Lohmann D, Wood E (2001) Predicting the discharge of global rivers. *J Clim* 15:3307–3323
48. Yang D, Kane DL, Hinzman LD, Zhang X, Zhang T, Ye H (2002) Siberian Lena river hydrologic regime and recent change. *J Geophys Res* 107:4694. doi:[10.1029/2002JD002542](https://doi.org/10.1029/2002JD002542)
49. Serreze MC, Bromwich DH, Clark MP, Etringer AJ, Zhang T, Lammers RB (2002) The large scale-hydro-climatology of the terrestrial arctic drainage system. *J Geophys Res* 107:8160. doi:[10.1029/2001JD000919](https://doi.org/10.1029/2001JD000919)
50. McCarthy J, Canziani OS, Leary N, Dokken D, White K (eds) (2001) *Climate change 2001: impacts, adaptation, and vulnerability*. Cambridge University Press, Cambridge, UK
51. Caspary HJ (2004) The August 2002 flood in Central and Eastern Europe and results from the EU 'STARDEX' Project, STARDEX Information Sheet 2. Fachhochschule Hochschule Für Stuttgart Technik, Stuttgart

52. Milly PCD, Wetherald RT, Dunne KA, Delworth TL (2002) Increasing risk of great floods in a changing climate. *Nature* 415(6871):514–517
53. Kron W, Berz G (2007) Flood disasters and climate change: trends and options—a (re-) insurers view. In: Lozán JL, Graßl H, Hupfer P, Menzel L, Schönwiese C-D (eds) *Global change: enough water for all? Wissenschaftliche Auswertungen/GEO*, Hamburg, pp 268–273
54. Kundzewicz ZW et al (2007) Freshwater resources and their management. In: Parry ML, Canziani OF, Palutikof JP, van der Linden PJ, Hanson CE (eds) *Climate change 2007: impacts, adaptation and vulnerability. Contribution of working group II to the fourth assessment report of the intergovernmental panel on climate change*. Cambridge University Press, Cambridge, UK, pp 173–210
55. Obasi GOP (1994) WMO's role in the international decade for natural disaster reduction. *Bull Am Meteorol Soc* 75(9):1655–1661
56. Mishra AK, Singh VP (2010) A review of drought concepts. *J Hyrol* 391:201–216
57. Le Comte D (1995) Weather highlights around the world. *Weatherwise* 48:20–22
58. Wheaton EE (2000) Canadian prairie drought impacts and experiences. In: Wilhite D (ed) *Drought: a global assessment, vol 1*. Routledge Press, London, UK, pp 312–330
59. Demuth S, Stahl K (eds) (2001) *Assessment of the regional impact of droughts in Europe. Final report to the European union, ENV-CT97-0553*. Institute of Hydrology, University of Freiburg, Germany
60. Feyen L, Dankers R (2009) Impact of global warming on streamflow drought in Europe. *J Geophys Res* 114:D17116. doi:[10.1029/2008JD011438](https://doi.org/10.1029/2008JD011438)
61. Wilhite DA, Hayes MJ (1998) Drought planning in the United States: status and future directions. In: Bruins HJ, Lithwick H (eds) *The arid frontier*. Kluwer, Dordrecht, The Netherlands, pp 33–54
62. Changnon SA, Pielke RA Jr, Changnon D, Sylves RT, Pulwarty R (2000) Human factors explain the increased losses from weather and climate extremes. *Bull Am Meteorol Soc* 81(3):437–442
63. Zhang Q (2003) Drought and its impacts. In: Chen H (ed) *China climate impact assessment*. China Meteorol Press, Beijing, pp 12–18
64. Dai AG, Trenberth KE, Qian TT (2004) A global data set of Palmer drought severity index for 1870–2002: relationship with soil moisture and effects of surface warming. *J Hydrometeorol* 5:1117–1130
65. Bond NR, Lake PS, Arthington AH (2008) The impacts of drought on freshwater ecosystems: an Australian perspective. *Hydrobiologia* 600:3–16
66. Wang GL (2005) Agricultural drought in a future climate: results from 15 global climate models participating in the IPCC 4th assessment. *Clim Dyn* 2005(25):739–753
67. Sheffield J, Wood EW (2008) Global trends and variability in soil moisture and drought characteristics, 1950–2000, from observation driven simulations of the terrestrial hydrologic cycle. *J Clim* 21:432–458
68. Burke EJ, Brown SJ, Christidis N (2006) Modelling the recent evolution of global drought and projections for the 21st century with the Hadley Centre climate model. *J Hydrometeorol* 7:113–1125
69. Dai A (2010) Drought under global warming: a review. *Wiley Interdiscip Rev Clim Change* 2:45–65
70. Haeberli W, Frauenfelder R, Hoelzle M, Maisch M (1999) On rates and acceleration trends of global glacier mass changes. *Geogr Ann A Phys Geogr* 81(4):585–591

71. Dyurgerov M (2003) Mountain and subpolar glaciers show an increase in sensitivity to climate warming and intensification of the water cycle. *J Hydrol* 282(1–4):164–176
72. Milliman JD, Farnsworth KL, Jones PD, Xu KH, Smith LC (2008) Climatic and anthropogenic factors affecting river discharge to the global ocean, 1951–2000. *Glob Planet Change* 62(3–4):187–194
73. Goudie AS (2006) Global warming and fluvial geomorphology. *Geomorphology* 79:384–394
74. Ramírez E et al (2001) Small glaciers disappearing in the tropical Andes: a case-study in Bolivia: Glaciar Chacaltaya (16° S). *J Glaciol* 47:187–194
75. Hodge SM et al (1998) Climate variations and changes in mass of three glaciers in western North America. *J Clim* 11(9):2161–2179
76. Williams RS, Ferrigno JG (eds) (2010) *Glaciers of Asia*. U.S. Geological Survey Professional Paper 1386-F, 349 pp
77. Kumar K, Dumka RK, Miral MS, Satyal GS, Pant M (2008) Estimation of retreat rate of Gangotri glacier using rapid static and kinematic GPS survey. *Curr Sci* 94(2):258–262
78. Arendt AA, Echelmeyer KA, Harrison WD, Lingle CS, Valentine VB (2002) Rapid wastage of Alaska glaciers and their contribution to rising sea level. *Science* 297(5580):382–386
79. Dyurgerov MB, Meier MF (2000) Twentieth century climate change: evidence from small glaciers. *Proc Natl Acad Sci U S A* 97(4):1406–1411
80. Dyurgerov M, Meier MF (2005) *Glaciers and changing earth system: a 2004 snapshot*. Occasional note 58. INSTAAR, Boulder, CO, 117 pp
81. Nakicenovic N, Swart R (eds) (2000) *Special report on emissions scenarios*. Cambridge University Press, Cambridge, UK, 599 pp
82. Lapp S, Byrne J, Townshend I, Kienzle S (2005) Climate warming impacts on snowpack accumulation in an alpine watershed. *Int J Climatol* 25(4):521–536
83. Adhikari S, Huybrechts P (2009) Numerical modelling of historical front variations and the 21st-century evolution of glacier AX010, Nepal Himalaya. *Ann Glaciol* 50(52):27–34
84. Sharma KP, Vorosmarty CJ, Moore B (2000) Sensitivity of the Himalayan hydrology to land-use and climatic changes. *Clim Change* 47(1):117–139
85. Vuille M, Francou B, Wagnon P, Juen I, Kaser G, Mark BG, Bradley RS (2008) Climate change and tropical Andean glaciers: past, present and future. *Earth Sci Rev* 89:79–96
86. Whetton PH, Haylock MR, Galloway R (1996) Climate change and snow-cover duration in the Australian Alps. *Clim Change* 32(4):447–479
87. Hirabayashi Y, Döll P, Kanae S (2010) Global-scale modeling of glacier mass balances for water resources assessments: glacier mass changes between 1948 and 2006. *J Hydrol* 390(3–4):245–256
88. Vergara W et al (2007) Economic impacts of rapid glacier retreat in the Andes. *Eos Trans Am Geophys Union* 88(25):261–264
89. Delpla I, Jung AV, Baures E, Clement M, Thomas O (2009) Impacts of climate change on surface water quality in relation to drinking water production. *Environ Int* 35(8):1225–1233
90. Van Vliet MTH, Zwolsman JJG (2008) Impact of summer droughts on the water quality of the Meuse river. *J Hydrol* 353:1–17.
91. Evans CD, Monteith DT, Cooper DM (2005) Long-term increases in surface water dissolved organic carbon: observations, possible causes and environmental impacts. *Environ Pollut* 137:55–71



92. Monteith DT, Stoddard JL, Evans CD, de Wit HA, Forsius M, Høgåsen T et al (2007) Dissolved organic carbon trends resulting from changes in atmospheric deposition chemistry. *Nature* 450:537–541
93. Worrall F, Burt T, Adamson J (2004) Can climate change explain increases in DOC flux from upland peat catchments? *Sci Total Environ* 326:95–112
94. Hejzlar J, Dubrovsky M, Buchtele J, Ružička M (2003) The apparent and potential effects of climate change on the inferred concentration of dissolved organic matter in a temperate stream (the Malše River, South Bohemia). *Sci Total Environ* 310:143–152
95. Zhu Z, Arp PA, Mazumder A, Meng F, Bourque CPA, Foster NW (2005) Modeling stream water nutrient concentrations and loadings in response to weather condition and forest harvesting. *Ecol Model* 185:231–243
96. Bloomfield JP, Williams RJ, Goody DC, Cape JN, Guha P (2006) Impacts of climate change on the fate and behaviour of pesticides in surface and groundwater—a UK perspective. *Sci Total Environ* 369:163–177
97. George G, Hurley M, Hewitt D (2007) The impact of climate change on the physical characteristics of the larger lakes in the English Lake District. *Freshw Biol* 52:1647–1666
98. Malmaeus JM, Blenckner T, Markensten H, Persson I (2006) Lake phosphorus dynamics and climate warming: a mechanistic model approach. *Ecol Model* 190:1–14
99. Psenner R, Schmidt R (1992) Climate-driven pH control of remote Alpine lakes and effects of acid deposition. *Nature* 356:781–783
100. Wilby RL, Whitehead PG, Wade AJ, Butterfield D, Davis RJ, Watts G (2006) Integrated modelling of climate change impacts on water resources and quality in a lowland catchment: River Kennet, UK. *J Hydrol* 330:204–220
101. Ducharme A, Baubion C, Beaudoin N, Benoit M, Billen G, Brisson N et al (2007) Long term prospective of the Seine river system: confronting climatic and direct anthropogenic changes. *Sci Total Environ* 375:292–311
102. Kaste Ø, Wright RF, Barkved LJ, Bjerkeng B, Engen-Skaugen T, Magnusson J et al (2006) Linked models to assess the impacts of climate change on nitrogen in a Norwegian river basin and fjord system. *Sci Total Environ* 365:200–222
103. Rodell M, Velicogna I, Famiglietti JS (2009) Satellite-based estimates of groundwater depletion in India. *Nature* 460(7258):999–1002
104. Delta Stewardship Council, Delta Science Program (2010) Measuring the depletion of groundwater resources worldwide. In: Walker L (ed). *Science News*, Sacramento, CA. [http://www.science.calwater.ca.gov/publications/sci\\_news\\_0410\\_grace.html](http://www.science.calwater.ca.gov/publications/sci_news_0410_grace.html)
105. Loáiciga HA, Maidment DR, Valdes JB (2000) Climate-change impacts in a regional karst aquifer, Texas, USA. *J Hydrol* 227(1–4):173–194
106. Bouraoui F, Vachaud G, Li LZ, Le Treut H, Chen T (1999) Evaluation of the impact of climate changes on water storage and groundwater recharge at the watershed scale. *Clim Dyn* 15(2):153–161
107. Döll P, Flörke M (2005) Global-scale estimation of diffuse groundwater recharge. Frankfurt hydrology paper 03. Institute of Physical Geography, Frankfurt University, Germany
108. UNESCO-IHE (2006) Groundwater resources assessment under the pressures of humanity and climate changes. United Nations Educational Scientific and Cultural Organization, Paris
109. Wolf AT, Natharius JA, Danielson JJ, Ward BS, Pender JK (1999) International river basins of the world. *Int J Water Resour Dev* 15:387–427

110. Wolf AT, Stahl K, Macomber MF (2003) Conflict and cooperation within international river basins: the importance of institutional capacity. *Water Resour Update* 125:1–10
111. McCaffrey SC (2003) *The law of international watercourses—non-navigational uses*. Oxford University Press, New York
112. IPCC (2001) *Climate change 2001: working group II: impacts, adaptation and vulnerability*. Cambridge University Press, Cambridge, UK
113. Cooley H, Christian-Smith J, Gleick PH, Allen L, Cohen M (2009) Understanding and reducing the risks of climate change for transboundary waters. Pacific Institute, Oakland, CA
114. Yates DN, Strzepek KM (1998) Modeling the Nile basin under climatic change. *J Hydrol Eng* 3 (2):98–108
115. Kim U, Kaluarachchi JJ, Smakhtin VU (2008) Generation of monthly precipitation under climate change for the upper blue Nile river basin, Ethiopia1. *J Am Water Resour Assoc* 44(5):1231–1247
116. Linnerooth J (1990) The Danube river basin: negotiating settlements to transboundary environmental issues. *Nat Resour J* 30(3):629–660
117. Arora VK, Boer GJ (2001) Effects of simulated climate change on the hydrology of major river basins. *J Geophys Res* 106(D4):3335–3348
118. ICPDR (International Commission for the Protection of the Danube River) (2010) *Improving water quality and combating effects of climate change among the priorities*. ICPDR, Vienna
119. Ingol-Blanco E, McKinney DC (2010) Transboundary climate change effects on the hydrologic regime in the Rio Conchos basin. In: Palmer RN (ed) *World environmental and water resources congress 2010: challenges of change*. ASCE, Providence, RI, pp 60–68
120. IPCC (2000) *Land use, land use change, and forestry*. In: Watson RT, Noble LR, Bolin B (eds) *A Special report of the IPCC*. Cambridge University Press, Cambridge, UK
121. Wood S, Sebastian K, Scherr SJ (2000) *Pilot analysis of global ecosystems: agroecosystems*. A joint study by the International Food Policy Research Institute and the World Resources Institute, Washington, DC
122. Fischer G, Shah M, van Velthuisen M, Nachtergaele FO (2001) *Global agro-ecological assessment for agriculture in the 21st century*. International Institute for Applied Systems Analysis, Laxenburg, Austria
123. Bindi M, Olesen JE (2000) *Agriculture*. In: Parry ML (ed) *Assessment of potential effects and adaptations for climate change in Europe: the Europe ACACIA project*. Jackson Environment Institute, University of East Anglia, Norwich, UK
124. Mohamed AB, Van Duivenbooden N, Abdoussallam S (2002) Impact of climate change on agricultural production in the sahel—part 1. Methodological approach and case study for millet in Niger. *Clim Change* 54(3):327–348
125. Adams RM, Rosenzweig C, Peart RM, Ritchie JT, McCarl BA, Glycer JD, Curry RB, Jones JW, Boote KJ, Allen LH (1990) Global climate change and US agriculture. *Nature* 345:219–224
126. IPCC (2001) *Intergovernmental Panel on Climate Change Working Group 2. Climate change 2001: impacts, adaptation and vulnerability*. IPCC Working Group 2
127. Parry ML, Rosenzweig C, Iglesias A, Livermore M, Fischer G (2004) Effects of climate change on global food production under SRES emissions and socio-economic scenarios. *Glob Environ Change* 14:53–67
128. World Bank (2007) *World development report 2008: agriculture for development*. World Bank, Washington, DC
129. Reilly J et al (2003) U.S. agriculture and climate change: new results. *Clim Change* 57:43–69

130. Falloon PD, Betts RA (2009) Climate impacts on European agriculture and water management in the context of adaptation and mitigation—the importance of an integrated approach. *Sci Total Environ* 408(23):5667–5687
131. Parry ML, Canziani OF, Palutikof JP, van der Linden PJ, Hanson CE (eds) (2007) Climate change: impacts, adaptation and vulnerability. Contribution of working group II to the fourth assessment report of the IPCC. Cambridge University Press, Cambridge, UK, p 976
132. Lobell DB, Field CB, Cahill KN, Bonfils C (2006) Impacts of future climate change on California perennial crop yields: model projections with climate and crop uncertainties. *Agric Meteorol* 141:208–218
133. Scott MJ, Vail LW, Jaksch JA, Stöckle CO, Kemanian AR (2004) Water exchanges: tools to beat El Niño climate variability in irrigated agriculture. *J Am Water Resour Assoc* 40(1):15–31
134. Ewert F, Rounsevell MDA, Reginster I, Metzger MJ, Leemans R (2005) Future scenarios of European agricultural land use I. Estimating changes in crop productivity. *Agric Ecosyst Environ* 107:101–116
135. Liu L, King JS, Giardina CP (2005) Effects of elevated concentrations of atmospheric CO<sub>2</sub> and tropospheric O<sub>3</sub> on leaf litter production and chemistry in trembling aspen and paper birch communities. *Tree Physiol* 25:1511–1522
136. Sitch S, Cox PM, Collins WJ, Huntingford C (2007) Indirect radiative forcing of climate change through ozone effects on the land-carbon sink. *Nature* 448:791–794
137. Semenov MA (2008) Impacts of climate change on wheat in England and Wales. *J R Soc Interface* 6(33):343–350
138. Maracchi G, Sirotenko O, Bindi M (2005) Impacts of present and future climate variability on agriculture and forestry in the temperate regions: Europe. *Clim Change* 70:117–135
139. Audsley E, Pearn KR, Simota C, Cojocaru G, Koutsidou E, Rounsevell MDA, Trnka M, Alexandrov V (2006) What can scenario modelling tell us about future European scale agricultural land use, and what not *Environ Sci Policy* 9:148–162
140. MAFF (2000) Climate change and agriculture in the United Kingdom. Ministry of Agriculture Fisheries and Food, HMSO, London
141. Wamelink GWW, ter Braak CJF, van Dobben HF (2003) Changes in large-scale patterns of plant biodiversity predicted from environmental economic scenarios. *Landsc Ecol* 18:513–527
142. Fischlin A, Midgley GF, Price JT, Leemans R, Gopal B, Turley C, Rounsevell MDA, Dube OP, Tarazona J, Velichko AA (2007) Ecosystems, their properties, goods, and services. In: Parry ML, Canziani OF, Palutikof JP, van der Linden PJ, Hanson CE (eds) *Climate change 2007: impacts, adaptation and vulnerability. Contribution of working group II to the fourth assessment report of the intergovernmental panel on climate change*. Cambridge University Press, Cambridge, UK, pp 211–272
143. Jansen E et al (2007) Paleoclimate. In: Solomon S, Qin D, Manning M, Chen Z, Marquis M, Averyt KB, Tignor M, Miller HL (eds) *Climate change 2007: the physical science basis. Contribution of working group I to the fourth assessment report of the intergovernmental panel on climate change*. Cambridge University Press, Cambridge, UK, pp 434–496
144. Reid WV et al (2005) *Ecosystems and human well-being: synthesis*. Island Press, Washington, DC, 155 pp
145. Foley JA et al (2005) Global consequences of land use. *Science* 309:570–574
146. Fahrig L (2003) Effects of habitat fragmentation on biodiversity. *Annu Rev Ecol Evol Syst* 34:487–515

147. Hsieh CH, Reiss CS, Hunter JR, Beddington JR, May RM, Sugihara G (2006) Fishing elevates variability in the abundance of exploited species. *Nature* 443:859–862
148. Aber J, Neilson RP, McNulty S, Lenihan JM, Bachelet D, Drapek RJ (2001) Forest processes and global environmental change: predicting the effects of individual and multiple stressors. *Bioscience* 51:735–751
149. Duraiappah AK (2005) *Ecosystems and human well-being: biodiversity synthesis*. Island Press, Washington, DC, 100 pp
150. Lauenroth WK, Epstein HE, Paruelo JM, Burke IC, Aguiar MR, Sala OE (2004) Potential effects of climate change on the temperate zones of North and South America. *Rev Chil Hist Nat* 77:439–453
151. Woodward FI, Lomas MR (2004) Simulating vegetation processes along the Kalahari transect. *Glob Change Biol* 10:383–392
152. Zha Y, Gao J, Zhang Y (2005) Grassland productivity in an alpine environment in response to climate change. *Area* 37:332–340
153. Pausas JG, Malak AD (2004) Spatial and temporal patterns of fire and climate change in the eastern Iberian Peninsula (Mediterranean Basin). In: Arianoutsou M, Papanastasis VP (eds) *Ecology, conservation and management of Mediterranean climate ecosystems of the world, 10th international conference on Mediterranean climate ecosystems*, Rhodes, Greece. Millpress, Rotterdam, pp 1–6
154. Fried JS, Torn MS, Mills E (2004) The impact of climate change on wildfire severity: a regional forecast for northern California. *Clim Change* 64:169–191
155. Midgley GF et al (2005) A status quo, vulnerability and adaptation assessment of the physical and socio-economic effects of climate change in the western Cape. Report to the Western Cape Government, Cape Town, South Africa. CSIR Report No. ENV-S-C 2005-073, CSIR Environmentek, Stellenbosch, 170 pp
156. Meehl GA et al (2007) Global climate projections. In: Solomon S, Qin D, Manning M, Chen Z, Marquis M, Averyt KB, Tignor M, Miller HL (eds) *Climate change 2007: the physical science basis. Contribution of working group I to the fourth assessment report of the intergovernmental panel on climate change*. Cambridge University Press, Cambridge, UK, pp 747–845
157. Kling J, Hayhoe K, Johnson LB, Magnuson JJ, Polasky S, Robinson SK, Shuter BJ, Wander MM, Wuebbles DJ, Zak DR (2003) *Confronting climate change in the Great Lakes region: impacts on our communities and ecosystems*. Union of Concerned Scientists and the Ecological Society of America, Cambridge, MA, 92 pp
158. Zalakevicius M, Svazas S (2005) Global climate change and its impact on wetlands and waterbird populations. *Acta Zool Lituonica* 15:215–217
159. Jackson DA, Mandrak NE (2002) Changing fish biodiversity: predicting the loss of cyprinid biodiversity due to global climate change. In: McGinn NA (ed) *Fisheries in a changing climate. American fisheries society symposium 32*, Phoenix, AZ. American Fisheries Society, Bethesda, MD, pp 89–98
160. Winder M, Schindler DE (2004) Climatic effects on the phenology of lake processes. *Glob Change Biol* 10:1844–1856
161. Frey KE, Smith LC (2005) Amplified carbon release from vast West Siberian peatlands by 2100. *Geophys Res Lett* 32, L09401
162. Keddy PA (2000) *Wetland ecology: principles and conservation*. Cambridge University Press, Cambridge, UK, 614 pp

163. Gopal B, Chauhan M (2001) South Asian wetlands and their biodiversity: the role of monsoons. In: Gopal B, Junk WJ, Davis JA (eds) *Biodiversity in wetlands: assessment, function and conservation*, vol 2. Backhuys, Leiden, pp 257–275
164. Naiman RJ, Decamps H, McClain ME (2005) *Riparia: ecology, conservation and management of streamside communities*. Elsevier, Amsterdam, 448 pp
165. Floder S, Burns CW (2004) Phytoplankton diversity of shallow tidal lakes: influence of periodic salinity changes on diversity and species number of a natural assemblage. *J Phycol* 40:54–61
166. <http://www.grida.no/climate/ipcc/emission/index.htm>. Accessed 31 Oct 2013
167. Christensen J et al (2007) Regional climate projections. In: Solomon S et al (eds) *Climate change 2007: the physical science basis. Contribution of working group I to the fourth assessment report of the intergovernmental panel on climate change*. Cambridge University Press, New York
168. Arnell NW (2004) Climate change and global water resources: SRES emissions and socio-economic scenarios. *Glob Environ Change* 14:31–52
169. Riebsame WE et al (1995) Complex river basins. In: Strzepek KM, Smith JB (eds) *As climate changes: international impacts and implications*. Cambridge University Press, Cambridge, UK, pp 57–91
170. Thomas CD, Cameron A, Green RE, Bakkenes M, Beaumont LJ, Collingham YC, Erasmus BFN, de Siqueira MF et al (2004) Extinction from climate change. *Nature* 427:145–148
171. Benhin JKA (2006) Climate change and South African agriculture: impacts and adaptation options. CEEPA discussion paper No. 21, Special series on climate change and agriculture in Africa. The Centre for Environmental Economics and Policy in Africa, University of Pretoria, Pretoria, 78 pp
172. Cury P, Shannon L (2004) Regime shifts in upwelling ecosystems: observed changes and possible mechanisms in the northern and southern Benguela. *Prog Oceanogr* 60:223–243
173. Alcamo J, Flörke M, Märker M (2007) Future long-term changes in global water resources driven by socio-economic and climatic changes. *Hydrolog Sci J* 52(2):247–275
174. Eitzinger J, Stastna M, Zalud Z, Dubrovsky M (2003) A simulation study of the effect of soil water balance and water stress in winter wheat production under different climate change scenarios. *Agric Water Manage* 61:195–217
175. Krüger A, Ulbrich U, Speth P (2002) Groundwater recharge in Northrhine-Westfalia by a statistical model for greenhouse gas scenarios. *Physics and chemistry of the earth, Part B: Hydrology. Oceans Atmos* 26:853–861
176. Somlyódy L (2002) Strategic issues of the Hungarian water resources management. Academy of Science of Hungary, Budapest, 402 pp (in Hungarian)
177. Donevska K, Dodeva S (2004) Adaptation measures for water resources management in case of drought periods. Proc. XXIIInd conference of the Danubian countries on the hydrological forecasting and hydrological bases of water management, Brno, 30 Aug–2 Sept 2004, CD-ROM
178. Holden NM, Brereton AJ, Fealy R, Sweeney J (2003) Possible change in Irish climate and its impact on barley and potato yields. *Agric Meteorol* 116:181–196
179. Giorgi F, Bi X, Pal J (2004) Mean, interannual variability and trend in a regional climate change experiment over Europe. II: Climate change scenarios 2071–2100. *Clim Dyn* 23:839–858. doi:10.1007/s00382-004-0467-0
180. Polemio M, Casarano D (2004) Rainfall and drought in southern Italy (1821–2001). UNESCO/IAHS/IWHA, Paris, 286
181. Lehner B, Czisch G, Vassolo S (2005) The impact of global change on the hydropower potential of Europe: a model-based analysis. *Energy Policy* 33:839–855

182. Jones PD, Lister DH, Jaggard KW, Pidgeon JD (2003) Future climate impact on the productivity of sugar beet (*Beta vulgaris* L.) in Europe. *Clim Change* 58:93–108
183. Trnka M, Dubrovski M, Zalud Z (2004) Climate change impacts and adaptation strategies in spring barley production in the Czech Republic. *Clim Change* 64:227–255
184. Peterson BJ, Holmes RM, McClelland JW, Vorosmarty CJ, Lammers RB, Shiklomanov AI, Shiklomanov IA, Rahmstorf S (2002) Increasing river discharge to the Arctic Ocean. *Science* 298:2172–2173
185. Iafiazova RK (1997) Climate change impact on mud flow formation in Trans-Ili Alatau mountains. *Hydrometeorol Ecol* 3:12–23 (in Russian)
186. Qin DH (2002) Assessment of environment change in western China, vol 2, Prediction of environment change in western China. Science Press, Beijing, 64, 73, 115, 132, 145–154, 160–161
187. Tao FL, Yokozawa M, Hayashi Y, Lin E (2005) A perspective on water resources in China: interactions between climate change and soil degradation. *Clim Change* 68(1–2):169–197
188. Higashi H, Dairaku K, Matuura T (2006) Impacts of global warming on heavy precipitation frequency and flood risk. *J Hydrosoci Hydraulic Eng* 50:205–210
189. Gupta SK, Deshpande RD (2004) Water for India in 2050: first-order assessment of available options. *Curr Sci* 86(9):1216–1224
190. World Bank (2002) World development indicators, CD-ROM. World Bank, Washington, DC
191. Tao F, Yokozawa M, Hayashi Y, Lin E (2003) Future climate change, the agricultural water cycle, and agricultural production in China. *Agric Ecosyst Environ* 95:203–215
192. IPCC Fourth Assessment Report: Climate Change (2007) [http://www.ipcc.ch/publications\\_and\\_data/ar4/wg1/en/contents.html](http://www.ipcc.ch/publications_and_data/ar4/wg1/en/contents.html)
193. CCME (2003) Climate, nature, people: indicators of Canada's changing climate. Climate change indicators task group of the Canadian Council of Ministers of the environment. Canadian Council of Ministers of the Environment Inc., Winnipeg, Canada, 51 pp
194. Christensen NS, Wood AW, Voisin N, Lettenmaier DP, Palmer RN (2004) The effects of climate change on the hydrology and water resources of the Colorado River basin. *Clim Change* 62(1–3):337–363
195. Mirza MMQ (2004) Climate change and the Canadian energy sector: report on vulnerability and adaptation. Adaptation and Impacts Research Group, Atmospheric Climate Science Directorate, Meteorological Service of Canada, Downsview, ON, 52 pp
196. Curriero F, Patz JA, Rose JB, Lele S (2001) The association between extreme precipitation and waterborne disease outbreaks in the United States, 1948–1994. *Am J Public Health* 91:1194–1199
197. Thomas MK, Charron DF, Waltner-Toews D, Schuster C, Maarouf AR, Holt JD (2006) A role of high impact weather events in waterborne disease outbreaks in Canada, 1975–2001. *Int J Environ Health Res* 16:167–180
198. Schuster CJ, Ellis A, Robertson WJ, Aramini JJ, Charron DF, Marshall B (2005) Drinking water related infectious disease outbreaks in Canada, 1974–2001. *Can J Public Health* 94:254–258
199. Reilly JM (ed) (2002) Agriculture: the potential consequences of climate variability and change. Cambridge University Press, Cambridge, UK, 136 pp
200. White MA, Diffenbaugh NS, Jones GV, Pal JS, Giorgi F (2006) Extreme heat reduces and shifts United States premium wine production in the 21st century. *Proc Natl Acad Sci U S A* 103:11217–11222

201. Vasquez-Leon M, West CT, Finan TJ (2003) A comparative assessment of climate vulnerability: agriculture and ranching on both sides of the US-Mexico border. *Glob Environ Change* 13:159–173
202. Smith SD, Huxman TE, Zitzer SF, Charlet TN, Housman DC, Coleman JS, Fenstermaker LK, Seemann JR, Nowak RS (2000) Elevated CO<sub>2</sub> increases productivity and invasive species success in an arid ecosystem. *Nature* 408:79–82
203. Bachelet D, Neilson RP, Lenihan JM, Drapek RJ (2001) Climate change effects on vegetation distribution and carbon budget in the United States. *Ecosystems* 4:164–185
204. UNMSM (2004) <http://Destacados/Destacados/contenido.php?mver=11>
205. PAHO (2003) Status report on malaria programs in the Americas. 44th Directing council, 55th session of the regional comité. Pan American Health Organization, Washington, DC
206. Van Lieshout M, Kovats RS, Livermore MTJ, Martens P (2004) Climate change and malaria: analysis of the SRES climate and socio-economic scenarios. *Glob Environ Change* 14:87–99
207. Hales S, de Wett N, Maindonald J, Woodward A (2002) Potential effect of population and climates change models on global distribution of dengue fever: an empirical model. *Lancet* 360:830–834
208. MDBC (2006) Basin statistics. Murray Darling Basin Commission. [http://www.mdbc.gov.au/about/basin\\_statistics](http://www.mdbc.gov.au/about/basin_statistics)
209. Beare S, Heaney A (2002) Climate change and water resources in the Murray Darling Basin, Australia; impacts and adaptation. Conference Paper 02.11, Australian Bureau of Agricultural and Resource Economics, 33 pp. <http://product.asp/product.asp?prodid=12389>
210. Jones R, Durack P (2005) Estimating the impacts of climate change on Victoria's runoff using a hydrological sensitivity model. Consultancy Report for the Victorian Department of Sustainability and Environment, 50 pp
211. Jenkins B (2006) Overview of environment Canterbury water issues, managing drought in a changing climate. Royal Society of New Zealand Drought Workshop, Christchurch, NZ, 10 Apr 2006
212. Woodruff RE, Guest CS, Garner MG, Becker N, Lindsay M (2006) Early warning of Ross River virus epidemics: combining surveillance data on climate and mosquitoes. *Epidemiology* 17 (5):569–575
213. SOE (2001) Australia State of the Environment 2001, independent report to the Commonwealth Minister for the environment and heritage. Australian State of the Environment Committee, CSIRO Publishing on behalf of the Department of the Environment and Heritage, 129 pp. <http://www.ea.gov.au/soe/2001>
214. Falconer IR (1997) Blue-green algae in lakes and rivers: their harmful effects on human health. *Aust Biol* 10(2):107–110
215. Bunn SE, Arthington AH (2002) Basic principles and ecological consequences of altered flow regimes for aquatic biodiversity. *Environ Manage* 30:492–507
216. Schallenberg M, Hall CJ, Burns CW (2003) Consequences of climate-induced salinity increases on zooplankton abundance and diversity in coastal lakes. *Marine Ecol Prog Ser* 251:181–189
217. Adger WN, Agrawala S, Mirza MMQ, Conde S, O'Brien K, Pulhin J, Pulwarty R, Smit B, Takahashi K (2007) Assessment of adaptation practices, options, constraints and capacity. In: Parry ML, Canziani OF, Palutikof JP, van der Linden PJ, Hanson CE (eds) *Climate change 2007: impacts, adaptation and vulnerability. Contribution of working group II to the fourth assessment report of the intergovernmental panel on climate change*. Cambridge University Press, Cambridge, UK

218. Adger WN, Arnell NW, Tompkins EL (2005) Successful adaptation to climate change across scales. *Glob Environ Change* 15:77–86
219. Osman-Elasha B, Goutbi N, Spanger-Siegfried E, Dougherty B, Hanafi A, Zakieldein S, Sanjak A, Atti H, Elhassan H (2006) Adaptation strategies to increase human resilience against climate variability and change: lessons from the arid regions of Sudan. AIACC working paper 42. International START Secretariat, Washington, DC, 42 pp
220. Wehbe M, Eakin H, Seiler R, Vinocur M, Afilu C, Marutto C (2006) Local perspectives on adaptation to climate change: lessons from Mexico and Argentina. AIACC working paper 39. International START Secretariat, Washington, DC, 37 pp
221. FAO (2004) Drought impact mitigation and prevention in the Limpopo river basin, a situation analysis. Land and water discussion paper 4. FAO, Rome, 160 pp
222. Easterling WE, Hurd BH, Smith JB (2004) Coping with global climate change: the role of adaptation in the United States. Pew Center on Global Climate Change, Arlington, VA, 40 pp
223. El Raey M (2004) Adaptation to climate change for sustainable development in the coastal zone of Egypt ENV/EPOC/GF/SD/RD(2004) 1/FINAL. OECD, Paris
224. Lasco R, Cruz R, Pulhin J, Pulhin F (2006) Tradeoff analysis of adaptation strategies for natural resources, water resources and local institutions in the Philippines. AIACC working paper No. 32. International START Secretariat, Washington, DC, 31 pp
225. Government of The Netherlands (2005) Fourth Netherlands national communication under the United Nations framework convention on climate change. Ministry of Housing, Spatial Planning and the Environment, The Hague, 208 pp
226. Smith JB, Rahman A, Haq S, Mirza MQ (1998) Considering adaptation to climate change in the sustainable development of Bangladesh. World Bank report. World Bank, Washington, DC, 103 pp
227. World Bank (2000) Cities, seas, and storms: managing change in Pacific island economies, vol 4, Adapting to climate change. World Bank, Washington, DC, 118 pp
228. Dore M, Burton I (2001) The costs of adaptation to climate change in Canada: a stratified estimate by sectors and regions—social infrastructure. Climate Change Laboratory, Brock University, St Catharines, ON, 117 pp
229. Nicholls RJ, Tol RSJ (2006) Impacts and responses to sea-level rise: a global analysis of the SRES scenarios over the 21st century. *Philos Trans R Soc A* 364:1073–1095
230. Kirshen P, Ruth M, Anderson W, Lakshmanan TR (2004) Infrastructure systems, services and climate changes: integrated impacts and response strategies for the Boston Metropolitan area. Climate's Long-term Impacts on Metro Boston (CLIMB) Final Report, 13 Aug 2004. Available online at <http://www.tufts.edu/tie/climb/>
231. Fankhauser S (1995) Protection versus retreat: the economic costs of sea-level rise. *Environ Plann A* 27:299–319
232. Yohe GW, Schlesinger ME (1998) Sea-level change: the expected economic cost of protection or abandonment in the United States. *Clim Change* 38:447–472
233. Darwin RF, Tol RSJ (2001) Estimates of the economic effects of sea level rise. *Environ Resour Econ* 19:113–129
234. Adams RM, McCarl BA, Mearns LO (2003) The effects of spatial scale of climate scenarios on economic assessments: an example from U.S. agriculture. *Clim Change* 60:131–148
235. Butt AT, McCarl BA, Angerer J, Dyke PT, Stuth JW (2005) The economic and food security implications of climate change. *Clim Change* 68:355–378



236. Rosenzweig C, Parry ML (1994) Potential impact of climate change on world food supply. *Nature* 367:133–138
237. Schneider SH, Easterling WE, Mearns LO (2000) Adaptation sensitivity to natural variability: agent assumptions and dynamic climate changes. *Clim Change* 45:203–221
238. Easterling WE, Chhetri N, Niu X (2003) Improving the realism of modelling agronomic adaptation to climate change: simulating technological substitution. *Clim Change* 60:149–173
239. Mendelsohn R, Morrison W, Schlesinger ME, Andronova NG (2000) Country-specific market impacts of climate change. *Clim Change* 45:553–569
240. Tol RSJ (2002) Estimates of the damage costs of climate change. Part 1: Benchmark estimates. *Environ Resour Econ* 21:47–73
241. Scheffer M, Carpenter S, Foley JA, Folke C, Walker B (2001) Catastrophic shifts in ecosystems. *Nature* 413:591–596
242. Steneck RS, Graham MH, Bourque BJ, Corbett D, Erlandson JM, Estes JA, Tegner MJ (2002) Kelp forest ecosystems: biodiversity, stability, resilience and future. *Environ Conserv* 29:436–459
243. Leary NJ et al (2006) For whom the bell tolls: vulnerabilities in a changing climate. AIACC working paper No. 30. International START Secretariat, Washington, DC, 31 pp
244. Derocher AE, Lunn NJ, Stirling I (2004) Polar bears in a warming climate. *Integr Comp Biol* 44:163–176
245. Folke C, Hahn T, Olsson P, Norberg J (2005) Adaptive governance of social-ecological systems. *Annu Rev Environ Resour* 30:441–473
246. Mace MJ (2006) Adaptation under the UN framework convention on climate change: the international legal framework. In: Adger WN, Paavola J, Huq S, Mace MJ (eds) *Fairness in adaptation to climate change*. MIT Press, Cambridge, MA, pp 53–76
247. Tol RSJ et al (2006) Adaptation to five metres of sea level rise. *J Risk Res* 9:467–482
248. Ikeme J (2003) Climate change adaptational deficiencies in developing countries: the case of Sub-Saharan Africa. *Mitig Adapt Strat Glob Chang* 8:29–52
249. Baer P (2006) Adaptation: who pays whom In: Adger WN, Paavola J, Huq S, Mace MJ (eds) *Fairness in adaptation to climate change*. MIT Press, Cambridge, MA, pp 131–153
250. World Bank (2006) *Clean energy and development: towards an investment framework*, annex K. World Bank, Washington, DC, 157 pp
251. Smit B, Skinner MW (2002) Adaptation options in agriculture to climate change: a typology. *Mitig Adapt Strat Glob Chang* 7:85–114
252. Mills E (2005) Insurance in a climate of change. *Science* 309:1040–1044
253. Lorenzoni I, Pidgeon NF, O'Connor RE (2005) Dangerous climate change: the role for risk research. *Risk Anal* 25:1387–1397
254. Moser S (2005) Impacts assessments and policy responses to sea-level rise in three U.S. states: an exploration of human dimension uncertainties. *Glob Environ Change* 15:353–369
255. Grothmann T, Patt A (2005) Adaptive capacity and human cognition: the process of individual adaptation to climate change. *Glob Environ Change* 15:199–213
256. Niemeyer S, Petts J, Hobson K (2005) Rapid climate change and society: assessing responses and thresholds. *Risk Anal* 25:1443–1455
257. Pulwarty R, Jacobs K, Dole R (2005) The hardest working river: drought and critical water problems in the Colorado river basin. In: Wilhite D (ed) *Drought and water crises: science, technology and management*. Taylor & Francis, New York, pp 249–285
258. Pretty J (2003) Social capital and the collective management of resources. *Science* 302:1912–1925

# Engineering Management of Agricultural Land Application for Watershed Protection

---

Lawrence K. Wang, Nazih K. Shammam, Gregory K. Evanylo,  
and Mu-Hao Sung Wang

## CONTENTS

NOMENCLATURE
INTRODUCTION
AGRICULTURAL LAND APPLICATION
PLANNING AND MANAGEMENT OF AGRICULTURAL LAND APPLICATION
DESIGN OF LAND APPLICATION PROCESS
PERFORMANCE OF LAND APPLICATION
OPERATION AND MAINTENANCE
NORMAL OPERATING PROCEDURES
EMERGENCY OPERATING PROCEDURES
ENVIRONMENTAL IMPACTS
LAND APPLICATION COSTS
PRACTICAL APPLICATIONS AND DESIGN EXAMPLES
LAND APPLICATION, CROP MANAGEMENT AND WATERSHED MANAGEMENT
GLOSSARY OF LAND APPLICATION AND WATERSHED PROTECTION TERMS
REFERENCES

---

**Abstract** The controlled application of biosolids to cropland by subsurface injection or surface spreading is introduced in this chapter. Specifically, the land application process operation, design criteria, performance, biosolids application rates, staffing requirements, process monitoring, sensory observation, normal operating procedures, process control considerations, emergency operating procedures, safety considerations, application and design examples, costs, and troubleshooting guide are presented and discussed in detail. Proper land application for watershed protection is discussed.

**Key Words** Agricultural land application • Watershed protection • Crop management • Nutrient management plan • Biosolids • Septage • Plant-available nitrogen • Agronomic rate • Design examples • Heavy metals • PAN • Nitrogen • Phosphorus • Potassium • Lime • Fertilizer • Watershed protection.

## NOMENCLATURE

$A$	Sludge application per acre in previous years, dry ton/acre
$AR$	Agronomic rate, dry ton/acre
$AR_{\text{design}}$	Sludge application rate selected for design, ton sludge/acre
$AR_L$	Lime-based agronomic rate, dry ton/acre
$AR_P$	Phosphorus-based agronomic rate, dry ton/acre
$CND$	Crop nitrogen deficit, lb N/acre
$CNFR$	Crop nitrogen fertilizer rate, lb N/acre
$D$	The concentration of the pollutant in the sewage sludge on a dry weight basis, in mg/kg
$D_{\text{ton}}$	Dry ton = 2,000 lbs
$E_m$	The effective mineralization factor for the growing season portion of the year
$F_{0-1}$	Sludge first-year organic-N mineralization factor based on the method of sludge treatment
$K_{\text{balance}}$	Positive value shows the excess lb K/acre; negative value shows the needed lb K/acre
$K_{\text{content}}$	Potassium content in sludge, lb K/ton sludge
$K_m$	Sludge crop year organic-N mineralization factor based on the method of sludge treatment, lb/ton/%
$K_{\text{required}}$	Potassium requirement on land, lb K/acre
$K_V$	Ammonium-N volatilization factor, based on the method of land application
$LB_{\text{ammonium}}$	Weight of ammonium nitrogen, lb
$LB_K$	Weight of potassium, lb
$LB_{\text{nitrate}}$	Weight of nitrate nitrogen, lb
$LB_{\text{nitrite}}$	Weight of nitrite nitrogen, lb
$LB_{\text{organic}}$	Weight of organic nitrogen, lb
$LB_P$	Weight of phosphorus, lb
$LB_{\text{TKN}}$	Weight of total Kjeldahl nitrogen, lb
$LB_{\text{total}}$	Weight of total nitrogen, lb
$L_{\text{content}}$	Lime content in sludge in terms of CCE, % (in decimal form; for instance, 40 % = 0.4)
$L_{\text{required}}$	Lime requirement for the land in terms of CCE, ton CCE/acre
$N_{\text{ammonium}}$	Ammonium nitrogen content in sludge, lb ammonium-N/ton of sludge
$NH_4^+ \text{-N}$	Ammonium nitrogen, mg/kg, %, or lb/ton
$N_{\text{nitrate}}$	Nitrate nitrogen content in sludge, lb nitrate-N/ton of sludge
$NO_2^- \text{-N}$	Nitrite nitrogen, mg/kg, %, or lb/ton

$\text{NO}_3^-$ -N	Nitrate nitrogen, mg/kg, %, or lb/ton
$N_{\text{organic}}$	Organic nitrogen content in sludge, lb organic-N/ton of sludge
$N_{\text{TKN}}$	Total Kjeldahl nitrogen content in sludge, lb TKN/ton of sludge
$N_{\text{total}}$	Total nitrogen content in sludge, lb N/ton of sludge
Organic- $N_r$	Biosolids organic nitrogen remaining from previous years, lbs/dry ton
PAN	Plant-available nitrogen
$\text{PAN}_{0-1}$	First-year plant-available nitrogen in sludge, lb N/ton of sludge
PANA	Crop year biosolids PAN applied in previous years, dry ton/acre
PANS	Crop year non-biosolids PAN applied in previous years, lb N/acre
PANT	Crop year total PAN applied in previous years, lb N/acre
$P_{\text{balance}}$	Positive value shows the excess lb P/acre; negative value shows the needed lb P/acre
$\text{PC}_{\text{nitrate}}$	Percent of nitrate nitrogen, %
$\text{PC}_{\text{nitrite}}$	Percent of nitrite nitrogen, %
$\text{PC}_{\text{organic}}$	Percent of organic nitrogen, %
$\text{PC}_P$	Percent of phosphorus, %
$\text{PC}_s$	Percentage of solids, %
$\text{PC}_{\text{TKN}}$	Percent of total Kjeldahl nitrogen, %
$\text{PC}_K$	Percent of potassium, %
$\text{PC}_{\text{ammonium}}$	Percent of ammonium nitrogen, %
$\text{PC}_{\text{nitrate}}$	Percent of nitrate nitrogen, %
$P_{\text{content}}$	Phosphorus content in sludge, lb P/ton sludge
$P_{\text{required}}$	Phosphorus requirement on land, lb P/acre
$R$	Rate of application, lb/acre
$R_{\text{As}}$	Sludge application rate based on arsenic content, ton sludge/acre
$R_{\text{Cd}}$	Sludge application rate based on cadmium content, ton sludge/acre
$R_{\text{Cr}}$	Sludge application rate based on chromium content, ton sludge/acre
$R_{\text{Cu}}$	Sludge application rate based on copper content, ton sludge/acre
$R_{\text{Hg}}$	Sludge application rate based on mercury content, ton sludge/acre
$R_{\text{max}}$	Max allowable sludge application rate based on the lowest of heavy metal content, ton/acre
$R_{\text{Mo}}$	Sludge application rate based on molybdenum content, ton sludge/acre
$R_{\text{Ni}}$	Sludge application rate based on nickel content, ton sludge/acre
$R_{\text{Pb}}$	Sludge application rate based on lead content, ton sludge/acre
$R_{\text{Se}}$	Sludge application rate based on selenium content, ton sludge/acre
$R_{\text{Zn}}$	Sludge application rate based on zinc content, ton sludge/acre
TKN	Total Kjeldahl nitrogen
TN	Total nitrogen
UNFR	Unit nitrogen fertilizer rate, lb N/unit crop yield
$W$	The concentration of the pollutant in the sewage sludge on a wet basis in mg/L
Yield	Crop yield, bu/acre or ton/acre harvested

## 1. INTRODUCTION

Land application of biosolids is defined as the spreading, spraying, injection, or incorporation of liquid, semiliquid, or solid organic by-product of the wastewater treatment process, onto or below the surface of the land to take advantage of the nutrient-supplying and soil property-enhancing qualities of the residuals. These organic by-products are land-applied to improve the structure of the soil and to supply nutrients to crops and other vegetation grown in the soil. These by-products are commonly applied to agricultural land (including pasture and range land), forests, reclamation sites, and, if properly treated, public contact sites (e.g., parks, turf farms, highway median strips, golf courses), lawns, and home gardens.

Biosolids contain significant concentrations of essential plant nutrients. The availability of these nutrients to vegetation at an application site depends on these materials' composition, processing, handling and method of application, as well as a number of soil and climatic factors. Under most situations, the amount of these materials that can be applied to the soil is based on satisfying a nutrient requirement of the vegetation. This quantity is called the "agronomic" rate of application.

This chapter illustrates how nutrient management is achieved using the approach of the US Environmental Protection Agency (US EPA) and how the agronomic rate of application on agricultural land is determined. Although the emphasis of this chapter is placed on application of biosolids on agricultural land, the same method of analysis can also be applied to livestock manure and other organic by-products.

### 1.1. *Biosolids*

Sewage sludge means any solid, semisolid, or liquid residue removed during the treatment of municipal wastewater or domestic sewage. Sewage sludge includes, but is not limited to, solids removed during primary, secondary, or advanced wastewater treatment; scum; septage; portable toilet pumpings; and sewage sludge products. Sewage sludge does not include grit or screenings or ash generated during the incineration of sewage sludge. Septage means the liquid and solid material pumped from a septic tank, cesspool, or similar domestic sewage treatment system, or holding tank when the system is cleaned or maintained. Biosolids are solid, semisolid or liquid materials, resulting from biological treatment of domestic sewage, that have been sufficiently processed to permit these materials to be safely land-applied. The term of biosolids was introduced by the wastewater treatment industry in the early 1990s and has been recently adopted by the US EPA to distinguish high-quality treated sewage sludge from raw sewage sludge and from sewage sludge containing large amounts of pollutants. Although the "biosolids" term does not evoke the same negative connotation as does "sewage sludge," the use of the term is appropriate when it makes the distinction described above.

### 1.2. *Biosolids Production and Pretreatment Before Land Application*

Biosolids are produced primarily through biological treatment of domestic wastewater. Biosolids comprise the solids that are removed from the wastewater and further processed before the treated water is released into streams or rivers.

Thickening, digestion, stabilization, conditioning, dewatering, composting, and heat drying processes are often employed additionally to improve the biosolids handling characteristics, increase the economic viability of land application, and reduce the potential for public health, environmental, and nuisance problems associated with land application practices. These processes control disease-causing organisms and reduce characteristics that might attract rodents, flies, mosquitoes, or other organisms capable of transporting infectious disease. Table 12.1 shows how various biosolids pretreatment processes will affect the suitability of biosolids to be applied on land especially for agricultural use.

### 1.3. Biosolids Characteristics

The suitability of biosolids for land application can be determined by biological, chemical, and physical analyses. Biosolids' composition depends on wastewater constituents and treatment processes. The resulting properties will determine application method and rate and the degree of regulatory control required. Several of the more important properties of biosolids are discussed below.

Total solids (TS) include suspended and dissolved solids and are usually expressed as the concentration present in biosolids. TS depend on the type of wastewater process and biosolids' treatment prior to land application. Typical solids contents of various biosolids are: liquid (2–12 %), dewatered (12–30 %), and dried or composted (50 %). Volatile solids (VS) provide an estimate of the readily decomposable organic matter in biosolids and are usually expressed as a percentage of total solids. VS are an important determinant of potential odor problems at land application sites. A number of biosolids treatment processes, including anaerobic digestion, aerobic digestion, and composting, can be used to reduce VS content and, thus, the potential for odor.

The degree of acidity or alkalinity of a substance is expressed as pH. The pH of biosolids is often raised with alkaline materials to reduce pathogen content and attraction of disease-spreading organisms (vectors). High pH (greater than 11) kills virtually all pathogens and reduces the solubility, biological availability, and mobility of most metals. Lime also increases the gaseous loss (volatilization) of the ammonia form of nitrogen (ammonia-N), thus reducing the N-fertilizer value of biosolids.

Pathogens are disease-causing microorganisms that include bacteria, viruses, protozoa, and parasitic worms. Pathogens can present a public health hazard if they are transferred to food crops grown on land to which biosolids are applied; contained in runoff to surface waters from land application sites; or transported away from the site by vectors such as insects, rodents, and birds. For this reason, federal and state regulations specify pathogen and vector attraction reduction requirements that must be met by biosolids applied to land. A list of pathogens that can be found in untreated sewage sludge and the diseases or symptoms that they can cause have been published [1–4].

Nutrients are elements required for plant growth that provide biosolids with most of their economic value. These include nitrogen (N), phosphorus (P), potassium (K), calcium (Ca), magnesium (Mg), sodium (Na), sulfur (S), boron (B), copper (Cu), iron (Fe), manganese (Mn), molybdenum (Mo), and zinc (Zn). Concentrations in biosolids can vary significantly

**Table 12.1**  
**Effects of biosolids treatment processes on land application practices. Source: Adapted from US EPA [1]**

Treatment process and definition	Effect on biosolids	Effect on land application practices
<i>Thickening</i>		
Low force separation of water and solids by gravity, flotation, or centrifugation	Increases solids content by removing water	Lowers transportation costs
<i>Digestion (anaerobic and aerobic)</i>		
Biological stabilization through conversion of organic matter to carbon dioxide, water, and methane	Reduces the biodegradable content (stabilization by conversion to soluble material and gas). Reduces pathogen levels and odor	Reduces the quantity of biosolids
<i>Alkaline stabilization</i>		
Stabilization through the addition of alkaline materials (e.g., lime, kiln dust)	Raises pH. Temporarily decreases biological activity. Reduces pathogen levels and controls putrescibility and odor	High pH immobilizes metals and provides liming capacity
<i>Conditioning</i>		
Processes that cause biosolids to coagulate to aid in the separation of water	Improves sludge dewatering characteristics. May increase dry solids mass and improve stabilization	The ease of consistent spreading may be reduced by treating biosolids with polymers
<i>Dewatering</i>		
High force separation of water and solids. Methods include vacuum filters, centrifuges, filter and belt presses, etc.	Increases solids concentration to 15–45 %. Lowers nitrogen and potassium concentrations. Improves ease of handling	Reduces land requirements and lowers transportation costs. Reduces potassium value of biosolids
<i>Composting</i>		
Aerobic, thermophilic, biological stabilization in a windrow, aerated static pile or vessel	Lowers pathogenic activity and converts sludge to humus-like material	Excellent soil conditioning properties. Contains less plant-available nitrogen than other biosolids
<i>Heat drying</i>		
Use of heat to kill pathogens and eliminate most of the water content	Disinfects sludge, destroys most pathogens, and lowers odors and biological activity	Greatly reduces sludge volume and mass

**Table 12.2**

**Means and variability of nutrient concentrations<sup>a</sup> in biosolids collected and analyzed in Pennsylvania between 1993 and 1997. Adapted from Stehouwer et al. [5]**

Nutrient	Total N <sup>b</sup> %	NH <sub>4</sub> -N	Organic-N	Total P	Total K
Mean	4.74	0.57	4.13	2.27	0.31
Variability <sup>c</sup>	1.08	0.30	1.03	0.89	0.27

<sup>a</sup>Concentrations are on a dried solids basis.

<sup>b</sup>Determined as total Kjeldahl nitrogen.

<sup>c</sup>Standard deviation of the mean.

(see Table 12.2); thus, the actual material being considered for land application should be analyzed.

Trace elements are found in low concentrations in biosolids. The trace elements of interest in biosolids are those commonly referred to as “heavy metals.” Some of these trace elements (e.g., copper, molybdenum, and zinc) are nutrients needed for plant growth in low concentrations, but all of these elements can be toxic to humans, animals, or plants at high concentrations. Possible hazards associated with a buildup of trace elements in the soil include their potential to cause phytotoxicity (i.e., injury to plants) or to increase the concentration of potentially hazardous substances in the food chain. Federal and state regulations have established standards for the following nine trace elements: arsenic (As), cadmium (Cd), copper (Cu), lead (Pb), mercury (Hg), molybdenum (Mo), nickel (Ni), selenium (Se), and zinc (Zn).

Organic chemicals are complex compounds that include man-made chemicals from industrial wastes, household products, and pesticides. Many of these compounds are toxic or carcinogenic to organisms exposed to critical concentrations over certain periods of time, but most are found at such low concentrations in biosolids that do not pose significant human health or environmental threats. Although no organic pollutants are included in the current US federal biosolids regulations, further assessment of specific organic compounds is continuing [6–8].

#### **1.4. Agricultural Land Application for Beneficial Use**

As an alternative to disposal by landfilling or incineration, land application seeks to beneficially recycle the soil property-enhancing constituents in biosolids, which are ultimately derived from crops grown on agricultural land. The US EPA [9] estimates that more than seven million dry metric tons (DMTs) of sewage sludge are produced annually. According to US EPA [9], over half the sludge produced (54 %) is “used beneficially,” that is, applied on agricultural, horticultural, forest, and reclamation land throughout the country.

Biosolids are about 50 % mineral and 50 % organic matter. The mineral matter includes plant nutrients, and organic matter is a source of slow-release nutrients and soil conditioners. Farmers can benefit from biosolids application by reducing fertilizer costs. The main fertilizer benefits are through the supply of nitrogen, phosphorus, and lime (where lime-stabilized



biosolids are applied). Biosolids also ensure against unforeseen nutrient shortages by supplying essential plant nutrients that are rarely purchased by farmers because crop responses to their application are unpredictable. These include elements such as sulfur, manganese, zinc, copper, iron, molybdenum, and boron. Land application replenishes valuable organic matter, which occurs in less than optimum amounts in most soils. The addition of organic matter can improve soil tilth, the physical condition of soil as related to its ease of tillage, fitness as a seedbed, and its impedance to seedling emergence and root penetration. Other benefits imparted by the addition of organic matter to soil include:

- (a) Increases water infiltration into the soil and soil moisture-holding capacity
- (b) Reduces soil compaction
- (c) Increases the ability of the soil to retain and provide nutrients
- (d) Reduces soil acidification
- (e) Provides an energy source (carbon) for beneficial microorganisms
- (f) Can contribute to soil carbon sequestration

The addition of organic matter in biosolids to a fine-textured clay soil can help make the soil more friable and can increase the amount of pore space available for root growth and entry of water and air into the soil. In coarse-textured sandy soils, organic residues in biosolids can increase the water-holding capacity of the soil and provide chemical sites for nutrient exchange and adsorption.

Land application is usually less expensive than alternative methods of disposal. Consequently, wastewater treatment facilities and the public they serve benefit through cost savings. The recycling of nutrients and organic matter can be attractive to citizens concerned with environmental protection and resource conservation.

Land application of biosolids involves some risks, which are addressed through federal and state regulatory programs. Pollutants and pathogens are added to soil with organic matter and nutrients. Human and animal health, soil quality, plant growth, and water quality could be adversely affected if land application is not conducted in an agronomically and environmentally sound manner. In addition, nitrogen and phosphorus in biosolids, as in any fertilizer source, can contaminate ground and surface water if the material is overapplied or improperly applied. There are risks and benefits to each method of biosolids disposal and reuse.

### ***1.5. US Federal and State Regulations***

The US EPA has developed the regulations and the standards for the use or disposal of sewage sludge (Title 40 of the Code of Federal Regulations [CFR], Part 503). The Part 503 Rule establishes minimum requirements when biosolids are applied to land to condition the soil or fertilize crops or other vegetation grown in the soil. The Clean Water Act (<http://www.epa.gov/lawsregs/laws/cwa.html>) required that this regulation protect public health and the environment from any reasonably anticipated adverse effects of pollutants and pathogens in biosolids. Determination of biosolids quality is based on trace element (pollutant) concentrations and pathogen and vector attraction reduction. Federal regulations require that state regulations be at least as stringent as the Part 503 Rule [10–12]. Many state regulations prohibit land application of low-quality sewage sludge and encourage the

**Table 12.3**

**Regulatory limits (adapted from US EPA [1]), mean concentrations measured in biosolids from the National Sewage Sludge Survey (adapted from US EPA [14]), and a survey of 12 Pennsylvania POTWs between 1993 and 1997 (adapted from Stehouwer et al. [5])**

Pollutant	CCL <sup>a,b</sup> , ppm	PCL <sup>a,c</sup> , ppm	CPLR <sup>a,d</sup> , lbs/acre	Mean <sup>a,e</sup> , ppm	Mean <sup>a,f</sup> , ppm
Arsenic (As)	75	41	36	10	5
Cadmium (Cd)	85	39	35	7	3
Copper (Cu)	4,300	1,500	1,340	741	476
Lead (Pb)	840	300	270	134	82
Mercury (Hg)	57	17	16	5	2
Molybdenum (Mo)	75	<sup>e</sup>	<sup>e</sup>	9	13
Nickel (Ni)	420	420	375	43	23
Selenium (Se)	100	100	89	5	4
Zinc (Zn)	7,500	2,800	2,500	1,202	693

*ppm* = part per million.

<sup>a</sup>Dry weight basis.

<sup>b</sup>CCL (ceiling concentration limits) = maximum concentration permitted for land application.

<sup>c</sup>PCL (pollutant concentration limits) = maximum concentration for biosolids whose trace element pollutant additions do not require tracking (i.e., calculation of CPLR).

<sup>d</sup>CPLR (cumulative pollutant loading rate) = total amount of pollutant that can be applied to a site in its lifetime by all bulk biosolids applications meeting CCL.

<sup>e</sup>Data from US EPA [14].

<sup>f</sup>Data from Stehouwer et al. [5].

<sup>g</sup>The February 25, 1994 Part 503 Rule amendment deleted Mo PCL for sewage sludge applied to agricultural land but retained Mo CCL.

application of biosolids that are of sufficient quality that they will not adversely affect human health or the environment [9, 13].

### 1.5.1. Trace Element Limits

The Part 503 Rule prohibits land application of sewage sludge that exceeds the *ceiling concentration limits* (see Table 12.3) for nine trace elements, including arsenic, cadmium, copper, lead, mercury, molybdenum, nickel, selenium, and zinc. Sewage sludge exceeding the ceiling concentration limit for even one of the regulated pollutants is not classified as biosolids and, hence, cannot be land-applied.

*Pollutant concentration limits* are the most stringent pollutant limits included in Part 503 for land application. Biosolids meeting pollutant concentration limits are subject to fewer requirements than biosolids meeting ceiling concentration limits. Results of the US EPA's 1990 National Sewage Sludge Survey (NSSS) [14] demonstrated that the mean concentrations of the nine regulated pollutants are considerably lower than the most stringent Part 503 pollutant limits (Table 12.3).

The *cumulative pollutant loading rate* (Table 12.3) is the total amount of a pollutant that can be applied to a site in its lifetime by all bulk biosolids applications meeting ceiling concentration limits. No additional biosolids meeting ceiling concentration limits can be applied to a site after the maximum cumulative pollutant loading rate is reached at that site for any one of the nine regulated trace elements. Only biosolids that meet the more stringent pollutant concentration limits may be applied to a site once a cumulative pollutant loading rate is reached at that site.

General Pretreatment Regulations [40 Code of Federal Regulations (CFR) Part 403] were developed to control the introduction of nondomestic wastes to publicly owned treatment works (POTWs). The purpose of the program is to protect POTWs from pollutant pass through and interference, to protect receiving waters, and to improve opportunities to recycle biosolids. The program relies on national categorical standards, prohibited discharge standards, and local limits. Control authorities are required to develop and enforce local limits as mandated by 40 CFR 403.5 and 40 CFR 403.8. In December 1987, the US Environmental Protection Agency (US EPA) published a technical document entitled *Guidance Manual on the Development and Implementation of Local Discharge Limitations* (<http://www.epa.gov/npdes/pubs/owm0275.pdf>). That guidance addressed the key elements in developing local limits such as identifying all industrial users, determining the character and volume of pollutants in industrial user discharges, collecting data for local limits development, identifying pollutants of concern, calculating removal efficiencies, determining the allowable headworks loading, and implementing appropriate local limits to ensure that the maximum allowable headworks loadings are not exceeded. Supplements to the 1987 manual intended to build on the initial information have been published (<http://cfpub.epa.gov/npdes/pretreatment/pstandards.cfm>). An improvement in the quality of biosolids over the years has largely been due to pretreatment and pollution prevention programs [15]. Such improvements in biosolids quality can be seen in the reduction in concentrations of metals measured in biosolids from the National Sewage Sludge Survey and a survey of 12 Pennsylvania POTWs between 1993 and 1997 (Table 12.3).

### 1.5.2. Organic Chemicals

Part 503 does not regulate organic chemicals in biosolids because the chemicals of potential concern have been banned or restricted for use in the USA, are no longer manufactured in the USA, are present at low concentrations based on data from US EPA's 1990 NSSS [14], or because the limit for an organic pollutant identified in the Part 503 risk assessment is not expected to be exceeded in biosolids that are land-applied [16]. Restrictions will be imposed for agricultural use if testing of certain toxic organic compounds verifies that biosolids contain levels that could cause harm to human health or the environment.

### 1.5.3. Pathogen Reduction

The US federal and state regulations require the reduction of potential disease-causing microorganisms, called pathogens (e.g., viruses, bacteria, and parasitic worms) and vector (e.g., rodents, birds, insects that can transport pathogens away from the land application site)

**Table 12.4**

**Class B biosolids application land use restrictions.** *Source: Adapted from Virginia Department of Environmental Quality [13]*

---

Root crops, where biosolids remain on land surface	
≥4 mos. prior to soil incorporation	Harvest 20 months after application
<4 mos. prior to soil incorporation	Harvest 38 months after application
Food crops that touch biosolids or soil	Harvest 14 months after biosolids application
Other food, feed or fiber crops	Harvest 30 days after application
Turf	Harvest 1 year after application when the turf is placed on land with high potential for public exposure
Grazing animals	
Lactating (milking) animals	No grazing prior to 60 days after application
Non-lactating animals	No grazing prior to 30 days after application
Public access to land	
High access potential	Restricted to 1 year after application
Low access potential	Restricted to 30 days after application

---

attraction properties. Biosolids intended for land application are normally treated by chemical or biological processes that greatly reduce the number of pathogens and odor potential in sewage sludge. Two levels of pathogen reduction, Class A and Class B, are specified in the regulations [10].

The goal of Class A requirements is to reduce the pathogens (including *Salmonella* sp., bacteria, enteric viruses, and viable helminth ova) to below detectable levels. Class A biosolids can be land-applied without any pathogen-related site restrictions. *Processes to further reduce pathogens* (PFRP) treatment, such as those involving high temperature, high pH with alkaline addition, drying, and composting, or their equivalent are most commonly used to demonstrate that biosolids meet Class A requirements.

The goal of Class B requirements is to ensure that pathogens have been reduced to levels that are unlikely to cause a threat to public health and the environment under specified use conditions. *Processes to significantly reduce pathogens* (PSRP), such as digestion, drying, heating, and high pH, or their equivalent are most commonly used to demonstrate that biosolids meet Class B requirements. Because Class B biosolids contain some pathogens, certain site restrictions are required. These are imposed to minimize the potential for human and animal contact with the biosolids until environmental factors (temperature, moisture, light, microbial competition) reduce the pathogens to below detectable levels. As an example of waiting periods after land application, Table 12.4 summarizes the Class B biosolids application land use restrictions imposed by the Virginia Department of Environmental Quality [13]. The site restriction requirements in combination with Class B treatment are expected to provide a level of protection equivalent to Class A treatment. All biosolids that are land-applied must, at a minimum, meet Class B pathogen reduction standards [10].

#### 1.5.4. Vector Attraction Reduction

The objective of vector attraction reduction is to prevent disease vectors such as rodents, birds, and insects from transporting pathogens away from the land application site. There are ten options available to demonstrate that land-applied biosolids meet vector attraction reduction requirements. These options fall into either of the following two general approaches: (a) reducing the attractiveness of the biosolids to vectors with specified organic matter decomposition processes (e.g., digestion, alkaline addition) and (b) preventing vectors from coming into contact with the biosolids (e.g., biosolids injection or incorporation below the soil surface within specified time periods).

#### 1.5.5. Categories of Biosolids Quality

The quality of biosolids (i.e., pollutant concentrations, pathogen levels, and vector attraction reduction control) determines which land application requirements must be met. There are three categories of biosolids quality that are discussed below and described in Table 12.5.

Biosolids that meet the Part 503 PCLs, Class A pathogen reduction, and a vector attraction reduction option that reduces organic matter are classified as Exceptional Quality, or EQ, biosolids. In general, EQ biosolids can be applied as freely as any other fertilizer or soil amendment to any type of land.

*Pollutant concentration* (PC) biosolids meet the same low pollutant limits (PCLs) as EQ biosolids, but PC biosolids usually meet Class B rather than Class A pathogen reduction requirements. Biosolids meeting Class A pathogen reduction requirements plus one of the practices designed to prevent vectors from coming into contact with biosolids also are PC biosolids.

*Cumulative pollutant loading rate* (CPLR) biosolids, unlike EQ or PC biosolids, require tracking of the cumulative metal loadings to ensure adequate protection of public health and the environment. Additional land application terminologies can be found from the “Glossary” section of this chapter and the literature.

#### 1.5.6. Nutrients

The US federal regulations specify that biosolids may only be applied to agricultural land at or less than the rate required to supply the nutrient (primarily N, P) needs of the crops to be grown. This “agronomic rate” was initially “designed: (a) to provide the amount of N needed by the food crop, feed crop, fiber crop, or vegetation grown on the land; and (b) to minimize the amount of N in the biosolids that passes below the root zone of the crop or vegetation grown on the land to the ground water (40 CFR 503.11 (B)).” Agronomic rate may also be based on crop phosphorus (P) needs if it is determined that excessive soil P poses a threat to water quality. The application rate of lime-stabilized biosolids can further be limited by soil pH.

#### 1.5.7. Site Suitability and Location

Site physical characteristics that influence the land application management practices include topography; soil permeability, infiltration, and drainage patterns; depth to groundwater; and proximity to surface water. Federal, state, and local regulations, ordinances, or

**Table 12.5**  
**Summary of requirements for different quality bulk biosolids. Source: Evanylo [17]**

Biosolids type	Ceiling concentration limit	Other pollutant limits	Pathogen class	Vector attraction reduction <sup>a</sup>	Siting restrictions	Track added pollutant	Required management practices
Exceptional quality (EQ)	Yes	Pollutant	A	Treatment options	No	No	No <sup>b</sup>
Pollutant concentration (PC)	Yes	Pollutant conc. limits	A or B	Any option	No <sup>a</sup> /yes <sup>b</sup>	No	Yes <sup>c</sup>
Cumulative pollutant loading rate (CPLR)	Yes	Cumulative Pollutant loading rate	A or B	Any option	Yes	Yes	Yes

<sup>a</sup>The eight vector attraction reduction treatment options that reduce the attractiveness of the biosolids to vectors by further decomposition of the volatile solids. Two additional management options (incorporation and injection) prevent vectors from coming into contact with the biosolids.

<sup>b</sup>EQ biosolids can be applied as freely as any other fertilizer or soil amendment to any type of land. Virginia requires additional recordkeeping for distribution of bulk quantities and specific labeling information for bagged products marketed under a registration filed with the Virginia Department of Agriculture and Consumer Services. EQ biosolids are exempt from Part 503 general requirements and management practices.

<sup>c</sup>Management practices are required when biosolids do not meet EQ criteria either because they meet vector attraction reduction through soil injection or incorporation.

**Table 12.6**

**Minimum distances (ft) to land application area.** *Source:* Virginia Department of Conservation and Recreation (<http://www.dcr.virginia.gov/documents/StandardsandCriteria.pdf>)

Adjacent feature	Surface application <sup>a</sup>	Incorporation	Winter <sup>b</sup>
Occupied dwellings	200	200	200
Water supply wells or springs	100	100	100
Property lines	100	50	100
Perennial streams and other surface water, except intermittent streams	50	35	100
Intermittent streams/drainage ditches	25	25	50
All improved roadways	10	5	0
Rock outcrops and sinkholes	25	25	25
Agricultural drainage ditches with slopes equal to or less than 2 %	10	5	10

<sup>a</sup>Not plowed or disced to incorporate within 48 h. 1 ft = 0.3048 m.

<sup>b</sup>Application occurs on average site slope greater than 7 % during period between November 16 of 1 year and March 15 of the following year.

<sup>c</sup>*Source:* Evanylo [17].

guidelines place limits on land application based on these physical characteristics. Potentially unsuitable areas for biosolids application include (a) areas bordered by ponds, lakes, rivers, and streams without appropriate buffer areas; (b) wetlands and marshes; (c) steep areas with sharp relief; (d) undesirable geology (fractured bedrock) if not covered by a sufficiently thick layer of soil; (e) undesirable soil conditions (rocky, shallow); (f) areas of historical or archeological significance; and (g) other environmentally sensitive areas, such as floodplains.

Many states have enacted regulations establishing site-specific management practice standards more demanding than the Part 503 Rule. Such regulations define standards of practice to ensure that biosolids use does not compromise the public health or the environment. An example of regulations promulgated by a state that are more stringent than the federal regulations is the Virginia Biosolids Use Regulations [17], which specify minimum distances to land application areas from occupied dwellings, water supply wells or springs, property lines, perennial streams and other surface waters, intermittent streams/drainage ditches, improved roadways, rock outcrops and sinkholes, and agricultural drainage ditches (see Table 12.6).

## 2. AGRICULTURAL LAND APPLICATION

### 2.1. Land Application Process

The land application operation and maintenance information in this chapter applies to controlled application of biosolids to cropland. The most appropriate application method for agricultural land depends on the chemical and physical characteristics of the biosolids and the soil, as well as the types of crops grown. Biosolids are generally land-applied using one of the following methods: (a) sprayed or spread on the soil surface and left on the surface for

pastures, range, and forest land; (b) incorporated into the soil after being surface-applied; or (c) injected directly below the surface for producing row crops or other vegetation. Biosolids application methods such as incorporation and injection can be used to meet Part 503 vector attraction reduction requirements. Alternatively, both liquid and dewatered biosolids may be applied to land without subsequent soil incorporation. Although there are many field variations to the land application operation, certain process requirements, limitations, design criteria, operating procedures, and monitoring methods must be established to optimize the process performance [1, 10–12, 17–29].

The most common form of biosolids applied to agricultural land is that which has undergone conditioning and dewatering. Dewatering typically increases the solids content of liquid biosolids from less than 5 % to 25–30 %, thus precluding the need to transport considerable quantities of water in liquid biosolids to the application site. Dewatered biosolids can be applied to cropland by equipment similar to that used for applying limestone, animal manures, or commercial fertilizer. Typically, dewatered biosolids will be surface-applied and incorporated by chisel plowing, disking, or another form of tillage. Incorporation is not used when applying dewatered biosolids to forages or to the increasing amount of no-till land.

Liquid biosolids can be applied by surface spreading or subsurface injection. Surface methods include spreading by tractor-drawn tank wagons, special applicator vehicles equipped with flotation tires, or irrigation systems. Surface application with incorporation is normally limited to soils with less than a 7 % slope. Biosolids are commonly incorporated by chisel plowing or disking after the liquid has been applied to the soil surface and allowed to partially dry, unless minimum or no-till systems are being used.

Spray irrigation systems generally should not be used to apply biosolids to forages or row crops during the growing season, although a light application to the stubble of a forage crop following a harvest is acceptable. The adherence of biosolids to plant vegetation can have a detrimental effect on crop yields by reducing photosynthesis. In addition, spray irrigation increases the potential for odor problems and reduces the aesthetics at the application site.

Liquid biosolids can also be injected below the soil surface using tractor-drawn tank wagons with injection shanks and tank trucks fitted with flotation tires and injection shanks. Both types of equipment minimize odor problems and reduce ammonia volatilization by immediate mixing of soil and biosolids. Injection can be used either before planting or after harvesting crops, but it is likely to be unacceptable for forages and sod production. Some injection shanks can damage the sod or forage stand and leave deep injection furrows in the field. Subsurface injection will minimize runoff from all soils and can be used on slopes up to 15 %. Injection should be made perpendicular to slopes to avoid having liquid biosolids run downhill along injection slits and pond at the bottom of the slopes. As with surface application, drier soil will be able to absorb more liquid, thereby minimizing downslope movement. Despite the advantages with regard to odor and maintaining soil vegetative cover with injecting liquid biosolids, such practice is much less common than surface application of dewatered biosolids.

Typical sludge injector trucks are shown in Fig. 12.1. Liquid application of biosolids from a sludge application truck is shown in Fig. 12.2. Figure 12.3 shows the application of liquid biosolids to a forest land.



**Fig. 12.1.** Biosolids injection equipment.  
*Source:* US EPA [21].



**Fig. 12.2.** Liquid application of biosolids. *Source:* US EPA [21].

## 2.2. Agricultural Land Application Concepts and Terminologies

To understand when and where to apply biosolids and/or manure on agricultural land, certain common terms must be understood [22].

The *farm field* is the basic management unit used for all farm nutrient management, as defined as “the fundamental unit used for cropping agricultural products.” An *area of cropland* that has been *subdivided* into several strips is not a single field. Rather, each strip represents an *individual field unit*. Individual fields that are managed in the same manner, with the similar yield goals, are called a *crop group*.

**Fig. 12.3.** Application of liquid biosolids to forest land. *Source:* US EPA [21].



The cycle of crop *planting and harvesting periods*, not the calendar year, dictates the timing of biosolids land application activities. Winter wheat and perennial forage grasses are examples of crops that may be established and harvested in different calendar years. In many regions, biosolids are commonly applied in the fall or early winter, in anticipation of a crop that will be planted the following spring. Crop nutrient management practices are linked to crop nutrient uptake (crop growth) and nutrient removal at harvest time. Agricultural land application programs must be coordinated with the cropping cycle.

The basic time management unit is often called the *crop year* or *planting season*. The *crop year* is defined as the year in which a crop receiving the biosolids treatment is harvested. For example, fall applications of biosolids in 2012 intended to provide nutrients for a crop to be harvested in 2013 are earmarked for *crop year* 2013. Likewise, biosolids applied immediately prior to planting winter wheat in October 2012 should be identified as fertilizer intended for *crop year* 2013 because the wheat will be harvested in the summer of 2013. Similarly, if instead of wheat, the field is planted with corn in the spring of 2013 that will be harvested in the fall of 2013, applications of biosolids made in the fall of 2012 should be credited to crop year 2013. Typically, biosolids applied January through June would be intended for a crop harvested in the same calendar year. Biosolids applied in the last 6 months of the calendar year usually fertilize crops harvested the next calendar year. This generalization does not always hold true. For example, biosolids may be applied in July on a grass forage crop or in preparation for a buckwheat crop that will be harvested before winter. Other common exceptions are likely in hot, humid sections of the USA [22]. The first step in computing the agronomic rate is to establish the amount of nitrogen needed for a desired crop yield. The crop yield consists of crop removal rates and nutrient

Table 12.7

Expected yield for various crops grown on common Virginia soils. Source: Virginia Department of Conservation and Recreation (<http://www.dcr.virginia.gov/documents/StandardsandCriteria.pdf>)

Soil series	Physiographic province	Corn	Wheat (intensive)	Soybean (full season)	Alfalfa	Tall grass hay
		bu/acre	bu/acre	bu/acre	tons/acre	tons/acre
Bojac	CP	100	70	25	NS	3.0–3.5
Cecil	PD	120	70	35	<4.0	3.5–4.0
Emporia	CP	140	70	40	<4.0	3.5–4.0
Frederick	RV	150	80	40	>6.0	3.5–4.0
Iredell	PD	80	30	20	NS	<3.0
Kempsville	CP	140	70	40	<4.0	3.5–4.0
Pamunkey	CP	180	80	50	4.0–6.0	>4.0

CP coastal plain, PD piedmont, RV ridge and valley, NS not suited.

recommendations for proposed crops. This is also a good time to evaluate other primary nutrient crop removal amounts (phosphate and potash), though these elements are not normally regulated at the state or federal level.

Realistic yield goals can be obtained from agronomy guidelines (or equivalent) published by state land-grant universities, cooperative extension, or state nutrient management planning certifying agencies. Yield goals are commonly based on soil productivity categorization of soils that take into account soil-moisture holding capacity, soil depth, drainage characteristics, and other soil features that affect plant-available water. Table 12.7 demonstrates how Virginia soils having diverse properties can influence crop yields differently. Biosolids and fertilizer nutrients recommended for such soils are based on residual soil nutrients as determined by soil testing ([http://www.mawaterquality.org/capacity\\_building/mid-atlantic%20nutrient%20management%20handbook/chapter7.pdf](http://www.mawaterquality.org/capacity_building/mid-atlantic%20nutrient%20management%20handbook/chapter7.pdf)) and crop nutrient uptake needs ([http://www.mawaterquality.org/capacity\\_building/mid-atlantic%20nutrient%20management%20handbook/chapter4.pdf](http://www.mawaterquality.org/capacity_building/mid-atlantic%20nutrient%20management%20handbook/chapter4.pdf); tables 4.3a–c). Fertilizer recommendations, regardless of the nutrient source, based on residual soil nutrients and supplemental crop needs have been published for Virginia by the state's nutrient management certifying agency—the Virginia Department of Conservation and Recreation—at <http://www.dcr.virginia.gov/documents/StandardsandCriteria.pdf>.

Only a portion of the total nitrogen present in biosolids is available for plant uptake. This *plant-available nitrogen (PAN)* is the actual amount of N in the biosolids that is available to crops during a specified period. The biosolids application rate is a field measurement determined for the particular application equipment.

*Total Kjeldahl nitrogen (TKN)* is the summation of *ammonium nitrogen* ( $\text{NH}_4^+\text{-N}$ ) and *organic nitrogen*. *Total nitrogen (TN)* is the summation of *ammonium nitrogen* ( $\text{NH}_4^+\text{-N}$ ), *nitrate nitrogen* ( $\text{NO}_3^-\text{-N}$ ), *nitrite nitrogen* ( $\text{NO}_2^-\text{-N}$ ), and *organic nitrogen*. Nitrite nitrogen

**Table 12.8****Estimated biosolids mineralization rate factors ( $F_{\text{year}}$ ) for Virginia. Source: Virginia Department of Environmental Quality [13]**

Percent organic-N mineralized from field applied biosolids ( $F_{\text{year}}$ )		
Time after biosolids application (crop year)	Lime stabilized or digested biosolids (%)	Composted biosolids (%)
0–1	30–35 <sup>a</sup>	10
1–2	15	5
2–3	7.5	3

<sup>a</sup>Depends on region in Virginia. East of the Blue Ridge Mountains (i.e., Coastal Plain and Piedmont) = 35 %; west of the Blue Ridge Mountains (i.e., Ridge and Valley and Appalachian Plateau) = 30 %.

is found in negligible amounts in biosolids and is usually ignored in the calculation of N rates. Crops directly utilize nitrogen in its inorganic forms, principally nitrate-N and ammonium-N. Biosolids nitrate-N concentrations, however, are typically less than 0.05 %. This translates to less than one pound per dry ton of biosolids. Hence, this fraction is usually insignificant and is not included in most agronomic rate calculations. However, it is advisable to test the biosolids nitrate-N content before eliminating this factor.

Most nitrogen exists in biosolids as organic-N, principally contained in proteins, nucleic acids, amines, and other cellular material. These complex molecules must be broken apart through biological degradation for nitrogen to become available to crops. The conversion of organic-N to inorganic ammonium-N is called *mineralization*.

The mineralization rate depends on soil factors such as temperature, moisture, pH, and availability of oxygen, as well as the inherent biodegradability of organic materials. Biosolids that are digested undergo some mineralization before ever reaching the farm field. Hence, the method and degree of biosolids treatment prior to application influence the amount of nitrogen easily released for plant uptake. Further microbial conversion of ammonium-N to nitrate-N occurs under aerobic conditions and is termed nitrification. Nitrification occurs rapidly in well-drained agricultural soils and results in a predominance of nitrate rather than ammonium-N by early summer in most humid, temperate climatic regions of the USA.

Organic-N in biosolids becomes available to crops (i.e., mineralized) over a period of several years. Because of the many influencing factors, we rely on estimates of mineralization. The mineralization factors for Virginia (Table 12.8) illustrate how time after field application affects the amount of biosolids PAN. The amounts of mineral-N formed percent organic-N is 6–7 lbs/dry ton for lime-stabilized or digested biosolids and 2 lbs/dry ton for composted biosolids.

Ammonium-N in biosolids can be significant, making up as much as half the initial PAN of biosolids. The ammonium-N in biosolids can vary widely depending on treatment and storage. Since ammonium-N is prone to volatilization (as ammonia gas,  $\text{NH}_3$ ), the application method affects PAN. For instance, surface-applied and unincorporated biosolids are expected

**Table 12.9**  
**Estimated plant-available percentage of ammonia from biosolids. Source: Virginia Department of Environmental Quality [13]**

Management practice	Biosolids pH < 10	Biosolids pH > 10
	Available portion (%)	
Injection below surface	100	100
Surface application with		
Incorporation within 24 h	85	75
Incorporation within 1–7 days	70	50
Incorporation after 7 days	50	25

to lose half of their ammonium-N. Conversely, direct subsurface injection or soil incorporation of biosolids within 24 h minimizes volatilization losses [22]. Table 12.9 presents the factors used to calculate biosolids ammonium-N that does not volatilize and, thus, can be counted as plant available in Virginia. Additional terminologies for agricultural land application process can be found in this chapter’s “Glossary and Land Application Terms” section.

### 3. PLANNING AND MANAGEMENT OF AGRICULTURAL LAND APPLICATION

#### 3.1. Planning

Biosolids nutrient management controls should be planned for activities before, during, and after land application, according to National Biosolids Partnership [22].

##### 3.1.1. Planning Before Land Application

The following are the planning activities before land application of biosolids: (a) confirm that the biosolids meet all pollutant, pathogen reduction, and vector attraction reduction requirements at the time proposed for application. Do not just rely on past history; a responsible representative must personally review the data to assure that all is in order; (b) confirm the N, P, and K content of the biosolids. If the material has been stored for greater than 6 weeks, nutrient content should be reevaluated; (c) review the farm nutrient management plan for the crop(s) being planted in order to calculate the biosolids agronomic rate; (d) access information on past biosolids applications in order to consider residual-N when calculating the biosolids agronomic rate; (e) calculate the “target” biosolids agronomic rate based on the nitrogen content of the biosolids, crop nitrogen need, and residual-N from past biosolids applications; (f) discuss the proposed biosolids application with the farm operator to confirm that the recycling program is consistent with the farm operator’s intentions. Address any last minute changes on the farm operator’s part; and (g) check that all regulatory approvals, notices, etc. have been completed.

### 3.1.2. Planning During Land Application

The following are the planning activities during land application of biosolids: (a) check the area applied versus the volume (or mass) of biosolids applied to confirm that the actual application rate is consistent with the target agronomic rate. This exercise should be performed daily. In addition, (b) record the location (field, portion of field) where each load of biosolids is applied, the current weather conditions, responsible parties involved, visits by regulators, and any unusual observations or complaints by neighbors.

### 3.1.3. Planning After Land Application

The following are the planning activities after land application of biosolids: (a) assemble and file all records documenting the application event, (b) submit any required regulatory reports, (c) provide pertinent information to the farm operator, particularly the biosolids nutrients applied, and (d) notify the farm operator (and specified regulatory officials as required) that land application activities have been completed.

## 3.2. Nutrient Management

### 3.2.1. Nutrient Management Goal

The goal of nutrient management is to develop environmentally responsible strategies for field application of agricultural fertilizers. A sound nutrient management plan (NMP) will provide a site-specific strategy for supplying necessary nutrients for crop growth while at the same time protecting local water quality. The Part 503 Rule limits land application of biosolids-N to only the amount used by growing crops [22]. The practice of limiting biosolids applications to supply only as much N as will be consumed by the crop and removed during harvest, “termed agronomic rate,” is not a new concept. Most state biosolids regulations have recognized this practice for decades.

Biosolids are not balanced fertilizers. The primary nutrients, N, P, and potassium (K), required to achieve target crop yields are not supplied by biosolids in the proportions needed by crops. For example, when biosolids are applied to meet crop-N needs, P is typically overapplied and K is often under-applied. The degree to which P and K are mismatched to crop needs depends on the particular biosolids, soil residual P and K concentrations, and the crop. Experience has shown that repeat applications of nutrients to the same farm field may eventually result in elevated levels of soil test P. When elevated soil test P is found, terms such as *high* or *excessive* are used in soil test reports to indicate that further addition of phosphate fertilizer will not increase crop yields. Such interpretations of soil fertility tests are based on agronomic/economic considerations, not on potential environmental risk posed by high soil test P levels. Current standard practice bases biosolids application on plant-available nitrogen (PAN) content. The approach strives to assure that at least two of the three primary nutrients, N and P, are present in the soil in sufficient quantities to achieve the desired crop yield.

### 3.2.2. Farm Identification Elements for Nutrient Management

Biosolids application can substantially offset or even completely eliminate the need for chemical fertilizers when careful and deliberate nutrient management is employed. There are four basic components to a voluntary biosolids nutrient management plan: (a) farm identification, (b) nutrient management plan summary, (c) nutrient allocation and use, and (d) restrictions [11].

The following is a list of required information in order to develop the first component, farm identification: (a) operator's name, address, telephone no., and signature (including a land-owner consent); (b) county(ies) where operation is located; (c) name(s) of adjacent streams; (d) indication of any special protection waters; (e) total acres of operation; (f) total cropland acres available for nutrient application; (g) total cropland acres planned for manure recycling, excluding biosolids and other organic-N nutrient sources; (h) total cropland acres planned for biosolids recycling, excluding manure and other organic-N nutrient sources; (i) total cropland acres to which biosolids and manure both will be applied; (j) number of animal equivalent units (AEUs) per acre receiving manure, if applicable; (k) name and certification number of nutrient management specialist, if applicable; (l) location maps showing outline of farm site and soil survey maps containing soil types and slopes with outline of farm site; and (m) farm maps of sufficient scale to show the field and operation boundaries and the areas where biosolids application is limited or restricted.

### 3.2.3. Nutrient Management Plan Summary Elements

A nutrient management plan summary should include the following elements: (a) manure management summary table, if applicable; (b) total manure generated on the farm site annually; (c) total manure used on the farm site annually; (d) total manure exported from the farm site annually; (e) biosolids management summary table; (f) total biosolids generated by contributing sources; (g) total amount of biosolids which could be recycled in accordance with the computed agronomic rate; (g) nutrient application rates by field or crop group; (h) general summary of excess manure utilization procedures; and (h) implementation schedule [22].

### 3.2.4. Nutrient Allocation and Use Elements

The following items/information are needed for development of the nutrient management plan: (a) amounts and various nutrient sources used on the operation; (b) the number of animals of each animal type, if applicable; (c) acreage and expected crop yields for each crop group; (d) the amount of nutrients necessary to meet expected crop yields; (e) residual-N from legumes; (f) the nutrient content of the manure(s), if applicable; (g) the amount of PAN originating from manure(s), considering the application method and planned manure incorporation time (volatilization losses), if applicable; (h) the amount of PAN originating from past manure applications, if applicable; (i) the nutrient content of conventional fertilizers that will be used regardless of other N sources (e.g., starter fertilizer and herbicide carrier solutions); (j) the amount of PAN originating from conventional fertilizers; (j) the nutrient content of the biosolids; (k) the amount of PAN originating from biosolids, considering the

biosolids treatment method, biosolids-N forms, and planned application method; (l) the amount of PAN originating from past biosolids applications; (m) planned manure application rate(s), if applicable; (n) target spreading periods for manure application, if applicable; (o) nitrogen balance calculation showing the biosolids agronomic rate for each management unit; and (p) winter manure-spreading procedures, if applicable.

The types and properties of conventional fertilizers that are commonly used by farmers for which biosolids may substitute are discussed at [http://www.mawaterquality.org/capacity\\_building/mid-atlantic%20nutrient%20management%20handbook/chapter8.pdf](http://www.mawaterquality.org/capacity_building/mid-atlantic%20nutrient%20management%20handbook/chapter8.pdf). The amount of plant-available nitrogen contributed by legumes that can be subtracted from the needed biosolids PAN can be estimated from the information in Table 4.4 at [http://www.mawaterquality.org/capacity\\_building/mid-atlantic%20nutrient%20management%20handbook/chapter4.pdf](http://www.mawaterquality.org/capacity_building/mid-atlantic%20nutrient%20management%20handbook/chapter4.pdf). State-specific guidance should be used when available [22].

### 3.2.5. Restrictions Elements

Land application of biosolids may be restricted by nutrient management plans under the following conditions: (a) frozen, snow-covered, and saturated soil conditions; (b) slope constraints; (c) manure application isolation distances; and (d) biosolids application isolation distances and harvest waiting periods. In addition, biosolids application to “environmentally sensitive sites” (i.e., any field which is particularly susceptible to nutrient loss to groundwater or surface water) may be further restricted. In Virginia, such sites include those characterized by (a) soils with high potential for leaching based on soil texture or excessive drainage; (b) shallow soils less than 41 in. deep likely to be located over fractured or limestone bedrock; (c) subsurface tile drains; (d) soils with high potential for subsurface lateral flow based on soil texture and poor drainage; (e) floodplains, as identified as soils prone to frequent flooding in county soil surveys; or (f) lands with slopes >15 % (<http://www.dcr.virginia.gov/documents/StandardsandCriteria.pdf>).

## 4. DESIGN OF LAND APPLICATION PROCESS

### 4.1. Biosolids Application Rate Scenario

Design criteria for land application programs address issues related to application rates and suitable sites. Biosolids, site, and vegetative characteristics are the most important design factors to consider. Biosolids must meet regulatory requirements for stabilization and pollutant content. In addition, nutrient content and physical characteristics, such as percent solids, are used to determine the appropriate application rate for the crop that will be grown and the soil in which the crops will be grown. Site suitability is determined based on such factors as soil characteristics, slope, depth to groundwater, and proximity to surface water. In addition, many states have established site requirements to further protect water quality. Some examples from various states include (a) sufficient land to provide areas of non-application (setbacks) around surface water bodies, wells, and wetlands; (b) depth from the soil surface to groundwater equal to at least 1 m; (c) soil pH in the range of 5.5–7.0 to optimize crop



growing conditions; and (d) site suitability is also influenced by the character of the surrounding area. While odors and truck traffic may not be objectionable in an agricultural area, both will adversely impact residential developments and community centers close to fields where biosolids are applied.

The type of vegetation to be grown is also a design consideration. Vegetation, like soil characteristics, will generally not exclude biosolids application since most vegetation will benefit from the practice. However, the type of vegetation will impact the choice of application equipment, the amount of biosolids to be applied, and the timing of applications. The amount of biosolids that may be applied to a site is a function of the amount of nutrients required by the vegetation.

Application frequency is typically state regulations specific. For instance, Virginia permits biosolids to be applied at agronomic-N rates only once every 3 years to reduce the risk of surface water impairment due to P runoff from soil that has accrued excessive amounts of the nutrient. Biosolids application timing is recommended for immediately prior to crop establishment to ensure most efficient use of the mobile forms of nitrogen. Timing can be determined by knowing the typical planting and harvesting times for crops, which are listed at the following website for the mid-Atlantic, USA: [http://www.mawaterquality.org/capacity\\_building/mid-atlantic%20nutrient%20management%20handbook/chapter5.pdf](http://www.mawaterquality.org/capacity_building/mid-atlantic%20nutrient%20management%20handbook/chapter5.pdf). Other factors to be considered in the timing of applications are soil conditions. Long periods of saturated or frozen ground limit opportunities for application. This is an important consideration in programs using agricultural lands; applications must be performed at times convenient to the farmer and must not interfere with the planting of crops. Most application of biosolids to agricultural land occurs in the early spring or late fall. As a result, storage or an alternate biosolids management option must be available to handle biosolids when application is not possible. Forest lands and reclamation sites allow more leeway in the timing of applications. In some areas of the USA, application can proceed year round. Application is most beneficial on agricultural land in late fall or early spring before the crop is planted.

Timing is less critical in forest applications when nutrients can be incorporated into the soil throughout the growing period or where no incorporation is required. Winter application is less desirable, even prohibited, in many locales. Rangelands and pasturelands also are more adaptable to applications during various seasons. Applications can be made as long as ground is not saturated or snow covered and whenever livestock can be grazed on alternate lands for at least 30 days after the application. The timing of single applications in land reclamation programs is less critical and may be dictated by factors such as regulatory compliance schedules.

The concentrations of certain trace elements in the biosolids determine whether biosolids can be applied and under what monitoring requirements. Table 12.3 presents the US EPA [1] ceiling concentration limits, pollutant concentration limits, cumulative pollutant loading rates, mean concentrations from the National Sewage Sludge Survey (NSSS [14]), and a Penn State University [5] survey of heavy metals. Table 12.10 presents possible trace elements concentration in typical unamended and biosolids-amended soils and the time required to reach cumulative loading limits for the regulated trace elements when biosolids containing metals at the concentrations found in the NSSS are applied annually at agronomic-N rates.

**Table 12.10**

**Possible trace element concentration in typical unamended and biosolids-amended soils and the time required to reach cumulative loading limits for the regulated trace elements.**

*Source: Evanylo [20]*

Trace element	Typical background soil concentration range for non-contaminated <sup>a</sup> , mg/kg	Theoretical soil concentration at US EPA cumulative loading limit <sup>b</sup> , mg/kg	Time required to reach cumulative loading limit <sup>c</sup> , years
Arsenic	6–10	21	360
Cadmium	0.2–0.5	20	500
Copper	17–65	750	181
Lead	8–22	150	201
Mercury	0.06–0.15	9	320
Nickel	7–45	210	871
Selenium	0.3–0.4	50	1,780
Zinc	19–82	1,400	208

<sup>a</sup>*Source: Pennsylvania State University [29].*

<sup>b</sup>Theoretical maximum soil concentrations after application of the maximum allowable amount of that element.

<sup>c</sup>Assumes an annual application rate of 5 dry tons/acre of a biosolid with trace element concentrations equal to the means allowable concentrations.

#### **4.2. Step-by-Step Procedures for Sludge Application Rate Determination**

The application rate is a function of biosolids characteristics, soil characteristics, and crop nutrient requirements. The estimated biosolids plant-available nitrogen content and the nitrogen requirements of the crop for the specific soil type are necessary to calculate the application rate. Nitrogen is present in aerobically digested biosolids in the organic, ammonium, and nitrate forms. Nitrate nitrogen is not present in anaerobically digested or lime-stabilized biosolids. Nitrogen is available for immediate plant use in the ammonium ( $\text{NH}_4^+$ ) or nitrate ( $\text{NO}_3^-$ ) forms. The availability of organic nitrogen to the crop depends on the mineralization rate and will normally be available over a period of several years.

Usually, the biosolids application rate is first determined based on nitrogen requirements. This rate is then used to calculate phosphorus supply and compared to soil and crop P needs. There are four basic steps involved in determining the biosolids agronomic rate (AR): (a) crop nitrogen fertilizer rate (CNFR) determination, (b) crop nitrogen deficit (CND) determination, (c) biosolids plant-available nitrogen (PAN) determination, and (d) agronomic rate (AR) calculation.

The following subsections provide detailed step-by-step procedures for calculation of sludge application rate (AR) using all of the separate components listed above. In practice, this analysis must be repeated for each farm field contained in a land application program [22].

#### 4.2.1. Determining Crop Nitrogen Fertilizer Rate (CNFR)

Table 12.7 provides mean expected yields of selected Virginia soils, and supplemental fertilizer-N, P and K rates are calculated from a combination of soil test recommendations and crop nutrient needs for a specific soil (<http://www.dcr.virginia.gov/documents/StandardsandCriteria.pdf>). The biosolids agronomic rate is based on meeting crop needs without overapplication of nitrogen. The total CNFR has been determined for various soil productivity group and has been tabulated at <http://www.dcr.virginia.gov/documents/StandardsandCriteria.pdf>.

Equation (12.1) is used for calculating CNFR:

$$\text{CNFR} = (\text{Yield})(\text{UNFR}) \quad (12.1)$$

Yield = crop yield, bu/acre or ton/acre (from Table 12.7)

UNFR = unit nitrogen fertilizer rate, lbs N, per unit crop yield (as show in Table 12.17)

#### 4.2.2. Determining Crop Nitrogen Deficit (CND)

Crop nitrogen deficit (CND) equals anticipated crop nitrogen fertilizer rate (CNFR) minus all past biosolids PAN (PANA) and non-biosolids sources (PANS), in the unit of lb N/acre, as shown in Equations (12.2) and (12.2a). Previous biosolids carryover nitrogen is included in this calculation:

$$\text{CND} = \text{CNFR} - (\text{PANA}) - (\text{PANS}) \quad (12.2)$$

$$\text{CND} = \text{CNFR} - (\text{PANT}) \quad (12.2a)$$

where

CND = crop nitrogen deficit, lb N/acre

CNFR = crop nitrogen fertilizer rate, lb N/acre

PANA = crop year biosolids PAN applied in previous years, lb N/acre

PANS = crop year non-biosolids PAN applied in previous years, lb N/acre

PANT = crop year total PAN applied in previous years, lb N/acre

Specifically, PAN contributions from all past and current planned non-biosolids sources must be subtracted from the calculated CNFR to determine the CND that may be supplied by biosolids applications for a particular field crop. Nitrogen from all past sources (PANT) that must be considered include (a) manure-N, if applicable, including current and historical applications; (b) residual legume-N, if applicable, carryover from previous legume crops; (c) starter fertilizer-N, if applicable; (d) conventional N-containing chemical fertilizers; (e) biosolids organic-N carryover including nitrogen originating from the previous 3-year applications; and (f) other nitrogen sources, such as land-applied crop or food-processing residuals, irrigation water, nitrogen-solution pesticide carriers, and other nonconventional fertilizer materials.

**Table 12.11**  
**Annual residual PAN from mineralization of organic-N from previous biosolids application (calculated from  $N_{min}$  rates in Table 12.8)**

Years after application	Mineralization rate, %	Biosolids organic-N content, % (dry weight basis)				
		2.0	3.0	4.0	5.0	6.0
Annual N available, lbs N/dry ton biosolids						
0-1	30	12	18	24	30	36
1-2	15	4.2	6.3	8.4	10.5	12.6
2-3	7.5	1.8	2.7	3.6	4.5	5.4
≥3	<4	Do no calculate for biosolids as values would be same as background soil N mineralization of 3-4 % annually				

Begins with growing season for which biosolids is applied and continues 2 more years.

For first year, this equals the % organic-N in the biosolids ×  $N_{min}$  factor × the rate of application. For years 1-2 and 2-3, this quantity equals the amount of organic-N remaining from the previous year × the residual  $N_{min}$  factor.

The PANA (i.e., mainly organic-N application per acre) carryover from past biosolids applications can be calculated using (12.3), Tables 12.8 and 12.11:

$$PANA = A(K_m)(Organic-N_r) \tag{12.3}$$

where

PANA = crop year biosolids PAN applied in previous years, lb N/acre

A = biosolids application per acre in previous years, dry ton/acre

Organic- $N_r$  = biosolids organic nitrogen remaining from previous years, lbs/dry ton (this is calculated by subtracting the organic-N that has mineralized in previous years)

$K_m$  = biosolids crop year organic-N mineralization factor based on the method of biosolids treatment, lb/ton/% (see Tables 12.8 and 12.11)

#### 4.2.3. Determining First-Year Plant-Available Nitrogen ( $PAN_{0-1}$ )

Computing biosolids plant-available nitrogen (PAN) should account for (a) the type of biosolids, (b) the method of biosolids application, (c) organic-N mineralization in subsequent growing seasons, and (d) both inorganic and organic contributions to PAN. Total nitrogen is the sum of nitrate nitrogen, nitrite nitrogen, organic nitrogen, and ammonia (all expressed as N). Note that for laboratory analysis purposes, total Kjeldahl nitrogen (TKN) is made up of both organic nitrogen and ammonia nitrogen.

The first-year plant-available nitrogen ( $PAN_{0-1}$ ) in biosolids may be summarized by Equations (12.4) and (12.4a), in which all biosolids mass is based on dry solids:

$$N_{total} = N_{ammonium} + N_{nitrate} + N_{organic} \tag{12.4}$$

$$PAN_{0-1} = (K_v)(N_{ammonium}) + N_{nitrate} + (F_{0-1})N_{organic} \tag{12.4a}$$

where,

$PAN_{0-1}$  = first-year plant-available nitrogen in biosolids, lb N/ton of biosolids

$N_{total}$  = total nitrogen content in biosolids, lb N/ton of biosolids

$N_{ammonium}$  = ammonium nitrogen content in biosolids, lb ammonium-N/ton of biosolids

$N_{nitrate}$  = nitrate nitrogen content in biosolids, lb nitrate-N/ton of biosolids

$N_{organic}$  = organic nitrogen content in biosolids, lb organic-N/ton of biosolids

$K_v$  = ammonium-N volatilization factor, based on the method of land application, as shown in Table 12.9

$F_{0-1}$  = biosolids first-year organic-N mineralization factor based on the method of biosolids treatment (see Table 12.8)

#### 4.2.4. Determining Biosolids Application Rate or Agronomic Rate

Determination of agronomic rate (AR) involves five basics: (a) selecting a realistic crop yield goal, (b) determining N needs of this crop, (c) estimating residual-N in the soil from past manures/legumes/biosolids, (d) determining the amount of supplemental-N needed to meet the crop need, and (e) calculating the amount of biosolids necessary to supply this amount.

All of the above-listed crop-N sources have been discussed in previous sections of this chapter. Note that the principal source for historical data is the farm operator. The agronomic rate is calculated using the first-year PAN content of the biosolids intended to be recycled and the CND. Any change in either of these factors will impact the computed AR. Equation (12.5) describes the calculation of agronomic rate (AR):

$$AR = (CND)/(PAN_{0-1}) \quad (12.5)$$

where

AR = agronomic rate, dry ton/acre

CND = crop nitrogen deficit, lb N/acre

$PAN_{0-1}$  = first-year plant-available nitrogen in biosolids, lb N/ton of biosolids

#### 4.2.5. Determining Allowable Lifetime Biosolids Application

The determination of the lifetime allowable biosolids application rate ( $R_{max}$ , maximum agronomic rate) is based on the total accumulated heavy metals for application of biosolids not meeting PCL. It should be noted that very few biosolids produced today fail to meet PCL for the nine regulated trace elements (As, Cd, Cu, Hg, Mo, Ni, Pb, Se, and Zn). The total metals that can be applied are shown in Table 12.3. Using the information from Table 12.3, the maximum total biosolids application rate ( $R_{max}$ ) is the lowest of the following computations:

$$R_{Pb} = (lb\ Pb/acre)/(mg/kg\ Pb \times 0.002) \quad (12.6)$$

$$R_{Zn} = (lb\ Zn/acre)/(mg/kg\ Zn \times 0.002) \quad (12.7)$$

$$R_{Cu} = (\text{lb Cu/acre})/(\text{mg/kg Cu} \times 0.002) \quad (12.8)$$

$$R_{Ni} = (\text{lb Ni/acre})/(\text{mg/kg Ni} \times 0.002) \quad (12.9)$$

$$R_{Cd} = (\text{lb Cd/acre})/(\text{mg/kg Cd} \times 0.002) \quad (12.10)$$

$$R_{As} = (\text{lb As/acre})/(\text{mg/kg As} \times 0.002) \quad (12.11)$$

$$R_{Hg} = (\text{lb Hg/acre})/(\text{mg/kg Hg} \times 0.002) \quad (12.12)$$

$$R_{Mo} = (\text{lb Mo/acre})/(\text{mg/kg Mo} \times 0.002) \quad (12.13)$$

$$R_{Se} = (\text{lb Se/acre})/(\text{mg/kg Se} \times 0.002) \quad (12.14)$$

where,

$R_{Pb}$  = biosolids application rate based on lead content, ton biosolids/acre

$R_{Zn}$  = biosolids application rate based on zinc content, ton biosolids/acre

$R_{Cu}$  = sludge application rate based on copper content, ton sludge/acre

$R_{Ni}$  = sludge application rate based on nickel content, ton sludge/acre

$R_{Cd}$  = sludge application rate based on cadmium content, ton sludge/acre

$R_{As}$  = sludge application rate based on arsenic content, ton sludge/acre

$R_{Hg}$  = sludge application rate based on mercury content, ton sludge/acre

$R_{Mo}$  = sludge application rate based on molybdenum content, ton sludge/acre

$R_{Se}$  = sludge application rate based on selenium content, ton sludge/acre

$R_{max}$  = maximum allowable sludge application rate based on the lowest of heavy metal (cadmium, nickel, copper, zinc, arsenic, mercury, molybdenum, selenium or lead) content, ton sludge/acre

#### 4.2.6. Determine Phosphorus Balance ( $P_{balance}$ )

$$P_{balance} = (AR_{design}) \times (P_{content}) - P_{required} \quad (12.16)$$

where

$AR_{design}$  = biosolids application rate selected for design, ton biosolids/acre

$P_{content}$  = phosphorus content in biosolids, lb P/ton biosolids (or lb  $P_2O_5$ /ton biosolids)

$P_{required}$  = phosphorus requirement on land, lb P/acre (or lb  $P_2O_5$ /acre)

$P_{balance}$  = positive value shows the excess lb P/acre; negative value shows the needed lb P/acre (or lb  $P_2O_5$ /acre)

Every 3 years, the phosphorus level in the soil should be determined and biosolids application be reduced or ceased if the phosphorus content in the soil has attained a

concentration significantly higher than needed for optimum crop yield. Soil test P methods vary among states. One must only use the method appropriate for their regional calibration ([http://www.mawaterquality.org/capacity\\_building/mid-atlantic%20nutrient%20management%20handbook/chapter7.pdf](http://www.mawaterquality.org/capacity_building/mid-atlantic%20nutrient%20management%20handbook/chapter7.pdf)).

#### 4.2.7. Determination of Potassium Balance ( $K_{balance}$ )

$$K_{balance} = (AR_{design}) \times (K_{content}) - K_{required} \quad (12.17)$$

where

$AR_{design}$  = biosolids application rate selected for design, ton biosolids/acre

$K_{content}$  = potassium content in biosolids, lb K/ton biosolids (or lb  $K_2O$ /ton biosolids)

$K_{required}$  = potassium requirement on land, lb K/acre (or lb  $K_2O$ /acre)

$K_{balance}$  = positive value shows the excess lb K/acre; negative value shows the needed lb K/acre (or lb  $K_2O$ /acre)

There is no specific limit on K and, generally, there will be a K deficiency (i.e.,  $K_{balance}$  = negative value) unless more K is added over that contained in biosolids.

## 5. PERFORMANCE OF LAND APPLICATION

The land application system should provide safe biosolids use as well as providing nutrients for crop growth. The majority of land application programs use agricultural land, with the balance applied to forest lands, rangelands, or land in need of reclamation. The use of land application has increased steadily due to including decreasing availability and increasing costs associated with landfill disposal and incineration and increasingly expensive fertilizers. Implementation of the Nationwide Pretreatment Program resulted in significant improvements in biosolids quality. The 1993 adoption of the Part 503 Rule created a structure for consistent application procedures across the nation. The regulations were developed with input from the US Department of Agriculture, the US Food and Drug Administration, biosolids generators, environmental groups, the public, state regulators, and academic researchers. Conservative assumptions were used to create regulations to “protect public health and the environment from all reasonably anticipated adverse effects.”

The most appropriate application method for agricultural land depends on the physical characteristics of the biosolids and the soil, as well as the types of crops grown. Biosolids are generally land-applied using one of the following methods: (a) sprayed or spread on the soil surface and left on the surface for pastures, range, and forest land and (b) incorporated into the soil after being surface-applied or injected directly below the surface for producing row crops or other vegetation. Both liquid and dewatered (or “cake”) biosolids may be applied to land with or without subsequent soil incorporation.

Liquid biosolids can be applied by surface spreading or subsurface injection. Surface methods include spreading by tractor-drawn tank wagons, special applicator vehicles

equipped with flotation tires, or irrigation systems. Surface application with incorporation is normally limited to soils with less than a 7 % slope. Biosolids are commonly incorporated by plowing or disking after the liquid has been applied to the soil surface and allowed to partially dry, unless minimum or no-till systems are being used.

Spray irrigation systems generally should not be used to apply biosolids to forage or row crops during the growing season, although a light application to the stubble of a forage crop following a harvest is acceptable. The adherence of biosolids to plant vegetation can have a detrimental effect on crop yields by reducing photosynthesis and provides a more direct pathway for pollutant consumption by grazing animals. In addition, spray irrigation increases the potential for odor problems and reduces the aesthetics at the application site.

Liquid biosolids can also be injected below the soil surface using tractor-drawn tank wagons with injection shanks and tank trucks fitted with flotation tires and injection shanks. Both types of equipment minimize odor problems and reduce ammonia volatilization by immediate mixing of soil and biosolids. Injection can be used either before planting or after harvesting crops, but it is likely to be unacceptable for forages and sod production. Some injection shanks can damage the sod or forage stand and leave deep injection furrows in the field.

Subsurface injection will minimize runoff from all soils and can be used on slopes up to 15 %. Injection should be made perpendicular to slopes to avoid having liquid biosolids run downhill along injection slits and pond at the bottom of the slopes. As with surface application, drier soil will be able to absorb more liquid, thereby minimizing downslope movement.

Dewatered biosolids can be applied to cropland by equipment similar to that used for applying limestone, animal manures, or commercial fertilizer. Typically, dewatered biosolids will be surface-applied and incorporated by plowing or another form of tillage. Incorporation is not used following the application of biosolids to forages. Incorporation and injection of biosolids can be used to meet Part 503 vector attraction reduction requirements.

Land application is a reliable biosolids management option as long as the system is designed to address such issues as storage or alternate management for biosolids during periods when application cannot take place due to unfavorable weather or field conditions. Public opposition rather than technical constraints is the most common reason for discontinuing land application programs.

## **6. OPERATION AND MAINTENANCE**

### **6.1. Process Monitoring**

The monitoring program consists of the analyses shown in Table 12.12. Sampling and monitoring must be performed by qualified personnel or outside certified laboratories.

Sensory observations can detect many problems before environmental monitoring tests. When injecting liquid biosolids, the application rate should prevent biosolids from moving to the soil surface. To remedy such an environmentally deleterious occurrence, the injector speed should be increased or the biosolids flow decreased in order to reduce the quantity of biosolids injected per unit area. Excessive injector travel speed may cause soil to be thrown away from the shank and create an open trench.



**Table 12.12**  
**Monitoring requirements of land application process. Source: US EPA [1]**

Medium	Required	Potentially useful
Biosolids	Pollutants—As, Cd, Cu, Pb, Hg, Mo, Ni, Se, Zn Pathogens—fecal coliform, <i>Salmonella</i> sp. Vector attraction reduction parameters—e.g., volatile solids	Nutrients—TKN, NH <sub>4</sub> -N, NO <sub>3</sub> -N, P, K, calcium carbonate equivalent Pathogens—enteric virus, helminth ova
Soil		pH; soil test P, K; specialized soil N tests; organic matter

If liquid biosolids are spread on the surface, the rate should be low enough to prevent excessive ponding or runoff. Excessive ponding is when the liquid is still above the surface several hours after biosolids application. Either excessive ponding or runoff indicates excessive application rates for the soil. This will vary widely from soil to soil.

### 6.2. Process O&M Considerations

Land application systems generally use uncomplicated, reliable equipment. Operations include pathogen reduction processing, dewatering, loading of transport vehicles, transfer to application equipment, and the actual application. Operations and maintenance considerations associated with pathogen reduction processing are discussed in another chapter. The other operations require labor skills of heavy equipment operators, equipment maintenance personnel, and field technicians for sampling, all normally associated with wastewater treatment facilities. In addition, the biosolids generator is responsible for complying with state and local requirements as well as federal regulations. The biosolids manager must be able to calculate agronomic rates and comply with record keeping and recording requirements. In fact, the generator and land applier must sign certification statements verifying accuracy and compliance. The generator should also allocate time to communicate with farmers, landowners, and neighbors about the benefits of biosolids recycling. Control of odors, along with a viable monitoring program, is most important for public acceptance [21].

### 6.3. Process Control Considerations

Control of biosolids land application involves determination of application rate by close monitoring of biosolids and soil conditions and determination of crop nutrient requirements. The operation may change substantially after each year of operation. For example, biosolids application rates may be lower each year due to residual nitrogen. The rate may be reduced

after several years of application due to phosphorus or heavy metal buildup. Added to this variability is crop rotation which the farmer may practice periodically.

Process control steps required are proper rate setting, as described previously, and daily control of actual biosolids quantities applied. The actual biosolids application rate is varied by changing the number of passes made by the truck over the site. The field should be marked with numbered stakes to aid the equipment operators in proper application.

#### **6.4. Maintenance Requirements and Safety Issues**

Maintenance requirements are mainly cleaning and equipment service. The cleaning operation includes daily flushing of the injectors and periodic flushing of the tanks. Truck and equipment preventative maintenance schedules will be specified in manufacturer's data.

Safety is related to vehicle and equipment operation. Generally, the highest potential for accidents is when equipment is being backed or trailers are being connected or disconnected from tractors. All drivers should be given a thorough drivers' training course including classroom and practice operation. All should be required to pass a drivers' test specially designed for this operation.

The only safety measure necessary beyond the usual common sense is to require a spotter to assist drivers when backing trailers at the plant and to ensure that truck tires are at adequate pressure and not excessively worn.

## **7. NORMAL OPERATING PROCEDURES**

### **7.1. Startup Procedures**

The start-up procedures include a daily check of trucks for oil level, fuel level, battery condition, radiator water level, lights, and turn signals. The injector(s) should be checked for flushing and lubrication after the previous use. Solids content of the biosolids should be determined in order to set the biosolids application rate. The total biosolids application rate should be determined and provided to operating personnel along with an application plan. If the biosolids have very high moisture content, the site may have to be covered more than once with rest periods between applications to prevent ponding.

### **7.2. Routine Land Application Procedures**

Biosolids are transferred to the site(s) and applied according to the predetermined plan. The operator should be alert for ponding or other signs of problems. A record of the biosolids application should be prepared and updated daily. These records will enable the farmer to determine additional fertilizer requirements, future sludge application rates, and provide plant personnel with a record of the biosolids application.

### 7.3. Shutdown Procedures

At the end of the day, the truck and applicator should be washed to remove any remaining solids and serviced. Tillage may be required if the biosolids were surface-applied rather than injected; however, sites permitted for pasture and hayland, no-till crop production, or forestland do not require incorporation.

## 8. EMERGENCY OPERATING PROCEDURES

### 8.1. Loss of Power and/or Fuel

Loss of electrical power will not affect the field or transport operations for biosolids application, but there may be an impact on the characteristics of the biosolids. The nature of this impact depends on the type of processes involved. Most likely the solids content will decrease. Under these circumstances the solids concentration should be determined for each load of biosolids. Nitrogen content and forms will change so the organic nitrogen, ammonia nitrogen and nitrate nitrogen should be checked for each load.

Adequate provisions must be made to pump biosolids from the holding tank to the transport truck at the sewage treatment plant. If the trucks are equipped with diesel engines and the fuel runs out, the entire fuel system must be bled to remove air prior to starting the engine.

### 8.2. Loss of Other Biosolids Treatment Units

Other treatment units which will directly impact the land application operation are those required for stabilization and concentration or dewatering. If the stabilization process is not operating properly, biosolids characteristics will change. If the concentration or dewatering process is not operating properly the biosolids moisture, content will be high and a greater volume must be handled. In either case, the biosolids application rate must be changed to account for the change in the biosolids characteristics.

## 9. ENVIRONMENTAL IMPACTS

Despite many positive impacts to the environment, land application can have negative impacts on water, soil, and air if not practiced correctly [10–12, 21]. Negative impacts to water result from the application of biosolids at rates that exceed the nutrient requirements of the vegetation. Excess nutrients in the biosolids (primarily nitrogen compounds) can leach from the soil and reach groundwater. Runoff from rainfall may also carry excess nutrients to surface water. However, because biosolids are a slow-release fertilizer, the potential for nitrogen compounds to leach from biosolids-amended soil is less than that posed by the use of chemical fertilizers. In areas fertilized by either biosolids or chemicals, these potential impacts are mitigated by proper management practices, including the application of biosolids at agronomic rates. Maintenance of buffer zones between application areas and surface water bodies and soil conservation practices will minimize impacts to surface water.

Negative impacts to soil can result from mismanagement of a biosolids land application. Federal regulations contain standards related to all metals of concern and application of biosolids, which meet these standards, should not result in the accumulation of metals to harmful levels. Stringent record keeping and reporting requirements on both the federal and state level are imposed to prevent mismanagement.

Odors from biosolids applications are the primary negative impact to the air. Most odors associated with land application are a greater nuisance than threat to human health or the environment. Odor controls focus on reducing the odor potential of the biosolids or incorporating them into the soil. Stabilization processes such as digestion can decrease the potential for odor generation. Biosolids that have been disinfected through the addition of lime may emit ammonia odors, but they are generally localized and dissipate rapidly. Biosolids stabilization reduces odors and usually results in an operation that is less offensive than manure application.

Overall, a properly managed biosolids land application program is preferable to the use of conventional fertilizers for the following reasons:

- (a) Biosolids are a recycled product, use of which does not deplete nonrenewable resources such as phosphorus.
- (b) The nutrients in biosolids are not as soluble as those in chemical fertilizers and are, therefore, released more slowly.
- (c) Biosolids' applicators are required to maintain setbacks from water resources and are often subject to more stringent soil conservation and erosion control practices, nutrient management, and record keeping and reporting requirements than farmers who use only chemical fertilizers or manures.
- (d) Biosolids composition and application programs are closely monitored.
- (e) The organic matter in biosolids improves soil properties for optimum plant growth, including tilth, friability, fertility, and water holding capacity.

A joint policy statement of the US Department of Agriculture, the US Food and Drug Administration, and the US EPA states, “. . .the use of high quality biosolids coupled with proper management procedures, should safeguard the consumer from contaminated crops and minimize any potential adverse effect on the environment” [21].

## **10. LAND APPLICATION COSTS**

It is difficult to estimate the cost of land application of biosolids without specific program details. For example, there is some economy of scale due to large equipment purchases. The same size machine might be needed for a program that manages 10 dry tons of biosolids/day as one managing 50 dry tons/day; the cost of that machine can be spread over the 10 or 50 dry tons, greatly affecting average costs per dry ton. One source identified costs for land application varying from USD 60 to USD 290/dry ton (M.S. Byerly, Georgia Tech; personal communication). This range reflects the wide variety in land application methods as well as varying methods to prepare biosolids for land application. For example, costs for programs using dewatered biosolids include an additional step, whereas costs for programs using liquid

biosolids do not reflect the cost of dewatering. They do, however, include generally higher transportation costs.

Despite the wide range of costs for land application programs, several elements must be considered in estimating the cost of any biosolids land application program: (a) purchase of application equipment or contracting for application services; (b) transportation; (c) equipment maintenance and fuel; (d) loading facilities; (e) labor; (f) capital, operation, and maintenance of stabilization facilities; (g) ability to manage and control odors; (h) dewatering (optional); (i) storage or alternate management option for periods when application is not possible due to weather or climate; (j) regulatory compliance, such as permit applications, site monitoring, and biosolids analyses; and (k) public education and outreach efforts.

Land must also be secured. Some municipalities have purchased farms for land application; others apply biosolids to privately held land. Some operating costs can be offset through the sale of the biosolids material. Since the biosolids reduce the need for fertilizers and pH adjustment, farmers sometimes pay to have biosolids applied to their lands.

## 11. PRACTICAL APPLICATIONS AND DESIGN EXAMPLES

### 11.1. *Biosolids Treatment Before Agricultural Land Application*

Discuss the necessity of having sludge stabilization before application of biosolids on agricultural land.

#### 11.1.1. *Solution*

The US Environmental Protection Agency's 40 CFR Part 503, *Standards for the Use and Disposal of Sewage Sludge* (the Part 503 Rule), requires that wastewater solids be processed before they are land-applied. This processing is referred to as "stabilization" and helps minimize odor generation, destroys pathogens (disease-causing organisms), and reduces vector attraction potential. There are several methods to stabilize wastewater solids, including (a) adjustment of pH, or alkaline stabilization; (b) digestion; (c) composting; and (d) heat drying.

The Part 503 Rule defines two types of biosolids with respect to pathogen reduction: Class A and Class B, depending on the degree of treatment the solids have received. Both types are safe for land application, but additional requirements are imposed on Class B materials, which are products of sewage sludge treated by a *Process to Significantly Reduce Pathogens* (PSRP). These are detailed in the Part 503 Rule and include restricting public access to the application site, limiting livestock grazing, and controlling crop harvesting schedules. Class A biosolids, a product of sewage sludge treated by a *Process to Further Reduce Pathogens* (PFRP) to eliminate detectable pathogens, are not subject to these restrictions.

In addition to stabilization, the Part 503 Rule sets maximum concentrations of trace elements which cannot be exceeded in biosolids that will be land-applied. These are termed ceiling concentration limits (CCLs). Part 503 also establishes cumulative pollutant loading rates (CPLRs) for eight trace elements which may not be exceeded by the application of

biosolids meeting CCLs at land application sites. A third set of trace element criteria, termed pollutant concentration limits (PCLs), is also included in Part 503. If these concentrations are not exceeded in the biosolids to be land-applied, the cumulative pollutant loading rates do not need to be tracked.

The term Exceptional Quality, or EQ, is often used to describe a biosolids product which meets Class A pathogen reduction requirements, the most stringent trace element limits (PCLs), and vector attraction reduction standards specified in the Part 503 Rule. Vectors such as flies, mosquitoes, rodents, and birds can transmit diseases directly to humans or play a specific role in the life cycle of a pathogen as a host. Vector attraction reduction refers to processing which makes the biosolids less attractive to vectors, thereby reducing the potential for transmitting diseases. Exceptional Quality biosolids products are as safe as other agricultural and horticultural products and may be used without site restrictions [20].

### ***11.2. Advantages and Disadvantages of Biosolids Land Application***

Discuss the applicability, advantages, and disadvantages of applying biosolids on agricultural land based on real case histories.

#### ***11.2.1. Solution***

Land application is well suited for managing solids from any size wastewater treatment facility. As the method of choice for small facilities, it offers cost advantages, benefits to the environment, and value to the agricultural community. However, biosolids produced by many major metropolitan areas across the country are also land-applied. For example, biosolids from the Blue Plains Wastewater Treatment Facility serving the District of Columbia and surrounding communities in Virginia and Maryland have been land-applied since the plant began operation in 1930. The cities of Philadelphia, Chicago, Denver, New York, Seattle, and Los Angeles all land-apply at least part of their biosolids production. Land application is most easily implemented where agricultural land is available near the site of biosolids production, but advances in transportation have made land application viable even where hauling distances are greater than 1,000 miles. For example, Philadelphia has shipped dewatered biosolids to reclaim strip mines in western Pennsylvania and, even, southwestern Virginia, and New York City ships some of its biosolids over 2,000 miles to Texas and Colorado.

Land application offers several advantages as well as some disadvantages that must be considered before selecting this option for managing biosolids. Land application is an excellent way to recycle wastewater solids as long as the material is quality-controlled. It returns valuable nutrients to the soil and enhances conditions for vegetative growth. Land application is a relatively inexpensive option, and capital investments are generally lower than other biosolids management technologies. Contractors can provide the necessary hauling and land application equipment. In addition, on-site spatial needs can be relatively minor depending on the method of stabilization selected.

Although land application requires relatively less capital, the process can be labor intensive. Even if contractors are used for application, management oversight is essential for program success. Land application is also limited to certain times of the year, especially in colder climates.

Biosolids should not be applied to frozen or snow-covered grounds, while farm fields are sometimes not accessible during the growing season. Therefore, it is often necessary to provide a storage capacity in conjunction with land application programs. Precipitation can preclude the use of application equipment on farm fields, necessitating biosolids storage until soil conditions improve. Another disadvantage of land application is potential public opposition, which is encountered most often when the beneficial use site is close to residential areas. Objectionable odor elicits strong emotional response, but the primary reasons for public concern are human health and environmental quality. In worst-case situations, local governments may pass ordinances which ban or restrict the use of biosolids. However, many successful programs have gained public support through effective communications, an absolutely essential component in the beneficial use of biosolids.

### ***11.3. Design Worksheet for Determining the Agronomic Rate***

A design worksheet for determining the agronomic rate has been prepared by US EPA [1]. Introduce the worksheet.

#### *11.3.1. Solution*

The US EPA worksheet for determining the agronomic rate is presented in Table 12.13.

### ***11.4. Calculation for Available Mineralized Organic Nitrogen***

Assume that anaerobically digested biosolids with a 3 % organic nitrogen content (dry weight basis) was applied to the site at a rate of 5 mt/ha in 2006. The following year (2007), 3 mt/ha of biosolids (same organic nitrogen content as in 2006) was applied to the same site. It is now 2008, and you want to calculate the plant-available nitrogen (PAN) from previous biosolids applications.

#### *11.4.1. Solution*

The worksheet and the calculations are both presented in Table 12.14 [1]. Here 1 hectare = 1 ha = 2.471 acres. 1 US ton = 2000 lbs = 0.908 mt. 1 metric ton = 1 mt = 1,000 kg. Note: The calculations employ 0.20-0.10-0.05 as the mineralization factors for anaerobically digested biosolids for years 0–1, 1–2, and 2–3 years after application, respectively. More recent research has resulted in some states adopting slightly different mineralization factors (Table 12.8).

### ***11.5. Risk Assessment Approach versus Alternative Regulatory Approach to Land Application of Biosolids***

Study the publications of G. K. Evanylo of Virginia Cooperative Extension [17–20] and discuss the risk assessment approach versus alternative regulatory approaches to the land application of biosolids.

**Table 12.13**  
**Design worksheet for determining the agronomic rate. Source: US EPA [1]**

Key to Symbols and Abbreviations	
NH <sub>4</sub> -N	= Ammonium nitrogen content of the sewage sludge obtained from analytical testing of the sewage sludge, kg/mt (dry weight basis).
Kv	= Volatilization factor estimating ammonium nitrogen remaining after atmospheric losses.
Org-N	= Organic nitrogen content of the sewage sludge obtained from analytical testing or determined by subtracting NH <sub>4</sub> -N from TKN, kg/mt (dry weight basis).
NO <sub>3</sub> -N	= Nitrate nitrogen content of the sewage sludge obtained from analytical testing, kg/mt (dry weight basis)
F <sub>0-1</sub>	= Mineralization rate for the sewage sludge during the first year of application, in percent of organic nitrogen expressed as a fraction (e.g., 20% = 0.2).
Helpful Conversions	
mg/kg	= lb/ton × 500
kg/ha	= lbs/acre × 1.12
kg/ha	= tons/acre × 2242
mt/ha	= tons/acre × 2.24

1.	Total available nitrogen from sewage sludge.	
a.	Ammonium nitrogen. <i>Calculated with the following formula: analytical result for NH<sub>4</sub><sup>+</sup> - N (kg/mt) × Kv</i>	_____ kg/mt
b.	Mineralized organic nitrogen for first year of application. <i>Calculated with the following formula: Org-N × F<sub>0-1</sub></i>	_____ kg/mt
c.	Nitrate nitrogen. <i>Use analytical result for NO<sub>3</sub>-N</i>	_____ kg/mt
d.	Total	_____ kg/mt
2.	Available nitrogen in the soil. <i>(Use whichever is greater a or b)</i>	_____ kg/ha
a.	Soil test results of background nitrogen in soil	
b.	Estimate of available nitrogen from previous sewage sludge applications	
3.	Nitrogen supplied from other sources (optional, but recommended):	
a.	Nitrogen from supplemental fertilizers (if appropriate)	_____ kg/ha
b.	Nitrogen from irrigation water (if appropriate)	_____ kg/ha
c.	Nitrogen from previous crop (unless #2 is based on soil testing)	_____ kg/ha
d.	Other (if appropriate) (specify): _____	_____ kg/ha
e.	Total (add a, b, c, d, if available).	_____ kg/ha
4.	Total nitrogen available from existing sources. <i>Add 2 and 3e</i>	_____ kg/ha
5.	Available nitrogen loss to denitrification (optional) (check with regulatory authority before using this site-specific factor)	_____ kg/ha
6.	Adjusted nitrogen available <i>Subtract 5 from 4</i>	_____ kg/ha
7.	Total nitrogen requirement of crop (obtain information from agricultural extension agents or other agronomy professionals)	_____ kg/ha
8.	Supplemental nitrogen needed from sewage sludge. <i>Subtract 4 or 6 from 7</i>	_____ kg/ha
9.	Agronomic loading rate. <i>Divide 8 by 1</i>	_____ mt/ha



**Table 12.14**  
**Calculation for available mineralized organic nitrogen. Source: US EPA [1]**

The organic nitrogen in sewage sludge continues to decompose and release mineral nitrogen through the mineralization process for several years following its initial application. This residual nitrogen from the previously applied sewage sludge must be accounted for as part of the overall nutrient budget when determining the agronomic rate for sewage sludge. Residual nitrogen can be determined through soil analysis or calculated using the following procedure. These calculations must be done for each yearly sewage sludge application unless soil analysis is performed prior to land application (see example calculations).

Instructions: Complete a separate table for each year sewage sludge was land applied. Note that most do not calculate beyond the third year because the values become negligible. Sum the values of mineralized Org-N (Column d) from each table for the particular calendar year you're trying to determine Org-N available. (See example below.)

a. Year <sup>1</sup>	b. Starting Org-N <sup>2</sup> (kg/ha)	c. Mineralization	d. Mineralized Org-N <sup>4</sup> (kg/ha)	e. Org-N Remaining <sup>5</sup> (kg/ha)
0-1 (year sewage sludge was applied)				
1-2 (1st year after)				
2-3 (2nd year after)				

<sup>1</sup>Begin with year sewage sludge is applied, and continue for 2 more years.

<sup>2</sup>In the first year, this equals the amount of Org-N initially applied. In subsequent years, it represents the amount of org-N remaining from the previous year (i.e., column e).

<sup>3</sup>The org-N content of the initially applied sewage sludge continues to be mineralized, at decreasing rates, for years after initial application.

<sup>4</sup>Multiply column b and column c.

<sup>5</sup>Subtract column d from column b.

**Example**

Assume that anaerobically digested sewage sludge with a 3% org-N content (dry weight basis) was applied to the site at a rate of 5 mt/ha in 2006. The following year, 2007, 3 mt/ha of sewage sludge (same org-N content as in 2006) was applied to the same site. It is now 2008, and you want to calculate the available nitrogen from previous sewage sludge applications.

In 2006, the org-N in the sewage sludge applied = (0.03) (5 mt/ha) (1,000 kg/mt) = 150 kg/ha.

In 2007, the org-N in the sewage sludge applied = (0.03) (3 mt/ha) (1,000 kg/mt) = 90 kg/ha.

Calculate the available nitrogen from 2006 and 2007 in the following manner (assume anaerobically digested sewage sludge).

a. Year*	b. Starting Org-N (kg/ha)	c. Mineralization	d. Mineralized Org-N (kg/ha)	e. Org-N Remaining (kg/ha)
<b>2006 Sewage Sludge</b>				
0-1 (first application-2006)	150	0.2	30	120
1-2 (2007)	120	0.1	12	108
2-3 (2008)	108	0.05	5.40	102.60
<b>2007 Sewage Sludge</b>				
0-1 (first application-2007)	90	0.2	18	72
1-2 (2008)	72	0.1	7.2	64.80
2-3 (2009)	64.8	0.05	3.24	61.56

To determine the total mineral&d organic nitrogen available in 2008 from the sewage sludge applied in 2006 and 2007, add the mineralized Org-N value in the 2008 row of column d of the table for the 2006 sewage sludge to the mineralized Org-N value in the 2008 row of column d of the table for the 2007 sewage sludge (i.e., 5.40 + 7.2 = 12.6 kg/ha).

**Total mineralized Org-N available in 2008 from previous sewage sludge 12.6 kg/ha.**

**Table 12.15**  
**Exposure pathways used in the risk assessment of land application [1, 20]**

Pathway	Description of highly exposed individual
1. Sludge > soil > plant > human	Human (except home gardener) lifetime ingestion of plants grown in sludge-amended soil
2. Sludge > soil > plant > human	Human (home gardener) lifetime ingestion of plants grown in sludge-amended soil
3. Sludge > human	Human (child) ingesting sludge
4. Sludge > soil > plant > animal > human	Human lifetime ingestion of animal products (animals raised on forage grown on sludge-amended soil)
5. Sludge > soil > animal > human	Human lifetime ingestion of animal products (animals ingest sludge directly)
6. Sludge > soil > plant > animal	Animal lifetime ingestion of plants grown on sludge-amended soil
7. Sludge > soil > animal	Animal lifetime ingestion of sludge
8. Sludge > soil > plant	Plant toxicity due to taking up sludge pollutants when grown in sludge-amended soils
9. Sludge > soil > organism	Soil organism ingesting sludge-soil mixture
10. Sludge > soil > predator	Predator of soil organisms that have been exposed to sludge-amended soils
11. Sludge > soil > airborne dust > human	Adult human lifetime inhalation of particles (dust) [e.g., tractor driver tilling a field]
12. Sludge > soil > surface water > human	Human lifetime drinking surface water and ingesting fish containing pollutants in sludge
13. Sludge > soil > air > human	Human lifetime inhalation of pollutants in sludge that volatilize to air
14. Sludge > soil > groundwater > human	Human lifetime drinking well water containing pollutants from sludge that leach from soil to groundwater

### 11.5.1. Solution

#### Risk Assessment Approach

The risk assessment process was the most comprehensive analysis of its kind ever undertaken by the US EPA. The resultant US Federal Regulations Part 503 was designed to provide “reasonable worst-case,” not absolute, protection to human health and the environment. The initial task of the 10-year risk assessment process was to establish a range of concentrations for trace elements and organic compounds that had the greatest potential for harm based on known human, animal, and plant toxicities. Maximum safe accumulations for the chemical constituents in soil were established from the most limiting of 14 pathways of exposure (Table 12.15), which included risks posed to human health, plant toxicity and uptake, effects on livestock or wildlife, and water quality impacts. A total of 200 chemical constituents were

screened by the US EPA [14, 16], and 50 of these were selected for further evaluation, using the criteria above and the availability of data for a preliminary risk assessment. Twenty-three of the 50 constituents were identified as warranting consideration for regulation based on the risk assessment. No regulatory limits were set for the 13 trace organic compounds in this group because the US EPA risk assessment showed that the safe levels were considerably higher than the observed concentrations in biosolids. The 503 Rule was then limited to ten trace elements (arsenic, cadmium, chromium, copper, lead mercury, molybdenum, nickel, selenium, and zinc). Chromium was subsequently dropped on a court challenge because the risk assessment had shown a very low risk level for this metal.

The most limiting pathway for each of the nine regulated trace elements was used to develop pollutant concentration limits and lifetime loading rate standards. For example, the greatest risk to a target organism from lead (Pb) is a child directly ingesting biosolids that have been applied to soil. The pollutant limits are therefore based on estimates of childhood soil consumption that US EPA considered conservative (i.e., they predict a greater impact on human health than is likely to occur). Ingestion of biosolids is the most limiting pathway for five of the trace elements (As, Cd, Pb, Hg, and Se), phytotoxicity was most limiting for three trace elements (Cu, Ni, and Zn), and feed consumption by animal was the most limiting for Mo.

Under Part 503, the cumulative pollutant loading rate (CPLR) limits established by US EPA for eight trace elements would allow the concentrations of these elements to increase to levels that are 10–100 times the normal background concentrations in soil (Table 12.10). The time that it would take for each of the eight elements to reach its cumulative loading limit when biosolids with typical trace element concentrations are applied annually at a rate of 5 dry tons/acre is also presented in Table 12.10. These are conservative estimates where agronomic loading rates are normally applied once every 3 years, not annually. The cumulative pollutant loading rate (CPLR) limits were developed to ensure that soil metals never reach harmful levels. Future applications of biosolids to the site would be prohibited if the cumulative loading limit for any of the nine trace elements is reached [20].

#### Alternative Regulatory Approach: Best Available Technology

An alternative to the risk assessment approach, termed *best available technology* (BAT) approach, limits contaminants in biosolids to concentrations attained by the best current technology (e.g., industrial pretreatment and separation of sanitary, storm, and industrial sewerage). BAT is more restrictive of land application than risk assessment (i.e., lower pollutant concentrations can be attained using the best available technology than are permitted under the risk assessment approach). Biosolids are more likely to be landfilled or incinerated under this approach than under risk assessment [20].

#### Alternative Regulatory Approach: Non-contamination Approach

The US EPA Part 503 Federal Regulations take the position that all biosolids management options incur some risk and that these risks can be evaluated so that regulations governing use and management options can be developed to reduce risk to acceptable (safe) levels. There are some who believe that the application of any biosolids that would cause an increase in the soil

concentration of any pollutant is unacceptable. This is called the “non-contamination” approach. According to this approach, any addition of a pollutant to the soil must be matched by removal of that pollutant so that no long-term buildup occurs in the soil. This is the most restrictive of approaches to the land application of biosolids and is favored by those who believe that any increase in pollutant concentration in the soil is undesirable, regardless of what risk assessment demonstrates. Although this approach reduces to zero any environmental risks from land application of biosolids, it diverts more biosolids to landfills or incinerators, thereby increasing the environmental risks associated with disposal and reducing recycling of nutrients and organic matter [20]. Each approach for regulating contaminants in biosolids has its technical and scientific foundation, but the approach selected is based primarily on legislative mandates and policy decisions [20].

### **11.6. Tracking Cumulative Pollutant Loading Rates on Land Application Sites**

Introduce the worksheet which has been prepared by US EPA.

#### *11.6.1. Solution*

The definition and environmental engineering significance of cumulative pollutant loading rate (CPLR) can be found from Table 12.3.

The US EPA worksheet for tracking CPLR is presented in Table 12.16 [1].

### **11.7. Management of Nitrogen in the Soils and Biosolids**

Study the US EPA report [1], and discuss the managerial strategy for controlling nitrogen in the soils and sewage sludge.

#### *11.7.1. Solution*

Nitrogen exists in the soils and biosolids in three basic forms:

- (a) Organic nitrogen: This refers mainly to carbon-based compounds such as proteins and amino acids. Little of this form is available to plants and must largely be converted to inorganic nitrogen by soil microorganisms. Mineralization is the conversion of organic-N to inorganic-N in the form of ammonium. Mineralization rates of organic-N in biosolids vary for different climatic regimes and soils. The rate of N mineralization decreases with time and is typically not calculated as for longer than 3 years after biosolids application.
- (b) Inorganic nitrogen (ammonium-N, nitrite-N, and nitrate-N): Plants readily assimilate nitrate and ammonium ions. The soil microbes and plants compete for this inorganic-N. Rapidly growing soil microbes can immobilize or “tie up” the ammonium and nitrate in the soil by converting it to the organic form and may temporarily deplete the available N in the soil for plant uptake when the C/N ratio of a soil amendment is wide (i.e., >25:1). The positively charged ammonium ions are adsorbed by clay and organic matter so that little of this form is leached. Nitrification is the process whereby soil microbes convert ammonium to nitrate. Nitrate is very mobile and readily leached. Nitrite is usually not present in significant concentrations.
- (c) Gaseous nitrogen (nitrogen gas, ammonia gas): Nitrogen gas is present in the soil atmosphere (air) and is a source of N for legumes, which can convert this to plant usable ammonium ion ( $\text{NH}_4^+$ ).

**Table 12.16**  
**Management worksheet for tracking CPLR on land application sites. Source: US EPA [1]**

TRACKING CUMULATIVE POLLUTANT LOADING RATES ON LAND APPLICATION SITES										
1. Site Name and Location (street address or latitude/longitude)		1		3. Date of Application of Sewage Sludge						
Pollutant	Cumulative Pollutant Loading Rates (CPLRs) (kg/ha)		Calculation for Determining Cumulative Loading							
	100 %	90 %	Concentration in Sewage Sludge (mg/kg) (dry weight)	X	Sewage Sludge Application Rates (M.T./ha) (from Item 2)	X	0.001 (conversion factor)	+	Amount of Pollutant Applied Since July 20, 1993 (kg/ha) <sup>2</sup>	Total Amount of Pollutant Applied to Date (kg/ha)
Arsenic	41	37		X		X	0.001	+	=	
Cadmium	39	35		X		X	0.001	+	=	
Chromium	3,000	2,700		X		X	0.001	+	=	
Copper	1,500	1,350		X		X	0.001	+	=	
Lead	300	270		X		X	0.001	+	=	
Mercury	17	15		X		X	0.001	+	=	
Nickel	420	378		X		X	0.001	+	=	
Selenium	100	90		X		X	0.001	+	=	
Zinc	2,800	2,520		X		X	0.001	+	=	

<sup>1</sup>Use the following equations to convert from English system units (i.e., tons per acre) to metric system units (i.e., metric tons per hectare):

- To convert from tons per acre to metric tons per hectare, multiply tons per acre by 2.2421
- To convert from acres to hectares, multiply the number of acres by 0.4047
- To convert from tons to metric tons, multiply the number of tons by 0.9072.

\* Land applicers are prohibited from applying CPLR sewage sludge to a site if CPLR sewage sludge was previously applied to the site after July 20, 1993, and the amounts of the pollutants regulated under Part 503 in the previously applied sewage sludge are unknown.

Under anaerobic conditions and readily available carbon source, microorganisms can convert nitrate to nitrogen gas and nitrous oxide ( $N_2O$ ) in a process termed denitrification. Under alkaline conditions, ammonium ions lose a hydrogen ion and become ammonia, which readily volatilizes as ammonia gas ( $NH_3$ ).

Plants use only a portion of the total nitrogen in biosolids. Some of the nitrate and ammonium is lost to the atmosphere by denitrification and volatilization, and some of the organic nitrogen becomes available over time as the mineralization process converts the organic forms to ammonium and nitrate. Some of the nitrate is lost through leaching. The goal when designing the agronomic rate for an application site is to supply the necessary amount of nitrogen needed for the crops or vegetation to produce the desired harvest yield while minimizing leaching of the nitrogen below the root zone. The rates of mineralization, plant uptake, volatilization, and denitrification are dependent on many factors and will vary from site to site and at the same site.

Predicting how much biosolids are needed to provide the nitrogen sufficient to meet crop yield goals and minimize leaching of nitrogen below the root zone requires consideration of numerous factors. The following are some factors that influence the amount of sewage sludge that can be applied:

1. Total nitrogen content in biosolids and the concentrations (or percentage of the total nitrogen) of the various nitrogen forms in the biosolids are influenced by the types of processing operations. Anaerobic digestion (30 days or longer) produces biosolids that have high concentrations of organic-N and ammonium but little nitrate (oxygen is required to proceed from ammonia to nitrate). Aerobically digested biosolids have higher levels of nitrate than anaerobically digested sewage sludge, but are still comprised largely of organic and ammonium forms of N. Dewatering reduces the concentrations of nitrate and ammonium-N, which are soluble in biosolids liquid fraction.
2. The mineralization rate at the application site is affected by how well the sewage sludge was stabilized in the digester. Poor stabilization results in more organic nitrogen for mineralization. Good stabilization converts most of the organic nitrogen into readily available inorganic-N, leaving only that which is relatively inert and resistant to further mineralization (this sewage sludge may have a low mineralization rate).
3. The mineralization rate is also influenced by soil temperature and texture. Higher temperature increases the metabolic rate of microorganisms; thus, mineralization rates are typically higher in warmer than in colder periods and regions. Mineralization and nitrification are increased by aeration; thus, coarser textured soils, which facilitate gas exchange and are more likely than fine-textured soils to be well drained, have higher rates of N mineralization and nitrification.
4. The amount of ammonium lost through volatilization to the atmosphere is affected by soil/biosolids pH: The fraction of  $NH_4/NH_3$  in the gaseous ammonia phase increases with pH. Volatilization losses of ammonia are reduced as biosolids are more thoroughly mixed with soil after application. Volatilization occurs rapidly, with the greatest loss occurring within the first week, if biosolids are left on the soil surface. Incorporation of surface-applied biosolids immediately after application or injection of liquid biosolids can greatly reduce the loss.
5. The amount of ammonia lost through volatilization is decreased when biosolids are incorporated into moist soils or when rainfall occurring immediately after surface application transports the soluble ammonia into the soil.

6. The amount of nitrate that is lost to the atmosphere by denitrification is affected by factors that contribute to anaerobic conditions and by the metabolic rate of the denitrifying microorganisms. The factors are the following:
- Soil moisture—Saturated soils have fewer pore spaces occupied by oxygen, thus creating anaerobic conditions that favor the growth of denitrifying microorganisms.
  - Soil type—Fine-textured soils are more likely to become anaerobic than coarse-textured soils, thus increasing the potential for denitrification even when soil is not saturated.
  - Carbon source—An abundant source of readily oxidizable carbon will increase the denitrification rate.
  - Nitrate levels—Denitrification will occur rapidly where nitrate levels provide a sufficient source of nitrogen for the microorganisms.

### 11.8. Converting Wet Weight Pollutant Concentrations to Dry Weight Basis

Laboratory results for biosolids are typically reported in one of two forms: (a) wet weight (i.e., mg/L) for liquid biosolids or dry weight (i.e., mg/kg) for biosolids containing greater than ~12 % solids. The concentration limits for pollutants and pathogens in the regulation are expressed as dry weight concentrations. Therefore, if laboratory results are reported on a wet weight basis, the percent solids content of the sewage sludge must be determined to verify compliance with sewage sludge requirements [30]. The percent solids value is used to convert analytical results expressed as wet weight basis to a dry weight basis, as demonstrated in this example [1]. If an engineer assumes that the specific gravity of the solids is equivalent to the specific gravity of water, a simplified equation can be used to express the concentration of pollutant on a dry weight basis:

$$\frac{W}{PC_s/100} = D \quad (12.18)$$

where

$W$  = the concentration of the pollutant in the sewage sludge on a wet basis in mg/L

$D$  = the concentration of the pollutant in the sewage sludge on a dry weight basis, in mg/kg

$PC_s$  = percentage of solids, %

For example, if the concentration of zinc in the sewage sludge is reported as 200 mg/L and the percent solids content of the sewage sludge is 24 %, determine the concentration on dry weight basis using Equation (12.18).

#### 11.8.1. Solution

$$\frac{W}{PC_s/100} = D \quad (12.18)$$

$$\frac{200}{24/100} = 833 \text{ mg/kg}$$

### 11.9. Converting Dry Ton of Nutrient per Acre to Pound of Nutrient per Acre

The following equations are used to convert “dry ton of nutrient per acre” to “pound of nutrient per acre” when percent content of a nutrient is known:

$$(\text{LB}_{\text{organic}})/\text{acre} = (D_{\text{ton}}/\text{acre}) (\text{PC}_{\text{organic}}) (20) \quad (12.19)$$

$$(\text{LB}_{\text{nitrate}})/\text{acre} = (D_{\text{ton}}/\text{acre}) (\text{PC}_{\text{nitrate}}) (20) \quad (12.20)$$

$$(\text{LB}_{\text{nitrite}})/\text{acre} = (D_{\text{ton}}/\text{acre}) (\text{PC}_{\text{nitrite}}) (20) \quad (12.21)$$

$$(\text{LB}_{\text{ammonium}})/\text{acre} = (D_{\text{ton}}/\text{acre}) (\text{PC}_{\text{ammonium}}) (20) \quad (12.22)$$

$$(\text{LB}_{\text{TKN}})/\text{acre} = (D_{\text{ton}}/\text{acre}) (\text{PC}_{\text{TKN}}) (20) \quad (12.23)$$

$$(\text{LB}_{\text{P}})/\text{acre} = (D_{\text{ton}}/\text{acre}) (\text{PC}_{\text{P}}) (20) \quad (12.24)$$

$$(\text{LB}_{\text{K}})/\text{acre} = (D_{\text{ton}}/\text{acre}) (\text{PC}_{\text{K}}) (20) \quad (12.25)$$

where

$\text{LB}_{\text{organic}}$  = weight of organic nitrogen, lb

$\text{LB}_{\text{nitrate}}$  = weight of nitrate nitrogen, lb

$\text{LB}_{\text{nitrite}}$  = weight of nitrite nitrogen, lb

$\text{LB}_{\text{ammonium}}$  = weight of ammonium nitrogen, lb

$\text{LB}_{\text{TKN}}$  = weight of total Kjeldahl nitrogen, lb

$\text{LB}_{\text{P}}$  = weight of phosphorus, lb

$\text{LB}_{\text{K}}$  = weight of potassium, lb

$D_{\text{ton}}$  = dry ton = 2,000 lbs

$\text{PC}_{\text{organic}}$  = Percent of organic nitrogen, %

$\text{PC}_{\text{nitrate}}$  = percent of nitrate nitrogen, %

$\text{PC}_{\text{nitrite}}$  = percent of nitrite nitrogen, %

$\text{PC}_{\text{ammonium}}$  = percent of ammonium nitrogen, %

$\text{PC}_{\text{TKN}}$  = percent of total Kjeldahl nitrogen, %

$\text{PC}_{\text{P}}$  = percent of phosphorus, %

$\text{PC}_{\text{K}}$  = percent of potassium, %

20 = a conversion factor (1 % = 20 lbs/ton = 20 lbs/2,000 lbs)

Total nitrogen (TN) is the summation of ammonium nitrogen ( $\text{NH}_4^+\text{-N}$ ), nitrate nitrogen ( $\text{NO}_3^-\text{-N}$ ), nitrite nitrogen ( $\text{NO}_2^-\text{-N}$ ), and organic nitrogen (organic-N). Nitrite nitrogen can be ignored because it will always be negligible. Total Kjeldahl nitrogen (TKN) is the summation of ammonium nitrogen ( $\text{NH}_4^+\text{-N}$ ) and organic nitrogen (organic-N).



For the purpose of illustration, determine the biosolids organic nitrogen applied ( $LB_{\text{organic}}$ )/acre, in the year of 2007, if the total biosolids applied = 2.5 dry tons/acre, and biosolids organic nitrogen content = 4.5 %.

### 11.9.1. Solution

$$\begin{aligned} (LB_{\text{organic}})/\text{acre} &= (D_{\text{ton}}/\text{acre}) (PC_{\text{organic}}) (20) \\ &= (2.5 \text{ dry tons/acre}) (4.5) (20) \\ &= 225 \text{ lbs organic-N/acre} \end{aligned}$$

### 11.10. Converting Percent Content to Pound per Dry Ton

The following equations can be used for converting “percent content” to “pound per dry ton” using the conversion factor of 1 % = 20 lbs/dry ton:

$$N_{\text{organic}} = (PC_{\text{organic}}) (20) \quad (12.26)$$

$$N_{\text{nitrate}} = (PC_{\text{nitrate}}) (20) \quad (12.27)$$

$$N_{\text{ammonium}} = (PC_{\text{ammonium}}) (20) \quad (12.28)$$

$$N_{\text{nitrite}} = (PC_{\text{nitrite}}) (20) \quad (12.29)$$

$$N_{\text{total}} = (PC_{\text{total}}) (20) \quad (12.30)$$

$$N_{\text{TKN}} = (PC_{\text{TKN}}) (20) \quad (12.30a)$$

where 20 = a conversion factor (1 % = 20 lbs/ton = 20 lbs/2,000 lbs)

Explain how the above equations are derived. Assuming aerobically digested biosolids contain 4 % organic nitrogen, determine the amount of nitrogen ( $N$ ) per dry ton of biosolids.

### 11.10.1. Solution

$$20 \text{ lbs/dry ton} = (20 \text{ lbs}) (\text{dry } 2,000 \text{ lbs}) = 1/100 = 1 \%$$

$$PC_{\text{organic}} = 4 \%$$

$$N_{\text{organic}} = (PC_{\text{organic}}) (20) = (4) (20) = 80 \text{ lbs N/dry ton}$$

### 11.11. Calculating Net Primary Nutrient Crop Need

The anticipated wheat yield for a field consisting of primarily Bojac soil is 70 bu/acre (Table 12.7), with a unit nitrogen fertilizer rate (UNFR) of 1.3 lbs of nitrogen per bushel (Table 12.17). Determine the resultant crop nitrogen fertilizer rate (CNFR), in “lb N/acre.”

**Table 12.17**  
**Nitrogen, phosphate, and potash removal from soil by various crops. Source: Brandt and Martin [31]**

Crop	Unit	N, lb removed per unit production	P <sub>2</sub> O <sub>5</sub> , lb removed per unit production	K <sub>2</sub> O, lb removed per unit production
Corn, grain	bu	1.0	0.4	0.3
Corn, silage (65 % moisture)	ton	7.0	3.0	9.0
Soybeans, grain	bu	3.8	1.0	1.5
Wheat, grain and straw	bu	1.5	0.7	1.4
Wheat, grain	bu	1.3	0.5	0.3

Note: This table is provided as an example only. Similar information is available for each state.

### 11.11.1. Solution

Equation (12.1) is used for calculating CNFR:

$$\text{CNFR} = (\text{Yield})(\text{UNFR}) \quad (12.1)$$

Yield = crop yield = 70 bu/acre harvested from Table 12.7

UNFR = unit nitrogen fertilizer rate = 1.3 lbs N/bu crop yield, as shown in Table 12.17

CNFR = crop nitrogen fertilizer rate

CNFR = (60 bu/acre) (1.3 lbs N/bu) = 78 lbs N/acre

### 11.12. Calculating the Components of Plant-Available Nitrogen (PAN) in Biosolids

For all practical purposes, total nitrogen (TN) in soil or nutrient-containing materials is the summation of *ammonium nitrogen* (NH<sub>4</sub><sup>+</sup>-N), *nitrate nitrogen* (NO<sub>3</sub><sup>-</sup>-N), and organic nitrogen because nitrite nitrogen occurs in negligible amount. Crops directly utilize nitrogen in its inorganic forms, principally nitrate-N and ammonium-N.

Analytical methods [38] determine only total Kjeldahl nitrogen (TKN), *ammonium nitrogen* (NH<sub>4</sub><sup>+</sup>-N), *nitrate nitrogen* (NO<sub>3</sub><sup>-</sup>-N), and nitrite nitrogen (NO<sub>2</sub><sup>-</sup>-N). Organic nitrogen (organic-N) can be calculated by subtracting ammonium-N from TKN as in (12.31c) below. The following equations are used to calculate plant-available N:

$$\text{TN} = (\text{NH}_4^+\text{-N}) + (\text{NO}_3^-\text{-N}) + (\text{organic-N}) \quad (12.31)$$

$$\text{TN} = \text{TKN} + (\text{NO}_3^-\text{-N}) \quad (12.31a)$$

$$\text{TKN} = (\text{NH}_4^+\text{-N}) + (\text{organic-N}) \quad (12.31b)$$

$$(\text{Organic-N}) = \text{TKN} - (\text{NH}_4^+\text{-N}) \quad (12.31c)$$

$$N_{\text{total}} = N_{\text{ammonium}} + N_{\text{nitrate}} + N_{\text{organic}} \quad (12.4)$$

$$N_{\text{TKN}} = N_{\text{ammonium}} + N_{\text{organic}} \quad (12.32)$$

$$N_{\text{organic}} = N_{\text{TKN}} - N_{\text{ammonium}} \quad (12.32a)$$

where

TN = total nitrogen, mg/kg, %, or lb/ton

TKN = total Kjeldahl nitrogen, mg/kg, %, or lb/ton

$\text{NH}_4^+$ -N = ammonium nitrogen, mg/kg, %, or lb/ton

$\text{NO}_3^-$ -N = nitrate nitrogen, mg/kg, %, or lb/ton

Organic-N = organic nitrogen, mg/kg, %, or lb/ton

The units of  $N_{\text{total}}$ ,  $N_{\text{TKN}}$ ,  $N_{\text{ammonium}}$ ,  $N_{\text{nitrate}}$ , and  $N_{\text{organic}}$  are all “lb N/ton of biosolids.”

The following is an example to illustrate how the components of PAN in biosolids can be calculated using the above equations. Lime-stabilized biosolids have a nitrate nitrogen concentration of 1,000 mg/kg, an ammonium nitrogen concentration of 2,000 mg/kg, and a total Kjeldahl nitrogen concentration of 27,000 mg/kg, all on a dry weight basis. The biosolids contain 17.6 % dry solids. Determine the components of plant-available nitrogen (PAN) in “lb N/ton of dry biosolids.”

#### 11.12.1. Solution

Since nitrate nitrogen concentration, ammonium nitrogen concentration, nitrite nitrogen concentration, and total Kjeldahl nitrogen (TKN) concentration are 1,000, 2,000, 0, and 27,000 mg/kg, respectively, then  $\text{PC}_{\text{nitrate}}$ ,  $\text{PC}_{\text{ammonium}}$ , and  $\text{PC}_{\text{TKN}}$  equal 0.1, 0.2, and 2.7 %, respectively. Equations (12.26)–(12.30) and (12.32) are used for the following calculations:

$$N_{\text{nitrate}} = (\text{PC}_{\text{nitrate}})(20) = (0.1)(20) = 2 \text{ lbs N/ton} \quad (12.27)$$

$$N_{\text{ammonium}} = (\text{PC}_{\text{ammonium}})(20) = (0.2)(20) = 4 \text{ lbs N/ton} \quad (12.28)$$

$$N_{\text{TKN}} = (\text{PC}_{\text{TKN}})(20) = (2.7)(20) = 54 \text{ lbs N/ton} \quad (12.30)$$

$$N_{\text{TKN}} = N_{\text{ammonium}} + N_{\text{organic}} \quad (12.4)$$

$$\begin{aligned} N_{\text{organic}} &= N_{\text{TKN}} - N_{\text{ammonium}} \\ &= 54 - 4 \\ &= 50 \text{ lbs N/ton} \end{aligned}$$

### 11.13. Calculating the First-Year $PAN_{0-1}$ from Biosolids

#### 11.13.1. Determining the First-Year $PAN_{0-1}$ from Lime-Stabilized Biosolids

Lime-stabilized sludge (i.e., biosolids) has a nitrate nitrogen concentration of 1,000 mg/kg, an ammonium nitrogen concentration of 2,000 mg/kg, a nitrite nitrogen concentration of 0 mg/kg, and a total Kjeldahl nitrogen (TKN) concentration of 27,000 mg/kg, all on a dry weight basis. The calcium carbonate equivalent (CCE) and pH of the lime-stabilized biosolids are 40 % and >10, respectively. The biosolids contain 17.6 % dry solids. The biosolids will be surface-applied and disked into the soil within 24 h in the mid-Atlantic region of the USA. Determine the first-year  $PAN_{0-1}$  from the lime-stabilized biosolids.

#### 11.13.2. Solution

From the design example in Sect. 11.12, the following parameters have been calculated:

$$\begin{aligned} N_{\text{ammonium}} &= \text{ammonium nitrogen content in biosolids} \\ &= 4 \text{ lbs ammonium-N/ton of biosolids} \end{aligned}$$

$$\begin{aligned} N_{\text{nitrate}} &= \text{nitrate nitrogen content in biosolids} \\ &= 2 \text{ lbs nitrate-N/ton of biosolids} \end{aligned}$$

$$\begin{aligned} N_{\text{organic}} &= \text{organic nitrogen content in biosolids} \\ &= 50 \text{ lbs organic-N/ton of biosolids} \end{aligned}$$

$PAN_{0-1}$  (first-year plant-available nitrogen in biosolids, lb N/ton of biosolids) can be calculated using Equation (12.4) when the ammonium nitrogen volatilization factor ( $K_V$ ) and the biosolids first-year organic nitrogen mineralization factor ( $F_{0-1}$ ) are also known. Here,

$K_V$  = ammonium-N volatilization factor, based on the method of land application = 75 % (from Table 12.9).

$F_{0-1}$  = biosolids first-year organic-N mineralization factor based on the method of sludge treatment = 30 % (from Table 12.8).

$$\begin{aligned} PAN_{0-1} &= (K_V)(N_{\text{ammonium}}) + N_{\text{nitrate}} + (F_{0-1})N_{\text{organic}} \\ &= (0.75)(4 \text{ lbs N/ton}) + (2 \text{ lbs N/ton}) + (0.3)(50 \text{ lbs N/ton}) \\ &= 20 \text{ lbs N/ton} \end{aligned} \tag{12.4}$$

#### 11.13.3. Determining the First-Year $PAN_{0-1}$ from an Anaerobically Digested Biosolids

An anaerobically digested biosolid has a nitrate nitrogen concentration of 0 %, an ammonium nitrogen concentration of 1 %, and a TKN concentration of 5 %, all on a dry weight basis. The biosolids will be surface-applied as a liquid without incorporation. Determine the first-year  $PAN_{0-1}$  from the anaerobically digested biosolids.

#### 11.13.4. Solution

Step 1. Determine the amount of nitrogen per dry ton of biosolids:

$$N_{\text{nitrate}} = (PC_{\text{nitrateN}})(20) = (0)(20) = 0 \text{ lb N/ton}$$

$$N_{\text{ammonium}} = (\text{PC}_{\text{ammoniumN}})(20) = (1)(20) = 20 \text{ lbs N/ton}$$

$$N_{\text{TKN}} = (\text{PC}_{\text{TKN}})(20) = (5)(20) = 100 \text{ lbs N/ton}$$

$$\begin{aligned} N_{\text{organic}} &= N_{\text{TKN}} - N_{\text{ammonium}} \\ &= 100 - 20 \\ &= 80 \text{ lbs N/ton} \end{aligned}$$

Step 2. Determine the first-year PAN from biosolids using Equation (12.4):

$K_V$  = ammonium-N volatilization factor, based on the method of land application = 50 % = 0.5 (from Table 12.9), assuming the biosolids pH is <10, and incorporation into soil is after 7 days.

$F_{0-1}$  = biosolids first-year organic-N mineralization factor based on the method of sludge treatment = 30 % = 0.3 (Table 12.8).

$$\begin{aligned} \text{PAN}_{0-1} &= (K_V)(N_{\text{ammonium}}) + N_{\text{nitrate}} + (F_{0-1})N_{\text{organic}} \\ &= (0.5)(20 \text{ lbs N/ton}) + (0 \text{ lb N/ton}) + (0.3)(80 \text{ lbs N/ton}) \\ &= 34 \text{ lbs N/ton} \end{aligned}$$

## 11.14. Calculating Biosolids Carryover PAN

### 11.14.1. Single Previous Biosolids Application

The PANA (i.e., mainly organic-N applied per acre) carryover from past biosolids applications can be calculated using (12.3) and Table 12.11. The following are the given information for a biosolids land application operation: (a) aerobically digested biosolids, (b) applied 2 years ago, (c) biosolids application rate = 5.1 dry tons/acre, and (d) organic nitrogen content = 4.0 %. Determine the biosolids PANA from previous biosolids application using the calculated annual residual PAN in Table 12.11.

### 11.14.2. Solution

$A$  = biosolids application per acre in previous years = 5.1 dry tons/acre

Organic-N = organic nitrogen concentration in sludge = 4.0 %

Biosolids mineralized organic-N carryover = 3.6 lbs/ton (see Table 12.11 for 2–3 years)

$$\begin{aligned} \text{PANA} &= \text{crop year biosolids PAN applied in previous years} \\ &= \text{the amount of biosolids } N \text{ carryover available} \\ &= A (\text{carryover mineralized organic-N}) \\ &= (5.1)(3.6) \\ &= 18.4 \text{ lbs N/acre} \end{aligned}$$

**Table 12.18**  
**Biosolids organic-N mineralization  $K_m$  “Shortcut” factor method for determination of PANA from past biosolids applications.** *Source: National Biosolids Partnership [22]*

<i>T</i>	<i>U</i>	<i>V</i>	<i>W</i>	<i>X</i>	<i>Y</i>	<i>Z</i>
Crop year (CY)	No. of years prior to plan year	Equivalent years since application	$K_m$ factor (from Table 12.11)	Total applied biosolids (dry ton/acre)	Biosolids organic-N content (%)	Mineralized PANA from past biosolids (lb/acre)
1 (CY) 2004	3	3–4	$K_m$ (3–4) value 0.42	4.0	4.9	$W1 \times X1 \times Y1 = 8.2 = Z1$
2 (CY) 2005	2	2–3	$K_m$ (2–3) value 0.90	3.0	4.6	$W2 \times X2 \times Y2 = 12.4 = Z2$
3 (CY) 2006	1	1–2	$K_m$ (1–2) value 2.1	2.5	4.3	$W3 \times X3 \times Y3 = 22.6 = Z3$
4 Plan CY 2007					Total	$Z1 + Z2 + Z3 = 43.2 = Z4$

Total carryover N from biosolids applied in three previous years equals (cell Z4).

11.14.3. Multiple Previous Biosolids Applications

Past biosolids applications are recorded in below:

Data from records	Previous year 2006	2 Years ago 2005	3 Years ago 2004
Total biosolids applied (dry ton/acre)	2.5	3.0	4.0
Biosolids organic-N content (%)	4.3	4.6	4.9
Biosolids organic-N applied <sup>a</sup> (lb N/acre)	215	276	392

<sup>a</sup>Biosolids organic-N lb/acre = (dry ton/acre) × (organic-N %) × 20

Determine the PANA from past biosolids applications using the biosolids organic-N mineralization  $K_m$  “shortcut” factor method [22]

11.14.4. Solution

The calculations and the answer are presented in Table 12.18.

11.15. Calculating Nitrogen Based Agronomic Rate

The following are the given technical information: (a) planned crop = corn, grain; (b) predominant soil series = Pamunkey; (c) target crop yield (based on soil productivity group) = 180 bu/acre; (d) unit nitrogen fertilizer rate (UNFR) = 1.0 lb N/bu yield; (e) previous year legume crop and yield = soybeans with 45 bu/acre; (f) starter fertilizer usage = 100 lbs/acre of 11-52-0; (g) Historical manure usage information—manure type = dairy;

**Table 12.19**  
**CNFR and CND determinations. Source: National Biosolids Partnership [22]**

	Units	Enter value
<i>STEP 1: CNFR determination</i>		
1a. Planned crop	Crop name	Corn, grain
1b. Predominant soil series (optional)	Soil series name	Pamunkey
1c. Soil productivity group (optional)	Soil group no.	Group 1a (Table 1.1 in website)
1d. Target crop yield	bu/acre or ton/acre	180 bu/acre (Table 12.7)
1e. Unit nitrogen fertilizer rate (UNFR)	lb N/bu	1.0 (Table 12.8)
1f. Crop nitrogen fertilizer rate (CNFR)	lb N/acre	180 (1d × 1e)
<i>STEP 2: CND determination</i>		
2a. PAN from legumes	lb N/acre	45 (Table 4.4 in website)
2b. PAN from conventional fertilizers	lb N/acre	11 = 100 × 11 %
2c. PAN from recent or panned livestock manure applications	lb N/acre	0
2d. PAN from historical livestock manure applications	lb N/acre	15 (Given)
2e. PAN from past biosolids applications (PANA)	lb N/acre	43.2 (Table 12.18)
2f. PAN from other sources	lb N/acre	0
2g. Total PAN (PANT from above)	lb N/acre	114.2 (Sum of above)
2h. Crop nitrogen deficit (CND)	lb N/acre	180 – 114.2 = 66

frequency of application = 5 out of last 10 year; typical manure application rate = 10 wet tons/acre; typical manure-N content = 10 lbs N/wet ton; and (h) past biosolids applications:

Data from records	Previous year 2006	2 Years ago 2005	3 Years ago 2004
Total biosolids applied (dry ton/acre)	2.5	3.0	4.0
Biosolids organic-N content (%)	4.3	4.6	4.9
Biosolids organic-N applied (lb N/acre)	215	276	392

Biosolids characteristics are given as the following: (a) biosolids stabilization method = aerobic digestion; (b) biosolids application method = dewatered and surface applied; (c) biosolids organic-N content = 4.9 %; (d) biosolids ammonium-N content = 0.1 %; (e) biosolids nitrate-N content = 0.0 %; and (f) biosolids solids content = 20 %.

Determine the nitrogen-based agronomic rate (AR) given the above conditions.

#### 11.15.1. Solution

The four steps outlined below and in Tables 12.19 and 12.20 for calculating agronomic rate (AR) of agricultural land application of biosolids are established by National Biosolids Partnership (NBP) [22]. This important design example illustrates how the nutrient

**Table 12.20**  
**Biosolids PAN and agronomic determinations. Source: National Biosolids Partnership [22]**

	Units	Enter value
<i>STEP 3: Biosolids PAN determination</i>		
3a. Biosolids stabilization method		Aerobic
3b. Biosolids application method		Surface
3c. Biosolids organic-N PAN when $F_{0-1} = 0.3$ (Table 12.8)	lb N/dry ton	29.4 (=4.9 × 20 × 0.3)
3d. Biosolids ammonium-N, PAN, when $K_v = 0.5$ (Table 12.9)	lb N/dry ton	1.0 (=0.1 × 20 × 0.5)
3e. Biosolids nitrate-N, PAN	lb N/dry ton	0.0 (=0.0 × 20)
3f. Total biosolids PAN <sub>0-1</sub>	lb N/dry ton	30.4 (=3c + 3d + 3e)
<i>STEP 4: Calculate AR</i>		
4a. Agronomic rate (AR)	Dry ton/acre	2 (=2 h/3f)
	Wet ton/acre	10 (=2/20 %)

management of biosolids and septage can be scientifically achieved using the US EPA method [1, 10]. It is suggested by NBP that the US EPA method be adopted and tailored for local cropping practices, and the regulatory requirements in each state ([16, 18, 22], [http://www.mawaterquality.org/capacity\\_building/mid-atlantic%20nutrient%20management%20handbook/chapter10.pdf](http://www.mawaterquality.org/capacity_building/mid-atlantic%20nutrient%20management%20handbook/chapter10.pdf)). The following are the four steps of tabulated calculations.

- Step 1. Calculating CNFR (Table 12.19)
- Step 2. Calculating CND (Table 12.19)
- Step 3. Calculating biosolids PAN (Table 12.20)
- Step 4. Calculating agronomic rate (AR) (Table 12.20)

In Step 4, the calculated AR is 2 dry tons/acre (equivalent to 10 wet tons/acre), as demonstrated in the AR calculation in Table 12.20. The AR in dry tons per acre is converted to wet tons per acre by dividing dry ton/acre by the solids content (in decimal form). In this case, 2 dry tons/acre is equivalent to 10 wet tons/acre when the solids given content is 20 %.

**11.16. Calculating the Required Land for Biosolids Application**

The recommended amount of nitrogen needed by a corn crop to be grown on a Cecil soil in Virginia is 120 lbs/acre/year. Biosolids containing 3 % nitrogen could be applied at up to 5.4 dry tons/acre if used to supply all the nitrogen needed by the crop (i.e., no other nitrogen fertilizers used). A POTW in Virginia produces 10 dry tons of biosolids/day. Determine the approximate area of corn field which will be needed for the agricultural land application.

*11.16.1. Solution*

- 1 % = 20 lbs/ton
- 3 % nitrogen content in biosolids = 3 (20 lbs/ton) = 60 lbs N/ton biosolids
- PAN required for corn crop = 120 lbs N/acre/year



Agricultural land application rate = (120 lbs N/acre/year)/(60 lbs N/ton) = 2 tons/acre/year

Maximum allowable land application rate = 5.4 dry tons/acre/year

Biosolids production rate = 10 dry tons/day

Area of land required for biosolids application = (10 tons/day)/(5.4 tons/acre/365 day) = 676 acres of corn field

### 11.17. Calculating the Nitrogen-Based and the Phosphorus-Based Agronomic Rates for Agricultural Land Application

Applying biosolids to meet the phosphorus, rather than the nitrogen, needs of the crop is a conservative approach for determining annual biosolids application rates ([1, 17, 19]; [http://www.mawaterquality.org/capacity\\_building/mid-atlantic%20nutrient%20management%20handbook/chapter10.pdf](http://www.mawaterquality.org/capacity_building/mid-atlantic%20nutrient%20management%20handbook/chapter10.pdf)). Supplemental nitrogen fertilization will be needed to optimize crop yields (except for nitrogen-fixing legumes) if biosolids application rates are based on a crop's phosphorus needs. The phosphorus in biosolids is estimated to be about half as available for plant uptake as the phosphorus normally applied to soils in commercial inorganic fertilizers. The phosphorus balance and the phosphorus-based agronomic rate of biosolids for land application can be determined by Equation (12.16) and Equation (12.33), respectively:

$$(AR_P) = (P_{\text{required}}) / [(P_{\text{content}})F] \quad (12.33)$$

where

$AR_P$  = Phosphorus-based agronomic rate, dry ton/acre

$P_{\text{content}}$  = phosphorus content in biosolids, lb P/ton biosolids (or lb  $P_2O_5$ /ton biosolids)

$P_{\text{required}}$  = phosphorus requirement for the land, lb P/acre (or lb  $P_2O_5$ /acre)

$F$  = a factor of availability = 0.5 (assuming 50 % will be available)

It should be noted that Equation (12.33) is another version of Equation (12.16) assuming  $P_{\text{balance}} = 0$ , and  $F = 0.5$  for practical applications. The units of  $P_{\text{content}}$  and  $P_{\text{required}}$  in the above equation must be compatible (i.e., both based on P, or both based on  $P_2O_5$ ).

$P_{\text{required}}$  is the phosphorus fertilizer recommendation for the harvested crop or the quantity of phosphorus removed by the crop. The US EPA assumes that only 50 % of  $P_{\text{content}}$  will be available as the plant-available phosphorus (PAP); however, this availability factor varies among states/regions. For example, the states bordering the Chesapeake Bay typically assume 100 % P availability unless a  $P$  index is employed to account for availability and transport factors (<http://www.mawaterquality.org/publications/pubs/PSIWhitePaper03-29-05.pdf>). Two conversion factors are used in determining the phosphorus-based agronomic rate:

1 % on dry basis = 20 lbs/ton = 10 kg/T (where 1 T = 1 mt = 1 metric ton = 1,000 kg)

1 lb P = 2.3 lbs  $P_2O_5$

1 kg P = 2.3 kg  $P_2O_5$

An example prepared by G.K. Evanylo of Virginia Tech [19] is presented here for showing how the phosphorus-based agronomic rate (AR) can be calculated for agricultural land application.

Lime-stabilized biosolids have a pH > 10, a calcium carbonate equivalent (CCE) of 40 %, a nitrate nitrogen concentration of 1,000 mg/kg (0.1 %), an ammonium nitrogen concentration of 2,000 mg/kg (0.2 %), a total nitrogen concentration of 27,000 mg/kg (2.7 %), and a total phosphorus concentration of 21,000 mg/kg (2.1 %), all on a dry weight basis (percent dry solids is 17.6 %). Corn for grain is to be grown on a Kempsville sandy loam soil that has a pH of 6.2; “high” Ca, Mg, and K soil test ratings; and a “low” P soil test rating. The biosolids will be surface-applied and disked into the soil within 24 h.

What should be the nitrogen-based agronomic rate and the phosphorus-based agronomic rate of the lime-stabilized biosolids?

### 11.17.1. Solution

#### Step 1. Nitrogen-based agronomic rate

The estimated yield potential of corn grown on a Kempsville soil is 140 bu/acre (Table 12.7), and the N rate permitted is 140 lbs/acre according to the Virginia Biosolids Use Regulations [13].

The nitrogen components of PAN in the biosolids have been calculated in Sect. 11.13.1 as follows:

$$\begin{aligned} \text{PAN}_{0-1} &= (K_V)(N_{\text{ammonium}}) + N_{\text{nitrate}} + (F_{0-1})N_{\text{organic}} \\ &= (0.75)(4 \text{ lbs N/ton}) + (2 \text{ lbs N/ton}) + (0.3)(50 \text{ lbs N/ton}) \\ &= 20 \text{ lbs N/ton} \end{aligned}$$

The nitrogen-based agronomic rate (7.0 dry tons/acre) is obtained by dividing the adjusted fertilizer nitrogen rate (140 lbs N/acre) by the calculated  $\text{PAN}_{0-1}$  (20 lbs N/dry ton):

$$\begin{aligned} \text{AR} &= \text{nitrogen-based agronomic rate} \\ &= (140 \text{ lbs N/acre}) / (20 \text{ lbs N/dry ton}) \\ &= 7 \text{ dry tons/acre} \end{aligned}$$

#### Step 2. Phosphorus-based agronomic rate

$$\begin{aligned} P_{\text{content}} &= \text{phosphorus content in biosolids} \\ &= 2.1 \% = 2.1 \times 20 \times 2.3 \text{ lbs P}_2\text{O}_5/\text{ton biosolids} \\ &= 96.6 \text{ lbs P}_2\text{O}_5/\text{ton biosolids} \end{aligned}$$

$F$  = factor of availability = 0.5 (assuming 50 % will be available)

$P_{\text{required}}$  = phosphorus requirement for the land = 120 lbs  $\text{P}_2\text{O}_5$ /acre; using local site recommendations (<http://www.dcr.virginia.gov/documents/StandardsandCriteria.pdf>)

$$\begin{aligned} (\text{AR}_P) &= \text{phosphorus-based agronomic rate, dry ton/acre} \\ &= (P_{\text{required}}) / [(P_{\text{content}})F] \\ &= (120) / [(96.6)0.5] \\ &= 2.5 \text{ dry tons/acre} \end{aligned}$$

(Note: It is about 1/3 of the nitrogen-based AR.)

### 11.18. Calculating the Lime-Based Agronomic Rate for Agricultural Land Application

Application rates for lime-stabilized or lime-conditioned biosolids may be computed by determining the biosolids calcium carbonate equivalent (CCE) [18]. The CCE provides a direct comparison of the liming value of the biosolids with calcium carbonate limestone, which is the basis for soil testing liming requirements. Biosolids conditioned or stabilized with lime may have a CCE of between 10 and 50 % on a dry weight basis. The agronomic lime rate for biosolids is determined from Equation (12.34):

$$(AR_L) = (L_{\text{required}})/(L_{\text{content}}) \quad (12.34)$$

where

$AR_L$  = lime-based agronomic rate, dry ton/acre

$L_{\text{content}}$  = lime content in sludge in terms of CCE, % (in decimal form; for instance, 40 % = 0.4)

$L_{\text{required}}$  = lime requirement for the land in terms of CCE, ton CCE/acre

Determine the lime-based agronomic rate for the same lime-stabilized biosolids introduced in Sect. 11.17.

#### 11.18.1. Solution

It is known that CCE of the lime-stabilized biosolids is 40 %. The coarse-textured Kempsville soil is permitted 0.75 tons limestone/acre according to Virginia Biosolids Use Regulations [13]. Thus, the rate of lime-stabilized biosolids to provide 0.75 tons CCE/acre can be calculated by Equation (12.34) as follows;

$L_{\text{content}}$  = lime content in biosolids in terms of CCE = 40 % = 0.4

$L_{\text{required}}$  = lime requirement for the land in terms of CCE = 0.75 ton CCE/acre

$$\begin{aligned} (AR_L) &= \text{lime-based agronomic rate, dry ton/acre} \\ &= (L_{\text{required}})/(L_{\text{content}}) \\ &= (0.75)/(0.4) \\ &= 1.9 \text{ tons biosolids/acre} \end{aligned}$$

In summary, the N-based, P-based, and lime-based agronomic rates for the examples presented in this section are 7, 2.5, and 1.9 dry tons/acre, respectively. The most limiting is the lime-based agronomic rate; thus, 1.9 dry tons or 10.8 wet tons (1.9 dry tons/acre divided by 0.176 dry tons/wet ton) should be the appropriate agronomic rate.

### 11.19. Calculating Potassium Fertilizer Needs

The amounts of plant-available nitrogen, phosphorus, and potassium, and other nutrients added by biosolids should be calculated once the design application rate ( $AR_{\text{design}}$ ) has been determined. Supplemental fertilizers should be applied if the amount of any nutrients in the biosolids is less than that recommended [1, 10, 19].

The amount of potassium applied in biosolids can be calculated from biosolids composition data (as done earlier for P) according to Equation (12.17):

$$K_{\text{balance}} = (AR_{\text{design}}) \times (K_{\text{content}})F - K_{\text{required}} \quad (12.17)$$

All of the potassium in biosolids can be assumed to be readily plant available because potassium is a soluble element. The availability factor  $F$  is assumed to be 100 % or 1.0 for potassium in biosolids.

In case the nitrogen-based agronomic rate (AR) has been chosen for agricultural land application of biosolids, then  $AR_{\text{design}} = AR$ .  $K_{\text{balance}}$  will be a negative value showing the needed lb K/acre (or lb  $K_2O$ /acre).

It has been known that the nitrogen-based agronomic rate ( $AR = 7$  dry tons/acre) is to be chosen to be for actual operation of land application. A biosolid containing 0.52 % K is to be applied to a wheat field, which has a potassium fertilizer recommendation of 135 lbs  $K_2O$ /acre. Determine the additional  $K_2O$  needed (i.e., a negative  $K_{\text{balance}}$  value) for the wheat field.

#### 11.19.1. Solution

$AR_{\text{design}} =$  biosolids application rate selected for design = nitrogen-based  $AR = 7$  dry tons biosolids/acre

$$\begin{aligned} K_{\text{content}} &= \text{potassium content in sludge} \\ &= 0.52 \% K = 0.52 \times 20 \text{ lbs K/ton biosolids} \\ &= 0.52 \times 20 \times 1.2 \text{ lbs } K_2O/\text{ton dry biosolids} \\ &= 12.48 \text{ lbs } K_2O/\text{ton dry biosolids} \end{aligned}$$

$$K_{\text{required}} = \text{potassium requirement for the wheat field} = 135 \text{ lbs } K_2O/\text{acre}$$

$$F = \text{availability factor } (F = 1.0 \text{ for potassium in biosolids})$$

$$\begin{aligned} K_{\text{balance}} &= \text{positive value shows the excess lb } K_2O/\text{acre; negative value shows the needed lb } K_2O/\text{acre} \\ &= (AR_{\text{design}}) \times (K_{\text{content}})F - K_{\text{required}} \\ &= (7 \text{ dry tons/acre}) \times (12.48 \text{ lbs } K_2O/\text{ton}) (1.0) - 135 \text{ lbs } K_2O/\text{acre} \\ &= -48 \text{ lbs } K_2O/\text{acre} \text{ (a negative value shows the needed lb } K_2O/\text{acre)} \end{aligned}$$

### 11.20. Land Application Inspection, Monitoring, Testing and Documentation

Discuss the needs of inspection, sampling, testing, recording, and laboratory equipment for biosolids land application.

#### 11.20.1. Solution

Pollutant concentrations and pathogen densities must be monitored regularly to ensure that the biosolids permitted for land application meet the standards necessary to protect health and environment [1, 10, 17]. The monitoring program includes the analyses shown in Table 12.12. Sampling and monitoring must be performed by qualified personnel or outside

laboratories. Sensory observations can detect many problems before environmental monitoring examinations.

When injecting biosolids, the application rate should be such that biosolids do not surface. If biosolids do surface, the injector speed should be increased or the biosolids flow decreased so that the quantity injected per unit area decreases. If the injector travel speed is excessive, soil may be thrown away from the shank creating an open trench. If the biosolids are spread on the surface, the rate should be low enough to prevent the excessive ponding or runoff. Excessive ponding is when the liquid is still above the surface several hours after application. Either excessive ponding or runoff indicates excessive application rates for the soil.

Both cleaning operation and equipment service are important. The cleaning operation includes daily flushing of the injectors (if used) and periodic flushing of the tanks. Truck, tractor, and equipment preventative maintenance schedules are usually specified in manufacturer's manuals. In addition to the normal record kept for monitoring and process control, the field operator(s) must keep a daily log or site map record to show where, when, and how much sludge has been applied.

Soil sampling and testing is a critical foundation of nutrient management plan development required to ensure that biosolids are applied appropriately. A detailed discussion of soil testing and analysis has been published ([http://www.mawaterquality.org/capacity\\_building/mid-atlantic%20nutrient%20management%20handbook/chapter7.pdf](http://www.mawaterquality.org/capacity_building/mid-atlantic%20nutrient%20management%20handbook/chapter7.pdf)).

## **12. LAND APPLICATION, CROP MANAGEMENT AND WATERSHED MANAGEMENT**

### ***12.1. Nonpoint Source Pollution from Land Application***

Runoff and/or leaching from a land application system may become a nonpoint source of pollution to streams, lakes, or groundwater. A coordinated effort is needed for implementation of the best management practices (BMP) that minimize nonpoint source pollution from a land application site. Such land application facilities require licensed operators to oversee the facility operation and management [1, 11, 13, 17, 19, 21, 22]. Pollutants include nutrients (nitrogen, phosphorus), BOD, COD, heavy metals, pathogenic microorganisms, and hormones [1, 4, 6–8, 20, 29].

### ***12.2. Land Application Operation, Crop Management, and Watershed Protection***

An optimized land application system may ensure its sustainable operation, adequate crop and forage management, public acceptance, and long-term watershed protection [32–41]. For environmental conservation and watershed protection, North Carolina State University [34] recommends the following knowledge and skills for a land application manager or operator: (a) irrigation and waste application system calibration and troubleshooting; (b) crop, forage, and nutrient management and crop problem identification; (c) soil, plant tissue, and waste testing and sampling; (d) winterization and maintenance of wasteland application equipment;

(e) sludge management and solids separation; (f) waste application scheduling; (g) record keeping and flow measurement; and (h) irrigation system design.

Some of the best management practices (BMP) concerning land application of manure and biosolids have been recommended by the University of Delaware [35] for both land application optimization and watershed protection: (a) operator should ask for assistance from state offices in planning to meet runoff requirements; (b) bioengineering (i.e., buffer streams with native, durable, non-crop vegetation) should be practiced; (c) nutrient management plans should be developed and implemented to guide the storage and land application of manure; (d) for better crop management, crop rotation and contour planting when appropriate should be established; (e) where possible, animal diets and feed should be modified to reduce the amounts of nutrients and hormones in manure; (f) land application system should be operated according to the comprehensive nutrient management plan in order to minimize water quality and public health risk; (g) tillage, crop residue management, grazing management, and other conservation practices should be used to minimize the movement of soil, organic materials, nutrients and pathogens to surface and groundwater from lands where manure is applied; (h) manure and biosolids need to be handled and stored properly to prevent water pollution from runoff and to reduce the potential for nutrient release into the air; (i) in vulnerable watersheds, where the potential for environmentally sound land application is limited, alternative uses of manure, such as the sale of manure to other farmers, composting, and sales of compost to home owners, and using manure for power generation may need to be considered; (j) operators should keep records that indicate the quantity of manure produced and ultimate application on land, including where, when, and amount of nutrients applied.

### ***12.3. Watershed Protection Act and Distressed Watershed Rules***

Watershed protection rules and regulations vary among states and regions in the USA, although their goals and requirements are similar. The authors of this chapter introduce The Watershed Protection Act (WPA) and Distressed Watershed Rules (DWR) of the Commonwealth of Massachusetts, USA, as typical examples. Only the portions of the WPA and DWR concerning land applications are emphasized. The Massachusetts Department of Conservation and Recreation (Massachusetts DCR) published its “Watershed Protection Act Guidance Document” in March 2006 [36, 37]. The WPA regulates land use and activities with certain designated areas in Massachusetts, for watershed protection.

WPA protects the quality of these drinking water sources by establishing two buffer zones around hydrologic water resources: (a) primary protection zone (within 400 ft of the reservoirs and 200 ft of tributaries and surface waters) in which any alteration is prohibited, and generation, storage, disposal, or discharge of pollutants is also prohibited and (b) secondary protection zone (between 200 and 400 ft of tributaries and surface waters, and on land within flood plains, over some aquifers, and within bordering vegetated wetlands) in which certain activities are specifically prohibited. These include storage/disposal/use of toxic, hazardous and other toxic materials, and the alteration of bordering vegetated wetlands as examples.

The Massachusetts DCR has identified numerical levels of each factor that give some indication of whether there will be substantial detriment or impairment of water quality. The

**Table 12.21**  
**Effects of soils, ground slope, stream slope, and topography on the likelihood of significant risk to water quality. Source: Massachusetts Watershed Protection Act [37]**

Variance factor	Likelihood of substantial detriment or impairment of water quality		
	Low	Potential	High
Soil: Erodibility, as defined by Natural Resource Conservation and service soil erosion factors	Low erodible $K^a < 0.18$	Potentially highly erodible $0.18 \leq K \leq 0.22$	Highly erodible $K > 0.22$
Soils: Percolation rate	More than 10 mpi <sup>b</sup>	Between 6 and 10 mpi, or equal to 10 mpi	Equal to/less than 6 mpi
Grand slope	Less than 3 %	Equal to/more than 3 % and less than 15 %	Equal to/more than 15 %
Stream slope	Less than 3 %	Equal to/more than 3 % and less than 10 %	Equal to/more than 10 %
Topography: Depth to groundwater	Equal to or more than 10'	Between 6' and 10'	Less than 6' <sup>c</sup>
Topography: Depth to ledge or refusal	Equal to or more than 10'	Between 6' and 10'	Less than 6'
Topography: Distance to water features	More than 400'	Between 200' and 400'	Equal to/less than 200'

<sup>a</sup>A factor of slope and fraction of fine soil particles.

<sup>b</sup>Minutes per in.

<sup>c</sup>1' = 1 ft = 0.3048 m.

**Table 12.22**  
**Effects of fecal coliform level, turbidity, and phosphorus on the likelihood of significant risk to water quality. Source: Massachusetts Watershed Protection Act [37]**

Variance factor	Likelihood of substantial detriment or impairment of water quality		
	Low	Potential	High
Fecal coliform level	Less than or equal to 20 organisms/100 mL	Less than or equal to 200, more than 20 organisms/100 mL	More than 200 organisms/100 mL
Turbidity	Equal to or less than 1 NTU	Less than or equal to 5 NTU, more than 1NTU	More than 5 NTU
Phosphorus	Equal to or less than 25 µg/L	Less than/equal to 50 µg/L more than 25 µg/L	More than 50 µg/L

numerical levels fall into three categories [37]: (a) low likelihood of substantial detriment to the public good or impairment of water quality, (b) potential for substantial detriment to the public good or impairment of water quality, and (c) high likelihood of substantial detriment to the public good or impairment of water quality.

**Table 12.23**  
**Effects of drainage area, soils, percolation rate, stream slope, proximity to reservoir, fecal coliform level, turbidity, phosphorus, and impervious surface on the likelihood of significant risk to water quality. Source: Massachusetts Watershed Protection Act [37]**

Variance factor	Likelihood of significant risk to water quality		
	Low	Potential	High
Drainage area (sq. mi.)	Less than 1	More than or equal to 1; less than 3	More than or equal to 3
Soils: Erodibility defined by NRCS Soil Erosion Factors	Low erodible $K^a < 0.18$	Potentially highly erodible $0.18 \leq K < 0.22$	Highly erodible $K > 0.22$
Percolation rate	More than 6 mpi <sup>b</sup> [30 if septic]	Equal to/less than 6 mpi; more than 2 mpi	Equal to/less than 2 mpi
Stream slope	Less than 3 %	Equal to/more than 3 %; less than 10 %	Equal to/more than 10 %
Proximity to reservoir <sup>c</sup>	Zone C	Zone B	Zone A
Fecal coliform level	More than 200 org/100 mL	Equal to/less than 200, more than 20 org/100 mL	Equal to/less than 20 org/100 mL
Turbidity	Equal to/less than 1 NTU	Equal to/less than 5 NTU, more than 1 NTU	More than 5 NTU
Phosphorus	Equal to/less than 25 µg/L	Equal to/less than 50 µg/L, more than 25 µg/L	More than 50 µg/L
Existing development: % of impervious surface	More than 20 %	Equal to/less than 20 %, more than 10 %	Equal to/less than 10 %
Proposed development: % of impervious surface	Equal to/less than 20 %	Equal to/less than 20 %, more than 10 %	More than 10 %

<sup>a</sup>A factor of slope and fraction of fine soil particles.

<sup>b</sup>Minutes per in..

<sup>c</sup>*Proximity to reservoir:* The closer a use is to a reservoir, the greater the risk of adverse impact to water quality.

*Zone A:* These areas fall within 400 ft (122 m) of the 100-year floodplain elevation as delineated on the Federal Emergency Management Agency (FEMA) maps, of all 314 CMR 4.00 Class A surface waters. These waters are not limited to the tributaries designated in the Watershed Protection Act. Streams or wetlands found to be on the site upon field investigation by DCR staff may be designated to be in this category. Zone A has the highest potential for significant risk to water quality.

*Zone B:* These areas are located one-half mile upgradient from the Zone A boundary or the watershed boundary, whichever is less.

*Zone C:* These areas encompass the remaining watershed not designated either Zone A or Zone B.

Table 12.21 shows the effects of soils, ground slope, stream slope, and topography on the likelihood of significant risk to water quality. Table 12.22 shows the effects of fecal coliform level, turbidity, and phosphorus on the likelihood of significant risk to water quality. Table 12.23 shows the effects of drainage area, soils, percolation rate, stream slope, proximity



to reservoir, fecal coliform level, turbidity, phosphorus, and impervious surface on the likelihood of significant risk to water quality.

A “distressed watershed” is a watershed which has its aquatic life and health that is impaired by nutrients (nitrogen and phosphorus) from agricultural land uses, including land application [32, 33]. Threats to public health, drinking water supplies, recreation, and public safety are also taken into consideration when and if a watershed is designated as a distressed watershed.

The Commonwealth of Massachusetts has developed the following designation criteria for a distressed watershed: (a) nutrient impacts from agricultural sources, (b) threats to public health, (c) periodic evidence of algal or cyano-bacterial blooms capable of producing toxins, (d) contaminants in public or private water supplies; (e) contaminants in recreational water, (e) contaminants in recreational water, and (f) nuisances impacting aquatic life.

Under the Massachusetts Distressed Watershed Rules, the land application operations and other concerned operators must prepare their nutrient management plans and submit them to the Massachusetts government (SWCD or ODNR) for review and approval. The plans must include soil and residuals analysis, be updated minimum of every 3 years, and validate 120 days of storage. Any new operation (including land application) must have plan approval prior to construction.

In summation, both the Watershed Protection Act and the Distressed Watershed Rules of the Commonwealth of Massachusetts are important to protection of the state’s watershed from contamination by land application of manure and other similar operations. The state government may thereby set specific requirements for the storage, handling and land application of manure, and also require nutrient management plans for land and operations within the designated watershed boundaries.

## GLOSSARY OF LAND APPLICATION AND WATERSHED PROTECTION TERMS

**Agricultural land** Land on which a food, feed, or fiber crop is grown. This includes range land or land used as pasture.

**Agronomic rate** The whole sludge application rate designed to (a) provide the amount of nitrogen needed by a crop or vegetation grown on the land and (b) minimize the amount of nitrogen in the sewage sludge that passes below the root zone of the crop or vegetation grown on the land to the ground water.

**Annual pollutant loading rate (APLR)** The maximum amount of a pollutant that can be applied to a unit area of land during a 365-day period. This term describes pollutant limits for sewage sludge that is given away or sold in a bag or other container for application to the land.

**Annual whole sludge application rate** The maximum amount of sewage sludge on a dry weight basis that can be applied to a land application site during a 365-day (1-year) period.

**Area of cropland** An *area of cropland* that has been *subdivided* into several strips is not a single field. Rather, each strip represents an *individual field unit*.

**Bagged sewage sludge** Sewage sludge that is sold or given away in a bag or other container (i.e., either an open or closed receptacle containing 1 mT or less of sewage sludge).

- Best management practice (BMP)** A method that has been determined to be the most effective, practical means of preventing or reducing pollution from nonpoint and point sources.
- Biosolids** Biosolids are solids, semisolids or liquid materials, resulting from biological treatment of domestic sewage that has been sufficiently processed to permit these materials to be safely land-applied. The term of biosolids was introduced by the wastewater treatment industry in the early 1990s and has been recently adopted by the US Environmental Protection Agency (US EPA) to distinguish high-quality, treated sewage sludge from raw sewage sludge and from sewage sludge containing large amounts of pollutants.
- Bulk sewage sludge** Sewage sludge that is not sold or given away in a bag or other container for application to the land.
- Ceiling concentration limits (CCL)** The *ceiling concentration limits* are the maximum concentrations of the nine trace elements allowed in biosolids to be land-applied. Sewage sludge exceeding the ceiling concentration limit for even one of the regulated pollutants is not classified as biosolids and, hence, cannot be land-applied.
- Class I sludge management facility** Publicly owned treatment works (POTWs) required to have an approved pretreatment program under 40 *CFR* 403.8(a), including any POTW located in a state that has elected to assume local pretreatment program responsibilities under 40 *CFR* 403.10(e). In addition, the Regional Administrator or, in the case of approved state programs, the Regional Administrator in conjunction with the state director, has the discretion to designate any treatment works treating domestic sewage (TWTDS) as a Class I sludge management facility.
- Crop group** Individual farm fields that are managed in the same manner, with the similar yield goals, are called a *crop group*.
- Crop management** The management involves crop group identification, crop nitrogen deficit determination, crop nitrogen fertilizer rate calculation, and crop yield optimization.
- Crop nitrogen deficit (CND)** Crop nitrogen deficit (CND) equals to anticipated crop nitrogen fertilizer rate (CNFR) minus all past PAN sources (PAN-past) and current planned non-biosolids PAN sources (PAN-plan), in the unit of lb N/acre. Previous biosolids carryover nitrogen is included in this calculation.
- Crop nitrogen fertilizer rate (CNFR)** CNFR is a rate (lb N/acre) = (yield) (UNFR), where UNFR is the unit nitrogen fertilizer rate (lb N/unit crop yield) and yield is the crop harvested, or crop yield (bu/acre or ton/acre).
- Crop year** The basic time management unit is often called the *crop year* or *planting season*. The *crop year* is defined as the year in which a crop receiving the biosolids treatment is harvested. For example, fall applications of biosolids in 2000 intended to provide nutrients for a crop to be harvested in 2001 are earmarked for *crop year* 2001. Likewise, biosolids applied immediately prior to planting winter wheat in October 2000 should be identified as fertilizer intended for *crop year* 2001 because the wheat will be harvested in the summer of 2001.
- Crop yield** It is the crop harvested in the unit of bu/acre or ton/acre.
- Cumulative pollutant loading rate (CPLR)** CPLR equals to the total amount of pollutant that can be applied to a site in its lifetime by all bulk biosolids applications meeting CCL. It is the maximum amount of an inorganic pollutant that can be applied to an area of land. This term applies to bulk sewage sludge that is land-applied.
- Designated use** Simple narrative description of water quality expectations or water quality goals. A designated use is a legally recognized description of a desired use of the waterbody, such as (a) support of communities of aquatic life, (b) body contact recreation, (c) fish consumption, and (d) public drinking water supply. These are uses that the state or authorized tribe wants the

waterbody to be healthy enough to fully support. The US Clean Water Act requires that waterbodies attain or maintain the water quality needed to support designated uses.

**Distressed watershed** It is a watershed which has aquatic life and health that is impaired by nutrients (nitrogen and phosphorus) from agricultural land uses, such as land application. Threats to public health, drinking water supplies, recreation, and public safety are also taken into consideration if a watershed is designated as a distressed watershed.

**Domestic septage** Either a liquid or solid material removed from a septic tank, cesspool, portable toilet, type III marine sanitation device, or similar treatment works that receives only domestic sewage. This does not include septage resulting from treatment of wastewater with a commercial or industrial component.

**Eutrophication** Enrichment of an aquatic ecosystem with nutrients (nitrogen, phosphorus) that accelerate biological productivity (growth of algae and weeds) and an undesirable accumulation of algal biomass.

**Exceptional quality sewage sludge** Sewage sludge that meets the most stringent limits for the three sludge quality parameters. In gauging sewage sludge quality, US EPA determined that three main parameters of concern should be considered as the following: (a) pollutant levels, (b) the relative presence or absence of pathogenic organisms, such as *Salmonella* and *E. coli* bacteria, enteric viruses, or viable helminth ova, and (c) the degree of attractiveness of the sewage sludge to vectors, such as flies, rats, and mosquitoes, that could potentially come in contact with pathogenic organisms and spread disease. Given these three variables, there can be a number of possible sewage sludge qualities. The term Exceptional Quality (EQ), which does not appear in the Part 503 regulation, is used to describe sewage sludge that meets the highest quality for all three of these sewage sludge quality parameters (i.e., ceiling concentrations and pollutant concentrations in 503.13 for metals, one of the Class A pathogen reduction alternatives, and one of the sewage sludge processing vector attraction reduction options 1 through 8).

**Farm field** The *farm field* is the basic management unit used for all farm nutrient management, as defined as “the fundamental unit used for cropping agricultural products.”

**Feed crop** Crops produced primarily for consumption by animals. These include, but are not limited to, corn and grass. For a crop to be considered a feed crop, it has to be produced for consumption by animals (e.g., grass grown to prevent erosion or to stabilize an area is not considered a feed crop).

**Fiber crop** Crops, such as flax and cotton, that were included in Part 503 because products from these crops (e.g., cotton seed oil) may be consumed by humans.

**Food crop** Crops consumed by humans. These include, but are not limited to, fruits, grains, vegetables, and tobacco.

**Forest land** Tract of land thick with trees and underbrush.

**Heavy metals** Trace elements are found in low concentrations in biosolids. The trace elements of interest in biosolids are those commonly referred to as “heavy metals.” Some of these trace elements (e.g., copper, molybdenum, and zinc) are nutrients needed for plant growth in low concentrations, but all of these elements can be toxic to humans, animals, or plants at high concentrations. Possible hazards associated with a buildup of trace elements in the soil include their potential to cause phytotoxicity (i.e., injury to plants) or to increase the concentration of potentially hazardous substances in the food chain. Federal and state regulations have established standards for the following eight heavy metals: arsenic (As), cadmium (Cd), copper (Cu), lead (Pb), mercury (Hg), molybdenum (Mo), nickel (Ni) and zinc (Zn), plus selenium (Se), which is not legally listed as a heavy metal.

**Impaired waterbody** A waterbody that does not meet the criteria that support its designated use.

**Indicator organism** An indicator organism (e.g. fecal coliform) is a nonpathogenic organism whose presence implies the presence of pathogenic organisms. Indicator organisms are selected to be conservative estimates of the potential for pathogenicity.

**Individual field unit** An *area of cropland* that has been *subdivided* into several strips is not a single field. Rather, each strip represents an *individual field unit*.

**Impaired waterbody** A waterbody that does not meet the criteria that support its designated use.

**Land application** Land application is defined as the spreading, spraying, injection, or incorporation of liquid or semiliquid organic substances, such as sewage sludge, biosolids, livestock manure, compost, septage, legumes, and other types of liquid organic waste, onto or below the surface of the land to take advantage of the soil-enhancing qualities of the organic substances. These organic substances are land-applied to improve the structure of the soil. It is also applied as a fertilizer to supply nutrients to crops and other vegetation grown in the soil. The liquid or semiliquid organic substances are commonly applied to agricultural land (including pasture and range land), forests, reclamation sites, public contact sites (e.g., parks, turf farms, highway median strips, golf courses), lawns, and home gardens.

**Land application site** An area of land on which sewage sludge is applied to condition the soil or to fertilize crops or vegetation grown in the soil.

**Manure** Any wastes discharged from livestock.

**Mesotrophic** The term describes reservoirs and lakes that contain moderate quantities of nutrients and are moderately productive in terms of aquatic animal and plant life.

**Mineralization** Most nitrogen exists in biosolids as organic-N, principally contained in proteins, nucleic acids, amines, and other cellular material. These complex molecules must be broken apart through biological degradation for nitrogen to become available to crops. The conversion of organic-N to inorganic-N forms is called *mineralization*.

**Narrative criteria** Nonnumeric descriptions of desirable or undesirable water quality conditions.

**Nonpoint source** Diffuse pollution source; a source without a single point of origin or not introduced into a receiving stream from a specific outlet. The pollutants are generally carried off the land by storm water. Common nonpoint sources are agriculture, forestry, urban areas, mining, construction, dams, channels, land disposal, saltwater intrusion, and city streets.

**Numeric criteria** Numeric descriptions of desirable or undesirable water quality conditions.

**Nutrients** Nutrients are elements required for plant growth that provide biosolids with most of their economic value. These include nitrogen (N), phosphorus (P), potassium (K), calcium (Ca), magnesium (Mg), sodium (Na), sulfur (S), boron (B), copper (Cu), iron (Fe), manganese (Mn), molybdenum (Mo), and zinc (Zn).

**Pasture** Land on which animals feed directly on feed crops such as legumes, grasses, or grain stubble.

**Pathogens** Pathogens are disease-causing microorganisms that include bacteria, viruses, protozoa, and parasitic worms. Pathogens can present a public health hazard if they are transferred to food crops grown on land to which biosolids are applied; contained in runoff to surface waters from land application sites; or transported away from the site by vectors such as insects, rodents, and birds.

**pH** pH is a measure of the degree of acidity or alkalinity of a substance. The pH of biosolids is often raised with alkaline materials to reduce pathogen content and attraction of disease-spreading organisms (vectors). High pH (greater than 11) kills virtually all pathogens and reduces the solubility, biological availability, and mobility of most metals. Lime also increases the gaseous loss (volatilization) of the ammonia form of nitrogen (ammonia-N), thus reducing the N-fertilizer value of biosolids.

- Plant-available nitrogen (PAN)** Only a portion of the total nitrogen present in biosolids is available for plant uptake. This *plant-available nitrogen* (PAN) is the actual amount of N in the biosolids/manure that is available to crops during a specified period.
- Planting and harvesting periods** The cycle of crop *planting and harvesting periods*, not the calendar year, dictates the timing of biosolids and manure land application activities. Winter wheat and perennial forage grasses are examples of crops that may be established and harvested in different calendar years.
- Planting season** The basic time management unit is often called the *crop year* or *planting season*. The *crop year* is defined as the year in which a crop receiving the biosolids treatment is harvested.
- Point source** A stationary location or fixed facility from which pollutants are discharged; any single identifiable source of pollution, such as a pipe, ditch, ship, ore pit, or factory smokestack.
- Pollutant** A contaminant in a concentration or amount that adversely alters the physical, chemical, or biological properties of the natural environment.
- Pollutant concentration limits (PCL)** *Pollutant concentration limits* are the maximum concentrations of heavy metals for biosolids whose trace element pollutant additions do not require tracking (i.e., calculation of CPLR (cumulative pollutant loading rate)). PCL are the most stringent pollutant limits included in US Federal Regulation Part 503 for land application. Biosolids meeting pollutant concentration limits are subject to fewer requirements than biosolids meeting ceiling concentration limits.
- Preparer** Either the person who generates sewage sludge during the treatment of domestic sewage in a treatment works or the person who derives a material from sewage sludge.
- Public contact site** Land with a high potential for contact by the public, including public parks, ball fields, cemeteries, nurseries, turf farms, and golf courses.
- Range land** Open land with indigenous vegetation.
- Reclamation site** Drastically disturbed lands, such as strip mines and construction sites, that can be reclaimed using biosolids.
- Septage** Septage means the liquid and solid material pumped from a septic tank, cesspool, or similar domestic sewage treatment system, or holding tank when the system is cleaned or maintained.
- Sewage sludge** The solid, semisolid, or liquid residue generated during the treatment of domestic sewage in a treatment works. Sewage sludge includes, but is not limited to, domestic septage, scum, and solids removed during primary, secondary, or advanced wastewater treatment processes. The definition of sewage sludge also includes a material derived from sewage sludge (i.e., sewage sludge whose quality is changed either through further treatment or through mixing with other materials).
- Stakeholder** Individual or organization that has a stake in the outcome of the watershed plan.
- Threatened waterbody** A waterbody that is meeting standards, but exhibits a declining trend in water quality such that it will likely exceed standards.
- Total Kjeldahl nitrogen (TKN)** TKN is the summation of *ammonium nitrogen* ( $\text{NH}_4^+\text{-N}$ ) and *organic nitrogen* (organic-N).
- Total maximum daily load (TMDL)** The amount, or load, of a specific pollutant that a waterbody can assimilate and still meet the water quality standard for its designated use. For impaired waterbodies the TMDL reduces the overall load by allocating the load among current pollutant loads (from point and nonpoint sources), background or natural loads, a margin of safety, and sometimes an allocation for future growth.
- Total nitrogen** It is the summation of *ammonium nitrogen* ( $\text{NH}_4^+\text{-N}$ ), *nitrate nitrogen* ( $\text{NO}_3^-\text{-N}$ ), nitrite nitrogen ( $\text{NO}_2^-\text{-N}$ ), and *organic nitrogen* (organic-N). Usually nitrite nitrogen is in negligible amount. Crops directly utilize nitrogen in its inorganic forms, principally nitrate-N and ammonium-N.

**Total solids (TS)** Total solids (TS) include suspended and dissolved solids and are usually expressed as the concentration present in biosolids. TS depend on the type of wastewater process and biosolids' treatment prior to land application. Typical solids contents of various biosolids are: liquid (2–12 %), dewatered (12–30 %), and dried or composted (50 %).

**Trace elements** Trace elements are found in low concentrations in biosolids. The trace elements of interest in biosolids are nearly all “heavy metals.”

**Treatment works** Federally owned, publicly owned, or privately owned device or system used to treat (including recycle or reclaim) either domestic sewage or a combination of domestic sewage and industrial waste of a liquid nature.

**Treatment works treating domestic sewage** A POTW or other sewage sludge or wastewater treatment system or device, regardless of ownership used in the storage, treatment, recycling, and reclamation of municipal or domestic sewage, including land dedicated for the disposal of sewage sludge.

**Unit nitrogen fertilizer rate (UNFR)** UNFR is a rate in lb-N per unit crop yield, where the unit can either bushel or ton. (*Note:* 1 bu (US bushel) = 1.2444 ft<sup>3</sup>; 1 British bushel = 1.2843 ft<sup>3</sup>; 1 t (British ton) = 2,000 lbs; and 1 T (metric ton) = 1,000 kg).

**Vectors** Vectors include rodents, birds, insects that can transport pathogens away from the land application site.

**Vector attraction** Characteristics (e. g., odor) that attract birds, insects, and other animals that are capable of transmitting infectious agents.

**Volatilization** Ammonium-N in biosolids can be significant, making up even half the initial PAN of biosolids. The ammonium-N of biosolids can vary widely depending on treatment and storage. Since ammonium-N is prone to volatilization (as ammonia gas, NH<sub>3</sub>), the application method affects PAN. For instance, surface-applied biosolids are expected to lose half of their ammonium-N. Conversely, direct subsurface injection or soil incorporation of biosolids within 24 h minimizes volatilization losses. The conversion of ammonium-N to ammonia gas form (NH<sub>3</sub>) is called *volatilization*.

**Volatile solids (VS)** Volatile solids (VS) provide an estimate of the readily decomposable organic matter in biosolids and are usually expressed as a percentage of total solids. VS are an important determinant of potential odor problems at land application sites.

**Water quality standards** Standards that set the goals, pollution limits, and protection requirements for each waterbody. These standards are composed of designated (beneficial) uses, numeric and narrative criteria, and anti-degradation policies and procedures.

**Watershed** A watershed is the area of land where all of the water that is under it or drains off of it goes into the same place, land area that drains to a common waterway, such as a stream, lake, estuary, wetland, or ultimately the ocean.

**Watershed approach** A flexible framework for managing water resource quality and quantity within specified drainage area, or watershed. This approach includes stakeholder involvement and management actions supported by sound science and appropriate technology.

**Watershed plan** A document that provides assessment and management information for a geographically defined watershed, including the analyses, actions, participants, and resources related to development and implementation of the plan.

**Yield** It is the crop harvested in the unit of bu/acre or ton/acre.

**REFERENCES**

1. US EPA (1995) Process design manual: land application of sewage sludge and domestic septage, EPA/625/R-95/001. US Environmental Protection Agency, Washington, DC
2. US EPA (1992) Technical support document for reduction of pathogens and vector attraction in sewage sludge, EPA 822-R-93-004. US Environmental Protection Agency, Washington, DC
3. US EPA (1999) Environmental regulations and technology: control of pathogens and vector attraction in sewage sludge, EPA/625/R-92/013. US Environmental Protection Agency, Washington, DC
4. Smith JE Jr, Millner PD, Jakubowski W, Goldstein N, Rynk R (2001) Contemporary perspectives on infectious disease agents in sewage sludge and manure. Proceedings of the workshop on emerging infectious disease agents and issues associated with sewage sludge, animal manures, and other organic by-products, Cincinnati, OH, June 2001
5. Stehouwer RC, Wolf AM, Doty WT (2000) Chemical monitoring of sewage sludge in Pennsylvania: variability and application uncertainty. *J Environ Qual* 29:1686–1695
6. Overcash M, Sims RC, Sims JL, Nieman JKC (2005) Beneficial reuse and sustainability: the fate of organic compounds in land-applied waste. *J Environ Qual* 34:29–41
7. Kester GB, Brobst RB, Carpenter A, Chaney RL, Rubin AB, Schoof RA, Taylor DS (2005) Risk characterization, assessment, and management of organic pollutants in beneficially used residual products. *J Environ Qual* 34:80–90
8. Xia K, Bhamdari A, Das K, Pillar G (2005) Occurrence and fate of pharmaceuticals and personal care products (PPCPs) in biosolids. *J Environ Qual* 34:91–104
9. US EPA (2002) Land application of biosolids: Office of Inspector General Status Report. 2002-S-000004. US Environmental Protection Agency, Washington, DC, December 2002. [http://www.epa.gov/oig/reports/2002/BIOSOLIDS\\_FINAL\\_REPORT.pdf](http://www.epa.gov/oig/reports/2002/BIOSOLIDS_FINAL_REPORT.pdf)
10. US EPA (1994) Land application of sewage sludge, EPA-831-B-93-002b. US Environmental Protection Agency, Washington, DC, December 1994
11. US EPA (2006) Emerging technologies for biosolids management, EPA-832-R-06-005. US Environmental Protection Agency, Washington, DC, September 2006
12. US EPA (2007) NPDES part II standard conditions. US Environmental Protection Agency, Washington, DC. [www.epa.gov/ne/npdes/permits/generic/partIIfinal2007.pdf](http://www.epa.gov/ne/npdes/permits/generic/partIIfinal2007.pdf)
13. VDEQ (2013) Biosolids use regulations. 12VAC-5-585-10et seq.32.1-164.5 of the Code of Virginia, Virginia Department of Environmental Quality, VA
14. US EPA (1990) National sewage sludge survey (NSSS) – availability of information and data, and anticipated impacts on proposed regulations. Federal Regulations 55:218. US Environmental Protection Agency, Washington, DC
15. US EPA (1991) National pretreatment program: report to congress. Technical report EPA-21-W-4004. US Environmental Protection Agency, Washington, DC
16. US EPA (1992) Technical support document for land application of sewage sludge, vol I. EPA-822-R-93-900-9. US Environmental Protection Agency, Washington, DC
17. Evanylo GK (1999) Agricultural land application of biosolids in Virginia: regulations. Publication 452-302. Virginia Cooperative Extension, Virginia Polytechnic Institute and State University, Blacksburg, VA. <http://pubs.ext.vt.edu/452/452-302/452-302.html>
18. Evanylo GK (1999) Agricultural land application of biosolids in Virginia: production and characteristics of biosolids. Publication 452-301. Virginia Cooperative Extension, Virginia

- Polytechnic Institute and State University, Blacksburg, VA. <http://pubs.ext.vt.edu/452/452-301/452-301.html>
19. Evanylo GK (1999) Agricultural land application of biosolids in Virginia: managing biosolids for agricultural use. Publication 452-303. Virginia Cooperative Extension, Virginia Polytechnic Institute and State University, Blacksburg, VA. <http://pubs.ext.vt.edu/452/452-303/452-303.html>
  20. Evanylo GK (1999) Agricultural land application of biosolids in Virginia: risks and concerns. Publication 452-304. Virginia Cooperative Extension, Virginia Polytechnic Institute and State University, Blacksburg, VA. <http://pubs.ext.vt.edu/452/452-304/452-304.html>
  21. US EPA (2000) Biosolids technology fact sheet – land application of biosolids, EPA-832-F-00-064. US Environmental Protection Agency, Washington, DC, September 2000
  22. US EPA, NACWA, and WEF (2005) Biosolids nutrient management-calculating agronomic rate of application. Chapter 13. National Manual of Good Practice for Biosolids. National Biosolids Partnership, Alexandria, VA, January (2005)
  23. US EPA (1995) Amendments to the standards for the use or disposal of sewage sludge (40 code of federal regulations part 503). US Environmental Protection Agency, Washington, DC
  24. US EPA (1994) Biosolids recycling: beneficial technologies for a better environment. Technical report EPA-832-R-94-009. US Environmental Protection Agency, Washington, DC
  25. US EPA (1993) Standards for the use or disposal of sewage sludge (40 code of federal regulations part 503). US Environmental Protection Agency, Washington, DC
  26. O’Dette RG (1996) Determining the most cost effective option for biosolids and residuals management. Proceedings of the 10th annual residuals and biosolids management conference: 10 years of progress and a look toward the future. Water Environment Federation, Alexandria, VA
  27. Haering KC, Daniels WL, Feagley SE (2000) Reclaiming mined lands with biosolids, manures, and papermill sludges. In: Barnhisel et al. (eds.) Reclamation of drastically disturbed lands. Agronomy 41. ASA, CSSA, SSSA, Madison, WI, pp 615–644
  28. WEF (1997) National outlook – state beneficial use of biosolids activities. Water Environment Federation, Washington, DC
  29. Deitzman MM, Mostaghimi S, Dillaha TA, Heatwole CD (1989) Tillage effects on P losses from sludge amended soils. Journal Soil and Water Conservation, 247–251
  30. Shamma NK, Wang LK (2007) Land application of biosolids, Chapter 23. In: Wang LK, Shamma NK, Hung YT (eds) Biosolids treatment processes. Humana, Totowa, NJ, USA, pp 705–746
  31. Brandt RC, Martin KM (1994) The food processing residual management manual. Pennsylvania Department of Environmental Protection, Harrisburg, PA, Pub. No. 2500-BK-DER-1649
  32. Hamilton R (2011) New rules for distressed watersheds. US Environmental Protection Agency, Region 5 and the Ohio Department of Natural Resources, Ohio. [www.epa.gov/Region5/agriculture/pdfs/nutrientworkshop/10hamilton.pdf](http://www.epa.gov/Region5/agriculture/pdfs/nutrientworkshop/10hamilton.pdf)
  33. Mustine D (2011) What is a distressed watershed? Ohio Department of Natural Resources, Athens, OH, [www.dnr.state.oh.us/tabid/8856/Default.aspx](http://www.dnr.state.oh.us/tabid/8856/Default.aspx)
  34. NCSU (2001) Land application, crop management and watershed management. North Carolina State University, Raleigh, NC, [www.bae.ncsu.edu/programs/extension/wqg/swetcenter/programs.html](http://www.bae.ncsu.edu/programs/extension/wqg/swetcenter/programs.html)
  35. UDEL (2013) Watershed preservation and restoration. University of Delaware Water Resources Agency, Dover, DL, [www.wr.udel.edu/cb/watershedpresandrestor.html](http://www.wr.udel.edu/cb/watershedpresandrestor.html)
  36. MDCR (2012) The Watershed Protection Act. Massachusetts Department of Conservation and Recreation, Boston, MA, June 2012



37. MDCR (2006) Watershed protection act guidance document. Massachusetts Department of Conservation and Recreation, Boston, MA, March 2006
38. Imai T, Liu Y, Ukita M, Hung YT (2010) Applications of composted solid wastes for farmland amendment and nutrient balance in soils. In: Wang LK, Tay JH, Tay STL, Hung YT (eds) Environmental bioengineering. Humana, Totowa, NJ, USA, pp 629–684
39. Wang LK, Shammas NK, Hung YT (eds) (2008) Biosolids engineering and management. Humana, Totowa, NJ, USA, p 800
40. Wang LK, Shammas NK, Hung YT (eds) (2009) Advanced biological treatment processes. Humana, Totowa, NJ, USA, p 738
41. US EPA (2008) Handbook for developing watershed plans to restore and protect our waters, EPA-841-B-08-002. US Environmental Protection Agency, Washington, DC

## Wetlands for Wastewater Treatment and Water Reuse

---

Azni Idris, Abdul Ghani Liew Abdullah, Yung-Tse Hung,  
and Lawrence K. Wang

### CONTENTS

NOMENCLATURE

INTRODUCTION

WHAT ARE WETLANDS?

NATURAL WETLANDS

CONSTRUCTED WETLANDS

MECHANISMS OF TREATMENT PROCESSES FOR CONSTRUCTED WETLANDS

SELECTION OF WETLAND PLANT

DESIGN OF CONSTRUCTED WETLAND SYSTEMS

WETLAND MONITORING AND MAINTENANCE

CASE STUDY

WETLAND: IDENTIFICATION, CREATION, UTILIZATION, RESTORATION,  
AND PROTECTION FOR POLLUTION CONTROL AND WATER CONSERVATION

GLOSSARY OF WETLAND

REFERENCES

---

**Abstract** This chapter discusses the use of natural and constructed wetlands for treatment of wastewaters. Mechanisms of treatment processes for wetlands were described. Function, roles, types, and selection of wetland plants were discussed. The chapter also covers design, monitoring, and maintenance of wetland treatment systems for wastewater. Case studies in the United States, Malaysia, and the United Kingdom were discussed. Pollution control and water reuse for watershed protection and environmental conservation are emphasized.

**Key Words** Wetland • Natural wetland • Constructed wetland • Wastewater treatment • Wetland treatment mechanism • Water reuse • Environmental conservation • Watershed protection.

## NOMENCLATURE

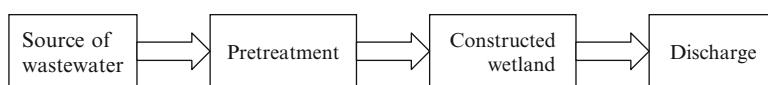
AN	Ammoniacal nitrogen
$A_s$	Surface area of wetland ( $m^2$ )
BOD	Biochemical oxygen demand (mg/L)
C	Carbon
$C_e$	Effluent pollutant concentration (mg/L)
CH <sub>4</sub>	Methane
$C_o$	Influent pollutant concentration (mg/L)
CO <sub>2</sub>	Carbon dioxide
COD	Chemical oxygen demand
$d_m$	Depth of media (m)
$d_w$	Depth of water from media surface (m)
EPA	Environmental Protection Agency
FWS	Free water surface
HFS	Horizontal flow system
HLR	Hydraulic loading rate (m/day)
HRT	Hydraulic retention time
$k_{20}$	Rate constant at 20 °C ( $day^{-1}$ )
$k_T$	Temperature-dependent first-order reaction rate constant ( $day^{-1}$ )
$L$	Length of the wetland cell (m)
$n$	Porosity or the space available for water to flow through the wetland (decimal)
N	Nitrogen
N <sub>2</sub>	Nitrogen
N <sub>2</sub> O	Nitrous oxide
NH <sub>3</sub>	Free ammonia (mg/L)
NH <sub>4</sub> <sup>+</sup>	Ammonium ion
NH <sub>4</sub> eff	Effluent ammonia (mg/L)
NO <sub>2</sub>	Nitrogen dioxide
NO <sub>2</sub> <sup>-</sup>	Nitrite
NO <sub>3</sub> <sup>-</sup>	Nitrate
NO <sub>3</sub> eff	Effluent nitrate (mg/L)
NO <sub>3</sub> inf	Influent nitrate (mg/L)
O <sub>2</sub>	Oxygen
P	Phosphorus
$Q$	The average flow through the wetland ( $m^3/day$ )
RRF	Rock-reed filter
rz	The percent of wetland bed depth occupied by root zone (decimal)
RZM	Root-zone method
SF	Surface flow

spp.	Species
SS	Suspended solids (mg/L)
SS <sub>e</sub>	Effluent SS (mg/L)
SSF	Subsurface flow
SS <sub>o</sub>	Influent SS (mg/L)
<i>t</i>	Hydraulic retention time (day)
<i>T</i>	Temperature
TKN	Influent Kjeldahl nitrogen (mg/L)
TN	Total nitrogen
TSS	Total suspended solids
US	United States
<i>V</i>	Volume of water in the system (m <sup>3</sup> )
VFS	Vertical flow system
VSB	Vegetated submerged bed
<i>W</i>	Width of the wetland cell (m)
°C	Degree Celsius (centigrade) (°C)
<i>θ</i>	Temperature coefficient

## 1. INTRODUCTION

In recent years, the selection of treatment methods for wastewater discharge from both municipalities and industrial sources has opened for wider options to include natural and constructed wetlands. The increasing capital and operation costs associated with modern mechanical treatment processes is a major driving force that calls for rethinking of using natural system to solve river pollution problems. Constructed wetlands are “designed and man-made complex of saturated substrates, emergent and submergent vegetation, animal life, and water that simulates natural wetlands for human use and benefits” [1]. Constructed wetlands are considered to be a low-cost system for treating wastewater discharged from municipal, agricultural, and industrial sources. A schematic process flow for a constructed wetland system is shown in Fig. 13.1 below.

Constructed wetlands represent an emerging eco-technological treatment system, in which are designed to overcome the disadvantages of natural wetlands. They have the qualities of reliability, cost-effectiveness, and versatility on top of the conventional engineering measures. Constructed wetlands have a great potential in treating wastewater as they can tolerate higher organic loading rate and shorter hydraulic retention time. In addition, they also have the capability of treating more than one type of pollutants simultaneously to some satisfactory levels as compared to other conventional treatment systems. Constructed wetlands can be created from existing marshlands or built at any land with limited alternative uses.



**Fig. 13.1.** A schematic process flow of a constructed wetland system.

## 2. WHAT ARE WETLANDS?

### 2.1. *Wetland Definition*

Wetlands are defined by the Convention of wetland of International Importance (the Ramsar Convention 1971) as: “areas of marsh, fen, peatland or water, whether natural or artificial, permanent or temporary, with water that is static or flowing, fresh, brackish or salt, including areas of marine water, the depth of which at low tide does not exceed 6 m. Wetlands include marshes, swamps, vleis, pans, bogs, ponds, reed beds and estuaries” [2]. Broadly defined, wetlands are land areas that have a prolonged high water or at least that are covered with shallow water. As a transition habitat between dry land and a deep water environment, they support plants that are adapted to grow in wet conditions.

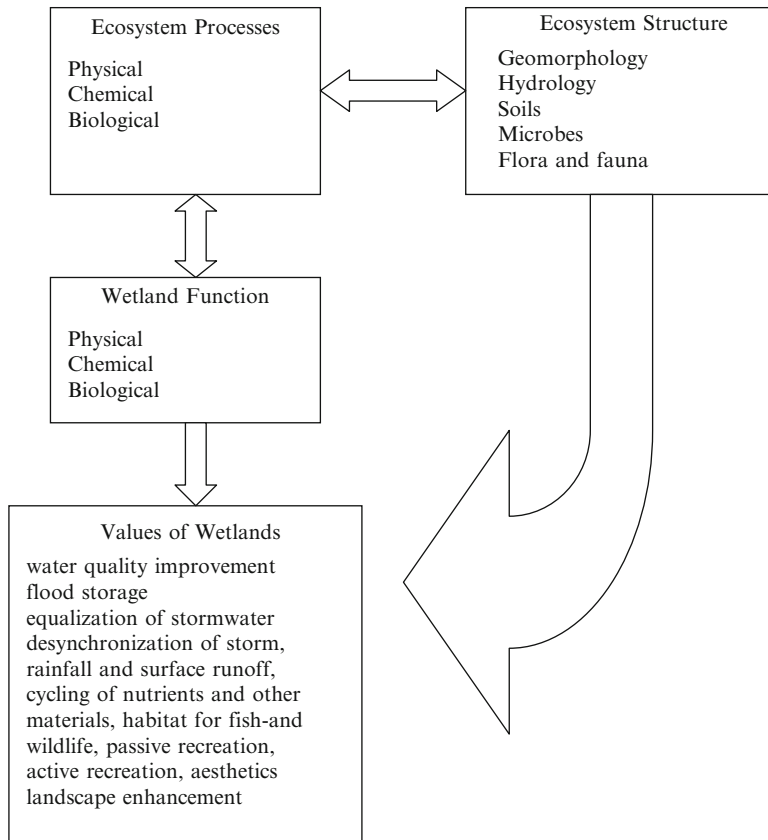
Wetlands are transitional areas between land and water. The boundaries between wetlands and uplands or deep water are therefore not always distinct. The term “wetlands” encompasses a broad range of wet environments, including marshes, bogs, swamps, wet meadows, tidal wetlands, floodplains, and ribbon (riparian) wetlands along stream channels. All wetlands (natural or constructed) have one characteristic in common, i.e., the presence of surface or near-surface water, at least periodically. In most wetlands, hydrological conditions are such that the substrate is saturated long enough during the growing season to create oxygen-poor conditions in the substrate. The lack of oxygen creates reducing (oxygen-poor) conditions within the substrate and limits the vegetation to those species that are adapted to low-oxygen environments.

The hydrology of wetlands is generally one of slow flows and either shallow waters or saturated substrates. The slow flows and shallow water depths allow sediments to settle as the water passes through the wetland. The slow flows also provide prolonged contact times between the water, substrates, and the surfaces within the wetland. The complex mass of organic and inorganic materials and the diverse opportunities for gas/water interchanges foster a diverse community of microbes that break down or transform a wide variety of substances. Most wetlands support a dense growth of vascular plants adapted to saturated conditions. This vegetation slows the water, creates microenvironments within the water column, and provides attachment sites for the microbial community. The litter that accumulates as a result of dead plants in the wetland creates additional material and exchange sites and provides a source of carbon, nitrogen, and phosphorous to fuel microbial processes.

### 2.2. *Wetland Functions and Values*

Wetland functions are the inherent processes occurring in wetlands; wetland values are the attributes of wetlands that society perceives as beneficial. The many values that wetlands provide result from their functions (hydrological, biogeochemical, and ecological). Hydrological functions may include floodwater retention, groundwater recharge and discharge, and sediment retention. Biogeochemical functions may include nutrient retention/removal and in situ carbon retention. Ecological functions may also include ecosystem maintenance and food web support.

Here a function can be defined as an activity that results from the interactions that occur between natural processes (physical, chemical, and biological) and the structural components such as geomorphology, hydrology, soil, flora, fauna, and microbes of the ecosystems.



**Fig. 13.2.** Interrelationship between wetland processes, functions, and values.

Under appropriate circumstances, constructed wetlands can provide extremely effective water quality improvement, flood storage, and the desynchronization of storm; rainfall and surface runoff; cycling of nutrients and other materials; habitat for fish and wildlife; passive recreation, such as bird watching and photography; and active recreation, such as hunting, education and research, aesthetics, and landscape enhancement [3]. Figure 13.2 shows the interrelationship between wetland functions and values.

### 3. NATURAL WETLANDS

Natural wetlands are sometimes called swamps, marshes, bogs, fens, wet meadows, or sloughs. Natural wetland definitions are not necessarily the same. Plant types and species, water, and geographic conditions vary, creating different kinds of wetlands in many different countries.

The 1977 Clean Water Act Amendments provide a broad definition of wetlands: “The term ‘wetlands’ means those areas that are inundated or saturated by surface or groundwater at a

frequency and duration sufficient to support, and that under normal circumstances do support, a prevalence of vegetation typically adapted for life in saturated soil conditions. Wetlands generally include swamps, marshes, bogs and similar areas.”

Wetlands are natural receptacles. Occurring in low-lying areas, wetlands receive runoff water and overflow from rivers and streams. In response, various wetland biological mechanisms or processes evolved over geological time to treat inflows. These mechanisms trap sediments and break down a wide range of pollutants into elemental compounds. Wetlands have a natural, innate ability to treat wastewater. Water moves slowly through wetlands, as shallow flows, saturated substrates, or both. Slow flows and shallow waters cause sediments to settle. The slow flows also act to prolong contact times between the water and surfaces within the wetland.

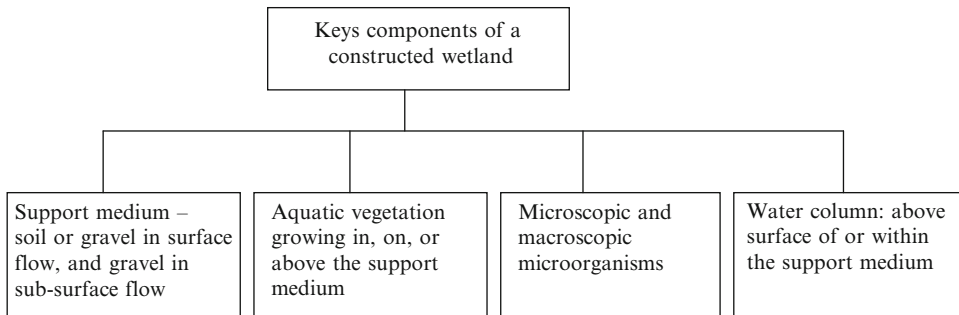
The organic and inorganic materials within a wetland form a complex mass. This mass along with the occurrence of gas/water interchanges promotes a varied community of microorganisms to break down or transform a wide variety of substances. Dense growths of vascular plants adapted to saturated conditions often thrive in wetlands and contribute to its treatment capacity. Along with slowing the flow of water, the vegetation creates microenvironments and provides the microbial community enormous attachment sites. Furthermore, plants die in some seasons and tend to accumulate as litter. This phenomena creates additional material and exchange sites as well as providing a source of carbon, nitrogen, and phosphorous to fuel microbial processes.

#### 4. CONSTRUCTED WETLANDS

The role of wetland in water resource management is fast gaining ground resulting in the construction wetland in most developed countries. This trend has evolved because wetlands have been added to wastewater facilities that provide only basic levels of primary or secondary treatment. Because of the potential for creating nuisance conditions in wetlands that receive poor quality wastewater, the European design preference has been to use subsurface flow through soil or sand planted with common reed.

Constructed wetlands are man-made system that involves altering the existing terrain to simulate wetland conditions. They primarily attempt to replicate the treatment that has been observed to occur when polluted water enters the natural wetland. These wetlands have been seen to purify water by removing organic compounds and oxidizing ammonia, reducing nitrates, and removing phosphorus. The mechanisms are complex and involve bacterial oxidation, filtration, sedimentation, and chemical precipitation.

Most constructed wetlands attempt to imitate the ecosystem's biochemical function as filtration and cleansing agents, followed closely by the hydrological function that is centered on flood mitigation. These constructed wastewater treatments may include swamps and marshes. Most of the constructed wetland systems are marshes. Marshes are shallow water regions dominated by emergent herbaceous vegetation including cattails, bulrush, reeds, rushes, and sedges.



**Fig. 13.3.** Key components of a constructed wetland [4].

#### 4.1. Components of Constructed Wetlands

A constructed wetland consists of a properly designed basin that contains water, a substrate, and, most commonly, macrophyte vegetation. These components can be manipulated in constructing a wetland. Other important components of wetlands, such as the communities of microbes and aquatic invertebrates, develop naturally. The essential components of both a natural wetland and a constructed wetland are shown in Fig. 13.3.

#### 4.2. Advantages of Constructed Wetlands for Wastewater Treatment

Constructed wetland is a cheaper alternative for wastewater treatment using locally available resources. Aesthetically, it is a presentable, scenic, and more landscaped looking wetland site compared to the conventional wastewater treatment plants. This promotes sustainable use of local aquatic plants, which is a more environment friendly biological wastewater treatment system.

Constructed wetlands can be created at lower costs than other treatment options, with low-technology methods where no new or complex technological tools are needed (essentially grading, dike construction, and vegetation planting). Properly designed and construction systems do not require chemical additions and other procedures used in the conventional treatment systems [5]. The system relies on renewable energy sources such as solar and kinetic energy and wetland plants and microorganisms, which are the active agents in the treatment processes.

The system can tolerate both large and small volumes of water with varying contaminant levels. These include municipal and domestic wastewater, urban storm runoff, agricultural wastewater, industrial effluents, and polluted surface waters in rivers and lakes. The system could be promoted to various potential users for water quality improvement and pollutant removal. These potential users include the tourism industry, governmental departments, private entrepreneurs, private residences, aquaculture industries, and agro-industries.

Utilization of local products and labor helps to reduce the operation and maintenance costs of a treatment system. Less energy and raw materials are needed, with periodic on-site labor, rather than continuous full-time attention. This system indirectly will contribute greatly in the reduction of use of natural resources in conventional treatment plants, and wastewater



discharges to natural waterways are also reduced. The constructed wetland system also could be used to clean polluted rivers and other water bodies. This derived technology can eventually be used to rehabilitate grossly polluted rivers in the country. The constructed wetland treatment system is widely applied for various functions. These functions include primary settled and secondary treated sewage treatment, tertiary effluent polishing and disinfecting, urban and rural runoff management, toxicant management, landfill and mining leachate treatment, sludge management, industrial effluent treatment, enhancement of in-stream nutrient assimilation, nutrient removal via biomass production and export, and groundwater recharge.

The primary purpose of constructed wetland treatment systems is to treat various kinds of wastewater (municipal, industrial, agricultural, and stormwater). However, the system usually serves other purposes as well. A wetland can serve as a wildlife sanctuary and provide a habitat for wetland animals. The wetland system can also be aesthetically pleasing and serve as an attractive destination for tourists and local urban dwellers. It can also serve as a public attraction sanctuary for visitors to explore its environmental and educational possibilities. It appeals to different groups varying from engineers to those involved in wastewater facilities as well as environmentalists and people concerned with recreation. This constructed wetland treatment system also provides a research and training ground for young scientists in this new research and education arena.

### 4.3. Types of Constructed Wetlands

Constructed wetland systems are classified into two general types: the horizontal flow system (HFS) and the vertical flow system (VFS). HFS has two general types: surface flow (SF) and subsurface flow (SSF) systems. It is called HFS because wastewater is fed at the inlet and flows horizontally through the bed to the outlet. VFS are fed intermittently and drains vertically through the bed via a network of drainage pipes.

#### 4.3.1. Surface Flow (SF) System

The use of SF systems is extensive in North America, whereby more than 200 constructed wetlands are in operation. These systems are used mainly for municipal wastewater treatment with large wastewater flows for nutrient polishing. The SF system tends to be rather large in size with only a few smaller systems in use. The majority of constructed wetland treatment systems are surface flow (SF) or free water surface (FWS) systems. These types utilize influent waters that flow across a basin or a channel that supports a variety of vegetation, and water is visible at a relatively shallow depth above the surface of the substrate materials. Substrates are generally native soils or other suitable medium to support emergent vegetation and clay or impervious geotechnical materials that prevent seepage. Typical emergent plants that are found in surface flow wetlands are cattails (*Typha* spp.), bulrushes (*Scirpus* spp.), and various sedges (*Carex* spp.). The shallow water depth with low flow velocity of water and presence of plants help to regulate flow, especially in a long narrow channel to ensure plug-flow conditions are met. Typically, bed depth of wetland is about 0.3–0.4 m. Figure 13.4 below shows a profile of a three-zone SF constructed wetland cell.

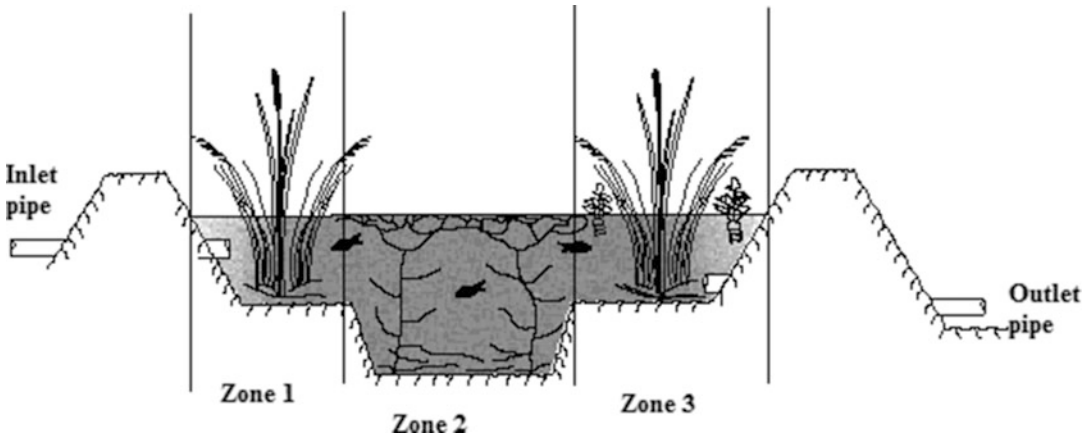


Fig. 13.4. Profile of a three-zone SF/FWS constructed wetland cell [6].

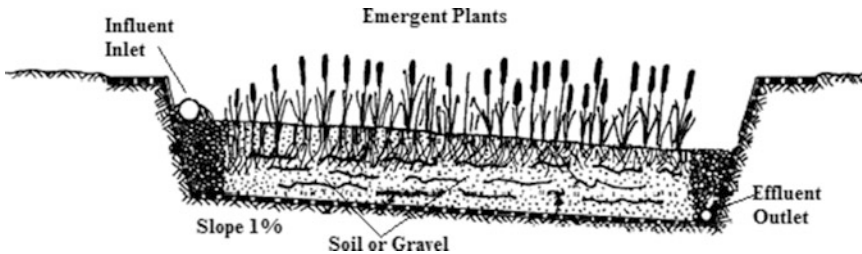


Fig. 13.5. A typical cross section of a subsurface flow wetland system [7].

#### 4.3.2. Subsurface Flow (SSF) System

The SSF system includes soil-based technology which is predominantly used in Europe, with more than 500 wetlands that are operational, and the vegetated gravel beds are found in Europe, Australia, South Africa, and almost all over the world. In a vegetated subsurface flow (SSF) system, water flows from one end to the other end through permeable substrates which are made of mixture of soil and gravel or crusher rock. The substrate will support the growth of rooted emergent vegetation. It is also called “root-zone method” (RZM) or “rock-reed filter” (RRF) or “emergent vegetation bed system” or “vegetated submerged bed” (VSB). The media depth is about 0.6 m deep and the bottom is a clay layer to prevent seepage. Media size for most gravel substrate ranged from 5 to 230 mm with 13–76 mm being typical. The bottom of the bed is sloped to minimize water that flows overland. Wastewater flows by gravity horizontally through the root zone of the vegetation about 100–150 mm below the gravel surface. Many macro and microorganisms inhabit the substrates. Free water is not visible. The inlet zone has a buried perforated pipe to distribute maximum flow horizontally through the treatment zone. Treated water is collected at outlets at the base of the media, typically 0.3–0.6 m below bed surface. In both systems, the flow of wastewater is maintained approximately 0.15–0.3 m below the bed surface [2]. Figure 13.5 shows a typical subsurface flow wetland system.

## 5. MECHANISMS OF TREATMENT PROCESSES FOR CONSTRUCTED WETLANDS

An understanding of the treatment mechanisms is necessary to ensure that constructed wetlands are designed effectively with improved treatment performances. Wetlands have been found to be effective in treating BOD, SS, N, and P as well as for reducing metals, organic pollutants, and pathogens. The principal pollutant removal mechanisms in constructed wetlands include biological processes such as microbial metabolic activity and plant uptake as well as physicochemical processes such as sedimentation, adsorption, and precipitation at the water-sediment, root-sediment, and plant–water interfaces [8]. Table 13.1 shows the summary of removal mechanisms in a constructed wetland.

### 5.1. Biodegradable Organic Matter Removal Mechanism

Microbial degradation plays a dominant role in the removal of soluble/colloidal biodegradable organic matter (BOD) in wastewater. Biodegradation occurs when dissolved organic matter is carried into the biofilms that attached on submerged plant stems, root systems, and surrounding soil or media by diffusion process. Wetland plants provide support medium for microbial degradation to take place and convey oxygen to the rhizosphere for aerobic degradation to occur.

**Table 13.1**  
**Summary of removal mechanisms in a constructed wetland**

Pollutant	Removal mechanism
Biochemical oxygen demand (BOD)	Oxidation Absorption Filtration Sedimentation Microbial decomposition
Suspended solids (SS)	Filtration Sedimentation
Nitrogen (N)	Adsorption Assimilation Absorption Ammonification–nitrification–denitrification
Heavy metals	Adsorption Cation exchange Bioaccumulation
Pathogenic bacteria and viruses	Adsorption Predation Sedimentation Sterilization by UV
Other pollutants	Precipitation Evaporation Evapotranspiration

Organic matter contains approximately 45–50 % carbon (C), which is utilized by a wide array of microorganisms as a source of energy. A large number of these microorganisms consume oxygen ( $O_2$ ) to break down organic C to carbon dioxide ( $CO_2$ ), a process that provides energy for growth. Therefore, the release of excessive amounts of organic C to surface waters can result in a significant depletion of  $O_2$  and subsequent mortality of fish and other  $O_2$ -dependent aquatic organisms.

Wetlands contain vast numbers of organic C-utilizing microorganisms adapted to the aerobic ( $O_2$ -rich) surface waters and anaerobic ( $O_2$ -depleted) soils at the bottom. Thus, wetlands are capable of highly effective removal of organic compounds from a variety of wastewaters. Organic C in wetlands is broken down to  $CO_2$  and methane ( $CH_4$ ), both of which are lost to the atmosphere. Wetlands also store and recycle copious amounts of organic C, contained in plants and animals, dead plant material (litter), microorganisms, and peat. Therefore, wetlands tend to be natural exporters of organic C as a result of decomposition of organic matter into fine particulate matter and dissolved compounds.

The more readily degradable organic C compounds typically found in municipal wastewater can be rapidly removed in wetlands. Biological removal of a variety of recalcitrant (not readily decomposed) organic C compounds, including lignin-based compounds and petroleum products, can also be achieved in wetlands, although removal rates may be substantially lower.

## 5.2. Suspended Solids Removal Mechanism

Settleable solids are removed easily by gravitational settlement since wetlands system generally have long hydraulic retention times. On the other hand, non-settling or colloidal solids are removed via processes such as filtration, adsorption on plants and wetlands media, and biodegradation. The types of removal mechanism at work are very dependent on the size and nature of solids present in the wastewater and type of filter media being used. In most cases, wetland plants have insignificant impact on the removal of suspended solids.

## 5.3. Nitrogen Removal Mechanism

Nitrogen (N) can exist in various forms, namely, ammoniacal nitrogen ( $NH_3$  and  $NH_4^+$ ), organic nitrogen, and oxidized nitrogen ( $NO_2^-$  and  $NO_3^-$ ). The removal of nitrogen is achieved through three main mechanisms: nitrification/denitrification, volatilization of ammonia ( $NH_3$ ), and uptake by wetland plants. A majority of nitrogen removal occurs through either plant uptake or denitrification. Nitrogen uptake is significant if plants are harvested and biomass is removed from the system. At the root–soil interface, atmospheric oxygen diffuses into the rhizosphere through the leaves, stems, rhizomes, and roots of the wetland plants, thus creating an aerobic layer similar to those that exist in the media-water or media-air interface. Nitrogen transformation takes place in the oxidized and reduced layers of media, the root media interface, and belowground portion of the emergent plants. Ammonification takes place where organic nitrogen is mineralized to  $NH_4^+$ -N in both oxidized and reduced layers. The oxidized layer and the submerged portions of plants are important sites for nitrification in which ammoniacal nitrogen (AN) is converted to nitrites N ( $NO_2^-$ ) by the *Nitrosomonas* bacteria and eventually to nitrates N ( $NO_3^-$ ) by the *Nitrobacter* bacteria. At higher pH of 10, some AN, which exist in form of  $NH_3$ , will be lost to the atmosphere by volatilization process.

Nitrate in the reduced zone is removed through denitrification, leaching, and some plant uptake. However, it is replenished by  $\text{NO}_3^-$  from the oxidized zone by diffusion. At the root–soil interface, atmospheric oxygen diffuses into rhizosphere through the leaves, stems, rhizomes, and roots of the wetland plants thus creating an aerobic layer that is similar to that existed at the media–water or media–air interface. Nitrification process occurs in the aerobic rhizosphere where AN is oxidized to  $\text{NO}_3^-$  which is either taken up by the plants or diffuses into the reduced zone where it is converted to  $\text{N}_2$  and  $\text{N}_2\text{O}$  by the denitrification process.

Nitrate removal efficiency typically is extremely high in wetlands. The biological process of denitrification, i.e., conversion of nitrate to nitrogen gas, provides a means for complete removal of inorganic N from wetlands, as opposed to storage within the vegetation or soil. Denitrification usually accounts for the bulk of the inorganic N removal in wetlands.

#### **5.4. Heavy Metals Removal Mechanism**

Wetlands soils are potentially effective traps, or sinks for metals, due to the relative immobility of most metals in wetland soils. Aquatic macrophytes remove heavy metals by absorption into living tissue. Decomposing plant litter also contributes to heavy metals removal by adsorption. Precipitation as metal hydroxides in the aerobic zones and as metal sulfides in the anaerobic zones. Cation exchange may involve binding of positively charged metal ions in solution to negatively charged sites on the surface of the particulates. A significant clay content may also enhance the potential for metal removal. Heavy metals are removed as insoluble sulfides formed during the anaerobic decomposition of dead vegetation. Complexation or chelation with organic materials and media material is also a possible pathway. Heavy metals are also reduced through direct uptake by wetland plants. However, overaccumulation may kill the plants.

Data on wetland performance for metals removal are relatively sparse. Based on a limited data set for treatment wetlands, metals removal efficiency is potentially very high, but also highly variable among sites.

#### **5.5. Pathogenic Bacteria and Viruses Removal Mechanism**

Pathogenic bacteria and viruses are removed mainly by sedimentation, filtration, and absorption by biomass and by natural die-off due to prolonged exposure to unfavorable environmental conditions such as temperature, pH, solar radiation, nutrient starvation, and predation.

#### **5.6. Other Pollutants Removal Mechanism**

Evapotranspiration is one of the mechanisms for pollutant removal. Atmospheric water losses from a wetland that occur from the water and soil are termed as evaporation and from emergent portions of plants are termed as transpiration. The combination of both processes is termed as evapotranspiration. Daily transpiration is positively related to mineral adsorption, and daily transpiration could be used as an index of the water purification capability of plants. Precipitation and evapotranspiration influence the water flow through a wetland system. Evapotranspiration slows water flow and increases contact times, whereas rainfall, which has the opposite effect, will cause dilution and increased flow. Precipitation and evaporation

are likely to have minimal effects on constructed wetlands in most areas. If the wetland type is primarily shallow open water, precipitation/evaporation ratios fairly approximate water balances. However, in large, dense stands of tall plants, transpiration losses from photosynthetically active plants become significant.

## 6. SELECTION OF WETLAND PLANT

### 6.1. Function of Wetland Plants

In general, the most significant functions of wetland plants (emergents) in relation to water purification are the physical effects brought by the presence of the plants. The plants provide a huge surface area for attachment and growth of microbes. The physical components of the plants stabilize the surface of the beds and slow down the water flow, thus assisting in sediment settling and trapping process and finally increasing water transparency. Wetland plants play a vital role in the removal and retention of nutrients and help in preventing the eutrophication of wetlands. A range of wetland plants has shown their ability to assist in the breakdown of wastewater. The common reed (*Phragmites* spp.) and cattail (*Typha* spp.) are good examples of marsh species that can effectively uptake nutrients. These plants have a large biomass both above (leaves) and below (underground stem and roots) the surface of the substrate. The subsurface plant tissues grow horizontally and vertically and create an extensive matrix, which binds the soil.

This accumulation of particles enables the creation of a large surface area for the uptake of nutrients and ions. Hollow vessels in the plant tissues enable oxygen to be transported from the leaves to the root zone and to the surrounding soil [9, 10]. This enables the active microbial aerobic decomposition process and the uptake of pollutants from the water system to take place. Some specific functions of wetland plants are summarized in Table 13.2.

### 6.2. Roles of Wetland Plants

The roles of wetland plants in constructed wetland systems can be classified into six categories as follows:

**Table 13.2**  
**Functions of wetland plants [7]**

Plant parts	Functions
Roots and/or stems in the water column	<ol style="list-style-type: none"> <li>1. Surface on which the bacteria attach and grow</li> <li>2. Media for filtration and adsorption of solids</li> </ol>
Stems and/or leaves at or above the water surface	<ol style="list-style-type: none"> <li>1. Attenuate sunlight and thus can prevent the growth of algae</li> <li>2. Reduce the effects of wind on the water, i.e., the transfer of gases between the atmosphere and water</li> <li>3. Important in the transfer of gases to and from the submerged parts of plants</li> </ol>

### 6.2.1. Physical

Macrophytes stabilize the surface of plant beds, provide good conditions for physical filtration, and provide a large surface area for attached microbial growth. Growth of macrophytes reduces current velocity, allowing for sedimentation and increase in contact time between effluent and plant surface area, thus to an increase in the removal of nitrogen.

### 6.2.2. Soil Hydraulic Conductivity

Soil hydraulic conductivity is improved in an emergent plant bed system. Turnover of root mass creates macropores in a constructed wetland soil system allowing for greater percolation of water, thus increasing effluent/plant interactions.

### 6.2.3. Organic Compound Release

Plants have been shown to release a wide variety of organic compounds through their root systems, at rates up to 25 % of the total photosynthetically fixed carbon. This carbon release may act as a source of food for denitrifying microbes [11]. Decomposing plant biomass also provides a durable, readily available carbon source for the microbial populations.

### 6.2.4. Microbial Growth

Macrophytes have above- and belowground biomass to provide a large surface area for growth of microbial biofilms. These biofilms are responsible for a majority of the microbial processes in a constructed wetland system, including nitrogen reduction [11].

### 6.2.5. Creation of Aerobic Soils

Macrophytes mediate transfer of oxygen through the hollow plant tissue and leakage from root systems to the rhizosphere where aerobic degradation of organic matter and nitrification will take place. Wetland plants have adaptations with suberized and lignified layers in the hypodermis and outer cortex to minimize the rate of oxygen leakage.

### 6.2.6. Aesthetic Values

The macrophytes have additional site-specific values by providing habitat for wildlife and making wastewater treatment systems aesthetically pleasing.

## 6.3. Types of Wetland Plants

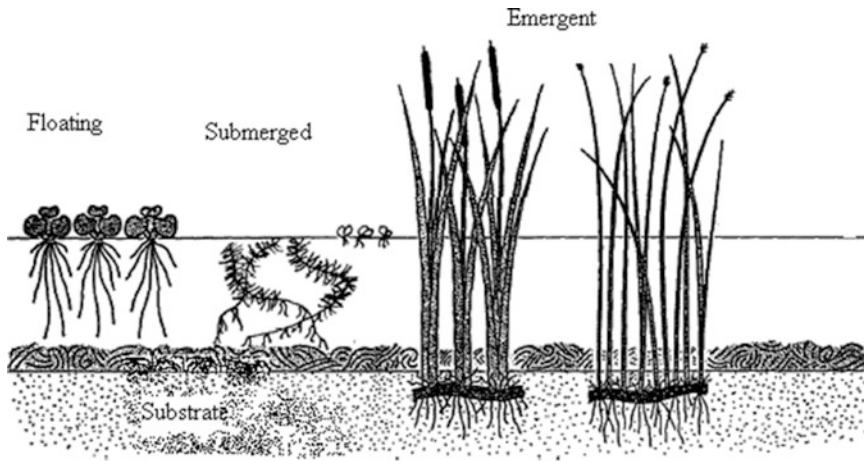
Wetland plants can be classified into three broad types. These broad types are:

**Floating**—these are plants that are free floating and not attached to any substrate.

**Submerged**—these are plants that are attached to the substrate or free floating but whose leaves and stems are permanently submerged. It includes plants whose flowers may be emergent.

**Emergent**—these are plants that are attached to the substrate and whose leaves and stems either float on the surface or protrude above the surface. It includes plants that are periodically or seasonally as well as permanently inundated.

Each of these types of plants has a different role to play in constructed wetlands and will produce different micro habitats. Use of the different types of plants leads to diversity within



**Fig. 13.6.** Types of wetland plants [6].

the wetland which results in a more biodiversity, better functioning, and a more stable wetland. Figure 13.6 illustrates the different types of wetland plants.

#### 6.4. Selection of Wetland Plants

In selecting plants for use in a constructed wetland, it is necessary to consider the factors that affect their natural distribution both within the state and locally, as these will have a major impact on the success of the plants that are used for wetland planting. Table 13.3 shows the characteristics of plants for constructed wetlands.

When selecting plants for constructed wetlands, it is necessary to consider the following factors:

- The species available or suitable for the proposed wetland site
- The substrate on which the plants will prefer to grow (e.g., sand, mud, clay, peat)
- Aerobic versus anaerobic conditions and when and where this is likely to occur within the wetland
- The depth of water where the plants normally grow, e.g., shallow or deep water
- The frequency and depth of inundation
- Periods of drying and the ability of the plants to withstand drying
- The pH of the water and its likely variance over time
- The local climate including the length and nature of the growing season

Other important factors that need to be taken into consideration may include:

- Containment, especially for free-floating species
- Potential interaction with animals and their likely destruction by animals, e.g., as nest sites
- Potential weediness of the species selected both within and also outside the wetland

Another factor to consider is the nature of the plants and their growth habits, e.g., free floating, bottom anchored, upright, spreading, or creeping. These different plant types can have an impact on the amount of shading of the wetland, and this can be important in algal control. In addition, the different sorts of plants provide different habitats for the various microflora



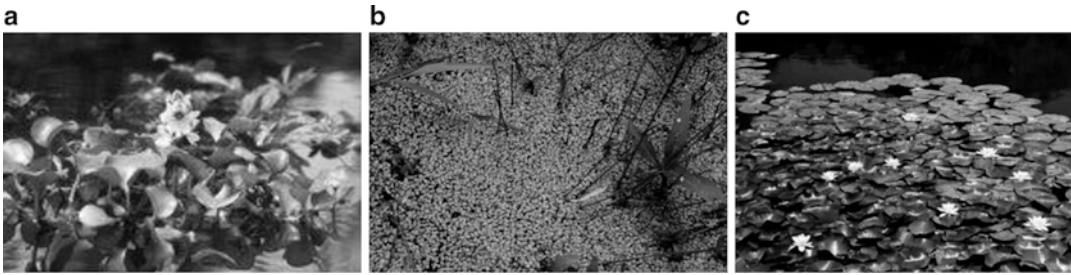
**Table 13.3**  
**Characteristics of plants for constructed wetlands [6]**

Types of plants	Characteristics and common examples	Function or importance to treatment process	Function or importance for habitat	Design and operational considerations
Free floating	Aquatic roots or rootlike structures suspended from floating leaves. Will move about with water currents. Will not stand erect out of the water. Common duckweed ( <i>Lemna</i> ), big duckweed ( <i>Spirodela</i> )	Primary purposes are nutrient uptake and shading to retard algal growth. Dense floating mats limit oxygen diffusion from atmosphere. Duckweed will be present as an invasive species	Dense floating mats limit oxygen diffusion from the atmosphere and block the sunlight from submerged plants. Plants provide shelter and food for animals	Duckweed is a natural invasive species in North America. No specific design is required
Routed floating aquatic	Usually with floating leaves, but may have submerged leaves. Routed to bottom. Will not stand erect water. Water lily ( <i>Nymphaea</i> ), pennywort ( <i>Hydrocotyle</i> )	Primary purposes are providing structure for microbial attachment and releasing oxygen to the water out of the column during daylight hours. Dense floating mats limit oxygen diffusion from the atmosphere	Dense floating mats limit oxygen diffusion from the atmosphere and block sunlight from submerged plants. Plants provide shelter and food for animals	Water depth must be designed to promote the type of plant (i.e., floating, submerged, emergent) desired while hindering other types of plants
Submerged aquatic	Usually totally submerged; may have floating leaves. Routed to bottom. Will not stand erect in air. Pondweed ( <i>Potamogeton</i> ), water weed ( <i>Elodea</i> )	Primary purposes are providing structure for microbial attachment and providing oxygen to the water column during daylight hours	Plants provide shelter and food for animals (especially fish)	Retention time in open water zone should be less than necessary to promote algal growth which can destroy these plants through sunlight blockage

(Continued)

**Table 13.3**  
**(Continued)**

Types of plants	Characteristics and common examples	Function or importance to treatment process	Function or importance for habitat	Design and operational considerations
Emergent aquatic	Herbaceous (i.e., nonwoody). Rooted to the bottom. Stand erect out of the water. Tolerate flooded or saturated conditions. Cattail ( <i>Typha</i> ), bulrush ( <i>Scirpus</i> ), common reed ( <i>Phragmites</i> )	Primary purpose is providing structure to induce enhanced flocculation and sedimentation. Secondary purposes are shading to retard algal growth, windbreak to promote quiescent conditions for settling, and insulation during winter months	Plants provide shelter and food for animals. Plants provide aesthetic beauty for humans	Water depths must be in the range that is optimum for the specific species chosen (planted)
Shrubs	Woody, less than 6 m tall. Tolerate flooded or saturated soil conditions. Dogwood ( <i>Cornus</i> ), holly ( <i>Ilex</i> )	Treatment function is not defined; it is not known if treatment data from unsaturated or occasionally saturated phytoremediation sites in upland areas is applicable to continuously saturated wetland sites	Plants provide shelter and food for animals (especially birds). Plants provide aesthetic beauty for humans	Possible perforation of liners by roots
Trees	Woody, greater than 6 m tall. Tolerate flooded or saturated soil conditions. Maple ( <i>Acer</i> ). Willow ( <i>Salix</i> )	Treatment function is not defined; it is not known if treatment data from unsaturated or occasionally saturated phytoremediation sites in upland areas is applicable to continuously saturated wetland sites	Plants provide shelter and food for animals (especially birds). Plants provide aesthetic beauty for humans	Possible perforation of liners by roots



**Fig. 13.7.** Examples of common floating plants. (a) Water hyacinth (*Eichhornia crassipes*). (b) Duckweed (*Lemna*). (c) Water lily.



**Fig. 13.8.** Examples of common emergent plants. (a) Cattail (*Typha* spp.). (b) Bulrush (*Scirpus* spp.). (c) Common reed (*Phragmites* spp.).

and microfauna that will live in the wetlands. Not all wetland species are suitable for wastewater treatment since plants for treatment wetlands must be able to tolerate the combination of continuous flooding and exposure to wastewater or stormwater containing relatively high and often variable concentrations of pollutants.

Floating and submerged plants are used in an aquatic plant treatment system. A range of aquatic plants have shown their ability to assist in the breakdown of wastewater. The water hyacinth (*Eichhornia crassipes*) and duckweed (*Lemna*) are common floating aquatic plants which have shown their ability to reduce concentrations of BOD, TSS, and total phosphorus and total nitrogen. Figure 13.7 shows some examples of common floating plants.

The common reed (*Phragmites* spp.) and cattail (*Typha* spp.) are good examples of emergent species used in constructed wetland treatment systems. Plant selection is quite similar for SF and SSF constructed wetlands. Emergent wetland plants grow best in both systems. These emergent plants play a vital role in the removal and retention of nutrients in a constructed wetland. Although emergent macrophytes are less efficient at lowering nitrogen and phosphorus contents by direct uptake due to their lower growth rates (compared to floating and submerged plants), their ability to uptake nitrogen and phosphorus from sediment sources through rhizomes is higher than from the water. Figure 13.8 shows some examples of common emergent plants.

Only selected species of wetland plants are chosen by wetland designers; the species must have a rapid and relatively constant growth rate. In a tropical system, wetland plants have a higher growth rate. These wetland plants are easily propagated by means of runners and by bits of mats breaking off and drifting to new areas. This will help in increasing the capacity of pollutant absorption by the plants. The plants should also be able to tolerate waterlogged-anoxic and hyper-eutrophic conditions. The plant species should be local species and widely available in the country. Use of exotic plants in constructed wetland systems should be avoided as they are highly invasive and difficult to control. The plant should be a perennial with a life cycle of more than 1 year or two growing seasons to ensure the sustainability of the constructed wetland system. Wetland plants with aesthetic appeal will provide a landscape-pleasing environment.

To assist in plant selection, a number of species that have been used successfully in the northeastern United States are listed in Table 13.4.

**Table 13.4**  
**Emergent plants for constructed wetlands [12]**

Recommended species	Maximum water depth <sup>a</sup>	Notes
Arrow arum <i>Peltandra virginica</i>	12 in.	Full sun to partial shade. High wildlife value. Foliage and rootstocks are not eaten by geese or muskrats. Slow grower. pH: 5.0–6.5
Arrowhead/duck potato <i>Sagittaria latifolia</i>	12 in.	Aggressive colonizer. Mallards and muskrats can rapidly consume tubers. Loses much water through transpiration
Common three-square bulrush <i>Scirpus pungens</i>	6 in.	Fast colonizer. Can tolerate periods of dryness. High metal removal. High waterfowl and songbird value
Soft-stem bulrush <i>Scirpus validus</i>	12 in.	Aggressive colonizer. Full sun. High pollutant removal. Provides food and cover for many species of birds. pH: 6.5–8.5
Blue flag iris <i>Iris versicolor</i>	3–6 in.	Attractive flowers. Can tolerate partial shade but requires full sun to flower. Prefers acidic soil. Tolerant of high nutrient levels
Broad-leaved cattail <sup>b</sup> <i>Typha latifolia</i>	12–18 in.	Aggressive. Tubers eaten by muskrat and beaver. High pollutant treatment, pH: 3.0–8.5
Narrow-leaved cattail <sup>b</sup> <i>Typha angustifolia</i>	12 in.	Aggressive. Tubers eaten by muskrat and beaver. Tolerates brackish water. pH : 3.7–8.5
Reed canary grass <i>Phalaris arundinacea</i>	6 in.	Grows on exposed areas and in shallow water. Good ground cover for berms
Lizard's tail <i>Saururus cernuus</i>	6 in.	Rapid grower. Shade tolerant. Low wildlife value except for wood ducks
Pickerelweed <i>Pontederia cordata</i>	12 in.	Full sun to partial shade. Moderate wildlife value. Nectar for butterflies. pH: 6.0–8.0

(Continued)

**Table 13.4**  
**(Continued)**

Recommended species	Maximum water depth <sup>a</sup>	Notes
Common reed <sup>b</sup> <i>Phragmites australis</i>	3 in.	Highly invasive; considered a pest species in many states. Poor wildlife value. pH: 3.7–8.0
Soft rush <i>Juncus effusus</i>	3 in.	Tolerates wet or dry conditions. Food for birds. Often grows in tussocks or hummocks
Spike rush <i>Eleocharis palustris</i>	3 in.	Tolerates partial shade
Sedges <i>Carex</i> spp.	3 in.	Many wetland and several upland species. High wildlife value for waterfowl and songbirds
Spatterdock <i>Nuphar luteum</i>	5 ft 2 ft minimum	Tolerant of fluctuating water levels. Moderate food value for wildlife, high cover value. Tolerates acidic water (to pH 5.0)
Sweet flag <i>Acorus calamus</i>	3 in.	Produces distinctive flowers. Not a rapid colonizer. Tolerates acidic conditions. Tolerant of dry periods and partial shade. Low wildlife value
Wild rice <i>Zizania aquatica</i>	12 in.	Requires full sun. High wildlife value (seeds, plant parts, and rootstocks are food for birds) Eaten by muskrats. Annual, nonpersistent. Does not reproduce vegetatively

<sup>a</sup>These depths can be tolerated, but plant growth and survival may decline under permanent inundation at these depths.

<sup>b</sup>Not recommended for stormwater wetlands because they are highly invasive, but can be used in treatment wetlands if approved by regulatory agencies.

## 7. DESIGN OF CONSTRUCTED WETLAND SYSTEMS

### 7.1. Design Principles

Characteristics of wastewater to be treated, as well as desired and/or required discharge limits, need to be taken into consideration in designing a constructed wetland treatment system. Main characteristics of the wastewater include both soluble and solid organic compounds, i.e., biochemical oxygen demand (BOD), suspended solids (SS), nitrogen compounds, phosphorus compounds, heavy metals, pathogenic bacteria, and/or viruses. Constructed wetlands could be designed to remove these characteristics. Design considerations in constructed wetland system may include hydraulic capacity, loading rate, retention time, plant type, and species. These in turn, are constrained by regulations and effluent discharge limits. Constructed wetlands are dynamic systems influenced by a wide suite of factors ranging from the regional climatic conditions and geological characteristics to the local vegetation to land-use patterns.

## 7.2. Hydraulics

The hydraulic capacity of a wetland can be defined as the ability of the wetland to process a given volume of wastewater in a given time. This period of time is known as hydraulic retention time (HRT), which is the expected average time in which a molecule of water will flow from one end to the other of the wetland. Requirements vary depending on the pollutant and the desired level of treatment. Typical detention times are 2–5 days for BOD removal and 7–14 days for nitrogen removal [13].

The hydraulic retention time in the wetland can be calculated using equation (13.1) below:

$$t = \frac{V}{Q} = \frac{LW(d_m n + d_w)}{Q} = A \frac{(d_m n + d_w)}{Q} \quad (13.1)$$

where

$t$  = hydraulic retention time, days

$L$  = length of the wetland cell, m (ft)

$W$  = width of the wetland cell, m (ft)

$d_m$  = depth of media, m (ft)

$d_w$  = depth of water from media surface, m (ft)

$n$  = porosity or the space available for water to flow through the wetland; porosity is percent expressed in decimal. Typically in a mature wetlands are in the range of 0.65–0.75.

$Q$  = the average flow through the wetland, m<sup>3</sup>/day (ft<sup>3</sup>/day)

$V$  = volume of water in the system, m<sup>3</sup> (ft<sup>3</sup>)

$A_s$  = surface area of wetland, m<sup>2</sup> (ft<sup>2</sup>)

The hydraulic loading rate (HLR) is a term that provides a measure of the volumetric application of wastewater into the wetland. It is often used to make comparisons between wetland systems and indicates their potential to be overloaded by wastewater.

Hydraulic loading rate is calculated using the following expression:

$$\text{HLR} = \frac{Q}{A_s} \quad (13.2)$$

where

HLR = hydraulic loading rate, m/day (ft/day)

$Q$  = the average flow through the wetland, m<sup>3</sup>/day (ft<sup>3</sup>/day)

$A_s$  = surface area of wetland, m<sup>2</sup> (ft<sup>2</sup>)

## 7.3. General Design Procedures [14]

A constructed wetland system can be considered to be attached growth biological reactors system, and their performance can also be estimated using first-order plug-flow kinetics for BOD and nitrogen removal.

**Table 13.5**  
**Apparent rate constant values for SF and SSF wetland systems [14]**

Wetland type	Pollutant removal	Temperature (°C)	Apparent rate constant (day <sup>-1</sup> )	Temperature coefficient ( $\theta$ )
SF	BOD	20	0.678	1.06
	NH <sub>4</sub>	20	0.2187	1.048
	NO <sub>3</sub>	20	1.000	1.1
SSF	BOD	20	1.104	1.06
	NH <sub>4</sub>	20	$K_{\text{NH}}$	1.048
	NO <sub>3</sub>	20	1.000	1.15

Note:  $K_{\text{NH}} = 0.01854 + 0.3922 (\text{rz})^{2.6077}$ .

The relationship for plug-flow models is given below by equation (13.3):

$$\frac{C_e}{C_o} = \exp(-k_T t) \quad (13.3)$$

where

$C_e$  = effluent pollutant concentration, mg/L

$C_o$  = influent pollutant concentration, mg/L

$k_T$  = temperature-dependent first-order reaction rate constant, day<sup>-1</sup>

$t$  = hydraulic retention time, day

The rate constant  $k_T$  at temperature  $T$  (°C) can be determined using the following equations (13.4):

$$k_T = k_{20}(\theta)^{T-20} \quad (13.4)$$

where

$k_{20}$  = rate constant at 20 °C, day<sup>-1</sup>

$\theta$  = temperature coefficient

Table 13.5 gives apparent rate constant values for SF and SSF wetland systems.

### 7.3.1. Surface Flow (SF) Wetland

Hence, it is possible to determine the surface area of the wetland by combining equations (13.1) and (13.3). Therefore, general design equation is as follows:

$$\frac{C_e}{C_o} = \exp[-K_T A_s (d_m n + d_w / Q)] \quad (13.5)$$

$$A_s = LW = Q(\ln C_o - \ln C_e)/K_T(d_m n + d_w) \quad (13.6)$$

Nitrogen removal is a temperature-dependent process and is highly sensitive to cold temperature. In winter time, once the temperature falls below 5 °C, nitrogen removal will be difficult. It is much easier for wetlands to remove nitrates than ammonia; hence, if nitrogen removal is a goal, then the treatment process should provide for nitrification, with subsequent discharge into wetlands for denitrification.

For nitrification process, the following assumptions are being made:

All the organic nitrogen entering the system will be converted to ammonia nitrogen (AN). AN removal is due entirely to nitrification.

Nitrification process is described by a plug-flow first-order model the same as equation (13.3) or equation (13.5) with  $C_e$  = effluent ammonia ( $\text{NH}_4$ ) concentration and  $C_o$  = influent TKN concentration as follows:

$$\ln(\text{TKN}/\text{NH}_{4\text{eff}}) = A_s k_T \times (d_m n + d_w)/Q \quad (13.7)$$

where

TKN = influent Kjeldahl nitrogen, mg/L

$\text{NH}_{4\text{eff}}$  = effluent ammonia, mg/L

The following are temperature-dependent functions to compute the rate constant for nitrogen removal:

$$\begin{aligned} k_T &= 0 \text{ day}^{-1} && \text{where } T = 0 \text{ }^\circ\text{C} \\ k_T &= 0.1367(1.15)^{(T-10)} \text{ day}^{-1} && \text{where } T = (1-10) \text{ }^\circ\text{C} \\ k_T &= 0.2187(1.048)^{(T-20)} \text{ day}^{-1} && \text{where } T > 10 \text{ }^\circ\text{C} \end{aligned}$$

Nitrate removal via denitrification process can be estimated using equation (13.6) with  $C_e$  = effluent nitrate ( $\text{NO}_3$ ) concentration and  $C_o$  = influent nitrate ( $\text{NO}_3$ ) concentration as follows:

$$\ln(\text{NO}_{3\text{inf}}/\text{NO}_{3\text{eff}}) = A_s k_T \times (d_m n + d_w)/Q \quad (13.8)$$

where

$\text{NO}_{3\text{inf}}$  = influent nitrate, mg/L

$\text{NO}_{3\text{eff}}$  = effluent nitrate, mg/L

However, the temperature-dependent rate constant,  $k_T$ , was suggested to be as follows:

$$\begin{aligned} k_T &= 0 \text{ day}^{-1} && \text{where } T = 0 \text{ }^\circ\text{C} \\ k_T &= 1.0(1.15)^{(T-20)} \text{ day}^{-1} && \text{where } T \geq 1 \text{ }^\circ\text{C} \end{aligned}$$

Suspended solids (SS) essentially involves filtration and retention times. SS removal is affected by velocity, thus



Equation (13.9) below can be used for SS removal calculation in SF wetland system. Water depth should not exceed 0.45 m (18 in.).

$$SS_e = SS_o \times [(0.1139 + 0.00213) \times \text{HLR}] \quad (13.9)$$

where

HLR = hydraulic loading rate, m/day

$SS_e$  = effluent SS, mg/L

$SS_o$  = influent SS, mg/L

### 7.3.2. Subsurface Flow (SSF) Wetland

The basic mechanisms for BOD removal in SSF wetlands are similar to SF/FWS wetlands as described above. However, for SSF wetlands, the  $d_w = 0$ . Therefore, equations (13.4) and (13.5) will be as follows:

$$\frac{C_e}{C_o} = \exp[-K_T A_s (d_m n) / Q] \quad (13.10)$$

$$A_s = LW = Q(\ln C_o - \ln C_e) / k_T (d_m n) \quad (13.11)$$

Nitrogen removal formulas are the same as for surface flow (SF) system, except that the reaction rate constants are different. For the nitrification process, this type of system is very dependent on the emergent plants to supply oxygen to the root zone for nitrification process to occur. Therefore, the nitrification rate constant should be a function of the root zone as follows:

$$k_{20} = 0.01854 + 0.3922(\text{rz})^{2.6077} \text{ day}^{-1} \quad (13.12)$$

where

$k_{20}$  = nitrification rate constant at 20 °C,  $\text{day}^{-1}$

rz = the percent of wetland bed depth occupied by root zone (decimal 0–1)

The temperature dependence of  $k_T$  is given by the following equation (13.13):

$$k_T = k_{20}(1.048)^{(T-20)} \text{ day}^{-1} \text{ for } T \geq 10^\circ\text{C} \quad (13.13)$$

Therefore, the design model or nitrification will be as follows:

$$\ln(\text{TKN}/\text{NH}_{4\text{eff}}) = A_s \left( 0.01854 + 0.3922(\text{rz})^{2.6077} \right) (1.048)^{(T-20)} \times (d_m n) / Q \quad (13.14)$$

where

TKN = influent total Kjeldahl nitrogen, mg/L

$\text{NH}_{4\text{eff}}$  = effluent ammonia, mg/L

For denitrification process, the design model is described by (13.10), with  $C_e$  and  $C_o$  defined as effluent nitrate ( $\text{NO}_3$ ) and influent nitrate ( $\text{NO}_3$ ) concentrations, respectively. The temperature-dependent  $k_T$  is the same as that for SF wetland.

$$\ln(\text{NO}_{3\text{inf}}/\text{NO}_{3\text{eff}}) = A_s k_T \times (d_m n)/Q \quad (13.15)$$

where

$\text{NO}_{3\text{inf}}$  = influent nitrate, mg/L

$\text{NO}_{3\text{eff}}$  = effluent nitrate, mg/L

Suspended solids (SS) essentially involves filtration and retention times. SS removal is affected by velocity; thus,

Equation (13.16) can be used for SS removal calculation in SSF wetland system [14]:

$$\text{SS}_e = \text{SS}_o \times [(0.1058 + 0.0011) \times \text{HLR}] \quad (13.16)$$

where

HLR = hydraulic loading rate, m/day

$\text{SS}_e$  = effluent SS, mg/L

$\text{SS}_o$  = influent SS, mg/L

### Example 1

Determine the area of a SSF constructed wetland for a residential area of 100 houses, each with a septic tank. Assume that all the wastewaters are collected using the existing septic tanks as pretreatment tanks. Average number per dwelling is 3.2 and average per capita flow is 50 gallons per day. Given the following data:

Influent BOD = 140 mg/L

Effluent BOD = 10 mg/L

Depth = 0.6 m (2 ft)

Porosity = 0.44

Assume the water temperature is the same as the ground temperature, i.e., 10 °C.

### Solution for Example 1

(a) Calculate the flow:  $100 \text{ houses} \times 3.2 \text{ people} \times 50 \text{ gpdpc} = 16,000 \text{ gpd} = 60.5 \text{ m}^3 \text{ day}^{-1}$

(b) Calculate rate constant:  $K_T = 1.104 \times 1.06^{(10 - 20)} = 0.62 \text{ day}^{-1}$

(c) Calculate the area:  $A_s = \frac{60.5 \times (\ln 140 - \ln 10)}{0.62 \times 0.6 \times 0.4} = \frac{160}{0.145} = 1,103 \text{ m}^2$

**Example 2**

Determine the area required for a FWS wetland system with the following data:

Influent BOD = 250 mg/L

Effluent BOD (desired) = 10 mg/L

Wastewater flow = 500 m<sup>3</sup>/day

Mean temperature (winter) = 10 °C

Mean temperature (summer) = 25 °C

Assume  $n = 0.75$  and bed depth of 0.6 m and water depth of 0.1 m throughout year round.

**Solution for Example 2**

(a) Calculate the value of  $k_T$  at 10 °C :  $K_T = 0.678 \times 1.06^{(10 - 20)} = 0.379 \text{ day}^{-1}$   
 $k_T$  at 25 °C:  $K_T = 0.678 \times 1.06^{(25 - 20)} = 0.907 \text{ day}^{-1}$

(b) Calculate hydraulic retention time (HRT) from equation (13.2):  $t = \frac{\ln C_o - \ln C_e}{K_T}$

$$\text{Winter: } t = \frac{\ln 250 - \ln 10}{0.379} = 3.5 \text{ day}^{-1}$$

$$\text{Summer: } t = \frac{\ln 250 - \ln 10}{0.907} = 8.5 \text{ day}^{-1}$$

(c) Calculate the area

$$\text{Winter: } A_s = \frac{500 \times 3.5}{(0.6 \times 0.75) + 0.1} = \frac{1,750}{0.55} = 3,182 \text{ m}^2 = 0.32 \text{ ha}$$

$$\text{Summer: } A_s = \frac{500 \times 8.5}{(0.6 \times 0.75) + 0.1} = \frac{4,250}{0.55} = 7,728 \text{ m}^2 = 0.77 \text{ ha}$$

**Example 3**

Compare the sizes of the SF/FWS and SSF wetlands for the same nitrogen removal design conditions:

Influent TKN = 25 mg/L

Effluent AN (desired) = 3 mg/L

Effluent TN (desired) = 3 mg/L

Mean water temperature = 25 °C

**Solution for Example 3**

*For SF/FWS Wetland*

(a) Determine the value of the rate constant for AN removal,  $k_{25}$  from:

$$k_T = 0.2187(1.048)^{(T-20)}$$

thus,  $k_{25} = 0.2187(1.048)^{(25 - 20)} = 0.2187(1.048)^5 = 0.2765 \text{ day}^{-1}$

(b) Determine the HRT,  $t$ , which is given by

$$t = \ln(25/3) / 0.2765 = 7.7 \text{ days}$$

Thus, the area of SF/FWS required for AN removal will be as follows:

$$A_s = Q / (d_m m + d_w) = 500 \times 7.7 / ((0.6 \times 0.75) + 0.1) = 7,000 \text{ m}^2$$

(c) Determine the rate constant for nitrate, N, removal as follows:

$$k_T = 1.000(1.15)^{(25-20)} = 1.000(1.15)^{(5)} = 2.011 \text{ day}^{-1}$$

(d) Determine the effluent nitrate N and TN

Wetland nitrate, N = 25 - 3 = 22 mg/L

Effluent nitrate, N = 22 exp[-(2.011)(7.7)] ≈ 0 mg/L

Effluent TN = 3 mg/L

For SSF Wetland

(a) Determine rate constant for AN removal assuming 50 % root zone:

$$k_{25} = \left[ 0.01854 + 0.3922(0.5)^{2.6077} \right] (1.048)^{(25-20)} = 0.3157 \text{ day}^{-1}$$

(b) Determine the HRT,  $t$ ,

$$t = \ln(25/3) / 0.3157 = 6.7 \text{ days}$$

Then determine the required area for SSF wetland for AN removal:

$$A_s = Q / d_m n = 500 \times 6.7 / 0.76 \times 0.35 = 12,594 \text{ m}^2$$

(c) Determine the effluent nitrate N and TN:

Effluent nitrate, N = 22 exp[-(2.011)(6.7)] ≈ 0 mg/L

Effluent TN = 3 mg/L

Notice that both area requirements for SF/FWS and SSF wetlands for N removal would be about 2–3 times larger than that required for BOD removal from 250 to 10 mg/L.

## 8. WETLAND MONITORING AND MAINTENANCE

Monitoring the water quality and maintenance of the wetland areas are essential components of a wetland operation. Wetland monitoring is required to obtain sufficient data to assess the wetland performance in fulfilling the objectives. Wetland maintenance is required to manage macrophytes and desirable species to remove invading weeds, to remove sediment from the wetlands, and to remove litter from the wetlands [15].

Effective wetland performance depends on adequate pretreatment, conservative constituent and hydraulic loading rates, collection of monitoring information to assess system performance, and knowledge of successful operation strategies. Sustaining a dense stand of desirable vegetation within the wetland is crucial to ensure treatment efficiency. Aggressive species will out-compete less competitive ones and cause gradual changes in wetland vegetation. Certain undesirable plant species or weeds may be introduced to the wetland from the catchment. Natural succession of wetland plants will take place. However, some aquatic weeds may require maintenance by periodic removal. Weed invasion can dramatically reduce the ability of wetlands to meet its design objectives. For example, pondweed (*Azolla*), duckweed (*Lemna*), water fern (*Salvinia molesta*), and water hyacinth (*Eichhornia crassipes*)

can form dense mats, exclude light, and reduce dissolved oxygen in the water. Manual removal of noxious and undesirable weeds column is necessary and eventually leads to an increase in the movement of nutrients through the system.

Water level management is crucial to control weed growth. Floods will cause plants to be scoured from the wetland and/or drowned. If a large area of plants is lost, reestablishment will need to be carried out. Small areas will generally recover naturally while larger areas above 5 m<sup>2</sup> may require replanting. Plant viability is vital to water quality improvement in wetlands. Visible signs of plant distress or pest attack should be investigated promptly. Severe infestation could lead to severe stunting and death of plants. Biopesticides or narrow spectrum pest-specific insecticides could be used if pest population exceeds a certain threshold value.

Water levels are important in wetlands which may have significant effects on hydrology and hydraulics and impact on wetland biota. Water level should be monitored using water level control structures to ensure successful plant growth. A recirculation system should be in place to allow water from outlet points to be fed back to the wetlands to supplement catchment flows during dry periods. Suspended solids from effluents and litter fall from plants will accumulate in time and gradually reduce the pore space which has to be flushed to prevent short-circuiting. In terms of health consideration, monitoring of mosquito populations should be undertaken to avoid diseases, which can result in a local health-related problem. Selected fish population can be introduced into wetland as a mean to kill mosquito larvae.

### **8.1. Water Quality Monitoring**

When constructed wetlands are used to treat wastewater, the main objective of measuring performance is to assess if the regulatory discharge limits are being met. Therefore, water quality data are a good indication of wetland performance. Water quality should be monitored through assessment of inflow and outflow water quality parameters.

Some important water quality parameters which could be monitored may include dissolved oxygen, redox potential, water temperature, pH value, and turbidity, which are the in situ parameters, while laboratory analysis parameters include total suspended solids (TSS), chemical conductivity, ammoniacal nitrogen (AN), nitrate-nitrogen, phosphorus, potassium, magnesium, soluble Fe, mercury, lead, zinc, iron, cyanide, arsenic, phenols, chemical oxygen demand (COD), biochemical oxygen demand (BOD), fecal coliforms, and oil and grease.

## **9. CASE STUDY**

### **9.1. Putrajaya Wetlands, Malaysia**

Constructed wetland is a new area of research in Malaysia. The use of constructed wetlands started in Malaysia in 1999 with the introduction of 200 ha of Putrajaya Wetlands which is one of the largest constructed freshwater wetlands in the tropics. Putrajaya Wetlands is a pioneer venture in constructed wetland system. It functions as a flood control system and a natural treatment system that filters most of the pollutants in river water and inflows to the

**Table 13.6**  
**Features of Putrajaya Wetlands [16, 17]**

Total area (ha)	Planted area (ha)	Open area (ha)	Weirs and islands (ha)	Zone of intermittent inundation (ha)	Maintenance tracks (ha)
197.20	77.70	76.80	9.60	23.70	9.40

wetlands before finally discharging to the lake. Apart from providing an expansive area for recreation and education, it forms an essential part of the ecosystem.

Table 13.6 shows the components that form the Putrajaya Wetlands [16].

The salient features of Putrajaya Wetland are as follows [17]:

Putrajaya Wetlands are the first man-made wetlands in Malaysia.

It is also one of the largest fully constructed freshwater wetlands in the tropics.

It is one of the largest man-made lakes in an urban setting.

At a level of 21 m, the resulting surface area is some 400 ha.

Average depth is 6.6 m.

Deepest depth of some parts is in the range of 12–13 m.

The Wetlands were constructed in March 1997 and was completed in August 1998. The water levels in the cells varies from level 32 m to level 23.5 m with water from each cell cascading down over each cell weir. The 400 ha lake was created by construction of a dam on the lower reaches of the Chuau River. Construction was undertaken in two phases. The first phase of approximately 110 ha involved the construction of a temporary dam across Chuau River. This allowed inundation of the upper half of the lake.

The dam was completed in May 1998 and the impoundment of the first phase of the lake commenced in September 1998 and was fully inundated in January 1999. The second phase of the lake begun thereafter, with the construction of the permanent dam in 2000. Two years later after the dam was completed, the lake was completely inundated by March 2003 reaching to level 21 m.

It is the intention of Perbadanan Putrajaya (local authority) that the lake will be utilized for various purposes, not only as an aesthetic one. The many uses envisaged included both primary and secondary contact recreation. To that end, guidelines were developed to manage the lake by Perbadanan Putrajaya and to regulate and manage lake activities.

The Putrajaya Wetlands are the first man-made wetlands in Malaysia. The lake is recognized as the most important feature of the city—providing the focal point for the development. At a water level of 21 m, the resulting surface area of the lake measures some 400 ha. The average depth of the wetland is 6.6 m and storage volume stands at 265 million cubic meters. It is one of the largest man-made lakes in an urban setting. It is expected to provide focus for many watersport activities as well being used for relaxation. Figure 13.9 shows the overall layout of Putrajaya Wetland system.



**Table 13.7**  
**Average performance of wetland in Acle, Norfolk in 1988 [4]**

Parameter	Influent (mg/l)	Effluent (mg/l)	Removal efficiency (%)
BOD	38	4.8	87
AN	6.1	5.3	13
SS	76	28	63

### 9.2. Acle, Norfolk, United Kingdom [4]

A constructed wetland-typed subsurface flow was built in Acle, Norfolk, England, United Kingdom (UK) in 1985, which is owned by Anglian Water, to treat tertiary treatment of domestic sewage. It has the area of 3,500 m<sup>2</sup> with layout consisting of two beds of 50 m (length) × 35 m (width). The wetland was designed for population equivalent (p.e.) of 1,300 (1 p. e. ≡ 150 L day<sup>-1</sup> ≡ 0.15 m<sup>3</sup> day<sup>-1</sup>).

The support medium used was 0.60 m soil from sugar beet washing, and the vegetation was *Phragmites australis*. The floor slope was in the ratio of 1:50. The wastewater flow through a slotted pipe buried in gravel and the treated effluent was discharged using a height-adjustable bellmouth.

The wetland has an average flow of 240 m<sup>3</sup> day<sup>-1</sup>, average hydraulic load of 0.07 m<sup>3</sup> m<sup>-2</sup> day<sup>-1</sup>, and plan surface area of 2.92 m<sup>2</sup> pe<sup>-1</sup>. The performance of the wetland can be seen in Table 13.7.

### 9.3. Arcata, California [6]

Arcata is located on the northern coast of California about 240 miles north of San Francisco. The population of Arcata is about 15,000. The major local industries are logging, wood products, fishing, and Humboldt State University. The surface flow (SF) constructed wetland located in Arcata is one of the most famous in the United States.

The community was originally served, starting in 1949, with a primary treatment plant that discharged undisinfected effluent to Arcata Bay. In 1957, oxidation ponds were constructed, and chlorine disinfection was added in 1966. In 1974, the State of California prohibited discharge to bays and estuaries unless “enhancement” could be proven, and the construction of a regional treatment plant was recommended. In response, the city of Arcata formed a Task Force of interested participants, and this group began research on lower-cost alternative treatment processes using natural systems. From 1979 to 1982, research conducted at pilot-scale wetland units confirmed their capability to meet the proposed discharge limits. In 1983, the city was authorized by the state to proceed with development, design, and construction of a full-scale wetland system.

Construction was completed in 1986, and the system has been in continuous service since that time. The wetland system proposed by the city was unique in that it included densely vegetated cells dedicated for treatment followed by “enhancement” marsh cells with a large percentage of open water for final polishing and habitat and recreational benefits.



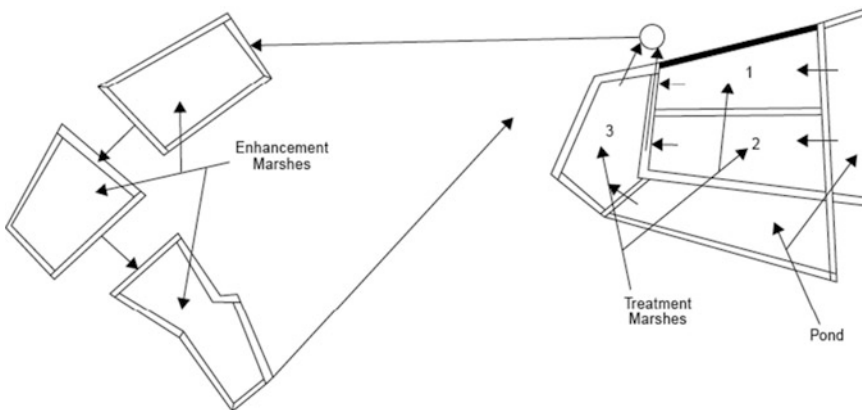
This combined system has been successful since start-up and has become the model for many wetland systems elsewhere.

Two NPDES permits are required for system operation: one for discharge to the enhancement wetlands for protection of public access and one for discharge to the bay. The NPDES limits for both discharges are BOD 30 mg/l and TSS 30 mg/l, pH 6.5–9.5, and fecal coliforms of 200 CFU/100 ml. Since public access is allowed to the enhancement marshes, the state required disinfection prior to transfer of the pond/treatment marsh effluent. The state then required final disinfection/dechlorination prior to final discharge to Arcata Bay. The effluent from the final enhancement marsh is pumped back to the treatment plant for this final disinfection step.

The basic system design for the treatment and enhancement marshes was prepared by researchers at Humboldt State University. The design was based on experience with a pilot wetland system that was studied from 1979 through 1982. The pilot wetland system included 12 parallel wetland cells, each 20 ft wide and 200 ft long (L:W 10:1), with a maximum possible depth of 4 ft. These were operated at variable hydraulic loadings, variable water depths, and variable initial plant types during the initial phase of the study. Hardstem bulrush (*Scirpus validus*) was used as the sole type of vegetation on all cells. The inlet structure for each cell was a 60° V-notch weir, and the outlet used an adjustable 90° V-notch weir, permitting control of the water depth. Heavy clay soils were used for construction of these cells, so a liner was not necessary and seepage was minimal. The second phase of the pilot study focused on the influence of open water zones, plant harvesting, and kinetics optimization for BOD, TSS, and nutrient removal. Some of the cells, for example, were subdivided into smaller compartments with baffles and weirs along the flow path. The results from these pilot studies not only provided the basis for full-scale system design but have contributed significantly to the state of the art for design of all wetland systems.

The full-scale treatment wetlands, with a design flow of 2.9 mgd, utilize three cells operated in parallel. Cells 1 and 2 have surface areas of about 2.75 acres each ( $L \approx 600$  ft,  $W \approx 200$  ft), and cell 3 is about 2.0 acres ( $L \approx 510$  ft,  $W \approx 170$  ft). The original design water depth was 2 ft, but at the time of the 1997 site visit for this report, they were being operated with a 4-ft depth. Hardstem bulrush was again used as the only plant species on these treatment marshes. Clumps of plant shoots and rhizomes were hand planted on about 1 m centers. Since nutrient removal is not a requirement for the full-scale system, the treatment marshes could be designed for a relatively short detention time primarily for removal of BOD and TSS. The HRT in these three cells is 1.9 days at design flow and a 2-ft water depth. These treatment marshes were designed to produce an effluent meeting the NPDES limits for BOD and TSS (30/30 mg/L) on an average basis. These wetland cells utilized the bottom area of former lagoon cells. A schematic diagram of the operating system is shown in Fig. 13.10.

The final “enhancement” marshes were intended to provide for further effluent polishing and to provide significant habitat and recreational benefits for the community. These three cells are operated in series at an average depth of 2.0 ft and have a total area of about 31 acres. Retention time is about 9 days at average flow rates. The first cell (Allen Marsh), completed in 1981, was constructed on former log storage area and contains about 50 % open water.



**Fig. 13.10.** Schematic diagram of wetland system at Arcata, CA [12].

The second cell (Gearheart Marsh), completed in 1981, was constructed on former pasture land and contains about 80 % open water. The third cell (Hauser Marsh) was constructed in a former borrow pit and contains about 60 % open water. These 31 acres of constructed freshwater (effluent) marshes have been supplemented with an additional 70 acres of saltwater marshes, freshwater wetlands, brackish ponds, and estuaries to form the Arcata Marsh and Wildlife Sanctuary, all of which has been developed with trails, an interpretive center, and other recreational features. The shallow water zones in these marshes contain a variety of emergent vegetation. The deeper zones contain submerged plants (sago pondweed) that provide food sources for ducks and other birds and release oxygen to the water to further enhance treatment.

The construction costs for the entire system, including modifications to the primary treatment plant, disinfection/ dechlorination, pumping stations, and so forth were USD 5,300,000 (1985). Construction costs for the treatment wetlands are only estimated to be about USD 225,000, or USD 30,000 per acre, or USD 78 per 1,000 gpd of design capacity (including removal of sludge from this site, which was previously a sedimentation pond for an aerated lagoon). This does not include pumping costs to transfer final effluent back to the chlorination contact basin, disinfection facilities, or the pumping and piping costs to reach the enhancement marshes. Land costs also are not included since the treatment wetlands were located on city-owned property.

Performance data were collected for a 2-year period during the Phase 1 pilot testing program. This program varied the flow rate and water depth in each of the two cells to compare BOD removal performance at different detention times and loading rates that would represent the potential range for full-scale application at Arcata. These data are summarized in Table 8.1. The BOD and TSS in the pond effluent varied considerably during this period, and not all of the cells were uniformly vegetated. Seasonal variations in performance were observed, but Table 13.8 presents only the average effluent characteristics for each of the cells over the entire study period. It is apparent from the data that the wetlands were able to produce excellent effluent quality over the full range of loadings and detention times used.

**Table 13.8**  
**Summary of results, phase 1 pilot testing, Arcata, CA [12]**

Item	HRT (days)	HLR (gal/ft <sup>2</sup> day)	BOD (mg/l)	TSS (mg/l)	Fecal coliform (CFU/100 ml)
Influent		26	37	3,183	
Effluent					
Cell 1	2.1/10.7	5.89/1.22	11	6.8	317
Cell 2	1.5/17	5.89/0.5	14.1	4.3	272
Cell 3	2.7/29	4.66/0.5	13.3	4.7	419
Cell 4	1.5/15	5.39/0.5	12.7	5.6	549
Cell 5	3.7	2.94	14.0	4.3	493
Cell 6	5.2	2.4	10.7	4.0	345
Cell 7	5.2	4.4	13.3	7.3	785
Cell 8	5.2	2.4	15.3	7.2	713
Cell 9	6.6	1.71	11.9	9.4	318
Cell 10	3.8	1.71	12.6	4.9	367
Cell 11	7.6	1.47	9.4	5.7	288
Cell 12	5.5	1.47	9.0	4.3	421

**Table 13.9**  
**Long-term average performance, Arcata [12]**

Location	BOD (mg/l)	TSS (mg/l)	TN (mg/l)
Raw influent	174	214	40
Primary effluent	102	70	40
Pond effluent	53	58	40
Wetlands	28	21	30
Enhancement marshes	3.3	3	3

The long-term average performance of the Arcata system is summarized in Table 13.9. It is clear that both the treatment and enhancement marshes provide significant treatment for BOD and TSS. The long-term removals follow the pilot project results. Most of the nitrogen is removed during the final stage in the enhancement marshes. This is because of the long hydraulic detention time (HRT = 9 days), the availability of oxygen and nitrifying organisms in the open water zones, and anoxic conditions for denitrification in the areas with emergent vegetation.

The treatment wetlands (7.5 acres), with nominal HRTs of 3 days, met weekly limits of 30 mg/l BOD and TSS 90 % of the time. The enhancement wetlands (28 acres), with a nominal HRT of 11 days, met weekly limits of less than 5 mg/l BOD/TSS 90 % of the time. Performance of both wetlands results primarily from proper operation and appropriate design that involves a combination of emergent vegetation and open water zones. TSS levels are higher in cell effluents where outlets are located in open water zones. Recent advances in wetland treatment can be found from the literature [18–32].

## 10. WETLAND: IDENTIFICATION, CREATION, UTILIZATION, RESTORATION, AND PROTECTION FOR POLLUTION CONTROL AND WATER CONSERVATION

According to the US Environmental Protection Agency (US EPA), wetlands are areas where water covers the soil or is present either at or near the surface of the soil all year or for varying periods of time during the year, including during the growing season. Water saturation largely determines how the soil develops and the types of plant and animal communities living in and on the soil. Wetlands may support both aquatic and terrestrial species. The prolonged presence of water creates conditions that favor the growth of specially adapted plants and promote the development of characteristic wetlands soils. Wetlands generally include swamps, marshes, bogs, and similar areas [25, 26]. There are many natural wetlands and constructed wetlands. Both can be used for pollution control, flood control, water conservation, and ecological protection. Therefore, both natural wetlands and constructed wetlands should be properly managed and protected in accordance with the government-specified wetland water quality standards [31].

A watershed, also called a drainage basin, is the area in which all water, sediments, and dissolved materials flow or drain from the land into a common river, lake, ocean, or other body of water. Wetlands are important elements of a watershed because they serve as the link between land and water resources. Wetlands protection programs are most effective when coordinated with other surface and groundwater protection programs and with other resource management programs, such as flood control, water supply, protection of fish and wildlife, recreation, control of stormwater, and nonpoint source pollution [26].

The quality of the wetlands and other water resources is directly linked to the quality of the environment surrounding these waters. A watershed-based approach to water and wetlands protection considers the whole system, including other resource management programs that address land, air, and water to successfully manage problems for a given water resource. The watershed approach thus includes not only the water resource but also the surrounding land from which the water drains [25–32].

Wetlands are important elements of a watershed because they serve as the link between land and water resources. Oceans, coasts, and estuaries provide critical natural habitat and recreational areas for our planet of earth. In case our wetlands and watersheds are contaminated, they must be properly restored [26, 28–30, 32]. Innovative use of compost has been found to be one of the good methods for wetlands restoration and habitat revitalization [29].

### GLOSSARY OF WETLAND

**Ambient monitoring** Monitoring within natural systems (e.g., lakes, rivers, estuaries, wetlands) to determine existing conditions.

**Constructed wetland or created wetland** A wetland at a site where it did not formerly occur. Constructed/created wetlands are designed to meet a variety of human benefits including, but not limited to, the treatment of water pollution discharges (e.g., municipal wastewater, stormwater) and the mitigation of wetland losses permitted under Section 404 of the Clean Water Act.

- Enhancement** An activity increasing one or more natural or artificial wetland functions. For example, the removal of a point source discharge impacting a wetland.
- Functions** The role wetlands serve which are of value to society or the environment.
- Habitat** The environment occupied by individuals of a particular species, population, or community.
- Hydrology** The science dealing with the properties, distribution, and circulation of water both on the surface and under the earth.
- Restoration** An activity returning a wetland from a disturbed or altered condition with lesser acreage or functions to a previous condition with greater wetland acreage or functions. For example, restoration might involve the plugging of a drainage ditch to restore the hydrology to an area that was a wetland before the installation of the drainage ditch.
- Riparian** Areas next to or substantially influenced by water. These may include areas adjacent to rivers, lakes, or estuaries. These areas often include wetlands.
- Upland** Any area that does not qualify as wetland because the associated hydrological regime is not sufficiently wet to elicit development of vegetation, soils, and/or hydrological characteristics associated with wetlands or is defined as open waters.
- Wetlands** Those areas that are inundated or saturated by surface or groundwater at a frequency and duration sufficient to support, and that under normal circumstances do support, a prevalence of vegetation typically adapted for life in saturated soil conditions. Wetland generally includes swamps, marshes, bogs, and similar areas.

## REFERENCES

1. Hammer DA (1989) Constructed wetlands for wastewater treatment – municipal industrial and agricultural. Lewis Publishers, Chelsea, MI
2. [http://www.ramsar.org/key\\_guide\\_list\\_e.htm](http://www.ramsar.org/key_guide_list_e.htm) (2013)
3. Campbell CS, Ogden MH (1999) Constructed wetlands in the sustainable landscape. Wiley, New York
4. Nuttall PM, Boon AG, Rowell MR (1997) Review of the design and management of constructed wetlands; report 180. Construction Industry Research and Information Association (CIRIA), London
5. Hairston JE (1995) Municipal wastewater treatment constructed wetlands: a new concept in treating wastewater; ANR-790-3.1.3. Agricultural and natural resources: water quality: managing wastewater; Alabama Cooperative Extension System (Alabama A&M and Auburn Universities), USA
6. US EPA (2001) Manual: constructed wetlands treatment of municipal wastewaters, EPA/625/R-99/010. Office of Research and Development, Cincinnati, OH
7. US EPA (1988) Design manual: constructed wetlands and aquatic plant systems for municipal wastewater treatment, EPA/625/1-88/022. Office of Research and Development, Cincinnati, OH
8. Reddy KR, De-Busk TA (1987) State-of-the-art utilization of aquatic plants in water pollution control. *Water Sci Technol* 19(10):61–79
9. Armstrong W, Armstrong J, Beckett PM (1990) Measurement and modeling of oxygen release from roots of *Phragmites australis*. In: Cooper PF, Findlater BC (eds) Use of constructed wetlands in water pollution control. Pergamon Press, Oxford, pp 41–53
10. Brix H, Schierup HH (1990) Soil oxygenation in constructed reed beds: the role of macrophyte and soil–atmosphere interface oxygen transport. *Water Res* 29(2):259–266

11. Brix H (1997) Do macrophytes play a role in constructed treatment wetlands? *Water Sci Technol* 35(5):11–17
12. Davis L (1995) A handbook of constructed wetland. A guide to creating wetlands for: agricultural wastewater, domestic wastewater, coal mine drainage, stormwater in the mid-Atlantic Region, vol 1: general considerations. Prepared for the United States Department of Agriculture (USDA) Natural resources Conservation Service and the Environment Protection Agency (EPA) Region III in cooperation with the Pennsylvania Department of Environmental Resources
13. Crites RW, Tchobanoglous G (1998) Small and decentralized wastewater management systems. WCB/McGraw Hill, San Francisco, CA
14. Reed SC, Crites RW, Middlebrooks EJ (1995) Natural systems for waste management and treatment, 2nd edn. McGraw Hill, Inc., New York
15. Beharrel M, Lim WH, Gan J (2002) Good practices in wetland management and conservation. In: Ahyaudin A, Salmah CR, Mansor M, Nakamura R, Ramakrishna S, Mundkur T (eds) Proceedings of a workshop on the Asian wetlands: bringing partnerships into good wetland practice, pp 582–594
16. Majizat A (2003) Operation and management of Putrajaya Lake and Wetlands. National seminar on constructed wetlands, Putrajaya, Malaysia
17. Ibrahim ZZ, Noordin N (2003) Putrajaya Lake and Wetlands: from concept to reality. National seminar on constructed wetlands, Putrajaya, Malaysia
18. White KD, Wang LK (2000) Natural treatment and on-site processes. *Water Environ Res* 72(5):1–12
19. Shammass NK, Wang LK (2009) Natural biological treatment processes, Chapter 15. In: Wang LK, Shammass NK, Hung YT (eds) Advanced biological treatment processes. Humana Press, Totowa, NJ, USA, pp 583–618
20. Wang LK, Ivanov V, Tay JH, Hung YT (eds) (2010) Environmental biotechnology. Humana Press, Totowa, NJ, USA, p. 975
21. Editor (2012) EcoSchool Design: water conservation and purification. [www.ecoschools.com/water/water\\_wSidebar.html](http://www.ecoschools.com/water/water_wSidebar.html)
22. US EPA (2012) Wetlands. U.S. Environmental Protection Agency, Washington, DC. <http://water.epa.gov/type/wetlands/index.cfm>. Accessed 24 May 2012
23. US EPA (2013) Wetlands and watersheds. U.S. Environmental Protection Agency, Washington, DC. <http://water.epa.gov/type/wetlands/outreach/fact26.cfm>
24. Wang LK, Tay JH, Tay STL, Hung YT (2010) Environmental bioengineering. Humana Press, Totowa, NJ, USA, p 867
25. US EPA (1995) America's wetlands, EPA843-K-95-001. U.S. Environmental Protection Agency, Washington, DC
26. US EPA (2003) An introduction and user's guide to wetland restoration, creation, and enhancement, EPA843-B-03-001. U.S. Environmental Protection Agency, Washington, DC
27. US EPA (2000) Guiding principles for constructed treatment wetlands, EPA843-B-00-003. U.S. Environmental Protection Agency, Washington, DC
28. US EPA (2002) Hypoxia and wetland restoration, EPA843-F-02-002. U.S. Environmental Protection Agency, Washington, DC
29. US EPA (1997) Innovative uses of compost: reforestation, wetlands restoration, and habitat revitalization, EPA530-F-97-046. U.S. Environmental Protection Agency, Washington, DC

30. US EPA (2004) Protecting water resources with smart growth, EPA231-R-04-002. U.S. Environmental Protection Agency, Washington, DC
31. US EPA (1990) Water quality standards for wetlands, EPA440-S-90-011. U.S. Environmental Protection Agency, Washington, DC
32. US EPA (2001) Wetland restoration, EPA843-F-01-002E. U.S. Environmental Protection Agency, Washington, DC

## Living Machines for Bioremediation, Wastewater Treatment, and Water Conservation

---

Yung-Tse Hung, Joseph F. Hawumba, and Lawrence K. Wang

### CONTENTS

NOMENCLATURE

INTRODUCTION

LIVING MACHINES: AS CONCEPT IN BIOREMEDIATION

COMPONENTS OF THE LIVING MACHINES

TYPES OF LIVING MACHINES OR RESTORERS

PRINCIPLE UNDERLYING THE CONSTRUCTION OF LIVING MACHINES

OPERATION OF LIVING MACHINES

CASE STUDIES OF CONSTRUCTED LIVING MACHINE SYSTEMS FOR BIOREMEDIATION,  
WASTEWATER TREATMENT, AND WATER REUSE

FUTURE PROSPECTS OF LIVING MACHINES

REFERENCES

---

**Abstract** This chapter describes the application of Living Machines, which are advanced ecologically engineered systems (AEES), which use natural abilities of living organisms to break down macromolecules and metabolize organic nutrients typically found in wastewater and polluted water bodies. The choice of any natural bioremediation strategy depends upon the nature and characteristics of the environment polluted, the nature of the pollutants, and the availability of the biological agents. This chapter focuses on the application of bioremediation approaches in the remediation of polluted water ecosystems, i.e., rivers, lakes, and estuaries. Fourteen case histories are presented for introduction of practical applications of Living Machine in bioremediation, wastewater treatment, and water reuse. The technology provides opportunities for environmental and water resources education, showcasing its water reuse advantages with broad applications in water shortage areas, such as California, Nevada, and New Mexico.



**Key Words** Living Machines • Advanced ecologically engineered systems • AEES • Living organisms • Bioremediation • Biological agents • Wetland cells • Wastewater treatment • Water reuse • Water shortage • Case histories • Water conservation • Aquaculture.

## NOMENCLATURE

PCB	Polychlorinated biphenyls
PAH	Polycyclic aromatic hydrocarbons
EPA	Environmental Protection Agency
BOD	Biochemical oxygen demand
COD	Chemical oxygen demand
NAS	National Academy of Sciences
AEES	Advanced ecologically engineered systems
SFS	Surface flow systems
FWS	Free water surface
EFB	Ecological fluidized beds
TSS	Total suspended solids
$\text{NH}_4^+$	Ammonium
$\text{NH}_3$	Ammonia
HFR	Horizontal flow reedbed
VFR	Vertical flow reedbed
PRS	Pond and reedbed system
CBOD <sub>5</sub>	Carbonaceous 5-day biochemical oxygen demand
TKN	Total Kjeldahl nitrogen
$\text{NO}_3^-$	Nitrate
TN	Total nitrogen
HRT	Hydraulic retention time
VOC	Volatile organic compounds
SBR	Sequencing batch reactor
UV	Ultraviolet
TP	Total phosphorous

## 1. INTRODUCTION

### 1.1. Ecological Pollution

Ecosystems comprising estuarine environments, marine shorelines, terrestrial environments, freshwater, groundwater, and wetlands are heavily polluted directly or indirectly by human activities such as mining operations, discharge of industrial wastes, agrochemical usage, and long-term applications of urban sewage sludge in agricultural soils, oil spills,

vehicles exhausts, and bilge oil as well as anthropogenic organic pollutants. These activities introduce into the various ecosystems a diverse array of pollutants including heavy metals, volatile organic compounds, nitro-aromatic compounds, phenolic compounds, xenobiotic chemicals (such as polychlorinated biphenyls (PCB), polycyclic aromatic hydrocarbons (PAHs), and pesticides), and high nutrient-loaded wastewater [1-7]. In the environment these pollutants pose great health risks to both human and wildlife. The adverse effects of various pollutants depend on their chemical nature and characteristics. For instance, PCBs, PAHs, and pesticide residues owe their toxicity to being recalcitrant, which means they persist in the environment for many years. Organophosphate-based pesticides have been demonstrated to exhibit neurotoxicological properties as well as being associated with the pathology and chromosomal damages associated with bladder cancer [8]. Heavy metals, on the other hand, pose the greatest health risk because of the difficulty associated with removal from the environment, which arises from the fact that they cannot be chemically or biologically degraded, making them (heavy metals) ultimately indestructible [2].

When it comes to water, the situation becomes more serious since both the quantity and the quality of freshwater present major problems over much of the world's continents. Freshwater lakes and rivers are polluted by oil spills as well as less satisfactorily treated effluents that come from various processing industries [9]. In addition, groundwater pollution is increasingly becoming widespread because of uncontrolled waste deposits, leakages from petrochemical tanks, and continued percolation of untreated sewage, agrochemicals, and other pollutants in the aquifers. Notably, over the last several hundred years, humans have begun living in higher and higher densities, leading to high volumes of sewage output in small geographic areas. This high density of sewage has led to the need to treat the wastewater in order to protect both humans and ecosystem health. Besides, fruits, vegetables, olive oil processing, and fermentation industries also generate solid waste and wastewater which is nutrient rich. Such wastewater has high biochemical oxygen demand (BOD), (which is a measure of oxygen consumption required by microbial oxidation or readily degradable organic and ammonia), chemical oxygen demand (COD) [9], and is usually acidic (low pH). These wastes often find their way into freshwater bodies (rivers and lakes) where they cause eutrophication (the process of becoming rich in nutrients), which triggers explosive algal blooms. Owing to exhaustion of micronutrients, toxic products or disease, the algal population eventually crashes. The decomposition of the dead algal biomass by heterotrophic microorganisms exhausts the dissolved oxygen in the water, precipitating extensive fish kills and septic conditions. Even though eutrophication does not go to this extreme, algal mats, turbidity, discoloration, and shifts of fish population from valuable species to more tolerant but less value forms represent undesirable eutrophication changes [10]. Besides, it is estimated that between 1.7 and 8.8 million metric tons of oil are released into the world's water every year, of which more than 90% is directly related to human activities including deliberate waste disposal [11, 12]. For example, marine oil spills emanating from large-scale spill accidents have received great attention due to their catastrophic damage to the environment: (a) the spill of 37,000 metric tons (11 million gallons) of North Slope crude oil into Prince William Sound, Alaska, from the Exxon Valdez in 1989 led to mortality of

thousands of seabirds and marine mammals, a significant reduction in population of many intertidal and subtidal organisms, and many long-term environmental impacts; (b) minor oil spills and oil contaminations from nonpoint source discharges (e.g., urban runoff and boat lodge) pollute rivers, lakes, and estuaries. As a matter of fact, the US Environmental Protection Agency National Water Quality Inventory reports nonpoint source pollution as the nation's largest source of water quality problem [13, 14], with approximately 40% of surveyed rivers, lakes, and estuaries not clean enough to meet basic uses such as fishing and swimming [12].

## ***1.2. Bioremediation Strategies and Advanced Ecologically Engineered Systems (AEES)***

In order to address these environmental/ecological pollution concerns, several bioremediation (natural or biological remediation approaches) strategies have been devised. For example, to address pollution of the environment by sewage and wastewater, an assortment of technologies including septic systems in rural areas and sewage treatment plants in urban have been developed. The purpose of these systems is to remove pathogens, solid waste, and organic carbon from the water. Some also remove nutrients such as nitrogen and phosphorus which normally cause eutrophication in aquatic systems [15]. There are, however, some problems with the current systems for sewage treatment. Septic tanks in particular do not effectively remove nutrients and many larger treatment plants generally rely on chemical treatment to remove some nutrients. Notably, phosphorus removal has largely relied on chemical precipitation. Although nitrogen removal primarily relies on microbiological processes, methanol is often added to stimulate the removal of nitrate. Treatment plants also typically use chemicals such as chlorine or ozone to remove pathogens. Another difficulty of conventional wastewater treatment is the large energy input required. A more fundamental problem with conventional wastewater treatment is its failure to take advantage of the potential resources embodied in wastewater. The nutrients in wastewater are an important resource that is currently going unused. By changing the way wastewater is processed, it is possible to take advantage of these resources [15].

Several biologically based technological systems, which are currently being developed as alternatives to conventional systems include, (a) the widely studied use of natural or constructed wetlands to treat wastes (discussed in Sect. 3.4) and (b) the use of a hybrid between sewage plants and wetlands. The use of a technology based on biological systems, microorganisms and plants (bioremediation/phytoremediation), known as advanced ecologically engineered systems (AEES), is beginning to emerge as promising technology, particularly as a secondary treatment option [12]. Specifically, these advanced ecologically engineered systems (AEES) use natural abilities of living organisms to break down macromolecules and metabolize organic nutrients typically found in wastewater and polluted water bodies. The major advantages of using AEES technology include the following: (a) it is less costly, (b) it is less intrusive to the contaminated site, and (c) it is more environmentally benign in terms of its end products [12]. However, the choice of any natural bioremediation strategy goes hand in hand with the nature and characteristics of the environment polluted, the

nature of the pollutant(s), and the availability of the biological agent(s). It is not the aim of this chapter to exhaust all aspects of application of bioremediation technology. However, this chapter dwells on the application of bioremediation approaches in the remediation of polluted water ecosystems, i.e., rivers, lakes, and estuaries.

## 2. LIVING MACHINES: AS CONCEPT IN BIOREMEDIATION

As already pointed out above (Sect. 1), water bodies are on a daily basis being contaminated with waste and therefore the availability of clean and safe drinking water on Earth is continually reducing. Besides, the chemical methods aimed at mitigating the problem introduce other residual pollutant as a result. On the other hand, bioremediation, which uses biological systems to mitigate the problem, has proven to be a more effective and safe way of restoring the ecosystem to its natural state. Ecological studies have, for long, revealed that nature has an inbuilt system to restore itself and thereby sustaining its continuity. It is the tilting of the balance in nature that always leads to undesirable consequences. In a typical ecosystem, different populations interact, whereby some of them benefit positively from the interactions while others may be negatively affected by the interactions [10]. For example, possible interaction between micro- and macropopulations can be recognized as negative interactions (competition and amensalism), positive interactions (commensalisms, synergism, and mutualism), or interactions that are positive for one but negative for the other population (parasitism and predation).

In simple communities, one or more of the above interactions can be observed. However, in a complex natural biological community, all of these possible interactions will probably occur between different populations concurrently [10]. Another important aspect emerging from ecological studies is the observation that positive interactions (cooperation) predominate at low population densities and negative ones (competition) at high population densities. As a result, there is an optimal population density for maximal growth rate [10]. In a natural ecosystem a balance always exists whereby different populations interact either positively or negatively until equilibrium is established. In other words, natural population can act as "Living Machines" in keeping the ecosystems habitable by every community member population. Living Machines as concept evolves around the utilization of different biological (microbial, plants, and animals) systems to decontaminate the environment of pollutants that are, on a daily basis, released as a result of various human activities. Carefully studied biological systems are selected and their metabolic and growth requirements evaluated. Then different community populations that cooperate in their interaction are given particular tasks, after which the product is used by yet another set of cooperative community populations. As the pollutant gets depleted, the populations likewise reduce in sizes. However, the engineered ecosystems (Living Machines) should have systems that reduce the population via the natural food chain. Therefore, instead of population downsizing through death, prey-predator relations/interactions are introduced. These keep the sizes of the various populations at optimal and thus maintain the performance of the systems. In other words, these systems differ from a typical natural ecosystem in as far combining a variety of natural

processes in a structured manner, which artificially accelerate wastewater purification [16]. The term Living Machines describes technologies that employ living organisms of all types and usually housed within a casing or structure made of extremely lightweight materials and powered primarily by sunlight. A typical Living Machine comprises a series of tanks or constructed ponds teeming with live plants, trees, grasses, and algae, koi and gold fish, tiny freshwater shrimps, snails, and a diversity of zooplanktons as well as bacteria [16]. In North America, the brothers Eugene Odum and Howard T. Odum laid out the conceptual framework for the practical concepts of ecological designs, and over the last three decades, these concepts have been transformed into part of the science called “ecological engineering” [17].

Ecological engineering is defined as *the design of sustainable ecosystems that integrate human society with its natural environment for mutual benefit*. It involves creating and restoring sustainable ecosystems that have value to both humans and nature. In so doing, ecological engineering combines basic and applied science for the restoration, design, and construction of aquatic and terrestrial ecosystems. Two major goals are achieved, namely, (a) the restoration of ecosystems that have been substantially disturbed by human activities such as environmental pollution or land disturbances and (b) the development of new sustainable ecosystems (Living Machines) that have both human and ecological value [18]. It is engineering in the sense that it involves the design of the natural environment through quantitative approaches, which rely on basic science, a technology whose primary tool is the self-designing ecosystem, and it is biology and ecology in the sense that the components are all of the biological species of the world [18].

The designing of Living Machines explores the chiefly two of nature’s attributes, namely, self-organization and self-designing capacities of ecosystems. Self-design and the related attribute of self-organization are important properties of ecosystems that require clear understanding in the context of creation and restoration of ecosystems. Self-organization, defined as *the property of systems in general to reorganize themselves given an environment that is inherently unstable and nonhomogeneous*, is a property that applies very well to ecosystems. This is so because in any ecosystem species are continually being introduced and deleted, while species interactions, e.g., predation, mutualism, etc., bring about change in dominance, as well as changes in the environment itself. Since ecological engineering often involves the development of new ecosystems as well as the use of pilot-scale models such as mesocosms to test ecosystem behavior, the self-organizing capacity of ecosystems remains an important concept for ecological engineering. Besides, self-organization develops flexible networks with a much higher potential for adaptation to new situations. It is for this reason that it is desirable for solving many of the ecological problems. Therefore, in the construction of Living Machines whereby biological systems are involved, the ability of the ecosystems to change, adapt, and grow according to forcing functions and internal feedbacks is most important [18].

On the other hand, self-design, which is defined as *the application of self-organization in the design of ecosystems*, ensures the continual presence and survival of species in ecosystems after their introduction by nature or humans. As a matter of fact, self-design is an ecosystem’s function in which the chance introduction of species ensures continuous sustainability of the system. The ecologically engineered system may be further augmented by multiple seeding of

species, which would speed the selection process during the process of self-organization [19]. In the context of ecosystem development, self-design means that if an ecosystem is open to allow “seeding” of enough species and their propagation through human or natural means, the system itself will optimize its design by selecting for the assemblage of plants, microbes, and animals that is best adapted for existing conditions. The ecosystem then “designs a mix of man-made and ecological components in a pattern that maximizes performance, owing to its ability to reinforce the strongest of alternative pathways that are provided by the variety of species and human initiatives” [19].

By applying these biological systems as the driving force, several living technological innovations have been designed [17]. Living Machines or AEES are primarily designed as either tank-based systems for treatment of point-source waste or floating systems placed on existing bodies of water that receive nonpoint source pollution [17]. Besides, ecological technologies are also useful in food production through waste conversions, architecture and landscape design, and environmental protection and restoration. It is thus clear that this technology is very advantageous to the conventional pollution management technologies.

### 2.1. Advantages of Living Machines

Living Machine technology offers a number of advantages over conventional treatment processes:

- (a) Living Machines use no chemicals and are thus less costly than conventional treatment plants. For example, in northern climates, some lagoon systems freeze over, making it necessary to find extensive storage space for wastewater until the warm discharge season. However, Living Machines can be small enough to be placed in a greenhouse near the source of the pollutant (sewage, wastewater from processing industries, agro-wastewater, etc.) for year-round treatment. Besides, the constant supply of treated effluent water is of such a high standard that it can be used for horticulture and aquaculture production in addition to being recycled to non-potable use such as toilets [16].
- (b) Living Machines have sensitive response systems. As such, a sudden influx of toxic pollutants, for example, is quickly obvious when snails move out of the water onto branches of leaves. In a conventional system it can take days to chemically measure toxicity. The levels of other indicators such as acidity can be determined by the color of the tails of certain species of fish. If these are integral part of the system, it saves both time and money [16].
- (c) Owing to their cleanliness and lack of odor, Living Machines may be integrated into buildings, providing an aesthetic dimension while at the same time reducing energy requirements. Consequently, they are amenable to various designs that not only provide a quality-working environment but are also an attraction to visitors [16]. Such systems serve as direct examples of human processes that are harmonious and symbiotic with natural systems.
- (d) They are easy to operate and maintain, i.e., the caring for a Living Machine such as a Restorer is less labor intensive since the operator works with living and growing ecologies, rather than with bags or tones of chemicals (15; 19).
- (e) Living Machines are capable of absorbing or resisting “shock loads” in the waste stream. They owe this capacity to the fact that they are natural and biologically diverse systems, yet they are also mechanically simple. Typical examples are the Lake Restorers. Restorer Technology is borrowed from an analogous component in nature called the floating island. Like the floating

islands, Restorers are an assembly of engineered ecologies incorporated into floating rafts. As the storm blows on the lake, the “Island” or Restorer migrates around with the changing wind. As this is done, the diverse ecologies of plant micro- and macroorganisms decontaminate the lake, thereby restoring the water back to acceptable health standards. In doing all this, any shock load is being resisted [16].

- (f) These systems are modular and can be made in various designs to meet the needs of a growing business or community. This means that the operations and efficiency of the Living Machines can be easily enhanced and improved without excessive costs involved. New Living Machines are already a third smaller than earlier. As the systems are refined and in some cases miniaturized, it will be possible to integrate them in different ways to support human population without destroying the rest of nature [16].
- (g) Since most ecosystems are primarily solar-powered systems, they are self-sustaining. Therefore, once an ecosystem (Living Machine) is constructed, it is able to sustain itself indefinitely through self-design with only a modest amount of intervention.
- (h) Living Machines have the ability to self-design. The engineer provides the containment vessels that enclose the Living Machine and then seed them with diverse organisms from specific environments. Within the Living Machine the organisms self-design the internal ecology in relation to their prescribed tasks and the energy and nutrient streams to which they are exposed [20].
- (i) Living Machines have the ability to self-replicate through reproduction by the vast majority of the organisms within the system. This means that, in theory at least, Living Machines can be designed to operate for centuries or even millennia. In Living Machines the intelligence of nature is reapplied to human ends. They are both garden and machines [20].

## 2.2. *Limitations of Living Machines*

In as much as Living Machines offer such versatile advantages, they are not without limitations:

- (a) The reliance of Living Machines on solar power means that a large part of land or water is needed. Therefore, if property purchase (which is, in a way, the purchase of solar energy) is involved in regions where land prices are high, then ecological engineering approaches may not be feasible [19].
- (b) Sometimes the species available may not be efficient in degrading very toxic and persistent, recalcitrant wastes. This may result in the persistence of such waste, and as a result pollution of such habitats and accompanying health impacts to flora and fauna persist.
- (c) Inasmuch as the natural system is desirable, in some instances the rate of inflow is so high that it overshoots the natural rates of removal of the pollutants. This means that a longer residence time may be required to give nature ample time to do the task. Accordingly, a large piece of land may be required to set up the Living Machine, which may not always be available.

## 3. COMPONENTS OF THE LIVING MACHINES

### 3.1. *Microbial Communities*

The notion that microbial communities are the foundation of Living Machines is obvious. What is less obvious is the diversity in communities of microorganisms required, if the potential of ecological engineering is to be optimized. On the one hand, bacteria are considered as ubiquitous organisms that organize life on the planet. This is suggested to be through

organization, not as distinct species as is conventionally understood in biology, but as unitary society of organisms with no analogous counterparts among other living organisms [21]. On the other hand, microbiology maintains that bacteria species have highly specific nutritional and environmental requirements and the ubiquity principle, which may work over long-term time frames, is inappropriate to the design of Living Technologies [21, 22]. In waste or intensive aquaculture, for example, if conditions are not right for nitrifying bacteria, e.g., not enough calcium carbonate as a carbon source, then *Nitrosomonas* and *Nitrobacter* will functionally disappear from the system. The only quick way to reestablish nitrification is through correcting the calcium carbonate deficiency and reinoculating the system with culture of appropriate bacteria. For their application in the design of Living Technologies, bacterial communities remain a vital component, but unfortunately they largely remained unexplored. Although some 10,000 species have been named and described and many important reactions characterized, the natural history and ecology of these bacterial species have been little studied and therefore their distribution and numbers remain obscure [21, 23]. Despite this limitation, the use of microorganisms in designing Living Technologies has proceeded in earnest. In their work with the system to degrade coal tar derivatives (PAHs), Margulis and Schwartz [23] inoculated the treatment systems with microbial communities from such diverse locations as salt marshes, sewage plants and rotting railroad ties, nucleated algae, water molds, slime molds, slime nets, and protozoa. While the bacterial communities provide a diverse array of metabolic pathways for the degradation of the pollutants, nucleated algae, water molds, slime molds, slime nets, and protozoa, which are less diverse metabolically than bacteria, are important for the efficiency of the system owing to their exceptionally diverse life histories and nutritional habits. For example, it has been shown that protozoans are important in removing coliform bacteria and pathogens from sewage as well as moribund bacteria thus improving the systems' efficiencies, while fungi are key decomposers in ecological systems [21]. Currently, the microbial communities are estimated to comprise about 100,000 species, many capable of excreting powerful enzymes from various metabolic pathways. Such heterogeneous microbial communities are efficient in the removal of organic matter from wastewater [21]. Fungi, however, tend to dominate in low pH and terrestrial soils than in aquatic environments. It may, therefore, be important that Living Technologies should incorporate soil-based acid sites linked to the main process cycles into their design.

### ***3.2. Macro-bio Communities (Animal Diversity)***

The macro-bio communities comprising various animal species are the regulators, control agents, and internal designers of ecosystems. Unfortunately, they are often little appreciated organisms. It has long been recognized that organisms from every phylogenetic level have a role in the design of Living Technologies and in the reversal of pollution and environmental destruction. For this reason, a search of the vast repository of life forms for species useful to ecological engineers is needed. Odum [24] empathized the need to find control species, meaning those organisms capable of directing living processes towards such useful end points including foods, fuels, waste recovery, and environmental repair. The potential contributions of animals to Living Technologies are therefore remarkable, yet their study has been badly



neglected in Biology of Wastewater Treatment. For example, mollusks are not mentioned [25], and in the two-volume Ecological Aspects of Used Water Treatment, snails are mentioned only once and referred to as nuisance organisms [26, 27]. It has now been found that snails play a central role to the functioning of Living Technologies. As a matter of fact, pulmonate snails, including members of the families *Physidae*, *Lymnaeidae*, and *Planorbidae*, feed on the slime and sludge communities. Snails also play a dominant role in sludge reduction, tank maintenance, and ecological fluidized bed and marsh cleaning. Ram's horn snails of the family *Planorbidae*, for example, graze and control filamentous algae mats that would otherwise clog and reduce the effectiveness of the diverse fluidized bed communities. Needless to say, some snails digest recalcitrant compounds. The salt marsh periwinkle, *Littorina irrorata*, produces enzymes that attack cellulose, pectin, xylan, bean gum, major polysaccharide classes, algae, fungi, and animal tissues as well as 19 other enzymes interactive with carbohydrates, lipids, and peptides [28]. Besides, snails can function as alarms in the Living Machines treating sewage. When a toxic load enters the Providence Sewage Treatment System, for example, the snails quickly leave the water column and move into the moist lower leaves of the floating plants above the water. Observing this behavior the operator then increases the rate of recycling clean water back upstream into the first cells. Consequently, performance losses are minimized due to the rapid behavioral response of these animals [21].

Virtually all phyla of animals in aquatic environments feed through some filtration mechanism. Bivalves, algivorous fish, zooplankton, protists, rotifers, insect larvae, sponges, and others are in this functional category [21]. They remove particles of approximately 0.1–50  $\mu\text{m}$  from the water column. Bivalves are significant filterers. For example, mussels can retain suspended bacteria smaller than 1  $\mu\text{m}$ . Efficiencies may reach 100% for particles larger than 4  $\mu\text{m}$  [29]. Individual freshwater clams of the genera *Unio* and *Anodonta* filter up to 40 L/day of water, extracting colloidal materials and other suspended organic and inorganic particles. Removal rates of 99.5 % may be achieved [30]. Zooplankton such as microcrustaceans, on the other hand, can be employed to good effect in applied mesocosms. They feed upon particles 25  $\mu\text{m}$  and smaller and their juvenile stages graze on sub-micrometer-sized particles. Since they can exchange the volume of a natural body of water several times per day, it is difficult to overstate their importance in ecological engineering [21]. In cells within the Living Machines, where fish predators are absent, their numbers are prodigious. Insects play pivotal roles in Living Technologies. Removed from predators in ecologically engineered systems, they proliferate and impact significantly on the water. For instance, chironomid larvae, which feed on sewage, may in turn be fed to fish with water quality improvement as an additional benefit [21].

Vertebrates play key roles in the functioning of Living Technologies. With an estimated 22,000 species, fishes are the most numerous and diverse of the vertebrates. In diet, behavior, habitat, and function, fish are extraordinarily diverse. Filter- and detritus-feeding fish are common to all the continents. The filtration rate of algivorous fish may be five orders of magnitude greater than their volume every day [21]. In theory it is possible for the total volume of a fishpond to pass through algae-filtering fish on a daily basis. There are edible fish species like the Central American characin, *Brycon guatemalensis*, which are capable of shredding and ingesting tough and woody materials. Members of the South American

armored catfish family *Plecostomidae* may be used to control sludge buildup in waste treatment and as food in culture Living Technologies as well. Tilapia, *Oreochromis* spp., may be used to harvest small plants like duckweed and aquatic ferns. In several Living Machines minnows, including the golden shiner, *Notemigonus crysoleucas*, and fathead minnow, *Pimephales promelas*, feed on organic debris and rotting aquatic vegetation. They breed among rafted higher plants grown on the surface of the water. Excess minnows may be sold as bait fish. Therefore, research into the aquarium and ichthyologic literature will be valuable to ecological engineers [21].

### 3.3. Photosynthetic Communities

Ecological engineering was founded on recognition of the role of sunlight and photosynthesis. By way of contrast, algae and higher plants are seen in civil engineering as nuisance organisms to be eliminated physically and chemically from the treatment process. Contemporary intensive aquaculture takes a similar view. The ecosystem-based solar aquaculture developed at the New Alchemy Institute in the 1970s and its successors constitute an exception to this trend [21]. Algae-based waste treatment systems were pioneered by Oswald (1988) and Lincoln and Earle (1990) in the USA, Fallowfield and Garrett (1985) in the UK, Shelef et al. (1980) in Israel, and a host of scientists in China and India (Ghosh, 1991). In these systems floating higher aquatic plants are used in a variety of waste treatment approaches. For instance, the use of emergent marsh plants and engineered marsh-based systems for waste treatment has gained prominence and technical sophistication over the last few decades. Notably, employing plant diversity can produce Living Technologies that require less energy, aeration, and chemical management. Root zones are superb micro-sites for bacterial communities. There has been, for instance, observed enhanced nitrification in treatment cells covered with pennywort, *Hydrocotyle umbellata*, and water hyacinth, *Eichhornia crassipes*, as compared with comparable cells devoid of higher plants. Some plants sequester heavy metals. One such species of mustard, *Brassica juncea*, has been found to remove metals from flowing waste streams and accumulating up to 60 % of its dry weight as lead. Metals can subsequently be recovered from harvested, dried, and burned plants. Apart from metal sequestering, certain species of higher plants such as *Mentha aquatica* produce antimicrobial compounds or antibiotics that may kill certain human pathogens. Such plants are vital as components of the Living Technology design. Besides pollution reductions or mitigations, there is economic potential of plants from Living Machines. Flowers, medical herbs, and trees used in rhizofiltration in a waste treatment facility may subsequently be sold as by-products. For example, the Frederick, Maryland, Living Machine sewage treatment facility produces horticultural crops for the water gardening industry [21].

### 3.4. Nutrient and Micronutrient Reservoirs

Carbon/nitrogen/phosphorus ratios need to be regulated and maintained. A full complement of macro and trace elements needs to be in the system so that complex food matrices can be established and allowed to “explore” a variety of successive strategies over time. This will support biological diversity. In designing Living Machines, mineral diversity should include

igneous, sedimentary, and metamorphic rocks. With a rich mineral base, they should support a wide variety of biological combinations and give the systems greater capacity to self-design and optimize. While mineral diversity provides the long-term foundation for nutrient diversity, in the near term microorganisms and plants require nutrients in an available form. If carbon is recalcitrant, or phosphorus in an insoluble state, or the NPK ratios are out of balance, or trace elements are missing, the ecosystems can become impoverished. There should, therefore, be a system to replenish the Living Machine of its vital nutrients. As a general rule, it is preferable that use is made of organic and rock-based amendments to correct imbalances and help meet the needs for trace minerals and potassium [21].

#### 4. TYPES OF LIVING MACHINES OR RESTORERS

##### 4.1. *Constructed Wetlands*

Natural wetland systems have often been described as the “earth’s kidneys” because they filter pollutants from water that flows through on its way to receiving lakes, streams, and oceans. For the reason that these systems can improve water quality, engineers and scientists construct systems that replicate the functions of natural wetlands. Constructed wetlands are accordingly defined as treatment systems or Living Machines that use natural processes involving wetland vegetation, soils, and their associated microbial assemblages to improve water quality [31]. The concept of using constructed wetlands for the treatment of wastewater has evolved from years of observing the high water quality inherent to natural wetlands, despite contaminated effluent. This natural process has been simulated in constructed wetlands, which are designed to take advantage of many of the same processes that occur in natural wetlands, but accomplish them within a more controlled environment. Some of these systems have been designed and operated with the sole purpose of treating wastewater, while others have been implemented with multiple-use objectives in mind, such as using treated wastewater effluent as a water source for the creation and restoration of wetland habitat for wildlife use and environmental enhancement. Moreover, constructed wetlands also control pollutants in surface runoff, create wildlife habitat, and add aesthetic value [31, 32].

In general, these systems should be engineered and constructed in uplands and outside floodplains in order to avoid damage to natural wetlands and other aquatic resources, unless the source water can be used to restore a degraded or former wetland. The degree of wildlife habitat provided by constructed treatment wetlands, or sections of these wetlands, varies broadly across a spectrum. At one end of the spectrum are those systems that are intended only to provide treatment for an effluent or other water source, in order to meet the requirements of the Clean Water Act (CWA), and these provide little or no wildlife habitat. At the other end are those systems that are intended to provide water reuse, wildlife habitat, and public use, while also providing a final polishing function for a pretreated effluent or other water source. By harnessing and encouraging the complex ecologies present in these natural treatment systems, constructed wetlands can provide basic or advanced treatment for organic nutrient loads [31, 33]. There are many advantages of using constructed wetlands in treatment of water pollution. (a) Constructed wetlands provide simple, low energy, low-maintenance alternatives

to conventional treatment methods. Accordingly, constructed wetlands can be integrated into a complete system including pretreatment, disinfection, and reuse. Options for reuse include subsurface irrigation, washdown water, toilet flushing, and industrial use. Besides, constructed wetlands can stand alone or function as an upgrade to conventional systems. (b) Constructed wetlands reduce residual wastewater sludges that typically require disposal and they are passive and exhibit reliable performance with minimal maintenance and operational costs, (c) they are simple to operate and simple to construct, (d) they can be operated year-round except in the coldest climates, and e) they can provide wildlife habitat, sites for wildlife observation, and environmental education.

There are two types of constructed wetlands [32]: subsurface flow system (SFS) and free water surface (FWS). Subsurface flow systems are designed to create subsurface flow through a permeable medium, keeping the water being treated below the surface, thereby helping to avoid the development of odors and other nuisance problems. Such systems have also been referred to as “root-zone systems,” “rock-reed filters,” and “vegetated submerged bed systems.” The media used (typically soil, sand, gravel, or crushed rock) greatly affect the hydraulics of the system. Free water surface systems, on the other hand, are designed to simulate natural wetlands, with the water flowing over the soil surface at shallow depths. Both types of wetlands treatment systems typically are constructed in basins or channels with a natural or constructed subsurface barrier to limit seepage. Constructed wetland treatment systems have diverse applications and are found across the USA and around the world. While they can be designed to accomplish a variety of treatment objectives, for the most part, subsurface flow systems are designed and operated in a manner that provides limited opportunity for benefits other than water quality improvement. On the other hand, free water surface systems are frequently designed to maximize wetland habitat values and reuse opportunities while providing water quality improvement [32].

The operations of constructed wetlands follow the same principle as other Living Technologies. Treatment of dissolved biodegradable material in wastewater is achieved through the synergistic work involving decomposing microorganisms, which are living on the exposed surfaces of the aquatic plants and soils, plants species, as well as various animal species. Decomposers such as bacteria, fungi, and actinomycetes are active in any wetland, breaking down dissolved and particulate organic material to carbon dioxide and water. This active decomposition in the wetland produces final effluents with a characteristic low dissolved oxygen level with low pH [32]. The effluent from a constructed wetland usually has a low BOD as a result of this high level of decomposition. Aquatic plants, on the other hand, play an important part in supporting these removal processes through such mechanisms as pumping atmospheric oxygen into their submerged stems, roots, and tubers. The oxygen is then utilized by the microbial decomposers attached to the aquatic plants below the level of the water. Plants also play an active role in taking up nitrogen, phosphorus, and other compounds from the wastewater. This active incorporation of nitrogen and phosphorus can be one mechanism for nutrient removal in a wetland. Some of the nitrogen and phosphorus is released back into the water as the plants die and decompose. In the case of nitrogen, much of the nitrate nitrogen can be converted to nitrogen gas through denitrification processes in the wetland [32]. While the use of wetlands is a promising idea, there are several potential obstacles. To be effective

these wetlands require a large land area. In addition, wastewater added to wetlands must be pretreated to remove solids, reducing the energetic saving. Another problem is that in temperate climates these marshes exhibit reduced functionality for much of the year [32].

#### 4.2. Lake Restorers

Restorers are an assembly of engineered ecologies incorporated into floating rafts. Restorer Technology is borrowed from an analogous component in nature known as the floating island, which is formed as dense mats of vegetation. Typically they are made up of cattails, bulrush, sedge, and reeds, which normally extend outward from shoreline wetlands. As the water gets deeper and the roots no longer reach the bottom, this vegetation uses the oxygen in their root mass for buoyancy, while the surrounding vegetation provides support that is crucial for retaining their top-side-up orientation. Moreover, the area beneath these floating mats is exceptionally rich in aquatic biota. Eventually, storm events may tear whole sections free from the shore. These resultant floating islands migrate around a lake with changing winds, occasionally reattaching to a new area of the shoreline, or breaking up in heavy weather [34].

Unlike the natural floating islands, Lake Restorers are construction that involves making rafts or wire cages that can float on water. They are then planted with different species of plants, which later provide habitats to various micro- and macroorganisms. Efficient airlift pumps and fine-bubble air diffusion systems incorporated in the design of Restorers add oxygen to the water as well as circulate water and nutrients over the Restorer's biological surfaces to stimulate the natural healing process. It is the complete body of water that treats itself. The resultant rafted floating ecologies can treat wastewater, assist in the upgrade of outdated and overloaded facultative lagoons, suppress algal growth, or help maintain the health of ponds and lakes. These diverse "floating islands" are installed in new or existing lagoons and ponds to provide a simple, robust, and beautiful method of treating waste and cleaning up polluted waters. The robustness of Restorers lies on the utilization of the widely recognized benefits of fixed biofilms to accelerate the natural processes found in a river, lake, pond, or constructed lagoon by:

- (a) Introducing oxygen and circulation to the stressed environment that often lacks sufficient oxygen-rich surface areas necessary to maintain a balanced ecology
- (b) Utilizing native higher plants and artificial media as biofilm substrate to support rich microbial, algae, and animal communities
- (c) Acting as a chemostat and incubator by producing great volumes of beneficial microorganisms that flow into the surrounding water and feed on excess nutrients and organic pollutants
- (d) Providing opportunities for benthic communities to establish themselves in the bottom areas that were once oxygen poor [34]

#### 4.3. Eco-Restorers

Eco-Restorers, unlike Lake Restorers, are more expensive to construct yet less energy efficient to operate. These systems, many of which were originally built under the name "Living Machines," are ideal for situations either where there is very little land available or where a significant element of visitor interest and interpretation is required [34]. In 1995

Jonathon Porritt opened Europe's first Eco-Restorer System—a Living Machine\*—at the Findhorn Foundation. This ecologically engineered plant is designed to treat sewage from the population of up to 300 people living at the Findhorn Foundation and provides a research and educational facility to promote this technology throughout Europe. Diverse communities of bacteria, algae, microorganisms, numerous species of plants and trees, snails, fish, and other living creatures interact as whole ecologies in tanks and biofilters. In this Living Machine system, anaerobically treated sewage flows into a greenhouse containing a series of tanks. These tanks contain species which breakdown the sewage naturally as it moves through. In many systems there are by-products of fish and plants being produced that can then be sold. Living Machines mirror processes that occur in the natural world but more intensively. At the end of the series of tanks, the resulting water is pure enough to be recycled. The technology not only is capable of meeting tough new sewage outflow standards but uses no chemicals and has a relatively inexpensive capital cost attached.

A typical design of an Eco-Restorer, using the Findhorn example, has five major components, which are housed in a single-span greenhouse, approximately 10 m wide by 30 m long. They comprise the anaerobic septic tanks, closed aerobic reactor, open aerobic reactors, the clarifiers, and the ecological fluidized beds (EFBs). This Living Machine at Findhorn receives about 60 m<sup>3</sup> wastewater per day for treatment. The raw wastewater is received in the first component of the system: the anaerobic septic tanks. Typically, three [3] anaerobic bio-reactors are buried outside the greenhouse, and their function is to reduce significantly the organic material and inorganic solids in the wastewater. The absence of oxygen in the wastewater promotes the growth of anaerobic and facultative bacterial populations. After the anaerobic digestion, the effluent from the anaerobic tanks flows into a closed aerobic tank in the greenhouse. Air is introduced through fine-bubble diffusers to convert the wastewater from an anaerobic to an aerobic state. Gases from the closed aerobic tank pass through an air filter system to eliminate odors. After this treatment, the effluent moves the open aerobic reactors. The Living Machine at Findhorn has four aerobic tanks containing diaphragm aerators, and each is planted with plant species with large root masses on floating plant racks. The BOD and TSS are reduced at this stage and ammonia is nitrified. The primary function of the plants is to provide favorable environments for enhanced microbial activity. Bacteria and other microorganisms attach themselves to the large surface area of submerged plant roots. These attached biofilms contribute significantly to the treatment process. The secondary plant functions include nutrient removal, metal sequestering, pathogen destruction, and some control of gas exchanges. The main objective is to have a healthy and diverse sequence of ecosystems present. The wide variety of plant species filling ecological niches in the system is a key to the robust nature of natural treatment systems. The ecological network of species creates internal biological redundancies compared with a purely microbial system or a monoculture duckweed system. This gives the potential for improved efficiency and greater resilience. Despite the efficiency of both microorganisms and plants, the effluent from the open aerobic tanks still contains some un-degraded suspended solids. The solids kept in suspension in the aerobic tanks are removed in the clarifier. The clarifier is a settling tank with cone-shaped bottom. The suspended solids settle at the bottom of the tank and are returned to the anaerobic primary tanks. In the clarifier tanks you may see tiny water creatures such as

Cyclops living in the water. They perform an important part in both treatment and in creating a complex food chain. The clarified effluent now is set to enter a final phase of treatment by the ecological fluidized beds (EFBs).

The ecological fluidized beds in each train are filled with light rock media. For aerobic operation, airlift pumps raise the water from the bottom of the fluidized bed to the surface, where the water flows down through the bed. Recycle rates can be varied up to 100 times the flow rate through the component. The aerobic operation provides reductions in BOD and TSS and nitrification. For the anaerobic operation of the fluidized beds for denitrification, mechanical pumps circulate water up through the bed. The fluidized beds are planted and benthic animals graze the surface. The first fluidized bed is usually run aerobically to nitrify any remaining ammonia in the waste stream. The second fluidized bed can be run anaerobically to denitrify. The third and final fluidized bed is run for final denitrification and polishing. The underlying concept behind the design involves rapid flows of water by recycling through the media-filled zones. The key attributes of an ecological fluidized bed are stable high surface area microenvironment sites for bacteria, ultrarapid exchanges across biological surfaces, direct  $\text{NH}_4^+/\text{NO}_3^-$  uptake, nitrification and denitrification cycles, the support of higher plant life and root systems within the media and in the aquatic environments, and self-cleaning. The biology is managed as a balanced ecosystem. The levels of dissolved oxygen, and carbon to nitrogen ratios, as well as recycle rates and bioaugmentation, are adjusted with the overall objective of reducing levels of BOD, ammonia ( $\text{NH}_3$ ), total nitrogen (TN), fecal coliform, and solids. Information on the efficiency of the Restorer system/Living Machine at Findhorn showed that the system treats sewage to advanced wastewater treatment (tertiary) standard. Specifically, biochemical oxygen demand (BOD), total suspended solids (TSS), total Kjeldahl nitrogen in water (TKN), ammonium ( $\text{NH}_4^+$ ), nitrate ( $\text{NO}_3^-$ ), and total phosphorous (TP) which were 250, 160, 40, 50, 10, and 7 mg/L, respectively, before treatment. After treatment, the effluent quality become 10 mg/L for BOD, TSS, and TKN, 2 mg/L for  $\text{NH}_4^+$ , 5 mg/L for  $\text{NO}_3^-$  and 5 mg/L for TP [34].

#### 4.4. Reedbeds

Reedbeds are natural systems, which are ideal for treatments on small scale or where there are no land restrictions. They are cost-effective to install and simple and inexpensive to run. They do however take up larger areas of land than Restorers. Currently there are several different alternative designs: (a) horizontal flow reedbeds (HFR)—in this design the wastewater is fed in and flows slowly through the bed in a horizontal path below the surface until it reaches the outlet zone. Here, it is collected before leaving via the level control arrangement at the outlet. As it flows, the wastewater comes into contact with a network of aerobic, anoxic, and anaerobic zones. The reed rhizomes open up the bed to provide new hydraulic pathways. (b) Vertical flow reedbeds (VFR)—these systems are often used to reduce on-site sludge production. The sludge is added to the reedbed and is degraded in the oxygen-rich environment by the plant roots. (c) Pond and reedbed systems (PRS)—the pond and reedbed systems are individually designed, robust, and self-maintaining and can treat domestic, municipal, agricultural, and industrial wastewater to very high standards. They consist of a series of

shallow outdoor ponds, fringed with various species of emergent plants, and are linked by areas of aggregate-filled constructed wetland. These systems can be built for as few as 5 and as many as 3,000 people. Land requirements are approximately 10 m<sup>2</sup> per person equivalent, depending on conditions [34].

## 5. PRINCIPLE UNDERLYING THE CONSTRUCTION OF LIVING MACHINES

As has been pointed out above (Sect. 2), Living Machines construction relies on the principles of ecology, and the resultant technological innovations, defined broadly as advanced ecologically engineered systems (AEES), are being considered for application to number of problem areas. Potential applications include a) the replacement of or provision of designs of ecological systems (ecotechnology) as alternatives to man-made/energy-intensive systems to meet various human needs (e.g., constructed wetlands for wastewater treatment); b) the restoration of damaged ecosystems and the mitigation of development activities; c) the management, utilization, and conservation of natural resources; and d) the integration of society and ecosystems in built environments (e.g., in landscape architecture, urban planning, and urban horticulture applications). These potential applications govern or offer a basis for the underlying principles for the construction of Living Technologies. Bergen and coworkers summarize these principles into five general principles to guide those practicing ecological engineering in any context or ecosystem [35]. There are specifically five principles governing the construction of Living Machines which are here below briefly explored.

### 5.1. *Living Machine Design to Be Consistent with Ecological Principles*

This principle emphasizes the importance of understanding the characteristics and behaviors of the natural systems. The designs accordingly produced with regard to, and taking advantage of, the characteristic behavior of natural systems shall be most successful. Also notable is the fact that when natural structures and processes are included and mimicked, then nature is treated as a partner in design and not as an obstacle to be overcome and dominated. This is because the capacity of ecosystems to self-organize is recognized and put into use. Mitsch and Jørgensen state that it is this “capability of ecosystems that allows nature to do some of the “engineering” and that ecological engineers participate as choice generators and as a facilitator of matching environments with ecosystems, but nature does the rest.” The key attributes of an ecosystem that allow for self-organization are complexity and diversity. Ecosystems can be complex structurally and in the temporal and spatial scales of processes. Significant ecological changes are often episodic, and critical processes, which occur at rates spread over several orders of magnitude, but clustered around a few dominant. Ecosystems are also heterogeneous, displaying patchy and discontinuous textures at all scales and do not function around a single stable equilibrium. They are rather defined by the functionally different states, which are created from the “destabilizing forces far from equilibria, multiple equilibria, and/or absence of equilibria define, and movement between states. These maintain structure and diversity of the ecosystems.” The structure and diversity produced by the large



*functional space* occupied by ecosystems is what allows them to remain healthy or to persist. The large functional space required for sustainable ecosystems is directly at odds with traditional engineering design practices that create systems that operate close to a single, chosen equilibrium point. Another important characteristic of ecosystems is that the outputs of one process serve as the inputs to others. No waste is generated and nutrients are cycled from one trophic level to the next. In constructing Living Machines, this concept should be well understood. A final characteristic of natural systems is that they tend to function near the edge of chaos or instability. Designing systems to include ecological characteristics would, therefore, depart from common engineering practice. Designing for ecological rather than engineering resilience would mean encouraging diversity and complexity, while allowing systems to self-organize, mature, and evolve. How to design systems to perform like ecosystems and still function as desired is explored in the remaining principles [35].

### ***5.2. Living Machine Design to Deal with Site-Specific Situation***

The complexity and diversity of natural systems cause a high degree of spatial variability. While the ecological characteristics discussed above are generally applicable, every system and location is different. The second principle suggests that one has to gain as much information as possible about the environment in which a design solution ought to function. Furthermore, the spatial variability rules out standardized designs, which means that the solutions should be site specific and small scale. Standardized designs imposed on the landscape without consideration for the ecology of a place will take more energy to sustain. In addition, knowledge of the place also allows for more holistic designs. Such design takes into account both the upstream and downstream effects of design decisions. For upstream issues such as what resources must be imported and appropriated to create and maintain a solution are considered while for downstream the site-specific and off-site impacts of the design on the environment are considered. In addition to the physical context of a design, knowledge of the cultural context is important. Designs are more likely to succeed and to be accepted by the local community when the people who live in a place are included in the design process. They bring knowledge of the particularities of a place and are empowered through direct participation in shaping their environment. Attention to group dynamics and conflict mediation is important for successful stakeholder participation [35].

### ***5.3. Living Machine Design to Maintain the Independence of Its Functional Requirements***

Ecological complexity adds high and often irreducible levels of uncertainty to the design process. Even under conditions of certainty, the amount of relevant information in possession may be overwhelming and often unmanageable, yet it is desirable that the solutions are kept simple and workable. Under these circumstances a strategy for dealing with such uncertainty would be to set the *tolerances* on the design functional requirements as wide as possible. The third principle, which is a restatement of the first design axiom of Suh (1990), entails that the “functional requirements (FRs),” which are the specific functions that a design solution is required to provide, are satisfied, individually, by the “design parameters (DPs).” This means

that the design parameters are the physical elements of the solution chosen to satisfy FRs. Therefore, best designs are those that have independent (not coupled) FRs and one and only one DP to satisfy each FR. Consequently, when modifying one DP affects more than one FR, then a design is described as being coupled. In these circumstances, wide tolerances on FRs can make the design essentially uncoupled. This is so because wide design tolerances allow a larger functional range for a system while the outputs remain within acceptable ranges. However, when interacting with ecological systems, the concept of functional independence becomes a lot less clear. This is so because ecosystems are complex with many levels of interconnection between components, which means that many elements of the system may be involved in more than one process. Since ecosystems can function and provide benefits to society without human intervention, the design FRs are incorporated or considered in any undertaking of Living Technology designs to satisfy unmet human needs. Therefore, the FRs for design follow from the statement of these needs, while the ecosystem processes that are in existence and their preservation needed while designing for unmet needs, act as constraints on design. Although the independence principle predicts that successful designs may be obtained when the FRs are kept uncoupled in the solution, in reality, however, it would be foolish not to take advantage of the multiple, coupled services an ecosystem can provide [35].

#### *5.4. Living Machine Design to Enhance Efficiency in Energy and Information*

The fourth principle follows from taking advantage of the self-organizing property of ecosystems. To let nature do some of the engineering means that the free flow of energy into the system from natural sources, primarily the Sun, should be put to maximum use. At the same time the energy expended to create and maintain the system directed, by design, from off-site sources, such as fossil fuels and large-scale hydroelectric sources, should be minimized. While utilizing free-flowing energy, however, it is important to follow where the energy would go without intervention, to make sure that it is not more critically needed downstream and that there is minimal adverse impact. This could be achieved by keeping the information content of the design to the minimum or simply stated making designs simple yet successful. For example, the energy input needed to restrict a stream channel to a confined space tends to be high and ultimately fails when a large flood occurs. A better design would recognize the expected variability in stream flows, and the system would be designed to withstand large variations in flow (wide tolerance) yet still maintain its ecological and engineering functions, i.e., minimizing information content. In this way the extra information required would be balanced by utilizing self-organization and wide tolerances. In other words, this can be considered as an up-front capital investment in diversity that would gain overall efficiency later through reduced energy requirements and a reduced risk of failure. Therefore, diversity provides insurance against uncertainty in addition to contributing to ecological resilience. In the case of an engineered wetland, for example, a wide range of species may be included in the initial construction, but natural processes are allowed to select those best suited for the imposed environment. Similarly, the first and second principles advocate an up-front investment in knowledge of the design context to minimize uncertainty and to allow less information to be transferred during design implementation [35].

### 5.5. *Living Machine Design to Acknowledge and Retain Its Values and Purposes*

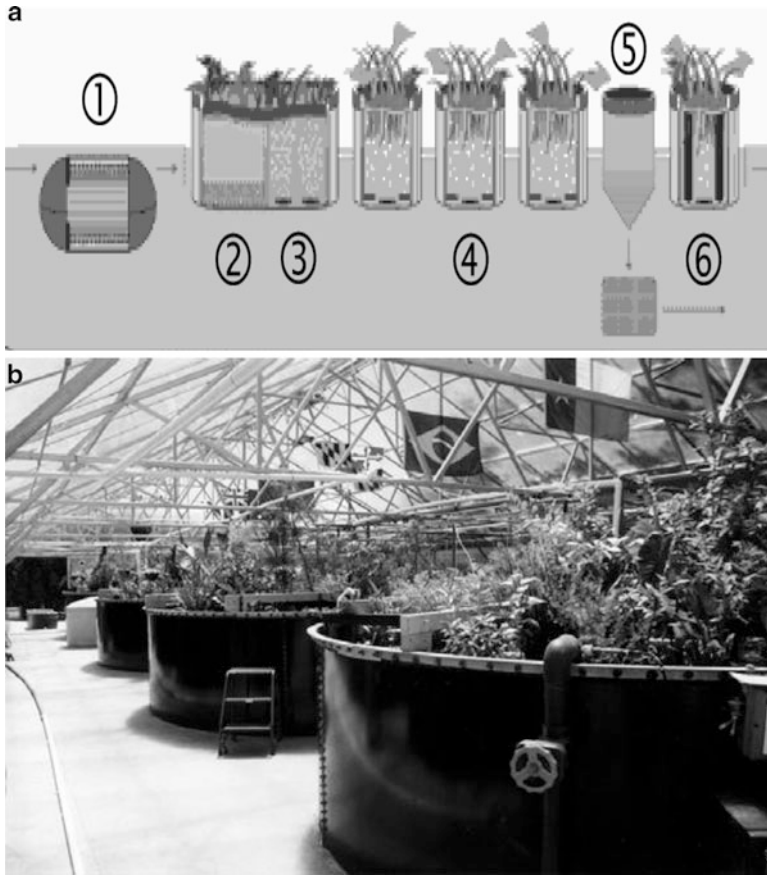
The major goal of Living Technologies is the provision of ecologically oriented designs that would benefit both society and the natural environment. Moreover, most engineering codes of ethics state at least that engineers have a responsibility to serve and protect society. From an ecological engineering perspective, this code has been explicitly broadened to include the responsibility of sustaining the natural systems that support life. Regardless of specific ideology, however, design practices that acknowledge the motivating values and purposes would be more successful. Recall that the third principle recommends using wide tolerances under conditions of uncertainty. Consequently, it follows that a precautionary approach for ecological engineering is ought to be adopted at all times. A precautionary approach should act as a form of insurance against unpleasant surprises in the future. In Living Technologies innovations, classical engineering should be applied sparingly, and complex solutions avoided where possible. Furthermore, design solutions that are both fail-safe and safe-fail should be pursued to avoid catastrophic failures. As opposed to traditional fail-safe approaches, safe-fail solutions acknowledge that our original functional requirements for a design may not be met or that there may be unexpected results. Failure in this case is not catastrophic. Therefore, in selecting the design, alternatives that have the best worst-case outcome should be advocated for [35].

## 6. OPERATION OF LIVING MACHINES

The operationalization of the Living Machine technology relies on the incorporation of plants and animals in many of the same basic processes (e.g., sedimentation, filtration, clarification, adsorption, nitrification and denitrification, volatilization, and anaerobic and aerobic decomposition) that are used in conventional biological treatment systems. A typical Living Machine comprises six principle treatment components: (1) an anaerobic reactor, (2) an anoxic tank, (3) a closed aerobic reactor, (4) aerobic reactors, (5) a clarifier, and (6) “ecological fluidized beds” (EFBs) (Fig. 14.1a). While the open aerobic reactors and EFBs are found in almost all Living Machines, the other components are not always utilized in the treatment process. The specific components used are selected by the designers depending upon the characteristics of the wastewater to be treated and the treatment objectives. Sometimes additional process components may be added if considered necessary by the designers [36].

### *Anaerobic Reactor (Step 1)*

In case it is incorporated into the treatment process, the anaerobic reactor serves as the initial step of the process. The reactor, which is similar in appearance and operation to a septic tank, reduces the concentrations of BOD<sub>5</sub> and solids in the wastewater prior to treatment by the other components of the process. Raw influent enters the reactor, which acts as a primary sedimentation basin. Some of the anaerobic reactors used have an initial sludge blanket zone, followed by a second zone for clarification. Additionally, strips of plastic mesh netting are



**Fig. 14.1.** (a) This illustrates the operational setup and components of the Living Machine®: (1) anaerobic reactor, (2) anoxic reactor, (3) closed aerobic reactor, (4) open aerobic reactors, (5) clarifier, and (6) “ecological fluid bed”. (b) This illustrates the operational setup of the open aerobic tanks of the Living Machine in South Burlington, VT. A series of tanks in a greenhouse are shown (Adapted from US Environment Protection Agency Fact Sheet, 2002).

sometimes used in the clarification zone to assist with the trapping and settling of solids, and to provide surface area for the colonization of anaerobic bacteria, which help to digest the solids. Sludge is typically removed periodically via perforated pipes on the bottom of the reactor and wasted to a reedbed or other biosolids treatment processes. Gases produced are passed through an activated carbon filter or biofilter for odor control [36].

#### *Anoxic Reactor (Step 2)*

The primary purpose of the anoxic reactor is to promote growth of floc-forming microorganisms, which will remove a significant portion of the incoming  $BOD_5$ . The anoxic reactor is mixed and has controlled aeration to prevent anaerobic conditions and to encourage floc-forming and denitrifying microorganisms. Mixing is accomplished through aeration by a coarse bubble diffuser. These diffusers are typically operated so that dissolved oxygen is

maintained below 0.4 mg/L. The space over the reactor is vented through an odor control device, which is usually a planted biofilter. In addition, an attached growth medium may be placed in the compartment to facilitate growth of bacteria and other microorganisms. Settled biosolids from the clarifier (Step 5) and nitrified process water from the final open aerobic reactor (Step 4) are recycled back into this reactor. The purpose of these recycles is to provide sufficient carbon sources to the anoxic reactor to support denitrification without using supplemental chemicals, such as methanol [36].

#### *Closed Aerobic Reactor (Step 3)*

The purpose of the closed aerobic reactor is to reduce the dissolved wastewater BOD<sub>5</sub> to low levels, to remove further odorous gases, and to stimulate nitrification. Aeration and mixing in this reactor are provided by fine-bubble diffusers. Odor control is again achieved by using a planted biofilter. This biofilter typically sits directly over the reactor and is planted with vegetation intended to control moisture levels in the filter material.

#### *Open Aerobic Reactors (Step 4)*

Next in the process train are the open aerobic reactors or aerated tanks. They are similar to the closed aerobic reactor in design and mechanics (i.e., aeration is provided by fine-bubble diffusers); however, instead of being covered with a biofilter, the surfaces of these reactors are covered with vegetation supported by racks. These plants serve to provide surface area for microbial growth, perform nutrient uptake, and can serve as a habitat for beneficial insects and microorganisms. With the variety of vegetation present in these reactors, these units (along with the ecological fluidized beds—Step 6) set the Living Machine apart from other treatment systems in terms of their unique appearance and aesthetic appeal (Fig. 14.1b). The aerobic reactors are designed to reduce BOD<sub>5</sub> to better than secondary levels and to complete the process of nitrification. The size and number of these reactors used in a Living Machine design are determined by influent characteristics, effluent requirements, flow conditions, and the design water and air temperatures [36].

#### *Clarifier (Step 5)*

The clarifier is basically a settling tank that allows remaining solids to separate from the treated wastewater. The settled solids are pumped back to the closed aerobic reactor (Step 3), or they are transferred to a holding tank and then removed for disposal. The surface of the clarifier is often covered with duckweed, which prevents algae from growing in the reactor.

#### *Ecological Fluidized Beds (Step 6)*

The final step in the typical Living Machine process is the “ecological fluidized beds” (EFBs). These are polishing filters that perform final treatment of the wastewater, and one to three are used in series to reduce BOD<sub>5</sub>, TSS, and nutrients to meet final effluent requirements. An EFB consists of both an inner and outer tank. The inner tank contains an attached growth medium, such as crushed rock, lava rock, or shaped plastic pieces. The wastewater flows into the EFB in the annular space between the inner and outer tanks and is raised by air lift pipes to the top of the inner ring that contains the media. The bottom of the inner tank is not sealed, so the wastewater percolates through the gravel media and returns to the outer annular space, from where it is again moved back to the top of the gravel bed. The air lifts also

serve to aerate the water and maintain aerobic conditions. The unit serves as a fixed bed, downflow, granular media filter and separates particulate matter from the water. Additionally, the microorganisms that occupy the granular media surfaces provide any final nitrification reactions. As sludge collects on the EFB, it reduces its ability to filter. This would eventually clog the bed completely. Therefore, additional aeration diffusers beneath the gravel bed are periodically turned on to create an upflow airlift, reversing the flow direction. This aeration is intended to “fluidize” the bed and release the trapped sludge (hence the name of this unit). This sludge is washed over and accumulated at the bottom of the outer annular space where it can be collected manually and wasted along with the biosolids from the anaerobic reactor. Consequently, the name “ecological fluidized bed” is somewhat misleading for this unit since, in its treatment mode, it acts like a typical, conventional, downflow coarse media contact filter unit. Only during backwash cleaning does the bed become partially fluidized. After this last step, the wastewater should be suitable for discharge to surface waters or a subsurface disposal system or reused for landscape irrigation, toilet flushing, vehicle washing, etc. [36].

## **7. CASE STUDIES OF CONSTRUCTED LIVING MACHINE SYSTEMS FOR BIOREMEDIATION, WASTEWATER TREATMENT, AND WATER REUSE**

### ***7.1. Sewage Treatment in Cold Climates: South Burlington, Vermont AEES, USA***

Ocean Arks International, which is a not-for-profit organization dedicated to the development of ecological design and its implementation into society, in 1995 constructed a tank-based “advanced ecologically engineered system” (AEES) or Living Machine in South Burlington, Vermont, to determine if the technology is capable of treating sewage to high standards in a northern New England climate, particularly during the cold and short day-length seasons [17]. The AEES facility, housed within a 725 m<sup>2</sup> (7,800 ft<sup>2</sup>) greenhouse, contained two parallel treatment systems designed to treat 300 m<sup>3</sup> per day (80,000 gal per day) of sewage from the city of South Burlington to advanced tertiary wastewater standards for 5-day carbonaceous biochemical oxygen demand (CBOD<sub>5</sub>), total suspended solids (TSS), total Kjeldahl nitrogen (TKN), ammonia (NH<sub>3</sub>), nitrate (NO<sub>3</sub><sup>-</sup>), and total nitrogen (TN). The performance target for removal of fecal coliforms in the system was 2,000 cfu/100 mL without disinfection. The Vermont Living Machine was biologically diverse. Over 200 species of vascular and woody plants were evaluated for their effectiveness and suitability for waste treatment between 1995 and 2000. Plants were evaluated for (a) their ability to tolerate sewage, (b) the extent of the root zones, (c) disease and pest resistance, (d) ease of management, and (e) secondary economic value. The plants were physically supported on the surface of the water by rigid plant racks designed to provide gentle flow over the roots in a highly aerated and turbulent surrounding environment. The system was designed to utilize microbial communities attached to plant roots, as well as flocculating bacteria in the open water to affect treatment. Invertebrates including microcrustaceans and freshwater clams provided biological filtration, while snails and fish were incorporated into the design to digest residual biosolids.

The flow was split between two 150 m<sup>3</sup> per day (40,000 gal per day) treatment trains with a hydraulic retention time (HRT) of 2.9 days. The facility was started in December 1995, operated at its design flow capacity by May 1996, and was maintained at this steady state until the end of 1999. Each treatment train comprised nine tanks connected in series and each tank was 4.6 m wide × 4.6 m deep (15 ft × 15 ft). Raw effluent entered and was mixed in an anoxic reactor. To control odors normally associated with raw sewage, an ecological gas scrubber, employing higher plants and a soil/bark/compost media, was mounted over the anoxic reactor tank. The wastewater flowed from the anoxic reactor into four aerobic reactors. Dense plantings were maintained on surface racks. The waste then flowed to a clarifier covered with floating aquatic plants. Biosolids from the clarifier were recycled to the anoxic reactor or wasted [17].

Downstream of the clarifier were three tanks containing ecological fluidized beds (EFBs) in series. The EFB in essence serves as a submerged trickling filter capable of supporting plants mounted over an outer ring of open water. The media that comprises the inner part of the EFB physically supports benthic organisms, including mollusks. Depending upon water quality and their position in the series, the EFBs could be operated anoxically to aid denitrification or aerobically for polishing and final filtration. The facility met and exceeded its design parameters for CBOD<sub>5</sub>, TSS, TKN, NH<sub>3</sub>, NO<sub>3</sub><sup>-</sup>, and TN as well as fecal coliform bacteria. A high level of performance was maintained even during the coldest months. In addition, phosphorus design standards were also met, but the AEES technology has yet to demonstrate phosphorus removal beyond what would be expected in a nitrifying activated sludge process.

One of the goals of the project was to grow organisms that not only provided treatment but also had potential economic benefits. Botanicals with economic value included young trees such as *Taxodium distichum* L. (bald cypress), *Zantedeschia aethiopica* L. (calla lily), and plants used for environmental remediation or wetland mitigation. Fish grown and harvested from the system included *Notemigonus crysoleucas* M. (golden shiners) and other bait fish, *Pimephales promelas* R. (fathead minnows), and ornamental fish including *Carassius auratus* L. (goldfish) and Japanese koi. All of the fish species fed upon organic material and plankton produced internally within the facility. One of the most striking aspects of the Vermont facility was its beauty. It remains a frequently visited educational facility and is currently operated as a test facility for the treatment of different types of high-strength organic wastes including brewery wastes. It is also a site where new economic by-products from both liquid and solid waste conversion processes are being developed [17].

## 7.2. Environmental Restoration: Flax Pond, Harwich, Massachusetts, USA

The Flax Pond, which is a 15 acre (6 ha) pond in Harwich, Massachusetts, has for decades been heavily impacted by leachates from an adjacent landfill and unlined septage holding lagoons. By 1989, the pond was closed to recreation and fishing because of contamination caused by the daily intrusion of 295 m<sup>3</sup> (78,000 gal) of leachate from the landfill [17, 37]. The pond had low oxygen levels, high coliform counts, excessive sediment buildup, and organic pollutants in the water column including volatile organic compounds (VOCs). Macro-benthic organisms were absent from many of the bottom sampling stations. Flax Pond had unusually

high sediment concentrations of total phosphorus (300 times greater) and iron (80 times greater) compared with other Cape Cod ponds [17, 38]. Ammonia levels in the sediments were found to be as high as 8000 mg/kg. The pond is delineated into an eastern zone and a western zone, the cloudier eastern zone being the predominant zone of impact from the landfill. The pond also had a maximum depth of 6 m and stratifies in its western end. In the autumn of 1992, construction of the first floating Pond Restorer was completed and anchored at the eastern end. It employed a windmill and solar panels for electrical generation and was capable of circulating through its nine cells up to 380 m<sup>3</sup> per day (100,000 gal per day) of water drawn from the bottom of the pond. The first three cells were filled with semi-buoyant pumice rock that supported diverse benthic life including freshwater clams of the genera *Unio* and *Anodonta*. Since phosphorus was limiting in the pond's water column, a slow release form of a clay-based soft phosphate was added to the EFB cells in the Restorer. Moreover, bacterial augmentation and mineral enrichment in the first three cells was routinely done. The final six cells supported over two-dozen species of terrestrial plants on racks. The Restorer was not operated during the winter months to allow the pond to freeze completely.

The first noticeable effect of the Restorer on the pond was the return of a positive oxygen regime to the bottom. By 1995, the sediment depth throughout the pond had been reduced by an average of 64 cm representing a total of 38,000 m<sup>3</sup> of digested sediments. Between the years 1999 and 2001, dramatic changes in the sediments took place, including large reductions (exceeding 50 %) in total phosphorus, ammonia, and TKN. However, total iron increased in the western end and decreased slightly in the eastern end of the pond. Alkalinity followed a similar pattern. The investigators could not establish which internal mechanisms were involved in the changes in sediment phosphorus, although TKN reduction was with certainty associated with nitrification and denitrification in the sediments (i.e., nitrates were below detectable limits in all sediment samples in both 1999 and 2001). Water clarity and the overall health of the pond have improved over the past decade, and biodiversity has increased [17].

### ***7.3. Organic Industrial Wastewater Treatment from a Poultry-Processing Waste in Coastal Maryland: Using Floating AEES Restorer***

In the late 1990s, the design of the Pond Restorer used in Flax Pond evolved into a linear AEES Restorer design for use on new and existing wastewater treatment lagoons. This technology combines the benefits of the small footprint AEES tank-based technology (Sect. 6.1) with the simplicity and efficiency of constructed wetlands. The first large-scale wastewater application of the floating AEES Restorer technology was installed in June 2001 on a wastewater treatment lagoon that treats 3,785 m<sup>3</sup> (1 million gallons per day) of high-strength poultry-processing waste in coastal Maryland. The Restorers were installed in a 34,100 m<sup>3</sup> (9 million gallon) storage lagoon downstream of a lagoon that had been run as a sequencing batch reactor (SBR) for over 15 years [17].

Twelve Restorers run 43 m (140 ft) each across the lagoon and are secured from the banks in multiple cells, creating a serpentine flow pattern with floating baffles. Twenty-five species of native plants (25,000 individuals) were installed in plant racks on the outside edges of the Restorers. The plants are a critical element in the technology. Their root system provides



surface areas and nutrient support for microbial communities, some nutrient uptake and they shade/inhibit suspended algae in the lagoons. Water is treated in the open areas on each side of the Restorers with fine-bubble linear aerators installed at the bottom of the lagoon. The center zones of the Restorers, with suspended fabric media, provide surface area for attachment and growth of microbial communities and as such are submerged, aerobic, fixed film reactors. The transition between the old SBR system and the new Restorer lagoon took place in October 2001. Although definitive quantitative data is not yet available, qualitative successes of the project in these early stages are worth noting.

Since start-up of the Restorer system, effluent standards have not exceeded state permit levels. The electrical energy use in the lagoons has been reduced by approximately 74 % compared to the former sequencing batch reactor (SBR) system [39, 40]. Energy reduction is the result of higher biological reaction rates in the Restorer lagoon and the efficiency of the new aeration design. Sludge has been trucked for 20 years from the poultry-processing plant for land application at nearby farms. The sludge comes from a variety of locations within the wastewater system, including the lagoons. Since installation of the Restorers the average truckloads of sludge leaving the processing facility have decreased significantly. This overall sludge reduction is the direct result of reduced sludge coming from the Restorer lagoon. Operation of the former SBR system required wasting of sludge for 8 h every day from the lagoons. Following installation of the new Restorer system, sludge is wasted for approximately 1 h every few weeks. In addition, 45 Sludge Judge samples have been taken monthly within the Restorer lagoon. Since August 2001 total sludge levels have decreased by approximately 10 cm (4 in.). This decrease indicates that sludge degradation is faster than sludge accumulation, even as the lagoon treats waste [17, 34].

#### ***7.4. Architectural Integration: Oberlin College, Ohio, USA***

In recent decades architecture has begun to include ecologically designed systems within structures for air purification, humidity control, water reuse, waste treatment, and food production. The bio-shelters developed by the Todds are being integrated in ecologically designed systems for living and life support [41]. A number of new buildings are employing ecologically engineered technologies for waste treatment, water reuse, and education including the Ontario, Canada, Boyne River School, and the Kitchener/Waterloo YMCA rural campus. The most recent of these is the Lewis Environmental Studies Center at Oberlin College in Ohio. The building includes renewable energy, natural daylighting, and nontoxic and recyclable materials. Within the structure is an AEES system or Living Machine for sewage treatment and biological research. This system, similar to the Vermont AEES, includes tanks connected in series and a constructed wetland within the building. The tanks support a diverse community of tropical and temperate plants. The purified wastewater is sterilized with UV before reuse in the toilets in the building. There is a growing interest in redefining the functioning of buildings in ecological terms. This is driving some architects towards conceptualizing buildings as “organisms.” New light-transmitting designs and self-regulating technologies optimize internal climates and support a diversity of ecological elements within the buildings. Nature is increasingly being brought indoors for practical and aesthetic reasons [17].

### **7.5. Tyson Foods at Berlin, Maryland, USA**

The poultry-processing facility acquired by Tyson Foods at Berlin, Maryland, came with a wastewater treatment system that was known to be the worst in the state. The major problem with this system was that it discharged its contents to Chincoteague Bay, which is a protected bay used for fishing and harvesting crabs and scallops. Owing to its inability to comply with the State of Maryland discharge standards, the downstream aquatic ecosystems could not be protected. This one million gallon per day poultry-processing waste treatment system required a wastewater treatment upgrade to meet effluent treatment standards and to reduce energy costs and the use of chemical treatment [34]. Ocean Arks International (OAI) installed such Restorers. Adding Restorers to existing waste treatment lagoons provided a robust and flexible treatment option. In the modified treatment system, an existing aerated lagoon is maintained with subsurface aeration only. At the beginning of this lagoon is an anoxic denitrifying cell. Wastewater is polished in a 9 million gallon lagoon using 12 linear Restorers. The nitrified effluent can be recycled back to the anoxic zone. This treatment method has reduced energy input by 70–80 %. Twelve floating Restorers (2,100 ft<sup>2</sup> each) were installed in the lagoon and secured from the banks in four separate cells, created with suspended fabric baffles. Water flows through the Restorer lagoon in a serpentine path to maximize treatment, gently aerated and circulated by subsurface, fine-bubble aeration. The wastewater is treated both beneath the Restorers and in the open channels between them. The plant roots and the curtains of suspended fabric media act as submerged, aerobic, fixed film reactors.

The biological design of the Restorers and their placement within the lagoon provides diverse habitat (in the water column, sediments, and the Restorers) for a variety of microbial communities, each of which performs an important function in the treatment process. Approximately 25,000 plants of 25 species were planted on the Restorers, only a handful of the 500 species that Ocean Arks has researched for use in wastewater treatment. Aquatic and water-loving species native to the region were chosen for their treatment properties, their ease of maintenance, and root mass area. The operation and maintenance of the Restorers is simple and low in cost. Walkways provide access to the plants. In addition to the newly planted diversity, several local plants as well as turtles have migrated into the system, creating a unique self-organizing ecosystem.

### **7.6. Old Trail School, Bath, Ohio, USA**

Old Trail School is an independent, coeducational day school for students aged toddler through grade eight. The Living Machine system at the school is an advanced on-site wetland system, composed of 3 different wetland processes which treat 5,000 gpd of wastewater. The alternating anaerobic and aerobic cycles are effective to treat the school's high-strength sewage in a safe, attractive, and cost-effective manner [42, 43].

### **7.7. US-Mexico Border, San Diego, California, USA**

The alternating anaerobic and aerobic Living Machine system treats 1,500 gpd of wastewater at the busiest commercial Otay Mesa Land Port of Entry. The system provides not only on-site wastewater treatment but also water reuse for the major facility [44].

### **7.8. US Marine Corps Recruit Depot, San Diego, California, USA**

The US Marine Corps Recruit Depot (MCRD) in San Diego provides basic training for over 21,000 recruits per year and has been recognized as one of the leading Department of Defense facilities for implementing clean green technology. The on-site Living Machine system recycles 10,000 gpd of wastewater for subsurface irrigation, minimizing its water usage in drought-prone San Diego area [45].

### **7.9. San Francisco Public Utilities Commission Administration Building, California, USA**

A 13-story, 277,500 ft<sup>2</sup> building generates its own energy through integrated solar panels and wind turbines, treats 5,000 gpd wastewater using a Living Machine system, and recycles all treated water for reuse. It can be seen that even in a dense urban area, it is possible to create buildings, communities, and regions that are resilient, sustainable, and able to produce and reuse valuable water resources on-site. The footprint of the San Francisco Living Machine system is about 1,000 ft<sup>2</sup> [46].

### **7.10. Esalen Institute, Big Sur, California, USA**

Many educational institutions around the world are trying to conserve the water and protect the environment [47-50]. For instance, the Esalen Institute, Big Sur, California, applies the Tidal Flow Wetland Living Machine technology to treat its laundry and lodging facility wastewaters and reuses the treated effluent for subsurface irrigation. Alternatively, the treated effluent is discharged to its existing leach fields for recharging the groundwater [49].

### **7.11. Guilford County School District, California, USA**

The Guilford County School District uses plant-based strategies to cleanse 30,600 gpd of wastewater and produces enough clean water to irrigate 3 athletic fields. This environmentally sound, on-site Living Machine system costs less than other pretreatment strategies and helps to reduce the amount of nitrogen entering the watershed [50].

### **7.12. Las Vegas Regional Animal Campus, Nevada, USA**

The Las Vegas Regional Animal Campus (RAC) serves the animal sheltering and adoption needs in the region. The 5,000–10,000 gpd of wastewater is treated by a Tidal Flow Wetland Living Machine system and reused for kennel washdown and other appropriate water uses [51].

### **7.13. Port of Portland, Oregon, USA**

The new headquarters office facility for the Port of Portland has adopted the Living Machine system as its showcase feature. The system includes a tiered series of wetland cells supporting the growth of indoor landscaping and ornamental flowers. It is designed to treat all of the facility wastewater to a quality for reuse, including toilet flushing and makeup water for cooling towers [52, 53].

#### 7.14. *El Monte Sagrado Resort, Taos, New Mexico, USA*

El Monte Sagrado Resort's Living Machine system is designed to treat 4,000 gpd of wastewater for producing a comprehensive design solution for a high desert resort. Wastewater from kitchens and bathrooms is treated by the Living Machine system, is filtered further by a set of constructed wetlands, and finally flows into the pond and waterfall. In addition, storm water on the site is collected through an extensive system of roof gutters and underground drainage pipes. Collected water is utilized to offset evaporative losses in a series of four cascading trout ponds and small waterfalls that utilize physical and biological filtration to promote flourishing and productive pond ecosystems. Rainwater is circulated in the irrigation channels to support agricultural practices downstream [54].

### 8. FUTURE PROSPECTS OF LIVING MACHINES

#### 8.1. *Integration of Industrial and Agricultural Sectors: Proposed Eco-Park in Burlington, Vermont, USA*

Ecological design concepts are starting to be applied to the development of integrated economic systems in an industrial context. A good example of one such system is the development or construction of eco-industrial parks. An eco-industrial park has been defined as "a community of businesses that cooperate with each other, and with the local community, to efficiently share resources (information, materials, water, energy, infrastructure and natural habitat) leading to economic gains, improved environmental quality, and equitable enhancement of human resources for business and local community" [55]. This idea is clearly illustrated by the work pioneered by the city of Burlington and the Intervale Foundation established the Intervale Community Enterprise Center (ICEC). The ICEC undertook to develop a year-round, agriculturally based eco-park in a 280 ha flood plain within Burlington's city limits. The eco-park would derive most of its energy from the utilization of waste heat from the 53 MW McNeil power station. The project has brought together a number of allied businesses including a brewery, several food processors, a restaurant, and a host of Intervale growers and suppliers to the eco-park. The University of Vermont's ecological design studio would also be housed in the complex [17]. The structure that will support the project combines greenhouses with a conventional light-manufacturing facility in a 3,800 m<sup>2</sup> (40,900 ft<sup>2</sup>) structure. The food culture team at Ocean Arks International (OAI) has been developing some of the agricultural components for the eco-park. Their approach has been to start with readily available organic wastes and through ecological processes convert the wastes to high-value products. The main goal is ecological and economic amplification of organic materials in an integrated manner similar to that developed by Yan and Ma [56]. On a pilot scale the materials being used include spent grain from a local brewery, straw, and bedding from an organic poultry operation. There are several stages in the conversion of materials.

*Stage 1:* The organic materials are blended, pasteurized, and inoculated with oyster mushroom spawn (*Pleurotus ostreatus* (Jacq: Fr.)). The substrate is placed in plastic bags punched with holes and placed in a mushroom incubator room. When the bags are fully

colonized by the mushroom mycelium, they are transferred to a grow room for fruiting and harvest. Biological efficiency of conversion, the ratio of wet weight of harvested mushrooms to the dry weight of the substrate, has exceeded 60 %. After harvest the remaining substrate has the potential to be used as a high-quality animal feed for livestock. In the process of mushroom production, the vegetative forms of fungi colonize the straw and spent grains and produce essential amino acids such as lysine. Tests with cattle and the fish tilapia have demonstrated a ready acceptance of the material.

*Stage 2:* The spent mushroom substrate is placed in earthworm or vermiculture chambers. The earthworms rapidly convert the materials to enriched compost. The earthworms, a product of the process, are then blended with aquatic plants, *Azolla* sp. (water fern) and *Lemna* spp. (duckweeds), to produce protein-rich fish feeds.

*Stage 3:* The mushroom/earthworm-based compost is then utilized in the growing of tropical plants in pots and the culture of salad greens. No additional fertilization to the compost is required for the production of greens. After several harvests of salad greens, the medium is then utilized as a soil amendment or as a potting soil.

## 8.2. Aquaculture

Another key component in the design of integrated food systems for urban settings is aquaculture. The food team at OAI has designed recirculating systems based upon four tank modules for the culture of aquatic animals. To date, OAI has successfully cultured *Oreochromis* sp. (tilapia) and *Perca flavescens* M. (yellow perch) in these systems. The system is designed to produce feeds for the fish internally, including attached algae turfs and their associated communities, floating aquatic plants including *Lemna* and *Azolla*, zooplankton, and snails. External feeds to the system include earthworms and commercial feeds. These ecosystem-based fish culture systems have proven to be efficient. The multiplicity of pathways for nutrients and materials to flow in the production of a diversity of crops is an integral part of ecological design. If such an approach proves to be economically viable in an urban setting, the larger issue of food security can be addressed through the application of applied ecological concepts [17, 39, 40].

## REFERENCES

1. Gemmell TR, Knowles JC (2000) Utilization of aliphatic compounds by acidophilic heterotrophic bacteria. The potential for bioremediation of acidic wastewaters contaminated with toxic organic compounds and heavy metals. *FEMS Microbiol Lett* 192:185–190
2. Mejáre M, Bülow L (2001) Metal-binding proteins and peptides in bioremediation and phytoremediation of heavy metals. *TRENDS in Biotechnol* 19(2):67–73
3. Abraham W-R, Nogales B, Golyshin P, Pieper HD, Timmis NK (2002) Polychlorinated biphenyl-degrading microbial communities in soil and sediments. *Curr Opin Microbiol* 5:246–253
4. Samanta KS, Singh VO, Jain KR (2002) *TRENDS in Biotechnol* 20(6):243–248
5. Novotný C, Svobodova K, Erbanova P, Cajthaml T, Kasinath A, Lang E, Šašek V (2004) Lignolytic fungi in bioremediation: extracellular enzyme production and degradation rate. *Soil Biol Biochem* 36:1545–1551

6. Environmental Protection Authority (EPA) Report (2004) EPA/600/R-04/075 report, Washington DC, 2004
7. Khan GA (2005) Role of soil microbes in the rhizospheres of plants growing on trace metal contaminated soils in phytoremediation. *J Trace Elem Med Biol* 18:355–364
8. Ang LE, Zhao H, Obbard PJ (2005) Recent advances in the bioremediation of persistent organic pollutants via biomolecular engineering. *Enzyme Microb Technol* 37:487–496
9. Thassitou PK, Arvanitoyannis IS (2001) Bioremediation: a novel approach to food waste management. *Trends in Food Sci Technol* 12:185–196
10. Atlas MR, Bartha R (1993) Interactions among microbial populations. In *MICROBIAL ECOLOGY: Fundamentals and Applications*. The Benjamin/Cummings Publishing Company, Inc. pp 37–65
11. National Academy of Sciences (NAS) (1985) Oil in the sea: fates and effects. National Academic Press, Washington DC
12. Zhu X, Venosa DA, Suidan TM (2004) Literature review on the use of commercial bioremediation agents for cleanup of oil-contaminated estuarine environments. Environmental Protection Agency (EPA) Report, EPA/600/R-04/075, Washington DC, pp 1–5
13. U.S. EPA (1996) A Series of Fact Sheets on Nonpoint Source (NPS) Pollution. EPA841-F-96-004, Office of Water, U.S. Environmental Protection Agency, Washington DC
14. U.S. EPA (2000) The Quality of Our Nation's Waters: A Summary of National Water Quality Inventory: 1998 Report to Congress. EPA841-S-00-001, Office of Water, U.S. Environmental Protection Agency, Washington DC
15. Editor (2012) Introduction to greenhouse-wetland treatment systems; <http://www.oberlin.edu/faculty>. Oberlin College, Oberlin, OH
16. Chen P, Brum M (1995) Ecological waste treatment: Hope in nature: In Peace and Environment News, March Issue
17. Todd J, Brown EJG, Wells E (2003) Ecological design applied. *Ecol Eng* 20:420–440
18. Mistch JW, Jorgensen ES (2003) Ecological engineering: A field whose time has come. *Ecol Eng* 20:363–377
19. Odum HT (1989) Ecological engineering and self-organization. In: Mitsch WJ, Jørgensen SE (eds) *Ecological engineering: An introduction to ecotechnology*. John Wiley & Sons, New York, NY, pp 79–101
20. Todd J (1997) Ecological design, living machines and purification of waters. In: Kilbert CJ, Wilson A (eds) *Reshaping the built environments; ecology, ethics and economics*. pp 133–149
21. Todd J, Josephson B (1996) The design of living technologies for waste treatment. *Ecol Eng* 6:109–136
22. Ehrlich KF, Cantin MC, Horsfall FL (1989) Bioaugmentation: biotechnology for improving aquacultural production and environmental protection. In: Murray K (ed) *Aquaculture engineering technologies for the future*. Inst. Chem. Eng. UK Symposium Ser. No. 111, pp 329–341
23. Margulis L, Schwartz KV (1988) *Five Kingdoms; An Illustrated Guide to the Phyla of Life on Earth*. W.H. Freeman, New York, NY
24. Odum HT (1971) *Environment, power and society*. Wiley Interscience, New York, NY
25. Gray NJ (1989) *Biology of wastewater treatment*. Oxford University Press, Oxford, UK
26. Curds CR, Hawkes HA (eds) (1975) *Ecological aspects of used water treatment*, vol 1. Academic, London, UK
27. Curds CR, Hawkes HA (eds) (1983) *Ecological aspects of used water treatment*, vol 2. Academic, London, UK

28. Barlocher F, Arsuffi TL, Newell SY (1989) Digestive enzymes of the saltmarsh periwinkle *Littorina irrorata* (Mollusca: Gastropoda). *Oecologia* 80:39–43
29. Hawkins A, Bayne B (1992) Physiological interrelations and the regulation of production. In: Gosling E (ed) *The mussel mytilus: Ecology, physiology, genetics and culture*. Developments in Aquaculture and Fisheries Science, vol 25. Elsevier, Amsterdam
30. Karnaukhov VN (1979) The role of filtrator molluscs rich in carotenoid in the self cleaning of fresh waters. *Symp Biol Hung* 19:151–167
31. U.S. EPA (2004) *Constructed Treatment Wetlands: Wetland Resources*: EPA843-F-03-013, Office of Water, U.S. Environmental Protection Agency, Washington DC
32. U.S. EPA (1993) *Constructed Treatment Wetlands for Wastewater Treatment and Wildlife Habitat*: EPA832-R-93-005, Office of Water, U.S. Environmental Protection Agency, Washington DC
33. U.S. EPA (2000) *Guiding Principles for Constructed Treatment Wetlands: Providing for Water Quality and Wildlife Habitat*: EPA843-B-03-003, Office of Water, U.S. Environmental Protection Agency, Washington DC
34. Living Technologies Ltd; (2013) [http://www.ltluk.com/lake\\_restorers.html](http://www.ltluk.com/lake_restorers.html)
35. Bergen SD, Bolton SM, Fridley JL (2001) Design principles for ecological engineering. *Ecol Eng* 18:201–210
36. U.S. EPA (2002) *Wastewater Technology Fact Sheet: The Living Machine*; Office of Water EPA 832-F-02-025, U.S. Environmental Protection Agency, Washington DC
37. Horsley W, Hegemann I (1991) Hydrogeologic investigation for groundwater discharge permit application. Report to the Town of Harwich, MA, p 43
38. K.V. Associates Inc., IEP Inc. (199) *Shallow pond diagnostic and feasibility study*. Report to the Town of Barnstable, MA, pp 113
39. Wang LK, Pereira NC, Hung YT (eds) (2009) *Biological treatment processes*. Humana, Totowa, NJ, USA
40. Wang LK, Hung YT, Shammass NK (eds) (2009) *Advanced biological treatment processes*. Humana, Totowa, NJ, USA
41. Todd NJ, Todd J (1994) *From eco-cities to living machines: Principles of ecological design*. North Atlantic Books, Berkeley, p 197
42. Editor (2010) *Living machine opens up acres for responsible development*. Faulkner County Business Journal, December 2010
43. Editor (2010) *Old Trail School selects natural, on-site living machine system over traditional central wastewater treatment*. Living Machines, Worrell Water Technologies, LLC. Charlottesville, VA, USA. [www.worrellwater.com](http://www.worrellwater.com)
44. Editor (2010). *Living machine system selected for federal green building at the second busiest commercial land port of entry on the US-Mexico border*, Living Machines, Worrell Water Technologies, LLC. Charlottesville, VA, USA
45. Editor (2011) *U.S. Marine Corps installs living machine system at San Diego Training Base*. Living Machines, Worrell Water Technologies, LLC. Charlottesville, VA, USA
46. Editor (2011) *San Francisco Public Utilities Commission selects living machine system for water recycling water savings in new green office building*. Living Machines, Worrell Water Technologies, LLC. Charlottesville, VA, USA
47. Elizabeth L (ed) (2000) *Ecological Schoolyards: Design Guidelines*, *New Village Journal*. Architects/Designers/Planners for Social Responsibility. Berkeley, CA: Issue 3, May 2002, pp 74–77

48. Editor (2012) Ecological Wastewater Treatment: An Artificial Ecosystem. [www.darrowschool.org/media\\_library/living\\_machine.pdf](http://www.darrowschool.org/media_library/living_machine.pdf)
49. Editor (2012) The Esalen Institute, Big Sur, California. Living Machines, Worrell Water Technologies, LLC. Charlottesville, VA, USA
50. Editor (2012) Guilford County Northern Middle and High Schools, Greensboro, North Carolina. Living Machines, Worrell Water Technologies, LLC. Charlottesville, VA, USA
51. Editor (2012) Las Vegas Regional animal Campus, Las Vegas, Nevada. *Living Machines*, Worrell Water Technologies, LLC. Charlottesville, VA, USA
52. Editor (2012) Port of Portland, Portland, Oregon. Living Machines, Worrell Water Technologies, LLC. Charlottesville, VA, USA
53. Editor (2012) Living Machine Projects. Living Machines, Worrell Water Technologies, LLC. Charlottesville, VA, USA
54. Editor (2012) El Monte Sagrado Resort, Taos, New Mexico. Living Machines, Worrell Water Technologies, LLC. Charlottesville, VA, USA
55. Presidents Council on Sustainable Development (1996) Eco-industrial park workshop proceedings, Cape Charles, Virginia, 17–18 Oct 1996, pp 141
56. Yan J, Ma S (1991) The function of ecological engineering in environmental conservation with some case studies from China. In: Etnier C, Guterstam B (eds) Proceedings of the international conference on the ecological engineering for wastewater treatment, Stensund Folk College, Sweden. Gothenburg, Sweden, pp 80–94, 24–28 Mar 1991



# Aquaculture System Management and Water Conservation

---

Yung-Tse Hung, Hamidi A. Aziz, Mohd Erwan Sanik,  
Mohd Suffian Yusoff, and Lawrence K. Wang

## CONTENTS

NOMENCLATURE

INTRODUCTION

REGULATIONS

WASTE MANAGEMENT OF AQUACULTURE OPERATION

DESIGN CRITERIA OF AQUACULTURE SYSTEM

APPLICATION OF AQUACULTURE SYSTEM FOR WASTEWATER TREATMENT AND WATER  
CONSERVATION

APPENDIX

REFERENCES

---

**Abstract** Aquaculture or aquafarming is the cultivation of aquatic populations, including both aquatic animals and plants, under controlled environments. This chapter describes the environmental issues and regulations regarding aquaculture. Aquaculture water management, water supply, waste management, waste characterization and water quality related to aquaculture operation, and design of aquaculture system are emphasized. The use of three aquaculture systems (water hyacinth system, natural wetland system, and man-made Living Machine) for wastewater treatment and water conservation are presented.

**Key Words** Aquaculture • Aquafarming • Aquaculture regulations • Aquaculture water management • Aquaculture waste management • Natural wastewater treatment • Water conservation • Water hyacinth • Natural wetland • Living machine.

## NOMENCLATURE

ADC	Apparent digestibility coefficients
BMPs	Best management practices
BOD	Biochemical oxygen demand
CWA	Clean Water Act
DEQ	Idaho Division of Environmental Quality
DO	Dissolved oxygen
FAO	Food and Agriculture Organization of the United Nations
FDA	Food and Drug Administration
FFS	Full-flow settling
N	Nitrogen
NH <sub>3</sub>	Un-ionized ammonia
NH <sub>4</sub> <sup>+</sup>	Ammonium ion
NO <sub>2</sub> <sup>-</sup>	Nitrite
NPDES	National Pollutant Discharge Elimination System
NRE	Nutrient retention efficiencies
OLS	Off-line settling
P	Phosphorus
QZ	Quiescent zone
R <sub>t</sub>	Retention time
SS	Suspended solids
TSS	Total suspended solids
US EPA	United States Environmental Protection Agency
V <sub>o</sub>	Overflow rate
V <sub>s</sub>	Settling velocity

## 1. INTRODUCTION

Aquaculture is the cultivation process of aquatic organisms. Unlike fishing, aquaculture, also referred as aquafarming, implies the cultivation of aquatic populations under controlled environments. Mariculture refers to aquaculture practices in marine environments. Particular kinds of aquaculture include algaculture (the production of kelp/seaweed and other algae), fish farming, growing of cultured pearls, shellfish farming, and shrimp farming. Referring to the National Aquaculture Act of 1980, 16 U.S.C. 2801, the name “aquaculture” stands for the propagation and rearing of aquatic species in controlled or selected environments. According to the US Environmental Protection Agency (US EPA) [14], aquaculture is defined as the active cultivation of marine and freshwater aquatic organisms under controlled conditions. Buck [3] describes aquaculture to consist of both the farming and the husbandry of fish, shellfish, and other aquatic plants and animals.

Another definition is given by the Food and Agriculture Organization (FAO) of the United Nations. The aquaculture term is defined as “the farming of aquatic organisms, including fish, molluscs, crustaceans, and aquatic plants”. Farming implies some sort of intervention in the

rearing process to enhance production, such as feeding, protection from predators, regular stocking, etc. Farming also implies individual or corporate ownership of the stock being cultivated [7]. Some states in the United States have classified aquaculture as an agricultural activity.

### **1.1. Environmental Issues**

Environmental decline is the consequence of improper aquaculture practices. Aquaculture activities can have a significant impact on the health and quality of receiving waters. Changes in oxygen, pH, temperature, and the addition of ammonia, drugs, metals, organic nitrogen, phosphorus, and suspended solids are often measurable downstream from hatcheries. The impact of farm discharges on the receiving waters depends on the level of nutrients already present. Nitrogen (N) and phosphorus (P) in farm wastes mainly originate from feeds and are of greatest concern as they can cause nutrient enrichment. According to Miller and Semmens [8], wastes from a fish farm come in three general forms: chemical, metabolic, and pathogenic. Wastewater effluent consists mainly of uneaten food and excretory wastes from cultivated organisms. Aquaculture wastewater effluent can also include a variety of chemicals, feed additives, and pesticides that are added to systems to condition the water, control pests, or cultivate organisms.

The latest issue regarding aquaculture and the environment which will not be focused in this chapter is the health issue. For a more precise statement, the food sourced from aquaculture industry is the concern of the public. In China, where seafood is the most common diet, 64 % of seafood is coming from aquaculture. Some environmental impacts causing concern domestically and internationally include eutrophication and algae blooms; antibiotics, pesticides, and fungicides; habitat destruction; depletion of wild fish stocks for feed; and monoculture and invasive species. There are also cases of contaminated aquaculture product such as poisonous melamine (synthetic nitrogen enhancer) in China, antibiotic contamination in the United States, malachite green in Hong Kong, and carcinogens (chloramphenicol, malachite green, and furazolidone) in China which are found in aquaculture products [6]. Carcinogenic contaminants in farmed fish are also found in Canada and the United States include polychlorinated biphenyl (PCB), which is a synthetic, organic chemical, and various dietary additives, pesticides, antibiotics, and fungicides [2]. So, a good and responsible management of aquaculture operation is essential to provide the source of fish and other aquaculture products which, according to the feeding operation, follow the fixed regulations.

## **2. REGULATIONS**

### **2.1. Agencies Regulating Aquaculture**

The US Environmental Protection Agency (US EPA) issues the National Pollutant Discharge Elimination System (NPDES) permit which establishes regulations for the discharge of various pollutants from point sources to waters of the United States [13]. NPDES permits

are obliged for fish farms, fish hatcheries, or other facilities that cultivate aquatic animals under the following conditions:

- Cold-water fish species or other cold-water aquatic animals in ponds, raceways, or similar structures that discharge at least 30 days per year, produce more than 9,071 kg (20,000 lb) of aquatic animals per year, or receive more than 2,268 kg (5,000 lb) of food during the month of maximum feeding.
- Warm-water fish species or other warm-water aquatic animals in ponds, raceways, or similar structures that discharge at least 30 days per year. This does not include closed ponds which discharge only during periods of excess runoff or warm-water facilities which produce less than 45,360 kg (100,000 lb) of aquatic animals per year.
- Facilities determined on a case-by-case basis by the permitting authority to be significant contributors of pollution to waters of the United States.

In addition, the US EPA also provides limits on the discharge of compounds, including some commonly used water treatments. Discharge of pollutants to waters of the United States from aquaculture production facilities, except as provided in the permit, is a violation of the Clean Water Act (CWA) and may be subject to enforcement action by the US EPA.

## ***2.2. The Federal Clean Water Act***

The Federal Water Pollution Control Act (PL 92-500) has been approved by Congress in 1972 and is commonly called the Clean Water Act (CWA). The objective of the CWA, as revised by the Water Quality Act of 1987 (Public Law 100-4), was to restore and maintain the chemical, physical, and biological integrity of the nation's waters.

## ***2.3. National Pollutant Discharge Elimination System Permit Requirements***

The NPDES program has been administrated by states in the United States by the authorization of the US EPA. Any facility that determines to discharge into the nation's waters must obtain a permit before they can be discharged. When the US EPA receives a hatchery permit application, it issues an initial draft permit. Finalization of the permit is done by the US EPA. The CWA, Section 401, requires any applicant for a federal discharge license or permit, who conducts any activity which may result in any discharge into navigable waters, to provide the licensing or permitting agency a certificate from the state that any such discharge will comply with applicable provisions of Sections 122.1 through 122.7, 122.24, and 122.25 of the CWA. Most states in the United States follow the US EPA guidelines that propose aquatic life and human health criteria for many of the 126 priority pollutants.

### ***2.3.1. Aquaculture Projects***

Discharges into an aquaculture project require an NPDES permit. An aquaculture project means a "defined managed water area which uses discharges of pollutants into that designated area for the maintenance or production of harvestable freshwater estuarine or marine plants or animals" [11].

### 2.3.2. Concentrated Aquatic Animal Production Facilities

Concentrated aquatic feeding operations are direct dischargers and require an NPDES permit if they annually meet the following general conditions [11]: (a) produce more than 9,090 harvest weight kilograms (about 20,000 lb) of cold-water fish (e.g., trout, salmon) or (b) produce more than 45,454 harvest weight kilograms (about 100,000 lb) of warm-water fish (e.g., catfish, sunfish, minnows).

## 2.4. General Criteria

The following general water quality criteria apply to all surface waters, in addition to the water quality criteria set forth for specifically classified waters [5]:

1. Deleterious materials
2. Excess nutrients
3. Floating, suspended, or submerged matter
4. Hazardous materials
5. Oxygen-demanding material
6. Radioactive materials
7. Sediment
8. Toxic substances

## 2.5. Beneficial Uses

The designated beneficial use classifications include [5]:

1. Aquatic life—general
2. Cold-water biota
3. Miscellaneous—wildlife habitat, aesthetics, and special resource waters
4. Primary and secondary contact recreation
5. Warm-water biota and salmonid spawning
6. Water supply—domestic, industrial, and agricultural

Surface waters have designated the use of classifications with specific numerical limits for parameters such as ammonia, bacteria, dissolved oxygen (DO), pH, temperature, and turbidity.

### 2.5.1. Primary Contact Recreation Waters

Recreation waters are surface waters which are proper or intended to be made proper for continuous and intimate contact by humans. Furthermore, they are also used for recreational activities when the ingestion of small quantities is likely to occur. They include also location of nonrestriction for those used for skin diving, swimming, or water skiing.

### 2.5.2. General Criteria of Aquatic Life

It applies to all aquatic life water use categories [5]:

1. Total chlorine residual.
2. Hydrogen ion concentration (pH) values within the range of 6.5–9.5.
3. The total concentration of dissolved gas not exceeding 110 % of saturation at the point of collection.

### 2.5.3. Cold-Water Biota of Aquatic Life

Waters which are suitable or intended to be made suitable for the maintenance and protection of viable communities of aquatic organisms and populations of significant aquatic species have optimal growing temperatures below 18 °C. Waters designated for cold-water biota are to exhibit the following characteristics [5]:

1. A 1-h concentration of un-ionized ammonia is not to exceed 0.14 mg/L or total ammonia of 5.73 mg/L at 14 °C at a pH of 8.0, and a 4-day average concentration of un-ionized ammonia is not to exceed 0.03 mg/L or total ammonia of 1.10 mg/L at 14 °C at a pH of 8.0.
2. Dissolved oxygen concentrations exceeding 6 mg/L at all times.
3. Turbidity, below any applicable mixing zone.
4. Water temperatures of 22 °C or less with a maximum daily average of no greater than 19 °C.

### 2.5.4. Salmonid Spawning of Aquatic Life

Salmonid spawning are waters which provide a habitat for active, self-propagating populations of salmonid fishes. Waters designated for salmonid spawning must maintain the following characteristics during the spawning and incubation periods for the particular species inhabiting those waters [5]:

1. A 1-h concentration of un-ionized ammonia is not to exceed 0.14 mg/L or total ammonia of 5.73 mg/L at 14 °C at a pH of 8.0.
2. Intergravel dissolved oxygen with a 1-day minimum of not less than 5.0 mg/L or a 7-day average mean of not less than 6.0 mg/L.
3. Water column dissolved oxygen with a 1-day minimum of not less than 6.0 mg/L or 90 % saturation, whichever is greater.
4. Water temperature of 13 °C or less with a maximum daily average no greater than 9 °C.

## 3. WASTE MANAGEMENT OF AQUACULTURE OPERATION

### 3.1. Aquaculture Waste Management

The management of aquaculture waste depends on the suitability and effectiveness of the system that is applied to the aquaculture operation. Recirculation systems in closed systems where some or all of the water is filtered and reused and single-pass systems which use troughs or channels with water flowing from one end to the other are required to manage the supply and condition of water in the system, including the management and removal of wastes. Aquaculture waste parameters depend on the types of aquaculture systems in operation.

Many aquaculture systems employ a constant through-flow of water. These systems typically generate wastewater at a relatively constant and high rate, with relatively low contamination levels [15]. Systems that filter, reoxygenate, and recycle water typically generate higher concentrated wastewater and sludges (from the filtration process) but at lower or intermittent rates [15]. Most tank-based aquaculture systems also generally have intermittent discharges of concentrated wastewater during cleaning and harvesting operations.

According to Miller and Semmens [8], Idaho's Division of Environmental Quality had published useful information on aquaculture waste management namely Idaho Waste

Management Guidelines for Aquaculture Operations. A waste management plan is compiled of a diversity of best management practices (BMPs). It is an effective method to reduce or prevent pollution generated from aquaculture production facilities. The objectives of aquaculture waste management are to:

- Design, build, and maintain aquaculture facilities in a manner that works towards the elimination of the discharge of solids and nutrients to surface or groundwater.
- Operate aquaculture facilities in a manner that minimizes the creation of solids and nutrients while providing optimal fish-rearing conditions.
- Promote management of the collected biosolids as a resource, preferably in a manner that utilizes the available nutrients while minimizing the potential of the nutrients impacting surface or groundwaters.

Appropriate planning and maintenance are the means to excellent waste management and effluent water quality. Combinations of factors are considered in order to determine the optimum waste management system. These factors are available capital, site location and water supply, handling options and waste collection, operational practices, and additional regulations and permit requirements [5].

### ***3.2. Water Supply***

Water supplies generally are classified as groundwater or surface water, for example, the river, stream, irrigation return, and source well or spring. Aquaculture production is using both types of water supply. Surface waters frequently bring sediment and nutrient loads which are considered in addition to the wastes generated by the aquaculture facility. The settling areas can be well designed with the determination of total solids loads. Cyclic arrangement of waste production and removal also will be affected. A large enough area is normally needed to accommodate fish production and adequate waste management areas. Closeness to agricultural land available is an important criterion for the application of collected wastes. In summary, the quality and quantity of available water determines the type of aquaculture facility which can be operated, as well as the most suitable methods for managing wastes.

### ***3.3. Options in Waste Management***

Development of waste management options also depends on the volume of water flow. Aquaculture facilities with small flow volumes can consider options for solids removal, such as collecting solids in the quiescent areas at the end of the rearing areas and removing this waste to separate off-line basin(s), settling and removing solids from a separate basin that receives the full flow from the facility (full-flow settling (FFS)), settling of solids in the rearing area (in-pond settling), and use of constructed wetlands or alternative treatments.

Operations with large flows may have fewer options. The common option is to remove wastes collected in quiescent areas below production areas to off-line settling (OLS) basin(s). In order to maintain better effluent quality, it is important to remove biosolids from rearing areas as efficiently as possible. Settled waste products can be collected in designated zones at the ends of ponds for easy removal. Selection of one of the three basic methods of waste

collection relying on solids settling (full flow, in-pond, and quiescent/off-line) is facility dependent. It is based on several interrelated factors which are depth of the settling area, overflow rate ( $V_o$ ) in the settling area, waste particle size and density (sink rate), water retention time ( $R_t$ ), water velocity, and flow distribution [5].

### **3.4. Operational Practices**

The amount and composition of biosolids are related to the cropping method; the facility loading, or biomass, feed type, and practices; and the fish size. It is essential to maintain a schedule for biosolids cleaning or harvesting. Eventually, biosolids which have not been harvested will begin to biodegrade and create problems in removing and solubilizing nutrients into the receiving stream. In general, regularly settled biosolids harvesting is necessary to maintain efficient waste management system.

### **3.5. Waste Management Plan**

A waste management plan is important to minimize, collect, and dispose of pollutants generated in the operations. A good waste management plan normally involves effective best management practices (BMPs) to control the release of pollutants and helps to comply with waste management requirements and the maintenance of optimum effluent water quality. According to the US EPA [15], best management practices (BMPs) designed to minimize potential detrimental health and environmental effects that may result from aquaculture operations are primarily focused on adopting alternative waste disposal options, reducing pollutant levels in effluent, or reducing the volume of waste injected. At least the plan shall include:

- A description of procedures governing quality assurance and quality control for the information collected.
- A description of the solids handling and removal system components.
- A monitoring plan that evaluates the effectiveness of the overall system.
- A plan for a solids disposal or other approved uses of the harvested waste material, including seasonal options.
- Schedules for cleaning the various waste collection components.

### **3.6. Characterization of Waste, Waste Management Issues, and Quality of Water**

Waste produced in aquaculture is mainly related to the type, amount, and composition of feed fed. These wastes are composed of biosolids and soluble nutrients. Biosolids and nutrients discharged into surface waters may result in violations of water quality standards and unfavorably affecting designated beneficial uses of water.

#### **3.6.1. Biosolids**

Uneaten feed and feces are the main source of biosolids. Influent water, depending upon the quality and source, also can contribute to the total loading of solids (inorganic sediments). Particularly where surface waters are used, these solids can significantly contribute to the



burden of sludge removal and disposal. The major components of biosolids are amino acids, carbohydrates, fats, nondigestible fiber, phosphorous, proteins, and inert material. The amount of biosolids generated is highly variable and depends upon digestibility of feed ingredients, feed conversion efficiency, management practices, fish health, and quality of diet. It is very difficult to accurately estimate the total amount of biosolids generated, and even more difficult to separately calculate the amount of different waste components generated. Total biosolids are calculated on a dry basis. An individual fecal pellet is covered by a mucous sheath. The mucous sheath will remain intact if the pellet is removed soon after deposition. If left where deposited for an extended period of time, the scouring or swimming motion of the fish will cause the feces to break into smaller particles. These particles can become resuspended and contribute to the suspended solids (SS) and total suspended solids (TSS) in the effluent if not completely settled and removed prior to discharge. This phenomenon also occurs to the uneaten feed particles. Additionally, leaching of nutrients and decomposition will accelerate because of the smaller particles. Hence, the biosolids should be removed as rapidly as possible and ideally without unnecessary disturbance to the structure of the biosolids. Intact fecal pellets have a rapid settling velocity ( $V_s$ ) but, when broken into smaller particles, take much longer to settle out. The smaller particles require lower water velocities to settle out; thus, a larger settling area is required to provide an adequate area to reduce the water velocity [5].

### 3.6.2. Soluble Nutrients

The nutrients originate from nutrient leaching and fish excretion from the biosolids. Influent water, depending upon the quality and source, also can contribute to the nutrients on the farm. Chemical monitoring of the effluent is necessary. The biological and nutritional approach is based on measurements of nutrient retention efficiencies (NRE), apparent digestibility coefficients (ADC), and the quantity of uneaten feed [5]. Total soluble nutrients are calculated on a dry basis. The soluble nutrients include forms of nitrogen and phosphorus.

Feed is the main source of nitrogen, which specifically comes from dietary protein. Fish excrete nearly all waste nitrogen as ammonia and urea. Only a small amount is excreted with the feces [5]. As with nitrogen, feed is the main source of phosphorus, which is excreted in soluble and particulate forms. The form of phosphorus consumed by the fish will affect the amount of soluble and particulate phosphorus excreted. Phosphorus is available from the plant and animal ingredients used to formulate the diet. Feedstuffs of animal origin (bone meal, fish meal, and meat) contain the highest concentrations of phosphorus. Phosphorus from animal feedstuffs is most commonly used than from plant materials. From 60 to 70 % of phosphorus in plant material is unavailable to the fish and is passed out with the feces. Any surplus dietary phosphorus is largely excreted by the kidneys [5].

Castledine [4] provides factors which can be used to estimate the waste generated from salmonid culture based upon feed consumption (Table 15.1).

These factors assume a dry feed with 10 % moisture, with a digestibility of 80 %, and a feed conversion of 1.2.

**Table 15.1**  
**Factors to estimate the waste generated from salmonid culture.**  
*Source: DEQ [5]*

Component	Factor (multiply by amount fed)
Settleable and total suspended solids	0.3000
Settleable and suspended phosphorus	0.0054
Dissolved phosphorus	0.0022
Total phosphorus	0.0076
Settleable and suspended nitrogen	0.0064
Dissolved nitrogen	0.0317
Ammonia	0.0383

Based upon these assumptions, each pound fed will generate 0.136 kg (0.3 lb) of solids:

$$0.45 \text{ kg} \times 0.300 (\text{factor for TSS and SS}) (1 \text{ lb feed} \times 0.300)$$

If a trout farmer fed 45,359 kg (100,000 lb) of feed in a year, the estimated amount of waste produced would be:

$$45,359 \text{ kg} \times 0.3000 = 13,607 \text{ kg TSS and SS}$$

$$45,359 \text{ kg} \times 0.0076 = 344.72 \text{ kg of total phosphorus}$$

$$45,359 \text{ kg feed} \times 0.0383 = 1,737.24 \text{ kg of ammonia}$$

Knowledge of waste characteristics is essential in the design of a waste management system. A properly designed waste management system will not only be more efficient but also more cost-effective for the operator.

### 3.6.3. Chemical or Physical Parameters

Groundwater contamination is one of the impacts of bad disposal of aquaculture wastes. Good waste management and water stewardship are necessary in order to ensure the quality of water in receiving streams. While water quality on the farm affects the health and productivity of an aquaculture facility, the effluent water quality affects the health and productivity of the receiving waters. Table 15.2 below shows the minimum and maximum values for common water quality parameters in an aquaculture operation [5].

Some of the chemical or physical parameters having the greatest potential effect are dissolved gases, nitrogen, pH, phosphorus, sediment, and water temperature.

**Table 15.2**  
**Suggested water quality criteria for aquaculture hatcheries or production facilities (salmonid water quality standards with modifications for warm-water situations). Source: DEQ [5]**

Parameter	Upper limits for continuous exposure and/or tolerance ranges
Ammonia (NH <sub>3</sub> )	0.0125 mg/L (un-ionized form)
Carbon dioxide	0–10 mg/L (0–5 mg/L) <sup>a</sup>
Chlorine	0.03 mg/L
Copper <sup>b</sup>	0.006 mg/L (in soft water)
Mercury (organic or inorganic)	0.002 mg/L maximum, 0.00005 mg/L mean
Nitrate (NO <sub>3</sub> <sup>-</sup> )	0–3.0 mg/L
Nitrite (NO <sub>2</sub> <sup>-</sup> )	0.1 mg/L in soft water, 0.2 mg/L in hard water (0.03–0.06 mg/L nitrite–nitrogen)
Ozone	0.005 mg/L
pH	6.5–8.0 (6.6–9.0)
Phosphorus	0.01–3.0 mg/L
Total suspended solids	<80.0 mg/L
Total alkalinity (as CaCO <sub>3</sub> )	10–400 mg/L (50–400 mg/L) <sup>a</sup>
Total hardness (as CaCO <sub>3</sub> )	10–400 mg/L (50–400 mg/L) <sup>a</sup>
Zinc	0.03 mg/L

Many freshwater species are grown in waters with salinity (1–3 ppt.), but low salinity can interfere with maturation and/or reproduction of species such as black bass (after Conte, 1992).

<sup>a</sup>Warm water situations.

<sup>b</sup>Copper at 0.005 mg/L may suppress gill adenosine triphosphate (ATP) and compromise smoltification in anadromous salmonids.

## Dissolved Gases

The dissolved gases that are normally found in highest concentrations in water are nitrogen and oxygen. This is mainly due to their relative abundance in the atmosphere. At equilibrium, freshwater contains approximately twice the amount of nitrogen as oxygen because of their differing atmospheric partial pressures and solubilities. Higher dissolved gases in an aquacultural environment require removal through very costly additional water treatment. Aquatic animals need oxygen to live therefore oxygen is absolutely the most important dissolved gas in an aquatic environment. Dissolved oxygen (DO) is produced through photosynthesis by aquatic plants and used during respiration by aquatic animals and plants. Aquatic animals require sufficient levels of DO in rearing areas to maintain health and growth. Table 15.3 shows DO concentrations, at equilibrium, for various temperatures and elevations in freshwater [5].

Dissolved oxygen concentrations in an aquaculture operation are depleted by aquatic animal respiration and chemical reactions with organic materials such as dead fish or plant matter, feces, and wasted feed. Limited replenishment of depleted oxygen is attained by

**Table 15.3**  
**Commonly observed temperature and dissolved oxygen operating ranges. Source: DEQ [5]**

---

Water temperature	
<i>Rainbow trout ranges</i>	
0.5–25.5 °C	Tolerance range
10.0–15.5 °C	Optimal rearing range
8–12.0 °C	Preferred egg development range
<i>Catfish temperature ranges</i>	
30.0–32.0 °C	Optimal rearing range
33–37.0 °C	Lethal maximum limit
21.0–29.0 °C	Normal spawning range
26.0 °C	Optimal spawning temperature
Dissolved oxygen	
<i>Limits of DO concentration for rainbow trout:</i>	
<3.0 mg/L	Lethal if exposure lasts longer than a few hours
4.0–7.0 mg/L	Normal hatchery ranges
>7.0 mg/L	Optimum
<i>Limits of DO for catfish:</i>	
<1.0 mg/L	Lethal if exposure lasts longer than a few hours
1.0–5.0 mg/L	Fish survive, but reproduction is poor and growth is slowed if exposure is continuous
>5.0 mg/L	Fish produce and grow normally

---

occasionally breaking up the water column and exposing the water to the atmosphere. Common techniques used for this purpose in an aquaculture facility are gas-powered mechanical aerators in pond system boards or screens in a flow-through pond system or splash electric. Other factors may also influence DO levels in an aquaculture facility. Aquatic plants can reduce DO levels during respiration at night. Aquaculture facilities with surface water sources can be adversely affected during these periods by the reduced available DO levels. This is in particular happening for warm-water aquaculture facilities, where water temperature limits the amount of oxygen present. Biochemical oxygen demand (BOD) and nitrification from bacteria and other microorganisms acting on organic matter also reduce oxygen levels, particularly if solid wastes are permitted to gather in rearing areas. Nearly all aquatic organisms can live on short periods at low oxygen levels, but prolonged exposure to low oxygen levels can harm organisms not adapted for such conditions. Furthermore, low oxygen levels can result in the release of nutrients stored in sediments. Continual periods of depletion can cause indigenous aquatic organisms to die and/or be replaced by a few specialized organisms tolerant of low oxygen levels, such as an anaerobic microorganism.

Dissolved nitrogen does not generally cause problem in aquaculture as normal concentrations lie at or below 100 % of saturation. However, at supersaturation levels exceeding 102 %, dissolved nitrogen can induce gas bubble disturbance in fish [5].

**Table 15.4**  
**Percent of total ammonia which is un-ionized in aqueous solutions at different pH values and temperatures. Source: DEQ [5]**

pH	Temperature (°C)									
	8	10	12	14	16	18	20	22	24	26
6.4	0.04	0.05	0.05	0.06	0.07	0.09	0.10	0.12	0.14	0.16
6.6	0.06	0.07	0.09	0.10	0.12	0.14	0.16	0.18	0.22	0.25
6.8	0.10	0.12	0.14	0.16	0.19	0.22	0.25	0.29	0.34	0.40
7.0	0.16	0.19	0.22	0.25	0.29	0.34	0.40	0.46	0.52	0.60
7.2	0.25	0.29	0.34	0.40	0.47	0.54	0.63	0.72	0.82	0.95
7.4	0.40	0.47	0.54	0.63	0.74	0.85	0.99	1.14	1.30	1.50
7.6	0.63	0.74	0.86	1.00	1.16	1.35	1.56	1.80	2.05	2.35
7.8	1.00	1.16	1.36	1.58	1.83	2.12	2.44	2.82	3.21	3.68
8.0	1.57	1.83	2.13	2.48	2.87	3.31	3.82	4.39	4.99	5.71
8.2	2.46	2.87	3.34	3.87	4.47	5.15	5.92	6.79	7.68	8.75
8.4	3.84	4.47	5.19	5.99	6.91	7.93	9.07	10.30	11.70	13.20
8.6	5.96	6.91	7.98	9.18	10.50	12.00	13.70	15.50	17.30	19.40
8.8	9.12	10.50	12.10	13.80	15.70	17.80	20.00	22.50	24.90	27.60
9.0	13.80	15.68	17.78	20.30	22.75	25.30	28.47	31.23	34.44	35.76

## Nitrogen

Nitrogen usually presents in several forms in the aquatic environment. Nitrite and ammonia are the biggest concern to aquaculturists. Ammonia is a direct by-product of aquatic animal metabolism and in the biodegradation of organic matter. Ammonia is a gas which dissolves in water to form ammonium ion ( $\text{NH}_4^+$ ) and un-ionized ammonia ( $\text{NH}_3$ ) which is lethal or harmful to aquatic organisms. This toxicity is greater at higher pH and temperature. When un-ionized ammonia levels exceed 0.0125–0.025 mg/L, growth rates of rainbow trout are reduced, and damage to liver, kidney, and gill tissue may occur [5]. The proportion of total ammonia in un-ionized form is shown in Table 15.4 at varying temperatures and pH levels, along with sample calculations for estimating un-ionized ammonia fractions [5].

*Example of calculation:* Find the concentration of un-ionized ammonia if total ammonia was measured at 1.0 mg/L at 14 °C and a pH of 8.0.

**% un-ionized at 14, pH 8.0 = 2.48**

**TAN 1.0 mg/L × 0.0248 un-ionized = 0.0248 mg/L un-ionized ammonia**

Nitrite ( $\text{NO}_2^-$ ) is an intermediate result in nitrification process, i.e., conversion of ammonia to nitrate ( $\text{NO}_3^-$ ). It is highly toxic to freshwater fish. However, nitrite is not considered to be a problem in most flow-through rearing systems as nitrification usually will not occur in the amount of time water is retained [5]. Nitrate can also be present in source water and is generally harmless to aquatic animals.

**Table 15.5**  
**Percent availability**  
**of phosphorus in**  
**common feedstuffs.**  
*Source: Ramseyer*  
**and Garling [9]**

Ingredient	Salmonid	Catfish	Carp
Blood meal	81		
Brewer's yeast	79–91		93
Feather meal	77		
Poultry by-product meal	81		
Anchovy meal		40	
Herring meal	52		
Menhaden meal	87	39	
Rice bran	19		25
Wheat germ	58		57
Wheat middlings	32	28	
Ground corn		25	
Dehulled soybean meal	36	29–54	

## pH

pH is defined as the negative logarithm of hydrogen ion concentration in water. pH shows alkalinity and acidity level of a given water sample. The ability of water to resist changes in pH (buffering), generally resulting from the presence of dissolved salts of carbonic acid. Aquatic organisms may be harmed when pH values lie beyond the normal range in the environment. Photosynthetic activity of aquatic plants in inadequately buffered waters may cause wide diurnal variations of pH in natural surface waters. pH rises when these plants use free carbon dioxide and some bicarbonate ions during daylight hours. Vice versa, pH decreases at night during aquatic respiration, because the respired carbon dioxide becomes a weak acid in water.

## Phosphorus

Phosphorus is an essential nutrient for the growth of aquatic plants. However, excessive amounts of phosphorus can unhinder growth of aquatic plants. In nature, available phosphorus in aquaculture can contribute to the growth of annoyance levels of aquatic plants in receiving waters and enhance the natural eutrophication processes. Phosphorus in aquatic animal feeds at levels above nutritional requirements will be discharged in urine and solid fecal wastes. The main part of this excreted phosphorus is found in the solids. Systems designed to facilitate frequent solids removal from the rearing environment, along with good management practices optimizing feed utilization while minimizing feed waste, should help reduce phosphorus contribution to receiving waters. Alternate methods of phosphorus treatment may be suitable under certain sets of conditions. Percent availability of phosphorus in common feedstuffs is as shown in Table 15.5 [9].

## Sediment

Fecal and feed solids (biosolids) and inorganic and organic sediments are the main form of sediments found in an aquaculture operation from source waters. Sediments discharged into receiving waters can unfavorably affect habitat and can change the abundance and types of

species of that habitat. The main concern is the biosolids generated during the production of aquatic animals. The oxidation of this organic solid reduces DO levels and results in the emission of dissolved nutrients. In addition, solids suspended in rearing areas can affect fish health and may lead to conditions such as environmental gill disease [5]. Solids are much easier to remove from the aquaculture operation prior to effluent discharge compared to the dissolved components of waste, such as ammonia and phosphorus. Good aquaculture waste management program emphasizes the prompt attention to a regular program of solids removal, facility design that maximizes solids removal efficiency, and feeding practices that minimize wasted feed and solids accumulation.

### Temperature

The types of organisms that can live in aquatic habitats are also influenced by temperature variations. Salmonids and other cold-water biota need specific temperatures for maintenance and reproduction; water temperatures which vary radically or move beyond optimal range can affect the production, changing waste generation and spreading of disease. Catfish, tilapia, and tropical fish are produced using warm-water wells or hot springs [5]. If the warm water is not cooled before being discharged, it could increase temperatures in the stream or any receiving waters.

#### 3.6.4. *General Characteristics of Aquaculture Effluent by the US EPA*

According to the US EPA [15], the primary components in waste from aquaculture operations are suspended and dissolved solids, phosphorus-based nutrients, and nitrogen-based nutrients. The factors that influence the concentration of these components in the effluent are feeding efficiency, the practice of low-intensity or high-intensity aquaculture, type and size of organisms involved, the water management systems, wastewater management systems, etc. Another additional constituent in the effluent is human pathogens or bacteria. Pathogenic bacteria in fish and wastewater from aquaculture operations are listed in Table 15.6 [15]. These bacteria are influenced by the type of operation and organism cultivated.

Samples from Sea Life Park, Hawaii, were taken to show the presence of microbial content in aquaculture operations. Tables 15.7 and 15.8 exhibit the list of the content [15]. However, different aquaculture operation has different content of microbial presence.

The concentration of additives, chemicals, and pesticides used in aquaculture operation is different depending on culture intensity (e.g., organism density), operation type, species raised, and water quality. The levels of these constituents in wastewaters are expected to be different.

#### 3.6.5. *Additives, Chemicals, and Pesticides*

There are guidelines on the use of drugs in aquaculture operations. The common antibiotics approved by the US EPA are sulfamerazine, sulfadimethoxine-ormetoprim, and oxytetracycline, but other antibiotics also can be used under the new regulation of the Food and Drug Administration (FDA) [15]. Fish hormones are common components used to increase the

**Table 15.6**  
**Human pathogenic bacteria found in fish and water at aquaculture operations. Source: US EPA [15]**

Pathogen	Possible effect on humans	Infection route
<i>Salmonella</i> sp.	Food poisoning	Ingestion
<i>Vibrio parahaemolyticus</i>	Food poisoning	Ingestion
<i>Campilopacter jejuni</i>	Gastroenteritis	Ingestion
<i>Aeromonas hydrophila</i>	Diarrhea/septicaemia	Ingestion
<i>Plesiomonas shigelloides</i>	Gastroenteritis	Ingestion
<i>Edwardsiella tarda</i>	Diarrhea	Ingestion
<i>Pseudomonas aeruginosa</i>	Wound infection	Dermal
<i>Pseudomonas fluorescens</i>	Wound infection	Dermal
<i>Mycobacterium fortuitum</i>	Mycobacteriosis	Dermal
<i>Mycobacterium marinum</i>	Mycobacteriosis	Dermal
<i>Erysipelothrix rhusiopathiae</i>	Erysipeloid	Dermal
<i>Leptospira interrogans</i>	Leptospirosis	Dermal

**Table 15.7**  
**Aquaculture injectate characteristics, Sea Life Park, Hawaii. Source: US EPA [15]**

Parameter	Average	Range
Ammonia (NH <sub>3</sub> ) (mg/L)	0.22	0.09–0.45
Nitrate and nitrite (mg/L)	1.46	1.31–1.75
Total nitrogen (mg/L)	2.45	1.45–3.48
Total phosphorus (mg/L)	0.22	0.18–0.31
Oil and grease (mg/L)	<10.0	All samples <10.0
Dissolved oxygen (mg/L)	6.33	6.14–6.48
pH	7.61	7.59–7.65
Temperature (°C)	25.9	25.9–26.0
Total coliform (colonies/100 mL)	–	12–TNTC
BOD <sub>5</sub> (mg/L)	<1.0	All samples <1.0
Total residual chlorine (mg/L)	None detected	None detected
Total suspended solids (mg/L)	3.35	2.86–4.28
Total dissolved solids (mg/L)	38,150	36,450–38,950
Turbidity (NTU)	0.28	0.21–0.33
Chloride (mg/L)	18,475	18,400–18,500



**Table 15.8**  
**Comparison of aquaculture injectate parameters to drinking water standards and health advisory levels. Source: US EPA [11, 15]**

Constituent	Primary drinking water standards and health advisory levels			Nearest value or exceedence in known injectate (mg/L except where noted)	Operation
	Primary MCL (mg/L except where noted)	Secondary MCL (mg/L except where noted)	HAL-noncancer lifetime (mg/L)		
Ammonia			30 (draft advisory)	1.2	Marine Shrimp Farm, HI
Nitrate (as N)	10			1.34	Ten Springs Farm, ID
Nitrite (as N)	1			–	–
Nitrate and nitrite (as N)	10			1.75	Sea Life Park, HI
Total dissolved solids		500		39	Sea Life Part, HI
pH (pH units)		6.5–8.5		7.59–7.65	Sea Life Paik, HI
Turbidity (NTU)	0.5–1.0			150	Freshwater fish farm, HI
Chloride		250		18,500	Sea Life Part, HI
Total coliform (colonies/100 ml)	Repeated detection <sup>a</sup>			12–TNTC <sup>b</sup>	Sea Life Park, HI

<sup>a</sup>No more than 5 % of samples collected during a month may be positive for coliform.

<sup>b</sup>Too numerous to count.

production of fish. Products such as FDA-approved color additives, carotenoids, are used on farmed salmon and trout to produce a pink/orange flesh [15]. In addition, vitamins and minerals are also used in the dietary of the fish. Drugs approved by the FDA for use in aquaculture, as well as drugs of low regulatory priority at FDA, are listed in Attachment [15].

The use of numerous algacides, fish toxins, and herbicides and also biologics is common in aquaculture operations to maintain the health of the fish and other organisms cultivated. The lists of these components are given in Attachment which is in accordance to US EPA regulations [15]. Some of the chemicals are not used in closed systems and only some are prevented from being in wastewater. Furthermore, herbicides are usually used in large water bodies that support open aquaculture operations. Pesticides and drugs regulated by the FDA and the US EPA that are likely to be present in the effluent of some aquaculture operations and could conceivably be present in current and future aquaculture operation are summarized in Table 15.9 below [15].

**Table 15.9**  
**Possible chemical contaminants in aquaculture effluent. Source: US EPA [15]**

---

*FDA-approved drugs*

Used as additives to tank water (likely to be in effluent in some operations):

Tricaine methanesulfonate	Sulfadimethoxine and ormetoprim
Formalin	Sulfamerizine

Oxytetracycline

Used as solutions into which fish are dipped briefly (may be disposed of via wastewater disposal system):

Acetic acid	Providone iodine compounds
Calcium oxide	Sodium bicarbonate
Fuller's earth	Sodium sulfite
Magnesium sulfate	Urea
Papain	Tannic acid

*Drugs of low regulatory priority for FDA used in aquaculture*

Generally used as additives to tank water (could be present in effluent in some operations):

Calcium chloride	Potassium chloride
Hydrogen Peroxide	Sodium chloride

*USEPA-registered pesticides for aquaculture*

Algacides, generally added to tank water (likely to be present in effluent if some operations, but in instances of high BOD, copper compounds are likely to be complexed with suspended organics, and thus may become biologically unavailable):

Chelated copper	Elemental copper
Copper (inorganic compounds)	Copper sulfate pentahydrate
	Endothall

Herbicides, possibly used as additives to some tanks (may be present in the effluent from some operations):

Acid blue and acid yellow	Diquat dibromide
Dechlorobenzil	Glyphosate

Fish toxins, generally added to tank water (likely to be present periodically in effluent of some operations but not likely in tank or raceway systems):

Antimycin
Rotenone

---

#### 4. DESIGN CRITERIA OF AQUACULTURE SYSTEM

The combination of different system components and design criteria is needed in order to develop efficient facilities which could comply with the effluent standards. The compliance to the NPDES permitted discharge limits depends on many factors such as the design, water source, species raised, water use, equipment, and fish diet and with conscientious operation of the aquaculture facilities when properly managed. Good system components and design criteria will minimize solids and nutrients in the effluent. An effective operation and

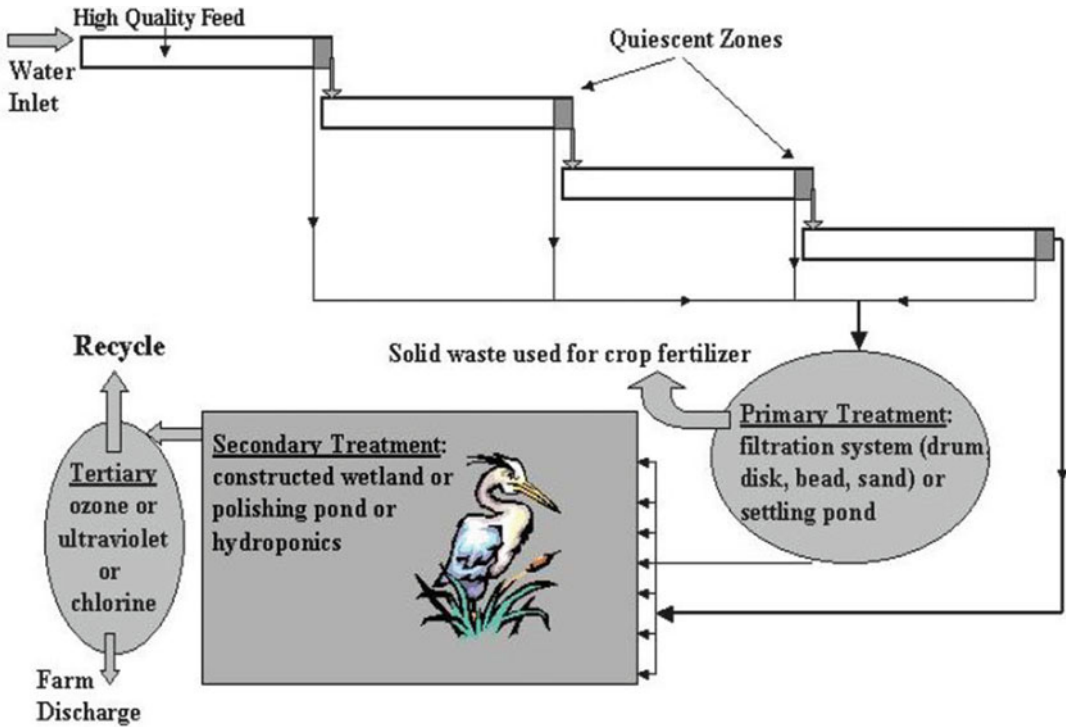


Fig. 15.1. Common raceway design. Source: Miller and Semmens [8].

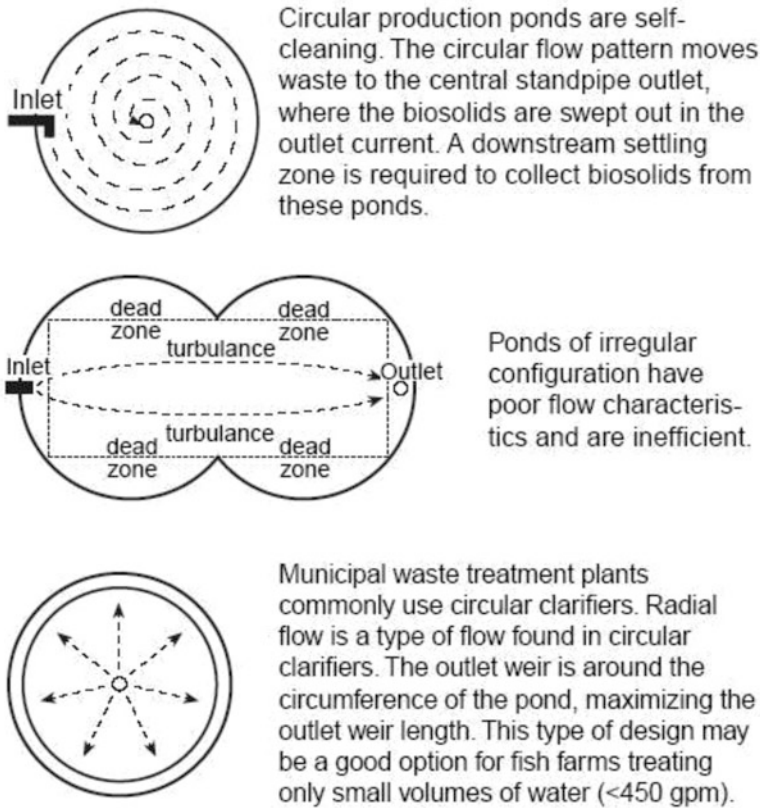
maintenance of a waste management system is able to capture nutrients and solids, record solids removal, remove solids frequently, and meet applicable regulations and standards. An example of a common cross section raceway design is shown in Fig. 15.1 [8].

#### 4.1. Criteria of Solids Removal

As much as possible solids have to be removed due to their significant impact to the environment. Removal of solids will influence phosphorus and, to a lesser extent, nitrogen control. Solids which are not removed may cause turbid waters and streambed drops instantly below the aquaculture facility. Removal of waste solids from the settling areas is the key to efficient solids management. Devastation of the particles speeds up leaching of nutrients and reduces particle settling [5].

##### 4.1.1. Settling Velocity, $V_s$

The settling velocity ( $V_s$ ) of a particle is expressed as meters per day (m/d), feet per second (ft/s), or centimeters per second (cm/s). Aquaculture biosolids are discrete particles [5]. Their specific gravity and size affects the variation of  $V_s$  values. Fecal casts are heavy and will have a  $V_s$  of 0.02–0.05 m/s (0.066–0.164 ft/s), but fine, lighter particles will range from 0.000457 to 0.000914 m/s (0.0015–0.0030 ft/s) [5]. Different aquaculture feeds produce biosolids with



**Fig. 15.2.** Flow characteristics of non-rectangular ponds. *Source:* DEQ [5].

variable  $V_s$  values. Particles in ponds are larger and will settle to the bottom rapidly [5]. However, particles that are passed through vacuum heads, pumps, and pipes become smaller and require larger areas for settling.

#### 4.1.2. Overflow Rate, $V_o$

Determination of the size or surface area necessary for discrete particle settling can be determined by comparing  $V_s$  values to overflow rate ( $V_o$ ). Overflow rate or hydraulic load is expressed as  $Q/A$ , where  $Q$  = volume of flow per unit of time and  $A$  = surface area. Overflow rate is expressed as centimeters per second (cm/s), feet per second (ft/s), feet per minute (ft/m), feet per day (ft/d), or meters per day (m/d). The surface area of the settling zone is sufficient for settling of the discrete particles if  $V_s$  is greater than  $V_o$ . The use of the  $V_s$  and  $V_o$  relationship to determine the surface area required for a settling zone is as shown in Example 1. Rectangular-shaped settling zones encourage laminar flow. Irregular shapes do not, nor are they efficient for particle settling (Fig. 15.2) [5]. Oversized settling zones help ensure solids removal fulfillment.

*Example 1: Settling zone size.* What size of settling zone would be required given the following?

Given  $V_s = 0.000457 \text{ m/s}$  ( $0.0015 \text{ ft/s}$ ) and  $Q = 0.028 \text{ m}^3/\text{s}$  ( $1.0 \text{ ft}^3/\text{s}$ ), then  $V_o$  must be  $< 0.000457 \text{ m/s}$ .

Since  $A = Q/V$ ,  $A = 0.028 \text{ m}^3/\text{s} \div 0.000457 \text{ m/s}$ , and  $A = 60 \text{ m}^2$ .

Double this to compensate for real-world conditions,  $2A = 120 \text{ m}^2$ .

Therefore the minimum size needed for this settling zone is **6 m wide by 20 m long**.

(Note that dimensions may vary as long as the total area is at least  $120 \text{ m}^2$ ).

#### 4.1.3. Retention Time and Storage Volume

Retention time is expressed as the volume of the settling zone divided by the rate of flow. It is not directly related to solids settling but is essential in determining the capacity of a settling zone. Normally a depth of 0.91–1.82 m (3–6 ft) provides adequate storage volume for solids from most aquaculture operations after the determination of the desired surface area relative to the  $V_s$  and  $V_o$  ratios [5]. By applying frequent harvest of the solids, deep ponds which are more difficult to build, maintain, and harvest are usually not needed. The amount of solids produced depends primarily on the amount of feed used and the feed conversion efficiency. Dry weight is used in the calculations for conversions, by-products, and weight gain. By-product and settling zone volume calculations representative of values for trout culture is as shown in Examples 2 and 3 [5].

*Example 2: How much by-product solids will 453 kg (1,000 lb) of feed generate?.* Fish feed is typically 92 % dry, so  $453 \text{ kg} \times 0.92 = 416.76 \text{ kg dry weight}$ .

(At a 1.3 conversion rate, this amounts to a fish weight gain of  $416.76 \text{ kg}/1.3$  or  $320 \text{ kg}$ .)

Fish are typically 26.15 % dry weight, so  $320 \text{ kg} \times 0.2615 = 83.83 \text{ kg fish dry weight}$ .

At 70–80 % feed digestibility, the amount used for maintenance of heat and energy is

$$142.88 - 183 \text{ kg maint.}$$

Of the dry feed weight, excreted solubles account for approximately **40.82 kg dry feed weight**.

Assuming no feed waste, the total solids by dry feed weight generated from 453 kg of feed is

$$416.76 \text{ kg} - 83.91 \text{ kg} - 142.88 \text{ to } 183 \text{ kg} - 40.82 \text{ kg} = 108.86 \text{ to } 149.68 \text{ kg of solids by dry feed weight.}$$

*Example 3: How much settling zone volume is required to accommodate 149.68 kg (330 lb) dry weight of by-product?.* Solids in the settling zones are typically with 82 % moisture, so  $149.68 \text{ kg}/0.18 = 831.55 \text{ kg wet weight}$ .

One liter weighs 1 kg, so  $831.55 \text{ kg}/1 \text{ kg/L} = 831.55 \text{ L}$ .

One cubic meter contains 1,000 L, so the amount of settling volume required to hold the equivalent of 149.68 kg of dry weight is  $831.55 \text{ L}/1,000 \text{ L/m}^3 = 0.831 \text{ m}^3$ .

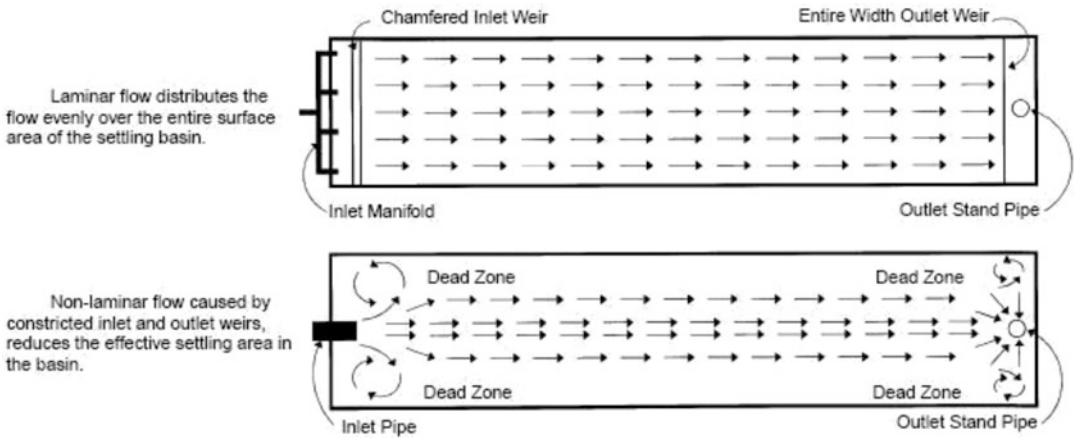


Fig. 15.3. Laminar flow. Source: DEQ [5].

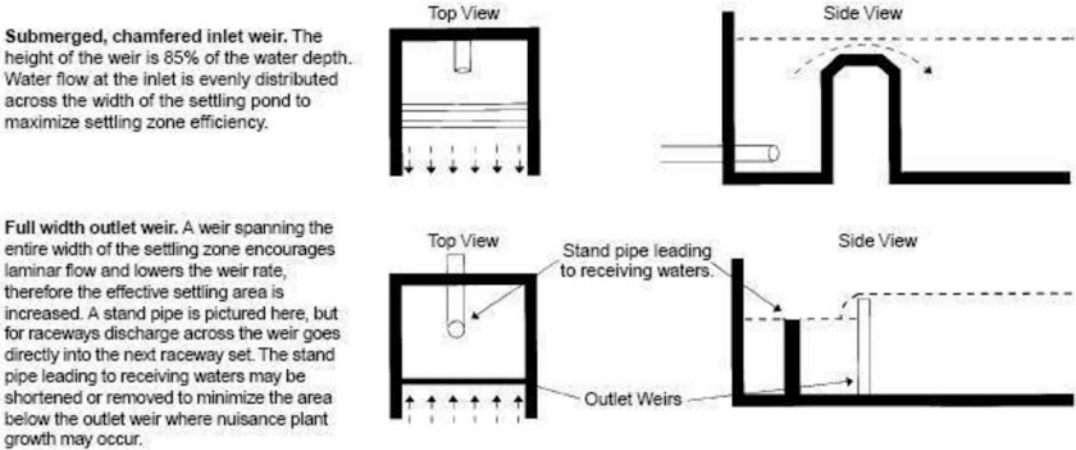


Fig. 15.4. Ideal weir design. Source: DEQ [5].

4.1.4. Laminar Flow

Laminar flow is referred as the flow distributed evenly over the entire surface area (Fig. 15.3). It is required for the better performance of a settling zone. Larger settling zones are required if scouring or short-circuiting takes place due to uneven current patterns. Laminar flow can be achieved when appropriate ways for water influent and effluent are designed.

Figure 15.4 demonstrates an ideal weir design. The objective is to allow water to enter and leave the settling pond in ideal condition with as little turbulence and as slow a current as possible. The height of the influent weir is normally 85 % of the water depth. Turbulence, scouring, and updraft currents will reduce the effectiveness of the settling zone (Fig. 15.5). Water entering or leaving on the side of a pond will short-circuit laminar flow or cause a

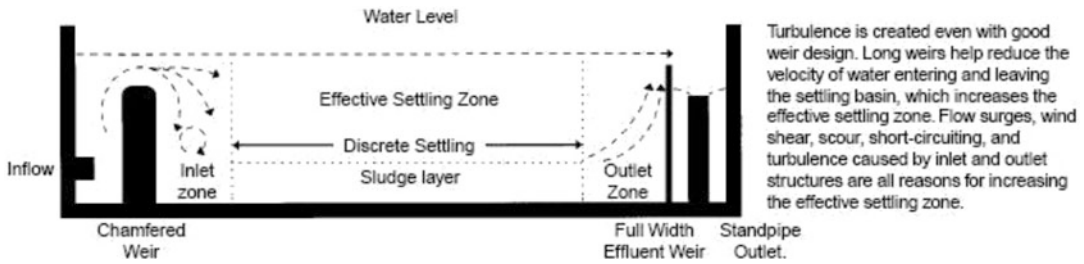


Fig. 15.5. The effective settling zones. Source: DEQ [5].

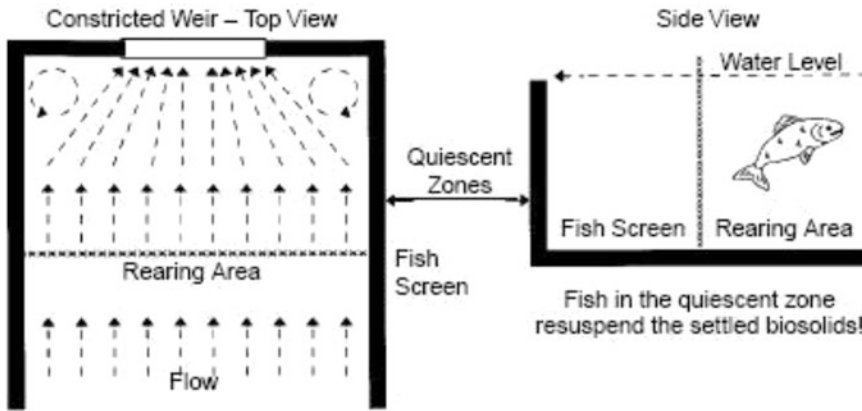
crosscurrent and reduce the effectiveness of the settling zone. Short-circuiting is also caused by irregular pond shapes.

Weir rate is  $Q/L$ , where  $Q$  = the volume of flow per unit of time and  $L$  = the length of the weir. Weir rate is expressed as meter cube per day per meter of length ( $\text{m}^3/\text{day}/\text{m}$ ). Overflow weir rate should be less than  $121 \text{ m}^3/\text{day}/\text{m}$  for fine particulate solids ( $V_s$  of  $0.000457\text{--}0.000914 \text{ m/s}$ ) [5]. Weir rates much greater than this will cause the velocity of the discharged water to speed up dramatically, increasing updraft and scouring. For larger solids with  $V_s$  values from  $0.02$  to  $0.05 \text{ m/s}$ , weir rate can be much higher at  $916\text{--}1,703 \text{ m}^3/\text{day}/\text{m}$  [5]. A long weir is desirable as it creates slowest water velocity across the weir. The most common efficient design is a rectangular settling pond with the weirs on the long sides of the pond. However, longer weir must be balanced due to their reduced water depth. If water depth across a weir is too shallow, moss growth on the weir, debris, or wind may occur which will prevent flow across some of the weir length. Wind also can cause serious short-circuiting which is speed of only  $1.78 \text{ m/s}$  can induce a surface current with a speed of  $0.0365 \text{ m/s}$ , greater magnitude than desired pond velocities or  $V_o$  values [5]. Screens which separate the fish in the rearing area from the quiescent zones (QZs) will create turbulence as water passes through the screen, diminishing the efficiency of the QZ.

#### 4.1.5. Oversizing Settling Zones

There are some additional reasons to build oversized settling zones besides turbulence from weirs, screens, and wind. Fish that may escape into the settling area results resuspension of biosolid particles. Scour may be caused by the surging of flow and should be minimized. Vacuuming and other work activities can cause resuspension of particles. Release of gases from microbial action may float the particles together with the gas bubbles. Doubling the surface area provides an adequate buffer to compensate for most of the effects which can reduce settling efficiency once the surface area requirement for a settling zone has been established relative to  $V_s$  and  $V_o$  values. Determination of the settling zone area is through the use of the following  $V_s$  values [5]:

- $0.000457 \text{ m/s}$  for OLS ponds
- $0.003962 \text{ m/s}$  for FFS ponds
- $0.009449 \text{ m/s}$  for QZs



**Fig. 15.6.** A constricted weir causes turbulence and scouring of settled biosolids. Quiescent zone length should be increased to compensate for the reduced efficiency of the settling zone. *Source:* DEQ [5].

## 4.2. System Components of Solids Removal

The solids collection system is the most important physical component for minimizing the solids and nutrients escaping in effluent.

### 4.2.1. Quiescent Zones

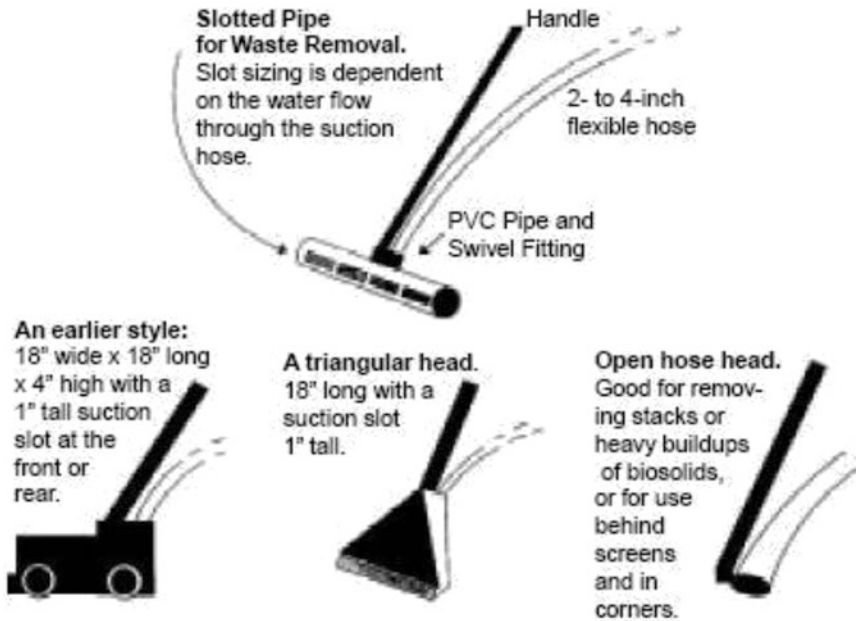
Quiescent zones (QZ) are the main areas where solids are collected and located on downstream of the rearing area and are devoid of fish. It is depicted in Fig. 15.6. It allows biosolids to settle unhindered while intact and large in size. This facilitates biosolids removal from the hatchery flow. It is necessary that each last-use rearing unit contain a QZ so biosolids can be settled before effluent water from the facility is discharged.

The dimension of quiescent zones must be adequate to ensure that  $V_o$  values are smaller than the  $V_s$  values of the particles to be collected. The accepted range of  $V_s$  values for biosolids in raceways is 0.00945 m/s to 0.05 m/s, so the dimensions of QZs should provide a  $V_o$  value smaller than 0.00945 m/s [5]. A large amount of settling occurs in the rearing area as solids slowly move downstream and resettle in the QZ. The opportunity for particles to start settling prior to the QZs makes these zones very efficient for settling particles found in the fish-rearing area. The most common depth for a raceway rearing area and QZ is 0.91 m, although depth is not critical to the efficient operation of the QZ [5].

### 4.2.2. Solids Harvest from Quiescent Zones

Figures 15.6 and 15.10 show the typical QZs. Once the solids are settled in the QZs, they are removed and transported to off-line settling (OLS) ponds. Vacuuming is the most common method of solids removal from QZs, as shown in Fig. 15.7. Typically, stand pipes in each QZ connect to a common 150–200-mm PVC pipe which carries the slurry of water and solids to the off-line destination [5]. Suction is provided by head pressure from pond water depth and by gravity or by pumps. Flexible hose and a swivel joint are used to connect the vacuum head





**Fig. 15.7.** Vacuum removal of solids: the solids that are collected are pumped or gravity-flowed to the off-line settling pond. *Source:* DEQ [5].

to the PVC standpipes to clean the QZ. Slurry transport pipes and pumps should be adequate in size to carry the required flow and provide adequate suction at the vacuum head. Insufficient vacuuming will resuspend solids and will increase the time required to clean a QZ. One hundred gpm is desirable to operate a 300–450-mm-wide vacuum head [5]. Generally, the operating labor investment in solids removal can exceed 25 % of the total farm labor [5].

Sufficient slope of the pipes is necessary in order to offer cleaning velocities and remove stagnant areas. Sloping the QZ floor towards the stand pipe or suction port adds to the cost of construction but enhances the efficiency of solids collection and removal. The standpipe to the off-line destination may be removed and the solids can be pushed with a broom or squeegee device to the suction. Solids removal is more rapid when high water flows through the solids suction port. Larger QZs can be divided into several smaller QZs which can be harvested individually as shown in Fig. 15.8. Quiescent zones should be cleaned as frequently as possible.

When left too long in QZs, removing the solids may be difficult. Anaerobic conditions may develop and cause resuspension of solids by anaerobic gases. Frequent harvest is preferable and benefits fish health in downstream rearing units. Frequent cleaning of QZs will protect receiving waters.

#### 4.2.3. Alternate Quiescent Zone Designs

There are many alternatives in QZ designs for frequent solids removal [5]. Some QZs which have floors 0.6–1.2 m (1–2 ft) lower than the rearing unit floor were originally designed to provide storage capacity for solids. However, due to frequent harvest of QZ nowadays, the

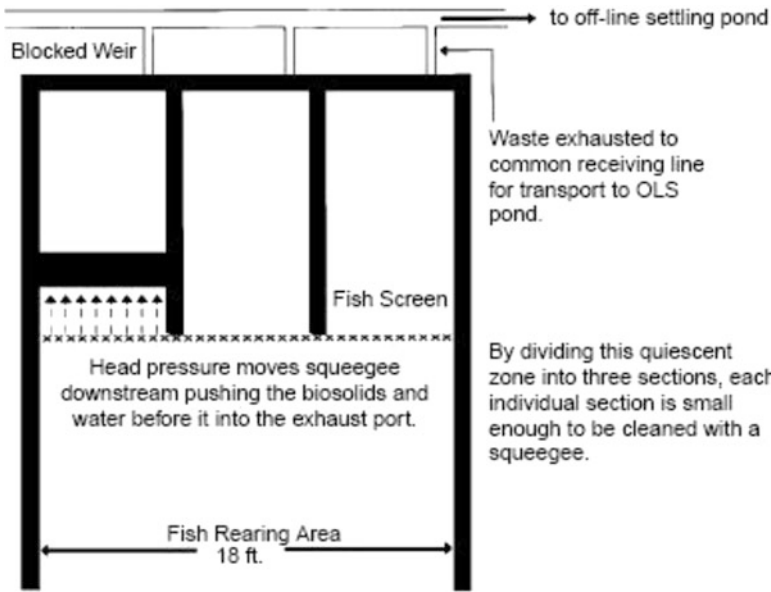


Fig. 15.8. An alternative cleaning method—“subdividing quiescent zones.” Source: DEQ [5].

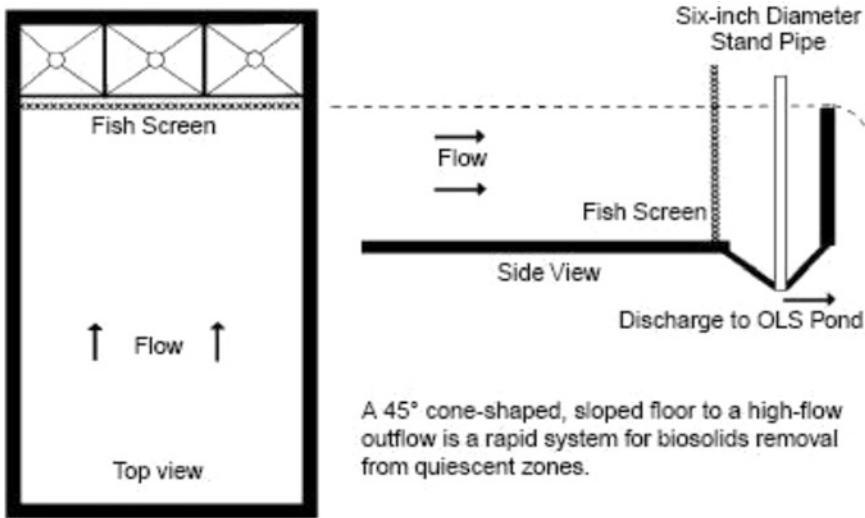
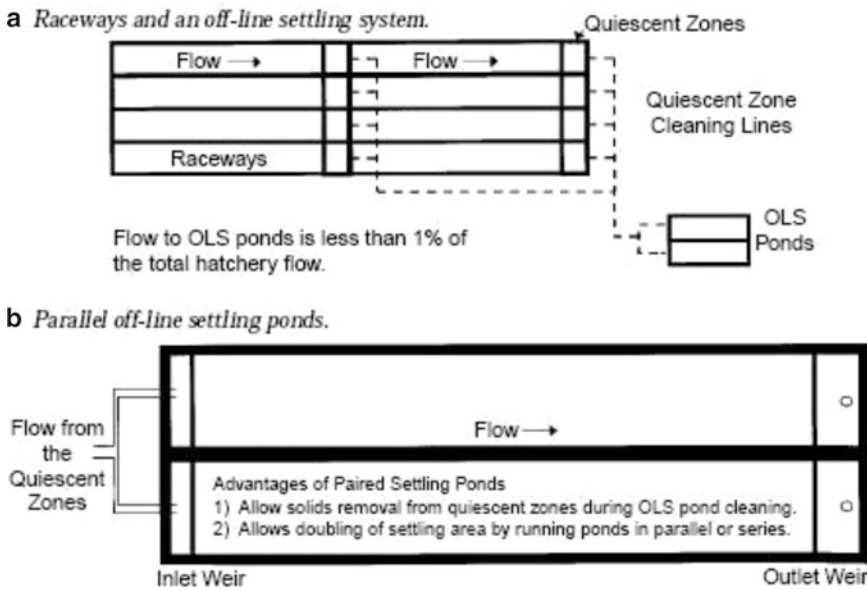


Fig. 15.9. Quiescent zone with a sloped, recessed floor. Source: DEQ [5].

storage capacity is no longer needed. While they may increase storage capacity, enhance solids removal, and save labor. The advantages they offer in collection or in separating solids from outflow weir entrainment may not be great if  $V_o$  values and the frequency of solids removal are already adequate. If adequate suction, floor slope, and proper dimensions are available, quiescent zones with recessed floors or those sloped to a center off-line exhaust port work very well and are labor efficient (Fig. 15.9).



**Fig. 15.10.** Off-line settling ponds. (a) Raceways and an off-line settling system. (b) Parallel off-line settling ponds. *Source:* DEQ [5].

Cones, v-shaped troughs, and perforated false floors and pipes were designed so that a valve could be opened. A strong suction is required to move the heavy, sticky solids, and only those very close (within 12 in.) to the suction port. A 450-mm-wide by 2.54-cm-high vacuum head requires at least 6.3 L/s to pick up solids with which it has direct contact [5]. This type of design reacts much differently than a QZ floor sloped 45° to a 150-mm stand pipe, a system which will pull 25.23 L/s of flow with 1.2 m (4 ft) of head pressure (Fig. 15.9) [5]. Separator plates are the closely spaced, thin, vertical, or inclined plates which span QZs from side to side and from a few inches below water level to several inches above the floor. Various designs are under consideration to improve solids collection in QZs, but because QZs in most ponds for fish larger than fingerlings are from 3.048 to 5.48 m wide, the plates tend to be expensive and require some structural integrity [5].

#### 4.2.4. Off-Line Settling Ponds

Off-line settling (OLS) ponds are settling zones that obtain the water and solids slurry removed from QZs and rearing areas. These zones are depicted in Fig. 15.10. These ponds are the second settling zone in the solids collection system. Quiescent zones in combination with OLS ponds include the most commonly used solids collection and removal system. Water leaving OLS ponds is considered to be treated effluent. Flow to OLS ponds is normally very small in comparison to the total facility flow. OLS pond effluent is usually less than 1.5 % of the total flow during daytime working hours and less than 0.75 % against 24-h averages.

The turbulence caused by the pipes and pumps that carry the solids from the QZs has made the solids particles become smaller before entering OLS ponds. The accepted  $V_s$  values for

these smaller particles are 0.000460–0.000920 m/s. The  $V_o$  value for OLS ponds must therefore be less than 0.00460 m/s [5]. Example 4 exhibits the  $V_o$  calculation for a typical OLS pond on a large farm. Depth of a typical OLS pond is 1.066 m, but many are even deeper to provide storage for solids. Minimum harvest frequency for OLS ponds is done in every 6 months. Frequent solids removal is desirable to avoid solids to break down and release dissolved nutrients into receiving waters. Normally, if TSS levels can be maintained below 100 mg/L, then the other parameters will also comply with the standard discharge limit [5]. Some OLS ponds need monthly solids removal to maintain compliance with the TSS.

*Example 4: OLS pond sizing.* OLS ponds are **9.144 m (30 ft)** wide by **54.86 m (180 ft)** long. Surface area is **501.63 m<sup>2</sup> (9.144 m × 54.86 m = 501.63 m<sup>2</sup>)**.

Average inflow during cleaning events or working hours is **50.47 L/s (800 gpm)**.

Overflow rate or  $V_o = 0.05047 \text{ m}^3/\text{s} \div 501.63 \text{ m}^2 = 0.0001 \text{ m/s}$ .

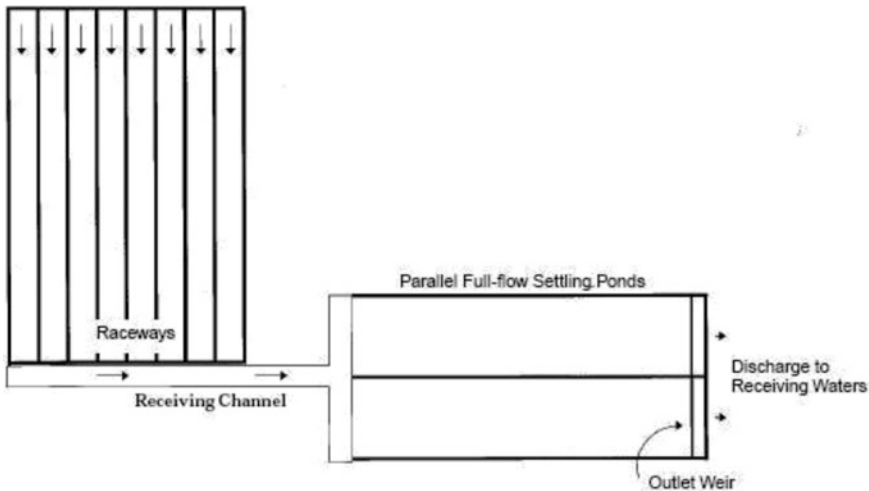
**The ideal  $V_s$  for OLS ponds is 0.000460 m/s. The  $V_o$  value of 0.000101 m/s is 4.57 times less than the ideal  $V_s$  and 2.28 times less than the final design value, so the dimensions of this OLS pond are more than adequate to handle 50.68 L/s (1.79 cfs) of inflow from quiescent zones.**

In order to provide better solids collection, many facilities provide multiple OLS ponds connected in series. Each individual pond in the series usually has a  $V_o$  value smaller than 0.000460 m/s. Some operations may have two OLS ponds next to the other, each within the recommended  $V_o$  value. When one is undergoing solids harvest, the other is receiving solids from the QZs. Vice versa, in order to improve solids collection, the common practice is to operate both OLS ponds simultaneously, either in series or in parallel. However, linking the ponds in parallel is advantageous as it splits the flow and improving  $V_o$  and weir rate. This results in reduction in water velocity and entrainment which makes the parallel application superior. Periodic flow to OLS ponds from QZs occurs primarily during regular working hours when personnel are cleaning the QZs. Periodic flow improves the settling of solids because the average flow would be less than the peak inflow, and the design  $V_o$  values of existing OLS ponds are based on the peak inflow rate.

Average TSS levels do become higher as an OLS pond fills with solids. This is particular when scouring and short-circuiting of laminar flow become more significant factors as the pond fills, entrainment, signifying the role of pond depth, solids resuspended by gas bubbles, and wind shear, especially if harvest frequency is not done on time. The influence of OLS ponds is where the majority of solids quickly settle.

Algae blooms are common in OLS ponds and some of the TSS is released in effluent making compliance difficult. Covering the OLS ponds from sunlight is one of the solutions, but this is costly and may hinder solids removal and other activities. Furthermore, ventilation has to be maintained to prevent serious condensation and possible gas increase inside the area.

Odor can also be a problem in OLS ponds mainly due to odor stems from anaerobic conditions. Odor is normally emitted when solids build up at the influent of the pond above the water surface. Effluent weirs will drip water gradually during the night lowering the surface level and revealing solids at the influent of the pond. In addition, solids exposure will occur in the absence of overnight decanting if the inflow weir is not well designed and maintained. In



**Fig. 15.11.** Full-flow settling ponds treat 100 % of the flow from the fish farm before it is discharged.  
*Source:* DEQ [5].

order to prevent outflow weir leakage, inflow weir needs to be designed properly with frequent harvesting of solids. It is necessary to run water through the waste treatment system to prevent odor or prevent pipes and settling areas from freezing during nonworking hours. This practice will release nutrients and solids from the settling pond.

Earthen ponds are cheaper but they can be more difficult to harvest. Laminar flow is more difficult to maintain in earthen ponds with irregularly shaped bottoms and sides. The influent needs to bypass to another OLS pond in order to remove the solids from an OLS pond. Concrete OLS ponds can be harvested by the same method. In addition, most have a ramp at one end where a front-end loader can enter the pond. Concrete OLS ponds are usually harvested by vacuuming the solids through slurry onto a tank truck. Some concrete OLS ponds have a sump with a floor that is lower than the OLS pond floor which is included at the deep end of the pond by an access point for truck and equipment.

#### 4.2.5. Full-Flow Settling Ponds

The full-flow solids collection system may not have QZs or OLS ponds as shown in Fig. 15.11. In order to collect the solids for the entire facility water flow, this system is built with one or two large settling zones. The individual rearing units may not have solids removal facilities but rather the water from all the rearing units combines and enters the FFS pond or ponds where the solids are collected. Solids particles in this type of system will be larger than solids in OLS ponds as there is no exposure to the turbulence of small pipes or pumps. However, there are still solids that are exposed to some turbulence as they pass through the fall from one rearing unit to the other or as they pass through the common collection channel to enter the FFS ponds, so the solids will be smaller than QZ solids. The ideal  $V_o$  value recommended for FFS ponds is 0.004 m/s (0.013 ft/s) or less [5].

Example 5.5 exhibits the FFS pond dimensions required for a given flow. FFS ponds are used mainly on smaller aquaculture facilities with low flow volumes [5]. Design must

comprise a bypass channel for the FFS pond for solids removal. FFS pond systems normally consist of two ponds operating in parallel for maintenance. One pond would remain operational during solids removal. Solids removal for FFS ponds is normally done at least every 6 months. Some operators batch collect their fish at the same time. Thus, the FFS pond can be harvested when the facility is empty and water is being bypassed.

*Example 5.5: FFS pond sizing.* If total flow = **1,415 L/s (50 cfs)** and minimum  $V_o = \mathbf{0.003962\ m/s}$ ,

then the required surface area is **1,415 L/s  $\div$  0.003962 m/s = 357 m<sup>2</sup>.**

If 15.24 m (50 ft.) is the desired pond width, then length is **357 m<sup>2</sup>  $\div$  15.24 m = 23.42 m.**

Doubling the surface area would give final dimensions of

**15.24 m wide  $\times$  46.82 m long or 30.48 m wide  $\times$  23.42 m long.**

#### 4.2.6. In-Pond Settling

In-pond settling is an effluent treatment system used in farm ponds, where waste is allowed to settle inside the rearing area. In-pond settling occurs in earthen ponds where the rearing area is also used for solids settling. In order to minimize the solids leaving the pond, fish are harvested at the upstream end of these ponds. Once fish is harvested, water is diverted around the pond to allow removal of solids. These ponds are always small in size with a low flow. They are often positioned on water supplies that receive some irrigation water and can supply a net reduction in solids and nutrients from incoming flow. Nearly all farm pond systems allow the operator to direct water around any pond while keeping other ponds in production. Hence, solids can be collected while there is no effluent from the pond.

#### 4.2.7. Rearing Area

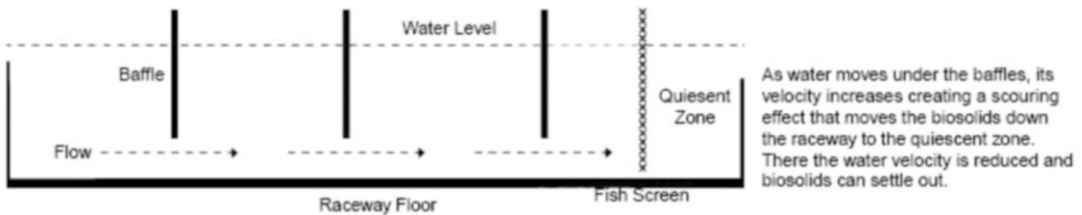
The rearing area is the part that is used for fish production. Circular tank effluent water is collected and passed through a downstream settling zone since the tanks are equipped with self-cleaning facilities. Rearing area design, equipment, and management affect both fish health and feed conversion, influencing the amount of nutrients and solids produced. The most common rearing unit is a concrete raceway as shown in Fig. 15.12 [5]. Typical dimensions are 3.048–5.48 m in width, 24.38–45.72 m in length, and 0.76–1.066 m in water depth, creating ideal conditions for personnel and facilitating fish production and solids collection [5]. Water flow in these raceways will range from 84.95 to 169.9 L/s. A typical earthen pond will be 6.096 m wide (20 ft), 45.72 m (150 ft) long, and 1.219 m (4 ft) deep with 99.1 L/s (3.5 cfs) of flow [5]. Best dimensions and water flow for any raceway depends on the amount of total water, harvest strategy, numbers of fish routinely available, and size of fish.

#### 4.2.8. Baffles

Baffles are linked to the side walls of a raceway and extend from side to side and from the water surface to 25–100 mm (1–4 in.) above the pond floor. Baffles are as shown in Fig. 15.13. Flow velocity along the bottom of the pond is increased by the water flow underneath the baffles, moving solids gently downstream to QZs for collection and efficient removal. However, baffles



**Fig. 15.12.** Raceways used for trout production. *Source:* DEQ [5].



**Fig. 15.13.** Baffles. *Source:* DEQ [5].

may become a place for moss growth in the summer and this is problematic. Baffles are normally made of lightweight materials (aluminum, fiberglass, or synthetic lagoon pond liner) for ease of use. Placement of baffles at the right location provides continuous cleaning of the rearing area. Placement of baffles will differ with fish size, flow, and pond dimensions.

4.2.9. *Flow Control*

It is important for the flow rate to be varied according to stocking density and fish size. In order to manage the flow rate, the water inlets to rearing ponds need to be adjustable. Laminar flow in rearing areas is preferable to avoid dead zones in ponds where solids will deposit and cause fish health problems. Laminar flows in rearing areas will provide the required laminar flow in QZs and keep solids close to the bottom as they approach the QZ. Consideration of laminar flow requirements is essential in designing water inflow and outflow for rearing areas in QZs.

4.2.10. *Dissolved Oxygen*

One of the measures of water quality is the DO levels at the rearing areas and the effluent. By fully utilizing the across of the facility, DO can be maximized for aquaculture process control.

#### 4.2.11. Fish Barriers and Predator Control

Fish barriers are very important to be designed correctly in rearing areas in order to keep fish in the pond at both the influent and effluent. Consideration of access and safety of personnel is also essential. Finally, elimination of predators, especially birds, has to be considered in the design. Predators can spread disease among fish populations resulting in higher effluent solids due to bad feed conversions.

## 5. APPLICATION OF AQUACULTURE SYSTEM FOR WASTEWATER TREATMENT AND WATER CONSERVATION

Aquaculture or aquafarming is the cultivation of aquatic populations, including both aquatic animals and plants, under controlled environments [1–21]. If the products are foods, aquaculture is a food production process. The wastewater generated from the aquaculture system during food production needs to be properly treated for environmental conservation. Aquaculture systems introduced in previous sections of this chapter are for harvesting aquatic animals (such as fish), therefore are aquafarming processes. Proper wastewater treatment aiming at water reuse has been discussed.

The aquaculture systems with the same theory, principles, operating procedures, and management methods can be used for wastewater treatment [22–24]. Under this condition, the aquatic animals and plants are used as means for wastewater treatment, the main product is the treated effluent which is either reused as non-potable water or recharged to the underground becoming the groundwater. The aquatic plants or animals harvested from aquaculture are the by-products. This section introduces wastewater treatment applications of various aquaculture systems.

### 5.1. Aquaculture Wastewater Treatment: Water Hyacinth System

Aquaculture or the production of aquatic organisms (both flora and fauna) under controlled conditions has been practiced for centuries, primarily for the generation of food, fiber, and fertilizer. The water hyacinth (*Eichhorina crassipes*) appears to be the most promising organism for wastewater treatment and has received the most attention. However, other organisms are being studied. Among them are duckweed, seaweed, midge larvae, alligator weeds, and a host of other organisms. Water hyacinths are large fast-growing floating aquatic plants with broad, glossy green leaves and light lavender flowers. A native of South America, water hyacinths are found naturally in waterways, bayous, and other backwaters throughout the South. Insects and disease have little effect on the hyacinth and they thrive in raw, as well as partially treated, wastewater. Wastewater treatment by water hyacinths is accomplished by passing the wastewater through a hyacinth-covered basin where the plants remove nutrients, BOD/COD/TOC, suspended solids, heavy metals, etc. Batch treatment and flow-through systems, using single and multiple cell units, are all possible. The treated wastewater is reused in a natural environment or recharged to the underground becoming the groundwater. Hyacinths harvested from these systems have been investigated as a fertilizer/soil conditioner after composting, animal feed, and a source of methane when anaerobically digested. The practical applications, design criteria, process performance, and water conservation efficiencies of the process can be found in the literature [22].



### **5.2. Aquaculture Wastewater Treatment: Natural Wetland System**

Aquaculture-wetland systems for wastewater treatment include natural and artificial wetlands as well as other aquatic systems involving the production of algae and higher plants (both submerged and emergent), invertebrates, and fish. Natural wetlands, both marine and freshwater, have inadvertently served as natural waste treatment systems for centuries; however, in recent years, marshes, swamps, bogs, and other wetland areas have been successfully utilized as managed natural “nutrient sinks” for polishing partially treated effluents under relatively controlled conditions. Constructed wetlands can be designed to meet specific project conditions while providing new wetland areas that also improve available wildlife wetland habitats and other numerous benefits of wetland areas. Managed planting of reeds (e.g., *Phragmites* sp.) and rushes (e.g., *Scirpus* spp. and *Schoenoplectus* spp.) as well as managed natural and constructed marshes, swamps, and bogs have been demonstrated to reliably provide pH neutralization and reduction of nutrients, heavy metals, organics, BOD/COD/TOC, suspended solids, fecal coliforms, and pathogenic bacteria.

Wastewater treatment by natural and constructed wetland systems is generally accomplished by sprinkling or flood irrigating the wastewater into the wetland area or by passing the wastewater through a system of shallow ponds, channels, basins, or other constructed areas where the emergent aquatic vegetation has been planted or naturally occurs and is actively growing. The treated wastewater is totally reused in a natural environment achieving almost 100 % water conservation. The vegetation produced as a result of the system’s operation may or may not be removed and can be utilized for various purposes: (a) composted for use as source of fertilizer/soil conditioner and (b) dried or otherwise processed for use as animal feed supplements or digested to produce methane. The practical applications, design criteria, process performance, and water conservation efficiencies of the process can be found from the literature [22].

### **5.3. Aquaculture Wastewater Treatment: Man-Made Living Machine System**

The natural wetland aquaculture system described in Sect. 5.2 adopts the natural environment as much as possible, and the entire process system except the inlet is controlled by gravity flow. The Living Machine system is also a man-made, patented wetland aquaculture wastewater treatment system which adapts and enhances the ecological processes in a series of tidal wetland cells or basins. Each cell or basin is filled with special gravel that promotes the development of micro-ecosystems. A computer controls fill and drain cycles, alternating anoxic (without oxygen) and aerobic (with oxygen) conditions. As wastewater moves through the system, the cells are alternately flooded and drained to create multiple tidal cycles each day, much like one finds in nature, resulting in high-quality reusable water. The cells/basins may be located inside and outside a greenhouse (depending on the region), wastewater flow always is below the surface of watertight cells in the pore spaces between rock particles so there is no smell, mosquitoes, or potential of contamination for people or wildlife. This tidal cycling helps make the Living Machine technology an efficient wastewater treatment and water reuse system [24].

## APPENDIX

**Table A1**  
**FDA-approved drugs used in aquaculture. Source: U.S. EPA [15]**

Trade name	Active drug	Species and uses
Finquel (MS-222)	Tricaine methanesulfonate	Temporary immobilization (anesthetic) for Ictaluridae, Salmonidae, Esocidae, and Percidae. For approved uses for other poikilothermic animals, refer to the product label.
Formalin-F	Formalin	Control of external protozoa and monogenetic trematodes in trout, salmon, catfish, large-mouth bass, and bluegill. Control of fungi of the family Saprolegniaceae on salmon, trout, and esocid eggs.
Paracide-F	Formalin	Control of external protozoa, monogenetic trematodes, and fungi in trout, salmon, catfish, large-mouth bass, and bluegill. Control of fungi of the family Saprolegniaceae on salmon, trout, and esocid eggs.
Parasite-S	Formalin	Control of external protozoa and monogenetic trematodes in all fish. Control of fungi of the family Saprolegniaceae on all fish eggs. Control of external protozoan parasites on cultured penaeid shrimp.
Romet 30	Sulfadimethoxine and ormetoprim	Control of enteric septicemia in catfish. Control of furunculosis in salmonids.
Sulfamerazine in Fish Grade	Sulfamerazine	Control of furunculosis in rainbow trout, brook trout, and brown trout.
Terramycin For Fish	Oxytetracycline	Control of bacterial hemorrhagic septicemia and control of gaffkemia in lobsters. Control of ulcer disease, furunculosis, bacterial hemorrhagic septicemia, pseudomonas disease in salmonids. Marking of skeletal tissue in Pacific salmon.

**Table A2**  
**Drugs of low regulatory priority for FDA used in aquaculture. Source: U.S. EPA [15]**

Name	Uses
Acetic acid	Used as a dip at a concentration of 1,000–2,000 mg/L for 1–10 min as a parasiticide for fish.
Calcium chloride	Used to increase water calcium concentration to ensure proper egg hardening. Dosages used would be those necessary to raise calcium concentration to 10–20 mg/L calcium carbonate. Also used to increase water hardness up to 150 mg/L to aid in maintenance of osmotic balance in fish by preventing electrolyte loss.

(Continued)

**Table A2**  
**(Continued)**

Name	Uses
Calcium oxide	Used as an external protozoacide for fingerling to adult fish at a concentration of 2,000 mg/L for 5 s.
Carbon dioxide gas	Used for anesthetic purposes in cold, cool, and warm water fish.
Fuller's earth	Used to reduce the adhesiveness of fish eggs in order to improve hatchability.
Garlic (whole)	Used for control of helminth and sea lice infestations in marine salmonids at all life stages.
Hydrogen peroxide	Used at 250–500 mg/L to control fungi on all species and at all life stages of fish, including eggs.
Ice	Used to reduce metabolic rate offish during transport.
Magnesium sulfate (Epsom salts)	Used to treat external monogenetic trematode infestations and external crustacean infestations in fish at all life stages. Used in freshwater species. Fish are immersed in a solution 30,000 mg/L magnesium sulfate and 7,000 mg/L sodium chloride for 5–10 min.
Onion (whole)	Permitted use: Used to treat external crustacean parasites and to deter sea lice from infesting external surface of fish at all life stages.
Papain	Used as a 0.2 % solution in removing the gelatinous matrix of fish egg masses in order to improve hatchability and decrease the incidence of disease.
Potassium chloride	Used as an aid in osmoregulation to relieve stress and prevent shock. Dosages used would be those necessary to increase chloride ion concentration to 10–2,000 mg/L.
Povidone iodine compounds	Used as a fish egg disinfectant at rates of 50 mg/L for 30 min during water hardening and 100 mg/L solution for 10 min after water hardening.
Sodium bicarbonate (baking soda)	Used at 142–642 mg/L for 5 min as a means of introducing carbon dioxide into the water to anesthetize fish.
Sodium chloride (salt)	Used as a 0.5–1 % solution for an indefinite period as an osmoregulatory aid for the relief of stress and prevention of shock. Used as a 3 % solution for 10–30 min as a parasiticide.
Sodium sulfite	Used as a 15 % solution for 5–8 min to treat eggs in order to improve hatchability.
Urea and tannic acid	Used to denature the adhesive component of fish eggs at concentrations of 15 g urea and 20 gNaCl/5L of water for approximately 6 min, followed by a separate solution of 0.75 g tannic acid/5L water for an additional 6 min. These amounts will treat approximately 400,000 eggs.

**Table A3****U.S. EPA-registered algaecides for aquaculture/aquatic sites. Source: U.S. EPA [15]**

Trade name	USEPA Reg. Na.	Registrant	Indications for use
<i>Common name: Chelated Copper</i>			
Algae-Rhap CU-7 Liquid	55146-42	Agtrol Chemical Products	Broad-range algaecide for use in farm and fish ponds, lakes, and fish hatcheries.
Algimycin PLL	7364-10	Guest Lakes Biochemical Co., Inc.	Algaecide for small, ornamental ponds and pools.
Algimycin PLL-C	7364-9	Guest Lakes Biochemical Co., Inc.	Algaecide for pools, lakes, ponds, and similar water.
Aquatrine Algaecide	8989-33	Applied Biochemists, Inc.	Algaecide for fish and shrimp aquaculture facilities (e.g., ponds, tanks, and raceways).
Copper Control Granular	47677-8	Argent Chemical Laboratories, Inc.	Algaecide for fish ponds and hatcheries.
Citrine Algaecide	8959-1	Applied Biochemists, Inc.	Algaecide for fish ponds, lakes, and hatcheries.
Citrine Granular Algaecide	8959-3	Applied Biochemists, Inc.	Granular algaecide for control of Chara and Nitella in fish ponds, lakes, and hatcheries.
Citrine Plus Algaecide/ Herbicide	8959-10	Applied Biochemists, Inc.	Algaecide/herbicide for fish ponds, lakes, and hatcheries.
Citrine Plus II Algaecide	8959-20	Applied Biochemists, Inc.	Algaecide for fish ponds, lakes, and hatcheries.
Citrine Plus Granular Algaecide	8959-12	Applied Biochemists, Inc.	Algaecide (especially for Chara and Nitella) in fish ponds and hatcheries.
Citrine Plus granular Algaecide	8959-12	Applied Biochemists, Inc.	Algaecide (especially for Chara and Nitella) in fish ponds and hatcheries.
Komeen Aquatic Herbicide	1812-312	Griffin Corporation	Algaecide for freshwater lakes and fish hatcheries.
K-Tea Algaecide	1812-307	Griffin Corporation	Algaecide for freshwater lakes and fish hatcheries.
SCI-62 Algaecide/ Bactericide	61943-1	Cham-A-Co., Inc.	Algaecide/bactericide for lakes and ponds.
Slow Release Algimycin PLL Concentrate	7364-26	Great Lakes Biochemical Co., Inc.	Algaecide (especially for chara and Nitella) in ponds and lakes.
<i>Common name: Copper</i>			
Alco Citrine Algaecide RTU	5481-140	Amvac Chemical Corporation	Algaecide for fish ponds, lakes, and hatcheries.

*(Continued)*

**Table A3**  
**(Continued)**

Trade name	USEPA Reg. Na.	Registrant	Indications for use
<i>Common name: Copper as elemental</i>			
Algon Algaecide	11474-15	Sungro Chemicals, Inc.	Algaecide for use in lakes, fish ponds, and fish hatcheries.
AV-70 Plus Algaecides	12014-10	A & V Inc.	Algaecides for fish ponds, lakes, and hatcheries.
A & V-70 Granular Algaecide	12014-5	A & V Inc,	Granular algaecide for lakes and ponds.
<i>Common name: Copper sulfate pentahydrate</i>			
Blue Viking Kocide Cop- per Sulfate State Glow Powder	1812-314	Griffin Corporation	Algaecide for freshwater lakes and ponds.
Blue Viking Kocide Cop- per Sulfate State Shine Crystals	1812-313	Griffin Corporation	Algaecide for lakes, ponds, and impounded water.
Calco Copper Sulfate	39295-8	Calabrian Interna- tional Corporation	For algae control in impounded water, lakes, and ponds.
Copper Sulfate Crystals	56576-1	Chem One Corporation	Algae control in impounded lakes and ponds.
Copper Sulfate Large Crystal	1109-1	Boliden Intertrade, Inc	For algae control in lakes and ponds.
Copper sulfate large Crystal	1109-19	Boliden Intertrade, Inc	For algae control in lakes and ponds.
Copper Sulfate Pentahydrate Algaecide/ Herbicide	35896-19	C.P. Chemicals	Algaecide/herbicide for controlled- outflow lakes and ponds.
Copper Sulfate Superfine Crystals	1109-32	Boliden Intertrade, Inc.	For algae control in lakes and ponds.
Copper Sulfate Powder	1109-7	Boliden Intertrade, Inc.	For algae control in lakes and ponds.
Dionne Roof Eliminator Granular Crystals Copper Sulfate	34797-39 1109-20	Quails, Inc. Boliden Intertrade, Inc.	For algae control in lakes and ponds. For algae control in lakes and ponds.
Kocide Copper Sulfate Pentahydrate Crystals	1812-304	Griffin Corporation	Algaecide for lakes and ponds.
Root Killer RK-11	8123-117	Frank Miller & Sons, Inc.	For algae control in impounded waters (e.g., lakes, ponds).
SA-50 Brand Copper Sulfate Granular Crystals	829-210	Southern Agricul- tural Insecticides, Inc.	For algae control in ponds.

(Continued)

**Table A3**  
**(Continued)**

Trade name	USEPA Reg. Na.	Registrant	Indications for use
Snow Crystals Copper Sulfate	1109-21	Boliden Intertrade, Inc.	For algae control in lakes and ponds.
Triangle Brand Copper Sulfate Crystals	1278-8	Phelps Dodge Refining Corporation	For algae control in impounded waters, lakes, ponds, and reservoirs.

**Table A4**  
**U.S. EPA-registered fish toxicants. Source: U.S. EPA [15]**

Trade name	USEPA registration number	Registrant	Comments and indications for use
<i>Common name: Antimycin</i>			
Fintrol Concentrate	39096-2	Aquabiotics Corporation	Fish toxicant/piscicide
<i>Common name: Cube Resins/Rotenone</i>			
Chem-Sect Brand Chem Fish Regular	1439-157	Tifa Limited Cube resins/rotenone	Fish toxicant/piscicide
Chem-Fish Synergized	1439-159	Tifa Limited	Fish toxicant/piscicide
Finery Ground Cube Powder	6458-6	Foreign Domestic Chemicals Corp	Fish toxicant/piscicide
Fish-Tox-5	769-309	Sureco, Inc.	Fish toxicant/piscicide
Martin's Rotenone Powder	299-227	C.J. Martin Company	Fish toxicant/piscicide
Noxfish Fish Toxicant Liquid Emulsifiable	431-172	Roussel Uclaf Corporation	Fish toxicant/piscicide
Nusyn-Noxfish Fish Toxicant	432-550	Roussel Uclaf Corporation	Fish toxicant/piscicide
Pearson's 5 % Rotenone Wettable Powder	19713-316	Drexel Chemical Company	Fish toxicant/piscicide
Powdered Cube	769-414	Sureco, Inc.	Fish toxicant/piscicide
Prentox Prenfish Toxicant	655-422	Prentiss Incorporated	Fish toxicant/piscicide
Prentox Rotenone Fish Toxicant Powder	655-691	Prentiss Incorporated	Fish toxicant/piscicide
Prentox Synpren Fish Toxicant	655-421	Prentiss Incorporated	Fish toxicant/piscicide
Rotenone 5 % Liquid Emulsifiable	47677-3	Argent Chemical Laboratories. Inc.	Fish toxicant/piscicide
Rotenone 5 % Fish Toxicant Powder	47677-4	Argent Chemical Laboratories. Inc.	Fish toxicant/piscicide

**Table A5**  
**U.S. EPA-registered herbicides. Source: U.S. EPA [15]**

Trade name	USEPA registration number	Registrant	Comments and indications for use
<i>Common name: Acid blue and acid yellow</i>			
Aquashade	33068-1	Applied Biochemists, Inc.	Aquatic plant control through selective light filtering; usable in controlled-outflow natural and man-made lakes and ponds.
<i>Common name: Dichlobenil</i>			
Acme Norosac 10G	2217-679	PBI/Gordon Corporation	Aquatic weed control for lakes and ponds.
Casoron 10-G	400-178	Uniroyal chemical Company, INC.	Aquatic herbicide for submerged weeds in non-flowing water.
<i>Common name: Dequat dibromide</i>			
Aqua Clear	2155-63	I. Schneid, Inc.	Contact, non-selective vegetation killer for aquatic weeds.
Aqua-Kil Plus	37347-6	Uni-Chem Corporation of Florida	Contact, non-selective vegetation killer for aquatic weeds.
Aquaquar	5080-4	Aquacide Company	Liquid weed killer for lakes and ponds with controlled outflow
Aquatic Weed Killer	10292-13	Venus Laboratories, Inc.	For the elimination of aquatic weeds and algae.
Clean-Up	2155-64	I. Schneid, Inc.	Algaecide and non-selective weed killer.
Conkill	10088-13	Athea Laboratories, Inc.	Contact, non-selective weed killer for aquatic weeds.
Contact Vegetation Controller	8123-102	Frank Miller & Sons, Inc	For the control of aquatic vegetation.
Diquat-L Weed Killer 1/5 lb.	34704-589	Platte Chemical Co., Inc.	Aquatic weed killer for controlled-outflow lakes and ponds.
Formula 268 AquaQuat	1635-64	State Chemical Manufacturing Company	Aquatic weed killer in lakes, ponds, and impounded water.
Ind-Sol 435	10827-78	Chemical Specialties, Inc.	Non-selective weed killer for controlled-outflow lakes and ponds.
Miller Liquid Vegetation Control	8123-37	Frank Miller & Sons, Inc	For the control of aquatic vegetation.
No. 401 Water Plant Killer	11515-29	ABC Chemical Corporation	Contact, non-selective weed killer for aquatic weeds.
Norkem 500	5197-37	Systems General, Inc.	Contact, non-selective weed killer for controlled-overflow ponds and lakes.

(Continued)

**Table A5**  
**(Continued)**

Trade name	USEPA registration number	Registrant	Comments and indications for use
P.D.Q. Non-selective Weed Killer	2155-43	I Schneid, Inc.	Algaecide and non-selective weed killer.
Selig's Mister Trim No. 10	491-201	Selig Chemical Industries	Contact, non-selective killer for aquatic weeds.
Watrol	1769-174	NCH Corporation	Herbicide for aquatic weeds.
Weedtrine D Aquatic Herbicide	8959-9	Applied Biochemists, Inc.	Aquatic herbicide for still lakes and fish ponds.
Yardman	10663-11	Sentry Chemical Company	Non-selective weed, algae, and aquatic foliage killer
<i>Common name: Endothall</i>			
Aquathol Granular Aquatic Herbicide	4581-201	Elf Atochem North America, Inc.	Aquatic herbicide in ponds and lakes.
Aquathol K Aquatic	4581-204	Elf Atochem North America, Inc.	Contact aquatic herbicide for lakes and ponds.
Hydrothol 191 Aquatic Algaecide and Herbicide	4581-174	Elf Atochem North America, Inc.	Aquatic algaecide/herbicide for lakes and ponds.
Hydrothol 191 Granular Aquatic Algaecide and Herbicide	4581-172	Elf Atochem North America, Inc.	Aquatic algaecide/herbicide for lakes and ponds.
<i>Common name: Fluridone</i>			
Sonar A.S.	62719-124	DowElanco	Herbicide for the management of aquatic vegetation in freshwater ponds, lakes, and drainage canals.
Sonar SRP	62719-123	DowElanco	Herbicide for the management of aquatic vegetation in freshwater ponds, lakes, and drainage canals.
<i>Common name: Glyphosate</i>			
Rodeo	524-343	The Agricultural Group of Monsanto Company	Aquatic herbicide for freshwater and brackish water applications.
<i>Common, name: 2,4-D</i>			
Weed-Rhap A-4D	5905-501	Helena Chemical Company	For control of aquatic weeds in lakes and ponds.
Weed-Rhap A-6D Herbicide	5905-503	Helena Chemical Company	For control of aquatic weeds in lakes and ponds.
<i>Common name: Acetic Acid, 2,4</i>			
A C Aquacide Pallets	5080-2	Aquacide Company	Herbicide for submerged weeds in recreational lakes and ponds. Pre-dominantly for broad-leaved plants.

*(Continued)*



**Table A5**  
**(Continued)**

Trade name	USEPA registration number	Registrant	Comments and indications for use
<i>Common name: 2,4-D and Butoxyethyl Ester</i>			
Aqua-Kleen	264-109	Rhone-Poulenc Agricultural Co.	Granular aquatic herbicide for controlling weeds.
Navigate	264-109-8959	Applied Biochemists, Inc.	For control of aquatic weeds in lakes and ponds.
<i>Common name: Dimethylamine salt of 2,4-D</i>			
Clean Crop Amine 2,4-D Granulese:	34704-645	Plane Chemical Co., Inc	Aquatic herbicide for immersed/submerged weeds.
Clean Crop Amine 6 2,4-D Herbicide	34704-646	Plane Chemical Co., Inc.	Herbicide for lakes and ponds.
Rhodia 2,4-D Gran 20	42750-16	Albaugh	Herbicide for aquatic weeds in lakes and ponds.
Weedestroy AM-40 Amine Salt	228-145	Riverdale Chemical Company	For control of broadleaf weeds and aquatic weeds in lakes and ponds
2,4-D Amine 4 Herbicide	42750-19	Albaugh	Herbicide for aquatic weeds in lakes and ponds.
2,4-D Amine 6 Herbicide	42750-21	Albaugh	Herbicide for aquatic weeds in lakes and ponds.
2,4-D380 Amine Weed Killer	407-430	Imperial, Inc.	Aquatic herbicide for lakes and ponds.
Weedar 64	264-2	Rhone-Poulenc Agricultural Co.	Broadleaf herbicide; toxic to aquatic invertebrates.
<i>Common name: Isooctyl ester of 2,4-D</i>			
Barrage (Weed-Rhap LV-5D Herbicide)	5905-504	Helena Chemical Company	For control of aquatic weeds in lakes and ponds.
Brush-Rhap Low Volatile 4-D Herbicide	5905-498	Helena Chemical Company	For control of aquatic weeds in lakes and ponds.
2,4-D Granules	228-61	Riverdale Chemical Company	For control of broadleaf and certain aquatic weeds.
2,4-D L. V. 4 Ester	228-139	Riverdale Chemical Company	For control of aquatic weeds in lakes and ponds.
2,4-D L. V. 6 Eate	228-95	Riverdale Chemical Company	For control of aquatic weeds in lakes and ponds.
SEE 2,4-D Low Volatile Ester Solventless Herbicide	42750-22	Albaugh	Herbicide for aquatic weeds in lakes arid ponds.
2,4-D L.V.4 Ester	228-139	Riverdale Chemical Company	For control of aquatic weeds in lakes and ponds.

(Continued)

**Table A5**  
**(Continued)**

Trade name	USEPA registration number	Registrant	Comments and indications for use
2,4-D LV Ester 6	5905-93	Helena Chemical Company	Selective aquatic herbicide.
Visko-Rhap Low Volatile Ester 2D	42750-17	Albaugh	Herbicide for aquatic weeds in lakes and ponds.
Weed-Rhap Low volatile Granular D Herbicide	5905-507	Helena Chemical Company	For control of aquatic weeds in lakes and ponds.
Weed-Rhap LV-4D	5905-505	Helena Chemical Company	For control of aquatic weeds in lakes and ponds.
Weed-Rhap LV-6D	5905-508	Helena Chemical Company	For control of aquatic weeds in lakes and ponds.

**Table A6**  
**USDA-licensed biologics for fish (vaccines). Source: U.S. EPA [15]**

Product name/Trade name	Licenses/Permittee	Species	Disease
Aeromonas Salmonicida Bacterin Biojec 1500	BioMed, Inc	Salmonids	Furunculosis
Aeromonas Salmonicida-Vibrio	BioMed, Inc.	Salmonids	Furunculosis, vibriosis
Autogenous Bacterin Autogenous Bacterin	BioMed, Inc	Fish	Bacterial diseases
Vibrio Anguillarum-Ordalii Bacterin	BioMed, Inc.	Salmonids	Vibriosis
Vibrio Anguillarum-Ordalii-Yersinia Ruckeri Bacterin	BioMed, Inc.	Salmonids	Vibriosis, yersiniosis (enteric red-mouth disease)
Yersinia Ruckeri Bacterin	BioMed, Inc	Salmonids	Yersiniosis (enteric red-mouth disease)
Vibrio Salmonicida Bacterin	BioMed, Inc.	Salmonids	Vibriosis
Vibrio Anguillarum-Salmonicida Bacterin	BioMed, Inc.	Salmonids	Vibriosis
Aeromonas Salmonicida Bacterin	Jerry Zinn, Aqua Health, Ltd.	Salmonids	Furunculosis
Autogenous Bacterin	Jerry Zinn, Aqua Health, Ltd.	Fish	Bacterial diseases
Edwardsiella Ictaluri Bacterin	Jerry Zinn, Aqua Health, Ltd.	Catfish	Enteric septicemia
Vibrio Anguillarum-Ordalii Bacterin	Jerry Zinn, Aqua Health, Ltd.	Salmonids	Vibriosis

(Continued)

**Table A6**  
**(Continued)**

Product name/Trade name	Licenses/Permittee	Species	Disease
Vibrio Anguillarum-Ordalii Bacterin	Jerry Zinn, Aqua Health, Ltd.	Salmonids	Vibriosis
Yersinia Ruckeri Bacterin	Jerry Zinn, Aqua Health, Ltd.	Salmonids	Yersiniosis (enteric red-mouth disease)

## REFERENCES

1. Article on Aquaculture (2007) <http://en.wikipedia.org/wiki/Aquaculture>
2. Bee N, Crevier NK (2006) Is something fishy in aquaculture? Environmental Working Group <http://www.ewg.org>
3. Buck EH (1999) Congressional Research Service report for Congress. IB10010: Fishery, Aquaculture, and Marine Mammal Legislation in the 106th Congress. Resources, Science, and Industry Division, 16 Jun 1999. Distributed by the Committee for the National Institute for the Environment. <http://www.cnie.org/nle/mar-27.html>. 28 Aug 1999
4. Castledine AJ (1986) Aquaculture in Ontario. Ontario Ministry of Natural Resources, Ontario Ministry of Agriculture and Food, Ontario Ministry of the Environment Publications, Queen's Printer, Ontario, Canada (2002)
5. DEQ (Idaho Division of Environmental Quality) (2002) Idaho waste management guidelines for aquaculture operations. Idaho: Idaho Division of Environmental Quality, pdf 584 kb, 87 pages
6. Ellis LJ, Turner JL (2007) Aquaculture and environmental health in China. China Environmental Forum, Issue 9
7. Food and Agriculture Organization (FAO) (1997) Aquaculture development. FAO technical guidelines for responsible fisheries, No. 5. FAO of the United Nations, Rome, Italy
8. Miller D, Semmens K (2002) Waste management in aquaculture. Aquaculture information series. Publication #AQ02-1. West Virginia University, Morgantown, WV
9. Ramseyer LJ, Garling DL (2002) Fish nutrition and aquaculture waste management. Department of Fisheries and Wildlife, Michigan State University, East Lansing, MI
10. The National Agricultural Law Center (2007) Clean Water Act—an overview. <http://www.nationalaglawcenter.org/assets/overviews/cleanwater.html>
11. US EPA (2007) Aquaculture operations—laws, regulations, policies, and guidance. U. S Environmental Protection Agency, Washington, DC, <http://www.epa.gov/oecaagct/anaquilaw.html>
12. US EPA (1999) Drinking water regulations and health advisories. U. S. Environmental Protection Agency, Washington, DC. EPA-822-b-96-002, Oct 1996. <http://www.epa.gov/OST/Tools/dwstds.html>
13. US EPA (2007) National Pollutant Discharge Elimination System (NPDES). U. S Environmental Protection Agency, Washington, DC, <http://cfpub.epa.gov/npdes/>
14. US EPA (1987) Report to Congress. Class V injection wells: current inventory, effects on ground water, technical recommendations. U. S. Environmental Protection Agency, Washington, DC

15. US EPA (1999) The class V underground injection control study, volume 11, aquaculture waste disposal wells. U. S. Environmental Protection Agency, Washington DC, EPA/816-R-99-014k or <http://www.epa.gov/safewater/uic/classv/pdfs/volume11.pdf>
16. Stickney RR (2009) Aquaculture. CABI Bookshop, 320 pages. <http://bookshop.cabi.org>. or [www.cabi.org](http://www.cabi.org)
17. Blier P, Carta C, Jobling M, LeFrancois NR (2010) Finfish aquaculture diversification. CABI Bookshop, 704 pages. <http://bookshop.cabi.org>. or [www.cabi.org](http://www.cabi.org)
18. Dunham R (2011) Aquaculture and fisheries biotechnology, 2nd edn. CABI Bookshop, 504 pages. <http://bookshop.cabi.org>. or [www.cabi.org](http://www.cabi.org)
19. Boyd CE (2012). Sustainable aquaculture practices: settling basin design and operation. *Global Aqua Advoc* 15(2):March–April 2012. pp 62–64
20. Flimlin G, Butner J, Webster D (2008) Aquaculture systems for the Northeast. University of Maryland, Northeastern Regional Aquaculture Center, College Park, MD. NRAC Publication No. 104-2008. [www.nrac.umd.edu](http://www.nrac.umd.edu)
21. UNFAO (2013) Aquaculture systems. Food and Agriculture Organization of the United Nations. <http://fao.org/fishery/topic/12313/en>
22. Wang LK, Shamma NK, Hung YT (eds) (2009) Advanced biological treatment processes. Humana Press, Totowa, NJ, USA, pp 583–618
23. Wang LK, Tay JH, Tay STL, Hung YT (eds) (2010) Environmental bioengineering. Humana Press, Totowa, NJ, USA, pp 233–350
24. Worrell Water Technologies, LLC (2012) Living machine projects. Worrell Water Technologies, LLC, Charlottesville, VI

## Glossary and Conversion Factors for Water Resources Engineers

---

Mu-Hao Sung Wang and Lawrence K. Wang

### CONTENTS

CONSTANTS AND CONVERSION FACTORS  
BASIC AND SUPPLEMENTARY UNITS  
DERIVED UNITS AND QUANTITIES  
PHYSICAL CONSTANTS  
PROPERTIES OF WATER  
PERIODIC TABLE OF THE ELEMENTS  
GLOSSARY FOR WATER RESOURCES ENGINEERS  
REFERENCES

---

**Abstract** Technical and legal terms commonly used by water resources engineers are introduced in this chapter. With the current trend toward metrication, the question of using a consistent system of units has been a problem. Wherever possible, the authors of this Handbook of Environmental Engineering series have used the US customary system (fps) along with the metric equivalent (SIU) or vice versa. For the convenience of the readers around the world, this book provides detailed conversion factors and glossary terms for water resources engineers. In addition, the basic and supplementary units, the derived units and quantities, important physical constants, the properties of water, and the periodic table of the elements are also presented in this chapter [1–3].

**Key Words** Water resources engineering • Glossary • Conversion factors • Water resources engineers • Physical constants • Periodic table of the elements • Water properties

## 1. CONSTANTS AND CONVERSION FACTORS

<i>Multiply</i>	<i>by</i>	<i>to obtain</i>
abamperes	10	amperes
abamperes	$2.99796 \times 10^{10}$	statamperes
abampere-turns	12.566	gilberts
abcoulombs	10	coulombs (abs)
abcoulombs	$2.99796 \times 10^{10}$	statcoulombs
abcoulombs/kg	30,577	statcoulombs/dyne
abfarads	$1 \times 10^9$	farads (abs)
abfarads	$8.98776 \times 10^{20}$	statfarads
abhenries	$1 \times 10^{-9}$	henries (abs)
abhenries	$1.11263 \times 10^{-21}$	stathenries
abohms	$1 \times 10^{-9}$	ohms (abs)
abohms	$1.11263 \times 10^{-21}$	statohms
abvolts	$3.33560 \times 10^{-11}$	statvolts
abvolts	$1 \times 10^{-8}$	volts (abs)
abvolts/centimeters	$2.540005 \times 10^{-8}$	volts (abs)/inch
acres	0.4046	ha
acres	43,560	square feet
acres	4047	square meters
acres	$1.562 \times 10^{-3}$	square miles
acres	4840	square yards
acre-feet	43,560	cubic feet
acre-feet	1233.5	cubic meters
acre-feet	325,850	gallons (U.S.)
amperes (abs)	0.1	abamperes
amperes (abs)	$1.036 \times 10^{-5}$	faradays/second
amperes (abs)	$2.9980 \times 10^9$	statamperes
ampere-hours (abs)	3600	coulombs (abs)
ampere-hours	0.03731	faradays
amperes/sq cm	6.452	amps/sq in
amperes/sq cm	$10^4$	amps/sq meter
amperes/sq in	0.1550	amps/sq cm
amperes/sq in	1550.0	amps/sq meter
amperes/sq meter	$10^{-4}$	amps/sq cm
amperes/sq meter	$6.452 \times 10^{-4}$	amps/sq in
ampere-turns	1.257	gilberts
ampere-turns/cm	2.540	amp-turns/in
ampere-turns/cm	100.0	amp-turns/meter
ampere-turns/cm	1.257	gilberts/cm

(continued)

(continued)

<i>Multiply</i>	<i>by</i>	<i>to obtain</i>
ampere-turns/in	0.3937	amp-turns/cm
ampere-turns/in	39.37	amp-turns/meter
ampere-turns/in	0.4950	gilberts/cm
ampere-turns/meter	0.01	amp-turns/cm
ampere-turns/meter	0.0254	amp-turns/in
ampere-turns/meter	0.01257	gilberts/cm
angstrom units	$1 \times 10^{-8}$	centimeters
angstrom units	$3.937 \times 10^{-9}$	inches
angstrom unit	$1 \times 10^{-10}$	meter
angstrom unit	$1 \times 10^{-4}$	micron or $\mu\text{m}$
ares	0.02471	acre (U.S.)
ares	1076	square feet
ares	100	square meters
ares	119.60	sq yards
assay tons	29.17	grams
astronomical unit	$1.495 \times 10^8$	kilometers
atmospheres (atm)	0.007348	tons/sq inch
atmospheres	76.0	cms of mercury
atmospheres	101.325	kN/m <sup>2</sup> (or kPa)
atmospheres	1.013	bar
atmospheres	$1.01325 \times 10^6$	dynes/square centimeter
atmospheres	33.90	ft of water (at 4° C)
atmospheres	29.92	inches of mercury (at 0° C)
atmospheres	1.033228	kg/sq cm
atmospheres	10,332	kg/sq meter
atmospheres	760.0	millimeters of mercury
atmospheres	14.696	pounds/square inch
atmospheres	1.058	tons/sq foot
avograms	$1.66036 \times 10^{-24}$	grams
bags, cement	94	pounds of cement
bar (pressure)	$10^5$	Newton/m <sup>2</sup>
bar (pressure)	14.504	lb/sq in
bar (pressure)	100.657	kPa
barleycorns (British)	1/3	inches
barleycorns (British)	$8.467 \times 10^{-3}$	meters
barrels (British, dry)	5.780	cubic feet
barrels (British, dry)	0.1637	cubic meters
barrels (British, dry)	36	gallons (British)
barrels, cement	170.6	kilograms
barrels, cement	376	pounds of cement

(continued)

(continued)

<i>Multiply</i>	<i>by</i>	<i>to obtain</i>
barrels, cranberry	3.371	cubic feet
barrels, cranberry	0.09547	cubic meters
barrels, oil	5.615	cubic feet
barrels, oil	0.1590	cubic meters
barrels, oil	42	gallons (U.S.)
barrels, (U.S., dry)	4.083	cubic feet
barrels (U.S., dry)	7056	cubic inches
barrels (U.S., dry)	0.11562	cubic meters
barrels (U.S., dry)	105.0	quarts (dry)
barrels (U.S., liquid)	4.211	cubic feet
barrels (U.S., liquid)	0.1192	cubic meters
barrels (U.S., liquid)	31.5	gallons (U.S.)
bars	0.98692	atmospheres
bars	$10^6$	dynes/sq cm
bars	$1.0197 \times 10^4$	kg/sq meter
bars	1000	millibar
bars	750.06	mm of Hg (0° C)
bars	2089	pounds/sq ft
bars	14.504	pounds/sq in
barye	1.000	dynes/sq cm
board feet	1/12	cubic feet
board feet	144 sq.in. $\times$ 1 in.	cubic inches
boiler horsepower	33,475	BTU (mean)/hour
boiler horsepower	34.5	pounds of water evaporated from and at 212° F (per hour)
bolts (U.S., cloth)	120	linear feet
bolts (U.S., cloth)	36.576	meters
bougie decimales	1	candles (int)
BTU (mean)	251.98	calories, gram (g. cal)
BTU (mean)	0.55556	centigrade heat units (chu)
BTU (mean)	$1.0548 \times 10^{10}$	ergs
BTU (mean)	777.98	foot-pounds
BTU (mean)	$3.931 \times 10^{-4}$	horsepower-hrs (hp-hr)
BTU (mean)	1055	joules (abs)
BTU (mean)	0.25198	kilograms, cal (kg cal)
BTU (mean)	107.565	kilogram-meters
BTU (mean)	$2.928 \times 10^{-4}$	kilowatt-hr (Kwh)
BTU (mean)	10.409	liter-atm
BTU (mean)	$6.876 \times 10^{-5}$	pounds of carbon to CO <sub>2</sub>
BTU (mean)	0.29305	watt-hours
BTU (mean)/cu ft	37.30	joule/liter

(continued)



(continued)

<i>Multiply</i>	<i>by</i>	<i>to obtain</i>
BTU/hour	0.2162	foot-pound/sec
BTU/hour	0.0700	gram-cal/sec
BTU/hour	$3.929 \times 10^{-4}$	horsepower-hours (hp-hr)
BTU/hour	0.2930711	watt (w)
BTU/hour (feet) <sup>°</sup> F	1.730735	joule/sec (m) <sup>°</sup> k
BTU/hour (feet <sup>2</sup> )	3.15459	joule/m <sup>2</sup> -sec
BTU (mean)/hour(feet <sup>2</sup> ) <sup>°</sup> F	$1.3562 \times 10^{-4}$	gram-calorie/second (cm <sup>2</sup> ) <sup>°</sup> C
BTU (mean)/hour(feet <sup>2</sup> ) <sup>°</sup> F	$3.94 \times 10^{-4}$	horsepower/(ft <sup>2</sup> ) <sup>°</sup> F
BTU (mean)/hour(feet <sup>2</sup> ) <sup>°</sup> F	5.678264	joule/sec (m <sup>2</sup> ) <sup>°</sup> k
BTU (mean)/hour(feet <sup>2</sup> ) <sup>°</sup> F	4.882	kilogram-calorie/hr (m <sup>2</sup> ) <sup>°</sup> C
BTU (mean)/hour(feet <sup>2</sup> ) <sup>°</sup> F	$5.682 \times 10^{-4}$	watts/(cm <sup>2</sup> ) <sup>°</sup> C
BTU (mean)/hour(feet <sup>2</sup> ) <sup>°</sup> F	$2.035 \times 10^{-3}$	watts/(in <sup>2</sup> ) <sup>°</sup> C
BTU (mean)/(hour)(feet <sup>2</sup> ) ( <sup>°</sup> F/inch)	$3.4448 \times 10^{-4}$	calories, gram (15 <sup>°</sup> C)/sec (cm <sup>2</sup> ) ( <sup>°</sup> C/cm)
BTU (mean)/(hour)(feet <sup>2</sup> ) ( <sup>°</sup> F/in.)	1	chu/(hr)(ft <sup>2</sup> )( <sup>°</sup> C/in)
BTU (mean)/(hour)(feet <sup>2</sup> ) ( <sup>°</sup> F/inch)	$1.442 \times 10^{-3}$	joules (abs)/(sec)(cm <sup>2</sup> ) ( <sup>°</sup> C/ cm)
BTU(mean)/(hour)(feet <sup>2</sup> ) ( <sup>°</sup> F/inch)	$1.442 \times 10^{-3}$	watts/(cm <sup>2</sup> ) ( <sup>°</sup> C/cm)
BTU/min	12.96	ft lb/sec
BTU/min	0.02356	hp
BTU/min	0.01757	kw
BTU/min	17.57	watts
BTU/min/ft <sup>2</sup>	0.1221	watts/sq inch
BTU/pound	0.5556	calories-gram(mean)/gram
BTU/pound	0.555	kg-cal/kg
BTU/pound/ <sup>°</sup> F	1	calories, gram/gram/ <sup>°</sup> C
BTU/pound/ <sup>°</sup> F	4186.8	joule/kg/ <sup>°</sup> k
BTU/second	1054.350	watt (W)
buckets (British, dry)	$1.818 \times 10^4$	cubic cm
buckets (British, dry)	4	gallons (British)
bushels (British)	1.03205	bushels (U.S.)
bushels (British)	1.2843	cubic feet
bushels (British)	0.03637	cubic meters
bushels (U.S.)	1.2444	cubic feet
bushels (U.S.)	2150.4	cubic inch
bushels (U.S.)	0.035239	cubic meters
bushels (U.S.)	35.24	liters (L)
bushels (U.S.)	4	pecks (U.S.)

(continued)

(continued)

<i>Multiply</i>	<i>by</i>	<i>to obtain</i>
bushels (U.S.)	64	pints (dry)
bushels (U.S.)	32	quarts (dry)
butts (British)	20.2285	cubic feet
butts (British)	126	gallons (British)
cable lengths	720	feet
cable lengths	219.46	meters
calories (thermochemical)	0.999346	calories (Int. Steam Tables)
calories, gram (g. cal or simply cal.)	$3.9685 \times 10^{-3}$	BTU (mean)
calories, gram (mean)	0.001459	cubic feet atmospheres
calories, gram (mean)	$4.186 \times 10^7$	ergs
calories, gram (mean)	3.0874	foot-pounds
calories, gram (mean)	4.186	joules (abs)
calories, gram (mean)	0.001	kg cal (calories, kilogram)
calories, gram (mean)	0.42685	kilograms-meters
calories, gram (mean)	0.0011628	watt-hours
calories, gram (mean)/gram	1.8	BTU (mean)/pound
cal/gram-°C	4186.8	joule/kg °k
candle power (spherical)	12.566	lumens
candles (int)	0.104	carcel units
candles (int)	1.11	hefner units
candles (int)	1	lumens (int)/steradian
candles (int)/square centimeter	2919	foot-lamberts
candles (int)/square centimeter	3.1416	lamberts
candles (int)/square foot	3.1416	foot-lamberts
candles (int)/square foot	$3.382 \times 10^{-3}$	lamberts
candles (int)/square inch	452.4	foot-lamberts
candles (int)/square inch	0.4870	lamberts
candles (int)/square inch	0.155	stilb
carats (metric)	3.0865	grains
carats (metric)	0.2	grams
centals	100	pounds
centares (centiares)	1.0	sq meters
centigrade heat units (chu)	1.8	BTU
centigrade heat units (chu)	453.6	calories, gram (15° C)
centigrade heat units (chu)	1897.8	joules (abs)
centigrams	0.01	grams
centiliters	0.01	liters
centimeters	0.0328083	feet (U.S.)
centimeters	0.3937	inches (U.S.)
centimeters	0.01	meters

(continued)

(continued)

<i>Multiply</i>	<i>by</i>	<i>to obtain</i>
centimeters	$6.214 \times 10^{-6}$	miles
centimeters	10	millimeters
centimeters	393.7	mils
centimeters	0.01094	yards
cm of mercury	0.01316	atm
cm of mercury	0.4461	ft of water
cm of mercury	136.0	kg/square meter
cm of mercury	1333.22	newton/meter <sup>2</sup> (N/m <sup>2</sup> )
cm of mercury	27.85	psf
cm of mercury	0.1934	psi
cm of water (4° C)	98.0638	newton/meter <sup>2</sup> (N/m <sup>2</sup> )
centimeters-dynes	$1.020 \times 10^{-3}$	centimeter-grams
centimeter-dynes	$1.020 \times 10^{-8}$	meter-kilograms
centimeter-dynes	$7.376 \times 10^{-8}$	pound-feet
centimeter-grams	980.7	centimeter-dynes
centimeter-grams	$10^{-5}$	meter-kilograms
centimeter-grams	$7.233 \times 10^{-5}$	pound-feet
centimeters/second	1.969	fpm (ft/min)
centimeters/second	0.0328	fps (ft/sec)
centimeters/second	0.036	kilometers/hour
centimeters/second	0.1943	knots
centimeters/second	0.6	m/min
centimeters/second	0.02237	miles/hour
centimeters/second	$3.728 \times 10^{-4}$	miles/minute
cms/sec./sec.	0.03281	feet/sec/sec
cms/sec./sec.	0.036	kms/hour/sec
cms/sec./sec.	0.02237	miles/hour/sec
centipoises	3.60	kilograms/meter hour
centipoises	$10^{-3}$	kilograms/meter second
centipoises	0.001	newton-sec/m <sup>2</sup>
centipoises	$2.089 \times 10^{-5}$	pound force second/square foot
centipoises	2.42	pounds/foot hour
centipoises	$6.72 \times 10^{-4}$	pounds/foot second
centistoke	$1.0 \times 10^{-6}$	meter <sup>2</sup> /sec
chains (engineers' or Ramden's)	100	feet
chains (engineers' or Ramden's)	30.48	meters
chains (surveyors' or Gunter's)	66	feet
chains (surveyors' or Gunter's)	20.12	meters
chaldrons (British)	32	bushels (British)

(continued)

(continued)

<i>Multiply</i>	<i>by</i>	<i>to obtain</i>
chaldrons (U.S.)	36	bushels (U.S.)
cheval-vapours	0.9863	horsepower
cheval-vapours	735.5	watts (abs)
cheval-vapours heures	$2.648 \times 10^6$	joules (abs)
chu/(hr)(ft <sup>2</sup> )( C/in.)	1	BTU/(hr)(ft <sup>2</sup> )( F/in.)
circular inches	0.7854	square inches
circular millimeters	$7.854 \times 10^{-7}$	square meters
circular mils	$5.067 \times 10^{-6}$	square centimeters
circular mils	$7.854 \times 10^{-7}$	square inches
circular mils	0.7854	square mils
circumferences	360	degrees
circumferences	400	grades
circumferences	6.283	radians
cloves	8	pounds
coombs (British)	4	bushels (British)
CORDS	8	cord feet
CORDS	$8' \times 4' \times 4'$	cubic feet
CORDS	128	cubic feet
CORDS	3.625	cubic meters
cord-feet	$4' \times 4' \times 1'$	cubic feet
coulombs (abs)	0.1	abcoulombs
coulombs (abs)	$6.281 \times 10^{18}$	electronic charges
coulombs (abs)	$2.998 \times 10^9$	statcoulombs
coulombs (abs)	$1.036 \times 10^{-5}$	faradays
coulombs/sq cm	64.52	coulombs/sq in
coulombs/sq cm	$10^4$	coulombs/sq meter
coulombs/sq in	0.1550	coulombs/sq cm
coulombs/sq in	1550	coulombs/sq meter
coulombs/sq meter	$10^{-4}$	coulombs/sq cm
coulombs/sq meter	$6.452 \times 10^{-4}$	coulombs/sq in
cubic centimeters	$3.531445 \times 10^{-5}$	cubic feet (U.S.)
cubic centimeters	$6.102 \times 10^{-2}$	cubic inches
cubic centimeters	$10^{-6}$	cubic meters
cubic centimeters	$1.308 \times 10^{-6}$	cubic yards
cubic centimeters	$2.6417 \times 10^{-4}$	gallons (U.S.)
cubic centimeters	0.001	liters
cubic centimeters	0.033814	ounces (U.S., fluid)
cubic centimeters	$2.113 \times 10^{-3}$	pints (liq.)
cubic centimeters	$1.057 \times 10^{-3}$	quarts (liq.)

(continued)

(continued)

<i>Multiply</i>	<i>by</i>	<i>to obtain</i>
cubic feet (British)	0.9999916	cubic feet (U.S.)
cubic feet (U.S.)	0.8036	bushels (dry)
cubic feet (U.S.)	28317.016	cubic centimeters
cubic feet (U.S.)	1728	cubic inches
cubic feet (U.S.)	0.02832	cubic meters
cubic feet (U.S.)	0.0370	cubic yard
cubic feet (U.S.)	7.48052	gallons (U.S.)
cubic feet (U.S.)	28.31625	liters
cubic feet (U.S.)	59.84	pints (liq.)
cubic feet (U.S.)	29.92	quarts (liq.)
cubic feet of common brick	120	pounds
cubic feet of water (60° F)	62.37	pounds
cubic foot-atmospheres	2.7203	BTU (mean)
cubic foot-atmospheres	680.74	calories, gram (mean)
cubic foot-atmospheres	2116	foot-pounds
cubic foot-atmospheres	2869	joules (abs)
cubic foot-atmospheres	292.6	kilogram-meters
cubic foot-atmospheres	$7.968 \times 10^{-4}$	kilowatt-hours
cubic feet/hr	0.02832	m <sup>3</sup> /hr
cubic feet/minute	472.0	cubic cm/sec
cubic feet/minute	1.6992	cu m/hr
cubic feet/minute	0.0283	cu m/min
cubic feet/minute	0.1247	gallons/sec
cubic feet/minute	0.472	liter/sec
cubic feet/minute	62.4	lbs of water/min
cubic feet/min/1000 cu ft	0.01667	liter/sec/cu m
cubic feet/second	1.9834	acre-feet/day
cubic feet/second	1.7	cu m/min
cubic feet/second	0.02832	m <sup>3</sup> /sec
cubic feet/second	448.83	gallons/minute
cubic feet/second	1699	liter/min
cubic feet/second	28.32	liters/sec
cubic feet/second (cfs)	0.64632	million gallons/day (MGD)
cfs/acre	0.07	m <sup>3</sup> /sec-ha
cfs/acre	4.2	cu m/min/ha
cfs/sq mile	0.657	cu m/min/sq km
cubic inches (U.S.)	16.387162	cubic centimeters
cubic inches (U.S.)	$5.787 \times 10^{-4}$	cubic feet
cubic inches (U.S.)	1.000084	cubic inches (British)

(continued)

(continued)

<i>Multiply</i>	<i>by</i>	<i>to obtain</i>
cubic inches (U.S.)	$1.639 \times 10^{-5}$	cubic meters
cubic inches (U.S.)	$2.143 \times 10^{-5}$	cubic yards
cubic inches (U.S.)	$4.329 \times 10^{-3}$	gallons (U.S.)
cubic inches (U.S.)	$1.639 \times 10^{-2}$	liters
cubic inches (U.S.)	16.39	mL
cubic inches (U.S.)	0.55411	ounces (U.S., fluid)
cubic inches (U.S.)	0.03463	pints (liq.)
cubic inches (U.S.)	0.01732	quarts (liq.)
cubic meters	$8.1074 \times 10^{-4}$	acre-feet
cubic meters	8.387	barrels (U.S., liquid)
cubic meters	28.38	bushels (dry)
cubic meters	$10^6$	cubic centimeters
cubic meters	35.314	cubic feet (U.S.)
cubic meters	61,023	cubic inches (U.S.)
cubic meters	1.308	cubic yards (U.S.)
cubic meters	264.17	gallons (U.S.)
cubic meters	1000	liters
cubic meters	2113	pints (liq.)
cubic meters (m <sup>3</sup> )	1057	quarts (liq.)
cubic meters/day	0.183	gallons/min
cubic meters/ha	106.9	gallons/acre
cubic meters/hour	0.2272	gallons/minute
cubic meters/meter-day	80.53	gpd/ft
cubic meters/minute	35.314	cubic ft/minute
cubic meters/second	35.314	cubic ft/sec
cubic meters/second	22.82	MGD
cubic meters/sec-ha	14.29	cu ft/sec-acre
cubic meters/meters <sup>2</sup> -day	24.54	gpd/ft <sup>2</sup>
cubic yards (British)	0.9999916	cubic yards (U.S.)
cubic yards (British)	0.76455	cubic meters
cubic yards (U.S.)	$7.646 \times 10^5$	cubic centimeters
cubic yards (U.S.)	27	cubic feet (U.S.)
cubic yards (U.S.)	46,656	cubic inches
cubic yards (U.S.)	0.76456	cubic meters
cubic yards (U.S.)	202.0	gallons (U.S.)
cubic yards (U.S.)	764.6	liters
cubic yards (U.S.)	1616	pints (liq.)
cubic yards (U.S.)	807.9	quarts (liq.)
cubic yards of sand	2700	pounds
cubic yards/minute	0.45	cubic feet/second

(continued)

(continued)

<i>Multiply</i>	<i>by</i>	<i>to obtain</i>
cubic yards/minute	3.367	gallons/second
cubic yards/minute	12.74	liters/second
cubits	45.720	centimeters
cubits	1.5	feet
dalton	$1.65 \times 10^{-24}$ gram	
days	1440	minutes
days	86,400	seconds
days (sidereal)	86164	seconds (mean solar)
debye units (dipole moment)	$10^{18}$	electrostatic units
decigrams	0.1	grams
deciliters	0.1	liters
decimeters	0.1	meters
degrees (angle)	60	minutes
degrees (angle)	0.01111	quadrants
degrees (angle)	0.01745	radians
degrees (angle)	3600	seconds
degrees/second	0.01745	radians/seconds
degrees/second	0.1667	revolutions/min
degrees/second	0.002778	revolutions/sec
degree Celsius	$^{\circ}\text{F} = (^{\circ}\text{C} \times 9/5) + 32$	Fahrenheit
degree Celsius	$^{\circ}\text{K} = ^{\circ}\text{C} + 273.15$	Kelvin
degree Fahrenheit	$^{\circ}\text{C} = (^{\circ}\text{F} - 32) \times 5/9$	Celsius
degree Fahrenheit	$^{\circ}\text{K} = (^{\circ}\text{F} + 459.67)/1.8$	Kelvin
degree Rankine	$^{\circ}\text{K} = ^{\circ}\text{R}/1.8$	Kelvin
dekagrams	10	grams
dekaliters	10	liters
dekameters	10	meters
drachms (British, fluid)	$3.5516 \times 10^{-6}$	cubic meters
drachms (British, fluid)	0.125	ounces (British, fluid)
drams (apothecaries' or troy)	0.1371429	ounces (avoirdupois)
drams (apothecaries' or troy)	0.125	ounces (troy)
drams (U.S., fluid or apoth.)	3.6967	cubic cm
drams (avoirdupois)	1.771845	grams
drams (avoirdupois)	27.3437	grains
drams (avoirdupois)	0.0625	ounces
drams (avoirdupois)	0.00390625	pounds (avoirdupois)
drams (troy)	2.1943	drams (avoirdupois)
drams (troy)	60	grains
drams (troy)	3.8879351	grams
drams (troy)	0.125	ounces (troy)

(continued)

(continued)

<i>Multiply</i>	<i>by</i>	<i>to obtain</i>
drams (U.S., fluid)	$3.6967 \times 10^{-6}$	cubic meters
drams (U.S., fluid)	0.125	ounces (fluid)
dynes	0.00101972	grams
dynes	$10^{-7}$	joules/cm
dynes	$10^{-5}$	joules/meter (newtons)
dynes	$1.020 \times 10^{-6}$	kilograms
dynes	$1 \times 10^{-5}$	newton (N)
dynes	$7.233 \times 10^{-5}$	poundals
dynes	$2.24809 \times 10^{-6}$	pounds
dyne-centimeters (torque)	$7.3756 \times 10^{-8}$	pound-feet
dynes/centimeter	1	ergs/square centimeter
dynes/centimeter	0.01	ergs/square millimeter
dynes/square centimeter	$9.8692 \times 10^{-7}$	atmospheres
dynes/square centimeter	$10^{-6}$	bars
dynes/square centimeter	$2.953 \times 10^{-5}$	inch of mercury at 0°C
dynes/square centimeter	$4.015 \times 10^{-4}$	inch of water at 4°C
dynes/square centimeter	0.01020	kilograms/square meter
dynes/square centimeter	0.1	newtons/square meter
dynes/square centimeter	$1.450 \times 10^{-5}$	pounds/square inch
electromagnetic fps units of magnetic permeability	0.0010764	electromagnetic cgs units of magnetic permeability
electromagnetic fps units of magnetic permeability	$1.03382 \times 10^{-18}$	electrostatic cgs units of magnetic permeability
electromagnetic cgs units, of magnetic permeability	$1.1128 \times 10^{-21}$	electrostatic cgs units of magnetic permeability
electromagnetic cgs units of mass resistance	$9.9948 \times 10^{-6}$	ohms (int)-meter-gram
electronic charges	$1.5921 \times 10^{-19}$	coulombs (abs)
electron-volts	$1.6020 \times 10^{-12}$	ergs
electron-volts	$1.0737 \times 10^{-9}$	mass units
electron-volts	0.07386	rydberg units of energy
electronstatic cgs units of Hall effect	$2.6962 \times 10^{31}$	electromagnetic cgs units of Hall effect
electrostatic fps units of charge	$1.1952 \times 10^{-6}$	coulombs (abs)
electrostatic fps units of magnetic permeability	929.03	electrostatic cgs units of magnetic permeability
ells	114.30	centimeters
ells	45	inches
ems, pica (printing)	0.42333	centimeters
ems, pica (printing)	1/6	inches

(continued)



(continued)

<i>Multiply</i>	<i>by</i>	<i>to obtain</i>
ergs	$9.4805 \times 10^{-11}$	BTU (mean)
ergs	$2.3889 \times 10^{-8}$	calories, gram (mean)
ergs	1	dyne-centimeters
ergs	$7.3756 \times 10^{-8}$	foot-pounds
ergs	$0.2389 \times 10^{-7}$	gram-calories
ergs	$1.020 \times 10^{-3}$	gram-centimeters
ergs	$3.7250 \times 10^{-14}$	horsepower-hrs
ergs	$10^{-7}$	joules (abs)
ergs	$2.390 \times 10^{-11}$	kilogram-calories (kg cal)
ergs	$1.01972 \times 10^{-8}$	kilogram-meters
ergs	$0.2778 \times 10^{-13}$	kilowatt-hrs
ergs	$0.2778 \times 10^{-10}$	watt-hours
ergs/second	$5.692 \times 10^{-9}$	BTU/min
ergs/second	$4.426 \times 10^{-6}$	foot-pounds/min
ergs/second	$7.376 \times 10^{-8}$	foot-pounds/sec
ergs/second	$1.341 \times 10^{-10}$	horsepower
ergs/second	$1.434 \times 10^{-9}$	kg-calories/min
ergs/second	$10^{-10}$	kilowatts
farad (international of 1948)	0.9995	farad (F)
faradays	26.80	ampere-hours
faradays	96,500	coulombs (abs)
faradays/second	96,500	amperes (abs)
farads (abs)	$10^{-9}$	abfarads
farads (abs)	$10^6$	microfarads
farads (abs)	$8.9877 \times 10^{11}$	statfarads
fathoms	6	feet
fathom	1.829	meter
feet (U.S.)	1.0000028	feet (British)
feet (U.S.)	30.4801	centimeters
feet (U.S.)	12	inches
feet (U.S.)	$3.048 \times 10^{-4}$	kilometers
feet (U.S.)	0.30480	meters
feet (U.S.)	$1.645 \times 10^{-4}$	miles (naut.)
feet (U.S.)	$1.893939 \times 10^{-4}$	miles (statute)
feet (U.S.)	304.8	millimeters
feet (U.S.)	$1.2 \times 10^4$	mils
feet (U.S.)	1/3	yards
feet of air (1 atmosphere, 60 °F)	$5.30 \times 10^{-4}$	pounds/square inch
feet of water	0.02950	atm
feet of water	0.8826	inches of mercury

(continued)

(continued)

<i>Multiply</i>	<i>by</i>	<i>to obtain</i>
feet of water at 39.2°F	0.030479	kilograms/square centimeter
feet of water at 39.2°F	2988.98	newton/meter <sup>2</sup> (N/m <sup>2</sup> )
feet of water at 39.2°F	304.79	kilograms/square meter
feet of water	62.43	pounds/square feet (psf)
feet of water at 39.2°F	0.43352	pounds/square inch (psi)
feet/hour	0.08467	mm/sec
feet/min	0.5080	cms/sec
feet/min	0.01667	feet/sec
feet/min	0.01829	km/hr
feet/min	0.3048	meters/min
feet/min	0.01136	miles/hr
feet/sec	30.48	cm/sec
feet/sec	1.097	km/hr
feet/sec	0.5921	knots
feet/sec	18.29	meters/min
feet/sec	0.6818	miles/hr
feet/sec	0.01136	miles/min
feet/sec/sec	30.48	cm/sec/sec
feet/sec/sec	1.097	km/hr/sec
feet/sec/sec	0.3048	meters/sec/sec
feet/sec/sec	0.6818	miles/hr/sec
feet/100 feet	1.0	percent grade
firkins (British)	9	gallons (British)
firkins (U.S.)	9	gallons (U.S.)
foot-candle (ft-c)	10.764	lumen/sq m
foot-poundals	$3.9951 \times 10^{-5}$	BTU (mean)
foot-poundals	0.0421420	joules (abs)
foot-pounds	0.0012854	BTU (mean)
foot-pounds	0.32389	calories, gram (mean)
foot-pounds	$1.13558 \times 10^7$	ergs
foot-pounds	32.174	foot-poundals
foot-pounds	$5.050 \times 10^{-7}$	hp-hr
foot-pounds	1.35582	joules (abs)
foot-pounds	$3.241 \times 10^{-4}$	kilogram-calories
foot-pounds	0.138255	kilogram-meters
foot-pounds	$3.766 \times 10^{-7}$	kwh
foot-pounds	0.013381	liter-atmospheres
foot-pounds	$3.7662 \times 10^{-4}$	watt-hours (abs)
foot-pounds/minute	$1.286 \times 10^{-3}$	BTU/minute
foot-pounds/minute	0.01667	foot-pounds/sec

(continued)

(continued)

<i>Multiply</i>	<i>by</i>	<i>to obtain</i>
foot-pounds/minute	$3.030 \times 10^{-5}$	hp
foot-pounds/minute	$3.241 \times 10^{-4}$	kg-calories/min
foot-pounds/minute	$2.260 \times 10^{-5}$	kw
foot-pounds/second	4.6275	BTU (mean)/hour
foot-pounds/second	0.07717	BTU/minute
foot-pounds/second	0.0018182	horsepower
foot-pounds/second	0.01945	kg-calories/min
foot-pounds/second	0.001356	kilowatts
foot-pounds/second	1.35582	watts (abs)
furlongs	660.0	feet
furlongs	201.17	meters
furlongs	0.125	miles (U.S.)
furlongs	40.0	rods
gallons (Br.)	$3.8125 \times 10^{-2}$	barrels (U.S.)
gallons (Br.)	4516.086	cubic centimeters
gallons (Br.)	0.16053	cu ft
gallons (Br.)	277.4	cu inches
gallons (Br.)	1230	drams (U.S. fluid)
gallons (Br.)	4.54596	liters
gallons (Br.)	$7.9620 \times 10^4$	minims (Br.)
gallons (Br.)	$7.3783 \times 10^4$	minims (U.S.)
gallons (Br.)	4545.96	mL
gallons (Br.)	1.20094	gallons (U.S.)
gallons (Br.)	160	ounces (Br., fl.)
gallons (Br.)	153.72	ounces (U.S., fl.)
gallons (Br.)	10	pounds (avoirdupois) of water at 62°F
gallons (U.S.)	$3.068 \times 10^{-4}$	acre-ft
gallons (U.S.)	0.031746	barrels (U.S.)
gallons (U.S.)	3785.434	cubic centimeters
gallons (U.S.)	0.13368	cubic feet (U.S.)
gallons (U.S.)	231	cubic inches
gallons (U.S.)	$3.785 \times 10^{-3}$	cubic meters
gallons (U.S.)	$4.951 \times 10^{-3}$	cubic yards
gallons (U.S.)	1024	drams (U.S., fluid)
gallons (U.S.)	0.83268	gallons (Br.)
gallons (U.S.)	0.83267	imperial gal
gallons (U.S.)	3.78533	liters
gallons (U.S.)	$6.3950 \times 10^4$	minims (Br.)
gallons (U.S.)	$6.1440 \times 10^4$	minims (U.S.)

(continued)

(continued)

<i>Multiply</i>	<i>by</i>	<i>to obtain</i>
gallons (U.S.)	3785	mL
gallons (U.S.)	133.23	ounces (Br., fluid)
gallons (U.S.)	128	ounces (U.S., fluid)
gallons	8	pints (liq.)
gallons	4	quarts (liq.)
gal water (U.S.)	8.345	lb of water
gallons/acre	0.00935	cu m/ha
gallons/day	$4.381 \times 10^{-5}$	liters/sec
gallons/ton	4.1721	liter/metric ton (L/T)
gpd/acre	0.00935	cu m/day/ha
gpd/acre	9.353	liter/day/ha
gallons/capita/day	3.785	liters/capita/day
gpd/cu yd	5.0	L/day/cu m
gpd/ft	0.01242	cu m/day/m
gpd/sq ft	0.0408	cu m/day/sq m
gpd/sq ft	$1.698 \times 10^{-5}$	cubic meters/hour/sq meter
gpd/sq ft	0.283	cu meter/minute/ha
gpm (gal/min)	8.0208	cfh (cu ft/hr)
gpm	$2.228 \times 10^{-3}$	cfs (cu ft/sec)
gpm	4.4021	cubic meters/hr
gpm	0.00144	MGD
gpm	0.0631	liters/sec
gpm/sq ft	2.445	cu meters/hour/sq meter
gpm/sq ft	40.7	L/min/sq meter
gpm/sq ft	0.679	liter/sec/sq meter
gallons/sq ft	40.743	liters/sq meter
gausses (abs)	$3.3358 \times 10^{-4}$	electrostatic cgs units of magnetic flux density
gausses (abs)	0.99966	gausses (int)
gausses (abs)	1	lines/square centimeter
gausses (abs)	6.452	lines/sq in
gausses (abs)	1	maxwells (abs)/square centimeters
gausses (abs)	6.4516	maxwells (abs)/square inch
gausses (abs)	$10^{-8}$	webers/sq cm
gausses (abs)	$6.452 \times 10^{-8}$	webers/sq in
gausses (abs)	$10^{-4}$	webers/sq meter
gilberts (abs)	0.07958	abampere turns
gilberts (abs)	0.7958	ampere turns
gilberts (abs)	$2.998 \times 10^{10}$	electrostatic cgs units of magneto motive force

(continued)

(continued)

<i>Multiply</i>	<i>by</i>	<i>to obtain</i>
gilberts/cm	0.7958	amp-turns/cm
gilberts/cm	2.021	amp-turns/in
gilberts/cm	79.58	amp-turns/meter
gills (Br.)	142.07	cubic cm
gills (Br.)	5	ounces (British, fluid)
gills (U.S.)	32	drams (fluid)
gills	0.1183	liters
gills	0.25	pints (liq.)
grade	0.01571	radian
grains	0.036571	drams (avoirdupois)
grains	0.01667	drams (troy)
grains (troy)	1.216	grains (avdp)
grains (troy)	0.06480	grams
grains (troy)	$6.480 \times 10^{-5}$	kilograms
grains (troy)	64.799	milligrams
grains (troy)	$2.286 \times 10^{-3}$	ounces (avdp)
grains (troy)	$2.0833 \times 10^{-3}$	ounces (troy)
grains (troy)	0.04167	pennyweights (troy)
grains	1/7000	pounds (avoirdupois)
grains	$1.736 \times 10^{-4}$	pounds (troy)
grains	$6.377 \times 10^{-8}$	tons (long)
grains	$7.142 \times 10^{-8}$	tons (short)
grains/imp gal	14.254	mg/L
grains/imp. gal	14.254	parts/million (ppm)
grains/U.S. gal	17.118	mg/L
grains/U.S. gal	17.118	parts/million (ppm)
grains/U.S. gal	142.86	lb/mil gal
grams	0.5611	drams (avdp)
grams	0.25721	drams (troy)
grams	980.7	dynes
grams	15.43	grains
grams	$9.807 \times 10^{-5}$	joules/cm
grams	$9.807 \times 10^{-3}$	joules/meter (newtons)
grams	$10^{-3}$	kilograms
grams	$10^3$	milligrams
grams	0.0353	ounces (avdp)
grams	0.03215	ounces (troy)
grams	0.07093	poundals
grams	$2.205 \times 10^{-3}$	pounds

(continued)

(continued)

<i>Multiply</i>	<i>by</i>	<i>to obtain</i>
grams	$2.679 \times 10^{-3}$	pounds (troy)
grams	$9.842 \times 10^{-7}$	tons (long)
grams	$1.102 \times 10^{-6}$	tons (short)
grams-calories	$4.1868 \times 10^7$	ergs
gram-calories	3.0880	foot-pounds
gram-calories	$1.5597 \times 10^{-6}$	horsepower-hr
gram-calories	$1.1630 \times 10^{-6}$	kilowatt-hr
gram-calories	$1.1630 \times 10^{-3}$	watt-hr
gram-calories	$3.968 \times 10^{-3}$	British Thermal Units (BTU)
gram-calories/sec	14.286	BTU/hr
gram-centimeters	$9.2967 \times 10^{-8}$	BTU (mean)
gram-centimeters	$2.3427 \times 10^{-5}$	calories, gram (mean)
gram-centimeters	980.7	ergs
gram-centimeters	$7.2330 \times 10^{-5}$	foot-pounds
gram-centimeters	$9.8067 \times 10^{-5}$	joules (abs)
gram-centimeters	$2.344 \times 10^{-8}$	kilogram-calories
gram-centimeters	$10^{-5}$	kilogram-meters
gram-centimeters	$2.7241 \times 10^{-8}$	watt-hours
grams-centimeters <sup>2</sup> (moment of inertia)	$2.37305 \times 10^{-6}$	pounds-feet <sup>2</sup>
grams-centimeters <sup>2</sup> (moment of inertia)	$3.4172 \times 10^{-4}$	pounds-inch <sup>2</sup>
gram-centimeters/second	$1.3151 \times 10^{-7}$	hp
gram-centimeters/second	$9.8067 \times 10^{-8}$	kilowatts
gram-centimeters/second	0.065552	lumens
gram-centimeters/second	$9.80665 \times 10^{-5}$	watt (abs)
grams/cm	$5.600 \times 10^{-3}$	pounds/inch
grams/cu cm	62.428	pounds/cubic foot
grams/cu cm	0.03613	pounds/cubic inch
grams/cu cm	8.3454	pounds/gallon (U.S.)
grams/cu cm	$3.405 \times 10^{-7}$	pounds/mil-foot
grams/cu ft	35.314	grams/cu meter
grams/cu ft	$10^6$	micrograms/cu ft
grams/cu ft	$35.314 \times 10^6$	micrograms/cu meter
grams/cu ft	$35.3145 \times 10^3$	milligrams/cu meter
grams/cu ft	2.2046	pounds/1000 cu ft
grams/cu m	0.43700	grains/cubic foot
grams/cu m	0.02832	grams/cu ft
grams/cu m	$28.317 \times 10^3$	micrograms/cu ft
grams/cu m	0.06243	pounds/cu ft

(continued)

(continued)

<i>Multiply</i>	<i>by</i>	<i>to obtain</i>
grams/liter	58.417	grains/gallon (U.S.)
grams/liter	$9.99973 \times 10^{-4}$	grams/cubic centimeter
grams/liter	1000	mg/L
grams/liter	1000	parts per million (ppm)
grams/liter	0.06243	pounds/cubic foot
grams/liter	8.345	lb/1000 gal
grams/sq centimeter	2.0481	pounds/sq ft
grams/sq centimeter	0.0142234	pounds/square inch
grams/sq ft	10.764	grams/sq meter
grams/sq ft	$10.764 \times 10^3$	kilograms/sq km
grams/sq ft	1.0764	milligrams/sq cm
grams/sq ft	$10.764 \times 10^3$	milligrams/sq meter
grams/sq ft	96.154	pounds/acre
grams/sq ft	2.204	pounds/1000 sq ft
grams/sq ft	30.73	tons/sq mile
grams/sq meter	0.0929	grams/sq ft
grams/sq meter	1000	kilograms/sq km
grams/sq meter	0.1	milligrams/square cm
grams/sq meter	1000	milligrams/sq meter
grams/sq meter	8.921	pounds/acre
grams/sq meter	0.2048	pounds/1000 sq ft
grams/sq meter	2.855	tons/sq mile
g (gravity)	9.80665	meters/sec <sup>2</sup>
g (gravity)	32.174	ft/sec <sup>2</sup>
hand	10.16	cm
hands	4	inches
hectare (ha)	2.471	acre
hectares	$1.076 \times 10^5$	sq feet
hectograms	100	grams
hectoliters	100	liters
hectometers	100	meters
hectowatts	100	watts
hemispheres	0.5	spheres
hemispheres	4	spherical right angles
hemispheres	6.2832	steradians
henries (abs)	$10^9$	abhenries
henries	1000.0	millihenries
henries (abs)	$1.1126 \times 10^{-12}$	stathenries
hogsheads (British)	63	gallons (British)
hogsheads (British)	10.114	cubic feet

(continued)

(continued)

<i>Multiply</i>	<i>by</i>	<i>to obtain</i>
hogsheads (U.S.)	8.422	cubic feet
hogsheads (U.S.)	0.2385	cubic meters
hogsheads (U.S.)	63	gallons (U.S.)
horsepower	2545.08	BTU (mean)/hour
horsepower	42.44	BTU/min
horsepower	$7.457 \times 10^9$	erg/sec
horsepower	33,000	ft lb/min
horsepower	550	foot-pounds/second
horsepower	$7.6042 \times 10^6$	g cm/sec
horsepower, electrical	1.0004	horsepower
horsepower	10.70	kg.-calories/min
horsepower	0.74570	kilowatts (g = 980.665)
horsepower	498129	lumens
horsepower, continental	736	watts (abs)
horsepower, electrical	746	watts (abs)
horsepower (boiler)	9.803	kw
horsepower (boiler)	33.479	BTU/hr
horsepower-hours	2545	BTU (mean)
horsepower-hours	$2.6845 \times 10^{13}$	ergs
horsepower-hours	$6.3705 \times 10^7$	ft poundals
horsepower-hours	$1.98 \times 10^6$	foot-pounds
horsepower-hours	641,190	gram-calories
horsepower-hours	$2.684 \times 10^6$	joules
horsepower-hours	641.7	kilogram-calories
horsepower-hours	$2.737 \times 10^5$	kilogram-meters
horsepower-hours	0.7457	kilowatt-hours (abs)
horsepower-hours	26,494	liter atmospheres (normal)
horsepower-hours	745.7	watt-hours
horsepower/1000 ft <sup>3</sup>	0.0263	kw/m <sup>3</sup>
hours	$4.167 \times 10^{-2}$	days
hours	60	minutes
hours	3600	seconds
hours	$5.952 \times 10^{-3}$	weeks
hundredweights (long)	112	pounds
hundredweights (long)	0.05	tons (long)
hundredweights (short)	1600	ounces (avoirdupois)
hundredweights (short)	100	pounds
hundredweights (short)	0.0453592	tons (metric)
hundredweights (short)	0.0446429	tons (long)

(continued)



(continued)

<i>Multiply</i>	<i>by</i>	<i>to obtain</i>
inches (British)	2.540	centimeters
inches (U.S.)	2.54000508	centimeters
inches (British)	0.9999972	inches (U.S.)
inches	$2.540 \times 10^{-2}$	meters
inches	$1.578 \times 10^{-5}$	miles
inches	25.40	millimeters
inches	$10^3$	mils
inches	$2.778 \times 10^{-2}$	yards
inches <sup>2</sup>	$6.4516 \times 10^{-4}$	meter <sup>2</sup>
inches <sup>3</sup>	$1.6387 \times 10^{-5}$	meter <sup>3</sup>
in. of mercury	0.0334	atm
in. of mercury	1.133	ft of water
in. of mercury (0°C)	13.609	inches of water (60 °F)
in. of mercury	0.0345	kgs/square cm
in. of mercury at 32°F	345.31	kilograms/square meter
in. of mercury	33.35	millibars
in. of mercury	25.40	millimeters of mercury
in. of mercury (60°F)	3376.85	newton/meter <sup>2</sup>
in. of mercury	70.73	pounds/square ft
in. of mercury at 32°F	0.4912	pounds/square inch
in. of water	0.002458	atmospheres
in. of water	0.0736	in. of mercury
in. of water (at 4°C)	$2.540 \times 10^{-3}$	kgs/sq cm
in. of water	25.40	kgs/square meter
in. of water (60°F)	1.8663	millimeters of mercury (0°C)
in. of water (60°F)	248.84	newton/meter <sup>2</sup>
in. of water	0.5781	ounces/square in
in. of water	5.204	pounds/square ft
in. of water	0.0361	psi
inches/hour	2.54	cm/hr
international ampere	.9998	ampere (absolute)
international volt	1.0003	volts (absolute)
international volt	$1.593 \times 10^{-19}$	joules (absolute)
international volt	$9.654 \times 10^4$	joules
joules	$9.480 \times 10^{-4}$	BTU
joules (abs)	$10^7$	ergs
joules	23.730	foot poundals
joules (abs)	0.73756	foot-pounds
joules	$3.7251 \times 10^{-7}$	horsepower hours
joules	$2.389 \times 10^{-4}$	kg-calories

(continued)

(continued)

<i>Multiply</i>	<i>by</i>	<i>to obtain</i>
joules (abs)	0.101972	kilogram-meters
joules	$9.8689 \times 10^{-3}$	liter atmospheres (normal)
joules	$2.778 \times 10^{-4}$	watt-hrs
joules-sec	$1.5258 \times 10^{33}$	quanta
joules/cm	$1.020 \times 10^4$	grams
joules/cm	$10^7$	dynes
joules/cm	100.0	joules/meter (newtons)
joules/cm	723.3	poundals
joules/cm	22.48	pounds
joules/liter	0.02681	BTU/cu ft
joules/m <sup>2</sup> -sec	0.3167	BTU/ft <sup>2</sup> -hr
joules/sec	3.41304	BTU/hr
joules/sec	0.056884	BTU/min
joules/sec	$1 \times 10^7$	erg/sec
joules/sec	44.254	ft lb/min
joules/sec	0.73756	ft lb/sec
joules/sec	$1.0197 \times 10^4$	g cm/sec
joules/sec	$1.341 \times 10^{-3}$	hp
joules/sec	0.01433	kg cal/min
joules/sec	0.001	kilowatts
joules/sec	668	lumens
joules/sec	1	watts
kilograms	564.38	drams (avdp)
kilograms	257.21	drams (troy)
kilograms	980,665	dynes
kilograms	15,432	grains
kilograms	1000	grams
kilograms	0.09807	joules/cm
kilograms	9.807	joules/meter (newtons)
kilograms	$1 \times 10^6$	milligrams
kilograms	35.274	ounces (avdp)
kilograms	32.151	ounces (troy)
kilograms	70.93	poundals
kilograms	2.20462	pounds (avdp)
kilograms	2.6792	pounds (troy)
kilograms	$9.84207 \times 10^{-4}$	tons (long)
kilograms	0.001	tons (metric)
kilograms	0.0011023	tons (short)
kilogram-calories	3.968	British Thermal Units (BTU)
kilogram-calories	3086	foot-pounds

(continued)

(continued)

<i>Multiply</i>	<i>by</i>	<i>to obtain</i>
kilogram-calories	$1.558 \times 10^{-3}$	horsepower-hours
kilogram-calories	4186	joules
kilogram-calories	426.6	kilogram-meters
kilogram-calories	4.186	kilojoules
kilogram-calories	$1.162 \times 10^{-3}$	kilowatt-hours
kg-cal/min	238.11	BTU/hr
kg-cal/min	3.9685	BTU/min
kg-cal/min	$6.9770 \times 10^8$	erg/sec
kg-cal/min	3087.4	ft-lb/min
kg-cal/min	51.457	ft-lb/sec
kg-cal/min	$7.1146 \times 10^5$	g cm/sec
kg-cal/min	0.0936	hp
kg-cal/min	69.769	joules/sec
kg-cal/min	0.0698	kw
kg-cal/min	46636	lumens
kg-cal/min	69.767	watts
kgs-cms. squared	$2.373 \times 10^{-3}$	pounds-feet squared
kgs-cms. squared	0.3417	pounds-inches squared
kilogram-force (kgf)	9.80665	newton
kilogram-meters	0.0092967	BTU (mean)
kilogram-meters	2.3427	calories, gram (mean)
kilogram-meters	$9.80665 \times 10^7$	ergs
kilogram-meters	232.71	ft poundals
kilogram-meters	7.2330	foot-pounds
kilogram-meters	$3.6529 \times 10^{-6}$	horsepower-hours
kilogram-meters	9.80665	joules (abs)
kilogram-meters	$2.344 \times 10^{-3}$	kilogram-calories
kilogram-meters	$2.52407 \times 10^{-6}$	kilowatt-hours (abs)
kilogram-meters	$2.7241 \times 10^{-6}$	kilowatt-hours
kilogram-meters	0.096781	liter atmospheres (normal)
kilogram-meters	$6.392 \times 10^{-7}$	pounds carbon to CO <sub>2</sub>
kilogram-meters	$9.579 \times 10^{-6}$	pounds water evap. at 212
kilograms/cubic meter	$10^{-3}$	grams/cubic cm
kilograms/cubic meter	0.06243	pounds/cubic foot
kilograms/cubic meter	$3.613 \times 10^{-5}$	pounds/cubic inch
kilograms/cubic meter	$3.405 \times 10^{-10}$	pounds/mil. foot
kilograms/m <sup>3</sup> -day	0.0624	lb/cu ft-day
kilograms/cu meter-day	62.43	pounds/1000 cu ft-day
kilograms/ha	0.8921	pounds/acre
kilograms/meter	0.6720	pounds/foot

(continued)

(continued)

<i>Multiply</i>	<i>by</i>	<i>to obtain</i>
kilograms/sq cm	980,665	dynes
kilograms/sq cm	0.96784	atmosphere
kilograms/sq cm	32.81	feet of water
kilograms/sq cm	28.96	inches of mercury
kilograms/sq cm	735.56	mm of mercury
kilograms/sq cm	2048	pounds/sq ft
kilograms/sq cm	14.22	pounds/square inch
kilograms/sq km	$92.9 \times 10^{-6}$	grams/sq ft
kilograms/sq km	0.001	grams/sq meter
kilograms/sq km	0.0001	milligrams/sq cm
kilograms/sq km	1.0	milligrams/sq meter
kilograms/sq km	$8.921 \times 10^{-3}$	pounds/acre
kilograms/sq km	$204.8 \times 10^{-6}$	pounds/1000 sq ft
kilograms/sq km	$2.855 \times 10^{-3}$	tons/sq mile
kilograms/sq meter	$9.6784 \times 10^{-5}$	atmospheres
kilograms/sq meter	$98.07 \times 10^{-6}$	bars
kilograms/sq meter	98.0665	dynes/sq centimeters
kilograms/sq meter	$3.281 \times 10^{-3}$	feet of water at 39.2° F
kilograms/sq meter	0.1	grams/sq centimeters
kilograms/sq meter	$2.896 \times 10^{-3}$	inches of mercury at 32° F
kilograms/sq meter	0.07356	mm of mercury at 0°C
kilograms/sq meter	0.2048	pounds/square foot
kilograms/sq meter	0.00142234	pounds/square inch
kilograms/sq mm.	$10^6$	kg/square meter
kilojoule	0.947	BTU
kilojoules/kilogram	0.4295	BTU/pound
kilolines	1000.0	maxwells
kiloliters	$10^3$	liters
kilometers	$10^5$	centimeters
kilometers	3281	feet
kilometers	$3.937 \times 10^4$	inches
kilometers	$10^3$	meters
kilometers	0.53961	miles (nautical)
kilometers	0.6214	miles (statute)
kilometers	$10^6$	millimeters
kilometers	1093.6	yards
kilometers/hr	27.78	cm/sec
kilometers/hr	54.68	feet/minute
kilometers/hr	0.9113	ft/sec

(continued)

(continued)

<i>Multiply</i>	<i>by</i>	<i>to obtain</i>
kilometers/hr	0.5396	knot
kilometers/hr	16.67	meters/minute
kilometers/hr	0.2778	meters/sec
kilometers/hr	0.6214	miles/hour
kilometers/hour/sec	27.78	cms/sec/sec
kilometers/hour/sec	0.9113	ft/sec/sec
kilometers/hour/sec	0.2778	meters/sec/sec
kilometers/hour/sec	0.6214	miles/hr/sec
kilometers/min	60	kilometers/hour
kilonewtons/sq m	0.145	psi
kilopascal (kPa)	1	kN/m <sup>2</sup>
kilopascal (kPa)	0.2691	in Hg (60°F)
kilopascal (kPa)	0.145	lb/in <sup>2</sup>
kilopascal (kPa)	0.0099	atm
kilowatts	56.88	BTU/min
kilowatts	$4.425 \times 10^4$	foot-pounds/min
kilowatts	737.6	ft-lb/sec
kilowatts	1.341	horsepower
kilowatts	14.34	kg-cal/min
kilowatts	10 <sup>3</sup>	watts
kilowatt-hrs	3413	BTU (mean)
kilowatt-hrs	$3.600 \times 10^{13}$	ergs
kilowatt-hrs	$2.6552 \times 10^6$	foot-pounds
kilowatt-hrs	859,850	gram-calories
kilowatt-hrs	1.341	horsepower hours
kilowatt-hrs	$3.6 \times 10^6$	joules
kilowatt-hrs	860.5	kg-calories
kilowatt-hrs	$3.6709 \times 10^5$	kilogram-meters
kilowatt-hrs	3.53	pounds of water evaporated from and at 212°F
kilowatt-hrs	22.75	pounds of water raised from 62° to 212°F
knots	6080	feet/hr
knots	1.689	feet/sec
knots	1.8532	kilometers/hr
knots	0.5144	meters/sec
knots	1.0	miles (nautical)/hour
knots	1.151	miles (statute)/hour
knots	2,027	yards/hr
lambert	2.054	candle/in <sup>2</sup>
lambert	929	footlambert
lambert	0.3183	stilb

(continued)

(continued)

<i>Multiply</i>	<i>by</i>	<i>to obtain</i>
langley	1	15° gram-calorie/cm <sup>2</sup>
langley	3.6855	BTU/ft <sup>2</sup>
langley	0.011624	Int. kw-hr/m <sup>2</sup>
langley	4.1855	joules (abs)/cm <sup>2</sup>
leagues (nautical)	3	miles (nautical)
leagues (statute)	3	miles (statute)
light years	63,274	astronomical units
light years	$9.4599 \times 10^{12}$	kilometers
light years	$5.8781 \times 10^{12}$	miles
lignes (Paris lines)	1/12	ponces (Paris inches)
lines/sq cm	1.0	gausses
lines/sq in	0.1550	gausses
lines/sq in	$1.550 \times 10^{-9}$	Webers/sq cm
lines/sq in	$10^{-8}$	Webers/sq in
lines/sq in	$1.550 \times 10^{-5}$	Webers/sq meter
links (engineer's)	12.0	inches
links (Gunter's)	0.01	chains (Gunter's)
links (Gunter's)	0.66	feet
links (Ramden's)	0.01	chains (Ramden's)
links (Ramden's)	1	feet
links(surveyor's)	7.92	inches
liters	$8.387 \times 10^{-3}$	barrels (U.S.)
liters	0.02838	bushels (U.S. dry)
liters	1000.028	cubic centimeters
liters	0.035316	cubic feet
liters	61.025	cu inches
liters	$10^{-3}$	cubic meters
liters	$1.308 \times 10^{-3}$	cubic yards
liters	270.5179	drams (U.S. fl)
liters	0.21998	gallons (Br.)
liters	0.26417762	gallons (U.S.)
liters	16,894	minims (Br.)
liters	16,231	minims (U.S.)
liters	35.196	ounces (Br. fl)
liters	33.8147	ounces (U.S. fl)
liters	2.113	pints (liq.)
liters	1.0566828	quarts (U.S. liq.)
liter-atmospheres (normal)	0.096064	BTU (mean)
liter-atmospheres (normal)	24.206	calories, gram (mean)
liter-atmospheres (normal)	$1.0133 \times 10^9$	ergs

(continued)

(continued)

<i>Multiply</i>	<i>by</i>	<i>to obtain</i>
liter-atmospheres (normal)	74.735	foot-pounds
liter-atmospheres (normal)	$3.7745 \times 10^{-5}$	horsepower hours
liter-atmospheres (normal)	101.33	joules (abs)
liter-atmospheres (normal)	10.33	kilogram-meters
liter-atmospheres (normal)	$2.4206 \times 10^{-2}$	kilogram calories
liter-atmospheres (normal)	$2.815 \times 10^{-5}$	kilowatt-hours
liter/cu m-sec	60.0	cfm/1000 cu ft
liters/minute	$5.885 \times 10^{-4}$	cubic feet/sec
liters/minute	$4.403 \times 10^{-3}$	gallons/sec
liter/person-day	0.264	gpcd
liters/sec	2.119	cu ft/min
liters/sec	$3.5316 \times 10^{-2}$	cu ft/sec
liters/sec	15.85	gallons/minute
liters/sec	0.02282	MGD
$\log_{10} N$	2.303	$\log_e N$ or $\ln N$
$\log_e N$ or $\ln N$	0.4343	$\log_{10} N$
lumens	0.07958	candle-power (spherical)
lumens	0.00147	watts of maximum visibility radiation
lumens/sq. centimeters	1	lamberts
lumens/sq cm/steradian	3.1416	lamberts
lumens/sq ft	1	foot-candles
lumens/sq ft	10.764	lumens/sq meter
lumens/sq ft/steradian	3.3816	millilamberts
lumens/sq meter	0.09290	foot-candles or lumens/sq
lumens/sq meter	$10^{-4}$	phots
lux	0.09290	foot-candles
lux	1	lumens/sq meter
lux	$10^{-4}$	phots
maxwells	0.001	kilolines
maxwells	$10^{-8}$	webers
megajoule	0.3725	horsepower-hour
megalines	$10^6$	maxwells
megohms	$10^{12}$	microhms
megohms	$10^6$	ohms
meters	$10^{10}$	angstrom units
meters	100	centimeters
meters	0.5467	fathoms
meters	3.280833	feet (U.S.)
meters	39.37	inches

(continued)

(continued)

<i>Multiply</i>	<i>by</i>	<i>to obtain</i>
meters	$10^{-3}$	kilometers
meters	$5.396 \times 10^{-4}$	miles (naut.)
meters	$6.2137 \times 10^{-4}$	miles (statute)
meters	$10^3$	millimeters
meters	$10^9$	millimicrons
meters	1.09361	yards (U.S.)
meters	1.179	varas
meter head of water (20°C)	9.79	kN/m <sup>2</sup>
meter head of water (20°C)	0.00979	N/mm <sup>2</sup>
meter head of water (20°C)	1.42	pound/sq in
meter-candles	1	lumens/sq meter
meter-kilograms	$9.807 \times 10^7$	centimeter-dynes
meter-kilograms	$10^5$	centimeter-grams
meter-kilograms	7.233	pound-feet
meters/minute	1.667	centimeters/sec
meters/minute	3.281	feet/minute
meters/minute	0.05468	feet/second
meters/minute	0.06	kilograms/hour
meters/minute	0.03238	knots
meters/minute	0.03728	miles/hour
meters/second	196.8	feet/minute
meters/second	3.281	feet/second
meters/second	3.6	kilometers/hour
meters/second	0.06	kilometers/min
meters/second	1.944	knots
meters/second	2.23693	miles/hour
meters/second	0.03728	miles/minute
meters/sec/sec	100.0	cm/sec/sec
meters/sec/sec	3.281	feet/sec/sec
meters/sec/sec	3.6	km/hour/sec
meters/sec/sec	2.237	miles/hour/sec
microfarad	$10^{-6}$	farads
micrograms	$10^{-6}$	grams
micrograms/cu ft	$10^{-6}$	grams/cu ft
micrograms/cu ft	$35.314 \times 10^{-6}$	grams/cu m
micrograms/cu ft	35.314	microgram/cu m
micrograms/cu ft	$35.314 \times 10^{-3}$	milligrams/cu m
micrograms/cu ft	$2.2046 \times 10^{-6}$	pounds/1000 cu ft
micrograms/cu m	$28.317 \times 10^{-9}$	grams/cu ft
micrograms/cu m	$10^{-6}$	grams/cu m

(continued)



(continued)

<i>Multiply</i>	<i>by</i>	<i>to obtain</i>
micrograms/cu m	0.02832	micrograms/cu ft
micrograms/cu m	0.001	milligrams/cu m
micrograms/cu m	$62.43 \times 10^{-9}$	pounds/1000 cu ft
micrograms/cu m	0.02404	ppm by volume (20°C)
	<hr/>	
	molecular weight of gas	
micrograms/cu m	$834.7 \times 10^{-6}$	ppm by weight
micrograms/liter	1000.0	micrograms/cu m
micrograms/liter	1.0	milligrams/cu m
micrograms/liter	$62.43 \times 10^{-9}$	pounds/cu ft
micrograms/liter	24.04	ppm by volume (20°C)
	<hr/>	
	molecular weight of gas	
micrograms/liter	0.834.7	ppm by weight
microhms	$10^{-12}$	megohms
microhms	$10^{-6}$	ohms
microliters	$10^{-6}$	liters
microns	$10^4$	angstrom units
microns	$1 \times 10^{-4}$	centimeters
microns	$3.9370 \times 10^{-5}$	inches
microns	$10^{-6}$	meters
miles (naut.)	6080.27	feet
miles (naut.)	1.853	kilometers
miles (naut.)	1.853	meters
miles (naut.)	1.1516	miles (statute)
miles (naut.)	2027	yards
miles (statute)	$1.609 \times 10^5$	centimeters
miles (statute)	5280	feet
miles (statute)	$6.336 \times 10^4$	inches
miles (statute)	1.609	kilometers
miles (statute)	1609	meters
miles (statute)	0.8684	miles (naut.)
miles (statute)	320	rods
miles (statute)	1760	yards
miles/hour	44.7041	centimeter/second
miles/hour	88	feet/min
miles/hour	1.4667	feet/sec
miles/hour	1.6093	kilometers/hour
miles/hour	0.02682	km/min
miles/hour	0.86839	knots
miles/hour	26.82	meters/min
miles/hour	0.447	meters/sec
miles/hour	0.1667	miles/min

(continued)

(continued)

<i>Multiply</i>	<i>by</i>	<i>to obtain</i>
miles/hour/sec	44.70	cms/sec/sec
miles/hour/sec	1.4667	ft/sec/sec
miles/hour/sec	1.6093	km/hour/sec
miles/hour/sec	0.4470	m/sec/sec
miles/min	2682	centimeters/sec
miles/min	88	ft/sec
miles/min	1.609	km/min
miles/min	0.8684	knots/min
miles/min	60	miles/hour
miles-feet	$9.425 \times 10^{-6}$	cu inches
millibars	0.00987	atmospheres
millibars	0.30	inches of mercury
millibars	0.75	millimeters of mercury
milliers	$10^3$	kilograms
millimicrons	$1 \times 10^{-9}$	meters
milligrams	0.01543236	grains
milligrams	$10^{-3}$	grams
milligrams	$10^{-6}$	kilograms
milligrams	$3.5274 \times 10^{-5}$	ounces (avdp)
milligrams	$2.2046 \times 10^{-6}$	pounds (avdp)
milligrams/assay ton	1	ounces (troy)/ton (short)
milligrams/cu m	$283.2 \times 10^6$	grams/cu ft
milligrams/cu m	0.001	grams/cu m
milligrams/cu m	1000.0	micrograms/cu m
milligrams/cu m	28.32	micrograms/cu ft
milligrams/cu m	1.0	micrograms/liter
milligrams/cu m	$62.43 \times 10^{-6}$	pounds/1000 cu ft
milligrams/cu m	24.04	ppm by volume (20°C)
	molecular weight of gas	
milligrams/cu m	0.8347	ppm by weight
milligrams/joule	5.918	pounds/horsepower-hour
milligrams/liter	0.05841	grains/gallon
milligrams/liter	0.07016	grains/imp. gal
milligrams/liter	0.0584	grains/U.S. gal
milligrams/liter	1.0	parts/million
milligrams/liter	8.345	lb/mil gal
milligrams/sq cm	0.929	grams/sq ft
milligrams/sq cm	10.0	grams/sq meter
milligrams/sq cm	$10^4$	kilograms/sq km
milligrams/sq cm	$10^4$	milligrams/sq meter

(continued)

(continued)

<i>Multiply</i>	<i>by</i>	<i>to obtain</i>
milligrams/sq cm	2.048	pounds/1000 sq ft
milligrams/sq cm	89.21	pounds/acre
milligrams/sq cm	28.55	tons/sq mile
milligrams/sq meter	$92.9 \times 10^{-6}$	grams/sq ft
milligrams/sq meter	0.001	grams/sq meter
milligrams/sq meter	1.0	kilograms/sq km
milligrams/sq meter	0.0001	milligrams/sq cm
milligrams/sq meter	$8.921 \times 10^{-3}$	pounds/acre
milligrams/sq meter	$204.8 \times 10^{-6}$	pounds/1000 sq ft
milligrams/sq meter	$2.855 \times 10^{-3}$	tons/sq mile
millihenries	0.001	henries
milliliters	1	cubic centimeters
milliliters	$3.531 \times 10^{-5}$	cu ft
milliliters	$6.102 \times 10^{-2}$	cu in
milliliters	$10^{-6}$	cu m
milliliters	$2.642 \times 10^{-4}$	gal (U.S.)
milliliters	$10^{-3}$	liters
milliliters	0.03381	ounces (U.S. fl)
millimeters	0.1	centimeters
millimeters	$3.281 \times 10^{-3}$	feet
millimeters	0.03937	inches
millimeters	$10^{-6}$	kilometers
millimeters	0.001	meters
millimeters	$6.214 \times 10^{-7}$	miles
millimeters	39.37	mils
millimeters	$1.094 \times 10^{-3}$	yards
millimeters of mercury	$1.316 \times 10^{-3}$	atmospheres
millimeters of mercury	0.0394	inches of mercury
millimeters of mercury (0°C)	0.5358	inches of water (60°F)
millimeters of mercury	$1.3595 \times 10^{-3}$	kg/sq cm
millimeter of mercury (0°C)	133.3224	newton/meter <sup>2</sup>
millimeters of mercury	0.01934	pounds/sq in
millimeters/sec	11.81	feet/hour
million gallons	306.89	acre-ft
million gallons	3785.0	cubic meters
million gallons	3.785	mega liters ( $1 \times 10^6$ )
million gallons/day (MGD)	1.547	cu ft/sec
MGD	3785	cu m/day
MGD	0.0438	cubic meters/sec
MGD	43.808	liters/sec

(continued)

(continued)

<i>Multiply</i>	<i>by</i>	<i>to obtain</i>
MGD/acre	9360	cu m/day/ha
MGD/acre	0.039	cu meters/hour/sq meter
mils	0.002540	centimeters
mils	$8.333 \times 10^{-5}$	feet
mils	0.001	inches
mils	$2.540 \times 10^{-8}$	kilometers
mils	25.40	microns
mils	$2.778 \times 10^{-5}$	yards
miner's in.	1.5	cu ft/min
miner's inches (Ariz., Calif. Mont., and Ore.)	0.025	cubic feet/second
miner's in. (Colorado)	0.02604	cubic feet/second
miner's inches (Idaho, Kan., Neb., Nev., N. Mex., N. Dak., S.Dak. and Utah)	0.020	cubic feet/second
minims (British)	0.05919	cubic centimeter
minims (U.S.)	0.06161	cubic centimeters
minutes (angles)	0.01667	degrees
minutes (angles)	$1.852 \times 10^{-4}$	quadrants
minutes (angles)	$2.909 \times 10^{-4}$	radians
minutes (angle)	60	seconds (angle)
months (mean calendar)	30.4202	days
months (mean calendar)	730.1	hours
months (mean calendar)	43805	minutes
months (mean calendar)	$2.6283 \times 10^6$	seconds
myriagrams	10	kilograms
myriameters	10	kilometers
myriawatts	10	kilowatts
nepers	8.686	decibels
newtons	$10^5$	dynes
newtons	0.10197	kilograms
newtons	0.22481	pounds
newtons/sq meter	1.00	pascals (Pa)
noggins (British)	1/32	gallons (British)
No./cu.cm.	$28.316 \times 10^3$	No./cu ft
No./cu.cm.	$10^6$	No./cu meter
No./cu.cm.	1000.0	No./liter
No./cu.ft.	$35.314 \times 10^{-6}$	No./cu cm
No./cu.ft.	35.314	No./cu meter
No./cu.ft.	$35.314 \times 10^{-3}$	No./liter

(continued)

(continued)

<i>Multiply</i>	<i>by</i>	<i>to obtain</i>
No./cu. meter	$10^{-6}$	No./cu cm
No./cu. meter	$28.317 \times 10^{-3}$	No./cu ft
No./cu. meter	0.001	No./liter
No./liter	0.001	No./cu cm
No./liter	28.316	No./cu ft
No./liter	1000.0	No./cu meter
oersteds (abs)	1	electromagnetic cgs units of magnetizing force
oersteds (abs)	$2.9978 \times 10^{10}$	electrostatic cgs units of magnetizing force
ohms	$10^9$	abohms
ohms	$1.1126 \times 10^{-12}$	statohms
ohms	$10^{-6}$	megohms
ohms	$10^6$	microhms
ohms (International)	1.0005	ohms (absolute)
ounces (avdp)	16	drams (avoirdupois)
ounces (avdp)	7.2917	drams (troy)
ounces (avdp)	437.5	grains
ounces (avdp)	28.349527	grams
ounces (avdp)	0.028350	kilograms
ounces (avdp)	$2.8350 \times 10^4$	milligrams
ounces (avdp)	0.9114583	ounces (troy)
ounces (avdp)	0.0625	pounds (avoirdupois)
ounces (avdp)	0.075955	pounds (troy)
ounces (avdp)	$2.790 \times 10^{-5}$	tons (long)
ounces (avdp)	$2.835 \times 10^{-5}$	tons (metric)
ounces (avdp)	$3.125 \times 10^{-5}$	tons (short)
ounces (Br. fl)	$2.3828 \times 10^{-4}$	barrels (U.S.)
ounces (Br. fl)	$1.0033 \times 10^{-3}$	cubic feet
ounces (Br. fl)	1.73457	cubic inches
ounces (Br. fl)	7.6860	drams (U.S. fl)
ounces (Br. fl)	$6.250 \times 10^{-3}$	gallons (Br.)
ounces (Br. fl)	0.07506	gallons (U.S.)
ounces (Br. fl)	$2.84121 \times 10^{-2}$	liters
ounces (Br. fl)	480	minims (Br.)
ounces (Br. fl)	461.160	minims (U.S.)
ounces (Br. fl)	28.4121	mL
ounces (Br. fl)	0.9607	ounces (U.S. fl)
ounces (troy)	17.554	drams (avdp)
ounces (troy)	8	drams (troy)

(continued)

(continued)

<i>Multiply</i>	<i>by</i>	<i>to obtain</i>
ounces (troy)	480	grains (troy)
ounces (troy)	31.103481	grams
ounces (troy)	0.03110	kilograms
ounces (troy)	1.09714	ounces (avoirdupois)
ounces (troy)	20	pennyweights (troy)
ounces (troy)	0.068571	pounds (avdp)
ounces (troy)	0.08333	pounds (troy)
ounces (troy)	$3.061 \times 10^{-5}$	tons (long)
ounces (troy)	$3.429 \times 10^{-5}$	tons (short)
ounces (U.S. fl)	$2.48 \times 10^{-4}$	barrels (U.S.)
ounces (U.S. fl)	29.5737	cubic centimeters
ounces (U.S. fl)	$1.0443 \times 10^{-3}$	cubic feet
ounces (U.S. fl)	1.80469	cubic inches
ounces (U.S. fl)	8	drams (fluid)
ounces (U.S. fl)	$6.5053 \times 10^{-3}$	gallons (Br.)
ounces (U.S. fl)	$7.8125 \times 10^{-3}$	gallons (U.S.)
ounces (U.S. fl)	29.5729	milliliters
ounces (U.S. fl)	499.61	minims (Br.)
ounces (U.S. fl)	480	minims (U.S.)
ounces (U.S. fl)	1.0409	ounces (Br. fl)
ounces/sq inch	4309	dynes/sq cm
ounces/sq. inch	0.0625	pounds/sq inch
paces	30	inches
palms (British)	3	inches
parsecs	3.260	light years
parsecs	$3.084 \times 10^{13}$	kilometers
parsecs	$3.084 \times 10^{16}$	meters
parsec	$19 \times 10^{12}$	miles
parts/billion (ppb)	$10^{-3}$	mg/L
parts/million (ppm)	0.07016	grains/imp. gal.
parts/million	0.058417	grains/gallon (U.S.)
parts/million	1.0	mg/liter
parts/million	8.345	lbs/million gallons
ppm by volume (20°C)	$\frac{\text{molecular weight of gas}}{24.04}$	micrograms/liter
ppm by volume (20°C)	$\frac{\text{molecular weight of gas}}{0.02404}$	micrograms/cu meter
ppm by volume (20°C)	$\frac{\text{molecular weight of gas}}{24.04}$	milligrams/cu meter
ppm by volume (20°C)	$\frac{\text{molecular weight of gas}}{28.8}$	ppm by weight

(continued)

(continued)

<i>Multiply</i>	<i>by</i>	<i>to obtain</i>
ppm by volume (20°C)	molecular weight of gas	pounds/cu ft
	$385.1 \times 10^6$	
ppm by weight	$1.198 \times 10^{-3}$	micrograms/cu meter
ppm by weight	1.198	micrograms/liter
ppm by weight	1.198	milligrams/cu meter
ppm by weight	28.8	ppm by volume (20°C)
	molecular weight of gas	
ppm by weight	$7.48 \times 10^{-6}$	pounds/cu ft
pascal (Pa; N/m <sup>2</sup> )	$1.4504 \times 10^{-4}$	pounds/sq ft
pascal (Pa; N/m <sup>2</sup> )	$2.0885 \times 10^{-2}$	pounds/sq ft
pascal (Pa; N/m <sup>2</sup> )	$2.9613 \times 10^{-4}$	in Hg (60°F)
pascal (Pa; N/m <sup>2</sup> )	$4.0187 \times 10^{-3}$	in H <sub>2</sub> O (60°F)
pecks (British)	0.25	bushels (British)
pecks (British)	554.6	cubic inches
pecks (British)	9.091901	liters
pecks (U.S.)	0.25	bushels (U.S.)
pecks (U.S.)	537.605	cubic inches
pecks (U.S.)	8.809582	liters
pecks (U.S.)	8	quarts (dry)
pennyweights	24	grains
pennyweights	1.555174	grams
pennyweights	0.05	ounces (troy)
pennyweights (troy)	$4.1667 \times 10^{-3}$	pounds (troy)
perches (masonry)	24.75	cubic feet
photos	929.0	foot-candles
photos	1	lumen incident/sq cm
photos	$10^4$	lux
picas (printers')	1/6	inches
pieds (French feet)	0.3249	meters
pints (dry)	33.6003	cubic inches
pints (liq.)	473.179	cubic centimeters
pints (liq.)	0.01671	cubic feet
pints (liq.)	$4.732 \times 10^{-4}$	cubic meters
pints (liq.)	$6.189 \times 10^{-4}$	cubic yards
pints (liq.)	0.125	gallons
pints (liq.)	0.4732	liters
pints (liq.)	16	ounces (U.S. fluid)
pints (liq.)	0.5	quarts (liq.)
planck's constant	$6.6256 \times 10^{-27}$	erg-seconds
poise	1.00	gram/cm sec
poise	0.1	newton-second/meter <sup>2</sup>

(continued)

(continued)

<i>Multiply</i>	<i>by</i>	<i>to obtain</i>
population equivalent (PE)	0.17	pounds BOD
pottles (British)	0.5	gallons (British)
pouces (Paris inches)	0.02707	meters
pouces (Paris inches)	0.08333	pieds (Paris feet)
poundals	13,826	dynes
poundals	14.0981	grams
poundals	$1.383 \times 10^{-3}$	joules/cm
poundals	0.1383	joules/meter (newton)
poundals	0.01410	kilograms
poundals	0.031081	pounds
pounds (avdp)	256	drams (avdp)
pounds (avdp)	116.67	drams (troy)
pounds (avdp)	444,823	dynes
pounds (avdp)	7000	grains
pounds (avdp)	453.5924	grams
pounds (avdp)	0.04448	joules/cm
pounds (avdp)	4.448	joules/meter (newtons)
pounds (avdp)	0.454	kilograms
pounds (avdp)	$4.5359 \times 10^5$	milligrams
pounds (avdp)	16	ounces (avdp)
pounds (avdp)	14.5833	ounces (troy)
pounds (avdp)	32.17	poundals
pounds (avdp)	1.2152778	pounds (troy)
pounds (avdp)	$4.464 \times 10^{-4}$	tons (long)
pounds (avdp)	0.0005	tons (short)
pounds (troy)	210.65	drams (avdp)
pounds (troy)	96	drams (troy)
pounds (troy)	5760	grains
pounds (troy)	373.2418	grams
pounds (troy)	0.37324	kilograms
pounds (troy)	$3.7324 \times 10^5$	milligrams
pounds (troy)	13.1657	ounces (avdp)
pounds (troy)	12.0	ounces (troy)
pounds (troy)	240.0	pennyweights (troy)
pounds (troy)	0.8229	pounds (avdp)
pounds (troy)	$3.6735 \times 10^{-4}$	tons (long)
pounds (troy)	$3.7324 \times 10^{-4}$	tons (metric)
pounds (troy)	$4.1143 \times 10^{-4}$	tons (short)
pounds (avdp)-force	4.448	newtons
pounds-force-sec/ft <sup>2</sup>	47.88026	newton-sec/meter <sup>2</sup>
pounds (avdp)-mass	0.4536	kilograms

(continued)



(continued)

<i>Multiply</i>	<i>by</i>	<i>to obtain</i>
pounds-mass/ft <sup>3</sup>	16.0185	kilogram/meter <sup>3</sup>
pounds-mass/ft-sec	1.4882	mewton-sec/meter <sup>2</sup>
pounds of BOD	5.882	population equivalent (PE)
pounds of carbon to CO <sub>2</sub>	14,544	BTU (mean)
pounds of water	0.0160	cu ft
pounds of water	27.68	cu in
pounds of water	0.1198	gallons
pounds of water evaporated at 212°F	970.3	BTU
pounds of water per min	$2.699 \times 10^{-4}$	cubic feet/sec
pound-feet	13,825	centimeter-grams
pound-feet (torque)	$1.3558 \times 10^7$	dyne-centimeters
pound-feet	0.1383	meter-kilograms
pounds-feet squared	421.3	kg-cm squared
pounds-feet squared	144	pounds-inches squared
pounds-inches squared	2926	kg-cm squared
pounds-inches squared	$6.945 \times 10^{-3}$	pounds-feet squared
pounds/acre	0.0104	grams/sq ft
pounds/acre	0.1121	grams/sq meter
pounds/acre	1.121	kg/ha
pounds/acre	112.1	kilograms/sq km
pounds/acre	0.01121	milligrams/sq cm
pounds/acre	112.1	milligrams/sq meter
pounds/acre	0.023	pounds/1000 sq ft
pounds/acre	0.32	tons/sq mile
pounds/acre/day	0.112	g/day/sq m
pounds/cu ft	0.0160	g/mL
pounds/cu ft	16.02	kg/cu m
pounds/cu ft	$16.018 \times 10^9$	micrograms/cu meter
pounds/cu ft	$16.018 \times 10^6$	micrograms/liter
pounds/cu ft	$16.018 \times 10^6$	milligrams/cu meter
pounds/cu ft	$385.1 \times 10^6$	ppm by volume (20°C)
	<u>molecular weight of gas</u>	
pounds/cu ft	$133.7 \times 10^3$	ppm by weight
pounds/cu ft	$5.787 \times 10^{-4}$	lb/cu in
pounds/cu ft	$5.456 \times 10^{-9}$	pounds/mil-foot
pounds/1000 cu ft	0.35314	grams/cu ft
pounds/1000 cu ft	16.018	grams/cu m
pounds/1000 cu ft	$353.14 \times 10^3$	micrograms/cu ft
pounds/1000 cu ft	$16.018 \times 10^6$	microgram/cu m

(continued)

(continued)

<i>Multiply</i>	<i>by</i>	<i>to obtain</i>
pounds/1000 cu ft	$16.018 \times 10^3$	milligrams/cu m
pounds/cubic inch	27.68	grams/cubic cm
pounds/cubic inch	$2.768 \times 10^4$	kgs/cubic meter
pounds/cubic inch	1728	pounds/cubic foot
pounds/cubic inch	$9.425 \times 10^{-6}$	pounds/mil foot
pounds/day/acre-ft	3.68	g/day/cu m
pounds/day/cu ft	16	kg/day/cu m
pounds/day/cu yd	0.6	kg/day/cu m
pounds/day/sq ft	4,880	g/day/sq m
pounds/ft	1.488	kg/m
pounds/gal	119.947	g/liter
pounds/1000-gal	120	g/1000-liters
pounds/horsepower-hour	0.169	mg/joule
pounds/in	178.6	g/cm
pounds/mil-foot	$2.306 \times 10^6$	gms/cu cm
pounds/mil gal	0.12	g/cu m
pounds/sq ft	$4.725 \times 10^{-4}$	atmospheres
pounds/sq ft	0.01602	ft of water
pounds/sq ft	0.01414	inches of mercury
pounds/sq ft	$4.8824 \times 10^{-4}$	kgs/sq cm
pounds/sq ft	4.88241	kilograms/square meter
pounds/sq ft	47.9	newtons/sq m
pounds/sq ft	$6.944 \times 10^{-3}$	pounds/sq inch
pounds/1000 sq ft	0.4536	grams/sq ft
pounds/1000 sq ft	4.882	grams/sq meter
pounds/1000 sq ft	4882.4	kilograms/sq km
pounds/1000 sq ft	0.4882	milligrams/sq cm
pounds/1000 sq ft	4882.4	kilograms/sq meter
pounds/1000 sq ft	43.56	milligrams/sq cm
pounds/1000 sq ft	13.94	milligrams/sq meter
pounds/sq in	0.068046	atmospheres
pounds/sq in	2.307	ft of water
pounds/sq in	70.307	grams/square centimeter
pounds/sq in	2.036	in of mercury
pounds/sq in	0.0703	kgs/square cm
pounds/sq in	703.07	kilograms/square meter
pounds/sq in	51.715	millimeters of mercury
pounds/sq in	6894.76	newton/meter <sup>2</sup>
pounds/sq in	51.715	millimeters of mercury at 0°C
pounds/sq in	144	pounds/sq foot

(continued)

(continued)

<i>Multiply</i>	<i>by</i>	<i>to obtain</i>
pounds/sq in (abs)	1	pound/sq in (gage) + 14.696
pounds/ton	0.5	kg/metric ton; kg/T
proof(U.S.)	0.5	percent alcohol by volume
puncheons (British)	70	gallons (British)
quadrants (angle)	90	degrees
quadrants (angle)	5400	minutes
quadrants (angle)	$3.24 \times 10^5$	seconds
quadrants (angle)	1.571	radians
quarts (dry)	67.20	cubic inches
quarts (liq.)	946.4	cubic centimeters
quarts (liq.)	0.033420	cubic feet
quarts (liq.)	57.75	cubic inches
quarts (liq.)	$9.464 \times 10^{-4}$	cubic meters
quarts (liq.)	$1.238 \times 10^{-3}$	cubic yards
quarts (liq.)	0.25	gallons
quarts (liq.)	0.9463	liters
quarts (liq.)	32	ounces (U.S., fl)
quarts (liq.)	0.832674	quarts (British)
quintals (long)	112	pounds
quintals (metric)	100	kilograms
quintals (short)	100	pounds
quires	24	sheets
radians	57.29578	degrees
radians	3438	minutes
radians	0.637	quadrants
radians	$2.063 \times 10^5$	seconds
radians/second	57.30	degrees/second
radians/second	9.549	revolutions/min
radians/second	0.1592	revolutions/sec
radians/sec/sec	573.0	revs/min/min
radians/sec/sec	9.549	revs/min/sec
radians/sec/sec	0.1592	revs/sec/sec
reams	500	sheets
register tons (British)	100	cubic feet
revolutions	360	degrees
revolutions	4	quadrants
revolutions	6.283	radians
revolutions/minute	6	degrees/second
revolutions/minute	0.10472	radians/second
revolutions/minute	0.01667	revolutions/sec

(continued)

(continued)

<i>Multiply</i>	<i>by</i>	<i>to obtain</i>
revolutions/minute <sup>2</sup>	0.0017453	radians/sec/sec
revs/min/min	0.01667	revs/min/sec
revs/min/min	$2.778 \times 10^{-4}$	revs/sec/sec
revolutions/second	360	degrees/second
revolutions/second	6.283	radians/second
revolutions/second	60	revs/minute
revs/sec/sec	6.283	rads/sec/sec
revs/sec/sec	3600	revs/min/min
revs/sec/sec	60	revs/min/sec
reyns	$6.8948 \times 10^6$	centipoises
rod	.25	chain (gunters)
rods	16.5	feet
rods	5.0292	meters
rods	$3.125 \times 10^{-3}$	miles
rods (surveyors' means)	5.5	yards
roods (British)	0.25	acres
scruples	1/3	drams (troy)
scruples	20	grains
sections	1	square miles
seconds (mean solar)	$1.1574 \times 10^{-5}$	days
seconds (angle)	$2.778 \times 10^{-4}$	degrees
seconds (mean solar)	$2.7778 \times 10^{-4}$	hours
seconds (angle)	0.01667	minutes
seconds (angle)	$3.087 \times 10^{-6}$	quadrants
seconds (angle)	$4.848 \times 10^{-6}$	radians
slugs	14.59	kilogram
slugs	32.174	pounds
space, entire (solid angle)	12.566	steradians
spans	9	inches
spheres (solid angle)	12.57	steradians
spherical right angles	0.25	hemispheres
spherical right angles	0.125	spheres
spherical right angles	1.571	steradians
square centimeters	$1.973 \times 10^5$	circular mils
square centimeters	$1.07639 \times 10^{-3}$	square feet (U.S.)
square centimeters	0.15499969	square inches (U.S.)
square centimeters	$10^{-4}$	square meters
square centimeters	$3.861 \times 10^{-11}$	square miles
square centimeters	100	square millimeters
square centimeters	$1.196 \times 10^{-4}$	square yards

(continued)

(continued)

<i>Multiply</i>	<i>by</i>	<i>to obtain</i>
square centimeters-square centimeter (moment of area)	0.024025	square inch-square inch
square chains (gunter's)	0.1	acres
square chains (gunter's)	404.7	square meters
square chains (Ramden's)	0.22956	acres
square chains (Ramden's)	10000	square feet
square feet	$2.29 \times 10^{-5}$	acres
square feet	$1.833 \times 10^8$	circular mils
square feet	144	square inches
square feet	0.092903	square meters
square feet	929.0341	square centimeters
square feet	$3.587 \times 10^{-8}$	square miles
square feet	1/9	square yards
square feet/cu ft	3.29	sq m/cu m
square foot-square foot (moment of area)	20,736	square inch-square inch
square inches	$1.273 \times 10^6$	circular mils
square inches	6.4516258	square centimeters
square inches	$6.944 \times 10^{-3}$	square feet
square inches	645.2	square millimeters
square inches	$10^6$	square mils
square inches	$7.71605 \times 10^{-4}$	square yards
square inches-inches sqd.	41.62	sq cm-cm sqd
square inches-inches sqd.	$4.823 \times 10^{-5}$	sq feet-feet sqd
square kilometers	247.1	acres
square kilometers	$10^{10}$	square centimeters
square kilometers	$10.76 \times 10^6$	square feet
square kilometers	$1.550 \times 10^9$	square inches
square kilometers	$10^6$	square meters
square kilometers	0.3861006	square miles (U.S.)
square kilometers	$1.196 \times 10^6$	square yards
square links (Gunter's)	$10^{-5}$	acres (U.S.)
square links (Gunter's)	0.04047	square meters
square meters	$2.471 \times 10^{-4}$	acres (U.S.)
square meters	$10^4$	square centimeters
square meters	10.76387	square feet (U.S.)
square meters	1550	square inches
square meters	$3.8610 \times 10^{-7}$	square miles (statute)
square meters	$10^6$	square millimeters
square meters	1.196	square yards (U.S.)

(continued)

(continued)

<i>Multiply</i>	<i>by</i>	<i>to obtain</i>
square miles	640	acres
square miles	$2.78784 \times 10^7$	square feet
square miles	2.590	sq km
square miles	$2.5900 \times 10^6$	square meters
square miles	$3.098 \times 10^6$	square yards
square millimeters	$1.973 \times 10^3$	circular mils
square millimeters	0.01	square centimeters
square millimeters	$1.076 \times 10^{-5}$	square feet
square millimeters	$1.550 \times 10^{-3}$	square inches
square mils	1.273	circular mils
square mils	$6.452 \times 10^{-6}$	square centimeters
square mils	$10^{-6}$	square inches
square rods	272.3	square feet
square yard	$2.1 \times 10^{-4}$	acres
square yards	8361	square centimeters
square yards	9	square feet
square yards	1296	square inches
square yards	0.8361	square meters
square yards	$3.228 \times 10^{-7}$	square miles
square yards	$8.361 \times 10^5$	square millimeters
statamperes	$3.33560 \times 10^{-10}$	amperes (abs)
statcoulombs	$3.33560 \times 10^{-10}$	coulombs (abs)
statcoulombs/kilogram	$1.0197 \times 10^{-6}$	statcoulombs/dyne
stafarads	$1.11263 \times 10^{-12}$	farads (abs)
stathenries	$8.98776 \times 10^{11}$	henries (abs)
statohms	$8.98776 \times 10^{11}$	ohms (abs)
statvolts	299.796	volts (abs)
statvolts/inch	118.05	volts (abs)/centimeter
statwebers	$2.99796 \times 10^{10}$	electromagnetic cgs units of magnetic flux
statwebers	1	electrostatic cgs units of magnetic flux
stilb	2919	footlambert
stilb	1	int. candle $\text{cm}^{-2}$
stilb	3.142	lambert
stoke (kinematic viscosity)	$10^{-4}$	$\text{meter}^2/\text{second}$
stones (British)	6.350	kilograms
stones (British)	14	pounds
temp. (degs. C.) + 273	1	abs. temp. (degs. K.)
temps (degs. C.) + 17.8	1.8	temp. (degs. Fahr.)

(continued)

(continued)

<i>Multiply</i>	<i>by</i>	<i>to obtain</i>
temps. (degs. F.) + 460	1	abs. temp. (degs. R.)
temps. (degs. F.) - 32	5/9	temp. (degs. Cent.)
toises (French)	6	paris feet (pieds)
tons (long)	$5.734 \times 10^5$	drams (avdp)
tons (long)	$2.613 \times 10^5$	drams (troy)
tons (long)	$1.568 \times 10^7$	grains
tons (long)	$1.016 \times 10^6$	grams
tons (long)	1016	kilograms
tons (long)	$3.584 \times 10^4$	ounces (avdp)
tons (long)	$3.267 \times 10^4$	ounces (troy)
tons (long)	2240	pounds (avdp)
tons (long)	2722.2	pounds (troy)
tons (long)	1.12	tons (short)
Tons (metric) (T)	1000	kilograms
Tons (metric) (T)	2204.6	pounds
Tons (metric) (T)	1.1025	tons (short)
tons (short)	$5.120 \times 10^5$	drams (avdp)
tons (short)	$2.334 \times 10^5$	drams (troy)
tons (short)	$1.4 \times 10^7$	grains
tons (short)	$9.072 \times 10^5$	grams
tons (short)	907.2	kilograms
tons (short)	32,000	ounces (avdp)
tons (short)	29,166.66	ounces (troy)
tons (short)	2000	pounds (avdp)
tons (short)	2,430.56	pounds (troy)
tons (short)	0.89287	tons (long)
tons (short)	0.9078	Tons (metric) (T)
tons (short)/acre	2.2422	metric ton/ha
tons (short)/sq ft	9765	kg/sq meter
tons (short)/sq ft	13.89	pounds/sq inch
tons (short)/sq in	$1.406 \times 10^6$	kg/sq meter
tons/sq mile	3.125	pounds/acre
tons/sq mile	0.07174	pounds/1000 sq ft
tons/sq mile	0.3503	grams/sq meter
tons/sq mile	350.3	kilograms/sq km
tons/sq mile	350.3	milligrams/sq meter
tons/sq mile	0.03503	milligrams/sq cm
tons/sq mile	0.03254	grams/sq ft
tons of water/24 hours	83.333	pounds of water/hr
tons of water/24 hours	0.16643	gallons/min

(continued)

(continued)

<i>Multiply</i>	<i>by</i>	<i>to obtain</i>
tons of water/24 hours	1.3349	cu ft/hr
torr (mm Hg, 0 C)	133.322	newton/meter <sup>2</sup>
townships (U.S.)	23040	acres
townships (U.S.)	36	square miles
tuns	252	gallons
volts (abs)	10 <sup>8</sup>	abvolts
volts (abs)	3.336 × 10 <sup>-3</sup>	statvolts
volts (international of 1948)	1.00033	volts (abs)
volt/inch	.39370	volt/cm
watts (abs)	3.41304	BTU (mean)/hour
watts (abs)	0.0569	BTU (mean)/min
watts (abs)	0.01433	calories, kilogram (mean)/ minute
watts (abs)	10 <sup>7</sup>	ergs/second
watts (abs)	44.26	foot-pounds/minute
watts (abs)	0.7376	foot-pounds/second
watts (abs)	0.0013405	horsepower (electrical)
watts (abs)	1.360 × 10 <sup>-3</sup>	horsepower (metric)
watts (abs)	1	joules/sec
watts (abs)	0.10197	kilogram-meters/second
watts (abs)	10 <sup>-3</sup>	kilowatts
watt-hours	3.415	British Thermal Units
watt-hours	3.60 × 10 <sup>10</sup>	ergs
watt-hours	2655	foot-pounds
watt-hours	859.85	gram-calories
watt-hours	1.34 × 10 <sup>-3</sup>	horsepower-hours
watt-hours	3.6 × 10 <sup>3</sup>	joule
watt-hours	0.8605	kilogram-calories
watt-hours	367.1	kilogram-meters
watt-hours	10 <sup>-3</sup>	kilowatt-hours
watt (international)	1.0002	watt (absolute)
watt/(cm <sup>2</sup> )(°C/cm)	693.6	BTU/(hr)(ft <sup>2</sup> )(°F/in)
wave length of the red line of cadmium	6.43847 × 10 <sup>-7</sup>	meters
webers	10 <sup>3</sup>	electromagnetic cgs units
webers	3.336 × 10 <sup>-3</sup>	electrostatic cgs units
webers	10 <sup>5</sup>	kilolines
webers	10 <sup>8</sup>	lines
webers	10 <sup>8</sup>	maxwells
webers	3.336 × 10 <sup>-3</sup>	statwebers

(continued)



(continued)

<i>Multiply</i>	<i>by</i>	<i>to obtain</i>
webers/sq in	$1.550 \times 10^7$	gausses
webers/sq in	$10^8$	lines/sq in
webers/sq in	0.1550	webers/sq cm
webers/sq in	1,550	webers/sq meter
webers/sq meter	$10^4$	gausses
webers/sq meter	$6.452 \times 10^4$	lines/sq in
webers/sq meter	$10^{-4}$	webers/sq cm
webers/sq meter	$6.452 \times 10^{-4}$	webers/sq in
weeks	168	hours
weeks	10,080	minutes
weeks	604,800	seconds
yards	91.44	centimeters
yards	3	feet
yards	36	inches
yards	$9.144 \times 10^{-4}$	kilometers
yards	0.91440	meters
yards	$4.934 \times 10^{-4}$	miles (naut.)
yards	$5.682 \times 10^{-4}$	miles (stat.)
yards	914.4	millimeters
years (sidereal)	365.2564	days (mean solar)
years (sidereal)	366.2564	days (sidereal)
years (tropical, mean solar)	365.2422	days (mean solar)
years (common)	8760	hours
years (tropical, mean solar)	8765.8128	hours (mean solar)
years (leap)	366	days
years (leap)	8784	hours
years (tropical, mean solar)	$3.155693 \times 10^7$	seconds (mean solar)
years (tropical, mean solar)	1.00273780	years (sidereal)

## 2. BASIC AND SUPPLEMENTARY UNITS

A *meter (m)* is 1,650,763.73 wavelengths in vacuo of the radiation corresponding to the transition between the energy levels  $2p_{10}$  and  $5d_5$  of the krypton 86 atom.

A *kilogram (kg)* is the mass of the international prototype in the custody of the Bureau International des Poids et Mesures at Sevres in France.

A *second (sec)* is the interval occupied by 9,192,631,770 cycles of the radiation corresponding to the transition of the cesium-133 atom when unperturbed by exterior fields.

An *ampere* is the constant current that if maintained in two parallel rectilinear conductors of infinite length of negligible circular cross section and placed at a distance of one meter apart in vacuo would produce between these conductors a force equal to  $2 \times 10^{-7}$  newton per meter length.

A *kelvin* ( $^{\circ}\text{K}$ ) is the degree interval of the thermodynamic scale on which the temperature of the triple point of water is 273.16 degrees.

A *candle* is such that the luminance of a full radiator at the temperature of solidification of platinum is 60 units of luminous intensity per square centimeter.

A *mole* (*mol*) is the amount of substance which contains as many elementary units as there are atoms in 0.012 kg of carbon-12. The elementary unit must be specified and may be an atom, an ion, an electron, a photon, etc., or a given group of such entities.

A *radian* is the angle subtended at the center of a circle by an arc of the circle equal in length to the radius of the circle.

A *steradian* is the solid angle that, having its vertex at the center of a sphere, cuts off an area of the surface of the sphere equal to that of a square with sides of length equal to the radius of the sphere.

### 3. DERIVED UNITS AND QUANTITIES

The *liter* was defined in 1901 as the volume of 1 kilogram of pure water at normal atmospheric pressure and maximum density equal therefore to  $1.000028 \text{ dm}^3$ . This 1901 definition applied for the purpose of the 1963 Weights and Measures Acts.

By a resolution of the 12th Conference General des Poids et Mesures (CGPM) in 1964 the word *liter* is now recognized as a special name for the  $\text{dm}^3$ , but is not used to express high precision measurements. It is used widely in engineering and the retail business, where the discrepancy of 28 parts in 1 million is of negligible significance.

A *newton* (*N*) is the force that, when applied to a body of mass of one kilogram, gives it an acceleration of one meter per second per second.

*Stress* is defined as the resultant internal force per unit area resisting change in the shape or size of a body acted on by external forces, and is therefore measured in *newtons per square meter* ( $\text{N/m}^2$ ).

A *bar* is a pressure equivalent to 100,000 newtons acting on an area of one square meter.

A *joule* (*J*) is the work done when the point of application of a force of one newton is displaced through a distance of one meter in the direction of the force.

A *watt* is equal to one joule per second.

*Dynamic viscosity* is the property of a fluid whereby it tends to resist relative motion within itself. It is the shear stress, i.e., the tangential force on unit area, between two infinite horizontal planes at unit distance apart, one of which is fixed while the other moves with unit velocity. In other words, it is the shear stress divided by the velocity gradient, i.e.,  $(\text{N/m}^2) \div (\text{m/sec/m}) = \text{N sec/m}^2$ .

*Kinematic viscosity* is the dynamic viscosity of a fluid divided by its density, i.e.,  $(\text{N sec/m}^2)/(\text{kg/m}^3) = \text{m}^2/\text{sec}$ .

*Density of heat flow rate* (or heat flux) is the heat flow rate (*W*) per unit area, i.e.,  $\text{W/m}^2$ .

*Coefficient of heat transfer* is the heat flow rate (*W*) per unit area per unit temperature difference, i.e.,  $\text{W/m}^2\text{ }^{\circ}\text{C}$ .

*Thermal conductivity* is the quantity of heat that will be conducted in unit time through unit area of a slab of material of unit thickness with a unit difference of temperature between the faces; in other words, the heat flow rate (*W*) per unit area per unit temperature gradient, i.e.,  $\text{W}/[\text{m}^2(\text{ }^{\circ}\text{C/m})] = \text{W}/\text{m}^{\circ}\text{C}$ .

The *heat capacity* of a substance is the quantity of heat gained or lost by the substance per unit temperature change, i.e.,  $\text{J}/^{\circ}\text{C}$ .

*Specific heat capacity* is the heat capacity per unit mass of the substance, i.e., J/kg° C.

*Internal energy* is the kinetic energy possessed by the molecules of a substance due to temperature and is measured in joules (J).

*Specific internal energy* ( $u$ ) is the internal energy per unit mass of the substance, i.e., J/kg. When a small amount of heat is added at constant volume the increase in specific internal energy is given by:  $du = c_v dT$ , where  $c_v$  is the specific heat capacity at constant volume, and  $dT$  is the increase in absolute temperature.

*Specific enthalpy* ( $h$ ) is defined by the equation:  $h = u + pv$ , where  $p$  is the pressure and  $v$  is the specific volume. Specific enthalpy is measured in J/kg. When a small amount of heat is added to a substance at constant pressure, the increase in specific enthalpy is given by:  $-dh = cp dT$ , where  $cp$  is the specific heat capacity at constant pressure.

The *specific latent heat* of a substance is the heat gained per unit mass without an accompanying rise in temperature during a change of state at constant pressure. It is measured in J/kg.

The *entropy* ( $S$ ) of a substance is such that when a small amount of heat is added, the increase in entropy is equal to the quantity of heat added ( $dQ$ ) divided by the absolute temperature ( $T$ ) at which the heat is absorbed; i.e.,  $dS = dQ/T$ , measured in J/°K.

The *specific entropy* ( $s$ ) of a substance is the entropy per unit mass, i.e., J/kg°K.

A *volt* is the difference of electric potential between two points of a conductor carrying a constant current of one ampere when the power dissipated is one watt.

A *weber* (Wb) is the magnetic flux through a conductor with a resistance of one ohm when reversal of the direction of the magnetic flux causes the transfer of one coulomb in the conductor loop.

*Tesla*: The magnetic flux density is the normal magnetic flux per unit area and is measured in *teslas*.

A *lumen*, the unit of luminous flux, is the flux emitted within unit solid angle of one steradian by a point source having a uniform intensity of one candle.

A *lux* is an illumination of one lumen per square meter.

*Luminance* is the luminous intensity per unit area of a source of light or of an illumination. It is measured in candles per square meter.

4. PHYSICAL CONSTANTS

Standard temperature and pressure (S.T.P.)	$\left\{ \begin{aligned} &= 273.15^\circ\text{K and } 1.013 \times 10^5 \text{N/m}^2 \\ &= 0^\circ\text{C and } 1.013 \text{ bar} \\ &= 0^\circ\text{C and } 760 \text{ mmHg} \end{aligned} \right.$	
Molecular volume of ideal gas at S.T.P.		= 22.4 litres/mol
Gas constant (R)		= 8.314 J/mol <sup>o</sup> K
$R^T(273.15^\circ\text{K})$	= 2.271 $\times 10^3$ J/mol	
Avogadro constant	= 6.023 $\times 10^{23}$ /mol	
Boltzmann constant	= 1.3805 $\times 10^{-23}$ J/K	
Faraday constant	= 9.6487 $\times 10^4$ C/mol (= A s/mol)	
Planck constant	= 6.626 $\times 10^{-34}$ J sec	
Stefan-Boltzman constant	= 5.6697 $\times 10^{-8}$ W/m <sup>2</sup> K <sup>4</sup>	
Ice point of water	= 273.15 <sup>o</sup> K (0 <sup>o</sup> C)	
Triple point of water	= 273.16 <sup>o</sup> K (0.01 <sup>o</sup> C)	
Speed of light	= 2.998 $\times 10^8$ m/sec	
Acceleration of gravity (Standard (Greenwich))	$\left\{ \begin{aligned} &= 9.80665 \text{ m/s}^2 \left[ \text{take g as } \right] \\ &= 9.81188 \text{ m/s}^2 \left[ 9.81 \text{ m/s}^2 \right] \end{aligned} \right.$	
Universal constant of gravitation	= 6.670 $\times 10^{-11}$ Newton m <sup>2</sup> /kg <sup>2</sup>	
Mass of hydrogen atom	= 1.6734 $\times 10^{-27}$ kg	

5. PROPERTIES OF WATER

U.S. Customary Units

Temperature (°F)	Specific weight, $\gamma$ (lb/ft <sup>3</sup> )	Mass density, $\rho$ (lb-sec <sup>2</sup> / ft <sup>4</sup> )	Dynamic viscosity, $\mu \times 10^5$ (lb-sec/ft <sup>2</sup> )	Kinematic viscosity, $\nu \times 10^5$ (ft <sup>2</sup> /sec)	Surface tension <sup>a</sup> , $\sigma \times 10^3$ (lb/ft)	Vapor pressure, $p_v$ (lb/ in. <sup>2</sup> )	Bulk modulus <sup>b</sup> , $E \times 10^{-3}$ (lb/in. <sup>2</sup> )
32	62.42	1.940	3.746	1.931	5.18	0.09	290
40	62.43	1.938	3.229	1.664	5.14	0.12	295
50	62.41	1.936	2.735	1.410	5.09	0.18	300
60	62.37	1.934	2.359	1.217	5.04	0.26	312
70	62.30	1.931	2.050	1.059	5.00	0.36	320
80	62.22	1.927	1.799	0.930	4.92	0.51	323
90	62.11	1.923	1.595	0.826	4.86	0.70	326
100	62.00	1.918	1.424	0.739	4.80	0.95	329
110	61.86	1.913	1.284	0.667	4.73	1.24	331
120	61.71	1.908	1.168	0.609	4.65	1.69	333
130	61.55	1.902	1.069	0.558	4.60	2.22	332

(continued)

## U.S. Customary Units (continued)

Temperature (°F)	Specific weight, $\gamma$ (lb/ft <sup>3</sup> )	Mass density, $\rho$ (lb-sec <sup>2</sup> / ft <sup>4</sup> )	Dynamic viscosity, $\mu \times 10^5$ (lb-sec/ft <sup>2</sup> )	Kinematic viscosity, $\nu \times 10^5$ (ft <sup>2</sup> /sec)	Surface tension <sup>a</sup> , $\sigma \times 10^3$ (lb/ft)	Vapor pressure, $p_v$ (lb/ in. <sup>2</sup> )	Bulk modulus <sup>b</sup> , $E \times 10^{-3}$ (lb/in. <sup>2</sup> )
140	61.38	1.896	0.981	0.514	4.54	2.89	330
150	61.20	1.890	0.905	0.476	4.47	3.72	328
160	61.00	1.896	0.838	0.442	4.41	4.74	326
170	60.80	1.890	0.780	0.413	4.33	5.99	322
180	60.58	1.883	0.726	0.385	4.26	7.51	318
190	60.36	1.876	0.678	0.362	4.19	9.34	313
200	60.12	1.868	0.637	0.341	4.12	11.52	308
212	59.83	1.860	0.593	0.319	4.04	14.7	300

<sup>a</sup>In contact with air ; <sup>b</sup>At atmospheric pressure.

## SI Units

Temperature, (°C)	Specific weight, $\gamma$ (kN/m <sup>3</sup> )	Mass density, $\rho$ (kg/m <sup>3</sup> )	Dynamic viscosity, $\mu \times 10^3$ (N · s/m <sup>2</sup> )	Kinematic viscosity, $\nu \times 10^6$ (m <sup>2</sup> /s)	Surface tension <sup>a</sup> , $\sigma$ (N/m)	Vapor pressure, $p_v$ (kN/m <sup>2</sup> )	Bulk modulus <sup>b</sup> , $E \times 10^{-6}$ (kN/m <sup>2</sup> )
0	9.805	999.8	1.781	1.785	0.0765	0.61	1.98
5	9.807	1000.0	1.518	1.519	0.0749	0.87	2.05
10	9.804	999.7	1.307	1.306	0.0742	1.23	2.10
15	9.798	999.1	1.139	1.139	0.0735	1.70	2.15
20	9.789	998.2	1.002	1.003	0.0728	2.34	2.17
25	9.777	997.0	0.890	0.893	0.0720	3.17	2.22
30	9.764	995.7	0.798	0.800	0.0712	4.24	2.25
40	9.730	992.2	0.653	0.658	0.0696	7.38	2.28
50	9.689	988.0	0.547	0.553	0.0679	12.33	2.29
60	9.642	983.2	0.466	0.474	0.0662	19.92	2.28
70	9.589	977.8	0.404	0.413	0.0644	31.16	2.25
80	9.530	971.8	0.354	0.364	0.0626	47.34	2.20
90	9.466	965.3	0.315	0.326	0.0608	70.10	2.14
100	9.399	958.4	0.282	0.294	0.0589	101.33	2.07

<sup>a</sup>In contact with air; <sup>b</sup> At atmospheric pressure.

6. PERIODIC TABLE OF THE ELEMENTS (COMPLIMENTS OF THE LENOX INSTITUTE OF WATER TECHNOLOGY)

Groups → I Periods & sub-shells ↓	1 1s	2 1s	3 1s	4 1s	5 1s	6 1s	7 1s	8 1s	9 1s	10 1s	11 1s	12 1s	13 1s	14 1s	15 1s	16 1s	17 1s	18 1s
	1 H 1.00794 Hydrogen	2 He 4.00260 Helium	3 Li 6.941 Lithium	4 Be 9.01218 Beryllium	5 B 10.811 Boron	6 C 12.011 Carbon	7 N 14.0067 Nitrogen	8 O 15.9994 Oxygen	9 F 18.9984 Fluorine	10 Ne 20.179 Neon	11 Na 22.9897 Sodium	12 Mg 24.305 Magnesium	13 Al 26.9815 Aluminum	14 Si 28.0855 Silicon	15 P 30.9738 Phosphorus	16 S 32.066 Sulfur	17 Cl 35.4527 Chlorine	18 Ar 39.948 Argon
19 K 39.098 Potassium	20 Ca 40.078 Calcium	21 Sc 44.9559 Scandium	22 Ti 47.88 Titanium	23 V 50.9415 Vanadium	24 Cr 51.996 Chromium	25 Mn 54.938 Manganese	26 Fe 55.847 Iron	27 Co 58.933 Cobalt	28 Ni 58.69 Nickel	29 Cu 63.546 Copper	30 Zn 65.39 Zinc	31 Ga 69.723 Gallium	32 Ge 72.64 Germanium	33 As 74.9216 Arsenic	34 Se 78.96 Selenium	35 Br 79.904 Bromine	36 Kr 83.80 Krypton	
37 Rb 85.468 Rubidium	38 Sr 87.62 Strontium	39 Y 88.9059 Yttrium	40 Zr 91.224 Zirconium	41 Nb 92.9064 Niobium	42 Mo 95.94 Molybdenum	43 Tc (98) Technetium	44 Ru 101.07 Ruthenium	45 Rh 102.906 Rhodium	46 Pd 106.42 Palladium	47 Ag 107.868 Silver	48 Cd 112.411 Cadmium	49 In 114.82 Indium	50 Sn 118.710 Tin	51 Sb 121.75 Antimony	52 Te 127.60 Tellurium	53 I 126.90 Iodine	54 Xe 131.29 Xenon	
55 Cs 132.905 Cesium	56 Ba 137.327 Barium	57 La 138.906 Lanthanum	58 Ce 140.116 Cerium	59 Pr 140.91 Praseodymium	60 Nd 144.24 Neodymium	61 Pm (145) Promethium	62 Sm 150.35 Samarium	63 Eu 157.25 Europium	64 Gd 157.25 Gadolinium	65 Tb 158.925 Terbium	66 Dy 162.50 Dysprosium	67 Ho 164.930 Holmium	68 Er 167.26 Erbium	69 Tm 168.934 Thulium	70 Yb 173.04 Ytterbium	71 Lu 174.967 Lutetium		
87 Fr (223) Francium	88 Ra (226) Radium	89 Ac (227) Actinium	90 Th 232.038 Thorium	91 Pa (231) Protactinium	92 U 238.029 Uranium	93 Np (237) Neptunium	94 Pu (244) Plutonium	95 Am (243) Americium	96 Cm (247) Curium	97 Bk (247) Berkelium	98 Cf (251) Californium	99 Es (252) Einsteinium	100 Fm (257) Fermium	101 Md (258) Mendelevium	102 No (259) Nobelium	103 Lr (262) Lawrencium		

## 7. GLOSSARY FOR WATER RESOURCES ENGINEERS

**Ablation** The process by which ice and snow waste away, owing to melting and evaporation.

**Absorption** The entrance of water into the soil or rocks by all natural processes. It includes the infiltration of precipitation or snowmelt, gravity flow of streams into the valley alluvium (see Bank storage) into sinkholes or other large openings, and the movement of atmospheric moisture.

**Acequia** Acequias are gravity-driven waterways, similar in concept to a flume. Most are simple ditches with dirt banks, but they can be lined with concrete. They were important forms of irrigation in the development of agriculture in the American Southwest. The proliferation of cotton, pecans, and green chile as major agricultural staples owes their progress to the acequia system.

**Acid** A substance that has a pH of less than 7, which is neutral. Specifically, an acid has more free hydrogen ions ( $H^+$ ) than hydroxyl ions ( $OH^-$ ).

**Acid neutralizing capacity (ANC)** The equivalent capacity of a solution to neutralize strong acids.

**Acid rain or acid precipitation** Precipitation having a pH lower than the pH range commonly found in natural waters, caused by absorption from the atmosphere of sulfur dioxide gas and nitrogen oxides gas, which then forms sulfuric acid and nitric acid, respectively, in solution.

**Action level** The level of toxic substances (such as lead or copper) which, if exceeded, triggers treatment or other requirements that a water system must follow.

**Acute health effect** An immediate (i.e., within hours or days) effect that may result from exposure to certain drinking water contaminants (e.g., pathogens).

**Advisory** A nonregulatory document that communicates risk information to those who may have to make risk management decisions. For example, a fish consumption advisory may recommend that people limit or avoid eating certain species of fish caught from certain lakes, rivers, or coastal waters. In some cases, advisories may include recommendations for specific groups (such as infants, children, the elderly, or women who are pregnant or may become pregnant).

**Agricultural and animal waste** Waste generated by the production and harvest of crops or trees or the rearing of animals. Animal waste is a subset of agricultural waste and includes waste (e.g., feed waste, bedding and litter, and feedlot and paddock runoff) from livestock, dairy, and other animal-related agricultural and farming practices.

**Agricultural land** Land on which a food, feed, or fiber crop is grown. This includes rangeland or land used as pasture.

**Agronomic rate** The whole sludge application rate designed to (1) provide the amount of nitrogen needed by a crop or vegetation grown on the land and (2) minimize the amount of nitrogen in the sewage sludge that passes below the root zone of the crop or vegetation grown on the land to the groundwater.

**Air pollutant** Any substance in air that could, in high enough concentration, harm humans, animals, vegetation, or material. Air pollutants can include almost any natural or artificial composition of matter capable of being airborne—solid particles, liquid droplets, gases, or a combination thereof. Air pollutants are often grouped in categories for ease in classification; some of the categories are sulfur compounds, volatile organic compounds, particulate matter, nitrogen compounds, and radioactive compounds.

**Air quality index (AQI)** An index for reporting daily air quality that characterizes air pollution levels and associated health effects that might be of concern. The US EPA calculates the AQI for five criteria pollutants. AQI values range from 0 to 500; the higher the AQI value, the greater the level of air pollution and the greater the health concern. AQI values below 100 are generally thought of as

satisfactory. When AQI values are above 100, air quality is considered to be unhealthy—at first for certain sensitive groups of people, then for everyone as AQI values get higher.

**Air quality system (AQS)** US EPA's electronic repository of ambient air monitoring data collected by US EPA and state, local, and tribal air pollution control agencies from thousands of monitoring stations. The AQS contains monitoring data, descriptive information about monitoring stations, and data quality assurance and quality control information.

**Air toxics** Air pollutants that cause or may cause cancer or other serious health effects, such as reproductive effects or birth defects, or adverse environmental and ecological effects. Examples of toxic air pollutants include benzene (found in gasoline), perchloroethylene (emitted from some dry cleaning facilities), and methylene chloride (used as a solvent by a number of industries). Air toxics are also known as hazardous air pollutants.

**Algal bloom** A sudden, excessive growth of algae in a waterbody.

**Alkaline** Sometimes water or soils contain an amount of alkali (strongly basic) substances sufficient to raise the pH value above 7.0 and be harmful to the growth of crops.

**Alkalinity** The capacity of water for neutralizing an acid solution.

**Alluvium** Deposits of clay, silt, sand, gravel, or other particulate material that have been deposited by a stream or other bodies of running water in a streambed, on a flood plain, on a delta, or at the base of a mountain.

**Ambient monitoring** Monitoring within natural systems (e.g., lakes, rivers, estuaries, wetlands) to determine existing conditions.

**Anabranch** A diverging branch of a river which reenters the mainstream.

**Anaerobic** Without oxygen; water and sediment environments without oxygen produce, for example, chemical conditions that precipitate and permanently store many metals from water and that release dissolved phosphorus to the water.

**Anchor ice** Ice in the bed of a stream or upon a submerged body or structure.

**Annual flood** The highest peak discharge in a water year.

**Annual flood series** A list of annual floods.

**Annual pollutant loading rate (APLR)** The maximum amount of a pollutant that can be applied to a unit area of land during a 365-day period. This term describes pollutant limits for sewage sludge that is given away or sold in a bag or other container for application to the land.

**Annual whole sludge application rate** The maximum amount of sewage sludge on a dry weight basis that can be applied to a land application site during a 365-day (1-year) period.

**Antecedent precipitation index** An index of moisture stored within a drainage basin before a storm.

**Anthropogenic** Originating from humans; not naturally occurring.

**Appropriation doctrine** The system for allocating water to private individuals used in most Western states. The doctrine of prior appropriation was in common use throughout the arid West as early settlers and miners began to develop the land. The prior appropriation doctrine is based on the concept of "First in Time, First in Right." The first person to take a quantity of water and put it to beneficial use has a higher priority of right than a subsequent user. Under drought conditions, higher-priority users are satisfied before junior users receive water. Appropriative rights can be lost through nonuse; they can also be sold or transferred apart from the land. Contrasts with riparian water rights.

**Aquaculture** (1) Farming of plants and animals that live in water, such as fish, shellfish, and algae; (2) a process for removing pollutants from water through the use of aquatic plants (such as water hyacinths) in pond contaminants. The contaminants are either synthesized by, or bioaccumulated in, the aquatic plants, which ultimately are harvested for disposal.



**Aquaculture, living machine system** A man-made wastewater-treatment system which adapts and enhances the ecological processes in a series of tidal wetland cells or basins. Each cell or basin is filled with special gravel that promotes the development of micro-ecosystems. A computer controls fill and drain cycles, alternating anoxic (without oxygen) and aerobic (with oxygen) conditions. As wastewater moves through the system, the cells are alternately flooded and drained to create multiple tidal cycles each day, much like one finds in nature, resulting in high-quality reusable water.

**Aquaculture, natural and constructed wetland systems** The aquatic wastewater-treatment systems involve in the production of algae and higher plants (both submerged and emergent), invertebrates, and fish for wastewater treatment and water conservation. Wastewater treatment by natural and constructed wetland systems is generally accomplished by sprinkling or flood irrigating the wastewater into the wetland area or by passing the wastewater through a system of shallow ponds, channels, basins, or other constructed areas where the emergent aquatic vegetation has been planted or naturally occurs and is actively growing. The treated wastewater is totally reused in a natural environment, achieving almost 100 % water conservation. The vegetation produced as a result of the system's operation may or may not be removed and can be utilized for various purposes: (a) composted for use as source of fertilizer/soil conditioner and (b) dried or otherwise processed for use as animal feed supplements, or digested to produce methane.

**Aquaculture, water hyacinth system** Wastewater treatment by aquaculture water hyacinth system is accomplished by passing the wastewater through a hyacinth-covered basin where the plants remove nutrients, BOD/COD/TOC, suspended solids, heavy metals, etc. Batch treatment and flow-through systems, using single and multiple cell units, are all possible. The treated wastewater is reused in a natural environment or recharged to the underground, becoming new groundwater. Hyacinths harvested from these systems can be used as a fertilizer/soil conditioner after composting, an animal feed, and a source of methane when anaerobically digested.

**Aqueduct** A pipe, conduit, or channel designed to transport water from a remote source, usually by gravity.

**Aquifer** A natural underground geological formation, often of sand or gravel, that is water bearing. A geological formation or structure that stores and/or transmits water, such as to wells and springs. Use of the term is usually restricted to those water-bearing formations capable of yielding water in sufficient quantity to constitute a usable supply for people's uses.

**Aquifer (confined)** Soil or rock below the land surface that is saturated with water. There are layers of impermeable material both above and below it, and it is under pressure so that when the aquifer is penetrated by a well, the water will rise above the top of the aquifer.

**Aquifer (unconfined)** An aquifer whose upper water surface (water table) is at atmospheric pressure and thus is able to rise and fall.

**Area of cropland** An area of cropland that has been subdivided into several strips is not a single field. Rather, each strip represents an individual field unit.

**Area source** A source of air pollution that is released over an area that cannot be classified as a point source. Area sources can include vehicles and other small engines, small businesses and household activities, or biogenic sources such as a forest that releases hydrocarbons.

**Area-capacity curve** A graph showing the relation between the surface area of the water in a reservoir and the corresponding volume.

**Arid** Pertaining to climatic conditions or a soil that lacks humidity.

**Arid climate** A climate characterized by less than 10 in. (25.4 cm) of annual rainfall.

**Artesian water** Groundwater that is under pressure when tapped by a well and is able to rise above the level at which it is first encountered. It may or may not flow out at ground level. The pressure in such

an aquifer commonly is called artesian pressure, and the formation containing artesian water is an artesian aquifer or confined aquifer. See Flowing well.

**Artificial recharge** A process where water is put back into groundwater storage from surface-water supplies such as irrigation or induced infiltration from streams or wells.

**Average discharge** In the annual series of the US Geological Survey's reports on surface-water supply, average discharge is the arithmetic average of all complete water years of record whether or not they are consecutive. Average discharge is not published for less than 5 years of record. The term "average" is generally reserved for average of record, and "mean" is used for averages of shorter periods, namely, daily mean discharge.

**Backwater** (1) Water backed up or retarded in its course as compared with its normal or natural condition of flow. (2) The increased depth of water upstream from an obstruction (such as dam, ice, weed, etc.) in a stream channel caused by the existence of such obstruction. (3) a water reserve obtained at high tide, and discharged at low tide.

**Bagged sewage sludge** Sewage sludge that is sold or given away in a bag or another container (i.e., either an open or a closed receptacle containing 1 metric ton or less of sewage sludge).

**Bank** The margins of a channel. Banks are called right or left as viewed facing in the direction of the flow.

**Bank storage** The water absorbed into the banks of a stream channel, when the stages rise above the water table in the bank formations, then returns to the channel as effluent seepage when the stages fall below the water table.

**Bankfull stage** Stage at which a stream first overflows its natural banks.

**Base** A substance that has a pH of more than 7, which is neutral. A base has less free hydrogen ions ( $H^+$ ) than hydroxyl ions ( $OH^-$ ).

**Base discharge (for peak discharge)** In the US Geological Survey's annual reports on surface-water supply, this is the discharge above which peak discharge data are published. The base discharge at each station is selected so that an average of about three peaks a year will be presented. (See also Partial-duration flood series.)

**Base flow** Sustained flow of a stream in the absence of direct runoff. It includes natural and human-induced streamflows. Natural base flow is sustained largely by groundwater discharges. (Also see Base runoff.)

**Base runoff** Sustained or fair weather runoff. In most streams, base runoff is composed largely of groundwater effluent. The term base flow is often used in the same sense as base runoff. However, the distinction is the same as that between streamflow and runoff. When the concept in the terms base flow and base runoff is that of the natural flow in a stream, base runoff is the logical term.

**Baseline** A reference condition against which changes or trends are judged—usually a set of conditions that exist at a particular point in time.

**Basic hydrologic data** Includes inventories of features of land and water that vary only from place to place (topographic and geological maps are examples) and records of processes that vary with both place and time. (Records of precipitation, streamflow, groundwater, and quality-of-water analyses are examples.)

**Basic hydrologic information** It is a broader term that includes surveys of the water resources of particular areas and a study of their physical and related economic processes, interrelations, and mechanisms.

**Basic-stage flood series** See Partial-duration flood series.

**Bedrock** The solid rock beneath the soil and superficial rock. A general term for solid rock that lies beneath soil, loose sediments, or other unconsolidated material.

- Benchmark** A concentration or other accepted measures against which environmental conditions are compared.
- Benefit maximization** The process of increasing benefits to the greatest extent possible within constraints such as limitation on financial resources.
- Benefits** A good, service, or attribute of a good or service that promotes or enhances the well-being of an individual, an organization, or a natural system.
- Best available technology** (1) A method that has been determined to be the most effective, practical means of preventing or reducing pollution from nonpoint and point sources. (2) The water treatment (s) that the government (such as the US Environmental Protection Agency) certifies to be the most effective for removing a contaminant.
- Bioaccumulative compound** A compound that tends to accumulate in tissues and build up in food webs. Some bioaccumulative compounds can potentially have adverse effects on ecosystems or human health.
- Bioavailable** The state of a toxicant such that there is increased physicochemical access to the toxicant by an organism. The less the bioavailability of a toxicant, the less its toxic effect on an organism.
- Biogenic source** An air emission source created by some sort of biological activity. Examples include emissions resulting from microbial activity in soils and emissions from trees and other vegetation. Emissions from biogenic sources are a subset of emissions from natural sources (see Natural source).
- Biological balance** The interrelationships among organisms, including the structure of food webs and the ability of ecological systems to maintain themselves over time. Balance is a dynamic characteristic, rather than a fixed state.
- Biological diversity** The variety and variability among living organisms and the ecological complexes in which they occur. Though it most often refers to the numbers of species, the term can apply to levels of organization ranging from genes to ecosystems.
- Biomarker** A molecular or cellular indicator (or “marker”) of an event or condition (exposure, effect, susceptibility) in a biological system or sample. It is the product of an interaction between a contaminant and some target molecule or cell.
- Biomarker of effect** A measure of disease progression, representing a measurable alteration at the molecular, cellular, or some other structural level in the body that can be recognized as a potential or established adverse health effect. Such a biomarker can indicate a biological response or health effect related to a chemical or other stressor; however, it is not always possible to link a biomarker with exposure to a single substance.
- Biomarker of exposure** The level of a contaminant or its metabolite collected from the body or from substances produced or excreted within biological systems. In humans, this measurement can reflect the amount of the contaminant that is stored in the body, and is sometimes referred to as the body burden. It indicates the level of exposure.
- Biomarker of susceptibility** A measurement of individual factors that can affect response to environmental agents. Examples include enzymes whose presence or absence may reflect a particular genetic condition.
- Biomonitoring** The measurement of human tissues or excreta from biological systems for direct or indirect evidence of exposure to chemical, biological, or radiological substances.
- Biosolids** Biosolids are solids, semisolids, or liquid materials, resulting from biological treatment of domestic sewage that has been sufficiently processed to permit these materials to be safely land applied. The term of biosolids was introduced by the wastewater-treatment industry in the early 1990s and has been recently adopted by the United States Environmental Protection Agency

(US EPA) to distinguish high-quality, treated sewage sludge from raw sewage sludge and from sewage sludge containing large amounts of pollutants.

**Biotic environment** The biological component of an ecosystem, including plants and animals.

**Braiding of river channels** Successive division and rejoining (of riverflow) with accompanying islands is the important characteristic denoted by the synonymous terms, braided or anastomosing stream. A braided stream is composed of anabranches.

**Bulk sewage sludge** Sewage sludge that is not sold or given away in a bag or other container for application to the land.

**Capillary action** The means by which liquid moves through the porous spaces in a solid, such as soil, plant roots, and the capillary blood vessels in our bodies, due to the forces of adhesion, cohesion, and surface tension. Capillary action is essential in carrying substances and nutrients from one place to another in plants and animals.

**Catchment area** See Drainage basin.

**Ceiling concentration limits (CCL)** The ceiling concentration limits are the maximum concentrations of the nine trace elements allowed in biosolids to be land applied. Sewage sludge exceeding the ceiling concentration limit for even one of the regulated pollutants is not classified as biosolids and, hence, cannot be land applied.

**Channel** A conduit formed by the flow of water and debris. The time and volume characteristics of water or debris can be altered by man, by climate change, or by alterations in protective vegetal cover on the land of the watershed. The stream channel adjusts to the new set of conditions.

**Channel (watercourse)** An open conduit either naturally or artificially created which periodically or continuously contains moving water or which forms a connecting link between two bodies of water. River, creek, run, branch, anabranch, and tributary are some of the terms used to describe natural channels. Natural channels may be single or braided (see Braiding of river channels). Canal and floodway are some of the terms used to describe artificial channels.

**Channel storage** The volume of water at a given time in the channel or over the flood plain of the streams in a drainage basin or river reach. Channel storage is great during the progress of a flood event.

**Channelization** The practice of straightening a waterway to remove meanders and make water flow faster. Sometimes concrete is used to line the sides and bottom of the channel.

**Chronic health effect** The possible result of exposure over many years to a drinking water contaminant at levels above its maximum contaminant level (MCL).

**Clarity** A measure of the amount of particles suspended in water, determined by using a disk or turbidity test.

**Class I sludge management facility** Publicly owned treatment works (POTWs) required to have an approved pretreatment program under 40 CFR 403.8(a), including any POTW located in a state that has elected to assume local pretreatment program responsibilities under 40 CFR 403.10(e). In addition, the Regional Administrator or, in the case of approved state programs, the Regional Administrator in conjunction with the State Director has the discretion to designate any treatment works treating domestic sewage (TWTDS) as a Class I sludge management facility.

**Clean Water Act (CWA)** The US law, codified generally as 33 USC 1251–1387, that establishes a regulatory and enforcement program administered by the US EPA to control pollutant discharges into US waters.

**Cleanup** Action taken to deal with a release (or threat of release) of a hazardous substance that could affect humans and/or the environment. This term is sometimes used interchangeably with the terms “remedial action,” “removal action,” “response action,” and “corrective action.”

- Climate** The sum total of the meteorologic elements that characterize the average and extreme condition of the atmosphere over a long period of time at any one place or region of the Earth's surface. The collective state of the atmosphere at a given place or over a given area within a specified period of time.
- Climate change** A term sometimes used to refer to all forms of climatic inconsistency; because the Earth's climate is never static, the term is more properly used to imply a significant change from one climatic condition to another. In some cases, "climate change" has been used synonymously with "global warming." Scientists, however, tend to use "climate change" in the wider sense to also include natural changes in climate.
- Climatic year** A continuous 12-month period during which a complete annual cycle occurs, arbitrarily selected for the presentation of data relative to hydrologic or meteorologic phenomena. The climatic year is usually designated by the calendar year during which most of the 12 months occur. (See Water year.)
- Cloudburst** A torrential downpour of rain, which by its spottiness and relatively high intensity suggests the bursting and discharge of a whole cloud at once.
- Coastal waters** Waters at the interface between terrestrial environments and the open ocean. Many unique habitats lie in coastal waters—for example, estuaries, coastal wetlands, sea grass meadows, coral reefs, mangrove and kelp forests, and upwelling areas.
- Coliform** A group of related bacteria whose presence in drinking water may indicate contamination by disease-causing, pathogenic microorganisms.
- Combined sewers and combined sewer overflow (CSO)** Pipes that carry both storm water and household sewage to sewage treatment plants. During a big storm, they may overflow and dump untreated sewage into streams, lakes, and coastal waters. These overflows are called combined sewer overflows or CSOs.
- Commercial water use** Water used for motels, hotels, restaurants, office buildings, other commercial facilities, and institutions. Water for commercial uses comes both from public-supplied sources, such as a county water department, and self-supplied sources, such as local wells.
- Community** In ecology, an assemblage of populations of different species within a specified location in space and time. Sometimes, a particular subgrouping may be specified, such as the fish community in a lake or the soil arthropod community in a forest.
- Community water system** A water system which supplies drinking water to 25 or more of the same people year-round in their residences.
- Compliance** The act of meeting all state and federal drinking water regulations.
- Concentration time** See Time of concentration.
- Concordant flows** Flows at different points in a river system that have the same recurrence interval or the same frequency of occurrence. It is most often applied to flood flows.
- Condensation** The process by which water vapor changes from the vapor state into the liquid or solid state. Water drops on the outside of a cold glass of water are condensed water. It is the reverse of evaporation.
- Condition of ecology** The state of a resource, generally reflecting a combination of physical, chemical, and biological characteristics such as temperature, water clarity, chemical composition, or the status of biological communities. The condition of fresh surface waters, groundwater, wetlands, coastal waters, recreational waters, and consumable fish and shellfish. (Also see Ecological condition.)
- Conservation storage** Storage of water for later release for useful purposes such as municipal water supply, power, or irrigation in contrast with storage capacity used for flood control.

**Constructed wetland or created wetland** A wetland at a site where it did not formerly occur.

Constructed/created wetlands are designed to meet a variety of human benefits including, but not limited to, the treatment of water pollution discharges (e.g., municipal wastewater, storm water) and the mitigation of wetland losses permitted under Section 404 of the Clean Water Act.

**Construction and demolition debris** Waste materials generated during the construction, renovation, and demolition of buildings, roads, and bridges. Construction and demolition debris often contains bulky, heavy materials such as concrete, wood (from buildings), asphalt (from roads and roofing shingles), gypsum (from drywall), metals, bricks, glass, plastics, building components (doors, windows, plumbing fixtures), and trees, stumps, earth, and rock from clearing sites.

**Consumptive use** (1) The quantity of water absorbed by the crop and transpired or used directly in the building of plant tissue together with that evaporated from the cropped area. (2) The quantity of water transpired and evaporated from a cropped area or the normal loss of water from the soil by evaporation and plant transpiration. (3) The quantity of water discharged to the atmosphere or incorporated in the products of the process in connection with vegetative growth, food processing, or an industrial process. (4) The part of water withdrawn that is evaporated, transpired by plants, incorporated into products or crops, consumed by humans or livestock, or otherwise removed from the immediate water environment. Also referred to as water consumed.

**Consumptive use, net** (1) The consumptive use decreased by the estimated contribution by rainfall toward the production of irrigated crops. (2) Net consumptive use is sometimes called crop irrigation requirement.

**Consumptive waste** The water that returns to the atmosphere without benefiting man.

**Contaminant** (1) Anything found in the environment (including microorganisms, minerals, chemicals, radionuclides) which may be harmful to human health. (2) Any physical, chemical, biological, or radiological substance or matter that has an adverse effect on air, water, or soil.

**Contaminated land** Land that has been polluted with hazardous materials and requires cleanup or remediation. Contaminated lands include sites contaminated as a result of improper handling or disposal of toxic and hazardous wastes, sites where improper handling or accidents released toxic or hazardous materials that are not wastes, and sites where toxics may have been deposited by wind or flooding.

**Contents** The volume of water in a reservoir. Unless otherwise indicated reservoir content is computed on the basis of a level pool and does not include bank storage.

**Control** A natural constriction of the channel, a long reach of the channel, a stretch of rapids, or an artificial structure downstream from a gaging station that determines the stage-discharge relation at the gage. A control may be complete or partial. A complete control exists where the stage-discharge relation at a gaging station is entirely independent of fluctuations in stage downstream from the control. A partial control exists where downstream fluctuations have some effect upon the stage-discharge relation at a gaging station. A control, either partial or complete, may also be shifting. Most natural controls are shifting to a degree, but a shifting control exists where the stage-discharge relation experiences frequent changes owing to impermanent bed or banks.

**Conveyance loss** Water that is lost in transit from a pipe, canal, or ditch by leakage or evaporation. Generally, the water is not available for further use; however, leakage from an irrigation ditch, for example, may percolate to a groundwater source and be available for further use.

**Correlation** The process of establishing a relation between a variable and one or more related variables. Correlation is simple if there is only one independent variable; multiple, if there is more than one independent variable. For gaging-station records, the usual variables are the short-term gaging-station record and one or more long-term gaging-station records.

- Correlative estimate** A discharge determined by correlation. A correlative estimate represents a likely value of the discharge for any particular period—commonly a month—according to a specified method of analysis.
- Cost minimization** The process of reducing costs to the lowest possible amount given constraints such as requirements that a specified level of benefits or other resources be attained or provided.
- Criteria pollutants** A group of six widespread and common air pollutants that US EPA regulates on the basis of standards set to protect public health or the environment (see National Ambient Air Quality Standards). The six criteria pollutants are carbon monoxide, lead, nitrogen dioxide, ozone, particulate matter, and sulfur dioxide.
- Crop group** Individual farm fields that are managed in the same manner, with the similar yield goals, are called a crop group.
- Crop management** The management involves crop group identification, crop nitrogen deficit determination, crop nitrogen fertilizer rate calculation, and crop yield optimization.
- Crop nitrogen deficit (CND)** Crop nitrogen deficit (CND) equals to anticipated crop nitrogen fertilizer rate (CNFR) minus all past PAN sources (PAN-past) and current planned non-biosolids PAN sources (PAN-plan) in the unit of lb N/acre. Previous biosolid carry-over nitrogen is included in this calculation.
- Crop nitrogen fertilizer rate (CNFR)** CNFR is a rate (lb N/acre) = (yield) (UNFR), where UNFR is the unit nitrogen fertilizer rate (lb N/unit crop yield) and yield is the crop harvested or crop yield (bu/acre or ton/acre).
- Crop year** The basic time management unit is often called the crop year or planting season. The crop year is defined as the year in which a crop receiving the biosolids/manure treatment is harvested. For example, fall applications of biosolids/manure in 2000 intended to provide nutrients for a crop to be harvested in 2001 are earmarked for crop year 2001. Likewise, biosolids/manure applied immediately prior to planting winter wheat in October 2000 should be identified as fertilizer intended for crop year 2001 because the wheat will be harvested in the summer of 2001.
- Crop yield** It is the crop harvested in the unit of bu/acre or ton/acre.
- Cryology** Science of ice and snow.
- Cryptosporidium** A microorganism commonly found in lakes and rivers, which is highly resistant to disinfection and has caused several large outbreaks of gastrointestinal illness, with symptoms that include diarrhea, nausea, and/or stomach cramps.
- Cumulative pollutant loading rate (CPLR)** CPLR equals to the total amount of pollutant that can be applied to a site in its lifetime by all bulk biosolid applications meeting CCL. It is the maximum amount of an inorganic pollutant that can be applied to an area of land. This term applies to bulk sewage sludge that is land applied.
- Current meter** An instrument for measuring the speed of flowing water. The Geological Survey uses a rotating cup meter.
- CWA §101** The objective of the Clean Water Act (CWA) is to restore and maintain the chemical, physical, and biological integrity of the nation's waters.
- CWA §303d** This section of the Clean Water Act (CWA) requires states to identify waters that do not or are not expected to meet applicable water quality standards with technology-based controls alone. Waters impacted by thermal discharges are also to be identified. After the identification and priority ranking of water quality-limited waters are completed, states are to develop TMDLs at a level necessary to achieve the applicable state water quality standards.

- CWA §314** This section of the Clean Water Act (CWA) establishes the Clean Lakes Program, which supports activities from initial identification of potential water quality problems through post-restoration monitoring. Cooperative grants provide funding for these activities.
- CWA §319** This section of the Clean Water Act (CWA) requires states to develop nonpoint-source control programs. The US EPA awards grants to implement approved programs that include, as appropriate, nonregulatory and regulatory programs for enforcement, technical assistance, financial assistance, education, training, technology transfer, and demonstration projects.
- CWA §320** This section of the Clean Water Act (CWA) establishes the National Estuary Program (NEP), a demonstration program designed to show how estuaries and their living resources can be protected through comprehensive, action-oriented management. Participation in the NEP is limited to estuaries determined by the US EPA Administrator to be of “national significance” after nomination by the Governors of the states in which the estuaries are located.
- CWA §402** This section of the Clean Water Act (CWA) establishes the National Pollutant Discharge Elimination System (NPDES), which provides for the issuance of point-source permits to discharge any pollutant or combination of pollutants, after opportunity for public hearing.
- CWA §404** The discharges of dredged or fill material into wetlands is regulated under this section of the CWA. Permits may be issued after notice and opportunity for public hearings.
- Cycle** A regularly recurring succession of events such as the cycle of the seasons. Use of cycle to describe a group of wet years followed or preceded by a group of dry years is to be avoided.
- Dead storage** The volume in a reservoir below the lowest controllable level.
- Deleted NPL site** A site that has been deleted from the Superfund National Priorities List because its cleanup goals have been met and there is no further need for federal action. (See Superfund and National Priorities List.)
- Dependable yield, *n*-years** The minimum supply of a given water development that is available on demand, with the understanding that lower yields will occur once in *n*-years, on the average.
- Depletion** The progressive withdrawal of water from surface- or groundwater reservoirs at a rate greater than that of replenishment. (See Recession curve and Streamflow depletion.)
- Depression storage** The volume of water contained in natural depressions in the land surface, such as puddles.
- Desalination** The removal of salts from saline water to provide freshwater. This method is becoming a more popular way of providing freshwater to populations.
- Designated use** Simple narrative description of water quality expectations or water quality goals. A designated use is a legally recognized description of a desired use of the waterbody, such as (1) support of communities of aquatic life, (2) body contact recreation, (3) fish consumption, and (4) public drinking water supply. These are uses that the state or authorized tribe wants the waterbody to be healthy enough to fully support. The US Clean Water Act requires that waterbodies attain or maintain the water quality needed to support designated uses.
- Direct runoff** The runoff entering stream channels promptly after rainfall or snowmelt. Superposed on base runoff, it forms the bulk of the hydrograph of a flood.
- Discharge** In its simplest concept discharge means outflow; therefore, the use of this term is not restricted as to course or location, and it can be applied to describe the flow of water from a pipe or from a drainage basin. If the discharge occurs in some course or channel, it is correct to speak of the discharge of a canal or of a river. It is also correct to speak of the discharge of a canal or stream into a lake, a stream, or an ocean. (See also Streamflow and Runoff.) The data in the reports of the Geological Survey on surface water represent the total fluids measured. Thus, the terms discharge, streamflow, and runoff represent water with the solids dissolved in it and the sediment mixed with



it. Of these terms, discharge is the most comprehensive. The discharge of drainage basins is distinguished as follows: (1) yield, total water runoff or crop, includes runoff plus underflow; (2) runoff, that part of water yield that appears in streams; and (3) streamflow, the actual flow in streams, whether or not subject to regulation, or underflow. Each of these terms can be reported in total volumes (such as acre-feet) or time rates (such as cubic feet per second or acre-feet per year). The differentiation between runoff as a volume and streamflow as a rate is not accepted.

**Discharge** The volume of water that passes a given location within a given period of time. Usually expressed in cubic feet per second.

**Discharge rating curve** See Stage-discharge relation.

**Disinfectant** A chemical (commonly chlorine, chloramine, or ozone) or physical process (e.g., ultraviolet light) that kills microorganisms such as bacteria, viruses, and protozoa.

**Dissolved oxygen (DO)** The amount of oxygen dissolved in water. The amount is usually expressed in parts per million (ppm) or milligrams per liter (mg/L).

**Distressed watershed** It is a watershed which has aquatic life and health that is impaired by nutrients (nitrogen and phosphorus) from agricultural land uses, such as land application. Threats to public health, drinking water supplies, recreation, and public safety are also taken into consideration if a watershed is designated as a distressed watershed.

**Distribution graph (distribution hydrograph)** A unit hydrograph of direct runoff modified to show the proportions of the volume of runoff that occurs during successive equal units of time.

**Distribution system** A network of pipes leading from a treatment plant to customers' plumbing systems.

**Diversion** The taking of water from a stream or other body of water into a canal, pipe, or other conduit.

**Domestic septage** Either a liquid or solid material removed from a septic tank, cesspool, portable toilet, Type III marine sanitation device, or similar treatment works that receives only domestic sewage. This does not include septage resulting from treatment of wastewater with a commercial or industrial component.

**Domestic water use** Water used for household purposes, such as drinking; food preparation; bathing; washing clothes, dishes, and dogs; flushing toilets; and watering lawns and gardens. About 85 % of domestic water is delivered to homes by a public-supply facility, such as a county water department. About 15 % of the nation's population supply their own water, mainly from wells.

**Double-mass curve** A plot on arithmetic cross-section paper of the cumulated values of one variable against the cumulated values of another or against the computed values of the same variable for a concurrent period of time.

**Drainage area** The drainage area of a stream at a specified location is that area, measured in a horizontal plane, which is enclosed by a drainage divide.

**Drainage basin** (1) A part of the surface of the Earth that is occupied by a drainage system, which consists of a surface stream or a body of impounded surface water together with all tributary surface streams and bodies of impounded surface water; (2) land area where precipitation runs off into streams, rivers, lakes, and reservoirs; (3) a land feature that can be identified by tracing a line along the highest elevations between two areas on a map, often a ridge. Large drainage basins, like the area that drains into the Mississippi River, contain thousands of smaller drainage basins. Also called a "watershed."

**Drainage density** Length of all channels above those of a specified stream order per unit of drainage area.

**Drainage divide** The rim of a drainage basin. (See Watershed.)

**Drawdown** A lowering of the groundwater surface caused by pumping.

**Drinking water quality** Refers to whether contaminants are present in water that people drink, including water from the tap, private wells, hauled water, untreated surface-water sources, and bottled water, at levels that could affect human health.

**Drinking water standards** Regulations that the government, such as the US EPA, sets to control the level of contaminants in the nation's drinking water. Enforceable standards include maximum contaminant levels (MCLs) and treatment techniques (TTs) (see separate entries for each). Drinking water standards apply to all public water systems (see Public water system).

**Drip irrigation** A common irrigation method where pipes or tubes filled with water slowly drip onto crops. Drip irrigation is a low-pressure method of irrigation and less water is lost to evaporation than high-pressure spray irrigation.

**Drop structure** A natural or man-placed structure that disrupts the continuous surface flow pattern in a river or stream by producing a pooling of water behind the structure and a rapid drop in the surface gradient for water flowing over the structure; used to improve habitat conditions for aquatic life and to increase the air (especially oxygen) content of water.

**Drought** A period of deficient precipitation or runoff extending over an indefinite number of days, but with no set standard by which to determine the amount of deficiency needed to constitute a drought. Thus, there is no universally accepted quantitative definition of drought; generally, each investigator establishes his/her own definition. When in an area that is ordinarily classed as humid, natural vegetation becomes desiccated or defoliates unseasonably and crops fail to mature owing to lack of precipitation, or when precipitation is insufficient to meet the needs of established human activities, drought conditions may be said to prevail. Although water for irrigation or other uses in arid areas is always limited, special shortages in such areas are also regarded as droughts. Unsatisfactory distribution of precipitation throughout the year may be as effective a factor in causing a drought as a shortage in the total amount. Temperature and wind may also play an important part, especially in relation to the damage done.

**Duration curve** See Flow-duration curve for one type.

**Ecological condition** A term referring to the state of the physical, chemical, and biological characteristics of the environment and the processes and interactions that connect them.

**Ecological connectivity** A term referring to the connected system of open space throughout an ecosystem and adjacent ecosystems. Includes the presence of ecotones, the transitional regions between ecosystems.

**Ecological processes** The metabolic functions of ecosystems—energy flow, elemental cycling, and the production, consumption, and decomposition of organic matter.

**Ecological system** A hierarchically nested area that includes all living organisms (people, plants, animals, and microorganisms), their physical surroundings (such as soil, water, and air), and the natural cycles that sustain them.

**Ecology** The study of the relationships between the environment and the living organisms and beings present.

**Ecoregion** (1) An area within which the ecosystems—and the type, quality, and quantity of environmental resources—are generally similar. An ecoregion can serve as a spatial framework for the research, assessment, management, and monitoring of ecosystems and ecosystem components. Several different classification schemes have been developed at various resolutions; (2) Ecological region that has broad similarities with respect to soil, relief, and dominant vegetation.

**Ecosystem** The interacting system of a particular biological community and its nonliving environmental surroundings or a class of such systems (e.g., forests or wetlands).

- Effective precipitation (rainfall)** (1) That part of the precipitation that produces runoff; (2) a weighted average of current and antecedent precipitation that is “effective” in correlating with runoff; (3) as described by the US Bureau of Reclamation, that part of the precipitation falling on an irrigated area that is effective in meeting the consumptive use requirements.
- Effluent** Water that flows from a sewage treatment plant after it has been treated.
- Emission factor** The relationship between the amount of pollution produced by a particular source and the amount of raw material processed. For example, an emission factor for a blast furnace making iron might be pounds of particulates emitted per ton of raw materials processed.
- Emission inventory** A listing, by source and pollutant, of the amount of air pollutants discharged into the atmosphere. Emission inventories can be based on emissions estimates, emissions measurements, or both.
- End state** Any one of a number of ecosystem characteristics observed at a point in time. The term is commonly used to represent the results of ecological processes.
- Endpoint** A biological or ecological characteristic that is the basis for evaluation or measurement.
- Energy cycling** The movement, or flow, and storage of energy among production and use components of ecological and physiological systems.
- Enhancement** An activity increasing one or more natural or artificial wetland functions. For example, the removal of a point-source discharge impacting a wetland.
- Ephemeral waters** Waterbodies (e.g., streams or wetlands) that contain water for brief periods, usually in direct response to a precipitation event. Ephemeral waters generally flow for a shorter time period than intermittent waters, although in some cases the terms are used interchangeably (see Intermittent waters).
- Epilimnion** See Thermal stratification.
- Erosion** The process in which a material is worn away by a stream of liquid (water) or air, often due to the presence of abrasive particles in the stream.
- Estuary** A place where fresh- and saltwater mix, such as a bay, salt marsh, or where a river enters an ocean.
- Eutrophication** Enrichment of an aquatic ecosystem with nutrients (nitrogen, phosphorus) that accelerate biological productivity (growth of algae and weeds) and an undesirable accumulation of algal biomass.
- Evaporation** (1) The process by which water is changed from the liquid or the solid state into the vapor state; (2) the process of liquid water becoming water vapor, including vaporization from water surfaces, land surfaces, and snow fields, but not from leaf surfaces. See Transpiration. In hydrology, evaporation is vaporization that takes place at a temperature below the boiling point.
- Evaporation opportunity (relative evaporation)** The ratio of the rate of evaporation from a land or water surface in contact with the atmosphere to the evaporativity under existing atmospheric conditions. It is the ratio of actual to potential rate of evaporation, generally stated as a percentage. The opportunity for a given rate of evaporation to continue is determined by the available moisture supply.
- Evaporation pan** An open tank used to contain water for measuring the amount of evaporation. The US Weather Bureau Class A pan is 4 ft (1.22 m) in diameter, 10 in. (25.4 cm) deep, set up on a timber grillage so that the top rim is about 16 in. (40.64 cm) from the ground. The water level in the pan during the course of observation is maintained between 2 and 3 in. (5.08 and 7.53 cm) below the rim.
- Evaporation, total** The sum of water lost from a given land area during any specific time by transpiration from vegetation and building of plant tissue; by evaporation from water surfaces, moist soil, and snow; and by interception. It has been variously termed “evaporation,” “evaporation from land areas,” “evapotranspiration,” “total loss,” “water losses,” and “fly-off.”

**Evaporativity (potential rate of evaporation)** The rate of evaporation under the existing atmospheric conditions from a surface of water that is chemically pure and has the temperature of the atmosphere.

**Evapotranspiration** (1) Water withdrawn from a land area by evaporation from water surfaces and moist soil and plant transpiration; (2) the sum of evaporation and transpiration; (3) the combined conversion of water to water vapor and loss resulting from both evaporation and transpiration.

**Evapotranspiration, potential** See Potential evapotranspiration.

**Exceptional quality sewage sludge** Sewage sludge that meets the most stringent limits for the three sludge quality parameters. In gaging sewage sludge quality, US EPA determined that three main parameters of concern should be considered: (1) pollutant levels; (2) the relative presence or absence of pathogenic organisms, such as salmonella and E. coli bacteria, enteric viruses, or viable helminth ova; and (3) the degree of attractiveness of the sewage sludge to vectors, such as flies, rats, and mosquitoes, that could potentially come in contact with pathogenic organisms and spread disease. Given these three variables, there can be a number of possible sewage sludge qualities. The term exceptional quality (EQ), which does not appear in the Part 503 regulation, is used to describe sewage sludge that meets the highest quality for all three of these sewage sludge quality parameters.

**Excessive rainfall** See Rainfall, excessive.

**Exemption** State or US EPA permission for a water system not to meet a certain drinking water standard. An exemption allows a system additional time to obtain financial assistance or make improvements in order to come into compliance with the standard. The system must prove that (1) there are compelling reasons (including economic factors) why it cannot meet an MCL or treatment technique, (2) it was in operation on the effective date of the requirement, and (3) the exemption will not create an unreasonable risk to public health. The state must set a schedule under which the water system will comply with the standard for which it received an exemption.

**Exposure** This is the amount of a chemical, physical, or biological contaminant at the outer boundary of the human or animal body available for exchange or intake via inhalation, ingestion, or skin or eye contact.

**Extent** The amount and distribution of a resource, which may be measured in terms of spatial area, volume, depth, or flow (e.g., for water resources). ROE questions address the extent of fresh surface waters, groundwater, wetlands, and coastal waters.

**Extraction and mining waste** Soil and rock generated during the process of gaining access to the ore or mineral body, as well as water that infiltrates the mine during the extraction process. This category also includes certain wastes associated with the beneficiation of ores and minerals, including wastes from the following activities: crushing, grinding, washing, dissolution, crystallization, filtration, sorting, sizing, drying, sintering, pelletizing, briquetting, calcining to remove water and/or carbon dioxide, roasting in preparation for leaching (except where the roasting/leaching sequence produces a final or intermediate product that does not undergo further beneficiation or processing), gravity concentration, magnetic separation, electrostatic separation, floatation, ion exchange, solvent extraction, electrowinning, precipitation, amalgamation, and heap, dump, vat, tank, and in situ leaching.

**Farm field** The farm field is the basic management unit used for all farm nutrient management, defined as “the fundamental unit used for cropping agricultural products.”

**Feed crop** Crops produced primarily for consumption by animals. These include, but are not limited to, corn and grass. For a crop to be considered a feed crop, it has to be produced for consumption by animals (e.g., grass grown to prevent erosion or to stabilize an area is not considered a feed crop).

- Fiber crop** Crops, such as flax and cotton, that were included in Part 503 because products from these crops (e.g., cottonseed oil) may be consumed by humans.
- Field capacity** See Field-moisture capacity.
- Field-moisture capacity** The quantity of water which can be permanently retained in the soil in opposition to the downward pull of gravity.
- Field-moisture deficiency** The quantity of water which would be required to restore the soil moisture to field-moisture capacity.
- Final NPL site** A site that has been formally added to the Superfund National Priorities List. (See Superfund and National Priorities List.)
- Finished water** Water that has been treated and is ready to be delivered to customers.
- Firn (firn snow)** Old snow on the top of glaciers, granular, and compact but not yet converted into ice. It is a transitional stage between snow and ice.
- Firn line** The highest level to which the fresh snow on a glacier's surface retreats during the melting season. The line separating the accumulation area from the ablation area.
- Flood** (1) An overflow or inundation that comes from a river or other body of water and causes or threatens damage; (2) any relatively high streamflow overtopping the natural or artificial banks in any reach of a stream; (3) a relatively high flow as measured by either gage height or discharge quantity; (4) an overflow of water onto lands that are used or usable by man and not normally covered by water. Floods have two essential characteristics: the inundation of land is temporary, and the land is adjacent to and inundated by overflow from a river, stream, lake, or ocean.
- Flood crest** See Flood peak.
- Flood event** See Flood wave.
- Flood peak** The highest value of the stage or discharge attained by a flood, thus peak stage or peak discharge. Flood crest has nearly the same meaning, but since it connotes the top of the flood wave, it is properly used only in referring to stage—thus crest stage, but not crest discharge.
- Flood plain** (1) A strip of relatively smooth land bordering a stream built of sediment carried by the stream and dropped in the slack water beyond the influence of the swiftest current. It is called a living flood plain if it is overflowed in times of high water but a fossil flood plain if it is beyond the reach of the highest flood. (2) The lowland that borders a river, usually dry but subject to flooding. (3) That land outside of a stream channel described by the perimeter of the maximum probable flood. (4) A strip of relatively flat and normally dry land alongside a stream, river, or lake that is covered by water during a flood.
- Flood plane** The position occupied by the water surface of a stream during a particular flood. Also, loosely, the elevation of the water surface at various points along the stream during a particular flood.
- Flood profile** A graph of elevation of the water surface of a river in flood, plotted as ordinate, against distance, measured in the downstream direction, plotted as abscissa. A flood profile may be drawn to show elevation at a given time or crests during a particular flood or to show stages of concordant flows.
- Flood routing** The process of determining progressively the timing and shape of a flood wave at successive points along a river.
- Flood stage** (1) The elevation at which overflow of the natural banks of a stream or body of water begins in the reach or area in which the elevation is measured; (2) the gage height of the lowest bank of the reach in which the gage is situated. The term "lowest bank" is, however, not to be taken to mean an unusually low place or break in the natural bank through which the water inundates an unimportant and small area. The stage at which overflow of the natural banks of a stream begins to cause damage in the reach in which the elevation is measured. See also Bankfull stage.

- Flood wave** A distinct rise in stage culminating in a crest and followed by recession to lower stages.
- Flood zone** The land bordering a stream which is subject to floods of about equal frequency, for example, a strip of the flood plain subject to flooding more often than once but not as frequently as twice in a century.
- Flood, 100-year** A 100-year flood does not refer to a flood that occurs once every 100 years, but to a flood level with a 1 % chance of being equaled or exceeded in any given year.
- Flood, maximum probable** The largest flood for which there is any reasonable expectancy in this climatic era.
- Flood-control storage** Storage of water in reservoirs to abate flood damage. (See Retarding reservoir.)
- Flood-frequency curve** (1) A graph showing the number of times per year on the average, plotted as abscissa, that floods of magnitude, indicated by the ordinate, are equaled or exceeded; (2) a similar graph but with recurrence intervals of floods plotted as abscissa.
- Floods above a base** See Partial-duration flood series.
- Floodway** (1) The channel of a river or stream and the parts of the flood plain adjoining the channel that are reasonably required to efficiently carry and discharge the floodwater or flood flow of a river or stream; (2) a part of the flood plain, otherwise leveled, reserved for emergency diversion of water during floods. A part of the flood plain which, to facilitate the passage of floodwater, is kept clear of encumbrances. The channel of a river or stream and those parts of the flood plains adjoining the channel, which are reasonably required to carry and discharge the floodwater or flood flow of any river or stream.
- Flow-duration curve** A cumulative frequency curve that shows the percentage of time that specified discharges are equaled or exceeded.
- Flowing well/spring** A well or spring that taps groundwater under pressure so that water rises without pumping. If the water rises above the surface, it is known as a flowing well.
- Food crop** Crops consumed by humans. These include, but are not limited to, fruits, grains, vegetables, and tobacco.
- Forest influences** Effects resulting from the presence of forest or brush upon climate, soil water, runoff, streamflow, floods, erosion, and soil productivity.
- Forestland** Tract of land thick with trees and underbrush.
- Fossil fuel combustion waste** Waste from the combustion of oil, natural gas, or petroleum coke; the combustion of coal at electric utilities and independent power-producing facilities, nonutilities, and facilities with fluidized bed combustion technology; or the combustion of mixtures of coal and other fuels (i.e., coburning of coal with other fuels) where coal is at least 50 % of the total fuel.
- Frazil (frazil ice)** A French-Canadian term for fine spicular ice, derived from the French for cinders which this variety of ice most resembles. When formed in saltwater, it is known as lolly ice. It is composed of fine particles which, when first formed, are colloidal and not seen in the water in which they are floating.
- Freshwater** Water that contains less than 1,000 mg/L of dissolved solids; generally, more than 500 mg/L of dissolved solids is undesirable for drinking and many industrial uses.
- Functions of wetland** The roles wetlands serve which are of value to society or the environment.
- Gage height** (1) The water-surface elevation referred to some arbitrary gage datum. Gage height is often used interchangeably with the more general term stage although gage height is more appropriate when used with a reading on a gage. (2) The height of the water surface above the gage datum (zero point).

- Gaging station** (1) A particular site on a stream, canal, lake, or reservoir where systematic observations of gage height or discharge are obtained. (See also Stream-gaging station.) (2) A site on a stream, lake, reservoir, or other body of water where observations and hydrologic data are obtained. The US Geological Survey measures stream discharge at gaging stations.
- Geographic information system (GIS)** A tool that links spatial features commonly seen on maps with information from various sources ranging from demographics to pollutant sources.
- Geomorphology** The geological study of the evolution and configuration of land forms.
- Geyser** A geothermal feature of the Earth where there is an opening in the surface that contains superheated water that periodically erupts in a shower of water and steam.
- Giardia lamblia*** A microorganism frequently found in rivers and lakes, which, if not treated properly, may cause diarrhea, fatigue, and cramps after ingestion.
- Giardiasis** A disease that results from an infection by the protozoan parasite *Giardia intestinalis*, caused by drinking water that is either not filtered or not chlorinated. The disorder is more prevalent in children than in adults and is characterized by abdominal discomfort, nausea, and alternating constipation and diarrhea.
- Glacier** (1) A huge mass of ice, formed on land by the compaction and recrystallization of snow, that moves very slowly downslope or outward due to its own weight. (2) Bodies of land ice that consist of recrystallized snow accumulated on the surface of the ground and that move slowly downslope.
- Global climate change** See Climate change.
- Greenhouse gas** Any gas that absorbs infrared radiation in the atmosphere. Greenhouse gases include water vapor, carbon dioxide (CO<sub>2</sub>), methane (CH<sub>4</sub>), nitrous oxide (N<sub>2</sub>O), halogenated fluorocarbons (HCFCs), ozone (O<sub>3</sub>), perfluorinated carbons (PFCs), and hydrofluorocarbons (HFCs).
- Greywater** Wastewater from clothes washing machines, showers, bathtubs, hand washing, lavatories, and sinks.
- Groundwater** (1) Water that flows or seeps downward and saturates soil or rock, supplying springs and wells. The upper surface of the saturate zone is called the water table; (2) water stored underground in rock crevices and in the pores of geological materials that make up the Earth's crust; (3) the supply of freshwater that is found under the Earth's surface in underground rock formations or soil; (4) water in the ground that is in the zone of saturation, from which wells, springs, and groundwater runoff are supplied; (5) the water that systems pump and treat from aquifers (natural reservoirs below the Earth's surface).
- Groundwater outflow** That part of the discharge from a drainage basin that occurs through the groundwater. The term "underflow" is often used to describe the groundwater outflow that takes place in valley alluvium (instead of the surface channel) and thus is not measured at a gaging station.
- Groundwater recharge** Inflow of water to a groundwater reservoir from the surface. Infiltration of precipitation and its movement to the water table is one form of natural recharge. Also, it is the volume of water added by this process.
- Groundwater runoff** That part of the runoff which has passed into the ground, has become groundwater, and has been discharged into a stream channel as spring or seepage water. See also Base runoff and Direct runoff.
- Groundwater, confined** Groundwater under pressure significantly greater than atmospheric, with its upper limit the bottom of a bed with hydraulic conductivity distinctly lower than that of the material in which the confined water occurs.
- Groundwater, unconfined** Water in an aquifer that has a water table that is exposed to the atmosphere.

**Guttation** The loss of water in liquid form from the uninjured leaf or stem of the plant, principally through water stomata.

**Habitat** The environment occupied by individuals of a particular species, population, or community.

**Hardness** A water quality indication of the concentration of alkaline salts in water, mainly calcium and magnesium. If the water you use is “hard,” then more soap, detergent, or shampoo is necessary to raise a lather.

**Hazardous air pollutants** See Air toxics.

**Hazardous waste** Waste with properties that make it dangerous or potentially harmful to human health or the environment. The universe of hazardous wastes is large and diverse. Hazardous wastes can be liquids, solids, contained gases, or sludge. They can be the by-products of manufacturing processes or simply discarded commercial products, like cleaning fluids or pesticides. Hazardous waste is regulated under the Resource Conservation and Recovery Act (RCRA) Subtitle C (see RCRA hazardous waste for the regulatory definition). States can identify additional wastes as hazardous beyond those identified by the US EPA.

**Headwater(s)** (1) The source and upper reaches of a stream and also the upper reaches of a reservoir. (2) The water upstream from a structure or point on a stream. (3) The small streams that come together to form a river. Also may be thought of as any and all parts of a river basin except the mainstream river and main tributaries.

**Health advisory** A US EPA document that provides guidance and information on contaminants that can affect human health and that may occur in drinking water, but which the US EPA does not currently regulate in drinking water.

**Health-based standards** Standards based on contaminant concentrations in environmental media or exposure doses that are likely to be without an appreciable risk of adverse health effects in humans. (Some health-based standards allow for consideration of technological and cost limitations.)

**Heat budget, annual (of a lake)** The amount of heat necessary to raise the water from the minimum temperature of winter to the maximum temperature of summer.

**Heavy metals** Trace elements are found in low concentrations in the environment, such as water, soil, or biosolids. They are commonly referred to as either “heavy metals” or “trace elements” (e.g., copper, molybdenum, and zinc) which are nutrients needed for plant or animal growth in low concentrations, but all of these elements can be toxic to humans, animals, or plants at high concentrations. Possible hazards associated with a buildup of trace elements in the soil include their potential to cause phytotoxicity (i.e., injury to plants) or to increase the concentration of potentially hazardous substances in the food chain. Federal and state regulations have established standards for the following nine trace elements: arsenic (As), cadmium (Cd), copper (Cu), lead (Pb), mercury (Hg), molybdenum (Mo), nickel (Ni), selenium (Se), and zinc (Zn).

**Hydraulic** Referring to water or other fluids in motion.

**Hydraulic fracturing** A process of aquifer development in which fluid is injected at pressures that exceed the tensile stress of the aquifer, causing cracks to develop and propagate in the formation. These cracks serve as conduits for liquid flow to a production well. This process can be used in petroleum (nature gas) recovery. It can also be used for increasing water production in rocklike aquifers or for contaminant recovery.

**Hydraulics** A science that studies water or other fluids in motion.

**Hydroelectric power water use** The use of water in the generation of electricity at plants where the turbine generators are driven by falling water.

**Hydrograph** A graph showing stage, flow, velocity, or other properties of water with respect to time.



**Hydrologic budget** An accounting of the inflow to, outflow from, and storage in a hydrologic unit, such as a drainage basin, aquifer, soil zone, lake, reservoir, or irrigation project.

**Hydrologic cycle** (1) The cyclic transfer of water vapor from the Earth's surface via evapotranspiration into the atmosphere, from the atmosphere via precipitation back to the Earth, and through runoff into streams, rivers, and lakes, and ultimately into the oceans. (2) A convenient term to denote the circulation of water from the sea, through the atmosphere, to the land, and, thence, with many delays, back to the sea by overland and subterranean routes and in part by way of the atmosphere, also the many short circuits of the water that is returned to the atmosphere without reaching the sea.

**Hydrologic equation** The equation balancing the hydrologic budget.

**Hydrology** (1) The science encompassing the behavior of water as it occurs in the atmosphere, on the surface of the ground, and underground. (2) The science that relates to the water of the Earth. (3) The science treating of the waters of the Earth, their occurrence, distribution, and movements. (4) The science dealing with the properties, distribution, and circulation of water both on the surface and under the Earth. In practice the study of the water of the oceans and the atmosphere is considered part of the sciences of oceanography and meteorology.

**Hyetograph** Graphical representation of rainfall intensity against time.

**Hypolimnion** See Thermal stratification.

**Hypoxia** The occurrence of low dissolved oxygen concentrations in water. Hypoxia is generally defined with respect to saturation; because saturation levels vary with temperature and salinity, the concentration that defines hypoxia may vary seasonally and geographically. In practice, scientists often use a threshold of 2 ppm (mg/L), the generally accepted minimum required for most marine life to survive and reproduce.

**Impaired waterbody** A waterbody that does not meet the criteria that support its designated use.

**Impermeable layer** A layer of solid material, such as rock or clay, which does not allow water to pass through.

**Impervious surface** (1) A hard surface area that either prevents or retards the entry of water into the soil mantle or causes water to run off the surface in greater quantities or at an increased rate of flow. (2) A paved or other hard surface that does not allow water to penetrate. Common impervious surfaces include rooftops, walkways, patios, driveways, parking lots, storage areas, concrete or asphalt paving, and gravel roads.

**Index** A single number, derived from two or more environmental variables, that is intended to simplify complex information. For example, the Index of Biological Integrity combines several metrics of benthic community condition into a single index score.

**Index period** In the US EPA's aquatic resource monitoring, a term used to describe the portion of the year when data are collected. The index period is often selected based on ecological considerations.

**Indicator** A numerical value derived from actual measurements of a stressor, state or ambient condition, exposure, or human health or ecological condition over a specified geographic domain, whose trends over time represent or draw attention to underlying trends in the condition of the environment.

**Indicator organism** An indicator organism (e.g., fecal coliform) is a nonpathogenic organism whose presence implies the presence of pathogenic organisms. Indicator organisms are selected to be conservative estimates of the potential for pathogenicity.

**Individual field unit** An area of cropland that has been subdivided into several strips is not a single field. Rather, each strip represents an individual field unit.

**Industrial nonhazardous waste** Waste generated from processes associated with the production of goods and products, such as electric power generation and manufacturing of materials such as pulp and paper, iron and steel, glass, and concrete. This waste usually is not classified as municipal solid waste by the federal government, but some states may classify it as such if it enters the municipal solid waste stream.

**Industrial source** A term used in this report to describe air emissions sources of industrial origin. The report breaks industrial sources down into contributions from selected industries, as appropriate.

**Industrial water use** Water used for industrial purposes in such industries as steel, chemical, paper, and petroleum refining. Nationally, water for industrial uses comes mainly (80 %) from self-supplied sources, such as a local wells or withdrawal points in a river, but some water comes from public-supplied sources, such as the county/city water department.

**Infiltration** (1) Flow of water from the land surface into the subsurface; (2) the flow of a fluid into a substance through pores or small openings. It connotes flow into a substance in contradistinction to the word percolation, which connotes flow through a porous substance.

**Infiltration capacity** The maximum rate at which the soil, when in a given condition, can absorb falling rain or melting snow.

**Infiltration index** An average rate of infiltration, in inches per hour, equal to the average rate of rainfall such that the volume of rainfall at greater rates equals the total direct runoff.

**Injection well** Refers to a well constructed for the purpose of injecting treated wastewater directly into the ground. Wastewater is generally forced (pumped) into the well for dispersal or storage into a designated aquifer. Injection wells are generally drilled into aquifers that don't deliver drinking water, unused aquifers, or below freshwater levels.

**Inorganic contaminants** Mineral-based compounds such as metals, nitrates, and asbestos. These contaminants are naturally occurring in some water but can also get into water through farming, chemical manufacturing, and other human activities. The US EPA has set legal limits on 15 inorganic contaminants.

**Interception** The process and the amount of rain or snow stored on leaves and branches and eventually evaporated back to the air. Interception equals the precipitation on the vegetation minus stemflow and through fall.

**Intermittent waters** Waterbodies (e.g., streams or wetlands) that contain water for part of each year, due to precipitation events and some groundwater contributions. Intermittent streams and wetlands typically contain water for weeks or months, while "ephemeral" streams and wetlands contain water for briefer periods, but in some cases, these terms are used interchangeably (see Ephemeral waters).

**Invasive species** A nonindigenous plant or animal species that can harm the environment, the human health, or the economy.

**Irrigated area** The gross farm area upon which water is artificially applied for the production of crops, with no reduction for access roads, canals, or farm buildings.

**Irrigation** The controlled application of water to arable lands to supply water requirements not satisfied by rainfall.

**Irrigation** The controlled application of water for agricultural purposes through man-made systems to supply water requirements not satisfied by rainfall. Here's a quick look at some types of irrigation systems.

**Irrigation efficiency** The percentage of water applied that can be accounted for in soil-moisture increase.

**Irrigation requirement** The quantity of water, exclusive of precipitation, that is required for crop production. It includes surface evaporation and other economically unavoidable wastes.

- Irrigation water use** Water application on lands to assist in the growing of crops and pastures or to maintain vegetative growth in recreational lands, such as parks and golf courses.
- Irrigation, supplemental** See Supplemental irrigation.
- Isohyet** See Isohyetal line.
- Isohyetal line (isohyet)** A line drawn on a map or chart joining points that receive the same amount of precipitation.
- Lag** Variously defined as time from beginning (or center of mass) of rainfall to peak (or center of mass) of runoff.
- Land application** Land application is defined as the spreading, spraying, injection, or incorporation of liquid or semiliquid organic substances, such as sewage sludge, biosolids, livestock manure, compost, septage, legumes, and other types of liquid organic waste, onto or below the surface of the land to take advantage of the soil-enhancing qualities of the organic substances. These organic substances are land applied to improve the structure of the soil. It is also applied as a fertilizer to supply nutrients to crops and other vegetation grown in the soil. The liquid or semiliquid organic substances are commonly applied to agricultural land (including pasture and rangeland), forests, reclamation sites, public contact sites (e.g., parks, turf farms, highway median strips, golf courses), lawns, and home gardens. (See Spray irrigation for land application of wastewater.)
- Land application site** An area of land on which sewage sludge is applied to condition the soil or to fertilize crops or vegetation grown in the soil.
- Land treatment unit** A site where physical, chemical, and biological processes occurring in the topsoil layers (e.g., naturally occurring soil microbes and sunlight) are used to treat and contain waste. Hazardous waste is applied directly to the soil surface or incorporated into the upper layers of the soil, where its constituents are degraded, transformed, or immobilized. Liner systems or leachate collection and removal systems are not required for land treatment units. Closure consists primarily of placing a vegetative cover over the unit and certifying that hazardous constituent levels in the treatment zone do not exceed background levels.
- Landfill** A disposal site for solid wastes spread in layers, compacted to the smallest practical volume and covered by material (e.g., soil). Landfills are designed to isolate waste from the surrounding environment (e.g., groundwater, rain, air). Landfills are subject to requirements that include installing and maintaining a final cover, operating leachate collection and removal systems, maintaining and monitoring the leak detection system, groundwater monitoring, preventing storm water run-on and runoff, and installing and protecting surveyed benchmarks.
- Leaching** The process by which soluble materials in the soil, such as salts, nutrients, pesticide chemicals, or contaminants, are washed into a lower layer of soil or are dissolved and carried away by water.
- Lentic waters** Ponds or lakes (standing water).
- Levee** A natural or man-made earthen barrier along the edge of a stream, lake, or river. Land alongside rivers can be protected from flooding by levees.
- Limnology** That branch of hydrology pertaining to the study of lakes.
- Livestock operation** A facility that raises animals such as cows, sheep, or hogs. Fecal coliform bacteria are present in livestock waste.
- Livestock water use** Water used for livestock watering, feedlots, dairy operations, fish farming, and other on-farm needs.
- Living machine system** A patented, man-made aquaculture wetland waste treatment system which adapts and enhances the ecological processes in a series of tidal wetland cells or basins. Each cell or basin is filled with special gravel that promotes the development of micro-ecosystems. A computer

controls fill and drain cycles, alternating anoxic (without oxygen) and aerobic (with oxygen) conditions. As wastewater moves through the system, the cells are alternately flooded and drained to create multiple tidal cycles each day, much like one finds in nature, resulting in high-quality reusable water.

**Long-period variations** Secular when a cycle or a change in trend is completed within a century, climatic when the period of change runs through centuries or a few millennia, and geological when the period runs into geological time.

**Lotic waters** Flowing waters, as in streams and rivers.

**Low-flow frequency curve** A graph showing the magnitude and frequency of minimum flows for a period of given length. Frequency is usually expressed as the average interval, in years, between recurrences of an annual minimum flow equal to or less than that shown by the magnitude scale.

**Lysimeter** Structure containing a mass of soil and designed to permit the measurement of water draining through the soil.

**Macroinvertebrate** Organism that lacks a backbone and is large enough to be seen with the naked eye.

**Manure** Any wastes discharged from livestock.

**Marginal costs** The incremental cost of increasing output of a good or service by a small amount.

**Mass curve** A graph of the cumulative values of a hydrologic quantity (such as precipitation or runoff), generally as ordinate, plotted against time or date as abscissa. (See Double-mass curve and Residual-mass curve.)

**Maximum contaminant level (MCL)** The highest level of a contaminant that the US EPA allows in drinking water. MCLs ensure that drinking water does not pose either a short-term or long-term health risk. The US EPA sets MCLs at levels that are economically and technologically feasible. MCLs are enforceable standards. Some states set MCLs which are more strict than the US EPA's.

**Maximum contaminant level goal (MCLG)** The level of a contaminant at which there would be no risk to human health. This goal is not always economically or technologically feasible, and the goal is not legally enforceable.

**Maximum probable flood** See Flood, maximum probable.

**Meander** The winding of a stream channel.

**Meander amplitude** Distance between points of maximum curvature of successive meanders of opposite phase in a direction normal to the general course of the meander belt, measured between centerlines of channels.

**Meander belt** Area between lines drawn tangential to the extreme limits of fully developed meanders.

**Meander breadth** The distance between the lines used to define the meander belt.

**Meander length** Distance in the general course of the meanders between corresponding points of successive meanders of the same phase. Twice the distance between successive points of inflection of the meander wave.

**Meandering stream** One that follows its natural course, creating winding curves.

**Medical waste** Any solid waste generated in the diagnosis, treatment, or immunization of human beings or animals; in research pertaining thereto; or in the production or testing of biologicals, excluding hazardous waste identified or listed under 40 CFR Part 261 or any household waste as defined in 40 CFR Subsection 261.4(b)(1).

**Meromictic lake** A lake in which some water remains partly or wholly unmixed with the main water mass at circulation periods is said to be meromictic. The process leading to a meromictic state is termed meromixis. The perennially stagnant deep layer of a meromictic lake is called the monimolimnion. The part of a meromictic lake in which free circulation can occur is called the

mixolimnion. The boundary between the monimolimnion and the mixolimnion is called the chemocline.

**Mesotrophic** The term describes reservoirs and lakes that contain moderate quantities of nutrients and are moderately productive in terms of aquatic animal and plant life.

**Metal mining sector** Metal mining facilities that fall within Standard Industrial Classification Code 10 and must report to the Toxics Release Inventory in accordance with Section 313 of the Emergency Planning and Community Right-to-Know Act.

**Microorganisms** Tiny living organisms that can be seen only with the aid of a microscope. Some microorganisms can cause acute health problems when consumed in drinking water. Also known as microbes.

**Mineralization** Most nitrogen exists in biosolids/manure as organic-N, principally contained in proteins, nucleic acids, amines, and other cellular material. These complex molecules must be broken apart through biological degradation for nitrogen to become available to crops. The conversion of organic-N to inorganic-N forms is called mineralization.

**Mining water use** Water use during quarrying rocks and extracting minerals from the land.

**Mobile source** A term used to describe a wide variety of vehicles, engines, and equipment that generate air pollution and that move, or can be moved, from place to place. "On-road" sources are vehicles used on roads to transport passengers or freight. "Nonroad" sources include vehicles, engines, and equipment used for construction, agriculture, transportation, recreation, and many other purposes.

**Moisture** Water diffused in the atmosphere or the ground.

**Moisture equivalent** The ratio of (1) the weight of water which the soil, after saturation, will retain against a centrifugal force 1,000 times the force of gravity to (2) the weight of the soil when dry. The ratio is stated as a percentage.

**Monitoring** Testing that water systems must perform to detect and measure contaminants. A water system that does not follow the US EPA's monitoring methodology or schedule is in violation and may be subject to legal action.

**Mudflow** A well-mixed mass of water and alluvium which, because of its high viscosity and low fluidity as compared with water, moves at a much slower rate, usually piling up and spreading over the fan like a sheet of wet mortar or concrete.

**Municipal solid waste** Waste from homes, institutions, and commercial sources consisting of everyday items such as product packaging, grass clippings, furniture, clothing, bottles and cans, food scraps, newspapers, appliances, consumer electronics, and batteries. (Excluded from this category are municipal wastewater-treatment sludge, industrial process wastes, automobile bodies, combustion ash, and construction and demolition debris.)

**Municipal water system** A water system that has at least five service connections or which regularly serves 25 individuals for 60 days, also called a public water system.

**Narrative criteria** Nonnumeric descriptions of desirable or undesirable water quality conditions.

**National ambient air quality standards (NAAQS)** Standards established by the US EPA that apply to outdoor air throughout the country. The Clean Air Act established two types of national air quality standards. Primary standards set limits to protect public health, including the health of "sensitive" populations such as asthmatics, children, and the elderly. Secondary standards set limits to protect public welfare, including protection against decreased visibility and damage to animals, crops, vegetation, and buildings. The US EPA has set NAAQS for the six criteria pollutants.

- National indicator** An ROE indicator for which nationally consistent data are available and which helps to answer an ROE question at a national scale. Some national indicators also present data broken down by US EPA region. (See ROE indicator.)
- National pollutant discharge elimination system (NPDES) permit** The regulatory agency document issued by either a federal or state agency that is designed to control all discharges of pollutants from point sources into US waterways. The NPDES permits regulate discharges into navigable waters from all point sources of pollution, including industries, municipal water and wastewater-treatment plants, power plants, sanitary landfills, large agricultural feedlots, and return irrigation flows.
- National priorities list (NPL)** The US EPA's list of the most serious uncontrolled or abandoned hazardous waste sites identified for possible long-term remedial action under Superfund. (See Superfund.)
- National Water Quality Inventory** A report the US EPA prepares every 2 years summarizing information from states about the quality of the nation's waters.
- Natural source** A term used in this report to describe any air emission source of natural origin. Examples include volcanoes, wild fires, windblown dust, and releases due to biological processes (see Biogenic source).
- Nephelometric turbidity unit (NTU)** Unit of measure for the turbidity of water. Essentially, a measure of the cloudiness of water as measured by a nephelometer. Turbidity is based on the amount of light that is reflected off particles in the water.
- NGVD** National Geodetic Vertical Datum. (1) As corrected in 1929, a vertical control measure used as a reference for establishing varying elevations. (2) Elevation datum plane previously used by the Federal Emergency Management Agency (FEMA) for the determination of flood elevations. FEMA currently uses the North American Vertical Datum Plane.
- NGVD of 1929** National Geodetic Vertical Datum of 1929. A geodetic datum derived from a general adjustment of the first-order level nets of the United States and Canada. It was formerly called "Sea Level Datum of 1929" or "mean sea level" in the USGS series of reports. Although the datum was derived from the average sea level over a period of many years at 26 tide stations along the Atlantic, Gulf of Mexico, and Pacific Coasts, it does not necessarily represent local mean sea level at any particular place.
- Nitrogen** Nutrient that is essential to plants and animals.
- Nonindigenous species** A species that has been introduced by human action, either intentionally or by accident, into an area outside its natural geographic range, also called an alien, exotic, introduced, or nonnative species. Certain nonindigenous species are considered "invasive." (See Invasive species.)
- Nonpoint source** Diffuse pollution source; a source without a single point of origin or not introduced into a receiving stream from a specific outlet. The pollutants are generally carried off the land by rainfall or snowmelt moving over and through the ground and carrying natural and human-made contaminants into lakes, rivers, streams, wetlands, estuaries, other coastal waters, and groundwater. Common nonpoint sources are agriculture, forestry, urban areas, mining, construction, dams, channels, land disposal, saltwater intrusion, and city streets.
- Nonpoint-source (NPS) pollution** Pollution discharged over a wide land area, not from one specific location. These are forms of diffuse pollution caused by sediments, nutrients, and organic and toxic substances originating from land-use activities, which are carried to lakes and streams by surface runoff. Nonpoint-source pollution is contamination that occurs when rainwater, snowmelt, or irrigation washes off plowed fields, city streets, or suburban backyards. As this runoff moves across the land surface, it picks up soil particles and pollutants, such as nutrients and pesticides.

**Nonproduction-related waste** Waste that is not production related, for example, waste associated with catastrophic events and cleanup actions. Toxic chemicals in nonproduction-related waste must be reported to the Toxics Release Inventory (see Toxics Release Inventory).

**Nonpublic water system** A water system that does not provide water for human consumption through at least 15 service connections, or regularly serve at least 25 individuals, for at least 60 days per year.

**Non-transient noncommunity water system** A type of public water system that supplies water to 25 or more of the same people at least 6 months per year in places other than their residences. Some examples are schools, factories, office buildings, and hospitals that have their own water systems. (See Public water system.)

**Normal** A central value (such as arithmetic average or median) of annual quantities for a 30-year period ending with an even 10-year, thus 1921–1950, 1931–1960, and so forth. This definition accords with that recommended by the Subcommittee on Hydrology of the Federal Interagency Committee on Water Resources.

**Numeric criteria** Numeric descriptions of desirable or undesirable water quality conditions.

**Nutrients** (1) Nutrients are elements required for plant growth that provide biosolids with most of their economic value. These include nitrogen (N), phosphorus (P), potassium (K), calcium (Ca), magnesium (Mg), sodium (Na), sulfur (S), boron (B), copper (Cu), iron (Fe), manganese (Mn), molybdenum (Mo), and zinc (Zn). (2) Any substance assimilated by living things that promotes growth. (3) Substances necessary for the growth of all living things, such as nitrogen, carbon, potassium, and phosphorus. Too many nutrients in waterbodies can contribute to algal blooms. The term is generally applied to nitrogen and phosphorus but is also applied to other essential and trace elements.

**Oil and gas production waste** Gas and oil drilling mud, oil production brines, and other wastes associated with exploration for, or development and production of, crude oil or natural gas.

**On-site treatment** See Treatment.

**Open channel flow** Flow of water or a liquid with its surface exposed to the atmosphere. The conduit may be an open channel or a closed conduit flowing partly full.

**Organic contaminants** Carbon-based chemicals, such as solvents and pesticides, which can get into water through runoff from cropland or discharge from factories. The US EPA has set legal limits on 56 organic contaminants.

**Organic matter** Plant and animal residues or substances made by living organisms. All are based upon carbon compounds.

**Osmosis** The movement of water molecules through a thin membrane. The osmosis process occurs in our bodies and is also one method of desalinating saline water.

**Outfall** The place where a sewer, drain, or stream discharges; the outlet or structure through which reclaimed water or treated effluent is finally discharged to a receiving waterbody.

**Overland flow** The flow of rainwater or snowmelt over the land surface toward stream channels. After it enters a stream, it becomes runoff.

**Oxygen demand** The need for molecular oxygen to meet the needs of biological and chemical processes in water. Even though very little oxygen will dissolve in water, it is extremely important in biological and chemical processes.

**Ozone depletion** Destruction of the stratospheric ozone layer, which shields the Earth from ultraviolet radiation harmful to life. This destruction of ozone is caused by the breakdown of certain chlorine- and/or bromine-containing compounds (chlorofluorocarbons or halons). These compounds break down when they reach the stratosphere and then catalytically destroy ozone molecules.

- Ozone-depleting substance** Any compound that contributes to stratospheric ozone depletion (see Ozone depletion).
- Partial-duration flood series** A list of all flood peaks that exceed a chosen base stage or discharge, regardless of the number of peaks occurring in a year. (Also called basic-stage flood series or floods above a base.)
- Particle size** The diameter, in millimeters, of suspended sediment or bed material. Particle-size classifications are (1) clay = 0.00024–0.004 mm, (2) silt = 0.004–0.062 mm, (3) sand = 0.062–2.0 mm, and (4) gravel = 2.0–64.0 mm.
- Particulates** Small pieces of material (such as sand) floating in the water.
- Pasture** Land on which animals feed directly on feed crops such as legumes, grasses, or grain stubble.
- Pathogen** (1) A disease-causing organism or (2) a disease-producing agent, usually applied to a living organism. Generally, any viruses, bacteria, or fungi that cause disease.
- Peak flow** The maximum instantaneous discharge of a stream or river at a given location. It usually occurs at or near the time of maximum stage.
- Per capita use** The average amount of water used per person during a standard time period, generally per day.
- Percolation** (1) The movement of water through the openings in rock or soil; (2) the entrance of a portion of the streamflow into the channel materials to contribute to groundwater replenishment; (3) the movement, under hydrostatic pressure, of water through the interstices of a rock or soil, except the movement through large openings such as caves.
- Percolation, deep** In irrigation or farming practice, the amount of water that passes below the root zone of the crop or vegetation.
- Permeability** The ability of a material to allow the passage of a liquid, such as water through rocks. Permeable materials, such as gravel and sand, allow water to move quickly through them, whereas unpermeable material, such as clay, don't allow water to flow freely.
- Pervious surface** A surface which allows water to soak into it.
- pH** (1) A measure of the degree of acidity or alkalinity of a substance. (2) A symbol for expressing the degree to which a solution is acidic or basic. It is based on a scale from 0 (very acid) to 14 (very basic). Water with a pH of 7 is neutral; lower pH levels indicate increasing acidity, while pH levels higher than 7 indicate increasingly basic solutions. The pH of biosolids is often raised with alkaline materials to reduce pathogen content and attraction of disease-spreading organisms (vectors). High pH (greater than 11) kills virtually all pathogens and reduces the solubility, biological availability, and mobility of most metals. Lime also increases the gaseous loss (volatilization) of the ammonia form of nitrogen (ammonia-N), thus reducing the N-fertilizer value of biosolids.
- Phosphorus** A nutrient that is essential to plants and animals.
- Photosynthesis** The conversion of light energy to chemical energy. At night, this process reverses: plants and algae suck oxygen out of the water.
- Plant available nitrogen (PAN)** Only a portion of the total nitrogen present in biosolids/manure is available for plant uptake. This plant available nitrogen (PAN) is the actual amount of N in the biosolids/manure that is available to crops during a specified period.
- Planting and harvesting periods** The cycle of crop planting and harvesting periods, not the calendar year, dictates the timing of biosolids and manure land application activities. Winter wheat and perennial forage grasses are examples of crops that may be established and harvested in different calendar years.



**Planting season** The basic time management unit is often called the crop year or planting season. The crop year is defined as the year in which a crop receiving the biosolids/manure treatment is harvested.

**Point source** A stationary location or fixed facility from which pollutants are discharged; any single identifiable source of pollution, such as a pipe, ditch, ship, ore pit, or factory smokestack.

**Point-source pollution** Water pollution coming from a single point, such as a sewage-outflow pipe.

**Pollutant** (1) A contaminant in a concentration or amount that adversely alters the physical, chemical, or biological properties of the natural environment. (2) Any substance introduced into the environment that may adversely affect the usefulness of a resource or the health of humans, animals, or ecosystems. For most environmental media, this term is commonly understood to refer to substances introduced by human activities. In the case of air, the convention is to include substances emitted from natural sources as well (see Air pollutant).

**Pollutant concentration limits (PCL)** Pollutant concentration limits are the maximum concentrations of heavy metals for biosolids whose trace element pollutant additions do not require tracking (i.e., calculation of CPLR (cumulative pollutant loading rate)). PCL are the most stringent pollutant limits included in US Federal Regulation Part 503 for land application. Biosolids meeting pollutant concentration limits are subject to fewer requirements than biosolids meeting ceiling concentration limits.

**Polychlorinated biphenyls (PCBs)** A group of synthetic, toxic industrial chemical compounds once used in making paint and electrical transformers, which are chemically inert and not biodegradable. PCBs were frequently found in industrial wastes, and subsequently found their way into surface and groundwaters. As a result of their persistence, they tend to accumulate in the environment. In terms of streams and rivers, PCBs are drawn to sediment, to which they attach and can remain virtually indefinitely. Although virtually banned in 1979 with the passage of the Toxic Substances Control Act, they continue to appear in the flesh of fish and other animals.

**Pondage** Small-scale storage at a waterpower plant to equalize daily or weekly fluctuations in riverflow or to permit irregular hourly use of the water for power generation to accord with fluctuations in load.

**Pool** (1) A deep reach of a stream. (2) In streams, a relatively deep area with low velocity; in ecological systems, the supply of an element or compound, such as exchangeable or weatherable cations or adsorbed sulfate, in a defined component of the ecosystem. The reach of a stream between two riffles. Natural streams often consist of a succession of pools and riffles.

**Pool-riffle ratio** The ratio of stream surface area covering pools to stream surface area covering riffles in a given segment of stream.

**Population** In ecology, a group of interbreeding organisms occupying a particular space. In other contexts, including human health, this term generally refers to the number of humans living in a designated area.

**Porosity** A measure of the water-bearing capacity of subsurface rock. With respect to water movement, it is not just the total magnitude of porosity that is important, but the size of the voids and the extent to which they are interconnected, as the pores in a formation may be open, or interconnected, or closed and isolated. For example, clay may have a very high porosity with respect to potential water content, but it constitutes a poor medium as an aquifer because the pores are usually so small.

**Potable water** Water of a quality suitable for drinking.

**Potential evapotranspiration** Water loss that will occur if at no time there is a deficiency of water in the soil for use of vegetation.

**Potential natural water loss** The water loss during years when the annual precipitation greatly exceeds the average water loss. It represents the approximate upper limit to water loss under the type and density of vegetation native to a basin, actual conditions of moisture supply, and other basin characteristics, whereas potential evapotranspiration represents the hypothetical condition of no deficiency of water in the soil at any time for use of the type and density of vegetation that would develop.

**Potential rate of evaporation** See Evaporativity.

**Precipitation** (1) Precipitation includes rain, snow, hail, sleet, dew, and frost. (2) As used in hydrology, precipitation is the discharge of water, in liquid or solid state, out of the atmosphere, generally upon a land or water surface. It is the common process by which atmospheric water becomes surface or subsurface water. The term "precipitation" is also commonly used to designate the quantity of water that is precipitated. Precipitation includes rainfall, snow, hail, and sleet and is therefore a more general term than rainfall.

**Precursor** In photochemistry, any compound antecedent to a pollutant. For example, volatile organic compounds (VOCs) and nitrogen oxides react in sunlight to form ozone or other photochemical oxidants. As such, VOCs and nitrogen oxides are precursors.

**Preparer** Either the person who generates sewage sludge during the treatment of domestic sewage in a treatment work or the person who derives a material from sewage sludge.

**Primacy state** A state that has the responsibility and authority to administer the US EPA's drinking water regulations within its borders. The state must have rules at least as stringent as the US EPA's.

**Primary pollutant** Any pollutant that is emitted into the atmosphere directly from its source and that retains the same chemical form. An example of a primary pollutant is dust that blows into the air from a landfill.

**Primary wastewater treatment** The first stage of the wastewater-treatment process where mechanical methods, such as filters and scrapers, are used to remove pollutants. Solid material in sewage also settles out in this process.

**Prior appropriation doctrine** The system for allocating water to private individuals used in most Western states. The doctrine of prior appropriation was in common use throughout the arid West as early settlers and miners began to develop the land. The prior appropriation doctrine is based on the concept of "First in Time, First in Right." The first person to take a quantity of water and put it to beneficial use has a higher priority of right than a subsequent user. The rights can be lost through nonuse; they can also be sold or transferred apart from the land. Contrasts with riparian water rights.

**Priority chemicals** A set of chemicals, found in the nation's products and wastes, that US EPA targets for voluntary reduction (or recovery and recycling if they cannot be eliminated or reduced at the source).

**Production-related waste** The sum of a facility's production-related on-site waste releases, on-site waste management (recycling, treatment, and combustion for energy recovery), and off-site transfers for disposal, treatment, recycling, or energy recovery. Toxic chemicals in production-related waste must be reported to the Toxics Release Inventory (see Toxics Release Inventory).

**Public contact site** Land with a high potential for contact by the public, including public parks, ball fields, cemeteries, nurseries, turf farms, and golf courses.

**Public notification** An advisory that the US EPA requires a water system to distribute to affected consumers when the system has violated MCLs or other regulations. The notice advises consumers what precautions, if any, they should take to protect their health.

**Public supply** Water withdrawn by public governments and agencies, such as a county water department, and by private companies that is then delivered to users. Public suppliers provide

water for domestic, commercial, thermoelectric power, industrial, and public water users. Most people's household water is delivered by a public water supplier. The systems have at least 15 service connections (such as households, businesses, or schools) or regularly serve at least 25 individuals daily for at least 60 days out of the year.

**Public water system (PWS)** A system that provides water for human consumption through at least 15 service connections, or regularly serves at least 25 individuals, for at least 60 days per year. Public water systems are divided into three categories (see Community water system, Non-transient noncommunity water system, and Transient noncommunity water system). Examples of public water systems include municipal water companies, homeowner associations, schools, businesses, campgrounds, and shopping malls. There are more than 170,000 PWSs providing water from wells, rivers and other sources to about 250 million Americans.

**Public water use** Water supplied from a public water supply and used for such purposes as firefighting, street washing, and municipal parks and swimming pools.

**Radioactive waste** Waste containing substances that emit ionizing radiation. Radioactive waste is classified by regulation according to its source and/or content. The types of waste that are typically considered "radioactive waste" include high-level waste, low-level waste, mixed low-level waste, transuranic waste (i.e., elements heavier than uranium), and certain wastes from the extraction and processing of uranium or thorium ore. Spent nuclear fuel, which is produced as a result of the controlled nuclear fission process in nuclear reactors, is considered a nuclear material rather than radioactive waste.

**Radionuclides** Any man-made or natural element that emits radiation and that may cause cancer after many years of exposure through drinking water.

**Rain** Liquid precipitation.

**Rainfall** The quantity of water that falls as rain only. Not synonymous with precipitation.

**Rainfall excess** The volume of rainfall available for direct runoff. It is equal to the total rainfall minus interception, depression storage, and absorption.

**Rainfall, excessive** Rainfall in which the rate of fall is greater than certain adopted limits, chosen with regard to the normal precipitation (excluding snow) of a given place or area. In the US Weather Bureau, it is defined, for states along the southern Atlantic coast and the Gulf coast, as rainfall in which the depth of precipitation is 0.90 in. at the end of 30 min and 1.50 in. at the end of an hour and, for the rest of the country, as rainfall in which the depth of precipitation at the end of each of the same periods is 0.50 in. and 0.80 in., respectively.

**Rangeland** Open land with indigenous vegetation.

**Rating curve** A drawn curve showing the relation between gage height and discharge of a stream at a given gaging station.

**Raw water** Water in its natural state, prior to any treatment for drinking.

**RCRA cleanup baseline** A priority subset of the universe of facilities that are subject to cleanup under the Resource Conservation and Recovery Act (RCRA) due to past or current treatment, storage, or disposal of hazardous wastes and that have historical releases of contamination.

**RCRA hazardous waste** A national regulatory designation for certain wastes under the Resource Conservation and Recovery Act (RCRA). Some wastes are given this designation because they are specifically listed on one of four RCRA hazardous waste lists (see <http://www.epa.gov/epaoswer/osw/hazwaste.htm>). Other wastes receive this designation because they exhibit at least one of four characteristics which are ignitability, corrosivity, reactivity, or toxicity.

- Reach** (1) The length of channel uniform with respect to discharge, depth, area, and slope. (2) The length of a channel for which a single gage affords a satisfactory measure of the stage and discharge. (3) The length of a river between two gaging stations. (4) More generally, any length of a river.
- Reaeration** The rate at which oxygen is absorbed back into water. This is dependent, among other things, upon turbulence intensity and the water depth.
- Receiving waters** A river, lake, ocean, stream, or other bodies of water into which wastewater or treated effluent is discharged.
- Recession curve** A hydrograph showing the decreasing rate of runoff following a period of rain or snowmelt. Since direct runoff and base runoff recede at different rates, separate curves, called direct runoff recession curves or base runoff recession curves, are generally drawn. The term “depletion curve” in the sense of base runoff recession is not recommended.
- Recharge** Water added to an aquifer. For instance, rainfall that seeps into the ground.
- Reclaimed wastewater** Treated wastewater that can be used for beneficial purposes, such as irrigating certain plants.
- Reclamation site** Drastically disturbed land, such as strip mines and construction sites, that is reclaimed using sewage sludge.
- Recurrence interval (return period)** The average interval of time within which the given flood will be equaled or exceeded once.
- Recycled water** Water that is used more than one time before it passes back into the natural hydrologic system.
- Regime** “Regime theory” is a theory of the forming of channels in material carried by the streams. As used in this sense, the word “regime” applies only to streams that make at least part of their boundaries from their transported load and part of their transported load from their boundaries, carrying out the process at different places and times in any one stream in a balanced or alternating manner that prevents unlimited growth or removal of boundaries. A stream, river, or canal of this type is called a “regime stream, river, or canal.” A regime channel is said to be “in regime” when it has achieved average equilibrium; that is, the average values of the quantities that constitute regime do not show a definite trend over a considerable period—generally of the order of a decade. In unspecialized use “regime” and “regimen” are synonyms. Regimen of a stream. The system or order characteristic of a stream; in other words, its habits with respect to velocity and volume, form of and changes in channel, capacity to transport sediment, and amount of material supplied for transportation. The term is also applied to a stream which has reached an equilibrium between corrosion and deposition or, in other words, to a graded stream.
- Regional indicator** An ROE indicator that helps to answer an ROE question on a smaller-than-national geographic scale. A regional indicator may cover a topic for which nationally consistent data are unavailable, or it may present an issue that is of particular concern within a certain geographic area. (See ROE indicator.)
- Regulation** The artificial manipulation of the flow of a stream.
- Remedial action** The actual construction or cleanup phase of a site cleanup.
- Remote sensing** (1) The analysis and interpretation of images gathered through techniques that do not require direct contact with the subject. (2) A discipline that evolved from photogrammetry, remote sensing of the Earth’s resources uses aerial or space photographs, electronic scanners, and other devices to collect data about the Earth’s surface and subsurface.
- Report on the environment (ROE)** A US EPA report which presents the best available indicators of information on national conditions and trends in air, water, land, human health, and ecological

systems that address all questions US EPA considers mission critical to protecting our environment and human health.

**Reregulating reservoirs** A reservoir for reducing diurnal fluctuations resulting from the operation of an upstream reservoir for power production.

**Reservoir** A pond, lake, or basin, either natural or artificial, for the storage, regulation, and control of water.

**Residual-mass curve** A graph of the cumulative departures from a given reference such as the arithmetic average, generally as ordinate, plotted against time or date, as abscissa. (See Mass curve.)

**Respiration** The biological oxidation of organic carbon with concomitant reduction of external oxidant and the production of energy. In aerobic respiration,  $O_2$  is reduced to  $CO_2$ . Anaerobic respiration processes utilize  $NO_3^-$  (denitrification),  $SO_4^{2-}$  (sulfate reduction), or  $CO_2$  (methanogenesis).

**Restoration** An activity returning a wetland from a disturbed or altered condition with lesser acreage or functions to a previous condition with greater wetland acreage or functions. For example, restoration might involve the plugging of a drainage ditch to restore the hydrology to an area that was a wetland before the installation of the drainage ditch.

**Retarding reservoir** Ungated reservoir for temporary storage of floodwater. Sometimes called detention reservoir.

**Return flow** (1) That part of a diverted flow that is not consumptively used and returned to its original source or another body of water. (2) (Irrigation) Drainage water from irrigated farmlands that reenters the water system to be used further downstream.

**Return flow (irrigation)** (1) Irrigation water that is applied to an area and which is not consumed in evaporation or transpiration and returns to a surface stream or aquifer; (2) that part of irrigation water that is not consumed by evapotranspiration and that returns to its source or another body of water. The term is also applied to the water that is discharged from industrial plants. Also called return water.

**Reverse osmosis** (1) (Desalination) The process of removing salts from water using a membrane. With reverse osmosis, the product water passes through a fine membrane that the salts are unable to pass through, while the salt waste (brine) is removed and disposed. This process differs from electrodialysis, where the salts are extracted from the feedwater by using a membrane with an electrical current to separate the ions. The positive ions go through one membrane, while the negative ions flow through a different membrane, leaving the end product of freshwater. (2) (Water quality) An advanced method of water or wastewater treatment that relies on a semipermeable membrane to separate waters from pollutants. An external force is used to reverse the normal osmotic process resulting in the solvent moving from a solution of higher concentration to one of lower concentration.

**Riffle** (1) A rapid in a stream; (2) a shallow section in a stream where water is breaking over rocks or other partially submerged organic debris and producing surface agitation.

**Riparian** (1) Areas next to or substantially influenced by water; (2) pertaining to the banks of a stream. These may include areas adjacent to rivers, lakes, or estuaries. These areas often include wetlands.

**Riparian water rights** The rights of an owner whose land abuts water. They differ from state to state and often depend on whether the water is a river, lake, or ocean. The doctrine of riparian rights is an old one, having its origins in English common law. Specifically, persons who own land adjacent to a stream have the right to make reasonable use of the stream. Riparian users of a stream share the

streamflow among themselves, and the concept of priority of use (prior appropriation doctrine) is not applicable. Riparian rights cannot be sold or transferred for use on non-riparian land.

**Risk** A measure of the chance that damage to life, health, property, or the environment will occur.

**Risk assessment** A methodology used to examine all possible risks involved with a particular product or organism. Risk assessment can be divided into four parts: identification of hazards, dose response (how much exposure causes particular problems such as cancer, convulsions, and death), exposure assessment (determining how much exposure will be received by people during particular activities), and risk characterization (determining a probability that a risk will occur).

**Risk factor** A characteristic (e.g., race, sex, age, obesity) or variable (e.g., smoking, occupational exposure level) associated with increased probability of an adverse effect.

**River** A natural stream of water of considerable volume, larger than a brook or creek.

**River morphology** Study of the evolution and configuration of river.

**ROE** See Report on the Environment.

**ROE indicator** An indicator that meets the ROE criteria and has been peer reviewed. (See Indicator.)

**Runoff** That part of the precipitation, such as snowmelt, or irrigation water that appears in uncontrolled surface streams, drains, or sewers. It is the same as streamflow unaffected by artificial diversions, storage, or other works of man in or on the stream channels. Runoff may be classified as follows: (1) classification as to speed of appearance after rainfall or snowmelting, direct runoff or base runoff, and (2) classification as to source, surface runoff (see Overland flow), storm seepage (storm inter), or groundwater runoff (see Stream, gaining). It can collect pollutants from air or land and carry them to streams and other waterbodies. Also defined as the depth to which a drainage area would be covered if all of the runoff for a given period of time were uniformly distributed over it.

**Runout** See Water yield.

**Saline water** Water that contains significant amounts of dissolved solids. Here are our parameters for saline water: freshwater, less than 1,000 ppm; slightly saline water, from 1,000 to 3,000 ppm; moderately saline water, from 3,000 to 10,000 ppm; and highly saline water, from 10,000 to 35,000 ppm Note: 1ppm=1 mg/L.

**Sample** The water that is analyzed for the presence of the US EPA-regulated drinking water contaminants. Depending on the regulation, the US EPA requires water systems and states to take samples from source water, from water leaving the treatment facility, or from the taps of selected consumers.

**Sanitary survey** An on-site review of the water sources, facilities, equipment, operation, and maintenance of a public water systems for the purpose of evaluating the adequacy of the facilities for producing and distributing safe drinking water.

**Secchi disk** A black-and-white disk used to measure the clarity of water. The disk is lowered into the water until it cannot be seen and then the depth of the disk is measured.

**Secondary Drinking Water Standards** Non-enforceable federal guidelines regarding cosmetic effects (such as tooth or skin discoloration) or aesthetic effects (such as taste, odor, or color) of drinking water.

**Secondary pollutant** Any pollutant that is formed by atmospheric reactions of precursor or primary emissions. An example of a secondary pollutant is ground-level ozone, which forms from chemical reactions involving airborne nitrogen oxides, airborne volatile organic compounds, and sunlight.

**Secondary wastewater treatment** Treatment (following primary wastewater treatment) involving the biological process of reducing suspended, colloidal, and dissolved organic matter in effluent from primary treatment systems and which generally removes 80–95 % of the Biochemical Oxygen Demand (BOD) and suspended matter. Secondary wastewater treatment may be accomplished by

biological or chemical-physical methods. Activated sludge and trickling filters are two of the most common means of secondary treatment. It is accomplished by bringing together waste, bacteria, and oxygen in trickling filters or in the activated sludge process. This treatment removes floating and settleable solids and about 90 % of the oxygen-demanding substances and suspended solids.

Disinfection is the final stage of secondary treatment.

**Second-foot** Same as cfs, or cubic foot per second. This term is no longer used in published reports of the US Geological Survey.

**Sediment** (1) Fragmental material that originates from weathering of rocks and is transported by, suspended in, or deposited by water or air or is accumulated in beds by other natural agencies.

(2) Usually applied to material in suspension in water or recently deposited from suspension. In its plural form the word is applied to all kinds of deposits from the waters of streams, lakes, or seas.

**Sediment discharge** The rate at which dry weight of sediment passes a section of a stream or refers to the quantity of sediment, as measured by dry weight or by volume, that is discharged in a given time.

**Sedimentary rock** Rock formed of sediment and specifically (1) sandstone and shale formed of fragments of other rock transported from their sources and deposited in water and (2) rocks formed by or from secretions of organisms, such as most limestone. Many sedimentary rocks show distinct layering, which is the result of different types of sediments being deposited in succession.

**Sedimentation tanks or basins** Wastewater tanks/basins in which floating scums are skimmed off and settled solids are removed for disposal.

**Seepage** (1) The slow movement of water through small cracks, pores, interstices, etc., of a material into or out of a body of surface or subsurface water. (2) The loss of water by infiltration into the soil from a canal, ditches, laterals, watercourse, reservoir, storage facilities, or other bodies of water or from a field.

**Seiche** The free oscillation of the bulk of water in a lake and the motion caused by it on the surface of the lake.

**Self-supplied water** Water withdrawn from a surface- or groundwater source by a user rather than being obtained from a public supply. An example would be homeowners getting their water from their own well.

**Septage** Septage means the liquid and solid materials pumped from a septic tank, cesspool, or similar domestic sewage treatment system or holding tank when the system is cleaned or maintained.

**Septic system** A system that treats and disposes of household wastewater under the ground.

**Septic tank** A tank used to detain domestic wastes to allow the settling of solids prior to distribution to a leach field for soil absorption. Septic tanks are used when a sewer line is not available to carry them to a treatment plant. A settling tank in which settled sludge is in immediate contact with sewage flowing through the tank, and wherein solids are decomposed by anaerobic bacterial action.

**Settling pond (water quality)** An open lagoon into which wastewater contaminated with solid pollutants is placed and allowed to stand. The solid pollutants suspended in the water sink to the bottom of the lagoon and the liquid is allowed to overflow out of the enclosure.

**Sewage sludge** The solid, semisolid, or liquid residue generated during the treatment of domestic sewage in a treatment works. Sewage sludge includes, but is not limited to, domestic septage, scum, and solids removed during primary, secondary, or advanced wastewater-treatment processes. The definition of sewage sludge also includes a material derived from sewage sludge (i.e., sewage sludge whose quality is changed either through further treatment or through mixing with other materials).

**Sewage sludge** A semisolid residue from any of a number of air- or water-treatment processes. When treated and processed, sewage sludge becomes a nutrient-rich organic material called biosolids.

**Sewage treatment plant** A facility designed to receive the wastewater from domestic sources and to remove materials that damage water quality and threaten public health and safety when discharged into receiving streams or bodies of water. The substances removed are classified into four basic areas: (1) greases and fats, (2) solids from human waste and other sources, (3) dissolved pollutants from human waste and decomposition products, and (4) dangerous microorganisms. Most facilities employ a combination of mechanical removal steps and bacterial decomposition to achieve the desired results. Chlorine is often added to discharges from the plants to reduce the danger of spreading disease by the release of pathogenic bacteria.

**Sewer** A system of underground pipes that collect and deliver wastewater to treatment facilities or streams.

**Shifting control** See Control.

**Sinkhole** A depression in the Earth's surface caused by dissolving of underlying limestone, salt, or gypsum. Drainage is provided through underground channels that may be enlarged by the collapse of a cavern roof.

**Site characterization** A location-specific or area-specific survey conducted to characterize physical, chemical, and/or biological attributes of an area; such surveys may be conducted at different times to provide information on how these attributes may change over time.

**Skimming** The diversion of water from a stream or conduit by a shallow overflow used to avoid diversion of sand, silt, or other debris carried as bottom load.

**Snow** A form of precipitation composed of ice crystals.

**Snow course** A line or series of connecting lines along which snow samples are taken at regularly spaced points.

**Snow density** Ratio between the volume of meltwater derived from a sample of snow and the initial volume of the sample. This is numerically equal to the specific gravity of the snow.

**Snow, quality of** The ratio of heat of melting of snow, in calories per gram to the 80 cal per gram for melting pure ice at 0 °C. Percentage by weight which is ice.

**Snowline** The general altitude to which the continuous snow cover of high mountains retreats in summer, chiefly controlled by the depth of the winter snowfall and by the temperature of the summer.

**Snowline, temporary** A line sometimes drawn on a weather map during the winter showing the southern limit of the snow cover.

**Soil moisture (soil water)** Water diffused in the soil, the upper part of the zone of aeration from which water is discharged by the transpiration of plants or by soil evaporation. See Field-moisture capacity and Field-moisture deficiency.

**Sole source aquifer** An aquifer that supplies 50 % or more of the drinking water of an area.

**Solubility** The ability of a chemical (e.g., pollutant) to be dissolved into a solvent (e.g., water column).

**Solute** A substance that is dissolved in another substance, thus forming a solution.

**Solution** A mixture of a solvent and a solute. In some solutions, such as sugar water, the substances mix so thoroughly that the solute cannot be seen. But in other solutions, such as water mixed with dye, the solution is visibly changed.

**Solvent** A substance that dissolves other substances, thus forming a solution. Water dissolves more substances than any other and is known as the "universal solvent."

**Source water** Water in its natural state, prior to any treatment for drinking.

**Specific conductance** A measure of the ability of water to conduct an electrical current as measured using a 1 cm cell and expressed in units of electrical conductance, i.e., Siemens per centimeter at 25 °C.



Specific conductance can be used for approximating the total dissolved solids content of water by testing its capacity to carry an electrical current. In water quality, specific conductance is used in groundwater monitoring as an indication of the presence of ions of chemical substances that may have been released by a leaking landfill or other waste storage or disposal facility. A higher specific conductance in water drawn from downgradient wells when compared to upgradient wells indicates possible contamination from the facility.

**Spray irrigation** (1) A method of land application by which wastewater is sprayed from nozzles onto land. (2) A common irrigation method where water is shot from high-pressure sprayers onto crops. Because water is shot high into the air onto crops, some water is lost to evaporation.

**Spring** A waterbody formed when the side of a hill, a valley bottom, or another excavation intersects a flowing body of groundwater at or below the local water table, below which the subsurface material is saturated with water.

**Stage** The height of a water surface above an established datum plane, also gage height.

**Stage, flood** See Flood stage.

**Stage–capacity curve** A graph showing the relation between the surface elevation of the water in a reservoir, usually plotted as ordinate, against the volume below that elevation, plotted as abscissa.

**Stage–discharge curve (rating curve)** A graph showing the relation between the gage height, usually plotted as ordinate, and the amount of water flowing in a channel, expressed as volume per unit of time, plotted as abscissa.

**Stage–discharge relation** The relation expressed by the stage–discharge curve.

**Stakeholder** Individual or organization that has a stake in the outcome of the watershed plan.

**Stemflow** Rainfall or snowmelt led to the ground down the trunks or stems of plants.

**Storage** (1) Water artificially impounded in surface or underground reservoirs for future use. The term regulation refers to the action of this storage in modifying streamflow. See also Conservation storage, Total storage, Dead storage, and Usable storage. (2) Water naturally detained in a drainage basin, such as groundwater, channel storage, and depression storage. The term “drainage basin storage” or simply “basin storage” is sometimes used to refer collectively to the amount of water in natural storage in a drainage basin.

**Storage ratio** The net available storage divided by the mean flow for 1 year.

**Storage, bank** See Bank storage.

**Storage, conservation** See Conservation storage.

**Storage, dead** See Dead storage.

**Storage, depression** See Depression storage.

**Storage, total** See Total storage.

**Storage, usable** See Usable Storage.

**Storage–required frequency curve** A graph showing the frequency with which storage equal to or greater than selected amounts will be required to maintain selected rates of regulated flow.

**Storm** A disturbance of the ordinary average conditions of the atmosphere which, unless specifically qualified, may include any or all meteorologic disturbances, such as wind, rain, snow, hail, or thunder.

**Storm seepage** That part of precipitation which infiltrates the surface soil and moves toward the streams as ephemeral, shallow, perched groundwater above the main groundwater level. Storm seepage is usually part of the direct runoff.

**Storm sewer** A sewer that carries only surface runoff, street wash, and snowmelt from the land. In a separate sewer system, storm sewers are completely separate from those that carry domestic and commercial wastewater (sanitary sewers).

**Stormflow** See Direct runoff.

**Stratosphere** The layer of the atmosphere that starts about 6–9 miles above the Earth's surface at midlatitudes and lies atop the troposphere. The stratosphere contains small amounts of gaseous ozone, which filters out about 99 % of the incoming ultraviolet radiation.

**Stream** A general term for a body of flowing water and natural water course containing water at least part of the year. In hydrology the term is generally applied to the water flowing in a natural channel as distinct from a canal. More generally as in the term stream gaging, it is applied to the water flowing in any channel, natural or artificial. Streams in natural channels may be classified as follows in relation to time: (1) perennial stream, one which flows continuously; (2) intermittent or seasonal stream, one which flows only at certain times of the year when it receives water from springs or from some surface source such as melting snow in mountainous areas; and (3) ephemeral stream, one that flows only in direct response to precipitation and whose channel is at all times above the water table. Streams in natural channels may be classified as follows in relation to space: (1) continuous stream, one that does not have interruptions in space and (2) interrupted stream, one which contains alternating reaches that are either perennial, intermittent, or ephemeral. Streams in natural channels may also be classified as follows in relation to groundwater: (1) gaining stream, a stream or reach of a stream that receives water from the zone of saturation; (2) losing stream, a stream or reach of a stream that contributes water to the zone of saturation; (3) insulated stream, a stream or reach of a stream that neither contributes water to the zone of saturation nor receives water from it—it is separated from the zones of saturation by an impermeable bed; and (4) perched stream, a perched stream is either a losing stream or an insulated stream that is separated from the underlying groundwater by a zone of aeration.

**Stream gaging** The process and art of measuring the depths, areas, velocities, and rates of flow in natural or artificial channels.

**Stream meander** The length of a stream channel from an upstream point to a downstream point divided by the straight line distance between the same two points.

**Stream order** A method of numbering streams as part of a drainage basin network. The smallest unbranched mapped tributary is called first order, the stream receiving the tributary is called second order, and so on. It is usually necessary to specify the scale of the map used. A first-order stream on a 1:62,500 map may be a third-order stream on a 1:12,000 map. Tributaries which have no branches are designated as the first order, streams which receive only first-order tributaries are of the second order, larger branches which receive only first-order and second-order tributaries are designated third order, and so on, the main stream being always of the highest order.

**Streamflow** (1) The water discharge that occurs in a natural channel. (2) A more general term than runoff, streamflow may be applied to discharge whether or not it is affected by diversion or regulation. The discharge that occurs in a natural channel. Although the term discharge can be applied to the flow of a canal, the word streamflow uniquely describes the discharge in a surface stream course.

**Streamflow depletion** The amount of water that flows into a valley or onto a particular land area minus the water that flows out the valley or off from the particular land area.

**Stream-gaging station** A gaging station where a record of discharge of a stream is obtained. Within the Geological Survey, this term is used only for those gaging stations where a continuous record of discharge is obtained.

**Stressor** A physical, chemical, or biological entity that can induce adverse effects on ecosystems or human health.

- Submeander** Small meander contained with banks of main channel, associated with relatively low discharges.
- Subsidence** A dropping of the land surface as a result of groundwater being pumped. Cracks and fissures can appear in the land. Subsidence is virtually an irreversible process.
- Subsurface runoff** See Storm seepage.
- Superfund** A program, operated under the legislative authority of the Comprehensive Environmental Response, Compensation, and Liability Act and the Superfund Amendments and Reauthorization Act, that funds and carries out the US EPA solid waste emergency and long-term removal and remedial activities. These activities include establishing the National Priorities List, investigating sites for inclusion on the list, determining their priority, and conducting and/or supervising cleanup and other remedial actions. (See National Priorities List.)
- Supplemental irrigation** Commonly, irrigation as carried on in humid areas. The term means that the irrigation water is supplementary to the natural rainfall rather than being the primary source of moisture as in the arid and semiarid West. Supplementary irrigation is used generally to prevent retardation of growth during periods of drought.
- Supplemental sources** When irrigation water supplies are obtained from more than one source, the source furnishing the principal supply is commonly designated the primary source, and the sources furnishing the additional supplies, the supplemental sources.
- Surface runoff** That part of the runoff which travels over the soil surface to the nearest stream channel. It is also defined as that part of the runoff of a drainage basin that has not passed beneath the surface since precipitation. The terms groundwater runoff and surface runoff are classifications according to source. The terms base runoff and direct runoff are time classifications of runoff.
- Surface tension** The attraction of molecules to each other on a liquid's surface. Thus, a barrier is created between the air and the liquid.
- Surface water** (1) Water on the surface of the Earth such as in a stream, river, lake, or reservoir. (2) The water that systems pump and treat from sources open to the atmosphere, such as rivers, lakes, and reservoirs.
- Suspended sediment** Very fine soil particles that remain in suspension in water for a considerable period of time without contact with the bottom. Such material remains in suspension due to the upward components of turbulence and currents and/or by suspension.
- Suspended solids** Solids that are not in true solution and that can be removed by filtration. Such suspended solids usually contribute directly to turbidity. Defined in waste management, these are small particles of solid pollutants that resist separation by conventional methods.
- Suspended-sediment concentration** The ratio of the mass of dry sediment in a water-sediment mixture to the mass of the water-sediment mixture. Typically expressed in milligrams of dry sediment per liter of water-sediment mixture.
- Suspended-sediment discharge** The quantity of suspended sediment passing a point in a stream over a specified period of time. When expressed in tons per day, it is computed by multiplying water discharge (in cubic feet per second) by the suspended-sediment concentration (in milligrams per liter) and by the factor 0.0027.
- Terrace** A berm or discontinuous segments of a berm, in a valley at some height above the flood plain, representing a former abandoned flood plain of the stream.
- Tertiary wastewater treatment** Selected biological, physical, and chemical separation processes to remove organic and inorganic substances that resist conventional treatment practices; the additional treatment of effluent beyond that of primary and secondary treatment methods to obtain a very high quality of effluent. The complete wastewater-treatment process typically involves a three-phase

process: (1) First, in the primary wastewater-treatment process, which incorporates physical aspects, untreated water is passed through a series of screens to remove solid wastes; (2) second, in the secondary wastewater-treatment process, typically involving biological and chemical processes, screened wastewater is then passed a series of holding and aeration tanks and ponds; and (3) third, the tertiary wastewater-treatment process consists of flocculation basins, clarifiers, filters, and chlorine basins or ozone or ultraviolet radiation processes.

**Thermal pollution** A reduction in water quality caused by increasing its temperature often due to disposal of waste heat from industrial or power generation processes. Thermally polluted water can harm the environment because plants and animals can have a hard time adapting to it.

**Thermal stratification (of a lake)** Vertical temperature stratification that shows the following: the upper layer of the lake, known as the epilimnion, in which the water temperature is virtually uniform; a stratum next below, known as the thermocline, in which there is a marked drop in temperature per unit of depth; and the lowermost region or stratum, known as the hypolimnion, in which the temperature from its upper limit to the bottom is nearly uniform.

**Thermocline** See Thermal stratification.

**Thermoelectric power water use** Water used in the process of the generation of thermoelectric power. Power plants that burn coal and oil are examples of thermoelectric-power facilities.

**Threatened waterbody** A waterbody that is meeting standards but exhibits a declining trend in water quality such that it will likely exceed standards.

**Throughfall** In a vegetated area, the precipitation that falls directly to the ground or the rainwater or snowmelt that drops from twigs or leaves.

**Time of concentration** The time required for water to flow from the farthest point on the watershed to the gaging station.

**TMDL process** The approach normally used to develop a TMDL for a particular waterbody or watershed. This process consists of five activities, including selection of the pollutant to consider, estimation of the waterbody's assimilative capacity, estimation of the pollution from all sources to the waterbody, predictive analysis of pollution in the waterbody and determination of total allowable pollution load, and allocation of the allowable pollution among the different pollution sources in a manner that water quality standards are achieved.

**Total Kjeldahl nitrogen (TKN)** TKN is the summation of ammonium nitrogen ( $\text{NH}_4^+\text{-N}$ ) and organic nitrogen (organic-N).

**Total maximum daily load (TMDL)** (1) The amount, or load, of a specific pollutant that a waterbody can assimilate and still meet the water quality standard for its designated use. (2) An estimate of the pollutant concentrations resulting from the pollutant loadings from all sources to a waterbody. The TMDL is used to determine the allowable loads and provides the basis for establishing or modifying controls on pollutant sources. For impaired waterbodies the TMDL reduces the overall load by allocating the load among current pollutant loads (from point and nonpoint sources), background or natural loads, a margin of safety, and sometimes an allocation for future growth.

**Total nitrogen** It is the summation of ammonium nitrogen ( $\text{NH}_4^+\text{-N}$ ), nitrate nitrogen ( $\text{NO}_3^-\text{-N}$ ), nitrite nitrogen ( $\text{NO}_2^-\text{-N}$ ), and organic nitrogen (organic-N). Usually nitrite nitrogen is in negligible amount. Crops directly utilize nitrogen in its inorganic forms, principally nitrate-N and ammonium-N.

**Total solids (TS)** Total solids (TS) include suspended and dissolved solids and are usually expressed as the concentration present in biosolids. TS depend on the type of wastewater process and biosolids' treatment prior to land application. Typical solids contents of various biosolids are liquid (2–12 %), dewatered (12–30 %), and dried or composted (50 %).

- Total storage** The volume of a reservoir below the maximum controllable level including dead storage.
- Toxic chemical** A chemical that can produce injury if inhaled, swallowed, or absorbed through the skin.
- Toxics release inventory (TRI)** A database containing detailed information on nearly 650 chemicals and chemical categories that over 23,000 industrial and other facilities manage through disposal or other releases, recycling, combustion for energy recovery, or treatment.
- Toxics release inventory (TRI) chemicals** The chemicals and chemical categories that appear on the current TRI toxic chemical list. As of December 2007, the TRI toxic chemical list contains 581 individually listed chemicals and 30 chemical categories (including three delimited categories containing 58 chemicals). The list of TRI chemicals is available at <http://www.epa.gov/tri/chemical/index.htm>.
- Toxics release inventory (TRI) facilities** The facilities that are required by Section 313 of the Emergency Planning and Community Right-to-Know Act to report to the TRI. In the 2005 reporting year, approximately 23,500 facilities reported to the TRI.
- Trace elements** Trace elements are found in low concentrations in biosolids. The trace elements of interest in biosolids are those commonly referred to as “heavy metals.”
- Transient noncommunity water system** A water system which provides water in a place such as a gas station or campground where people do not remain for long periods of time. These systems do not have to test or treat their water for contaminants which pose long-term health risks because fewer than 25 people drink the water over a long period. They still must test their water for microbes and several chemicals.
- Transmissibility (groundwater)** The capacity of a rock to transmit water under pressure. The coefficient of transmissibility is the rate of flow of water, at the prevailing water temperature, in gallons per day, through a vertical strip of the aquifer 1 ft wide, extending the full saturated height of the aquifer under a hydraulic gradient of 100 %. A hydraulic gradient of 100 % means a 1 ft (0.3048 m) drop in head in 1 ft (0.3048 m) of flow distance.
- Transpiration** (1) The quantity of water absorbed and transpired and used directly in the building of plant tissue, in a specified time. (2) Process by which water that is absorbed by plants, usually through the roots, is evaporated into the atmosphere from the plant surface, such as leaf pores. (See Evapotranspiration). It does not include soil evaporation. The process by which water vapor escapes from the living plant, principally the leaves, and enters the atmosphere. As considered practically, transpiration also includes guttation.
- Treatment** Any process that changes the physical, chemical, or biological character of a waste to make it less of an environmental threat. Treatment can neutralize the waste, recover energy or material resources from it, render it less hazardous, or make it safer to transport, store, or dispose of.
- Treatment technique (TT)** A required process intended to reduce the level of a contaminant in drinking water.
- Treatment works** Federally owned, publicly owned, or privately owned device or system used to treat (including recycle or reclaim) either domestic sewage or a combination of domestic sewage and industrial waste of a liquid nature.
- Treatment works treating domestic sewage** A POTW (publicly owned treatment works) or other sewage sludge or wastewater-treatment system or device, regardless of ownership used in the storage, treatment, recycling, and reclamation of municipal or domestic sewage, including land dedicated for the disposal of sewage sludge.

- Trend** A statistical term referring to the direction or rate of increase or decrease in magnitude of the individual members of a time series of data when random fluctuations of individual members are disregarded.
- Tributary** A smaller river or stream that flows into a larger river or stream. Usually, a number of smaller tributaries merge to form a river.
- Trophic state** The state of nutrition (e.g., amount of nutrients) in a body of water.
- Troposphere** The layer of the atmosphere closest to the Earth's surface. The troposphere extends from the surface up to about 6–9 miles.
- Turbidity** (1) The cloudy appearance of water caused by the presence of tiny particles. High levels of turbidity may interfere with proper water treatment and monitoring. (2) The amount of solid particles that are suspended in water and that cause light rays shining through the water to scatter. Thus, turbidity makes the water cloudy or even opaque in extreme cases. Turbidity is measured in nephelometric turbidity units (NTU). (3) A measure of the degree of clarity of a solution. For cloudy water, turbidity would be high; for clear water, turbidity would be low.
- Underflow** The downstream flow of water through the permeable deposits that underlie a stream and that are more or less limited by rocks of low permeability.
- Underground injection or well injection** The technology of placing fluids underground in porous formations of rocks, through wells or other conveyance systems. The fluids may be water, wastewater, or water mixed with chemicals. Regulations for disposing of waste this way vary depending on type of waste. RCRA hazardous waste is placed in highly regulated (Class 1) wells.
- Unit hydrograph** The hydrograph of direct runoff from a storm uniformly distributed over the drainage basin during a specified unit of time; the hydrograph is reduced in vertical scale to correspond to a volume of runoff of 1 in. from the drainage basin.
- Unit nitrogen fertilizer rate (UNFR)** UNFR is a rate in lb-N per unit crop yield, where the unit can be either bushel or ton. [Note: 1 bu (US bushel) = 1.2444 ft<sup>3</sup>, 1 British bushel = 1.2843 ft<sup>3</sup>, 1 t (British ton) = 2,000 lb, 1 T (metric ton or mt) = 1,000 kg].
- Unsaturated zone** The zone immediately below the land surface where the pores contain both water and air, but are not totally saturated with water. These zones differ from an aquifer, where the pores are saturated with water.
- Upland** Any area that does not qualify as wetland because the associated hydrologic regime is not sufficiently wet to elicit development of vegetation, soil, and/or hydrologic characteristics associated with wetlands or is defined as open waters.
- Urbanization** The concentration of development in relatively small areas (cities and suburbs). The US Census Bureau defines "urban" as referring to areas with more than 1.5 people per acre.
- Usable storage** The volume normally available for release from a reservoir below the stage of the maximum controllable level.
- Variance** State or the US EPA permission not to meet a certain drinking water standard. The water system must prove that (1) it cannot meet a MCL, even while using the best available treatment method, because of the characteristics of the raw water, and (2) the variance will not create an unreasonable risk to public health. The state or the US EPA must review, and allow public comment on, a variance every 3 years. States can also grant variances to water systems that serve small populations and which prove that they are unable to afford the required treatment, an alternative water source, or otherwise comply with the standard.
- Vector attraction** Characteristics (e.g., odor) that attract birds, insects, and other animals that are capable of transmitting infectious agents.

- Vectors** Vectors include rodents, birds, insects that can transport pathogens away from the land application site.
- Violation** A failure to meet any state or federal drinking water regulation.
- Volatile solids (VS)** Volatile solids (VS) provide an estimate of the readily decomposable organic matter in biosolids and are usually expressed as a percentage of total solids. VS are an important determinant of potential odor problems at land application sites.
- Volatilization** Ammonium-N in biosolids/manure can be significant, making up even half the initial PAN of biosolids/manure. The ammonium-N of biosolids/manure can vary widely depending on treatment and storage. Since ammonium-N is prone to volatilization (as ammonia gas,  $\text{NH}_3$ ), the application method affects PAN. For instance, surface applied biosolids are expected to lose half of their ammonium-N. Conversely, direct subsurface injection or soil incorporation of biosolids within 24 h minimizes volatilization losses. The conversion of ammonium-N to ammonia gas form ( $\text{NH}_3$ ) is called volatilization.
- Vulnerability assessment** An evaluation of drinking water source quality and its vulnerability to contamination by pathogens and toxic chemicals.
- Wadeable stream** A stream, creek, or small river that is shallow enough to be sampled using methods that involve wading into the water. Wadeable streams typically include waters classified as first through fourth order in the Strahler Stream Order Classification system.
- Wastewater** Water that has been used in homes, industries, and businesses that is not for reuse unless it is treated.
- Wastewater-treatment return flow** Water returned to the environment by wastewater-treatment facilities.
- Water balance** See Hydrologic budget.
- Water conservation** Promotion of the efficient use of water through the economically or socially beneficial lessening of water withdrawals, water use, or wastewater reduction. Conservation can forestall future water supply capacity needs and can be implemented on water supply as well as on water demand. It can consist of both temporary and permanent measures for improvement of both water quantity and water quality.
- Water content of snow** See Water equivalent of snow.
- Water crop** See Water yield.
- Water cycle** The circuit of water movement from the oceans to the atmosphere and to the Earth and return to the atmosphere through various stages or processes such as precipitation, interception, runoff, infiltration, percolation, storage, evaporation, and transportation.
- Water equivalent of snow** Amount of water that would be obtained if the snow should be completely melted. Water content may be merely the amount of liquid water in the snow at the time of observation.
- Water loss** The difference between the average precipitation over a drainage basin and the water yield from the basin for a given period. The basic concept is that water loss is equal to evapotranspiration, that is, water that returns to the atmosphere and thus is no longer available for use. However, the term is also applied to differences between measured inflow and outflow even where part of the difference may be seepage.
- Water quality** A term used to describe the chemical, physical, and biological characteristics of water, usually in respect to its suitability for a particular purpose.
- Water quality standard (WQS)** The combination of a designated use and the maximum concentration of a pollutant which will protect that use for any given body of water. For example, in a trout stream, the concentration of iron should not exceed 1 mg/L.

**Water quality standards** Standards that set the goals, pollution limits, and protection requirements for each waterbody. These standards are composed of designated (beneficial) uses, numeric and narrative criteria, and anti-degradation policies and procedures.

**Water requirement** The quantity of water, regardless of its source, required by a crop in a given period of time, for its normal growth under field conditions. It includes surface evaporation and other economically unavoidable wastes.

**Water table** (1) The top of the water surface in the saturated part of an aquifer; (2) the upper surface of a zone of saturation; (3) the boundary between the saturated and unsaturated zones. Generally, the level to which water will rise in a well (except artesian wells).

**Water use** Water that is used for a specific purpose, such as for domestic use, irrigation, or industrial processing. Water use pertains to human's interaction with and influence on the hydrologic cycle and includes elements, such as water withdrawal from surface- and groundwater sources, water delivery to homes and businesses, consumptive use of water, water released from wastewater-treatment plants, water returned to the environment, and instream uses, such as using water to produce hydroelectric power.

**Water year** In the US Geological Survey reports dealing with surface-water supply, it is the 12-month period, October 1 through September 30. The water year is designated by the calendar year in which it ends and includes 9 of the 12 months. Thus, the year that ended last September 30, 1959, is called the "1959 water year."

**Water yield (water crop or runoff)** The runoff from the drainage basin, including groundwater outflow that appears in the stream plus groundwater outflow that bypasses the gaging station and leaves the basin underground. Water yield is the precipitation minus the evapotranspiration.

**Watershed** (1) A watershed is the area of land where all of the water that is under it or drains off of it goes into the same place at a lower elevation. (2) The land area from which water drains into a stream, river, or reservoir. (3) Land area that drains to a common waterway, such as a stream, lake, estuary, wetland, or ultimately the ocean. (4) The land area that drains water to a particular stream, river, or lake. It is a land feature that can be identified by tracing a line along the highest elevations between two areas on a map, often a ridge. Large watersheds, like the Mississippi River basin, contain thousands of smaller watersheds. (5) The divide separating one drainage basin from another and in the past has been generally used to convey this meaning. However, over the years, the use of the term to signify drainage basin or catchment area has come to predominate, although drainage basin is preferred. Drainage divide, or just divide, is used to denote the boundary between one drainage area and another.

**Watershed approach** A flexible framework for managing water resource quality and quantity within a specified drainage area or watershed. This approach includes stakeholder involvement and management actions supported by sound science and appropriate technology.

**Watershed plan** A document that provides assessment and management information for a geographically defined watershed, including the analyses, actions, participants, and resources related to development and implementation of the plan.

**Watershed protection approach (WPA)** The US EPA's comprehensive approach to managing water resource areas, such as river basins, watersheds, and aquifers. WPA contains four major features: targeting priority problems, stakeholder involvement, integrated solutions, and measuring success.

**Water-treatment plant** A facility designed to receive and treat the raw surface water, raw groundwater, or rainwater for production of drinking water meeting the government's drinking water standards or for production of industrial water meeting the specific industrial water quality standards.



- Watt-hour (Wh)** An electrical energy unit of measure equal to 1 W of power supplied to, or taken from, an electrical circuit steadily for 1 h.
- Well (water)** An artificial excavation put down by any method for the purposes of withdrawing water from the underground aquifers. A bored, drilled, or driven shaft or a dug hole whose depth is greater than the largest surface dimension and whose purpose is to reach underground water supplies or oil or to store or bury fluids below ground.
- Wellhead protection area** The area surrounding a drinking water well or well field which is protected to prevent contamination of the well(s).
- Wetland** (1) An area that is inundated or saturated by surface or groundwater at a frequency and duration sufficient to support, and that under normal circumstances does support, a prevalence of vegetation typically adapted for life in saturated soil conditions. Wetlands generally include swamps, marshes, bogs, and similar areas. (2) An area where water covers the soil or is present either at or near the surface of the soil all year (or at least for periods of time during the year). (3) Those areas that are inundated or saturated by surface or groundwater at a frequency and duration sufficient to support, and that under normal circumstances do support, a prevalence of vegetation typically adapted for life in saturated soil conditions. Wetland generally includes swamps, marshes, bogs and similar areas.
- Width/depth ratio** The width to depth ratio describes a dimension of bankfull channel width to bankfull mean depth. Bankfull discharge is defined as the momentary maximum peak flow which occurs several days a year and is related to the concept of channel-forming flow.
- Width/meander length ratio** The ratio of the average width of a stream or river over a reach divided by the average length over successive cycles of left and right bends of the stream or river.
- Wildlife refuge** An area designated for the protection of wild animals, within which hunting and fishing are either prohibited or strictly controlled.
- Withdrawal** Water removed from a ground- or surface-water source for use.
- Withdrawal use of water** The water removed from the ground or diverted from a stream or lake for use.
- Xeriscaping** A method of landscaping that uses plants that are well adapted to the local area and are drought resistant. Xeriscaping is becoming more popular as a way of saving water at home.
- Yield** (1) It is the crop harvested in the unit of bu/acre or ton/acre. (2) Mass per unit time per unit area.
- Zone of aeration** The zone above the water table. Water in the zone of aeration does not flow into a well.
- Zone of saturation** The zone in which the functional permeable rocks are saturated with water under hydrostatic pressure. Water in the zone of saturation will flow into a well and is called groundwater.

## 8. REFERENCES

1. Wang MHS and Wang LK (1978). Conversion factors for environmental engineers and scientists. Water & Sewage Works. pp. R203–R214
2. Wang LK (1974). Environmental Engineering Glossary. Calspan Corporation, Buffalo, NY, USA. 439 pages
3. Wang LK, Shammass NK, Selke WA, Aulenbach DB (2010). Flotation Technology. Humana Press, Totowa, NJ, USA. pp. 619–665

- Ablation, 41–43, 806, 820
- Absorption, 165, 174, 175, 527, 529, 652, 654, 661, 806, 835, 839
- Acequia, 806
- Acid, 165, 166, 180, 184, 539, 589, 613, 637, 689, 710, 723, 728, 732, 748, 749, 753, 754, 806, 807, 828, 832
- Acid neutralizing capacity (ANC), 806
- Acid rain/acid precipitation, 166, 180, 539, 806
- Acle, Norfolk, England, United Kingdom, 673
- Acute health effect, 806
- Adaptation to climate change, 551–555
- Adaptive management, 238, 254, 269–275
- Advanced ecologically engineered systems (AEES), 684–685, 687, 697, 703–706
- Advantages and disadvantages of biosolids land application, 607–608
- Advantages of constructed wetlands for wastewater treatment, 649–650
- Advisory, 731, 806, 834
- AEES. *See* Advanced Ecologically Engineered Systems (AEES)
- Aeration, 134, 165, 615, 691, 701–703, 706, 707, 840, 841, 843, 849
- Africa, 95, 101, 536, 542, 543, 546–547, 552, 553
- Agricultural and animal waste, 806–807
- Agricultural land, 84, 129, 256, 574, 577, 579, 582, 584–590, 594, 600, 606–607, 624–626, 628, 631, 634, 636, 637, 807, 816, 826  
 application, 571–634, 807  
 application concepts and terminologies, 586–590  
 application for beneficial use, 577–578
- Agriculture, 40, 50, 98, 128, 129, 160, 184–186, 242, 250, 280, 287, 306, 327, 380, 386, 387, 443, 468, 512, 513, 528, 538, 543–544, 549, 551, 552, 583, 600, 637, 806, 829, 830
- Agronomic rate, 574, 582, 587, 589–593, 595, 596, 598, 602, 603, 608, 609, 615, 623–629, 634, 807
- Air pollutant, 807, 814, 818, 823, 832
- Air quality index (AQI), 807
- Air quality system (AQS), 807
- Air toxics, 807, 823
- Algae, 164, 167, 168, 195, 636, 655, 686, 689–691, 694, 695, 702, 706, 710, 716, 717, 742, 746, 751–754, 807, 819, 832
- Algal bloom, 160, 165, 539, 551, 683, 717, 742, 807, 831
- Alkaline, 165, 575, 576, 581, 582, 606, 615, 637, 806, 823, 832
- Alkalinity, 247, 272, 273, 540, 575, 637, 705, 725, 728, 807, 832
- Alluvial fans, 156, 397
- Alluvial river simulation, 340, 353–355
- Alluvium, 272, 806, 807, 823, 829
- Alpha and beta diversities, 203–208
- Alternative regulatory approach to land application of biosolids, 608–613
- Ambient monitoring, 677, 807
- Anabranche, 807, 811
- Anaerobic, 575, 576, 615, 616, 653, 654, 657, 695, 696, 700, 701, 703, 707, 726, 739, 742, 807, 836, 839
- Anaerobic respiration, 836
- Analyses of species requirements, 216–217, 257
- ANC. *See* Acid neutralizing capacity (ANC)
- Anchor ice, 807
- Annual flood, 62–66, 70–73, 75, 79, 82, 412, 807
- Annual flood series, 807
- Annual heat budget, 824
- Annual pollutant loading rate (APLR), 634, 808
- Annual whole sludge application rate, 634, 808
- Antecedent precipitation index, 808
- Anthropogenic, 4, 7, 84, 194, 213, 412, 527–529, 536, 543, 544, 563, 808
- Anticipated crop nitrogen fertilizer rate (CNFR), 596, 635, 814
- Anticipatory Governance, 412, 424–425
- Application of Q-learning, 476, 482
- Appropriation doctrine, 808
- Aquaculture, 649, 687, 689, 691, 710, 715–757, 827  
 living machine system, 747, 808  
 natural and constructed wetland systems, 808  
 water hyacinth system, 746, 808
- Aquatic macro-invertebrates, 193
- Aqueduct, 128–130, 808

- Aquifer, 2, 25, 33, 49, 51, 52, 55, 57, 403–406, 469, 513, 540, 631, 683, 809, 823, 824, 826, 833, 835, 837, 840, 845–848  
     confined, 809  
     unconfined, 809  
 Arcata, California, 673–676  
 Architectural integration, 706  
 Area-capacity curve, 809  
 Area of cropland, 586, 634, 637, 809, 825  
 Area source, 32, 584, 809  
 Arid climate, 37, 809  
 Arid environment, 129, 156  
 Artesian water, 809  
 Artificial recharge, 809  
 Asia, 536, 538, 539, 548–549  
 Assessment of adaptation costs and benefits, 552–553  
 Assessment of river ecosystems, 191–230  
 Atmospheric patterns, 4–6  
 Australia and New Zealand, 550–551  
 Average discharge, 340, 341, 809
- Backwater, 173, 198, 222, 225, 258, 268, 285, 286, 292, 320, 746, 809  
 Bagged sewage sludge, 634, 809  
 Bankfull stage, 809, 871  
 Bank storage, 809, 814, 841  
 Base, 68, 69, 72, 98, 208, 210, 222, 223, 293, 296, 299, 306, 325, 378, 389, 398, 512–514, 517, 591, 651, 692, 807, 809, 816, 821, 823, 831, 835, 837  
     discharge (for peak discharge), 809–810  
     flow, 272, 810  
     runoff, 810, 816, 823, 835, 837  
 Baseline, 215, 271, 294, 810, 835  
 Basic and supplementary units, 803  
 Basic hydrologic data, 810  
 Basic hydrologic information, 810  
 Basic-stage flood series, 810, 831  
 Bedrock, 165, 168, 169, 222, 329, 584, 593, 810  
 Bed sorting and armoring downstream from a dam, 366–367  
 Bellman equation, 473–475  
 Benchmark, 66, 215, 810, 827  
 Benefit(s), 129, 181, 183, 280, 283–285, 290, 291, 296, 299, 300, 306, 307, 309, 312, 330–332, 385, 386, 419, 425, 470, 473, 478, 482, 485, 501, 502, 515, 517, 519, 520, 552–553, 577, 578, 594, 602, 607, 645, 673, 674, 677, 685, 686, 690, 693, 694, 699, 700, 704, 705, 739, 747, 810, 813, 814  
 Benefit maximization, 810  
 Best available technology, 612, 810  
 Bioaccumulative, 810  
 Bioassessment, 195, 213–217  
 Bioavailable, 810
- Biodegradable organic matter removal mechanism, 652–653  
 Biogenic source, 809, 810, 829  
 Biological assemblages, 167–171  
 Biological balance, 810  
 Biological diversity, 201, 215, 691, 810  
 Biomarker, 811  
     of effect, 811  
     of exposure, 811  
     of susceptibility, 811  
 Biomonitoring, 811  
 Bioremediation, 681–710  
 Bioremediation strategies, 684–685  
 Biosolids, 612–616, 618–631, 635–639, 701–704, 721–723, 728, 729, 733, 737, 738, 811, 814, 815, 824, 826, 828, 830, 832, 839, 844, 846  
     application rate scenario, 593–595  
     characteristics, 575–577, 584, 593, 595, 600, 604, 623  
     pretreatment before agricultural land application, 574–575, 606–607  
     production, 574–575, 607, 626  
 Biotic environment, 811  
 Birds and mammals, 173, 194, 266  
 Boundary science, 431  
 Braiding of river channels, 811, 812  
 Bulk sewage sludge, 634, 811
- Calculating biosolids carry-over PAN, 622–623  
 Calculating net primary nutrient crop need, 618–619  
 Calculating nitrogen based agronomic rate, 623–625  
 Calculating potassium fertilizer needs, 628–629  
 Calculating the components of plant available nitrogen (PAN) in biosolids, 619–620  
 Calculating the first year PAN0-1 from biosolids, 621–622  
 Calculating the lime-based agronomic rate for agricultural land application, 628  
 Calculating the nitrogen-based and the phosphorus-based agronomic rates, 626–627  
 Calculating the required land for biosolids application, 625–626  
 Calculation for available mineralized organic nitrogen, 608, 610  
 Capillary action, 440, 811  
 Carbon dioxide (CO<sub>2</sub>), 40, 247, 528, 529, 533, 539, 540, 543–545, 576, 653, 693, 725, 728, 749, 820, 823, 836  
 CASC2D-SED2.2, 448  
 Catchment area, 13, 299, 314, 384, 539, 811, 848  
 Ceiling concentration limits (CCL), 579, 580, 583, 594, 606, 607, 635, 638, 711, 815, 832  
 Cell-cell interfaces, 143  
 Central and South America (Latin America), 550  
 Changes in precipitation pattern, 531–533, 548  
 Channel, 32, 127, 159, 238, 285, 341, 384, 439, 473, 538, 637, 646, 693, 720, 811

- degradation downstream of the Mosul dam in Iraq, 365–366
- storage, 313, 812, 836
- transport capacity relationships, 445–447
- watercourse, 811–812
- Channelization, 181, 209, 210, 250, 812
- Chemocline, 828
- Chezy equation, 136, 139
- Chezy formula, 136
- Chronic health effect, 812
- Classification systems, 16, 215–216, 257, 272
- Class I sludge management facility, 635, 812
- Clean Air Act, 829
- Cleanup, 270, 753, 812, 814, 815, 830, 835, 836, 842
- Clean Water Act (CWA), 578, 636, 647, 677, 692, 718, 812, 813, 815, 816
  - CWA §101, 815
  - CWA §303d, 815
  - CWA §314, 815
  - CWA §319, 815
  - CWA §320, 815
  - CWA §402, 815
  - CWA §404, 815
- Climate, 3, 155, 173, 269, 283, 388, 412, 443, 468, 525, 606, 657, 687, 812
  - change, 4, 155, 177, 269, 283, 412, 468, 525, 822
  - change and sediment yield, 297–299
  - variability, 82, 102, 103, 155, 291, 527, 536, 543, 553, 554
- Climatic year, 812
- Cloudburst, 814
- CND. *See* Crop nitrogen deficit (CND)
- CNFR. *See* Crop nitrogen fertilizer rate (CNFR)
- Coastal ecosystem restoration, 502–519
- Coastal waters, 812, 813, 823, 830
- Coliform, 602, 632–634, 637, 670, 674, 676, 689, 696, 703, 704, 730, 731, 747, 812, 825, 827
- Combined sewer(s), 469, 470, 485–502, 520, 812–813
- Combined sewer overflow (CSO), 485–502, 812–813
- Commercial water use, 813
- Community, 129, 138, 154, 156, 163–165, 168, 171, 172, 174, 175, 177, 178, 180, 183, 187, 191, 194–197, 201, 203, 204, 208, 210, 213–216, 220, 221, 228, 244, 248–251, 257, 266, 267, 272, 273, 309, 331, 400, 416, 417, 423, 542, 545, 594, 607, 635, 646, 648, 649, 673, 674, 677, 678, 685, 688–691, 694, 695, 698, 703, 706–710, 720, 813, 816, 818, 823, 825, 834
- Community water system, 813, 834
- Comparative evaluation of optimal operating rules, 482–485
- Comparison standard, 215
- Compliance, 594, 602, 606, 616, 732, 742, 813, 819
- Concentration time, 813
- Concordant flows, 813, 821
- Condensation, 9, 18, 529, 742, 813
- Condition of ecology, 813
- Confined ground water, 823
- Conservation storage, 474, 813, 841
- Constructed living machine case studies, 703–709
- Constructed wetland, 503, 645, 647–658, 660–670, 673, 677, 684, 692–694, 697, 705, 706, 709, 721, 747, 808, 813
- Construction and demolition, 813, 829
- Consumptive use, 24–31, 406, 482, 813, 818, 847
- Consumptive use, net, 813
- Consumptive waste, 813
- Contaminant, 46, 184, 185, 308, 327, 469, 539, 612, 634, 638, 649, 717, 732, 811, 812, 814, 820, 823, 824, 826–832, 838, 844, 845
- Contaminated land, 814
- Contents, 2, 6, 14, 25, 35, 38, 40, 99, 209, 238, 320, 452, 453, 473, 532, 533, 539, 543, 544, 575, 576, 585, 589–593, 597, 599, 600, 603, 604, 608, 615–618, 621–629, 637, 639, 654, 660, 699, 707, 729, 814, 817, 832–834, 840, 844, 847
- Continuous stream, 841
- Control, 14, 133, 160, 238, 280, 356, 378, 426, 451, 469, 544, 575, 657, 689, 717, 814
- Control volume, 14, 133, 134, 139, 141, 143, 144, 292
- Conversion factors, 489, 618, 626, 759–802
- Converting dry ton of nutrient per Acre to pound of nutrient per Acre, 617–618
- Converting percent content to pound per dry ton, 618
- Converting wet weight pollutant concentrations to dry weight basis, 616
- Conveyance loss, 814
- Coriolis parameter, 142
- Correction factor, 24, 52, 56–58, 130, 131
- Correlation, 4, 7, 8, 38, 42, 55, 60, 62, 83, 85–88, 164, 173, 192, 215, 341, 343, 474, 485, 495, 814
- Correlative estimate, 814
- Cost minimization, 814
- Coupled atmosphere ocean patterns, 5–6
- CPLR. *See* Cumulative pollutant loading rate (CPLR)
- Created wetland, 677, 813
- Criteria pollutants, 718, 814, 829
- Crop
  - group, 586, 592, 635, 769
  - management, 443, 630–634, 814
  - yield, 38, 40, 544, 585, 587, 588, 591, 592, 600, 601, 615, 624, 626, 635, 639, 846
  - year, 587, 589, 596, 597, 622, 623, 635, 638, 814–815, 832
- Crop nitrogen deficit (CND), 595–598, 624, 635, 814
- Crop nitrogen fertilizer rate (CNFR), 595, 596, 618, 619, 624, 635, 814
- Cryology, 815
- Cryptosporidium, 815
- CSO. *See* Combined sewer overflow (CSO)

- Cumulative pollutant loading rate (CPLR), 579, 580, 582, 583, 594, 606, 612–614, 635, 638, 815, 832
- Current meter, 769
- Current planned non-biosolids PAN sources (PAN-plan), 596, 635, 814
- Cycle, 2, 3, 5, 37, 40, 45, 47, 50, 84, 94, 99, 155, 171, 181, 184, 193, 223, 244, 246, 267, 274, 321, 527, 540, 542, 544, 545, 555, 556, 587, 607, 637, 661, 689, 696, 707, 747, 808, 812, 815, 818, 827, 832, 847, 849
- Dead storage, 282, 441, 815, 841
- Debate on climate change, 529
- Dechlorination, 134, 674, 675
- Decision making under uncertainty, 411–433
- Decision theater, 431–432
- Deep uncertainty, 420
- Deleted NPL site, 815
- Dendrohydrology for extending hydrologic data, 102–103
- Denitrification, 615, 616, 654
- Dependable yield,  $n$ -years, 816
- Depletion, 816
- Deposition, 365–366, 446–447
- Depression storage, 12, 13, 17, 45, 439, 440, 452, 816, 835, 841
- Depth averaged shallow water equation, 138, 140, 142–143
- Derived units, 803–807
- Desalination, 816, 837
- Designated use, 635, 816
- Design
  - of constructed wetland systems, 662–669
    - principles, 662
    - procedures, 663–669
    - storm application, 457–461
  - worksheet for determining the agronomic rate, 608
- Direct runoff, 816, 823, 826
- Discharge, 272, 326, 489, 718–719, 816
- Discharge rating curve, 816
- Discounting scheme for optimal average returns, 478
- Discrete Time Optimal Control Algorithm (OPTCON), 489–493, 498–502
- Disinfectant, 816
- Dissipation of energy in flows, 134
- Dissolved oxygen (DO), 165, 247, 248, 271, 539, 719, 720, 725, 726, 729, 730, 745, 816
- Distressed watershed, 636, 816
- Distribution graph, 816
- Distribution hydrograph, 816
- Distribution system, 816
- Disturbances affecting rivers, 250–252
- Diversion, 816
- Diversity Indices, 197–203, 689–691
- Domestic septage, 635, 817
- Domestic water use, 817
- Double-mass curve, 817, 828
- Downstream impacts of flushing, 321–323
- Drainage
  - area, 460, 633, 817
  - basin, 811, 817
  - density, 817
  - divide, 817, 848
- Drawdown, 317–318, 817
- Dredging, 305, 324–326
- Drinking water standards, 817
- Drip, 817
- Drop structure, 817
- Drought, 101, 536–537, 552, 817–818
- Dry excavation, 326
- Duration curve, 818
- Ecological, 162, 169, 188, 189, 192, 194, 195, 201, 239, 255, 257, 258, 263, 265, 267, 269, 273, 419, 478, 504, 507, 515, 542, 554, 646, 677, 685–688, 690–691, 695, 698–700, 703, 704, 706, 710, 818
  - conditions, 163–167, 179, 204, 208, 220, 221, 238, 253, 271, 818, 825
  - connectivity, 818
  - functions of rivers, 160, 171–176, 243
  - pollution, 682–684
  - principles, 221, 697–698
  - processes, 241, 271, 709, 747, 808, 818, 819, 827
  - stresses to river, 176–187
  - system, 47, 240, 250, 330, 689, 697, 699, 810, 818–819, 832, 833
- Ecology, 156, 159–229, 290, 470, 542, 686, 688, 689, 694, 697, 698, 813, 818, 833
- Eco-Park in Burlington, Vermont, USA, 709–710
- Ecoregion, 818
- Eco-restorers, 694–696
- Ecosystem, 160–163, 248
- Effective precipitation, 818
- Efficiency in energy and information, 699
- Effluent, 649, 650, 656, 662, 664–670, 673–676, 683, 687, 692, 693, 695, 696, 702, 704, 706–708, 717, 721–724, 729, 731, 732, 735, 737, 738, 741, 742, 744–747, 809, 831, 835, 838, 843
- Elements of robust decision making, 423–424
- El Monte Sagrado Resort, Taos, New Mexico, USA, 709
- Emergency operation procedures, 604
- Emission factor, 818
- Emission inventory, 818
- Endpoint, 689, 818
- End state, 818
- Energy cycling, 818
- Engineering management, 468, 571–634
- Enhancement, 238, 241, 267, 350, 351, 383, 512, 647, 650, 673–676, 678, 692, 818

- Environmental impacts, 281, 318, 321, 377, 520, 604–605, 684, 717
- Environmental restoration, 704–705
- Ephemeral stream, 826, 841
- Ephemeral waters, 818, 826
- Epilimnion, 819, 843
- Erosion, 40, 144, 160, 246, 292, 340, 416, 437, 538, 605, 819
- Esalen Institute, Big Sur, California, USA, 708
- Estuary, 160, 162, 189, 190, 470, 506, 507, 512–519, 639, 819, 830
- Europe, 97, 98, 177, 187, 312, 321, 417, 533, 535, 536, 538, 539, 542, 544, 547–548, 651, 695
- Eutrophication, 160, 167, 189, 551, 636, 655, 683, 684, 717, 728, 819
- Evaporation, 13, 17–18, 23, 25–31, 38, 45, 94, 98–101, 244, 298, 388, 413, 440, 473, 505, 531, 540, 652, 654, 655, 806, 813, 814, 817, 819, 826, 833, 837, 840, 845, 847
- from land areas, 819
  - opportunity, 819
  - pan, 19, 21, 22, 24, 773
- Evaporativity, 819, 833
- Evapotranspiration, 3, 17–34, 49, 51, 99, 100, 102, 177, 244, 391, 403, 404, 406, 412, 440, 533, 652, 654, 819, 824, 833, 837, 845, 847, 848
- Evapotranspiration potential, 25, 26, 49, 177, 819
- Exceptional quality sewage sludge, 636, 819
- Excessive rainfall, 819, 835
- Exotic species, 171, 180, 187–191, 194, 211, 213
- Exposure, 419, 581, 611, 654, 660, 725, 726, 742, 743, 806, 811, 812, 820, 824, 825, 835, 837
- Extent, 4, 5, 38, 100, 210, 216, 217, 222, 250, 266, 292, 293, 297, 301, 302, 328, 332, 387, 390, 414, 469, 472, 496, 515, 530, 534, 536, 543, 547–549, 554, 703, 733, 810, 820, 833
- Extraction and mining waste, 820
- Extremes matter, 416–419
- Farm field, 25, 29, 586, 589, 591, 595, 608, 635, 636, 814, 820
- Federal Emergency Management Agency (FEMA), 156, 395, 397, 633, 830
- Feed crop, 582, 636, 637, 820, 831
- Fiber crop, 581, 582, 634, 636, 807, 820
- Field capacity, 25, 26, 29–31, 36, 58, 820
- Field-moisture capacity, 820, 840
- Field-moisture deficiency, 820, 840
- Final NPL, 840
- Financial barriers, 554
- Finished water, 820
- Finite element methods, 139, 141, 151
- Finite volume method, 139, 141, 142, 144, 151
- Firm (firm snow), 820
- Firm line, 820
- Fish, 152, 159, 251, 290, 474, 545, 611, 647, 683, 716, 808
- Flax Pond, Harwich, Massachusetts, USA, 704–705
- Floating AEES restorer, 705–706
- Flood, 2, 128, 159, 250, 280, 356, 378, 412, 450, 468, 526, 631, 647, 699, 747, 807
- above a base, 821, 831
  - crest, 820
  - event, 50, 55–57, 64, 76, 79, 96, 141, 311, 315, 317, 328, 330, 331, 821
  - 100-year, 75, 80, 821
  - maximum probable, 821, 828
  - peak, 83, 268, 292, 412, 821, 831
  - plane, 821
  - profile, 821
  - routing, 821
  - stage, 175, 356, 821, 840
  - wave, 821
  - zone, 821
- Flood-control storage, 821
- Flood-frequency curve, 228, 260, 821
- Flood plain, 2, 31, 79, 131, 140, 155, 160, 162, 173, 175, 178, 179, 184, 215, 229, 230, 240, 242–244, 246, 250, 251, 256, 258, 261, 265, 266, 268, 269, 275, 296, 297, 299, 306, 308, 309, 320, 377, 378, 380, 386, 395–399, 416, 417, 450, 551, 584, 593, 631, 633, 646, 692, 709, 807, 812, 821, 843
- geodatabase, 396–397
  - hydraulic modeling with GIS, 397–399
  - management, 395–399
  - mapping requirements, 395–396
- Floodway, 155, 266, 821
- Flow-duration curve, 147, 148, 246, 822
- Flowing well/spring, 822
- Flushing equations, 323–324
- Fly off, 819
- Food crop, 433, 581, 582, 636, 822
- Forest
- influences, 822
  - land, 584, 585, 587, 594, 600, 636, 822
- Fossil fuel combustion, 822
- Frazil, 822
- Frazil ice, 822
- Free-flow flushing, 319–321
- Frequency analysis of hydrologic data, 63–82
- Freshwater, 2, 170, 171, 199, 223, 413, 502, 503, 526, 527, 543, 545–547, 551, 555, 670, 671, 675, 682, 683, 686, 690, 703, 705, 716, 718, 725, 727, 731, 747, 749–751, 754, 816, 822, 823, 836–838
- Function of wetland plants, 655
- Future sedimentation rate and pattern, 295–296
- Fuzzy operating rules, 470, 507–511, 513, 518, 519
- GA for multiobjective optimization, 514–515
- Gage height, 820–821, 835, 840

- Gaging station, 296, 311, 814, 822, 823, 835, 842, 844, 848
- Gaining stream, 841
- Generalized sediment transport, 340, 353–355
- Genetic algorithms, 470, 502–519
- Geographic information system (GIS), 10, 140, 297, 303, 306, 373–377, 448, 451, 452, 822
- analysis functions, 382–384, 390
  - basics, 378–379
  - data development and maintenance, 379–380
  - data for surface water hydrology, 386–390
  - data models and geodatabases, 381–382
  - for floodplain management, 395–399
  - for groundwater modeling, 403–405
  - for surface water hydrology modeling, 390–395
  - software, 381, 385, 386, 390
  - system planning and implementation, 385–386
  - water supply demand forecasting, 400
- Geomorphology, 96, 156, 180, 215, 250, 251, 272, 646, 822
- Geum River Basin, South Korea, 469, 472, 478–485, 519–520
- Geyser, 822
- Giardia lamblia*
- Giardiasis, 822
- GIS. *See* Geographic information system (GIS)
- Glacial and snow fusion methods, 42–45
- Glacial equipment, 45
- Glacier, 2, 40–46, 85, 98–101, 530, 538, 548, 550, 820, 822
- Global climate change, 822
- Glossary
- for water resources engineers, 759–806
  - of land application and watershed protection, 634–639
  - of wetland, 677–678
- Godunov scheme, 143
- Gravity constant, 142
- Gravity force vector, 150
- $\epsilon$ -Greedy actions, 476–477
- Greenhouse gases (CGHs), 40, 414, 527–529, 543, 821
- Green's theorem, 143
- Greywater, 823
- Groundwater, 2, 32, 33, 49, 83, 85, 94, 98–101, 175, 185, 187, 266, 272, 273, 413, 425–427, 429, 430, 448, 468, 469, 513, 539, 542, 546, 549, 555, 593, 604, 611, 630–632, 647, 650, 677, 678, 682, 683, 708, 721, 724, 746, 807–810, 813, 814, 816, 817, 820, 822, 823, 826, 827, 832, 833, 839–842, 847–849
- hydrology, 378, 403–407
  - outflow, 51, 823, 848
  - recharge, 184, 268, 424, 540, 541, 547, 646, 650, 823
  - runoff, 244, 823, 835, 842
- Guilford County School District, California, USA, 708
- Guttation, 823, 845
- Habitat, 155, 159, 238, 290, 422, 468, 544, 646, 688, 717, 823
- diversity, 173, 181, 217–221
  - evaluation and modeling, 217–230
  - modeling, 222–223
- Habitat evaluation procedure (HEP), 192, 216, 221–222, 257
- Halogenated fluorocarbons (HCFCs), 822
- Hardness, 272, 273, 748, 823
- Hazardous air pollutants, 807, 823
- Hazardous waste, 814, 823, 825, 827–829, 835
- Headwater, 91, 169, 243, 244, 263, 394, 455, 538, 823
- Health advisory, 731, 823
- Health-based standards, 824
- Heavy metals, 180, 486, 577, 594, 598, 599, 602, 630, 636, 638, 652, 654, 662, 683, 691, 746, 747, 808, 824, 832, 844
- Heavy metals removal mechanism, 654
- HEP. *See* Habitat evaluation procedure (HEP)
- HIS. *See* Hydrologic information systems (HIS)
- Human factors in water sector, 430–432
- Human-induced stresses, 180–187
- Hydraulic, 14, 127, 160, 244, 280, 340, 380, 439, 469, 645, 693, 734, 824
- engineering, 128, 129, 137, 160, 355–368
  - fracturing, 824
  - jump, 134, 135, 149
  - mixing, 134
- Hydroclimate system, 4, 6, 8, 40
- Hydroclimate system patterns, 4–8
- Hydroclimatology, 2–9
- Hydroelectric power water use, 824
- Hydrofluorocarbons (HFCs), 822
- Hydrograph, 8, 32, 96, 272, 295, 311, 318, 360, 363, 391, 448, 456, 490, 497–499, 534, 816, 824, 835, 846
- Hydrologic budget, 13, 824, 847
- Hydrologic cycle, 2, 3, 40, 45, 47, 50, 84, 94, 244, 527, 555, 556, 824, 851
- Hydrologic data acquisition, 94–103
- Hydrologic data and irrigation demands, 512–513
- Hydrologic equation, 824
- Hydrologic information systems (HIS), 103
- Hydrology, 1–103, 160, 173, 179, 180, 186, 215, 228, 229, 244, 250, 321, 362, 364, 378, 386–395, 403–407, 448, 450, 452, 456–457, 468, 470, 471, 512, 517, 519, 545, 646, 670, 678, 819, 824, 827, 830, 833, 836, 841
- Hydrology of glaciers, 40–45
- Hydrometeorology, 156
- HydroSed2D, 138, 142, 144, 145, 147, 153
- Hyetograph, 12, 500, 824
- Hypolimnion, 824, 843
- Hypoxia, 824–825

- Impaired waterbody, 637, 825, 844
- Impermeable layer, 825
- Impervious surface, 307, 308, 387, 393, 633, 634, 825
- Implementation steps, 330–332
- Increase in temperature, 539, 544, 549, 553, 729
- Independence of its functional requirements, 698–699
- Index, 6, 14, 42–45, 80, 81, 99, 191, 195, 197, 198, 200, 204–206, 208, 209, 211, 212, 214, 217, 218, 220–222, 224, 227, 392, 491, 537, 626, 654, 807, 808, 825
- Index period, 825
- Indicator, 150, 220, 271, 288, 291, 297, 533, 538, 687, 811, 825, 829, 836, 837
  - organism, 637, 825
  - species, 191–196, 208, 257
- Indices of biotic integrity, 208–213
- Individual field unit, 586, 634, 637, 809, 825
- Industrial, 12, 184, 191, 239, 280, 282, 327, 478, 480, 482, 486, 528, 551, 580, 612, 636, 639, 645, 649, 650, 682, 693, 696, 705–706, 709, 719, 813, 817, 822, 825, 829, 833, 834, 837, 843–845, 847, 848
- Industrial and agricultural sectors, 709–710
- Industrial non-hazardous waste, 825
- Industrial water, 480, 482, 825, 848
- Infiltration, 12–17, 33, 34, 37, 38, 40, 45, 51, 54, 55, 57, 94, 180, 185–187, 244, 305–307, 439, 440, 444, 448, 449, 496, 540, 578, 582, 806, 809, 823, 825, 838, 847
  - capacity, 13, 15, 40, 51, 54, 55, 440, 540, 825
  - index, 825
- Inflow and demand data sets, 481–482
- Informational and cognitive barriers, 554–555
- Information systems, 2, 94–103, 377, 385
- Injection well, 825–826, 845
- Inorganic contaminants, 826
- Insulated stream, 841
- Integrated reservoir sizing and operating rule
  - optimization: OPTI6, 504–507
- Interactions across scales and extreme events, 7–8
- Interception, 12–13, 17, 45, 50, 51, 244, 439, 448, 449, 452, 455, 819, 826, 835, 847
- Interception and depression storage, 12–13, 17, 45, 835
- Interfacial flux, 144
- Intermittent, 83, 84, 86, 88, 91, 266, 584, 671, 720, 818, 826, 841
- Intermittent or seasonal stream, 841
- Interrupted stream, 841
- Invasive species, 155, 189, 544, 558, 717, 826, 830
- Inviscid and viscous fluxes, 143
- Irrigated area, 818, 826
- Irrigation, 2, 17, 24–32, 82, 128, 129, 180, 184, 255, 270, 280–282, 286, 319, 321, 330, 356, 403, 406, 505–507, 510, 512, 513, 515, 526, 544, 547, 549–551, 554, 585, 596, 601, 630, 631, 693, 703, 708, 709, 721, 744, 809, 813, 814, 817, 824, 826, 829, 830, 832, 836, 837, 840
  - efficiency, 826
  - requirement, 813, 826
  - supplemental, 470, 504, 520, 826, 842
  - water use, 826
- Isohyet, 826
- Isohyetal line, 826
- Iterative calculation of hydraulic sewer flows, 491–492
- Jordan recurrent ANN architecture, 493–495
- Kinetic energy, 130, 131, 151, 649
- Lag, 40, 55, 84–88, 92, 474, 495, 826
- Lake
  - mescalero unlined emergency spillway, 360–362
  - restorers, 687, 694
- Land application, 571–639, 706, 808, 816, 826, 832, 840, 844, 846
  - costs, 605–606
  - crop management and watershed management, 630–634
  - inspection, monitoring, testing and documentation, 629–630
  - process, 584–586
- Landfill, 528, 600, 612, 613, 650, 704, 705, 827, 829, 834, 840
- Land treatment unit, 827
- Large river systems, 94, 101–102
- Las Vegas Regional Animal Campus, Nevada, USA, 708
- Leaching, 540, 544, 593, 615, 630, 654, 723, 733, 820, 827
- Lentic waters, 172, 208, 827
- Levee, 31, 143, 181, 187, 229, 258, 266, 269, 272, 356, 359, 515, 827
- Limitations in adaptation to the climate changes, 553–555
- Limnology, 827
- Livestock
  - operation, 827
  - water use, 828
- Living machines, 681–710, 747
  - design, 697–670
  - system, 707–709, 747, 827
- Longitudinal sedimentation patterns, 285–286
- Long-period variations, 827
- Losing stream, 841
- Loss of other biosolids treatment units, 604
- Loss of power and/or fuel, 604
- Lotic waters, 172, 827
- Low-flow frequency curve, 515, 827
- Lysimeter, 43, 827



- Machine  
  learning, 467–520  
  learning of optimal regulator control, 492–493
- Macro-bio communities (animal diversity), 689–691
- Macroinvertebrate, 167, 169, 172, 187, 193, 196–207, 214, 217, 218, 220–222, 827
- Maintenance requirements and safety issues, 603
- Management of nitrogen in the soils and biosolids, 613–616
- Manning equation, 136, 139, 222, 257, 355
- Manning's formula, 137, 142, 356
- Manure, 574, 585, 586, 592, 593, 596, 598, 601, 605, 623, 624, 631, 634, 637, 814, 826–828, 832, 846
- Marginal costs, 827
- Mass curve, 828, 836
- Maximum contaminant level (MCL), 731, 812, 817, 819, 828, 834, 846
- Maximum contaminant level goal (MCLG), 828
- Maximum probable flood Meander, 821, 828
- Meander  
  amplitude, 828  
  belt, 828  
  breadth, 828  
  length, 828
- Meandering stream, 308, 828
- Meromictic lake, 828
- Meromixis, 828
- Mesotrophic, 637, 828
- Metal mining sector, 828
- Methane (CH<sub>4</sub>), 528, 543, 576, 653, 732, 746–748, 808, 822
- Methanogenesis, 836
- Metrics of biodiversity, 195–213
- Microbial communities, 646, 648, 688–689, 706
- Microorganisms, 545, 575, 578, 580, 613, 615, 630, 637, 648, 649, 651, 653, 683, 684, 688, 689, 692–695, 701–703, 726, 812, 814–816, 818, 822, 828, 839
- Mineralization, 539, 572, 589, 595, 597, 598, 608, 613, 615, 621, 623, 637, 828
- Minimum energy dissipation rate theory, 351–353, 355, 359, 369
- Mining water use, 828
- Mississippi River Lock and Dam No. 26 Replacement Project, 359–362
- Mixolimnion, 828
- Mobile, 152, 174, 175, 259, 594, 613
- Model calibration, 8, 46, 52, 55–57, 138, 329, 403, 456–457, 469, 496–497, 512
- Modeling of sediment management activities, 328–330
- MODFLOW for rio grande valley, 405–407
- Moisture, 3, 9, 14, 16, 18, 25, 26, 29–40, 45, 57, 94, 98–102, 177, 180, 189, 228–230, 244, 268, 306, 318, 387, 439, 453–455, 532, 533, 536, 543, 544, 546, 549, 557, 559, 578, 581, 588, 589, 603, 604, 616, 619, 702, 723, 735, 806, 808, 819, 820, 826, 829, 833, 842
- Moisture equivalent, 829
- Monimolimnion, 828
- Monitoring, 94, 98, 99, 192, 194, 195, 225, 238, 254, 269–274, 331, 332, 394, 405, 424, 425, 450, 451, 455, 460, 519, 540, 548, 585, 594, 601–602, 606, 629–630, 669–670, 677, 722, 723, 807, 815, 818, 825, 827, 829, 840, 845  
  techniques, 271–273
- Mudflow, 321, 548, 829
- Multi-beam echo-sounder (MBES) bathymetric survey, 145
- Multiobjective optimization model, 480–481
- Multi-reservoir system, 470–485, 519
- Municipal solid waste, 825, 829
- Municipal water system, 829
- Naesung stream model set-up, 451–456
- Naesung stream site description and database, 450–451
- Narrative criteria, 637, 639, 829, 847
- National Ambient Air Quality Standards (NAAQS), 814, 829
- National estuary program (NEP), 815
- National geodetic vertical datum (NGVD), 830  
  of 1929, 830
- National indicator, 829
- National Pollutant Discharge Elimination System (NPDES), 674, 717–719, 732, 815, 829  
  permit, 674, 717–719, 732, 829
- National priorities list (NPL), 815, 820, 829, 842
- National water quality inventory, 684, 829
- Natural open channels, 156
- Natural processes, 266, 306, 529, 646, 692, 694, 699, 806
- Natural source, 699, 810, 829, 832
- Natural stresses, 177–180
- Natural wetland, 645, 647–649, 677, 692, 693, 746–747
- Nephelometric turbidity unit (NTU), 632, 633, 730, 731, 830, 845
- Neural network module, 492–496
- New synergies, 156
- Newton's second law of motion, 133
- NGVD. *See* National geodetic vertical datum (NGVD)
- Nitrogen, 167, 174, 175, 185, 247, 539, 544, 575–578, 587–590, 593–598, 602, 604, 608, 610, 613–630, 634, 635, 637, 638, 646, 648, 652–654, 656, 660, 662, 663, 665, 666, 668, 670, 676, 684, 691, 693, 696, 703, 708, 717, 723–730, 733, 806, 814, 816, 819, 828, 830, 832, 833, 838, 844
- Nitrogen removal mechanism, 653–654
- Nitrous oxide (N<sub>2</sub>O), 528, 615, 654, 822
- Non-indigenous species, 830
- Nonpoint source (NPS), 84, 183–185, 637, 638, 677, 684, 687, 815, 830, 844

- Non-point source (NPS) pollution, 630, 677, 684, 687, 830, 832  
 from land application, 630
- Non-production-related, 830
- Non-public water, 830
- Nonroad sources, 829
- Nonstationarity, 3, 61, 83, 93–94, 420
- Non-transient non-community water system, 830, 834
- Normal, 7, 25, 28, 64–71, 87–90, 142, 143, 155, 165, 187, 204, 287, 291, 292, 310, 315, 317, 318, 325, 419, 430, 480, 484, 495, 498, 603, 612, 630, 648, 678, 726, 728, 809, 813, 828, 830, 835, 837, 847, 848
- North America, 7, 102, 187, 531, 534, 536, 538, 539, 549, 650, 658, 754, 818, 830
- NPDES. *See* National Pollutant Discharge Elimination System (NPDES)
- NPL. *See* National priorities list (NPL)
- NTU. *See* Nephelometric turbidity unit (NTU)
- Numerical modeling, 137–153, 328, 329, 331, 498
- Numerical schemes, 59, 137, 138, 140, 141, 143–144, 149, 151, 490
- Numeric criteria, 637, 830
- Nutrients, 155, 159, 163, 167, 168, 173–175, 179–181, 184–187, 189, 195, 247, 251, 266, 268, 272, 273, 419, 505, 539, 544, 545, 555, 575, 577, 578, 582, 594–596, 600, 602, 604, 607, 613, 617–619, 624, 628, 631–632, 634–637, 646, 647, 650, 654, 655, 658, 660, 661, 670, 674, 683, 684, 688, 693–695, 698, 702, 706, 710, 717, 719, 721, 723, 726, 728, 729, 732, 733, 737, 742, 744, 746, 747, 808, 811, 815, 816, 819, 824, 826, 828–831, 839, 845  
 and micronutrient reservoirs, 691–692  
 management, 574, 586–588, 590–593, 605, 630, 634, 636, 820
- Oberlin College, Ohio, USA, 706
- Ocean system patterns, 6–7
- Oil and gas production, 831
- Old Trail School, Bath, Ohio, USA, 707
- One-dimensional modeling, 138–140
- On-road sources, 828
- Onsite treatment, 831
- Open channel  
 flow, 130, 133, 137–140, 149–153, 156, 831  
 hydraulics, 127–156
- Operational guidelines, 480, 507
- OPTCON. *See* Discrete Time Optimal Control Algorithm (OPTCON)
- Optimal control module, 487–493, 495, 498–500
- Optimal fuzzy rules, 502–519
- OPTI6 results for integrated reservoir sizing and operations, 515–519
- Organic contaminants, 831
- Organic industrial wastewater treatment, 705–706
- Organic matter, 165, 167, 174, 175, 247, 575–578, 582, 602, 605, 613, 652, 653, 656, 726, 727, 818, 831, 838
- Osmosis, 831
- Outfall, 488, 831
- Overland  
 flow, 32, 33, 50–52, 54, 57, 58, 268, 350, 351, 384, 387, 391, 393, 440, 441, 444, 448–450, 457, 496, 831, 837  
 sediment transport capacity relationships, 444–445
- Oxygen, 165, 167, 169, 177, 178, 188, 193, 209, 212, 217, 247, 271, 273, 321, 322, 539, 589, 615, 646, 652–656, 658, 666, 670, 675, 676, 683, 693–696, 701, 704, 717, 719, 720, 725, 726, 730, 745, 747, 807, 816, 817, 824, 827, 831, 832, 835, 838
- Ozone (O<sub>3</sub>), 528, 529, 544, 684, 725, 814, 816, 822, 831, 833, 838, 841, 843
- Ozone depletion, 528, 831
- PAN. *See* Plant available nitrogen (PAN)
- Partial-duration flood series, 831
- Particle, 9, 34, 48, 168, 185, 218, 246, 247, 251, 259, 261, 272, 296, 305, 341, 345–348, 388, 438, 442, 444–447, 449, 452, 453, 455, 529, 611, 632, 633, 655, 690, 722, 723, 733, 734, 737, 738, 741, 743, 747, 807, 812, 819, 822, 830, 831, 843, 845
- Particulates, 653, 654, 693, 703, 723, 736, 831
- Past PAN sources (PAN-past), 635, 814
- Pasture, 30, 50, 161, 266, 306, 512, 529, 551, 574, 584, 600, 604, 637, 675, 831
- Pathogen, 486, 575, 576, 578, 580–582, 590, 602, 606, 607, 629, 631, 652, 684, 689, 691, 695, 729, 831
- Pathogenic bacteria and viruses removal mechanism, 36
- PCL. *See* Pollutant concentration limits (PCL)
- Peak flow, 8, 50, 96, 457, 458, 496, 831
- Per capita use, 423, 433, 831
- Perched stream, 841
- Percolation, 31, 51, 54, 440, 633, 683, 832
- Percolation, deep, 31, 832
- Perennial stream, 584, 841
- Perfluorinated carbons (PFCs), 822
- Performance computers, 137
- Periodic table of the elements, 806
- Permeability, 51, 55, 185, 268, 582, 832
- Pervious surface, 832
- PET. *See* Potential evapotranspiration (PET)
- Phosphorus (P), 167, 174, 175, 221, 222, 247, 572, 573, 575, 577, 578, 582, 595, 599, 603, 605, 626–628, 630–634, 648, 660, 662, 670, 684, 691–693, 704, 705, 716, 717, 723–725, 728, 729, 733, 832

- Photosynthesis, 165, 247, 585, 601, 725, 832  
 Photosynthetic communities, 691  
 Physical constants, 804  
 Pipe network design with GIS, 400–403  
 Planning, 8, 61, 82, 90, 92, 94, 128, 161, 173, 238, 240, 242–244, 252–269, 273, 274, 283, 332, 377, 380, 383, 385–386, 400, 411–433, 468–470, 518, 588, 590–593, 631, 697, 721  
 Plant available nitrogen (PAN), 573, 576, 588, 589, 591–593, 595–598, 608, 619–622, 624, 625, 627, 628, 638, 832  
 Planting and harvesting periods, 587, 638, 832  
 Planting season, 587, 638, 832  
 Point source, 184, 455, 638, 687, 832  
 Point-source pollution, 184, 832  
 Pollutant concentration limits (PCL), 579–580, 582, 594, 598, 607, 612, 638, 832  
 Pollutant removal mechanism, 45  
 Pollution control, 239, 470, 677, 718  
 Polychlorinated biphenyls (PCBs), 682, 683, 7897  
 Pondage, 833  
 Pool-riffle ratio, 272, 273, 833  
 Population, 62, 63, 66, 71, 74, 81, 85, 165, 170–172, 176, 187, 191, 192, 195–198, 210, 216, 217, 221, 223, 250, 253, 273, 283, 299, 322, 377, 403, 414, 420, 421, 426–430, 478, 502, 511, 515, 526, 540, 541, 543, 545, 546, 548, 550, 555, 656, 670, 673, 683–685, 688, 695, 716, 720, 745, 746, 833  
 Porosity, 14, 187, 355, 453, 663, 667, 833  
 Port of Portland, Oregon, USA, 708  
 Potable water, 833  
 Potential evapotranspiration (PET), 25, 26, 49, 177, 537, 833  
 Potential natural water loss, 833  
 Potential rate of evaporation, 819, 833  
 Poultry processing waste in coastal maryland, USA, 705  
 Precipitation, 2, 172, 244, 298, 377, 412, 439, 527, 608, 648, 684, 806  
 Precursor, 833  
 Preparer, 638, 833  
 Pressure flushing for localized sediment scour, 319  
 Pretreatment before land application, 574–575  
 Primacy state, 834  
 Primary pollutant, 834  
 Primary wastewater, 834  
 Prior appropriation doctrine, 834  
 Priority chemicals, 834  
 Process
  - control considerations, 602
  - monitoring, 601–602
  - O&M considerations, 602
 Production-related waste, 834  
 Properties of water, 805–806, 824  
 Public contact site, 574, 638, 834  
 Public notification, 834  
 Public supply, 834  
 Public water, 834  
 Public water system, 834  
 Putrajaya Wetlands, Malaysia, 670–673  
  
 Q-learning method, 469, 475–476, 519  
  
 Radiative forcing, 528–529  
 Radionuclides, 835  
 Rainfall
  - excess, 16, 33, 835
  - excessive, 819, 835
 Raise the Dam, 326–327  
 Range land, 574, 638  
 Rapid bioassessment, 213–214  
 Rating curve, 101, 295, 311–313, 329, 331, 490, 835  
 Raw water, 321, 835  
 Reach, 12, 25, 29, 33, 52, 79, 96, 138, 144–146, 152, 154, 161, 165, 168, 176, 180, 194, 208, 210, 211, 215, 218, 220, 222, 223, 225, 242, 243, 253, 255, 257, 259, 261, 262, 272, 305, 315–318, 332, 343, 352, 355–359, 362, 366, 386, 399, 447, 460, 489, 491, 594, 595, 604, 612, 675, 690, 694, 835  
 Re-aeration, 247, 835  
 Real-time control, 468–470, 485–502, 517, 520  
 Receiving waters, 470, 485–487, 580, 717, 724, 728, 729, 739, 742, 835  
 Recession curve, 835  
 Recharge, 33, 34, 184, 268, 403, 404, 424, 426, 427, 540, 541, 546, 547, 646, 650, 835  
 Reclaimed wastewater, 835  
 Reclamation site, 574, 594, 638, 826, 835  
 Recover, increase or reallocate storage volume, 305, 318–327  
 Rectangular channel, 131, 132, 134, 135  
 Recurrence interval (return period), 63, 835  
 Recycled, 426, 592, 598, 605, 687, 695, 702, 704, 707, 835  
 Reduce sediment production, 305–309  
 Reedbeds, 696–697, 701  
 Regime, 82, 93, 132, 154, 160, 229, 230, 250, 256, 261, 272, 343, 473, 491, 502, 533, 536, 540, 544, 545, 549, 613, 705, 836, 846  
 Regional, 2, 37, 61, 80–82, 100, 203, 204, 212, 272, 283, 293, 297, 302–303, 405, 413, 414, 421, 422, 426, 427, 430, 431, 479, 526, 533, 545, 546, 551, 556, 600, 662, 673  
 Regional analysis, 61, 302–303  
 Regulation, 93, 280, 284, 291, 419, 469–471, 481, 486, 491, 496, 555, 575, 577–584, 591, 594, 600, 602, 605, 611, 612, 616, 626–628, 631, 636, 662, 717–721, 729, 731, 733, 816, 836  
 Reinforcement learning, 469–485

- Relative evaporation, 819
- Remedial action, 836
- Remote sensing, 94, 96, 98–100, 373–407, 448, 541, 836
- Report on the environment (ROE), 836, 837
- Re-regulating reservoirs, 836
- Reservoir
  - construction, 84, 281–283, 301, 328, 416
  - delta formation, 364, 367–368
  - deltas, 286–287
  - sedimentation, 286, 306, 328, 340, 353, 362–365
  - surveys to measure sedimentation, 293–295
  - sustainability, 283–285
  - trap efficiency, 293, 299–300, 329
  - volume loss and reservoir half-life, 290–292
- Residual-mass curve, 836
- Resistance, 33, 130, 135–140, 146, 155, 177, 188, 229, 261, 262, 281, 316, 355, 439, 441, 452, 457, 703
- Resource Conservation and Recovery Act (RCRA), 823, 835, 845
  - cleanup baseline, 835
  - hazardous, 835
- Respiration, 195, 247, 725, 726, 728, 836
- Restoration
  - implementation, 269–274
  - target: flow distribution, 513–514
- Restorers, 687, 688, 692–697, 705–707
- Retarding reservoir, 836
- Return flow, 481, 482, 836
- Reuse of reservoir sediments, 327
- Reverse osmosis, 837
- Reynolds numbers, 149
- Richness and abundance, 195–197
- Riemann problem, 143, 144
- Riffle, 173, 181, 208, 209, 243, 263, 264, 272, 273, 353, 356, 837
- Riparian, 154, 155, 160, 162–164, 167, 173, 174, 179, 181, 182, 186, 192–194, 198–200, 202–204, 206, 208, 215, 227–229, 238, 239, 253, 256, 258, 263, 266–269, 272, 273, 312, 542, 545, 646, 678, 837
- Riparian water rights, 837
- Risk analysis, 140, 420, 552
- Risk assessment, 271, 396, 433, 552, 608, 611–613, 837
- Risk assessment approach to land application of biosolids, 608, 611–613
- River
  - basin modeling, 2, 45–61
  - ecosystems, 159–176, 183, 187, 191–230
  - morphology, 339–369, 837
  - restoration, 237–274
    - design, 257–269
    - planning, 238, 242, 252–269
- ROE indicator, 829, 836
- Roles of wetland plants, 74
- Roughness coefficient, 54, 142, 153, 356, 360, 362, 367, 441, 496, 498
- Route sediments, 305, 309–318
- Routine land application procedures, 603
- Runoff, 8, 160, 244, 296, 339, 377, 415, 440, 469, 526, 575, 647, 684, 718
- Runoff model calibration and validation, 496–497
- Runout, 816, 838
- Saline, 513, 816, 831
- San Francisco Public Utilities Commission Administration Building, California, USA, 708
- Sanitary survey, 838
- Satellite precipitation estimation, 94–96
- Scaling of soil moisture, 38–40
- Scenario planning, 412, 421–423
- Secchi disk, 838
- Secondary drinking water standards, 838
- Secondary wastewater treatment, 838
- Sedimentary rock, 838
- Sediment
  - bulk density, 293, 296, 300–301
  - bypass at onstream reservoirs, 314–315
  - bypass by offstream reservoir, 312–314
  - characteristics, 145, 247, 345
  - discharge, 247, 280, 309–311, 323, 326, 341–344, 355, 451, 457, 460, 838
  - management strategies, 279–332
  - rating relationships, 311–312
  - routing by reservoir drawdown, 317–318
  - transport, 32, 84, 93, 101, 140, 145, 152, 154, 156, 160, 174, 176, 246, 250, 258, 261–263, 292, 295, 298, 301, 318, 323, 326, 328, 329, 331, 339–368, 392, 439, 442, 444, 445, 448–453, 456, 457
  - trapping above the reservoir, 309
  - yield, 50, 280, 293, 295–301, 303–311, 314, 329, 439, 443, 451, 457, 460
  - deposition in the upper Rhone River in Switzerland, 365–366
- Sedimentation
  - assessment for a single reservoir, 301–302
  - impacts above pool elevation, 292
  - impacts below the dam, 292–293
  - impact thresholds, 293
  - processes and impacts, 285–293
  - tanks or basins, 838
- Seepage, 19, 20, 505, 513, 650, 651, 674, 693, 838
- Seiche, 839
- Selection of indicator species, 192
- Selection of wetland plants, 657–662
- Self-supplied, 839
- Sensitivity analysis, 47, 57–58
- Septage, 574, 625, 638, 704, 839
- Septic tank, 574, 667, 684, 695, 839

- Settling pond, 736, 737, 739, 741–743, 839
- Sewage  
 sludge, 572, 574, 575, 577–581, 594, 606, 613, 615, 616, 638, 682, 839  
 treatment, 604, 650, 684, 690, 691, 703–704, 706, 839  
 treatment in cold climates, 703–704
- Shallow water equations, 138, 140, 142–143, 152
- Shifting control, 814, 839
- Shutdown procedures, 604
- Simulation/exploratory modeling, 423
- Sinkhole, 584, 806, 839
- Site-specific situation, 698
- Skimming, 315, 839
- Sluice gate, 134, 318, 491
- Snow course, 839
- Snow density, 840
- Snowline, 42, 840
- Snowline, temporary, 840
- Snowmelt and glacier melt, 45, 100, 538
- Social and cultural barriers, 555
- Soil  
 erosion relationships, 443–444  
 moisture hydrology, 34–40  
 moisture recycling, 37
- Sole source aquifer, 840
- Solution of the Saint Venant Equations (UNSTDY), 490–491
- Sources of climate uncertainty, 413–415
- Source water, 84, 719, 727, 728, 840, 962
- South Burlington, Vermont, USA, 703–704
- Space-borne methods, 96–101
- Spatial elements of river ecosystems, 160–163
- Specific energy, 130–133
- Specific force, 133–135
- Specific momentum, 13–135
- Spray irrigation, 585, 601, 840
- Spring, 174, 178, 179, 530, 534, 549, 550, 587, 594, 721, 795
- Stage-capacity curve, 840
- Stage-discharge curve (rating curve), 840
- Stage-discharge relation, 257, 451, 840
- Stage, flood, 840
- Stakeholder, 59, 238, 253, 257, 274, 412, 421, 422, 427, 430, 431, 433, 468, 698, 840
- Startup Procedures, 603
- Stationarity assumption, 415–416
- Step-by-Step procedures for biosolids application rate determination, 595–600
- Stilling basin, 19, 134, 135
- St. Lucie Estuary, 470, 502, 503, 512–520
- Stochastic methods, 61, 82–94
- Stochastic optimization, 470–485, 519, 520
- Storage, bank, 841
- Storage-required frequency curve, 841
- Storm  
 flow, 33, 179, 841  
 seepage, 841, 842  
 water management, 502–519, 553
- Strain rate tensor, 150
- Stratosphere, 841
- Streamflow, 32, 33, 45, 46, 55, 57, 61, 62, 82–88, 90–94, 96, 101–103, 291, 293, 311, 313, 317, 406, 471, 480–482, 484, 485, 519, 533, 534, 536, 539, 551, 842
- Streamflow depletion, 842
- Stream gaging, 842
- Stream-gaging station, 842
- Stream meander, 308, 842
- Stream order, 257, 842
- Stressor, 213, 255, 842
- Structural modifications, 327
- Submeander, 842
- Subsidence, 413, 842
- Subsurface, 2, 19, 32–34, 36, 38, 48, 96, 101, 165, 185, 260, 289, 290, 439, 453, 585, 590, 593, 600, 601, 639, 648, 650, 651, 655, 666, 673, 693, 703, 707, 708, 825, 833, 836, 838, 840, 842, 846
- Sub-surface flow (SSF) wetland system, 650, 651, 666–669, 673, 693
- Suitability indices, 193, 233–227
- Sulfate reduction, 836
- Superfund, 842
- Supplemental irrigation, 470, 504, 520, 842
- Supplemental sources, 842
- Surface flow (SF) wetland system, 664–669, 693
- Surface runoff, 11, 13, 33, 57, 184, 185, 187, 244, 440–442, 460, 647, 692, 842
- Surface tension, 34, 843
- Surface water, 2, 9–33, 96–99, 101, 175, 185, 244, 288, 289, 386–430, 448, 469, 513, 539, 541, 543, 548, 549, 575, 578, 582, 584, 593, 594, 604, 631, 633, 649, 653, 703, 719, 721, 722, 726, 728, 843
- Surface water hydrology, 2, 9–33, 386–395
- Suspended sediment, 101, 102, 224, 226, 287, 289, 296, 297, 307, 310, 311, 313, 321, 322, 329, 346, 355, 843
- Suspended sediment discharge, 843
- Suspended solids removal mechanism, 653
- Sustainability criteria, 284–285
- Sustainable use of reservoirs, 279–332
- Sustainable water systems, 433
- Tarbela Reservoir Sedimentation Study, 362–365
- Technological limits, 554
- TELEMAC, 142
- Temporal difference learning, 477–478
- Terrace, 162, 246, 266, 272, 316, 843
- Tertiary wastewater, 703, 843
- Testing the neural-optimal control model, 501–502

- Thermal pollution, 555, 843  
 Thermal stratification, 539, 819, 824, 843  
 Thermocline, 289, 843  
 Thermoelectric power water use, 843  
 Threatened waterbody, 638, 843  
 Three-dimensional CFD modeling, 138, 149–153  
 Threshold level of ecosystem, 553–554  
 Throughfall, 12, 843  
 Time of concentration, 813, 844  
 Timewise variation in sediment yield, 297, 310–311  
 TMDL. *See* Total maximum daily load (TMDL)  
 Total loss, 12, 79, 819  
 Total maximum daily load (TMDL), 58, 638, 815, 844  
 Total solids (TS), 575, 639, 721, 723, 735, 844, 846  
 Total storage, 283, 841, 844  
 Total water runoff or crop, 816  
 Toxic chemical, 251, 830, 834, 844, 846  
 Toxics release inventory (TRI), 828, 830, 834, 844  
 Toxics release inventory chemicals, 844  
 Trace elements, 577–580, 594, 595, 598, 606, 607, 611, 612, 635, 638, 639, 691, 692, 824, 831, 832, 844  
 Tracking cumulative pollutant loading rates on land application sites, 613  
 Training and testing of recurrent ANN, 495–496  
 Training the recurrent ANN with optimal gate controls, 500–501  
 Transboundary problems, 541–543  
 Transient non-community water system, 830, 834, 844  
 Transmissibility (ground water), 845  
 Transpiration, 17, 24, 244, 654, 655, 661, 819, 833, 837, 840, 845  
 Transport equation, 145, 150, 261, 262, 297, 321, 329, 348  
 Treatment technique (TT), 817, 820, 845  
 Treatment works, 635, 638, 639, 812, 817, 833, 839, 845  
 Treatment works treating domestic sewage, 845  
 TREX, 448–450  
 Tributary, 98, 101, 162, 173, 183, 204, 313, 314, 316, 322, 366, 543, 811, 817, 842, 845  
 Trophic state, 845  
 TUFLOW, 142  
 Turbid density currents, 285, 287–290, 310, 315–316, 327, 332  
 Turbulence models, 149–151  
 Turbulent eddy viscosity, 150  
 Two dimensional depth averaged modeling, 140, 142, 152  
 Two dimensional model, 140, 144, 152, 156, 328, 398  
 Types of constructed wetlands, 650–651, 693  
 Types of living machines, 692–694  
 Types of wetland plants, 78  
 Tyson Foods at Berlin, Maryland, USA, 707
- Uncertainty analysis, 2, 58–94, 420  
 Unconfined ground water, 823  
 Underflow, 288, 816, 823, 845  
 Underground injection, 845
- Underwater video/image analysis, 145  
 Unit hydrograph, 391, 448, 816, 846  
 Unit nitrogen fertilizer rate (UNFR), 618, 623, 624, 635, 639, 814, 846  
 Unit stream power formula  
   for surface erosion, 349–351  
   for rivers and reservoirs, 343–349  
 Unsaturated zone, 33, 846, 847  
 UNSTDY hydraulic model development, 491, 498  
 Upland, 163, 179, 184, 185, 191, 228, 242, 243, 250, 258, 263, 267, 272, 290, 325, 646, 659, 662, 678, 692, 846  
 Upland erosion, 297, 437–461  
 Uplift pressure, 134  
 Urbanization, 2, 93, 176, 184, 240, 250, 308, 414, 420, 468, 470, 540, 556, 846  
 Usable storage, 841, 846  
 U.S. Army Corps of Engineers, 129, 154, 292, 295, 302, 328, 332, 356, 359, 397, 481, 502, 503  
 U.S. Environmental Protection Agency (US EPA), 214, 332, 489, 490, 574, 576–580, 586, 587, 594, 602, 605, 606, 608–614, 625, 626, 635, 636, 677, 716–718, 722, 729–732, 807, 811, 812, 815, 817, 819, 823, 825, 826, 828, 829, 831, 834, 836, 838, 842, 846, 848  
 User interfaces and interaction modes, 384–385  
 US Federal and State Regulations, 486, 578–584  
 US Marine Corps Recruit Depot, San Diego, California, USA, 708  
 US-Mexico Border, San Diego, California, USA, 707
- Values and purposes, 700  
 Variability of soil moisture, 37–38  
 Variance, 38, 40, 59, 62, 66, 83–86, 88, 89, 92, 171, 632, 633, 657, 846  
 Vector(s), 47, 48, 143, 144, 146, 147, 150, 152, 381–383, 386, 390, 473, 474, 477, 488, 575, 578, 580, 582, 583, 585, 590, 601, 602, 606, 607, 636, 637, 639, 819, 832, 846  
 Vector attraction, 575, 578, 582, 583, 590, 601, 602, 606, 607, 636, 639, 846  
 Vegetation-hydroperiod modeling, 227–230, 257  
 Volatile organic compounds (VOCs), 683, 704, 807, 836, 838  
 Volatile solids (VS), 575, 583, 602, 632, 639, 846  
 Volatilization, 543, 575, 585, 589, 590, 592, 598, 601, 613, 615, 621, 622, 637, 639, 653, 700, 832, 846  
 Vulnerability assessment, 846  
 Vulnerability to extreme events, 419–420
- Wadeable stream, 846  
 Wastewater treatment, 415, 430, 487, 489, 496, 497, 520, 574, 578, 602, 607, 635, 638, 643–678, 684, 690, 696, 697, 703–709, 747–757, 808, 811, 829, 834, 837–839, 843, 845, 847

- Wastewater-treatment return, 8447
- Water
- balance, 8, 17, 45, 49, 184, 185, 542, 565, 847
  - bodies, 17, 18, 100, 160, 251, 382, 486, 539, 593, 650, 683, 685, 702
  - conservation, 307, 331, 556, 677–678, 681–710, 746–757, 762, 808, 847
  - content of snow, 847
  - crop, 847, 848
  - cycle, 50, 99, 244, 246, 540, 847
  - density, 142
  - equivalent of snow, 847
  - loss, 819, 833, 847
  - planning as a social process, 430
  - purification, 134, 654, 686
  - quality, 18, 55, 56, 58, 84, 93, 101, 160, 184, 188, 191, 194, 204, 209, 210, 220, 238, 239, 247, 253, 256, 257, 268, 271, 302, 322, 323, 332, 378, 392, 449, 474, 478, 479, 539–540, 542, 548, 549, 551, 555, 578, 591, 593, 611, 631–639, 647, 649, 669, 670, 677, 684, 690, 692, 693, 704, 718, 719, 721, 722, 724, 725, 729, 745, 815–817, 823, 829, 830, 833, 837, 839, 840, 843, 844, 847, 848
  - quality monitoring, 548, 670
  - reuse, 424, 643–678, 692, 703–709, 746, 747
  - surface profiles, 141, 368, 392
  - table, 17, 179, 512, 588, 809, 823, 840, 841, 847, 849
  - treatment plant, 848
  - use, 280, 323, 400, 403, 420, 423, 424, 426, 433, 480, 481, 543, 551, 556, 719, 732, 813, 817, 824–828, 831, 834, 843, 847
  - vapor, 8, 9, 17, 18, 20–22, 24, 99, 553, 813, 819, 822, 824, 845
  - year, 482, 484, 807, 809, 812, 847
  - yield, 816, 838, 847, 848
- Water Quality Standard (WQS) water requirement, 194, 638, 639, 677, 722, 725, 815, 844, 847
- Water Resources Planning and Management, 411–433, 468, 469
- Water reuse, 424, 643–678, 692, 703–709, 746, 747
- Watershed, 2, 154, 160, 238, 293, 383, 415, 439, 470, 526, 573, 677, 708, 844
- approach, 238, 639, 677, 848
  - model application, 450–461
  - modeling, 48, 59, 98, 306, 308, 391, 448–450
  - plan, 638, 639, 840, 848
  - protection, 630–631, 848
- Watershed Protection Act and distressed Watershed Rules, 631–634
- Watershed protection approach (WPA), 631, 848
- WaterSim: An Example of DMUU, 425, 430
- Watt-hour (Wh), 848
- Wellhead protection area, 848
- Well injection, 845
- West Point Combined Sewer System, Seattle, Washington USA, 496–502
- Wetland, 2, 161, 239, 290, 380, 455, 503, 545, 584, 643, 682, 721, 807
- creation, 677, 692
  - definition, 646, 647functions and values, 646–647
  - monitoring and maintenance, 669–670
  - restoration, 677
  - utilization, 677
- Width/depth, 272, 849
- Width/meander length, 849
- Wildlife refuge, 849
- Withdrawal, 291, 426, 513, 816, 825, 847, 849
- Withdrawal use of water, 849
- Xeriscaping, 849
- Yield, 8, 133, 197, 280, 387, 416, 443, 472, 543, 585, 807
- Zone of aeration, 840, 841, 849
- Zone of saturation, 823, 841, 847, 849