

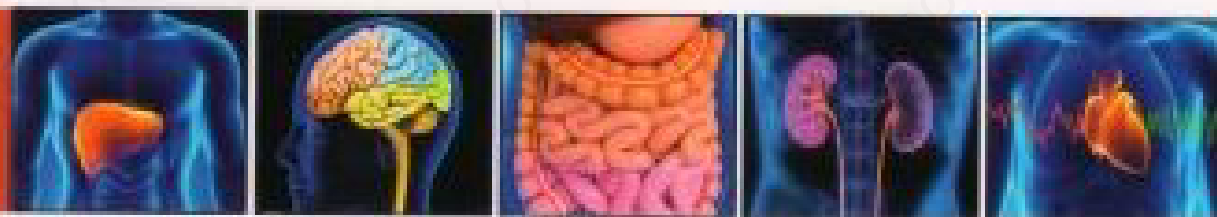

First Physiology Review Book by Subject Specialist
Thoroughly Updated with all Recent and Image-based Questions

Free Online Exam Support: WWW.ACCESSPGMEE.COM

Review of PHYSIOLOGY



*Based on Ganong 25th, Guyton 13th, Berne & Levy 6th updated,
Kandel 5th, Harrison 19th, Harper 30th, Sembulingam 7th
Updated based on latest editions of standard books*

Soumen Manna

2nd Edition

Highlights

- First Physiology book by subject specialist.
- First Physiology book with image-based questions.
- Probable future questions at the end of every chapter.
- Author online support
- Includes color plates of all image-based questions.

Explained Referenced Answers

- All Recent Questions (2016)
- All India (2012–1991)
- AIIMS (Nov 2016–1991)
- AP, JIPMER, Bihar, UPSC CMS, PGM CET (2016)
- Other State Exams (2016–1991)
- Image-based questions

Online support:
Facebook group: Physiology: Dr. Soumen Manna
Website: www.drsoumenmanna.com

A must-buy book for All India, AIIMS, PGI, JIPMER, DNB, FMGE & State entrance exams

Review of Physiology

Second Edition

Soumen Manna

MBBS, MD Physiology (AIIMS)

Assistant Professor

Himalayan Institute of Medical Sciences,
Dehradun, Uttarakhand, India



JAYPEE *The Health Sciences Publisher*

New Delhi | London | Panama



Jaypee Brothers Medical Publishers (P) Ltd

Headquarters

Jaypee Brothers Medical Publishers (P) Ltd.
4838/24, Ansari Road, Daryaganj
New Delhi 110 002, India
Phone: +91-11-43574357
Fax: +91-11-43574314
E-mail: jaypee@jaypeebrothers.com

Overseas Offices

J.P. Medical Ltd.
83, Victoria Street, London
SW1H 0HW (UK)
Phone: +44-20 3170 8910
Fax: +44(0)20 3008 6180
E-mail: info@jpmedpub.com

Jaypee-Highlights Medical Publishers Inc.
City of Knowledge, Bld. 235, 2nd Floor, Clayton
Panama City, Panama
Phone: +1 507-301-0496
Fax: +1 507-301-0499
E-mail: cservice@jphmedical.com

Jaypee Brothers Medical Publishers (P) Ltd.
17/1-B, Babar Road, Block-B, Shaymali
Mohammadpur, Dhaka-1207
Bangladesh
Mobile: +08801912003485
E-mail: jaypeedhaka@gmail.com

Jaypee Brothers Medical Publishers (P) Ltd.
Bhotahity, Kathmandu, Nepal
Phone: +977-9741283608
E-mail: kathmandu@jaypeebrothers.com

Website: www.jaypeebrothers.com
Website: www.jaypeedigital.com

© Digital Version 2018, Jaypee Brothers Medical Publishers

The views and opinions expressed in this book are solely those of the original contributor(s)/author(s) and do not necessarily represent those of editor(s) of the book.

All rights reserved. No part of this publication may be reproduced, stored or transmitted in any form or by any means, electronic, mechanical, photocopying, recording or otherwise, without the prior permission in writing of the publishers.

All brand names and product names used in this book are trade names, service marks, trademarks or registered trademarks of their respective owners. The publisher is not associated with any product or vendor mentioned in this book. Medical knowledge and practice change constantly. This book is designed to provide accurate, authoritative information about the subject matter in question. However, readers are advised to check the most current information available on procedures included and check information from the manufacturer of each product to be administered, to verify the recommended dose, formula, method and duration of administration, adverse effects and contraindications. It is the responsibility of the practitioner to take all appropriate safety precautions. Neither the publisher nor the author(s)/editor(s) assume any liability for any injury and/or damage to persons or property arising from or related to use of material in this book.

This book is sold on the understanding that the publisher is not engaged in providing professional medical services. If such advice or services are required, the services of a competent medical professional should be sought.

Every effort has been made where necessary to contact holders of copyright to obtain permission to reproduce copyright material. If any have been inadvertently overlooked, the publisher will be pleased to make the necessary arrangements at the first opportunity.

Inquiries for bulk sales may be solicited at: jaypee@jaypeebrothers.com

Review of Physiology

Second Edition: **Digital Version 2018**

First Edition: 2016

ISBN: 978-93-86322-37-1

Dedicated to

*My parents, my brother, my wife and my son
for their love and moral support*

Preface to the Second Edition

First edition of this book was published in the last year. During the last one year, I had received many feedbacks in the form of appreciation as well as criticism from many teachers and students. I have tried to incorporate all of their suggestions and corrections in this present edition. I thank them all and hope that I will continue to receive such help in the future as well.

In this new edition, all the chapters have been rearranged altogether. Important points have been kept in the 'side boxes' so that the students can revise the book easily within a short period of time. New flow charts, diagrams and tables have also been added.

One new chapter has been added in this edition – "Male and Female Reproductive Physiology" – as chapter number 18 and one new topic "Control of Food Intake and Metabolic Rate" has been added in chapter 16: "Gastrointestinal Physiology".

In view of the current examination pattern, I think students should build up more concepts while reading the "text/note" of every chapter. MCQs should be checked thereafter. Keeping this in mind, I have written the notes in a simple language. MCQs of recent NEET pattern have also been added.

Best of luck for your examination. You are free to contact me at my e-mail ID: drsoumen.manna@gmail.com.

Soumen Manna

Preface to the First Edition

'Review of Physiology', the book is intended to aid basic understanding of the subject to the students who are preparing for the postgraduate medical entrance examination (PGMEE). It is a concise review of key physiologic principles and is intended to help the students recall material taught during their first years MBBS. It is not intended to substitute for comprehensive textbooks, although the students may find it a useful adjunct to physiology and pathophysiology courses.

This book is considerably shorter than the full-length, standard physiology textbook. Most of this book evolved from the 25th edition of **Ganong's Review of Medical Physiology**, 13th edition of **Guyton's Textbook of Medical Physiology**, 6th edition of **Berne & Levy's Physiology and Essentials of Medical physiology by Sembulingam**.

The material is organized by organ system into eighteen chapters, which include General Physiology (Chapters 1-2), Nerve-Muscle Physiology (Chapters 3-4), Cardiovascular System (Chapter 5-8), Respiratory System (Chapters 9-11), Central Nervous System (Chapters 12-18), Renal (Chapter 15), Gastrointestinal (Chapter 16), Endocrine Physiology (Chapter 17) and One Special Topic Exercise Physiology (Chapter 18).

Difficult concepts are explained stepwise, concisely, and clearly, with appropriate illustrative examples. More than 140 full illustrations and flow diagrams and more than 120 tables will help the students visualize the material quickly and aid in long-term retention.

Each chapter begins with a concise theory of each topic, followed by multiple-choice questions (MCQs) and their clear, concise, proper explanations with references of the standard textbooks and/or research papers. NBE pattern questions and various states PG examination questions had been separated from AIIMS/PGI/JIPMER questions, so that the students can easily concentrate different examinations according to their choice.

Each chapter ends with predicted MCQs for future examination, based on current examination pattern, under the heading "Future Trends" along with their detail explanations. This section also includes image-based questions.

I wish that the students will go through this book thoroughly and will do excellence in their examinations.

Best of luck in your preparation for postgraduate medical entrance examination. Genuine doubts, suggestions are always welcome. You are free to contact at my email: drsoumen.manna@gmail.com.

Soumen Manna

Acknowledgments

First and foremost, I would like to thank God, the Almighty, for His showers of blessings throughout my work to complete this book successfully.

A special acknowledgement and thanks to my family for having the patience with me and supporting throughout, specially my mother, my father, my brother, who gave me encouragement in their particular way.

I would like to thank my wife Subha Laxmi for standing beside me throughout my career and writing this book. She has been my inspiration and motivation for continuing to improve my knowledge and move my career forward. I also thank my wonderful son, Sayantan for always making me smile and for understanding on those weekend mornings when I was writing this book instead of playing with him.

I would like to thank my other family members including my in-laws, who have always supported me throughout my career and authoring this book and I really appreciate it.

I wish to thank The Hon'ble Vice Chancellor, The Principal and The Dean of my college, Himalayan Institute of Medical Sciences, Dehradun.

It is a great pleasure to acknowledge the inspiration and help of my colleagues and seniors (Dr. Rani Gupta, Dr. Brijesh Purwar, Dr. Jyoti Dvivedi, Dr. Anupama Nautiyal, Dr. Abha Shrivastava, Dr. Yogesh Saxena) in my department for their constant help and support.

I would like to thank Shri Jitendar P Vij (Group Chairman), Mr Ankit Vij (Group President) and Mrs Chetna Malhotra Vohra (Associate Director–Content Strategy) of Jaypee Brothers Medical Publishers (P) Ltd. New Delhi, India, for enabling me to publish this book. I would also like to thank Ms Payal Bharti (Project Manager), Mrs Neeti Dobriyal, (Typesetter) and Mr Rajib Chaterjee (Proofreader) for helping me in the process of selection and editing.

Lastly I would like to thank all my students who have been my inspiration and support for writing this book.

Contents

<i>Annexures</i>	<i>i-iv</i>
<i>Color Plates</i>	

Section 1: General Physiology

1. Body Fluid: Distribution and Measurement	3
2. Cell Membrane, Transport and Membrane Potential	24

Section 2: Nerve-Muscle Physiology

3. Physiology of Nerve	55
4. Physiology of Muscle	84

Section 3: Cardiovascular System

5. Electrophysiology of Heart	117
6. Cardiac Output and Regulation	140
7. Blood Pressure and Regulation	162
8. Vascular System and Regional Circulation	185

Section 4: Respiratory System

9. Mechanics of Respiration with Lung Volumes and Capacities	213
10. Gaseous Exchange	247
11. Regulation of Respiration and Applied Physiology	277

Section 5: Central Nervous System

12. Sensory Physiology	305
13. Motor Physiology	350
14. Higher Functions and Special Senses	386

Section 6: Renal System

15. Renal Physiology	419
----------------------	-----

Section 7: Gastrointestinal System

16. Gastrointestinal Physiology	459
---------------------------------	-----

Section 8: Endocrine & Reproductive System

17. Endocrine Physiology	499
18. Male and Female Reproductive Physiology	547
19. Special Topic: Exercise Physiology	574

Annexures

Annexure 1

GLUCOSE TRANSPORTERS ARE OF TWO MAIN TYPES

- Na⁺ dependent glucose co-transporters (SGLT, members of a larger family transporter, gene name *SLC5A*)
- Facilitative Na⁺ independent sugar transporters (GLUT family, gene name *SLC2A*)

	Major site of expression	Proposed functions
SGLT1	Kidney (PST), intestine	Glucose reabsorption in intestine and kidney
SGLT2	Kidney (PCT)	Low affinity and high selectivity for glucose
SGLT3	Small intestine, skeletal muscle	Glucose activated Na ⁺ channel

	Major sites of expression	Proposed functions
GLUT1	<i>Highest level in RBC.</i> Main glucose transporter of brain, placenta, RBC. Moderate levels in adipose tissue, muscle and the liver.	Basal glucose uptake
GLUT2	Pancreatic b-cells (glucose sensor) Liver (sinusoidal membrane) Kidneys (basolateral membrane of PCT) Intestine (basolateral transporter)	High-capacity low-affinity transport
GLUT3	Brain, WBC	Neuronal transport
GLUT4	Heart, skeletal muscle and adipose tissue. <i>Also found in brain.</i>	Insulin-responsive glucose transporter
GLUT5	Small intestine, testis and the kidneys	Transport of fructose
GLUT6	Spleen, leucocytes	
GLUT7	Not present. Sequencing artifact	
GLUT8	Testis (differentiation of spermatocyte stage1), blastocyst , brain and adipose tissue	Fuel supply of mature spermatozoa; <i>Insulin-responsive transport in blastocyst</i>
GLUT9	Liver and kidneys	It is a <i>urate transporter</i>
GLUT10	Liver, Pancreas	
GLUT11	Short form: Heart and skeletal muscle Long form: Liver, lung, trachea and brain	Muscle-specific; fructose transporter
GLUT12	Heart, prostate, White adipose tissue, mammary gland	<i>Insulin-responsive</i>

- **Insulin-responsive GLUT: GLUT4 and GLUT 12**
- Insulin-responsive GLUT in **blastocyst: GLUT8**

- Fructose transporter GLUT: **GLUT5 and GLUT 11**

Kidney: SGLT2 is the dominant transporter than SGLT1. GLUT2 is present on basolateral membrane.

Pancreas: GLUT2 is the major glucose transporter for the islet beta-cells.

Mammary Gland: GLUT1, 8, 12 and SGLT1. During late pregnancy to early lactation main transporter is GLUT1.

Glucose Transport in Brain

GLUT-1	Most abundant glucose transporter in the brain , present on BBB (endothelium) and Glial cell/astrocyte (ubiquitously present), but <i>not on neurons</i> .
GLUT-3	Major glucose transporter in the neurons of the cerebellum, striatum, cortex, hippocampus and less number in glial and endothelial cells
GLUT2	Hypothalamus
GLUT-4 (Insulin-responsive)	Olfactory bulb, hippocampus (dentate gyrus), and hypothalamus cerebellum. Expressed in glucose excitatory and glucose inhibitory neuron in hypothalamus.
GLUT-5	Major glucose transporter in microglia.
GLUT-8	Hypothalamus, hippocampus, amygdala, olfactory cortex

Fetal and Placental GLUT

Placenta	GLUT1 (major) and GLUT3
Fetal	GLUT1 is the major. GLUT2, 3 are also present. Insulin-responsive GLUT in blastocyst: GLUT8

Annexure 2

TISSUE DISTRIBUTION OF MAMMALIAN AQUAPORINS (AQPs)

Tissue	Aquaporin types
CNS	AQP1 in the choroid plexus and pain-processing C-fibres AQP4 on astrocyte end-feet and glia
Eye	AQP0 in lens AQP1 in the corneal endothelium AQP3 in the conjunctiva and corneal epithelium AQP4 in the retinal muller cells and lacrimal gland AQP5 in the corneal epithelium and lacrimal gland
Salivary glands	AQP4 in duct cells AQP5 in acini
Inner ear	AQP4 in Claudius, Hensen and inner sulcus cells

Tissue	Aquaporin types
Olfactory epithelial cells	AQP4
Vascular endothelial cells	AQP1 is expressed in all vascular endothelial cells except in the CNS.
GIT	AQP4 in parietal cell of stomach AQP3, AQP4 and AQP8 in epithelial cells of the intestine
Lung	AQP3 in submucosal glands AQP4 in airway cells AQP5 in alveolar type I cells
Erythrocytes	AQP1, AQP3 and AQP9 on membrane.
Kidney	AQP1 in proximal tubule, thin descending limb of loop of Henle and vasa recta AQP2 in luminal side of collecting duct principal cells AQP3 and AQP4 in basolateral side of collecting duct principal cells AQP7 in S3 segment of proximal tubule.
Macrophages and T cells	AQP3
Skin	AQP3 in epidermal cells, primarily in the stratum basale.
Adipocytes	AQP7
Skeletal muscle	AQP4 on fast twitch fibres
Tumour cells	Several types of AQPs. Glioblastoma cells: AQP1, AQP4 and AQP9 AQP1 in microvascular endothelium of tumors in general

DIFFERENT TYPES OF MAMMALIAN AQUAPORINS (AQPs)

Aquaporins	Tissue
AQP0	Lens
AQP1	RBC, kidney, vascular endothelium, brain and eye
AQP2	Kidney, vas deferens
AQP3	RBC, Kidney, skin, lung, eye, colon.
AQP4	Brain, Eye, Muscle, Kidney, Lung, Stomach and Small intestine
AQP5	Salivary gland, lacrimal gland, sweat gland, lung, cornea .
AQP6	Kidney
AQP7	Kidney, adipose tissue, testis.
AQP8	Kidney, testis, liver, pancreas, small intestine, colon.
AQP9	Liver, leucocyte, brain and testis
AQP10	Small intestine
AQP11	Kidney, testis, liver and brain.
AQP12	Acinar cells of pancreas

Annexure 3

Region	Mass (kg)	Blood Flow		Arteriovenous Oxygen Difference (mL/L)	Oxygen consumption		Resistance (R units) ^a		Percentage of Total	
		mL/min	mL/100 g/min		mL/min	mL/100 g/min	Absolute	per kg	Cardiac Output	Oxygen Consumption
Liver	2.6	1500	57.7	34	51	2.0	3.6	9.4	27.8	20.4
Kidneys	0.3	1260	420.0	14	18	6.0	4.3	1.3	23.3	7.2
Brain	1.4	750	54.0	62	46	3.3	7.2	10.1	13.9	18.4
Skin	3.6	462	12.8	25	12	0.3	11.7	42.1	8.6	4.8
Skeletal muscle	31.0	840	2.7	60	50	0.2	6.4	198.4	15.6	20.0
Heart muscle	0.3	250	84.0	114	29	9.7	21.4	6.4	4.7	11.6
Rest of body	23.8	336	1.4	129	44	0.2	16.1	383.2	6.2	17.6
Whole body	63.0	5400	8.6	46	250	0.4	1.0	63.0	100.0	100.

Resting blood flow and O₂ consumption of various organs in a 63-kg adult man with a mean arterial blood pressure of 90 mm Hg and an O₂ consumption of 250 mL/min.

SECTION

1

General Physiology

CHAPTERS

1. Body Fluid: Distribution and Measurement
2. Cell Membrane, Transport and Membrane Potential

CHAPTER

1

Body Fluid: Distribution and Measurement

BODY COMPOSITION (AS % OF BODY WEIGHT)

Human body is composed of the following:

Atomic/ Elementary level		Molecular or, chemical level		Histology/Tissue level	
Oxygen	60%	Water	60%	Skeletal muscle	36%
Carbon	20%	Protein	18%	Non-skeletal	29%
Hydrogen	15%	Fat	15%	Adipose tissue	25%
Calcium	1%	Mineral	6%	Bone	10%
Others	4%	Glycogen	1%		

Body Water as % Body Weight

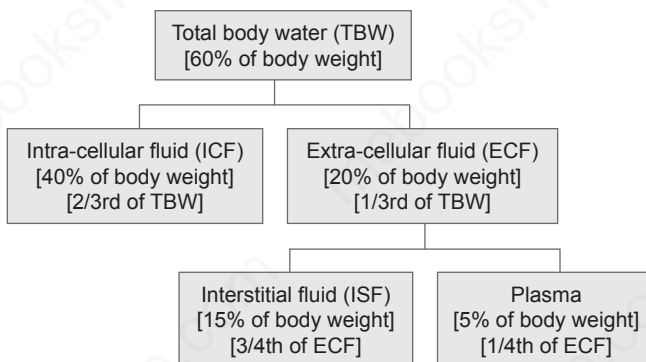

- **Total blood volume** = 8% of body weight (Since, plasma volume = 5% of body weight and blood cell volume = 3% of body weight)

$$\text{Total blood volume: } \frac{\text{Plasma volume}}{(1 - \text{Hematocrit})}$$

Transcellular Fluid

This compartment includes fluid in the synovial, peritoneal, pericardial, and intraocular spaces, as well

I IMPORTANT

A man weighing 70 kg, total water content of body is 42 L (60%). ECF = 14 L and ICF = 28 L

I IMPORTANT

The normal internal cell functions depend upon the consistency of the fluid that forms the actual immediate environment of the cells. For this reason the ECF environment, more particularly the ISF is known as "milieu interieur", a term coined by **Claude Bernerd**.

I IMPORTANT

Maintenance of the internal milieu was first called the "wisdom of the body" by **Starling**.

I IMPORTANT

The term homeostasis was later coined by **Walter Cannon** to describe the physiologic processes that, in aggregate, maintain the constancy of the internal chemistries, as well as BP, body temperature, and energy balance.

as the cerebrospinal fluid; it is usually considered to be a specialized type of ECF, although in some cases, its composition may differ markedly from that of the plasma or ISF. All the transcellular fluids together constitute about 1 to 2 liters (1% to 3% of body weight).

- ❑ Pericardial fluid: 50 ml
- ❑ Pleural fluid: 10–20 ml
- ❑ Peritoneal fluid: Male–no fluid, Female–20 ml (early luteal phase) and 5 ml (late luteal phase).
- ❑ Synovial fluid:
 - About 1 ml of fluid is present in each large joint like knee, hip, ankle, shoulder, elbow and wrist (range 0.5 ml to 1.5 ml). In Osteoarthritis it may be upto 100 ml.

Mesenchymal tissue fluid: Fluid in the mesenchymal tissues such as dense connective tissue, cartilage and bones contain about 6% of the body water. The interstitial fluid, transcellular fluid and mesenchymal tissue fluid combinedly form the 75% of ECF.

Some Important Aspects of Body Fluid:

- ❑ Due to relatively greater amount of adipose tissue in the females, the TBW is ~10% less in a normal young adult female than that in an average adult male. In both sexes the value decreases with age.
- ❑ Brain (contains 74% to 80% of water) forms a large fraction and bones (contains 20% water) form a small fraction of body weight in infant as compared to adult. Because of this infant contains proportionately more body fluid than adult.

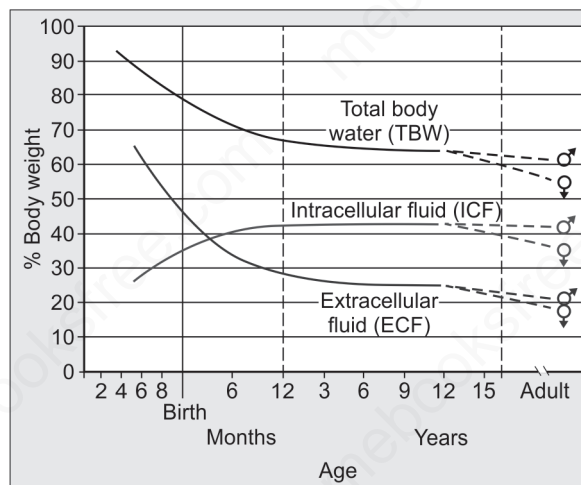

Fig. 1: Body fluid (as percentage of body) changes with age

I IMPORTANT

Maximum bulk of ICF is contained in the muscles.

- ❑ In infant relatively more fluid is present in ECF compartment (prone to dehydration). Thus, the ECF to ICF fluid volume ratio is larger in infants and children as compared to adults.
- ❑ The normal postnatal diuresis causes an immediate decrease in the ECF volume. It is followed by continued expansion of the ICF volume, which results from cellular growth.
- ❑ By the age of 3–4 month postnatal life ICF and ECF volume becomes equal. And by 1 year of age, **the ratio** of the ICF volume to the ECF volume approaches adult levels.
- ❑ By the age of two years, **total body fluid percentage** approaches the adult percentage of 60% and at puberty body fluid percentage and distribution becomes equal to adult percentage.
- ❑ At puberty, for the first time the sex difference in fluid content appears.
- ❑ Total body water volume in different age group is given in the following table:

Age	~ Total body water (As % of body weight)
Premature infant	90%
Full term Newborn	70-80%
One year	64%
Puberty to 39 years	Men: 64% Women: 52%
40 to 60 years	Men: 55% Women: 47%
>60 years	Men: 52% Women: 46%

Ref: Fluid and Electrolyte Balance By Norma M. Metheny

Measurement of Body Fluid

The volume of water in different compartment can be measured by *Volume of distribution principle* (indicator dilution principle).

$$v = \frac{Q - e}{C}$$

Where,

v = Volume of fluid

Q = Quantity of indicator given

C = Concentration of the indicator

e = The amount of indicator which has either been lost or metabolized

I IMPORTANT

At puberty, body fluid percentage and distribution is similar to adult. At the same time, male-female differences of body fluid % appears for the first time.

I IMPORTANT

Relative water content of various tissues in body: Blood (83%) > Kidney (82.7%) > Heart (79.2%) > Lung (79%) > Spleen (75.8%). Least water content: Adipose tissue (10%)

I IMPORTANT

Water content of lean body mass is 71-72 mL/100 gm of tissue (Lean body mass = body mass devoid of fat) and it is independent of sex.

I IMPORTANT

Most accurate method of measuring the volume of ECF is by using inulin (polysaccharide, MW 5200).

Substances Used for Measurement of Various Compartments

Compartment	Indicator used
Plasma volume	Evans' blue (T1824), ^{125}I -albumin (most commonly used)
RBC volume	Tagging RBC with ^{51}Cr , ^{59}Fe , ^{32}P ; also antigenic tagging
Total blood volume	Plasma volume/(1–Hematocrit)
ECF volume	Inulin , sucrose, Mannitol, Sodium thiosulphate, sodium thiocyanate, ^{22}Na , ^{125}I -iothalamate
Interstitial fluid	Cannot be measured directly; can be calculated as (ECF volume–Plasma volume)
ICF	Cannot be measured directly; can be calculated as (Total body water–ECF)
Total body water	D_2O is most frequent used; also, tritium oxide, antipyrine

Normal Fluid Balance in Body

- ❑ **Daily intake of water:** Total 2300 ml (Fluids ingested 2100 ml and from metabolism 200 ml)
- ❑ **Daily loss of water:**
 - Insensible Water Loss 700 ml (from skin 350 ml and from lungs 350 ml)
 - Sweat 100 ml
 - Feces 100 ml
 - Urine 1400 ml
 - Minimum water requirement in adult is 1.5 L/day

Shifts of Water between Compartments

It is important to understand how volume and osmolarity of ECF and ICF in abnormal states changes. The relationship is easily explained by Darrow-Yannet Diagram, which is explained below:

- ❑ Remember:
 - Water moves rapidly across cell membranes; therefore, the osmolarities of ICF and ECF remain almost exactly equal to each other except for a few minutes after a change in one of the compartments.
 - Cell membranes are almost completely impermeable to many solutes; therefore, the number of osmoles in the ECF or ICF generally remains constant unless solutes are added to or lost from the ECF compartment.

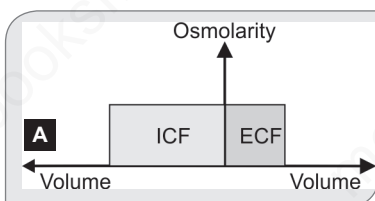

- ❑ Y-axis: solute concentration or, osmolality
- ❑ X-axis: Volume of ICF (2/3) and ECF (1/3)
 - In normal control state, osmolality of ICF and ECF is equal.
 - Whenever any solution is added or, lost from body, its changes the ECF volume or, osmolality or, both according to the type of solution (isotonic, hypotonic or, hypertonic).
 - ICF volume varies with ECF osmolality and ICF osmolality changes inversely to volume change.

Now Carefully Check the Given Diagrams

(Broken line indicates shifts from normal).

Gain of Isotonic Fluid (B)

Infusion of isotonic solution will lead to increase ECF volume but no change in osmolality. Because there is no change in osmolality, ICF volume remains same.

Loss of Isotonic Fluid (C)

Will only decrease the ECF volume.

Gain of Hypotonic Fluid (D)

It increases the ECF volume, but because of its hypotonicity, the final osmolality of ECF decreases. Water shifts from ECF to ICF (osmosis), which leads to increase ICF volume. Because its only shift of water from ECF to ICF, osmolality of ICF reduces until new equilibrium reached.

Loss of Hypotonic Fluid (E)

Hypotonic loss leads to decrease volume but increase osmolality of ECF. Water shifts from ICF to ECF (osmosis), which decrease ICF volume.

Gain of Hypertonic Fluid (F)

Increase in effective volume and osmolality of ECF. Water shifts from ICF to ECF, which leads to decrease ICF volume and increase osmolality until new equilibrium reached.

Loss of Hypertonic Fluid (G)

Decrease ECF volume and tonicity because of hypertonic fluid loss. Decrease tonicity of ECF, shifts the fluid from ECF to ICF (osmosis). So, ICF volume increases and tonicity decreases.

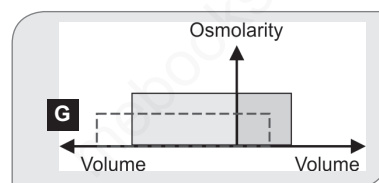
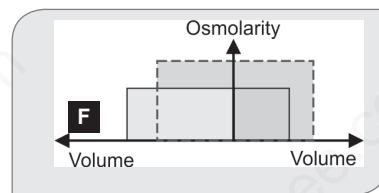
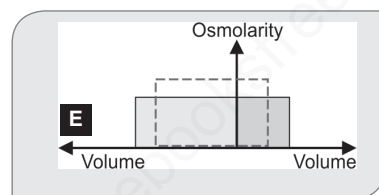
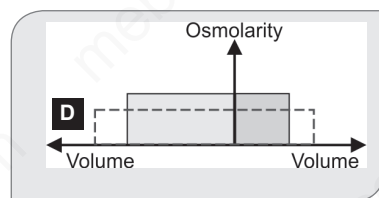
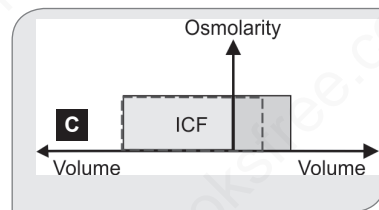
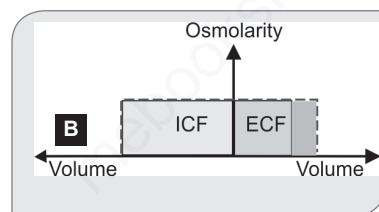

I IMPORTANT

Hypotonic fluid distributed both in ECF and ICF

- ❖ Example. If there is loss of 1 L of water (hypotonic), isotonic NaCl, or half-isotonic NaCl fluid from body, calculate amount of ECF loss in all three conditions.
- ❖ **Water loss:** If 1 L of water is lost, the ICF volume will decrease by 667 mL, whereas the ECF volume will fall by only 333 mL.
- ❖ **Isotonic loss:** ECF volume will decrease by 1 L, no change in ICF volume.
- ❖ **Half-isotonic loss:** One liter of half-isotonic NaCl is equivalent to 500 mL of water plus 500 mL of isotonic saline. So, 500 mL water will be lost from ECF and ICF. And another 500 mL will be lost from ECF only. Therefore, the loss of 1 L of half-isotonic saline decreases the ECF and ICF volumes by 667 mL and 333 mL, respectively.

I IMPORTANT

Ca⁺⁺ ion concentration is least in ICF. Thus, concentration gradient between ECF and ICF is maximum for Ca⁺⁺ (~12000:1).

I IMPORTANT

The dissimilarity between the anions in the ICF and the ECF is largely determined by the presence of intracellular molecules that do not cross the cell membrane.

I IMPORTANT

The difference in the distribution of cations (sodium and potassium) is a result of the activity of the Na⁺ – K⁺ – ATPase pump.

SUMMARY OF DARROW-YANNET DIAGRAM

Type (diagram no)	Example	ECF volume	ICF volume	ECF osmolarity
Gain of isotonic fluid (B)	Isotonic NaCl infusion	Increased	No change	No change
Loss of isotonic fluid (C)	Hemorrhage Diarrhea Vomiting	Decreased	No change	No change
Gain of hypotonic fluid (D)	SIADH Drinking of tap water	Increased	Increased	Decreased
Loss of hypotonic fluid (E)	Sweating, Diabetes insipidus	Decreased	Decreased	Increased
Gain of Hypertonic fluid (F)	Excessive NaCl intake, mannitol	Increased	Decreased	Increased
Loss of Hypertonic fluid (G)	Adrenocortical insufficiency	Decreased	Increased	Decreased

COMPOSITION OF DIFFERENT FLUID COMPARTMENT**ECF**

Ionic composition of plasma and interstitial fluid (ISF) is similar.

- ❑ The most important difference between these two compartments is the higher concentration of protein in the plasma.
- ❑ Because of the Donnan effect, negatively charged plasma protein holds a slightly greater (~2%) cations in the plasma than in the interstitial fluid.

ICF

Only small quantities of Na⁺ and Cl⁻ ions and almost no Ca⁺⁺ ions. Instead, it contains large amounts of K⁺ and phosphate ions plus moderate quantities of Mg⁺⁺ and sulfate ions. Also, cells contain large amounts of protein, almost four times as much as in the plasma.

TYPICAL IONIC CONCENTRATION OF MAMMALIAN CELL

Ion	Cell (ICF) in mOsm/L	ISF in mOsm/L	Blood (ECF) in mOsm/L
K ⁺	140 (max cation)	4	4.2
Na ⁺	14	139	145 (max cation)
Cl ⁻	4	108	108 (max anion)
HCO ₃ ⁻	10	28	24
HPO ₄ , H ₂ PO ₄	11 (max anion)	2	2
Protein	4	0.2	1.2
Ca ²⁺	<0.0002	1.2	1.8
Mg ²⁺	20	0.7	1.5
Corrected osmolar activity (mOsm/L)	281	281	282
Total osmotic pressure at 37°C (mm Hg)	5423	5423	5443

In an average 70-kg adult, the whole-body:

- **Sodium content:** 3500 to 5000 mEq (mMol), which is ~58mEq/kg body weight. Of this amount, 90% is in the ECF compartment and 10% is in the ICF compartment (**primarily in the Bone**). Daily turnover is 4%.
- **Potassium content:** 3000 to 3750 mEq (mMol), which is ~53 mEq/kg body weight. Of this amount, 98% is in the ICF compartment (**primarily in the muscle**) and 2% is in the ECF compartment. Because plasma constitutes 1/4th of ECF, K⁺ content of plasma will be 0.5% of total body K⁺. Daily turnover is 2.3%.
- **Calcium content:** 60,000 mEq, with a daily turnover of 0.01%.
- **Magnesium content:** 2000 mEq with a turnover of 0.5%.
- **Phosphate content:** 18,000 mMol with a turnover of 0.17%.

I IMPORTANT

It is important to note that:

- ❖ Essentially all of the body K⁺ is in the exchangeable pool.
- ❖ Only 65–70% of the body Na⁺ is exchangeable.
- ❖ Almost all of the body Ca²⁺ and Mg²⁺ are non-exchangeable.
- ❖ Only the exchangeable solutes are osmotically active.

UNITS OF MEASUREMENTS

Moles

A mole is the molecular weight of the substance in grams. Each mole (mol) consists of 6×10^{23} molecules.

The millimole (mmol) is 1/1000 of a mole, and the micromole (μmol) is 1/1,000,000 of a mole.

Example: 1 mol of NaCl = 23 g + 35.5 g = 58.5 g, and 1 mmol = 58.5 mg. (Atomic weight of Na = 23 and CL = 35.5)

EQUIVALENTS

One equivalent (Eq) is 1 mol of an ionized substance divided by its valence.

Examples: One mole of NaCl dissociates into 1Eq of Na^+ and 1Eq of Cl^- . One equivalent of Na^+ = 23 g, but 1 Eq of Ca^{2+} = $40 \text{ g}/2 = 20 \text{ g}$.

OSMOLE

It expresses concentration of osmotically active particles.

1 Osmole = Mol/Number of freely moving particles each molecule liberates in solution

Examples:

- 1 mol of NaCl = 2 osmoles because each NaCl molecule given one Na^+ and one Cl^- particle in solution.
- 1 mol of Na_2SO_4 = 3 osmoles because each Na_2SO_4 molecule gives 2 Na^+ and 1 SO_4 in solution
- 1 mol of, CaCl_2 = 3 osmoles, because each molecule of CaCl_2 give 3 particles (1 calcium and 2 Cl^-) in solution.

CONVERTING WEIGHT TO OSMOLALITY

$$\text{mOsmol/L} = \frac{\text{weight of the substance (g/L)}}{\text{Molecular weight (g)}} \times \text{number of species} \times 1000$$

CONVERTING WEIGHT TO MILLIEQUIVALENTS

$$\text{mEq} = \frac{\text{mg} \times \text{valence}}{\text{molecular or, formula weight}}$$

Example A: Convert the expression 10 mg% of Ca^{++} to mEq/L and mOsmol/L

1. 10 mg% of Ca^{++} means, 10 mg/100 ml = 100 mg/L
2. According to the above equation: $\text{mEq/L} = \frac{100 \times 2}{40} = 5 \text{ mEq/L}$

$$3. \text{ According to equation: } \text{mOsmol/L} = \frac{0.1 \text{ (g/L)}}{40 \text{ (g)}} \times 1 \times 1000 = 2.5 \text{ mOsmol/L}$$

Example B: How many mEq of KCl are in 1.5 g of KCl

1. Molecular weight of KCl = 39 + 35.5 = 74.5
2. According to equation: $\frac{\text{mEq}}{\text{L}} = \frac{1500 \text{ mg} \times 1}{74.5} = 20 \text{ mEq/L}$

Example C: 100 mg each of NaCl, CaCl₂ and FeCl₃ in 1 L of water. Determine the concentration in percent, molarity, milliequivalent (mEq) and milliosmolarity (mOsmol).

Percent (g/volume)

- ❑ NaCl: 100 mg of NaCl in 1 L solution = 0.1 g/1000 ml = 0.01 g/100 ml = 0.01%
- ❑ CaCl₂: 100 mg of CaCl₂ in 1 L solution = 0.1 g/1000 ml = 0.01 g/100 ml = 0.01%
- ❑ FeCl₃: 100 mg of FeCl₃ in 1 L solution = 0.1 g/1000 ml = 0.01 g/100 ml = 0.01%
- ❑ Molarity NaCl: Molecular weight = 58.5 g (so, 1 Mol = 58.5 g) 0.01 g/58.5 g = 0.00017 M = 0.17 mMol
- ❑ CaCl₂: Molecular weight = 111 g (so, 1 Mol = 111 g) 0.01 g/111 g = 0.00009 M = 0.09 mMol
- ❑ FeCl₃: Molecular weight = 162.2 g (so, 1 Mol = 162.2 g) 0.01 g/162.2 g = 0.000062 M = 0.062 mMol

Milliequivalent

- ❑ NaCl: Molecular weight = 58.5 g valence 1
- ❑ CaCl₂: Molecular weight = 111 g and valence 2
- ❑ FeCl₃: Molecular weight = 162.2 g and valence 3

So according to formula: mEq =

$$\frac{\text{mg} \times \text{valence}}{\text{molecular or, formula weight}}$$

$$\text{NaCl: mEq} = \frac{100 \times 1}{58.5} = 1.7 \text{ mEq/L}$$

$$\text{CaCl}_2: \text{mEq} = \frac{100 \times 2}{111} = 1.8 \text{ mEq/L}$$

$$\text{FeCl}_3: \text{mEq} = \frac{100 \times 3}{162.2} = 1.85 \text{ mEq/L}$$

MILLIOSMOLE

We have already discussed, that 1 mol of NaCl = 2 osmoles, 1 mol of, CaCl₂ = 3 osmoles. Similarly 1 mol FeCl₃ = 4 osmoles.

So,

$$1.7 \text{ mM of NaCl} = (2 \times 1.7) \text{ mOsmol} = 3.4 \text{ mOsmol/L}$$

$$0.9 \text{ mM of CaCl}_2 = (3 \times 0.9) \text{ mOsmol} = 2.7 \text{ mOsmol/L}$$

$$0.62 \text{ mM of FeCl}_3 = (4 \times 0.62) = 24.8 \text{ mOsmol/L}$$

Or, directly using the formula

$$\text{mOsmol/L} = \frac{\text{weight of the substance (g/L)}}{\text{Molecular weight (g)}} \times \text{number of species} \times 1000$$

will give the same result.

Relation of Osmolality to Osmotic Pressure

- At 37°C, a concentration of 1 osmole per liter will cause 19,300 mm Hg (25.4 atm) osmotic pressure in the solution. Likewise, 1 mOsmol per liter concentration is equivalent to 19.3 mm Hg osmotic pressure.
- Multiplying this value by the 300 mOsmol (concentration of the body fluids) gives a total calculated osmotic pressure of the body fluids of 5790 mm Hg.

I IMPORTANT

Normal "osmolal gap" are within 10 mOsm/kg.

TONICITY

Definition: This is the osmolality of a solution with respect to plasma osmolality.

Example: 0.9% NaCl is isotonic; 5% glucose is isotonic initially; later has become hypotonic.

Calculated Osmolarity (CO)/Osmolality

When unit of Na and K are in mEq/L or, mmol/L, and unit of Glucose and BUN are in mg/dl

$$\text{Plasma Osmolality} = 2(\text{Na} + \text{K}) + \frac{\text{Glucose}}{18} + \frac{\text{BUN}}{2.8}$$

Or,

$$\text{Plasma Osmolality} = 2(\text{Na}) + \frac{\text{Glucose}}{18} + \frac{\text{BUN}}{2.8}$$

I IMPORTANT

Normal plasma oncotic pressure is 28 mm Hg. 19 mm of this pressure is caused by molecular effects of the dissolved protein and 9 mm is caused by the Donnan effect (extra osmotic pressure caused by Na⁺, K⁺, and the other cations held in the plasma by the proteins).

When all units are in mmol/L:

$$\text{Plasma Osmolality} = 2(\text{Na} + \text{K}) + \text{Glucose} + \text{BUN}$$

Or,

$$\text{Plasma Osmolality} = 2(\text{Na}) + \text{Glucose} + \text{BUN}$$

I IMPORTANT

The osmolality of the ECF can be determined, and it usually equals the ICF osmolality.

Measured Osmolality (MO)

The most accurate way of finding out the osmolality is by *freezing point depression*.

OSMOLAL GAP

If there is a difference between the CO and MO, it is called osmolal gap. Osmolol gap indicates the presence of a foreign substance like usually a toxic alcohol such as ethanol, methanol or isopropyl alcohol.

So, sometime a different equation is used when the patient has ingested ethanol, or, mannitol therapy:

Plasma Osmolality =

$$2(\text{Na}) + \frac{\text{Glucose}}{18} + \frac{\text{BUN}}{2.8} + \frac{\text{Ethanol}}{3.7} + \frac{\text{Mannitol}}{18}$$

I IMPORTANT

The most common and most accurate plasma osmolality is measured by the degree of freezing point depression.

TONICITY OF DIFFERENT SOLUTION

Tonicity		mOs- mol/Kg	Glucose (g/L)	Comments
Dextrose solution				
5%	<i>Isotonic</i> but physiologically hypotonic	278	50	Provide 170 Cal/L
10%	Hypertonic	556	100	Provide 340 Cal/L
Saline solution				
0.45%	Hypotonic	154	0	No Calories
0.9%	<i>Isotonic</i>	308	0	Only solution that may be administered with blood product
3%	Hypertonic	1026	0	No Calories

I IMPORTANT

The normal osmolality of the ECF and ICF fluids is ~280-290 mOsm kg. In the plasma of the total osmolality Na⁺, Cl⁻ and HCO₃⁻ contribute 270 mOsm. The remaining 20 mOsm are contributed by glucose and urea.

- ❖ Because of the large molecular weight and hence lesser number of particles, **plasma proteins** (70g/L) contribute 2 mOsm to the total plasma osmolality.
- ❖ There are altogether, around 36 formulas for osmolality calculation!!!!
- ❖ The best equation is: **Zander's optimized equation**, which is not commonly used.
- ❖ The best method for measurement is: **freezing point depression**.

Contd...

Contd...

Tonicity		mOs- mol/Kg	Glucose (g/L)	Comments
Dextrose in saline				
5% in 0.225%	<i>Isotonic</i>	355	50	Provide 170 Cal/L
5% in 0.45%	Hypertonic	432	50	Provide 170 Cal/L
5% in 0.9%	Hypertonic	586	50	Provide 170 Cal/L
Multiple electrolytes solution				
Ringer's solution	<i>Isotonic</i>	309	0	Similar in composition to plasma except it has excess Cl ⁻ and No Mg ⁺⁺ , no HCO ₃ ⁻
Lactate Ringer's (Hartmann's Solution)	<i>Isotonic</i>	274	0	Similar in composition to plasma except it has No Mg ⁺⁺

MULTIPLE CHOICE QUESTIONS

BODY FLUIDS

RECENT MCQs

1. Volume of ICF in body:

- a. $0.2 \times$ body wt.
- b. $0.4 \times$ body wt
- c. $0.6 \times$ body wt.
- d. $0.8 \times$ body wt.

2. ECF is how much part of total body weight:

- a. One third b. Half
- c. Two third d. None

3. ICF is:

- a. 14 L
- b. 20% of body weight
- c. 28 L
- d. 33% of body weight

4. Major cation in ECF:

- a. Na^+ b. K^+
- c. Ca^{++} d. Mg^{++}

5. Most osmotically active intracellular cation:

- a. K^+ b. Na^+
- c. Mg^{+2} d. Protein

6. True regarding Na^+ ion:

- a. Responsible for Donnan effect
- b. Responsible for Resting membrane potential
- c. Responsible for Depolarization
- d. Does not help other ions in transport

7. Water content of lean body mass is (in ml/100 gm of tissue):

- a. 40 b. 50
- c. 60 d. 70

8. Exchangeable potassium in the body is:

- a. 10% b. 40%
- c. 70% d. Almost 100%

9. The normal plasma oncotic pressure is:

- a. 10 mm Hg b. 15 mm Hg
- c. 20 mm Hg d. 30 mm Hg

10. All are seen more in ECF *except*:

- a. Na^+ b. Cl^-
- c. Mg^{++} d. HCO_3^-

11. Daily water loss in sweat during normal activities:

- a. 50-100 ml b. 200-400 ml
- c. 500-700 ml d. 1000-1200 ml

12. The majority of body sodium is present:

- a. ECF b. ICF
- c. Plasma d. Bone

13. Bound potassium is mainly found in the following *except*:

- a. Brain b. Bones
- c. RBC's d. Platelets

14. Volume of blood in a child, per kg of body weight:

- a. 70-80 b. 100-150
- c. 150-200 d. 200-250

15. Plasma protein contributes only ~1 mosm/litre in plasma osmolality because of:

- a. High concentration, Low molecular weight
- b. Low concentration, High molecular weight
- c. Low concentration, Low molecular weight
- d. High concentration, High molecular weight

16. Plasma protein contributes only ~1 mosm/litre in plasma osmolality because of:

- High molar concentration, Low molecular weight
- Low molar concentration, High molecular weight
- Low molar concentration, Low molecular weight
- High molar concentration, High molecular weight

17. Edema is first clinically detectable when the volume of interstitial fluid is:

- 1½ times the normal
- 2 times the normal
- 3 times the normal
- 4 times the normal

18. Normal safety factor against edema is:

- 7 mm Hg
- 17 mm Hg
- 27 mm Hg
- 37 mm Hg

AIIMS/PGI/JIPMER

19. Interstitial fluid volume can be calculated by: [AIIMS Nov 2015]

- Radioactive iothalamate
- Using radiolabeled water and ¹³¹I labeled albumin
- Using radiolabeled water
- Radiolabeled Na⁺ and radiolabeled albumin

20. K⁺ homeostasis in human is: [PGI June 2005]

- Most of the K⁺ are intracellular
- Most of the K⁺ extracellular
- An essential electrolyte for different organ functions
- Actively secreted in the distal tubules
- Maintains the Na⁺-K⁺ ATPase activity

21. Potassium is maximum in: [PGI 1982, 84, 90]

- Cell
- Plasma
- Interstitium
- Bone

22. Total body sodium in meq/kg is: [PGI 1982]

- 42
- 58
- 70.7
- 90.0

23. Plasma K⁺ constitutes what percentage of total body potassium? [AIIMS 1986, JIPMER 2001]

- 0.4%
- 7.6%
- 10.4%
- 89.6%

24. A man weighing 70 kg, water content of body is: [JIPMER 1980]

- 20-30L
- 30-40L
- 40-45L
- 50-60L

25. Plasma osmolality is: [JIPMER 2014]

- 85-95 mOsm/L
- 185-195 mOsm/L
- 285-295 mOsm/L
- 385-395 mOsm/L

AIIMS/PGI/JIPMER

26. The following are true about body water: [PGI Dec 07]

- Water constitutes 60% of the body weight
- Plasma volume constitutes 10% of the total body water
- ECF volume can be determined by dilution methods
- 10% is intracellular water

27. ECF forms what percentage of body weight? [AI 97]

- a. 10% b. 25 %
c. 33% d. 60%

28. True statements are: [PGI Dec 04]

- a. Total body water constitutes about 60% of body weight
b. Most intracellular water is the musculoskeletal system
c. Extracellular water constitutes about 40% of body weight
d. Total plasma constitutes about 10% body weight
e. Extracellular fluid can be measured by dilution method

29. Which of the following methods is not used for measurement of body fluid volumes? [AIIMS May 05]

- a. Antipyrine for total body water
b. Inulin for extracellular fluid
c. Evans blue for plasma volume
d. I²⁵ albumin for blood volume

30. Most accurate measurement of extracellular fluid volume (ECF) can be done by using: [AIIMS May 03]

- a. Sucrose b. Mannitol
c. Inulin d. Aminopyrine

31. Predominant extracellular ions are:

- a. Na⁺ b. K⁺
c. Cl⁻ d. HCO₃⁻
e. PO₄

32. True statements about ions composition in body: [PGI June 06]

- a. Intracellular and extracellular ions compositions are same
b. Phosphorus and Mg⁺⁺ are major ions intracellularly
c. Na⁺, Cl⁻ principal ions in ECF
d. Kidney tightly regulates Na⁺, K⁺, Cl⁻ composition

33. About sodium, true: [PGI Dec 07]

- a. Normal serum level is 135-145 mEq/L
b. Daily intake is 150 mmol of NaCl
c. Major portion is extracellular
d. Major reserve is skeletal muscle

34. Total body water differences between male and female is not seen at the age of: [JIPMER]

- a. Above 60 years b. 40-60 years
c. 10-18 years d. 18-25 years

35. Osmotic pressure of 1 mole of ideal solute relative to pure water is:

[PGI May 09]

- a. 6.5 atm
b. 22.4 atm
c. 4 atm
d. 1 atm
e. 2 atm

36. Ineffective osmols is [JIPMER 02]

- a. Na⁺ b. K⁺
c. Urea d. All

FUTURE TRENDS

37. One person has ingested 1500 ml of water. Calculate the amount that will be present in ISF after equilibrium:

- a. 1000 ml
b. 500 ml

- c. 375 ml
d. 125 ml

Answer questions number 38 and 39 from the following diagram (dashed lines represent original conditions and solid lines the final steady-state situation).

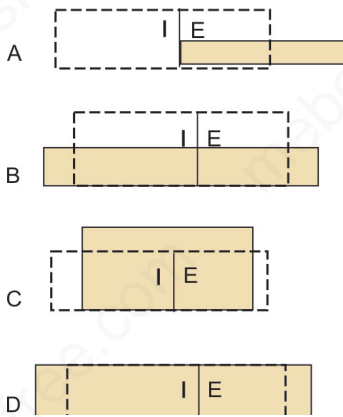

38. Which of the diagram best illustrates the fluid shifts resulting from infusion of 1 L of distilled water into the bloodstream?

- a. A
- b. B
- c. C
- d. D

39. Which best illustrates the status of a person who received 1 L of a hypertonic saline solution intravenously.

- a. A
- b. B
- c. C
- d. D

40. A 60 kg patient has a hematocrit reading of 40 and a plasma volume of 3 liters. What is his total blood volume?

- a. 4.0 liters
- b. 5.0 liters
- c. 6.0 liters
- d. 7.0 liters

41. What is the calculated osmolarity of a solution containing 12 mmol NaCl, 4 mmol KCl and 2 millimolar CaCl₂ (mOsmol/L)?

- a. 16
- b. 26
- c. 38
- d. 32

42. Assuming complete dissociation of all solutes, which of the following solutions would be hyperosmotic to 1 mM NaCl?

- a. 1 mM glucose
- b. 1.5 mM glucose
- c. 1 mM CaCl₂
- d. 1 mM sucrose

43. Which of the following best describes the changes in cell volume that will occur when red blood cells (previously equilibrated in a 280-mOsmol solution of NaCl) are placed in a solution of 140 mmol NaCl containing 20 mmol urea, a relatively large but permeant molecule?

- a. Cells shrink initially, then swell over time and lyse
- b. Cells shrink transiently and return to their original volume over time
- c. Cells swell and lyse
- d. No change in cell volume will occur

The diagram below illustrates possible changes in RBC volume resulting from a change in ECF composition for a cell equilibrated in 150 mM/L NaCl solution at time 0. Answer questions number 25 and 26 below:

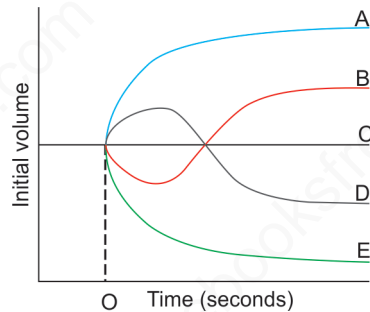

44. Which curve best illustrates the volume change caused by immersion of the cell into an aqueous solution of 300 mOsm CaCl₂?

- a. A
- b. B
- c. C
- d. D

45. Which curve best illustrates the volume change caused by immersion of the cell into a mixture of aqueous solution of 200 mOsm/L NaCl and 200 mOsm/L of glycerol?

- a. A
- b. B
- c. C
- d. D

ANSWERS WITH EXPLANATIONS

1. Ans. b. 0.4 x body wt.

(Ref: Ganong's Physiology 24th ed. pp 2)
ICF is 40% of total body weight.

2. Ans. d. None

(Ref: Ganong's Physiology 24th ed. pp 2)
ECF is 20% of total body weight, so, its 1/5th of body weight and 1/3rd of total body water (33%)

3. Ans. c. 28 L

(Ref: Ganong's Physiology 24th ed. pp 2)
ICF is 40% of total body weight. Adult person with 70 Kg body weight, total body water is 42 L and ICF (2/3rd) volume is 28L

4. Ans. a. Na⁺

(Ref: Ganong's Physiology 24th ed. pp 3)
In ECF Major cation is Na⁺ and anion is Cl⁻. In ICF major cation is K⁺ and anion is phosphate.

5. Ans. a. K⁺

(Ref: Ganong's Physiology 24th ed. pp 2)
Osmolality depends on number of molecules. As K⁺ concentration is maximum in cell, most osmotically active particle is K⁺

6. Ans. c. Responsible for Depolarization

(Ref: Ganong's Physiology 24th ed. pp 6)
Donnan effect is distribution of all permeable ions due to presents of non-permeable ions. K⁺ is responsible for °RMP.

7. Ans. d. 70 ml

(Ref: Human Physiology edited by R.F. Schmidt, G. Thews pp. 643)
Water content of lean body mass is 73.2 ± 3%.

8. Ans. d. Almost 100%

(Ref: Medical Physiology for Undergraduate Students by Indu Khurana, pp 7)

Essentially all of the body K⁺ is in the exchangeable pool. Only 65–70% of the body Na⁺ is exchangeable.

9. Ans. d. 30 mm Hg

(Ref: Guyton's Physiology 13th edn. pp. 196)
Plasma proteins cause colloid osmotic pressure or, oncotic pressure. The colloid osmotic pressure of normal human plasma averages about 28 mm Hg; 19 mm of this pressure is caused by molecular effects of the dissolved protein and 9 mm is caused by the Donnan effect—that is, extra osmotic pressure caused by sodium, potassium, and the other cations held in the plasma by the proteins.

10. Ans. c. Mg⁺⁺

(Ref: Guyton's Physiology 13th edn. pp. 307)
Mg⁺⁺ is mainly intracellular.

11. Ans. a. 50-100 ml

(Ref: Medical Physiology for Undergraduate Students by Indu Khurana, pp7)
Water loss by the production of sweat from skin can vary from 100 mL/day in routine at room temperature of 23°C to 1400 mL in hot weather to 5000 mL following prolonged exercise.

12. Ans. d. Bone

(Ref: Nutrition Review Volume 19, Issue 5:May 1961 Pages 134–135)
Total sodium content in body is 3500 to 5000 mEq (mMol), which is ~58 mEq/kg body weight. Of this amount, 90% is in the ECF compartment and 10% is in the ICF compartment (primarily in the Bone).

13. Ans. d. Platelets

(Ref: *Clinical Methods: The History, Physical, and Laboratory Examinations. 3rd edition. Chapter 195*)

Maximum potassium is in Cell (ICF = 98%), primarily in the muscle, skin, subcutaneous tissue, and red blood cells. As platelet cytoplasm volume is very small as compared to other cell, platelet contains little potassium.

14. Ans. a. 70-80

(Ref: *Bulletin of the World Health Organization 2011;89:46-53*)

- ❑ A person's total blood volume (TBV) is related to body weight. The TBV of a child is around 75–80 ml/kg and is higher in the neonatal period (from 85 ml/kg it rises to a peak of 105 ml/kg by the end of the first month and then drops progressively over ensuing months). Thus, the TBV of a 3.5-kg 2-week-old will be about 350 ml while that of a 10-kg 15-month-old will be about 800 ml.
- ❑ Blood volume can be estimated as approximately 70 mL/kg for adults, 80 mL/kg in children and 100 mL/kg in neonates. (Ref: *Australian Red cross Society*).

15. Ans. (d) High concentration, High molecular weight

(Ref: *Boron Text Book 2nd edition page 109*)

Plasma proteins concentration in plasma is ~14 meq/L. However, because these proteins usually have many negative charges per molecule, not many particles (~1 mM) are necessary to account for these milliequivalents (One equivalent is 1 mol of an ionized substance divided by its valence).

Moreover, even though the protein concentration-measured in terms of grams per liter-may be high, the high molecular weight of the average protein means that the

protein concentration- measured in terms of moles per liter (molar concentration)- is very low. Thus, proteins actually contribute only slightly to the total number of osmotically active particles (~1 mOsm).

16. Ans. b. Low molar concentration, High molecular weight

(Ref: *Boron Text book of Medical Physiology 2nd Edn. Page 109*)

Note: Options and answer are different here. Explanation is given above.

17. Ans. a. 1½ times the normal

(Ref: *Porth Pathophysiology: Concepts of Altered Health States By Charlotte Pooler, pp735*)

Edema can be defined by palpable swelling produced by expansion of interstitial fluid volume. Edema does not become clinically evidence until the interstitial fluid volume has been increased by 2.5L to 3.5L. So, if we consider the normal ISF is around 10L, best possible answer of the question will be 1.5 times than normal.

18. Ans. b. 17mmHg

(Ref: *Guyton's Physiology 13th edn. pp. 318*)

Three major safety factors prevent excessive fluid accumulation in the interstitial spaces:

- ❑ Low compliance of the interstitium in the negative pressure range = 3 mm Hg
- ❑ Safety factor caused by increased lymph flow = 7 mm Hg.
- ❑ Safety factor caused by washdown of proteins from the interstitial spaces = 7 mm Hg.

Therefore, the total safety factor against edema is about 17 mm Hg. is means that the capillary pressure in a peripheral tissue could theoretically rise by 17 mm Hg, or approximately double the normal value, before marked edema would occur.

19. Ans. d. Radiolabeled Na⁺ and radio labeled albumin

(Ref: Guyton-Physiology-13th edn.pp 309)

Here, you need two substances: one for ECF estimation and one for plasma volume estimation. ISF = (ECF-Plasma). ECF is measured by Inulin (Best), ²²Na, ¹²⁵I-iothalamate, thiosulfate, mannitol, sucrose. Plasma is measured by ¹²⁵I-albumin, Evans blue dye (T-1824).

So, obviously D is the answer of choice.

20. Ans. a. Most of the K⁺ are intracellular, c. An essential electrolyte for different organ functions, d. Actively secreted in the distal tubules

(Ref: Clinical Methods: The History, Physical, and Laboratory Examinations. 3rd edition. Chapter 195)

- ❑ Total body potassium is approximately 55mEq/kg body weight. Of this amount, 98% is in the intracellular compartment (primarily in the muscle, skin, subcutaneous tissue, and red blood cells) and 2% is in the extracellular compartment.
- ❑ Some active potassium secretion takes place in the most distal part of the distal convoluted tubules but potassium excretion is primarily a passive process.
- ❑ Na-K-ATPase pump maintains the distribution of K⁺ ion.

21. Ans. a. Cell

(Ref: Clinical Methods: The History, Physical, and Laboratory Examinations. 3rd edition. Chapter 195)

Maximum potassium is in Cell (ICF = 98%), primarily in the muscle, skin, subcutaneous tissue, and red blood cells. Maximum sodium stored in bone.

22. Ans. b. 58

(Ref: Nutrition Review Volume 19, Issue 5:May 1961 Pages 134–135)

Total sodium content in body is 3500 to 5000 mEq (mMol), which is ~58 mEq/kg body weight. Of this amount, 90% is in the ECF compartment and 10% is in the ICF compartment (primarily in the Bone).

23. Ans. a. 0.4%

(Ref: Clinical Methods: The History, Physical, and Laboratory Examinations. 3rd edition. Chapter 195)

Total potassium content of body 3000 to 3750 mEq (mMol), which is ~53 mEq/kg body weight. Of this amount, 98% is in the ICF compartment (primarily in the muscle) and 2% is in the ECF compartment. Because plasma constitutes 1/4th of ECF, K⁺ content of plasma will be 0.5% of total body K⁺.

24. Ans. C. 40-45L

(Ref: Ganong's Physiology 25th ed. Pp 4)

A man weighing 70kg, total water content of body is 42L (60%). ECF = 14L and ICF = 28L

25. Ans. c. 285-295 mOsm/L

(Ref: Guyton-Physiology-13th edn.pp 309)

26. Ans. a. Water constitutes 60% of the body weight

(Ref: Ganong's Physiology 24th ed. pp 2)

c. ECF volume can be determined by dilution methods

Plasma volume is 5% of total body weight. In a 70 kg person, plasma volume is 3.5 L and total body water is 42 L (60% of body weight). So, plasma is 8.3% of total body water [(3.5/42)×100]

27. Ans. b. 25%

(Ref: Ganong's Physiology 24th ed. pp 2)

ECF is 20% of total body weight. So, close answer is 25% with the provided options.

28. Ans. a. Total body water constitutes about 60% of body weight

b. Most intracellular water is the musculoskeletal system

e. Extracellular fluid can be measured by dilution method

(Ref: Ganong's Physiology 24th ed. pp 2)

ECF constitute 20% of total body weight. Total plasma is 5% of body weight.

29. Ans. d. I¹²⁵ albumin for blood volume

(Ref: Guyton-Physiology-13th edn.pp 49)

I¹²⁵ albumin is used for plasma volume not blood volume.

30. Ans. c. Inulin

(Ref: Guyton-Physiology-13th edn.pp 49)

Inulin is best for ECF measurement.

31. Ans. a. Na⁺ c. Cl⁻ d. HCO₃⁻

(Ref: Ganong's Physiology 24th ed. Pp 3)

Predominant ECF: Na⁺, Cl⁻, HCO₃⁻ and Ca⁺⁺

Predominant ICF: K⁺, Mg⁺⁺, phosphate and protein.

32. Ans. b. Phosphorus and Mg⁺⁺ are major ions intracellularly,

c. Na⁺, Cl⁻ principal ions in ECF

d. Kidney tightly regulates Na⁺, K⁺, Cl⁻ composition

(Ref: Ganong's Physiology 24th ed. pp 3)

33. Ans. a. Normal serum level is 135-145 mEq/L

b. Daily intake is 150 mmol of NaCl

c. Major portion is extracellular

(Ref: Ganong's Physiology 24th ed. pp 3)

Major reserve of Na is bones not muscle.

34. Ans. c. 10-18 years

(Ref: Fluid and Electrolyte Balance By Norma M. Metheny)

Difference is not seen upto the age of puberty

35. Ans. b. 22.4 atm

(Ref: Guyton's Physiology 12th edn.pp. 299 & 13th edn.pp 51)

"At 37°C, a concentration of 1 osmole per liter will cause 19,300 mm Hg osmotic pressure in the solution. Likewise, 1 mOsmol per liter concentration is equivalent to 19.3 mm Hg osmotic pressure."

36. Ans. c. Urea

(Ref: Guyton's Physiology 12th edn. pp. 299 & 13th edn.pp 52)

"Highly permeating substances, such as urea, can cause transient shifts in fluid volume between the ICF and ECF, but given enough time, the concentrations of these substances eventually become equal in the two compartments and have little effect on intracellular osmolality and volume under steady-state conditions." That's why urea is an ineffective osmoles.

37. Ans. c. 375 ml

Water is a hypotonic fluid so, it will be distributed equally in both ECF and ICF according to their volume.

So,

□ 2/3rd of 1500 ml will be distributed in ICF = 1000 ml

□ 1/3rd of 1500 ml will be distributed in ECF = 500 ml

□ ISF is 3/4th of ECF = 3/4th of 500 ml = 375 ml.

38. Ans. b. B

Infusion of distilled water would decrease body osmolarity and increase the volume of the ECF. The decreased ECF osmolarity would cause water to diffuse into cells and raise ICF volume.

39. Ans. None

Infusing hypertonic saline will increase body osmolarity. Since fluid is given, the volume

of the ECF compartment will increase. The increased osmolarity of the ECF will cause water to diffuse out of cells, decreasing ICF volume. None of the diagram is matching.

40. Ans. b. 5.0 Liters

Hematocrit (Hct) = 40% = 0.4

Blood volume = Plasma volume/(1-Hct) = 3/(1-0.4) = 5 L

41. Ans. c. 38

1 mmol solution has 1mOsmol when the solute does not dissociate. NaCl and KCl both dissociate into two molecules and CaCl₂ dissociate into 3 molecules. So, 12 mmol of NaCl has an osmolality of 24 mOsmol, 4 mmol of KCl = 8 mOsmol and 2 mmol of CaCl₂ = 6 mOsmol. Total 38 mOsmol.

42. Ans. c. 1 mM CaCl₂

The 1 mM CaCl₂ solution (osmolarity = 3 mOsm/L) is hyperosmotic to 1 mM NaCl (osmolarity = 2 mOsm/L). The 1 mM glucose, 1.5 mM glucose, and 1 mM sucrose solutions are hyposmotic to 1 mM NaCl.

43. Ans. b. Cells shrink transiently and return to their original volume over time

Cell is placed in a solution of 140 mmol NaCl with 20-mmol urea. A solution of 140 mmol NaCl has an osmolarity of 280 mOsmol, which is iso-osmotic relative to "normal" intracellular osmolarity. If RBC were placed in 140 mmol NaCl alone, there would be no

change in cell volume. But the additional presence of 20-mmol urea, however, increases the solution's osmolarity and makes it hypertonic relative to the ICF solution. Water will initially move out of the cell, but because the plasma membrane is permeable to urea, urea will diffuse into the cell and equilibrate across the plasma membrane. As a result, water will re-enter the cell, and the cell will return to its original volume. So, B better answer>>>D.

44. Ans. c. C

❑ The RBC was equilibrated in 150 mM NaCl (means 300 mOsmol NaCl) that is an isotonic saline solution. A 300 mOsm CaCl₂ solution is also an isotonic solution of a nonpenetrating solute, thus, there will be no change in RBC volume.

45. Ans. b. B

❑ 200 mOsm NaCl is nonpenetrating but the 200 mOsm glycerol penetrates slowly. Initially the effective osmolarity of the solution is 400 mOsm (200 NaCl+ 200 glycerol), thus the cell shrinks. With time the glycerol penetrates and the final effective osmolarity of the solution is only 200 mOsm due to the NaCl. Thus, as the glycerol penetrates, water moves into the red blood cell and final volume will be greater than at time zero. Curve B, which shows an initial shrinkage then overall swelling, is the best answer.

CHAPTER

2

Cell Membrane, Transport and Membrane Potential

I IMPORTANT

- ❖ The major lipids of the plasma membrane are phospholipids or phosphoglycerides.
- ❖ The cholesterol serves to stabilize the membrane at normal body temperature (37°C).
- ❖ Cholesterol is important for the maintenance of the correct permeability and fluidity membrane.

I IMPORTANT

Mass Ratio of protein to lipid
is almost 1:1 in most biological membrane.

- ❖ The ratio is maximum in inner mitochondrial membrane (3.2) > Sarcoplasmic reticulum (2.0) > Outer mitochondrial membrane (1.1)
- ❖ The ratio is minimum in myelin (0.23) < Mouse liver cells (0.85)
- ❖ In human erythrocyte the ratio is 1.1

I IMPORTANT

- Membranes are asymmetric structures because
- ❖ Proteins have unique orientations in membranes
 - ❖ External location of the carbohydrates attached to membrane proteins.

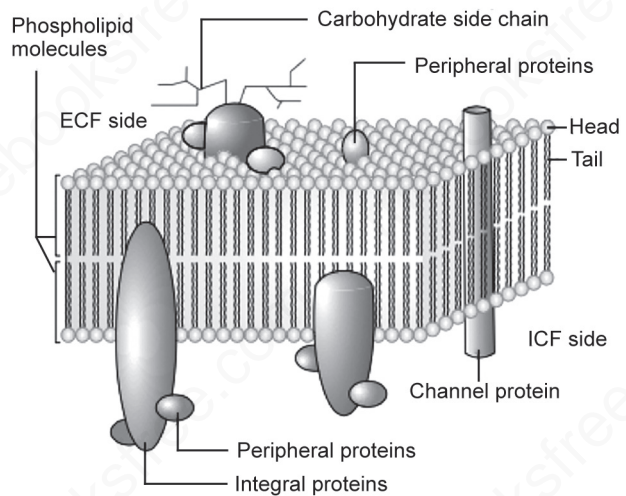

Fig. 2.1: Simplified view of cell membrane

CELL MEMBRANE

Cell membrane: 7.5 to 10 nanometers thick

□ Lipid (~ 40%)

- Phospholipids (25%): Phospholipid phosphatidylcholine and sphingomyelin are found predominantly in the outer leaflet of the membrane, whereas phosphatidylethanolamine, phosphatidylserine, and phosphatidylinositol are found in the inner leaflet.
- Cholesterol (13%): Cholesterol found in both leaflets.
- Other lipids (4%). TG = 0%
- Lipid-soluble substances (e.g. O₂, CO₂, steroid hormones) cross cell membranes because they can dissolve in the hydrophobic lipid bilayer.

- Water-soluble substances (e.g. Na⁺, Cl⁻, glucose, H₂O) cross through water-filled channels, or pores, or may be transported by carriers.
- ❑ **Proteins (~ 55%)**
 - Integral proteins: Most membrane proteins fall into the integral class
 - Are anchored to, and imbedded in, the cell membrane through **hydrophobic interactions** and some by **Van der Waals Forces**.
 - May span the cell membrane.
 - Include ion channels, transport proteins, receptors, and guanosine 5'-triphosphate (GTP)-binding proteins (G proteins).
 - Peripheral proteins
 - Are loosely attached to the *cell membrane by covalent bond* and with *integral protein by electrostatic interactions and hydrogen bond*.

❑ **Carbohydrates (3%)**

- Glycoprotein and glycolipids

Membrane fluidity and the fluid mosaic model of membrane:

- ❑ The fluid mosaic model of membrane structure proposed in 1972 by Singer and Nicolson.
- ❑ According to this model: integral membrane proteins are like "icebergs" floating in a sea of (predominantly) fluid formed by phospholipid molecules.

The fluidity of the membrane is determined by temperature and by its lipid composition.

- ❑ As *temperature* increases, the membrane becomes more fluid. Due to increase in temperature, the hydrophobic side chains undergo a transition from the ordered state (more gel-like or crystalline phase) to a disordered one, taking on a more fluid arrangement.
- ❑ The temperature at which membrane structure undergoes the transition from ordered to disordered (i.e. melts) is called the "transition temperature" (T_m).
- ❑ The presence of *unsaturated fatty acyl chains* in phospholipids and glycolipids also increases membrane fluidity. Longer and more saturated fatty acid decreases membrane fluidity and thus causes higher values of T_m.
- ❑ Cholesterol acts as a buffer to modify the fluidity of membranes.
 - At temperatures below the T_m: increases fluidity.
 - At temperatures above the T_m: decreases fluidity.

I IMPORTANT

- ❖ Cell membrane repairs after micro-injury (micro-needle insertion) by: **RAPID RESEALING** or, self-sealing of membrane. This self-sealing process is purely based on **HYDROPHOBIC INTERACTION**.
- ❖ Large break (macro-injury) repair is done by calcium dependent process.
- ❖ Lateral diffusion of protein is a normal phenomenon, which is the basis of **FLUID MOSAIC MODEL** by Singer and Nicolson in 1972. The essence of their model is that membranes are two-dimensional solutions of oriented lipids and globular proteins. Membrane proteins are free to diffuse laterally in the lipid matrix unless restricted by special interactions. But the above normal process is not for micro-injury repair.

I IMPORTANT

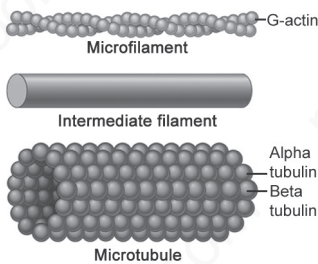

Fig. 2.2: Cytoskeletal elements of the cell

CYTOSKELETON

Maintains the structure of the cell and permits it to change shape and move.

Types of cytoskeleton:

- ❑ Dynamic
 - Microtubules (diameter 25 nM)
 - Microfilament (diameter 7 nM)
- ❑ Static
 - Intermediate filament (diameter 10 nM)

Microtubules

- ❑ Long, hollow structures with 5-nm walls
- ❑ Made up of two globular protein subunits: α - and β -tubulin (stacked rings, with each ring usually containing 13 subunits). A third subunit, γ -tubulin, is associated with the production of microtubules by the centrosomes.
- ❑ The tubules interact with GTP to facilitate their formation.
- ❑ Microtubules are polar with assembly predominating at the “+” end and disassembly predominating at the “-” end.
- ❑ **Functions:**
 - Intracellular transport
 - Cilia and flagella
 - Centriole-mitotic spindle

Microfilaments

- ❑ Long solid fibers, made up of actin.
- ❑ It is the most abundant protein in mammalian cells (as much as 15% of the total protein in the cell)
- ❑ Actin filaments polymerize (ATP dependent) and depolymerize in vivo
- ❑ Filamentous (F) actin refers to intact microfilaments and globular (G) actin refers to the unpolymerized protein actin subunits.
- ❑ **Functions:**
 - Cell junction
 - Muscle contraction
 - Slow axoplasmic transport

Intermediate Filaments

- ❑ Made up of various subunits
- ❑ Some of these filaments connect the nuclear membrane to the cell membrane

- ❑ In their absence, cells rupture more easily, and when they are abnormal in humans, blistering of the skin is common
- ❑ The proteins that make up intermediate filaments are cell-type specific, and are thus frequently used as cellular markers, for example, Vimentin: mesenchyme, cytokeratin: epithelial cells, glial fibrillary acidic protein: glial cells (astrocyte).
- ❑ **Functions:**
 - Cell adhesion
 - Cell shape

INTERCELLULAR JUNCTIONS

- ❑ Junctions that fasten the cells to one another and to surrounding tissues
 - Zonula occludens (Tight Jn.)
 - Zonula adherens (Adherens Jn.)
 - Desmosome
 - Hemidesmosome
 - Focal adhesion
- ❑ Junctions that permit transfer of ions and other molecules from one cell to another.
 - The gap junction.

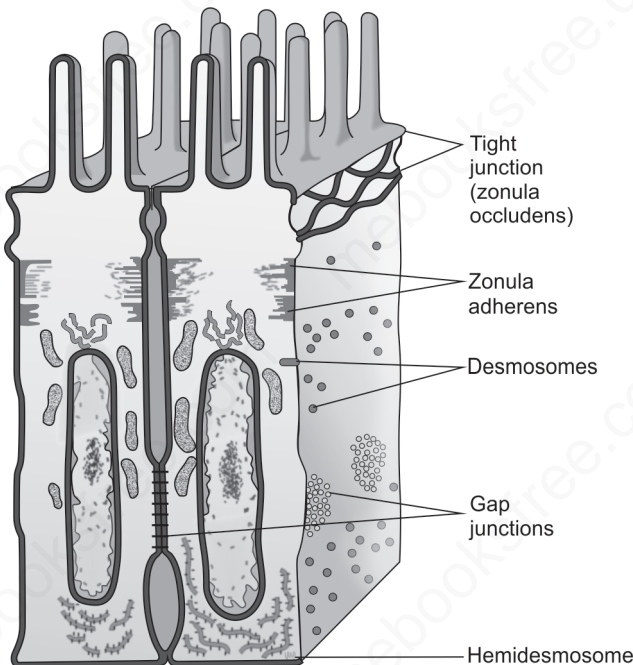

Fig. 2.3: Intercellular junctions in the mucosa of the small intestine

I IMPORTANT

- ❖ Actin filaments in muscle cells are critical components of the contractile apparatus. In other cells they are involved in locomotion.
- ❖ **Cyclical polymerization and depolymerization play the pivotal role in cell locomotion.**
- ❖ Microtubule may play a role in fine-tuning of locomotion.
- ❖ Intermediate filament not directly involve in locomotion.

I IMPORTANT

- ❖ *Colchicine* and *vinblastine* prevent microtubule assembly.
- ❖ *Paclitaxel (Taxol)* binds to microtubules and makes them so stable that organelles cannot move. Mitotic spindles cannot form, and the cells die.

I IMPORTANT

- Connexin mutations responsible for almost 20 different human diseases. For examples:
- ❖ Clouston syndrome (a connexin 30 (Cx30) defect)
 - ❖ Erythrokeratoderma variabilis (Cx30.3 and Cx31)
 - ❖ Inherited deafness (Cx26, Cx30, and Cx31)
 - ❖ Predisposition to myoclonic epilepsy (Cx36)
 - ❖ Predisposition to arteriosclerosis (Cx37)
 - ❖ Cataract (Cx46 and Cx50)
 - ❖ Idiopathic atrial brillation (Cx40)
 - ❖ X-linked Charcot-Marie-Tooth disease (Cx32)
 - ❖ Exocytosis/Endocytosis

Tight Junctions

- ❑ Characteristically surround the apical margins of the cells in epithelia
- ❑ There are three main families of transmembrane proteins that contribute to tight junctions: occludin, junctional adhesion molecules (JAMs), and claudins
- ❑ Tight junctions permit the passage of some ions and solute in between adjacent cells (paracellular pathway).

Adherens Junction

- ❑ Continuous structure on the basal side of the tight junction, and it is a major site of attachment for *intracellular microfilaments*
- ❑ It contains cadherins.

Desmosomes

- ❑ Apposed thickenings of the membranes of two adjacent cells
- ❑ Attached to the thickened area in each cell are *intermediate filaments*
- ❑ Contains desmoglein protein.

Hemidesmosomes

- ❑ Look like half-desmosomes that attach cells to the *underlying basal lamina* and are connected intracellularly to *intermediate filaments*. However, they contain integrins.

Focal Adhesions

- ❑ Attach cells to their basal laminas
- ❑ They are labile structures associated with actin filaments inside the cell, and they play an important role in cell movement.

Gap Junctions

- ❑ At gap junction, intercellular space narrows from 25 nm to 3 nm, and units called **connexons**
- ❑ Each connexon is made up of six protein subunits called **connexins**
- ❑ Permits substances to pass between the cells without entering the ECF
- ❑ The diameter is 0.8 and 1.4 nm, which permits the passage of ions, sugars, amino acids, and other solutes with molecular weights up to about 1000.

TRANSPORT ACROSS CELL MEMBRANE

Given enough time, virtually any molecule will diffuse across a protein-free lipid bilayer down its concentration gradient. The rate at which it does so, however, varies enormously, depending partly on the size of the molecule, but mostly on its relative solubility in oil.

- ❑ In general, the smaller the molecule and the more soluble it is in oil (the more hydrophobic, or nonpolar, it is), the more rapidly it will diffuse across a lipid bilayer.
- ❑ Small nonpolar molecules, such as O_2 and CO_2 , readily dissolve in lipid bilayers and therefore diffuse rapidly across them.
- ❑ Small uncharged polar molecules, such as water or urea, also diffuse across a bilayer, albeit much more slowly.
- ❑ By contrast, lipid bilayers are highly impermeable to charged molecules (ions), no matter how small: the charge and high degree of hydration of such molecules prevents them from entering the hydrocarbon phase of the bilayer.

There are two main classes of membrane transport proteins: Carriers and Channels

Carrier Proteins

- ❑ They are transmembrane proteins with fixed topology
- ❑ They undergo a series of conformational changes to transfer the bound solute across the membrane
- ❑ With carrier proteins there is never an open channel all the way through the membrane
- ❑ They exhibit Michaelis-Menten kinetics
- ❑ Types: Uniporter, Symporter, antiporter.

Channel Proteins

They cycle between an open and closed conformations. When open, a channel provides continuous aqueous pores that extend across the lipid bilayer; pathway through the bilayer, allowing flux of many ions.

I IMPORTANT

- ❖ Ca^{2+} -dependent interactions of the extracellular domains of transmembrane proteins cadherin forms adherent junction.
- ❖ Adhering junctions serve a signaling role during organ development and remodeling.

I IMPORTANT

- ❖ Neighboring cells can be electrically and metabolically coupled by means of gap junctions.
- ❖ The permeability of gap junctions regulated by changes in cytosolic concentrations of Ca^{2+} cAMP, H^+ and membrane potential.

I IMPORTANT

- All channel proteins and many carrier proteins allow solutes to cross the membrane only passively ("downhill"), a process called passive transport, or facilitated diffusion.
- Active transport is mediated by Carrier Proteins coupled to an energy source.
- Active transport against the electrochemical gradient ("uphill") is mediated by carriers, which are also called pumps.

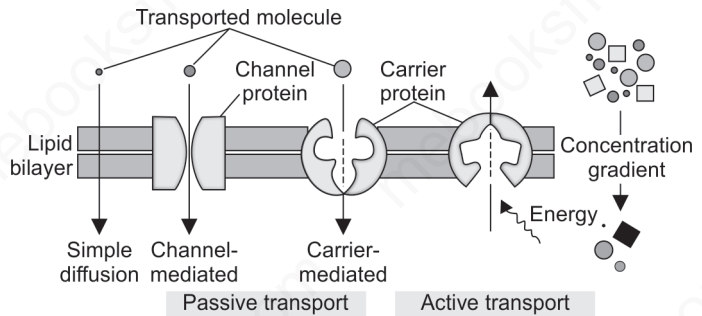
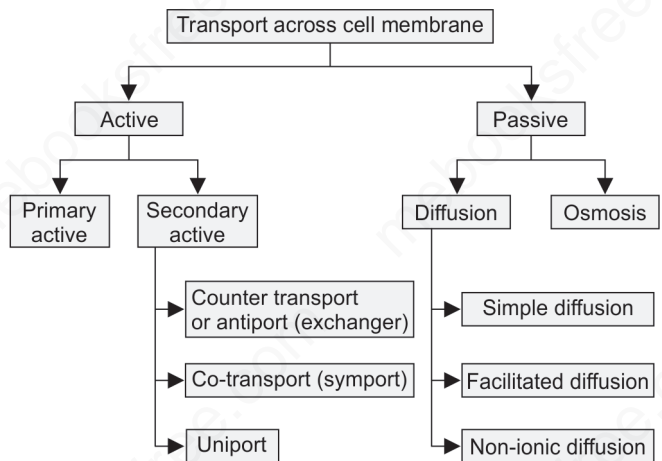

Fig. 2.4: Passive and active transport compared

**I IMPORTANT****Porins**

- ❖ Beta barrel proteins that act as a pore, through which molecules can passively diffuse
- ❖ Medium-sized or charged molecules (sugars, ions, and amino acids) move through a porin.
- ❖ They are present in the outer membrane of Gram-negative bacteria and some Gram-positive bacteria of the group mycolata, the mitochondria, and the chloroplast.

Active Transport

Energy is used.

- ❑ Primary active transport: Energy is derived directly by the transporter itself.
 - **Examples:** All transporters ending with "ATPase" are primary active like $\text{Na}^+ \text{K}^+$ ATPase pump.
- ❑ Secondary active transport: Energy is derived indirectly.
 - **Examples:** Sodium-linked glucose transport (SGLT) in kidney and GIT.

Passive Transport

No energy required

a. Simple diffusion

- No carrier molecule involved
- No T_m (No transport maximum, i.e. not saturable)
- Follows Fick's law of diffusion

Fick's Law of diffusion (net rate of diffusion):

$$J = -\frac{DA}{X} \Delta C$$

Where, J = Net rate of diffusion
 D = Diffusion coefficient
 A = Area
 ΔC = Concentration difference
 X = thickness of the membrane

The negative sign indicates the direction of diffusion: For diffusion from higher to lower concentration, the sign is negative.

Example: O_2/CO_2 exchange in alveoli.

b. Facilitated diffusion

- No energy is required
- A carrier molecule is involved to which the substance binds, therefore, it is also called passive carrier-mediated transport
- Has a T_m (it is saturable)
- It can be competitively and noncompetitively inhibited
- It follows the enzyme-substrate kinetics of Michaelis-Menten
- Example: Glucose transport by glucose transporters (GLUT)

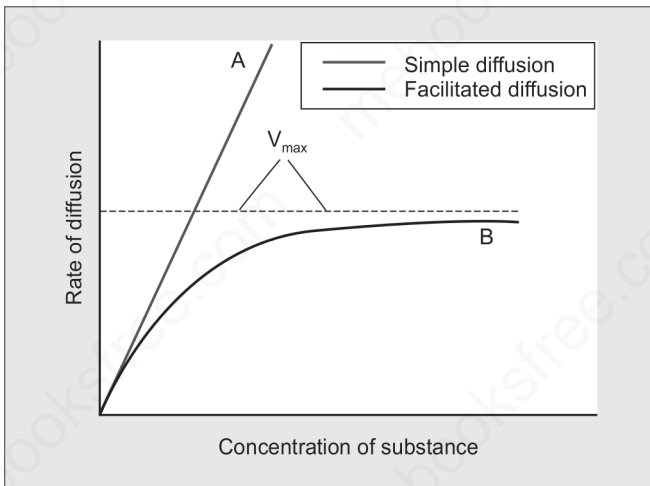

Fig. 2.5: Effect of concentration of a substance on rate of diffusion through membrane

I IMPORTANT

Ionophore

- ❖ Ionophore means "ion carriers" as these compounds catalyze ion transport across hydrophobic membranes
- ❖ Some ionophores are synthesized by microorganisms to import ions into their cells.

Example: Ionomycin is an ionophore produced by the bacterium, *Streptomyces conglobatus* for Ca^{++} transport. Valinomycin is an ionophore for K^+ ion carrier.

I IMPORTANT

Neutral molecule transport:

To some extent they can pass hydrophobic layer by simple diffusion, like very small neutral molecule (CO_2 , O_2 and urea). Large neutral molecule (sugar) cannot pass by simple diffusion.

I IMPORTANT

- ❖ The main driving force for the passive diffusion of an uncharged solute is the difference of concentration between the inside and the outside of the cell.
- ❖ In the case of an electrically charged solute (such as an ion) diffusion is also driven by the membrane potential, which is the electrical gradient across the membrane.

c. **Non-ionic diffusion**

- In case of weak acids or bases, where the acid/base can cross the membrane in the non-ionized form but cannot cross the membrane in the ionized form

Example: Ammonia transport in GIT/Kidney

Summary of different types of transport:

Type	Electrochemical gradient	Carrier mediated	Metabolic energy	Inhibition of Na-K ATPase
Simple diffusion	Downhill	No	No	No
Facilitated diffusion	Downhill	Yes	No	No
Primary active transport	Uphill	Yes	Yes	Inhibits
Secondary active transport	Uphill (One or more solutes are transported uphill; Na ⁺ is transported downhill)	Yes	Yes	Inhibits

I IMPORTANT

Na⁺-K⁺ ATPase pump

- ❖ Most common pumps, present in all parts of body
- ❖ It is a heterodimer made up of an α subunit and a β subunit.
- ❖ α and β subunits are heterogeneous, with $\alpha 1$, $\alpha 2$, and $\alpha 3$ subunits and $\beta 1$, $\beta 2$, and $\beta 3$ subunits
- ❖ **Beta subunit** contains **3 ECF glycosylation sites**, all of which attached carbohydrate residues
- ❖ ICF side of **alpha subunits** binds, ATP and 3 Na⁺ ions. ECF side of alpha subunits has binding sites for **ouabain** and 2 K⁺
- ❖ It is an electrogenic pump with a coupling ratio of 3:2
- ❖ It regulates cell volume, pressure and also maintains RMP of cell (5-10%)
- ❖ The pump is stimulated by thyroid hormones, insulin, aldosterone and G-actin whereas it is inhibited by **ouabain** and related **digitalis** glycosides.

OSMOSIS AND OSMOTIC PRESSURE

- ❑ Osmosis is the flow of water across a semipermeable membrane from a solution with low solute concentration to a solution with high solute concentration.
- ❑ **Calculating osmotic pressure (van't Hoff's law):** This law states that osmotic pressure depends on the concentration of osmotically active particles. The concentration of particles is converted to pressure according to the following equation:
 - $\pi = g \cdot C \cdot R \cdot T$
Where: π = osmotic pressure (mm Hg or atm),
 g = number of particles in solution (osm/mol),
 C = concentration (mol/L), R = gas constant, T = absolute temperature (K)
- To exert osmotic pressure across a membrane, a molecule must not cross the membrane.
- ❑ RBC is impermeable to sucrose, so sucrose exerts an osmotic pressure whereas, urea is readily able to cross the RBC membrane, and it cannot exert an osmotic pressure.
- ❑ Consequently, sucrose is termed an *effective osmole*, whereas urea is an *ineffective osmole*.

To take into account the effect of a molecule's membrane permeability on osmotic pressure, it is necessary to rewrite van't Hoff's law equation as:

$$\pi = \sigma(nCRT)$$

Where σ is the *reflection coefficient* or osmotic coefficient, which is a measure of the relative ability of the molecule to cross the cell membrane.

- ❑ $\sigma = 0$ means the molecule can freely cross the cell membrane (such as urea) and no effective osmotic pressure is exerted (i.e. urea is an ineffective osmole RBC).
- ❑ $\sigma = 1$ means the solute cannot cross the cell membrane (i.e. sucrose). Such a substance is said to be an effective osmole.
- ❑ Many molecules are neither completely able nor completely unable to cross cell membranes (i.e. $0 < \sigma < 1$), and they generate an osmotic pressure that is only a fraction of what is expected from the molecule's concentration in solution.

Oncotic Pressure

Oncotic pressure or, colloid osmotic pressure is the osmotic pressure generated by large molecules (especially proteins) in solution.

- ❑ The magnitude of the osmotic pressure generated by a solution of protein does not conform to van't Hoff's law, because van't Hoff's law is more precise with small, globular proteins than with larger protein molecules.
- ❑ The oncotic pressure exerted by proteins in human plasma has a normal value of approximately 26 to 28 mm Hg. Although this pressure appears to be small when considered in terms of osmotic pressure (28 mm Hg \approx 1.4 mOsm/kg H₂O), it is an important force involved in fluid movement across capillaries.

Exocytosis

- ❑ The process by which the contents of secretory vesicles are delivered to the extracellular fluid is called exocytosis. Depending upon the type of cell, exocytosis may occur over the entire surface or be localized to a small discrete area. For example, nerve cells release their neurotransmitters only at synapses that comprise only a tiny fraction of their surface area.

I IMPORTANT

- ❖ K⁺ ion channels are **tetramers** with four identical subunits. Similarly **Aquaporins** are also tetramers.
- ❖ Ligand gated cations or, anion channels have **FIVE identical subunits**.
- ❖ Several types of Cl⁻ channels are **dimer**.

I IMPORTANT

Carrier-mediated transport:

includes facilitated diffusion and primary and secondary active transport.

The characteristics of carrier-mediated transport are:

- ❖ **Stereospecificity:** For example, D-glucose (the natural isomer) is transported by facilitated diffusion, but the L-isomer is not.
- ❖ **Saturation:** The transport rate increases as the concentration of the solute increases, until the carriers are saturated. The transport maximum (T_m) is analogous to the maximum velocity (V_{max}) in enzyme kinetics.
- ❖ **Competition:** Structurally related solutes compete for transport sites on carrier molecules. For example, galactose is a competitive inhibitor of glucose transport in the small intestine.

I IMPORTANT

The volume of RBC placed in a NaCl solution (osmolarity of 280 mosm/kg H₂O) is 100 fl. What will be the steady state volume when they are placed in a NaCl solution with an osmolarity of 350 mosm/kg H₂O?

Answer: After steady state, the concentration of solute in the RBC will remain same as there will be only exchange of water (osmosis).
Formula; $C_1V_1 = C_2V_2$ [Where, Initial Concentration C₁, volume V₁, and Final concentration C₂, volume V₂]
So, $(280 \times 100) = 350 \times V_2$
Therefore, $V_2 = 80$ fl

I IMPORTANT

The nonconstitutive pathway is sometimes called the **regulated pathway**, but this term is misleading because the output of proteins by the constitutive pathway is also regulated.

- Vesicular membrane fuses with cell membrane and the area of fusion then breaks down, leaving the contents of the vesicle outside and the cell membrane intact. This is the Ca⁺² dependent process of **exocytosis**.
- Exocytosis occurs via two pathways. In the **non-constitutive pathway**, proteins from the Golgi apparatus initially enter secretory granules, where processing occurs before exocytosis. The other pathway, the **constitutive pathway**, involves the prompt transport of proteins to the cell membrane in vesicles, with little or no processing or storage.

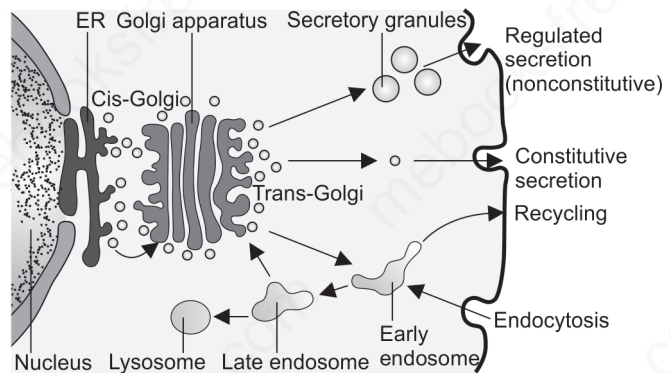
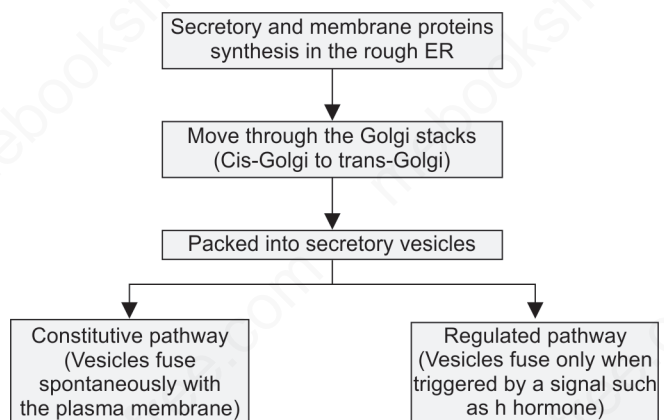

Fig. 2.6: Cellular structures involved in protein processing

**ENDOCYTOSIS**

Endocytosis is the reverse of exocytosis. There are various types of endocytosis:

1. **Phagocytosis ("cell eating")**: is the process by which bacteria, dead tissue, or other bits of

microscopic material are engulfed by cells such as the polymorphonuclear leukocytes of the blood. The material makes contact with the cell membrane, which then invaginates.

2. **Pinocytosis (“cell drinking”)**: is a similar process with the vesicles much smaller in size and the substances ingested are in solution.
3. **Clathrin-mediated endocytosis**: also known as receptor-mediated endocytosis, occurs at membrane indentations where the protein **clathrin** accumulates.
 - Clathrin molecules have the shape of triskelions, with three “legs” radiating from a central hub. As endocytosis progresses, the clathrin molecules form a geometric array that surrounds the endocytotic vesicle. Once the complete vesicle is formed, the clathrin falls off and the three-legged proteins recycle to form another vesicle.
 - Clathrin-mediated endocytosis is responsible for the internalization of many receptors and the ligands bound to them-including, for example, nerve growth factor and low-density lipoproteins. It also plays a major role in synaptic function.

RESTING MEMBRANE POTENTIAL (RMP)

Equations used for Membrane Potential

- Donnan effect/Gibbs-Donnan equilibrium
- Nernst equation
- Goldman-Hodgkin-Katz (G-H-K) equation or, Goldman constant field equation or chord conductance equation.

Donnan Effect

Presence of an impermeant ion on one side of the membrane repels similarly charged permeant ions to the other side and holds opposite charged permeant ions to the same side.

Gibbs-Donnan Equilibrium

Mathematics of Donnan effect

The effects of presence of the impermeant ion on the distribution of permeant ions are:

- It causes an asymmetric distribution of the permeant ions

- ❑ More osmotically active particle on the side containing the impermeant ion
- ❑ The product of the concentration of the permeant ions on one side equal, the product of the concentration of the permeant ions on the other side
- ❑ However, the total number of positive charges on one side equals the total number of negative charges.

Side 1	K ⁺ 9	K ⁺ 6	Side 2
	Cl ⁻ 4	Cl ⁻ 6	
	Protein 5		

Nernst Equation

Gives the value of *equilibrium potential* (E_Q) or *isoelectric potential*. Equilibrium potential is the membrane potential at which equilibrium is reached (i.e. there is no Net flux of that ion).

$$E = - 23 \frac{RT}{zF} \log_{10} \frac{C_i}{C_e}$$

E = equilibrium potential (mV), C_i = intracellular concentration (mM), C_e = extracellular concentration

(mM) and $23 \frac{RT}{zF} = 60 \text{ mV at } 37^\circ\text{C}$

Example: If the intracellular $[\text{Na}^+]$ is 15 mM and the extracellular $[\text{Na}^+]$ is 150 mM, what is the equilibrium potential for Na^+ ?

$$\begin{aligned} \text{With the help of above equation: } E &= - 60 \log_{10} \frac{15}{150} \\ &= - 60 \log_{10} 0.1 \\ &= + 60 \log_{10} 10 \\ &= + 60 \text{ mV} \end{aligned}$$

Note: You need not remember which concentration goes in the numerator. Because it is a log function, perform the calculation either way to get the absolute value of 60 mV. Then use an “intuitive approach” to determine the correct sign. [Intuitive approach: The (Na^+) is higher in extracellular fluid than in intracellular fluid, so Na^+ ions will diffuse from extracellular to intracellular, making the inside of the cell positive (i.e. +60 mV at equilibrium)].

Ion	Equilibrium potential (mV)
Na ⁺	+ 63 to + 65
K ⁺	- 94 to - 96
Cl ⁻	- 64 to - 70
Ca ⁺⁺	+ 132 to + 137
H ⁺	- 12
HCO ₃ ⁻	- 13
Mg ²⁺	+ 9

I IMPORTANT

Relative permeability of different molecules: hydrophobic molecules (CO₂, O₂, N₂, steroid hormones) >>> small uncharged polar molecules (H₂O, urea, glycerol) >>> large uncharged polar molecules (glucose, sucrose) >>> Ions (Na⁺, K⁺, Cl⁻)

RESTING MEMBRANE POTENTIAL

- ❑ When two electrodes are connected through a suitable amplifier and placed on the surface of a single axon, no potential difference is observed. However, if one electrode is inserted into the interior of the cell, a constant **potential difference** is observed, with the inside negative relative to the outside of the cell at rest. A membrane potential results from separation of positive and negative charges across the cell membrane. In neurons, the **resting membrane potential** is usually about -70 mV, which is close to the equilibrium potential for K⁺.
- ❑ Every cell shows a potential difference, with the inside being negative. Its value varies from cell to cell.

I IMPORTANT

- ❖ Permeability of different ions through synthetic biological membrane: Cl⁻ >> K⁺ >> Na⁺
- ❖ Permeability of different ions through cell membrane: K⁺ >> Cl⁻ >> Na⁺

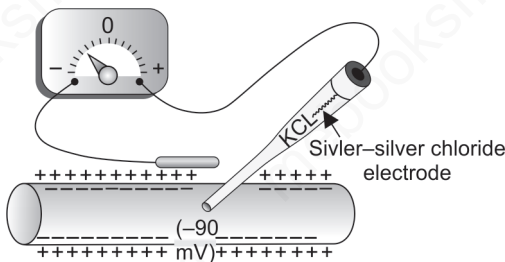

Fig. 2.7: Recording of membrane potential

Genesis of RMP

- ❑ **Diffusion of K⁺:** This is the most important cause. The most permeable ion in resting condition of cell is K⁺ >> Cl⁻ >> Na⁺. Permeability of K⁺: Na⁺: Cl⁻ = 1.0: 0.04: 0.45
- ❑ **Na⁺ - K⁺ ATPase:** Maintains the RMP (5-10%).
- ❑ **Donnan effect:** This also maintains the diffusion gradient for K⁺.

I IMPORTANT

- ❖ In general all excitable cell membrane at rest is maximally permeable to K⁺ and thus RMP is **close to** equilibrium potential of K⁺ ion.
- ❖ RMP of neuron (-70 mV) is exactly **equal to** equilibrium potential of Cl⁻ ion (-70 mV).

I IMPORTANT

1. Membrane potential is recorded with microelectrode (tip diameter <0.5 micrometer)
2. Electrode is filled with KCl solution

RMP AND THRESHOLD VOLTAGE OF DIFFERENT TISSUES

Tissue	RMP (mV)	Threshold (mV)
Nodal tissue	Range: -65 to -40 SA node: -50 AV node: -60	-40 to -30
Myocardium	-90	-65
Purkinje fiber	-80	
Smooth muscle	-55 to -40	-40
Skeletal muscle	-90	-55
Neuron	-70	-55
Hair cell	-60 to -70 with respect to the perilymph -150 with respect to the endolymph	-50

CALCULATION OF RMP

- **Goldman-Hodgkin-Katz Equation:** Gives the magnitude of the *membrane potential (RMP)*. It depends on:
- The distribution of Na⁺, Cl⁻, K⁺ between ECF and ICF
 - Permeability of the membrane to each of these ions

If permeabilities are known, a RMP can be calculated using the theoretical Goldman-Hodgkin-Katz (GHK) or **constant field equation**:

$$V = 60 \text{ mV} \log_{10} \frac{P_{\text{Na}} \text{Na}_o^+ + P_{\text{K}} \text{K}_o^+ + P_{\text{Cl}} \text{Cl}_i^-}{P_{\text{Na}} \text{Na}_i^+ + P_{\text{K}} \text{K}_i^+ + P_{\text{Cl}} \text{Cl}_o^-}$$

where, P_{Na} → Permeability of Na and Na_o^+ → concentration of Na outside (Similarly others)

MCQ: If the ECF K⁺ concentration increases from 3.5 to 5 mM, what happens to the resting membrane potential of an adipose cell?

Ans. It becomes less negative, means cell depolarizes. Depolarization of cell is known as decreases in RMP. But remember this depolarization cannot fire action potential.

Explanation: Excess ECF K⁺ decreases the diffusion of K⁺ from cell. This cause extra K⁺ (positive charge) inside cell (depolarization). But remember this is NOT DUE TO: Increase in ECF K⁺ would cause K⁺ to rush into

the cell down its concentration gradient (because ICF K^+ concentration is very high even after increase in ECF K^+).

Remember that membrane potential is not an absolute number, but the difference between the inside of the cell and the outside ground. Thus, a decrease in the membrane potential difference (RMP) means that the voltage has moved closer to ground or become more positive.

Effect of change in ECF Na^+/K^+ on RMP

- **Hyponatremia:** little effect on RMP (because Na is least permeable in resting condition)
- **Hypernatremia:** little effect on RMP.
- **Hyperkalemia:** decreases RMP (explained above). For example, from -70 mV, it may become -65 mV. Hypokalemia will have opposite effect.
- **Hypokalemia:** RMP increases.

MULTIPLE CHOICE QUESTIONS

CELL MEMBRANE AND CYTOSKELETON

RECENT MCQs

1. Plasma membrane is mainly composed of:

- a. Cholesterol b. Carbohydrate
c. Phospholipid d. Protein

2. In cell membrane, following are true:

- a. Lipids are regularly arranged
b. Lipids are symmetrical
c. Protein displaced laterally
d. None

3. On weight basis, the membrane contains protein and lipid in the ratio of:

- a. 1:2 b. 1:1
c. 2:1 d. 4:1

4. The fluidity of the plasma membrane is due to:

- a. Phospholipids b. Cholesterol
c. Glycolipids d. Glycoproteins

5. Peripheral cell membrane proteins are:

- a. Pumps b. Channels
c. Adhesion molecule
d. Enzyme receptor

6. Cell membrane integrity is maintained by:

- a. Heat stress b. Na-K-ATPase
c. Ankyrin d. Spectrin

7. Ion channels in the cell membrane are lined by:

- a. Protein
b. Carbohydrates
c. Lipid
d. Polysaccharide

8. Cell Protein:Lipid ratio in erythrocyte is:

- a. 3.00 b. 2.33
c. 1.50 d. 1.14

9. Decrease protein lipid ratio is seen in:

- a. Inner mitochondrial membrane
b. Outer mitochondrial membrane
c. Sarcoplasmic reticulum membrane
d. Myelin sheath membrane

10. Normal plasma membrane resistance is:

- a. 7 Ohms
b. 10 Ohms
c. 50 Ohms
d. 100 Ohms

11. Substances help in linking cytoskeleton of the cell to plasma membrane:

- a. Tubulin b. Spectrin
c. Laminin d. Ankyrin

12. Cell shape and motility is provided by:

- a. Centrosomes
b. Microtubules
c. Golgi apparatus
d. Nucleus

13. Cell motility is due to protein:

- a. Motilin b. Tubulin
c. Laminin d. Tactilin

14. The cell junctions allowing exchange of cytoplasmic molecule between two cells called:

- a. Gap junction b. Tight junction
c. Focal junction d. Desmosome

15. Gap junctions are found in:

- a. Intestine b. Brain
c. Kidney d. Cardiac muscle

16. Eukaryotic plasma membrane is made up of all except: [AIIMS May 10, 09]

- a. Carbohydrates
b. Triglycerides
c. Lecithin
d. Cholesterol

17. The transmembrane region of protein is likely to have: [AI 04]

- a. A stretch of hydrophilic amino acids
b. A stretch of hydrophobic amino acids
c. A disulphide loop
d. Alternating hydrophilic and hydrophobic amino acids

18. Which important component of cell membrane has carbohydrate moiety?

- a. Phosphoglyceride [PGI June 01]
b. Triacylglycerol

- c. Sphingomyelin
d. Cholesterol
e. GM2 Gangliosides

19. True about lipid bilayer of cell wall:

[PGI June 01]

- a. Asymmetrical arrangement of cell membrane component
b. Lateral diffusion of ions
c. Symmetrical arrangement of cell membrane components
d. Not made up of amphipathic lipids

20. Membrane fluidity is increased by:

[AIIMS May 05]

- a. Stearic acid
b. Palmitic acid
c. Cholesterol
d. Linoleic acid

21. Transition temperature of lipid bilayers of cell membrane is increased by:

[AIIMS Nov 00, Kerala 01]

- a. Cholesterol
b. Saturated fatty acids
c. Hydrocarbons
d. Unsaturated fatty acids

22. Which of the following membrane has the highest protein content per gram tissue? [AIIMS May 02]

- a. Inner mitochondrial membrane
b. Outer mitochondrial membrane
c. Plasma membrane
d. Myelin sheath

23. Lipids and proteins interact in membrane by: [PGI June 07]

- a. Hydrophobic interactions
b. Both hydrophobic and covalent interactions
c. Covalent bonds
d. Hydrogen bonds

AIIMS/PGI/JIPMER

24. The ionic channels in excitable membrane are lined by:

[AIIMS 1984]

- a. Cephalin
- b. Proteins
- c. Lipids
- d. Carbohydrates

25. Which of the following is a membrane protein? [AIIMS Nov 2012]

- a. GPI
- b. Sec A protein
- c. TRAP
- d. None of the above

26. Not a cell adhesion molecule:

[JIPMER 2014]

- a. Integrin
- b. Selectin
- c. Cadherin
- d. Spectrin

TRANSPORT ACROSS THE MEMBRANE**RECENT MCQs**

27. Glucose is co-transported with Na^+ ions. This is a type of:

- a. Secondary active transport
- b. Primary active transport
- c. Facilitated diffusion
- d. Simple diffusion

28. Na-K ATPase:

- a. 3 Na out/2K in
- b. 3Na in/2K out
- c. 2Na out/3K in
- d. 2Na in/3K out

29. Binding site present on beta unit of Na^+ - K^+ pump is:

- a. Na^+
- b. K^+
- c. ATP
- d. Glycosylation

30. Which of the following is used in exocytosis?

- a. Ca^{++}
- b. Mg^{++}
- c. Na^+
- d. K^+

31. Osmolarity is defined as:

- a. Number of osmole per litre
- b. Number of osmole per kg

- c. Weight of solute per litre
- d. Weight of solvent per litre

32. Gap junctions are found in:

- a. Intestine
- b. Brain
- c. Kidney
- d. Cardiac muscles

33. Which of the following moves rapidly across the cell membrane?

- a. CO_2
- b. Water
- c. Glucose
- d. Urea

34. Most permeable to pure phospholipid bilayer:

- a. Oxygen
- b. Na^+
- c. Water
- d. None

35. Which one of the following substance's movement across the membrane is most affected by osmotic pressure?

- a. Sodium
- b. Potassium
- c. Water
- d. Glucose

36. Fick's law gives the rate of transport in case of:

- a. Simple diffusion
- b. Facilitated diffusion
- c. Non-ionic diffusion
- d. Secondary active transport

37. All are true about Na-K- pump except:

- a. Needs ATP for its functioning
- b. Is inactive at 40 degree centigrade
- c. It is electrogenic
- d. Needed for generation of action potential

38. The emeiocytosis or, reverse pinocytosis requires which ion?

[AIIMS 1984, PGI 1983]

- a. Na⁺
- b. K⁺
- c. Ca⁺⁺
- d. Mg⁺⁺

AIIMS/PGI/JIPMER

39. The cell junctions allowing exchange of cytoplasmic molecules between the two cells are called:

[AI 03]

- a. Gap junctions
- b. Tight junctions
- c. Focal junctions
- d. Adherent junction

40. Transport of neutral substances across the cell membrane occurs via:

[AI 08]

- a. Porins
- b. Ionophore
- c. Lipopolysaccharides
- d. Diffusion

41. Which of the following statements about facilitated diffusion is true?

[AI 09]

- a. It is a form of active transport
- b. It requires a carrier protein
- c. Rate of transport is proportionate to the concentration gradient
- d. Requires creatine phosphate

42. True about facilitated diffusion are all except:

[PGI June 98]

- a. Occur in direction of concentration gradient
- b. Does not require energy

- c. Occur in direction opposite to electrical gradient
- d. Facilitated by charge of molecule

43. All of the following are true except:

[AIIMS May 08]

- a. Facilitated diffusion requires energy
- b. Active transport is an energy dependent process
- c. Co-transport is mediated via the use of carriers
- d. Glucose is transported via passive diffusion

44. Active transport across the cell membrane is mediated by:

[AIIMS May 01]

- a. G-proteins
- b. Na⁺-K⁺ ATPase
- c. Carrier protein
- d. Channel protein

45. All of the following transport process follows 'saturation kinetics' except:

[AIIMS Nov 05]

- a. Facilitated diffusion
- b. Na⁺- Ca²⁺ exchanger
- c. Simple diffusion
- d. Na⁺ coupled active transport

46. Fick's law, flux of Geomembrane increased in:

[PGI June 08]

- a. Concentration across
- b. Temperature
- c. Increased size of molecule
- d. Weight
- e. Area

47. For sodium-potassium pump the coupling ratio is:

[AIIMS 95]

- a. 1:1
- b. 2:3
- c. 3:2
- d. 1:4

48. Entracellular binding site on Na⁺-K⁺ pump is:

[JIPMER 06]

- a. Na⁺
- b. ATP
- c. PO₄
- d. Quabain

49. True about $\text{Na}^+\text{-K}^+$ pump is that:

[PGI 04, Dec 06]

- a. Involves ATPase activity
- b. It can move Na^+ in and out of cell
- c. Electrically neutral
- d. Pumps out one Na^+ for one K^+
- e. Pumps 3 Na and 2K inside the cell

50. The sodium-potassium pump is an example of:

[AIIMS May 06]

- a. Active transport
- b. Passive transport
- c. Facilitated diffusion
- d. Osmosis

51. Which of them is TRUE about $\text{Na}^+\text{-K}^+$ pump?

[AIIMS June 99]

- a. K^+ is pumped against the gradient
- b. 2K^+ are exchanged with 5Na^+
- c. Hypercalcemia causes arrest in $\text{Na}^+\text{-K}^+$ pump
- d. Increase in intracellular Na^+ increases action potential

52. Regarding transport of Ca^{++} across a membrane following are true:

[PGI June 03]

- a. Ca^{++} calmodulin binding
- b. It is a passive mechanism
- c. Required hydrolysis of ATP
- d. It is a symport
- e. It is an active process

53. True statements about Ca^{2+} transport across membrane:

[PGI Dec 03]

- a. Calcium clamodulin mediated
- b. Maintain intracellular Ca^{2+} 10,000 times higher the extracellular Ca^{2+}

- c. Requires hydrolysis of ATP
- d. It is symport

54. The process by which fusion of part of a cell membrane occurs is/are:

[PGI June 05]

- a. Cell division
- b. Endocytosis
- c. Exocytosis
- d. Virus replication

55. Exocytosis:

[PGI June 2K]

- a. Extrusion of cell bound vesicles
- b. Intrusion of liquid particles
- c. Intrusion of solid particles
- d. All of the above

56. Clathrin is used in:

[AIIMS Nov 01]

- a. Receptor mediated endocytosis
- b. Exocytosis
- c. Cell to cell adhesion
- d. Plasma membrane

57. Receptor mediated endocytosis is by:

[AIIMS Dec 98]

- a. Clathrin
- b. Porine
- c. Cytocin
- d. Vimentin

58. The following is an example of 'Regulated pathway':

[JIPMER 02]

- a. Constitutive exocytosis
- b. Receptor mediated endocytosis
- c. Constitutive endocytosis
- d. Nonconstitutive exocytosis

RESTING MEMBRANE POTENTIAL

RECENT MCQs

59. Nernst potential for K^+ is:

- a. +90 mV
- b. -90 mV
- c. +70 mV
- d. -70 mV

60. Resting membrane potential of nerve is equal to equilibrium potential of:

- a. Na^+
- b. K^+
- c. HCO_3^-
- d. Cl^-

61. Resting membrane potential in nerve fibre:

- Is equal to the potential of ventricular muscle fibre
- Can be measured by surface electrodes
- Increases as extracellular K^+ increases
- Depends upon K^+ equilibrium

AIIMS/PGI/JIPMER

62. Equilibrium potential for an ion is calculated using: [AIIMS May 08]

- Gibbs-Donnan equation
- Nernst equation
- Goldman equation
- Donnan equation

63. Resting membrane potential is close to the isoelectrical potential of:

[AIIMS 96, AI 93]

- Na^+
- Cl^-
- K^+
- Mg^{++}

64. Resting membrane potential is mainly due to: [PGI June 03]

- Na^+
- K^+
- Cl^-
- Mg^{++}

65. What is/are effect on membrane when extracellular concentration of K^+ is decreased? [PGI May 09, Dec 08]

- Decreased magnitude of RMP
- Increased negativity of the membrane
- Increased magnitude of RMP
- Decreased negativity of membrane

66. Most diffusable ion in excitable tissue is: [AI 98]

- Na^+
- K^+
- PO_4^-
- Cl^-

67. Excitable tissue at rest is least permeable to: [AI 96]

- Na^+
- K^+
- Ca^{++}
- Cl^-

68. Intracellular concentration of K^+ ion is 10 mM and extracellular concentration is 100 mM. Calculate the equilibrium potential of K^+ based on Nernst equation: [AIIMS Nov 2015]

- 60 mV
- 0 mV
- 100 mV
- 90 mV

69. Negative ion concentration is 100 mMol/L outside the cell membrane and 10 mMol/L inside cell membrane. Nernst potential of this ion:

- +10
- +61
- 10
- 61

FUTURE TRENDS

70. A muscle cell has an intracellular $[Na^+]$ of 14 mM and an extracellular $[Na^+]$ of 140 mM. Assuming that $2.3 RT/F = 60$ mV, what would the RMP if the muscle cell membrane were permeable only to Na^+ ?

- +90 mV
- 60 mV
- +60 mV
- +80 mV

The table shown below is the concentration of 4 ions across the plasma membrane of a cell model. Answer the following questions (number 71-73):

Intracellular (mM)	Extracellular (mM)
140 K^+	14 K^+
10 Na^+	100 Na^+
11 Cl^-	110 Cl^-
10^{-4} Ca^{++}	2 Ca^{++}

71. What is the equilibrium potential for Cl^- across the plasma membrane of this cell?

- a. 0 millivolts b. -122 millivolts
c. 60 millivolts d. -60 millivolts

72. If the membrane potential of this cell is -80 millivolts, the driving force is greatest for which ion?

- a. Ca^{++}
b. Cl^-

- c. K^+
d. Na^+

73. If this cell were permeable only to K^+ , what would be the effect of reducing the extracellular K^+ concentration from 14 to 1.4 mmol?

- a. 10 mV hyperpolarization
b. 122 mV hyperpolarization
c. 60 mV depolarization
d. 60 mV hyperpolarization

ANSWERS WITH EXPLANATIONS

1. Ans. d. Protein

(Ref: Guyton-Physiology-12th edn. pp 14 & 13th edn. pp 9)

It is mainly composed of protein > Lipid

2. Ans. c. Protein displaced laterally

(Ref: Guyton-Physiology-12th edn. pp 14 & 13th edn. pp 9)

There is lateral diffusion of protein and lipids in membrane.

3. Ans. b. 1:1

(Ref: Guyton-Physiology-12th edn. pp 14 & 13th edn. pp 9)

The cell membrane contains protein and lipid in a 55:45 ratio. This is approximately 1:1.

4. Ans. b. Cholesterol

(Ref: Harper's Illustrated Biochemistry, 30th edn. pp 267)

Cholesterol is an amphipathic lipid and as such is an essential structural component of membranes, where it is important for the maintenance of the correct permeability and fluidity, and of the outer layer of plasma lipoproteins.

5. Ans. c. Adhesion molecule

(Ref: Guyton-Physiology-13th edn. pp 13)

Integral proteins provide structural component of membrane like channels (or

pores), carrier proteins (pumps), receptor (enzyme receptor) etc. Peripheral protein molecules are often attached to the integral proteins.

6. Ans. b. Na-K-ATPase > a. Heat stress

(Ref: Ganong's Review of Medical Physiology 25th pp.49)

Na-K-ATPase pump regulate the cell volume and membrane integrity.

7. Ans. a. Protein

(Ref: Guyton-Physiology-13th edn. pp 13)

Integral proteins provide structural component of membrane like channels (or pores), carrier proteins (pumps), receptor (enzyme receptor) etc.

8. Ans. d. 1.14

(Ref: Harper's Illustrated Biochemistry, 30th edn. pp 478)

Mass ration of protein to lipid in human erythrocyte the ratio is 1.1.

9. Ans. d. Myelin sheath membrane

(Ref: Harper's Illustrated Biochemistry, 30th edn. pp 478)

Mass ratio of protein to lipid is 3.2 in inner mitochondrial membrane > 2.0 in sarcoplasmicreticulum > 1.1 in outer mitochondrial membrane (1.1) >>> 0.23 in myelin sheath.

10. Ans. None

(Ref: *Biophysics & Biophysical Chemistry* By D. Das page 281)

Resistance of intracellular fluid 10^2 Ohm.cm². Resistance of the extracellular fluid is very low compared to ICF. The resistance across the cell membrane may be high up to 10^5 Ohm.cm² (Average membrane resistance is 3450 Ohm.cm²).

11. Ans. d. Ankyrin

(Ref: *Harper's Illustrated Biochemistry*, 30th edn. pp 482)

Ankyrin is a peripheral protein bound to the inner aspect of the integral protein "band 3" of the erythrocyte membrane.

Spectrin, a cytoskeletal structure within the erythrocyte, is in turn bound to ankyrin and thereby plays an important role in maintenance of the biconcave shape of the erythrocyte.

12. Ans. b. Microtubules

(Ref: *Ganong's Review of Medical Physiology* 25th edn pp.38)

Microtubule is a cytoskeletal protein, which maintains the size and shape of the cell. Microtubule may play a role in fine-tuning of locomotion.

13. Ans. b. Tubulin

(Ref: *Ganong's Review of Medical Physiology* 25th edn pp.36, 38)

- ❑ Tubulins are the structural subunits of microtubules, which regulates cell motility.
- ❑ Motilin is a 22-amino acid polypeptide hormone in humans, which regulates intestinal motility.
- ❑ Laminin is an extracellular matrix protein, which regulates cell development and growth. Others matrix protein with similar functions are collagens, bronectin, tenascin, and various proteoglycans.
- ❑ Tactilin: no such term in medical dictionary.

14. Ans. a. Gap junction

(Ref: *Ganong's Review of Medical Physiology* 25th edn pp.41)

The pore diameter in the channel is estimated between 0.8 and 1.4 nm, which permits the passage of ions, sugars, amino acids, and other solutes with molecular weights up to about 1000 Da.

15. Ans. d. Cardiac muscle

(Ref: *Ganong's Review of Medical Physiology* 25th edn pp.112)

Gap junctions are present in electrically excitable cells, such as neurons, heart, and smooth muscle. Indeed, gap junctions (electrical synapses) were first discovered in myocardium and nerve because of their properties of electrical transmission between adjacent cells.

16. Ans. b. Triglycerides

(Ref: *Guyton-Physiology*-12th edn. pp 14 & 13th edn.pp 9)

17. Ans. b. A stretch of hydrophobic amino acids

(Ref: *Ganong's Physiology* 24th ed. pp 32)

The uncharged, hydrophobic portions of the proteins are usually located in the interior of the membrane, whereas the charged, hydrophilic portions are located on the surfaces.

18. Ans. e. GM2 Gangliosides

(Ref: *Harper's Illustrated Biochemistry*, 30th edn. pp 477)

Membrane carbohydrates occur almost invariably in combination with lipids in the form of glycolipids, e.g. Gangliosides and cerebroside.

19. Ans. a. Asymmetrical arrangement of cell membrane component

(Ref: *Harper's Illustrated Biochemistry*, 30th edn. pp 477)

20. Ans. d. Linoleic acid

(Ref: *Harper's Illustrated Biochemistry, 30th edn. pp 477*)

The fluidity of membrane depends on lipid composition. More saturated fatty acids makes the membrane stiffer (so, decrease fluidity and increase T_m). Unsaturated fatty acids (linoleic acid) increase the fluidity of membrane (decrease T_m).

Cholesterol increase fluidity below T_m and above T_m it decrease fluidity of membrane.

21. Ans. b. Saturated fatty acids

(Ref: *Harper's Illustrated Biochemistry, 30th edn. pp 477*)

Increase T_m means more rigid (decrease fluidity) membrane.

22. Ans. a. Inner mitochondrial membrane

(Ref: *Harper's Illustrated Biochemistry, 30th edn. pp 477*)

Highest protein in inner mitochondrial membrane and highest lipid in myelin sheath.

23. Ans. a. Hydrophobic interactions**b. Both hydrophobic and covalent interactions****c. Covalent bonds**

(Ref: *Harper's Illustrated Biochemistry, 30th edn. pp 477*)

Electrostatic and hydrogen bond are present between peripheral and integral protein (not between protein and lipid).

24. Ans. b. Protein

(Ref: *Guyton-Physiology-13th edn. pp 13*)

Integral proteins provide structural component of membrane like channels (or pores), carrier proteins (pumps), receptor (enzyme receptor) etc.

25. Ans. a. GPI

(Ref: *Harper's Illustrated Biochemistry, 30th edn. pp 577*)

- ❑ One of the major classes of glycoproteins is the membrane-bound proteins that are anchored to the lipid bilayer by a glycosylphosphatidylinositol (GPI) tail. GPI linkage is the commonest way in which various proteins are anchored to cell membranes.
- ❑ The Sec A protein is a part of Sec machinery (or translocase), which provides a major pathway of protein translocation from the cytosol across the cytoplasmic membrane in bacteria.
- ❑ Tartrate-resistant acid phosphatase (TRAP or TRAPase) is a glycosylated monomeric metalloprotein enzyme expressed in mammals.

26. Ans. d. Spectrin

(Ref: *Ganong's Review of Medical Physiology 25th edn pp.40*)

Cells are attached to the basal lamina and to each other by cell adhesion molecule (CAMs) that are prominent parts of the intercellular connections. The CAMs can be divided into four broad families:

- ❑ Integrins
- ❑ Adhesion molecules of the IgG superfamily of immunoglobulins
- ❑ Cadherins
- ❑ P-Selectins.

27. Ans. a. Secondary active transport

(Ref: *Ganong's Review of Medical Physiology pp 48*)

"In many situations, the active transport of Na is coupled to the transport of other substances (secondary active transport). For example, the luminal membranes of mucosal cells in the small intestine contain a symport that transports glucose into the

cell only if Na^+ binds to the protein and is transported into the cell at the same time."

28. Ans. a. 3 Na out/2K in

(Ref: Ganong's Review of Medical Physiology pp 47)

Na-K-ATPase "It is an electrogenic pump in that it moves three positive charges out of the cell for each two that it moves in, and it is therefore said to have a coupling ratio of 3:2".

29. Ans. d. Glycosylation

(Ref: Ganong's Review of Medical Physiology pp 47)

"The β subunit has a single membrane-spanning domain and three extracellular glycosylation sites, all of which appear to have attached carbohydrate residues."

30. Ans. a. Ca^{++}

(Ref: Ganong's Review of Medical Physiology pp 43)

The area of fusion (between vesicle and cell membrane) breaks down, leaving the contents of the vesicle outside and the cell membrane intact. This part is the Ca^{++} dependent process of exocytosis.

31. Ans. a. Number of osmole per litre

(Ref: Ganong's Review of Medical Physiology pp 6)

"The **osmolarity** is the number of osmoles per liter of solution (e.g. plasma), whereas the **osmolality** is the number of osmoles per kilogram of solvent."

32. Ans. d. Cardiac muscles

(Ref: Ganong's Review of Medical Physiology 24th edn pp39)

Gap junctions are present in myocardium, smooth muscle and neurons. But not in skeletal muscle.

33. Ans. a. CO_2

(Ref: Alberts - Molecular Biology of the Cell 5th Edition pp.652)

Relative permeability of different molecules: hydrophobic molecules (CO_2 , O_2 , N_2 , steroid hormones) >>> small uncharged polar molecules (H_2O , urea, glycerol) >>> large uncharged polar molecules (glucose, sucrose) >>> Ions (Na^+ , K^+ , Cl^-)

34. Ans. a. Oxygen [Explanation see Q. 33]

35. Ans. c. Water

(Ref: Ganong's Review of Medical Physiology 25th edn pp.6)

Osmosis is process of diffusion of solvent molecules into a region in which there is a higher concentration of a solute to which the membrane is impermeable. Na^+ , K^+ and glucose are responsible for generation of osmolality/osmotic pressure.

36. Ans. a. Simple diffusion

(Ref: Ganong's Review of Medical Physiology 25th edn pp.6)

Fick's law is used to calculate the rate of simple diffusion.

37. Ans. d. Needed for generation of action potential

(Ref: Ganong's Review of Medical Physiology pp.49)

The pump is responsible for maintenance of resting membrane potential not the AP generation.

38. Ans. c. Ca^{++}

(Ref: Ganong's Review of Medical Physiology pp.46)

Reverse pinocytosis is an exocytosis process require the presence of Ca^{++} .

39. Ans. a. Gap junctions

(Ref: Ganong's Review of Medical Physiology 24/e pp 39)

The diameter of the channel is normally about 2 nm, which permits the passage of ions, sugars, amino acids, and other solutes with molecular weights up to about 1000.

40. Ans. d. Diffusion

(Ref: *Alberts Molecular Biology of the Cell 5th edn. pp. 655*)

See explanation in text.

41. Ans. b. It requires a carrier protein

(Ref: *Guyton's Physiology 13th edn. pp 35*)

42. Ans. c. Occur in direction opposite to electrical gradient

(Ref: *Guyton's Physiology 13th edn. pp 35*)

43. Ans. a. Facilitated diffusion requires energy

(Ref: *Guyton's Physiology 13th edn. pp 35*)

44. Ans. c. Carrier protein

(Ref: *Guyton's Physiology 13th edn. pp 35*)

Active transports are of two types: primary active transport (Na-K ATPase) and secondary active transport. Both types are mediated by carrier protein.

45. Ans. c. Simple diffusion

(Ref: *Guyton's Physiology 13th edn. pp 35*)

Carrier dependent transport follows saturation kinetics. Simple diffusion does not require carrier protein.

46. a. Concentration across

e. Area

(Ref: *Ganong's Review of Medical Physiology pp 4*)

47. Ans. c. 3:2

(Ref: *Ganong's Review of Medical Physiology 24th end. pp 43*)

48. Ans. d. Quabain

(Ref: *Ganong's Review of Medical Physiology 24th end. pp 43*)

49. a. Involves ATPase activity

(Ref: *Ganong's Review of Medical Physiology 24th end. pp 43*)

50. Ans. a. Active transport

(Ref: *Guyton's Physiology 13th edn. pp 42*)

51. Ans. a. K⁺ is pumped against the gradient

(Ref: *Guyton's Physiology 13th edn. pp 42*)

52. Ans. c. Requires hydrolysis of ATP

e. It is an active process

(Ref: *Guyton's Physiology 13th edn. pp 43*)

Calcium transport is done by Na⁺-Ca⁺⁺ exchanger (NCX), which transport 3Na⁺ in and 1Ca⁺⁺ out of the cell normally. It is a secondary active transport (antiport), which requires energy.

53. Ans. c. Requires hydrolysis of ATP

(Ref: *Guyton's Physiology 13th edn. pp 42*)

See above explanation.

54. Ans. b. Endocytosis

c. Exocytosis

(Ref: *Ganong's Review of Medical Physiology pp 43*)

During phagocytosis (endocytosis) the invagination is pinched off, leaving the engulfed material in the membrane-enclosed vacuole and the cell membrane intact.

55. Ans. a. Extrusion of cell bound vesicles

(Ref: *Ganong's Review of Medical Physiology pp 43*)

Vesicles containing material for export are targeted to the cell membrane, where they bond via the v-SNARE/t-SNARE arrangement. The area of fusion then breaks down, leaving the contents of the vesicle outside and the cell membrane intact. This is the Ca²⁺-dependent process of exocytosis.

56. Ans. a. Receptor mediated endocytosis

(Ref: Ganong's Review of Medical Physiology pp 43)

Clathrin-mediated endocytosis is responsible for the internalization of many receptors and the ligands bound to them including, for example, nerve growth factor and low-density lipoproteins. It also plays a major role in synaptic function.

57. Ans. a. Clathrin

(Ref: Ganong's Review of Medical Physiology pp 43)

58. Ans. d. Nonconstitutive exocytosis

(Ref: Ganong's Review of Medical Physiology pp 43)

In the **nonconstitutive pathway**, proteins from the Golgi apparatus initially enter secretory granules, where processing of pro-hormones to the mature hormones occurs before exocytosis. The other pathway, the **constitutive pathway**, involves the prompt transport of proteins to the cell membrane in vesicles, with little or no processing or storage. *The nonconstitutive pathway is sometimes called the regulated pathway, but this term is misleading because the output of proteins by the constitutive pathway is also regulated.*

59. Ans. b. - 90 mV

(Ref: Ganong's Review of Medical Physiology pp 84)

60. d. Cl⁻

(Ref: Ganong's Review of Medical Physiology pp 84)

RMP of neurone is - 70 mV, which is equal to equilibrium potential of Cl⁻.

61. Ans. d. Depends upon K⁺ equilibrium

(Ref: Ganong's Review of Medical Physiology pp 84)

RMP depends on ion which has maximum permeability in resting stage. As K⁺ has

highest permeability in esting stage, RMP is close to K⁺ equilibrium.

62. Ans. b. Nernst equation

(Ref: Ganong's Review of Medical Physiology pp 84)

63. Ans. c. K⁺

(Ref: Ganong's Review of Medical Physiology pp 84)

64. Ans. b. K⁺

(Ref: Ganong's Review of Medical Physiology pp 84)

65. Ans. b. Increased negativity of the membrane**c. Increased magnitude of RMP**

(Ref: Principles of Neural Science-4th edn. By Eric Kandel)

Hypokalemia causes shift of extra K⁺ from cell interior. Due to loss of extra K⁺ (positive ions), RMP of the cell becomes more negative (which is known as increase RMP).

66. Ans. b. K⁺

(Ref: Principles of Neural Science-4th edn. By Eric Kandel)

Order of diffusibility: K⁺ >> Cl⁻ >> Na⁺.
Permeability of K⁺:Na⁺:Cl⁻ = 1.0:0.04:0.45

67. Ans. a. Na⁺

(Ref: Principles of Neural Science-4th edn. By Eric Kandel)

68. Ans. a. 60mV (it will be - 60mV if ECF, ICF concentration reverse)

$$\text{Nernst } E^Q: \quad E = 2.3 \frac{RT}{ZF} \log_{10} \left(\frac{\text{Conc. } i}{\text{Conc. } o} \right)$$

$$- 2.3 \frac{RT}{ZF} = - 60 \text{ mV @ } 37^\circ\text{C}$$

$$\text{So, } E = + 60 \log_{10} \left(\frac{\text{Conc. } o}{\text{Conc. } i} \right)$$

In the question: $E_k = 60 \log_{10} \left(\frac{100}{10} \right)$
 $= 60 \log_{10} 10$
 $= 60 \times 1 = 60 \text{ mV}$

69. Ans. d. – 61 [See explanation of Q. 68]

Negative ion is high in ECF. So, it enters into the cell and makes the cell negative.

70. Ans. c. + 60 mV

RMP in this case will be equal to Na equilibrium potential.

71. Ans. d. – 60 milli volts

The equilibrium potential for chloride (E_{Cl}) can be calculated using the nernst equation: E_{Cl} (in millivolts) = $60 \times \log (C_i/C_o)$, where C_i is ICF concentration and C_o is ECF concentration. In this case, $E = 60 \times \log (11/110) = -60 \text{ mV}$. Determine the absolute value, and decide the sign. As Cl^- is high outside, so it will enter into the cell and makes the interior of the cell negative. So, it is -60 mV .

72. Ans. a. Ca^{++}

Quantitatively, the driving force on any given ion is the difference in between the membrane potential (V_m) and the equilibrium potential for that ion (E_Q). In this cell, $E_K = -60 \text{ mV}$, $E_{Cl^-} = -60 \text{ mV}$, $E_{Na^+} = +60 \text{ mV}$, and $E_{Ca^{++}} = 516 \text{ mV}$ ($\log 20000 = 4.3$). Therefore, Ca^{++} is the ion with the equilibrium potential farthest from V_m . This means that Ca^{++} would have the greatest tendency to cross the membrane through an open channel (in this particular example). If Ca^{++} not in the choice the answer would be Na^+ (positive Eq).

73. Ans. d. 60 mV hyperpolarization

If a membrane is permeable to only a single ion, membrane potential (RMP) of the cell is equal to the equilibrium potential for that ion. In this cell, $E_{K^+} = -60 \text{ mV}$, so RMP is -60 mV . If the extracellular K^+ concentration is reduced 10-fold, $E_{K^+} = 60 \times \log (1.4/140) = -120 \text{ mV}$ [$\log (1.4/140) = 2$], which is a hyperpolarization of 60 mV .

SECTION

2

Nerve-Muscle Physiology

CHAPTERS

3. Physiology of Nerve
4. Physiology of Muscle

mebooksfree.com

CHAPTER

3

Physiology of Nerve

NERVE (FIG. 3.1)

A nerve is a compact bundle of axons located outside the CNS.

- ❑ Individual nerve fibers (single axons) are covered with varying amounts of myelin and then covered by endoneurium.
- ❑ These individually wrapped nerve fibers are then grouped into bundles of fibers called fascicles, which are covered by perineurium.
- ❑ Finally, groups of fascicles are bundled together to form the peripheral nerve (such as the median nerve), which is covered by epineurium.
- ❑ Perineurium forms blood neuron barrier.

I IMPORTANT

In human nervous system:

- ❖ Number of neurons: 10^{11} (100 billions)
- ❖ Number of glia: 10-50 times more than the number of neurons
- ❖ One neuron makes ~ 2000 synapse
- ❖ Total number of synapses: 2×10^{14}
- ❖ The CNS is a complex organ; $\sim 40\%$ of the human genes participate in its development.

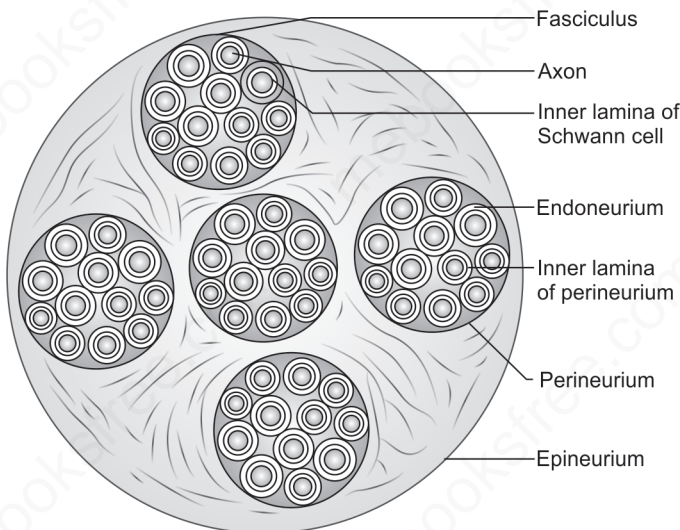

Fig. 3.1: Cross-section of a peripheral nerve

Neuron: Neuron, or the nerve cell, is the structural and functional unit of the nervous system.

I IMPORTANT

Nissl bodies or granules

- ❖ RNA rich, basophilic structure composed of rough endoplasmic reticulum and polyribosome aggregates. So, it is the biosynthetic apparatus of neuron.
- ❖ Distributed throughout the cell body and large dendrites but no Nissl bodies present in the axon hillock and axon.
- ❖ Nissl bodies are more obvious in large, highly active cells, such as spinal motor neurons.

Parts of Neuron (FIG. 3.2)

The typical neuron consists of:

- ❑ Perikaryon or soma or, cell body: Contains many Nissl bodies and Golgi bodies
- ❑ Dendrites: are known as receptor zone where graded electrogenesis occurs
- ❑ Axon hillock: The thickened area of cell body from which axon arises. They lack RER, free ribosomes, and Golgi apparatus
- ❑ Initial segment (50–100 μM): The first unmyelinated portion of the axon; this has the lowest threshold
- ❑ Axon telodendria: Also called synaptic knobs or terminal buttons.

Myelin (Length: 1 to 2 mm)

- ❑ **In peripheral nerves:** Schwann cell forms myelin on one axon. There is a protein called protein P_0 in Schwann, which is responsible for compaction of myelin. Mutation in P_0 leads to peripheral neuropathies.
- ❑ **In CNS:** By oligodendroglia. Oligodendroglia forms myelin on many axons.

Types of Neuron Figs 3.3 and 3.4

- ❑ **Unipolar:** These neurons have one process, with different segments serving as receptive surfaces and releasing terminals. **Example:** Only found in the mesencephalic nucleus of the Vth cranial nerve.
- ❑ **Pseudounipolar:** Subclass of bipolar cells called pseudounipolar cells. As the cell develops, a single process splits into two, both of which function as axons—one going to skin or muscle and another to the spinal cord.

Example: Dorsal root ganglion neuron (sensory neuron) (Figs. 3.3 and 3.4).

- ❑ **Bipolar:** These neurons have two specialized processes: a dendrite that carries information to the cell and an axon that transmits information from the cell.

Example: Retina, olfactory epithelium, sensory ganglia of cochlear and vestibular nerves.

- ❑ **Multipolar:** These neurons have one axon and many dendrites. **Example:** Motor neurons, hippocampal pyramidal cells and cerebellar Purkinje cells.

Neurons may also be classified according to size:

❑ **Golgi type I neurons:** These neurons have a long axon that may be 1 m or more in length in extreme cases.

Examples: The axons of these neurons form the long fiber tracts of the brain and spinal cord and the nerve fibers of peripheral nerves. The pyramidal cells of the cerebral cortex, the Purkinje cells of the cerebellar cortex, and the motor cells of the spinal cord are good examples.

❑ **Golgi type II neurons:** These neurons have a short axon that terminates in the neighborhood of the cell body or is entirely absent. They greatly outnumber the Golgi type I neurons. The short dendrites that arise from these neurons give them a star-shaped appearance. These neurons are numerous in the cerebral and cerebellar cortex and are often inhibitory in function.

I IMPORTANT

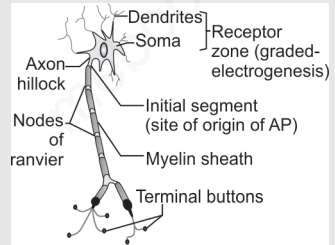

Fig. 3.2: Functional parts of neuron

Functional Areas of Neuron

Function	Area of neuron
Voltage gates Na ⁺ channel location (per square micrometer)	Myelinated: <ul style="list-style-type: none"> • Node of Ranvier: 2000–12,000 (maximum) • Initial segment: 350–500 • Cell body: 50–75 • Axon terminal: 20–75 • Surface of myelin: less than 25 Unmyelinated: axon ~110
Graded electrogenesis	Dendrite (receptor)>>Soma
Generation (initiation) of action potentials or, Lowest threshold	<ul style="list-style-type: none"> • The initial segment in motor neuron. • The first node of Ranvier in cutaneous sensory neurons.
Transmission of action potential	Axonal process
Release of synaptic transmitter	Nerve endings

Axonal Transport (Fig. 3.5)

Neurons are secretory cells. The apparatus for protein synthesis is located for the most part in the cell body but secretory zone is generally at the end of the axon, far removed from the cell body. The transport of proteins and polypeptides to the axonal ending is known as axoplasmic transport, which are typical of intracellular transport.

I IMPORTANT

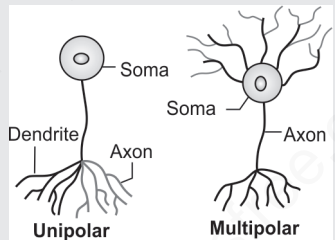

Fig. 3.3: Types of neuron

I IMPORTANT

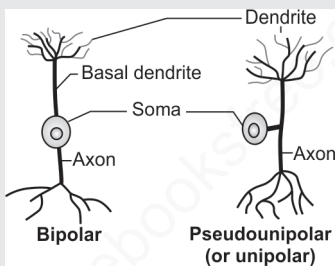

Fig. 3.4: Different types of neurons

I IMPORTANT

- ❖ Myosin is also a molecular motor apart from kinesin and dynein
- ❖ Myosin-V (one of 18 known classes of myosin motors) is involved in fast axonal/dendritic transport both in the anterograde and retrograde direction.
- ❖ Other types of myosin that are also involved in neuronal transport are classes I and VI.
- ❖ Myosin II powers muscle contraction (not molecular motor).

- ❑ **Anterograde transport:** occurs along microtubules that run along the length of the axon.
- ❑ **Retrograde transport:** in the opposite direction (from the nerve ending to the cell body).

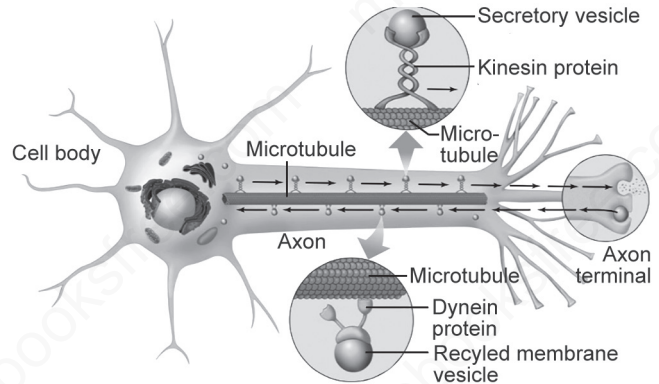

Fig. 3.5: Axonal transport along microtubules by dynein and kinesin

Different types of axonal transport			
Transport type	Speed	Mechanism	Transported material
Fast anterograde (plus end directed)	~ 400 mm/day	Salutatory movement along microtubule by molecular motor Kinesin (ATP dependent)	Golgi-derived carrier vesicles and mitochondria
Fast retrograde transport (minus end directed)	~200 mm/day	Salutatory movement along microtubule by molecular motor Dynein (ATP dependent)	Degraded vesicular membrane, toxin, growth factor and viruses
Slow anterograde	0.5 to 10 mm/day	Not clear. Possible Molecular motor.	Cytoskeletal elements (microfilament, component of microtubules, actin)

Note: Plus end of neuron → growing end (towards axon terminal). Minus end → towards cell body

ACTION POTENTIAL (AP) IN NEURON

Instruments Required for Membrane Potentials Recording

- ❑ Stimulating electrodes: Cathode and anode.
- ❑ Recording electrodes: **Glass microelectrodes** (tip diameter < 0.5 μm)

- ❑ Display: CRO (cathode ray oscilloscope), like a computer screen
- ❑ Squid giant axon: It is a large diameter (up to 0.5 mm) neuron from where recording of potential is easier.

Instruments Set-up for Membrane Potential Recording

- ❑ Both stimulating electrodes (cathode and anode) are placed on the surface of the neuron.
- ❑ The recording electrodes: One electrode is on the surface and the other, inside the cell (monophasic action potential recording) or else, both recording electrodes can be on the surface.
- ❑ When both the electrodes are on the surface, a biphasic action potential is recorded.
- ❑ *Cathode is depolarizing and anode is hyperpolarizing potential.*

Concept of Polarity

All cells have a resting membrane potential (RMP). If a cell with a RMP of say, -70 mV changes to say -60 mV, the cell is said to be depolarized (note that one has to ignore the negative sign while commenting on the change of polarity).

From	To	State
-70 mV	-90 mV	Hyperpolarized
-70 mV	$+40$ mV	Depolarized
-70	-40 mV	Depolarized

While stimulating the nerve, the following changes/ events occur sequentially:

- ❑ **Electrotonic potentials:** These are potential changes that occur in the nerve due to passive addition of charge; e.g. at the cathodal end of the stimulating electrode, negative charge are added on the surface of membrane and at the anodal end of the stimulating electrode, positive charges are added.

Examples: if RMP is -70 mV.

- **Cathodic Stimulation:** Addition of negative charge (say for example ' -2 ' charge) at membrane surface leads to change in RMP from -70 mV to -68 mV [$(-70) - (-2) = -68$]. So, *cathodal current is depolarizing.*
- **Anodic stimulation:** Addition of positive charge (say for example '+1' charge) leads to change in RMP to -71 mV (hyperpolarized) at anodal end [$(-70) - (+1) = -71$]. So, *Anodal current is hyperpolarizing.*

I IMPORTANT

- ❖ Electrotonic potential is due to passive deposition of charge on membrane.
- ❖ Electrotonic potential can be either cat-electrotonic or an-electrotonic. Cat-electronic (Cathode) potential is **depolarizing and anelectronic (anode) potential is hyperpolarizing.**

I IMPORTANT

Local potential is due to opening of ion channels (active) as well as passive addition of charge (passive).

- **Local response (Fig. 3.6):** When electronic potential reaches upto a certain level, say from -70 mv to -63 mv, gradual opening of voltage gated Na^+ channel occurs. But at this point number of open Na^+ channels is very few. The potential due to this Na^+ is called the local potential. This change in the potential is more than what you would expect on the basis of passive addition of charge.

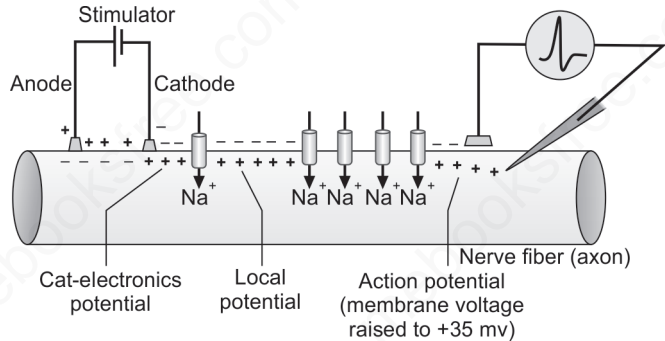

Fig. 3.6: Sequential change in membrane potential during stimulation by cathodal current. Stimulating device is placed on one part of membrane and recording devices are placed on other side of membrane

- **Action potential (AP):** When the local response brings out a change of say 15 mV (i.e. from -70 mV to -55 mV), the threshold level (firing level) is reached wherein a very large number of voltage-gated Na^+ channels open up simultaneously and cause the action potential (AP).
 - Action potential (AP) is a rapid, all-or-none change in the membrane potential followed by a return to the resting membrane potential.
 - AP is propagated with the same shape and size along the entire length of an axon.

Difference between local potential and AP are:

Local potential	Action potential
Proportional to stimulus strength (graded)	Independent of stimulus strength (all or, none)
Does not follow all or none law	Follows all or none law
Not propagated but decremental with distance	Propagated unchanged in amplitude
Can be depolarizing/ hyperpolarizing	Always depolarizing
Exhibits summation	Summation not possible

Example of local potentials: EPSP/IPSP, dendritic potentials, synaptic potentials, electrotonic potentials, generator potentials, receptor potentials and motor end plate potential.

DIFFERENT PHASES OF AP (FIG. 3.7)

Depolarization

Depolarization is caused by rapid increase in conductance of Na^+ ($g_{\text{Na}} \gg \text{K}^+$ conductance).

- ❑ AP moves toward the equilibrium potential for Na^+ (+65 mV).
- ❑ But, the peak of AP does not reach +65 mV because of rapid inactivation Na^+ channels and simultaneous but slower increase in g_{K} which causes opposition to depolarization.

Repolarization

- ❑ Continuing increase in g_{K} , as well as by the decrease in g_{Na}
- ❑ The Na^+ channels rapidly enter into an **inactivated state** and remain in this state for a few milliseconds before returning to the resting state, when they again can be activated.

After-hyperpolarization

- ❑ The slow return of the K^+ channels to the closed state.
- ❑ g_{Na} has returned to base-line levels but g_{K} remains still elevated (Fig. 3.8).
- ❑ Thus, the resting membrane potential is pulled even closer to the K^+ equilibrium potential (-90 mV), and the membrane remains hyperpolarized as long as g_{K} remains elevated.

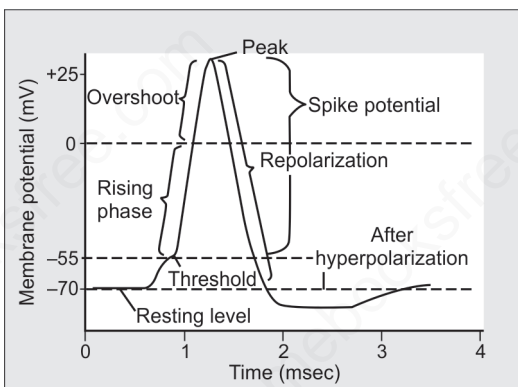

Fig. 3.7: Different phases of action potential

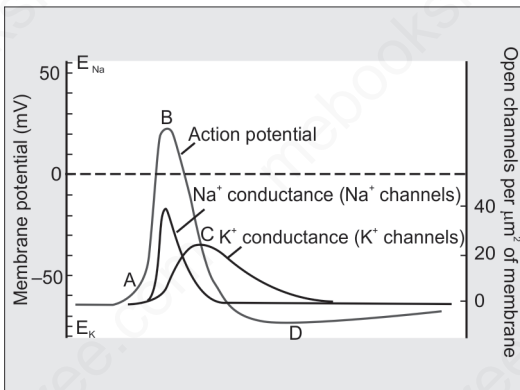

Fig. 3.8: Conductance of Na^+ and K^+ during action potential

Refractory Period (Fig. 3.9)

□ Absolute:

- Period when cell is unable to fire a second AP no matter how strongly it is stimulated.
- Starting from the firing level to the point when repolarization is one third complete.
- The cell is refractory because a large fraction of its Na^+ channels are voltage inactivated and cannot be reopened until the membrane is repolarized.

□ Relative:

- Starting from the point when repolarization is one third complete to the end of after-depolarization.
- The cell is able to fire a second action potential, but a stronger than normal stimulus is required.
- Some of the Na^+ channels are still voltage inactivated. Therefore, a stronger than normal stimulus is required to open the critical number of Na^+ channels needed to trigger AP.

I IMPORTANT

- ❖ **Accommodation:** Refers to a gradual increase in threshold caused by prolonged slowly rising sub-threshold nerve depolarization, resulting from the inactivation of sodium channels.
- ❖ **Adaptation:** If a supra-threshold (NOT sub-threshold) stimulus persists unchanged for several minutes without a change in position or amplitude (NOT slowly rising), the neural response diminishes and sensation is lost, a condition called receptor adaptation.

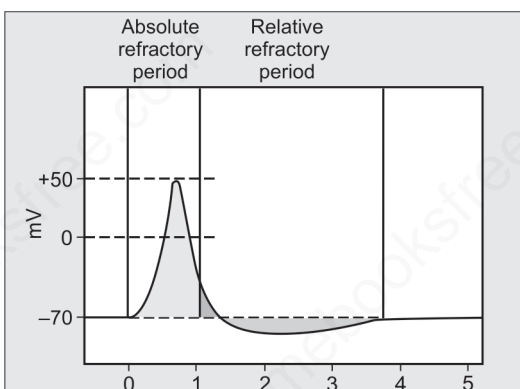

Fig. 3.9: Absolute and relative refractory period

I IMPORTANT

- ❖ TTX (tetrodotoxin, from pufferfish) or STX (saxitoxin, from 'red tide' dinoflagellates) blocks voltage gated Na^+ current and prevent AP generation.
- ❖ TEA (tetraethylammonium) blocks voltage gated K^+ channels during repolarization. In this case slow repolarization occurs via leaky K^+ channels.

Ionic Basis of AP in Different Tissue

AP (depolarization) in various tissue	Ionic basis
Nerve	Na^+
Skeletal muscle	Nonspecific cation channel (Na^+ channel)
Smooth muscle	Ca^{++}
SA Node	Ca^{++}
Ventricular muscle	Na^+
Endolymphatics potentials	K^+ influx

Other Types of Action Potential (Fig. 3.10)

Biphasic action potential	This type of record is obtained when both the recording electrodes are on the surface of the nerve typically about 1 cm apart.
Compound action potential (CAP)	When a nerve bundle is stimulated, more than one axon may be excited. The electrical recording of the combination of the action potentials produced is called CAP. <ul style="list-style-type: none"> • It is a biphasic AP also. • Seen in a mixed nerve bundle • It is a multipeaked action potential. These peaks are due to different types of fiber like alpha, beta (check image below) • Does not follow all or none law.

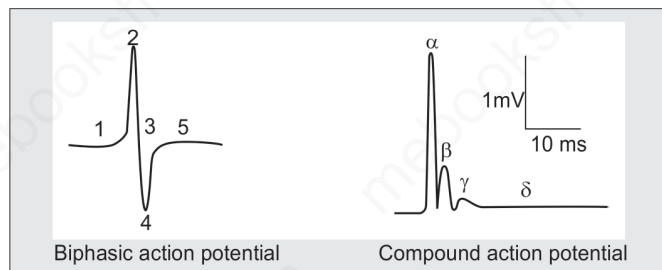
**Fig. 3.10:** Biphasic and compound action potential**Conduction of AP (Nerve Impulse)**

- ❑ The AP generated in the middle of an axon would be conducted in both directions simultaneously.
- ❑ Conduction is unilateral in synapse. In the natural situation, impulses pass in one direction only, i.e. from synaptic junctions or receptors along axons to their termination. Such conduction is called **orthodromic**.
- ❑ Conduction in the opposite direction (towards cell body) is called **antidromic**. Because synapses, unlike axons, permit conduction in one direction only, an

antidromic impulse will fail to pass the first synapse they encounter and die out at that point.

- ❑ The shape and size of the AP are relatively constant (**non-decremental**).
- ❑ **Space constant (length constant)**: The distance a given potential can travel before it is reduced to 37% (loss of 63%) of its maximum amplitude/height. Normally it is 1–3 mm in neuron. More the space constant, better the chances of summation.

Electrolytes abnormality and AP

- **Hyponatremia**: reduces the size/amplitude of the AP but little effect on RMP.
- **Hypernatremia**: Increase amplitude of AP but little effect on RMP.
- **Hyperkalemia**: increasing the external K^+ , increases AP duration and decreases RMP.
- **Hypokalemia**: rapid repolarization leads to decrease AP duration. RMP increases.
- **Hypocalcemia**: decrease in extracellular Ca^{2+} increases the excitability of nerve and muscle cells by decreasing the amount of depolarization necessary to initiate the changes in the Na^+ and K^+ conductance that produce the action potential.
- **Hypercalcemia**: increase in extracellular Ca^{2+} concentration can stabilize the membrane by decreasing excitability.

Factor Affecting Conduction Velocity of AP

- ❑ **Axon diameter**: More the diameter, more the speed of conduction.
 - Increases in diameter:
 - **Leads to decrease R_a (axonal resistance)** with the square of the diameter.
 - **Increases the capacitance (C_m)** of the membrane in direct proportion to diameter.
 - So increase in the diameter of the axon causes greater decrease in R_a and increase in C_m . The net effect is a decrease in $R_a C_m$.
- ❑ **Myelination**: Increases conduction velocity by saltatory conduction.
 - **Myelination decreases C_m** of the axon membrane and thus $R_a C_m$ also decrease.
 - Myelination results in a proportionately much greater decrease in $R_a C_m$ than does the same increase in the diameter of the axon core because

I IMPORTANT

The rate of passive spread of AP varies **inversely with the product $R_a C_m$ (Axonal resistance \times Capacitance)**. If this product is reduced, the rate of passive spread increases and the action potential propagates faster.

I IMPORTANT

The relationship between fiber diameter (thickness) and conduction velocity is linear for myelinated axons and parabolic relation for non-myelinated axons.

the many layers of membrane wrapped in the myelin sheath produce a very large decrease in C_m .

- Also remember, myelination increases transmembrane resistance (resistance across cell membrane)

I IMPORTANT

1. A and B fibers are myelinated, C fiber is unmyelinated
2. Numerical classification of nerve fiber is proposed by Llyod & Hunt

I IMPORTANT

- ❖ A and B are myelinated fiber; C are unmyelinated fiber.
- ❖ **Spike duration: C fiber- 2 ms (maximum), B fiber- 1.2 ms, A fiber- 0.4 to 0.5 ms.**

Nerve Fiber Classification: Erlanger and Gasser classification

Fiber types		Numerical Classification by Llyod and Hunt	Functions	Fiber diameter (μm)	Conduction velocity (m/s)
A	Alpha	Ia and Ib	Proprioception; somatic motor	12–20	70–120
	Beta	II	Touch, pressure	5–12	30–70
	Gamma		Efferent to muscle spindles	3–6	15–30
	Delta	III	Pain, temperature (cold)	2–5	12–30
B			Preganglionic (sympathetic main) autonomic	<3	3–15
C	Dorsal root	IV	Pain, temperature (warm), some mechano-sensation	0.4–1.2	0.5–2
	Sympathetic		Postganglionic autonomic (sympathetic main)	0.3–1.3	0.7–2.3

Strength–Duration Curve

Quantitatively stimulus has two characteristics: intensity (strength) and duration (time). Both are important in determining AP generation. In general, stronger the stimulus, less duration is required producing AP.

Rheobase	The <i>minimum strength</i> of a stimulus, which is able to produce AP in an excitable tissue (e.g. nerve, muscle), regardless of the duration it takes.
Utilization time (UT)	Minimum <i>time (duration)</i> for which <i>the rheobase</i> has to be applied for excitation of tissue.
Chronaxie	Minimum <i>time (duration)</i> for which a stimulus <i>doubles the rheobase</i> has to be applied for excitation of tissue.

- ❑ **Strength:** Duration curve gives idea of excitability of a tissue.
- ❑ Chronaxie is a better index than rheobase and UT for comparing the excitability of a tissue.
- ❑ Less the chronaxie (lower threshold), more is the excitable.
- ❑ **Chronaxie:** Nerve << skeletal muscle << myocardium << smooth muscle. Means nerve is most excitable tissue in body.
- ❑ **Excitability in nerve:** $A\alpha \gg A\beta \gg A\delta \gg B \gg C$ ($A\alpha$ most excitable; so, lowest threshold for activation).

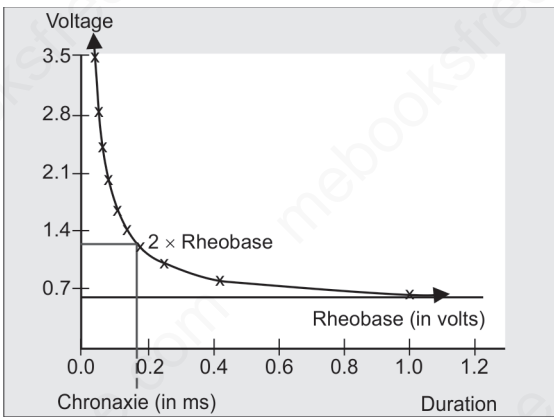

Fig. 3.11: Chronaxie and rheobase of an excitable tissue

From the graph above (Fig. 3.11), the rheobase is approximately 0.64 volts, and the chronaxie is about 0.16 ms.

Right and upward shift of the curve occurs (Fig. 3.12), when tissue is less excitable (more chronaxie).

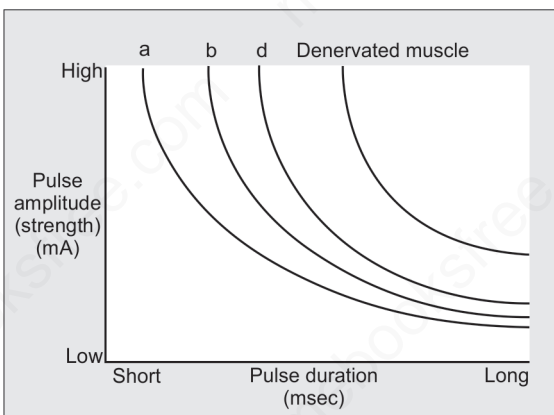

Fig. 3.12: Strength-duration curve of different nerve fibers

I IMPORTANT

- ❖ **Cold:** Carried by Ad fiber.
- ❖ Warm, burning pain and freezing pain carried by: C
- ❖ Proprioception is carried by muscle and skeletal mechanoreceptors. Examples of proprioceptors are muscle spindle ($A\alpha$, $A\beta$ and $A\gamma$), Golgi tendon organ ($A\alpha$), joint capsule receptor ($A\beta$) and Stretch-sensitive free endings ($A\delta$).

I IMPORTANT

- ❖ **Local anesthetic:** Susceptibility order $A\gamma$ and $A\delta \gg A\alpha$ and $A\beta \gg B \gg C$
- ❖ **Pressure:** Susceptibility order $A\alpha > A\beta > A\gamma > A\delta > B > C$ (largest diameter are most susceptible).
- ❖ **Hypoxia:** Susceptibility order $B > A > C$

I IMPORTANT

- ❖ **Paresthesias** (inappropriate sensations such as burning or prickling) usually seen when A-delta is involved.
- ❖ Pallesthesia is loss of vibration sense.

DEGENERATION AND REGENERATION OF NEURONS

When the axon of neuron is injured, a series of degenerative changes starts in different parts of neuron. Within a short time period, along with the degenerative changes, the reparative process (regeneration) also starts.

GRADING OF NERVE INJURY

Two classification systems exist:

1. Seddon's classification (neurapraxia, axonotmesis, neurotmesis)
2. Sunderland's classification (1st degree to 5th degree)

SEDDON'S CLASSIFICATION

Characteristic	Neurapraxia	Axonotmesis	Neurotmesis
Etiology	Nerve compression injury	Nerve crush injury	Nerve transection
Description	<ul style="list-style-type: none"> • Axon intact, local myelin injury only • Physiological conduction block • Motor > sensory fibers affected • Least severe injury 	<ul style="list-style-type: none"> • Axonal and myelin interruption • Connective tissue (endo-, epi-, perineurium), Schwann cell intact • Conduction failure • Wallerian degeneration occurs due to loss of axoplasmic flow 	<ul style="list-style-type: none"> • Axonal interruption • Connective tissue (end-, peri-, and in the most severe case, epineurium) disruption • Conduction failure • Most severe form
Nerve conduction study	Normal signal distal to lesion and abnormal across it	Conduction resemble neurapraxia 4–5 days until Wallerian degeneration starts	Conduction resemble axonotmesis but does not demonstrate recovery
Recovery	Hours to months (avg 6–8 weeks)	Weeks to months	Incomplete; Imperfect

Sunderland's Classification: Consists of 5 degrees of injury

1st degree (type 1)	Essentially the same as neurapraxia.
2nd degree (type 2)	Same as axonotmesis.
3rd degree (type 3)	Axonotmesis, plus endoneurium disruptions.
4th degree (type 4)	Axonotmesis, plus endo- and perineurium disruptions.
5th degree (type 5)	Same as neurotmesis (complete transection)

Stage of Degeneration

- ❑ Degenerative changes in axon distal to the site of injury: anterograde degeneration or *Wallerian degeneration*.
- ❑ Degenerative changes in the neuron proximal (attached to cell body) to the injury: retrograde degeneration.

Sequences of Degenerative Changes (Fig. 3.13)

1. After axotomy the *nerve terminals* of the injured neuron begin to degenerate.
2. The distal axonal stump separates from the parental cell body, becomes irregular, and undergoes *Wallerian degeneration*.

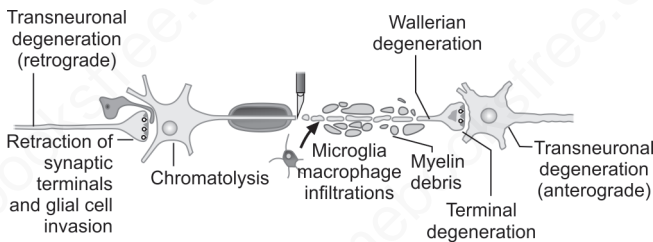

Fig. 3.13: Degenerative changes in injured neuron and its synaptic partners. Labeled number description is in text

Source: Adapted from Kandel Principles of Neural Science.

Myelin begins to fragment.

3. The lesion site is invaded by phagocytic cells (macrophage infiltration).
4. The cell body of the damaged neuron undergoes chromatolysis: The cell body swells and the nucleus moves to an eccentric position.
5. Synaptic terminals that contact the damaged neuron withdraw and the synaptic site is invaded by glial cell processes.
6. The injured neuron's inputs degenerate.
7. The targets neuron can atrophy and degenerate.

Axonal Regeneration

- ❑ Axonal sprouting occurs from the proximal stump, growing toward the nerve ending. This results from growth-promoting factors secreted by Schwann cells that attract axons toward the distal stump.
- ❑ Denervated distal stumps are able to upregulate production of neurotrophins that promote growth.
- ❑ Once the regenerated axon reaches its target, a new functional connection (e.g. neuromuscular junction) is formed, allowing for considerable, although not full, recovery.
- ❑ Unlike the central nervous system (CNS), the adult mammalian peripheral nervous system (PNS) readily regenerates after injury.
- ❑ This is due to the fact that, macrophages and Schwann cells rapidly clear myelin debris after injury. Also, the Schwann cells go on to de-differentiate, and they downregulate all myelin inhibitory proteins, so that they become permissive for regeneration.
- ❑ CNS neurons do not have the growth-promoting chemicals needed for regeneration. In fact, CNS myelin is a potent inhibitor of axonal growth.
- ❑ In addition, after a CNS injury, **astrocytic proliferation, activation of microglia, scar formation, inflammation, and invasion of immune cells** create an inappropriate environment for regeneration.
- ❑ Factors, which inhibit neuron growth such as myelin-associated glycoprotein (Mag) and oligodendrocyte myelin glycoprotein (Omg), as well as Nogo receptor (Ngr) and p75 neurotrophin receptor (p75NTR), are present in the PNS as well as CNS. Clearly these factors are not responsible for difference in regeneration between PNS and CNS.

Neurotrophins

Regulators of neural survival, development, function, and plasticity.

Types of Neurotrophins

- ❑ Nerve growth factor (NGF)
- ❑ Brain-derived neurotrophic factor (BDNF)
- ❑ Neurotrophin-3 (NT-3)
- ❑ Neurotrophin-4 (NT-4), also known as NT-5

Synthesis of Neurotrophins

- ❑ Synthesized and secreted by sympathetic and sensory **target organs**. From these sources, it is captured in

nerve terminals by receptor-mediated endocytosis and is transported through axons to neuronal cell bodies where it acts to promote neuronal survival and differentiation.

- ❑ Glia cell of brain.
- ❑ Schwann cells and fibroblasts within the injured nerve.
- ❑ Mast cell and some neurons.

Neurotrophins Receptor

Tropomyosin-related kinase (Trk) receptor: family of tyrosin kinase receptor.

Neurotrophin type	Receptor	Major target neuron
Nerve growth factor (NGF)	Trk A	Growth factor for sympathetic neurons, some sensory neurons and cholinergic neurons in the basal forebrain and striatum
Brain-derived neurotrophic factor (BDNF)	Trk B	GF for peripheral sensory neurons and vestibular ganglia
Neurotrophin 3 (NT-3)	Trk C> Trk B	GF for cutaneous mechanoreceptors (proprioceptor)
Neurotrophin 4 (NT-4)	Trk B	GF for cerebellar granule cells, mesencephalic dopaminergic neurons, and retinal ganglion cells
<ul style="list-style-type: none"> • The <i>NT-6</i> and <i>NT-7</i> genes have been identified only in fish and probably do not have mammalian orthologs. • Motor neurons survival depends on all neurotrophins except NGF. 		
<p>Additional low-affinity receptor: p75NTR (75-kDa protein), binds all four of the listed neurotrophins with equal affinity. In the absence of Trk receptors, p75NTR cause apoptosis (opposite effect of neurotrophins)</p>		

Ref: Eric J Huang et al. *Annu Rev Neurosci.* 2001;24:677–736 and Ganong's 25th edtn.

OTHER FACTORS AFFECTING NEURONAL GROWTH

Ciliary Neurotrophic Factor (CNTF)

Produced by Schwann cells and astrocytes. Promotes the survival of damaged and embryonic spinal cord neurons and may prove to be of value in treating human diseases in which motor neurons degenerate.

Glial Cell Line-Derived Neurotrophic Factor (Gd-NF)

Maintains midbrain dopaminergic neurons and enteric nervous system.

MULTIPLE CHOICE QUESTIONS

NEURONS AND ACTION POTENTIAL

RECENT MCQs

1. Node of Ranvier is seen in:

- a. Cell body b. Dendrites
c. Axons d. Terminal buttons

2. In a neuron, graded electrogenesis occurs at:

- a. Soma-dendritic zone
b. Initial segment
c. Axon d. Nerve ending

3. Initiation of impulse starts in:

- a. Axon *[NIMHANS 01]*
b. Axon hillock + initial segment
c. Cell body
d. Dendritic tree

4. Orthodromic conduction is:

- a. An axon can conduct impulse in one direction only
b. An axon can conduct impulse in both direction
c. The jumping of depolarization from node to node
d. The print at which a runaway spike potential

5. Pseudounipolar cells:

- a. Sympathetic ganglia
b. Parasympathetic
c. Cranial nerve ganglion
d. Dorsal root ganglion

6. Neurons in sympathetic ganglia are:

- a. Unipolar
b. Bipolar
c. Pseudounipolar
d. Multipolar

7. Nissl bodies located intracytoplasmic are in:

- a. Perikaryon of neuron
b. Smooth muscle
c. Skeletal muscle
d. Cardiac muscle

8. Thickening of axon leads to:

- a. Increased speed of conduction
b. Decreased speed of conduction
c. Increased absolute refractory period
d. Unmyelination

9. Action potential is:

- a. Decremental phenomenon
b. Does not obey all or none phenomenon
c. K^+ goes from ECF to ICF
d. Threshold stimulus is required

10. Donnan effect is seen on distribution of:

- a. Diffusible ion
b. Diffusible and non-diffusible ions
c. Non-diffusible ion
d. Only proteins

11. Most diffusible ion in excitable tissue is:

- a. Na^+
b. K^+
c. Ca^{++}
d. Cl^-

12. RMP of nerve cell is equal to which ion's equilibrium potential?

- a. K^+
b. Cl^-
c. Na^+
d. Ca^{++}

13. An increase in external K^+ concentration:

- a. Decrease RMP
- b. Increase RMP by -10 mv for each 10 mEq/L increase in K^+
- c. No change
- d. Increase RMP by -20 mv for each 10 meq/L increase in K^+

14. Maximum number of Na^+ channels per square micrometer is present in:

- a. Cell body
- b. Axon terminal
- c. Surface of myelin
- d. Nodes of Ranvier

15. Action potential is initiated at the axon hillock/initial segment of neuron because:

- a. Threshold for excitation is lowest
- b. Neurotransmitter is released at this site
- c. It is an unmyelinated segment
- d. Has lowest concentration of voltage gated Na^+ channel

16. Rheobase indicates:

- a. Magnitude of current
- b. Rate of discharge
- c. Velocity of nerve conduction
- d. Specificity of impulse transmission

17. Axonal transport is:

- a. Antegrade
- b. Retrograde
- c. Antegrade and Retrograde
- d. None

18. The maximum rate of axonal transport is:

- a. 200 mm/day
- b. 400 mm/day
- c. 600 mm/day
- d. 800 mm/day

AIIMS/PGI/JIPMER**19. Increased velocity of conduction in a nerve is favored by:** [PGI June 2008]

- a. Increased capacitance
- b. Decreased capacitance
- c. Increased resistance
- d. Decrease resistance
- e. Increased velocity

20. Non-myelinated axons differs from myelinated in that they: [AIIMS 1979]

- a. Are more excitable
- b. Lack node of Ranvier
- c. Are capable of regeneration
- d. Are not associated with Schwann cells

21. Synaptic potential can be recorded by: [AIIMS 2005]

- a. Patch clamp technique
- b. Voltage clamp technique
- c. Microelectrode
- d. EEG

22. Magnitude of action potential is determined by: [JIPMER 2010]

- a. Na^+
- b. Mg^{++}
- c. K^+
- d. Ca^{++}

23. Relationship between nerve thickness and conduction velocity is:

[AIIMS 1978]

- a. Linear
- b. Parabolic
- c. Hyperbolic
- d. No relation

24. Sodium channels are specifically blocked by: [AIIMS 1985]

- a. Nifedipin
- b. Tetrodotoxin
- c. Tetraethyl lead
- d. Choline

25. First changes to occurs in the distal segment of cut nerve: [AIIMS 1992]

- a. Myelin degeneration
- b. Axonal degeneration
- c. Mitosis of Schwann cell
- d. Sprouting

26. Neurapraxia is a type of:

[JIPMER 2014]

- a. Physiological conduction block
- b. Axonal disruption
- c. Endoneurium disruption
- d. Nerve trunk discontinuation

27. Axonotmesis includes discontinuity in:

[PGI June 2006]

- a. Perineurium
- b. Epineurium
- c. Endoneurium
- d. Axon
- e. Myelin sheath

28. Motor march is seen in: [JIPMER 2012]

- a. Axonotmesis b. Neurapraxia
- c. Neurotmesis
- d. Nerve regeneration

29. Action potential is initiated at the axon hillock-initial segment of the neuron because:

[AI 09, 01]

- a. Threshold for excitation is lowest
- b. Neurotransmitter is released at this site
- c. It is an unmyelinated segment
- d. Has lowest concentration of voltage-gated sodium channels

30. Synaptic conduction is mostly orthodromic because:

[AI 03]

- a. Dendrites cannot be depolarized
- b. Once repolarized, an area cannot be depolarized
- c. The strength of antidromic impulse is less
- d. Chemical mediator is localized only in the presynaptic terminal

31. True about nerve impulse is:

[AIIMS May 94]

- a. Travels in one direction along axon
- b. If current is increased too slow nerve respond fast

- c. Travels in one direction at synapse
- d. Travels with the speed of electric current

32. Unidirectional flow of a nerve impulse is at:

[AI 96]

- a. Synapse
- b. Axon
- c. Dendrites
- d. All of the above

33. True about Nissl granule:

[PGI May 10]

- a. Involves in RNA synthesis
- b. Present in axon
- c. Present in dendrite
- d. Involves in protein synthesis
- e. Structurally they are endoplasmic reticulum

34. Rapid axonal flow in the neurons is mediated by all except:

[AIIMS Nov 07]

- a. Dynein b. Kinesin
- c. Neurofilaments
- d. Microtubules

35. Axonal transport is: [AIIMS Nov 09]

- a. Antegrade
- b. Retrograde
- c. Antegrade and retrograde
- d. None

36. The neurons may get irreversibly damaged if exposed to significant hypoxia for:

[AIIMS Nov 02]

- a. 8 min b. 2 min
- c. 30 sec d. 15 sec

37. Which is TRUE regarding nerve conduction?

[AIIMS Dec 94]

- a. All or none phenomenon
- b. Conduction independent of amplitude
- c. Propagated action potential is generated in dendrites
- d. Faster in unmyelinated fibers

38. Which of the following is TRUE about propagated nerve action potential?

- a. Decremental [AIIMS Dec 98]
 b. Not affected by hypoxia
 c. Fastest in C fibers
 d. Not affected by membrane capacitance

39. A travelling nerve impulse does not depolarize the area immediately behind it, because: [AIIMS 02]

- a. It is hyperpolarized
 b. It is refractory
 c. It is not self-propagating
 d. The condition is always orthodromic

40. Increase in threshold level on applying sub-threshold, slowly rising stimulus is known as: [AIIMS May 08]

- a. Adaptation b. Accommodation
 c. Refractoriness d. Electrotonus

41. The increase in threshold of a receptor when a series of stimuli of subthreshold intensity are applied in succession is called: [AIIMS May 08, Nov 06]

- a. Adaptation
 b. Accommodation
 c. Initiation d. Resistance

42. Equal strength stimulus of which type is least likely to produce a nerve stimulation: [AIIMS May 02]

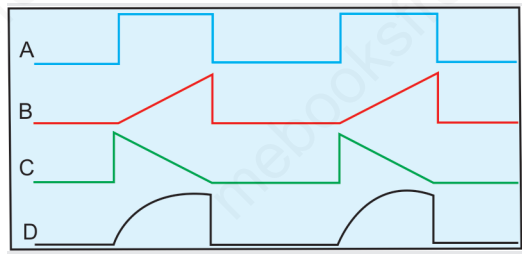

CLASSIFICATIONS OF NERVE FIBERS

RECENT MCQs

43. Person wakes up with pain, paresthesia, tingling of the arms. He had slept with arm below the head. Which fibers are involved?

- a. Type A fibers b. Type B
 c. Type C (pain)
 d. Type C (postganglionic)

44. Nociception from abdomen is transmitted by:

- a. A gamma b. A α
 c. C fibers d. B

45. Burning pain is carried by which type of fibres?

- a. A alpha b. A delta
 c. A beta d. C

46. Postganglionic sympathetic fibers are:

- a. A alpha b. C
 c. B fibers d. A gamma

47. A gamma nerve diameter is:

- a. 13–20 μ M b. 4–13 μ M
 c. 3–6 μ M d. 0.2–1.0 μ M

48. Spike duration is maximum in which nerve fiber?

- a. A-alpha b. A-beta
 c. A-delta d. C

49. Percentage of sensory fibers in a pure motor nerve is:

- a. 0% b. 10%
 c. 2% d. 40%
 e. 25%

50. A man slept with head over forearm, next morning he complains of tingling, numbness over forearm. It is caused by:

- a. Sensitivity to hypoxia A > B > C
 b. Sensitivity to pressure A > B > C
 c. Sensitivity to hypoxia C > B > A
 d. Sensitivity to pressure B > A > C

AIIMS/PGI/JIPMER

51. Nerve fibers involved in proprioception: [PGI Dec 04]

- a. Type A fiber b. Type B fiber
c. Type C fiber d. Type IV fiber
e. J fiber

52. Efferent neuron for skeletal muscle is:

- a. Alpha motor neuron [JIPMER II]
b. Gamma motor neuron
c. Ia fiber
d. Ib fiber

53. Group B muscle fibers are:

[A198, AIIMS Dec 97]

- a. Sympathetic preganglionic
b. Sympathetic postganglionic
c. Parasympathetic preganglionic
d. Parasympathetic postganglionic

54. Group B nerve fibers are situated in:

- a. Muscle spindles [AIIMS Dec 97]
b. Fibers carrying pain sensation
c. Preganglionic autonomic fibers
d. Postganglionic autonomic fibers

55. The correct order of susceptibility of the different types of nerve fibers to local anesthetics is: [AIIMS May 08]

- a. $B > C > A$ b. $A > B > C$
c. $C > A > B$ d. $C > B > A$

56. Group A nerve fibers most susceptible to: [AIIMS May 05]

- a. Pressure b. Hypoxia
c. Local anesthetics d. Temperature

57. The afferent fibers which are most sensitive to local anesthetic belong to groups: [AIIMS May 04]

- a. A b. B
c. C d. D

58. If one of your nerves is compressed and this leads to paresthesia for some time, the type of nerve fiber affected is probable: [PGI June 99]

- a. A alpha b. A delta
c. C d. B

59. Conduction in which type of nerve fibers is blocked maximally by pressure: [JIPMER 92]

- a. C fibers b. A alpha fibers
c. A beta d. A gamma

FUTURE TRENDS

For questions 60 and 61 choose from the diagram below the labeled line which best illustrates the change in resting membrane potential (RMP) of a neuron resulting from:

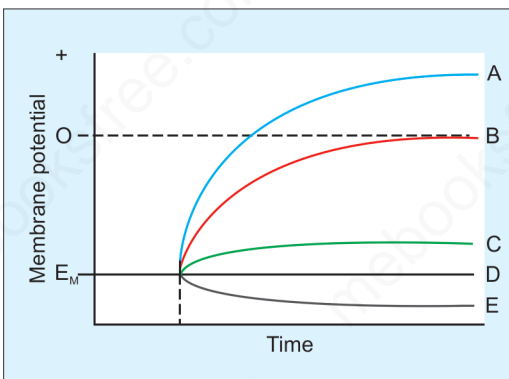

60. A two-fold decrease in extracellular potassium concentration:

- a. B
b. C
c. D
d. E

61. Maximal increase in sodium conductance:

- a. A
b. B
c. C
d. D

Following is an action potential recorded from a squid giant axon. Answer questions 62 to 64.

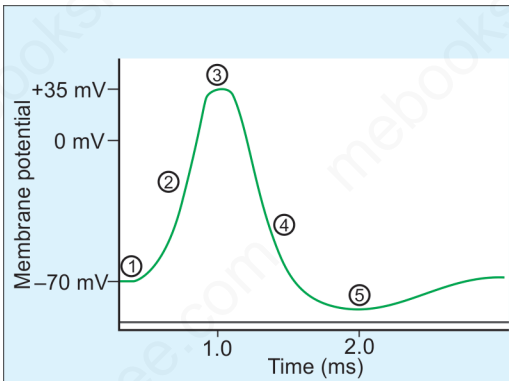

62. At which labeled point on the action potential is the K^+ closest to electrochemical equilibrium?

- 2
- 3
- 4
- 5

63. Point at which driving force for Na^+ is maximum?

- 1
- 3
- 4
- 5

64. What process is responsible for the change in membrane potential that occurs between point 3 and point 4?

- Movement of Na^+ into the cell
- Movement of Na^+ out of the cell
- Movement of K^+ into the cell
- Movement of K^+ out of the cell

65. Chronaxie of:

- Innervated muscle is of very long pulse duration
- Denervated muscle is less than that of innervated
- Denervated muscle is more than that of innervated
- A and B

66. Find out the chronaxie and rheobase from the graph below:

- Chronaxie 0.22 ms, rheobase 0.35V
- Chronaxie 0.35 ms, rheobase 0.22V
- Chronaxie 0.68 ms, rheobase 0.22V
- Chronaxie 0.22 ms, rheobase 0.68V

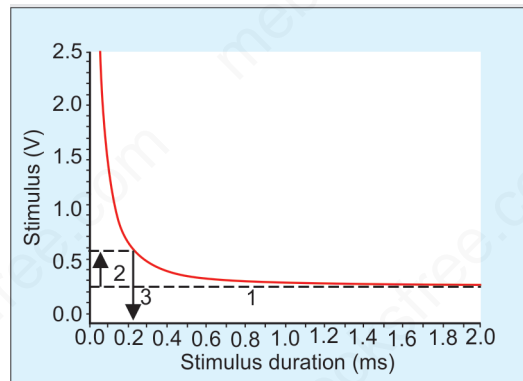

67. The distance from between one stimulating electrode to recording electrode is 4.5 cm. When the axon is stimulated, the latent period is 1.5 ms. What is the conduction velocity of the axon?

- 15 m/s
- 30 m/s
- 40 m/s
- This cannot be determined from the information given

ANSWERS WITH EXPLANATIONS

1. Ans. c. Axons

(Ref: Ganong's Physiology 24th edn. pp 82)

2. Ans. a. Soma-dendritic zone

(Ref: Ganong's Physiology 24th edn. pp 82)

Graded electrogenesis is local potential generation of which occurs in dendrite or, soma.

Neurons generally have some important zones: (1) a receptor, or dendritic zone, where multiple local potential generated by synaptic connections are integrated; (2) a site where propagated action potentials are generated (the initial segment in spinal motor neurons, the initial node of Ranvier in cutaneous sensory neurons).

3. Ans. b. Axon hillock + initial segment

(Ref: Ganong's Physiology 24th edn. pp 82)

See above explanation.

4. Ans. a. An axon can conduct impulse in one direction only

(Ref: Ganong's Physiology 24th edn. pp 88)

5. Ans. d. Dorsal root ganglion

(Ref: Ganong's Physiology 24th edn. pp 81 fig. 4.3)

Some sensory neurons are in a subclass of bipolar cells called pseudounipolar cells. As the cell develops, a single process splits into two, both of which function as axons—one going to skin or muscle and another to the spinal cord.

6. Ans. d. Multipolar

(Ref: BRS Gross Anatomy By Kyung Won Chung, Harold M. Chung)

Ventral, lateral, dorsal horn neurons and sympathetic chain ganglia are multipolar but dorsal root ganglion neurons are pseudounipolar.

7. Ans. a. Perikaryon of neuron

(Ref: Gray's Anatomy 41st edn. pp-43)

8. Ans. a. Increased speed of conduction

(Ref: Ganong's Physiology 24th edn. pp 87)

9. Ans. d. Threshold stimulus is required

(Ref: Ganong's Physiology 24th edn. pp 81 fig. 4.3)

10. Ans: a. Diffusible ion

(Ref: Ganong's Physiology 25th edn. pp 8)

Due to presence of a non-diffusible ion on one side of a membrane, the distribution of other ions to which the membrane is permeable (diffusible ion) is affected in a predictable way. This is Donnan effect.

11. Ans: b. K⁺

(Ref: Kandel's Principles of Neural Science 5th edn. pp 135)

- ❑ Permeability of different ions through synthetic biological membrane: $\text{Cl}^- \gg \text{K}^+ \gg \text{Na}^+$
- ❑ Permeability of different ions through cell membrane: $\text{K}^+ \gg \text{Cl}^- \gg \text{Na}^+$

12. Ans. b. Cl⁻

(Ref: Ganong's Physiology 25th edn. pp 90)

- ❑ In general all excitable cell membrane at rest is maximally permeable to K⁺ and thus RMP is close to equilibrium potential of K⁺ ion.
- ❑ RMP of neuron (-70 mv) is exactly equal to equilibrium potential of Cl⁻ ion (-70 mv)

13. Ans: a. Decrease RMP

(Ref. Berne & Levy Physiology, 6th edn. pp 25)

With hyperkalemia, membrane voltage is depolarized gradually. Depolarization of membrane voltage means decrease in RMP. Remember, a decrease in the membrane potential (RMP) means that the voltage has moved closer to ground (0 mv) or become more positive.

14. Ans: d. Nodes of Ranvier

(Ref: Ganong's Physiology 25th edn. pp 93)

Max: Nodes of Ranvier >> Initial segment

15. Ans: a. Threshold for excitation is lowest

(Ref: Kandel's Principles of Neural Science 5th edn. pp 32)

Because the initial segment of the axon has the highest density of voltage-sensitive Na⁺ channels and therefore the lowest threshold for generating an action potential.

16. Ans: a. Magnitude of current

(Ref: Understanding Medical Physiology: A Textbook for Medical Students By RL Bijlani, S Manjunatha pp510)

The minimum strength or, magnitude of a stimulus, which is able to produce AP in an excitable tissue (e.g. Nerve, muscle), regardless of the duration it takes.

17. Ans: c. Antegrade and Retrograde

(Ref: Ganong's Physiology 25th edn. pp 89, Fig. 4.4)

Fast anterograde (400 mm/day) transport occurs by kinesin molecular motor and retrograde transport (200 mm/day) occurs by dynein molecular motor.

18. Ans: b. 400 mm/day

(Ref: Ganong's Physiology 25th edn. pp 89, Fig. 4.4)

Check Q.17.

19. Ans: a. Increased capacitance, d. Decrease resistance

(Ref. Berne & Levy Physiology, 6th edn. pp 25)

The rate of passive spread of action potential varies inversely with the product $R_a \times C_m$ (Axonal resistance \times Capacitance). If this product is reduced, the rate of passive spread increases and the action potential propagates faster.

20. Ans: b. Lack node of Ranvier

(Ref. Berne & Levy Physiology, 6th edn. pp 56)

Remember, two types of Schwann cell: Myelinating and non-myelinating types. In the PNS, unmyelinated axons are surrounded by Schwann cells (non-myelinating), whereas myelinated axons are ensheathed by multiply wrapped membranes of Schwann cells, much as the oligodendroglia ensheath central axons.

21. Ans: c. Microelectrode

(Ref: Ganong's Physiology 25th edn. pp 121)

Synaptic potential is recorded with inserting one microelectrode inside cell and one electrode outside the cell.

22. Ans: a. Na⁺

(Ref: Ganong's Physiology 25th edn. pp 91)

Maximum magnitude is determined by equilibrium potential of Na⁺ ion.

23. Ans: a. Linear

(Ref: Form and Function in the Brain and Spinal Cord: Perspectives of a Neurologist By Waxman & McDonald, pp6)

Fiber diameter (thickness) and conduction velocity relationship: The relationship is linear for myelinated axons and parabolic relation for non-myelinated axons.

24. Ans: b. Tetrodotoxin

(Ref. Berne & Levy Physiology, 6th edn. pp 71)

Tetrodotoxin (TTX), one of the most potent poisons known, specifically blocks the Na⁺ channel. TTX binds to the extracellular side of the sodium channel.

25. Ans: b. Axonal degeneration

(Ref: Kandel's Principles of Neural Science 5th edn. pp 1286)

After axotomy the nerve terminals of the injured neuron begin to degenerate (first).

The distal axonal stump separates from the parental cell body, becomes irregular, and undergoes Wallerian degeneration (second).

26. Ans: a. Physiological conduction block

(Ref: *Physical Medicine and Rehabilitation Board Review, 3rd edn*,
By Sara J. Cuccurullo, pp 355)

In neurapraxia, axon is intact, only local myelin injury occurs, which leads to conduction block.

27. Ans: d. Axon, e. Myelin sheath

Ref: *Physical Medicine and Rehabilitation Board Review, 3rd edn*,
By Sara J. Cuccurullo, pp 355

In axonotmesis, axon and myelin sheath is interrupted but connective tissue remains intact.

28. Ans: a. Axonotmesis

(Ref: *Campbell's Operative Orthopaedics By Canale & Beaty, 12th edn. pp 3067*)

Motor March: When recovery occurs after axonotmesis, the proximal muscles recover earlier than the distal muscles. It progresses from proximal to distal. Motor march is seen with injury where Wallerian degeneration occurs.

In neurapraxia, simultaneous return of motor functions occurs in proximal and distal muscle group.

29. Ans: a. Threshold for excitation is lowest

(Ref: *Kandel's Principles of Neural Science 5th edn. pp 32*)

'Because the initial segment of the axon has the highest density of voltage-sensitive Na⁺ channels and therefore the lowest threshold for generating an action potential.'

30. Ans: d. Chemical mediator is localized only in the presynaptic terminal

(Ref: *Ganong's Physiology 24th edn. pp 88*)

31. Ans: c. Travels in one direction at synapse

(Ref: *Ganong's Physiology 24th edn. pp 88*)

In the natural situation, impulses pass in one direction only, i.e. from synaptic junctions or receptors along axons to their termination. Such conduction is called orthodromic. Conduction in the opposite direction is called antidromic.

32. Ans: a. Synapse

(Ref: *Kandel's Principles of Neural Science 5th edn. pp 32*)

See explanation of Q. 31

33. Ans: c. Present in dendrite, d. Involves in protein synthesis, e. Structurally they are endoplasmic reticulum

(Ref: *Gray's Anatomy 41st edn. pp 43*)

Nissl bodies are basophilic structure composed of rough endoplasmic reticulum and polyribosome aggregates. Distributed throughout the cell body and large dendrites but no Nissl bodies in the axon. It is also rich in RNA but does not synthesize it.

34. Ans: c. Neurofilaments

(Ref: *Ganong's Physiology 24th edn. pp 83*)

See text.

35. Ans: c. Antegrade and Retrograde

(Ref: *Ganong's Physiology 24th edn. pp 83*)

36. Ans: a. 8 min

(Ref: *Neuropathology By Richard A. Prayson and Textbook of Pharmacology By Seth*)

Irreversible damage occurs if there is no O₂ supply for > 5 min.

37. Ans: a. All or none phenomenon

(Ref: *Ganong's Physiology 24th edn. pp 87*)

38. Ans: NONE. Single best choice b. Not affected by hypoxia

(Ref: *Int J Impot Res. 2013;25:1-6*)

Acute and chronic hypoxias are associated with reduced nerve conduction velocity, neuronal action potential generation and axonal transport. In the central neurons, the reduction of nerve cell excitability in hypoxia is primarily because of increased K^+ conductance.

So, hypoxia also affects action potential. But compared to other statements, its can be the answer.

39. Ans. b. It is refractory

(Ref: Ganong's Physiology 24th edn pp 87)

It remains in a relative refractory period.

40. Ans. b. Accommodation

(Ref: Rhode's Medical Physiology 4th edn pp 73 and Kandel's Principles of Neural Science 5th edn. pp 462)

Accommodation: refers to a gradual increase in threshold caused by prolonged slowly rising sub-threshold nerve depolarization, resulting from the inactivation of sodium channels.

Adaptation: If a supra-threshold (NOT sub-threshold) stimulus persists unchanged for several minutes without a change in position or amplitude (NOT slowly rising), the neural response diminishes and sensation is lost, a condition called receptor adaptation.

41. Ans. b. Accommodation (see Q. 21)

42. Ans. B.

(Ref: Rhode's Medical Physiology 4th edn. pp 73)

Check the rate of rise (slope) of stimulus. Slowly rising stimulus produces accommodation, so chance of AP development is less.

Graph A: Best stimuli to produce AP (rapidly rising stimuli, no chance of Na channel accommodation)

Graph B: Least effective stimuli to produce AP, among the options provided (slowest rising stimuli among the provided options, so chance of Na channel accommodation)

43. Ans. a. Type A fibers

(Ref: Kandel's Principles of Neural Science 5th edn. pp 310)

Patients with paresthesias (inappropriate sensations such as burning or prickling) usually have impaired perception of cutaneous sensations (pain and temperature), often because the small myelinated fibers that carry these sensations are selectively affected.

So, paresthesia is basically pain fiber involvement, which is myelinated (A δ).

Recall, A fiber is most susceptible to pressure but that is not paresthesia.

44. Ans. c. C fibers

(Ref: Ganong's Physiology 24th edn. pp 169)

Superficial pain: A delta fiber.

Visceral pain and deep pain: C fiber. This is probably due to a relative deficiency of A δ nerve fibers in deep structures, so there is little rapid, bright pain.

45. Ans. d. C

(Ref: Guyton-Physiology 13th edn. pp 699)

Burning pain is mediated by slow fiber.

46. Ans. b. C

(Ref: Ganong's Physiology 24th edn. pp 89 table)

47. Ans. c. 3–6 μ M

(Ref: Ganong's Physiology 24th edn pp 89 table)

48. Ans: d. C

(Ref: Ganong's Physiology 25th edn. pp 94)

Spike duration: C (2 ms) >> B (1.2 ms) >> A (0.4 to 0.5 ms)

49. Ans: d. 40%

(Ref: General Anatomy By Vishram Singh, pp 130)

The nerve supplying the muscle is known as motor nerve but strictly speaking, it is a mixed nerve. It contains motor fibers (60%) as well as sensory fiber (40%).

So, basically the question here is: % of sensory fibers in a motor nerve?

50. Ans: b. Sensitivity to pressure A > B > C

(Ref: Ganong's Physiology 25th edn. pp 95)

These symptoms are due to involvement of Ad fiber (paresthesia).

51. Ans. a. Type A fiber

(Ref: Kandel's Principles of Neural Science 5th edn. pp-480, Table)

Proprioception is carried by muscle and skeletal mechanoreceptors. Examples of proprioceptors are muscle spindle (A α , A β and A γ), Golgi tendon organ (A α), Joint capsule receptor (A β) and Stretch-sensitive free endings (A δ).

52. Ans. a. Alpha motor neuron

(Ref: Ganong's Physiology 24th edn. pp 89 table)

Efferent to skeletal muscle: A α (alpha motor neuron)

Efferent to Muscle Spindle: A γ (gamma motor neuron)

53. Ans. a. Sympathetic preganglionic

(Ref: Ganong's Physiology 24th edn pp 89 table and Miller's Anesthesia by Roland D et al. 8th edn.)

Type B includes Preganglionic sympathetic (main) and parasympathetic both.

54. Ans. c. Preganglionic autonomic fibers

(Ref: Ganong's Physiology 24th edn. pp 89 table)

55. Ans. b. A > B > C

(Ref: Miller's Anesthesia by Roland D et al. 8th edn. and Lee's Synopsis of Anaesthesia by N.J.H David et al.)

Miller's Anesthesia: 'A drug bolus is delivered by percutaneous injection, analogous to clinical peripheral nerve block, show unequivocally that small myelinated axons (A gamma motor and A delta sensory fibers) are the most susceptible to impulse annihilation. Next in order of block are

the large myelinated (A alpha and A beta) fibers, and the least susceptible are the small, nonmyelinated C fibers. In fact, in this last group, impulses in the slowest conducting population (conduction velocity of 0.5 to 0.8 m/sec) are the most resistant to local anesthetic. The widespread notion that local anesthetics block the smallest fibers first or most is thus clearly wrong.'

Lee's Synopsis: 'Peripheral nerve fibres are differentially sensitive to local anaesthetics. The principle that the smaller the fibre diameter the greater its blockade holds among the myelinated axons. The most susceptible are the A γ spindle efferents and the A δ nociceptive fibres. With myelinated fibres the length of exposed nerve and the number of nodes of Ranvier it contains are important.'

56. Ans. a. Pressure

(Ref: Ganong's Physiology 24th edn. pp 90 table)

57. Ans. a. A

(Ref: Miller's Anesthesia by Roland D et al. 8th edn. And Lee's Synopsis of Anaesthesia by N.J.H David et al.)

Explained above.

58. Ans. b. A delta

(Ref: Kandel's Principles of Neural Science 5th edn. pp 310)

Patients with paresthesias (inappropriate sensations such as burning or prickling) usually have impaired perception of cutaneous sensations (pain and temperature), often because the small myelinated fibers that carry these sensations are selectively affected.

59. Ans. b. A alpha fibers

(Ref: Essentials of Orthopaedics & Applied Physiotherapy By Jayant Joshi)

Largest myelinated nerve fiber is most susceptible to pressure induced conduction block. So, A-alpha will be blocked earliest and maximally by pressure followed by A-beta and A-delta.

Paresthesias (inappropriate sensations such as burning or prickling) usually seen when A-delta is involved.

60. Ans. d. E

A decrease in the extracellular concentration of potassium would accelerate the potassium efflux from the cell. Removing positive charges from the cell would produce hyperpolarization, line E.

61. Ans. a. A

A large increase in sodium conductance would produce sodium influx and depolarize the cell to a value close to the equilibrium potential for sodium. Since this is a positive potential, it would cross the zero potential line. Therefore, line A (not B) is the best answer.

62. Ans. d. 5

The hyperpolarizing after potential represents the period during which K^+ permeability is highest, and the membrane potential is closest to the K^+ equilibrium potential.

63. Ans. d.

The driving force for Na^+ is greatest at the point at which membrane potential (V_m) is the farthest from E_{Na^+} . So, at point 5, the cell is the most hyperpolarized (farthest from V_m).

64. Ans. d. Movement of K^+ out of the cell

The process responsible for repolarization is the opening of K^+ channels.

65. Ans. c. Denervated muscle is more than that of innervated

Denervated muscle is less excitable (more chronaxie) than innervated muscle.

66. Ans. a. Chronaxie 0.22 ms, rheobase 0.35 V

The following steps are followed in order to determine rheobase and chronaxie

- ❑ Step 1: Determine the rheobase, which is the minimum Stimulus Strength that will produce a response. In the example above, this value is 0.35 V (check Y axis value).
- ❑ Step 2: Calculate $2 \times$ rheobase ($= 0.7$ V in the above example).
- ❑ Step 3: Determine chronaxie, which is 0.22 ms (on X axis).

67. Ans. b. 30 m/s

Latent period is the time between the application of stimuli and onset of action potential (AP). In this case, the latent period (1.5 ms) is the travelling time for the AP from stimulating to recording electrodes (4.5 cm). So, conduction velocity = (distance/latent period) = $(4.5/1.5) = 3$ cm/ms = 30 m/sec.

CHAPTER

4

Physiology of Muscle

I IMPORTANT

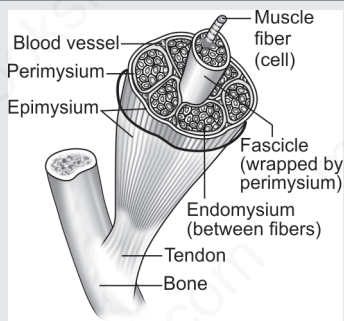

Fig. 4.1: Hierarchy of skeletal muscle structure

I IMPORTANT

- ❖ **Dystropin:** Completely absent in Duchenne's muscular dystrophy and partially absent in Becker's muscular dystrophy.
- ❖ **Malignant hyperthermia:** mutation in RyR channel. The mutation results in an inefficient feedback mechanism to shut down Ca^{2+} release after stimulation of the RyR, and thus, increased contractility and heat generation.

SKELETAL MUSCLE

Hierarchy of Muscle Structure (Fig. 4.1)

- ❑ **Muscle:** made up of many **fascicles**. Connective tissue sheath that surrounds the muscle-**epimysium**.
- ❑ **Fascicles:** made up of group of **muscle fibers**. Connective tissue surrounding fascicle-**perimysium**. Within the perimysium are the blood vessels and nerves that supply the individual muscle fibers.
- ❑ **Muscle fiber (or muscle cell):** made up of **Myofibrils**: **Endomysium** surrounds each of these fibers.
- ❑ **Myofibril:** made up of **contractile proteins**.
- ❑ All the connective tissue layers come together to form a tendon. The connective tissue layers are composed mainly of elastin and collagen fibers.

STRUCTURAL COMPONENT OF A MUSCLE CELL (FIBER)

- ❑ **Sarcolemma (muscle membrane):**
 - Integral protein (transmembrane protein): dystroglycan and sarcoglycan
 - Peripheral protein: dystropin and dystrobrevin.
- ❑ **Sarcotubular system:**
 - **L tubules** (Longitudinal tubule): this is the sarcoplasmic reticulum (SR). The portion of the SR nearest the T tubules is called the terminal cisternae, and it is the site of Ca^{2+} release. The L tubule cistern has ryanodine receptors (RyR). RyR is a ligand gated calcium channel. The 2 cisterns associated on either side of the T-tubule are called **triad (skeletal muscle)**. In **cardiac muscle its diad**.

- **T tubules** (Transverse tubule): this is the invagination of the sarcolemma into the muscle cell. A gap (≈ 15 nm in width) separates the T tubules from the SR. T-tubule has dihydropyridine receptor (DHPR). This is nothing but a voltage-gated Ca^{++} channel.
- ❑ **Myofibrils:** A myofibril can be subdivided longitudinally into **sarcomeres**.

CYTOSKELETAL PROTEINS IN MYOFIBRIL

1. Contractile:

- **Myosin:** The type of myosin present in skeletal muscle is **myosin II**.
 - Each myosin II is a hexamer (actually two trimers) composed of two intertwined myosin heavy chains (MHC), two *essential* myosin light chains (MLC), and two *regulatory* light chains (Fig. 4.2).
 - The two heavy chains have three regions: head, hinge and rod (tail). The globular head has actin binding site and catalytic site for hydrolysis of ATP. Each head also binds one MLC and one regulatory light chain.
- **Actin (thin filament):** Thin filament is made up of actin (mainly), tropomyosin and troponin (troponin I, T, C).

2. Regulatory (relaxing):

- **Tropomyosin:** Extend over the entire actin filament and cover myosin-binding sites on the actin molecules. *Prevent attachment of actin and myosin.*
- **Troponin:** There are 3 'parts' of troponin: troponin I, T and C.
 - Troponin T: binds to tropomyosin
 - Troponin I: facilitates the inhibition of myosin and actin
 - Troponin C: have **four** Ca^{++} binding sites.

3. Anchoring:

- **α -Actinin and capZ protein:** Anchor the thin filament to the Z line.
- **Titin (connectin)** extends from M to Z line. **Elasticity** of muscle is due to this protein. Myosin filaments is tethered to the Z lines by titin.

I IMPORTANT

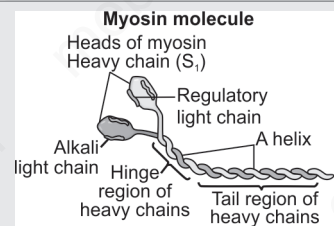

Fig. 4.2: Myosin II in skeletal muscle

I IMPORTANT

- ❖ Active sites of actin are covered by: Tropomyosin
- ❖ Essential for muscle contraction: Cellular calcium.

- **Nebulin:** Extends along the length of the thin filament (tip of actin to Z line) and participates in regulation of the **length** of the thin filament.
- **Tropomodulin:** Located at the end of the thin filament, toward the center of the sarcomere, and participate in regulation of the length of the thin filament
- **Myomesin:** Present in M line. Binds titin with M line.

STRUCTURE OF SARCOMERE (FIGS. 4.3A AND B)

The average length of a sarcomere is 2 μm .

I IMPORTANT

Average length of sarcomere 2 to 2.2 μm

Maximum length of sarcomere without rupture: 3.6 μm

Minimum length of sarcomere: 1.6 μm

Bands/Lines

□ Bands—A, I, H

□ Lines—Z, M

- **A band (Anisotropic to polarized light)**—Dark, made up of myosin (thick filament).
- **I band (Isotropic to polarized light)**—Light, made up of actin, **mainly**.
- **H band (from the German 'heller', brighter)**—The lighter portion of A band at the center of sarcomere, where there is no overlap of actin and myosin.
- **M line (from the German 'Mittelscheibe', the disk in the middle of the sarcomere)**—The central bulge in the myosin filament.
- **Pseudo-H**—light portion on two sides of M line because of absence of cross bridges (no myosin head).
- **Z line**—The actin filaments get anchored here; the length of the muscle between 2 Z lines is called sarcomere.

I IMPORTANT

❖ **Myosin:** Length 1.6 μm and molecular weight 480,000.

❖ **Actin:** Length 1 μm polymer of G-actin molecules, each having a molecular weight of about 42,000.

❖ **Tropomyosin:** Length 40 nm and molecular weight 70,000.

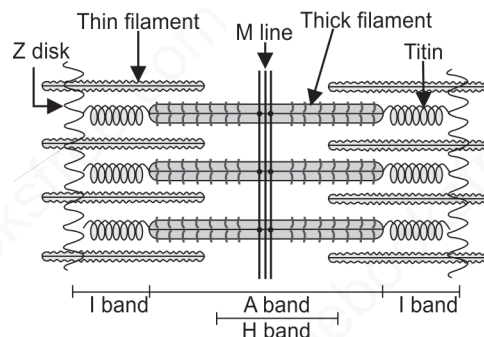

Fig. 4.3A: Structure of a sarcomere

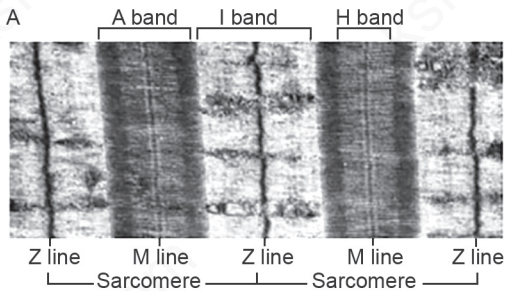

Fig. 4.3B: Electromicroscopic features of skeletal muscle

I IMPORTANT

Muscle contraction

Two Z lines come closer; the length of the 'A band' remains constant whereas the length of H and I band decreases. The M line becomes more prominent.

EXCITATION-CONTRACTION COUPLING

The process by which depolarization of the muscle fiber initiates contraction is called excitation-contraction coupling.

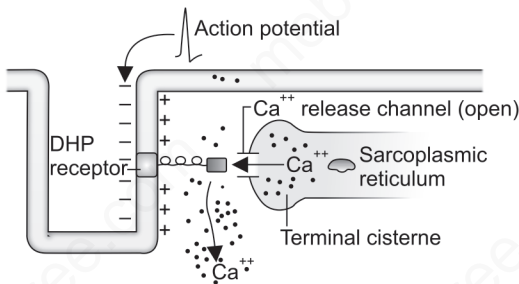

Fig. 4.4: Excitation-contraction coupling in skeletal muscle

Events (Fig. 4.4)

- ❑ Action potential is transmitted along the sarcolemma of the muscle fiber and then down the T tubules
- ❑ Depolarization of T-tubules causes conformation change in DHP receptors, opening the Ca²⁺ release channels in the terminal cisternae of the sarcoplasmic reticulum
- ❑ This triggers release of Ca²⁺ from the terminal cisterns of the L-tubule. Ca²⁺ peaks at approximately 20 msec after the AP
- ❑ The released Ca²⁺ binds to troponin-C
- ❑ Troponin-C facilitates movement of the associated tropomyosin molecule toward the cleft of the actin filament
- ❑ The tropomyosin 'moves away', exposes the myosin binding site on the actin filament
- ❑ This triggers the **cross-bridge cycling**, including the power-stroke
- ❑ The active pumping of Ca²⁺ back into the sarcoplasmic reticulum brings about relaxation.

CROSS-BRIDGE CYCLING—SARCOMERE SHORTENING (SLIDING FILAMENT THEORY) (FIG. 4.5)

- ❑ **Step 1: ATP binding.** ATP binding to the head of the myosin heavy chain (MHC) reduces the affinity of myosin for actin, causing the myosin head to release from the actin filament.
- ❑ **Step 2: ATP hydrolysis (resting stage of muscle).** The breakdown of ATP to ADP and inorganic phosphate (Pi) occurs on the myosin head. As a result of hydrolysis, the myosin head pivots around the hinge into a “cocked” position (at a 90-degree angle to the thick and thin filaments—fully relaxed).
- ❑ **Step 3: Cross-bridge formation.** The cocked myosin head now binds to its new position on the actin filament.

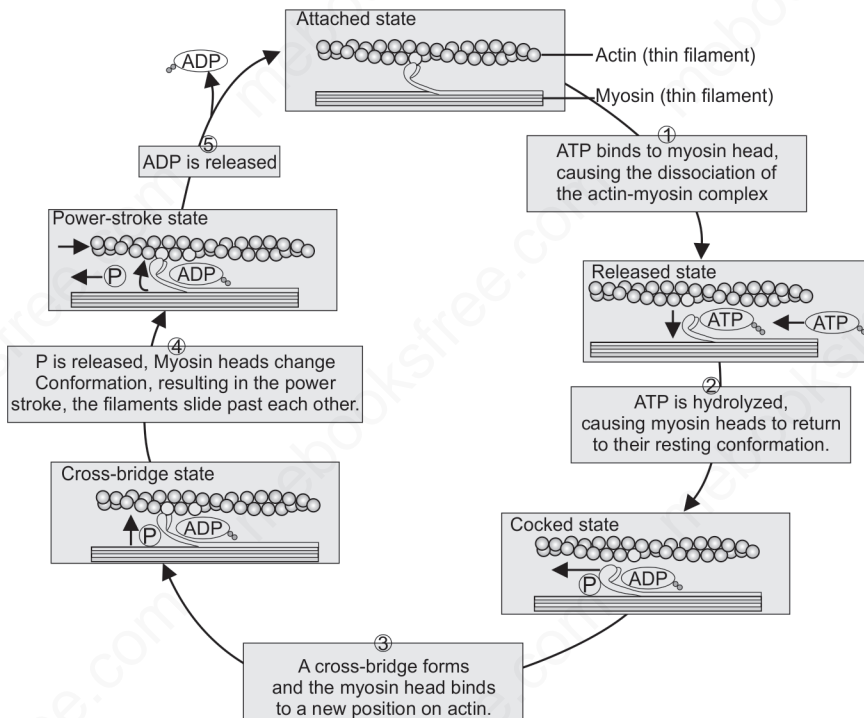

Fig. 4.5: Cross bridge cycle. Number inside circle in each step has been described in the text

- ❑ **Step 4: Release of Pi from the myosin. Dissociation of Pi from the myosin head triggers the *power stroke*,** a conformational change in which the myosin head bends ~45 degrees about the hinge and pulls the actin filament ~11 nm toward the tail of the myosin molecule, thereby generating force and motion.

- ❑ **Step 5: ADP release. Dissociation of ADP** from myosin completes the cycle, and the actomyosin complex is left in a rigid state (at a 45-degree angle). The ADP-free myosin complex remains bound to actin until another ATP molecule binds and initiates another cycle.
- ❑ The cycle continues until the SERCA (Sarcoplasmic-Endoplasmic Ca-ATPase) pumps Ca^{2+} back into the SR. As $[\text{Ca}^{2+}]$ falls, Ca^{2+} dissociates from troponin C, and the troponin-tropomyosin complex moves and blocks the myosin binding sites on the actin filament. If the supply of ATP is exhausted, as occurs with death, the cycle stops in state of permanent actin-myosin complexes (i.e., **the rigor state**). In this state the muscle is rigid and the condition is termed 'rigor mortis.'
- ❑ These Ca^{2+} binding proteins buffer the $[\text{Ca}^{2+}]$ increase in the SR during Ca^{2+} re-uptake. The principal Ca^{2+} -binding protein in skeletal muscle, calsequestrin, is also present in cardiac and some smooth muscle. Calreticulin is a ubiquitous Ca^{2+} binding protein that is found in particularly high concentrations within the SR of smooth muscle.

MOTOR UNIT (FIG. 4.6)

- ❑ **Definition:** Each single spinal motor neuron along with the muscle fibers it innervates is called a motor unit. The motor unit is the functional contractile unit because all the muscle cells within a motor unit contract synchronously when the motor nerve fires.
- ❑ A motor unit follows the all or none law.
- ❑ **Size principle:** Small motor units innervate slow twitch muscle fibers, large motor units innervate fast twitch muscle fibers.
- ❑ **Henneman principle:** In large muscles, the small, slow units are recruited first; then if require, the large units are recruited. Derecruitment in opposite order (**Recruited first, derecruited last**).

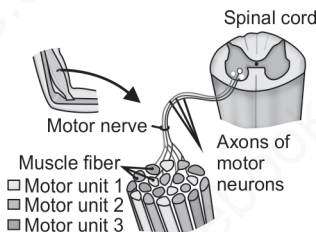

Fig. 4.6: Motor unit

I IMPORTANT

- ❖ The number of muscle fibers supplied by a single neuron is known as **innervation ratio** of a motor unit. The ratio is low in muscle concerned with precise movement. **The extraocular and hand muscle has a ratio of 3-6 (total 3000 motor units)** whereas gastrocnemius and back muscle (concern with posture) has a innervation ratio of 2000 (total 600 units).

I IMPORTANT**Fibrillation/Fasciculation**

- ❖ If the motor nerve is cut, muscle fasciculation occurs. Fibrillation occurs after several days.
- ❖ **Fasciculation:** Involuntary contraction of a single motor unit. Visible grossly.
- ❖ **Fibrillation:** Spontaneous, repetitive contraction of a single muscle fiber. Not visible grossly. The muscle fibrillations reflect supersensitivity to acetylcholine. At this time, the cholinergic receptors have spread out over the entire cell membrane.

A contraction of a muscle can be a single, brief contraction or a maintained contraction due to continuous excitation of muscle fibers:

- ❑ When a single stimulus is applied to the nerve supplying the skeletal muscle, a sharp, momentary contraction of the muscle occurs, followed immediately by its relaxation. This response of the muscle is known as muscle twitch or, simple muscle twitch.
- ❑ If this muscle twitch is recorded, it looks like Figure 4.7.

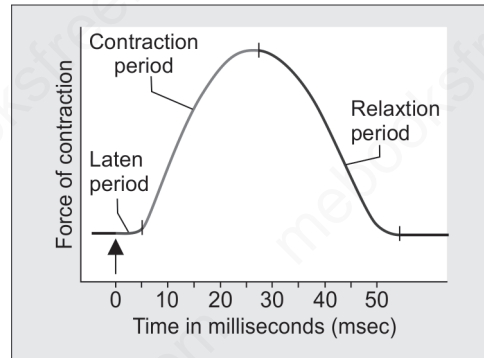

Fig. 4.7. Simple muscle twitch recorded from skeletal muscle.
Arrow indicates "point of stimulus"

- ❑ In the above recording, contraction does not begin immediately upon application of the stimulus. The brief interval between the moment of stimulation and the start of contraction is called the latent period. It is followed by the contraction and the relaxation periods.
- ❑ If a second stimulus is applied before the muscle fibers have relaxed, the second contractile event builds on the first. It can be said that the two contractions **summate**.

Summation: means the adding together of individual twitch contractions to increase the intensity of overall muscle contraction. Two types:

- ❑ **Temporal (frequency summation):** A single motor unit, stimulated by increasing the frequency of contraction:
 - With rapidly repeated stimulation, the individual responses fuse into one continuous contraction. Such a response is called *tetanus* (*tetanic contraction*).
 - It is a complete tetanus when no relaxation occurs between stimuli and an incomplete

I IMPORTANT

In a skeletal muscle, the typical duration of:

- ❖ Latent period = 10 ms
- ❖ Contraction period = 40 ms
- ❖ Relaxation period = 50 ms
- ❖ So, the total twitch duration = 100 ms

tetanus when periods of incomplete relaxation take place between the summated stimuli.

- When the multiple stimulus falling after complete relaxation of the previous contraction then, the strength of contraction increases to a plateau, a phenomenon called the *staircase effect*, or *treppe*.

- ❑ **Spatial (multiple fiber summation or, quantal summation):** As strength of the signal increases, it increases the number of motor units contracting simultaneously. This follows the Henneman size principle.

In the diagram below (Fig. 4.8): Recordings of contractile force during twitch contractions (left) and tetanic contraction (right) of skeletal muscle. A twitch contraction is a single brief muscle contraction that occurs in response to a single threshold stimulus. Tetanic contraction, or tetanus, is a constant contraction of skeletal muscle due to continuous excitation of muscle fiber.

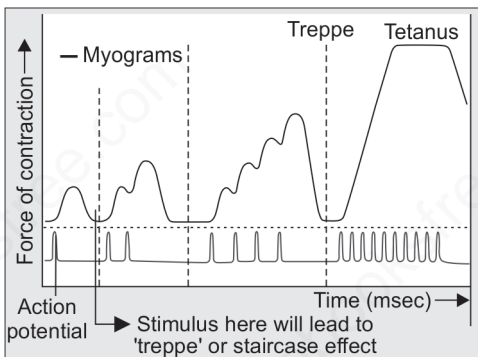

Fig. 4.8: Frequency summation and phenomena of tetanus

LENGTH-TENSION RELATIONSHIP (SINGLE ISOLATED SKELETAL MUSCLE FIBER)

- ❑ The tension developed depends upon the number of cross-bridges that can be formed between actin and myosin.
- ❑ In human body all skeletal muscle remains in a particular initial length at which the active tension developed is maximum. This is called the resting length (also called *optimum length*). At sarcomere level this length is 2-2.2 μm .
- ❑ Equilibrium length is the length acquired by skeletal muscle in isolated condition (if we cut both attachments) and it is less than optimum length.

I IMPORTANT

- ❖ Tetanizing frequency = $1/\text{contraction period}$.
- ❖ Height of contraction in tetanized muscle = $4 \times$ height of contraction of simple muscle twitch.
- ❖ The maximum strength of tetanic contraction of a muscle operating at a normal muscle length averages between 3-4 kg/cm^2 cross sectional area.

I IMPORTANT

- ❖ **Optimum length** refers to that length of the muscle at which it will develop maximum active tension.
- ❖ **Resting length** of a muscle represents the length of the muscle during relaxed state under natural conditions in the body. The resting length of many muscles in the body is optimum length.
- ❖ **Equilibrium length** refers to the length of a relaxed muscle cut free from its bony attachments.
- ❖ **Initial length** is the length of the muscle before it contracts.

RELATIONSHIP BETWEEN SARCOMERE LENGTH AND MUSCLE TENSION (ACTIVE) (FIG. 4.9)

- ❑ **At point A:** Sarcomere length is 1.65 μm . At this point, the two Z disks of the sarcomere are about the ends of the myosin filaments. So, number of cross bridge is less and the strength of contraction decreases.
- ❑ **At point B:** Sarcomere length is 2 μm . At this point, the ends of the two-actin filaments begin to overlap each other in addition to overlapping the myosin filaments and maximum cross bridge formation occurs. So, the sarcomere maintains full tension.
- ❑ **At Point C:** 0.2 μm increase in sarcomere length from point B, does not alter number of cross bridge or, tension.
- ❑ **At point D:** Actin filament has pulled all the way out to the end of the myosin filament, with no actin-myosin overlap. At this point, the tension developed by the activated muscle is zero.

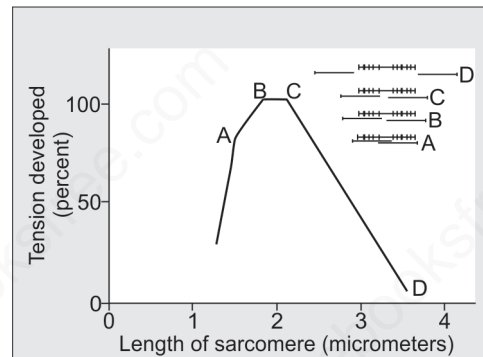

Fig. 4.9: Length tension relationship. In right upper corner, actin-myosin interaction has been shown

EFFECT OF MUSCLE LENGTH ON FORCE OF CONTRACTION IN THE WHOLE INTACT MUSCLE

- ❑ In an **isometric contraction**, the muscle length is held constant during the development of force. An example would be an individual pushing against an immovable object such as the wall of a house.
- ❑ In an **isotonic contraction**, the muscle shortens while exerting a constant force. An example would be an individual lifting a glass of water to his or her mouth.
- ❑ **Total tension:** The tension that a stimulated muscle develops when it contracts. It's the sum of passive and active tension.

- ❑ **Passive tension:** Exerted by the elastic tissue of the muscle fiber when stretched.
- ❑ **Active tension:** Depends upon the number of cross-bridges that formed between actin and myosin.

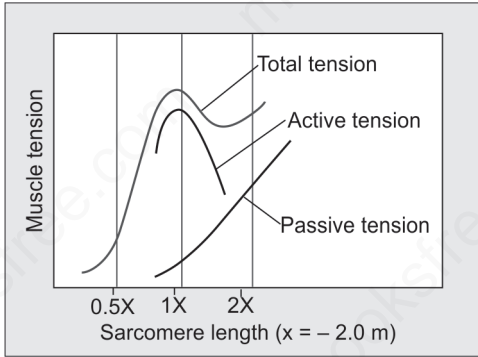

Fig. 4.10: Active and passive tension

Active tension graph: Similar to Figure 4.10.

Passive tension graph: When muscle is fully relaxed (at 0.5X), no passive tension. It starts increasing after muscle is sufficiently stretched (1X).

Total tension graph: Sum of active and passive tension.

ENERGY FOR MUSCLE CONTRACTION

- ❑ ATP store-immediate source. May sustain for only 3 sec
- ❑ ATP from creatinine phosphate (Phosphagen system): 8 to 10 sec
- ❑ ATP from glycolysis
- ❑ ATP from aerobic metabolism.

RELAXATION OF SKELETAL MUSCLE

- ❑ Ca^{2+} is reduced in the muscle cell by the sarcoplasmic or endoplasmic reticulum Ca^{2+} ATPase (SERCA) pump. The SERCA pump uses energy from ATP hydrolysis to remove Ca^{2+} from the cytosol back into the terminal cisterns, where it is stored until released by the next action potential.
- ❑ Once the Ca^{2+} concentration outside the reticulum has been lowered sufficiently, chemical interaction between myosin and actin ceases and the muscle relaxes.

MUSCLE FIBER TYPES

	Type I (SO)	Type IIA (FOG)	Type IIB (FG)
Other names	Slow, Oxidative	Fast, oxidative, glycolytic	Fast, glycolytic
Color	Red	Red	White
Myosin ATPase activity	Slow	Fast	Fast
Ca ²⁺ pumping capacity of sarcoplasmic reticulum	Moderate	High	High
Twitch duration	Large (up to 90 ms)	Small (up to 7.5 ms)	Small (up to 7.5 ms)
Tetanzing frequency	Low	High	High
Oxidative capacity, capillary density, myoglobin content and mitochondria	High	High	Low
Glycolytic capacity	Moderate	High	High
Fatigability	Fatigue late (resistant)	Fatigue early (Resistant)	Fatigue earliest (Fatiguable)
Diameter of fiber	Small	Intermediate	Large
Size of motor neuron	Small	Intermediate	Large
Function	For long, slow contractions	For fine, skilled movement	For fine, skilled movement

I IMPORTANT

In reality, each whole muscle is composed of fibers of each twitch type, although one type of fiber predominates in any given muscle.

MUSCLE-CARDIAC MUSCLE**Functional Histology of Myocardium (Contractile Cell)**

- Striated muscle
- Muscle fibers branch and interdigitate
- Intercalated disks are present at Z lines. Intercalated disk is the place of mechanical electrical coupling of muscle fibers (Electrical coupling is by means of gap junctions, mechanical coupling by fusion of plasma membrane with help of desmosome)
- Act as a functional syncytium because of gap junction

- ❑ Single nucleus per cell
- ❑ The T-tubule system is at Z lines (In skeletal muscle it is at A-I junction)
- ❑ In cardiac muscle there is one T-tubular system per sarcomere (In skeletal muscle there are two T-tubular system per sarcomere).

Histology of Modified Myocardium (Conduction System of Heart-Pacemaker Cell)

- ❑ Few striation due to less amount of actin/myosin
- ❑ Less no of cell organelle
- ❑ Contain P cells (Pacemaker cell)-produce spontaneous impulse
- ❑ Gap junctions are also present.

Electrical activity

This is different in the—

- ❑ Pacemaker Cells (SA node, AV node)
- ❑ Contractile Cell (Myocardium)

Detail Description given in Chapter 5.

I IMPORTANT

- ❖ Action potential in cardiac muscle is prolonged **lasting 150 to 300 msec**, which is substantially longer than the action potentials in skeletal muscle (≈ 5 msec).
- ❖ The long action potential duration in cardiac muscle is **due to a slow inward Ca^{2+} current through a voltage-gated L-type Ca^{2+} channel** in the sarcolemma. This is the reason as to why cardiac muscle **cannot be tetanized**.

Action potential in pacemaker cell	Action potential in myocardium		
	Phase	Name	Cause
<ul style="list-style-type: none"> • Prepotential: <ul style="list-style-type: none"> – Slow Na (funny current) – Ca^{++} influx (through T-type Ca^{++} channels) – Decrease in K^+ efflux. • Action potential: <ul style="list-style-type: none"> – Depolarization: \uparrow in Ca^{++} influx through L type Ca^{++} channel. – Repolarization: \uparrow in K^+ efflux. 	0	Initial rapid depolarization and overshoot	Opening of Na^+ channels
	1	Initial rapid repolarization (prominent in epicardial region of left ventricular wall)	Efflux of K^+ Closure of Na^+ channels
	2	Plateau	Ca^{2+} influx (L type) and K^+ efflux
	3	Text Repolarization	Closure of Ca^{2+} channels; K^+ efflux through various types of K^+ channels
	4	RMP	

Mechanism of Contraction (Fig. 4.11)

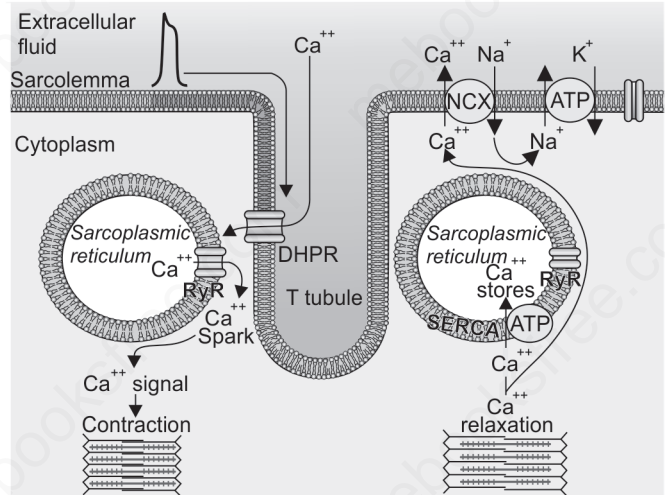

Fig. 4.11: Mechanism of contraction and relaxation in cardiac muscle

- ❑ This is similar to skeletal muscle, although few differences are there.
- ❑ One important phenomenon in myocardium is **CICR or calcium-induced calcium release**. This means that Ca²⁺ entry from ECF into the cardiac muscle cell triggers the release of more Ca²⁺ from the sarcoplasmic reticulum (Flowchart 4.1)
- ❑ ECF Ca⁺⁺ enters into cardiac muscle cell via L-type Ca⁺⁺ channels
- ❑ The L-type Ca²⁺ channel is composed of five subunits ($\alpha 1$, $\alpha 2$, β , γ , and δ). The $\alpha 1$ subunit is also called the dihydropyridine receptor (DHPR) because it binds the dihydropyridine class of Ca²⁺ channel blocking drugs (e.g., nimodipine).
- ❑ Terminal regions of the SR (sarcoplasmic reticulum) are enriched in ryanodine receptors (RYRs; an SR Ca²⁺ release channel). The RYR is a Ca²⁺-gated Ca²⁺ channel, so influx of Ca⁺ during an action potential is able to initiate release of Ca²⁺ from the SR in cardiac muscle (**Ca²⁺ spark**).
- ❑ The amount of Ca²⁺ released into the cytosol from the SR is much greater than that entering the cytosol from the ECF, although release of Ca²⁺ from the SR does not occur without this entry of "trigger" Ca²⁺

I IMPORTANT

Ca²⁺ spark (Ca⁺⁺ released from SR) is also seen in skeletal muscle and smooth muscle.

- ❑ This contrasts with skeletal muscle, where release of Ca^{2+} from the SR does not involve entry of Ca^{2+} across the sarcolemma but instead results from a voltage-induced conformational change in the DHPR
- ❑ Thus, excitation-contraction coupling in **cardiac muscle is termed electrochemical** coupling (involving Ca^{2+} -induced release of Ca^{2+}), whereas excitation contraction coupling in **skeletal muscle is termed electromechanical** coupling (involving direct interactions between the DHPR in the T tubule and the RYR in the SR).

Flowchart 4.1: Calcium-induced calcium release (CICR) in cardiac muscle

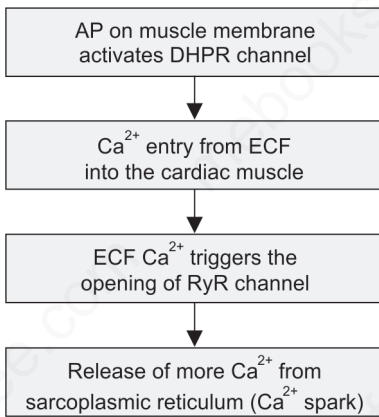

Relaxation

- ❑ Relaxation is by decreasing the cytosolic Ca^{2+} level by:
 - Ca^{2+} pump in sarcoplasmic reticulum (SERCA) = 80%
 - Na-Ca-Antiport (NCX) ($1\text{Ca}^{++}: 3\text{Na}^{+}$) = 20%
 - $\text{Na}^{+}\text{-K}^{+}$ ATPase.

Effect of Epinephrine (Sympathetic System Stimulations)

- ❑ Positive effect on following:

Term	Related to
Inotropic	Force of contraction
Chrono-	Heart rate
Dromo-	Conduction velocity
Bathmo-	Excitability
Lusio-	Relaxation time

I IMPORTANT

- ❖ Extracellular Ca^{2+} is essential for cardiac muscle, different from that of skeletal muscle, which can contract in the total absence of extracellular Ca^{2+} .
- ❖ The amount of ECF Ca^{2+} is relatively small and serves as a trigger for release of Ca^{2+} from the SR.
- ❖ In the absence of ECF Ca^{2+} , **one is still able to initiate an action potential** in cardiac muscle, although it is considerably shorter in duration and **unable to initiate a contraction**.

Mechanism of Sympathetic System Effects on Heart (Flowchart 4.2)

- Sympathetic system (Epi/NE) activate β -adrenergic receptors on the cardiac muscle cells.

Flowchart 4.2: Effect of sympathetic system activation on myocardium

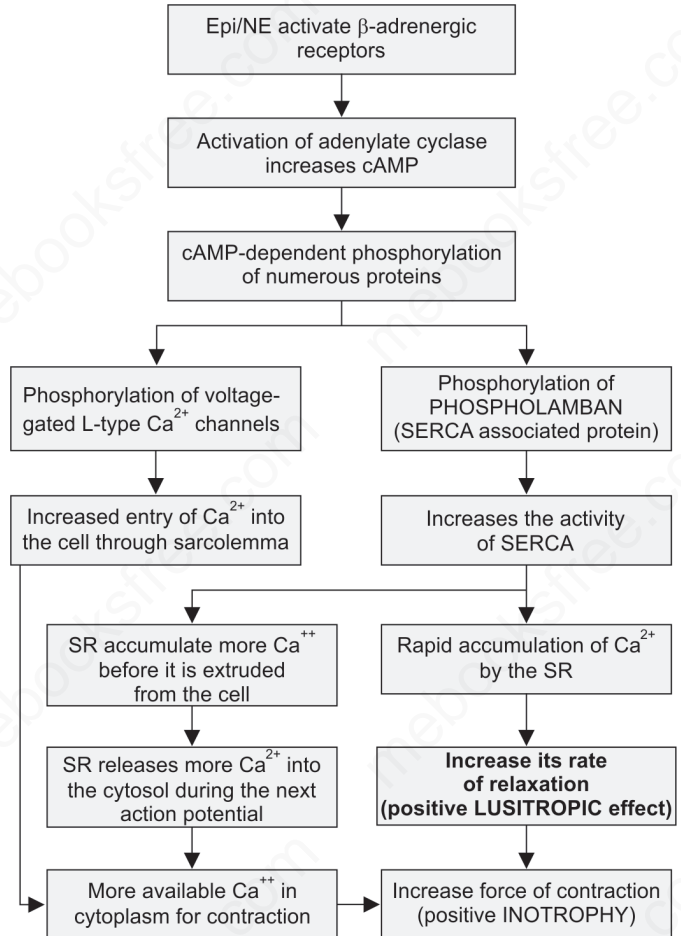

MUSCLE—SMOOTH MUSCLE

Nerve Supply

- Less complex NM junction.
- The nerve shows varicosities; the nerve establishes functional contact at several points on the muscle as it courses alongside it; this is called *synapse en passant*.
- There can be excitatory or inhibitory junctional potentials.

FUNCTIONAL ANATOMY (FIG. 4.12)

- ❑ Junctions between membrane are Gap junction and Adherent junction
- ❑ Cell has a single, centrally located nucleus
- ❑ **No T tubules** but Presence of caveolae (invaginations of the smooth muscle membrane). The voltage-gated L-type Ca^{++} channel and the $3\text{Na}^{+}-1\text{Ca}^{++}$ antiporter, are associated with caveolae
- ❑ **No (or rudimentary) sarcoplasmic reticulum**
- ❑ Not well-organized myofibrils
- ❑ **No Z lines** (The anchorage for the actin filaments is provided by structures called **dense bodies**)
- ❑ Thick and thin filament present
- ❑ Tropomyosin and titin present. **Tropomyosin enhances actomyosin interaction (opposite to skeletal muscle)**
- ❑ **NO troponin (but Calmodulin) and NO nebulin**
- ❑ Contains two proteins not found in striated muscle: **caldesmon and calponin** (role not known)
- ❑ Thin filaments are composed of actin, tropomyosin, caldesmon and calmodulin in ratio **14:2:1:1 (actin:tropomyosin:troponin = 7:1:1 in skeletal muscle)**
- ❑ Few mitochondria (Energy comes mainly from glycolysis).

Types of Smooth Muscle

- ❑ **Single unit (visceral or, Unitary)**—Cells are electrically coupled (gap junctions) such that electrical stimulation of one cell is followed by stimulation of adjacent smooth muscle cells. For example, Smooth muscle present in hollow viscera.
- ❑ **Multi unit (multitary)**—Cells are not electrically coupled. For example, Intraocular muscle of the eye (ciliaris, iris) and vas deferens of the male genital tract.

Electrical Activity

- ❑ There is no steady resting membrane potential in smooth muscle (RMP is -60 to -40 mV)
- ❑ Action potentials (AP) occur in unitary smooth muscle (such as visceral muscle) in the same way that they occur in skeletal muscle. They do not normally occur in many, multi-unit types of smooth muscle.
- ❑ AP of visceral smooth muscle occur in one of two forms:
 - **Spike potentials**—duration 10-15 ms

I IMPORTANT

Calmodulin is the calcium binding protein present in smooth muscle.

I IMPORTANT

Fig. 4.12: Physical structure of smooth muscle (Adapted from Guyton's Physiology)

I IMPORTANT

Excitation contraction coupling in visceral smooth muscle is a very slow process as compared to skeletal muscle and myocardium

➤ **AP with plateaus**—duration ~1000 ms (1 second). This type of AP helps in prolong contraction that occurs in some types of smooth muscle, such as the ureter, the uterus.

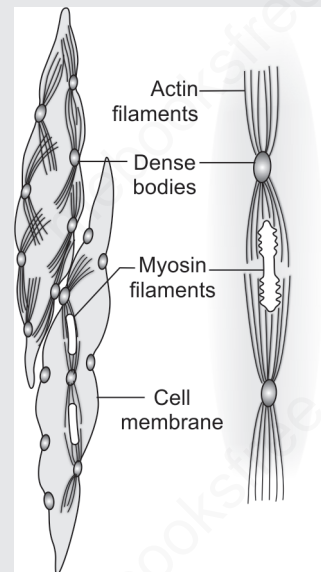
- ❑ Some smooth muscle is self-excitatory. This often is associated with a basic *slow wave rhythm* of the membrane potential. A typical slow wave is seen in a visceral smooth muscle of the gut (BER of GIT). [Detail in Chapter 16]

Mechanism of Contraction

- ❑ First Ca^{2+} entry into the cell and binds to calmodulin
- ❑ The Ca^{2+} —calmodulin complex activates myosin light chain kinase (MLCK), a phosphorylating enzyme
- ❑ Activation of MLCK causes phosphorylation of regulatory light chain that is associated with the myosin II molecule, which causes increased myosin ATPase activity and binding of myosin to actin
- ❑ This initiates the cross-bridge cycling and contraction
- ❑ Relaxation is by dephosphorylation of myosin by myosin phosphatase.

Flowchart 4.3: Sequence of events in contraction and relaxation of smooth muscle

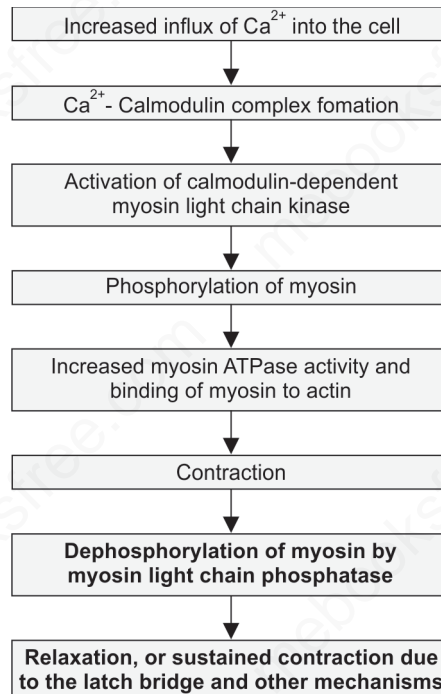

Sources of Ca⁺⁺ in Smooth Muscle

Extracellular Calcium

- ❑ Voltage gated calcium channels(1,4 dihydropyridine)
- ❑ Numerous different ligand-gated channels
- ❑ Stretch activated calcium channels
- ❑ Small number of unregulated “leak” channels (not significant).

Intracellular Calcium (SR)

- ❑ Efflux via inositol 1, 4, 5-triphosphate (IP3)
- ❑ Efflux via RyR channel
- ❑ Ca²⁺ stimulated calcium release (CICR).

Many hormones and neurotransmitters contract smooth muscle through ligand gated calcium channel. Activation of ligand-gated calcium channels generally does not generate action potentials in smooth muscle except at very high agonist concentrations. Contraction of smooth muscle via ligand-gated calcium channels without the generation of an action potential is called **pharmacomechanical coupling**.

SOME UNIQUE FEATURES OF SMOOTH MUSCLE CONTRACTION

- ❑ The process is slow
- ❑ It is a low-energy mechanism
- ❑ It shows the presence of **latching or latch state**. This is the state in smooth muscle where, even after dephosphorylation of myosin, the cross-bridges continue to ‘cling on’ for sometime. The advantage is that it allows sustained contraction with minimum energy (ATP) expenditure.
- ❑ **Plasticity:** A smooth muscle exhibits the property of plasticity (it can readjust its resting length). Therefore, the length-tension relationship curve in a smooth muscle is not a smooth curve but a lagged line. The usual length-tension relationship that is valid for striated muscles.
- ❑ **Stress relaxation:** When stretched, smooth muscle is unlatched and it relaxes.
- ❑ There is a higher percentage of shortening (80% shortening in smooth muscle as compared with 30% shortening in skeletal muscle). This is due to side polar nature of cross bridges.

- ❑ There is no fixed length-tension relationship in smooth muscle. It shows the property of plasticity.
- ❑ **Smooth muscle can generate as even more tension than skeletal muscle/cardiac muscle (4-6 kg/cm²).**
- ❑ Smooth muscle is stimulated when stretched.

FEW IMPORTANT DIFFERENCES BETWEEN THREE TYPES OF MUSCLE

I IMPORTANT

In terms of speed of contraction:

- ❖ Skeletal muscle is fastest, then
- ❖ Cardiac muscle, then
- ❖ Smooth muscle.

	Skeletal muscle	Cardiac muscle	Smooth muscle
Electrical activity of muscle	Action potential spike	Action potential plateau	Action potential spike, plateau
Ca ⁺⁺ sensor	Troponin	Troponin	Calmodulin
Excitation contraction coupling	Mechanical coupling between DHPR and RyR	Electromechanical coupling between DHPR and RyR	Electromechanical and pharmacological coupling
AP duration	3-5 ms	200-400 ms	10-15 ms, may be 1 sec
Twitch duration	20-200 ms	200-400 ms	200 ms-sustained
Phospho-lamban	Present	Present	Present
Case-questrin	Present	Present	Present

MULTIPLE CHOICE QUESTIONS

SKELETAL MUSCLES

RECENT MCQs

- The site where myosin heads bind to actin in skeletal muscles are covered by:
 - Tropomyosin
 - Troponin
 - Calcium
 - None of the above
- Actin's active site is covered by:
 - Myosin
 - Tropomyosin
 - Troponin
 - Desmin
- Thin filament consists of all *except*:
 - Actin
 - Troponin
 - Myosin
 - Tropomyosin
- Skeletal muscle contraction ends when:
 - Ions move out of cytoplasm
 - Ach is absorbed from the NMJ
 - Closure and in-drawing of receptors
 - Decreased calcium outside reticulum
- Myosin filament has a fixed length of:
 - 0.16 nm
 - 1.6 μm
 - 16 nm
 - 1.6 mm
- Fine, irregular contraction of individual fibers called:
 - Fasciculations
 - Fibrillation
 - Tics
 - Spasm
- When the tension in a muscle fiber is maximum, its length is called as:
 - Equilibrium length
 - Optimum length
 - Initial length
 - None
- The number of muscle fibers innervated by a motor axon is smallest in:
 - Gastrocnemius
 - Orbicularis oculi
 - Single-unit smooth muscle
 - Soleus
- Staircase phenomenon (Treppe) is due to:
 - Increased availability of intracellular calcium
 - Synthesis of stable troponin C molecules
 - Summation
 - Tetanus
- A twitch of motor unit is called:
 - Myoclonic jerk
 - Tremor
 - Fasciculation
 - Chorea
- Sarcomere ends between:
 - A band and I band
 - Two Z lines
 - Two I bands
 - None
- During skeletal muscle contraction:
 - A band shorten
 - Both H and I band shorten
 - Both A and I band shorten
 - Both A and H band shorten
- Skeletal muscle contraction requires all *except*:
 - Depends on Action potential
 - Recruitment of more number of fibers produces more contraction
 - Increase in the strength of action potential increases contraction
 - Local tension

14. Duration of maximum contraction depends upon:

- a. Absolutely refractory period
- b. Relative refractory period
- c. Both
- d. None of the two

15. Tetanic contraction is due to accumulation of:

- a. Na⁺
- b. Ca⁺⁺
- c. K⁺
- d. Cl⁻

16. Tetany in muscle occurs inspite of normal serum calcium level. Responsible ion is:

- a. Mg⁺⁺
- b. K⁺
- c. Ca⁺⁺
- d. Na⁺

17. Type I muscle fibers are:

- a. Red
- b. Anerobic
- c. Large
- d. Glycolytic

18. True about type II muscle fibers:

- a. Contracts slowly
- b. Higher mitochondrial content
- c. Glycolytic
- d. Not useful for intense moments of short duration

19. Most distinguishable features between skeletal muscle and smooth muscle:

- a. Troponin
- b. Tropomyosin
- c. Myosin
- d. Actin

AIIMS/PGI/JIPMER

20. In muscle contraction all are true except: [PGI 03]

- a. A band remains unchanged
- b. H zone disappears
- c. I band becomes wider
- d. Two Z lines come closer

21. The site where myosin heads bind to actin in skeletal muscles are covered by: [AI08]

- a. Tropomyosin
- b. Troponin
- c. Calcium
- d. None of the above

22. Tropomyosin: [AI 02]

- a. Helps in the fusion of actin and myosin
- b. Covers myosin and prevents attachments of actin and myosin
- c. Slides over myosin
- d. Causes Ca²⁺ release

23. Which of the following triggers muscle contraction? [AI 08]

- a. Ca binding tropomyosin
- b. Ca binding troponin C
- c. ATP breakdown
- d. Ca binding troponin I

24. Twitch of a single motor unit is called: [AI 99]

- a. Myoclonic-jerk
- b. Fasciculation
- c. Tremor
- d. Chorea

25. The force of muscle contraction can be increased by all of the following except: [AI 04]

- a. Increasing the frequency of activation of motor units
- b. Increasing the number of motor units activated
- c. Increasing the amplitude of action potentials in the motor neurons
- d. Recruiting larger motor units

26. The properties of fast twitch muscle are: [PGI Nov 11]

- a. Extensive sarcoplasmic reticulum
- b. Extensive blood supply
- c. Large glycolytic pathway
- d. Abundant mitochondria
- e. Made up of large number of small fibers with some long fiber muscles

27. Feature(s) of slow twitching muscle is are: [PGI Nov 11]

- a. Contain large amounts of myoglobin
- b. Composed of smaller fibers
- c. Contain larger amount of glycolytic enzyme
- d. White in color
- e. It has high ATPase activity

28. Which of the following is not a sarcolemmal protein? [AI 08]

- a. Sarcoglycan
- b. Dystrophin
- c. Dystroglycan
- d. Perlecan

29. There is mutation of gene coding for the ryanodine receptors in malignant hyperthermia. Which of the following statements best explains the increased heat production in malignant hyperthermia?

[AIIMS May 05]

- a. Increased muscle metabolism by excess of calcium
- b. Thermic effect of blood
- c. Increased sympathetic discharge
- d. Mitochondria thermogenesis

CARDIAC MUSCLE

30. Heart muscle, true are all except: [AI 07]

- a. Act as syncytium
- b. Has multiple nuclei
- c. Has gap junctions
- d. Has branching

31. Function of phospholamban is:

- a. Regulates Na K pump [AIIMS June 00]
- b. Transports calcium out of the mitochondria
- c. Binds actin with myosin
- d. Collects calcium into the sarcoplasmic reticulum

32. For cardiac muscle, V_{max} can be used as a measured of:

- a. Excitability
- b. Contractility

- c. Rhythmicity
- d. Conductivity

33. Which of the following is not a feature of cardiac muscle?

- a. All or none phenomenon
- b. Length-tension relationship
- c. Tetany (tetanus)
- d. Pacemaker potential

34. Vulnerable period of heart is a time occurring during _____ wave and represent a period when premature beats may lead to fibrillation:

- a. P
- b. R
- c. S
- d. T

SMOOTH MUSCLES

RECENT MCQs

35. Most distinguishing feature between skeletal muscle and smooth muscle:

- a. Troponin
- b. Tropomyosin

- c. Myosin
- d. Actin

36. Calmodulin activates:

- a. Muscle phosphorylase
- b. 2, 3 DPG
- c. Protein kinase
- d. Glucokinase

AIIMS/PGI/JIPMER

37. Which one of the following acts to increase the release of Ca^{2+} from endoplasmic reticulum?

[AIIMS Nov 04, AI 04]

- a. Inositol triphosphate
- b. Decreased parathyroid hormone
- c. 1,25-dihydroxy cholecalciferol
- d. Diacylglycerol

38. Increase in cytosolic calcium from intracellular storage, during smooth muscle contraction is/are due to:

[PGI Dec 08]

- a. cAMP
- b. CCMP
- c. Ca^{2+} channel
- d. cGMP
- e. IP3-DAG

39. Action of calmodulin is:

[PGI Dec 02]

- a. Ca^{2+} dependent
- b. Through calmodulin dependent kinases
- c. Through CAMP dependent kinases
- d. Through CGMP dependent kinases

40. The difference between skeletal and smooth muscle contraction and relaxation is/are:

[PGI Dec 06]

- a. Troponin (+ve)
- b. Myosin light chain kinase
- c. Ca^{2+}
- d. Actin
- e. Myosin

41. True regarding excitation contraction coupling in smooth muscles is:

[AIIMS May 02]

- a. Presence of troponin is essential
- b. Sustained contraction occurs with high calcium concentration
- c. Phosphorylation of actin is required for contraction
- d. Presence of cellular calcium is essential to cause muscle contraction

42. True for smooth muscle contraction is A/E:

[PGI Dec 09]

- a. Latch bridge are less cycle less ATP bridge
- b. Dephosphorylation causes definite relaxation
- c. LC phosphatase is essential for binding
- d. Slow and prolonged contractile response independent of nerve supply
- e. Length tension relationship does not exist

43. The nerve impulse which leads to initiation of smooth muscle contraction:

[AI 12]

- a. Causes opening of the calcium channels which leads to increase in Ca^{+2} concentration
- b. Causes both the plasma membrane and T-tubules to undergo hyperpolarization
- c. Inhibits Na^{+} entry in sarcomere
- d. Is initiated by binding of acetylcholine to receptors in the sarcoplasmic reticulum

FUTURE TRENDS

44. The following diagram shows the length-tension relationship for a single sarcomere. Why is the tension development maximal between points B and C?

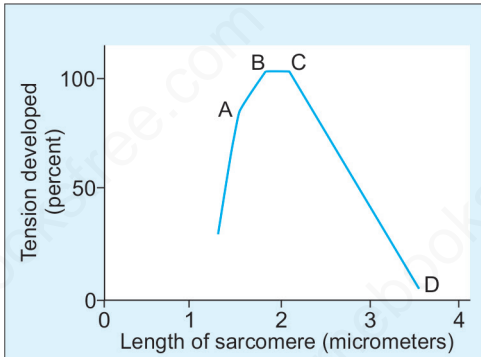

- a. Actin filaments are overlapping each other
- b. The Z disks of the sarcomere abut the ends of the myosin filament
- c. There is optimal overlap between the actin and myosin filaments
- d. There is minimal overlap between the actin and myosin filaments

The diagram illustrates the isometric length-tension relationship in a representative intact skeletal muscle. Answer the following three questions (number 45 to 47), use the letters in the diagram to identify each of the following:

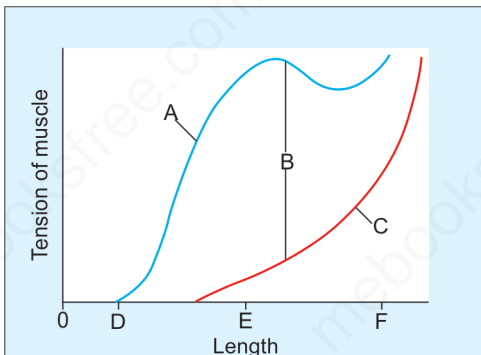

45. "Active tension" or contraction-dependent tension:

- a. A
- b. B
- c. C
- d. E

46. The muscle length at which active tension is maximal?

- a. A
- b. B
- c. C
- d. E

47. The contribution of noncontractile muscle elements to total tension:

- a. A
- b. B
- c. C
- d. E

48. The diagram below shows the force-velocity relationship for isotonic contractions of skeletal muscle. The differences in the three curves result from differences in which of the following?

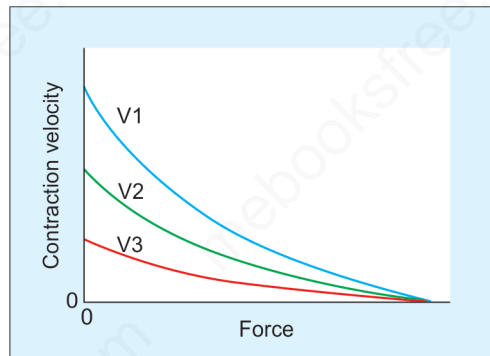

- a. Frequency of muscle contraction
- b. Muscle mass
- c. Myosin ATPase activity
- d. Recruitment of motor units

The diagram illustrates below is the single isometric twitch characteristics of two skeletal muscles, A and B, in response to a depolarizing stimulus. Refer to it when answering the next two questions.

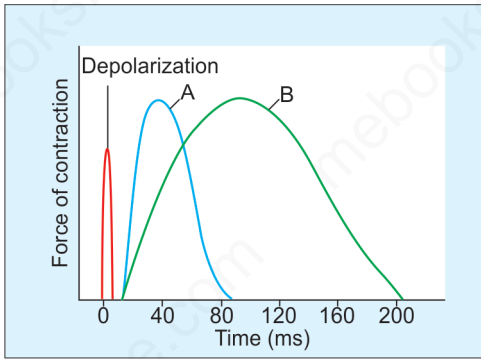

49. Which of the following best describes muscle B, when compared to muscle A?

- a. Adapted for rapid contraction
- b. Composed of larger muscle fibers

- c. Fewer mitochondria
- d. Innervated by smaller nerve fibers

50. The delay between the termination of the transient depolarization of the muscle membrane and the onset of muscle contraction observed in both muscles A and B reflects the time necessary for which of the following events to occur?

- a. ADP to be released from the myosin head
- b. ATP to be synthesized
- c. Ca^{++} to accumulate in the sarcoplasm
- d. Myosin head to complete one cross-bridge cycle

ANSWERS WITH EXPLANATIONS

1. Ans. a. Tropomyosin

(Ref: Guyton-Physiology-13th edn. pp 89)

In the resting state, the tropomyosin molecules lie on top of the active sites of the actin strands, so that attraction cannot occur between the actin and myosin filaments to cause contraction.

2. Ans. b. Tropomyosin

(Ref: Guyton-Physiology-13th edn. pp 89).

Explanation above.

3. Ans. c. Myosin

(Ref: Ganong's Physiology 24th edn. pp 96)

Myosin is thick filament. All others in the options are thin filaments.

4. Ans. d. Decreased calcium outside reticulum

(Ref: Ganong's Physiology 24th edn. pp 100)

"Once the Ca^{2+} concentration outside the reticulum has been lowered sufficiently, chemical interaction between myosin and actin ceases and the muscle relaxes."

5. Ans. b. 1.6 μm

(Ref: Guyton-Physiology-13th edn. pp 89)

The total length of each myosin filament is uniform, almost exactly 1.6 micrometers.

6. Ans. b. Fibrillation

(Ref: Ganong's Physiology 24th edn. pp 104)

Fine, irregular contractions of individual fibers is non as fibrillations. This is the classic picture of a lower motor neuron lesion. If the motor nerve regenerates, the fibrillations disappear. Usually, the contractions are not visible grossly, and they should not be confused with fasciculations, which are jerky, visible contractions of groups of muscle fibers that occur as a result of pathologic discharge of spinal motor neurons.

7. Ans. b. Optimum length

(Ref: Medical Physiology by Indu Khurana. 2nd edn. pp 73)

8. Ans. b. Orbicularis oculi

(Ref: Medical Physiology by Indu Khurana. 2nd edn. pp 75)

The extraocular and hand muscle has a ratio of 3-6 (total 3000 motor units) whereas gastrocnemius and back muscle (concern with posture) has a innervation ratio of 2000 (total 600 units).

9. Ans. a. Increased availability of intracellular calcium

(Ref: Guyton-Physiology-13th edn. pp 96)

Changes in muscle strength at the onset of contraction due to repeated stimuli are known as staircase effect (Treppe). Although all the possible causes of the staircase effect are not known, primarily by increasing calcium ions in the cytosol because of the release of more and more ions from the sarcoplasmic reticulum with each successive muscle action potential and failure of the sarcoplasm to recapture the ions immediately.

10. Ans. c. Fasciculation

(Ref: Ganong's Physiology 25th edn. pp 110)

See explanation of Q. No. 6.

11. Ans. b. Two Z lines

(Ref: Ganong's Physiology 25th edn. pp 101)

Sarcomere is the length between two Z lines. In resting condition, this length is 2-2.2 μm .

12. Ans. b. Both H and I band shorten

(Ref: Ganong's Physiology 25th edn. pp 101)

During muscle contraction, two Z lines come closer; the length of the 'A band' remains constant whereas the length of H and I band decreases. The M line becomes more prominent.

13. Ans. c. Increase in the strength of action potential increases contraction

(Ref: Ganong's Physiology 25th edn. pp 103)

Action potential (AP) follow all or, none law. So, amplitude (strength) of AP normally does not change. Even if it changes theoretically, it will not alter the strength of contraction of muscle.

14. Ans. c. Both

(Ref: Medical Physiology for Undergraduate Students—Indu Khurana, pp77)

Summation of contraction depends on both ARP and RRP. Summation of skeletal muscle fiber contractions is possible because the absolute refractory period of the sarcolemma is considerably less than the duration of raised cytoplasmic Ca^{2+} concentration and subsequent tension generation. If a second stimulus is applied to the muscle before it has fully relaxed from the first, the response to the second stimulus will add to the residual response of the first stimulus (Summation). Summation leads to increase in height and duration of contraction.

15. Ans. b. Ca^{2+}

(Ref: Medical Physiology for Undergraduate Students – Indu Khurana, pp77)

Ionic basis of tetanus: The Ca^{2+} ions released in the cytoplasm during single muscle twitch are removed quickly and relaxation occurs. When the muscle is stimulated in rapid succession, there occurs a progressive accumulation of Ca^{2+} ions in the cytoplasm. The longer stay and increased amount of Ca^{2+} ions in the cytoplasm increase the tension developed rises to tetanic levels.

16. Ans. c. Ca^{2+}

(Ref: Medical Physiology for Undergraduate Students—Indu Khurana, pp. 77)

(See the explanation of above question also). Here the physiological mechanism of tetany development is the question.

Repeated stimulation to a skeletal muscle produced persistence strong contractile state, which is tetany. This strong contraction is due to large amount of Ca^{2+} in the cytoplasm of muscle, although serum Ca^{2+} is normal. Hypomagnesemia also produces tetany by increasing hyperexcitability of neurone, which stimulates the muscle repeatedly. That also produces tetany by the same mechanism discussed above.

17. Ans. a. Red

(Ref: Ganong's Physiology 25th edn. pp. 108)

Type I muscle fibers are slow twitch, oxidative with high capillary density and myoglobin content. So, the colour is red.

18. Ans. c. Glycolytic

(Ref: Ganong's Physiology 25th edn. pp 108)

Type II fibers are white muscle fibers with fast twitch and high glycolytic activity.

19. Ans. a. Troponin

(Ref: Ganong's Physiology 24th edn. pp 110).

Actin, myosin, tropomyosin are present in both skeletal muscle and smooth muscle. But troponin is absent in smooth muscle, in place of that CALMODULIN is present in smooth muscle.

20. Ans. c. I band becomes wider

(Ref: Ganong's Physiology 24th edn. pp 95)

I band shorten, not wider.

21. Ans. a. Tropomyosin

(Ref: Guyton-Physiology-13th edn. pp 89)

See question no. 1.

22. Ans. b. Covers myosin and prevents attachments of actin and myosin

(Ref: Guyton-Physiology-13th edn. pp 86)

23. Ans. b. Ca binding troponin C

(Ref: Ganong's Physiology 24th edn. pp 96)

Troponin C contains the binding sites for the 4 molecule of Ca^{2+} that helps to initiate contraction.

24. Ans. b. Fasciculation

(Ref: Ganong's Physiology 24th edn pp. 104).

See question no. 6.

Single motor unit: Fasciculation

Single muscle fiber: Fibrillation

25. Ans. c. Increasing the amplitude of action potentials in the motor neurons

(Ref: Ganong's Physiology 24th edn. pp 101).

Increasing frequency of motor unit activation leads to summation of contractions, which increase force of contraction. More motor unit activation or, larger motor unit activation means large number of muscle fiber will contract simultaneously, so force of contraction will be more.

Amplitude of AP has no effect on force of contraction.

26. Ans. a. Extensive sarcoplasmic reticulum, c. Large glycolytic pathway

(Ref: Ganong's Physiology 24th edn. pp 103).

See 'Text' for difference between two types of fiber.

27. Ans. a. Contain large amounts of myoglobin, b. Composed of smaller fibers, e. It has high ATPase activity

(Ref: Ganong's Physiology 24th edn. pp 103).

28. Ans. d. Perlecan

(Ref: Ganong's Physiology 24th edn. pp 97 and Cell Mol Life Sci. 2006;63:2435-2445)

Perlecan is a large extracellular matrix proteoglycan that plays a crucial role in tissue development and organogenesis.

29. Ans. a. Increased muscle metabolism by excess of calcium

(Ref: Ganong's Physiology 24th edn. pp 98, clinical box).

"Malignant hyperthermia has been traced to a mutation in RyR, the Ca^{2+} release channel in the sarcoplasmic reticulum. The mutation results in an inefficient feedback mechanism

to shut down Ca^{2+} release after stimulation of the RyR, and thus, increased contractility and heat generation."

30. Ans. b. Has multiple nuclei

(Ref: Ganong's Physiology 24th edn. pp 106).

Single nucleus per cell is a feature of myocardium. Multiple nuclei per cell is a feature of skeletal muscle.

31. Ans. d. Collects calcium into the sarcoplasmic reticulum

(Ref: Berne and Levy Physiology 6th edn. pp 262)

Phospholamban regulates the SERCA pump for Ca^{++} transport into the sarcoplasmic reticulum.

32. Ans. b. Contractility

(Ref: Medical Physiology for Undergraduate Students—Indu Khurana, pp 77)

When load is zero, the muscle contracts rapidly (isotonic contraction) and the velocity of muscle shortening is maximum. This is known as V_{max} .

As the load increases the velocity of shortening decreases. With further increases in the load, a stage comes when the muscle is unable to lift the load. At this point muscle contracts isometrically.

33. Ans. c. Tetany (tetanus)

(Ref: Medical Physiology for Undergraduate Students—Indu Khurana, pp 77)

Tetanus development is not possible in cardiac muscle due to long refractory period.

34. Ans. d. T

(Ref: Guyton-Physiology 13th edn. pp 132 & Berne & Levy Physiology, 6th edn. pp 317)

In electrocardiography, the T wave represents the repolarization of the ventricles. The interval from the beginning of the QRS complex to the apex of the T wave is referred to as the absolute refractory period. The last half of the T wave is referred

to as the relative refractory period (or vulnerable period). During this period ventricular fibrillation is often initiated when a premature impulse arrives during this period.

35. Ans. a. Troponin

(Ref: Ganong's Physiology 24th edn. pp 110).

In smooth muscle, Ca^{2+} binds to calmodulin (Troponin is absent). All others options (actin, myosin, tropomyosin) are present both in skeletal and cardiac muscle.

36. Ans. c. Protein kinase

(Ref: Ganong's Physiology 24th edn. pp 110).

"In smooth muscle, Ca^{2+} binds to calmodulin, and the resulting complex activates calmodulin-dependent myosin light chain kinase." Phosphorylase is responsible for relaxation.

37. Ans. a. Inositol triphosphate

(Ref: Ganong's Physiology 24th edn. pp 110).

Ca^{2+} increase can be due to influx through voltage- or ligand-gated plasma membrane channels, efflux from intra-cellular stores through the RyR, efflux from intracellular stores through the inositol triphosphate receptor (IP_3R) Ca^{2+} channel, or via a combination of these channels. DAG activates PKC not Ca^{++} release.

38. Ans. c. Ca^{2+} channel, e. IP_3 -DAG

(Ref: Ganong's Physiology 24th edn. pp 110).

See Q. 24

39. Ans. a. Ca^{2+} dependent, b. Through calmodulin dependent kinases

(Ref: Ganong's Physiology 24th edn. pp 110).

Calmoduline is a calcium dependent protein. After activation it acts through calmoduline dependent kinase.

40. Ans. a. Troponin (+ve)

(Ref: Ganong's Physiology 24th edn. pp 110).

41. Ans. d. Presence of cellular calcium is essential to cause muscle contraction

(Ref: Guyton-Physiology 13th edn. pp 95)

Troponin is not present in smooth muscle. Sustained contraction is possible even with fewer amounts of Ca^{++} and less use of ATP (latch bridge phenomenon). Phosphorylation of MYOSIN is required for contraction.

42. Ans. b. Dephosphorylation causes definite relaxation, c. LC phosphatase is essential for binding

(Ref: Guyton-Physiology 12th edn. pp 97)

A latch bridge state is sustained contraction with less number of cross-bridge cycle and less ATP use. In this situation, even after dephosphorylation, myosin heads remain attached with actin.

Option e: Length tension relation is not specific in smooth muscle but it present.

43. Ans a. Causes opening of the calcium channels, which leads to increase in Ca^{+2} concentration

(Ref: Guyton-Physiology 12th edn. pp 97)

44. Ans. c.

Tension development in a single sarcomere is directly proportional to the number of active myosin cross-bridges attached to actin filaments. Overlap between the myosin and actin filaments is optimal at sarcomere lengths of about 2.0 to 2.5 micrometers, which allows maximal contact between myosin heads and actin filaments. At lengths less than 2.0 micrometers, the actin filaments protrude into the H band, where no myosin heads exist. At lengths greater than 2.5 micrometers, the actin filaments are pulled toward the ends of the myosin filaments, again reducing the number of possible cross-bridges.

45. Ans. b. Point B

In this diagram, “active” or contraction-dependent tension is the difference between total tension (trace A) and the passive tension contributed by noncontractile elements (trace C). So, difference between A and C trace is line B in the diagram.

46. Ans. d. Point E

“Active” tension is maximal at normal physiological muscle lengths. At point E, there is optimal overlap between actin and myosin filaments to support maximal cross-bridge formation and tension development is maximum.

47. Ans. c. Point C

Trace C represents the passive tension contributed by noncontractile elements, including fascia, tendons, and ligaments. This passive tension accounts for an increasingly large portion of the total tension recorded in intact muscle as it is stretched beyond its normal length.

48. Ans. c. Myosin ATPase activity

The diagram shows that the maximum velocity of shortening (V_{\max}) occurs when there is no afterload on the muscle (force = 0). Increasing afterload decreases the velocity of shortening until a point is reached where shortening does not occur (isometric contraction) and contraction velocity is thus 0 (where curves intersect X-axis). The maximum velocity of shortening is dictated by the ATPase activity of the muscle, increasing to high levels when the ATPase activity is elevated. Choice A: Increasing

the frequency of muscle contraction will increase the load that a muscle can lift within the limits of the muscle, but will not affect the velocity of contraction. Choices B and D: increasing muscle mass, and recruiting additional motor units will increase the maximum load that a muscle can lift, but these will not affect the maximum velocity of contraction.

49. Ans. d. Innervated by smaller nerve fibers

Muscle B is characteristic of a slow twitch muscle (Type 1) composed of predominantly slow twitch muscle fibers. These fibers are smaller in size and are innervated by smaller nerve fibers. They typically have a more extensive blood supply, a greater number of mitochondria, and large amounts of myoglobin, all of which support high levels of oxidative phosphorylation.

50. Ans. c. Ca^{++} to accumulate in the sarcoplasm

Muscle contraction is triggered by an increase in sarcoplasmic Ca^{++} concentration. The delay between the termination of the depolarizing pulse and the onset of muscle contraction, also called the “lag,” reflects the time necessary for the depolarizing pulse to be translated into an increase in sarcoplasmic Ca^{++} concentration. This process involves a conformational change in the voltage-sensing, or dihydropyridine receptor, located on the T tubule membrane; the subsequent conformational change in the ryanodine receptor on the sarcoplasmic reticulum; and the release of Ca^{++} from the sarcoplasmic reticulum.

Cardiovascular System

CHAPTERS

5. Electrophysiology of Heart
6. Cardiac Output and Regulation
7. Blood Pressure and Regulation
8. Vascular System and Regional Circulation

CHAPTER

5

Electrophysiology of Heart

CONDUCTING SYSTEM OF HEART (FIGS. 5.1A AND B)

- ❑ The conducting system is made up of modified cardiac muscle.
- ❑ Though there are 'latent pacemakers' in other portions of the conducting system, the SA node is the normal **pacemaker** of the heart because its prepotential is the steepest (maximum heart rate).
- ❑ The SA node is situated at the junction of superior vena cava and right atrium.
- ❑ The AV node is situated in the right posterior portion of the inter atrial septum. It is known as the **gatekeeper** of the heart, because it regulates impulses coming from the SA node.
- ❑ Internodal bundles of atrial fibers from SA node to AV node are (contain Purkinje-type fibers): anterior-**Bachman**, middle-**Wenckebach**, posterior-**Thorel**.
- ❑ Conduction also occurs through atrial myocytes, but it is more rapid in these bundles.
- ❑ The AV node is continuous with the bundle of His, which gives off a left bundle branch at the top of the interventricular septum and continues as the right bundle branch.
- ❑ The left bundle branch divides into an **anterior fascicle** and a **posterior fascicle**.
- ❑ The branches and fascicles run subendocardially down either side of the septum and come into contact with the Purkinje system, whose fibers spread to all parts of the ventricular myocardium.

I IMPORTANT

The atrial and ventricular muscle normally do not show prepotential.

I IMPORTANT

P cells are actual pacemaker cells which are small round cells present in different parts of conducting system. Because of this cell, different parts of conducting system produces spontaneous beats (Automaticity).

I IMPORTANT

The property of automaticity (the ability to initiate its own beat) is due to presence of 'P' cell.

The discharge rate of the SA node is faster than the natural self-excitatory discharge rate of either the AV node or the Purkinje fibers. That's why SA node is the normal pacemaker of heart.

I IMPORTANT

The rate of this intrinsic rhythmical discharge in different parts of conducting system are:

Tissue	Discharge rate (beat/min)
Sinus node	70-80 (max up to 100)
AV node	40-60
His bundle	
Purkinje fibers	15-40

I IMPORTANT

The only conducting tissue between the atria and ventricles is the bundle of His.

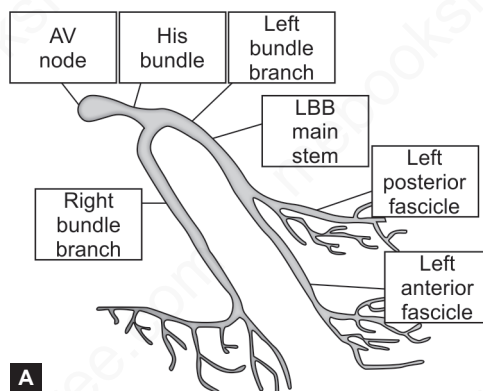
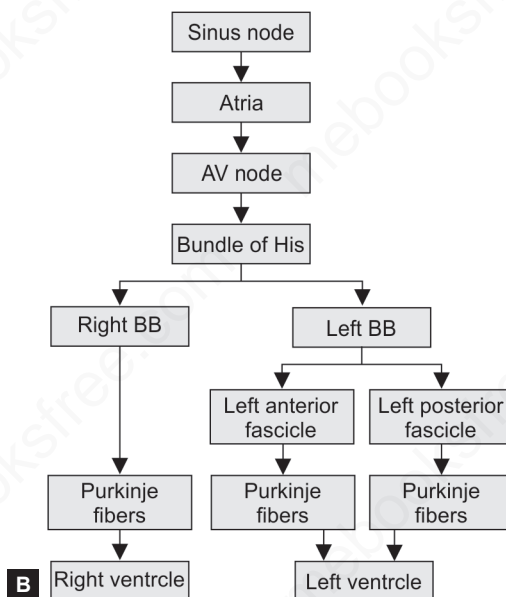
**A****B**

Figs. 5.1A and B: Conducting system of heart

Spread of Cardiac Excitation

- ❑ **Atrial depolarization** starts at SA node
- ❑ **Atrial repolarization** also starts near SA node
- ❑ **Ventricular depolarization:**
 - **First part** of the ventricle to get depolarized is the left endocardial surface of the interventricular septum at the *middle portion*, then the right endocardial surface of the interventricular septum. It then passes down and through the Purkinje system, depolarizes both the ventricles simultaneously from endocardium to epicardium.

- **Last part:** The uppermost part of the inter-ventricular septum and the posterobasal epicardial surface of left ventricle are the last to be depolarized.
- ❑ **Ventricular repolarization:** The apical epicardial surface is the first to repolarize; the base endocardial surface is the last to repolarize.

Time of impulse arrival at different regions of the heart is as follows:

Regions	Time
SA node	0.00 sec
AV node	0.03 sec (from SA node to AV node conduction time ~30 ms)
Bundle of His	0.12 sec (AV nodal conduction time or, delay ~90 ms)
Ventricular septum	0.16 sec (conduction time through His bundle ~40 ms)
Endocardium	0.17–0.19 sec (first ventricular depolarization starting)
Epicardium	0.21–0.22 sec (complete depolarization of heart)

AUTONOMIC INNERVATION

Innervation of SA node and AV node		
	SA node	AV node
Parasympathetic (endocardial location)	Right vagus	Left vagus
Sympathetic (epicardial location)	Right stellate ganglion	Left stellate ganglion

Stimulation of:		
Right vagus	Inhibits SA node	Decrease heart rate
Left vagus	Inhibits AV node	Slow A-V conduction
Right stellate ganglion	Stimulates SA node	Increase heart rate
Left stellate ganglion	Stimulate AV node	Shortens AV conduction time and refractoriness

Sympathetic stimulation to the heart leads to:

- ❑ Increase force of contraction (positive inotropic effect)
- ❑ Increase the cardiac rate (positive chronotropic effect)

I IMPORTANT

Conduction speed of impulse (velocity of conduction):

Tissue	Rate (m/s)
SA node	0.05
Atrial pathways	1
AV node	0.02 to 0.05
Bundle of His	1
Purkinje system	4
Ventricular muscle	1

I IMPORTANT

Conduction velocity of AV node is least because of:

- ❖ Less number of gap junctions
- ❖ Slow type of action potential
- ❖ Small fiber diameter

Maximum gap junctions are present in Purkinje system.

I IMPORTANT

- ❖ Parasympathetic block (atropine) increases the HR to 150–180 beats/min
- ❖ Block of both noradrenergic and cholinergic systems, the heart rate is ~ 100 beats/min.
- ❖ Transplanted heart, resting heart rate = 95–100/min

- ❑ Increase rate of transmission (positive dromotropic effect)
 - ❑ Increase excitability (positive bathmotropic effect)
 - ❑ Increase rate of relaxation (positive lusitropic effect)
- Sympathetic also inhibit the effects of vagal parasympathetic stimulation, probably by release of neuropeptide Y, which is a cotransmitter in the sympathetic endings.

**THE CARDIAC ACTION POTENTIAL (AP)
(FIG. 5.2)**

Two main types of action potentials occur in the heart and they are:

	Fast response AP	Slow response AP
Occurs in	Atrial and ventricular myocytes and Purkinje fibers	SA node and AV node
Phases	Five phases: Depolarization (phase 0): Rapid Early repolarization (phase 1) Plateau (phase 2) Repolarization (phase 3) RMP (phase 4)	Three phases: Depolarization (phase 0): Slow upstroke Phase 1 absent. Phase 2 may be short or, absent. Repolarization (phase 3) RMP (phase 4): also known as prepotential or, pacemaker potential phase.
RMP	Myocytes: - 90 mV Purkinje fiber: - 80 mV	SA node: - 50 mV AV node: - 60 mV
Max amplitude of phase 0	+35 mV	Approx. + 10 mV

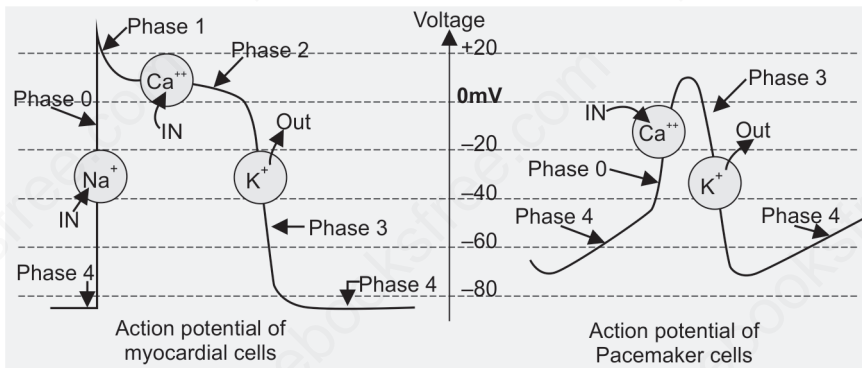

Fig. 5.2: Comparison of action potential between fast response (Myocardial cell) and slow response tissue (Nodal cell)

Fast-Response Action Potentials: Ionic Basis

- ❑ **Depolarization (phase 0):** Influx of Na^+ into the myocyte
 - Na^+ enters through specific fast voltage-activated Na^+ channels
 - The Na^+ channels **activate** very rapidly (in about 0.1 msec)
 - Once open, the Na^+ channels **inactivate** rapidly (time course ≈ 1 to 2 msec)
 - These channels can be blocked by the puffer fish toxin tetrodotoxin and many antiarrhythmic drugs.
- ❑ **Early repolarization (phase 1):** efflux of K^+ from the cell (main) and closure of Na^+ channel.
 - This repolarization is brief because of activation of a **transient outward current (i_{to})** carried mainly by K^+
 - This phase is **prominent** in myocytes of the epicardial and midmyocardial regions of the left ventricular wall
 - It is less prominent in the presence of 4-aminopyridine, which blocks the K^+ channels that carry i_{to} .
- ❑ **Plateau (phase 2):** Ca^{++} enters myocardial cells via voltage-regulated L-type Ca^{++} channels (dihydropyridine receptor channel; DHP).
 - Ca^{++} is counterbalanced by the efflux of K^+
 - K^+ exits through transient outward (i_{to}), delayed rectifier (i_K), and inward rectifier (i_{K1}) channel
 - Ca^{++} channels antagonists such as verapamil, amlodipine, and diltiazem block L-type channels.
- ❑ **Repolarization (phase 3):** The process of final repolarization (phase 3) starts when efflux of K^+ from the cardiac cell begins to exceed influx of Ca^{++} .
 - Three outward K^+ currents (i_{to} , i_K and i_{K1}) contribute to the final repolarization (phase 3) of the cardiac cell
 - The transient outward (i_{to}) and the delayed rectifier (i_K) currents help initiate repolarization.
 - The inwardly rectified K^+ current (i_{K1}) does not participate in the initiation. However, the i_{K1} channels contribute substantially to the rate of repolarization once phase 3 has been initiated.
- ❑ **Restoration of ionic concentrations (phase 4): RMP**
 - Restoration of Na^+ and K^+ are done by Na^+ - K^+ -ATPase.

I IMPORTANT

When the Na^+ channels are in the inactivated state, they cannot be reopened, and another action potential cannot be generated. During this period the cell is said to be in the **absolute refractory period**.

I IMPORTANT

As the cell repolarizes (phase 3), the inactivated channels begin to transition to the closed state. This period is called the relative refractory period.

I IMPORTANT

- ❖ Phase 1 of myocardium AP is due to K^+ opening \gg inactivation of Na^+ channel
- ❖ Phase 2 of myocardium AP starts with Ca^{++} entry
- ❖ Long duration of myocardium AP is due to phase 2.

I IMPORTANT

- ❖ Action potential (AP) of myocardium is based on fast Na^+ current
- ❖ AP of nodal tissue is based on slow Ca^{++} current
- ❖ Prepotential of nodal tissue is mainly based on slow Na^+ (funny) current.

I IMPORTANT

Stimulation of the sympathetic nerves: Stimulates opening of I_f (funny current). So, the rate of spontaneous discharge increases. It also facilitates the opening of L-type Ca^{++} channels. So, the rapidity of the depolarization phase of the impulse. The net effect is increase in heart rate.

I IMPORTANT

Stimulation of cholinergic vagal fibers: The nodal tissue membrane becomes hyperpolarized and the slope of the prepotentials is decreased because the acetylcholine released at the nerve endings increases the K^+ conductance of nodal tissue.

- Similarly, a $3\text{Na}^+-1\text{Ca}^{++}$ antiporter eliminates most of the excess Ca^{++} ions that had entered the cell mainly during phase 2.

Slow-Response Action Potentials: Ionic Basis

- ❑ **Phase 4/prepotential/pacemaker potential/diastolic depolarization:** Mediated by:
 1. **Inward funny current (i_f):** Main current carried by **slow type Na^+ channel** (h channel). This channel is activated as the membrane potential hyperpolarized beyond -50 mV (h; hyperpolarization-induced channel)
 2. **Inward calcium current (i_{Ca}):** Occurs via **transient, rapid T-type Ca^{++} channel**
 3. **Decrease outward K^+ current:** Reduced K^+ permeability along with increase permeability of Na^+ (i_f) and Ca^{++} causes prepotential
- ❑ **Depolarization (phase 0):** Influx of Ca^{++} through L-type Ca^{++} channels.
- ❑ **Repolarization (phase 3):** Inactivation of the Ca^{++} channels and the increased K^+ conductance through the i_{K1} and i_{K} channels.

BASICS OF ELECTROCARDIOGRAPHY (ECG)

The 12-lead ECG consists of:

- ❑ 3 bipolar limb leads/standard Limb Leads (leads I, II, III): Invented by **Willem Einthoven**
- ❑ 3 unipolar (augmented) limb leads (aVR, aVL, aVF): Invented by **E Goldberger**
- ❑ 6 unipolar chest leads (V1 to V6): Invented by **Frank Wilson**

Bipolar limb leads (Figs 5.3 to 5.5): Measurement of potential difference between two electrodes (+ and -) attached to the body.

Lead type	Positive input	Negative input
Lead I	Left arm (LA)	Right arm (RA)
Lead II	Left foot/leg (LL)	Right arm (RA)
Lead III	Left foot /leg (LL)	Left arm (LA)

Einthoven's triangle (Fig. 5.6): Triangle drawn around the area of the heart. The two apices at the upper part of the triangle represent the points at which the two arms (RA and LA) connect electrically with the fluids around

the heart, and the lower apex is the point (pubis) at which the left leg (LL) connects with the fluids.

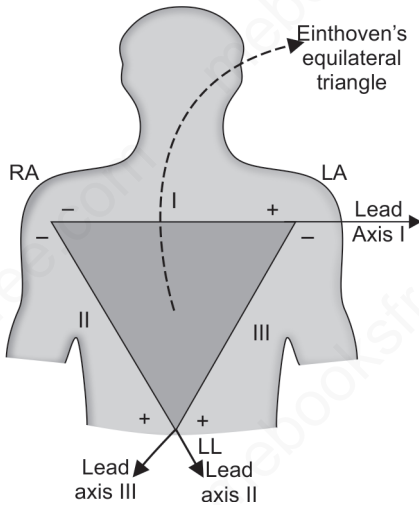

Fig. 5.6: Einthoven's triangle

Einthoven's law (Fig. 5.7): Mean deflection in lead II = Mean deflection in lead I + Mean deflection in lead III (II = I + III)

Example:

$$\begin{aligned} \text{Lead II} &= \text{Lead I} + \text{Lead III} \\ \text{or,} \\ 7 \text{ mm} + 5 \text{ mm} &= 12 \text{ mm} \end{aligned}$$

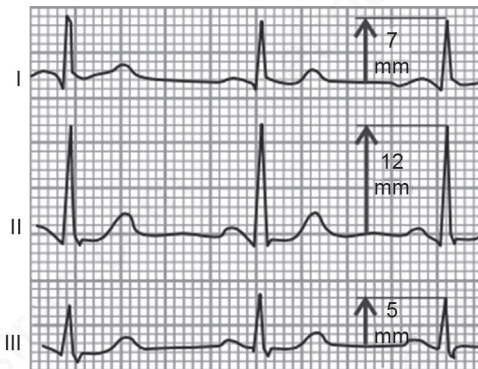

Fig. 5.7: Application of Einthoven's law in standard bipolar leads

Problem:

In Figure 5.8:

- ❑ Right arm (RA) is -0.2 mV (negative) with respect to the average potential in the body,

I IMPORTANT

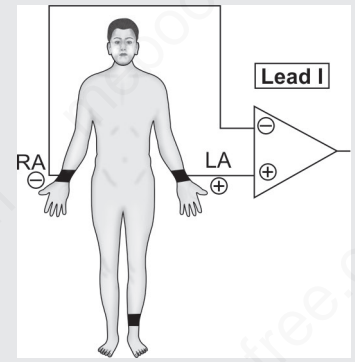

Fig. 5.3: Connections of lead I

I IMPORTANT

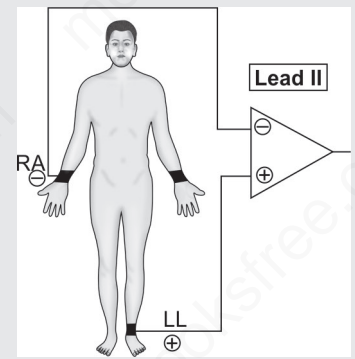

Fig. 5.4: Connections of lead II

I IMPORTANT

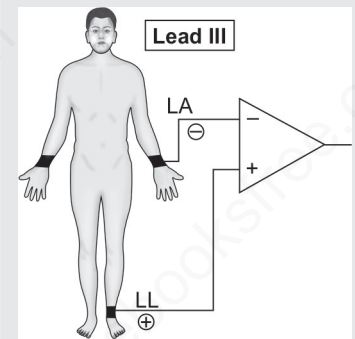

Fig. 5.5: Connection of lead III

I IMPORTANT

- ❖ Normally, the voltages in the three standard bipolar limb leads, as measured from the peak of the R wave to the bottom of the S wave, vary between 0.5 and 2.0 millivolts, with lead III usually recording the lowest voltage and lead II the highest.
- ❖ In general, when the sum of the voltages of all the QRS complexes of the three standard leads is greater than 4 millivolts, the patient is considered to have a high-voltage electrocardiogram.
- ❖ The cause of high-voltage QRS complexes most often is increased muscle mass of the heart, which ordinarily results from hypertrophy of the muscle.

- ❑ Left arm (LA) is +0.3 mV (positive)
 - ❑ Left leg (LL) is +1.0 mV (positive)
- Calculate the Lead I, lead II and lead III and prove Einthoven's law.

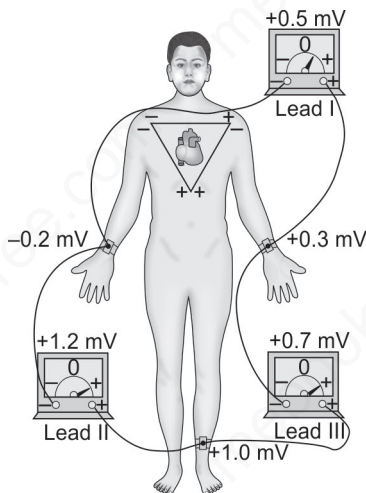

Fig. 5.8: Correction of bipolar leads

Solutions:

- ❑ **Lead I:** Difference between LA and RA = $[(+ 3) - (- 0.2)] = + 0.5 \text{ mV}$
- ❑ **Lead II:** Difference between LL and RA = $[(+ 1) - (- 0.2)] = + 1.2 \text{ mV}$
- ❑ **Lead III:** Difference between LL and LA = $[(+ 1) - (+ 0.3)] = + 0.7 \text{ mV}$

Now, note that the sum of the voltages in leads I and III equals the voltage in lead II; that is, $+ 0.5$ plus $+ 0.7$ equals $+ 1.2$. Mathematically, this principle, called **Einthoven's law**.

Augmented Unipolar Limb Leads (Figs 5.9 to 5.13)

- ❑ The reference points are RA (right arm), LA (left arm) and LL (left foot/leg).
- ❑ VRA is the potential at the right arm (RA). VLA is the potential at the left arm (LA). VLL is the potential at the left leg (LL).
- ❑ These leads are called "augmented" hence the letter "a" is applied to the VR, VL and VF leads (aVR, aVL, aVF)
- ❑ The "augmentation" is in terms of amplitude of deflection.
- ❑ aVR amplitude is $1\frac{1}{2}$ times or, 50% of original (the amplitude in RA).

Lead type	Positive input	Negative input
aVR	Right arm (VR)	Mean of left arm (VL) and left foot (VF) potential
aVL	Left arm (VL)	Mean of right arm (VR) and left foot (VF) potential
aVF	Left foot (VF)	Mean of right arm (VR) and left arm (VL) potential

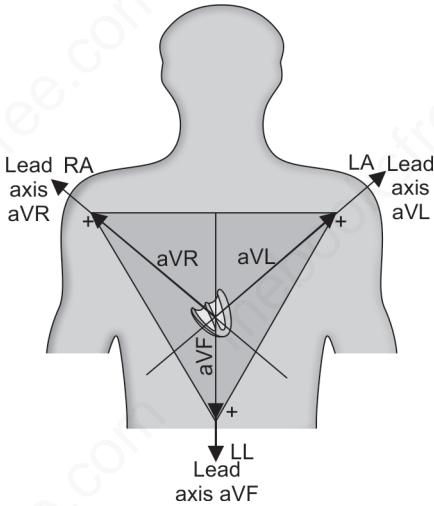
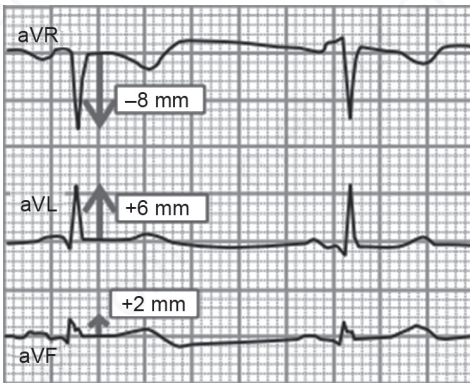

Fig. 5.12: Axis of different augmented leads



$$aVR + aVF + aVL = 0$$

or,

$$6 \text{ mm} + 2 \text{ mm} - 8 \text{ mm} = 0$$

This law is very useful to detect lead misplacement!

Fig. 5.13: Recording from 3 augmented limb leads

I IMPORTANT

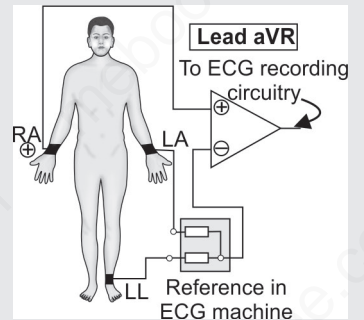

Fig. 5.9. Connection of aVR lead

I IMPORTANT

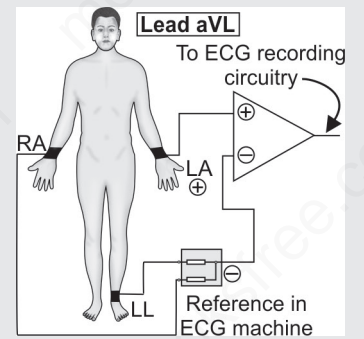

Fig. 5.10: Connection of aVL lead

I IMPORTANT

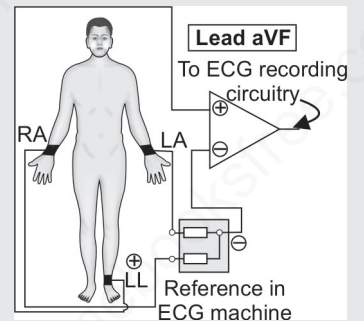
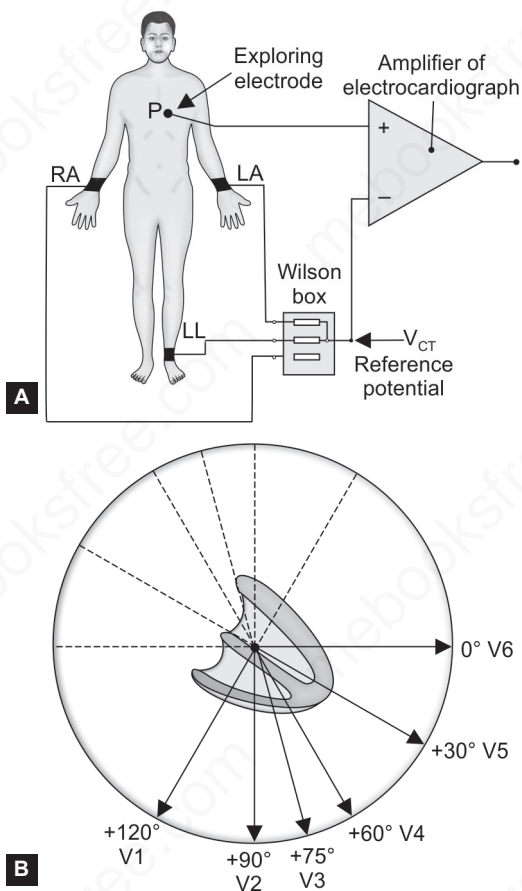

Fig. 5.11. Connection of aVF

Unipolar Chest Leads (Figs 5.14A and B)

In the unipolar chest leads, one electrode that is kept at the point where the potential is to be measured is called the exploring electrode (chest wall). The other electrode (called indifferent electrode) is kept at near theoretical zero potential (reference potential) by connecting 3 wires from the right arm, left arm and left foot, through a resistance (~5 kilo ohm). This is also called the Wilson's terminal. So it is the potential difference between exploring electrode and Wilson's terminal (V_{CT}).



Figs. 5.14A and B: Connection of chest leads and their axis

Lead type	Positive input	Negative input
V1	Right side of the sternum in the fourth intercostal space	Wilson terminal
V2	Left side of the sternum in the fourth intercostal space	Wilson terminal

Contd...

Contd...

Lead type	Positive input	Negative input
V3	Midway between V2 and V4	Wilson terminal
V4	Left midclavicular line in the fifth intercostal space	Wilson terminal
V5	Left anterior axillary line at the same level as V4	Wilson terminal
V6	Left midaxillary line at the same level as V4	Wilson terminal
Other precordial leads		
V7	Left posterior axillary line (same level as V4)	Wilson terminal
V8	Left posterior scapular line (same level as V4)	Wilson terminal
V9	Left border of spine (same level as V4)	Wilson terminal

The 12 Leads Put Together (Fig. 5.15)

- ❑ The 12-lead ECG provides 12 different views of the electrical activity of the heart, each view looking from outside of the chest toward the reference point within the heart.
- ❑ All chest leads (V1 to V6) are in horizontal plane and other 6 leads (I, II, III, aVR, aVL, aVF) are in frontal plane.
- ❑ Lead aVR is directed opposite to that of the other leads and is often ignored (“the forgotten 12th lead”).

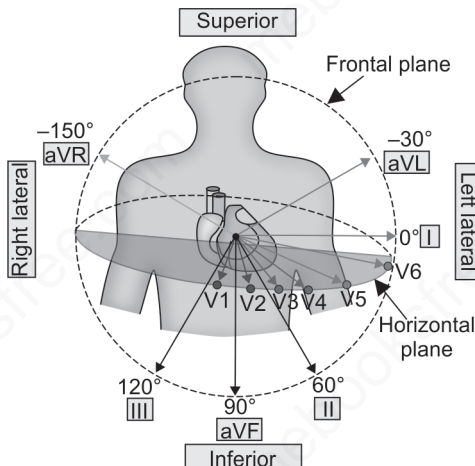

Fig. 5.15: Different leads record different parts of heart

Different leads record different parts of heart:

I High Lateral	aVR	V1 Anteroseptal	V4 Anterior
II Inferior	aVL High lateral	V2 Anteroseptal	V5 Low lateral
III Inferior	aVF Inferior	V3 Anterior	V6 Low lateral

The Basic Principle of Electrical Recording

- ❑ When the atria (or ventricles) undergo depolarization, the wave of depolarization that spreads across the muscle mass occurs in many different directions simultaneously.
- ❑ If a snapshot of electrical activity could be taken at a given instant during the process of depolarization, many individual waves of depolarization (**instantaneous vectors**) represented by arrows (Fig. 5.16) could be observed.
- ❑ The **mean electrical vector** represents the sum of all of these individual vectors (instantaneous vectors) at a given instant in time.

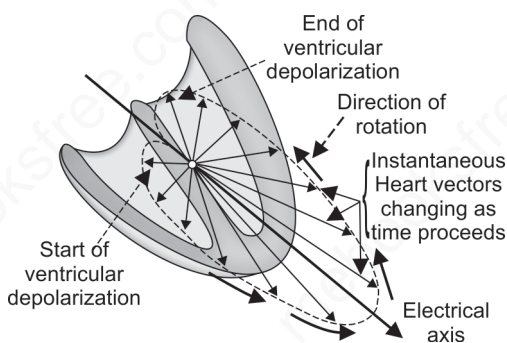

Fig. 5.16: Instantaneous mean vector

- ❑ This mean electrical vector:
 - Determined at a specific *point in time* is known as **instantaneous mean vector**.
 - Determined *over time*, for example, during the entire phase of depolarization of the ventricle, is termed the **mean electrical axis for the ventricles**.
- ❑ It is this *instantaneous mean vector* that is “seen” by the recording electrode at a given instant of time.
- ❑ If the direction of this vector is towards the recording electrode, a positive (upward) deflection is recorded; if it is moving away from the recording electrode, a negative (downward) deflection is recorded.

- ❑ The height of deflection depends on
 - The strength of the *instantaneous mean vector*
 - How this vector is oriented to the lead axis. If it is parallel, it records maximum deflection; if it is perpendicular, it records minimum deflection.

CALCULATION OF MEAN ELECTRICAL AXIS

The hexaxial reference system (Fig. 5.17) composed of the lead axes of the six frontal plane leads (Leads I, II, III and aVR, aVL, aVF).

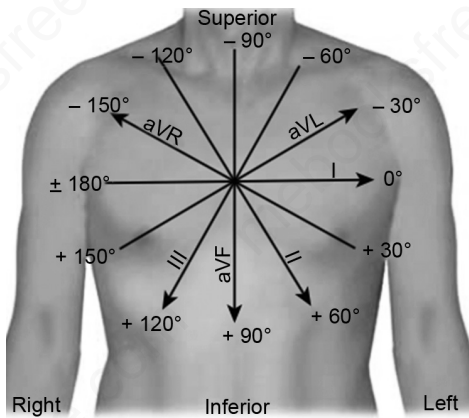

Fig. 5.17: The hexaxial reference system

The lead axes of the six frontal plane leads have been rearranged so that their centers overlay one another. These axes divide the plane into 12 segments, each subtending 30 degrees. Positive ends of each axis are labeled with the name of the lead.

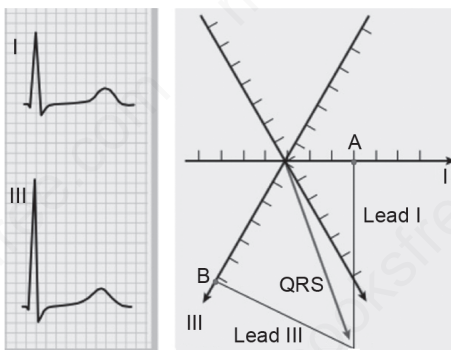

Fig. 5.18: Calculation of mean electrical axis

To calculate the cardiac axis from Figure 5.18, following steps are followed:

I IMPORTANT

- ❖ The normal mean QRS axis in adults lies between -30 degrees and +100 degrees.
- ❖ Mean QRS axes more positive than +100 degrees represent right axis deviation, and those more negative than 30 degrees represent left axis deviation.

I IMPORTANT

- ❖ **Left axis deviation:** Occur as a normal variant but is more commonly associated with left ventricular hypertrophy, a block in the anterior fascicle of the left bundle system (left anterior fascicular block or hemiblock), or inferior myocardial infarction.

I IMPORTANT

- ❖ **Right axis deviation:** Occur as a normal variant (particularly in children and young adults), as a spurious finding due to reversal of the left and right arm electrodes, or in conditions such as right ventricular overload (acute or chronic), infarction of the lateral wall of the left ventricle, dextrocardia, left pneumothorax, and left posterior fascicular block.

Net amplitude of lead I = 6 box (7 box positive and 1 box negative): Plotted on lead I on graph paper (**point A**). [Smallest division in graph paper = 2 box text]

Net amplitude of Lead III = ~12 box (13 box positive and 1 box negative): Plotted on lead III on graph paper (**point B**).

Perpendicular lines are drawn on lead I and lead III at point A and point B, respectively. Meeting point of these two perpendicular lines (point C) is connected with the center. This connection is the mean cardiac axis. Angle of cardiac axis is calculated with respect to lead I (0 degree). (In this case, the axis is at ~70 degree angle).

Normal ECG (Fig. 5.19)

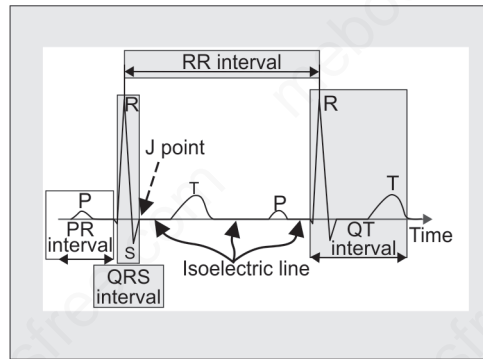

Fig. 5.19: Normal ECG

- ❑ Intervals are periods of time including waves and complexes.
- ❑ Segments are always measured between waves but never include them.
- ❑ The baseline or isoelectric line is a straight flat line seen when no electric activity of the heart is detected.

ECG Waves/Interval

Wave/interval	Physiological correlates	Amplitude	Duration
P wave	Atrial depolarization	0.1–0.3 mV	< 120 ms 2.75 small squares
PR interval	Time between start of atrial depolarization to ventricular depolarization.		< 200 ms 5 small squares

Contd...

Contd...

Wave/interval	Physiological correlates	Amplitude	Duration
PR segment	AV delay		90 to 100 ms
Q wave	Septal depolarization	< 1/3 or R	< 120 ms 3 small squares
R wave	Ventricular depolarization	1 mV	
S wave	Depolarization of base of ventricles		
ST segment	Complete depolarization		
T wave	Repolarization of ventricles	0.2–0.3 mV	
QT interval	Duration of ventricular contraction		350 to 420 ms 10 small squares

Normal Pattern of ECG in Different Leads

Lead	Feature(s)
aVR	All the deflections are negative
aVL/aVF	Predominantly positive or biphasic
V1 V2	No Q wave; deep S wave
V3 V4	Biphasic
V5 V6	Small Q wave, Tall R wave
Leads I, II, III	All positive deflection; largest in lead II

His Bundle Electrogram (Figs 5.20 and 5.21)

- ❑ In patients with heart block, the electrical events in the AV node, bundle of His, and Purkinje system are frequently studied with a catheter containing an electrode at its tip that is passed through a vein to the right side of the heart and manipulated into a position close to the tricuspid valve.
- ❑ The record of the electrical activity obtained with the catheter is the His bundle electrogram (HBE).
- ❑ Three or more standard electrocardiographic leads are recorded simultaneously.
- ❑ Three deflection (wave) in HBE are:
 1. A deflection when the AV node is activated,
 2. H spike during transmission through the His bundle
 3. V deflection during ventricular depolarization.

I IMPORTANT

❖ Extreme axis deviations:

When mean axes lying between -90 and -180 degrees (or equivalently between $+180$ and $+270$ degrees).

- ❖ The designation indeterminate axis is applied when all six extremity leads show biphasic (QR or RS) patterns; this finding can occur as a normal variant or may be seen in a variety of pathological conditions.

I IMPORTANT

❖ Rate-corrected QT or QTc intervals:

The normal values for the QT interval depend on the heart rate (HR). As the HR increases, the QT interval normally shortens.

- ❖ Bazett formula is used for this HR correction of QT interval, which is known as QTc.

$$QTc = QT / (\sqrt{RR \text{ interval}})$$
 Normally the QTc is between about 0.33 sec (330 msec) and about 0.44 sec or (440 msec).

I IMPORTANT

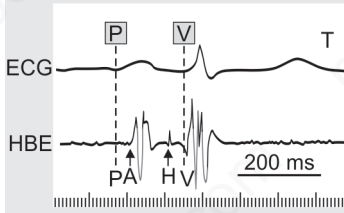

Fig. 5.20: His bundle electro-gramlead

- ❑ Three intervals: With the help of HBE and the standard ECG
 - PA interval: Time from first appearance of P wave of standard ECG to A wave in HBE, which represents conduction time from SA node to AV node.
 - AH interval: From A wave to the start of H spike, which represents AV nodal conduction time.
 - HV interval: Time from the start of H spike to the start of QRS deflection in the standard ECG, which represents conduction in bundle of His and bundle branches.
- ❑ The approximate normal values for these intervals in adults are PA= 27 ms; AH = 92 ms (normal = 60 to 125 ms); and HV, 43 ms (normal = 35 to 55 ms).

I IMPORTANT

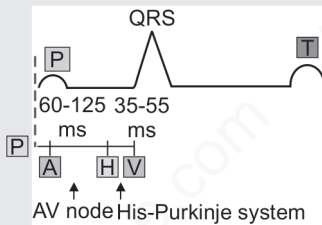

Fig. 5.21: Different interval in HBE

MULTIPLE CHOICE QUESTIONS

CONDUCTING SYSTEM AND AP

RECENT MCQs

1. Gatekeeper of the heart is:

- a. SA node b. AV node
c. Purkinje fibers d. Bundle of His

2. Plateau phase of ventricular muscle is due to opening of: [PGI May 11]

- a. Na⁺ channel
b. K⁺ channel
c. Ca-Na channel
d. Closure of K⁺ channel

3. Inward flow of Na⁺ in heart leads to:

- a. Plateau phase b. Action potential
c. Repolarization d. No change

4. Initial rapid repolarization in cardiac muscle is mediated through:

- a. Opening of K⁺ channel
b. Opening of Ca channel
c. Opening of Na channel
d. Closing of Na channel

5. The pacemaker potential is due to:

- a. Fast Na⁺ channel
b. Decrease in K⁺ permeability
c. Slow Ca⁺⁺ channel
d. Rapid repolarization

6. AV nodal delay is: [Orissa 04]

- a. 0.2 sec b. 0.13 sec
c. 0.01 sec d. 0.3 sec

7. Calcium enters the cardiac cell during: [Karn 03]

- a. Rapid upstroke of the action potential
b. Down slope of the action potential

- c. Plateau phase of the action potential
d. Slow diastolic depolarization (phase 4) of the action potential

AIIMS/PGI/JIPMER

8. SA node acts as a pacemaker of the heart because of the fact that it:

[AI 05]

- a. Is capable of generating impulses spontaneously
b. Has rich sympathetic innervations
c. Has poor cholinergic innervations
d. Generates impulses at the highest rate

9. Speed of conduction is fastest in:

[PGI Dec 05]

- a. AV node b. SA node
c. Bundle of His d. Purkinje system
e. Ventricular muscle

10. Least conduction velocity is seen in:

[PGI Dec 98, UP 08]

- a. AV node b. Purkinje fibers
c. Bundle of his
d. Ventricular myocardial fibres

11. Conduction velocity is least in:

[JIPMER 93, PGI 98]

- a. AV node b. Bundle of His
c. SA node d. Purkinje fibers

12. Normal AV delay of 0.1 seconds is due to: [JIPMER 10]

- a. Decrease in amplitude of firing
b. Resistance offered by myocytes
c. Decrease in number of gap junctions
d. Lack of tight junctions

13. Depolarization of human ventricular muscle starts from: [AIIMS May 12]

- Posterobasal part of ventricle
- Left side of interventricular septum
- Uppermost portion of interventricular septum
- Basal portion of ventricle

14. Which of the following is the order of activation after stimulation of Purkinje fibers is: [AIIMS Dec 95]

- Septum → Endocardium → Epicardium

- Endocardium → Septum → Epicardium
- Epicardium → Septum → Endocardium
- Septum → Epicardium → Endocardium

15. Repolarization in isolated muscle piece fiber proceeds from:

[PGI Dec 98]

- Epicardium to endocardium
- Endocardium to epicardium
- Left to right
- Right to left

AUTONOMIC INNERVATION

RECENT MCQs

16. Not a direct effect of Ach:

- Decrease BP
- Increase contraction of heart
- Decrease heart rate
- Decrease conduction

17. On increasing vagal tone following occurs in pacemaker:

- Increased Na⁺ increased slope
- Decreased Na⁺ decreased slope
- Increased Na⁺ decreased slope
- Decreased Na⁺ increased slope

18. All are effects of sympathetic stimulation except:

- Increased conduction velocity
- Increased heart rate
- Increased refractory period
- Increased contractility of heart

AIIMS/PGI/JIPMER

19. Vagal stimulation of the heart causes:

- Increased heart rate [AIIMS Nov 08]
- Increased R-R interval in ECG

- Increased force of heart contraction
- Increased cardiac output

20. Sympathetic stimulation causes all of the following except: [AI 99]

- Increase in heart rate
- Increase in blood pressure
- Increase in total peripheral resistance
- Increase in venous capacitance

21. TRUE regarding human heart:

[AI 08]

- Conduction of impulse from endocardium to inwards
- During exercise duration of systole is reduced more than diastole
- HR increases with parasympathetic denervation
- Vagal stimulation decreases force of contraction

22. Single most important factor in control of automatic contractility of heart is:

[AI 01]

- Myocardial wall thickness
- Right atrial volume
- SA node pacemaker potential
- Sympathetic stimulation

23. Which of the following statement is least correct? [AI 08]

- a. Vagal stimulation decreases rate of contraction

- b. Noradrenaline increases force of contraction
c. Denervated heart has more heart rate
d. During exercise systole is shortened more than diastole

ELECTROCARDIOGRAPHY

RECENT MCQs

24. Einthoven's law is:

- a. $I + III = II$
b. $I - III = II$
c. $I + II + III = 0$
d. $I + III = aVL$

25. Einthoven's triangle, what is the value of Lead III when Lead I = 2 mV and Lead II = 1 mV?

- a. 1
b. 2
c. 3
d. 4

26. In a standard electrocardiogram, an augmented limb lead measures the electrical potential difference between:

- a. Two limbs
b. One limb and two other limbs
c. One limb and neutral (zero)
d. Two limbs and two other limbs

AIIMS/PGI/JIPMER

27. QRS complex indicates:

[UP 07, AI 98]

- a. Atrial repolarization
b. Atrial depolarization
c. Ventricular repolarization
d. Ventricular depolarization

28. The ECG of a 40-year-old male was recorded using standard bipolar limb leads. The sum of voltage of the three standard leads was found to be 5 millivolts. This indicates:

[AIIMS May 05]

- a. A normal heart
b. Right ventricular hypertrophy
c. Left ventricular hypertrophy
d. Increased cardiac muscle mass

29. True statement about instantaneous means vector:

[PGI May 11]

- a. Equal and same as mean QRS vector
b. It is drawn through the centre of vector in a direction from base toward apex
c. Summated vector of generated potential at particular instant caused by inflowing septal depolarization
d. When a vector is exactly horizontal and directed toward the person's left side, the vector is said to extend in the direction of 0 degree

30. Ventricular contraction lasts for:

[PGI Nov 11]

- a. Beginning of Q wave to end of S wave
b. Beginning of Q wave to the end of T wave
c. Beginning of P wave to end of T wave
d. Beginning of R wave to the end of T wave, if Q wave is absent
e. Beginning of P wave to the end of S wave

FUTURE TRENDS

31. If the SA node discharges at 0.00 second, when will the action potential normally arrive at the epicardial surface at the base of the left ventricle?

- a. 0.22 sec
- b. 0.18 sec
- c. 0.16 sec
- d. 0.12 sec

32. A male long-term smoker who is 62-year-old, weighs 250 lb. He had the following EKG recorded at his local hospital. Which of the following is the mean electrical axis calculated from standard Leads I, II and III shown in his EKG?

- a. -110°
- b. -20°
- c. $+90^\circ$
- d. $+105^\circ$



33. The phases of the ventricular muscle action potential is given below:

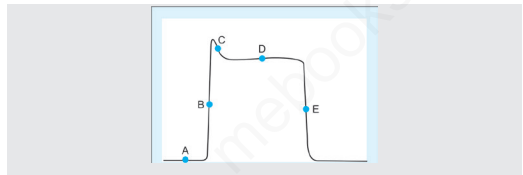

At which point on the above ventricular action potential is membrane potential most dependent on calcium permeability?

- a. Point B
- b. Point C
- c. Point D
- d. Point E

ANSWERS WITH EXPLANATIONS

1. Ans. b. AV node

(Ref. *Flip and See ECG By Elizabeth Gross Cohn 4th edn.*)

“The AVnode is located on the floor of the right atrium. It has an intrinsic firing rate of 40-60 beats per minute. It is known as the gatekeeper of the heart, because it regulates impulses coming from the SA node.”

2. Ans. c. Ca-Na channel

(Ref. *Guyton-Physiology-13th edn. pp 171*)

Ca⁺⁺ and K⁺ channels remain open during plateau phase (phase 2) of AP. But Ca²⁺ initiates the plateau phase, as K⁺ channels are already open from phase 1. This Ca⁺⁺ channel in phase 2 is also known as calcium-sodium channel.

3. Ans. b. Action potential

(Ref. *Ganong's Physiology 24th edn. pp 490*)

Influx of Na⁺ via fast Na channel leads of phase 0 or, beginning of AP in myocardium.

4. Ans. a. Opening of K⁺ channel >> d. Closing of Na channel

(Ref. *Berne & Levy Physiology, 6th Updated edn. pp 295*)

The main factor is opening of K⁺ channel. Although Ganong has maintained both closure of Na⁺ channels and opening of one type of K⁺ channel and closure of Na channel only the recent concept is K⁺ channel opening is the main reason of phase 1.

5. Ans. b. Decrease in K⁺ permeability

(Ref. *Ganong's Physiology 24th edn. pp 491*)

Pacemaker potential is due to slow Na⁺ >> Rapid Ca⁺⁺ >> decrease K⁺ permeability. So, with the provided options, best answer is decrease K⁺ permeability.

6. Ans. b. 0.13 sec

(Ref. *Guyton-Physiology-13th edn. pp 176*)

AV nodal delay is more than 0.1 sec (Guyton), ~100 ms (Ganong), 60–125 ms (Harrison's Internal Medicine).

7. Ans. c. Plateau phase of the action potential

(Ref. *Ganong's Physiology 24th edn pp 490*)

8. Ans. d. Generates impulses at the highest rate

(Ref; *Ganong's Physiology 24th edn. pp 490*)

Spontaneous impulse can be generated by SA node as well as other latent pacemakers in the heart (AV node etc.). But SA node determine the heart rate, as rate of impulse production is highest in SA node (pacemaker).

9. Ans. d. Purkinje system

(Ref. *Ganong's Physiology 24th edn. pp 492*)

10. Ans. a. AV node

(Ref. *Ganong's Physiology 24th edn. pp 492*)

11. Ans. a. AV node

(Ref. *Ganong's Physiology 24th edn. pp 492*)

12. Ans. c. Decrease in number of gap junctions

(Ref. *Essential Medical Physiology By Leonard R. Johnson. 3rd edn. pp 179*)

AV node conduction velocity is lowest because of: Less number of gap junctions, small diameter fibers and slow type AP.

13. Ans. b. Left side of interventricular septum

(Ref. *Ganong's Physiology 24th edn. pp 492*)

Depolarization start from left side of septum and then moves to right across the mid portion of septum.

14. Ans. a. Septum → Endocardium → Epicardium

(Ref. Ganong's Physiology 24th edn. pp 492)

15. Ans. b. Endocardium to epicardium

(Ref. Goldbergers Clinical Electrocardiography 8th edn. pp 5)

Depolarization and repolarization both starts from the endocardium, in isolated cardiac muscle. The reason for this is still not known.

16. Ans. b. Increase contraction of heart

(Ref. Ganong's Physiology 24th edn. pp 556)

Ach decreases the HR.

17. Ans. b. Decreased Na⁺ decreased slop

(Ref. Ganong's Physiology 24th edn pp 491)

18. Ans. c. Increased refractory period

(Ref. Ganong's Physiology 24th edn. pp 556)

Sympathetic causes faster conduction (decrease refractory period).

19. Ans. b. Increased R-R interval in ECG

(Ref. Ganong's Physiology 24th edn. pp 556)

Vagal stimulation decreases HR (so, RR interval will be prolonged).

20. Ans. d. Increase in venous capacitance

(Ref. Ganong's Physiology 24th edn. pp 556)

Sympathetic causes venoconstriction (decreases venous capacitance).

21. Ans. c. HR increases with parasympathetic denervation, d. Vagal stimulation decreases force of contraction

(Ref. Ganong's Physiology 24th edn. pp 556)

Vagal stimulation has more effect on HR than contractility.

22. Ans. c. SA node pacemaker potential

(Ref. Ganong's Physiology 24th edn. pp 512 and 556)

The property of automaticity (the ability to initiate its own beat) is due to presence

of 'P' cell. 'P' cell has pacemaker potential (spontaneous depolarization).

23. Ans. d. During exercise systole is shortened more than diastole

(Ref. Ganong's Physiology 24th edn. pp 512 and 556)

During exercise diastole decreases more than systole. All other options a, b, c are correct.

24. Ans. a. I + III = II

(Ref. Guyton-Physiology-13th edn. pp 183)

"The sum of the voltages in leads I and III equals the voltage in lead II."

25. Ans. a. 1

(Ref. Guyton-Physiology-13th edn. pp 183)

Einthoven's law: II = I + III

So, III = (II-I) = (1-2) = - 1 mV

26. Ans. b. One limb and two other limbs

(Ref. Ganong's Physiology 24th edn. pp 494)

The augmented limb leads are recordings between one limb and the other two limbs. This increases the size of the potentials by 50% without any change in configuration from the nonaugmented record.

27. Ans. d. Ventricular depolarization

(Ref. Ganong's Physiology 24th edn. pp 494)

28. Ans. d. Increased cardiac muscle mass

(Ref. Guyton-Physiology-12th edn. pp 140)

"When the sum of the voltages of all the QRS complexes of the three standard leads is greater than 4 mV, the patient is considered to have a high-voltage electrocardiogram. The cause of high-voltage QRS complexes most often is increased muscle mass of the heart, which ordinarily results from hypertrophy of the muscle." So, in general its hypertrophy of heart (may be right or, left ventricular), but you cannot determine whether it is due to right or, left ventricular hypertrophy.

29. Ans. b. It is drawn through the centre of vector in a direction from base toward apex, d. When a vector is exactly horizontal and directed toward the person's left side, the vector is said to extend in the direction of 0 degree

(Ref. Guyton-Physiology-13th edn, pp 196)

Option a is not correct (they are not same). Option C is not correct because of the word 'septal depolarization'. See text for detail explanation.

30. Ans. b. Beginning of Q wave to the end of T wave, d. Beginning of R wave to the end of T wave, if Q wave is absent

(Ref. Guyton-Physiology-13th edn. pp 180)

31. Ans. a. 0.22 sec

After the S-A node discharges, the action potential travels through the atria, through the A-V bundle system and finally to the

ventricular septum and throughout the ventricle. The last place that the impulse arrives is at the epicardial surface at the base of the left ventricle, which requires a transit time of 0.22 sec.

32. Ans. d. +105°

Note that lead III has the strongest vector, therefore the mean electrical axis will be closer to this lead than to leads I or II. The angle of lead III is 120°, and the resultant vector (mean electrical axis) is close to that lead and has a value of + 105°.

33. Ans. c. Point D

The plateau phase (phase 2) is the result of the influx of calcium. Although calcium channels begin to open during the upstroke (phase 0), the greatest number of calcium channels is open during the plateau.

CHAPTER

6

Cardiac Output and Regulation

I IMPORTANT

During exercise, duration of cardiac cycle decreases because of increase in HR. In this situation, both diastolic and systolic duration decreases, but diastole decrease to a much greater than systole.

CARDIAC CYCLE

- ❑ Electrical and mechanical events that occur during systole and diastole of heart is cardiac cycle.
- ❑ Mechanical events follow electrical events.
- ❑ Atrial systole starts after 'P' wave and ventricular systole starts near the end of 'R' wave and ends just after 'T' wave.
- ❑ Both left and right sides of heart have similar events but slightly asynchronous. Right atrial depolarization and right ventricular ejection starts before left. But left ventricular depolarization starts earlier than right.

Duration of 1 cardiac cycle = 0.8 second (60 sec/HR)

	Systole (Second)	Diastole (Second)
Ventricle	0.3	0.5
Atrial	0.1	0.7

Phases in the Cardiac Cycle

Same in both the ventricles.

Ventricular systole		Ventricular diastole	
Phases	Time (sec)	Phases	Time (Sec)
Isovolumic contraction (IVC)	0.05	Protodiastole	0.04
Rapid ejection (RE)	0.1	Isovolumic relaxation (IVR)	0.06
Slow ejection (SE)	0.15	First rapid filling phase (FRFP)	0.1
		Slow filling (diastasis)	0.2
		Last rapid filling phase (LRFP)	0.1

Phases during Diastole (Figs 6.1 and 6.2)

- ❑ **Protodiastole:** Period just before the closure of semilunar valve when blood is moving out of the ventricle due to momentum of blood even though ventricular muscle has started relaxing.
- ❑ **Isovolumic relaxation:** Starts with closure of semilunar valves and ends with opening of AV valves. Ventricle relaxes as a closed cavity (all valves are closed) with small amount of blood (ESV). Ventricular pressure becomes lowest (0 mm Hg) at the end of this phase.
- ❑ **First rapid filling phase:** Opening of atrioventricular (AV) valves leads to rapid entry of blood within the ventricle. During this phase pressure gradient between atrium and ventricle is high.
- ❑ **Slow filling (diastasis):** Due to reduced pressure gradient between atrium and ventricle during this phase, filling occurs slowly. *Because of slow filling ventricular wall motions is least in this phase.*
- ❑ **Last rapid filling phase:** This filling phase of ventricle corresponds with atrial contraction. Because of atrial contraction, filling becomes rapid. Duration of this phase is same with atrial systole duration (0.1 sec).

I IMPORTANT

- ❖ **Active filling of ventricle:** Filling due to atrial contraction or, its LRFP. It contributes 30% of total ventricular filling.
- ❖ **Passive filling of ventricle:** Filling without contraction of atrium. It includes FRFP and diastasis. 70% of the ventricular filling occurs during passive phase.

I IMPORTANT

- ❖ Normally atrial contraction contributes only 25-30% of ventricular filling. At high heart rates when there is less time for passive ventricular filling, the atrial contraction may account for up to 40% or, more of ventricular filling.

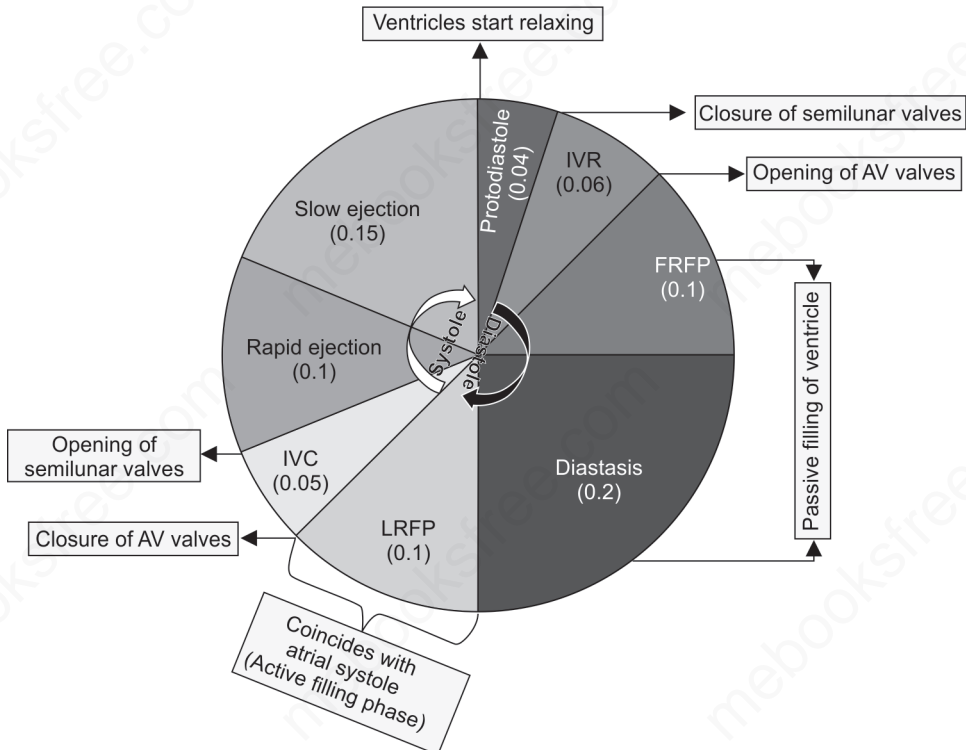

Fig. 6.1: Different phases of cardiac cycle

I IMPORTANT

- ❖ Maximum blood ejected from ventricle during “rapid ejection” phase although duration of this phase is less than “slow/reduced ejection” phase.

I IMPORTANT

- ❖ Ventricular wall motion is least in mid diastole (diastasis) and maximum during isovolumic contraction phase.

I IMPORTANT

- ❖ Total volume of blood ejected from a single ventricle during RE and SE phase, is known as stroke volume (SV).
- ❖ And the remaining blood within a single ventricle is end systolic volume (ESV).

I IMPORTANT

- ❖ Maximum rise of ventricular pressure (dp/dt) occurs during “isovolumic contraction” phase.
- ❖ Maximum pressure develops within ventricle during “rapid ejection” phase.

- ❑ At the end of ventricular filling, the total volume of blood within a single ventricle is known as end diastolic volume (EDV).

Phases during Systole (Figs 6.1 and 6.2)

- ❑ **Isovolumic contraction:** Starts with closure of AV valves and lasts about 0.05 s, until the pressures in the left and right ventricles exceed the pressures in the aorta (80 mm Hg; 10.6 kPa) and pulmonary artery (10 mm Hg) respectively and the aortic and pulmonary valves open. Ventricle contracts with a closed cavity during this phase. The volume (EDV) within the ventricle during this phase remains same. *Ventricular wall motions is maximum in this phase.*
- ❑ **Rapid ejection:** As the ventricular pressure becomes more than aortic pressure/pulmonary artery pressure, during IVC, semilunar valves open up. This leads to ejection of blood with high velocity.
- ❑ **Slow ejection:** Ejection velocity reduces during this phase due to decrease in ventricular pressure.

Parameter	Definition	Normal value
Stroke volume (SV)	This is the amount of blood ejected by each ventricle per stroke	70–90 ml
End-diastolic volume (EDV)	This is the amount of blood in the ventricle at the end of diastole	130 ml
End-systolic volume	= EDV – SV	~50 ml
Ejection fraction	= (SV/EDV) × 100	55%–68%. (Avj. 65%)
Cardiac output	= S.V. × Heart rate	~ 5 L/min
Cardiac index	= Cardiac output/ body surface area (m ²)	3.2 L/min/m ² (Range: 2.8–4.2)
Mean blood pressure	= C.O × peripheral resistance	70–100
Systemic vascular resistance (dyn.s/cm ⁵)	Resistance of all systemic/peripheral vessels.	900–1400
Pulmonary vascular resistance (dyn.s/cm ⁵)	Resistance of all pulmonary vasculature.	40–120

Events of the Cardiac Cycle

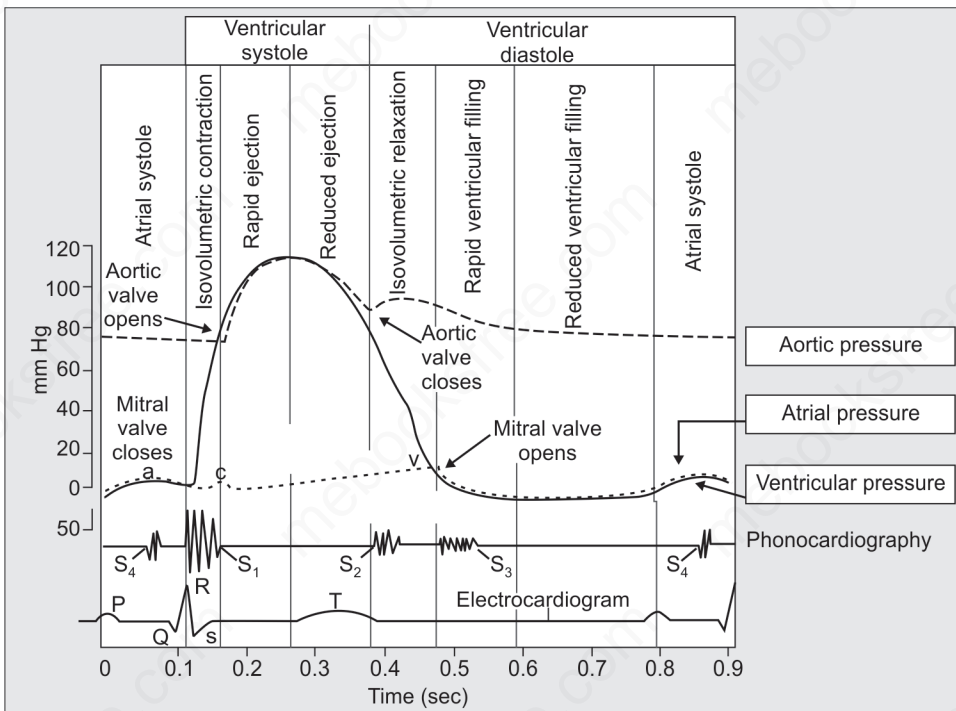

Fig. 6.2: The timing of various hemodynamic and related events during the cardiac cycle

Look Carefully

- ❑ Position of aortic valve opening (end of isovolumic contraction) and aortic valve close (Dicrotic notch—beginning of diastole).
- ❑ Mitral valve opening (start of ventricular filling—end of isovolumic relaxation) and mitral valve closure (Start of ventricular contraction—beginning of isovolumic contraction).
- ❑ Aortic pressure change is recorded with *carotid pressure transducer*.
- ❑ Note that late in systole, aortic pressure actually exceeds left ventricular pressure. However, the momentum of the blood keeps it flowing out of the ventricle for a short period.
- ❑ Phonocardiography is a graphic representation of heart sounds (S).

I IMPORTANT

- ❖ **QS2 (electromechanical systole):** Time interval between the start of Q wave and second heart sound. To record this both ECG and phonocardiography is required.
- ❖ **Left ventricular ejection time (LVET):** is the period from the beginning of the carotid pressure rise to the dicrotic notch. To record this only carotid pressure transducer is sufficient.
- ❖ **Pre-ejection period (PEP):** is the difference between QS2 and LVET. It represents the time for the electrical as well as the mechanical events that precede systolic ejection
- ❖ *Ratio of PEP/LVET is normally about 0.35.*
- ❖ *The value of PEP/LVEF negatively correlated with ejection fraction (EF).*
- ❖ So, decrease PEP/LVET is seen with digitalis and beta-adrenergic stimulation and increase PEP/LVET is seen with beta-blockade, left bundle branch block.
- ❖ With left ventricular dysfunctions (general myocardial deterioration) PEP increases with shortening of LVET, without a change in QS2.
- ❖ In aortic valvular disease, PEP and PEP/LVET decrease, and LVET and QS2 increase.

Heart Sound

Acceleration and deceleration of blood within the heart causes production of vibrations, which lead to the production of sounds in the heart. Each sound is created by specific velocity changes and vibrations based on the particular physiological circumstances at that time in the cardiac cycle. As opening and closing of the valves present in the heart are the determinants of this change in velocity of blood flowing in the heart, the heart sounds correspond to the various phases in the cardiac cycle.

Heart sound	Frequency	Duration	Associated event	Relationship with ECG
First heart sound	25-45 Hz	0.15 sec	Closure of A-V valves—onset of ventricular systole	Later half of the R wave
Second heart sound	50 Hz	0.12 sec	Closure of semilunar valves—onset of ventricular diastole	Later half of the T wave
Third heart sound	Low	0.1 sec	First rapid filling phase of ventricular diastole	Between the T and P wave
Fourth heart sound	Below 20 Hz	0.1 sec	Last rapid filling phase of ventricular diastole due to atrial contraction	Following P wave

CARDIAC OUTPUT: MEASUREMENT AND REGULATION**Definition**

Amount of blood ejected by each ventricle per minute.
Value = 5 L/ min

Measurement

- Fick method
- Dye dilution/thermodilution
- Doppler plus echocardiograph
- MRI

Fick Principle (1870)

Most accurate method for CO measurement, but invasive.

- ❑ Compute cardiac output (CO) indirectly from whole body oxygen consumption (VO_2) and the mixed venous (CvO_2) and arterial oxygen concentrations (CaO_2).
- ❑ It can be calculated by the following equation: $CO = VO_2 / (CaO_2 - CvO_2)$
- ❑ If CaO_2 and CvO_2 are 0.2 ml and 0.15 ml O_2 /ml blood, respectively, and VO_2 is 250 ml O_2 /minute, then $CO = 5000$ ml/min, or 5 L/min.

Dye/Thermodilution Technique**[Stewart (1897)-Hamilton (1932) Principle]**

- ❑ This method was initially described using an indicator dye (*indocyanine green dye*) later replaced by thermodilution (thermal indicator). The fundamental physical basis for the indicator dilution method is given by the Stewart-Hamilton equation.

$$Q = \frac{I}{\int_0^{\infty} C \cdot dt}$$

Where, Cardiac Output (Q), Amount of indicator (I), concentration (C) over time (dt).

Simplification of the above formula:

$$Q(\text{ml/min}) = \frac{\text{mg of dye injected} \times 60}{\text{average conc. of the dye in each ml} \times \text{duration of the curve in sec}}$$

- ❑ The dye dilution method has not maintained widespread clinical popularity because it requires continuous withdrawal of arterial blood to plot the dye concentration curve.
- ❑ A special thermistor-tipped catheter (Swan-Ganz catheter) is inserted from a peripheral vein into the pulmonary artery for thermodilution method.
- ❑ A **cold saline solution (0.9% NaCl)** of known temperature and volume (10 ml @Room Temperature over 4 Second or, 5 ml Ice cold NaCl over 2 Sec) is injected into the right atrium from a proximal catheter port. The injected cold saline mixes with the blood as it passes through the ventricle and into the pulmonary artery, thus cooling the blood.

I IMPORTANT

For Fick Principle:

- ❖ Mixed venous blood is obtained from pulmonary artery.
- ❖ Systemic arterial blood obtained from any systemic artery (Brachial/Radial).
- ❖ Rate of oxygen absorption is measured by oxygen meter or, spirometer.

I IMPORTANT

For dye or, indicator dilution method:

- ❖ Dye is injected into a large systemic vein or, preferably, into the right atrium.
- ❖ Concentration of the dye is recorded from one of the peripheral arteries (Brachial/Radial).

I IMPORTANT

For thermodilution method:

- ❖ Cold saline is injected into right atrium.
- ❖ Change in the blood temperature is measured in the pulmonary artery.

- ❑ The blood temperature is measured by a thermistor at the catheter tip, which lies within the pulmonary artery, and a computer is used to acquire the thermodilution profile; that is, the computer quantifies the change in blood temperature as it flows over the thermistor surface.
- ❑ The cardiac output computer then calculates flow (cardiac output from the right ventricle) using the blood temperature information, and the temperature and volume of the injectate.
- ❑ The injection is normally repeated a few times and the cardiac output averaged. Because cardiac output changes with respiration, it is important to inject the saline at a consistent time point during the respiratory cycle. *In normal practice this is done at the end of expiration.*
- ❑ *Complication of this method are arrhythmias, infection, pulmonary artery rupture, and right heart valve damage and does not improve patient outcomes.*

Doppler-Echocardiographic Techniques and Radionuclide Imaging Techniques

- ❑ Estimate real-time changes in ventricular dimensions, thus computing stroke volume, which when multiplied by heart rate, gives cardiac output.
- ❑ This method is limited by the reproducibility of its component elements

Velocity Encoded Phase Contrast Magnetic Resonance Imaging (MRI)

- ❑ *It is the most accurate technique for measuring flow in large vessels in mammals.*
- ❑ MRI flow measurements have been shown to be highly accurate and less variable than both the Fick principle and thermodilution.

Method	Most reliable	Less reliable
Fick's method	Low cardiac output state	High cardiac output state
Thermodilution	High cardiac output state	Pulmonary regurgitation Tricuspid regurgitation Intracardiac shunt

Regulation of Cardiac Output

Since $CO = HR \times SV$, it can be regulated by HR and SV (Flowchart 6.1)

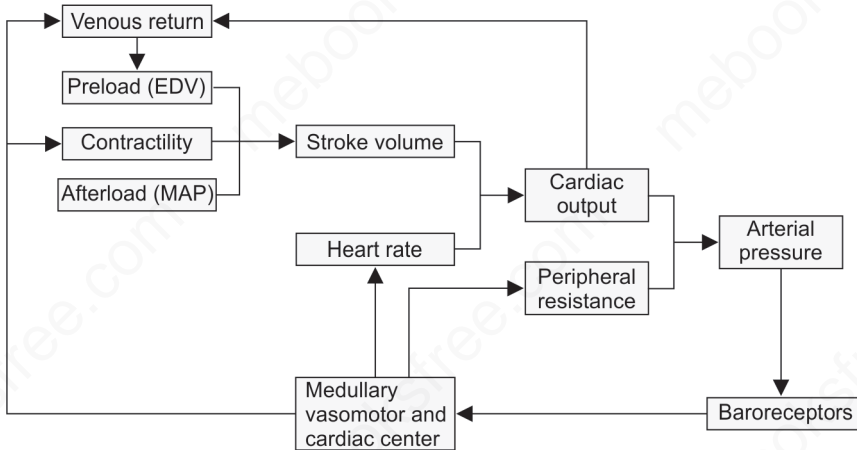
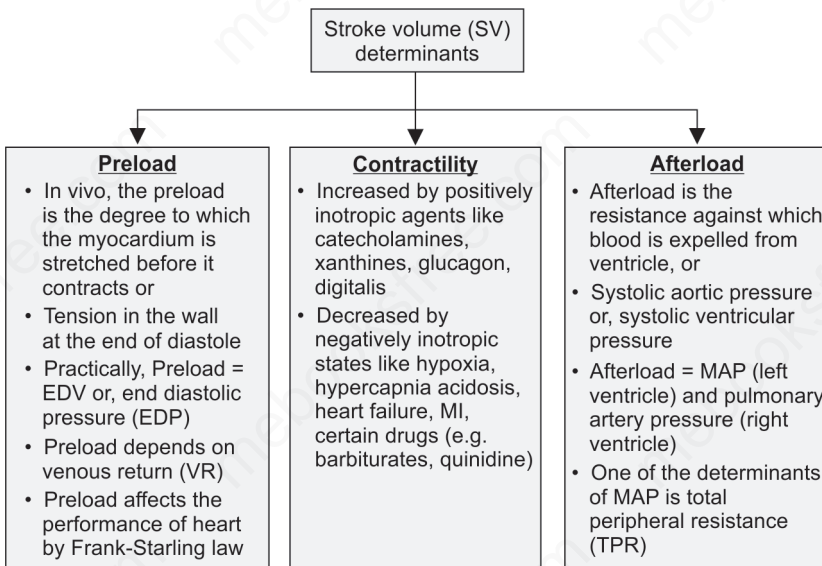
Flowchart 6.1: Interaction of different factors regulating cardiac output**Flowchart. 6.2:** Determinants of preload, contractility and afterload

- ❑ HR: This is regulated by:
 - Sympathetic and parasympathetic innervation
 - Bainbridge reflex and Baroreceptor reflex
- ❑ SV: This can be changed by: Preload, contractility and afterload (Flowchart 6.2)

All of these factors, which affect SV, can be divided into following types:

1. **Heterometric regulation:** The factors that change the initial length of myocardium are heterometric regulator. Preload is the heterometric regulator of CO.

I IMPORTANT

- ❖ Best index of preload is EDV or, EDP
- ❖ Best index of afterload is mean aortic pressure (left ventricle)

I IMPORTANT

Bowditch effect: An increase in heart rate also stimulates inotropy (Bowditch effect; frequency-dependent inotropy).

2. **Homocentric regulation:** The factors, which change the SV, for the same initial length (No muscle length change before onset of contraction). All the factors that change contractility (discuss above) and afterload are homometric regulator.

Condition or, factors affecting cardiac output:

Condition or Factor	
No change	Sleep Moderate change in environment temperature
Increased	Anxiety and excitement (50–100%) Eating (30%) Exercise (up to 700%) High environmental temperature Pregnancy (~40%) Epinephrine
Decrease	Sitting or standing from lying position (20–30%) Rapid arrhythmias Heart disease

Frank-Starling Law (Fig. 6.3)

Otto Frank with Ernest Starling describe that if all other factors are constant, an increase in the end-diastolic volume (preload) will result in an increased stroke volume. This is known as the Frank-Starling or Starling's Law.

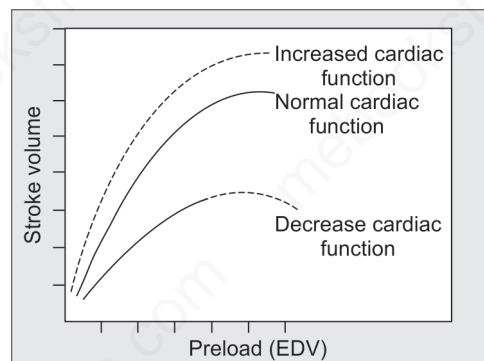

Fig. 6.3: Effect of changes in myocardial contractility on the Frank-Starling curve

The curve shifted left and upward as contractility increases like catecholamines, xanthines, glucagon and digitalis.

The curve shifts downward and to the right as contractility is decreased like Hypoxia Hypercapnia, acidosis and in case of heart failure.

Change of Frank-Starling Curve in Disease States and Response to Therapy: Heart Failure

- ❑ Below 15 mm Hg filling pressure (EDP) represents the classic Frank-Starling relation described in physiology texts (Fig. 6.4).
- ❑ Beyond approximately 15 mm Hg, there is a plateau of performance.
- ❑ Preloads greater than 20–25 mm Hg result in pulmonary congestion.

Heart Failure

Preload is usually increased in heart failure because of increased blood volume and venous tone. Because the function curve of the failing heart is lower, the plateau is reached at much lower values of stroke work or output. Reduction of high filling pressure is the goal of salt restriction and diuretic therapy in heart failure. Venodilator drugs (e.g. nitroglycerin) also reduce preload by redistributing blood away from the chest into peripheral veins.

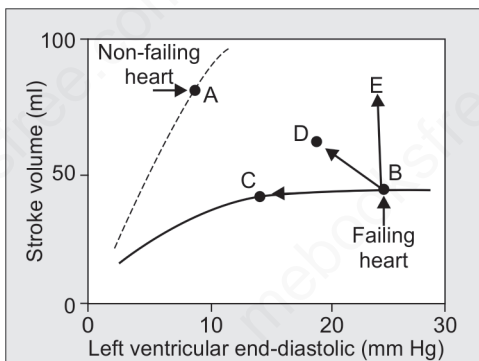

Fig. 6.4: Effect of various drug therapies in heart failure patient on Frank-Starling curve

In Figure 6.4

- ❑ **Point A:** Operating point of normal heart.
- ❑ **Point B:** Operating point of failing heart.
- ❑ **Point C:** Effect of preload reduction (Diuretics). Alleviates congestive symptoms by reducing EDV in the same Frank-Starling curve.
- ❑ **Point D:** Effect of afterload reduction (ACE inhibitors). Increases CO at any given EDV and thereby elevates the Frank-Starling curve.
- ❑ **Point E:** Effect of positive inotrope (Digitalis)

I IMPORTANT

- ❖ **Mean Circulatory Filling Pressure (MCFP):** When heart pumping is stopped (cardiac arrest), the flow of blood everywhere in the circulation ceases a few seconds later. Without blood flow, the pressures everywhere in the circulation become equal. This equilibrated pressure level is called the mean *circulatory filling pressure* (**whole circulation stops**).
- ❖ **Mean Systemic Filling Pressure (MSFP):** It is the pressure measured everywhere in the *systemic circulation* after blood flow has been stopped by clamping the large blood vessels at the heart, so that the pressures in the systemic circulation can be measured independently from those in the pulmonary circulation (**only systemic circulation stops**).
- ❖ Both MCFP and MSFP are almost equal (7 mm Hg).

Venous Return

Three principal factors that affect venous return to the heart from the systemic circulation are:

1. Right atrial pressure (central venous pressure), which exerts a backward force on the veins to impede flow of blood from the veins into the right atrium.
2. Degree of filling of the systemic circulation (measured by the mean systemic filling pressure), which forces the systemic blood toward the heart.
3. Resistances to blood flow between the peripheral vessels and the right atrium.

Venous return =

$$\frac{(\text{Mean systemic filling pressure} - \text{Right atrial pressure})}{\text{Resistance to venous return}}$$

Venous Return Increases by the Following Factors:

- ❑ Thoracic pump: During inspiration (due to more negative intrathoracic pressure)
- ❑ Cardiac pump: Has two types of effect:
 - *Vis a fronte* (force acting from front): pumping of blood by ventricles leads to suction of more blood from great veins into atria.
 - *Vis a tergo* (force from behind): contraction of heart and elastic recoil of arterial wall pushes the blood through venules towards heart.
- ❑ Increase in blood volume
- ❑ Venoconstriction by sympathetic activation (due to increase venous pressure)
- ❑ During exercise (due to muscle pump)
- ❑ Deep fascia of thigh (prevent bulging of veins)
- ❑ Venous valves
- ❑ Perforating veins also has some role as it is seen that damage to the **perforating veins** leads to backward flow of blood and elevated pressures in the lower leg.

P-V Loop in Cardiovascular System (Fig. 6.5)

The relationship between ventricular pressure (Y-axis) and volume (X-axis) throughout the cardiac cycle is represented by this loop.

Start reading the graph from point A (starting of ventricular filling phase).

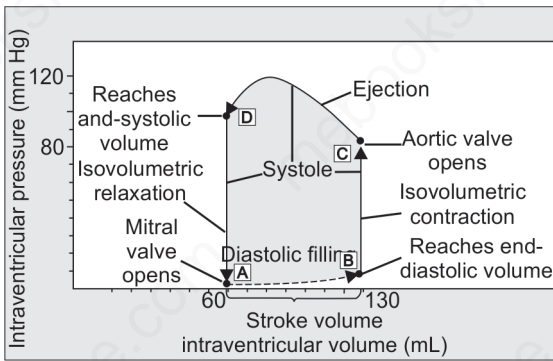

Fig. 6.5: A pressure–volume loop representation of the cardiac cycle

- Point A: Mitral valve opens; Ventricular pressure is lowest.
- Point B: Mitral valve closes; Ventricle reaches EDV
- Point C: Aortic valve opens; Ventricular pressure close to aortic pressure
- Point D: Aortic valve closes; Dicrotic notch

The PV loop is shifted to right when there is volume overload (increase EDV). The loop is shifted to left in case of increased contractility or, decrease compliance (decreased EDV).

Valvular Heart Disease and PV Loop (Fig. 6.6)

	Preload	Afterload	Contractility	
			Early	Late
Aortic stenosis	No change	Increased	Increased	Decreased
Aortic regurgitation	Increased	Increased	No change	Decreased
Mitral stenosis	Decreased	No change	No change	No change
Mitral regurgitation	Increased	Decreased	Increased	Decreased

Cardiomyopathies and PV Loop (Fig. 6.7)

- ❑ **Dilated:** Left and/or right ventricular enlargement, impaired systolic function, congestive heart failure.
- ❑ **Hypertrophic:** Disproportionate left ventricular hypertrophy, typically involving septum more than free wall, with or without an intraventricular systolic pressure gradient; usually of a nondilated left ventricular cavity.

I IMPORTANT

Shift in PV loop in valvular heart disease:

- MR: Right and down
- AR: Right and tall
- AS: Upward (main) and left
- MS: Left and narrow

I IMPORTANT

Shift in PV loop in cardiomyopathies (CM):

- Dilated CM: Right
- Restrictive CM: Upward and narrow
- Hypertrophic CM: Left and narrow

❑ **Restrictive:** Endomyocardial scarring or myocardial infiltration resulting in restriction to left and/or right ventricular filling.

	EDV	ESV	Contractility
Dilated	Increased	Increased	Decreased
Hypertrophic	Decreased	Decreased	Increased
Restrictive	Decreased or, Normal	Decreased or, Normal	Decreased or, Normal

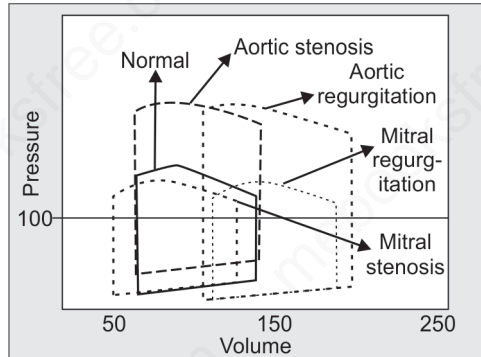

Fig. 6.6: Effect of valvular diseases on pressure–volume loop of the cardiac cycle

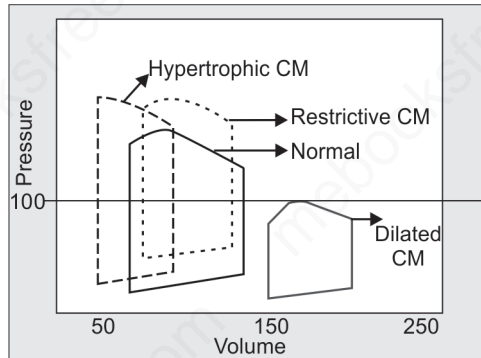

Fig. 6.7: Effect of cardiomyopathies on pressure–volume loop of the cardiac cycle

Ref.

1. The Cleveland Clinic Cardiology Board Review by Brian P. Griffin, Samir R. Kapadia, Curtis M. Rimmerman
2. Harrison's Principle of Internal Medicine.

MULTIPLE CHOICE QUESTIONS

CARDIAC CYCLE

RECENT MCQs

1. Isometric relaxation is defined as:

- a. Relaxation of both atria
- b. Relaxation of both atria with all valves open
- c. Relaxation of LV with mitral and aortic valve closed
- d. Relaxation of LV with mitral and aortic valve open

2. Preload leads to:

- a. Isovolumetric relaxation
- b. Isovolumetric contraction
- c. Peripheral resistance increase
- d. Parasympathetic nervous system activation

3. The duration of atrial systole is:

- a. 0.80 second
- b. 0.57 second
- c. 0.11 second
- d. 0.44 second

4. Duration of 2nd heart sound is:

- a. 0.15 sec
- b. 0.12 sec
- c. 0.08 sec
- d. 0.1 sec

5. S2 is due to:

- a. Rapid gush of blood in ventricle
- b. Atrial contraction
- c. AV valve closure
- d. Semilunar valve closure

6. The third heart sound is due to:

- a. Closure of AV valve
- b. Closure of aortic valve
- c. Mid diastolic flow in the ventricle
- d. Atrial contraction

7. The fourth heart sound is caused by:

- a. Closure of AV valves
- b. Closure of semilunar valves

- c. Rapid ventricular filling
- d. Atrial contraction

8. The fourth heart sound is caused by:

[Comed 07, Karn 04]

- a. Closure of the aortic and pulmonary valves
- b. Vibrations in the ventricular wall during systole
- c. Ventricular filling
- d. Closure of the mitral and tricuspid valves

AIIMS/PGI/JIPMER

9. During the cardiac cycle the opening of the aortic valve takes place at the:

[AI 04]

- a. Beginning of systole
- b. End of isovolumetric contraction
- c. End of diastole
- d. End of diastasis

10. At the end of isometric relaxation phase:

[AI 00]

- a. Atrioventricular valves open
- b. Atrioventricular valves close
- c. Corresponds to peak of "C" wave in JVP
- d. Corresponds to T wave in ECG

11. Of the following which one correlates with isovolumic contraction phase:

[AIIMS June 98]

- a. AV opening and aortic and pulmonary valve closure
- b. AV closure and aortic and pulmonary valve opening
- c. Both valves are closed
- d. Both valves are open

12. Isovolumic relaxation phase of the cardiac cycle ends with: [AI 98]

- Peak of 'C' waves
- Opening of AV valve
- Closure of semilunar valve
- Beginning of 'T' wave

13. Electromechanical systole is the time interval between: [AI 12]

- Q wave and T wave
- S wave and T wave
- R wave and first heart sound
- Q wave and second heart sound

14. A cardiologist asks for measurement electromechanical systole (QS2) and left ventricular ejection time (LVET), and pre-ejection period (PEP). The

technician informs the cardiologist that the carotid transducer is not functioning. Which of the following readings could not be obtained?

[AIIMS May 02]

- QS2
- QS2 and LVET
- QS2 and PEP
- LVET and PEP

15. Which of the following is true about fourth heart sound? [AI 07]

- Can be heard by the unaided ear
- Frequency is greater than 20 Hz
- Heard during ventricular filling phase
- Heard during ventricular ejection phase

CARDIAC OUTPUT AND REGULATION

RECENT MCQs

16. Cardiac output is determined by:

- Ratio of organ to total peripheral resistance
- Mean stroke volume
- Mean BP
- Contractility of heart

17. Ejection fraction is:

- SV/EDV
- EDV/SV
- ESV/EDV
- SV/EDV

18. Normal cardiac index is:

- 3.2
- 4.4
- 2.8
- 5.4

19. Preload is increased by:

- Increased blood volume
- Increased total peripheral resistance
- Standing
- Sitting

20. Starling's law implies:

- Increased VR leads to increased CO
- Increased discharge leads to increased CO
- Increased HR leads to increased CO
- Increased BP leads to increased CO

21. Stroke volume is decreased in:

- Lying down
- Standing
- Hypervolemia
- Increased muscle tone

22. Cardiac output is increased in:

- Sleep
- Pregnancy
- Sitting
- Standing

23. Which one of the following is the best index of afterload?

- Left ventricular end-diastolic pressure

- b. Left ventricular mean systolic pressure
- c. Pulmonary capillary wedge pressure
- d. Total peripheral resistance

24. Cardiac reserve (%) is:

- a. 100-200
- b. 300-400
- c. 500-600
- d. 800-1000

25. Direct Fick's method of measuring cardiac output requires estimation of:

- a. O_2 content of arterial blood
- b. O_2 content of venous blood
- c. O_2 consumption per unit time
- d. All of the above

26. The following measurement were obtained in male patient:

Heart rate: 70/min
 Pulmonary vein $O_2 = 0.24$ ml O_2 /ml
 Pulmonary artery = 0.16 ml O_2 /ml
 Whole body O_2 consumption: 500 ml/min
 What is this patient cardiac output?

- a. 1.65 L/min
- b. 4.55 L/min
- c. 5.00 L/min
- d. 6.25 L/min

27. Mrs. Jones donated one of her kidney to her brother. What would be the effect on her cardiac output?

- a. Increase
- b. Decrease
- c. No effect
- d. Variable effect

28. The pressure-volume curve is shifted to the left in:

- a. MR
- b. AR
- c. MS
- d. AS

AIIMS/PGI/JIPMER

29. Cardiac output in L/min divided by heart rate equals: [AI 95]

- a. Cardiac efficiency
- b. Mean stroke volume
- c. Cardiac index
- d. Mean arterial pressure

30. Basal cardiac output in an adult in nearly: [PGI Dec 99]

- a. 7.5 litre
- b. 5 litre
- c. 12 litre
- d. 10 litre

31. Cardiac index is defined as: [PGI June 98]

- a. Stroke volume/ m^2 BSA
- b. CO per unit body surface area
- c. Systolic pressure/ m^2 BSA
- d. End diastolic volume

32. In a patient with cardiac output 5 liters/minute and body surface area 1.7 m^2 , what will be the cardiac index?

[PGI June 04]

- a. 3 liter/min/ m^2
- b. 4 liter/min/ m^2
- c. 5 liter/min/ m^2
- d. 2.5 liter/min/ m^2
- e. 4.7 liter/min/ m^2

33. The cardiac output can be determined by all except: [PGI June 99]

- a. Fick's principle
- b. V/Q ratio
- c. Echocardiography
- d. Thermodilution

34. Which scientific principle is the basis of the thermodilution method used in measurement of cardiac output?

[AI 12]

- a. Hagen Poiseuille principle
- b. Bernoulli's principle
- c. Stewart-Hamilton principle
- d. Universal gas equation

35. All of the following factors normally increase the length of the ventricular cardiac muscle fibers *except*: [AI 05]

- Increased venous tone
- Increased total blood volume
- Increased negative intrathoracic pressure
- Lying-to-standing change in posture

36. Volume determining preload is: [JIPMER 10, PGI 98]

- End diastolic volume of ventricles
- End systolic volume
- Volume of blood in aorta
- Ventricular ejection volume

37. Cardiac output decreases during: [AI 12]

- Moderate increase in environmental temperature
- Anxiety and excitement

- Eating
- Standing from lying down position

38. Total cardiac output doesn't change during: [JIPMER 11]

- Sleep
- From supine to standing position
- Exercise
- Arrhythmias

39. Venous return to heart during quiet standing is facilitated by all of the following factors, *except*: [AI 10, AIIMS 08]

- Calf muscle contraction during standing
- Valves in perforators
- Deep fascia
- Gravitational increase in arterial pressure

FUTURE TRENDS

A 60-year-old woman has a resting heart rate of 70 beats/min, arterial pressure is 130/85 mm Hg, and body temperature is normal. Her pressure-volume diagram of the left ventricle is shown below. Answer questions no 40-42.

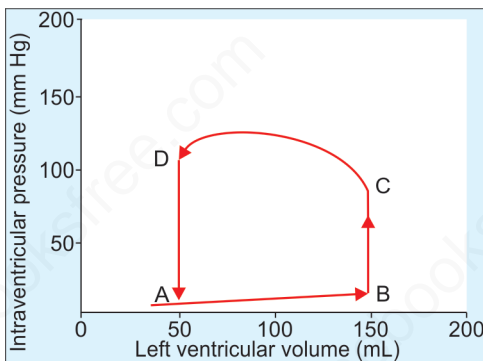

40. What is her cardiac output in milliliters per minute?

- 3000
- 4000
- 6000
- 7000

41. When does the third heart sound occur in the ventricular pressure-volume relationship?

- At point D
- Between point A and point B
- Between point B and point C
- Between point D and point A

42. What is her ventricular ejection fraction?

- 33%
- 60%
- 67%
- 80%

Use the following diagram of three Starling curves to answer the questions number 43 and 44.

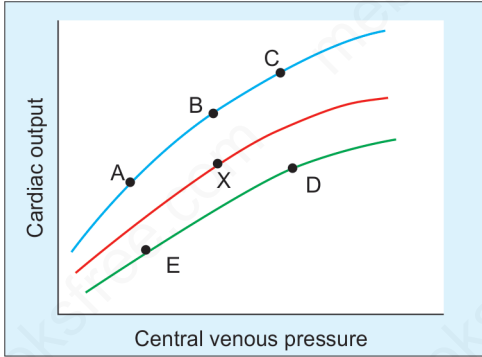

43. A mild hemorrhage will cause stroke volume to shift from point X to point:

- a. A
- b. C
- c. D
- d. E

44. An increase in afterload and venous compliance can cause stroke volume to change from the point marked X to point:

- a. A
- b. C
- c. D
- d. E

Use the following diagram to answer the questions number 45 and 46.

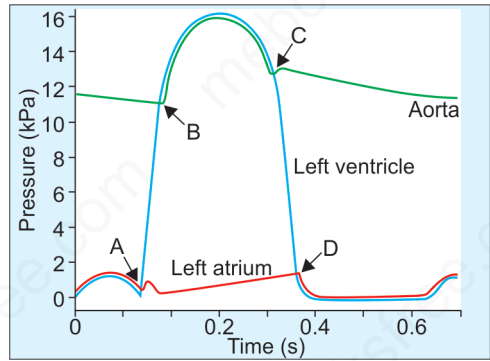

45. Ventricular filling begins at point:

- a. A
- b. B
- c. C
- d. D

46. Closing of the mitral valve begins at point:

- a. A
- b. B
- c. C
- d. D

ANSWERS WITH EXPLANATIONS

1. Ans. c. Relaxation of LV with mitral and aortic valve closed

(Ref: Ganong's Physiology 24th edn. pp 509)

"After the valves are closed (Aortic and pulmonary), pressure continues to drop rapidly during the period of isovolumetric ventricular relaxation."

2. Ans. b. Isovolumetric contraction

(Ref: Ganong's Physiology 24th edn. pp 508)

Preload is EDV at the end of ventricular diastole. A preload leads to onset of ventricular contraction.

3. Ans. c. 0.11 second

(Ref: Ganong's Physiology 24th edn. pp 509)

4. Ans. b. 0.12 sec

(Ref: Ganong's Physiology 24th edn. pp 512)

Second heart sound duration is 0.1 to 0.14 sec (average 0.12 sec).

5. Ans. d. Semilunar valve closure

(Ref: Ganong's Physiology 24th edn. pp 512)

6. Ans. c. Mid diastolic flow in the ventricle

(Ref: Ganong's Physiology 24th edn. pp 512)

"A soft, low-pitched third sound is heard about one third of the way through diastole in many normal young individuals."

7. Ans. d. Atrial contraction

(Ref: Ganong's Physiology 24th edn. pp 512)

Fourth heart sound is due to rapid filling of ventricle, which occurs due to atrial contraction.

8. Ans. c. Ventricular filling

(Ref: Ganong's Physiology 24th edn. pp 512)

"A fourth sound can sometimes be heard immediately before the first sound when

atrial pressure is high or the ventricle is stiff in conditions such as ventricular hypertrophy. It is due to ventricular filling and is rarely heard in normal adults."

9. Ans. b. End of isovolumetric contraction

(Ref: Ganong's Physiology 24th edn. pp 508)

"This period of isovolumetric (isovolumic, isometric) ventricular contraction lasts about 0.05 s, until the pressures in the left and right ventricles exceed the pressures in the aorta (80 mm Hg) and pulmonary artery (10 mm Hg) and the aortic and pulmonary valves open."

10. Ans. a. Atrioventricular valves open

(Ref: Ganong's Physiology 24th edn. pp 509)

"Isovolumetric relaxation ends when the ventricular pressure falls below the atrial pressure and the AV valves open."

11. Ans. c. Both valves are closed

(Ref: Ganong's Physiology 24th edn. pp 508)

See Q. 9.

12. Ans. b. Opening of AV valve

(Ref: Ganong's Physiology 24th edn. pp 509)

See Q. 10.

13. Ans. d. Q wave and second heart sound

(Ref: Ganong's Physiology 24th edn. pp 510)

"Total electromechanical systole (QS2), the pre-ejection period (PEP), and the left ventricular ejection time (LVET) is done by recording the ECG, phonocardiogram, and carotid pulse simultaneously. QS2 is the period from the onset of the QRS complex to the closure of the aortic valves, as determined by the onset of the second heart sound."

14. Ans. d. LVET and PEP

(Ref: Ganong's Physiology 24th edn. pp 510)

QS2: ECG and phonocardiogram are required.

LVET: Carotid pressure transducer is required.

$$\text{PEP} = (\text{QS2} - \text{LVET})$$

So, without carotid pressure transducer, LVET and PEP calculation would not be possible.

15. Ans. c. Heard during ventricular filling phase

(Ref: *Ganong's Physiology 24th edn. pp 512*)

16. Ans. b. Mean stroke volume

(Ref: *Ganong's Physiology 24th edn. pp 515, Figure 31-5*)

$$\text{CO} = \text{SV} \times \text{HR}$$

17. Ans. a. SV/EDV

(Ref: *Ganong's Physiology 24th edn. pp 508*)

"Ejection fraction, the percent of the end-diastolic ventricular volume that is ejected with each stroke, is about 65%."

18. Ans. a. 3.2

(Ref: *Ganong's Physiology 24th edn. pp 514*)

"The cardiac output per minute per square meter of body surface (the cardiac index) averages 3.2 L."

19. Ans. a. Increased blood volume

(Ref: *Ganong's Physiology 24th edn. pp 515 & 518*)

Preload increased by increased venous return (VR) to heart. Increase blood volume increases VR to heart due to increase venous pressure. Standing, sitting or, increase total peripheral resistant decreases VR to heart.

20. Ans. a. Increased VR leads to increased CO

(Ref: *Ganong's Physiology 24th edn. pp 515*)

"Energy or, force of contraction is proportional to the initial length of the cardiac muscle fiber" (Starling's law of the heart or the Frank-Starling law). For the heart, the length of the muscle fibers (i.e. the

extent of the preload, which depends on VR) is proportional to the end-diastolic volume. The relation between ventricular stroke volume and end-diastolic volume is called the Frank-Starling curve. So, increase VR will lead to increase SV and CO.

21. Ans. b. Standing

(Ref: *Ganong's Physiology 25th edn. pp 544*)

CO decreases in sitting or standing from lying position (20–30%).

22. Ans. b. Pregnancy

(Ref: *Ganong's Physiology 25th edn. pp 544*)

In pregnancy there is ~40% increase in CO. This is due to increase in both SV (30%) and HR (15%).

23. Ans. b. Left ventricular mean systolic pressure

(Ref: *Circulation 74, No. 5, 1114-1123, 1986*)

Afterload is the force against which the ventricle ejects its contents. The afterload of the left ventricle is the mean systemic arterial pressure; the afterload of the right ventricle is the mean pulmonary arterial pressure.

So, best index of LV afterload is arterial pressure (mean) in the absence of aortic stenosis.

In the clinical setting, the most commonly used measure of ventricular afterload is systemic vascular resistance (SVR/TPR). However, SVR is a measure of vasomotor tone that reflects only the non-pulsatile component of peripheral load. In contrast, left ventricular systolic wall stress reflects the combined effects of peripheral loading conditions and factors internal to the heart.

24. Ans. b. 300-400

(Ref: *Guyton and Hall Physiology 13th edn, pp 277*)

The maximum percentage that the cardiac output can increase above normal is called the cardiac reserve.

Cardiac reserve: 300 to 400% in the healthy young adult, 500 to 600% in athletic, 200-250% in old age. Maximum cardiac reserve is reached during exercise and minimum during heart failure.

25. Ans. d. All of the above

(Ref: Guyton and Hall Physiology 13th edn, pp 257)

For Fick Principle:

- Mixed venous blood is obtained from pulmonary artery.
- Systemic arterial blood obtained from any systemic artery (Brachial/Radial).
- Rate of oxygen absorption is measured by oxygen meter or, spirometer.

26. Ans. d. 6.25 L/min

(Ref: Guyton and Hall Physiology 13th edn, pp 257)

Cardiac Output = Oxygen Consumption / Arteriovenous O₂ difference

Here, CO = 500 / (0.24 - 0.16) = 500 / 0.08 = 6250 ml/min

27. Ans. b. Decrease

(Ref: Guyton 13th edn pp 176)

Therefore, amputation of a limb or surgical removal of a kidney also removes a parallel circuit and reduces the total vascular conductance and total blood flow (i.e. cardiac output) while increasing total peripheral vascular resistance.

28. Ans. c. MS

(Ref: The Cleveland Clinic Cardiology Board Review by BP Griffin, SR Kapadia, CM Rimmerman)

MR: Right and down

MS: Left and narrow

AR: Right and tall

AS: Upward and left.

29. Ans. b. Mean stroke volume

(Ref: Ganong's Physiology 24th edn. pp 515)

Figure 31-5)

$$CO = SV \times HR$$

30. Ans. b. 5 litre

(Ref: Ganong's Physiology 24th edn. pp 514)

In a resting, supine man, it averages about 5.0 L/min (70 mL × 72 beats/min).

31. Ans. b. CO per unit body surface area

(Ref: Ganong's Physiology 24th edn. pp 514)

"The cardiac output per minute per square meter of body surface (the cardiac index) averages 3.2 L."

32. Ans. a. 3 liter/min/m²

(Ref: Ganong's Physiology 24th edn. pp 514)

See Q. 23

33. Ans. b. V/Q ratio

(Ref: Ganong's Physiology 24th edn. pp 513).

"Two methods of measuring output that are applicable to humans, in addition to Doppler combined with echocardiography, are the direct Fick method and the indicator dilution method."

34. Ans. c. Stewart-Hamilton principle

(Ref: Essential Equations for Anaesthesia by ET. Gilbert-Kawai)

The thermodilution technique utilizes the Stewart-Hamilton equation.

35. Ans. d. Lying-to-standing change in posture

(Ref: Ganong's Physiology 24th edn. pp 555).

Lying-to-standing change in posture decreases VR to heart due to increase venous pooling in the lower part of body.

36. Ans. a. End diastolic volume of ventricles

(Ref: Ganong's Physiology 24th edn. pp 515).

Preload is the initial stretch on muscle before onset of contraction. Preload is equal

to EDV and it is determined by venous return to heart.

37. Ans. d. Standing from lying down position

(Ref: Ganong's Physiology 24th edn. pp 555).

Lying-to-standing change in posture decreases VR to heart due to increase venous pooling in the lower part of body. This decreases SV and CO.

38. Ans. a. Sleep

(Ref: Ganong's Physiology 24th edn. pp 514)

Table

No change in CO occurs during sleep and moderate changes in environmental temperature.

39. Ans. d. Gravitational increase in arterial pressure

(Ref: Berne & Levy Physiology, 6th Updated Edn- Bruce M Koeppen pp 395)

Arterial pressure has very least influence on venous return. All other factors in the options are important regulator of venous return.

40. Ans. d. 7000

This patient has a heart rate of 70 beats/, and you can determine the cardiac output by using the following formula: cardiac output = heart rate × stroke volume. The stroke volume can be determined from the figure, which is 100 ml, the volume change during the C-D segment. Using this you can determine that the cardiac output is 7000 ml/min.

41. Ans. b. Between point A and point B

Between points A and B is the period of ventricular filling. The vibration of the ventricular walls makes this sound after sufficient blood has entered the ventricular chambers.

42. Ans. c 67%

The ejection fraction is the stroke volume/end-diastolic volume. Stroke volume is 100 ml, and the end systolic volume at point D is 150 ml. This gives you an ejection fraction of 0.667 or in terms of percentage 66.7%.

43. Ans. a. A

(See Explanation Below Ans. 44)

44. Ans. d. E

The Starling curve above the one on which the X is marked will result from an increase in contractility or a decrease in afterload. The Starling curve below the one on which the X is marked will result from a decrease in contractility or an increase in afterload. A mild hemorrhage, which causes a decrease in blood volume and pressure, will evoke the baroreceptor reflex, which produces an increase in contractility. The low blood volume decreases the end-diastolic volume. Therefore, the stroke volume will be at the point marked A.

An increase in afterload indicates that the new stroke volume will be on the lower curve. The increase in venous compliance results in a decrease in end-diastolic volume, and, therefore, the stroke volume will be at the point-marked E.

45. Ans. d. D

(See Explanation Below Ans. 46)

46. Ans. a. A

At point D, the pressure within the left ventricle is less than the pressure in the left atrium, and, therefore, the mitral valve opens and ventricular filling begins.

At point A, the ventricle begins to contract, raising its pressure above that in the atrium and closing the mitral valve. The aortic valve opens at point B and closes at point C.

CHAPTER

7

Blood Pressure and Regulation

I IMPORTANT

- ❖ Blood pressure, if expressed in SI units, is expressed in Kilopascals (kPa). Kilopascals may be converted into mm Hg by multiplying them by 7.5. Thus $\text{BP in mm Hg} = (\text{BP in kPa} \times 7.5)$ or $1 \text{ mm Hg} = 0.133 \text{ kPa}$.

BLOOD PRESSURE

Blood pressure is the lateral pressure exerted by the column of blood on the walls of the arteries.

Most commonly used unit of BP is mm Hg.

Type of BP	Definition	Normal value (mm Hg)	Determinant
Systolic BP (SBP)	The maximum arterial pressure attained during systole	90–130	<ul style="list-style-type: none">• SV (directly proportional)• Compliance of aorta (inversely proportional)
Diastolic BP (DBP)	The minimum pressure recorded during diastole	60–85	<ul style="list-style-type: none">• Elastic recoil of aorta/ major vessels (directly proportional)• Total peripheral resistance (directly proportional)
Pulse pressure (PP)	The difference between the systolic and diastolic pressure	~40	<ul style="list-style-type: none">• Ratio of stroke volume to compliance of the arterial tree
Mean blood pressure (MAP)	Average pressure throughout the cardiac cycle	~93	<ul style="list-style-type: none">• (Cardiac output \times Total peripheral resistance)

$$\begin{aligned}
 \square \text{ Mean BP} &= \text{DBP} + 1/3 \text{ Pulse pressure} \\
 &= \text{DBP} + 1/3 (\text{SBP} - \text{DBP}) \\
 &= (3\text{DBP} + \text{SBP} - \text{DBP})/3 \\
 &= 2/3 \text{ DBP} + 1/3 \text{ SBP}
 \end{aligned}$$

Note: The mean BP is weighted 2:1 in favor of diastolic BP. This is because diastole duration is much more than in cardiac cycle. Therefore, arterial pressure is near the diastolic pressure for a longer part of cardiac cycle than it is near the systolic pressure; hence, greater weight is given to the diastolic BP in the calculation of mean BP.

Mean arterial pressure (MAP) may be estimated from an arterial blood pressure tracing by measuring the *area under the pressure curve* (shaded area under the curve in Fig. 7.1) and *dividing this area by the time interval involved*.

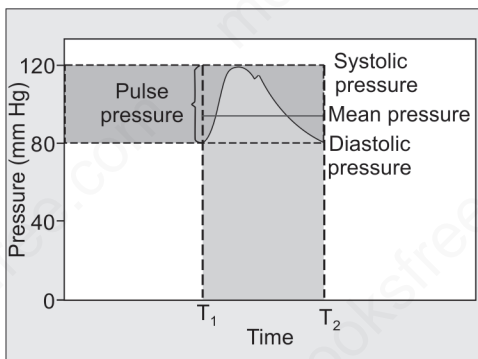

Fig. 7.1: Arterial systolic, diastolic, pulse and mean pressure

This typical record of arterial blood pressure at the root of the aorta (Fig. 7.1) is known as **pressure pulsations**.

Velocity of pressure pulse transmission:

- In general, the greater the compliance of each vascular segment, the slower the velocity of pressure pulsation, which explains the slow transmission in the aorta and the much faster transmission in the much less compliant small distal arteries.
- In the aorta, the velocity of transmission of the pressure pulse is 15 or more times the velocity of blood **flow** **because** the pressure pulse is simply a moving wave of pressure that involves little forward total movement of blood volume.

I IMPORTANT

- ❖ Mean BP is not the arithmetic mean or average of the systolic or diastolic BP.

I IMPORTANT

The velocity of pressure pulse transmission:

1. Aorta: 3–5 m/sec;
2. Large arterial: 7–10 m/sec;
3. Small arteries: 15–35 m/sec.

I IMPORTANT

- ❖ Pressure pulsation shape depends on resistance and compliance of vessels.
- ❖ Pulsatile blood flow is almost absent in capillary.
- ❖ In major peripheral artery, SBP is higher and DBP is lower in comparison to aortic blood pressure.

- ❑ Shape of the pressure pulsation: the progressive diminution of the pulsations in the periphery is called damping of the pressure pulses (Fig. 7.2).

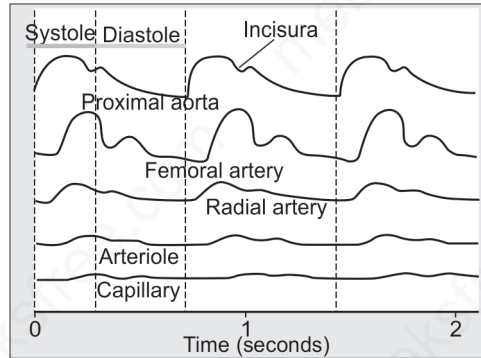

Fig. 7.2: Changes in the pulse pressure contour as the pulse wave travels toward the smaller vessels

- ❑ *The cause of this dampening (shape change): Resistance to blood movement in the vessels and compliance of the vessels.*
- ❑ The degree of damping is almost directly proportional to the product of resistance times compliance.
- ❑ In comparison to the root of the aorta the large and medium-sized arteries (femoral artery) have a slightly lower mean pressure, but they have a slightly higher SBP and lower DBP.

Measurement of Blood Pressure

- ❑ **Direct method or intra-arterial method:** Most accurate method.
- ❑ **Indirect method (Sphygmomanometer):** Non-invasive most commonly used method.

Sphygmomanometer: Mercury, Aneroid, and Hybrid Sphygmomanometers

- ❑ The brachial artery is occluded by a cuff (*Riva-Rocci cuff*) placed around the upper arm and inflated to above systolic pressure.
- ❑ As it is gradually deflated, pulsatile blood flow is re-established and accompanied by sounds (Korotkoff) that can be detected by a stethoscope held over the artery just below the cuff.
- ❑ Traditionally, the sounds have been classified as 5 phases: phase I, appearance of clear tapping sounds corresponding to the appearance of a palpable

pulse; phase II, sounds become softer and longer; phase III, sounds become crisper and louder; phase IV, sounds become muffled and softer; and phase V, sounds disappear completely. The fifth phase is thus recorded as the last audible sound.

- ❑ **The sounds are thought to originate from a combination of turbulent blood flow and oscillations of the arterial wall.**
- ❑ There is agreement that the onset of phase I corresponds to systolic pressure.
- ❑ The disappearance of sounds (phase V) corresponds to diastolic pressure.
- ❑ No clinical significance has been attached to phases II and III.

Auscultatory Gap

- ❑ In older patients with a wide pulse pressure and in some hypertensive patient, the Korotkoff sounds may become inaudible between systolic and diastolic pressure, and reappear as cuff deflation is continued. This phenomenon is known as the auscultatory gap.
- ❑ In some cases, this may occur because of fluctuations of intra-arterial pressure and is most likely to occur in subjects with target organ damage.
- ❑ The auscultatory gap often can be eliminated by elevating the arm overhead for 30 seconds before inflating the cuff and then bringing the arm to the usual position to continue in the measurement. This maneuver reduces vascular volume in the limb and improves inflow to enhance the Korotkoff sounds.
- ❑ This gap may give falsely low recording of systolic BP.

Cuff Size for BP Recording

- ❑ The width of the cuff should be 40% of the circumference or 1.2 times the diameter of the extremity. The length of the inflatable cuff (bladder) should be 80% of arm circumference (a length-to-width ratio of 2:1).
- ❑ The use of too small a cuff will yield falsely high BP values and using too wide a cuff will result in falsely low values.
- ❑ Beside small cuff size, obesity and thick calcified arteries (e.g., in elderly, atherosclerosis, diabetes and Monckeberg's sclerosis) can give rise to spuriously high BP (Pseudohypertension) as in these conditions, vessels are difficult to compress and higher cuff pressure is required to compress them.

I IMPORTANT

Standard sphygmomanometer underestimates systolic pressure by 10 ± 3 mm Hg and overestimates diastolic pressure (phase V) by 8 ± 5 mm Hg (*British Medical Journal 1978*). **So, Intra-arterial blood pressure is always higher than sphygmomanometer.**

I IMPORTANT

Auscultatory gap may give *falsely low* recording of systolic BP. Small cuff size, obesity and thick calcified arteries can give rise to falsely high BP.

I IMPORTANT

Renin angiotensin mediated vasoconstriction is an intermediate acting mechanism but water conservation by renin-aldosterone is a long term mechanism for BP control.

I IMPORTANT

Baroreceptor most sensitive to Pulse pressure >> Mean arterial pressure.

I IMPORTANT

Among all these mechanisms:

- ❖ Most rapidly acting mechanism: Baroreceptor reflex >> Chemo-receptor reflex
- ❖ Maximum blood pressure increase by: RAS system >> CNS ischemic response

Normal Value for Hemodynamic Measurement

		Pressure (mm Hg)
Left ventricle	Peak systolic	90–130
	End diastolic	5–12
Aorta	Peak systolic	90–130
	End diastolic	60–85
	Mean	70–100
Right ventricle	Peak systolic	17–32
	End diastolic	1–7
Pulmonary artery	Peak systolic	17–32
	End diastolic	1–7
	Mean	9–19
Pulmonary capillary wedge	Mean	4–12
Left atrium	Mean	4–12
Right atrium	Mean	0–5

REGULATION OF ARTERIAL BLOOD PRESSURE

Rapidly acting mechanisms (acts within seconds to minutes):

- Baroreceptor reflex
- Chemoreceptor reflex
- CNS ischemic response
- Epinephrine secreted from adrenal medulla

Intermediate acting mechanisms (few minutes to hours):

- Capillary fluid shift mechanism
- Stress relaxation and reverse stress relaxation
- Renin-Angiotensin mediated vasoconstriction

Long-term mechanisms (3–10 days):

- Renal fluid conservation mechanism by ADH, ANP, Aldosterone
- RAS-Aldosterone system

Baroreceptor (Fig. 7.3)

- Located within the walls of the carotid sinus near the bifurcation of the common carotid arteries and aortic arch wall (adventitial layer).
- Carotid sinus baroreceptors are not stimulated at all by pressures between 0 and 50–70 mm Hg, but above these levels, they respond progressively more rapidly and reach a maximum at about 170 mm Hg. **So, working range 70–170 mm Hg.**

- ❑ The responses of the aortic baroreceptors are similar to those of the carotid baroreceptor, except that they operate, in general, at pressure levels about 30 mm Hg higher.
- ❑ **Most sensitive** to changing pressure than constant pressure. So, more sensitive to **pulse pressure** than mean arterial pressure.

I IMPORTANT

Baroreceptors are most sensitive to pulse pressure >> MAP

	Baroreceptor reflex	Chemoreceptor reflex
Receptor location	Carotid sinus and aortic arch wall	Carotid body and aortic body
Stimulated by	Increased stretch (increased BP)	Hypoxia Hypercapnia Acidosis
Afferent	IX (sinus nerve of Hering) and X (vagus)	IX (sinus nerve of Hering) and X (vagus)
Center for reflex	Medulla (VMC and CIC)	Medulla (VMC and CIC)
Efferent	Sympathetic and parasympathetic	Sympathetic and parasympathetic
Main response	<ul style="list-style-type: none"> • Decrease BP when stimulated (main) • Decrease ventilation also 	<ul style="list-style-type: none"> • Increase Ventilation (main) • Increase BP also

I IMPORTANT

Function of the baroreceptors during changes in body posture

❖ Immediately on standing → decrease BP in upper part of the body → decrease baroreceptors firing → No inhibition to RVLM → RVLM activated (tonically active center) → strong sympathetic discharge throughout the body.

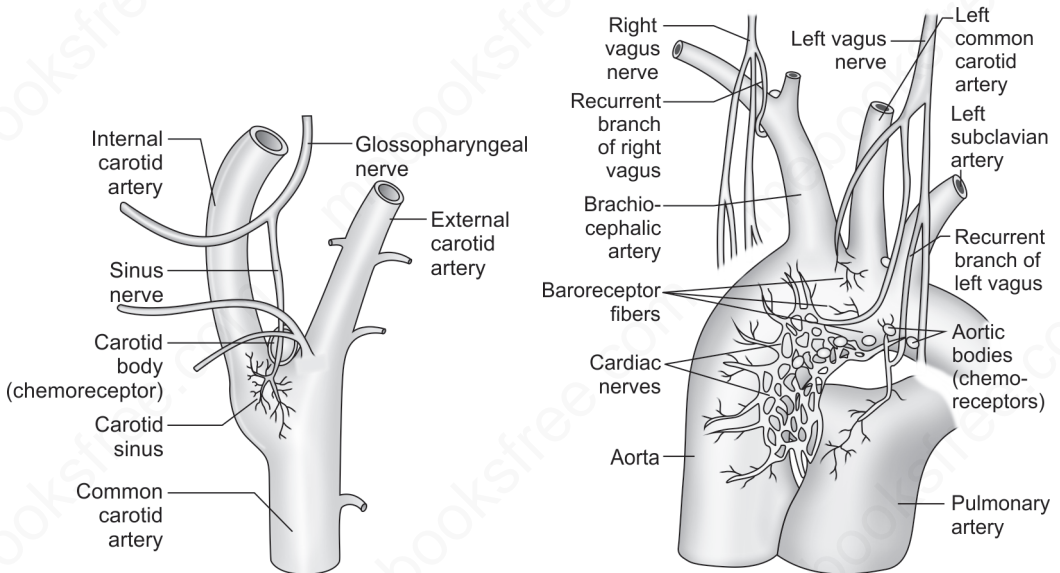

Fig. 7.3: Location and innervation of baroreceptor and chemoreceptors (bodies) in carotid and aortic arch region

I IMPORTANT

What happens when BP rises suddenly?

- ❖ Increased BP → Baroreceptors stimulated → stimulation to NTS → stimulation of CVLM → inhibition of RVLM → inhibition of sympathetic system.
- ❖ Stimulation of NTS also stimulates vagal motor neurons in the nucleus ambiguus.
- ❖ Thus, increased baroreceptor discharge inhibits the tonic discharge of sympathetic nerves and excites the vagal innervation of the heart. These neural changes produce vasodilation, venodilation, drop in BP, bradycardia, and a decrease in cardiac output.

Central Connection of Baroreceptor and Chemoreceptors (Fig. 7.4)

- Vasomotor center (VMC): **Tonically active center.**
 - Other name of this area is rostral ventrolateral medulla (RVLM).
 - The axons of RVLM neurons connected to the thoracolumbar intermediolateral gray column (IML) of spinal cord, which is origin point of sympathetic system.
 - So, it is the excitatory input to sympathetic system.
- Cardiovascular center (CVC) or, cardioinhibitory center:
 - It is the major site of origin of excitatory input to cardiac vagal motor neurons (parasympathetic) in the *nucleus ambiguus*.
 - Both VMC and CIC has input from cerebral cortex via hypothalamus.

NTS: Nucleus of the solitary tract
CVLM: Caudal ventrolateral medulla
Sympath: Sympathetic fibers
Parasymp: Parasympathetic fibers
+: Stimulatory pathway (glutamate)
-: Inhibitory pathway (GABA)

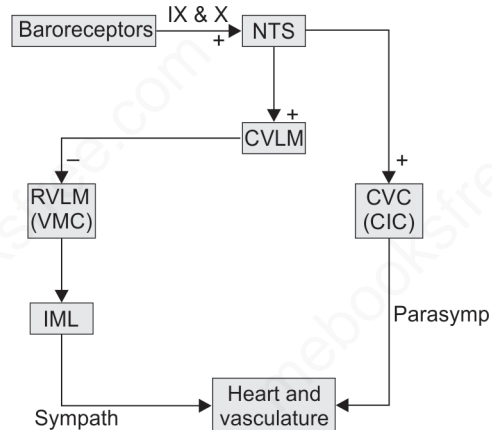

Fig. 7.4: Baroreceptor reflex pathway

Note: Baroreceptors are connected with NTS (nucleus tractus solitarius).
 Baroreceptors stimulation leads to activation of NTS.

Chemoreceptors (Fig. 7.3)

- Sensitive to O₂ lack, CO₂ excess, and H⁺ ion excess.
- Located in carotid bodies, which lies in the bifurcation of each common carotid artery, and usually one to three aortic bodies adjacent to the aorta.
- **Note:** Whenever the arterial BP falls below a critical level ($\ll 70$ mm Hg), the chemoreceptors gets stimulated because diminished blood flow

causes decreased O_2 as well as excess buildup of CO_2 and H^+ ions that are not removed by the slowly flowing blood.

- ❑ The signals transmitted from the chemoreceptors excite the VMC, and this elevates BP back toward normal (Fig. 7.5).

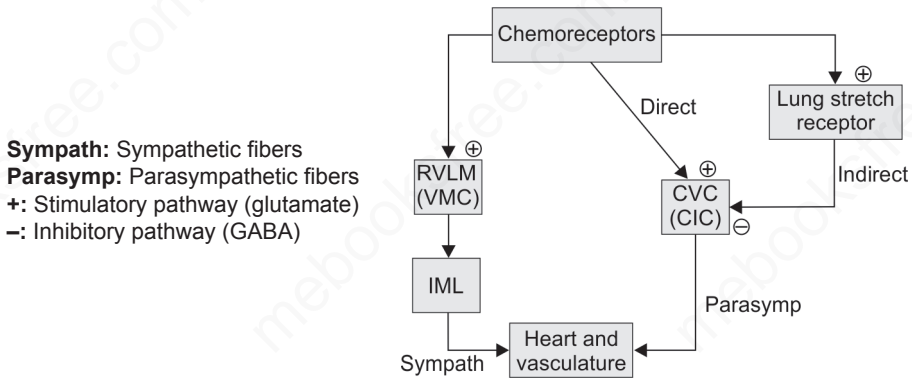

Fig. 7.5: Effects of chemoreceptor stimulation on heart and vasculature

Heart Rate (HR) Response When Chemoreceptor is Stimulated

- ❑ It can cause bradycardia and tachycardia both.
- ❑ The magnitude of the ventilatory response determines whether the HR increases or decreases as a result of carotid chemoreceptor stimulation.
- ❑ Mild stimulation of chemoreceptor: primary effect is to excite CIC in medulla and decrease HR [direct pathway (Fig. 7.5)]
- ❑ Moderate to severe chemoreceptor stimulation: the respiratory system mediates secondary reflex effects. The respiratory stimulation by arterial chemoreceptors tends to inhibit the CIC and leads to increase HR.

Central Nervous System Ischemic Response—Control of Arterial Pressure

- ❑ When blood flow to the VMC decreased severely (cerebral ischemia)—the VMC responds directly to this ischemia and becomes strongly excited. This raises the BP to a very high level.

I IMPORTANT

Occluding both common carotid arteries proximal to carotid sinus

- ❖ Reduce sinus pressure → baroreceptors inactive → VMC (RVLM) more active → rise of BP and HR

I IMPORTANT

Occluding both common carotid arteries distal to carotid sinus

- ❖ Increase sinus pressure → baroreceptors active → VMC inhibition → decrease in BP and HR

I IMPORTANT

- ❖ Chemoreceptor stimulation leads to rise in BP but HR response can be bradycardia (direct) or, tachycardia (indirect).
- ❖ **Note:** Stimulation of baroreceptors → decreases BP but Stimulation of chemoreceptors → increases BP

- ❑ This effect is caused by failure of the slowly flowing blood to carry CO₂ away from the brainstem VMC (high local concentration of CO₂).
- ❑ This arterial pressure elevation in response to cerebral ischemia is known as CNS ischemic response.
- ❑ This response is activated only when BP falls below 60 mm Hg, reaching its greatest degree of stimulation at a pressure of 15 to 20 mm Hg.
- ❑ It can elevate the mean arterial pressure for as long as 10 minutes, to as high as 250 mm Hg.
- ❑ It operates principally as an emergency pressure control system that acts rapidly and very powerfully to prevent further decrease in BP. That's why it is sometimes called the "last ditch stand" pressure control mechanism.

Cushing's reflex: It is one form of CNS ischemic response.

When CSF pressure raises cerebral artery compressed and begins to collapse. This compromises cerebral blood flow and causes hypoxia and hypercapnia in medulla, which directly stimulates the VMC. Stimulation increases the BP to a high level. The increase in BP, through the baroreceptor mechanisms causes *reflex Bradycardia*.

The blood pressure is maintained at a new higher level and the brain is protected from further loss of adequate blood flow.

Cushing reflex causes the symptoms of Cushing triad:

1. Bradycardia
2. Hypertension (with widened pulse pressure)
3. Irregular respiration (bradypnea)

It is indicative of an advanced increased intracranial pressure (brain's last gasp).

CARDIOPULMONARY BARORECEPTORS

- ❑ These receptors are involved in monitoring and modulating the filling of the heart.
- ❑ There are two types of these receptors; type A receptors that fire during atrial contraction and type B receptors that fire during atrial diastole.
- ❑ These receptors are modulated by atrial filling and atrial contraction.
- ❑ If there is an increase in blood volume and hence an increase in venous return leading to increased atrial filling, the atria are stretched, and this is detected by these receptors.
- ❑ When these receptors are stimulated, three things happen:

1. Increase in the heart rate (Bainbridge reflex)
2. Inhibition of antidiuretic hormone synthesis from hypothalamus.
3. Secretion of atrial natriuretic peptide (ANP) by atrial myocytes.

Bainbridge Reflex

In 1915, Bainbridge reported that infusing blood or saline into dogs accelerated their heart rate. This change in heart rate (HR) is independent of BP.

- ❑ **Receptor:** Stretch receptors in both atrial walls. These receptors are located principally in the venoatrial junctions: in the right atrium at its junctions with the venae cavae and in the left atrium at its junctions with the pulmonary veins.
- ❑ **Activation of receptor:** Stretch on right atrium (increase in venous return) activates these receptors (so-called *low-pressure baroreceptors*).
- ❑ **Low-pressure baroreceptor are of two types:** Those that discharge primarily during atrial systole (type A), and those that discharge primarily late in diastole, at the time of peak atrial filling (type B).
- ❑ **Afferent:** Vagal afferent. Bilateral transection of the vagi abolish this response.
- ❑ **Center:** Brainstem.
- ❑ **Efferent:** Parasympathetic (decrease) and sympathetic (increase).
- ❑ **Response:** Increase in HR. The response is highly selective to heart. Reflex increase in HR is large but changes in ventricular contractility are generally negligible. Furthermore, there is no increase in sympathetic activity in the peripheral arterioles.

OTHER REFLEXES IN CARDIOVASCULAR SYSTEM

Bezold-Jarisch Reflex (Coronary Chemoreflex)

- ❑ **Receptor:** Chemoreceptors and Mechanoreceptors present within the left ventricular wall (noncapsulated terminal of C fiber). These type of receptors are also located in juxtacapillary region of alveoli, atria, great veins, and pulmonary artery.
- ❑ **Afferent:** Unmyelinated vagal afferent (type C fibers).
- ❑ **Efferent:** Parasympathetic (increase) and sympathetic (decrease).

I IMPORTANT

An increase in right atrial filling increases HR as much as 75% because of two reasons:

- ❖ Bainbridge reflex (60%).
- ❖ Stretching of the SA node causes increase rate of pacemaker firing (15%).

I IMPORTANT

The Bainbridge reflex is a cardiac reflex that is produced by a combination of decreased vagal tone and the excitation of cardiac accelerator fibers during periods of increased venous return to the heart.

I IMPORTANT

Hemorrhage (decrease blood volume) inhibits the Bainbridge reflex due to decreasing blood volume in the right atrium. This is known as reverse Bainbridge reflex.

I IMPORTANT

The systemic effects between the Bainbridge reflex and the carotid sinus and aortic arch baroreceptor are directly opposite of each other.

In hypovolemic state, carotid sinus and aortic arch baroreceptor is dominant over the Bainbridge reflex.

In hypervolemic state, Bainbridge reflex is dominant over the carotid sinus and aortic arch baroreceptor.

- ❑ **Response:** *Bradycardia, hypotension, and coronary artery vasodilation (triad)*. Apnea followed by rapid shallow breathing also occurs.

This reflex can be elicited by injecting a variety of substances including capsaicin, serotonin, phenylbiguanide, and veratridine in the left ventricle or, coronary artery (cats, rabbits).

In human this reflex may be activated:

- ❑ During myocardial ischemia or, reperfusion (thrombolytic therapy) as a result of increased production of oxygen radicals.
- ❑ By agents used as radiocontrast for coronary angiography.
- ❑ Vasovagal syncope has been attributed to activation of the Bezold-Jarisch reflex.

BJR is cardioprotective by producing bradycardia, thus reduce the amount substances get absorbed into the blood.

BJR is less pronounced in cardiac hypertrophy or, atrial fibrillation.

- ❑ **Prevention:** The activation of BJR can be prevented by interventions like preventing the decrease in ventricular volume using intravenous fluids, preventing ventricular hypercontractility by using β -adrenergic blocking drugs, or inhibiting the afferent limb of the reflex using a vagolytic drug.
- ❑ **Management:** vagolytics, epinephrine or fluid infusion.

Oculocardiac Reflex

- ❑ Traction on the extraocular muscles (especially the medial rectus), conjunctiva, or orbital structures causes hypotension and a reflex slowing of the HR, as well as arrhythmias.
- ❑ This reflex may be elicited during retrobulbar block, ocular trauma, or pressure on the tissue that remains after enucleation.
- ❑ The vagal response to the heart can be inhibited by anticholinergic agent (atropine or glycopyrrolate).
- ❑ **Afferent:** Long and short ciliary nerves to the ciliary ganglion of the oculomotor nerve and then the ophthalmic division of the trigeminal nerve (cranial nerve V) to the gasserian ganglion.
- ❑ **Efferent:** Vagus nerve. This reflex may be blunted by the use of retrobulbar block or the release of the offending stimulus.

- **Blood Pressure Waves:** In direct recording (intra-arterial) of BP, many types of waves can be seen:
 - **Cardiac Waves:** These are the waves because of the systolic rise and diastolic fall.
 - **Traube-Hering (T-H) Waves:** These are the fluctuation in the BP, synchronous with respiration.
 - **Mayer Waves:** These are oscillations of BP seen in conditions like hypotension. The fluctuation of BP may be as great as 10–40 mm Hg. The duration of each cycle varies from 26 seconds in the anesthetized dog to 7–10 seconds in the unanesthetized human. These waves are called vasomotor waves or “Mayer waves”. They are caused mainly by oscillation of the **baroreceptor reflex**. It may be due to chemoreceptor or, CNS ischemic response also.

I IMPORTANT

- ❖ Mayer waves are oscillations of arterial pressure at a frequency (~0.1 Hz in humans) lower than respiratory frequency.

Valsalva Maneuver

There are 4 physiological phases in the Valsalva maneuver: (I) onset of strain, (II) continued strain, (III) release, and (IV) recovery.

- ❑ Normally, exhaling against an obstructed airway (closed glottis) causes increased intrathoracic pressure and a rise in systolic blood pressure (Fig. 7.6) due to compression of the aorta and pulmonary circulation (phase I).
- ❑ This is followed by a decrease in venous return and a decline in systolic blood pressure to *below baseline* as positive intrathoracic pressure is maintained (phase II).
- ❑ The release and recovery phases represent compensations for normal physiologic mechanisms that are activated due to the decline in intrathoracic pressure. These compensations include a decrease in systolic blood pressure during phase III caused by initial pooling of blood in the pulmonary vasculature followed by an overshoot in systolic blood pressure (phase IV) resulting from increased cardiac output and *vasoconstriction* from sympathetic overactivity.
- ❑ The Korotkoff sounds, which correspond to the periods in which there is a rise in systolic blood pressure, are normally heard while auscultating over the brachial artery during phases I and IV in response to the changes in systolic arterial pressure (i.e., normal sinusoidal pattern).

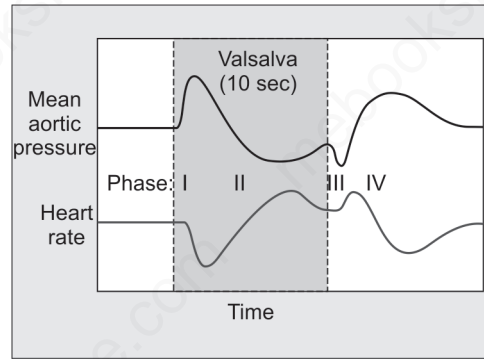

Fig. 7.6: Recording of MAP and HR during Valsalva maneuver

Applied

- ❑ The increase in intensity of murmurs during performance of the Valsalva maneuver in patients with hypertrophic obstructive cardiomyopathy distinguishes this type of murmur from other types of systolic murmurs (65% sensitivity, 95% specificity).
- ❑ During the maneuver, the murmur and click of mitral valve prolapses occur earlier during systole.
- ❑ Two abnormal patterns have been found in heart failure patients during assessment with the Valsalva maneuver. The abnormality in phase II is seen as a square root pattern recognized by the maintenance of systolic blood pressure, and in phase IV as the absence of the normal overshoot of systolic blood pressure.

LOCAL REGULATION OF CVS

Autoregulation

- ❑ The capacity of tissues to regulate their own blood flow despite changes in blood pressure within a certain range is referred to as **autoregulation**.
- ❑ **Autoregulation is strong in heart (Range: 60-200 mm Hg), brain (Range: 65-140 mm Hg), and kidney (Range: 75-160 mm Hg), moderate in GIT and skeletal muscle, little in skin and no autoregulation in lung.**
- ❑ **Mechanisms of autoregulation:**
 - **Myogenic theory of autoregulation:** As the pressure rises, the blood vessels are distended

and the vascular smooth muscle fibers that surround the vessels contract (Ca^{++} mediated).

- **Metabolic theory of autoregulation:** Vasodilator substances tend to accumulate in active tissues, and these “metabolites” dilates blood vessels. When blood flow increases, they tend to be washed away.

Substances Secreted by the Endothelial Cells

They secrete many growth factors and vasoactive substances. The vasoactive substances include prostaglandins and thromboxanes, nitric oxide, and endothelins.

Prostacyclin and Thromboxane A2

- ❑ Prostacyclin is produced by endothelial cells and thromboxane A2 by platelets from their common precursor arachidonic acid.
- ❑ Thromboxane A2 promotes platelet aggregation and vasoconstriction, whereas prostacyclin inhibits platelet aggregation and promotes vasodilation.

Nitric Oxide

- ❑ Many different stimuli act on the endothelial cells to produce **endothelium-derived relaxing factor (EDRF)**, a substance that is now known to be **nitric oxide (NO)**.
- ❑ NO is synthesized from arginine in a reaction catalyzed by nitric oxide synthase (NO synthase, NOS).
- ❑ Three isoforms of NOS have been identified:
 - NOS 1-in CNS
 - NOS 2-in macrophages and other immune cells
 - NOS 3-in endothelial cells.
- ❑ The NO that is formed in the endothelium diffuses to smooth muscle cells, where it activates soluble guanylyl cyclase, producing cyclic 3,5-guanosine monophosphate (cGMP), which in turn mediates the relaxation of vascular smooth muscle.
- ❑ NO is inactivated by hemoglobin.

I IMPORTANT

Vasodilator Metabolites

The metabolic changes that produce vasodilation include:

- ❖ Decreases in O_2 tension and pH.
- ❖ Increases in CO_2 tension and osmolality. The direct dilator action of CO_2 is most pronounced in the skin and brain.
- ❖ Increase in temperature and lactate.
- ❖ K^+ dilates vessels due to hyperpolarization of vascular smooth muscle.
- ❖ Adenosine vasodilates in cardiac muscle and exercise induced skeletal muscle.

I IMPORTANT

Endothelins

- ❖ Most potent vasoconstrictor agents produce by endothelial cells.
- ❖ Endothelin-1 (ET-1), endothelin-2 (ET-2), and endothelin-3 (ET-3) are the members of a family of three similar 21-amino-acid polypeptides.

MULTIPLE CHOICE QUESTIONS

MEASUREMENT OF BP

RECENT MCQs

1. Mean arterial pressure depends upon:

- a. Cardiac output
- b. Cardiac output and peripheral resistance
- c. Arterial compliance
- d. Peripheral resistance

2. The basis of Korotkoff sound is related to: [Kar 11, Corneil 09]

- a. Aortic valve closure
- b. Production of heart sound
- c. Arterial turbulence
- d. Arterial valve expansion

3. Blood pressure in right ventricle: [MAHE 05]

- a. 25 mm Hg
- b. 80 mm Hg
- c. 95 mm Hg
- d. 120 mm Hg

AIIMS/PGI/JIPMER

4. Blood pressure is defined as the product of: [PGI Dec 98]

- a. Systolic pressure \times pulse
- b. Diastolic pressure \times pulse rate
- c. Pulse pressure \times pulse rate
- d. Cardiac output \times peripheral resistance

5. Mean arterial pressure is: [AI 96]

- a. Systolic + (Diastolic BP)/2
- b. Systolic + 1/3rd Pulse pressure
- c. Diastolic + (Systolic BP)/2
- d. Diastolic + 1/3rd Pulse pressure

6. Mean arterial pressure is calculated as: [AIIMS Nov 11, 06]

- a. $(SBP + 2DBP)/3$
- b. $(DBP + 2SBP)/3$
- c. $(SBP + 3DBP)/2$
- d. $(DBP + 3SBP)/2$

7. SI unit for measuring blood pressure is: [AI 02]

- a. Torr
- b. mm Hg
- c. kPa
- d. Barr

8. During diastole, the arterial pressure is maintained by: [AI 09]

- a. Elastic recoil of aorta
- b. Musculature of arteries
- c. Constriction of capillaries
- d. Contraction of left ventricle

9. The blood pressure measured by a sphygmomanometer: [JIPMER 10, AI 08, 01]

- a. Is lower than the intra-arterial pressure
- b. Is higher than the intra-arterial pressure
- c. Is same as the intra-arterial pressure
- d. Is the same with different cuff sizes

10. Spuriously high BP is seen in all except: [AIIMS May 01]

- a. Auscultatory gap
- b. Small cuff
- c. Thick calcified vessels
- d. Obesity

11. True about blood pressure measurement is all except: [AIIMS May 07]

- a. Cuff width should be 40% of arm circumference
- b. Diastolic blood pressure is indicated by fourth Korotkoff sound
- c. Small cuff measures spuriously elevated diastolic blood pressure
- d. Monckeberg' sclerosis causes pseudohypertension

12. Shape of the arterial pulse is influenced by: [AIIMS Dec 97]

- a. Viscosity of blood
- b. Velocity of blood

- c. Arterial wall expansion
- d. Cross sectional area of artery

13. In elastic vascular beds there is non-linear pressure flow relationship due to:

- a. The arrangement is parallel of big arteries
- b. The arrangement is series of big arteries
- c. Arteriolar constriction
- d. Distension of elastic vessels when pressure increases

REGULATION OF BLOOD PRESSURE

RECENT MCQs

14. Occlusion of common carotid artery on both sides leads to:

[Manipal 04, TN 02]

- a. Increase in HR and BP
- b. Increase in BP and decrease in HR
- c. Decrease in HR and BP
- d. No effect on BP and HR

15. Low-pressure receptors that play role in minimal arterial pressure changes, due to volume changes are located in:

[MHCET 10]

- a. Left atrium
- b. Right atrium
- c. Pulmonary arteries
- d. All of the above

16. Baroreceptor reflex: true is:

- a. From aortic body and carotid body
- b. Causes atrial vasoconstriction when BP falls
- c. Causes decrease in HR when BP increases
- d. Causes increase in HR when BP increases

17. Volume receptors are:

- a. Affected by total cardiovascular output
- b. Stimulate by atrial systole and diastole
- c. Stimulated by left ventricular contraction
- d. Stimulated by aortic pressure

AIIMS/PGI/JIPMER**18. Baroreceptor stimulation produces:**

[PGI June 05]

- a. Decreased heart rate and BP
- b. Increased heart rate and BP
- c. Increased cardiac contractility
- d. Decreased cardiac contractility

19. Pressure on carotid sinus cause:

[PGI Dec 99]

- a. Hyperpnea
- b. Reflex bradycardia
- c. Tachycardia
- d. Dyspnea

20. Discharge from Baroreceptors cause inhibition of:

[AI 12]

- a. Caudal ventrolateral medulla
- b. Rostral ventrolateral medulla
- c. Nucleus of tractus solitarius
- d. Nucleus ambiguus

21. Detectable fall in blood pressure occur in:

[JIPMER 10]

- a. Sympathetic stimulation
- b. Inhibition of VMC
- c. Disinhibition of VMC
- d. Stimulation of vagal center

22. Carotid body baroreceptor is most sensitive to:

[JIPMER 10]

- a. Mean blood pressure
- b. Diastolic blood pressure
- c. Systolic blood pressure
- d. Pulse pressure

23. Two students, Vineet and Kamlesh were asked to demonstrate in dogs the role of sinus nerve in hypovolemic shock. Vineet severed the sinus nerve when the mean blood pressure (MBP) was 85 mm Hg and Kamlesh cut the sinus nerve when the mean blood

pressure was 60 mm Hg. On cutting the sinus nerve: [AI 03]

- a. Vineet recorded the increase in MBP but Kamlesh recorded a decrease in MBP
- b. Vineet recorded a decrease in MBP but Kamlesh recorded an increase in MBP
- c. Both recorded an increase in MBP
- d. Both recorded a decrease in MBP

24. Clamping of the carotid arteries above the carotid sinus result in:

[AI 12]

- a. Increase in blood pressure and increase in heart rate
- b. Increase in blood pressure and decrease in heart rate
- c. Decrease in blood pressure and increase in heart rate
- d. Decrease in blood pressure and decrease in heart rate

25. When a person changes position from standing to lying down, following change is seen:

[AI 09, AIIMS Nov 07]

- a. Heart rate increases
- b. Venous return to heart increases immediately
- c. Cerebral blood flow increases
- d. Blood flow at apices of lung decreases

26. A shift of posture from supine to upright posture is associated with cardiovascular adjustments. Which of the following is NOT true in this context?

[AIIMS May 03]

- a. Rise in central venous pressure
- b. Rise in heart rate
- c. Decrease in cardiac output
- d. Decrease in stroke volume

27. Which of the following statements about vasomotor center (VMC) is true?

[AIIMS May 11, AI 09]

- a. Independent of corticohypothalamic inputs
- b. Influenced by baroreceptor signals but not by chemoreceptors

- c. Acts along with the cardiovagal center (CVC) to maintain blood pressure
- d. Essentially silent in sleep

28. Regarding nitric oxide, false is:

[AIIMS Nov 07]

- a. Derived from endothelium
- b. Acts by increasing cAMP levels
- c. Vasodilator
- d. Derived from arginine

LOCAL REGULATION OF CVS

AIIMS/PGI/JIPMER

29. Mechanism of action of Nitric oxide is through:

[AI 00]

- a. cGMP
- b. cAMP
- c. Ca⁺⁺
- d. Tyrosine

30. NO is synthesized by:

[AIIMS May 09]

- a. Uracil
- b. Aspartate
- c. Guanosine
- d. Arginine

31. True statement regarding Nitric oxide is:

[AI 99]

- a. NO is synthesized from arginine
- b. NO is spontaneous produced from NO₂
- c. NO causes vasoconstriction
- d. NO is released from mitochondria

32. The primary action of Nitric oxide (NO) in the gastrointestinal tract is:

[AI 10]

- a. Vasodilatation
- b. Vasoconstriction

- c. Gastrointestinal smooth muscle relaxation
- d. Gastrointestinal slow smooth muscle contraction

33. All are true about nitric oxide except:

[AIIMS Nov 07]

- a. Acts through cAMP
- b. Helps to regulate vascular tone
- c. Important role in penile erection
- d. Present in low concentration in cigarette smokers

34. Nitric oxide is produced in:

[PGI June 2K]

- a. Endothelium
- b. Plasma
- c. Platelets
- d. Serum

35. True regarding endothelin-1 is all except:

[AIIMS May 07]

- a. Bronchodilation
- b. Vasoconstriction
- c. Decreased GFR
- d. Has inotropic effect
- e. Local regulation

FUTURE TRENDS

36. Sympathetic nerve activity would be expected to increase:

- If glutamate receptors were activated in the NTS
- If GABA receptors were activated in the RVLM
- If glutamate receptors were activated in the CVLM
- Destruction of NTS

37. The diagram below is the response to straining (the Valsalva maneuver) in a normal man, recorded with a needle in the brachial artery.

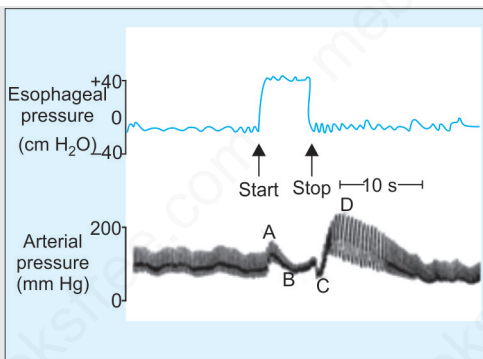

The increase in BP at point A is due to:

- Increase in venous return
- Reflex sympathetic activation

- Inhibition of baroreceptor
- Compression of the aorta and pulmonary circulation

38. The following record demonstrates an individual's response to drug X:

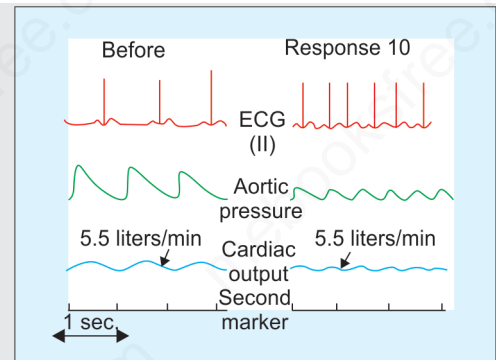

On the basis of these data you could conclude that drug X produced:

- An increased pulse pressure
- An increased peripheral resistance
- A decreased arterial pressure due to venous dilation
- A reflex increase in heart rate

ANSWERS WITH EXPLANATIONS

1. Ans. b. Cardiac output and peripheral resistance

(Ref: Ganong's Physiology 24th edn. pp 115)

2. Ans. c. Arterial turbulence

(Ref: Ganong's Physiology 24th edn. pp 540)

"Constriction of an artery increases the velocity of blood flow through the constriction, producing turbulence and sound beyond the constriction. Examples are bruits heard over arteries constricted by atherosclerotic plaques and the sounds of Korotkoff heard when measuring blood pressure."

3. Ans. a. 25 mm Hg

(Ref: Harrison's Principles of Internal Medicine 19th edn. Table 272-2)

Right ventricular pear systolic pressure: 17–32 mm Hg, End diastolic pressure: 1–7 mm Hg

Left ventricular pear systolic pressure: 90–130 mm Hg, End diastolic pressure: 5–12 mm Hg.

4. Ans. d. Cardiac output x peripheral resistance

(Ref: Ganong's Physiology 24th edn. pp 115)

5. Ans. d. Diastolic + 1/3rd P pulse pressure

(Ref: Ganong's Physiology 24th edn. pp 544)

6. Ans. a. (SBP + 2DBP)/3

(Ref: Ganong's Physiology 24th edn. pp 544)

$$\begin{aligned} \text{Mean BP} &= \text{DBP} + 1/3 \text{ pulse pressure} \\ &= \text{DBP} + 1/3 (\text{SBP} - \text{DBP}) \\ &= (3\text{DBP} + \text{SBP} - \text{DBP}) / 3 \\ &= 2/3 \text{ DBP} + 1/3 \text{ SBP} = (\text{SBP} + 2\text{DBP})/3 \end{aligned}$$

7. Ans. c. kPa

(Ref: Ganong's Physiology 24th edn. pp 544)

"The arterial pressure is conventionally written as systolic pressure over diastolic

pressure, for example, 120/70 mm Hg. One millimeter of mercury equals 0.133 kPa, so in SI units this value is 16.0/9.3 kPa."

8. Ans. a. Elastic recoil of aorta

(Ref: Berne & Levy Physiology, 6th edn. Bruce M Koeppen. pp 337)

There is stretching of aorta and arteries during systole due to ejection of blood from ventricle. During ventricular diastole the previously stretched aorta and arteries recoil. The volume of blood that is displaced by the recoil furnishes continuous capillary flow throughout diastole. The lateral pressure exerted by this flowing blood is diastolic pressure.

9. Ans. a. Is lower than the intra-arterial pressure

(Ref: British Medical Journal, 1978, 2, 159-162 & Hypertension 2005;45:142-161)

Sphygmomanometer always underestimates systolic pressure and overestimate diastolic BP (not always). So, better answer: intra-arterial is higher than sphygmomanometer measurement.

10. Ans. a. Auscultatory gap

(Ref: Hypertension 2005;45:142-161)

Auscultatory gap gives falsely low BP measurement.

11. Ans. b. Diastolic blood pressure is indicated by fourth Korotkoff sound

(Ref: Hypertension 2005;45:142-161)

Diastolic BP indicated by fifth phase of Korotkoff sound.

12. Ans. d. Cross sectional area of artery c. Arterial wall expansion

(Ref: Guyton-Physiology-12th edn. pp 137)

Shape of the pressure pulsation is not linear because of elastic expansion of arterial wall

(expansion causes dampening of pressure). The shape progressively changes towards peripheral arteries. The cause of this shape change is resistance to blood movement in the vessels. So, resistance of vessel is the main factor determining shape of arterial pulse. Resistance indirectly depends on cross sectional area (diameter).

13. Ans. d. Distension of elastic vessels when pressure increases

(Ref: Guyton-Physiology-12th edn. pp 137)

See Q. 12

14. Ans. a. Increase in HR and BP

(Ref: Guyton-Physiology-12th edn. pp 210)

“Occluding the two common carotid arteries, reduces the carotid sinus pressure; as a result, the baroreceptors become inactive and lose their inhibitory effect on the vasomotor center. The vasomotor center then becomes much more active than usual, causing the aortic arterial pressure to rise and remain elevated.”

15. Ans. d. All of the above

(Ref: Ganong's Physiology 24th edn. pp 561)

Low-pressure baroreceptor are located within the wall of both right (main), left atrium and pulmonary artery.

16. Ans. c. Causes decrease in HR when BP increases > b. Causes atrial vasoconstriction when BP falls

(Ref: Ganong's Physiology 24th edn. pp 560)

Baroreceptor directly activated by the increase BP. Active baroreceptor inhibits vasomotor center and activates vagal center. Vagal center stimulation decreases HR.

When BP falls, the baroreceptors become inactive and lose their inhibitory effect on the vasomotor center. The vasomotor center then becomes much more active than usual (Tonically active), and causes vasoconstriction via sympathetic system.

So, it is not direct effect of baroreceptor but the effect of tonically active VMC.

17. Ans. b. Stimulate by atrial systole and diastole

(Ref: Ganong's Physiology 24th edn. pp 560)

“Volume receptors are low-pressure baroreceptor located within atrium. The stretch receptors in the atria are of two types: those that discharge primarily during atrial systole (type A), and those that discharge primarily late in diastole, at the time of peak atrial filling (type B).”

Cardiac output will affect the high pressure baroreceptor (carotid sinus and aortic arch) not the volume receptor.

18. Ans. a. Decreased heart rate and BP, d. Decreased cardiac contractility

(Ref: Ganong's Physiology 24th edn. pp 559)

Baroreceptor stimulation inhibits vasomotor center and stimulates cardiovagal center. So, Sympathetic system will be inhibited and parasympathetic will be stimulated.

19. Ans. b. Reflex bradycardia

(Ref: Guyton-Physiology-12th edn. pp 210)

Pressure on carotid sinus activates baroreceptors. Active baroreceptor reflexly decreases HR by inhibiting vasomotor center and stimulating cardiac vagal center.

20. Ans. b. Rostral ventrolateral medulla

(Ref: Ganong's Physiology 24th edn. pp 559)

Active baroreceptor inhibits rostral ventrolateral medulla (vasomotor center). All other center in the options are activated.

21. Ans. b. Inhibition of VMC

(Ref: Ganong's Physiology 24th edn. pp 559)

VMC is a tonically active center. Disinhibition of VMC leads to spontaneous activation of sympathetic system. Although stimulation of vagal center may decrease BP, the effect is not significant.

22. Ans. d. Pulse pressure

(Ref: Ganong's Physiology 24th edn. pp 567)

Baroreceptor respond much more to a rapidly changing pressure than to a stationary pressure. "These receptors (baroreceptor) are most sensitive to changes in pulse pressure but also respond to changes in mean arterial pressure."

23. Ans. a. Vineet recorded the increase in MBP but Kamlesh recorded a decrease in MBP (see explanation)

Vineet: At 85 mm Hg: during this time Baroreceptors are still active (in a lesser degree). Active Baroreceptor inhibits VMC/Sympathetic system (means during this time, Baroreceptor still has some inhibitory effect on VMC). So, cutting the sinus nerve during this time, all inhibitory effect on VMC will be lost, BP will rise (although rise will not be very severe).

Kamlesh: At 60 mm Hg: during this time Baroreceptors are completely inactive, but chemoreceptors are active. Active chemoreceptor stimulates VMC/sympathetic system (means during this time, Chemoreceptor is trying to rise the BP by stimulatory effect on VMC). So, cutting the sinus nerve during this time, excitatory effect on VMC due to chemoreceptor will be lost, BP will fall.

So, Vineet will record increase in BP, Kamlesh will record decrease in BP (option A).

24. Ans. d. Decrease in blood pressure and decrease in heart rate

(Ref: Guyton-Physiology-12th edn. pp 210)

Clamping above carotid sinus, increases sinus pressure and activate baroreceptor.

25. Ans. b. Venous return to heart increases immediately

(Ref: Guyton-Physiology-12th edn. pp 210)

Change of posture from standing to lying down, increases venous return (VR) to

heart. This increases BP and decrease HR via baroreceptor reflex. Blood flow to apex of lung will be high due to high CO but blood flow to brain will remain constant due to autoregulation.

26. Ans. a. Rise in central venous pressure

(Ref: Guyton-Physiology-12th edn. pp 210)

Due to decrease venous return, central venous pressure decreases (RAP).

27. Ans. c. Acts along with the cardiovagal center (CVC) to maintain blood pressure

(Ref: Ganong's Physiology 24th edn. pp 557)

VMC and CIC are the centre for both baroreceptor and chemoreceptor. Both are influenced by corticohypothalamic inputs.

28. Ans. b. Acts by increasing cAMP levels

(Ref: Ganong's Physiology 24th edn. pp 564, Fig. 33-9)

NO acts via cGMP.

29. Ans. a. cGMP

(Ref: Ganong's Physiology 24th edn. pp 564, Fig. 33-9)

30. Ans. d. Arginine

(Ref: Ganong's Physiology 24th edn. pp 564, Fig. 33-9)

"NO is synthesized from arginine in a reaction catalyzed by nitric oxide synthase (NO synthase, NOS)".

31. Ans. a. NO is synthesized from arginine

(Ref: Ganong's Physiology 24th edn. pp 564, Fig. 33-9)

32. Ans. c. Gastrointestinal smooth muscle relaxation

(Ref: Ganong's Physiology 24th edn. pp 472, GIT chapter)

33. Ans. a. Acts through cAMP

(Ref: Ganong's Physiology 24th edn. pp 564)

34. Ans. a. Endothelium

(Ref: Ganong's Physiology 24th edn. pp 564)

NO is synthesized from arginine in a reaction catalyzed by nitric oxide synthase (NO synthase, NOS). Three isoforms of NOS have been identified: NOS 1, found in the nervous system; NOS 2, found in macrophages and other immune cells; and NOS 3, found in endothelial cells.

35. Ans. a. Bronchodilation

(Ref: Ganong's Physiology 24th edn. pp 564)

36. Ans. d. Destruction of NTS

Destruction of NTS leads to loss of inhibition on RVLM. RVLM being a tonically active center, activates the sympathetic system in this situation.

37. Ans. d. Compression of the aorta and pulmonary circulation

□ **Point A:** Slight increase in BP due to compression of the aorta and pulmonary circulation.

□ **Point B:** Decrease in venous return and a decline in systolic blood pressure.

□ **Point C:** Decrease in systolic blood pressure by initial pooling of blood in the pulmonary vasculature.

□ **Point D:** Overshoot in systolic blood pressure resulting from increased cardiac output and vasoconstriction from sympathetic overactivity.

Detail explanation in 'Text'**38. Ans. d. A reflex increase in heart rate**

The data shown demonstrate the following:

ECG → increased heart rate

Aortic pressure → decreases

Cardiac output → no change

Therefore, based on our hemodynamic equation that applies to the systemic circuit:

$$\text{MAP} = \text{CO} \times \text{TPR}$$

The conclusion is that the decreased blood pressure must be caused by a decrease in TPR. Decrease BP reflexly increases heart rate.

CHAPTER

8

Vascular System and Regional Circulation

VASCULAR SYSTEM AND PRINCIPLES OF HEMODYNAMICS

- ❑ Endothelium is present in all vessels including heart chambers and surface of valves.
- ❑ Elastic tissue and smooth muscle are present in all vessels except venules and capillary.
- ❑ Outermost fibrous tissue is present in all vessels except capillary.
- ❑ Sympathetic adrenergic supply is present in all vessels except capillary, metarterioles and precapillary sphincter. Stimulation causes vasoconstriction of vein and artery.
- ❑ *Precapillary sphincters are controlled by oxygen concentration in tissue and local metabolites.*
- ❑ Parasympathetics are associated with blood vessels of certain organ such as salivary gland, GIT and genital erectile tissue. Ach causes vasodilation here.

Distribution of Blood

- ❑ Total cross-sectional area: is minimum for aorta and maximum for capillaries.
- ❑ Maximum % of blood volume in capacitance vessels and minimum % in arterioles.
- ❑ Velocity of blood flow is maximum in ascending aorta and minimum in capillary.
- ❑ Resistance is maximum at the level of arteriole. They control the distribution of blood flow to different organ.

I IMPORTANT

Central circulation	
Vessels	% of total blood
Pulmonary artery	3
Pulmonary capillary	4
Pulmonary vein	5
Chambers of heart	5 to 7
Peripheral circulation	
Aorta	2
Artery	8
Arterioles	1
Capillary	5
Venules	25
Vein	21
Vena cava	18

I IMPORTANT

Vena cava has lowest 'wall thickness to lumen' ratio.

Type of blood vessels	
Type	Features and example
Windkessel vessels	Aorta and major arteries. They have a lot of elastic tissue; show elastic recoil effect (Windkessel effect) is seen when stretched.
Resistance vessels	Arterioles. They have some elastic tissue and a lot of smooth muscle (have maximum wall thickness to lumen ratio)
Exchange vessels	Capillaries. No innervation. Controlled by precapillary sphincters
Capacitance vessels	Veins (venous system).
Shunt vessels	A-V anastomoses. They have thick muscular wall; very richly innervated. Sites- Fingertips, earlobes.

Capillaries

Small exchange vessels (6–10 μ) composed of highly attenuated (very thin) endothelial cells surrounded by basement membrane—no smooth muscle. Three types.

- Continuous:** *Most prevalent type of capillary in body.*
 - **With tight junction (TJ):** For example, brain and spinal cord, retina, enteric nervous system. *Brain capillary has least permeability.*
 - **With loose junction:** Skin, all muscle, lung, *intestinal mesentery, cortical bone, and adipose tissue.*
- Fenestrated:** 50–80 nm gaps. For example *intestinal mucosa, glomeruli and peritubular capillary of kidney, endocrine glands, exocrine gland, circumventricular organs, synovium, choroid plexus, connective tissue and nerve epineurium.*
- Sinusoidal (an extreme form of fenestrated capillary):** For example, liver, spleen, bone marrow. Liver has the maximum permeability among all.

Pericytes

These are associated with capillaries and some post-capillary venules. Capillary of retina, lung and skeletal muscle exhibits more pericytes than capillary in the endocrine gland like adrenal gland. They are similar to the mesangial cells in the renal glomeruli.

- They are contractile.
- They release vasoactive agents.

- ❑ They synthesize and release constituents of bone marrow and extracellular matrix.
- ❑ One of their functions is to regulate the flow through the junction between the endothelial cells, especially during inflammation.

BIOPHYSICAL PRINCIPLES

Blood flow through a blood vessel is determined by two factors:

1. Pressure difference of the blood between the two ends of the vessel, which is the force that pushes the blood through the vessel (Fig. 8.1).
2. Resistance to blood flow through the vessel

Applying Ohm's law ($V = IR$) in circulation: $F = P/R$

(Where, F = Blood flow, P = Effective perfusion pressure, R = Resistance to blood flow)

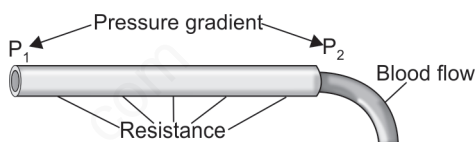

Fig. 8.1: Inter-relationships among pressure, resistance, and blood flow.

$$\text{Effective perfusion pressure (P)} = (P_1 - P_2)$$

In the above diagram, $F = (P_1 - P_2)/R$

- ❑ If P is expressed in mm Hg and flow is expressed in mL/sec, then resistance will be expressed in 'R' units.
- ❑ The overall blood flow in the total circulation of an adult person at rest is about 5000 mL/min. This is called the cardiac output because it is the amount of blood pumped into the aorta by the heart each minute.

- **Examples:** A 22-year-old man has a muscle blood flow of 250 mL/min. He has a mean arterial pressure of 130 mm Hg and a muscle venous pressure of 5 mm Hg. Calculate vascular resistance in the muscle of this man.

Answer: From above discussion;

- $R = (P_1 - P_2)/F = (130 - 5)/250 = 0.5 \text{ mm Hg/mL/min.}$

Calculation of resistance (R): Poiseuille-Hagen formula

$$R = \frac{8\eta L}{\pi r^4}$$

(Where R = Resistance, η = Viscosity, L = Length of the vessel and r = Radius)

- **Examples:** Calculate change of resistance in a vessel after 50% increase in vessel radius.

Answer:

- If original resistance = r
- After 50% increase, the final resistance would be = $(r + \frac{1}{2}r) = \frac{3}{2}r$

$$R \propto \frac{1}{\left(\frac{3}{2}r\right)^4} = \frac{1}{\frac{81}{16}r} = \frac{16}{81}r. \text{ So, R will decrease 5 times.}$$

Types of Blood Flow

- Blood flow is a volume measurement per unit time (mL per sec).
- Two types of blood flow: Laminar and turbulent

Laminar	Turbulent
Silent	Noisy
Parabolic velocity profile: flow is maximum in the center of the vessel and goes on decreasing towards the vessel wall.	No such gradient in flow rate from center towards periphery
More efficient (less energy consumption)	Less efficient

- Examples of turbulent flow: Korotkoff sound, murmur, arterial bruit.

Reynold's number: This number calculates the probability of turbulence.

$$Re = \rho DV/\eta$$

(Where Re = Reynold's number, ρ = Density of the fluid, D = Diameter of the vessel, V = Velocity of flow and η = Viscosity)

- *More the Reynold's number, more the chances of turbulence. Velocity is more important determinant of turbulence than diameter.*
- If D is measured in cm, V in cm/s, η in poises, then if Re is < 2000 there is usually no turbulence; if Re is > 3000, turbulence almost always there.

I IMPORTANT

Critical velocity: for every artery there is a velocity, above which flow will become turbulent. Laminar flow occurs till critical velocity.

Average velocity of flow: Velocity is inversely proportional to cross-sectional area.

$$V = Q/A$$

(Where V = Velocity, Q = Quantity/amount of fluid and A = Total cross-sectional area)

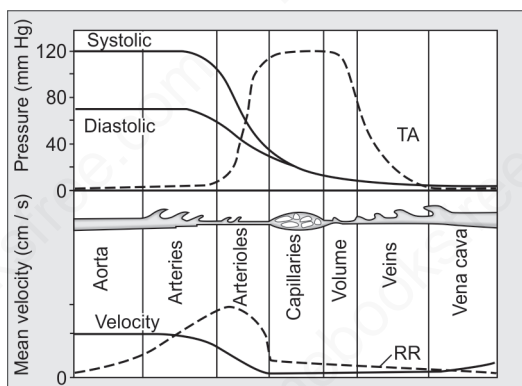

Fig. 8.2: Diagram of the changes in pressure and velocity as blood flows through the systemic circulation. TA, total cross-sectional area of the vessels, which increases from aorta to the capillaries. RR, relative resistance, which is highest in the arterioles

- ❑ So, if area is more, velocity is less. Therefore, velocity is maximum in aorta (30-35 cm/sec) with least cross-sectional area and minimum at the level of capillary (0.2-0.3 mm/sec) with maximum cross-sectional area.
- ❑ **Velocity: Aorta > Vena cava > Artery > Vein > Arterioles > Venule > Capillary (Fig. 8.2)**
- ❑ Blood pressure is maximum at the level of aorta, decreases minimum to vena cava.
- ❑ **Blood Pressure: Aorta > Artery > Arterioles > Capillary > Venule > Vein > Vena cava (Fig. 8.2)**
- ❑ Clinically, the velocity of the circulation can be measured by injecting a **bile salt** preparation into an arm vein and timing the first appearance of the bitter taste it produces. **The average normal arm-to-tongue circulation time is 15 sec.**
- ❑ Shear stress is applied by the blood against the vessel wall. The direction of the shear stress vector is determined by the direction of the blood flow velocity vector very close to the vessel wall. Shear stress is applied mainly to the inner layer of the arterial wall in contact with the blood, the vascular endothelium.
- ❑ Shear rate is velocity gradient, $v = du/dr$,

I IMPORTANT

Velocity and radius:

Velocity $\propto 1/A$

The cross-sectional area of a vessel (A) = $\pi \cdot r^2$

$V \propto 1/r^2$ at constant flow, e.g. If radius of a great vessel is increased by 2 times, velocity will decrease by $2^2 = 4$ times

I IMPORTANT

Viscosity and Plasma protein:

The most decisive factor among the determinants of the plasma viscosity is the shape of the protein molecules in solution.

The viscosity of a 2% fibrinogen solution is about the same as those of 25% albumin and 15% globulin solutions or that of whole blood.

So, Fibrinogen is most important plasma protein for blood viscosity.

Where u is the velocity and r is the radius, $v =$ shear rate

- ❑ Shear stress is maximum in arterioles > capillary and minimum in large vein > vena cava (Fig. 8.3).

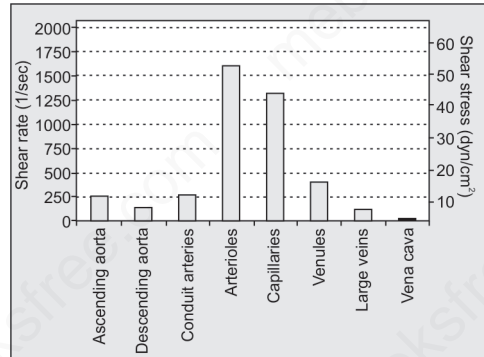

Fig. 8.3: Level of shear stress in different parts of vascular system

Law of Laplace

- ❑ Law of Laplace gives the relationship between distending pressure and tension.
- ❑ This law states that tension (T) in the wall of a cylinder is equal to the product of the transmural pressure (P) and the radius (r) divided by the wall thickness (w): $T = Pr/w$
- ❑ In a thin-walled viscus, the law is $P = 2T/r$ (Wall thickness is negligible)
- ❑ In a cylinder such as a blood vessel, one radius is infinite so, the law is $P = T/r$
- ❑ Application:
 - **Capillaries do not rupture, although they are thin walled:** Smaller the radius of a blood vessel, the lower the tension in the wall necessary to balance the distending pressure. So, less wall tension will be produced in capillary. For example, when the BP is normal, the tension in human aorta is about 170,000 dynes/cm, and in the vena cava it is about 21,000 dynes/cm; but in the capillaries, it is ~16 dynes/cm.
 - **Work done by dilated heart is more than non-dilated:** When the radius of a cardiac chamber is increased, a greater tension must be developed in the myocardium to produce any given pressure; consequently, a dilated heart must do more work than a nondilated heart.

Bernoulli's Principle

- ❑ If a cannula is inserted into an artery, the arterial pressure can be measured directly with a mercury manometer or a suitably calibrated strain gauge. When an artery is tied off beyond the point at which the cannula is inserted, an **end pressure** is recorded. This end pressure, therefore, measures **total energy (TE)**.
- ❑ If, alternatively, a T tube is inserted into a vessel and the pressure is measured in the side arm of the tube, a **side pressure or, lateral pressure** is recorded. This pressure would be the same as that experienced by the walls of the vessel. The lateral pressure measures the potential energy (PE).
- ❑ The difference between the end and side pressures in a flowing fluid is due to the kinetic component.
- ❑ The kinetic energy (KE) = $\frac{1}{2} mv^2$,
Where m = mass and v = velocity

Bernoulli's Principle: The total energy (TE) of blood flow in a blood vessel is the sum of its potential energy (PE) and its kinetic energy (KE). The total of potential and kinetic energy at any given point in a system is **constant**.

- ❑ Application: Any increase in one form of the energy has to come at the expense of the other. For example, as flow velocity increases, lateral pressure (PE) must decrease to keep the total energy of the system constant (Fig. 8.4).
- ❑ When a vessel is narrowed, the velocity of flow in the narrowed portion increases and the distending pressure decreases. Therefore, when a pathologic process such as an atherosclerotic plaque narrows a vessel, the lateral pressure at the constriction is decreased and the narrowing tends to maintain it.

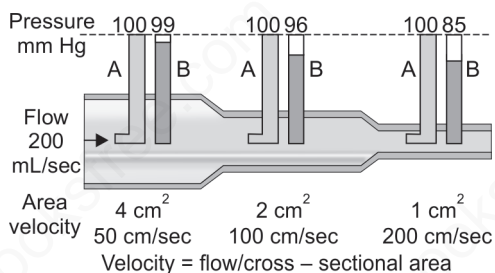

Fig. 8.4: Effect of flow velocity on lateral intravascular pressure. If any given flow of blood is forced through progressively smaller cross-sectional areas, the velocity of blood flow must increase. The Bernoulli principle states that increased flow velocity reduces the lateral pressure of the flow stream exerted against the wall of the vessel

I IMPORTANT

Coronary blood flow: Measurement is done by **Kety method**.

- ❖ Coronary flow at rest in humans is about 250 mL/min (5% of the cardiac output, 84 mL/100 gm/min).
- ❖ Blood flow in the left ventricle is about 80 mL/min/100 gm, which is twice the flow in the right ventricle and four times the flow in the atria.

CORONARY CIRCULATION

The major vessels of the coronary circulation are the left main coronary that divides into left anterior descending and circumflex branches, and the right main coronary artery. The left and right coronary arteries originate at the base of the aorta from openings called the coronary ostia located behind the aortic valve leaflets.

- ❑ So, pressure in coronary artery is equal to aortic pressure. And the pressure difference between aortic pressure and ventricular pressure = Coronary perfusion pressure, which determines the blood flow to ventricular myocardium.
- ❑ Coronary blood flow directly proportional to the perfusion pressure and perfusion time and inversely proportional to vascular resistance.

Pressure gradients and flow in the coronary vessels:

	Pressure (mm Hg) in			Pressure difference (mm Hg) between aorta and ventricle	
	Aorta	Left ventricle	Right ventricle	Left ventricle	Right ventricle
Systole	120	121	25	- 1	95
Diastole	80	0	0	80	80

Note: If pressure difference between aorta and ventricle is positive, blood flow occurs in myocardium.

From the above table, blood flow to myocardium via coronary artery occurs:

- ❑ **In left ventricle:** Only during diastole.
- ❑ **In right ventricle:** Both during systole and diastole and more during systole rather than diastole.

The following summarizes important features of coronary blood flow:

- ❑ **The major factor** in the regulation of coronary blood flow is by changes in the metabolic activity of the heart (local metabolites).
- ❑ In nondiseased coronary vessels, whenever cardiac activity and O_2 consumption increases, there is an increase in coronary blood flow (*active hyperemia*) that is nearly proportionate to the increase in O_2 consumption.
- ❑ **Autoregulation:** Between 60 and 200 mm Hg mean arterial pressure coronary blood flow remains constant.

I IMPORTANT

Maximum blood flow to myocardium:

- ❖ **In left ventricle:** Early diastole (Isovolumic relaxation phase)
- ❖ **In right ventricle:** During systole (ejection phase)

Because no blood flow occurs during systole in the subendocardial portion of the left ventricle, this region is prone to ischemic damage and is the most common site of myocardial infarction.

- ❑ **Adenosine (Metabolites)** is an important mediator of active hyperemia and autoregulation (coronary vasodilator). Other coronary vasodilator includes nitric oxide, CO_2 , H^+ , K^+ , lactate, prostaglandins.
- ❑ **Sympathetic:** Activation causes only transient vasoconstriction mediated by $\alpha 1$ -adrenoceptors. This brief (and small) vasoconstrictor response is followed by vasodilation caused by enhanced production of vasodilator metabolites (active hyperemia) due to increased mechanical and metabolic activity of the heart resulting from $\beta 1$ -adrenoceptor activation of the myocardium. Therefore, **sympathetic activation to the heart results in coronary vasodilation and increased coronary flow due to increased metabolic activity** (increased heart rate, contractility) despite direct vasoconstrictor effects of sympathetic activation on the coronaries. This is termed “functional sympatholysis”.
- ❑ **Parasympathetic:** Stimulation (i.e., vagal nerve activation) elicits **modest coronary vasodilation** (due to the direct effects of released acetylcholine on the coronaries). However, if parasympathetic activation of the heart results in a significant decrease in myocardial oxygen demand due to a reduction in heart rate, then intrinsic metabolic mechanisms will increase coronary vascular resistance by constricting the vessels and coronary blood flow decreases.

Determinant of Myocardial O_2 Consumption

Myocyte contraction is the primary factor determining myocardial oxygen consumption (MVO_2) above basal levels.

Therefore, any factors that *enhance tension development by the cardiac muscle cells or, the rate of tension development, or the number of tension generating cycles per unit time will increase MVO_2 .*

So, Factors increasing MVO_2

- **Increase heart rate.**
- **Increasing contractility.**
- **Increasing afterload.**
- **Increasing preload**-increase in MVO_2 is much less than what might be expected in this case because of the Laplace relationship.

I IMPORTANT

Oxygen consumption:

- ❖ O_2 consumption of normal beating heart is 9.7 mL/min/100 g
- ❖ O_2 consumption in arrested heart (no beat) is 2 mL/min/100 g
- ❖ Myocardium has highest A-V (arterio-venous) O_2 difference of among all organs (10-13 mL/100 mL).

I IMPORTANT

- ❖ Stroke work of left ventricle is greater than right ventricle because of high afterload in left ventricle.
- ❖ Although increase external work, increases O_2 consumption, the relationship between these two are not constant.

Energy Expenditure by the Heart

- ❑ Basal metabolism (energy consumed in cellular processes other than contraction): 25% of myocardial ATP use
- ❑ Muscle contraction: 75% of myocardial energy use.
 - Isovolumetric contraction (~50%)
 - Ejection phase (25%)
- ❑ The high energy needed for isovolumetric contraction is mainly due to the cardiac afterload, although external work done during this period is zero. So, *cardiac afterload is a major determinant of myocardial oxygen consumption.*
- ❑ During ejection phase of the cardiac, heart actually performs external work and the energy the heart expends during ejection depends on how much **external work** it is doing. In a fluid system, work done = Pressure \times volume.
- ❑ The external physical work done by the left ventricle in one beat, that is, the **Stroke Work** = Afterload (pressure) \times SV (volume) = (93 mm Hg \times 90 mL)
- ❑ Stroke work in right ventricle = Afterload \times SV = (15 mm Hg \times 90 mL)

CEREBRAL CIRCULATION**Role of Intracranial Pressure: Monro-Kellie Doctrine**

The cranial cavity normally contains a brain weighing ~1400 g, 75 mL of blood, and 75 mL of spinal fluid. Monro-Kellie doctrine, or hypothesis is that the sum of volumes of brain, CSF, and intracranial blood is constant. An increase in one should cause a decrease in one or both of the remaining two. That means, the cerebral vessels are compressed whenever the intracranial pressure rises. Any change in venous pressure promptly causes a similar change in intracranial pressure.

Autoregulation

- ❑ Autoregulation is prominent in the brain. Blood flow remains constant at mean arterial pressures of 65–140 mm Hg.
- ❑ As in the coronary circulation, cerebral vessels are predominantly under the control of metabolic activity of brain.
- ❑ **CO₂ is major controller** of cerebral blood flow.

I IMPORTANT**Cerebral blood flow in adults:**

Measurement is done by Kety method.

- ❖ The average adult brain weighs about 1400 gm.
- ❖ The blood flow for the whole brain is about 750 mL/min (14% of CO and 54 mL/100 gm/min)
- ❖ Blood flow in gray matter is 69 mL/100 g/min compared with 28 mL/100 g/min in white matter.
- ❖ In subjects who are awake but at rest, blood flow is greatest in the premotor and frontal regions.

- ❑ CO₂ is a potent cerebral vasodilator. Over the range of arterial CO₂ pressures, which can be tolerated by normal subjects (20-80 mm Hg) there, is a roughly linear relation between cerebral blood flow and PaCO₂ (i.e. halving PaCO₂ from 40 to 20 mm Hg halves blood flow and raising PaCO₂ from 40 to 80 mm Hg doubles it. Beyond these limits responses to changes in CO₂ pressures are less marked.
- ❑ Other candidates for cerebral vasodilation include H⁺, K⁺, and adenosine.
- ❑ **Sympathetic stimulation:** The constant-flow, or plateau part of the pressure-flow curve is extended to the right (Fig. 8.5); that is, greater increases in pressure can occur without an increase in flow.
- ❑ Vasodilator hydralazine and the angiotensin-converting enzyme (ACE) inhibitor reduce the length of the plateau.
- ❑ **Parasympathetic stimulation:** Exerts a very weak vasodilatory response in the brain.

CUTANEOUS CIRCULATION

- ❑ The skin has one of the lowest metabolic rates in the body and requires relatively little blood flow for purely nutritive functions.
- ❑ Has extensive sympathetic innervation.
- ❑ Parasympathetic vasodilator system is not present in skin.
- ❑ Nervous regulation is the major controller of blood flow to skin.
- ❑ **Temperature regulation** is the principal function of the cutaneous sympathetic nerves.
- ❑ Sympathetic neural control of skin blood flow includes the noradrenergic vasoconstrictor system and a sympathetic active vasodilator system (cholinergic), the latter of which is responsible for 80% to 90% of the substantial cutaneous vasodilation that occurs with whole body heat stress.

SKELETAL MUSCLE CIRCULATION

- ❑ Controlled by the extrinsic sympathetic innervation of blood vessels in skeletal muscle and by local metabolic factors.
- ❑ **Sympathetic innervation:** Is the primary regulator of blood flow to the skeletal muscle at rest.

I IMPORTANT

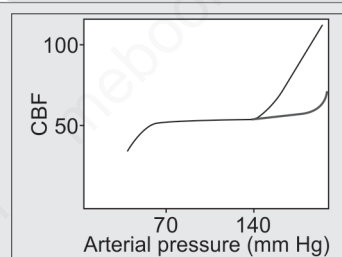

Fig. 8.5: Autoregulation of cerebral blood flow (CBF) during steady-state conditions. Alteration produced by sympathetic stimulation during autoregulation is shown by right shift of the plateau line

I IMPORTANT

- ❖ O₂ consumption by the human brain averages about 3.5 mL/min per 100 g.
- ❖ Neurons are more sensitive to hypoxia followed by oligodendrocyte, astrocyte and endothelium.
- ❖ **Most sensitive** neurons in adult are pyramidal cell of CA1 region of hippocampus (Sommer's sector), Purkinje cell of cerebellum and striatal neurons.
- ❖ **Most resistant** to hypoxic damage are brain stem and spinal cord.
- ❖ Grey matters are more sensitive to injury due to its high metabolic requirement for oxygen and glucose to supply a large number of synapses.
- ❖ Irreversible damage occurs, if there is no O₂ supply for > 5 min.

Ref: Neuropathology by Richard A Prayson and Textbook of Pharmacology by Seth.

I IMPORTANT

- ❖ **Active hyperemia:** Blood flow to an organ is proportional to its metabolic activity. For example, if metabolic activity in skeletal muscle increases as a result of strenuous exercise, blood flow to the muscle will increase proportionately to meet metabolic demands.
- ❖ **Reactive hyperemia:** Is an increase in blood flow to an organ that occurs after a period of occlusion of flow. The longer the period of occlusion is, the greater the increase in blood flow is above preocclusion levels.
- ❖ **Autoregulation:** Constant blood flow to an organ over a wide range of perfusion pressures.

- ❑ **Local Metabolic control:** Blood flow in skeletal muscle exhibits autoregulation and *active and reactive hyperemia*. Demand for O_2 in skeletal muscle varies with metabolic activity level, and blood flow is regulated to meet demand.

PULMONARY CIRCULATION

- ❑ Pulmonary circulation is a low-pressure, low-resistant, high compliance vascular bed.

Pressure in Pulmonary Circulation

- ❑ Pulmonary artery pressure is 25 mm Hg systolic and 10 mm Hg diastolic. Mean pressure is 15 mm Hg.
- ❑ Perfusion pressure (mean pressure–left atrial pressure) is 7 mm Hg (assuming left atrial pressure = 8 mm Hg). Whereas perfusion pressure for systemic circulation is 90 mm Hg.
- ❑ Because the flow is same ($CO = 5 \text{ L/min}$) for both systemic and pulmonary circulation but perfusion pressure is much lower in pulmonary circulation indicates, pulmonary vascular resistance is lower than systemic.

Pulmonary Vascular Resistance (PVR)

- ❑ PVR is 1/10th of systemic vascular resistance (SVR).
- ❑ Lower PVR is due to *large diameter, short length and more parallel elements in pulmonary circulation* than systemic circulation.
- ❑ In systemic circulation arterioles are the major site of SVR but all vessels contributes equally to PVR (1/3rd pulmonary artery, 1/3rd capillary, 1/3rd pulmonary veins).
- ❑ Effect of gravity has significant effect on PVR but very little role in SVR.
- ❑ PVR decreases in gravity dependent portion of lung because of hydrostatic effect of blood.
- ❑ PVR is lowest at FRC. Increase or, decrease in lung volume from FRC causes increase in PVR.

Compliance of Pulmonary Vessels

- ❑ Pulmonary vessels are **more compliant** than systemic because, increase pressure in pulmonary artery cause recruitment of more capillary and passive distension of vessels.

- ❑ Because of this there is less rise in pressure in pulmonary vascular bed during exercise (high CO).
- ❑ In the lungs, hypoxia causes vasoconstriction. This response is the opposite of that in other organs, where hypoxia causes vasodilation.

Distribution of Pulmonary Blood Flow (Fig. 8.6)

- ❑ When a person is supine, blood flow is nearly uniform throughout the lung.
- ❑ When a person is standing, blood flow is unevenly distributed because of the effect of gravity.
- ❑ Blood flow is lowest at the apex of the lung (zone 1) and highest at the base of the lung (zone 3).

Zone 1: Blood Flow is Lowest

- ❑ Alveolar pressure (P_A) > Arterial pressure (P_a) > Venous pressure (P_v).
- ❑ Blood flow does not occur throughout the cardiac cycle. So, alveoli become alveolar dead space.
- ❑ Zone 1 normally not present in lungs. But it can be created during positive pressure ventilation.

Zone 2: Blood Flow is Medium

- ❑ Arterial pressure > alveolar pressure > venous pressure.
- ❑ Intermittent blood flow occurs during systole.
- ❑ Flow here is sometimes compared to a waterfall effect.
- ❑ This zone in the lungs is generally situated 3 cm above heart.

Zone 3: Blood Flow is Highest

- ❑ Arterial pressure > venous pressure > alveolar pressure. Continuous blood flow occurs both during systole and diastole.
- ❑ In zone 3, blood flow is driven by the difference between arterial and venous pressures, as in most vascular beds.

Zone 4: Similar to Zone 3

- ❑ Arterial pressure >>> venous pressure > alveolar pressure.
- ❑ These conditions prevail at the extreme base of the lungs. In zone 4, the alveolar vessels behave as in zone 3.

I IMPORTANT

- ❖ **Autoregulation** is strong in **Heart** (60 and 200 mm Hg) >> **Brain** (65-140 mm Hg), and **Kidney** (75-160 mm Hg).
- ❖ GIT and skeletal muscle show moderate autoregulation. Skin has very little autoregulation.
- ❖ Lung has no autoregulation.

I IMPORTANT

- ❖ *Autoregulation is not seen in pulmonary circulation.* Blood flow through pulmonary circulation depends on right ventricular output. Instead of autoregulating blood flow, pulmonary circulation autoregulates Pulmonary Artery Pressure.

These lung zones are physiological, not anatomical. The boundaries between the zones are neither fixed nor sharp. For example, the boundaries can move downward with positive-pressure ventilation (which increases alveolar pressure) and upward with exercise (which increases pulmonary artery pressure).

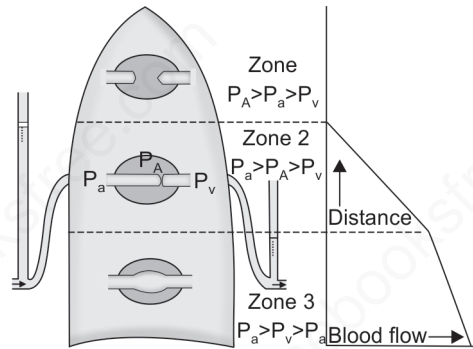

Fig. 8.6: The zones of the lung. The effects of gravity and alveolar pressure on the perfusion of the lung

MULTIPLE CHOICE QUESTIONS

PRINCIPLES OF HEMODYNAMICS AND VASCULAR SYSTEM

RECENT MCQs

1. Windkessel effect is seen in:

- a. Large elastic vessels
- b. Capacitance vessels
- c. Through fare channels
- d. Capillaries

2. Maximum reservoir of blood:

- | | |
|---------------|----------------|
| a. Large vein | b. Aorta |
| c. Heart | d. Capillaries |

3. Arterioles true:

- | | |
|---------------|-------------|
| a. Resistance | b. Exchange |
| c. Reservoir | d. Pressure |

4. Highest compliance is seen in which vessel?

- | | |
|-------------|----------------|
| a. Arteries | b. Veins |
| c. Aorta | d. Capillaries |

5. Bernoulli's principle states: [TN 03]

- a. Sum of kinetic energy of flow and pressure energy is constant
- b. Low tones producing maximal stimulation at apex of cochlea
- c. Magnitude of the sensation felt is proportionate to the intensity of stimulus
- d. Force of contraction is proportional to the stretch of cardiac muscle

6. Laplace's law, all except:

[MHCET 10, PGM CET 07]

- a. $P = T/r$
- b. $P = 2T/r$
- c. $T = Pr/w$
- d. $T = WP/r$

7. Blood flow through a vessel varies directly with: [Kerla 01]

- a. Resistance
- b. Viscosity
- c. Pressure of difference
- d. Length of vessel

8. Laminar flow is dependent on:

[TN03]

- a. Critical velocity
- b. Viscosity
- c. Constant velocity
- d. Critical closing pressure

AIIMS/PGI/JIPMER

9. In a study to measure BP, two students Rakesh and Arif conduct a study on a dog. Rakesh measures BP using a mercury sphygmomanometer on the right femoral artery and Arif measures using a pressure transducer and pulse tracing on the left femoral artery. The mean arterial pressure for both Rakesh and Arif is the same, i.e. 100 mm Hg. After 5 minutes of injection of adrenaline, Rakesh measures blood pressure 130 mm Hg and Arif as 120 mm Hg. The difference of 10 mm Hg is explained by:

- a. Falsely high values at low pressure in pulse tracing [AIIMS May 02]
- b. Falsely low values at high pressure in pulse tracings
- c. Femoral artery is more sensitive to adrenaline on right side
- d. Ventricular filling affects diastole period

10. Which of the following increases turbulence in blood flow?

[AIIMS Nov 06]

- Reynolds number less than 2000
- Decreases in velocity of blood
- Decrease in density of blood
- Increase in diameter of blood vessel

11. Flow is laminar in small vessels because:

[AI 11]

- Reynolds number is >2000
- Total cross-sectional area of small vessels is smaller
- Diameter of smaller vessels is less
- Effective velocity in small vessels is less

12. Main site of peripheral vascular resistance is:

[JIPMER 04]

- Precapillary arterioles
- Precapillary sphincters
- Capillaries
- Windkessel vessels

13. The velocity of blood is maximum in the:

[AIIMS May 05]

- Large veins
- Small veins
- Venules
- Capillaries

14. Maximum difference of BP occurs between:

[PGI Dec 07]

- Descending aorta and common iliac artery
- Femoral artery and femoral vein
- Arterial end and venous end
- Capillaries and venules
- Venules and vein

15. Distribution of blood flow is mainly regulated by the:

[AI 05]

- Arteries
- Arterioles
- Capillaries
- Venules

16. Which of the following is not correct regarding capillaries?

[AI 01]

- Greatest cross-sectional area
- Contain 25% of blood
- Contains less blood than veins
- Have single layer of cells bounding the lumen

17. Which of the following statements is true about capillaries?

[AI 00]

- Contains 5% of total blood volume
- Contain 10% of total blood volume
- Velocity of blood flow is maximum
- Offer maximum resistance to blood flow

18. Precapillary sphincter relaxation is caused by:

[AIIMS 98]

- Local metabolites
- Circulating catecholamines
- Sympathetic activity
- Fall in capillary pressure

19. Which of the following favors filtration at the arteriolar end of the capillary bed?

[AIIMS Nov 06]

- Decrease in hydrostatic pressure of capillaries
- Increase in hydrostatic pressure of capillaries
- Increase in oncotic pressure of capillaries
- Decrease in oncotic pressure of interstitium

20. Which of the following statements regarding the flow of lymph from lower limb is true?

[AI 08]

- Increased with change from supine to standing position
- Decreased in increased capillary permeability
- Decreased in deep vein valve incompetence
- Increased by massage of foot

CORONARY CIRCULATION

RECENT MCQs

21. Amount of coronary flow per minute is:

- a. 225 mL b. 250 mL
c. 50 mL d. 300 mL

22. Coronary blood flow, true is:

- a. 500 mL/min
b. Maximum during systole
c. Adenosine decreases it
d. More than skin

23. Regulation of coronary circulation is:

- a. Autonomic
b. Autoregulatory
c. Hormonal
d. Sympathetic

24. Major portion of coronary blood flow occurs during:

- a. Systole
b. Diastole
c. Not related to phases
d. It is variable

25. Amount of blood in heart:

- a. 250-300 ml
b. 500-600 ml
c. 1-2 litre
d. 100-200 ml

26. In fetal circulation pulmonary vascular resistance is more than systemic vascular resistance. At which stage it becomes normal to adult level?

- a. 4-10 weeks b. 3-7 weeks
c. 10-14 weeks d. 20-22 weeks

27. Myocardial contractility is increased by:

- a. Atropine
b. Decreased end diastolic volume

- c. Increased heart rate from 70 to 150 beats/min
d. Reduced arterial pH to 7.3

28. Critical closing pressure is:

- a. Arterial pressure minus venous pressure
b. Capillary pressure minus venous pressure
c. Pressure below which capillaries close
d. None of the above

29. Microcirculation consists of:

- a. Capillaries
b. Capillaries venules and arterioles
c. Aorta
d. Arteries and veins

AIIMS/PGI/JIPMER

30. Which one of the following is the correct statement regarding coronary food flow? *[AIIMS May 06]*

- a. Coronary blood flow is directly related to perfusion pressure and inversely related to resistance
b. Coronary blood flow is inversely related to perfusion pressure and inversely related to resistance
c. Coronary blood flow is directly related to perfusion pressure and also to resistance
d. Coronary blood flow is inversely related to both pressure and resistance

31. Myocardial oxygen demand depend upon: *[PGI Nov 09]*

- a. Preload
b. Afterload
c. Intramyocardial tension
d. Blood Hb concentration

32. True about cardiac O₂ demand is:*[AIIMS Nov 07]*

- a. Directly proportional to mean arterial pressure
- b. Inversely proportional to heart rate
- c. Inversely proportional to cardiac work
- d. Has a constant relation to the external work done by the heart

33. True regarding myocardial O₂ demand:*[AIIMS May 11]*

- a. Inversely related to heart rate
- b. Has constant relation to external cardiac work

- c. Directly proportional to duration of systole
- d. Is negligible at rest

34. Which of the following statements about myocardial oxygen demand is true?*[AI 09]*

- a. Correlates with heart rate
- b. Is directly proportional to external cardiac work
- c. Is negligible when heart is at rest
- d. Depends upon duration of systole

CEREBRAL CIRCULATION**RECENT MCQs****35. Perfusion pressure is:**

- a. Arterial pressure
- b. Venous pressure
- c. Arterial-venous pressure difference
- d. Pressure in left ventricle

36. Brain blood supply:

- a. 55 mL/100 gm/min
- b. 400 mL/100 gm/min
- c. 100 mL/100 gm/min
- d. 200 mL/100 gm/min

AIIMS/PGI/JIPMER**37. Cerebral blood flow is regulated by all except:***[AIIMS May 08, 07]*

- a. Blood pressure
- b. Arterial pCO₂
- c. Potassium ions
- d. Cerebral metabolic rate

38. For cerebral blood flow to be doubled, pCO₂ should be:*[PGI 95]*

- a. 40 mm Hg
- b. 80 mm Hg
- c. 100 mg Hg
- d. 200 mg Hg

39. Increased BP and decreased heart rate is seen in:

- a. Hemorrhage
- b. High altitude
- c. Raised intracranial pressure
- d. Anemia

40. Increase in intracranial pressure is not associated with:*[AIIMS Nov 00]*

- a. Deterioration of consciousness
- b. Tachycardia
- c. Respiratory depression
- d. Increase in BP

PULMONARY CIRCULATION

AIIMS/PGI/JIPMER

41. Pulmonary circulation differs from systemic circulation:

[AIIMS May 08, 06]

- Pulmonary vasodilation in hypoxia
- Pulmonary vasoconstriction in hypoxia
- Decreased blood volume during systole
- Increased basal vasoconstrictor tone

42. True regarding vascularity of lung is:

[AIIMS May 02]

- Hypoxia causes vasodilation
- Pulmonary resistance is half of the systemic vascular resistance
- Perfusion is more in the apical lobe than in base
- Distended pulmonary veins in the lower lobe

43. During heavy exercise the cardiac output (CO) increases up to five-fold while pulmonary arterial pressure rises very little. This physiological ability of the pulmonary circulation is best explained by:

[AI 10]

- Increase in the number of open capillaries
- Sympathetically mediated greater distensibility of pulmonary vessels
- Large amount of smooth muscle in pulmonary arterioles
- Smaller surface area of pulmonary circulation

44. All of the following statements about bronchial circulation are true, except:

[AI 10]

- Contribute 2% of systemic circulation
- Contribute to gaseous exchange
- Cause venous admixing of blood
- Provide nutritive function to lung

MISCELLANEOUS

45. Blood in splanchnic area during exercise is decreased due to:

[AI 97]

- Venoconstriction with decreased blood flow
- Venodilation with decreased blood flow
- Venodilation with increased blood flow
- Venodilation with normal blood flow

46. True about blood flow in various organs:

[PGI June 99]

- Liver > Kidney > Brain > Heart
- Liver > Brain > Kidney > Heart
- Kidney > Brain > Heart > Liver
- Liver > Heart > Brain > Kidney

47. Kidney receives about % of cardiac output:

[JIPMER 11]

- 5%
- 10%
- 15%
- 20%

48. True about shunt vessels:

[AIIMS May 11, AI 09]

- Evenly distributed throughout the skin
- Role in nutrition
- Play a role in thermoregulation
- No autonomic nervous regulation

49. The local control in blood flow is seen in A/E:

[AIIMS Nov 99]

- Skin
- Muscle
- Splanchnic vessels
- Cerebrum

50. The vasodilatation produced by carbon dioxide is maximum in one of the following:

[AI 05]

- Kidney
- Brain
- Liver
- Heart

FUTURE TRENDS

51. A 60-year-old man has a mean arterial blood pressure of 130 mm Hg, a heart rate of 78 beats/min, a right atrial pressure of 0 mm Hg, and a cardiac output of 3.5 L/min. He also has a pulse pressure of 35 mm Hg and a hematocrit of 40. What is the approximate total peripheral resistance in this man?
- 17 mm Hg/L/min
 - 1.3 mm Hg/L/min
 - 27 mm Hg/L/min
 - 37 mm Hg/L/min

52. At which point in the following diagram of an aortic pressure wave is coronary blood flow the greatest?

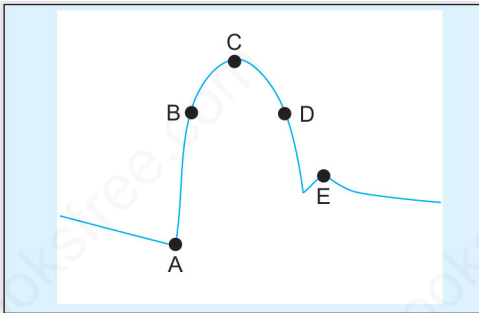

- B
- C
- D
- E

53. The following diagram illustrates the relative resistance of three vessels. The ratio of the flow in vessel X to the flow in vessel Y is:

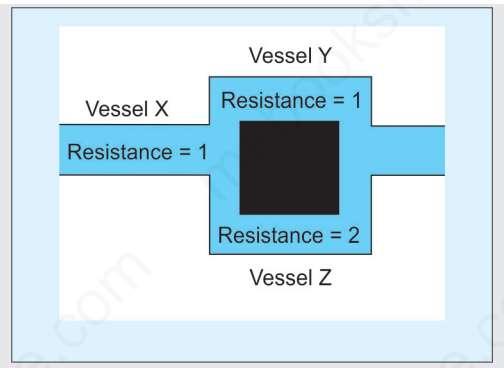

- 1:1
- 3:2
- 2:1
- 3:1

ANSWERS WITH EXPLANATIONS

1. Ans. a. Large elastic vessels

(Ref. Berne & Levy Physiology, 6th Updated Edn-Bruce M Koeppen pp 336)

2. Ans. a. Large vein

(Ref. Berne & Levy Physiology, 6th Updated Edn-Bruce M Koeppen pp 291)

Venous system contains ~67% of total blood volume.

3. Ans. a. Resistance

(Ref. Ganong's Physiology 24th edn. pp 543)

"The small arteries and arterioles are referred to as resistance vessels because they are the principal site of the peripheral resistance."

4. Ans. b. Veins

(Ref. Ganong's Physiology 24th edn. pp 543)

"A large amount of blood can be added to the venous system before the veins become distended to the point where further increments in volume produce a large rise in venous pressure. The veins are therefore called capacitance vessels."

5. Ans. a. Sum of kinetic energy of flow and pressure energy is constant

(Ref. Ganong's Physiology 24th edn. pp 545)

"In a tube or a blood vessel the total energy—the sum of the kinetic energy of flow and the potential energy is constant (Bernoulli's principle)."

6. Ans. d. $T = WP/r$

(Ref. Ganong's Physiology 24th edn. pp 542)

Tension in the wall of a cylinder (T) is equal to the product of the transmural pressure (P) and the radius (r) divided by the wall thickness (w): $[T = Pr/w]$

In a sphere: $P = 2T/r$

In a cylinder like blood vessel (where r is infinite): $P = T/r$

7. Ans. c. Pressure of difference

(Ref. Ganong's Physiology 24th edn. pp 541)

Blood flow follows Ohm's law $[V = IR]$, V = pressure difference between two end of vessels, I = blood flow, R = resistance. So, I is directly proportional to V (pressure difference).

8. Ans. a. Critical velocity

(Ref. Ganong's Physiology 24th edn. pp 540)

"Laminar flow occurs at velocities up to a certain critical velocity. At or above this velocity, flow is turbulent."

9. Ans. a. Falsely high values at low pressure in pulse tracing

(Ref. Clinical Anesthesia, 7th edn. by Paul Barash, Bruce F. Cullen et al. pp 708)

"Pressure transducer system tends to overestimate systolic blood pressure by 15-30 mm Hg." So, the recording obtained by pressure transducer system is more (falsely high) of around 10 mm Hg in this case.

10. Ans. d. Increase in diameter of blood vessel

(Ref. Ganong's Physiology 24th edn. pp 540)

When Re is more than 3000, turbulence is almost always present. The probability of turbulence is also related to the diameter of the vessel (directly proportional), density of blood (directly proportional) and the viscosity of the blood (inversely proportional).

11. Ans. d. Effective velocity in small vessels is less >>c. Diameter of smaller vessels is less

(Ref. Ganong's Physiology 24th edn. pp 540)

Both are the cause of laminar flow in small vessels. But velocity is more important parameter.

12. Ans. a. Precapillary arterioles.

See Q. 3.

13. Ans. a. Large veins

(Ref. Ganong's Physiology 24th edn. pp 540)

"The average velocity of fluid movement at any point in a system of tubes in parallel is inversely proportional to the total cross-sectional area at that point. The average velocity of blood flow increases again as the blood enters the veins and is relatively high in the vena cava, although not so high as in the aorta."

14. Ans. b. Femoral artery and femoral vein

(Ref. Ganong's Physiology 24th edn. pp 544)

Blood pressure in decreasing order: Aorta > artery > arterioles > capillary > venules > vein > vena cava.

15. Ans. b. Arterioles

(Ref. Ganong's Physiology 24th edn. pp 543)

The small arteries and arterioles are referred to as resistance vessels. Regulation of resistance by autonomic nervous system regulates the distribution of blood in different organs.

16. Ans. b. Contain 25% of blood

(Ref: Berne & Levy Physiology, 6th Updated Edn- Bruce M Koeppen pp 291)

Capillary contains 5% of total blood volume, veins contain ~21% of total blood volume.

17. Ans. a. Contains 5% of total blood volume

See Q. 16 (above).

18. Ans. a. Local metabolites

(Ref: Guyton-Physiology-13th edn. pp 192)

There is no autonomic supply to precapillary sphincters but control of these sphincters is done by **oxygen concentration** in tissue and **local metabolites**.

19. Ans. b. Increase in hydrostatic pressure of capillaries

(Ref. Ganong's Physiology 24th edn. pp 548)

Fluid moves into the interstitial space at the arteriolar end of the capillary and into the capillary at the venular end. An increase in intracapillary hydrostatic pressure favors movement of fluid from the vessel interior to the interstitial space, whereas an increase in the concentration of osmotically active particles within vessels favors movement of fluid into the vessels from the interstitial space.

20. Ans. a. Increased with change from supine to standing position

(Ref. Ganong's Physiology 24th edn. pp 551)

21. Ans. b. 250 mL

(Ref. Ganong's Physiology 24th edn. pp 579)

Coronary flow at rest in humans is about 250 mL/min (5% of the cardiac output).

22. Ans. None. Single best Ans. b. Maximum during systole

(Ganong's Physiology 24th edn. pp 579)

Although maximum blood flow occurs during diastole in left ventricle, in right ventricle it is maximum during systole.

23. Ans. b. Autoregulatory

(Ref. Ganong's Physiology 24th edn. pp 579)

All options are regulator of coronary circulation but the most important one is autoregulation.

24. Ans. b. Diastole

(Ref: Ganong's Review of Physiology 25th, pp 611)

25. Ans. a. 250-300 ml

(Ref: Berne & Levy Physiology, 6th edn. Bruce M Koeppen. pp 291)

It is 5 to 7% of total cardiac output (250 to 350 ml). Here we have to consider both ventricles. (So, EDV = 130/ventricle. Both ventricles will have 260 ml average).

26. Ans. a. 4-10 weeks

(Ref: *Pediatrics Cardiology by W. Johnson & J Moller pp. 136 and Pathophysiology the Biological Basis for Disease in Adults and Children by KL McCance*)

By 2 months of age, pulmonary resistance may approximate adult levels.

"Immediately after birth, the lungs expand with air, dropping the pulmonary vascular resistance; and as the placenta is disconnected from the systemic circuit, the systemic resistance nearly doubles. The pulmonary arterioles continue to change gradually. The media becomes thinner and the lumen becomes wider. Thus, the pulmonary vascular resistance falls, almost reaching adult levels by the time the child is close to 8 weeks of age."

27. Ans. c. Increased heart rate from 70 to 150 beats/min

(Ref: *Best & Taylor's Physiological Basis of Medical Practice, 13th edn. pp 205*)

Option A: Atropine is a muscarinic receptor antagonist that is used to inhibit the effects of excessive vagal activation on the heart, which is manifested as sinus bradycardia and AV nodal block. Effect on contractility is negligible.

Option B: Decrease EDV decreases contractility by Frank Starling law.

Option D: Acidosis, hypercapnoea and hypoxia inhibit myocardium contractility.

Option C: This effect is known as Bowditch Effect (Myocardial tension increases with an increase in heart rate).

28. Ans. c. Pressure below, which capillaries close

(Ref: *Ganong's Review of Physiology 25th, pp 611*)

The pressure at which flow ceases in a vessel is called the critical closing pressure. When the pressure in a small blood vessel

is reduced, a point is reached at which no blood flows, even though the pressure is not zero. This occurs because of the pressure exerted by the tissues surrounding the vessel is more than intraluminal pressure.

29. Ans. b. Capillaries venules and arterioles

(Ref: *Cardiovascular Physiology Concepts, 2nd edn.*)

The microcirculation is comprised of arterioles, capillaries, venules, and terminal lymphatic vessels.

30. Answer a. Coronary blood flow is directly related to perfusion pressure and inversely related to resistance

(Ref: *Ganong's Physiology 24th edn. pp 579*)

Blood flow to coronary vessels also follows the general rule [Ohm's law].

31. Ans. a. Preload, b. Afterload, c. Intra-myocardial tension

(Ref: *Medical Physiology A Systems Approach by Raff*)

Hb concentration determines the O₂ supply to myocardium not myocardial O₂ demand.

32. Ans. a. Directly proportional to mean arterial pressure

(Ref: *Medical Physiology A Systems Approach by Raff*)

O₂ consumption increases with increase external work done but the relation is not constant.

33. Ans. c. Directly proportional to duration of systole

(Ref: *Medical Physiology A Systems Approach by Raff*)

Duration of systole increases the myocardial wall tension (tension time index). So, O₂ consumption will be high.

34. Ans. a. Correlates with heart rate >> d. Depends upon duration of systole

(Ref. *Medical Physiology A Systems Approach* by Raff)

35. Ans. c. Arterial-venous pressure difference

(Ref. *Ganong's Physiology 24th edn.* pp 570)

36. Ans. a. 55 mL/100 gm/min

(Ref. *Ganong's Physiology 24th edn.* pp 570, Table)

37. Ans. a. Blood pressure

(Ref. *Ganong's Physiology 24th edn.* pp 573)

Because of strong autoregulation, BP within a limit can't change cerebral blood flow.

38. Ans. b. 80 mm Hg

(Ref. *The Principles and Practice of Human Physiology* by OG Edhoim and *Textbook of Anesthesia for Postgraduates* by TK Agasti. pp 228)

CO₂ is a potent cerebral vasodilator. Over the range of arterial CO₂ pressures, which can be tolerated by normal subjects (20-80 mm Hg) there, is a roughly linear relation between cerebral blood flow and PaCO₂ (i.e. halving PaCO₂ from 40 to 20 mm Hg halves blood flow and raising PaCO₂ from 40 to 80 mm Hg doubles it. Beyond these limits responses to changes in CO₂ pressures are less marked.

39. Ans. c. Raised intracranial pressure

(Ref. *Ganong's Physiology 24th edn.* pp 562)

This is due to Cushing reflex. (Read Chapter 7).

40. Ans. b. Tachycardia

(Ref. *Ganong's Physiology 24th edn.* pp 562)

Reflex bradycardia occurs due to Cushing reflex activation.

41. Ans. b. Pulmonary vasoconstriction in hypoxia

(Ref. *Medical Physiology A Systems Approach* by Raff pp 343)

42. Ans. d. Distended pulmonary veins in the lower lobe

(Ref. *Medical Physiology A Systems Approach* by Raff pp 343)

Pulmonary resistance is about 1/10th of systemic resistance. Blood flow is more in base of the lung, so veins are more distended.

43. Ans. a. Increase in the number of open capillaries

(Ref. *Medical Physiology A Systems Approach* by Raff pp 344)

During exercise, high CO flows through pulmonary vessels. But due to recruitment of more capillary and dilatation of pulmonary capillary (high compliance), resistance does not change significantly.

44. Ans. b. Contribute to gaseous exchange

(Ref. *Ganong's Physiology 24th edn.* pp 592)

Pulmonary circulation is responsible for gas exchange (Not bronchial circulation).

45. Ans. a. Venospasm with decreased blood flow

(Ref. *Ganong's Physiology 24th edn.* pp 746)

During exercise venospasm in splanchnic vessels divert the blood from splanchnic to skeletal muscle.

46. Ans. a. Liver > Kidney > Brain > Heart

(Ref. *Ganong's Physiology 24th edn.* pp 570, Table)

47. Ans. d. 20%

(Ref. *Ganong's Physiology 24th edn.* pp 570, Table)

Kidneys receive about 24% of total CO.

48. Ans. c. Play a role in thermoregulation

(Ref. *Ganong's Physiology 24th edn.* pp 538)

"In the fingers, palms, and ear lobes, short channels connect arterioles to venules, bypassing the capillaries. These arteriovenous (A-V) anastomoses, or shunts, have thick,

muscular walls and are abundantly innervated, presumably by vasoconstrictor nerve fibers."

49. Ans. a. Skin

(Ref. *Ganong's Physiology 24th edn. pp 538*)

Skin has very little autoregulation. Lung has no autoregulation.

50. Ans. b. Brain

(Ref. *The Principles and Practice of Human Physiology by OG Edhoim*)

CO₂ is a potent vasodilator in brain. See explanation Q. 33.

51. Ans. d. 37 mm Hg/L/min

Total peripheral vascular resistance = (arterial pressure-right atrial pressure)/cardiac output. In this example, total peripheral vascular resistance = (130 mm Hg/3.5 L/min), or ~37 mm Hg/L/min.

52. Ans. d. E

The greatest coronary blood flow occurs early in diastole, when the ventricle has relaxed and the aortic perusing pressure is still relatively high. So, point E is isovolumic relaxation phase.

53. Ans. b. 3:2

The ratio of the blood flow through vessels Y and Z is inversely proportional to their resistance:

Therefore, the flow of blood through vessel Y is twice the flow of blood through vessel Z. The blood flowing through vessel X is the sum of the blood flowing through vessels Y and Z (2 + 1 = 3). Therefore, the ratio of the flow of blood through vessel X to the flow of blood through vessel Y is 3:2.

SECTION

4

Respiratory System

CHAPTERS

9. Mechanics of Respiration with Lung Volumes and Capacities
10. Gaseous Exchange
11. Regulation of Respiration and Applied Physiology

CHAPTER

9

Mechanics of Respiration with Lung Volumes and Capacities

FUNCTIONAL ANATOMY

- ❑ **Weibel's classification (Fig. 9.1):** From trachea to alveolar sacs, the airways divide 23 times (Trachea is generation 0).

I IMPORTANT

The ~300–500 million alveoli have a combined surface area of 50–100 m² and an aggregate maximal volume of 5–6 L in the two lungs.

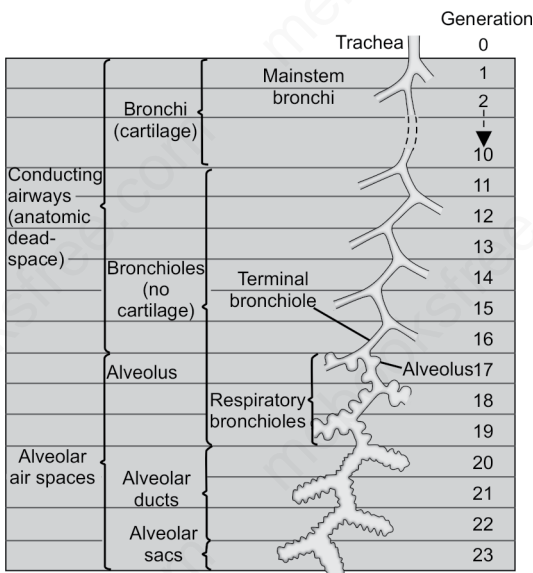

Fig. 9.1: Generations of airways (Weibel's classification)

- ❑ **Conducting zone:** The first 16 generations (including nose and lips)—consists of **bronchi (up to 10th generation)** and **terminal bronchioles (from generations 11th to 16th)**.
- ❑ **Exchange and respiratory zones:** The remaining 7 generations—consists of **respiratory bronchioles (generations 17th to 19th)**, **alveolar ducts (generations 20 to 22)** and finally **alveolar sacs (generation 23)**.

I IMPORTANT

Major site of airway resistance is medium or, intermediate size (2–4 mm diameter) bronchi, which are located in and around division number 7 of Weibel's classification

- As we move from trachea to alveoli
 - Diameter of airway decreases
 - Probability of turbulences decreases
 - **Velocity and cross-sectional area (Fig. 9.2):** The total cross-sectional area at generation 3 has a minimum value, where velocity has its maximum (inverse relation between velocity and cross-sectional area).

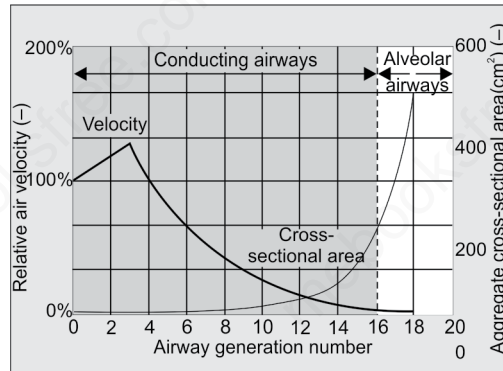

Fig. 9.2: Dependence of aggregate cross-sectional area and of linear velocity on generation number. At generation 3, the aggregate cross-sectional area has a minimum (not visible) where velocity has its maximum

I IMPORTANT

Cilia: Present up to respiratory bronchioles. Defective mucociliary transport is a feature of several rare diseases, including Kartagener's syndrome, Young's syndrome and ciliary dysmotility syndrome, which are characterized by repeated sinopulmonary infections and bronchiectasis.

I IMPORTANT

Cartilage and sub-mucosal gland: Only in trachea and bronchi.
Smooth muscle: Maximum in terminal bronchiole.

- **Clara cells (nonciliated cell)** present in bronchioles.
 - They secrete surfactant protein (SP-B) that line the bronchioles and play a role in the defense system of the airways.
 - They are stem cell responsible for regeneration of ciliated epithelium (terminal bronchioles).
 - Helps in xenobiotics metabolism (cytochrome p450 monooxygenase system).
 - Clara cell secretory protein CC10 (CCSP) regulates inflammatory response and used as a Clara cell marker.
 - Produce a 16-KD protein known as Clara cell secretory protein (CC16), which is an abundant component of the airway secretion. Chronic lung diseases such as chronic obstructive pulmonary disease (COPD) and asthma are associated with changes in the abundance of CC16 in airway fluid and serum. CC16 is used as a measurable pulmonary marker in bronchoalveolar lavage fluid and serum. Secretion of CC16 into the bronchial tree decreases during lung injury

(because of damage to the Clara cells), whereas serum levels of CC16 may increase because of leakage across the air-blood barrier.

- ❑ **Pulmonary neuroendocrine cells (PNEC)** are found as solitary neuroendocrine cells (NEC) and clusters, the neuroepithelial bodies (NEB) throughout the tracheobronchial tree.
 - *Microvilli* are present in apical border of these cells.
 - **They secrete** biogenic amines, including *dopamine* and *5-hydroxytryptamine (serotonin)*, *gastrin-releasing peptide (GRP)*, *calcitonin gene-related peptide (CGRP)*, *calcitonin*, *substance P*, *somatostatin*, *chromogranin A*, and *synaptophysin (SYP)*.
 - PNEC may play a role as *chemoreceptors* in hypoxia and hypercapnia detection, *regulate pulmonary blood flow*, *control bronchial tonus*, *modulate immune responses*, and *maintain a stem cell niche (Clara cell regeneration)*.
 - More numerous in a fetus than in an adult and hyperplasia is seen in Sudden Infant Death syndrome (SIDS).
 - They appear to be the cells of origin for a rare bronchial tumor called bronchial carcinoid.
 - Innervation: *Predominantly by vagal afferent fibers* derived from the nodose ganglion but its still not confirmatory.

Types of Cells in Alveolar Epithelial

These are of 3 types:

1. Type I (there form the main lining, much thinner): Cover 90–95% of the alveolar surface and represent the shortest route for gas diffusion. Fluid transport is also possible by Aquaporin 5 channel.
2. Type II (also called granular pneumocytes, thick cytoplasm): Type II cells are spherical pneumocytes, which comprise only 5% of the alveolar surface area, yet they constitute 60% of alveolar epithelial cells and 10–15% of all lung cells.
3. Type III pneumocyte cell (brush): Microvilli. The cell may lie adjacent to either a type I or, a type II cells. No function, as yet, has been attributed to the alveolar or any brush cell with certainty.

I IMPORTANT

Four major functions have been attributed to alveolar type II cells: (1) synthesis and secretion of surfactant, secretion of the antiprotease alpha1-antitrypsin and interleukin 1beta and IL-8; (2) xenobiotic metabolism; (3) transepithelial movement of water and solutes; and (4) regeneration of the alveolar epithelium following lung injury (progenitor cell for type I).

I IMPORTANT**Bronchoconstriction and dilation**

- ❖ **Bronchoconstriction:** Reflexly (by irritants; this is cholinergically mediated), cool air, exercise, expiration, leukotrienes, substance P, cholinergic stimulation, early morning (around 6 am).
- ❖ **Bronchodilation:** Adrenergic stimulation, by nonadrenergic–noncholinergic nerve stimulation (NANC) where the neurotransmitter is VIP, inspiration, in the evening (around 6 pm).

Other cells:

- ❑ Pulmonary alveolar macrophages (PAMS) or (dust cells): These are the phagocytic cells.
- ❑ Plasma cells, APUD cells, mast cells.

MECHANICS OF RESPIRATION**Different Types of Pressures****1. Intrapleural pressure:**

- This is pressure within the pleural space (also called intrathoracic pressure). Mid-thoracic oesophageal pressure measures intrapleural pressure.
- The volume of fluid in the intrapleural “space” is small (2.0–10 mL), but closely regulated by Starling forces. It is essential that intrapleural fluid volume remain small so that the cohesive forces linking the lung to the inner chest wall are preserved and thoracic cage enlargement results in lung expansion.
- *A net Starling force of about 9 cm H₂O favors fluid filtration from the parietal-side circulation into the intrapleural “space,” whereas an oncotic force of about 10 cm H₂O favors the reabsorption of fluid from the intrapleural “space” into the visceral-side circulation. These interacting Starling forces function to keep the intrapleural space from excessive fluid accumulation.*

2. Intrapulmonary pressure (intra-alveolar pressure):
This is the pressure in the airways or in the alveoli.**3. The transmural pressures are:**

- **Transpulmonary:** The pressure difference between intrapulmonary and intrapleural pressure.
- **Transthoracic:** The pressure difference between the intrapleural pressure and atmospheric pressure.
- **Transrespiratory:** The pressure difference between the intrapulmonary pressure and atmospheric pressure.

INSPIRATION AND EXPIRATION MECHANISM**❑ Muscles involved in quiet respiration**

- **Inspiration:** Diaphragm is the main muscle (75%) and external intercostal muscle (25%).
- **Expiration:** No expiratory muscle (passive)

❑ **Muscles involved in forceful respiration**

- **Inspiration:** Scalene, sternocleidomastoid.
- **Expiration:** Internal intercostal muscles, anterior abdominal muscle.

Events involved in a normal Inspiration: Inspiration is an active process.

1. Brain initiates inspiratory effort.
2. Nerves carry the inspiratory command to the inspiratory muscles
3. Diaphragm (and/or external intercostal muscles) contracts
4. Thoracic volume increases as the chest wall expands
5. Intrapleural pressure becomes more negative (normally it is -2.5 mm Hg at the start of inspiration, decreases to about -6 mm Hg)
6. Alveolar transmural pressure gradient increases.
7. Alveoli expand in response to the increased transmural pressure gradient. This increases alveolar elastic recoil.
8. Alveolar pressure falls below atmospheric pressure as the alveolar volume increases, thus establishing a pressure gradient for airflow (at the peak of inspiration, it is -1 mm Hg).
9. Airflows into the alveoli until alveolar pressure equilibrates with atmospheric pressure (Fig. 9.3).

Events involved in a normal expiration: Passive process:

1. Brain ceases inspiratory command.
2. Inspiratory muscles relax.
3. Thoracic volume decreases, causing intrapleural pressure to become less negative and decreasing the alveolar transmural pressure gradient.
4. Decreased alveolar transmural pressure gradient allows the increased alveolar elastic recoil to return the alveoli to their preinspiratory volumes.
5. Decreased alveolar volume increases alveolar pressure above atmospheric pressure, thus establishing a pressure gradient for airflow.
6. Airflows out of the alveoli until alveolar pressure equilibrates with atmospheric pressure.

I IMPORTANT

Pressure changes during respiration:

- ❖ **Intrapleural pressure:** At the beginning of quiet inspiration, it is -2.5 mm Hg or -5 cm H₂O (at the base of the lung), i.e. 2.5 mm Hg less than atmospheric pressure of 760 mm Hg; at the end of inspiration, it becomes -6.0 mm Hg. Again returns to -2.5 mm Hg at end of expiration.
- ❖ **Intraalveolar pressure:** At the peak of inspiration, it is -1 mm Hg; at the peak of expiration, it is $+1$ mm Hg. *At the beginning, at the end of both inspiration and expiration, the intraalveolar pressure is zero, i.e. same as atmosphere pressure*
- ❖ Strong inspiratory efforts reduce intrapleural pressure to values as low as -30 mm Hg.

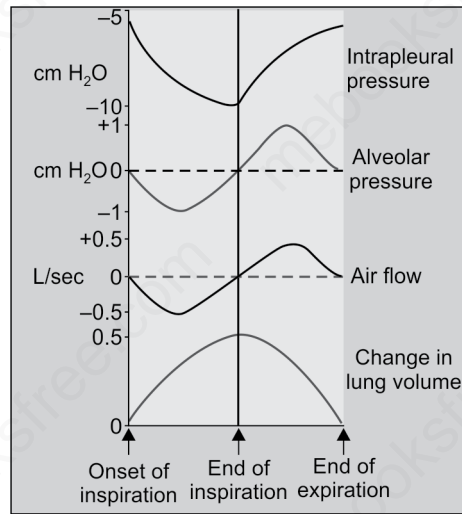

Fig. 9.3: Pressure in the alveoli and the plural space relative to atmospheric pressure during inspiration and expiration

ELASTIC RECOIL AND COMPLIANCE

- ❑ Elastic recoil is defined as the ability of a stretched or inflated lung to return to its resting volume (FRC). *Elastic recoil* of the lung is *directly related to lung stiffness*, that is, *the stiffer the lung, the greater the elastic recoil* (but lower compliance).
- ❑ The lung volume at which elastic recoil of lung and elastic recoil of chest wall are at equilibrium (i.e. equal elastic recoil force but in opposite directions) is represented by FRC. Because the lungs and chest walls are recoiling equally but, in opposite directions at FRC, FRC is often referred to as *the resting volume of the lungs*.
- ❑ A change in the elastic properties of either the lungs or chest wall has a significant effect on FRC. For example, *if the elastic recoil of the lungs is increased* (i.e. lower compliance), a new equilibrium is established between the lungs and chest wall, resulting in *a decreased FRC*.
- ❑ Conversely, *if the elastic recoil of the chest wall is increased*, *FRC is higher* than normal. The elastic recoil of the chest wall at low lung volumes is a major determinant of RV in young people.
- ❑ The elastic recoil of the chest wall is such that if the chest were unopposed by the recoil of the lung, it would expand to about 70% of TLC. This

I IMPORTANT

- ❖ Elastic recoil of lung and elastic recoil of chest wall balance out each other (in opposite directions) at FRC.

volume represents the resting position of the chest wall unopposed by the lung. If the chest wall is mechanically expanded beyond its resting position, it recoils inward. At volumes < 70% of TLC, the recoil of the chest wall is directed outward and is opposite to the elastic recoil of the lung. The outward elastic recoil of the chest wall is greatest at RV, whereas the inward elastic recoil of the lung is greatest at TLC.

COMPLIANCE

This is defined as the change in volume for a unit change in pressure. It measures the distensibility or, stretchability of lung.

Compliance

$$= \frac{\Delta \text{Lung volume}}{\Delta (\text{Alveolar pressure} - \text{Intrapleural pressure})}$$

$$= \frac{\Delta \text{Lung volume}}{\Delta \text{Transpulmonary pressure}} = \frac{\Delta V}{\Delta P}$$

Types of compliance measurements:

1. **Static compliance:** This is the measurement made without taking into account the effect of the different phases of respiration.
2. **Dynamic compliance:** Compliance measurement during the difference phases of respiratory.

Specific compliance = Compliance/FRC

Static Compliance

A plot of the change in lung volume with a change in transpulmonary pressure is the volume–pressure curve, as is shown below.

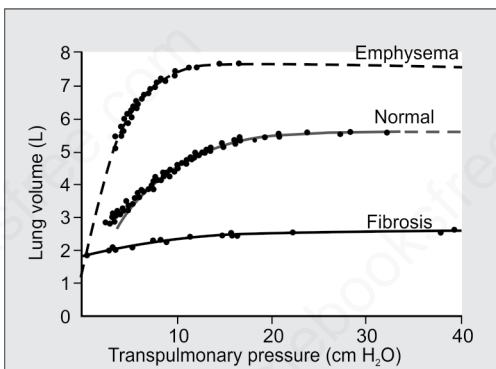

Fig. 9.4: Static expiratory pressure–volume curves of lungs in normal subjects and subjects with severe emphysema and pulmonary fibrosis

I IMPORTANT

- ❖ Normal compliance of human lung = 200 mL/cm H₂O (indicates 1 cm H₂O pressure change will cause 200 mL lung volume change)
- ❖ The compliance of combined lung and chest wall (respiratory system compliance) is normally 70–85 mL/cm H₂O.

I IMPORTANT

Compliance and elasticity: It is important to remember that compliance is inversely proportional to elasticity, or, elastic recoil. Compliance denotes the ease with which something can be stretched or distorted; elasticity refers to the tendency for something to oppose stretch or distortion, as well as to its ability to return to its original configuration after the distorting force is removed.

So, in emphysema: Loss of elastic tissue (less elastic recoiling force) leads to increase compliance.

I IMPORTANT

If static and dynamic compliance both decreasing, it means lungs are becoming stiffer:

- ❖ Pulmonary edema
- ❖ Consolidation
- ❖ Atelectasis
- ❖ Pleural effusion
- ❖ Pneumothorax

If only the dynamic compliance is decreased but the static compliance has remain relatively normal, it means the airway is obstructed:

- ❖ Endotracheal tube obstruction
- ❖ Heat moisture exchanger blockage
- ❖ Bronchospasm

- ❑ Slope of the curve determine the compliance.
- ❑ Lungs with high compliance have a steep slope on their pressure–volume curves.
- ❑ The curve is shifted downward and to the right (compliance is decreased) by pulmonary congestion and interstitial pulmonary fibrosis (there is stiffening and scarring of the lung).
- ❑ The curve is shifted upward and to the left (compliance is increased) in emphysema because of destruction of elastic tissue (Fig. 9.4).

Factors Affecting Compliance

- ❑ Lung volume: Smaller the lungs, smaller are the compliance. Therefore, specific compliance measurement normalizes the effect of lung size on compliance.
- ❑ For a given lung size, the compliance becomes less at extremes of lung volume.
- ❑ Compliance is more during deflation than during inflation.
- ❑ If surface tension is more, compliance is less.

Condition in Which Compliance is Affected

- ❑ Compliance decreased: Pulmonary congestion, pulmonary fibrosis, etc.
- ❑ Compliance increased: Emphysema, old age, less in asthma and at a minor degree in chronic bronchitis.

Dynamic Compliance

Dynamic compliance of lung is measured when the air is still flowing through the bronchial tree. It reflects not only the lung and chest wall stiffness but also the *airway resistance* against which distending forces have to act to expand the lungs.

- ❑ So it's a measure of static compliance (lungs and chest wall stiffness) plus airway resistance = *impedance of lung*.
- ❑ Static compliance reflects the distensibility of the respiratory system whereas the dynamic compliance reflects impedance (measure of both compliance and airway resistance).
- ❑ When the lungs and chest wall are stiff both the static compliance and dynamic compliance decreases, whereas in states of high airways resistance only dynamic compliance decrease.

Static and dynamic compliance in various lung conditions:

Lung conditions	Dynamic compliance	Static compliance
Cardiogenic pulmonary edema	Decreased	Decreased
ARDS	Decreased	Decreased
Bronchospasm without hyperinflation	Decreased	Unchanged
Bronchospasm with hyperinflation	Decreased	Decreased
Atelectasis	Decreased	Decreased
Pneumonia	Decreased	Decreased
Emphysema	Decreased	Increased
Pulmonary embolism	Unchanged	Unchanged
Tube obstruction	Decreased	Unchanged

Ref. Understanding Mechanical Ventilation: A Practical Handbook By Ashfaq Hasan.

ALVEOLAR SURFACE TENSION

- ❑ The surface of the alveolar membrane is moist and is in contact with air, producing a large air-liquid interface.
- ❑ Tension at the air-liquid interface of the alveoli is known as surface tension.
- ❑ Surface tension (measured in dyne/cm) arises because water molecules are more strongly attracted to one another than to air molecules.
- ❑ In the alveoli, surface tension produces an **inwardly directed force** that tends to reduce alveolar diameter.
- ❑ Surface tension has inverse relationship with compliance of lung (when surface tension is eliminated, the lung is far more compliant).
- ❑ With air-filled lungs, the gas-liquid interface creates surface tension. However, with saline-filled lungs, the air-liquid interface is eliminated and the surface tension is eliminated. So, *compliance of saline (liquid) filled lung is more than normal lung.*

Surfactant Lowers Surface Tension

- ❑ Surfactant is a mixture of lipids, proteins and carbohydrates.
- ❑ Predominant lipid is dipalmitoyl phosphatidylcholine (phosphatidylcholine is also called lecithin)-62%.

I IMPORTANT

Functions of surfactant:

1. Prevents alveolar collapse.
2. Prevents pulmonary oedema.
3. Decrease work of breathing

I IMPORTANT

- ❖ Surfactant production begins by 20–24 weeks.
- ❖ Surfactant production mature between 35 and 37 weeks.
- ❖ It appears in amniotic fluid between 28 and 32 weeks of gestation.

I IMPORTANT

Surface tension is inversely proportional to their concentration per unit area. The surfactant molecules move further apart as the alveoli enlarge during inspiration, and surface tension increases, whereas it decreases when they move closer together during expiration. So, surface tension is less at lower lung volumes.

I IMPORTANT

Cigarette smoking and long term pure oxygen therapy reduces and altered the surfactant. Deficiency of surfactant also occurred in a serious disease of newborn, know as hyaline membrane disease (HMD) or, infant respiratory distress syndrome (IRDS).

I IMPORTANT

Note: When the person is supine, blood flow is uniform throughout the lung. So, V/P ratio will be equal (0.8) in every part of lung. The above finding will be seen in case of a standing or, sitting person.

- ❑ The four unique proteins are: Surfactant protein (SP)-A, SP-B, SP-C, and SP-D. A mutation of the gene for SP-C has been reported to be associated with familial interstitial lung disease.
- ❑ *Surfactant is produced by type II alveolar epithelial cells.* Surfactant containing membrane bound organelles in this cell are known as lamellar bodies, which are secreted into the alveolar lumen by exocytosis.
- ❑ Following secretion, the phospholipids of surfactant line up in the alveoli with their hydrophobic fatty acid tails facing the alveolar lumen and *hydrophilic chains* breaks the water layer, thus reducing surface tension.

VENTILATION-PERFUSION**Ventilation-perfusion Gradients from Base to Apex of the Lung (in the Upright Position)**

- ❑ **Ventilation per unit lung volume decreases from base to the apex:** The reason for this is that at the start of inspiration, intrapleural pressure is less negative at the base (-2.5 mm Hg) than at the apex (-10 mm Hg). So, the transpulmonary pressure is less at the base than apex. That means, at the apex, the lung is more expanded (larger alveoli); that is, the percentage of maximum lung volume is greater. Because of the stiffness of the lung, the increase in lung volume per unit increase in pressure is smaller when the lung is initially more expanded and ventilation is consequently greater at the base.
- ❑ **Perfusion also decreases from base to the apex:** This is due to gravitational effect.
- ❑ *The relative change in blood flow from the apex to the base is greater than the relative change in ventilation, so the ventilation/perfusion ratio is low at the base and high at the apex.*
- ❑ The ventilation and perfusion differences from the apex to the base of the lung have usually been attributed to gravity; they tend to disappear in the supine position.
- ❑ *However, the inequalities of ventilation and blood flow in humans were found to persist to a remarkable degree in the weightlessness of space.* Therefore, other factors also play a role in producing the inequalities.

Zone	Alveolar ventilation (L/min)	Perfusion (L/min)	V/P ratio	pO ₂ (mm Hg)	pCO ₂ (mm Hg)	pN ₂ (mm Hg)	pH ₂ O (mm Hg)
Apex	2	0.6	3.3	132	28	553	47
Middle	4	5	0.8	100	40	573	47
Base	6	10	0.6	89	42	582	47

From the above table, we can easily understand:

- ❑ Ventilation decreases from base to apex.
- ❑ Perfusion also decreases from base to apex.
- ❑ In apex, perfusion decreases more than ventilation, so V/P ratio is maximum in apex (3.3)
- ❑ O₂ tension is maximum at apex and CO₂ tension is maximum at base.

ANATOMICAL DEAD SPACE

- ❑ Anatomic dead space is the volume of gas within the conducting (from mouth, nose up to terminal bronchioles)
- ❑ It is ~ 2 mL/kg in the upright position.

Factors that increase Anatomical dead space: (Concept: dilation or, increase length of airway)

- ❑ Deep inspiration
- ❑ Anticholinergic drugs
- ❑ Positive pressure ventilation (i.e. increased airway pressure)
- ❑ Neck extension and jaw protrusion (can increase it twofold)
 - Neck extended and jaw protruded: 143 mL
 - Normal position: 119 mL
 - Neck flexed and chin depressed: 73 mL
- ❑ Posture: Upright posture increases.
 - Sitting: 147 mL
 - Semi-reclining: 124 mL
 - Supine: 101 mL
- ❑ Emphysema (enlarged caliber of airway)
- ❑ General anesthesia—multifactorial, including bronchoconstrictor tone
- ❑ Anesthesia apparatus/circuit
- ❑ Artificial airway
- ❑ ↑Age: accompanied by increase dead space
- ❑ Hyperventilation (turbulence flow increases functional dead space volume)

I IMPORTANT

In microgravity (zero gravity) situation, there is evidence for reduction in top-to-bottom gradients, but persisting inequality of both ventilation and perfusion persists. So, V/P ratio is not homogenous (= 0.8).

I IMPORTANT

Ventilation–perfusion Imaging

In this technique, the lungs are imaged using a gamma camera that is able to distinguish two isotopes, inhaled ¹³³Xe (yielding ventilation images) and injected macro-aggregates of ^{99m}Tc-albumin (yielding perfusion images). Pulmonary emboli appear as perfusion defects with preserved ventilation.

I IMPORTANT**Work of Breathing**

This is required to do:

- ❖ Elastic work (compliance work) (65%)
 - Tissue elasticity (1/3rd)
 - Surface tension elasticity (2/3rd)
- ❖ Non-elastic work (35%)
 - Viscous resistance (tissue resistance) (7%)
 - Airway resistance (28%)

I IMPORTANT

- ❖ Since the airway resistance becomes more during turbulent flow, the work of breathing is more during turbulent flow than during laminar flow.
- ❖ The work of breathing is increased in conditions such as emphysema, asthma (increase airway resistance).
- ❖ The major sites of airway resistance are the lobar and segmental bronchi, which are medium size bronchi (about the seventh generation of airway branches).
- ❖ Airway resistance is maximum at RV and minimum at TLC of lungs.

Measurement of Anatomical Dead Space

Single breath N_2 washout method (Fowler's method).

ALVEOLAR DEAD SPACE

Alveolar dead space may be defined as that part of the inspired gas which passes through the anatomical dead space to mix with gas at the alveolar level but which does not take part in gas exchange.

Parallel dead space is synonymous with alveolar dead space.

Factors That Increase Alveolar Dead Space

- ❑ **Decrease alveolar perfusion:** In normal subject, perfusion is less to the supraclavicular parts of the lungs in the upright position. This can give rise to alveolar dead space but, the effect is really too small to measure with available techniques.
 - Non-perfusion of alveoli will be markedly increased in *pulmonary hypotension* (low-output circulatory failure) or, *embolism*.
- ❑ **Ventilation of nonvascular air space:** This occurs in obstructive lung disease following widespread destruction of alveolar septa and the contained vessels. This is the principal cause of the very marked increase in physiological dead space reported in patients with chronic lung disease (*emphysema*).
- ❑ **Posture:** Less in the supine than in the upright position. However, effect is negligible.
 - In the lateral position, ~2/3rd of the pulmonary blood flow is distributed to the dependent side. During spontaneous respiration the greater part of the ventilation is also distributed to the lower lung and there is probably little change in alveolar dead space. If, however, the patient is ventilated artificially in the lateral position, ventilation is distributed in favor of the upper lung. Under these conditions, it may be expected that much of the ventilation of the upper lung will constitute alveolar dead space.

PHYSIOLOGICAL DEAD SPACE

- ❑ The physiological dead space is defined as that part of the tidal volume, which does not participate in gaseous exchange.

- ❑ Physiological dead space = (Anatomical dead space + Alveolar dead space)

Measurement: Bohr mixing equation:

Physiological dead space =

$$TV \times \frac{\text{Alveolar CO}_2 - \text{Expired CO}_2}{\text{Alveolar CO}_2}$$

Values of CO₂ can be expressed as partial pressure of CO₂ or percentage of CO₂

LUNG VOLUMES AND CAPACITY

Two types:

1. *Static Lung Volumes and Capacities:* Time factor is not involved. Expressed in mL or, L.
2. *Dynamic Lung Volumes and Capacities:* Time dependent. Expressed in mL/min or, L/min.

Static Lung Volumes and Capacities are:

Measurement	Value	Definition
Lung volumes (mL)		
Tidal volume (TV)	500–750	Amount of air inhaled or exhaled in one breath during relaxed, quiet breathing
Inspiratory reserve volume (IRV)	2000	Amount of air in excess of tidal inspiration that can be inhaled with maximum effort
Expiratory reserve volume (ERV)	1000	Amount of air in excess of tidal expiration that can be exhaled with maximum effort
Residual volume (RV)	1300	Amount of air remaining in the lungs after maximum expiration; keeps alveoli inflated between breaths and mixes with fresh air on next inspiration
Closing volume (CV)	Close to RV	It is the lung volume above the residual volume at which airway in the lower, dependent parts of the lungs begin to close off.
Lung capacities (mL)		
Total lung capacity (TLC)	5000	= (IRV + TV + ERV + RV) Depends on lung compliance.
Vital capacity (VC)	3500	= (IRV + TV + ERV)
Inspiratory capacity (IC)	2500	= (TV + IRV)
Expiratory capacity (EC)	1500	= (TV + ERV)
Functional residual capacity (FRC)	2500	= (ERV + RV)

I IMPORTANT

Special points: Change in VC with different body position

Body position	Decrease in VC with sitting position is baseline
Lithotomy position	18%
Trendelenburg position (20°)	15%
Jack-knife prone position	12.5%
Supine	9%

I IMPORTANT

All of these volumes and capacities are measured by spirometer except RV, CV, FRC and TLC which are measured by (discussed below):

- ❖ N₂ washout method
- ❖ Helium dilution method
- ❖ Body plethysmography (best method)

I IMPORTANT

Normal young adult: CV \ll FRC; At 65 years age: CV \approx FRC; Small airway disease: CV \gg FRC.

Closing Volume

- ❑ During forced expiration, alveoli (small bronchioles) in the lower dependent part of the lung begin to close because of decreased transpulmonary pressure. Volume at which this happens is known as closing volume. This is slightly more than residual volume.
- ❑ Sometimes the closing capacity is reported. This is the closing volume plus the residual volume.
- ❑ In young normal subjects, the closing volume is about 10% of the vital capacity (VC). It increases steadily with age and is equal to about 40% of the VC, that is, the FRC, at about the age of 65 years. *Relatively small amounts of disease in the small airways apparently increase the closing volume.*

Closing Volume and Anatomical Dead Space are Measured by Single-Breath N₂ Washout Method

Fig. 9.5: Single-breath N₂ curve. From mid-inspiration, the subject takes a deep breath of pure O₂ then exhales steadily. The changes in the N₂ concentration of expired gas during expiration are shown, with the various phases of the curve indicated by roman numerals

Suppose a subject takes a vital capacity breath of 100% O₂, and during the subsequent exhalation the N₂ concentration at the lips is measured (by N₂ meter). The concentration of N₂ in the expiratory air is plotted over a graph (Fig. 9.5).

Four phases can be recognized from the graph:

- ❑ **Phase 1:** Pure dead space is exhaled—this volume of air is equal to *anatomical dead space* volume.
- ❑ **Phase 2:** A mixture of dead space and alveolar gas
- ❑ **Phase 3:** Pure alveolar gas.

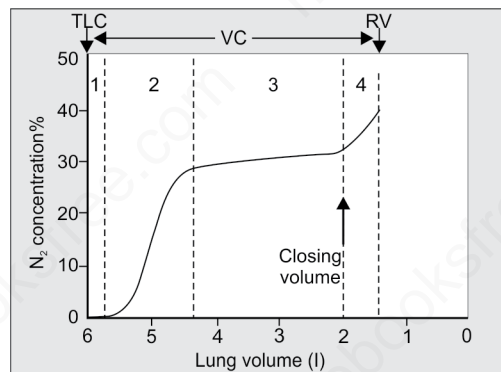
- ❑ **Phase 4:** Toward the end of expiration, an abrupt increase in N_2 concentration is seen. This signals closure of airways at the base of the lung (*closing volume*) and is caused by preferential emptying of the apex, which has a relatively high concentration of N_2 . The reason for the higher N_2 at the apex is that during a vital capacity breath of O_2 , this region expands less, and, therefore, the N_2 there is less diluted with O_2 . Thus, the volume of the lung at which dependent airways begin to close can be read off the tracing.

Helium Dilution Method

- ❑ The subject is connected to a spirometer containing a known volume (V_1) and known concentration (C_1) of helium (Fig. 9.6), which is virtually insoluble in blood.
- ❑ Subject is connected with spirometer at this time with an **unknown** volume in lungs (V_2), which we are going to measure (may be FRC or RV).
- ❑ After some breaths, the helium concentrations in the spirometer and lung become the same (equilibrium).
- ❑ Because no helium has been lost, the amount of helium present before equilibration (concentration times volume) is $C_1 \times V_1$
- ❑ If concentration of helium after equilibrium is C_2 , then:

$$C_1 \times V_1 = C_2 \times (V_1 + V_2)$$

$$\text{So, } V_2 = V_1 \times \frac{(C_1 - C_2)}{C_2}$$

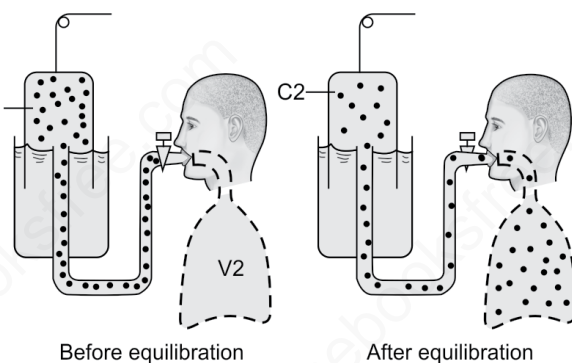

Fig. 9.6: Measurement of the functional residual capacity by helium dilution

I IMPORTANT

❖ Components of FVC:

- **FEV1 (forced expiratory volume in 1 sec):** Volume of FVC expired in 1 sec of exhalation. Normally, it is 80% of FVC.
- **FEV2:** Volume of FVC expired in 2 sec of exhalation. Normally 95%
- **FEV3:** Volume of FVC expired in 3 sec of exhalation. Normally 99–100%

Body Plethysmograph (Fig. 9.7)

- ❑ This is a large airtight box, like an old telephone booth, in which the subject sits. *At the end of a normal expiration* (lung volume is at FRC), a shutter closes the mouthpiece and the subject is asked to make respiratory efforts.
- ❑ As the subject tries to inhale, he (or she) expands the gas in his lungs; lung volume increases, and the box pressure rises because its gas volume decreases. Boyle's law states that pressure \times volume is constant (at constant temperature).

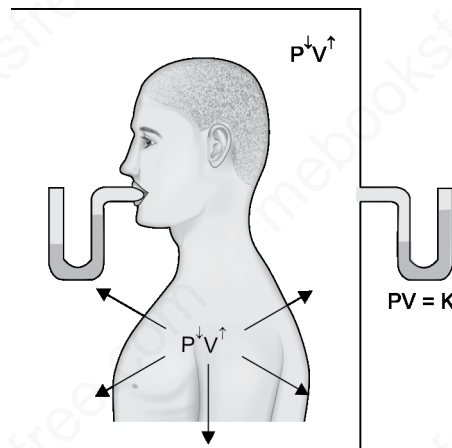

Fig. 9.7: Measurement of FRC with a body plethysmograph. When the subject makes an inspiratory effort against a closed airway, he slightly increases the volume of his lung, airway pressure decreases, and box pressure increases. From Boyle's law, lung volume is obtained

Therefore, if the pressures in the box before and after the inspiratory effort are P_1 and P_2 , respectively, V_1 is the preinspiratory box volume, and ΔV is the change in volume of the box (or lung), we can write

$$P_1.V_1 = P_2 (V_1 - \Delta V)$$

Thus, ΔV can be obtained. This ΔV is the volume, which has been decreased inside box, and same volume (ΔV) has been increased in the lungs also.

Next, Boyle's law is applied to the gas in the lung. Now, $P_3.V_2 = P_4 (V_2 + \Delta V)$

Where, P_3 and P_4 are the mouth pressures before and after the inspiratory effort, and V_2 is the initial lung

volume at the start of the experiment (FRC). Thus, FRC can be obtained.

Dynamic Lung Volumes and Capacities are:

1. **Forced Vital Capacity (FVC) or, Timed Vital Capacity:** Maximum volume of air which can be breathed out as 'forcefully' and 'rapidly' as possible following a maximal inspiration. Similar to VC except it is 'rapid, forcible' exhalation.
2. **Force Expiratory Flow during 25-75% of Expiration (FEF_{25-75%}):** This is the average expiratory flow rate during the middle 50% of FVC. It is also known as Maximum Mid Expiratory Flow Rate (MMEFR). Normally, it is 300 L/min.
3. **Minute Ventilation (MV) or, Pulmonary ventilation (PV):** Tidal volume (TV) × respiratory rate (RR) = 500 × 12 = 6000 mL/min
4. **Alveolar Ventilation:** (TV – dead space) × RR = (500 – 150) × 12 = 4200 mL/min.
5. **Maximum Voluntary Ventilation (MVV) or, Maximum Breathing Capacity (MBC):** It is the largest volume of air that can be taken into and out of the lungs in one minute by maximum voluntary efforts. Normally: 90-170 L/min (average 100 L/min)
6. **Pulmonary Reserve or, Breathing Reserve (BR) = (MVV-PV):** If it is expressed as percentage of MVV, it is known as Dyspnoeic Index.

$$\text{So, Dyspnoeic Index} = \frac{\text{MVV} - \text{PV}}{\text{MVV}} \times 100$$

I IMPORTANT

Normal Dyspnoeic Index is ≥ 60-70%. If it is < 60%, dyspnea is usually present.

DIFFERENTIATION BETWEEN OBSTRUCTIVE AND RESTRICTIVE DISEASE

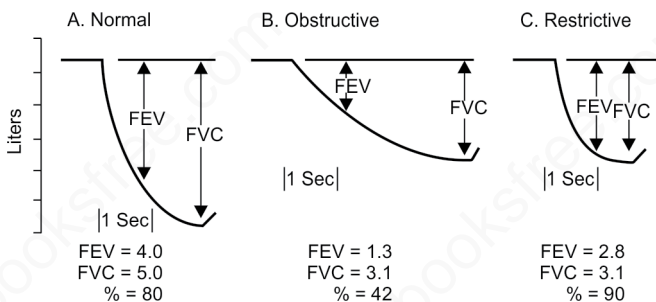

Fig. 9.8: Forced expiratory volume (FEV1) and forced vital capacity (FVC) curve from normal subject and comparison with restrictive and obstructive disease patient

- ❑ **Obstructive Disease:** Decrease in both FEV1 and FVC but FEV1 decrease more than FVC. So ratio (FEV1/FVC) decreases.
- ❑ **Restrictive Disease:** Decrease in both FEV1 and FVC but FVC decrease more than FEV1. So ratio (FEV1/FVC) increases.

	TLC	RV	VC	FEV1/FVC
Obstructive: Disease	Normal or, increased	Increased	Reduced	Reduced
Restrictive: Parenchymal	Reduced	Reduced	Reduced	Normal or, increased
Restrictive: Extra-parenchymal	Reduced	Increased	Reduced	Variable

Flow–Volume Curves (Fig. 9.9)

- ❑ Flow rates are plotted against lung volume for expiratory efforts of different intensities.
- ❑ Used to assess airway resistance.
- ❑ At high lung volumes, the airflow rate is **effort-dependent** (greater efforts increases flow rate), which can be seen in the left-hand portion of the curves.

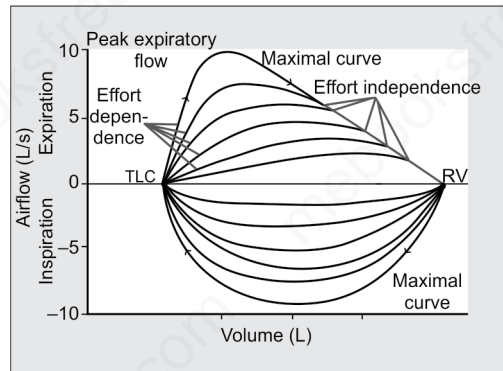

Fig. 9.9: Flow–volume curves of varying intensities, demonstrating effort dependence at high lung volumes and effort independence at low lung volumes. Note that there is no effort dependence in inspiration. The peak expiratory flow (PEF) is labeled for the maximal expiratory curve. TLC, total lung capacity; RV, residual volume

- ❑ At low lung volume, the expiratory efforts of different initial intensities all merge into the same **effort-independent** curve, as seen in the right-hand portion of the curve (Fig. 9.9). Effort independent

indicates that flow rate cannot be increased with further increase in intrapleural pressure. This difference is because intrapleural pressures high enough to cause dynamic compression of small airway.

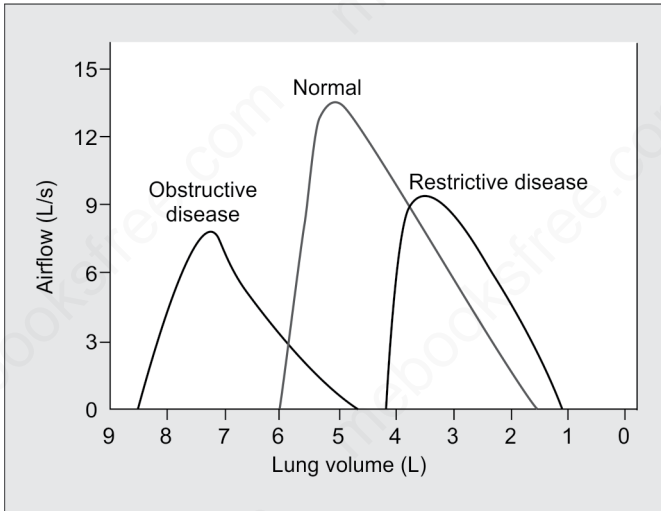

Fig. 9.10: Maximal expiratory flow–volume curves representative of obstructive and restrictive diseases

The maximal flow–volume curve is used to distinguish between two major classes of pulmonary diseases—**obstructive diseases** and **restrictive diseases**.

Both obstruction and restriction can cause a decrease in the maximal flow rate that the patient can attain, the peak expiratory flow (PEF).

Obstructive Disease (Fig. 9.10)

- ❑ Effort-independent portion of the curve depressed inward (scooped-out appearance): Flow rates are low for any relative volume.
- ❑ High lung volumes (TLC) and high RV.

Restrictive Disease (Fig. 9.10)

- ❑ Low TLC and low RV
- ❑ Effort independent portion is not depressed.

Flow-volume curves are very useful in assessing obstructions of the *upper airways and the trachea* (Fig. 9.11). These types of obstruction are two types:

I IMPORTANT

Pneumonectomy or lobectomy will have restrictive disease like features.

- ❖ Compliance, TLC, FRC, RV, VC, FVC, EFV1 reduces, but FEV1/FVC ratio increased or, slightly decrease. Dead space may increase due to hyperinflation of remaining lung may decrease due to removal of conducting zone.
- ❖ **D_LCO:** After resection of one lung, the other functioning lung accommodates the whole cardiac output, so carbon monoxide (CO) uptake per unit volume of functioning lung (Kco) increased, and as a result D_LCO changes very little.
- ❖ **PaO₂, SaO₂, PaCO₂ and specific compliance also remain unchanged.**
- ❖ **Increase in:** Inspiratory resis-

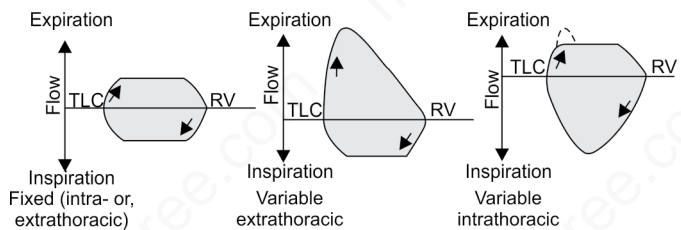
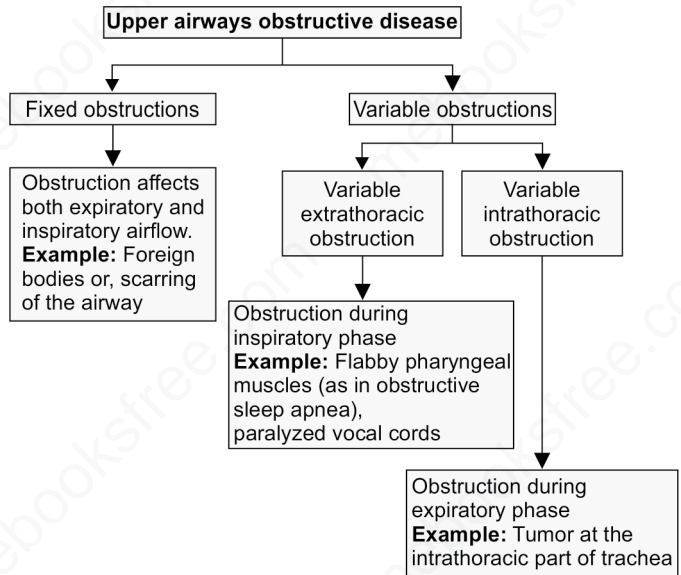

Fig. 9.11: Inspiratory and expiratory flow–volume curves representing the patterns in: fixed intrathoracic or extrathoracic obstruction; variable extrathoracic obstruction; and variable intrathoracic obstruction

MULTIPLE CHOICE QUESTIONS

MECHANICS OF RESPIRATION

RECENT MCQs

1. When gases flow through an orifice which factor is least likely to effect turbulence?

- a. Density of gas
- b. Viscosity of gas
- c. Pressure of gas
- d. Diameter of orifice

2. Normal intrapleural pressure at the start/beginning of inspiration is _____ cm of H₂O.

- a. -7.5
- b. -5.0
- c. -2.0
- d. -0.5

3. Pleural pressure positive in:

- a. End of inspiration
- b. End of expiration
- c. End of forced expiration
- d. Start or beginning of inspiration

4. Normal alveolar ventilation pressure on inspiration is:

- a. -1 cm water
- b. -1 cm Hg
- c. +1 cm water
- d. +1 cm Hg

5. Regarding dead space volume in a normal individual:

- a. Anatomical dead space > physiological dead space
- b. Anatomical dead space = Physiological dead space
- c. Anatomical dead space < Physiological dead space
- d. Anatomical dead space is not related to physiological dead space

AIIMS/PGI/JIPMER

6. Increased airway resistance is/are caused by: [PGI Nov 11]

- a. Forced expiration
- b. Denser air
- c. Low lung volume
- d. High lung volume

7. Small airways have laminar airflow because: [AI 11]

- a. Reynold's number >2000
- b. Very small diameter
- c. Extremely low velocity
- d. Low cross-sectional area

8. True about inspiration: The intrapleural pressure becomes: [PGI Dec 06]

- a. More negative
- b. More positive
- c. Same
- d. Initially positive, then negative
- e. No relation

9. The intrapleural pressure is negative both during inspiration and expiration because: [AIIMS May 05]

- a. Intrapulmonary pressure is always negative
- b. Thoracic cage and lungs are elastic structure
- c. Transpulmonary pressure determines the negativity
- d. Surfactant prevents the lungs to collapse

10. Intrapleural pressure is negative because [AI 12]

- a. Chest wall and lungs recoil in opposite directions to each other
- b. Transpulmonary pressure is negative
- c. Intrapulmonary pressure is negative
- d. Pulmonary collapse is prevented by surfactants

11. Negative intrapleural pressure is due to: [AIIMS Nov 10]

- a. Uniform distribution of surfactant over alveoli
- b. Negative intraalveolar pressure
- c. Absorption by lymphatics
- d. Presence of cartilage in the upper airway

12. True about normal expiration

[PGI Nov. 10]

- a. At the end of normal expiration air in lung is ERV

- b. Chest wall has a tendency to move outward which is balanced by inward recoil of alveoli
- c. In expiration pleural pressure is equal to alveolar pressure
- d. Muscles that elevate the chest cage are classified as muscles of expiration

13. A person is having normal lung compliance and increased airway resistance. The most economical way of breathing for him: [AIIMS Nov 00]

- a. Rapid and deep
- b. Rapid and shallow
- c. Slow and deep
- d. Slow and shallow

14. Respiration stops in the last stage of expiration, in forced expiration because of: [AIIMS June 98]

- a. Respiratory muscle fatigue
- b. Collapse of alveoli
- c. Dynamic compression of airways
- d. Breaking effect of inspiratory muscles

COMPLIANCE-SURFACTANT-VENTILATION-PERFUSION**RECENT MCQs****15. Compliance of lungs is:**

- a. 200 mL/cm water
- b. 800 mL/cm water
- c. 500 mL/cm water
- d. 1000 mL/cm water

16. Pulmonary surfactant is secreted by:

- a. Type I pneumocytes
- b. Type II pneumocytes
- c. Clara cells
- d. Bronchial epithelial cells

17. Pulmonary surfactant is secreted by:

- a. Type I pneumocytes
- b. Clara cells

- c. Bronchial epithelial cells
- d. Goblet cell

18. The primary function of surfactant is: [SGPGI 05]

- a. Prevent overexpansion of alveoli
- b. Decrease the surface tension of the fluid lining the alveoli
- c. Facilitate diffusion of oxygen
- d. Prevent airway closure

19. Surfactant production in lungs starts at:

- a. 28 weeks
- b. 32 weeks
- c. 34 weeks
- d. 36 weeks

20. Respiratory distress syndrome is due to a defect in the biosynthesis of:

- a. Dipalmitoyl lecithin [COMED 00]
- b. Dipalmitoyl cephalin
- c. Dipalmitoyl serine
- d. Dipalmitoyl inositol

21. Surfactant production is accelerated by: [UP 07]

- a. Thyroxine
- b. Glucocorticoids
- c. Carbamazepine
- d. Iodine

22. Compliance of lung is measured by:

- a. Elasticity
- b. Amount of air
- c. Blood flow
- d. Presence of fluid

23. True statement regarding pulmonary ventilation is:

- a. PaO_2 is maximum at the apex
- b. V/Q is maximum at the base
- c. Ventilation per unit lung volume is maximum at the apex
- d. Blood circulation is minimum at the base

24. Comparison of the apex of the lung, the base of the lung has: [UP 08]

- a. High pulmonary arterial pressure O_2
- b. High pulmonary arterial pressure CO_2
- c. High ventilation/perfusion ratio
- d. Same ventilation/perfusion ratio

25. Which of the following true about ventilation and perfusion in alveoli in erect posture? [Manipal 06]

- a. Ventilation/perfusion ratio is max at apex
- b. Ventilation/perfusion ratio is max at base
- c. Ventilation is max at apex
- d. Perfusion is max at apex

26. Surfactant is made up of:

- a. Fibrin
- b. Phospholipids
- c. Mucoprotein
- d. Fibrinogen

27. Physiological dead space is calculated by:

- a. Boyle's law
- b. Dalton's law
- c. Bohr equation
- d. Charles' law

28. In zero gravity v/q ratio is:

- a. 0.8
- b. 1
- c. 2
- d. 3

AIIMS/PGI/JIPMER

29. The mechanism of action of surfactant is: [AIIMS Nov 07]

- a. Lubricates the flow of CO_2 diffusion
- b. Binds oxygen
- c. Makes the capillary surface hydrophilic
- d. Breaks the structure of water in the alveoli

30. Stability of alveoli is maintained by: [AIIMS Nov 09]

- a. Compliance of the lungs
- b. Residual air in alveoli
- c. Negative intrapleural pressure
- d. Reduce surface tension by surfactant

31. Pulmonary compliance is decreased in all of the following conditions except:

- a. Pulmonary congestion [AI 11]
- b. COPD
- c. Decreased surfactant
- d. Pulmonary fibrosis

32. Ventilation perfusion ratio is maximum at: [AI 98]

- a. Apex of lung
- b. Base of lung
- c. Posterior lobe of lung
- d. Middle of the lung

LUNG VOLUMES AND CAPACITIES

RECENT MCQs

- 33. Volume of air taken in and given out during normal respiration is referred to as:**
- IRV
 - TV
 - ERV
 - VC
- 34. Vital capacity is sum of:**
- Inspiratory reserve volume, tidal volume and expiratory reserve volume
 - Tidal volume, inspiratory reserve volume and residual volume
 - Expiratory reserve volume, inspiratory reserve volume and residual volume
 - Residual volume, inspiratory volume and expiratory volume
- 35. In which of the following conditions, the respiratory muscles are relaxed?** [UP 08]
- Residual volume
 - Functional residual capacity
 - Expiratory reserve volume
 - Inspiratory reserve volume
- 36. Spirometry can demonstrate and measure all of the following except:**
- Tidal volume
 - Residual volume
 - Vital capacity
 - Inspiratory reserve capacity
- 37. Nitrogen washout method is used for estimating:**
- Dead space volume
 - Functional residual capacity
 - Tidal volume
 - Diffusion capacity
- 38. Measurement of anatomic dead space is by:**
- O₂ breath test
 - Helium dilution test
 - N₂ breath test
 - PCO₂
- 39. Maximum voluntary ventilation is:**
- 25 L/min
 - 50 L/min
 - 100 L/min
 - 150 L/min
- 40. Closing capacity of lung is related to:**
- Small size bronchioles without cartilage in nondependent portion of lung
 - Small size bronchioles without cartilage in dependent portion of lung
 - Medium size bronchioles without cartilage in nondependent portion of lung
 - Medium size bronchioles without cartilage in dependent portion of lung
- 41. Closing volume is the volume of lung:**
- Above residual volume in non-dependent part of lung
 - Above residual volume in dependent part of lung
 - Above tidal volume in non-dependent part of lung
 - Above tidal volume in dependent part of lung
- 42. Closing volume of lung is:**
- Volume of air in lungs after maximum inspiration
 - Volume of air in lungs at end-expiratory position
 - Lung volume above residual volume at which airways in the lower lungs begins to close off.
 - Maximum amount of air above pulmonary ventilation, which can be breathed in/out in one minute.

AIIMS/PGI/JIPMER**43. Tidal volume is calculated by:** [AI 01]

- Inspiratory capacity minus the inspiratory reserve volume
- Total lung capacity minus the reserve volume
- Functional residual capacity minus residual volume
- Vital capacity minus expiratory reserve volumes

44. Functional residual capacity of lung is defined as: [PGI June 97]

- Volume expired after normal expiration
- Volume remaining after forced expiration
- ERV + RV
- Tidal volume + volume inspired forcefully

45. In normal adult Vd/Vt ratio is: [PGI June 99]

- 20
- 0.35
- 40
- 50

46. Total alveolar ventilation volume (in L/min) is: [AI 96]

- 1.5
- 3.5
- 4.2
- 5.0

47. Calculate the alveolar ventilation per minute of a patient with respiratory rate 14/min, tidal vol. 500 mL with a vital capacity 7000 mL:

[AIIMS May 01]

- 4900 mL
- 2000 mL
- 7700 mL
- 7000 mL

48. Routine spirometer can't estimate: [PGI Dec 04]

- FRC
- VC
- RV
- ERV
- FEV1

49. Spirometry can demonstrate and measure all of the following except:

[AI 97]

- Tidal volume
- Residual volume
- Vital capacity
- Inspiratory reserve capacity

50. Which of the following is used to measure the resistance to small airways?

- Vital capacity [AIIMS Dec 97]
- FEV1
- Max. mid respiratory flow rates
- Closing volume

51. A man connected to a body plethysmograph for estimation of FRC inspires against a closed glottis. Which of the following statements is true? [AI 11]

- The pressure in both the lungs and the box increases
- The pressure in both the lungs and the box decreases
- The pressure in the lungs decreases, but that in the box increases
- The pressure in the lungs increases, but that in the box decreases

52. Pulmonary function changes seen in emphysema are: [AI 98]

- Increased TLC
- Decreased RV
- Increased FEV1
- Increased VC

53. Set of data which correctly defines restrictive lung disease is: [AI 97]

- ↑ FRC, ↓ compliance of lung tissue
- ↑ FEV1/FVC, ↓ compliance of lung tissue
- ↓ FEV1/FVC, ↓ compliance of lung tissue
- ↑ TLC, RV is ↓

54. Pulmonary function abnormalities in interstitial lung diseases include all of the following except: [AIIMS Nov 05]

- a. Reduced vital capacity
- b. Reduced FEV1/FVC ratio
- c. Reduced diffusion capacity
- d. Reduced total lung capacity

55. In upper airway obstruction all of the following changes are seen except: [AI 99]

- a. Decreased maximum breathing capacity
- b. RV decreased
- c. Decreased FEV
- d. Decreased vital capacity

56. Regarding pulmonary function test all are true, except: [AIIMS June 99]

- a. Total lung volume increases in emphysema

- b. Compliance decreases in interstitial lung disease
- c. Compliance is total lung distensibility
- d. FEV1 is forced expiratory rate at one minute

57. Total lung capacity depends upon:

[AI 98]

- a. Size of airway
- b. Closing volume
- c. Lung compliance
- d. Residual volume

58. Hyaline membrane disease of lungs is characterized by:

[AIIMS Nov 10]

- a. FRC is smaller than closing volume
- b. FRC is greater than closing volume
- c. FRC is equal to closing volume
- d. FRC is independent of closing volume

FUTURE TRENDS

Answer the following two questions from the diagram below:

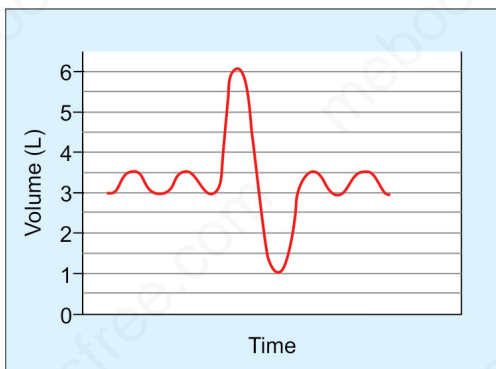

59. A 27-year-old man is breathing quietly. He then inhales as much air as possible and exhales as much air as he

can, producing the spirogram shown in the previous figure. What is his expiratory reserve volume (in liters)?

- a. 2.0
- b. 2.5
- c. 3.0
- d. 3.5

60. In the above subject, a residual volume of 1.0 L was determined using the helium dilution technique. What is her functional residual capacity (in liters)?

- a. 2.0
- b. 2.5
- c. 3.0
- d. 3.5

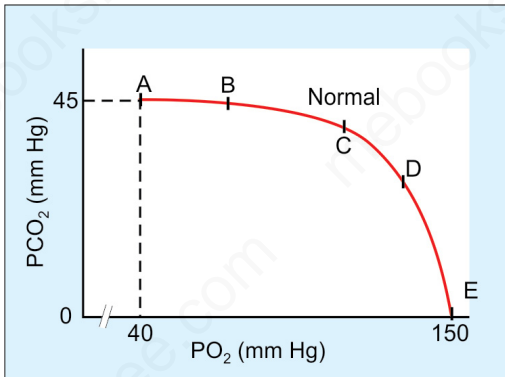

With the help of above diagram, answer the following two questions (61, 62):

61. A 67-year-old man has a solid tumor that pushes against an airway partially obstructing airflow to the distal alveoli. Which point on the ventilation-perfusion line of the O_2 - CO_2 diagram corresponds to the alveolar gas of these distal alveoli?

- A
- B
- D
- E

62. A 55-year-old male has a pulmonary embolism that partially blocks the blood flow to his right lung. Which point on the ventilation-perfusion line of the O_2 - CO_2 diagram corresponds to the alveolar gas of his right lung?

- A
- B
- D
- E

63. A 62-year-old man complains to his physician that he has difficulty breathing. The following diagram shows a maximum expiratory flow-volume (MEFV) curve from the patient (curve B) and from a typical healthy individual (curve A). Which of the following best explains the MEFV curve of the patient?

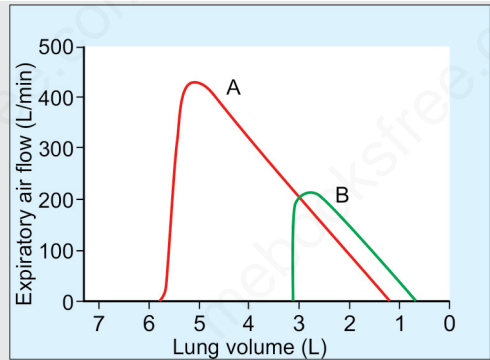

- Asbestosis
- Asthma
- Bronchospasm
- Old age

64. The volume-pressure curves shown here were obtained from a normal subject and a patient suffering from a pulmonary disease. Which of the following abnormalities is most likely present in this patient?

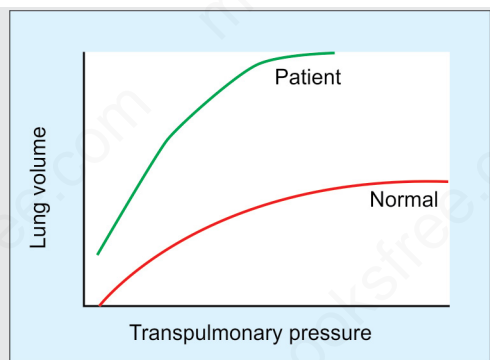

- a. Asbestosis
- b. Emphysema
- c. Mitral obstruction
- d. Rheumatic heart disease

65. A 45-year-old man inhaled as much air as possible and then expired with a maximum effort until no more air could be expired. This produced the maximum expiratory flow-volume curve shown in the following diagram. What is the forced vital capacity of this man (in liters)?

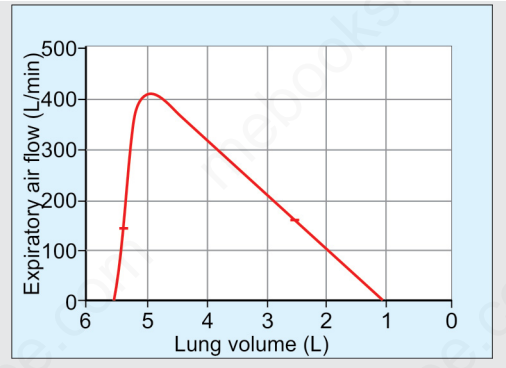

- a. 1.5
- b. 2.5
- c. 3.5
- d. 4.5

ANSWERS WITH EXPLANATIONS

1. Ans: c. Pressure of gas

(Ref. Ganong's Physiology 24th edn. pp 540)

Probability of turbulent flow through orifice depends on Reynolds number (Re). $Re = \rho DV/\eta$, where ρ is the **density** of the fluid/gas; D is the **diameter** of the orifice under consideration; V is the **velocity** of the flow; and η is the viscosity of the fluid/gas. The higher the value of Re, the greater the probability of turbulence. When D is in cm, V is in cm/s^{-1} , and η is in poise; flow is usually not turbulent if Re is less than 2000. When Re is more than 3000, turbulence is almost always present.

2. Ans: b. - 5.0

(Ref. Rhodes Medical Physiology 4th edn. pp 332)

At rest, pleural pressure is - 5 cm H₂O (or, - 2.5 to -3.8 mm Hg) and alveolar pressure is zero.

3. Ans: c. End of forced expiration

(Ref. Rhodes Medical Physiology 4th edn. pp 332)

Pleural pressure is always negative during normal quiet breathing. It becomes positive in case of forceful breathing.

4. Ans: a. - 1 cm water

(Ref. Ganong's Physiology 24th edn. pp 592)

During inspiration, alveolar pressure become negative (approximate - 1 mm Hg), which is approx. = - 1 cm H₂O

5. Ans: b. Anatomical dead space = Physiological dead space

(Ref. Ganong's Physiology 24th edn. pp 600)

It is important to distinguish between the anatomic dead space (respiratory system

volume exclusive of alveoli) and the total (physiologic) dead space (volume of gas not equilibrating with blood; i.e. wasted ventilation). In healthy individuals, the two dead spaces are identical and can be estimated by body weight (body weight in pounds).

6. Ans: a. Forced expiration, b. Denser air, c. Low lung volume

(Ref. Rhodes Medical Physiology 4th edn. pp 349)

Airway resistance depends on the diameter of airway. Maximum airway resistance is at Residual Volume (RV): at the end of forceful breathing when lungs are fully compressed.

7. Ans: c. Extremely low velocity >> b. Very small diameter

(Ref. Ganong's Physiology 24th edn. pp 540)

Low velocity and low diameter, both are the cause of laminar flow in small airway. Velocity is the more important than diameter.

8. Ans: a. More negative

(Ref. Ganong's Physiology 24th edn. pp 592)

Intrapleural pressure becomes - 6 mm Hg (more negative) during normal quiet breathing.

9. Ans: b. Thoracic cage and lungs are elastic structure

(Ref. Ganong's Physiology 24th edn. pp 591)

"The lungs and the chest wall are elastic structures. Normally, no more than a thin layer of fluid is present between the lungs and the chest wall (intrapleural space). The lungs slide easily on the chest wall, but resist being pulled away from it in the same way that two moist pieces of glass slide on each other but resist separation. The pressure in

the 'space' between the lungs and chest wall (intrapleural pressure) is subatmospheric."

10. Ans. a. Chest wall and lungs recoil in opposite directions to each other

(Ref. Ganong's Physiology 24th edn. pp 591)

The lungs and chest wall are elastic in nature. Elastic recoil of lungs is in opposite directions to chest wall. Because the lungs and chest wall are recoiling in opposite directions, the intrapleural pressure becomes negative.

11. Ans: c. Absorption by lymphatics

(Ref. Kendig and chernick's disorders of the respiratory tract in Children 8th edn. pp 977)

Negative intrapleural pressure maintained by pumping out the excessive fluid by lymphatics. The net absorption of fluid by lymphatics is slightly greater than secretory pressure.

12. Ans. b. Chest wall has a tendency to move outward which is balanced by inward recoil of alveoli

(Ref. Ganong's Physiology 24th edn. pp 591)

- Option A: At the end of normal expiration, FRC remains in lungs.
- Option C: Pleural pressure never equal to alveolar pressure, during normal breathing.
- Option D: Inspiratory muscle expands the chest wall.

13. Ans. c. Slow and deep

(Ref. Rhodes Medical Physiology 4th edn. pp 349 and Nelson Textbook of Pediatrics by Robert M Kliegman 19th edn. pp 1421)

In diseases in which airway resistance is increased (asthma), more energy is needed to overcome airway resistance. Slow and deep breathing is most economical in such a situation because of relatively lower flow rate, and greater alveolar inflation is possible without stretching of the airway smooth muscle earlier during inspiration. In diseases of compliance (pulmonary edema), rapid

and shallow breathing is most economical to keep the elastic work at minimum. Because of the stiffer alveoli in such situations, the transpulmonary pressure is transmitted to the airway smooth muscle earlier during inspiration, stimulating the stretch receptors and turning off inspiration.

14. Ans. c. Dynamic compression of airways

(Ref. Rhodes Medical Physiology 4th edn. pp 350)

Forced expiration causes airway compression and increases airway resistance. Because of dynamic compression, collapse occurs at smaller airways (alveoli).

15. Ans. a. 200 mL/cm water

(Ref. Rhodes Medical Physiology 4th edn. pp 343)

Normal lung compliance is about 0.2 L/cm H₂O in adult humans.

16. Ans. b. Type II pneumocytes

(Ref: Ganong's Physiology 24th edn. pp 591)

Note: Clara cell also produces SURFACTANT proteins.

17. Ans. b. Clara cells

(Ref. The Journal of Immunology 2003; 171;2:1051-1060)

Clara cells are known to produce surfactant proteins (SP), such as SP-A, -B, and -D, with critical lung homeostatic functions.

18. Ans. b. Decrease the surface tension of the fluid lining the alveoli

(Ref. Ganong's Physiology 24th edn. pp 591)

By decreasing surface tension, surfactant promotes alveolar stability, prevents atelectasis, keeps alveoli dry and decreases work of breathing.

19. Ans. a. 28 weeks

(Ref: Nelson Textbook of Pediatrics 20th edn. Chapter 8)

- Surfactant production begins by 20–24 weeks. By 22–24 weeks, numerous

lamellar bodies containing surfactant are found inside type II pneumocytes.

- ❑ Surfactant production mature between 35 and 37 weeks.
- ❑ It appears in amniotic fluid between 28 and 32 weeks of gestation.

20. Ans. a. Dipalmitoyl lecithin

(Ref: Ganong's Physiology 24th edn. pp 598)

Surfactant deficiency is an important cause of infant respiratory distress syndrome (IRDS, also known as hyaline membrane disease), the serious pulmonary disease that develops in infants born before their surfactant system is functional. Surfactant is mainly phospholipids mainly dipalmitoylphosphatidylcholine (dipalmitoyl lecithin).

21. Ans. b. Glucocorticoids >> a. thyroxine

(Ref: Maternal, Fetal, and Neonatal Physiology By Susan Blackburn, 4th edn. pp 317)

- ❑ The steroids stimulate (via the fibroblast-pneumocyte factor) production of surfactant phospholipids by alveolar type II cells.
- ❑ Glucocorticoids are the major stimulus for surfactant.
- ❑ Other hormones that stimulate or accelerate lung maturity include thyroid hormones, estradiol, vascular epithelial growth factor, fibroblast growth factor, prolactin, thyrotropin-releasing hormone, catecholamines, TGF- α , and epidermal growth factor.

22. Ans. b. Amount of air

(Ref: Ganong's Physiology 24th edn. pp 595)

- ❑ Compliance is measure of stretchability of lung. Stretchability is measured in term of air entry into the lungs. Compliance is inversely related to elasticity.

23. Ans. a. PaO₂ is maximum at the apex

(Ref: Ganong's Physiology 24th edn. pp 603)

Ventilation is maximum at base of the lungs. Perfusion is maximum at the base of the lungs.

V/Q ratio is maximum at the apex of the lungs.

PO₂ is maximum at the apex.

PCO₂ is maximum at base.

24. Ans. b. High pulmonary arterial pressure CO₂

(Ref: Ganong's Physiology 24th edn. pp 603)

25. Ans. a. Ventilation/perfusion ratio is max at apex

(Ref: Ganong's Physiology 24th edn. pp 603)

26. Ans. b. Phospholipids

(Ref: Ganong's Physiology 24th edn. pp 591)

27. Ans. c. Bohr equation

(Ref: Ganong's Physiology 25th edn. pp 633)

Physiological dead space is measured by Bohr mixing equation.

28. Ans. a. 0.8

(Ref: Basic Physiology for Anaesthetists By Chambers, Huang, & Matthews, pp 71)

The common thinking is that, V.Q will be homogenous as gravity is zero. But that's not the actual situation. In microgravity (zero gravity) situation, there is evidence for reduction in top-to-bottom gradients, but persisting inequality of both ventilation and perfusion persists. So, it is not homogenous (better answer 0.8).

29. Ans. d. Breaks the structure of water in the alveoli

(Ref: Rhodes Medical Physiology 4th edn. pp 347)

The surface of the alveolar membrane is moist and is in contact with air, producing a large air-liquid interface. With air-filled lungs, the gas-liquid interface creates surface tension. Surface tension arises because water molecules are more strongly attracted to one another than to air molecules. In the alveoli, surface tension produces an inwardly directed force that tends to reduce alveolar diameter.

Surfactant (phospholipids) enters in between water molecules and thus breaks the continuous water layer.

30. Ans. d. Reduce surface tension by surfactant

(Ref. *Rhodes Medical Physiology 4th edn.* pp 346)

Surfactant lowers surface tension and stabilizes alveoli at low lung volumes.

31. Ans. b. COPD

(Ref. *Pulm Med.* 2012;2012:542769)

Compliance is increased in obstructive lung disease like pulmonary emphysema, less in asthma and at a minor degree in chronic bronchitis.

32. Ans. a. Apex of lung

(Ref. *Ganong's Physiology 24th edn.* pp 603)

33. Ans: b. TV

(Ref. *Ganong's Physiology 24th ed.* pp 593)

34. Ans. a. Inspiratory reserve volume, tidal volume and expiratory reserve volume

(Ref. *Ganong's Physiology 24th edn.* pp 593)

35. Ans. b. Functional residual capacity

(Ref. *Ganong's Physiology 24th ed.* pp 596)

The relaxation volume is the point where the recoil of the chest and the recoil of the lungs balance. Respiratory muscles are relaxed at this point. The volume inside the lungs is FRC.

36. Ans. b. Residual volume

(Ref. *Ganong's Physiology 24th edn.* pp 593)

37. Ans. b. Functional residual capacity

(Ref. *Ganong's Physiology 24th edn.* pp 599)

N_2 -washout method measure RV, FRC, Anatomical dead space and closing volume of lungs.

38. Ans. c. N_2 breath test

(Ref. *Ganong's Physiology 24th edn.* pp 599)

N_2 -Washout method may be single breath or, multiple breaths. This N_2 -Washout method is also known as Fowler's method.

39. Ans. c. 100 L/min

(Ref. *Ganong's Physiology 25th edn.* pp 629)

Normally MVV: 90-170 L/min (average 100 L/min).

40. Ans: b. Small size bronchioles without cartilage in dependent portion of lung

(Ref. *Ganong's Physiology 25th edn.* pp 633)

During forced expiration, alveoli (small bronchioles) in the lower dependent part of the lung begin to close because of decreased transpulmonary pressure. Volume at which this happens is known as closing volume.

Sometimes the closing capacity is reported. This is the closing volume plus the residual volume.

41. Ans. b. Above residual volume in dependent part of lung

(Ref. *Ganong's Physiology 25th edn.* pp 633)

Closing volume: It is the lung volume above the residual volume at which airway in the lower, dependent parts (base in upright position) of the lungs begin to close off.

42. Ans. c. Lung volume above residual volume at which airways in the lower lungs begins to close off

(Ref. *Ganong's Physiology 25th edn.* pp 633)

Explanation: (See Answer of Q. 41)

43. Ans: a. Inspiratory capacity minus the inspiratory reserve volume

(Ref. *Ganong's Physiology 24th edn.* pp 593)

44. Ans. c. ERV + RV

(Ref. *Ganong's Physiology 24th edn.* pp 593)

45. Ans. b. 0.35

(Ref: Ganong's Physiology 24th edn. pp 593)

Dead space volume = 150 mL

Tidal volume = 500-750 mL

46. Ans. c. 4.2

(Ref: Ganong's Physiology 24th edn. pp 600)

Alveolar ventilation = (TV – dead space) × RR = (500 – 150) × 12 = 4200 mL/min

47. Ans. a. 4900 mL

(Ref: Ganong's Physiology 24th edn. pp 600)

Dead space volume = 150 mL

Alveolar ventilation = (TV – dead space) × RR = (500 – 150) × 14 = 4900 mL/min

48. Ans. a. FRC, c. RV

(Ref: Ganong's Physiology 24th edn. pp 600)

49. Ans. b. Residual volume

(Ref: Ganong's Physiology 24th edn. pp 600)

50. Ans. c. Max. mid respiratory flow rates

(Ref: Rhodes Medical Physiology 4th edn, pp 346)

Max. mid respiratory flow rates (FEF₂₅₋₇₅) limitation illustrates the importance of dynamic airway compression, which is a very sensitive marker of small airway limitations.

51. Ans. c. The pressure in the lungs decreases, but that in the box increases

(Ref: Rhodes Medical Physiology 4th edn, pp 338)

Body plethysmography works on Boyle's law. Inspiration will increase lungs volume but decreases lungs pressure. Opposite changes are seen in the plethysmography box.

52. Ans: a. Increased TLC

(Ref: Harrison's Principles of Internal Medicine 19th edn. pp 306-e5)

Emphysema (COPD): Increased in TLC, FRC, RV and decrease in FEV₁, FVC, FEV₁/FVC ratio.

53. Ans. b. ↑ FEV₁/FVC, ↓ compliance of lung tissue

(Ref: Harrison's Principles of Internal Medicine 19th edn. pp 306-e5)

Restrictive disease: Decrease in TLC, FEV₁, FVC. FEV₁/FVC ratio increases. FRC-normal or, decrease. RV-decrease, normal or, increased.

54. Ans. b. Reduced FEV₁/FVC ratio

(Ref: Harrison's Principles of Internal Medicine 19th edn. pp 306-e5)

FEV₁/FVC ratio increases in all restrictive disease.

55. Ans: b. RV decreased

(Ref: Harrison's Principles of Internal Medicine 19th edn. pp 306-e5)

RV increases in upper airway obstruction.

56. Ans. d. FEV₁ is forced expiratory rate at one minute

(Ref: Harrison's Principles of Internal Medicine 19th edn. pp 306-e5)

FEV₁ is volume expired forcefully at 1 sec.

57. Ans. c. Lung compliance

(Ref: Rhodes Medical Physiology 4th edn. pp 336)
Total lung capacity depends on distensibility of lung.

58. Ans: a. FRC is smaller than closing volume

(Ref: Rhodes Medical Physiology 4th edn. pp 336)

HMD causes decrease in FRC below closing volume level.

59. Ans. a. 2.0

The expiratory reserve volume (ERV) is the maximum extra volume of air that can be

expired by forceful expiration after the end of a normal tidal expiration. ERV is equal to the difference between the functional residual capacity (FRC, 3 L) and the residual volume (RV, 1 L).

60. Ans: c. 3.0

The functional residual capacity (FRC) equals the expiratory reserve volume (2 L) plus the residual volume (1.0 L). This is the amount of air that remains in the lungs at the end of a normal expiration. FRC is considered to be the resting volume of the lungs because none of the respiratory muscles are contracted at FRC.

61. Ans: a. A

When the ventilation is reduced to zero ($V/Q = 0$) alveolar air equilibrates with the mixed venous blood entering the lung, which causes the gas composition of the alveolar air to become identical to that of the blood. This occurs at point A, where the alveolar PO_2 is 40 mm Hg and the alveolar PCO_2 is 45 mm Hg, as shown on the diagram. A reduction in VA/Q (caused by the partially obstructed airway in this problem) causes the alveolar PO_2 and PCO_2 to approach the values achieved when $V/Q = 0$.

62. Ans: d. E

A pulmonary embolism decreases blood flow to the affected lung causing ventilation to exceed blood flow. When the embolism completely blocks all blood flow to an area of the lung, the gas composition of the inspired air entering the alveoli equilibrates with blood trapped in the alveolar capillaries so that within a short time, the gas composition of the alveolar air is identical to that of inspired air. This situation in which VA/Q is equal to infinity

corresponds to point E on the diagram (inspired gas). An increase in V/Q caused by the partially obstructed blood flow in this problem causes the alveolar PO_2 and CO_2 to approach the values achieved when $V/Q = \text{infinity}$.

63. Ans: a. Asbestosis

Asbestosis is a constricted lung disease characterized by diffuse interstitial fibrosis. In constricted lung disease (more commonly called restrictive lung disease), the MEFV curve begins and ends at abnormally low lung volumes, and the flow rates are often higher than normal at any given lung volume, as shown on the diagram. Lung volumes are expected to be higher than normal in asthma, bronchospasm, emphysema, old age, and other instances in which the airways are narrowed or radial traction of the airways is reduced allowing them to close more easily.

64. Ans: b. Emphysema

The loss of alveolar walls with destruction of associated capillary beds in the emphysematous lung reduces the elastic recoil and increases the compliance. Asbestosis are associated with deposition of fibrous tissue in the lungs, which decreases the compliance. Mitral obstruction and rheumatic heart disease can cause pulmonary edema, which also decreases the pulmonary compliance.

65. Ans: d. 4.5

The forced vital capacity (FVC) is equal to the difference between the total lung capacity (TLC) and the residual volume (RV). The TLC and RV are the points of intersection between the abscissa and flow-volume curve, that is, $TLC = 5.5 \text{ L}$ and $RV = 1.0 \text{ L}$. Therefore, $FVC = 5.5 - 1.0 = 4.5 \text{ L}$.

CHAPTER

10

Gaseous Exchange

PHYSICAL PRINCIPLES OF GAS EXCHANGE

Diffusion Capacity of Lung

The diffusion capacity of the lung (D_L) is defined as the volume of gas diffusing across the respiratory membrane in 1 minute when the pressure gradient is 1 mm Hg.

Factors:

$$D_L \propto \frac{\Delta P \times A \times S}{d \times \sqrt{MW}}$$

Where

D_L = Diffusion capacity of the lung

ΔP = Partial pressure difference

A = Area of the membrane

S = Solubility of the gas

MW = Molecular weight of the gas

d = Thickness of the membrane

- $\frac{S}{\sqrt{MW}}$ is called the diffusion coefficient; the diffusion coefficient is entirely based on the characteristic of the gas. This is, the relative rates at which different gases at the same partial pressure diffuses are proportional to their diffusion coefficients.

OXYGEN AND CARBON DIOXIDE EXCHANGE

When gas transported through capillary blood, partial pressure of different gases changes with time. Following diagram (Fig. 10.1) shows this relationship.

I IMPORTANT

Exchange of oxygen and carbon dioxide in alveoli occurs via simple diffusion process.

I IMPORTANT

Diffusion coefficient of the gas determine by solubility and molecular weight together. It determines the relative rates at which different gases at the same partial pressure levels will diffuse.

I IMPORTANT

- ❖ Assuming that the diffusion coefficient for oxygen is 1, the relative diffusion coefficients for different gases are:
- Oxygen = 1
 - Carbon dioxide = 20.3
 - Carbon monoxide = 0.81
 - Nitrogen = 0.53
 - Helium = 0.95

I IMPORTANT

Small molecule or one that is very soluble will diffuse at a fast rate; for example, the diffusion coefficient of carbon dioxide in aqueous solutions is about 20 times greater than that of oxygen because of its higher solubility, even though it is a larger molecule than O_2 .

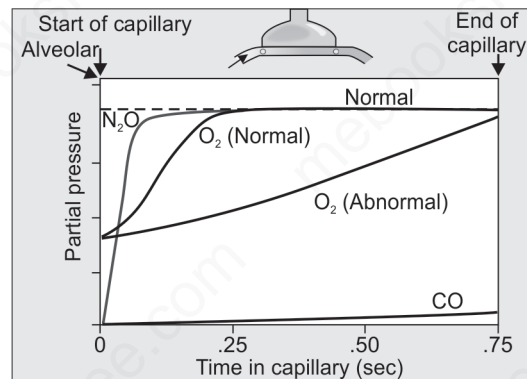

Fig. 10.1: Uptake of N_2O , O_2 and CO in blood relative to their partial pressures and the transit time of the red blood cell in the capillary. For gases that are perfusion limited (N_2O and O_2), their partial pressures have equilibrated with alveolar pressure before exiting the capillary. In contrast, the partial pressure of CO, a gas that is diffusion limited, does not reach equilibrium with alveolar pressure

From the above Diagram

- ❑ An average capillary *transit time through lungs* is 0.75 sec.
- ❑ *Diffusion equilibrium* of oxygen normally occurs between blood and gas in only 0.25 sec, providing a three-fold safety factor.
- ❑ However, if D_L for O_2 is decreased sufficiently with **lung disease (like fibrosis)**, then capillary PO_2 may not equilibrate with P_AO_2 during the transit time (Fig. 10.1: Abnormal O_2 curve).

Perfusion-limited Gas

N_2O is an example. Diffusion equilibrium between alveoli and pulmonary capillary achieves rapidly (plateau, from Fig. 10.1). So, changes in the diffusing capacity have no effect on the uptake of a perfusion-limited gas or its partial pressure in the blood and body. The only way to increase its uptake is to increase the amount of blood flowing through the alveolar capillaries.

Diffusion-limited Gas

CO (carbon monoxide) is an example. CO binds with hemoglobin 210 times faster than oxygen. So, partial pressure of CO in capillary blood does not raised (partial pressure depends on dissolve form, not chemically bound form). Diffusion equilibrium between alveoli and pulmonary capillary never comes (Fig. 10.1). The uptake

of a gas that does not achieve diffusion equilibrium could obviously increase if the diffusing capacity increased.

Measurement of Diffusion Capacity

- ❑ Diffusion capacity of carbon monoxide (D_{LCO}) is taken as an index of diffusion capacity. D_{LO_2} is never measured directly; it is expressed with D_{LCO} as the index.
- ❑ If very low levels of CO are inspired (about 0.1%), then hemoglobin saturation with CO is very low, arterial oxygenation is not disturbed, and there are no toxic effects.
- ❑ In theory, D_{LCO} could be used to calculate the D_L for O_2 by correcting for physical factors that determine diffusing capacity (MW and solubility). However, only D_{LCO} is reported clinically.

Cause of High D_{LCO}

- ❑ Recruitment of blood in alveolar capillary bed:
 - Supine position
 - Hyperdynamic circulation (fever and exercise)
 - Bronchial asthma
 - Muller's maneuver
 - Left to right cardiac shunting
 - Early congestive failure
- ❑ Miscellaneous causes:
 - Polycythemia
 - Alveolar hemorrhage
 - Obesity (cause uncertain)
 - High altitude (due to low FiO_2 , increase binding of CO with Hb)
 - Following bronchodilation in obstructive disease (6% increase)
 - Smoking (within 24 hours)

Cause of Low D_{LCO}

- ❑ Decrease surface area for diffusion:
 - Pulmonary resection
 - Emphysema
 - V/Q mismatch (pulmonary obstruction)
 - Lung fibrosis
- ❑ Alveolar capillary membrane disease:
 - ILD (sarcoidosis, connective tissue disease)
 - Pulmonary vascular disease (embolism, pulmonary hypertension, vasculitis)

I IMPORTANT

- ❖ **Oxygen and carbon dioxide exchange in the lung is perfusion limited.**
- ❖ **The only diffusion-limited gases are CO and O_2 under hypoxic conditions.** Means, all other gases are perfusion limited, including O_2 under normoxic conditions in healthy lungs.

I IMPORTANT

Value

- ❖ $D_{LCO} = 20$ to 30 mL/min/mm Hg (Avg. 25)
- ❖ D_{LCO_2} is 20 times D_{LO_2} (because diffusion coefficient of CO_2 is 20 times more than O_2)
- ❖ D_{LO_2} is 1.23 times D_{LCO}

- Alveolar edema
- Cardiac insufficiency
- ❑ Miscellaneous cause:
 - Anemia
 - Lung cancer

Normal D_{LCO}

- ❑ Chronic bronchitis
- ❑ Cystic fibrosis

GAS TRANSPORT

Symbols that are used:

P: Partial pressure I: Inspired air E: Expired air
 A: Alveolar a: Arterial v: Venous
 \bar{v} : Mixed venous
 e.g. PIO_2 means partial pressure of O_2 in inspired air

Composition of Alveolar Air

	Atmospheric air		Humidified air	Alveolar air	Expired air	
	~ % of total	mm Hg	mm Hg	mm Hg	mm Hg	~ % of total
N_2	78.6	597	563	569	566	75
O_2	20.8	159	149	104	120	16
CO_2	0.04	0.3	0.3	40	27	4
H_2O	0.5	3.7	47	47	47	6

Humidification of the Air

When atmospheric air enters the upper respiratory passages (conducting zone), the fluids that cover the respiratory surfaces humidify it.

- ❑ The partial pressure of water vapor (humidification) at a normal body temperature of $37^\circ C$ is 47 mm Hg.
- ❑ This water vapor dilutes all other gases in alveoli, thus reducing the partial pressure (total pressure 760 mm Hg remains constant). [Note $PO_2 = 149$ mm Hg, less than atmospheric air]

Alveolar Air Oxygen

When air from upper respiratory passage enters the alveoli (exchange zone), partial pressure of oxygen falls further due to high CO_2 in alveolar gas.

Partial pressure of oxygen in alveoli ($P_A O_2$) can be calculated by the following equation:

$$P_A O_2 = (P_{\text{baro}} - P_{H_2O}) \times FiO_2 - \frac{P_A CO_2}{R.Q}$$

Where, P_{baro} = Barometric pressure, P_{H_2O} = Vapor pressure, FiO_2 = Fraction of oxygen in inspiratory air, $P_A CO_2$ = Partial pressure of CO_2 at alveoli, R.Q = Respiratory quotient

- Using the above equation, $P_A O_2 = 100 \text{ mm Hg}$

Physiological Shunt

- Partial pressure of O_2 in **arterial blood** is 95–98 mm Hg, which is less than alveolar oxygen partial pressure of 100 to 104 mm Hg (*see diagram below*).
- This decrease in systemic arterial blood partial pressure is because of physiologic shunt.
- The physiologic shunt is due to mixing of bronchial venous blood (2% of cardiac output) with pulmonary capillaries or veins, which contains purely oxygenated blood.
- Because of this mixing, final partial pressure of O_2 is less than alveolar partial pressure of O_2 [Note: PO_2 of arterial blood 95 mm Hg less than alveolar PO_2 of 100 mm Hg].

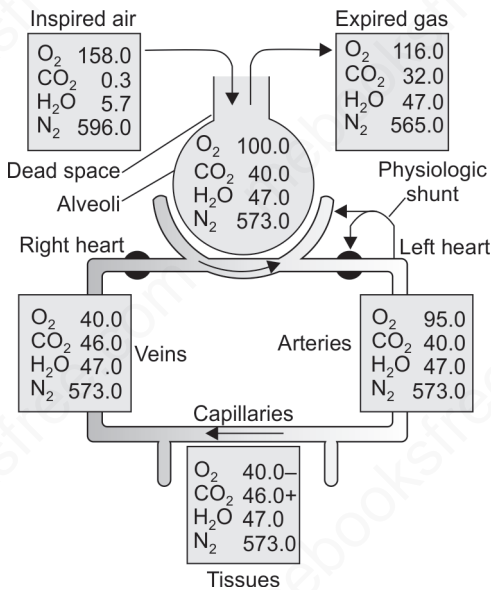

Fig. 10.2: Partial pressures of gases (mm Hg) in various parts of the respiratory system and in the circulatory system

I IMPORTANT

Gaseous exchange at the level of lungs and tissue occurs via simple diffusion process.

O₂ TRANSPORT

Transport occurs via two processes:

- ❑ Hemoglobin bound O₂ (99%)
- ❑ Dissolve O₂ (1%)

Calculation of Hb-Bound O₂: This depends on saturation of Hb (SaO₂/SpO₂) with oxygen. SaO₂ depends on PaO₂

❑ **In arterial blood:**

- At PaO₂ of 95 mm Hg, 97% hemoglobin is saturated with oxygen.
- With this saturation, 1 gm of Hb, contains 1.34 mL of O₂.
- Therefore 100 mL of blood contains 20.1 mL of oxygen (when normal Hb = 15 gm%)
- When hemoglobin is 100% saturated with O₂, hemoglobin binds 1.39 mL O₂ per gm of Hb (This is known as **oxygen capacity** [O₂cap] of Hemoglobin).

❑ **In venous blood:** At PvO₂ of 40 mm Hg, Hb is only 75% saturated (SO₂ = 75%).

❑ Therefore, 100 mL of venous blood would carry 14.4 mL of O₂.

Calculation of Dissolve O₂: This depends on PaO₂.

❑ **In arterial blood:**

- The amount of dissolved O₂ in 100 mL plasma is = (0.003 × mm Hg of PaO₂) [0.003 = physical solubility for O₂ in blood, which is a constant].
- At a PaO₂ of 95 mm Hg, the amount of dissolved O₂ is (0.003 × 95) = 0.28 mL of O₂ in 100 mL arterial blood.

❑ **In venous blood:** At a PvO₂ of 40 mm Hg, the amount of dissolved O₂ is (0.003 × 40) = 0.12 mL of O₂ in 100 mL venous blood.

Calculation of total O₂ carrying capacity of arterial blood (CaO₂) or, O₂ concentration = (Hb-bound + Dissolve) oxygen = (20.1 + 0.28) = 20.3 mL per 100 mL blood.

Calculation of total O₂ carrying capacity of venous blood (CvO₂) or, O₂ concentration = (Hb-bound + Dissolve) oxygen = (14.4 + 0.12) = 14.52 mL per 100 mL blood

Or,

Oxygen concentration of blood can directly calculated by the following formula:

$$CO_2 = \left(O_2 \text{cap} \times \frac{SO_2}{100} \right) + (0.003 \times PO_2)$$

Where CO_2 is the concentration of O_2 in blood (venous or, arterial), $O_2 \text{cap} = O_2$ capacity, $SO_2 =$ saturation, and $0.003 =$ physical solubility for O_2 in blood. [$O_2 \text{cap} = 1.39 \text{ mL}$ when Hb is fully saturated: Explained above].

Oxygen-Hb Dissociation Curve (OHDC)

- ❑ This is a plot of the partial pressure of O_2 and the % saturation of Hb with O_2 . It is normally sigmoid-shaped due to co-operative binding property of hemoglobin.
- ❑ P_{50} : It is the partial pressure of oxygen at which Hb is 50% saturated. In arterial blood, it is 26 mm Hg and in venous blood it is 29 mm Hg.

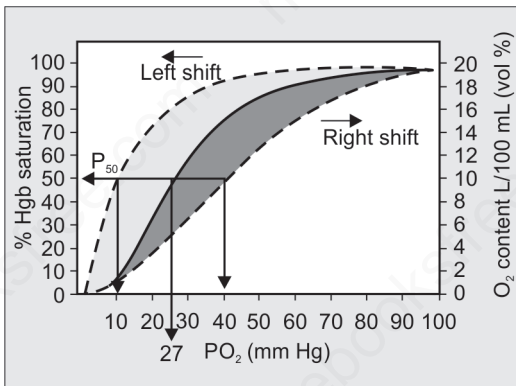

Fig. 10.3: Oxyhemoglobin dissociation curve showing the relationship between the partial pressure of O_2 in blood and the percentage of Hb binding sites that are occupied by oxygen molecules (percent saturation). The P_{50} is the partial pressure at which Hb is 50% saturated with O_2 .

Remembering the following points on the curve:

- ❑ $PO_2 = 0 \text{ mm Hg}$, $SO_2 = 0\%$ (the origin of the curve)
- ❑ $PO_2 = 26 \text{ mm Hg}$, $SO_2 = 50\%$ (P_{50} , defined as the PO_2 at 50% saturation)
- ❑ $PO_2 = 40 \text{ mm Hg}$, $SO_2 = 75\%$ (normal mixed venous blood)
- ❑ $PO_2 = 95 \text{ mm Hg}$, $SO_2 = 97\%$ (normal arterial blood)
- ❑ $PO_2 = 100 \text{ mm Hg}$, $SO_2 = 98\%$ (normal arterial blood, which is almost fully saturated)

I IMPORTANT

Extraction ratio = (Oxygen consumption/oxygen supply)

- ❖ From above calculations, we conclude that 100 mL of arterial blood was carrying ~20.1 mL of O_2 and 100 mL venous blood was carrying ~15 mL of O_2
- ❖ So, 100 mL blood delivers 5 mL of O_2 to the tissues
- ❖ Thus extraction ratio is 25% [Extraction ratio = (Consumption/Supply) $\times 100$]
- ❖ Extraction ratio in exercise can increase.

I IMPORTANT

Respiratory Exchange Ratio

The ratio of CO_2 output to O_2 uptake at any given time whether or not equilibrium, has been reached is called the respiratory exchange ratio (R).

$R =$ Rate of oxygen uptake/Rate of carbon dioxide output

The same ratio in steady state condition is known as respiratory quotient (RQ).

I IMPORTANT

The RQ of:

Carbohydrate = 1.00

Fat = 0.70

Protein = 0.82

Mixed diet = 0.825

I IMPORTANT

Effect of pH on OHDC

- ❖ ↓ pH: Direct effect: Shift to right. Indirectly by decreasing 2,3-DPG, shift to left.
- ❖ ↑ pH: Direct effect: Shift to left. Indirectly by increasing 2,3-DPG, shift to right

I IMPORTANT

Myoglobin: 1 molecule of myoglobin binds 1 molecule of O₂. The shape of O₂ myoglobin dissociation curve (OMDC) is a rectangular hyperbola. It lies to the left of the O₂-Hb dissociation curve.

I IMPORTANT**2,3-DPG and Role in Oxygen Transport**

- ❖ **2,3-DPG increases unloading of oxygen in tissue capillaries.**
- ❖ At the pH prevailing in the erythrocyte, the net charge on the 2,3-DPG molecule is -5 (negative charge). The binding site between the two β-chains of hemoglobin contains eight positively charged amino acid residues side chains contributed by the Val1, His 2, Lys 82, and His 143 of each β chain.
- ❖ The five negative charges of 2,3-DPG find proper positive charges to form salt bridges just under the edge of the central cavity between the two-β-chains.
- ❖ **This site in the central cavity is the only binding site for 2-3 DPG in hemoglobin; therefore, one 2,3-DPG molecule binds per tetramer of hemoglobin.**
- ❖ Deoxyhemoglobin binds 2,3-DPG, oxyhemoglobin does not, because in oxyhemoglobin, the β-subunits are close together, the cleft between them being too small for entry of the 2,3-DPG molecules.

Shift to the right means:

If the OHDC is shifted to the right, it means that the affinity of Hb for O₂ has become less (which favors O₂ delivery) and P₅₀ has increased.

Factors causing rightshift:

- ↓ pH
- ↑ CO₂
- ↑ in temperature
- ↑ in 2,3-DPG

Increases 2,3-DPG caused by:

- Exercise
- High altitude
- Anemia
- Alkalosis
- Inosine, pyruvate, phosphate
- Thyroid hormones, growth hormone, androgens,
- Hypoxia

Factors Causing Left Shift

- Bank blood (stored blood) → 2,3-DPG is decreased (acidic solution inhibits 2,3-DPG formation)
- Fetal Hb: Gamma chains (rather than beta) do not bind 2,3-DPG; hence, it has a greater affinity for O₂
- CO poisoning: Partial saturation of Hb with CO shifts the OHDC curve of the remainder Hb to left. Curve becomes less sigmoid shaped.
- Hypothermia, alkalosis, hypocapnia.

Bohr Effect

- The effect of carbon dioxide and hydrogen ions on hemoglobin's affinity for oxygen is known as the Bohr effect.
- There is a decrease in O₂ affinity of Hb with a decrease in pH.
- Rightward shift of the oxygen equilibrium curve resulting from a rise in blood carbon dioxide and hydrogen ions is Bohr effect.

Effects of Carbon Monoxide (CO) and Anemia on Blood-O₂ Equilibrium Curves

Anemia (when, 7.5 g/dL total hemoglobin) decreases O₂ concentration but does not change the shape of the

curve. CO poisoning (7.5 g/dL hemoglobin available for O_2 binding) decreases O_2 concentration and shifts the curve to the left. P_vO_2 must decrease to maintain the arterial-venous O_2 concentration difference.

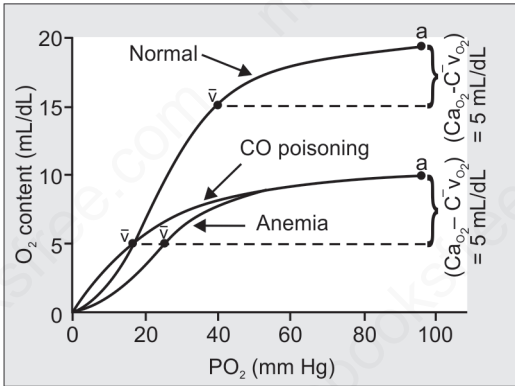

Fig. 10.4: Effects of carbon monoxide (CO) and anemia on blood- O_2 equilibrium curves

I IMPORTANT

Double Bohr Effect

This occurs in placenta because Bohr effect occurs both in maternal as well as fetal tissue.

Carbon Monoxide

The affinity of Hb for CO is 240 times greater than it is for O_2 , so even very small amounts of CO greatly reduce the capacity of hemoglobin to bind O_2 . It has following effects:

- ❑ Decreases the O_2 carrying capacity, or maximum height of the concentration curve (Fig. 10.4).
- ❑ Decreases the P_{50} and makes the Hb- O_2 curve less sigmoidal.
- ❑ Left shift of the curve by altering the ability of the hemoglobin molecule to bind O_2 .
- ❑ It has direct effects on cellular cytochromes, but the amount of CO required to poison the cytochromes is 1000 times the lethal dose; tissue toxicity thus plays no role in clinical CO poisoning.
- ❑ CO poisoning does not stimulates peripheral chemoreceptors.
- ❑ Hyperbaric O_2 exposure is used to treat CO poisoning.

CO₂ TRANSPORT

- ❑ The total CO_2 concentration of arterial blood is ~48 mL/dL.

- ❑ As blood courses through the systemic capillary beds, it picks up ~4 mL/dL of CO₂, so that the total CO₂ of mixed-venous blood is ~52 mL/dL.

In what forms does blood carry this incremental 4 mL/dL of CO₂ to the lungs?

- ❑ Dissolved CO₂: ~10%
- ❑ As HCO₃⁻: ~68%
- ❑ As carbamino compounds: ~22%

In blood, ~11% of total CO₂ remains in blood plasma and ~89% enters the RBCs.

	Plasma (~11%)	RBC (~89%)	Total in blood
Dissolve CO ₂	5%	5%	10%
As carbamino compounds	1%	21%	22%
As HCO ₃ ⁻	5%	63%	68%

- ❑ **Carbamino compounds:**

- **In plasma**-CO₂ combined with plasma proteins.
- **In RBC**-CO₂ combined with hemoglobin (Hb).
- Carbamino compound more in RBC because Hb concentration (33 g/dL) higher than plasma protein (8 g/dL) and Hb forms carbamino compound easily than plasma protein.

- ❑ **As HCO₃⁻**: Once CO₂ diffuses through the tissue and enters plasma, it quickly dissolves. The reaction of CO₂ with H₂O to form carbonic acid (H₂CO₃) provides the major pathway for the generation of HCO₃⁻ in red blood cells.



- ❑ This reaction normally proceeds quite slowly; however, RBC contains high level of enzyme carbonic anhydrase (CA), which accelerate the conversion (5000 times). The HCO₃⁻ diffuses out of the RBC in exchange for Cl⁻ via anion exchanger (AE1). The process is known as **chloride shift or, Hamburger shift (Fig. 10.5)**.
- ❑ The free H⁺ is quickly buffered within the RBC by binding to Hb. Buffering of H⁺ ion is critical to keep the reaction moving toward the synthesis of HCO₃⁻.

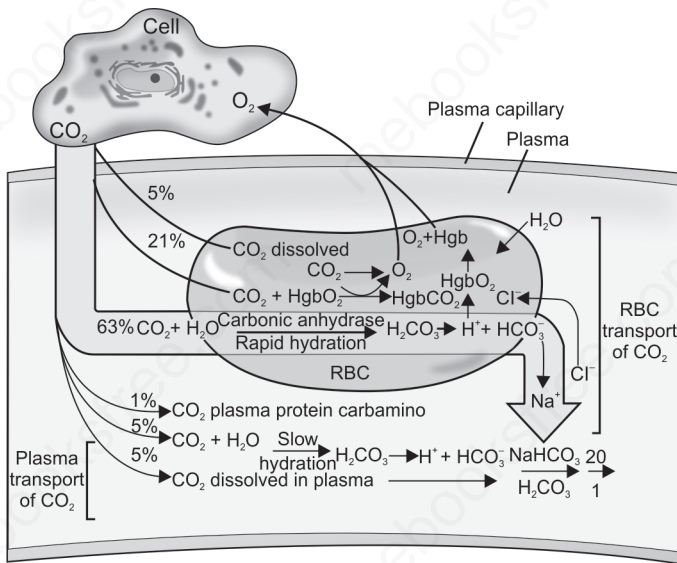

Fig. 10.5: Mechanisms of CO₂ transport in blood

When mixed-venous blood reaches the pulmonary capillaries, CO₂ moves from the RBC and blood plasma into the alveolar air space. All of the reactions discussed earlier reverse. In the process, Cl⁻ and H₂O leave the RBC, and the cells shrink.

The binding of oxygen with hemoglobin in the pulmonary capillary tends to displace CO₂ from the blood. This effect is called the *Haldane effect*, which is quantitatively far more important in promoting carbon dioxide transport than is the Bohr effect in promoting oxygen transport.

The Haldane effect results from the simple fact that the combination of O₂ with Hb in the lungs causes the Hb to become a stronger acid. This displaces CO₂ from the blood and into the alveoli in two ways:

- ❑ The more highly acidic Hb has less tendency to combine with CO₂ to form carbaminohemoglobin.
- ❑ The increased acidity of the Hb also causes it to release an excess of H⁺ ions, and these bind with HCO₃⁻ ions to form carbonic acid; this then dissociates into water and CO₂, and the CO₂ is released from the blood into the alveoli.

I IMPORTANT

Because H₂O enters the cell during the HCO₃⁻ formation, RBC swells as they pass through systemic capillary. So, PCV of venous blood is 3% higher than arterial blood.

Significance of the Haldane Effect on the Transport of CO_2 from the Tissues to the Lungs

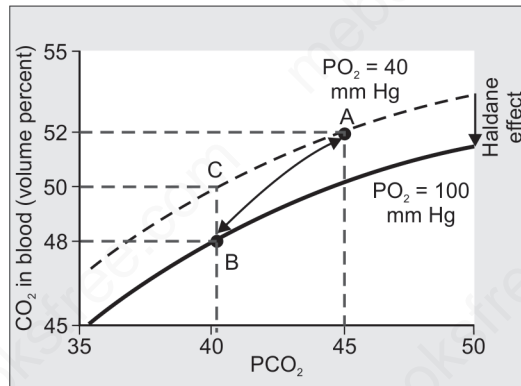

Fig. 10.6: Portions of the carbon dioxide dissociation curve when the PO_2 is 100 mm Hg or 40 mm Hg. The arrow represents the Haldane effect on the transport of carbon dioxide, as discussed in the text

Figure 10.6 shows two CO_2 dissociation curves: (a) when the PO_2 is 100 mm Hg (capillaries of the lungs) and (b) when the PO_2 is 40 mm Hg (tissue capillaries).

- ❑ **Point A (at tissue):** Normal PCO_2 of 45 mm Hg causes 52 volumes % of CO_2 to combine with the blood.
- ❑ **Point B (at lungs):** Because of Haldane effect CO_2 dissociation curve shifts to the lower curve. Normal PCO_2 of 40 mm Hg in lungs causes fall of CO_2 content to 48 volumes %.
- ❑ So, total loss of 4 volume % CO_2 (52 minus 48).
- ❑ **Point C (at lungs):** In absence of Haldane effect if the CO_2 dissociation curve did not shift because of the Haldane effect, the CO_2 content of the blood would fall only to 50 volumes %, which would be a loss of only 2 volumes % of CO_2 .

Thus because of Haldane effect, an additional 2 volumes % loss of CO_2 occurs in lungs. Thus, the Haldane effect approximately doubles the amount of CO_2 released from the blood in the lungs and approximately doubles the pickup of CO_2 in the tissues.

HYPOXIA

- ❑ **Hypoxia:** O_2 deficiency at the tissue level.
- ❑ **Hypoxemia:** Decrease partial pressure of oxygen (PaO_2) in arterial blood.

Four categories of hypoxia are:

- ❑ **Hypoxic hypoxia:** The PO_2 of the arterial blood is reduced.
- ❑ **Anemic hypoxia:** Arterial PO_2 is normal but the amount of hemoglobin available to carry O_2 is reduced.
- ❑ **Stagnant or ischemic hypoxia:** Blood flow to a tissue is so low that adequate O_2 is not delivered to it despite a normal PO_2 and hemoglobin concentration.
- ❑ **Histotoxic hypoxia:** Amount of O_2 delivered to a tissue is adequate but, because of the action of a toxic agent, the tissue cells cannot make use of the O_2 supplied to them.

	Hypoxic hypoxia	Anemic hypoxia	Stagnant or ischemic hypoxia	Histotoxic hypoxia
Causes	High altitudes, pneumonia, pulmonary fibrosis, ventilation-perfusion imbalance, venous-to-arterial shunts	Anemia, CO poisoning, methemoglobinemia	Slow circulation (heart failure), shock, hemorrhage	Cyanide poisoning
PaO_2	Low	Normal	Normal	Normal
PvO_2	Low	Low	Low	High
(a-v) PO_2	Decreased	Increased	Increased	Decreased
Dissolve O_2 content of arterial blood	Decreased	Normal	Normal	Normal
Hb-bound O_2 content	Decreased	Decreased	Normal	Normal
Peripheral chemoreceptor	Stimulated	Not stimulated	Stimulated	Stimulated
Central chemoreceptor	Stimulated if associated high CO_2	Not stimulated	Not stimulated	Not stimulated
Cyanosis	Present	Rare	Present	Never present

Oxygen Treatment of Hypoxia

- ❑ **Not useful for:** Stagnant, anemic, and histotoxic hypoxia and hypoxic hypoxia due to shunting of unoxygenated venous blood past the lungs.

I IMPORTANT

- ❖ Hypoxic hypoxia is the most common form of hypoxia seen clinically.
- ❖ The most common cause of hypoxic hypoxia is ventilation-perfusion mismatch.
- ❖ Arterial-venous (a-v) oxygen difference increased in stagnant hypoxia (diagnostic); but decreased in histotoxic hypoxia (diagnostic).

I IMPORTANT

- ❖ The blood flow to peripheral chemoreceptor is very high (~2000 mL/100 g/min). Because of this enormous blood flow, the O_2 needs of the cells can be met largely by dissolved O_2 alone. Therefore, the receptors are not stimulated in conditions such as anemia or carbon monoxide poisoning, in which the amount of dissolved O_2 in the blood is generally normal.

I IMPORTANT**Cyanosis**

- ❖ Cyanosis is a bluish color of mucous membranes and/or skin.
- ❖ Cyanosis detecting threshold for various form of hemoglobin in capillary blood:
 - Deoxyhemoglobin ≥ 4 gm/dL
 - Methemoglobin ≥ 1.5 gm/dL
 - Sulfhemoglobin ≥ 0.5 gm/dL.
- ❖ In some instances, central cyanosis can be detected reliably when the SaO_2 has fallen to 85%; in others, particularly in dark-skinned persons, it may not be detected until it has declined to 75%.

- ❑ In other forms of **hypoxic hypoxia**, O_2 is of great benefit.
- ❑ **Hyperbaric O_2 therapy:** Demonstrated value in carbon monoxide poisoning, radiation-induced tissue injury, gas gangrene, very severe blood loss anemia, diabetic leg ulcers and other wounds that are slow to heal, and rescue of skin flaps and grafts in which the circulation is marginal. It is also the primary treatment for decompression sickness and air embolism.

MULTIPLE CHOICE QUESTIONS

GASEOUS EXCHANGE AND TRANSPORT

RECENT MCQs

1. Oxygen saturation of venous blood is:

[Dec 2016]

- a. 25% b. 50%
c. 75% d. 100%

2. Partial pressure for O₂ at sea level:

[Dec 2016]

- a. 100 mm Hg
b. 150 mm Hg
c. 160 mm Hg
d. 40 mm Hg

3. Compliance increased in all *except*:

- a. Pulmonary fibrosis
b. Emphysema
c. Old age
d. Increased surfactant

4. What will be the effect of sodium fluoride on oxygen dissociation curve?

- a. Right shift
b. Left shift
c. No effect on curve
d. Initial right then left shift

5. Arterial blood gas of 5-year-old: pH-7.4, PaO₂-100 mm Hg, pCO₂-40 mm Hg; child being ventilated at 80% O₂, what will be (A-a) pO₂ (mm Hg)?

- a. 570.4 b. 520.4
c. 470.4 d. 420.4

6. At altitude of 6500 metre, atmosphere pressure is 347 mm hg. Inspired O₂ will be (mm Hg):

- a. 83 b. 73
c. 63 d. 53

7. Normal diffusion of CO₂ at rest:

- a. 20-25 mL/min b. 50-100 mL/min
c. 100-200 mL/min d. 300-400 mL/min

8. Diffusion of gas in respiratory membrane:

[UP 07]

- a. Directly proportional to thickness of respiratory
b. No lipid - water solubility
c. Inversely proportional to pressure gradient
d. Inversely proportional to molecular weight of the gas

9. Difference in the amount of O₂ inspired and CO₂ expired:

- a. 20 mL/min b. 50 mL/min
c. 75 mL/min d. 100 mL/min

10. PO₂ over 8 kPa is (Hb saturation):

- a. 60% b. 70% [Manipal 08]
c. 80% d. 90%

11. Arterial blood O₂ in mL of O₂ per dL of blood:

- a. 12 b. 19.8
c. 15.6 d. 27.8

12. Dissolved oxygen is not dependent on:

- a. Hb
b. Atmospheric pressure
c. Alveolar pressure
d. Arterial tension of O₂

13. Oxygen carrying capacity of blood is largely determined by:

[Manipal 08]

- a. Hb level
b. Amount of CO₂ in blood
c. Acidosis
d. Plasma concentration

14. Percentage of O₂ carried in chemical combination:

- a. 97% b. 3%
c. 66% d. 33%

15. Venous blood with high hematocrit is seen in:

- a. RBC high chloride
b. Plasma high Na
c. Plasma high HCO₃⁻
d. RBC high K

16. False about the O₂ dissociation curve:

- a. Sigmoid curve
b. Combination of the first heme in the Hb molecule with O₂ increases the affinity of the second heme for O₂
c. Increase in pH shifts curve to right
d. Fall in temperature shifts curve to left

17. Which of these is not a cause of rightward shift of oxygen-hemoglobin dissociation curve?

- a. Increased hydrogen ions
b. Decreased CO₂
c. Increased temperature
d. Increased BPG

18. Increase in P50 in oxygenation curve is due to decrease in:

- a. pH b. Oxygen
c. Temperature d. CO₂

19. Haldane effect is:

- a. pH changes with CO₂ transport
b. Binding of CO₂ to hemoglobin reduces its affinity for O₂
c. Binding of O₂ to hemoglobin reduces its affinity for CO₂
d. Shift of Cl⁻ ion for HCO₃⁻ ion

20 Haldane effect:

- a. Effect of 2,3-BPG
b. Dissociation of CO₂ on oxygenation

- c. Dissociation of O₂ on addition of CO₂
d. Chloride shift

21. Increased oxygen delivery to tissues in response to increased CO₂ is:

- a. Bohr effect
b. Haldane effect
c. Hamburger effect
d. Chloride shift

AIIMS/PGI/JIPMER**22. Transport of carbon monoxide (CO) is diffusion limited because:**

[AIIMS Nov 09]

- a. High affinity of CO for haemoglobin
b. Alveolar membrane is less permeable to CO
c. CO crosses epithelial barrier slowly
d. On exposure to air there is sudden increase in partial pressure

23. CO₂ is primarily transported in the arterial blood as:

[UP 08, Comed 07, AI 05]

- a. Dissolved CO₂
b. Carbonic acid
c. Carbaminohemoglobin
d. Bicarbonate

24. CO₂ diffuses more easily through the respiratory membrane than O₂ because it is:

[AIIMS Nov 10]

- a. Less dense
b. More soluble in plasma
c. Less molecular weight
d. Less PCO₂ in the alveoli

25. Least amount of CO₂ is in:

[JIPMER 04]

- a. Anatomical dead space-end inspiration phase
b. Anatomical dead space-end expiration phase
c. Alveoli-end inspiration phase
d. Alveoli-end expiration phase

26. Mouth-to-mouth respiration provides an oxygen concentration of: [AI 94]

- a. 16% b. 20%
c. 22% d. 24%

27. The fraction of inspired air in mouth-to-mouth respiration is: [AI 96]

- a. 0.16 b. 0.19
c. 0.21 d. 0.26

28. Arterial carbon dioxide level:

[PGI June 04]

- a. 40 mm Hg b. 37 mm Hg
c. 45 mm Hg d. 60 mm Hg
e. 42 mm Hg

29. O_2 , which is about 21% of inspired air, exerts a partial pressure of:

[JIPMER 10]

- a. 160 mm Hg b. 240 mm Hg
c. 580 mm Hg d. 760 mm Hg

30. One intern calculated the concentration of O_2 in blood as 0.0025 mL/mL of blood. Considering atmospheric pressure as 760 mm Hg, how much approx. O_2 tension could have been in the blood? [AI 04]

- a. 40 mm Hg b. 60 mm Hg
c. 80 mm Hg d. 100 mm Hg

31. O_2 delivery to tissues depends on all, except: [AIIMS May 07]

- a. Cardiac output
b. Type of fluid administered
c. Hemoglobin concentration
d. Affinity of hemoglobin for O_2

32. Which of the following statement(s) is/are true about Hb- O_2 dissociation curve? [PGI Dec 08]

- a. Fetal Hb shifts curve to left
b. Hypothermia shifts curve to left
c. Hypercarbia shifts curve to left
d. Left shift cause more O_2 release to tissue

33. O_2 delivery to tissue is decreased by:

[PGI Dec 03]

- a. Decreased hemoglobin level
b. Decreased PaO_2
c. Increased $PaCO_2$
d. Increased HCO_3^-
e. Increased pH

34. Fetal hemoglobin has higher affinity for oxygen due to: [AIIMS May 09]

- a. Decreased 2,3-DPG concentration
b. Reduced pH
c. Increased release of carbon dioxide
d. Oxygen dissociation curve is shifted to right

35. An increase in which of the following parameters will shift the O_2 dissociation curve to the left: [AI 03]

- a. Increased temperature
b. Increased partial pressure of CO_2
c. Increased 2,3-DPG concentration
d. Increased oxygen affinity of hemoglobin

36. Oxygen affinity is increased by all of the following except: [AI 95]

- a. Alkalosis b. Hypoxia
c. Increased HbF d. Hypothermia

37. The factor responsible for the left shift of Hb- O_2 dissociation curve is:

[AIIMS June 99]

- a. Increase in 2,3-DPG in RBC
b. Fall in temperature
c. Fall in pH
d. Increase level of CO_2 blood

38. All of the following factors influence hemoglobin dissociation curve, except:

[AIIMS May 06]

- a. Chloride ion concentration
b. CO_2 tension
c. Temperature
d. 2,3-DPG levels

39. O₂ dissociation curve is shifted to right in all except: [AIIMS Dec 98]

- a. Hypercapnea
- b. Rise in temperature
- c. Raised 2,3-DPG level
- d. Metabolic alkalosis

40. True about Hb dissociation curve is: [PGI June 98]

- a. Acidosis shifts O₂ dissociation curve to right
- b. Increased CO₂ shifts the curve to left
- c. Hypoxia shifts curve to left
- d. 2,3-DPG has no effect on curve

41. Oxygen dissociation curve shifts to right in all except: [AI 00]

- a. Diabetic ketoacidosis
- b. Blood transfusion
- c. High altitude
- d. Anemia

42. During exercise increase in O₂ delivery to muscles is because of all except: [AI 00]

- a. Oxygen dissociation curve shifts to left
- b. Increased stroke volume
- c. Increased extraction of oxygen from the blood
- d. Increased blood flow to muscles

43. True regarding conversion of deoxyhemoglobin to oxyhemoglobin is: [AIIMS May 02]

- a. Binding of O₂ causes release of H⁺
- b. One mole of deoxyhemoglobin binds two moles of 2,3-DPG
- c. pH of blood has no affect on the binding of O₂
- d. Binding of O₂ causes increased binding of 2,3-DPG

44. Decreased glycolytic activity impairs oxygen transport by hemoglobin due to: [AI 03]

- a. Reduced energy production
- b. Decreased production of 2-3-bisphosphoglycerate
- c. Reduced synthesis of hemoglobin
- d. Low levels of oxygen

45. In hyperventilation: [PGI June 07]

- a. p50 and Hb affinity for O₂ increases
- b. p50 and Hb affinity for O₂ decreases
- c. p50 increases and O₂ affinity decreases
- d. p50 decreases and O₂ affinity increase
- e. No change

46. Hemoglobin unlike myoglobin shows [PGI June 98]

- a. Sigmoid curve of oxygen dissociation
- b. Positive cooperativity
- c. Hills coefficient of one
- d. None of the above

47. The oxygen hemoglobin dissociation curve is sigmoid because: [AI 09]

- a. Binding of one oxygen molecule increases the affinity of binding other O₂ molecules
- b. Binding of one oxygen molecule decrease the affinity of binding other O₂ molecules
- c. Oxygen affinity of hemoglobin decreases when the pH of blood falls
- d. Binding of oxygen to hemoglobin reduces the affinity of Hb for CO₂

48. Transport of carbon monoxide (CO) is diffusion limited because: [AIIMS Nov 09]

- a. High affinity of CO for hemoglobin
- b. Alveolar membrane is less permeable to CO

- c. CO crosses epithelial barrier slowly
- d. On exposure to air there is sudden increase in partial pressure

49. Which of the following does not occur as the blood passes through systemic capillaries? [AIIMS Nov 07]

- a. Increased protein content
- b. Shift of hemoglobin dissociation curve to left

- c. Increased hematocrit
- d. Decreased pH

50. The normal value of P50 on the oxy-hemoglobin dissociation curve in an adult is: [AIIMS Nov 04]

- a. 1.8 kPa
- b. 2.7 kPa
- c. 3.6 kPa
- d. 4.5 kPa

HYPOXIA AND CYANOSIS

RECENT MCQs

51. Arterial O₂ content is reduced in one of the following

- a. Stagnant hypoxia
- b. Anemic hypoxia
- c. Histotoxic hypoxia
- d. Ischemic hypoxia

52. Oxygen therapy is least useful in:

- a. Anemia
- b. ARDS
- c. Alveolar damage
- d. COPD

AIIMS/PGI/JIPMER

53. Anemic hypoxia is due to: [AI 96]

- a. Decreased PO₂ in arterial blood
- b. Increased PO₂ in arterial blood
- c. Increased PCO₂ in arterial blood
- d. Decreased O₂ content in arterial blood

54. Carbon monoxide poisoning is a type of: [Jipmer 11]

- a. Anemic hypoxia
- b. Histotoxic hypoxia
- c. Hypoxic hypoxia
- d. Stagnant hypoxia

55. Which of the following conditions leads to tissue hypoxia without alteration of oxygen content of blood? [AIIMS May 05]

- a. CO poisoning
- b. Met Hb
- c. Cyanide poisoning
- d. Respiratory acidosis

56. In which of the following a reduction in arterial oxygen tension occurs? [AI 05]

- a. Anemia
- b. CO poisoning
- c. Moderate exercise
- d. Hypoventilation

57. Which of the following variants of hypoxia does not stimulate peripheral chemoreceptors? [AI 97]

- a. Hypoxic hypoxia
- b. Anaemic hypoxia
- c. Stagnant hypoxia
- d. Histotoxic hypoxia

58. Tachycardia is caused by hypoxia due to: [AIIMS Dec 98]

- a. Reflexly through peripheral chemoreceptors
- b. Diffuse vasodilation
- c. Through central chemoreceptor
- d. Secondarily after by hyperventilation

59. Hypoxemia independent of:

[AIIMS Nov 10]

- a. FiO_2
- b. Altitude
- c. Hb
- d. PaCO_2

60. Toxic effects of high oxygen tension include all of the following except:

- a. Pulmonary edema [AI 07]
- b. Decreased cerebral blood flow
- c. Retinal damage
- d. CNS excitation and convulsion

61. Hyperbaric oxygen is dangerous because it:

[PGI Dec 99]

- a. Decreases displacement of O_2 from kHb
- b. Decreases respiratory drive
- c. Enzyme damage
- d. Is toxic to tissues

62. Concentration of methemoglobin to cause cyanosis:

[PGI June 07]

- a. 5 gm/dL
- b. 2 gm/dL
- c. 1.5 gm/dL
- d. 12 gm/dL

63. Central cyanosis is seen if:

[PGI June 01]

- a. Methemoglobin 0.5 gm/dL
- b. O_2 saturation < 85%
- c. O_2 saturation < 94%
- d. Hb-4 gm%

64. Cyanosis does not occur in severe anemia because:

[AI 09]

- a. Hypoxia stimulates erythropoietin production

- b. Oxygen carrying capacity of available Hb is increased
- c. Critical concentration of Hb required to produce cyanosis is reduced
- d. Oxygen hemoglobin curve shift to the right

65. Condition where severe hypoxemia occurs without cyanosis:

[PGI June 04]

- a. CO poisoning
- b. High altitude
- c. Anemia
- d. Interstitial lung disease
- e. Pulmonary AV malformation

66. Cyanosis in trauma is interpreted as:

[AIIMS Nov 10]

- a. Early sign of hypoxia
- b. Late sign of hypoxia
- c. Absence of cyanosis means adequate tissue ventilation
- d. Absence of cyanosis means adequate tissue oxygenation

67. Regarding carbon monoxide toxicity true are A/E:

[PGI June 08]

- a. Cytochrome toxicity is lethal
- b. Treated by 5% CO_2
- c. PO_2 is decreased
- d. Shift HbO_2 dissociation curve to left
- e. Gaseous vasodilator

68. Regarding carbon monoxide poisoning, wrong statement:

[AI 12]

- a. Oxygen dissociation curve shifted to right
- b. Oxygen dissociation curve shifted to left
- c. COHb is formed
- d. Hyperbaric oxygen can be used

FUTURE TRENDS

69. Which of the point on the following figure represent arterial blood in severely anemic person?

- Point E
- Point B
- Point C
- Point D

Answer questions number 70-72 with the help of following diagrams.

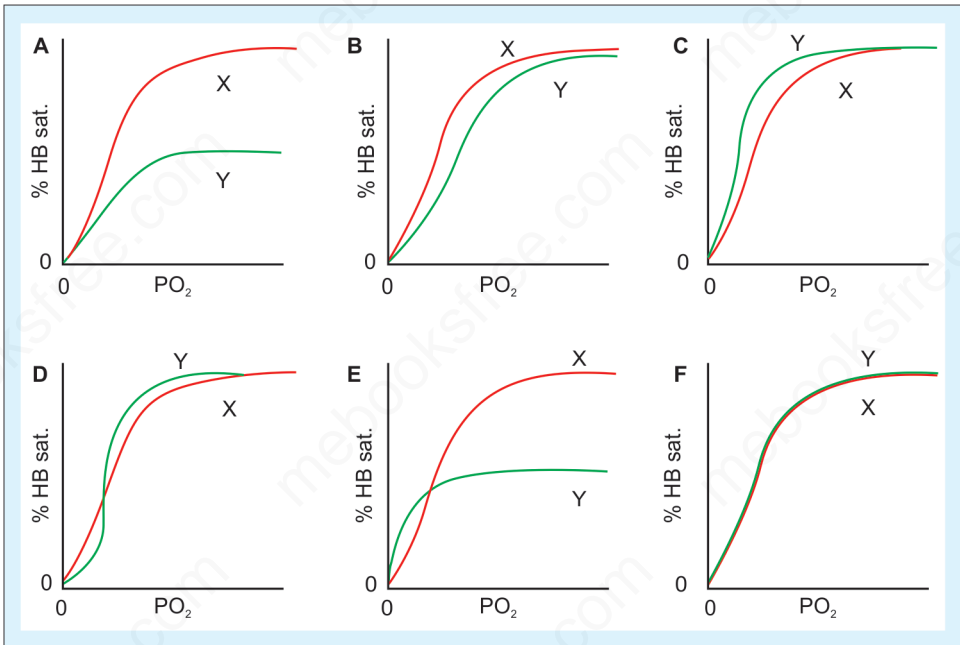
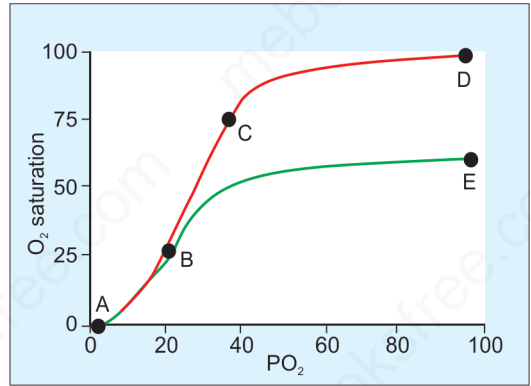

70. Which of the diagram below oxygen-hemoglobin dissociation curves corresponds to normal blood (X-line) and blood containing carbon monoxide (Y-line)?

- B
- C
- D
- E

71. Which of the following oxygen-hemoglobin dissociation curves corresponds to blood during resting conditions (X-line) and blood during exercise (Y-line)?

- a. A
- b. B
- c. C
- d. D

72. Which of the following oxygen-hemoglobin dissociation curves corresponds to blood from an adult (X-line) and blood from a fetus (Y-line)?

- a. A
- b. B
- c. C
- d. D

ANSWERS WITH EXPLANATIONS

1. Ans. c. 75%

(Ref. Guyton-Physiology-13th edn. pp 530)

PO₂ of systemic arterial blood is about 95 mm Hg and O₂ saturation averages 97% percent. Conversely, in normal venous blood, the PO₂ is about 40 mm Hg, and the saturation of hemoglobin averages 75%.

2. Ans. c. 160 mm Hg

(Ref. Guyton-Physiology-13th edn. pp 519)

At sea level with an atmospheric pressure of 760 mm Hg, percentage of O₂ is approx. 21%. So, partial pressure of oxygen = (760 × 21/100) = 159.6 mm Hg

3. Ans. a. Pulmonary fibrosis

(Ref. Ganong's Physiology 24th edn. pp 631)

Compliance is reduced in lung fibrosis.

4. Ans. c. No effect on curve

(Ref. Harper's Biochemistry 30th edn. pp. 171)

Using Sodium Fluoride (NaF) it totally arrests glycolysis by inhibiting the enzymes. So, glucose is neither used for anaerobic glycolysis or Rappaport Leubering cycle. NaF is used to decrease glucose utilization. So it don't have any effect on ODC by affecting the level of 2,3-BPG.

5. Ans. d. 420.4 mmHg

(Ref. Ganong's Physiology 24th edn. pp 634)

Alveolar O₂

$$P_A O_2 = (760 - P_{H_2O}) F_i O_2 - \frac{P_A CO_2}{0.8}$$

Here,

$$P_A CO_2 = 40, F_i O_2 = 80\% = 0.8 \quad P_{H_2O} = 47$$

$$\text{So, } P_A O_2 = (760 - 47) \cdot 0.8 - \frac{40}{0.8}$$

$$= 570.4 - 50 = 520.4 \text{ mm Hg}$$

PaO₂ = 100 mm Hg (given)

$$\therefore (P_A - P_a) O_2 = (520.4 - 100)$$

$$= 420.4 \text{ mm Hg}$$

6. Ans. c. 63 mm Hg

(Ref. Ganong's Physiology 24th edn. pp 634)

Total pressure = 347

$$P_{H_2O} = 47$$

$$P_{O_2} = (760 - 47) \cdot 0.8 - \frac{40}{0.8}$$

$$= 300 \cdot \frac{21}{100} = 63 \text{ mm H}_2\text{O}$$

7. Ans. d. 300-400 mL/min

(Ref. Ganong's Physiology 24th edn. pp 612)

Normal diffusion of CO₂ is 200 mL/min and O₂ diffusion is 250 mL/min in normal lungs.

8. Ans. d. Inversely proportional to molecular weight of the gas

(Ref: Rhodes Medical Physiology 4th edn, pp 357)

Explanation in text.

9. Ans: b. 50 mL/min

(Ref: Ganong's Physiology 24th edn. pp 612)

The lungs take up 250 mL of O₂ per minute and 200 mL CO₂ expired through lungs in one minute (That's why diffusion capacity of O₂ is 250 mL/min and CO₂ is 200 mL/min).

10. Ans. d. 90%

(Ref: Ganong's Physiology 24th edn. pp 610)

1 kPa = 7.5 mm Hg. So, 8 kPa = 60 mm Hg

From OHD curve:

When

- PO₂ = 0 mm Hg, SO₂ = 0%
- PO₂ = 100 mm Hg, SO₂ = 98%
- PO₂ = 40 mm Hg, SO₂ = 75% (normal mixed venous blood)
- PO₂ = 26 mm Hg, SO₂ = 50% (P50, defined as the PO₂ at 50% saturation)

So, saturation will be higher than 75% (Its exactly 89%).

11. Ans. b. 19.8

(Ref: Ganong's Physiology 24th edn. pp 610)

12. Ans. a. Hb

(Ref: Ganong's Physiology 24th edn. pp 610)

The amount of dissolved O_2 is a linear function of the PO_2 (0.003 mL/dL blood/mm Hg PO_2).

13. Ans. a. Hb level

(Ref: Ganong's Physiology 24th edn. pp 610)

99% of arterial oxygen is carried by Hemoglobin, only 1% in the form of dissolved oxygen.

14. Ans. a. 97%

(Ref: Ganong's Physiology 24th edn. pp 610)

99% of arterial oxygen is carried by hemoglobin (chemical bound), only 1% in the form of dissolved oxygen.

15. Ans. a. RBC high chloride

(Ref: Ganong's Physiology 24th edn. pp 613)

Although the HCO_3^- content of RBC is high in venous blood than plasma, most of these HCO_3^- leaves the RBC in exchange with Cl^- . This exchange process is known as chloride shift. Because of this chloride shift, the Cl^- content of the red cells in venous blood is significantly greater than that in arterial blood. The chloride shift occurs rapidly and is essentially complete within 1 s.

High chloride, increases osmotic tension of venous blood RBC, the red cells take up water and increase in size. So, the hematocrit of venous blood is normally 3% greater than that of the arterial blood.

16. Ans. c. Increase in pH shifts curve to right

(Ref: Ganong's Physiology 24th edn. pp 611)

Increase in pH (alkalosis) shifts the curve to left. Although alkalosis increases 2,3-DPG-production and increase 2,3-DPG can shift

the curve left, this is an indirect effect of alkalosis.

Option B: This property is known as cooperative binding character of Hb (reason for sigmoid curve).

17. Ans. b. Decreased CO_2

(Ref: Ganong's Physiology 24th edn. pp 611)

Increased CO_2 causes right shift, not decrease.

18. Ans. a. pH >> b. Oxygen

(Ref: Ganong's Physiology 24th edn. pp 611)

P_{50} is the PO_2 at which hemoglobin is half saturated with O_2 . The higher the P_{50} , the lower the affinity of hemoglobin for O_2 . Increase P_{50} indicates right shift of the OHD-Curve.

So, decrease pH (acidosis) causes right shift.

[Note: Decrease oxygen (hypoxia) also causes right shift, but that is due to increased 2,3-DPG production, not direct effect.]

19. Ans. c. Binding of O_2 to hemoglobin reduces its affinity for CO_2

(Ref: Ganong's Physiology 24th edn. pp 612)

Option b: Its Bohr effect. The decrease in O_2 affinity of hemoglobin when the pH of blood falls (increased CO_2) is called the Bohr effect (occurs in body tissue).

Haldane effect: Binding of O_2 to hemoglobin reduces its affinity for CO_2 (occurs in lungs).

20. Ans. b. Dissociation of CO_2 on oxygenation

(Ref: Ganong's Physiology 24th edn. pp 612)

Explained in Q. no. 19.

21. Ans. a. Bohr effect

(Ref: Ganong's Physiology 24th edn. pp 611)

Increased CO_2 , decreases the O_2 affinity of hemoglobin. This leads to more oxygen delivery to tissue (right shift of OHD-curve).

22. Ans. a. High affinity of CO for haemoglobin

(Ref. Johnson's Essential Medical Physiology, 3rd edn. pp 304)

Diffusion-limited gas: CO is an example. CO binds with hemoglobin 210 times faster than oxygen. So, partial pressure of CO in capillary blood does not raised (partial pressure depends on dissolve form, not chemically bound form). Diffusion equilibrium between alveoli and pulmonary capillary never comes. The uptake of a gas that does not achieve diffusion equilibrium could obviously increase if the diffusing capacity increased.

23. Ans. d. Bicarbonate

(Ref. Ganong's Physiology 24th edn. pp 612)

About 68-70% CO₂ transported as HCO₃⁻ form.

24. Ans. b. More soluble in plasma

(Ref. Rhodes Medical Physiology 4th edn, pp 357)

Diffusion coefficient is one of the determinants of gas transfer rate. The diffusion coefficient of a gas is directly proportional to its solubility and inversely related to the square root of its molecular weight (MW) of the gas.

Therefore, a small molecule or one that is very soluble will diffuse at a fast rate; for example, the diffusion coefficient of carbon dioxide in aqueous solutions is about 20 times greater than that of oxygen because of its higher solubility, even though it is a larger molecule than O₂.

25. Ans. a. Anatomical dead space-end inspiration phase

(Ref. Medical Physiology by WF Boron and EL Boulpaep 2nd edn. Chapter 31)

Alveolar CO₂ is more than anatomical dead space, because there is always diffusion of CO₂ at the level of alveoli. This results in a

steady increase in alveolar PCO₂ towards the end of expiration.

At end of inspiration, where atmospheric air enters into the alveoli; diluting alveolar CO₂.

Anatomical dead space CO₂ at end inspiration is equal to atmospheric CO₂, which is very low (0.3 mm Hg).

At the end expiration, phase the CO₂ from the alveoli comes to the anatomical dead space and its concentration is increased.

So, maximum CO₂: Alveolar gas-end expiration (similar to arterial PCO₂).

Minimum CO₂: Anatomical dead space-end inspiration (similar to atmospheric air PCO₂).

26. Ans. a. 16%

(Ref. Guyton-Physiology-13th edn. pp 394)

Mouth to mouth breathing deliver oxygen, which is equal to expiratory air oxygen. Oxygen content of expiratory air = 16%.

27. Ans. a. 0.16

(Ref. Guyton-Physiology-13th edn. pp 394)

28. Ans. a. 40 mm Hg

(Ref. Guyton-Physiology-13th edn. pp 394)

29. Ans. a. 160 mm Hg

(Ref. Guyton-Physiology-13th edn. pp 394)

Partial pressure = (P_{baro} × % of Gas) = (760 × 21/100) = ~160 mm Hg

30. Ans. c. 80 mm Hg

(Ref. Ganong's Physiology 24th edn. pp 610)

The amount of dissolved O₂ in 100 mL plasma is = (0.003 × mm Hg of PaO₂) [0.003 = physical solubility for O₂ in blood, which is a constant].

In this examples, calculated dissolve O₂ = 0.0025 mL/mL of blood = 0.25 mL/100 mL blood.

So, PaO₂ = (0.25/0.003) = 83.33 mm Hg

31. Ans. b. Type of fluid administered

(Ref. Ganong's Physiology 24th edn. pp 610)

Amount of oxygen delivered to tissue is mainly carried by hemoglobin; dissolve oxygen is very small in amount. So, changing the fluid will affect only the dissolve oxygen content, not the hemoglobin bound oxygen.

32. Ans. a. Fetal Hb shifts curve to left, b. Hypothermia shifts curve to left

(Ref. Ganong's Physiology 24th edn. pp 611)

33. Ans. a. Decreased haemoglobin level, d. Increased HCO_3^- , e. Increased pH

(Ref. Ganong's Physiology 24th edn. pp 611)

Right shift causes increased delivery of oxygen to tissue. Increased PaCO_2 causes right shift. All others options in question, are causes of left shift.

34. Ans. a. Decreased 2,3-DPG concentration

(Ref. Ganong's Physiology 24th edn. pp 611)

2,3-BPG is very plentiful in red cells. It is a highly charged anion that binds to the β chains of deoxyhemoglobin. One mole of deoxyhemoglobin binds 1 mol of 2,3-BPG.

Fetal Hb does not binds 2,3-DPG because of its gamma chains.

35. Ans. d. Increased oxygen affinity of hemoglobin

(Ref. Ganong's Physiology 24th edn. pp 611)

36. Ans. b. Hypoxia

(Ref. Ganong's Physiology 24th edn. pp 611)

Hypoxia causes right shift by increasing 2,3-DPG productions.

37. Ans. b. Fall in temperature

(Ref. Ganong's Physiology 24th edn. pp 611)

38. Ans. a. Chloride ion concentration

(Ref. Ganong's Physiology 24th edn. pp 611)

39. Ans. d. Metabolic alkalosis

(Ref. Ganong's Physiology 24th edn. pp 611)

Metabolic acidosis causes left shift of OHD-curve. But alkalosis also increases 2,3-DPG productions, which can causes right shift (indirect effect).

40. Ans. a. Acidosis shifts O_2 dissociation curve to right

Hypoxia via increased 2,3-DPG productions, shifts the curve to right.

41. Ans. b. Blood transfusion

(Ref. Textbook of Blood Banking and Transfusion Medicine by Sally V Rudmann. pp 266)

Transfusion of stored blood shifts the curve to left.

42. Ans. a. Oxygen dissociation curve shifts to left

(Ref. Ganong's Physiology 24th edn. pp 611)

Exercise has been reported to produce an increase in 2,3-BPG within 60 mins, although the rise may not occur in trained athletes. The P_{50} is also increased during exercise, because the temperature rises in active tissues and CO_2 and metabolites accumulate, lowering the pH. In addition, much more O_2 is removed from each unit of blood flowing through active tissues because the tissues' PO_2 declines. Finally, at low PO_2 values, the oxygen-hemoglobin dissociation curve is steep, and large amounts of O_2 are liberated per unit drop in PO_2 .

43. Ans. a. Binding of O_2 causes release of H^+

(Ref. Ganong's Physiology 24th edn. pp 611)

Oxyhemoglobin is a stronger acidic molecule than deoxyhemoglobin.

One molecule of 2,3-DPG binds with one molecule of deoxygenated hemoglobin.

44. Ans. b. Decreased production of 2-3-bisphosphoglycerat

(Ref: Ganong's Physiology 24th edn. pp 611)

"2,3-BPG is very plentiful in red cells. It is formed from 3-phosphoglyceraldehyde, which is a product of glycolysis via the Embden-Meyerhof pathway."

45. Ans. d. p50 decreases and O₂ affinity increase

(Ref: Ganong's Physiology 24th edn. pp 611)

Hyperventilation washes out CO₂ from body, leading to alkalosis. So, OHD curve will shift to left (high affinity), decreasing P50 of hemoglobin.

46. Ans. a. Sigmoid curve of oxygen dissociation

b. Positive cooperativity

(Ref: Ganong's Physiology 24th edn. pp 611 and Concise Biochemistry

By A Bezkorovainy, Max E. Rafelson. pp163)

Myoglobin is an iron-containing pigment found in skeletal muscle. It resembles hemoglobin but binds 1 rather than 4 mol of O₂ per mole. Its dissociation curve is a rectangular hyperbola rather than a sigmoid curve. Because its curve is to the left of the hemoglobin curve, it takes up O₂ from hemoglobin in the blood.

Hill coefficient determines the binding of a ligand to a macromolecule.

Hill coefficient > 1: Positive cooperative binding, means once one ligand molecule is bound to the enzyme, its affinity for other ligand molecules increases (e.g. Hemoglobin = 2.8).

Hill coefficient < 1: Negatively cooperative binding: Once one ligand molecule is bound to the enzyme, its affinity for other ligand molecules decreases.

Hill coefficient = 1: Noncooperative binding (e.g. Myoglobin = 1).

47. Ans. a. Binding of one oxygen molecule increases the affinity of binding other O₂ molecules

(Ref: Ganong's Physiology 24th edn. pp 611 and Concise Biochemistry by A Bezkorovainy and Max E Rafelson. pp 163)

Hemoglobin shows positive co-operative binding. [See explanation above].

48. Ans. a. High affinity of CO for hemoglobin

(Ref: Johnson's Essential Medical Physiology, 3rd edn. pp 304)

[Check explanation of question number 16].

49. Ans. b. Shift of hemoglobin dissociation curve to left

(Ref: Ganong's Physiology 24th edn. pp 611)

At the level of tissue, high CO₂ and low pH shifts the OHD-curve to the right; thus releasing more oxygen to tissue.

Because of small amount of fluid filtration into tissue, protein concentration increases a little.

50. Ans. c. 3.6 kPa

(Ref: Ganong's Physiology 24th edn. pp 610)

Normal P50 of Hemoglobin = 23 to 27 mm Hg (avg 26 mm Hg). 1 kPa = 7.500617 mm Hg.

51. Ans. b. Anemic hypoxia

(Ref: Ganong's Physiology 24th edn. pp 621, Figure)

Oxygen content is reduced because of less Hb content in blood. In all other given options in questions, oxygen content of arterial blood remains constant.

52. Ans. a. Anemia

(Ref: Ganong's Physiology 24th edn. pp 621)

"Administration of oxygen-rich gas mixtures is of very limited value in hypoperfusion, anemic, and histotoxic hypoxia because all that can be accomplished in this way is an increase in the amount of dissolved O₂

in the arterial blood. This is also true in hypoxic hypoxia when it is due to shunting of unoxygenated venous blood past the lungs. In other forms of hypoxic hypoxia, O_2 is of great benefit."

53. Ans. d. Decreased O_2 content in arterial blood

(Ref: *Ganong's Physiology 24th edn.* pp 621, Figure)

In anaemic hypoxia, PaO_2 remains normal.

54. Ans. a. Anemic hypoxia

(Ref: *Ganong's Physiology 24th edn.* pp 621)

Carbon monoxide poisoning is often listed as a form of anemic hypoxia because the amount of hemoglobin that can carry O_2 is reduced, but the total hemoglobin content of the blood is unaffected by CO.

55. Ans. c. Cyanide poisoning

(Ref: *Ganong's Physiology 24th edn.* pp 622)

Hypoxia due to inhibition of tissue oxidative processes is most commonly the result of cyanide poisoning. Cyanide inhibits cytochrome oxidase and possibly other enzymes. Because of this, tissue can't utilize oxygen. So, oxygen content of arterial blood remains same and venous blood oxygen increases compared to normal.

56. Ans. d. Hypoventilation

(Ref: *Ganong's Physiology 24th edn.* pp 620)

The underventilated alveoli have a low alveolar P_AO_2 , which decreases the PaO_2 .

In CO poisoning, anaemia and during mild to moderate exercise PaO_2 remains normal.

57. Ans. b. Anemic hypoxia

(Ref: *Ganong's Physiology 24th edn.* pp 629)

The blood flow in each 2 mg carotid body (chemoreceptor) is very high (~2000 mL/100 g/min). Because the blood flow per unit of tissue is so enormous, the O_2 needs of the cells can be met largely by dissolved O_2 alone. Therefore, the receptors are not

stimulated in conditions such as anemia or carbon monoxide poisoning, in which the amount of dissolved O_2 in the blood reaching the receptors is generally normal, even though the combined O_2 in the blood is markedly decreased.

So, except anemic type hypoxia, all others hypoxia stimulates chemoreceptors (peripheral).

58. Ans. d. Secondarily after by hyperventilation

(Ref: *Berne & Levy Physiology, 6th Updated Edn- Bruce M Koeppen* pp 373)

Stimulation to chemoreceptor by hypoxia causes hyperventilation (respiratory effect-main effect). The respiratory system mediates secondary reflex effects. The respiratory stimulation by arterial chemoreceptors tends to inhibit the medullary vagal center. This inhibition varies with the level of concomitant stimulation of respiration; small increases in respiration inhibit the vagal center slightly, whereas large increases in ventilation inhibit the vagal center more profoundly. Vagal centre inhibition results in tachycardia.

59. Ans. c. Hb

(Ref: *Clinical Methods: The History, Physical, and Laboratory Examinations.* 3rd edn. H K Walker)

Hypoxemia: Decrease in partial pressure of oxygen in arterial blood.

Hypoxia: Decrease amount of oxygen in tissue level.

Partial pressure of oxygen in arterial blood (PaO_2) does not depend on chemical bound oxygen (Hb-bound), it only depends on dissolve oxygen.

60. Ans. NONE. Single best ans: b. Decreased cerebral blood flow

(Ref: *Ganong's Physiology 24th edn.* pp 622)

❑ Oxygen toxicity: Respiratory passages irritation, inflammation, and pulmonary

edema. It also produces substernal distress, nasal congestion, sore throat, and coughing.

- ❑ Some infants treated with O_2 develop bronchopulmonary dysplasia, retinopathy of prematurity (retrolental fibroplasia). It can also lead to muscle twitching, ringing in the ears, dizziness, convulsions, and coma.
- ❑ 100% oxygen inhalation causes arterial vasoconstriction with an associated small (10%–15%) reduction in cerebral blood flow (CBF) (Ref: *American Journal of Neuroradiology* 2008;29:663–667).

61. Ans. c. Enzyme damage, d. Is toxic to tissues

(Ref. *Ganong's Physiology* 24th edn. pp 622)

100% O_2 has been demonstrated to exert toxic effects not only in animals but also in bacteria, fungi, cultured animal cells, and plants. The toxicity seems to be due to the production of reactive oxygen species including superoxide anion (O_2^-) and H_2O_2 .

62. Ans. c. 1.5 gm/dL

(Ref. *Clinical Methods: The History, Physical, and Laboratory Examinations*. 3rd edn. HK Walker)

Deoxy (reduced) hemoglobin for cyanosis ≥ 5 gm/dL

Methemoglobin producing cyanosis ≥ 1.5 gm/dL

Sulfhemoglobin producing cyanosis ≥ 0.5 gm/dL.

63. Ans. b. O_2 saturation < 85%

(Ref. *Clinical Methods: The History, Physical, and Laboratory Examinations*. 3rd edn. HK Walker)

If one assumes a normal cardiac output, hemoglobin, and tissue extraction of O_2 , an arterial O_2 saturation of ~80% would be required to cause cyanosis.

64. Ans. c. Critical concentration of Hb required to produce cyanosis is reduced

(Ref. *Clinical Methods: The History, Physical, and Laboratory Examinations*. 3rd edn. HK Walker)

In anemic patients, when hemoglobin level is very low, much more profound decreases in tissue oxygen levels are required to produce 5 gm/dL of deoxyhemoglobin in capillary blood, which is generally not possible.

65. Ans. None

(Ref. *Ganong's Physiology* 24th edn. pp 622)

If the question is hypoxia (Not hypoxemia) without cyanosis, then answers: a. CO poisoning, c. Anemia

Cyanosis is rare in anemic hypoxia. Cyanosis is also not seen due to the cherry-red color of COHb visible in the skin.

66. Ans. b. Late sign of Hypoxia

(Ref. *International trauma life support* 6th edn. JE Campbell)

“Cyanosis is an extremely late sign of hypoxaemia and may not appears at all.”

67. Ans. a. Cytochrome toxicity is lethal, c. PO_2 is decreased

(Ref. *Ganong's Physiology* 24th edn. pp 621)

CO is also toxic to the cytochromes in the tissues, but the amount of CO required to poison the cytochromes is 1000 times the lethal dose; tissue toxicity thus plays no role in clinical CO poisoning.

Ventilation with O_2 is preferable for treatment. Sometime 5% CO_2 and 95% O_2 is used, rather than pure oxygen. Hyperbaric oxygenation is also useful in this condition.

Vasodilator effect of CO is similar to NO (nitric oxide).

68. Ans. a. Oxygen dissociation curve shifted to right

(Ref: Ganong's Physiology 24th edn. pp 621)

69. Ans. d. Point D

When a person is anemic, there is a decrease in O_2 content. The oxygen saturation of hemoglobin in the arterial blood and the arterial oxygen partial pressure are not affected by the hemoglobin concentration of the blood.

70. Ans. d. E

Carbon monoxide (CO) combines with hemoglobin at the same point on the hemoglobin molecule as oxygen and therefore can displace oxygen from the hemoglobin, reducing the oxygen saturation of hemoglobin. Because CO binds with hemoglobin (to form carboxyhemoglobin) with about 250 times as much tenacity as oxygen, even small amounts of CO in the blood can severely limit the oxygen carrying capacity of the blood. The presence of carboxyhemoglobin also shifts the oxygen dissociation curve to the left (which means that oxygen binds

more tightly to hemoglobin), which further limits the transfer of oxygen to the tissues.

71. Ans. b. B

In exercise, several factors shift the oxygen-hemoglobin curve to the right with normal saturation of arterial blood. These factors include increased quantities of carbon dioxide released from the muscle fibers, increased hydrogen ion concentration in the muscle capillary blood, and increased temperature resulting from heat generated by the exercising muscle.

72. Ans. c. C

Structural differences between fetal hemoglobin and adult hemoglobin make fetal hemoglobin unable to react with 2,3 diphosphoglycerate (2,3-DPG) and thus to have a higher affinity for oxygen at a given partial pressure of oxygen. The fetal dissociation curve is thus shifted to the left relative to the adult curve. Typically, fetal arterial oxygen pressures are low, and hence the leftward shift enhances the placental uptake of oxygen.

REGULATION OF RESPIRATION (FIG. 11.1)

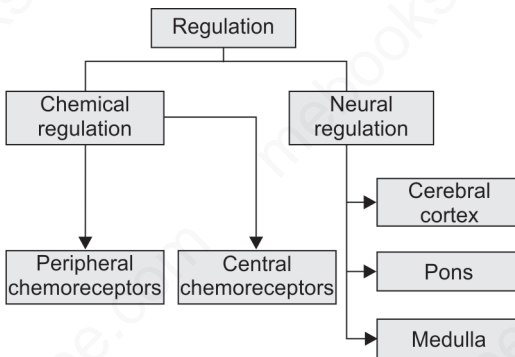

Fig. 11.1: Regulation of respiration by chemoreceptors and different neural centers

- ❑ **The chemoreceptors for chemical control are the:**
 1. Peripheral chemoreceptors located in the carotid and the aortic bodies. Carotid body is the main peripheral chemoreceptor.
 2. Central chemoreceptors situated just beneath ventral surface of the medulla.

Peripheral Chemoreceptors

- ❑ **Respond to:** An increase in CO_2 ($\uparrow\text{PaCO}_2$) and H^+ (acidosis) and a decrease in O_2 ($\downarrow\text{PaO}_2$) in arterial blood.
- ❑ **Sensor cell:** The type I glomus cells inside chemoreceptors are the sensor cells, which respond directly to hypoxia. They have O_2 -sensitive K^+ channels.
- ❑ **Blood flow:** Both chemoreceptors have highest blood flow in body (2000 mL/min/100 gm of tissue).

Because of this, O_2 needs of these cells can be met by dissolve O_2 only (does not respond to anemic hypoxia).

❑ **Mechanism of Activation (Fig. 11.2):**

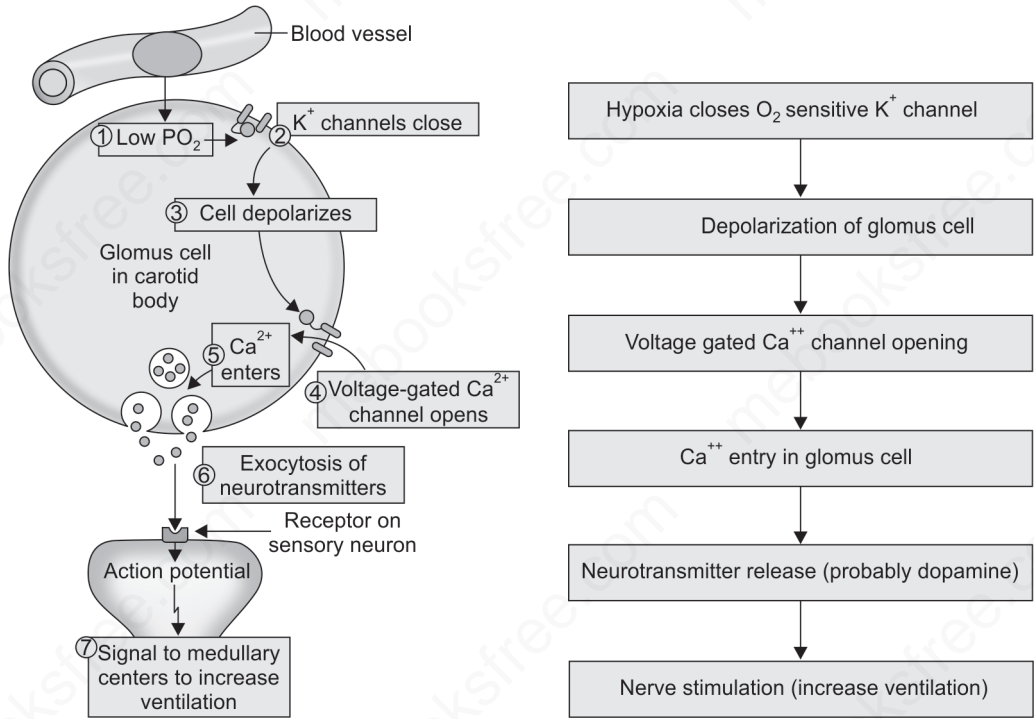

Fig. 11.2: Mechanism of chemoreceptor (glomus cell) activation

Central Chemoreceptors

- ❑ The central chemoreceptors (neurons) project directly to the respiratory centers.
- ❑ They respond to increase H^+ ion of CSF or, ISF of medulla. But increase blood H^+ ions (acidosis) fail to stimulates central chemoreceptor (because BBB does not allow charged ions)
- ❑ Blood CO_2 can influence these central chemoreceptors indirectly by getting converted into H^+ (Fig. 11.3). *By virtue of this, CO_2 is able to act on both central (70–80% of the effect of CO_2) as well as on peripheral (20–30% of the effect of CO_2) chemoreceptors.*
- ❑ Hypoxia also cannot stimulate central chemo-receptors; rather they are depressed by hypoxia.

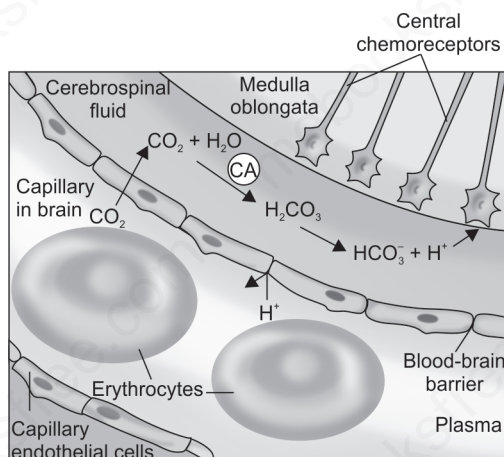

Fig. 11.3: Central chemoreceptor activation by CO_2 via production of H^+ ions

Ventilatory Response to CO_2

The link between metabolism and ventilation is CO_2 and not O_2 . There is a **linear** relationship between respiratory minute volume and alveolar PCO_2

Ventilatory Response to O_2 Lack (Fig. 11.4)

The relationship is not linear.

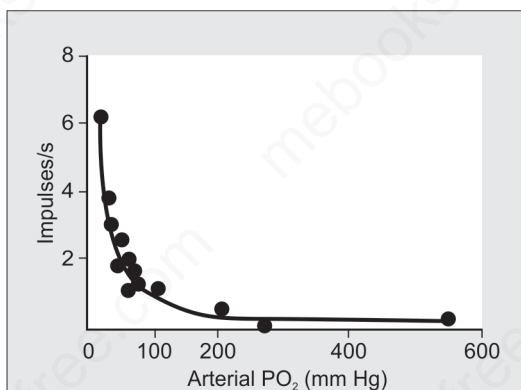

Fig. 11.4: Effect of PO_2 on afferent nerve firing. The rate of discharge of a single afferent fiber from the carotid body is plotted at several PO_2 (circles) and fitted to a line

There is no increase in ventilation till the P_AO_2 (alveolar PO_2) becomes less than 60 mm Hg. The reasons for this lack of response are:

I IMPORTANT

- ❖ Carotid and aortic bodies can also be **strongly stimulated by cyanide ion** but **not stimulated** by anemia or, CO poisoning.
- ❖ **Primary stimulus** for peripheral chemoreceptor is hypoxia.
- ❖ When all gas parameter are normal, increased PaCO_2 stimulates ventilation more than hypoxia. (Increased PaCO_2 is the **most sensitive stimulus**).

I IMPORTANT

- ❖ **Primary stimulus** for central chemoreceptor is H^+ ion of CSF or, ISF of medulla.
- ❖ **Most sensitive stimulus** for central chemoreceptor is increased PaCO_2 .

- ❑ Hb is a weaker acid than HbO₂; therefore with less O₂, there is more Hb, which by being weaker acid tends to inhibit the ventilation.
- ❑ Also, as ventilation increases, the CO₂ that is washed out counters the increase in ventilation.

Ventilatory Response to CO₂ and O₂ (Fig. 11.5)

- ❑ This exhibits a complex relationship, the effect of CO₂ excess and O₂ lack is **more than** additive. If one were to plot a curve between CO₂ and ventilation at different fixed O₂ levels, one would get a fan of curves. The slope of the curve (between CO₂ and ventilation) would increase significantly with decreased O₂ levels.

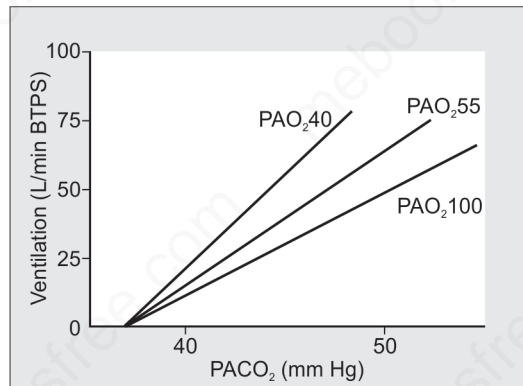

Fig. 11.5: Fan of lines showing CO₂ response curves at various fixed values of alveolar PO₂. Decreased P_aO₂ results in a more sensitive response to P_aCO₂.

I IMPORTANT

- ❖ Apnoea point: PaCO₂ lower than 37 mm Hg causes temporary cessation of respiration.

- ❑ The intersection of this fan of curves is at one single point (~PaCO₂ = 37 mm Hg). PaCO₂ lower than this value will cause temporary cessation of respiration (**apnoea point**).
- ❑ Since this point of intersection is below the normal value of P_ACO₂ of 40 mm Hg, it shows that there is normally a slight but definite CO₂ drive of the respiratory center.

Ventilatory Response to H⁺ and CO₂

The effect is simply additive.

Effect Baroreceptors Stimulation

Inhibits respiration; the effect is almost of no physiologic importance.

Effect of Sleep

There is a decrease in sensitivity to CO_2 during slow wave sleep; during REM sleep, there is even further decrease in sensitivity to CO_2 .

Voluntary hyperventilation:

- It raises alveolar and arterial PO_2 and lower PCO_2 . This fall in PCO_2 that is responsible for the depression in respiration that follows hyperventilation. This may cause apnoea.
- Breathing pure oxygen raises the alveolar PO_2 even more markedly than hyperventilation, it does not depress respiration. (Recall, hypoxia is a stimulus for respiration. So, high oxygen should depress, but it does not).
- On the other hand, if hyperventilation is performed while breathing 5% carbon dioxide so that alveolar PCO_2 does not fall, respiration is not depressed after the hyperventilation (hyperventilation continues).
- Both these experimental observations indicate that depression of respiration following hyperventilation is due only to the washing out of carbon dioxide and not due to rise in PO_2 .

NEURAL REGULATION OF RESPIRATION

1. Automatic control: Brainstem (upper medulla and pons)
2. Voluntary control: Cerebral cortex.

Pre-Bötzing complex (pre-BÖTC): Known as pace-maker cells of respiration or, central pattern generator.

- ❑ Located on either side of the medulla between the nucleus ambiguus and the lateral reticular nucleus.
- ❑ These neurons discharge rhythmically, and they produce rhythmic discharges in phrenic motor neurons.
- ❑ Neurons in the pre-Bötzing complex have neurokinin1 (NK-1) and μ -opioid receptors that are responsive to the neurotransmitter, substance P and opioids.
- ❑ *In-vivo*, substance P stimulates and opioids inhibit respiration. Depression of respiration is a side effect that limits the use of opioids in the treatment of pain.
- ❑ However, it is now known that 5HT_4 receptors are present in the pre-Bötzing complex and treatment with 5HT_4 agonists blocks the inhibitory effect of opiates on respiration in experimental animals, without inhibiting their analgesic effect.

I IMPORTANT

- ❖ In the disease process of COPD, the normal CO_2 -sensitive chemoreceptors become less sensitive leading to high arterial levels of CO_2 and low levels of O_2 (retention of CO_2).
- ❖ Therefore, for the person with COPD, the stimulus to breathe is low arterial levels of oxygen (Hypoxia) acting via peripheral chemoreceptor.

I IMPORTANT

- ❖ The main components of the respiratory control pattern generator responsible for automatic respiration are located in the medulla, which is known as Pre-Bötzing complex.

I IMPORTANT

Breath-Holding

- ❖ The breaking point is the point at which breathing can no longer be voluntarily hold or, inhibited (because of increase in CO_2 and decrease in O_2)
- ❖ Breath holding can be prolonged by
 - Removal of carotid bodies
 - Breathing 100% O_2 before breath holding
 - Hyperventilating room air (because of the initial \downarrow in CO_2 of arterial blood)
 - Encouragement

I IMPORTANT

- ❖ VRG contains three regions that performs specific functions:
 - Rostral VRG: known as Bötzinger complex: Expiratory neurons.
 - Intermediate VRG: Pre-Bötzinger complex: inspiratory neurons generate respiratory rhythm.
 - Caudal VRG: Expiratory neurons
- ❖ So, pre-Bötzinger complex is a part of VRG.

I IMPORTANT

- ❖ Major inhibitory neurotransmitters of CNS, GABA and glycine, are not necessary for rhythm generation.
- ❖ Glutamate is the major excitatory neurotransmitter within the central pattern generator..

I IMPORTANT

- ❖ Pneumotaxic center is primarily to limit inspiration by inhibiting apneustic center. So, a secondary effect of increasing the rate of breathing.

DRG AND VRG

Dorsal and ventral groups of respiratory neurons (DRG and VRG) are present in the medulla. However, lesions of these neurons do not abolish respiratory activity, and they apparently project to the pre-Bötzinger pacemaker neurons.

- ❑ DRG contains mainly I (inspiratory neurons) neurons and is part of the nucleus of the solitary tract (or nucleus tractus solitarius, NTS).
- ❑ *The afferent input from arterial chemoreceptors and lung mechanoreceptor synapses on neurons in the NTS near the DRG.*
- ❑ So, major function of DRG is integration of sensory information from respiratory system.
- ❑ VRG is a column of neurons that fire action potentials in phase with respiration.
- ❑ It includes neurons depolarizing during inspiration (I neurons) and expiration (E neurons).
- ❑ All of these respiratory centers are bilaterally symmetrical on the right and left sides of the brainstem.

PONTINE INFLUENCES

Modify pacemaker neurons, but not essential for respiration.

Pneumotaxic Center

Control rate of breathing.

- ❑ Located in the medial parabrachial and Kölliker-Fuse nuclei of the dorsolateral pons.
- ❑ Contains both E neurons and I.
- ❑ The normal function of the pneumotaxic center is unknown, but it may play a role in smooth switching between inspiration and expiration (“fine-tune” the breathing).
- ❑ A strong pneumotaxic signal can increase the rate of breathing 30–40 breaths per minute, whereas a weak pneumotaxic signal may reduce the rate to only 3–5 breaths per minute.

Apneustic Center

- ❑ An area in the in caudal (lower part) pons, control depth of breathing by stimulating inspiratory neurons of pre-Bötzinger complex. *The center is tonically active.* This center may act as an integration site for afferent information. The specific group of neurons that function, as the apneustic center has not been identified.

Modern View

Pneumotaxic center is not required for eupnoea. Apneustic neurons are not present. Thus, the term, pneumotaxic and apneustic are primarily used because of their historical significance only.

Role of Vagal Fibers

Stretching of the lungs during inspiration initiates impulses in afferent pulmonary vagal fibers. These impulses inhibit inspiratory discharge (I neurons) via apneustic center and DRG. This is why the depth of inspiration is increased after vagotomy. Vagal feedback activity does not alter the rate of rise of the neural activity in respiratory motor neurons.

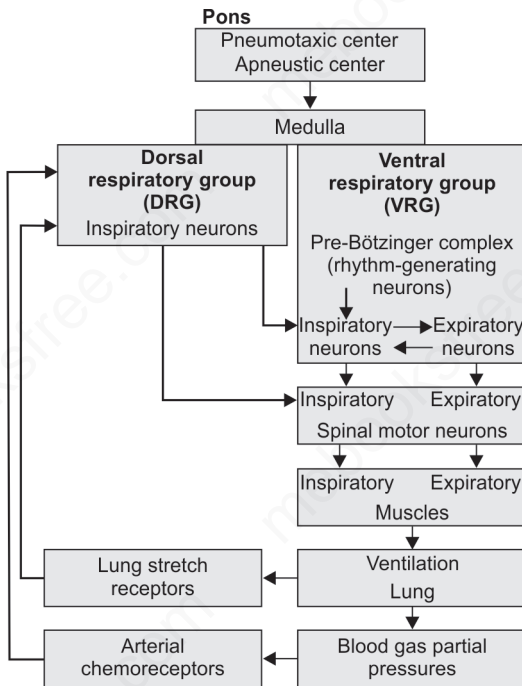

Fig. 11.6: Brainstem respiratory control centers responsible for respiratory rhythm generation

Experimental Basis of Neural Control of Ventilation (Fig. 11.7)

- **Section A:** Cut at upper part of pons: (Decerebration): Normal rhythmic breathing continues. Loss of voluntary breathe holding. If vagi are cut, increase in depth and slow breathing.

I IMPORTANT

In German legend Ondine was a water nymph, who married Hans, her mortal lover. He promised her that he would never marry again. Later Hans remarried. The king of the water nymphs cursed Hans not to have any automatic function, including respiratory control.

- ❖ As a result, he could stay alive by voluntary respiration while awake. He was living with the curse. But, he eventually fell asleep from sheer exhaustion, and his respiration stopped.
- ❖ Patients with bulbar poliomyelitis or disease processes that compress the medulla may have this kind of disorder.

I IMPORTANT

- ❖ VRG contains both I and E groups of neurons.
- ❖ A part of VRG, known as Pre-Bötzinger complex is the rhythm generator of respiration.
- ❖ Peripheral afferents acts via DRG.
- ❖ Pneumotaxic control rate and apneustic control depth of respiration. But these two centers are not required for eupnoea.

- ❑ **Section B:** Cut at mid-pons: Apneustic center (Ap) intact but pneumotaxic separated. Ap stimulates Inspiratory (I) neurons, which increase depth of breathing.
 - **Vagi intact:** Regular respiration with deep and slow breathing (increase in TV and a slight decrease in RR).
 - **Vagi cut:** Arrest of respiration in maximum inspiratory phase (apneusis) interrupted by brief expiration.
- ❑ **Section C:** Cut at inferior portion of pons: All the pontine tissue is separated
 - **Vagi intact:** Irregular and gasping but it is rhythmic (because pacemaker tissue is intact).
 - **Vagi cut:** Same effect as above, because vagi are connected to Ap center.
- ❑ **Section D:** Cut below medulla: Complete transection of brainstem:
 - Stops all respiration (apnoea and death).

Bilateral vagotomy only: Regular respiration with deep and slow breathing (increase in TV and a slight decrease in RR)

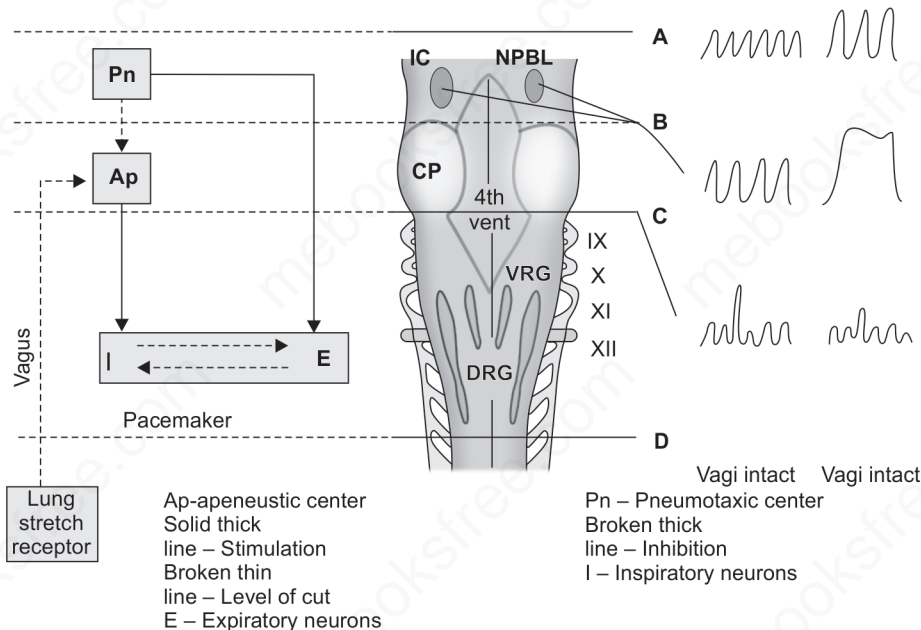

Fig. 11.7: Respiratory neurons in the brainstem. Dorsal view of brainstem. Note: pneumotaxic center (Pn) is inhibitory to apneustic center (Ap) and stimulatory to expiratory neurons (E). Apneustic centre in turn is stimulatory to inspiratory neurons (I). The effects of various lesions and brainstem transections are shown; the spirometer tracings at the right indicate the depth and rate of breathing

HERING-BREUER'S REFLEX

Self-regulatory negative feedback reflex.

- ❑ **Receptor:** Pulmonary stretch receptors lie within the smooth muscle of large and small airways (bronchi and bronchioles). These receptors are slowly adapting receptor.
- ❑ **Stimulus for receptor:** Distension of the lungs, when TV is more than 1 L
- ❑ **Afferent:** Vagus nerve via large myelinated fibers.
- ❑ **Main effect:** Decreases in respiratory rate due to an increase in expiratory time (inflation reflex).

The Hering-Breuer inflation reflex (also called *inhibitory-inspiratory reflex*):

Inflation of the lungs tended to inhibit further inspiratory muscle activity.

- ❑ With lung inflation, stretch receptors (describe above) are stimulated and send neural signals via vagal afferents to inhibit the apneustic center.
- ❑ Thus, they function to facilitate termination of inspiration and starts expiration, which becomes prolonged. Because of prolonged expiration, respiratory rate becomes slower. It may also produce apnea.

Hering-Breuer Deflation reflex (or excitatory-inspiratory reflex):

Deflation of the lungs tends to inhibit further deflation (initiate inspiratory activity). It decreases duration of expiration.

- ❑ This reflex is initiated either by decreased activity in the same airway stretch receptors involved in the inflation reflex or by stimulation of *other proprioceptors* that are activated by lung deflation.
- ❑ This information is also conveyed via vagal afferents to the brainstem respiratory centers to encourage inspiration.

HEAD'S PARADOX REFLEX

Inflation of the lungs augment further inflation (Henry Head 1884). The strength of contraction is not increased but their duration is prolonged and a tonic inspiratory contraction appears during the inflation.

- ❑ **Receptor:** Rapidly adapting pulmonary stretch receptor (RARs) distinct from Hering-Breuer's reflex mediated by slowly adapting receptor (SARs)
- ❑ **Afferent:** Vagus
- ❑ **Example:** Only seen during "first cry of newborn baby". This reflex is absent in adult.

I IMPORTANT

- ❖ Receptor for Hering-Breuer's reflex (stretch receptor of lungs) is activated when TV increases 2 times more than normal (TV > 1L)

I IMPORTANT

- ❖ Hering-Breuer's Inflation reflex is of historic interest because it was the first description of negative feedback in a physiologic control system in 1868.
- ❖ Hering-Breuer reflex is strongest in rabbit and weakest in man. It is stronger in infant but in adult only activated when TV is more than 1 L.

I IMPORTANT

In patients with heart-lung transplants, Hering-Breuer reflex is absent (afferent fibers do not regrow) but their pattern of breathing at rest is normal, indicating that these reflexes do not play an important role in the regulation of *resting* respiration in humans.

I IMPORTANT

Note:

J (C-fiber receptor) receptors do not show a firing pattern that can be associated with normal respiration. So, they do not control normal breathing. Physiological role of J receptors are postulated during exercise in high altitude, when fluid entrapped in interstitial fluid.

J-REFLEX (PULMONARY C-FIBER RECEPTOR)

- ❑ **Discovered by:** Indian physiologist AS Paintal in 1954.
- ❑ **Location:** Juxtapulmonary capillary (J) receptors are located in alveolar walls or, lung interstitial tissue close to pulmonary capillary.
- ❑ **Afferent:** The impulses pass up the vagus nerve in slowly conducting nonmyelinated fibers (pulmonary C-fiber receptors).
- ❑ **Stimuli:** The receptors are activated by:
 - Engorgement of pulmonary capillaries
 - Increases in the interstitial fluid volume (Pulmonary edema, ARDS)
 - Pneumonia
 - Pulmonary microembolism
 - Hyperinflation of the lungs
 - Chemical like phenyl diguanide or capsaicin injected into the pulmonary circulation and volatile agents such as halothane.
- ❑ **Response:** When stimulated, the receptors produce following symptoms:
 - Rapid shallow breathing
 - Intense stimulation causes apnea
 - Bronchoconstriction
 - Increased mucus secretion
 - Bradycardia and hypotension
 - Weakness of muscles.

DIFFERENT TYPES OF BREATHING PATTERN

Conditions	Description	Causes	Recording
Eupnea	Normal breathing rate and pattern		
Tachypnea	Increased respiratory rate	Fever, anxiety, exercise, shock	
Bradypnea	Decreased respiratory rate	Sleep, drugs, metabolic disorder, head injury, stroke	
Hyperpnea	Normal rate, but deep respirations	Emotional stress, diabetic ketoacidosis	
Cheyne-Stokes breathing	Gradual increases and decreases in respirations with periods of apnea	Severe cardiac failure, brain damage, Increasing intracranial pressure, brain stem injury	
Biot's breathing	Rapid, deep respirations (gasps) with short pauses between sets	Spinal meningitis, CNS causes, head injury	
Kussmaul's breathing	Tachypnea and hyperpnea	Diabetic Ketoacidosis, Uremia, Sepsis, Salicylates, Methanol, Aldehyde, Lactic acidosis	

APPLIED RESPIRATORY PHYSIOLOGY

- ❑ High altitude physiology
- ❑ Deep-sea diving physiology

HIGH ALTITUDE PHYSIOLOGY

Basic Points

Total barometric pressure decreases at high altitudes. At ~5800 m, barometric pressure is one half that of sea level; and on the summit of Mt. Everest (8848 m), the barometric pressure is 253 mm Hg.

The fractional concentration of oxygen (21%) in the atmosphere remains normal.

Partial pressure of oxygen (PaO_2) decreases due to decrease total barometric pressure. This produces hypoxic hypoxia.

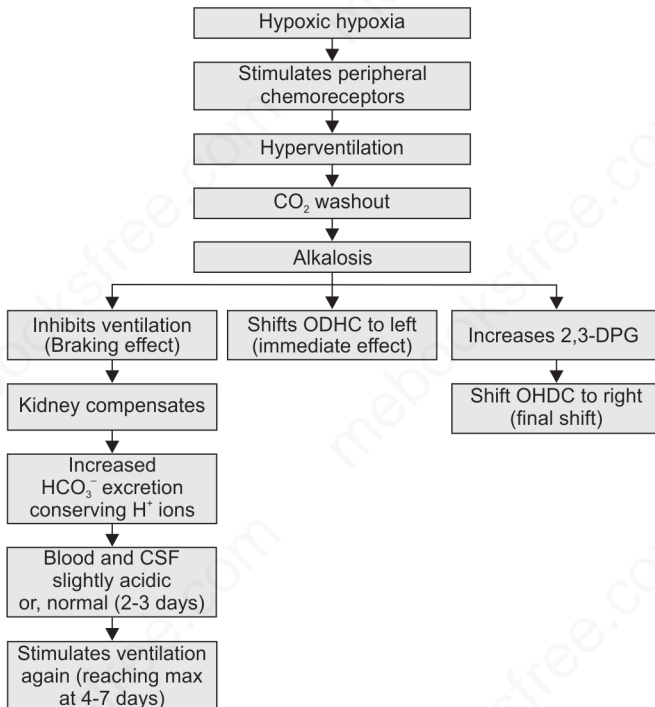

Fig. 11.8: Various effects of hypoxia in high altitude

Physiological Adaptations at High Altitude: Acclimatization

The process by which individuals gradually adjust to hypoxia and enhance survival and performance is

termed acclimatization. The following changes occur during acclimatization:

- ❑ **Ventilation:** Effect shown above (Fig. 11.8).
- ❑ **Circulations:**
 - **Systemic circulation:** Increased sympathetic activity (hypoxic stimulation to VMC) causes an initial mild *increase in BP*, a moderate *increase in HR and cardiac output*. Pulmonary capillary wedge pressure (left arterial pressure) is low, and no left ventricular dysfunction is seen.
 - **Pulmonary circulation:** Hypoxia causes hypoxic pulmonary vasoconstriction (HPV); this increases the pulmonary arterial pressure, causing *pulmonary hypertension*. Right atrial pressure did not rise and right ventricular function was intact in spite of extreme hypoxemia and pulmonary hypertension.
 - **Cerebral circulation:** CBF increases, despite the hypocapnia, when PaO_2 is less than 60 mm Hg (altitude greater than 2800 m).
- ❑ **Blood:** Hypoxia is the main stimulus for the release of the hormone *erythropoietin* from the kidney. Erythropoietin acts on the erythropoietin-sensitive committed stem cells in the bone marrow to stimulate *red blood cell production*. The hormone is detectable within 2 hours of ascent, nucleated immature red blood cells can be found on peripheral smear within days, and new red blood cells are in circulation within 4–5 days.
- ❑ **Oxygen-hemoglobin dissociation curve:** Immediate left shift due to respiratory alkalosis. But a concomitant increase in red cell 2,3-diphosphoglycerate (2,3-DPG) *shifts the curve to the right*.
- ❑ **Tissue changes:** Hypoxia causes production of hypoxia-inducible factor-1 α which stimulate vascular endothelial growth factor (VEGF) production. This promotes *angiogenesis*, augmenting blood flow and supplying more oxygen to the tissues. *The mitochondria*, which are the sites of oxidative reactions, increase in number, and *myoglobin increases*, which facilitates movement of O_2 into the tissues. The tissue content of *cytochrome oxidase* also increases.

I IMPORTANT

Work capacity at high altitude is reduced in unacclimatized person. Low grade, endurance type (long duration) exercise, increases the work capacity in such situation.

High Altitude Illnesses

1. **Acute mountain sickness:** This syndrome develops 8–24 hours after arrival at altitude and lasts 4–8 days.

- **Definition:** Acute mountain sickness (AMS) is defined as headache in the setting of recent altitude gain and typical symptoms, which include anorexia, nausea, vomiting, insomnia, dizziness or fatigue
 - **Pathophysiology:**
 - Mild-to-moderate AMS is characterized by hypoventilation, interstitial edema, and increased sympathetic drive.
 - Moderate-to-severe AMS is associated with white matter edema in the brain. Edema is due to leak of fluid may be due to increase in intravascular pressure (cerebral vasodilation).
 - **Treatment:**
 - Halting the descent and waiting for acclimatization to improve.
 - Acetazolamide speeds up acclimatization.
 - Dexamethasone relieves symptoms.
 - Analgesics (aspirin, ibuprofen or other NSAIDs) for headache.
 - Promethazine for nausea and vomiting.
 - Oxygen, if available, is particularly effective. Hyperbaric chambers aid acclimatization.
2. **High-altitude cerebral edema (HACE):** HACE can be diagnosed if ataxia occurs in a person with acute mountain sickness, or both ataxia and mental status changes occur in the absence of AMS. Pathophysiology is similar to severe AMS.
3. **High-altitude pulmonary edema (HAPE):** HAPE usually occurs within the first 2–4 days of ascent to higher altitudes, most commonly on the second night.
- Hypoxic pulmonary vasoconstriction (HPV) occurs which is nonhomogeneous (uneven) and patchy. This leads to increased pressure and flow in the perfused areas, causing pulmonary hypertension and subsequent edema.
 - The pulmonary edema is of *high-permeability type*, with leakage of proteins and white blood cells.
 - **Treatment:** Immediate descent. Oxygen should be administered immediately. Drugs are of limited necessity in HAPE. Calcium channel blocker nifedipine and glucocorticoids are successful. Nitric oxide and PDE-5 inhibitors (sildenafil and tadalafil) have been tested but result not confirmatory.

I IMPORTANT

The HAPE is due to raised pulmonary capillary pressure and high-permeability of pulmonary capillary. This leads to leakage of proteins and white blood cells.

DEEP-SEA DIVING PHYSIOLOGY

Basic Points

- ❑ **Relationship of pressure to sea depth:** A column of seawater 33 feet deep exerts the same pressure at its bottom as the pressure of the atmosphere above the sea. Therefore, a person 33 feet beneath the ocean surface is exposed to 2 ATM pressure, 1 ATM of pressure caused by the weight of the air above the water and the second ATM by the weight of the water itself. At 66 feet the pressure is 3 ATM, and so forth.
- ❑ As the total pressure increases, the partial pressures of the constituent gases also increase, according to *Dalton's law*. The biologic effects of gases are generally dependent on their partial pressures rather than on their fractional concentrations. Also, as the partial pressures of gas increases, the amount dissolved in the tissues of the body increases, according to *Henry's law*.
- ❑ The individual gases to which a diver is exposed when breathing air are nitrogen, oxygen, and carbon dioxide; each of these gases at times can cause significant physiologic effects at high pressures.

The toxicity of these gases due to high partial pressure are listed below:

1. **Oxygen toxicity at high pressures:** The extremely high tissue PO_2 may cause seizures followed by coma in most people within 30–60 minutes. Other symptoms encountered in acute oxygen poisoning include nausea, muscle twitchings, dizziness, disturbances of vision, irritability, and disorientation.
2. **Carbon dioxide toxicity:** Up to 80 mm Hg $PACO_2$, (twice that in normal alveoli) diver usually tolerates by increasing the minute respiratory volume maximally. Beyond 80 mm Hg alveolar $PACO_2$ the situation becomes intolerable, and eventually the respiratory center begins to be depressed, rather than excited.
3. **Nitrogen toxicity (narcosis):** Nitrogen narcosis has characteristics similar to those of alcohol intoxication, and for this reason it has frequently been called “raptures of the depths.”
 - First symptoms of mild narcosis appear is about 120 feet. At this level the diver begins to exhibit joviality. At 150–200 feet, the diver becomes drowsy. At 200–250 feet, driver becomes too clumsy to perform the work required. Beyond

I IMPORTANT

Nitrogen narcosis symptoms resemble alcohol intoxication. The first symptoms is the euphoria.

250 feet (8.5 atmospheres pressure), the diver usually becomes almost useless as a result of nitrogen narcosis if he or she remains at these depths too long.

- The mechanism of the narcotic effect is due to dissolves N_2 in the fatty substances in neuronal membranes and, because of its physical effect on altering ionic conductance through the membranes, reduces neuronal excitability.

Sudden decompression of the diver after excess exposure to high pressure: Decompression sickness (synonyms: Bends, Compressed Air Sickness, Caisson Disease, Diver's Paralysis, Dysbarism):

- Nitrogen bubbles can develop in the body fluids and can cause minor or serious damage in almost any area of the body (because nitrogen is not metabolized by the body).
- Gas bubbles blocking many blood vessels in different tissues cause the symptoms of decompression sickness.
- Most common symptoms (85–90%): Pain in the joints and muscles of the legs and arms. The joint pain accounts for the term “bends”.
- Nervous system symptoms (5–10%): Dizziness, paralysis or collapse and unconsciousness.
- The chokes (2%): Massive numbers of microbubbles plugging the capillaries of the lungs leading to shortness of breath, often followed by severe pulmonary edema and, occasionally, death.

I IMPORTANT

Caisson's disease occurs due to sudden lower lowering of pressure like Scuba driver, individual in unpressurized aircraft in rapid ascent (in pilot).

MULTIPLE CHOICE QUESTIONS

REGULATION OF RESPIRATION

RECENT MCQs

1. Peripheral hemoreceptors are most sensitive to:

- a. PO_2 b. PCO_2
c. H^+ d. HCO_3^-

2. Peripheral and central chemoreceptors may both contribute to increased ventilation that occurs as a result of decreased:

- a. Arterial BP
b. Arterial tension
c. Arterial O_2 concentration
d. H^+

3. Peripheral chemoreceptors is stimulated maximally by:

- a. Cyanide b. Anemia
c. Hypocapnia d. Alkalosis

4. Hering-Breuer reflex is an increase in:

- a. Duration of inspiration
b. Duration of expiration
c. Depth of inspiration
d. Depth of expiration

5. Depth of inspiration controlled by:

- a. Pneumotaxic center
b. Posterior medulla
c. Apneustic center
d. Pons

6. Inspiratory depth is halted by:

- a. Pneumotaxic center
b. Apneustic center
c. Inspiratory center
d. Expiratory center

7. Chemoreceptors in anemic hypoxia not stimulated due to:

[Dec 2016]

- a. Dissolve oxygen is normal in anemia
b. Oxygen content is normal in anemia
c. Hb is less in anemia
d. Hypoxia is less severe in anemia

8. RAMP signal initiation by:

[Dec 2016]

- a. DRG
b. VRG
c. Pre-Bötzingler
d. Pneumotaxic centre

9. Sensitivity of central chemoreceptors in COPD:

- a. Decreased to H^+
b. Increased to H^+
c. Increased to PCO_2
d. Increased to PO_2

10. True about Ondine's curse is:

- a. Voluntary control of respiration is disrupted
b. Automated control of respiration intact
c. Seen in spinal poliomyelitis
d. Such patients can stay alive by breathing voluntarily

11. Hering-Breuer reflex activated when tidal volume is:

- a. Normal
b. 2 times the normal
c. 3 times the normal
d. Always

12. Concerning the Hering-Breuer inflation reflex, which of the following are incorrect?

- It results in further inspiratory efforts if the lung is maintained inflated
- Abolishing the reflex in many animals causes rapid, shallow breathing
- It is seen in adults at small tidal volumes
- All of the above

13. Acclimatization at mountain phenomenon involved:

- Respiratory alkalosis
- Respiratory acidosis
- Metabolic alkalosis
- Metabolic acidosis

AIIMS/PGI/JIPMER

14. The primary direct stimulus for excitation of central chemoreceptors regulating ventilation is:

[AIIMS May 11, AI 09]

- Increased H^+
- Increased CO_2
- Increased O_2
- Decreased CO_2

15. Central chemoreceptors are most sensitive to following changes in blood:

[AI 09]

- Increased PCO_2
- Decreased PCO_2
- Increased H^+
- Increased PO_2

16. Which of the following does not stimulate peripheral chemoreceptors?

[AI 95]

- Hypoxia
- Hypocapnia
- Acidosis
- Low perfusion pressure

17. Administration of pure O_2 to hypoxic patients is dangerous because:

[PGI June 99]

- Apnea occurs due to hypo-stimulation of peripheral chemoreceptors
- Pulmonary edema
- DPG
- Convulsions

18. Pacemaker regulating the rate of respiration:

[AIIMS Nov 10, Nov 09]

- Pneumotoxic center
- Dorsal group of nucleus
- Apneustic center
- Pre-Bötzinger

19. Complex transection at mid pons level results in:

[AIIMS Nov 09]

- Asphyxia
- Hyperventilation
- Rapid and shallow breathing
- Apneusis

20. What will be the effect on respiration if a transmission is made between the pons and medulla?

[AIIMS June 00]

- Apnea
- Irregular and gasping
- No effect
- Slow and deep

21. If a cat apneustic center is destroyed along with cutting of vagi. Which of the following statement is correct regarding the breathing pattern seen in cat?

[PGI Dec 05]

- Prolonged inspiratory spasm
- Prolonged expiratory spasm
- Slow and shallow respiration
- Animal will die

22. "Inflation of lungs induces further inflation" is explained by:

[AIIMS Nov 03]

- Hering-Breuer inflation reflex
- Hering-Breuer deflation reflex
- Head's paradoxical reflex
- J-reflex

23. Not a stimulus for normal/resting ventilation: [AIIMS Nov 10]

- a. Stretch receptors
- b. J receptors
- c. PO_2
- d. PCO_2

24. Moderate exercise tachypnea is due to stimulation of which receptor? [AI 98, MP 98]

- a. Proprioception
- b. J receptor
- c. Lung receptor
- d. Baro receptor

APPLIED RESPIRATORY PHYSIOLOGY

RECENT MCQs

25. Acclimatization does not include:

- a. Hyperventilation
- b. Decreased concentration of 2,3-DPG in RBC
- c. Increased erythropoiesis
- d. Kidney excrete more alkali

26. A person unacclimatized develops pulmonary edema:

- a. 19-21 days
- b. 2nd-3rd month
- c. 2-3 days
- d. 6-7 days

27. The stimulation of which of the following causes hyperventilation at high altitude:

- a. Peripheral chemoreceptors
- b. Vagal afferents
- c. Central chemoreceptors
- d. Proprioceptors

28. The following acute respiratory response to ascent to high altitude, there is normalization of blood pH. The mechanism is:

- a. Increased erythropoiesis leads to increased buffering by hemoglobin
- b. Increased excretion of HCO_3^- by the kidneys

- c. Increased levels of 2,3-DPG
- d. Retention of bicarbonate by the kidneys

29. True about caisson's disease:

- a. O_2 release from tissues
- b. CO_2 release from tissues
- c. N_2 release from tissues
- d. H^+ release from tissues

30. In caissons disease pain in joint is because of:

- a. Nitrogen bubble
- b. Oxygen bubble
- c. Carbon monoxide
- d. Air in joint

31. Compensating mechanisms involved at high altitude: [PGI Dec 04]

- a. Hyperventilation
- b. Hypoventilation
- c. Respiratory depression
- d. Respiratory acidosis
- e. Respiratory alkalosis

AIIMS/PGI/JIPMER

32. Which of the following is seen in high altitude climbers? [PGI Dec 01]

- a. Hyperventilation
- b. Decreased $PaCO_2$
- c. Pulmonary edema
- d. Hypertension
- e. Bradycardia

33. A 32-year-old high altitude mountaineer is observed to have a hematocrit of 70%. Which of the following represents the most likely cause/explanation? [AI 11]

- Polycythemia with increased red cell mass
- Relative polycythemia due to dehydration
- Polycythemia due to hemoconcentration
- Polycythemia with high altitude pulmonary edema

34. In high altitude mountain sickness, feature of pulmonary edema is:

[PGI June 9]

- Decreased pulmonary capillary permeability
- Increased pulmonary capillary pressure
- Normal left atrial pressure
- Increases left ventricular back pressure

35. A mountaineer ascends 18,000 feet in 2 days without supplemental oxygen. At the height of ascent the changes are: [PGI Dec 03]

- Increased PaCO_2
- Decreased barometric pressure
- Decreased inspired O_2
- Decreased PaO_2
- Increased pH

36. During acclimatization to high altitude all of the following take place except: [AI 04]

- Increase in minute ventilation
- Increase in the sensitivity of central chemoreceptors
- Increase in the sensitivity of carotid body to hypoxia
- Shift in the oxygen dissociation curve to the left

37. A person goes to the mountains. When he reaches about 5000 ft, he develops dyspnea. Which of following correctly explains for the symptoms?

- CNS depression [AIIMS Nov 00]
- CO_2 wash out
- Increased work of breathing
- Increased blood flow to the pulmonary tissues

38. Which of the following adaptations will be apt to increase the work capacity at high altitude? [AI 07]

- Increasing workload, decreasing duration of exercise
- Increasing workload, increasing duration of exercise
- Decreasing workload, increasing duration of exercise
- Decreasing workload, decreasing duration of exercise

39. Nitrogen narcosis is caused due to:

[AIIMS May11, Nov 08]

- Nitrogen inhibits dismutase enzyme
- Increase production of nitrous oxide
- Increased solubility of nitrogen in nerve cell membrane
- Decrease in oxygen free radicals

40. Caisson's disease is: [AIIMS Nov 10]

- Gas embolism
- Fat embolism
- Amniotic fluid embolism
- Tumor embolism

41. Decompression sickness is seen in:

- Diver [PGI Dec 02]
- Pilot
- Diver and pilot
- Diver, pilot and mountaineer
- Diver, pilot, mountaineer and astronauts

FUTURE TRENDS

42. Which diagram best describes the relationship between alveolar ventilation (VA) and arterial carbon dioxide tension (PCO₂) when the PCO₂ is

changed acutely over a range of 35 to 75 mm Hg?

- a. A
- b. D
- c. E
- d. F

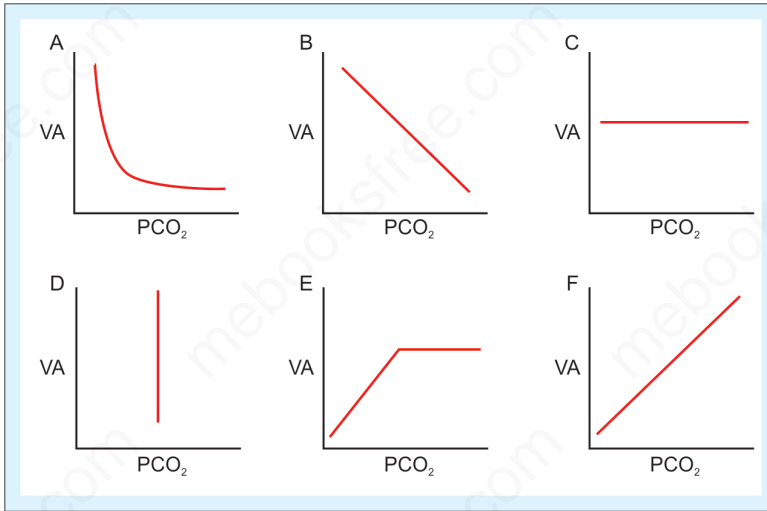

43. Which diagram best describes the relationship between alveolar ventilation (VA) and arterial oxygen tension (PO₂) when the PO₂ is changed acutely over a range of 0–160 mm Hg and the

arterial PCO₂ and hydrogen ion concentration remain normal?

- a. A
- b. B
- c. C
- d. D

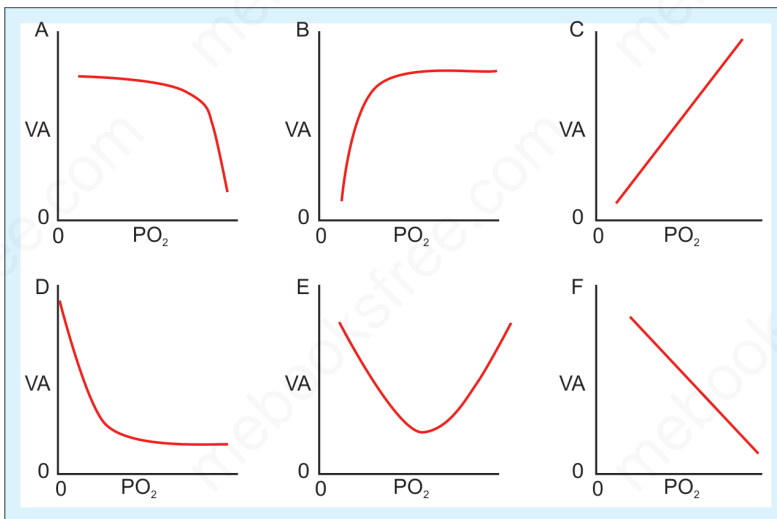

44. The following diagram shows the depth of respiration of a 45-year-old man who suffered a head injury in an automobile accident. This “crescendo-decrescendo” pattern of breathing is called which of the following?

a. Apnea

- b. Biot breathing
c. Cheyne-Stokes breathing
d. Hyperpnea

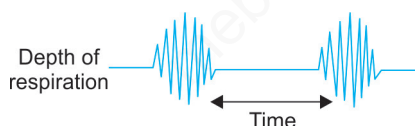

ANSWERS WITH EXPLANATIONS

1. Ans. b. PCO_2

(Ref. *Medical Physiology* by WF Boron and EL Boulpaep 2nd edn. Chapter 32)

Both central and peripheral chemoreceptor most sensitive to $PaCO_2$

But, primary stimulus for peripheral chemoreceptor is hypoxia and for central chemoreceptor H^+ ion.

2. Ans. a. Arterial BP

(Ref. *Medical Physiology* by WF Boron and EL Boulpaep 2nd edn. Chapter 32)

Note: The question is: as a result of decrease?

H^+ ion decrease never stimulates peripheral or, central chemoreceptors.

Decrease BP produces hypoperfusion of organ, which leads to hypoxia and CO_2 retention. CO_2 retention can stimulate both central and peripheral chemoreceptors.

3. Ans. a. Cyanide

(Ref. *Rhodes Medical Physiology* 4th edn. pp 389)

“Carotid and aortic bodies can also be strongly stimulated by certain chemicals, particularly cyanide ion and other poisons of the metabolic respiratory chain.” Cyanide produces histotoxic hypoxia of glomus cell. Hypoxia leads to closure of O_2 sensitive K^+ channel of glomus cell and stimulation.

4. Ans. b. Duration of expiration

(Ref. *West-Respiratory Physiology the Essentials* 9th edn. pp 132)

“The main reflex effect of stimulating these receptors is a slowing of respiratory frequency due to an increase in expiratory time. This is known as the Hering-Breuer inflation reflex.”

5. Ans. c. Apneustic center

(Ref. *West-Respiratory Physiology the Essentials* 9th edn. pp 127)

- ❑ Apneustic center control depth of respiration.
- ❑ Pneumotaxic center controls rate of rate of inspiration.

“The inspiratory ramp can be ‘turned off’ prematurely by inhibitory impulses from the pneumotaxic center. In this way, inspiration is shortened and, as a consequence, the breathing rate increases.”

“Apneustic center is situated in the lower pons. This area is so named because if the brain of an experimental animal is sectioned just above this site, prolonged inspiratory gasps (apneuses) interrupted by transient expiratory efforts are seen. Apparently, the impulses from the center have an excitatory effect on the inspiratory area of the medulla, tending to prolong the ramp action potentials.”

"A strong pneumotaxic signal can increase the rate of breathing 30–40 breaths per minute, whereas a weak pneumotaxic signal may reduce the rate to only 3–5 breaths per minute.".. Guyton's Physiology.

6. Ans. a. Pneumotaxic center

(Ref. West-Respiratory Physiology the Essentials 9th edn. pp 127)

Here, the question of inspiration halt.

Pneumotaxic stimulation inhibits apneustic center which halts inspiratory depth.

7. Ans. a. Dissolve oxygen is normal in anemia

(Ref: Ganong's Review of Physiology 25th, pp 659)

Blood flow in each 2 mg carotid body (chemoreceptor) is about 2000 mL/100 g of tissue/min. Because of this enormous blood flow, the O₂ needs of the cells (glomus cell) can be met largely by dissolved O₂ alone. Therefore, the receptors are not stimulated in conditions such as anemia or carbon monoxide poisoning, in which the amount of dissolved O₂ in the blood reaching the receptors is generally normal, even though the combined O₂ in the blood is markedly decreased.

8. Ans. c. Pre-Böttinger

(Ref. Boron and Boulpaep Medical Physiology 2nd edn. pp 731)

Within the rostral pole of the intermediate VRG is a group of inspiratory neurons defined as the Pre-Böttinger complex (pre-BÖTC), which is involved in generating the respiratory rhythm.

The inspiratory rhythm begins weakly and increases steadily in a ramp manner for about 2 seconds in normal respiration. It then ceases abruptly for next 3 seconds, which turns off the excitation of the diaphragm and expiration occurs.

9. Ans. a. Decreased to H⁺

(Ref. Johnson's Essential Medical Physiology 3rd edn. pp 330)

- Normally, in healthy subjects changes in arterial level of CO₂ trigger chemoreceptors. It stimulates both peripheral (20–30% effect) and central chemoreceptors (70–80%). CO₂ acts on central chemoreceptor via production of H⁺ ion in CSF.
- In the disease process of COPD, the normal CO₂-sensitive chemoreceptors become less sensitive leading to high arterial levels of CO₂ and low levels of O₂ (retention of CO₂).
- Therefore, for the person with COPD, the stimulus to breathe is low arterial levels of oxygen (hypoxia) acting via peripheral chemoreceptor.
- Therefore caution is needed when administering oxygen to the person with COPD. In some patients, supplemental oxygen causes ventilation to decrease, presumably by relieving hypoxic stimulation of arterial chemoreceptors.

10. Ans. d. Such patients can stay alive by breathing voluntarily

(Ref. Ganong's Review of Physiology 25th, pp 663)

In Ondine's curse: Voluntary control intact, but automatic control is lost. It is seen in case of bulbar poliomyelitis (not spinal poliomyelitis) or disease processes that compress the medulla may have this kind of disorder.

11. Ans. b. 2 times the normal

(Ref. John B West Respiratory Physiology, 9th edn. pp 132)

2 times normal is a better option. Ref. John B West Respiratory Physiology (more authentic). According to Guyton, its 3 times.

12. Ans. d. All of the above

(Ref. *John B West Respiratory Physiology, 9th edn. pp 132*)

Option a (false): Hering-Breuer reflex is a slow adapting reflex. So, sustained stretch on lungs by inflation inhibits inspiratory efforts.

Option b (false): Abolishing the reflex by cutting vagus nerve results in deep breathing (not shallow).

Option c (false): Its more strong in infant. In adult, it is seen when TV > 1 liter.

13. Ans. a. Respiratory alkalosis

(Ref. *Guyton's Physiology, 13th edn. pp 564*)

Respiratory alkalosis occurs in mountain sickness and does not involve in pathogenesis of mountain sickness.

On initial exposure to hypoxia, the peripheral chemoreceptors (in the carotid bodies) produce hyperventilation. This hyperventilation is progressive and reaches a plateau after 5–6 days. Hyperventilation causes transient decreases in PaCO₂ (washout) and increases in blood pH to produce a respiratory alkalosis. Alkalosis may persist even after acclimatization.

14. Ans. a. Increased H⁺

(Ref. *Medical Physiology by WF Boron and EL Boulpaep 2nd edn. Chapter 32*)

Explained in Q. No. 1.

15. Ans. a. Increased PCO₂

(Ref. *Medical Physiology by WF Boron and EL Boulpaep 2nd edn. Chapter 32*)

Explained in Q. No. 1.

16. Ans. b. Hypocapnia

(Ref. *Medical Physiology by WF Boron and EL Boulpaep 2nd edn. Chapter 32*)

Hypercapnia is a stimulus not hypocapnia. Low perfusion produces hypoxia and hyper-

capnia at the level of chemoreceptors; thus stimulating them.

17. Ans. a. Apnea occurs due to hypoventilation of peripheral chemoreceptors, b. Pulmonary edema, d. Convulsions

(Ref. *West-Respiratory Physiology the Essentials 9th edn. pp 132*)

In some patients with severe lung disease, the hypoxic drive to ventilation becomes very important. These patients have chronic CO₂ retention, and the pH of their brain extracellular fluid has returned to near normal in spite of a raised PCO₂ (renal compensation). Thus, they have lost most of their increase in the stimulus to ventilation from CO₂. Under these conditions, the arterial hypoxemia becomes the chief stimulus to ventilation. If such a patient is given a high O₂ mixture to breathe to relieve the hypoxemia, ventilation may become grossly depressed.

Pulmonary edema and convulsion are side effects of pure oxygen therapy.

18. Ans. d. Pre-Bötzinger

(Ref. *Medical Physiology by WF Boron and EL Boulpaep 2nd edn. Chapter 32*)

Pacemaker of respiration is pre-Bötzinger complex of neurons, which is a part of VRG in medulla.

19. None. Single best: d. Apneusis

(Ref. *Ganong's Physiology 24th edn. pp 626*)

Correct answer is deep, slow breathing. But if vagi are cut alone with mid pons cut, then it will produce apneusis.

20. Ans. b. Irregular and gasping

(Ref. *Ganong's Physiology 24th edn. pp 626*)

Breathing will continue spontaneously in this situation, because pacemaker in medulla is intact, but the respiration will be irregular.

Because pneumotaxic and apneustic centers in pons are responsible for "fine-tuning"

of respiration; breathing will be irregular after their separation.

21. Ans. b. Prolonged expiratory spasm

(Ref. *Physiology by AK Jain, 6th edn. and Concise Textbook of Physiology for Dental Students by Tripathi*)

Pneumotaxic center not only inhibits apneustic center (inhibits inspiration) but also stimulates expiratory neurons in pacemaker cell. By stimulating expiratory neurons, it prolonged expiratory spasm.

22. Ans. c. Head's paradoxical reflex

(Ref. *Understanding Medical Physiology: A Textbook for Medical Students by RL Bijlani, S Manjunatha, 4th edn, Chapter 4.5*)

Since, inflation of lungs stimulates further inflation, the reflex is known as paradoxical.

23. Ans. b. J receptors

(Ref. *Understanding Medical Physiology: A Textbook for Medical Students by RL Bijlani, S Manjunatha, 4th edn, Chapter 4.5*)

J-receptor has no role in normal/resting ventilation control.

24. Ans. a. Proprioception

(Ref. *Ganong's Physiology 24th edn. pp 636*)

"The abrupt increase at the start of exercise is presumably due to psychic stimuli and afferent impulses from proprioceptors in muscles, tendons, and joints."

25. Ans. b. Decreased concentration of 2,3-DPG in RBC

(Ref. *Ganong's Physiology 24th edn. pp 619*)

Acclimatization: The respiratory alkalosis produced by the hyperventilation shifts the oxygen-hemoglobin dissociation curve to the left, but a concomitant increase in red blood cell 2,3-BPG tends to decrease the O_2 affinity of hemoglobin. The net effect is a small increase in P_{50} (right shift).

Erythropoietin secretion increases promptly on ascent to high altitude. The increase in circulating red blood cells triggered by the erythropoietin begins in 2–3 days and is sustained as long as the individual remains at high altitude.

26. Ans. c. 2–3 days

(Ref. *Indian J Occup Environ Med 2010;14: 6–12*)

High altitude pulmonary edema usually occurs within the first 2–4 days of ascent to higher altitudes, most commonly on the second night.

27. Ans. a. Peripheral chemoreceptors

(Ref. *Ganong's Physiology 24th edn. pp 618*)

At high altitudes, the increased ventilation is due to the decline in alveolar PO_2 . PO_2 stimulates peripheral chemoreceptors.

28. Ans. b. Increased excretion of HCO_3^- by the kidneys

(Ref. *Guyton-Physiology- 13th edn. pp 540*)

The immediate increase in pulmonary ventilation on rising to a high altitude blows off large quantities of CO_2 and increasing the pH of the body fluids. These changes inhibit the brain stem respiratory center and thereby oppose the effect of low PO_2 to stimulate respiration by way of the peripheral arterial chemoreceptors in the carotid and aortic bodies. But during the ensuing 2–5 days, this inhibition fades away, allowing the respiratory center to respond with full force to the peripheral chemoreceptor stimulus from hypoxia, and ventilation increases to about five times normal.

The cause of this fading inhibition is believed to be mainly a reduction of bicarbonate ion concentration in the cerebrospinal fluid as well as in the brain tissues.

29. Ans. c. N_2 release from tissues

(Ref. *Guyton-Physiology-13th edn. pp 548*)

If a diver has been beneath the sea long enough that large amounts of nitrogen have

dissolved in his or her body and the diver then suddenly comes back to the surface of the sea, significant quantities of nitrogen bubbles can develop in the body fluids either intracellularly or extracellularly and can cause minor or serious damage in almost any area of the body, depending on the number and sizes of bubbles formed; this is called decompression sickness/Caisson Disease, Diver's Paralysis, Dysbarism.

30. Ans. a. Nitrogen bubble

(Ref. Guyton-Physiology-13th edn. pp 548)

In most people with decompression sickness, the symptoms are pain in the joints and muscles of the legs and arms, affecting 85–90% of those persons who develop decompression sickness. This pain is due to N_2 bubbles blocking many blood vessels in different tissues. The joint pain accounts for the term "bends" that is often applied to this condition.

31. Ans. a. Hyperventilation

(Ref. Ganong's Physiology 24th edn. pp 619)

Hyperventilation leads to respiratory alkalosis. But respiratory alkalosis is not the compensatory mechanism.

32. Ans. a. Hyperventilation, b. Decreased $PaCO_2$, c. Pulmonary edema, d. Hypertension

(Ref. Raff's Medical Physiology A Systems Approach, 2011, pp 736)

There is an increase in cardiac output, heart rate, and systemic blood pressure at altitude due to hypoxic stimulation to vasomotor center.

33. Ans. a. Polycythemia with increased red cell mass

(Ref. Ganong's Physiology 24th edn. pp 619)

Erythropoietin secretion increases promptly on ascent to high altitude. The increase in circulating red blood cells triggered by the

erythropoietin begins in 2–3 days and is sustained as long as the individual remains at high altitude.

34. Ans. b. Increased pulmonary capillary pressure

c. Normal left atrial pressure

(Ref. Raff's Medical Physiology A Systems Approach, 2011, pp 736)

High-altitude pulmonary edema is a patchy edema of the lungs that is related to the marked pulmonary hypertension that develops at high altitude. This hypertension is due to pulmonary vasoconstriction.

Due to pulmonary vasoconstriction, right ventricular workload increased greatly but left arterial pressure remains normal.

35. Ans. b. Decreased Barometric pressure, d. Decreased PaO_2 , e. Increased pH

(Ref. Guyton-Physiology-13th edn. pp 540)

In high altitude, barometric pressure decreases but the composition of O_2 (21%) remains normal. But because of decrease in total barometric pressure, PaO_2 also decreases. This decreased PaO_2 stimulates peripheral chemoreceptors, which stimulates ventilation. This immediate increase in pulmonary ventilation on rising to a high altitude blows off large quantities of CO_2 and increasing the pH of the body fluids.

36. Ans. d. Shift in the oxygen dissociation curve to the left

(Ref. Ganong's Physiology 24th edn. pp 619)

Explained in Q. no. 18.

37. Ans. b. CO_2 washout

(Ref. Ganong's Physiology 24th edn. pp 619)

Among the given options, answer is CO_2 washout due to hyperventilation.

Other probable answer option C: Remember; Decreased density of the gas reduces the work of breathing at any given

workload with increasing altitude. So, option C is not correct.

38. Ans. c. Decreasing workload, increasing duration of exercise

(Ref. *Indian J Occup Environ Med.* 2010;14: 6-12)

Exercise increases oxygen requirements, which must now be met in the face of this decreased oxygen. Increase workload, will increase sever O_2 demand, which cannot be met at high altitude due to low partial pressure of oxygen, furthermore it can precipitate pulmonary edema. But decrease workload and increase duration, will produce a low-grade hypoxic drive. This hypoxia produces hypoxia-inducible factor-1 α , which stimulate vascular endothelial growth factor (VEGF) production. This promotes angiogenesis, augmenting blood flow and supplying more oxygen to the tissues. All these changes are helpful for acclimatization.

39. Ans. c. Increased solubility of nitrogen in nerve cell membrane

(Ref. *Guyton-Physiology-13th edn.* pp 548)

In 5–10% of people with decompression sickness, nervous system symptoms occur, ranging from dizziness in about 5% to paralysis or collapse and unconsciousness in as many as 3%. The paralysis may be temporary, but in some instances, damage is permanent.

The mechanism of the narcotic effect is due to N_2 dissolves in the fatty substances in neuronal membranes and, because of its physical effect on altering ionic conductance through the membranes, reduces neuronal excitability.

40. Ans. a. Gas embolism

(Ref. *Guyton-Physiology-13th edn.* pp 548)

Explained in Q. No. 22.

41. Ans. a. Diver, b. Pilot, c. Diver and pilot

(Ref. *Guyton-Physiology-13th edn.* pp 548)

Jet fighter pilots who very rapidly ascend from sea level to high altitude can get the bends for the same reason as divers: too rapid ascent causing nitrogen bubbles to form in the tissues and blood.

42. Ans. d. Curve F

Alveolar ventilation can increase by more than eightfold when the arterial carbon dioxide tension is increased over a physiological range from about 35–75 mm Hg. This increase is linear.

43. Ans: d. Curve D

The arterial oxygen tension has essentially no effect on alveolar ventilation when it is higher than about 100 mm Hg, but ventilation approximately doubles when the arterial oxygen tension falls to 60 mm Hg and can increase as much as fivefold at very low oxygen tensions.

44. Ans. c. Cheyne-Stokes breathing

Cheyne-Stokes breathing is the most common type of periodic breathing. The person breathes deeply for a short interval and then breathes slightly or not at all for an additional interval. This pattern repeats itself about every minute. Apnea is a transient cessation of respiration so it is true that Cheyne-Stokes breathing is associated with periods of apnea.

Biot breathing refers to sequences of uniformly deep gasps, apnea, and then deep gasps.

Hyperpnea means increased breathing, usually referring to increased tidal volume with or without increased frequency.

Tachypnea means increased frequency of breathing.

SECTION

5

Central Nervous System

CHAPTERS

- 12. Sensory Physiology
- 13. Motor Physiology
- 14. Higher Functions and Special Senses

mebooksfree.com

CELLS IN NERVOUS SYSTEM

Although there are about 100 billion neurons in the brain, there may be about 10 to 50 times that many glial cells in the brain. Glial cells are:

Flowchart 12.1: Types of glial cell and their functions

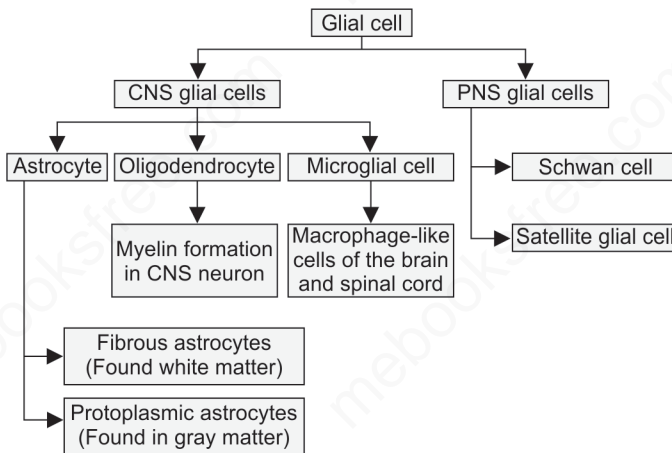

I IMPORTANT

Schwann Cell

Schwann cells are two major types:

- ❖ Myelinating Schwann cells: myelin formation around axons in the PNS
- ❖ Nonmyelinating Schwann cells: which invest multiple small axons and do not synthesize myelin.

I IMPORTANT

Satellite Glial Cells

- ❖ Cover the surface of nerve cell bodies in sensory, sympathetic and parasympathetic ganglia.

Functions of Astrocyte

1. They produce substances that are tropic to neurons (growth factors)
2. They help maintain the appropriate concentration of ions and neurotransmitters by taking up K^+ and the neurotransmitters glutamate, GABA.
3. They contact both capillaries and neurons and are thought to have a nutritive function to neurons.
4. They are also involved in forming the blood-brain barrier.

I IMPORTANT**Radial Glial Cells**❖ **Role in CNS development:**

They are the first glia to appear, in ontogeny and phylogeny.

- ❖ They start differentiate with the onset of neurogenesis from neuroepithelial cells by acquiring glial hallmarks, such as expression of vimentin, the glial fibrillary acidic protein (GFAP), the two astrocyte-specific glutamate transporters (Slc1a3, and Slc1a2).

❖ **Radial glial cells act as stem and progenitor cells in the healthy adult brain.**

Endogenous neurogenesis persists in the adult mammalian brain in few niches like the subependymal zone in the lateral wall of the lateral ventricle, the subgranular zone in the dentate gyrus, and the hypothalamus.

I IMPORTANT

Myelination:

- ❖ PNS myelination begins before CNS myelination.
- ❖ Earliest myelination: Sciatic nerve at 12-week of gestation
- ❖ Last myelination: Subcortical area of frontal and temporal lobe

I IMPORTANT**Location of barrier sites in the CNS**

Three main sites:

1. Endothelium cell of brain capillary (BBB)
2. Arachnoid epithelium (middle layer of the meninges)
3. Choroid plexus epithelium (Blood CSF barrier)

At each site, tight junctions cause the physical barrier.

Function of Satellite Glial Cells

- ❑ Control over the microenvironment of sympathetic ganglia. They are thought to have a similar role to astrocytes in the central nervous system (CNS).
- ❑ They supply nutrients to the surrounding neurons and also have some structural function.
- ❑ Satellite cells also act as protective, cushioning cells.

MYELINATION OF NERVOUS SYSTEM: FEW POINTS

- ❑ Before the onset of myelination, there is a period of rapid proliferation of oligodendrocyte and Schwann cell, term *myelination gliosis*. It stops at the onset of myelination.
- ❑ Myelination is always preceded by an increase in vascularization, followed by a rapid increase in lipid synthesis in Schwann cell and oligodendrocyte.
- ❑ **PNS myelination begins before CNS myelination.** Nerve is myelinated in a proximodistal manner along the growing peripheral nerve.
- ❑ **Order:** Peripheral nerve, spinal cord (dorsal column), brainstem, cerebellum, basa-ganglia, thalamus and then cortex are myelinated (centrifugal).
- ❑ **Sciatic nerve is myelinated at 12-week of gestation (earliest).**
- ❑ **CNS myelination:** Evident at 24-week of gestation in gray matter nuclei, white matter tracts of brainstem and cerebellum.
- ❑ **At birth:** Myelination present in superior and inferior cerebral peduncle, cerebellar vermis, ventrolateral nucleus of thalamus, posterior limb of internal capsule, leg area of the cortex, dorsal brainstem (cranial nerve nuclei) medial longitudinal bundle of midbrain.
- ❑ **From 38 weeks of gestation to 6 weeks after birth:** Very rapid myelination to whole pons, middle cerebellar peduncle and cerebellar white matter, olive, brainstem, calcarine cortex, leg area of cortex.
- ❑ **By 3-month of life:** Cerebellum, which was poorly myelinated at birth, resembles that of adult.
- ❑ **Corpus callosum starts myelination at 8 weeks after birth.**
- ❑ **Myelination is complete** on T2-weighted image at **3 years** (some book: 4 years). At 1 year of age pattern of myelination is very similar to that of adult on T1-weighted image.

- ❑ **The last area to myelinate (terminal zone):** Subcortical area of frontal and temporal lobe >> Peritrigonal region (posterior and superior to trigon of lateral ventricle) which myelinate completely near early adulthood.

SYNAPSE

- ❑ Impulses are transmitted from one nerve cell to another cell at synapses
- ❑ Charles Sherrington introduced the term “synapse”.
- ❑ Types of synapse in CNS: Electrical synapse and Chemical synapse. Difference between them are:

Types of synapse	Synaptic cleft	Cytoplasmic continuity between neurons	Ultra structural component	Agent of transmission	Synaptic delay	Direction of transmission
Electrical	4 nm	Yes	Gap junction channel	Ion current	Nil	Bidirectional
Chemical	20 to 40 nm	No	Presynaptic vesicle	Chemical transmitter	At least 0.3 ms. Usually 1–5 ms	Unidirectional

SYNAPTIC TRANSMISSION IN CHEMICAL SYNAPSE

Presynaptic Event

- ❑ Presynaptic terminals resemble small round or oval knobs and, therefore, are sometimes called terminal knobs, boutons, end-feet, or synaptic knobs.
- ❑ The terminal has neurotransmitter containing vesicles.
- ❑ The membrane of the presynaptic terminal is called the presynaptic membrane. It contains large numbers of voltage-gated calcium channels.

The events occur after the arrival of action potential (AP) in presynaptic terminal has been described in (Fig. 12.1):

- ❑ The details of the processes by which synaptic vesicles fuse with the cell membrane (Step No. 6 in Fig. 12.1) involve the V-SNARE protein (synaptobrevin) in the vesicle membrane locking with the T-SNARE protein (syntaxin and SNAP-25) in the terminal membrane (Fig. 12.2).

I IMPORTANT

Electrical synapses occur between excitatory projection neurons of the inferior olivary nucleus and between inhibitory interneurons of the neocortex, hippocampus, and thalamus.

I IMPORTANT

Synaptic vesicle glycoprotein 2A (SV2A) is a small protein helps in vesicle release. This protein is blocked by **Levetiracetam** (anti-epileptic drug).

- ❑ A multiprotein complex regulated by small GTPases such as rab3 is also involved in the process.
- ❑ **Synaptotagmin** is a V-SNARE protein acts as a Ca^{2+} sensor during the process (contains four Ca^{2+} -binding sites in its cytosolic domain).

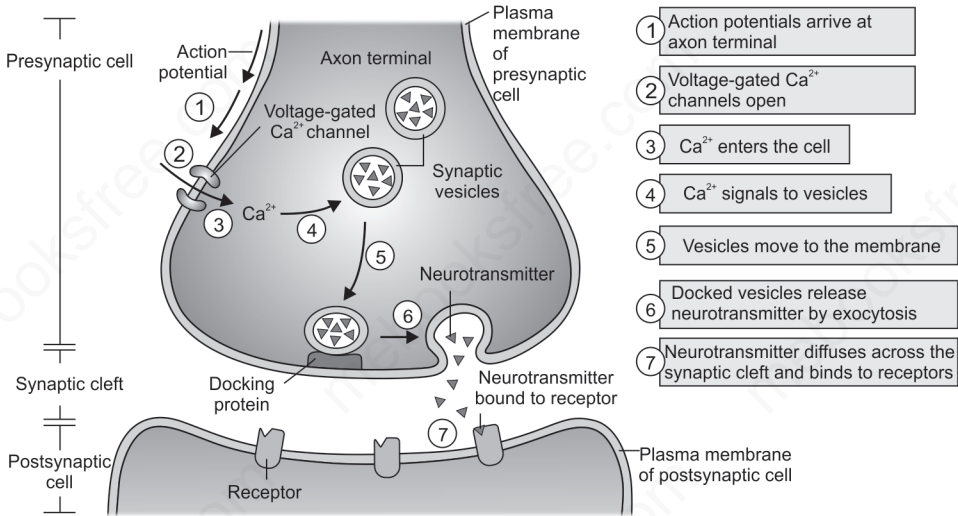

Fig. 12.1: Presynaptic events during synaptic transmission

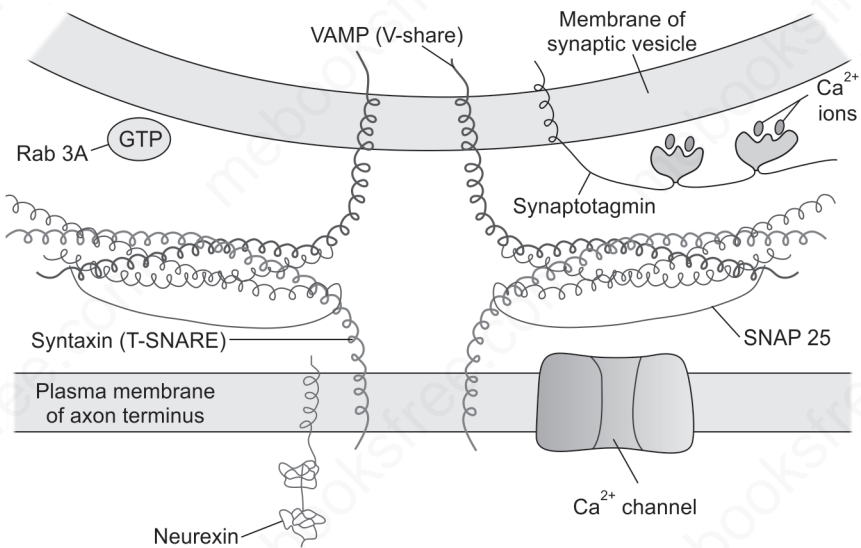

Fig. 12.2: Fusion of vesicle and release of neurotransmitter

Postsynaptic Events: EPSP and IPSP

- ❑ At the postsynaptic membrane, neurotransmitter molecules bind to membrane-bound receptor molecules with recognition sites specific for that neurotransmitter.
- ❑ Binding of the neurotransmitter to the receptor triggers a postsynaptic response specific for that receptor.
- ❑ These responses can be either excitatory or inhibitory, depending on the properties of the receptor.
 - If receptor stimulation occurs in the postsynaptic membrane it becomes more electrically positive (depolarized). It is an excitatory postsynaptic potential (EPSP).
 - If postsynaptic membrane becomes more negative (hyperpolarized), it is an inhibitory postsynaptic potential (IPSP).

Before discussing detail of EPSP and IPSP, we must have to understand the different neurotransmitter and their receptors in CNS. They are as follows:

NEUROTRANSMITTERS IN CNS

Two main types of neurotransmitter:

1. Excitatory: Glutamate
2. Inhibitory: GABA, Glycine

All these three neurotransmitters (glutamate, GABA, glycine) are amino acids in nature.

Other Neurotransmitters in CNS:

Name (Chemical nature)	Location	Actions
Acetylcholine (monoamines)	Basal forebrain , Basal ganglia, Cortex (Betz cell) , RAS	Excitatory: Nicotinic Inhibitory: Muscarinic
Anandamide (fatty acid) present in chocolate	Cortex, cerebellum, limbic system	Relaxation, hunger, analgesia
Dopamine (catecholamine)	Basal ganglia , Limbic system, Hypothalamus	Usually inhibitory
Endorphin (Peptide)	Basal ganglia, Brainstem, Hypothalamus	Inhibitory (narcotic like effect)
Epinephrine (catecholamine)	Minor	Excitatory
Norepinephrine (catecholamine)	Locus ceruleus (Pons) , Limbic system, Hypothalamus, cortex	Usually inhibitory, some excitatory
Serotonin (5HT) (tryptophan derivative monoamines)	Raphe Nucleus of brainstem , Limbic system, basal ganglia, cortex	Inhibitory
Histamine (histidine derivative monoamines)	Hypothalamus	Inhibitory

I IMPORTANT

Botulinum and tetanus toxins

- ❖ Several deadly toxins, which block neurotransmitter release, are **zinc endopeptidases** that cleave and hence inactivate proteins in the fusion-exocytosis complex.
- ❖ Tetanus toxin acts on synaptobrevin.
- ❖ **Botulinum toxins:** B, D, F, and G act on synaptobrevin; C acts on syntaxin; A and B act on SNAP-25.
- ❖ Clinically, tetanus toxin causes spastic paralysis (block neurotransmitter release in the CNS).
- ❖ Botulism causes flaccid paralysis (block release of acetylcholine at the neuromuscular junction).

RECEPTOR OF NEUROTRANSMITTERS

Glutamate Receptors

Glutamate is the main excitatory transmitter in the brain and spinal cord and has been calculated to be responsible for 75% of the excitatory transmission in the CNS. Glutamate acts on two types of receptors as follows:

Flowchart 12.2: Types of glutamate receptor and their ion permeability. Note: Basically all glutamate receptor increase cation permeability of postsynaptic membrane [AMPA: α -amino-3-hydroxy-5-methylisoxazole-4-propionate; Kainite: kainate is an acid isolated from seaweed; NMDA: N-methyl-D-aspartate; IP3 & DAG: inositol 1,4,5 triphosphate (IP3) and diacylglycerol (DAG)].

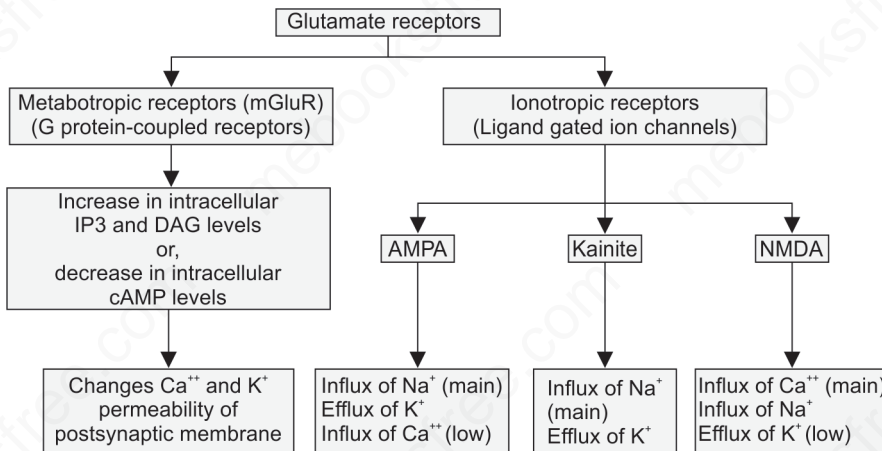

Salient Features of NMDA Receptor

- ❑ Glycine facilitates its function by binding to it, and glycine appears to be essential for its normal response to glutamate.
- ❑ At normal membrane potentials, its channel is blocked by Mg^{2+} ion. This block is removed only when the neuron containing the receptor is partially depolarized by activation of AMPA (depolarization induced channel).
- ❑ The concentration of NMDA receptors in the hippocampus is high, and blockade of these receptors prevents long-term potentiation (mechanism of memory formation).

Gaba Receptors

- ❑ The $GABA_A$ and $GABA_B$ receptors are widely distributed in the CNS but $GABA_C$ almost exclusively in retina.

I IMPORTANT

- ❖ Ionotropic glutamate receptors are tetramers composed of different subunits whose helical domains span the membranes three times.
- ❖ Metabotropic receptors are 7-transmembrane G-protein-coupled receptors (GPCR).
- ❖ mGluR involved in the production of synaptic plasticity, particularly in the hippocampus and the cerebellum.

- ❑ GABA_A and GABA_C are ionotropic receptors: influx of Cl⁻
- ❑ GABA_B metabotropic receptor: K⁺ efflux and closure of Ca⁺⁺ channel.

Glycin Receptors

- ❑ Glycine has both excitatory and inhibitory effects in the CNS.
- ❑ Glycine is also responsible in part for *direct inhibition* primarily in the brainstem and spinal cord.
- ❑ Glycine *facilitates function* of NMDA receptor of glutamate by binding to it (makes NMDA more sensitive), and glycine appears to be essential for its normal response to glutamate. This way, glycine may facilitate pain transmission by NMDA receptors in the dorsal horn.
- ❑ Glycin receptor is ionotropic: increases the influx of Cl⁻.

MECHANISMS OF EPSP AND IPSP (POSTSYNAPTIC EVENT)

- ❑ Binding of a neurotransmitter to an excitatory receptor opens a channel (non-voltage gated) that admits Na⁺ ions or both Na⁺ and Ca⁺⁺ ions.
- ❑ Channel opening leads to local depolarization of the postsynaptic plasma membrane, promoting generation of an action potential in postsynaptic neuron (Fig. 12.3A).
- ❑ This excitatory potential in the postsynaptic membrane is known as excitatory postsynaptic potential (EPSP).
- ❑ In contrast, binding of a neurotransmitter to an inhibitory receptor on the postsynaptic cell causes opening of K⁺ (K⁺ efflux) or, Cl⁻ channels (Cl⁻ influx).
- ❑ The resulting membrane hyperpolarization inhibits generation of an action potential in the postsynaptic cell (Fig. 12.3B).
- ❑ This inhibitory potential in the postsynaptic membrane is known as inhibitory postsynaptic potential (IPSP).

I IMPORTANT

- ❖ Topiramate (anti-epileptic drug) limits activation of AMPA and kainate receptors. Although the main action of topiramate is inhibition of voltage-gated Na⁺ currents in cerebellar granule cells.
- ❖ Felbamate, Phencyclidine and Ketamine bind to block NMDA channel.

I IMPORTANT

Glutamate induced cell death:

- ❖ Although glutamate is required for normal brain function, the presence of excessive amounts of glutamate can lead to huge Ca²⁺ influx and cell death (excitotoxic cell death).
- ❖ The above effect is mediated by NMDA receptor.
- ❖ Glutamate antagonists (**NMDA** antagonist) are used as neuro-protective therapies (**MEMANTINE** in Alzheimer disease and **RILUZOLE** in amyotrophic lateral sclerosis).

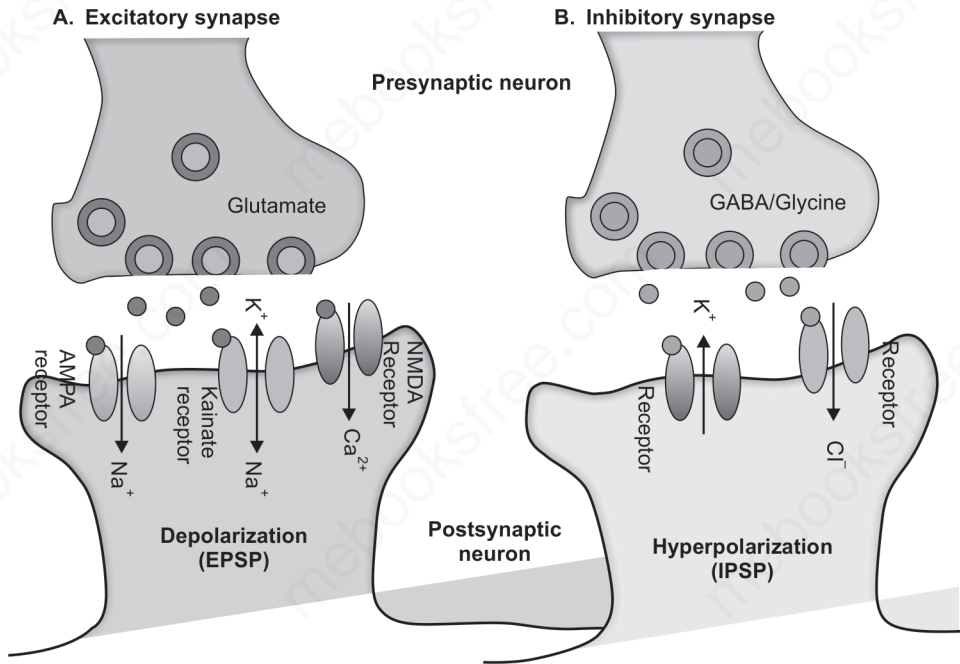

Figs. 12.3A and B: (A) EPSP and (B) IPSP

Types of EPSP

Type	Timing	Cause	Site
EPSP	Latency: 0.5 ms Peak: 0.5 to 1.5 ms Time constant: 3 ms	Na and/or, Ca influx	All
Slow EPSP	Latency: 100–500 ms Last: 20 sec	Decrease K efflux	Autonomic ganglia (muscarinic cholinergic), cardiac muscle, smooth muscle, cortical neurons
Late slow EPSP	Latency: 1–5 sec Last: 10–30 min	Decrease K efflux	Sympathetic ganglia

Types of IPSP

Type	Timing	Cause	Site
IPSP	Latency: 0.5 ms Peak: 0.5 to 1.5 ms Time constant: 3 ms	Cl ⁻ influx	All
Slow IPSP	Latency: 100–500 ms Last: several sec	Increased K efflux	Autonomic ganglia (muscarinic cholinergic), cardiac muscle, smooth muscle, cortical neurons

SYNAPTIC TRANSMISSION IN NEUROMUSCULAR (NM) JUNCTION

- The axon supplying a skeletal muscle fiber divides into a number of terminal boutons, or endfeet.
- The endfeet contain clear vesicles that contain acetylcholine, the transmitter at these junctions.
- The endfeet fit into the muscle membrane (this portion of muscle membrane is known as motor endplate).
- The whole structure is known as the neuromuscular, or myoneural junction.

NM Transmission:

- Mechanism of Ach release from neuron (presynaptic membrane) is same like that of CNS presynaptic mechanisms (Fig. 12.1).
- Postsynaptic mechanism is different in NM junction. It includes:
 - Binding of acetylcholine to their receptors on motor endplate increases the Na^+ and K^+ conductance of the membrane, and the resultant influx of Na^+ produces a depolarizing potential, the motor endplate potential (MEPP).
 - If endplate potential crosses the threshold voltage of the muscle membrane, action potential (AP) develops.
 - The muscle AP in turn, initiates muscle contraction.
- Each nerve impulse releases about 60 to 125 acetylcholine vesicles, and each vesicle contains about 10,000 molecules of the neurotransmitter.
- *This huge amount of Ach produces a MEPP of ~40 mV.*
- *Small quanta (packets) of acetylcholine are released randomly from the nerve cell membrane even at rest. Each produces a small depolarizing spike called a miniature end plate potential, which is about 0.5 mV in amplitude.*

I IMPORTANT

Ganglionic Neurotransmission (EPSP and IPSP): Ach released from presynaptic neuron causes 4 different changes in postsynaptic membrane potential

1. An initial EPSP, via nicotinic receptors that may result in an action potential
2. An IPSP mediated by M_2 muscarinic receptors
3. A secondary slow EPSP mediated by M_1 muscarinic receptors
4. A late, slow EPSP mediated by myriad peptides.

INHIBITION AT SYNAPSES

Inhibition in the CNS can be postsynaptic or presynaptic.

1. **Postsynaptic inhibition:** occurs during the course of an IPSP is called **direct inhibition** because it is not a consequence of previous discharges of the postsynaptic neuron (see Fig. 12.4 and table below).
2. **Presynaptic inhibition:** inhibition exerted on a presynaptic axon terminal.

I IMPORTANT

There is evidence for direct inhibition of transmitter release independent of Ca^{2+} influx into the excitatory ending. So, decrease NT release is the main step of this inhibition (not the reduced Ca^{2+} entry).

3. Negative feedback inhibition: rensshaw cell inhibition is the typical example.

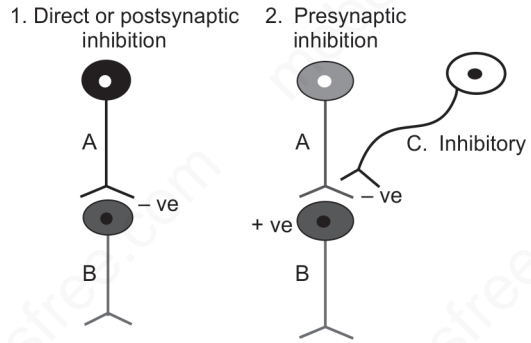
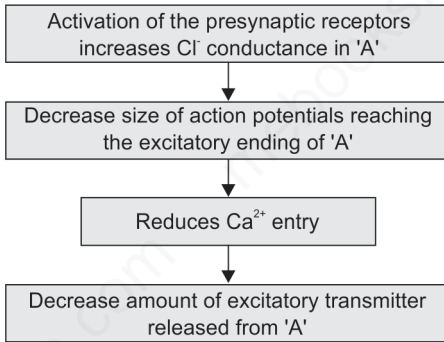

Fig. 12.4: Postsynaptic inhibition (1) and presynaptic inhibition (2). '+ve' indicates stimulatory synapse and '-ve' indicates inhibitory synapse

Postsynaptic inhibition	Presynaptic inhibition
<ul style="list-style-type: none"> • Neuron 'A' is inhibiting neuron B directly. • This is because of the release of an inhibitory neurotransmitter (NT) from neuron A. • This produces an IPSP in neuron B. • Strychnine inhibits postsynaptic inhibition by antagonizing the action of glycine in spinal cord. 	<ul style="list-style-type: none"> • Neuron 'A' releases an excitatory NT, to excite B (excitatory synapse). • But an inhibitory interneuron, 'C' ends presynaptically at 'A' • Activation of 'C' decrease the release of the excitatory NT from 'A', which causes inhibition of synapse between A and B. <p>Salient Features of Presynaptic Inhibition:</p> <ul style="list-style-type: none"> • It is example of axo-axonic synapse. • It is stimulated by general anaesthetics. • It is inhibited by picrotoxin.

Detail Mechanisms of Presynaptic inhibition (Fig. 12.4):

- The transmitter shown to produce presynaptic inhibition is GABA.
- So, in the above diagram (Fig. 12.4), neuron 'C' produces GABA, which acts on $GABA_A$ and $GABA_B$ receptors present on axon terminal of neuron 'A'.



RENSHAW CELL INHIBITION

- ❑ Each spinal motor neuron regularly gives off a recurrent collateral that synapses with an inhibitory interneuron, which terminates on the cell body of the same spinal neuron and other spinal motor neurons (Fig. 12.5).
- ❑ This particular inhibitory interneuron is sometimes called a Renshaw cell after its discoverer.
- ❑ This type of *feedback inhibition* is also known as homonymous *recurrent inhibition*.
- ❑ Impulses generated in the motor neuron activate the inhibitory interneuron to secrete inhibitory mediators, and this slows or stops the discharge of the motor neuron.
- ❑ Each Renshaw cell can be activated by multiple motor neurons, mainly from those innervating synergist muscles.
- ❑ Similar inhibition via *recurrent collaterals* is seen in the cerebral cortex and limbic system.

I IMPORTANT

- ❖ Renshaw cell is depressed during strong voluntary contractions (presumably due to inhibition of the Renshaw cell by descending input).
- ❖ Spinal cord injury that disrupts the descending cortical input to Renshaw cell, may lead to CLONUS due to repetitive firing of motor neuron.
- ❖ STRYCHNINE poison specifically acts on Renshaw cell's ability to control alpha motor neuron firing by binding to the glycine receptors on the motor neuron.

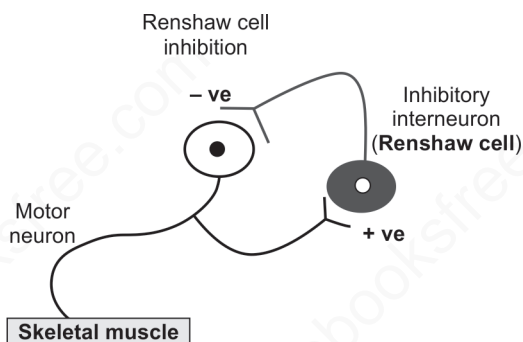

Fig. 12.5: Feedback or, recurrent inhibition by Renshaw cell. '+ve' indicates stimulatory synapse and '-ve' indicates inhibitory synapse

I IMPORTANT**Two-point Discrimination:**

- ❖ 1 mm on the fingertips of young adults; by the sixth or seventh decade of life it declines on average to ~ 2 mm.
 - **Receptor: Merkel cell**
>>Meissner's corpuscle (as Merkel cell has the smallest receptive field).
- ❖ Braille Reading: For blind person, **Braille** dots (spaced ~ 3 mm apart) are perceived as separate dot because of **Merkel cell**. Meissner's corpuscle also contributes to detection of Braille patterns because they sense motion.

I IMPORTANT

- ❖ In human body 3 to 10 times cold spots (receptors) are present than warmth spots.
- ❖ Maximum cold spots are present in the lips (15 to 25 cold spots/cm²), 3 to 5 in the finger and less than 1 cold in some areas of the trunk.

SOMATOSENSORY RECEPTORS

Cutaneous receptors can be classified as:

1. **Mechanoreceptors:**
 - a. Tactile receptor (touch, pressure)
 - b. Proprioceptor: Muscle spindle, Golgi tendon organ, joint capsule receptors
 - c. Nociceptors
2. **Thermoreceptors:**
 - a. Cold receptor (Ad fibre)
 - b. Warm receptor (C fibre)
 - c. Heat nociceptor (Ad fibre)
 - d. Cold nociceptor (C fibre)
3. Chemoreceptor: smell, taste, osmoreceptors.
4. Photoreceptor (electromagnetic receptor)-rods and cones
5. Polymodal receptor: Nociceptors

TACTILE RECEPTORS

- ❑ Active and passive touch is differentiated by cognitive features of the person. Both type of touch excite the same population of receptors in the skin and evoke similar responses in afferent fibers.
- ❑ Tactile receptors are mechanoreceptors.
- ❑ They are mainly divided into two categories: Rapidly adapting and slow adapting receptor.

The difference between two types are:

Rapidly adapting (Phasic) receptor	Slow adapting (tonic) receptor
<ul style="list-style-type: none"> • Sense rate of change of stimulus • Detect motion and vibration • They are encapsulated 	<ul style="list-style-type: none"> • Sense steady stimulus • Detect object pressure and form (shape, size, texture) • They are expanded
Examples: <ul style="list-style-type: none"> • Pacinian corpuscle • Meissner's corpuscle • Hair end organ 	Examples: <ul style="list-style-type: none"> • Merkel cells • Ruffini endings • Free nerve ending

- **Pacinian corpuscle** is the *most sensitive* mechanoreceptor in the somatosensory system.
- **Meissner's corpuscle** is the *most numerous* tactile receptors in the hand, reaching a density of approximately 2 per mm² at the fingertip in man.
- Receptive fields on the fingertips are the smallest on the body, averaging 11 mm² for Merkel's cell fibers and approximately 25 mm² for Meissner's corpuscle.
- Tactile acuity is slightly greater in women than in men and varies between fingers but not between hands. The distal pad of the index finger has the maximum sensitivity.
- The Ruffini ending provides information about the shape of large objects grasped with the entire hand, the "power grasp" in which all five fingers press an object against the palm.
- Free nerve ending detects tickle and *Itch*.

Properties of different tactile receptors:

	Pacinian corpuscle	Meissner's corpuscle	Merkel cell	Ruffini ending
Location	Dermis	Dermal papillae	Tip of epidermis (Iggo-Dome receptor)	Dermis
Best stimulus	Vibration	Lateral motion (movement)	Edges, points, corner	Skin stretch
Frequency range	5–1000	1–300	0–100	--
Best frequency (Hz) detection	200	50	5	--
μM threshold indentation (uM)	0.01	2	8	40

THERMORECEPTORS

They are:

- **Cold receptor:** Range 10°C to slightly above 40°C. *Peak 24°C*
- **Warm receptor:** Range 30°C to 49°C. *Peak 45°C*
- **Heat nociceptor:** stimulated when temp >45°C
- **Cold nociceptor:** stimulated when temp < 5°C

I IMPORTANT

Chemicals that excite the chemical type of pain (slow, suffering type of pain) are **bradykinin (most potent)**, serotonin, histamine, potassium ions, acids, acetylcholine, and proteolytic enzymes.

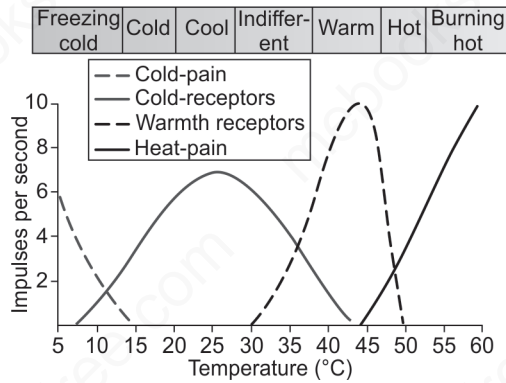

Fig. 12.6: Discharge frequencies at different skin temperature of a cold-pain fiber, a cold fiber, a warmth fiber, and a heat-pain fiber

Molecular Physiology of Nociceptors and Thermoreceptors

- ❑ Nociceptors mediate pain.
- ❑ They can be stimulated by:
 - Mechanical stimulus
 - Thermal stimulus
 - Chemical stimulus.
- ❑ They are polymodal nociceptor because they respond to different modalities of stimuli.
- ❑ **Fast pain** is elicited by the mechanical and thermal types of stimuli, whereas **slow pain** can be elicited by all three types of stimuli.

Chemicals that are active in nociceptive transduction:

Substance	Source	Effect on primary afferent
Nociceptor activators		
Bradykinin	Plasma protein	+++
Histamins	Mast cell	+
Serotonin	Platelets	++
K ⁺ (potassium)	Damaged cell	++
Nociceptor sensitizers		
Prostaglandins	Damaged cell	+/-
Leukotrienes	Damaged cell	+/-
Substance P	Primary afferent	+/-

I IMPORTANT

- ❖ Human body contains around 25000–30000 muscle spindles (4000 per arm, 7000 per leg) and individual muscle can contain up to 500 spindles.
- ❖ *The density is higher in muscle, which require for fine control (e.g., the small muscles of the hand and eye).*

- ❑ These nociceptors are located on ending of nociceptive nerve (free nerve ending) that mediates pain and temperature (Ad and C fibre)
- ❑ Actually nociceptors are *ion channel*, which are called *Transient Receptor Potential channel (TRP)*.
- ❑ All TRP channels are gated by temperature and various chemical ligands, but different types respond to different temperature ranges and have different activation thresholds.
- ❑ At least six types of TRP receptors have been identified in sensory neurons. They are:

TRP channel classification	
Type of ion channel	Respond to
TRPV1 (Vanilloid receptor 1)	Capsaicin, protons and temperatures above 43°C
TRPV2 (VRL1)	Temp above 52°C
TRPV3	Temp above 35°C
TRPV4	Temp above 27°C
TRPM8 (CMR1)	Temp around 8 to 28°C, menthol and mints.
TRPA1	Temp below 17°C
<ul style="list-style-type: none"> • At resting skin temperature only TRPV4> TRPV3 are active • TRPV1 and TRPV2 receptors produce burning pain sensations • TRPM8 is the receptor for moderate cold. • TRPV1 (VR) is a polymodal pain receptor. 	
<p>V: refers to group of chemical called vanilloids, M: menthol, A: ankyrin, CMR1: Cold Menthol sensitive receptor 1, VR: Vanilloid receptor</p>	

PROPRIOCEPTORS

Measure muscle activity and joint positions.

These receptors include:

1. Muscle- spindle endings
2. Golgi tendon organ
3. Joint-capsule receptors

MUSCLE SPINDLE

- ❑ Muscle spindles (0.5 to 10 mm in length) are found in almost all skeletal muscles.
- ❑ The muscle fibers within the spindle are called **intrafusal fibers** to distinguish them from the

I IMPORTANT

The dynamic reaction occurs in response to a sudden change in length of the muscle as occurs during performance of knee jerk or, any deep tendon reflex.

regular or **extrafusal fibers** (contractile units of the muscle).

- ❑ The intrafusal fibers are positioned in **parallel to the extrafusal fibers**.
- ❑ Intrafusal fibers do not contribute to the overall contractile force of the muscle, but rather serve a pure sensory function.

There are two types of intrafusal fibers (Fig. 12.7):

1. *Nuclear Bag*: Many nuclei in a dilated central area and is called a nuclear bag fiber (**2–3 bag fibers in each spindle**).
 - a. Dynamic nuclear bag fiber: *detects velocity (rate of change in length) of muscle.*
 - b. Static nuclear bag fiber: *detects tonic length of muscle.*
2. *Nuclear chain fiber*: Nuclei are arranged in a row (**each spindle has 5–9 chain fibers**). They are only static in nature: *detects tonic length of muscle.*

Afferent from Spindle

1. *Primary (group Ia) ending: (Annulospiral Ending)*: 1 in number. Wraps around the center of the dynamic and static nuclear bag fibers and nuclear chain fibers (*center of all fibers*).
2. *Secondary (group II) endings: (Flower spray ending)*: up to 8 in number. Located adjacent to the centers of the static nuclear bag and nuclear chain fibers; these fibers do not innervate the dynamic nuclear bag fibers.

Efferent supply to spindle: By γ -motor neurons at the polar regions of spindle. There are two types of γ -motor neurons:

- ❑ Dynamic γ : supply the dynamic nuclear bag fibers
- ❑ Static γ : supply the static nuclear bag fibers and the nuclear chain fibers.

Central connection: Ia fibers end directly on α -motor neurons supplying the extrafusal fibers of the same muscle at spinal cord.

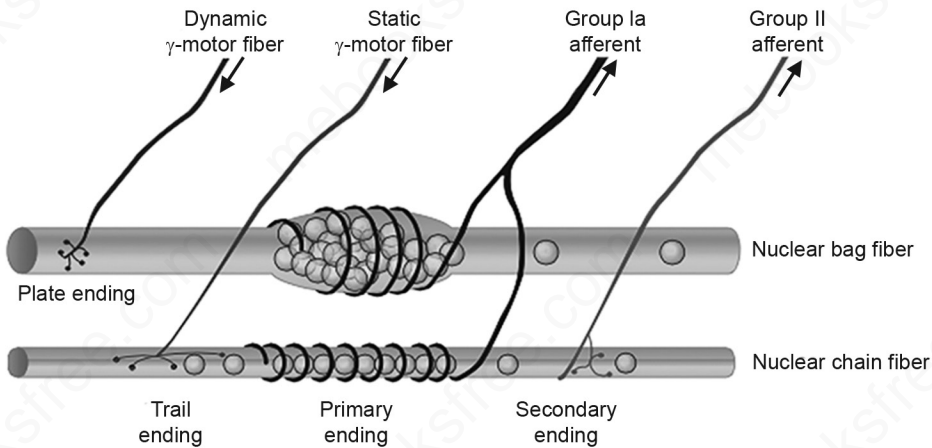

Fig. 12.7: Muscle spindle with afferent and efferent supply

Functions: Stretch Reflex (Myotatic)

- ❑ When the muscle is *passively stretched*, the spindles are also stretched (parallel with the extrafusal), referred to as “*loading the spindle.*”
- ❑ The stretching stimulates group Ia afferent fibers.
- ❑ Group Ia afferents synapse directly on α -motor neurons in the spinal cord. The pool of α -motor neurons that is activated innervates the homonymous muscle.
- ❑ This initiates reflex contraction of the extrafusal fibers in the muscle that was stretched. This is known as *stretch reflex* (Fig. 12.8).
- ❑ As muscle contracts, it shortens, decreasing the stretch on the muscle spindle and returning it to its original length.

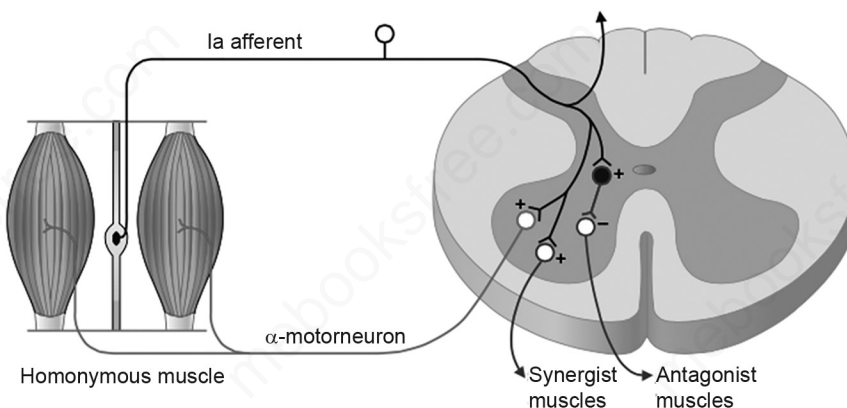

Fig. 12.8: Stretch reflex

I IMPORTANT

- ❖ Golgi bottle neuron is an inhibitory interneuron in spinal cord for reciprocal inhibition.
- ❖ Reciprocal inhibition is a bisynaptic reflex

Thus, activation of γ -motor neurons increases the sensitivity of the muscle spindle.

- ❑ **Reciprocal innervation:** The organization of the stretch reflex arc such that one set of α motor neurons is activated and the opposing set (antagonize muscle) is inhibited.
- ❑ So, contraction of one-muscle group leads to relaxation of antagonist muscle group. This arrangement is known as *reciprocal innervation* (Fig. 12.8).
- ❑ The pathway mediating this effect is **bisynaptic**. A collateral from each Ia fiber passes in the spinal cord to an inhibitory interneuron (**Golgi bottle neuron**) that synapses on a motor neuron supplying the antagonist muscles. This example of postsynaptic inhibition.
- ❑ **Example of stretch reflex:** All deep tendon reflexes like knee jerk, ankle jerk.
- ❑ The time between the application of the stimulus and the response is called the **reaction time**. In humans, the reaction time for a stretch reflex such as the knee jerk is 19–24 ms.
- ❑ The **central delay**, is the time taken for the reflex activity to traverse the spinal cord synapse for the knee jerk is 0.6–0.9 ms.

Effect of γ -motor: Descending motor commands from the brain typically activate α and γ motor neurons **simultaneously** and thus cause a synchronous contraction of extrafusal and intrafusal muscle fibers. This co-contraction means that as the muscle shortens from the contraction of extrafusal fibers, the polar regions of the intrafusal fibers also shorten, thereby maintaining relatively constant tension on the equatorial portion and thus the sensitivity of the spindle apparatus.

GOLGI TENDON ORGAN**Location**

- ❑ Embedded within the musculotendinous junction (90%) and in the tendon itself (10%).
- ❑ Each organ is attached with **less than 25 extrafusal fibers** (>25 fiber are present in 5% of Golgi tendon organ) (**Ganong: 3–25 fiber, Guyton: 10–15 fiber**) from a small number of *motor units* (<15 motor unit). Unlike muscle spindle, these fibers are *in series* with extrafusal fibers of muscle.

Stimulated by: Increase Tension at Muscle Tendon

- ❑ They are stimulated by both passive stretch and active contraction of the muscle.
- ❑ The threshold of the Golgi tendon organs is low.

Afferent: Ib fiber (myelinated).

Efferent supply to muscle spindle: Not present

Central connection: Ib fibers on α -motor neurons via an inhibitory interneuron in spinal cord.

Functions: Inverse stretch reflex

- ❑ Active muscle contraction stimulates the Golgi tendon organs and group Ib afferent fibers.
- ❑ The group Ib afferents stimulates inhibitory interneurons in the spinal cord. These interneurons inhibit α -motor neurons and cause relaxation of the muscle that was originally contracted.
- ❑ At the same time, antagonistic muscles are excited (contraction). This is *inverse stretch* (myotatic) reflex.
- ❑ It is a bisynaptic or, disynaptic reflex.

WITHDRAWAL REFLEX

- ❑ **Typical polysynaptic reflex:** occurs in response to a painful stimulation (group III, IV fiber) of the skin or subcutaneous tissues and muscle. Stimulation of touch receptors (group II fiber) can also elicit a weaker and less response. Groups II, III and IV are known as flexion reflex afferents (FRAs).
- ❑ Components of withdrawal reflex (Fig. 12.9):
 - Flexor reflex
 - Reciprocal inhibition
 - Crossed extensor response
 - After-discharge lasting many fractions of a second after the stimulus is over.
- ❑ When a stimulus is applied, FRA cause excitatory interneurons to activate the α motor neurons that supply the flexor muscles in the ipsilateral limb and cause inhibitory interneurons to inhibit the α motor neurons that supply the antagonistic extensor muscles.
- ❑ The response is flexor muscle contraction (*flexor reflex*) and inhibition of extensor muscles (*reciprocal inhibition*), so that the body part stimulated is flexed and withdrawn from the stimulus.

I IMPORTANT

Spasticity: Excessive discharge to γ -motor neuron. Excessive tone is generally one group of muscle (extensor).

- ❖ Example: **Clasp-knife reflex or, lengthening reaction:** it is an exaggerated form of the Golgi tendon reflex, can occur with disease of the corticospinal tracts. If stretch is applied to a spastic muscle continuously, the resistance increases then suddenly gives away, as a result of inhibition by Golgi tendon organ system. This sudden loss of resistance is known as clasp knife or, lengthening reaction, which is nothing but activation of inverse stretch reflex (golgi tendon organ).

I IMPORTANT

Rigidity: increased activity of α -motor neurons to both agonist and antagonist muscles.

- ❖ Example: Lead pipe rigidity. When a joint is flexed passively, there is uniform resistance throughout the movement (lead pipe rigidity). Sometime a series of "catches" takes place during the passive motion. This is known as cogwheel rigidity. It is a manifestation of extrapyramidal disease. The sudden loss of resistance seen in a spastic extremity is absent.

I IMPORTANT

Clonus: repetitive muscular contraction in response to stretch. It is due to operation of stretch and inverse stretch reflex.

- ❑ When a strong stimulus is applied to a limb, about 0.2 to 0.5 second after the stimulus, there is also extension of the opposite limb (*crossed extensor reflex*).
- ❑ The after-discharge that occurs in the flexor reflex, lasting for about 6 to 8 milliseconds, results from repetitive firing of the excited interneurons themselves.

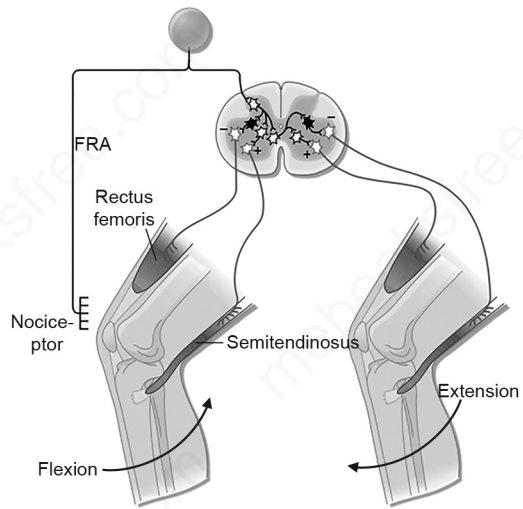

Fig. 12.9: Withdrawal reflex

Summary of Muscle Reflexes

Reflex	Number of synapse	Stimulus	Afferent fiber	Response
Stretch reflex	Monosynaptic	Muscle is stretched	Ia	Contraction of the muscle
Golgi tendon reflex (inverse myotatic)	Disynaptic	Muscle contracts	Ib	Relaxation of the muscle
Flexor-withdrawal reflex	Polysynaptic	Pain, touch	II, III, and IV	Ipsilateral flexion; contralateral extension

JOINT-CAPSULE RECEPTORS

This type of proprioceptors as follows:

Type	Location	Appearance	Physiological functions
I Slow adapting	Capsule and ligaments, High density in proximal joints	Ruffini-like corpuscle	Active at rest and during movement

II Rapidly adapting	Junction of synovial and fibrosum of capsule. High density in <i>distal joints</i>	Pacinian-like corpuscle	Active at onset and termination movement
III Slow adapting	Collateral ligaments <i>Not found</i> in intrspinous ligaments of cervical region	Golgi tendon organ like corpuscle	Active at end of joint range
IV Slow adapting	Capsule and ligaments but <i>absent in</i> synovial tissue	Free nerve ending	Active only to extreme mechanical stimulation

SOMATOSENSORY PATHWAYS

This includes (Fig. 12.10):

1. **Dorsal Column Pathway:** This carries pressure (high degree localizing pressure), vibration, proprioception, fine touch and two-point discrimination.
2. **Anterior Spinothalamic Tract:** This carries crude touch and pressure (crude localizing ability), Tickle and itch sensations, sexual sensations.
3. **Lateral Spinothalamic Tract:** This carries pain and temperature.

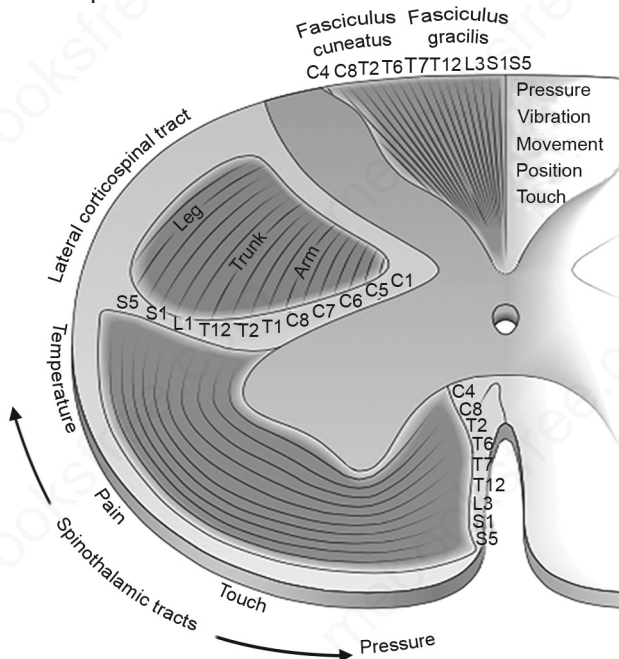

Fig. 12.10: Cross-sectional areas of different tracts

Anatomical Organization of the Ascending Tracts

- ❑ **The first neuron**, the first-order neuron, has its cell body in the posterior root ganglion of the spinal nerve. A peripheral process connects with a sensory receptor ending, whereas a central process enters the spinal cord through the posterior root to synapse on the second-order neuron.
- ❑ **The second-order neuron** gives rise to an axon that decussates (crosses to the opposite side) and ascends to a higher level of the central nervous system, where it synapses with the third-order neuron.
- ❑ **The third-order neuron** is usually in the thalamus and gives rise to a projection fiber that passes to a sensory region of the cerebral cortex.
- ❑ This three-neuron chain is the most common arrangement, but some afferent pathways use more or fewer neurons.

1. Dorsal Column Pathway: Fasciculus Gracilis and Fasciculus Cuneatus (Fig. 12.11)

- ❑ Axons of the first order neuron enter the spinal cord from the posterior root ganglion and pass directly to the posterior white column of the *same side*.
- ❑ These long ascending fibers in the posterior white column are known as the *fasciculus gracilis* and *fasciculus cuneatus*.
- ❑ *Fasciculus gracilis* contains the long ascending fibers from the sacral, lumbar, and lower six thoracic spinal nerves.
- ❑ The fasciculus cuneatus is situated laterally in the upper thoracic and cervical segments of the spinal cord and contains the long ascending fibers from the upper six thoracic and all the cervical spinal nerves.
- ❑ The fibers of the fasciculus gracilis and fasciculus cuneatus ascend ipsilaterally and terminate by synapsing on the second-order neurons in the *nuclei gracilis and cuneatus* of the medulla oblongata.
- ❑ The axons of the second-order neurons, called the internal arcuate fibers cross the median plane.
- ❑ The fibers then ascend as a single compact bundle, the medial lemniscus, through the medulla oblongata, the pons, and the midbrain.
- ❑ The fibers terminate by synapsing on the third-order neurons in the ventral posterolateral nucleus of the thalamus.

- ❑ The axons of the third-order neuron leave and pass through the posterior limb of the internal capsule and corona radiata to reach the somesthetic area in the postcentral gyrus of the cerebral cortex

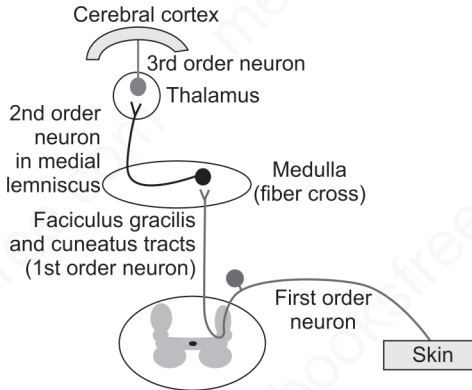

Fig. 12.11: Dorsal column pathways

2. Anterior Spinothalamic Tract

- ❑ The cell bodies of the 1st neurons (pseudo-unipolar) lie in the dorsal root ganglia of the spinal nerve.
- ❑ The central processes of these cells enter the spinal cord through the *medial division* of dorsal root of the spinal nerve, where they divide into ascending and descending branches.
- ❑ These branches travel for a distance of 1 or 2 segments of the spinal cord, contributing to the *posterolateral tract of Lissauer* and finally terminate by synapsing with the cells in the substantia gelatinosa group of posterior gray column.
- ❑ The axons of the 2nd neurons now cross obliquely to the opposite side *within several spinal segments* and ascend in the opposite anterolateral white column as the *anterior spinothalamic tract*.
- ❑ 2nd order neurons terminate by synapsing with the 3rd order neurons in the *ventral posterolateral nucleus of thalamus*.
- ❑ 3rd order neurons pass through the posterior limb of the internal capsule and the corona radiata to reach the somesthetic area in the postcentral gyrus of the cerebral cortex.

3. Lateral Spinothalamic Tract (Fig. 12.12)

- ❑ The cell bodies of the 1st neurons (pseudo-unipolar) lie in the dorsal root ganglia of the spinal nerve.

- ❑ The central processes of these cells enter the spinal cord through the *lateral division* of the dorsal root of the spinal nerve, where they divide into ascending and descending branches.
- ❑ These branches travel for a distance of 1 or 2 segments of the spinal cord, contributing to the *posterolateral tract of Lissauer* and finally terminate by synapsing with the cells in the substantia gelatinosa group of posterior gray column.
- ❑ The axons of the 2nd neurons now cross obliquely to the opposite side *within one spinal segment* and ascend in the opposite anterolateral white column as the *lateral spinothalamic tract*.
- ❑ 2nd order neurons terminate by synapsing with the 3rd order neurons in the *ventral posterolateral nucleus of thalamus*.
- ❑ 3rd order neurons pass through the posterior limb of the internal capsule and the corona radiata to reach the somesthetic area in the postcentral gyrus of the cerebral cortex.

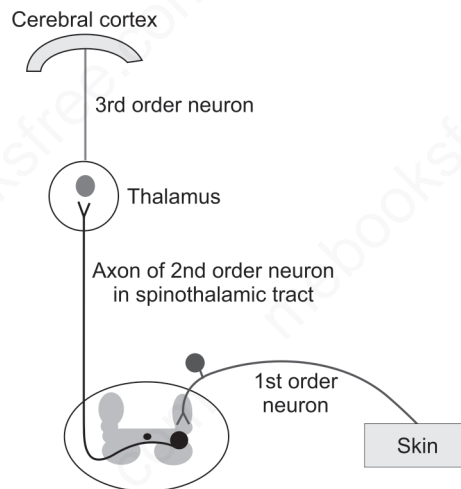

Fig. 12.12: Lateral spinothalamic tract

Spinocerebellar tracts: They carry unconscious proprioceptive sensations (information from the muscle spindles, tendon organs, and joint receptors) to the cerebellum and play important role in balance and muscular coordination.

- ❑ **Posterior (lateral) Spinocerebellar Tract (Fig. 12.13):** The axons entering the spinal cord from the

posterior root ganglion enter the posterior gray column and terminate by synapsing on the second-order neurons at the base of the posterior gray column. These neurons are known collectively as the *nucleus dorsalis (Clarke's column)*. The axons of the second-order neurons enter the posterolateral part of the lateral white column on the *same side* and ascend as the posterior spinocerebellar tract to the medulla oblongata. Here, the tract joins the inferior cerebellar peduncle and terminates in the cerebellar cortex. *Note that it does not ascend to the cerebral cortex.*

- **Anterior Spinocerebellar Tract:** First order neurons synapse with second-order neurons in the nucleus dorsalis (Clarke's column), same like posterior tract. The majority of the axons of the second-order neurons cross to the *opposite side* and ascend as the anterior spinocerebellar tract in the contralateral white column; the minority of the axons ascend as the anterior spinocerebellar tract in the lateral white column of the same side. The fibers, having ascended through the medulla oblongata and pons, enter the cerebellum through the superior cerebellar peduncle and terminate in the cerebellar cortex. It is believed that those fibers that *crossed over to the opposite side in the spinal cord cross back within the cerebellum.*

I IMPORTANT

Brown-Sequard Syndrome

- ❖ A functional hemisection of the spinal cord
- ❖ Damage occurs to ipsilateral dorsal-column pathway, contralateral spinothalamic tract and ipsilateral descending motor (corticospinal tract) pathways.
- ❖ Ipsilateral loss of discriminative touch, vibration, and proprioception below the level of lesion.
- ❖ Contralateral loss of pain and temperature sensation beginning one or two segments below the lesion.
- ❖ Weakness and spasticity in certain muscle groups on the same side of the body.

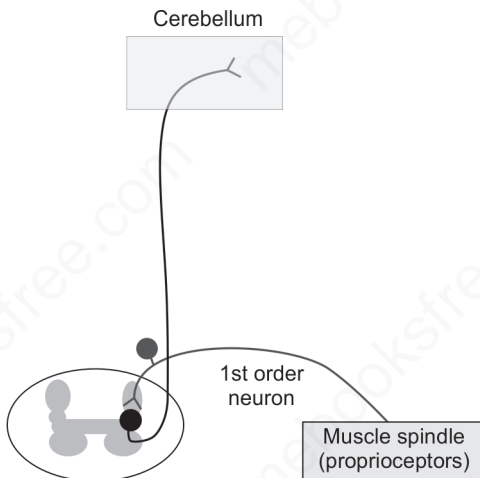

Fig. 12.13: Spinocerebellar tract

Somatosensory Pathways Summary:

Sensation	1st order neuron	2nd order neuron	3rd order neuron	Pathway	Destination
Temperature and pain	Posterior root ganglia	Substantia gelatinosa	Ventral posterior lateral nucleus of thalamus	Lateral spinothalamic tract , spinal lemniscus	Somatosensory cortex
Crude touch (light touch) and pressure	Posterior root ganglia	Substantia gelatinosa	Ventral posterior lateral nucleus of thalamus	Anterior spinothalamic tract , spinal lemniscus	Somatosensory cortex
Discriminatory touch (fine touch), vibration, proprioception	Posterior root ganglia	Nuclei gracilis and cuneatus	Ventral posterior lateral nucleus of thalamus	Fasciculi gracilis and cuneatus , medial lemniscus	Somatosensory cortex
Unconscious proprioception	Posterior root ganglia	Nucleus dorsalis (Clarke's column)		Anterior and posterior spino-cerebellar tract	Cerebellar cortex

I IMPORTANT

- ❖ The main excitatory neurotransmitter released by the A delta fibers and the C fibers is the amino acid glutamate. Substance P is also released from the C fibers.

Conduction of Pain to the Central Nervous System:

Pain can be divided into two main types: fast pain and slow pain.

- ❑ **Fast pain** is sharp, acute pain experienced within about 0.1 second after the pain stimulus is applied. Fast pain travels in peripheral nerves in large diameter *A delta axons*.
- ❑ **Slow pain** is burning pain, aching pain, and throbbing pain, felt 1.0 second or later after the stimulation. Slow pain travels in the *small diameter C fibers*.

Pain Control in the Central Nervous System:**1. The Gating Theory:**

- ❑ Massage and the application of liniments (balm) to painful areas in the body can relieve pain. The technique of acupuncture and low-frequency transcutaneous electrical nerve stimulation (TENS) of the skin also relieves pain in certain cases. Although the precise mechanism for these phenomena is not understood, the gating theory was proposed some years ago.
- ❑ **Ronald Melzak and Patrick Wall proposed this theory in 1960.**
- ❑ The hypothesis focused on the interaction of neurons in the dorsal horn of the spinal cord (Lamina I to IV).
- ❑ Stimulation of C fiber, inhibits inhibitory interneuron (substantia gelatinosa, SG cell) and opens the gate for pain transmission via projection neuron (Fig. 12.14).

- Simultaneous stimulation of A-beta fibers (touch, pressure) stimulates SG cell. SG cell in turn inhibits projection neuron for pain transmission (gate closed). This reduces pain perception.

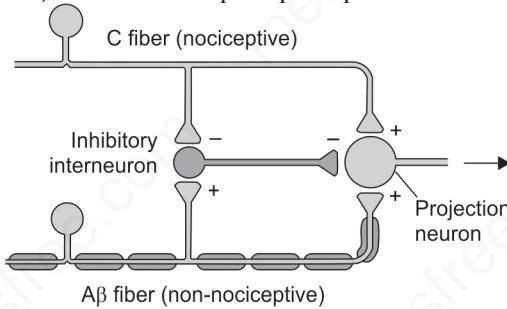

Fig. 12.14: Gate control theory of pain

2. The Analgesia System

The analgesia system consists of following components:

1. **The periaqueductal gray (PAG) and periventricular areas** of the mesencephalon and upper pons surround the aqueduct of Sylvius and portions of the third and fourth ventricles. **These neurons secrete enkephalin.**
2. These PAG neurons project directly to and activate two groups of neurons in the brainstem: *serotonergic neurons* in the **nucleus raphe magnus** and *catecholaminergic neurons* in the **rostral ventromedial medulla**.
3. Neurons in both of these regions project to the **dorsal horn of the spinal cord** where the released serotonin and norepinephrine inhibit the activity of dorsal horn neurons that receive input from nociceptive afferent fibers (type C and type Aδ).
4. This inhibition occurs, at least in part, due to the activation of the dorsal horn enkephalin-containing interneurons. *The enkephalin is believed to cause both presynaptic and postsynaptic inhibition* of incoming type C and type Aδ pain fibers where they synapse in the dorsal horns.
5. There is also a group of brainstem catecholaminergic neurons in the **locus coeruleus** that are elements of this descending pain modulating pathway.
6. The release of endogenous **cannabinoids** such as 2-ara-chidonoylglycerol (2AG) and anandamide may also contribute to stress-induced analgesia.

I IMPORTANT

Lesion of primary somatosensory cortex:

- ❖ **First sensation lost:** Graphesthesia and stereognosis are lost earliest. Proprioception and fine touch are most affected by cortical lesions. Temp followed by pain lost at the last.
- ❖ **Recovery** of sensory lost occurs in the reverse order. Pain recovers earliest and fine touch graphesthesia last.

I IMPORTANT

lesions in SII produce deficits in **learning by object manipulation and in recognizing the texture and size of hand-held objects.**

I IMPORTANT

- ❖ In patients with bilateral lesions along the inferior surface of the temporal lobes (main) and occipital lobes results in the inability to recognize faces (prosopagnosia).
- ❖ Astereognosis (tactile agnosia) is often caused by a lesion in the region of the middle third of the postcentral gyrus (posterior parietal cortex-somatosensory area), where the hand is represented. It can also be caused by lesion in dorsal column (Cuneatus > Gracilus).

LAWS IN SENSORY PHYSIOLOGY

1. **Muller's Doctrine of specific nerve energies:** No matter where along the nerve pathway one stimulates, the type of sensation will depend on which part of the brain is finally going to be stimulated.
2. **Law of Projection:** No matter where along the nerve pathway one stimulates, the sensation will be felt at the site of the receptor. Phantom limb sensation is best described by this law.
3. **Bell-Megendie Law:** This law states that the dorsal root is sensory and ventral root is motor.
4. **Labelled-line theory:** All the sensations from the different parts of the body travel along specified paths. For example, in the posterior column, fibers from the lower parts of the body are placed medially.
5. **Weber-Fechner's law:** In 1834 Weber demonstrated that the *sensitivity of a sensory system* to differences in intensity depends on the absolute *strength of the stimulus*. We easily perceive that 1 kg is different from 2 kg, but it is difficult to distinguish 50 kg from 51 kg. Yet both sets differ by 1 kg. This relationship is expressed in the equation now known as:
 - **Weber's law:** $\Delta S = K \cdot S$ [where ΔS is the minimal difference in strength between a reference stimulus S and a second stimulus that can be discriminated, and K is a constant.]
 - **Fechner** extended Weber's law to describe the relationship between the stimulus strength (S) and the intensity of the sensation (I) experienced by a subject: $I = K \log (S/S_0)$[where S_0 is the threshold amplitude of the stimulus and K is a constant.]
 - **Stevens' law** states that: $I = K (S - S_0)^n$

SOMATOSENSORY CORTEX

The primary somatosensory cortex (SI): the postcentral gyrus and the posterior paracentral lobule of the parietal lobe (**Brodmann area 3,1,2**).

- Widespread bilateral excision of somatosensory area I causes loss of the following types of sensory judgment:
 - The person is unable to localize discretely the different sensations in the different parts of the body.
 - The person is unable to judge shapes or forms of objects. This is called *astereognosis*.

The secondary somatosensory cortex (SII): located inferiorly in the pars opercularis of the parietal lobe, which forms part of upper lip of the lateral sulcus (no Brodmann name).

- ❑ SII neurons send their axons to SI, association cortex, motor cortex, and insula. The latter projection, to the insula, influences structures such as the amygdala and hippocampus. These structures are important in tactile learning and memory.
- ❑ The projection to the somatosensory association cortex is involved in higher order processing required for recognizing **hand-held objects by texture and size**.

The somatosensory association cortex (Brodmann 5 and 7): located in the superior parietal lobe (also known as posterior parietal cortex), which is posterior to SI.

- ❑ Large lesions involving the posterior parietal cortex and the adjoining superior temporal gyrus may result in an attentional deficit called "*neglect*", wherein there is a partial neglect (inattention) to tactile, proprioceptive and/or visual stimuli delivered contralateral to the lesion site.
- ❑ The patient is described as ignoring the contralesional half of her/his body and space. The perception of a "whole" body is lost and the body parts affected may be considered to belong to someone else. Visual stimuli on the contralesional side may also be ignored.
- ❑ This complex sensory deficit is called *amorphosynthesis*.

Cortical Plasticity

- Numerous animal studies point to dramatic reorganization (plasticity) of cortical structures.
- If a digit is amputated in a monkey, the cortical representation of the neighboring digits spreads into the cortical area that was formerly occupied by the representation of the amputated digit.
- Conversely, if the cortical area representing a digit is removed, the somatosensory map of the digit moves to the surrounding cortex.
- The explanation of these shifts appears to be that cortical connections of sensory units to the cortex have extensive convergence and divergence, with connections that can become weak with disuse and strong with use.

MULTIPLE CHOICE QUESTIONS

SYNAPSE AND NEUROTRANSMITTERS

RECENT MCQs

1. All are neuroglial cells in CNS except:

- a. Astrocytes
- b. Microglia
- c. Oligodendrocytes
- d. Trophosomes

2. Features of Neuroglia cells include all except:

- a. Protoplasmic astrocytes are found in gray matter
- b. Oligodendrocytes are derived from ectoderm
- c. Microglia are mesodermal in origin
- d. Central neuroglial cells are derived from Schwann cells

3. Phagocytosis in the CNS is done by:

- a. Astrocytes
- b. Schwann cells
- c. Microglia
- d. Oligocytes

4. Function of microglia in CNS:

- a. Phagocytosis
- b. Myelin synthesis
- c. Fibrosis
- d. Nutrition to neurons.

5. Substrate P, actions all except:

- a. Vasoconstriction
- b. Pain transmission
- c. Axon reflex
- d. Peristalsis

6. The raphe nuclei located in lower pons and medulla secrete the following neurotransmitter:

- a. Norepinephrine
- b. Dopamine
- c. Serotonin
- d. Acetylcholine

7. Pain-sensitive intracranial structure is:

- a. Pia mater
- b. Pial vessels
- c. Dura mater
- d. Brain matter

8. Strychnine acts by:

- a. Exciting all the excitatory synapses in the cord
- b. Blocking inhibitory synapses
- c. Being incorporated as substitute transmitter in monoaminergic synapses
- d. Directly exciting the skeletal muscle fibrosis

AIIMS/PGI/JIPMER

9. Stimulation by touching or pulling on which of the following structures is likely to cause a painful sensation?

[PGI Nov 12]

- a. The postcentral gyrus
- b. The dura overlying the postcentral gyrus
- c. Branches of the middle meningeal artery that lie superficial to the dura over the postcentral gyrus
- d. Branches of the middle cerebral artery that supply the postcentral gyrus
- e. Temporal cortex

10. Excitatory Neurotransmitters are:

[PGI Dec 04]

- a. Acetylcholine
- b. Glycine
- c. GABA
- d. Glutamine
- e. NMDA

11. The main excitatory neurotransmitter in the CNS is: [AI 04]

- a. Glycine
- b. Acetylcholine
- c. Aspartate
- d. Glutamate

12. The inhibitory neurotransmitter in CNS neurons is: [AIIMS May 04]

- a. Glutamate
- b. Aspartate
- c. Gamma-amino butyric acid
- d. Taurine

13. The hyperkinetic features of the Huntington's disease are due to the loss of: [AI 06]

- a. Nigrostriatal dopaminergic system
- b. Intrastratial cholinergic system
- c. GABA-ergic and cholinergic system
- d. Intrastratial GABA-ergic and cholinergic system

14. Which of the following statements is true for excitatory postsynaptic potential (EPSP)?

- a. Are self propagating
- b. Shows all or none response
- c. Arc proportional to the amount of transmitter released by the presynaptic neuron
- d. Are inhibitory at presynaptic terminal

15. EPSP is due to:

- a. K^+ influx
- b. Na^+ efflux
- c. Na^+ influx
- d. Ca^{++} influx

16. IPSP is due to:

- a. Cl^- influx
- b. K^+ influx
- c. Na^+ influx
- d. Ca^{++} influx

17. Slow IPSP in autonomic ganglia is generated by: [PGI Dec 05]

- a. Nicotinic cholinergic
- b. Muscarinic cholinergic

- c. Dopamined GnRH
- e. Adrenaline

18. Simulation of postganglion sympathetic neurons leads to:

[PGI Dec 02]

- a. Fast EPSP
- b. Slow EPSP
- c. Fast IPSP
- d. Slow IPSP
- e. Very slow EPSP

19. Renshaw cell inhibition is a:

- a. Feedback facilitation
- b. Feed forward inhibition
- c. Feed forward facilitation
- d. Feedback inhibition

20. True about Renshaw cell inhibition is:

- a. Add on collateral sensation
- b. Increases by local anaesthetics
- c. Has memory for spinal cord
- d. Inhibition of feedback propagation

21. Which of the following statements is true about presynaptic inhibition?

[AIIMS Nov 08]

- a. It results due to failure of the action potential to reach
- b. It results due to hyperpolarization of presynaptic membrane
- c. It occurs due to inhibition of release of neurotransmitter from presynaptic terminal
- d. It occurs due to blockade of neurotransmitter receptors

22. Synaptic potentials can be recorded by: [AIIMS May 05]

- a. Patch clamp technique
- b. Voltage clamp technique
- c. Microelectrode
- d. EEG

SOMATOSENSORY RECEPTORS

RECENT MCQs

23. Which one of the following sensory receptors is found in epidermis?

- a. Merkel disc
- b. Meissner's corpuscles
- c. Ruffini ending
- d. Pacinian corpuscles

24. Meissner's corpuscles are for:

- a. Touch
- b. Temperature
- c. Pressure
- d. Proprioception

25. The distance by which two touch stimuli must be separated to be perceived as two separate stimuli is greatest at:

- a. The lips
- b. The palm of the hand
- c. The back of scapula
- d. The dorsum of the hand

26. Vibration sensation is mediated by:
[NIMHANS 06]

- a. Merkel's disc
- b. Ruffini's end organ
- c. Pacinian corpuscle
- d. Meissner's corpuscle

27. Dynamic response is due to:

- a. Primary ending
- b. Secondary ending
- c. Tertiary ending
- d. AU

28. Number of Golgi tendon organs per 100 muscle fibres:

- a. 1–20
- b. 200–400
- c. 50–60
- d. 80–100

29. Golgi tendon apparatus conveys message to CNS, depends upon:

- a. Tension in muscle
- b. Length of muscle

- c. Rapidity of contraction
- d. Blood supply

AIIMS/PGI/JIPMER

30. Which of the following phrase adequately describes Pacinian corpuscles?

[AIIMS May 04]

- a. A type of pain receptors
- b. Slowly adapting touch receptors
- c. Rapidly adapting touch receptors
- d. Located in the joints

31. Pacinian corpuscles transmit which sensation?
[AIIMS May 95]

- a. Touch
- b. Vibration
- c. Cold
- d. Heat

32. All of the following are thermal modalities except:
[PGI June 05]

- a. Cold receptor
- b. Warm receptor
- c. Pain receptor
- d. Stretch receptor
- e. Pressure receptor

33. Vanilloid receptors are activated by:
[AIIMS May 06]

- a. Pain
- b. Vibration
- c. Touch
- d. Pressure

34. If a single spinal nerve is cut, the area of tactile loss is always greater than the area of loss of painful sensations, because:
[AIIMS Nov 04]

- a. Tactile information is carried by myelinated fast conducting fibres
- b. Tactile receptors adapt quickly
- c. Degree of overlap of fibres carrying tactile sensation is much less
- d. In the primary sensory cortex tactile sensation is represented on a larger area

35. Kinesthetic sensation is: [AI 94]

- a. Transmitted by the beta-type of sensory nerve
- b. Located in Merkel's disc
- c. Transmitted by Meissner's corpuscles
- d. Means abnormal perception of sensation

36. True is all except regarding intrafusal fibers: [PGI 96]

- a. Nuclear chain fibers are shorter and thinner
- b. Nuclear bag fibers are lesser
- c. Primary endings excited by bag fibers only
- d. Secondary endings excited by chain fibers only

37. The intrafusal fibers of the striated skeletal muscles are innervated by one of the following type of motor neurons. Choose the correct answer:

[AIIMS May 04]

- a. Alpha
- b. Beta
- c. Gamma
- d. Delta

38. Find faulty statement regarding muscle spindle: [JIPMER 00]

- a. Central zone has no active and myosin
- b. Peripheral zone has no actin and myosin
- c. Type 1 nuclear bag fibers has low myosin ATPase activity
- d. Type 2 nuclear bag fiber has high level of myosin ATP activity

39. In intersegmental reflex, the afferents come from: [AIIMS June 99]

- a. Golgi tendon
- b. Ia fibers
- c. Ib fibers
- d. Muscle spindles

40. Muscle spindle detects: [AIIMS May 09]

- a. Tension
- b. Length
- c. Proprioception
- d. Stretch

41. Golgi tendon organs detect:

[AIIMS May 08]

- a. Static muscle length
- b. Dynamic muscle length
- c. Muscle tension
- d. Muscle action

42. Regarding Golgi tendon organ true is:

[AIIMS Nov 06, May 2014]

- a. Senses dynamic length of muscle
- b. Involved in reciprocal innervation
- c. Alpha-motor neuron stimulation
- d. Senses muscle tension

43. Receptor of joint capsule and ligaments is: [AIIMS May 2014]

- a. Slow adapting
- b. Fast adapting
- c. Different to slow and fast adapting
- d. Non-adapting

44. True about Nuclear bag fibers:

[AIIMS May 2014]

- a. Sense dynamic length of muscle
- b. Involved in reciprocal innervation
- c. Alpha motor neuron stimulation
- d. Senses muscle tension

SOMATOSENSORY PATHWAYS

RECENT MCQs

45. Loss of proprioception and fine touch:

- a. Anterior spinothalamic tract
- b. Lateral spinothalamic tract
- c. Dorsal column
- d. Corticospinal tract

46. Venterolateral cordotomy for relief of pain in right lower limb due to cutting:

- a. Left ventral spinothalamic tract
- b. Left lateral spinothalamic tract
- c. Right ventral spinothalamic tract
- d. Right lateral spinothalamic tract

47. Pain and temperature are carried by:

- a. Anterior spinothalamic tract
- b. Lateral spinothalamic tract
- c. Dorsal column
- d. None

48. The principle that is the spinal cord dorsal roots are sensory and the ventral roots are motor is known as:

- a. Laplace's law
- b. Bell-Magendle's law
- c. Frank-Starling's law
- d. Weber-Fechner's law

49. Brown-Sequard syndrome:

- a. Pain loss in the opposite side of lesion
- b. Fine touch lost in opposite side of lesion
- c. UMN paralysis in opposite side of lesion
- d. LMN paralysis in opposite side of lesion

50. Pain and temperature in thalamus is controlled by nucleus:

- a. VPM
- b. VPL
- c. Anterior
- d. Posterior

AIIMS/PGI/JIPMER**51. Posterior column lesion which of the following is not affected: [PGI June 08]**

- a. Vibration
- b. Temperature
- c. Fine touch
- d. Position sense
- e. Crude sense

52. Conscious proprioception is carried by: [AI 00]

- a. Dorsal column fibres
- b. Anterior spinothalamic tract

- c. Lateral spinothalamic tract
- d. Vestibular tract

53. Which of the following sensation are transmitted by the Dorsal Tract/Posterior column? [AI 08]

- a. Fine touch
- b. Pain
- c. Temperature
- d. All of the above

54. A lesion of ventrolateral part of spinal cord will lead to loss (below the level of lesion) of: [AI 03]

- a. Pain sensation on the ipsilateral side
- b. Proprioception on the contralateral side
- c. Pain sensation on the contralateral side
- d. Proprioception on the ipsilateral side

55. An anterolateral cordotomy relieving pain in right leg is effective because it interrupts the:

[AI 12, AIIMS Nov 05]

- a. Left dorsal column
- b. Left ventral spinothalamic tract
- c. Left lateral spinothalamic tract
- d. Right lateral spinothalamic tract

56. All are features of Brown-Sequard syndrome except: [AIIMS Nov 11]

- a. Ipsilateral pyramidal tract features
- b. Contralateral dorsal column
- c. Contralateral spinothalamic tract
- d. Ipsilateral plantar extensor

57. All are true about Brown-Sequard syndrome: [PGI 09]

- a. Ipsilateral loss of joint sensation
- b. Contralateral loss of joint sensation
- c. Ipsilateral loss of pain and temperature
- d. Segmental signs are bilateral
- e. Contralateral loss of vibration

58. Modality that is lost on the ipsilateral side in Brown-Sequard syndrome is:

[AI 97]

- a. Pain
- b. Temperature
- c. Crude touch
- d. Proprioception

59. Perception of normal sensory stimuli as painful is called:

[AIIMS May 08]

- a. Hyperalgesia
- b. Allodynia
- c. Hyperpathia
- d. Causalgia

60. Repetitive stimulation increases pain sensation, the probable cause is:

[AIIMS June 99]

- a. Hypersensitization
- b. Decreased reflex time
- c. Increase in threshold of pain
- d. Decreased receptor area

61. True about Visceral pain:

[PGI Nov 11]

- a. It is poorly localized
- b. Resembles "fast pain" produced by noxious stimulation of the skin
- c. Mediated by B fibers in the dorsal roots of the spinal nerves
- d. Causes relaxation of nearby skeletal muscles.
- e. Shows relatively rapid adaptation

62. Massage and the application of liniments to painful areas in the body relieves pain due to:

[AIIMS Nov 04]

- a. Stimulation of endogenous analgesic system
- b. Release of endorphins by the first order neurons in the brainstem
- c. Release of glutamate and substance P in the spinal cord
- d. Inhibition by large myelinated afferent fibers

63. Hot water bottle relieves pain of abdominal spasm by:

[AI 10]

- a. Stimulation of adrenergic fibers
- b. Stimulation of cholinergic fibers
- c. Inhibition of cold receptors
- d. Inhibition of heat receptors

64. Gate system for pain control at:

[JIPMER 04]

- a. Substantia gelatinosa
- b. Dorsal root ganglion
- c. Both
- d. None

65. Nerve ending sensitive to noxious stimuli are present in all except:

[PGI May 09]

- a. Stomach
- b. Intestine
- c. Mesentery
- d. Liver
- e. Brain

66. Ascending pain pathway is inhibited in dorsal midbrain by enkephalin and:

[PGI Nov 10]

- a. 5-HT (serotonin)
- b. Noradrenaline
- c. Substance P
- d. Glutamate
- e. Adenosine

67. Mechanism of analgesia is by:

[PGI June 05]

- a. Nociceptin stimulation
- b. Nocistatin stimulation
- c. OLRI
- d. Anamide receptors
- e. Nicotinic and cholinergic receptor

68. Transcutaneous stimulation of pain relief?

[AIIMS Nov 2013]

- a. Gate theory of pain
- b. Allodynia
- c. Referred pain
- d. Pain relief by analgesics

69. Substance P is increased in response to pain in periphery by which of the following?

[AIIMS Nov 09]

- a. Mast cells
- b. Endothelium
- c. Plasma
- d. Nerve terminals

70. Intensity of sensory stimulation is directly related to: [AIIMS Dec 95]

- a. Duration of action potential
- b. Frequency of AP
- c. Amplitude of AP
- d. All of the above

71. Weber-Fechner's law is: [AIIMS Nov 08]

- a. Magnitude of stimulus strength perceived is approximately proportionate to the log of the intensity of stimulus strength
- b. Magnitude of stimulus strength perceived is directly proportional to the intensity of stimulus strength

- c. Threshold of receptor is directly proportional to stimulus strength
- d. Threshold of receptor is inversely proportional to stimulus strength

72. Weber-Fechner's law is related with: [AI 97]

- a. Amplitude
- b. Surface area
- c. Number of sensory fibre involvement
- d. Stimulus discrimination

73. Phantom limb sensations are best described by: [AIIMS May 05]

- a. Weber-Fechner's law
- b. Power law
- c. Bell-Magendie law
- d. Law of projection

SENSORY CORTEX

RECENT MCQS

74. Cortical representation of body in the cerebrum is: [AIIMS May 09]

- a. Horizontal
- b. Vertical
- c. Tandem
- d. Oblique

75. Somatosensory area I largest representation is for:

- a. Arm
- b. Leg
- c. Back
- d. Head

76. Which of the following sensations is most affected by cortical lesions?

- a. Proprioception
- b. Temperature
- c. Itch
- d. Crude touch

77. Somatosensory cortex lesion will affect:

- a. Pain
- b. Temperature
- c. Localization
- d. Vibration

78. A man loses his right hand in a farm accident, four year later, he has episodes of severe pain in the missing hand (phantom limb pain). A detailed PET scan study of his cerebral cortex might be expected to show:

- a. Expansion of the right hand area in his right somatic sensory area I (SI)
- b. Expansion of the right hand area in his left SI
- c. Projection of fibre from neighboring sensory areas into the right hand area of his right SI
- d. Projection of fibers from neighboring sensors' areas into the right hand area of his left SI

79. Loss of feel of size and shape of a object is seen in lesion of: [AIIMS 97]

- a. Tractus solitarius
- b. Tractus cuneatus
- c. Lateral spinothalamic tract
- d. Cerebral cortex

80. Stereoaesthesia is due to lesion of:

[AI 93]

- a. Nucleus Gracilis
- b. Nucleus cuneatus
- c. Cerebral cortex
- d. Spinothalamic tract

81. Appreciation of shape and size of an object placed in the hand is lost in the lesion of:

[AI 95]

- a. Tractus gracilis
- b. Tractus cuneatus
- c. Lateral spinothalamic tract
- d. Spinoreticular tract

82. Ability to perceive shape and size is lost due to lesion of:

[AI 98]

- a. Tractus gracilis
- b. Tractus cuneatus

- c. Spinothalamic tract
- d. Spinoreticular tract

83. The inability to perceive the texture and shape an object occurs in lesion of:

[AIIMS Sept 96]

- a. Lateral spinothalamic tract
- b. Nucleus gracilis
- c. Spinoreticular tract
- d. Nucleus cuneatus

84. Ablation of the 'somatosensory area I' of the cerebral cortex leads to:

[AI 02]

- a. Total loss of pain sensation
- b. Total loss of touch sensation
- c. Loss of tactile localization but not of two point discrimination
- d. Loss of tactile localization and two point discrimination

FUTURE TRENDS

85. Each of the figures in the diagram below illustrates a train of action potentials in response to a sudden limb movement. The sensory neuron encoding the velocity of the limb movement is illustrated by which figure?

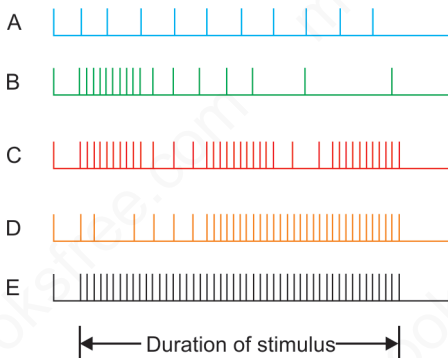

- a. A
- b. B
- c. C
- d. D

86. Which of the following receptors is responsible for measuring the inten-

sity of a steady pressure on the skin surface?

- a. Pacinian corpuscle
- b. Ruffini's ending
- c. Merkel's disk
- d. Meissner's corpuscle

87. The following diagram is firing rates of individual tactile receptor with stimulus intensity. Duration of stimulus is signaled by time course of firing.

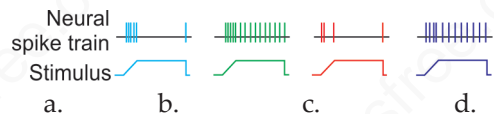

The recording C is obtained from which of the following receptor?

- a. Pacinian corpuscles
- b. Meissner's corpuscles
- c. Merkel's cell
- d. Ruffini's ending

88. A 50-year-old woman undergoes a neurological exam that indicates loss of pain and temperature sensitivity, vibratory sense, and proprioception in both legs. These symptoms could be explained by:

- a. Tumor on the medial lemniscal pathway in the sacral spinal cord
- b. Peripheral neuropathy
- c. Large tumor in the sacral dorsal horn

- d. Large tumor affecting the posterior paracentral gyri
- e. Large tumor in the ventral posterolateral and posteromedial thalamic nuclei

89. Withdrawal reflexes are not:

- a. Initiated by nociceptive stimuli
- b. Prolonged if the stimulus is strong
- c. An example of a flexor reflex
- d. Accompanied by the same response on both sides of the body

ANSWERS WITH EXPLANATIONS

1. Ans. d. Troposomes

(Ref. Ganong's Physiology 24th edn. pp 80)

Neuroglial cells are two types: Microglial cells are the scavenger cells. Macroglial cell: There are three types of macroglia cells; oligodendrocytes, Schwann cells, and astrocytes. Macroglia are derived from neuroectoderm whereas microglia originate from mesoderm.

2. Ans. d. Central neuroglial cells are derived from Schwann cells

(Ref. Ganong's Physiology 24th edn. pp 80)

3. Ans. c. Microglia

(Ref. Ganong's Physiology 24th edn. pp 80)

4. Ans. a. Phagocytosis

(Ref. Ganong's Physiology 24th edn. pp 80)

5. Ans. a. Vasoconstriction

(Ref. Ganong's Physiology 24th edn. pp 169)

Substance P sensitizes nociceptive terminals. Substance P acts on mast cells to cause degranulation and release histamine, which activates nociceptors. Substance P causes plasma extravasation and CGRP dilates blood vessels; the resulting edema.

6. Ans. c. Serotonin

(Ref. Ganong's Physiology 24th edn. pp 169)

Serotonin is found within the brainstem in the midline raphe nuclei, which project to portions of the hypothalamus, the limbic system, the neocortex, the cerebellum, and the spinal cord.

7. Ans. c. Dura mater

(Ref. Guyton-Physiology-12th edn. pp 606 & Emergency Neurology: Principles and Practice By Sid M. Shah. pp. 104)

Pain sensitive structure in brain: Venous sinuses around the brain, tentorium, dura at

the base of the brain, blood vessels of the meninges (especially middle meningeal artery).

In contrast, the skull, choroidal plexus brain parenchyma, ependymal lining of the ventricles, and major portion of the dura and pia mater are pain insensitive.

8. Ans. b. Blocking inhibitory synapses

(Ref. Ganong's Physiology 24th edn. pp 169)

Strychnine antagonizes the action of glycine. The clinical picture of convulsions and muscular hyperactivity produced by strychnine is due to inhibition of postsynaptic inhibition in normal neural function. Strychnine has no action on presynaptic inhibition.

9. Ans. c. Branches of the middle meningeal artery that lie superficial to the dura over the postcentral gyrus

d. Branches of the middle cerebral artery that supply the postcentral gyrus

[Explained in Q. No. 7]

10. Ans. a. Acetylcholine

(Ref. Ganong's Physiology 24th edn. pp 135)

ACh can have either excitatory or inhibitory effects in CNS. In PNS, it is excitatory. Glutamine in CNS is the precursor of the neurotransmitter: glutamate, aspartate, and the inhibitory amino acid GABA. NMDA is an excitatory receptor, not neurotransmitter.

11. Ans. d. Glutamate >> c. Aspartate

(Ref. Ganong's Physiology 24th edn. pp 138)

Aspartate and Glutamate, both are excitatory neurotransmitter in CNS. But glutamate is the major fast excitatory synaptic neurotransmitter.

12. Ans. c. Gamma-aminobutyric acid

(Ref. Ganong's Physiology 24th edn. pp 142)

GABA is the major inhibitory mediator in the brain. Glycine has both excitatory and inhibitory effects in the CNS.

13. Ans. d. Intrastratial GABA-ergic and cholinergic system

(Ref. Ganong's Physiology 24th edn. pp 252)

The abnormal movements of Huntington's disease are believed to be caused by loss of most of the cell bodies of the GABA-secreting neurons in the caudate nucleus and putamen and of acetylcholine-secreting neurons in many parts of the brain.

The dementia in Huntington's disease probably does not result from the loss of GABA neurons but from the loss of acetylcholine-secreting neurons, perhaps especially in the thinking areas of the cerebral cortex.

14. Ans. c. Arc proportional to the amount of transmitter released by the presynaptic neuron

(Ref. Ganong's Physiology 24th edn. pp 252)

EPSP is an excitatory local potential developed in postsynaptic membrane. It is a graded potential, so does not follow all or, none law. Amplitude of this potential depends on the neurotransmitter release.

15. Ans. c. Na⁺ influx >> d. Ca²⁺ influx

(Ref. Ganong's Physiology 24th edn. pp 120)

The excitatory transmitter opens Na⁺ or Ca²⁺ ion channels in the postsynaptic membrane, producing an inward current.

16. Ans. a. Cl⁻ influx

(Ref. Ganong's Physiology 24th edn. pp 120)

IPSP is mediated by Cl⁻ influx in cell. They can also produced opening of K⁺ channels, with movement of K⁺ out of the postsynaptic cell, or by closure of Na⁺ or Ca²⁺ channels.

17. Ans. a. Nicotinic cholinergic, b. Muscarinic cholinergic, c. Dopamine

(Modern Pharmacology with Clinical Applications by Charles R. Craig)

Slow EPSPs and IPSPs have been described in autonomic ganglia which can be mediated

by Nicotinic, muscarinic and dopaminergic receptors.

18. Ans. a. Fast EPSP, b. Slow EPSP, c. Fast IPSP

(Ref. Goodman and Gilman's The Pharmacological Basis of Therapeutics 12th edn pp 269)

Ach in ganglion causes initial fast EPSP followed by fast IPSP, slow EPSP and a late, slow EPSP.

19. Ans. d. Feedback inhibition

(Ref. Ganong's Physiology 24th edn. pp 121)

Renshaw cell inhibition at spinal motor neuron is a recurrent or, feedback inhibition.

20. Ans. d. Inhibition of feedback propagation

(Ref. Ganong's Physiology 24th edn. pp 121)

Other options are not related to Renshaw cell inhibition.

21. Ans. c. It occurs due to inhibition of release of neurotransmitter from presynaptic terminal, b. It results due to hyperpolarization of presynaptic membrane

(Ref. Ganong's Physiology 24th edn. pp 122)

Both the above options are correct. But C is the final step. And also, "there is evidence for direct inhibition of transmitter release independent of Ca²⁺ influx into the excitatory ending". So, its obvious, neurotransmitter release is more important than Ca²⁺ entry and hyperpolarization.

22. Ans. c. Microelectrode

(Ref. Ganong's Physiology 24th edn. pp 120, Fig. 6.8)

Patch clamp technique: allows the study of single or multiple ion channels in cells.

Voltage clamp: measure the ion currents through the membranes of excitable cells, such as neurons, while holding the membrane voltage at a set level.

23. Ans. a. Merkel disc

(Ref. Guyton-Physiology-12th edn. pp 586)

Merkel disc is the only touch receptor located in epidermis.

24. Ans. a. Touch

(Ref. Ganong's Physiology 24th edn. pp 150)

Meissner's corpuscle is a rapidly adapting touch receptor.

25. Ans. c. The back of scapula

(Ref. Guyton-Physiology-12th edn. pp 593)

On the tips of the fingers, a person can distinguish two separate points even when they are close together as 1 to 2 mm; whereas on person's back, the needles must usually be as far apart as 30 to 70 mm.

26. Ans. c. Paccinian corpuscle >> d. Meissner's corpuscle >> a. Merkel's disc

(Ref. Kandel Principles of Neural Science 5th edn, pp 500)

Paccinian corpuscle is for high frequency vibration, whereas other two (Meissner's and Merkel's) are for low frequency vibration.

27. Ans. a. Primary ending

(Ref. Ganong's Physiology 24th edn. pp 158)

Ia afferents (primary ending) are very sensitive to the velocity of the change in muscle length during a stretch (dynamic response).

[Please read text for concept]

28. Ans. a. 1-20

(Ref. Ganong's Physiology 24th edn. pp 162)

One Golgi tendon organ contains 3–25 fibers (average 10–15). So, in between 100 muscle fibers around 4 (100/25) to 33 (100/3) Golgi tendon can be accommodated.

29. Ans. a. Tension in muscle

(Ref. Ganong's Physiology 24th edn. pp 162)

Golgi tendon organs are in series with the muscle fibers, they are stimulated by both

passive stretch and active contraction of the muscle, when tension increases inside muscle.

30. Ans. c. Rapidly adapting touch receptors

(Ref. Ganong's Physiology 24th edn. pp 151)

Rapidly adapting touch receptors are: Pacinian corpuscle, Meissner's corpuscle and hair end organ.

[Please read text for detail description]

31. Ans. b. Vibration >> a. Touch

[Check Q. No. 26].

32. Ans. d. Stretch receptor, e. Pressure receptor

(Ref. Ganong's Physiology 24th edn. pp 168)

Pain receptor can also detect hot (burning pain; temp > 49 °C) and cold (freezing pain; temp < 5 °C).

33. Ans. a. Pain

(Ref. Ganong's Physiology 24th edn. pp 168)

Vanilloid receptors (VR) respond to noxious heat. Vanillins are a group of compounds, including capsaicin, that *cause pain*. The VR1 receptors respond not only to capsaicin but also to protons and to potentially harmful temperatures above 43°C.

34. Ans. c. Degree of overlap of fibres carrying tactile sensation is much less

(Ref. Guyton-Physiology-12th edn. pp 578)

There is much overlapping between pain carrying fibers as compared to touch.

35. Ans. None >> a. Transmitted by the beta-type of sensory nerve

(Ref. Integrated Neuroscience and Neurology: A Clinical Case History Problem ...By Elliott M. Marcus)

Rate of movement sense is known as kinaesthesia or dynamic proprioception. Proprioception is carried by A-alpha type fibers. A-beta also has some role.

36. Ans. c. Primary endings excited by bag fibers only, d. Secondary endings excited by chain fibers only

(Ref. Ganong's Physiology 24th edn. pp 158)

The Ia afferent (primary) fiber wraps around the center of the dynamic and static nuclear bag fibers and nuclear chain fibers.

Group II sensory fibers (secondary) are located adjacent to the centers of the static nuclear bag and nuclear chain fibers; these fibers do not innervate the dynamic nuclear bag fibers.

37. Ans. c. Gamma

(Ref. Ganong's Physiology 24th edn. pp 158)

Gamma motor neuron is the efferent supply to the muscle spindle.

38. Ans. b. Peripheral zone has no actin and myosin

(Ref. Ganong's Physiology 24th edn. pp 158)

Actin and myosin are present only in the terminal part of muscle spindle.

39. Ans. d. Muscle spindles

(Ref. The Human Nervous System: Structure and Function, 2005 By CR. Noback, pp 143)

A **segmental reflex** comprises neurons associated with one or even a few spinal segments. An **intersegmental reflex** consists of neurons associated with several to many spinal segments. A **suprasegmental reflex** involves neurons in the brain that influence the reflex activity in the spinal cord.

Reflex in which sensory receptor is muscle spindle (stretch reflex) is an example of intersegment reflex.

40. Ans. b. Length

(Ref. Ganong's Physiology 24th edn. pp 158)

Muscle spindle detects length (static fibers) and velocity (dynamic fibers) of skeletal muscle.

41. Ans. c. Muscle tension

(Explained in Q. No. 29).

42. Ans. d. Senses muscle tension

(Explained in Q. No. 29).

43. Ans. a. Slow adapting

(Ref. Phys Ther. 1982; 62:22-29)

Most of the receptors are slow adapting, although fast adapting receptors are there.

44. Ans. a. Sense dynamic length of muscle, b. Involved in reciprocal innervation, c. Alpha motor neuron stimulation

(Ref. Ganong's Physiology 24th edn. pp 158)

All three above options are true. But option 'a' is a direct action of muscle spindle.

(For detail read text)

45. Ans. c. Dorsal column

(Ref. Ganong's Physiology 24th edn. pp 173)

46. Ans. b. Left lateral spinothalamic tract

(Ref. Ganong's Physiology 24th edn. pp 174)

Pain and temperature carried by lateral spinothalamic tract. This tract cross obliquely to the opposite side within one spinal segment and ascend in the opposite anterolateral white column as the lateral spinothalamic tract.

So, pain from right leg relieved by cutting left lateral spinothalamic tract.

47. Ans. b. Lateral spinothalamic tract

(Check Q. No. 50)

48. Ans. b. Bell-Magendle's law

(Ref. Ganong's Physiology 24th edn. pp 158)

The principle that in the spinal cord the dorsal roots are sensory and the ventral roots are motor is known as the Bell-Magendie law.

49. Ans. a. Pain loss in the opposite side of lesion

(Ref. Ganong's Physiology 24th edn. pp 177)

Brown-Sequard syndrome is due to hemisection of spinal cord. This leads to

ipsilateral loss of discriminative touch, vibration, and proprioception below the level of lesion. The loss of the spinothalamic tract leads to contralateral loss of pain and temperature sensation beginning one or two segments below the lesion.

Damage to the corticospinal tract (UMN lesion) produces weakness and spasticity in certain muscle groups on the same side of the body.

50. Ans. b. VPL

(Ref. Ganong's Physiology 24th edn. pp 175)

Fibers from dorsal column and anterolateral spinothalamic tracts synapse in the VPL (ventral posterior lateral) nucleus of thalamus.

51. Ans. b. Temperature, e. Crude sense

(Ref. Ganong's Physiology 24th edn. pp 173)

52. Ans. a. Dorsal column fibers

(Ref. Ganong's Physiology 24th edn. pp 173)

Conscious proprioception: Dorsal column
Unconscious proprioception: spinocerebellar tract.

53. Ans. a. Fine touch

(Ref. Ganong's Physiology 24th edn. pp 173)

54. Ans. c. Pain sensation on the contralateral side

(Ref. Ganong's Physiology 24th edn. pp 174)

(Check Q. No. 46)

55. Ans. c. Left lateral spinothalamic tract

(Explained in Q. No. 46)

56. Ans. b. Contralateral dorsal column

(Explained in Q. No. 49)

57. Ans. a. Ipsilateral loss of joint sensation

(Explained in Q. No. 49)

58. Ans. d. Proprioception

(Explained in Q. No. 49)

59. Ans. b. Allodynia

(Ref. Ganong's Physiology 24th edn. pp 169)

Hyperalgesia is an exaggerated response to a noxious stimulus, whereas allodynia is a sensation of pain in response to an innocuous stimulus. Hyperalgesia and allodynia signify increased sensitivity of nociceptive afferent fibers.

Causalgia is a type of neuropathic pain.

Hyperpathia is a clinical symptom of certain neurological disorders wherein nociceptive stimuli evoke exaggerated levels of pain.

60. Ans. a. Hypersensitization

(Explained in Q. No. 59)

61. Ans. a. It is poorly localized

(Ref. Ganong's Physiology 24th edn. pp 169)

Visceral pain is poorly localized, unpleasant, and associated with nausea and autonomic symptoms.

Afferent fibers from visceral structures reach the CNS via sympathetic and parasympathetic nerves (C fiber).

There are no proprioceptors in the viscera, and few temperature and touch receptors.

62. Ans. d. Inhibition by large myelinated afferent fibres

(Ref. Ganong's Physiology 24th edn. pp 177)

Transcutaneous electrical nerve stimulation (TENS), acupuncture, Massage and the application of liniments to painful areas in the body relieve pain by a mechanism known as gate control theory.

Activation of large diameter touch fiber closes the gate; relieve pain sensation.

63. Ans. a. Stimulation of adrenergic fibers

(Ref. The Lancet London: A Journal of British and Foreign Medicine Volume 2, pp 410)

Probably activation of adrenergic system decreases intestinal motility and relieve spasm.

64. Ans. a. Substantia gelatinosa

(Ref. Ganong's Physiology 24th edn. pp 177)

Gate control theory operates at dorsal horn of spinal cord (not dorsal root ganglia), in lamina I to IV.

65. Ans. d. Liver, e. Brain (Ref. Guyton-Physiology-12th edn. pp 606)

Visceral nociceptive ending not present in liver, lungs and brain.

66. Ans. a. 5-HT (serotonin), b. Noradrenaline

(Ref. Ganong's Physiology 24th edn. pp 177)

Projections from the periaqueductal gray matter to the nearby noradrenergic and descending serotonergic fibers mediate the pain inhibition.

67. Ans. a. Nociceptin stimulation, d. Anandamide receptors, e. Nicotinic and cholinergic receptor

(Ref. Nature 392, 286-289;1998 & Ganong's Physiology 24th edn. pp 179)

Nociceptin (also known as orphanin FQ) is a peptide acts like an endogenous ligand for the orphan opioid-like receptor, induces both hyperalgesia and allodynia. **Nocistatin**, a peptide blocks nociceptin action in pain transmission.

Anandamide produces analgesia by blocking CB1 (cannabinoid) receptor.

Nicotinic and cholinergic stimuli modulate pain in CNS.

68. Ans. a. Gate theory of pain

[Explained in Q. No. 62]

69. Ans. d. Nerve terminals

(Ref. Ganong's Physiology 24th edn. pp 169, Fig.10.1)

Tissue injury releases bradykinin and prostaglandins that sensitize or activate nociceptors, which in turn releases substance P and calcitonin gene-related peptide (CGRP).

Substance P acts on mast cells to cause degranulation and release histamine, which activates nociceptors.

70. Ans. b. Frequency of AP

(Ref. Ganong's Physiology 24th edn. pp 152)

Intensity of stimulation is coded by frequency of AP in the sensory neuron. More the intensity of stimulus, more will be the frequency of AP, amplitude will not change (all or, none law).

71. Ans. a. Magnitude of stimulus strength perceived is approximately proportionate to the log of the intensity of stimulus strength

(Ref. Ganong's Physiology 24th edn. pp 153)

Magnitude of the sensation felt is proportional to the log of the intensity of the stimulus (Weber-Fechner's law).

72. Ans. d. Stimulus discrimination

(Ref. Ganong's Physiology 24th edn. pp 153)

Weber demonstrated that the sensitivity of a sensory system to differences in intensity depends on the absolute strength of the stimuli.

73. Ans. d. Law of projection

(Ref. Ganong's Physiology 24th edn. pp 155)

No matter where a particular sensory pathway is stimulated along its course to the cortex, the conscious sensation produced is referred to the location of the receptor. This principle is called the law of projection. Phantom limb sensation is an example of this.

74. Ans. b. Vertical

(Ref. Ganong's Physiology 24th edn. pp 175)

Parts of the body are represented in order along the postcentral gyrus, with the legs on top and the head at the foot of the gyrus (vertical).

75. Ans. d. Head

(Ref. Ganong's Physiology 24th edn. pp 175)

For the somatosensory cortex: mouth, tongue and fingers are very large whereas trunk, arms and legs are tiny.

76. Ans. a. Proprioception

(Ref. Ganong's Physiology 24th edn. pp 176)

Graphesthesia and stereognosis are lost earliest in SSI lesion. Proprioception and fine touch (tactile localization) are most affected by cortical lesions. Temp followed by pain lost at the last.

77. Ans. c. Localization

(Ref. Ganong's Physiology 24th edn. pp 176)

78. Ans. d. Projection of fibers from neighboring sensors areas into the right hand area of his left SI

(Ref. Ganong's Physiology 24th edn. pp 176)

"If a digit or, arm is amputated in a monkey, the cortical representation of the neighboring digits spreads into the cortical area that was formerly occupied by the representation of the amputated digit."

79. Ans. d. Cerebral cortex >> b. Tractus cuneatus

(Ref. Ganong's Physiology 24th edn. pp 155)

Feel of size and shape of a object is known as stereognosis. Loss of stereognosis is an early sign of damage to the cerebral cortex.

80. Ans. c. Cerebral cortex

[Explained in Q. No. 77]

81. Ans. b. Tractus cuneatus

(Ref. Ganong's Physiology 24th edn. pp 155)

Appreciation of shape and size of an object placed in the hand (stereognosis) is a function of cerebral cortex. As the object has been placed in hand, the sensation (fine touch) travels via dorsal column (cuneatus

tract). So, lesion of dorsal column also produces astereognosis.

82. Ans. b. Tractus cuneatus

(Explained in Q. No. 80)

83. Ans. d. Nucleus cuneatus

(Explained in Q. No. 80)

84. Ans. d. Loss of tactile localization and two point discrimination

(Explained in Q. No. 74)

85. Ans. b. B

A phasic receptor (rapid adaptation), illustrated by figure B, produces a high-frequency burst of action potentials when stimulated. The frequency of discharge slows down or stops even though the stimulus is maintained. In contrast, a tonic receptor, illustrated in A and C, continues to fire at a frequency proportional to the magnitude of the stimulus for as long as the stimulus is applied.

86. Ans. b. Ruffini ending

The Ruffini ending is a tonic receptor (steady stimulus detector) that produces a train of action potentials proportional to the intensity of pressure applied to the skin. Merkel's although a slow adapting receptor, detect sharp end of object. The Pacinian corpuscle and Meissner's corpuscle are rapidly adapting receptor.

87. Ans. a. Pacinian corpuscles.

Curve C for rapidly adapting receptors. B and D are slowly adapting receptors. A is from most rapidly adapting receptors.

88. Ans. d. Large tumor affecting the posterior paracentral gyri**89. Ans. d. Accompanied by the same response on both sides of the body**

[Read crossed extensor reflex from text]

PHYSIOLOGICAL ANATOMY OF THE CEREBRAL CORTEX

Neocortex consists of six layers. They are:

Layer	Contents
I (molecular layer)	Few neuronal cell bodies; instead, mostly axon terminals and synapses
II (external granular layer)	Mostly stellate cells (granule cell)
III (external pyramidal layer)	Mostly of small pyramidal cells
IV (internal granular layer)	Mostly stellate cells (granule cell)
V (internal pyramidal layer)	Dominated by large pyramidal cells . These cells are the main source of cortical efferents to most subcortical regions
VI (multiform layer)	Pyramidal, fusiform , and other types of cells. This layer is also an important origin of cortical efferents, those that target thalamic nuclei.

Afferent and Efferent Fibers of Neocortex

- ❑ Thalamocortical **afferent fibers** from thalamic nuclei (incoming specific sensory fibers) end chiefly in layers III, IV, and VI.
- ❑ Neurons in other thalamic nuclei (particularly those relaying input from the reticular formation) project diffusely and terminate in layers I and VI.
- ❑ Several nonthalamic, diffusely projecting nuclei (including the basal nucleus of Meynert, the locus, and the dorsal raphe nucleus) project to all cortical layers.
- ❑ The cortical **efferent axons** (output signals) originate from pyramidal cells. The pyramidal cells of layers II and III project to other cortical areas, either ipsilaterally or contralaterally, via the corpus callosum.

- ❑ The pyramidal cells of **layer V project** in many **descending pathways** and have synaptic targets in the spinal cord, brainstem, striatum, and thalamus.
- ❑ The pyramidal cells of layer VI form corticothalamic projections to the thalamic nuclei with specific cortical projections.

I IMPORTANT

Pyramidal and stellate cells are the most common cell type in cerebral cortex.

NERVE CELLS OF THE CEREBRAL CORTEX

Two Types

I. Excitatory cell:

Name of cell	Special features
Spiny stellate cell (granule cell)	Small size (8 µm) cell body. Present in layer IV of sensory cerebral cortex.
Pyramidal cell	Measuring about 50-100 µm long. The apices of the pyramidal cell extend towards pial surface. From the apex a thick dendrite extends towards pia, give rise to many types of collateral. Each dendrite has many dendritic spines.
Betz cell	Giant pyramidal cell with cell body 120 µm
Fusiform cell	Mainly in the deepest layer of cerebral cortex (layer VI). Alone with pyramidal cell, it forms the excitatory output of cerebral cortex.
Star pyramidal cell	Intermediate in form between stellate and pyramidal cell.

II. Inhibitory cell: GABA is the neurotransmitter. They have less spine density compare to excitatory cell (aspinous cell).

Type of cell	Name of cell	Special features
Soma targeting inhibitory cell	Basket cell	
Axon targeting inhibitory cell	Chandelier cell	
Dendrite targeting inhibitory cell	Double bouquet cell, bitufted cell and bipolar cell	Bipolar found in layer II to V. they express GABA and VIP
Others inhibitory interneuron		
Martinotti cell	Small multipolar cell, present throughout cortex. The cell has small dendrites but axon is directed towards pial surface, where it ends in a more superficial layer, commonly the most superficial layer.	
Cajal-Retzius	Important during development. Present in most superficial layer (layer I) of cortex <i>horizontally</i> .	
Neuroglialform cell	Spider web like cell.	

MOTOR CORTEX

- These areas are the primary motor cortex (**Brodmann's area 4**), the premotor cortex, and the supplementary motor area (**Brodmann's area 6**).
- **Primary motor cortex (Brodmann's area 4, M1 area):**
 - Primary motor cortex does not generally control individual muscles directly, but rather appears to control individual movements or sequences of movements that require the activity of multiple muscle groups.
- **The premotor cortex and supplementary motor areas** appear to be higher level areas that encode **complex patterns of motor output** and that select appropriate motor plans to achieve desired end results.
 - **Premotor cortex neurons:**
 - Signal the preparation for movement. This type of neuron is called a **motor-set neuron**, as it fires when the monkey is preparing, or getting set, to make a movement.
 - Signal various sensory aspects associated with particular motor acts. These neurons are called "**mirror**" **neurons**, because they respond not only to a particular action of the monkey but also to the sight (or sound) of another individual performing the same action.
 - **The supplementary motor area (SMA)** is involved in programming complex sequences of movements and coordinating bilateral movements.

I IMPORTANT

- ❖ The corticospinal tract (pyramidal tract) contains about a million axons of varying diameter. The majorities are myelinated.
 - Most have a diameter of 1–4 μm
 - 10% have diameters of 5–10 μm
 - 3% have diameters of 11–22 μm
 - The largest-diameter axons arise from the giant pyramidal neurons (Betz cells) are located in the primary motor cortex of the precentral gyrus.

I IMPORTANT

- ❖ Most corticospinal fibers are believed to terminate contralaterally *on interneurons* in the laminae IV to VIII bilaterally (densest concentration lamina VI).
- ❖ Terminals are also associated with contralateral *motor neuro-nal cell body* in lamina IX.

Others important Brodmann's Areas:

Area name	Number
Frontal eye field	8 (saccad eye movement)
Primary visual area	17
Visual association area	18, 19
Primary auditory area	41
Auditory association area	22, 21
Broca's area	44
Wernicke's area	22

PYRAMIDAL AND EXTRAPYRAMIDAL TRACTS

- The term pyramidal tract is used commonly by clinicians and refers specifically to the corticospinal tracts (Fig. 13.1).

- ❑ The term extrapyramidal tracts refer to all the descending tracts other than the corticospinal tracts.
- ❑ Extrapyramidal fibers are the motor fibers which do not pass through the medullary pyramids but which nevertheless exert a measure of control over bodily movements.
- ❑ Extrapyramidal includes **basal ganglia** and other descending tract (Rubrospinal tract, Tectospinal tract, Vestibulospinal tracts, Reticulospinal tracts).

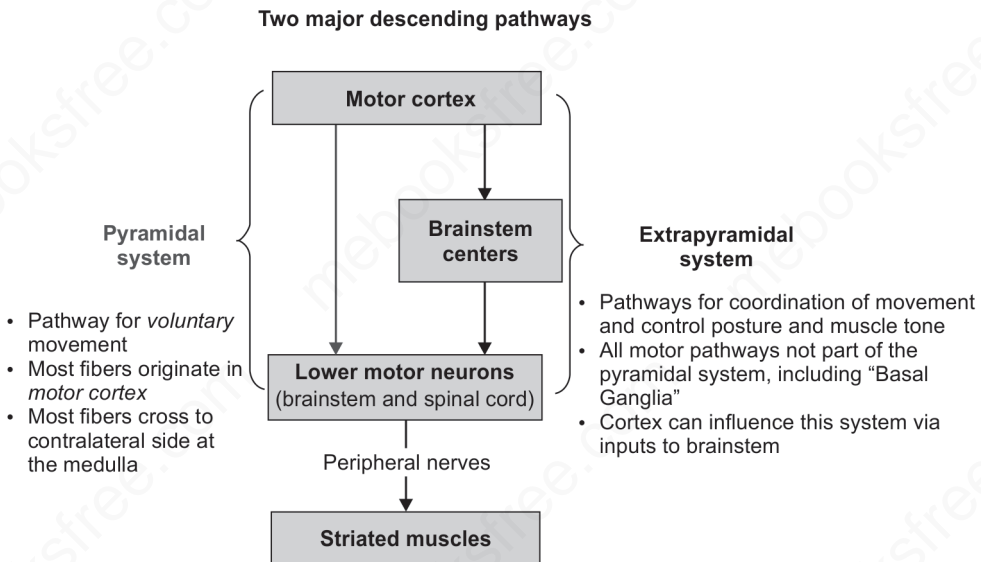

Fig. 13.1: Pyramidal and extrapyramidal system

CORTICOSPINAL TRACT (PYRAMIDAL TRACT)

Origin: Pyramidal cell in V layer of cerebral cortex.

- ❑ In the monkey, 30% of corticospinal fibers arise from motor cortex (area 4), 30% from secondary motor cortex (area 6), and 40% from the parietal regions (area 5,7) and primary somatosensory cortex (area 3,1,2). So, *2/3rd from precentral gyrus and 1/3rd from post central gyrus.*

Midline-Cross

Just rostral to the level of the spinomedullary junction (Fig. 13.2).

- ❑ 75–90% of the corticospinal fibers in the pyramid cross the median plane and continue caudally as the lateral corticospinal tract.

I IMPORTANT

Corticospinal fibers from parietal sources are phylogenetically the oldest part of the corticospinal system.

I IMPORTANT

- ❖ Axons from the sensory cortex terminate chiefly in laminae IV (main) and V. They are concerned with the supraspinal modulation of the transmission of afferent impulses to higher centers, including the motor cortex.
- ❖ ***α and γ motor neurons cell bodies are located in lamina IX.***

- ❑ The rest of the fibers continue uncrossed as the ventral corticospinal tract.

Extended up to

- ❑ The lateral corticospinal tract descends until about the 4th sacral segment. The lateral corticospinal tract is somatotopically organized: such that axons destined for spinal segments innervating the upper limbs are located more medially.
- ❑ The ventral corticospinal tract descends up to mid-thoracic cord levels. Near their termination, most fibers of the tract cross the median plane to synapse on contralateral neurons.

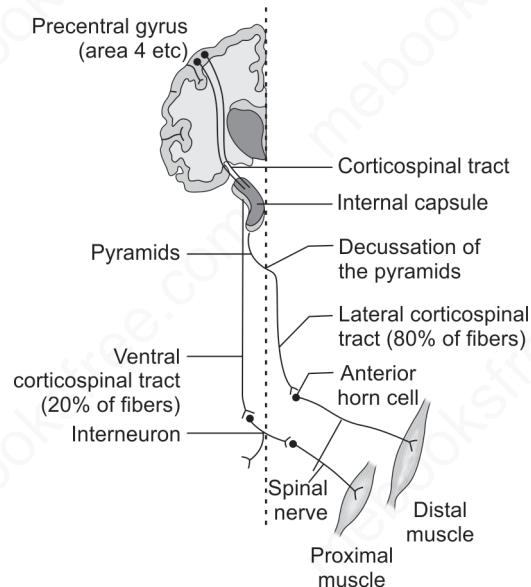

Fig. 13.2: Corticospinal tract

EXTRAPYRAMIDAL TRACTS**Rubrospinal Tract**

- ❑ Arises from neurones in the caudal magnocellular part of the red nucleus (midbrain tegmentum). This nucleus contains 150–200 large neurons.
- ❑ The tract appears to be rudimentary in human.
- ❑ The tract cross in the ventral tegmental decussation and descend in the lateral funiculus intermingled with, fibers of the lateral corticospinal tract.

- ❑ In humans it appears to project only to the upper three cervical cord segments on α and γ motor neurones (similar to those of corticospinal fibers).

Tectospinal Tract

- ❑ Originate from intermediate and deep layers of the superior colliculus of the midbrain.
- ❑ It crosses in the dorsal tegmental decussation.
- ❑ Fibers of the tract project only to the upper cervical cord segments.
- ❑ They make polysynaptic connections with motor neurones serving muscles in the neck, facilitating those that innervate contralateral muscles and inhibiting those that innervate ipsilateral ones.

Vestibulospinal Tracts

The vestibular nuclear complex lies in the lateral part of the floor of the fourth ventricle, at the level of the pontomedullary junction. It gives rise to the lateral and medial vestibulospinal tracts.

- ❑ **The lateral vestibulospinal tract:** originate from lateral vestibular nucleus (Deiters' nucleus). It descends ipsilaterally, uncrossed. Fibers project up to lumbosacral segments of the cord.
- ❑ **The medial vestibulospinal tract:** arises from medial vestibular nucleus, and some from inferior and lateral vestibular nuclei. It contains both crossed and uncrossed fibers, and does not extend beyond the mid-thoracic cord level.
- ❑ The vestibular nuclei exert a strong excitatory influence upon the antigravity muscles of the vertebral column and the extensor muscles of the lower limbs. It also inhibits the flexor group.

Reticulospinal Tracts

Throughout the midbrain, pons and medulla, groups of scattered nerve cells that are collectively known as reticular formation.

- ❑ The pontine reticulospinal tract originates from the pontine tegmentum.
- ❑ The medullary reticulospinal tract arises from the nucleus gigantocellularis.

I IMPORTANT

Tracts in Lateral white matter:

- ❖ Lateral corticospinal tract
- ❖ Rubrospinal tract
- ❖ Medullary reticulospinal tract

I IMPORTANT

Tracts in anterior white matter:

- ❖ Vestibulospinal tract
- ❖ Tectospinal tract
- ❖ Anterior corticospinal tract
- ❖ Pontine reticulospinal tract

- ❑ Both α and γ motor neurones are influenced by reticulospinal fibers, through polysynaptic and monosynaptic connections.
- ❑ The pontine reticulospinal tract appears to be tonically active and is excitatory to the antigravity muscles, including the epaxial muscles of the vertebral column and the extensor muscles of the lower limbs.
- ❑ Medullary reticulospinal tract is inhibitory to antigravity muscles.

Summary of Extrapyramidal Tracts (Fig. 13.3):

Midline crossing Extend up to					
	Origin	Corticospinal tract		Termination	Functions
Lateral Corticospinal Tract	Pyramidal cell in V layer of cerebral cortex	Spinomedullary junction	4th sacral segment	α and γ motor neurons (α main)	Highly fractionated, precision movements of the limbs
Anterior Corticospinal Tract		Near their termination (mid-thoracic)	Mid-thoracic cord		Facilitates flexor, inhibits extensors
Rubrospinal tract					
Rubrospinal tract	Red nucleus of midbrain tegmentum	Ventral tegmentum (At the level of nucleus)	Upper three cervical region	Same like corticospinal tract	Same like corticospinal tract
Tectospinal tract					
Tectospinal tract	Superior colliculus of the midbrain	Dorsal tegmentum (Soon after origin)	Upper cervical cord segments	Facilitates contralateral muscles and inhibiting ipsilateral	Reflex postural movement in response to visual stimuli
Vestibulospinal tract					
The lateral vestibulospinal tract	Lateral vestibular nucleus	Uncrossed	Up to lumbosacral	Both α and γ motor neurons (α main)	Facilitates extensor muscle of lower limbs. Also inhibits flexor
The medial vestibulospinal tract	Medial, inferior and lateral vestibular nuclei	Both cross and uncrossed	Up to mid-thoracic		
Reticulospinal tracts					
Pontine reticulospinal tract	Pontine tegmentum	Uncrossed (Mostly)	Up to lumbosacral	Both α and γ motor neurons (main γ)	Excitatory to antigravity muscles (tonically active)
Medullary reticulospinal tract	Nucleus gigantocellularis (medulla)	Both crossed and uncrossed			Inhibitory to antigravity muscles

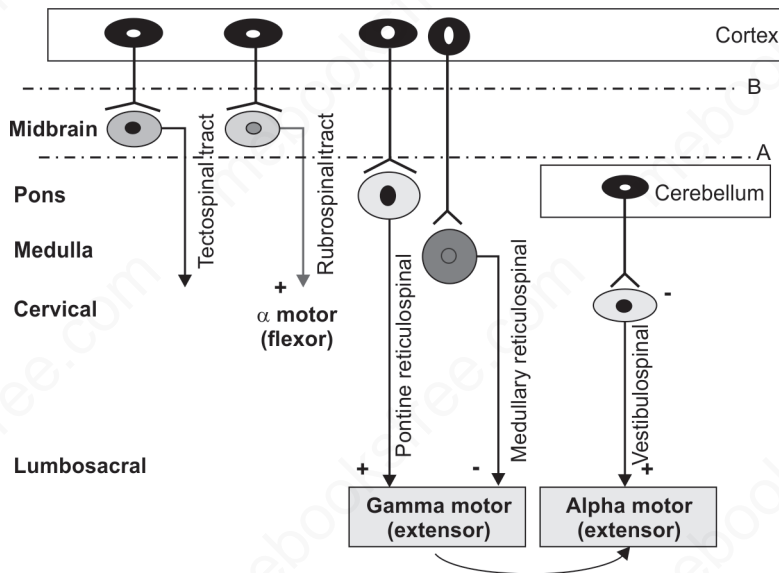

Fig. 13.3: Extrapyramidal tracts. Origin and extension of different tracts have been shown here. Collection of neuronal cell bodies (Nucleus) have been shown as circular or oval shaped structures in different levels. Straight arrow from nucleus indicates 'uncrossed' tract. Stimulation of gamma neurone, indirectly activates Ia fibre. Gamma and alpha motor are neurons are connected by Ia fibre

Decerebration

- A complete transection of the brainstem between the superior and inferior colliculi permits the brainstem pathways to function independent of their input from higher brain structures.
- This is called a midcollicular decerebration and is diagramed in Figure 13.3 by the dashed line labeled A.
- This lesion interrupts all input from the cortex (corticospinal and corticobulbar tracts) and red nucleus (rubrospinal tract), primarily to distal muscles of the extremities.
- The excitatory and inhibitory reticulospinal pathways (primarily to postural extensor muscles) remain intact.
- Pontine reticulospinal nucleus is a tonically active nucleus. This leads to hyperactivity in extensor muscles in all four extremities, which is called decerebrate rigidity.
- The excitatory input from the reticulospinal pathway activates γ -motor neurons, which indirectly activate α -motor neurons (via Ia spindle afferent activity). This is called the gamma loop.

Decortication

- Removal of the cerebral cortex (decortication; dashed line B in Fig. 13.3) produces decorticate rigidity, which is characterized by flexion of the upper extremities at the elbow and extensor hyperactivity in the lower extremities.

I IMPORTANT

In clinical practice, it is rare to have an organic lesion that is restricted only to the pyramidal tracts or only to the extrapyramidal tracts. Usually, both sets of tracts are affected to a variable extent, producing both groups of clinical signs.

I IMPORTANT

- ❖ As the pyramidal tracts normally tend to increase muscle tone and the extrapyramidal tracts inhibit muscle tone, the balance between these opposing effects will be altered, producing different degrees of muscle tone.
- ❖ So, pure pyramidal tracts lesion produces hypotonia.

- The flexion can be explained by active rubrospinal excitation of flexor muscles in the upper extremities; the hyperextension of lower extremities is due to the same changes that occur after midcollicular decerebration.

Clinical Features in Lesions of Pyramidal and Extrapyramidal Tracts

- ❑ Lower motor neurons (LMN) refer to the spinal and cranial motor neurons that directly innervate skeletal muscles.
- ❑ Upper motor neurons (UMN) are those in the cortex and brainstem that activate the lower motor neurons.
- ❑ UMN has two parts: pyramidal system and extrapyramidal system.
- ❑ Clinical features due to lesion of the UMN and LMN are given below:

Upper motor neuron lesions		Lower motor neuron lesions
Lesions of the corticospinal tracts (pyramidal tracts)	Lesions of extrapyramidal tracts	Final common pathway
The Babinski sign is present	Severe paralysis	Flaccid paralysis
The superficial reflexes (abdominal, cremasteric) are absent.	Little or no muscle atrophy (except secondary to disuse)	Atrophy
Loss of performance of fine-skilled voluntary movements	Exaggerated deep muscle reflexes and clonus	Loss of reflexes
	Hypertonicity of the muscles	Hypotonicity
	Clasp-knife reaction	Reaction of degeneration Muscular fasciculation

CONTROL OF POSTURE

- ❑ *Stretch reflex is fundamental to posture control.* The major factor in posture control is by a change in the threshold of the stretch reflex. This can be achieved:
 - Directly by a change in the excitability of the motor neuron
 - Indirectly by change in the rate of discharge of gamma efferent nerve to muscle spindle

- ❑ There are 6 supraspinal influences on the stretch reflex viz:
 - Cortex = inhibits gamma motor neuron
 - Basal ganglia = inhibits gamma motor neuron
 - Cerebellum = inhibits gamma motor neuron
 - Reticular formation-pontine (facilitatory area tonically active) = stimulates gamma motor neuron
 - Reticular formation-medullary (inhibitory area) = inhibits gamma motor neuron
 - Vestibular nuclei (4 on each side) = stimulates alpha motor neuron

Stretch reflex can be made hyperactive either by increasing gamma stimulation or by increasing alpha stimulation.

Postural Reflexes and Centres

Reflexes	Integrated in
Stretch reflex Positive supporting reaction (Magnet) Negative supporting reaction	Spinal cord
Tonic labyrinthine and tonic neck reflexes (Antigravity reflexes attitudinal reflexes)	Medulla
Righting reflexes (except optical righting reflex) Labyrinthine righting reflexes Neck righting reflexes Body on head righting reflexes Body on body righting reflexes	Midbrain
Conditioned reflex Optical righting reflexes Hopping and Placing reaction	Cortex

BASAL GANGLIA

Basal ganglia nomenclature			
Corpus striatum (1+2+3+4)		1. Nucleus accumbens	Striatum or, neostriatum (1+2+3)
		2. Caudate nucleus	
Lenticular nucleus, or Lentiform nucleus (3+4)		3. Putamen	
		4. Globus pallidus	
		5. Subthalamic nucleus	
		6. Substantia nigra	

I IMPORTANT

- ❖ A basic spinal reflex is one integrated by the spinal cord; that is, all components necessary for linking afferent input to efferent response are present within the spinal cord. The simplest basic spinal reflex is the stretch reflex, which is fundamental to posture control.

I IMPORTANT

- ❖ The withdrawal reflex is also an example of a polysynaptic basic spinal reflex. Components of withdrawal reflex:
 1. Flexor reflex
 2. Reciprocal inhibition
 3. Crossed extensor response
 4. After-discharge lasting many fractions of a second after the stimulus is over.

I IMPORTANT

- Recovery of reflex after spinal shock:
- ❖ The DPR is generally the first reflex to appear.
 - ❖ After DPR, reflexes tend to return in the following sequence: bulbocavernosus, cremasteric, ankle jerk, Babinski sign, and knee jerk.
 - ❖ The general pattern of recovery appears to be cutaneous (polysynaptic) reflexes before deep tendon reflex (DTR)

I IMPORTANT

- ❖ *The globus pallidus is divided into external and internal segments (GPe and GPi).*
- ❖ *The substantia nigra is divided into a pars compacta and a pars reticulata.*

I IMPORTANT

- ❖ *Dopaminergic projections from SNc stimulate the direct pathway (facilitator to cortex) and inhibit the indirect pathway (inhibitor to cortex). The next result is facilitation of cortex by both pathways.*
- ❖ *The appropriate balance between the direct and indirect pathway maintains a suitable excitatory tone within the cortical motor pathway.*
- ❖ *Destruction of this projection (Parkinson's disease) causes bradykinesia or, akinesia.*

I IMPORTANT

- ❖ *That there is a closed-loop connection between the cerebral cortex and basal ganglia.*
- ❖ *Excitatory projections from cortex (corticostriate pathway) to striatum are glutaminergic.*
- ❖ *Excitatory projections from STN to GPi are glutaminergic.*
- ❖ *Dopaminergic projections from SNc to striatum are both excitatory (D1 receptor) and inhibitory (D2 receptor).*
- ❖ *Other inhibitory pathways in basal ganglia are GABAergic.*

Connections of the basal ganglia (Fig. 13.4):

- ❑ **Afferents:** The main inputs to the basal ganglia terminate in the striatum. They are:
 - Excitatory **corticostriate pathway** from M1 and premotor cortex to striatum
 - Projection from intralaminar nuclei of the thalamus to the striatum (**thalamostriatal pathway**).
- ❑ **Efferent:**
 - Mainly from the GPi to the ventrolateral, ventro-anterior and centromedian nuclei of thalamus.
 - From substantia nigra to the thalamus.
- ❑ **Interconnections between the parts of the basal ganglia:**
 - **Direct pathway:** From Putamen → GPi → Thalamus. It causes disinhibition of thalamus (and stimulation of cortex). Dopaminergic projections from substantia nigra (SNc) stimulate this direct pathway via D1 receptor (dopamine receptor).
 - **Indirect pathway:** Putamen → GPe → STN → GPi → Thalamus or, Putamen → GPe → GPi → Thalamus. It causes inhibition of thalamus (and inhibition of cortex). Dopaminergic projections from substantia nigra (SNc) inhibit this direct pathway via D2 receptor (dopamine receptor).

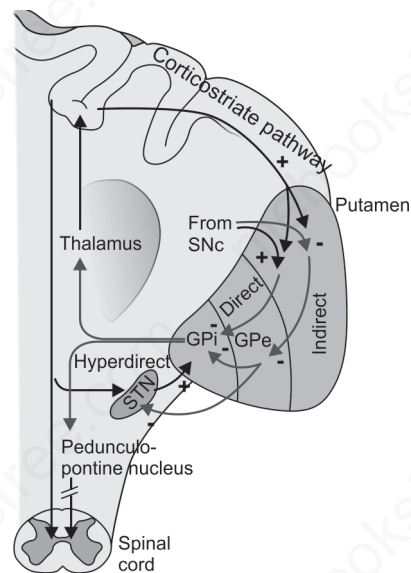

Fig. 13.4: The basal ganglia-thalamocortical circuitry. External and internal segments of the globus pallidus (GPe and GPi, respectively), the substantia nigra pars compacta (SNc), and the subthalamic nucleus (STN). “+” Excitatory and “-” Inhibitory

Functions of Basal Ganglia

- Planning and programming of movements.
- Role in cognitive processes (especially that of the caudate nucleus).

Diseases of the Basal Ganglia in Humans

- **Huntington disease (HD):** In HD there is degeneration of the **striatum (mainly caudate nucleus)** with selective loss of GABAergic and cholinergic neurons, and also degeneration of the deep layers of the cortex (mainly frontal).
The main clinical features are movement disorder (which includes chorea, athetosis, dystonia, motor restlessness, tremor, and myoclonus), personality change, psychiatric disorder, and cognitive impairment.
- **Parkinson's disease (PD):** PD is characterized by depigmentation, loss of dopamine containing neurons in the **substantia nigra** pars compacta, and the presence of Lewy bodies in the substantia nigra, locus coeruleus, nucleus basalis, raphe and ventral tegmental area.
The cardinal manifestations of Parkinson's disease (PD) are tremor, rigidity, bradykinesia, and postural instability.
- **Wilson's disease (WD):** WD is also known as hepatolenticular degeneration. The cerebral pathology of WD mainly affects the **lenticular nuclei (pallidus and putamen)**, but abnormalities can also be found in the caudate, thalamus, cerebellar nuclei, and white matter. The main neurological abnormalities are rigidity, dystonia, chorea, athetosis, dysarthria, and tremor.
- **Athetosis:** Diffuse lesion of globus pallidus and corpus striatum.
- **Ballismus:** Degenerative changes in subthalamic nucleus.

CEREBELLUM

Anatomical Divisions: The cerebellum is divided into three lobes by two deep fissures.

- Anterior lobe
- Posterior lobe
- Flocculonodular lobe. *The flocculonodular lobe is the oldest of all portions of the cerebellum, appearing first in fishes.*

Functional divisions (Fig. 13.5):

- Spinocerebellum

I IMPORTANT

The cerebellar has 3 layers, 4 nuclei and 5 types of cells:

- ❖ **The 3 layers of cerebellar cortex are:** outer molecular layer, middle Purkinje layer, inner granular.
- ❖ **The 4 deep nuclei are** (4 on each side): Dentate, Emboliform, Fastigial, Globose (*emboliform and globose are together referred to as the Interposed*)
- ❖ **The 5 cells are:** Purkinje, Granular, Golgi, Stellate, Basket
- ❖ **Stellate and Basket cells are located in outer molecular layers.**
- ❖ **Purkinje cells are located in middle Purkinje layer.**

- ❑ Cerebrocerebellum (or neocerebellum)
- ❑ Vestibulocerebellum

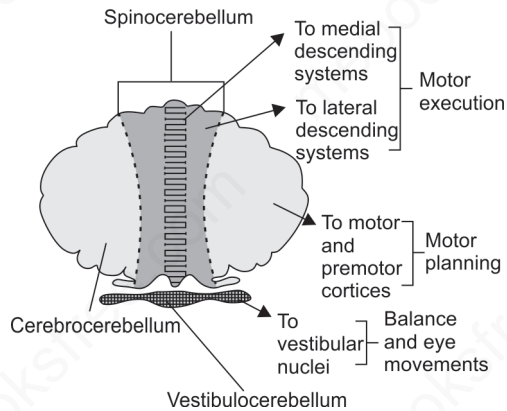

Fig. 13.5: Functional divisions of the cerebellum

Different Inputs and Outputs of Cerebellum

Part	Constituents	Afferent (input)	Efferent (output)	Functions
Spinocerebellum	Vermis (except the nodulus)	Somatosensory input from the head and proximal parts of the body. Also visual, auditory, and vestibular input.	Via fastigial nucleus to the medial descending systems.	Controls proximal muscles of the body and limbs. The vermis governs posture and locomotion as well as eye movements.
	Adjacent medial portions of the hemispheres	Somatosensory input from the limbs	Via interposed nucleus to lateral corticospinal and rubrospinal systems.	Controls the more distal muscles of the limbs and digits (smoothens and coordinates movements)
Cerebrocerebellum (or neocerebellum)	The lateral portions of hemispheres	Input from cerebral cortex	Via dentate nucleus to motor, premotor, and prefrontal cortices.	Planning, programming and executing movement.
Vestibulocerebellum (or the flocculonodular lobe)	The nodulus and flocculus	Vestibular and visual inputs	Projects to the vestibular nuclei in the brainstem (direct projection).	Participates in balance, other vestibular reflexes , and eye movements.

Internal Organization

The cerebellum is organized as:

- ❑ An external cerebellum cortex separated by
- ❑ White matter from the
- ❑ Deep cerebellar nuclei.

Internal connections (Fig. 13.6):

- ❑ **Afferent:** There are 2 main primary afferent inputs:
 - **Mossy fibers:** They come from many sources. The fibers first end on the dendrites of the granule cells in “glomeruli”. The mossy fibers convey proprioceptive input from all parts of the body and also input from the cerebral cortex via pontine nuclei to the cerebellar cortex.
 - **Climbing fibers:** They come from one single source via the inferior olivary nuclei. The climbing fibers convey proprioceptive inputs from all over the body.
- ❑ Both of these are excitatory; they send collateral to the deep nuclei and pass to the cerebellar cortex.
- ❑ The climbing fibers ends on the *single* Purkinje cell; the mossy fibers end on the *multiple* Purkinje cell, but through the granule cell.

I IMPORTANT

- ❖ Thus the input to the Purkinje cell from the climbing fiber is 1:1; it is a strong excitatory input and produces a complex spike (action potential) whereas the input to the Purkinje cell from the mossy fiber is 1:1 million; it is a weak input to Purkinje cell and produces a simple spike.

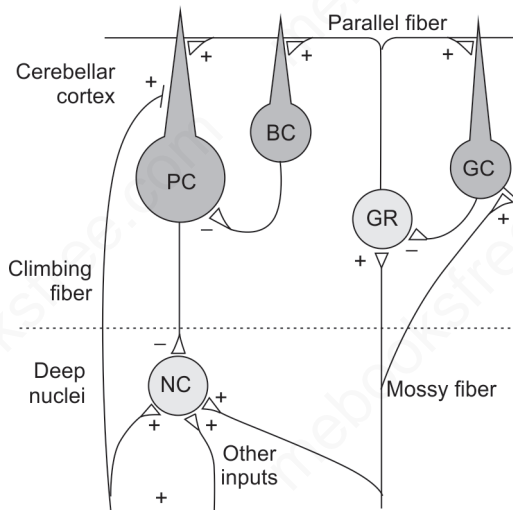

Fig. 13.6: Neural connections in the cerebellum. Plus (+) and minus (-) signs indicate whether endings are excitatory or inhibitory. BC, basket cell; GC, Golgi cell; GR, granule cell; NC, cell in deep nucleus; PC, Purkinje cell

- ❑ **Interconnection between different cells:**
 - a. **Purkinje cell:** The Purkinje cell projects to the deep nuclei; the deep nuclei then gives its output out of the cerebellum. The input from the Purkinje cell to the deep nuclei is inhibitory; however, *the deep nuclei output is always excitatory*. Even at rest deep nuclei continuously discharge excitatory inputs. When movement occurs, the

I IMPORTANT

Out of the 5 cells in the cerebellar cortex only the output from the granule cell is excitatory. The output from the rest of the cells is inhibitory.

- ❖ Granule cell: Stimulates the Purkinje, Basket and stellate cells
- ❖ Purkinje cell: Inhibits deep nuclei
- ❖ Golgi cell: Inhibits granule cell
- ❖ Basket cell: Inhibits Purkinje cell
- ❖ Stellate cell: Inhibits Purkinje cell

I IMPORTANT

- ❖ The granule cell synthesizes glutamate but has GABA receptor on it. The Golgi cell inhibits granule cell via the GABA receptors.

I IMPORTANT

- ❖ The synapse between mossy fibers with dendrites of granule cell is known as glomeruli.

deep nuclei discharge increase at first; within a few milliseconds, inhibition of this discharge occurs by the Purkinje cell. This allows *damping*.

- b. **Granule cell:** Output from the granule cell axons bifurcate and give rise to *parallel fibers*. The granule cell stimulates the Purkinje cell; however, the granule cell also ends at basket/ stellate cells and stimulates them. But the basket and stellate cells in turn inhibit the Purkinje cell (this inhibition by the basket/stellate cell is an example of *feed forward inhibition*). The granule cell itself is inhibited by the Golgi cell (*feedback inhibition*).

Functions of the various tracts carried by the climbing and mossy fibers (afferent tracts) are:

Afferent tract	Transmits
Vestibulocerebellar	Vestibular impulses from labyrinth, direct and via vestibular nuclei (<i>Ipsilateral</i>)
Dorsal spinocerebellar	Proprioceptive and exteroceptive impulses from body (trunk/leg) (Ipsilateral)
Ventral spinocerebellar	Proprioceptive and exteroceptive impulses from body (trunk/leg) (Contralateral)
Cuneocerebellar	Proprioceptive impulses from head and neck (Ipsilateral)
Olivocerebellar	Proprioceptive impulses from all over body through relay in inferior olive
Tectocerebellar	Auditory and visual impulses via inferior and superior colliculi
Pontocerebellar	Impulses from motor and other parts of cerebral cortex via pontine nuclei (From opposite cerebral cortex)
Rubrocerebellar	Impulses from opposite red nucleus
Reticulocerebellar	Impulses from brainstem reticular formation

NOTE:

- **The olivocerebellar pathway projects to cerebellar cortex via climbing fibers. The rest of the listed pathways project via mossy fibers.**
- The sensory input to the cerebellum is mostly ipsilateral.
- Therefore, the cerebellum regulates the activity of the **SAME side** of the body. In cerebellar lesions, there is a *decrease in muscle tone* on the same side and the patient tends to fall on same side.
- Note that the *afferent inputs* go both to the cerebellar cortex and to the deep nuclei. In other words, deep nuclei receive input from the cerebellar cortex (except vestibulocerebellum) as well (as via the collateral) from the afferent inputs of the cerebellum.

Functions of Cerebellum

- ❑ **Maintenance of equilibrium:** This is the function of the vestibulocerebellum (i.e. the flocculonodular lobe). There is inter connection between the vestibular apparatus and the flocculonodular lobe.
- ❑ **Role in regulation of tone and posture:** The effects of the cerebellum on the stretch reflex are complex. With cerebellar disease one would expect an increased in tone. But in humans, hypotonia occurs in cerebellar disease. The spinocerebellum projects on the alpha motor neurons (through efferent output to vestibular nuclei) and the gamma motor neurons (through efferent output to reticular formation).
- ❑ There is a perfect co-ordination between the alpha and gamma motor neuron discharge (the alpha-gamma linkage). The linkage exists at the level of the spinal cord; the 'switch' for the linkage is in the cerebellum.
- ❑ **Error control function/effects on movement:** By comparing plan with performance (the cerebellum gets input from the cortex as well as various sensory inputs), the cerebellum makes anticipatory corrections.
- ❑ **Planning and programming functions:** This is the function of the neocerebellum.
- ❑ **Role in learning:** The cerebellum is concerned with learned adjustments to repetitive tasks.

I IMPORTANT

Cerebellar lesions/disease: Features

- ❖ No paralysis
- ❖ No sensory deficit
- ❖ No abnormalities at rest (except the changes in stretch reflexes)
- ❖ Ataxia (drunken gait)
- ❖ Slurred/scanning speech
- ❖ Dysmetria (past-pointing)
- ❖ Intention tremor
- ❖ Rebound phenomenon
- ❖ Adiadokodinesia
- ❖ Decomposition of movement

I IMPORTANT

[Electrical activity in cerebellum: the basic electrical of frequency rhythm of the cerebellar cortex is of frequency 150-300/s and 200 μv amplitude. Superimposed on this basic rhythm is a 1000-2000/s component of smaller amplitude].

HYPOTHALAMUS

The hypothalamus is the portion of the anterior end of the diencephalon that lies below the hypothalamic sulcus and in front of the interpeduncular nuclei. It is divided into a variety of nuclei:

Region(s)	Zone(s)	Nucleus	Functions
Anterior	Medial	Paraven-tricular	TRH, CRH, Oxytocin and regulation of ANS activity
		Preoptic (Medial)	Thermoregulation (response to Hot), GnRH
		Preoptic (Ventrolateral)	Sleep promoting area (GABA)
		Anterior hypothalamic nucleus	Thermoregulation (response to Hot), Sexual behavior
		Suprachias-matic	Biological rhythms (circadian rhythm)
	Supraoptic	ADH	
	Lateral	Lateral nucleus	Thirst and hunger

Region(s)	Zone(s)	Nucleus	Functions
Tuberal	Medial	Dorsomedial	Emotion (rage), BP, HR
		Ventromedial	Appetite (satiety), Insulin regulation
		Arcuate	Dopamine (PIH), GHRH, GnRH
	Lateral	Lateral Complex	Thirst and hunger
Posterior	Medial	Posterior	Thermoregulation (response to cold)
		Mammillary Tubero- mammillary	Emotion, short-term memory and feeding Wake promoting area (histaminergic)

SOME IMPORTANT AREAS/FUNCTIONS OF HYPOTHALAMUS

GnRH Neurons

- ❑ Found primarily within the septal region, preoptic area, and anterior hypothalamus. GnRH neurons also are found in more caudal regions of the hypothalamus, specifically within the medial basal hypothalamus (MBH).
- ❑ Posterior and lateral hypothalamus and contain a peptide **hypocretin (or orexin)** which are responsible for arousal and regulation of behavioral state.

Sexual Drive

- ❑ The most **anterior (medial preoptic area is main)** and most posterior portions of the hypothalamus.
- ❑ The **medial preoptic** region participates in the control of masculine sexual behavior, such as erection, mounting, and ejaculation, whereas **ventral** regions of the hypothalamus play a major role in the control of feminine sexual behaviors, such as lordosis.

Osmoreceptor

- ❑ Subfornical organ and AV3V region (includes OVLT and the median preoptic nucleus), the paraventricular and supraoptic nuclei.

Thirst Center

- ❑ Lateral hypothalamic nucleus, periaqueductal gray area and paraventricular nucleus.

Control of Thirst by Hypothalamus (Fig. 13.7)

- ❑ Increased osmolality of plasma acts via osmoreceptors, located in the anterior hypothalamus.
- ❑ A decrease in ECF volume (hemorrhage) increases circulating angiotensin II (AgII). The AgII acts on the subfornical organ to stimulate the neural areas concerned with thirst.

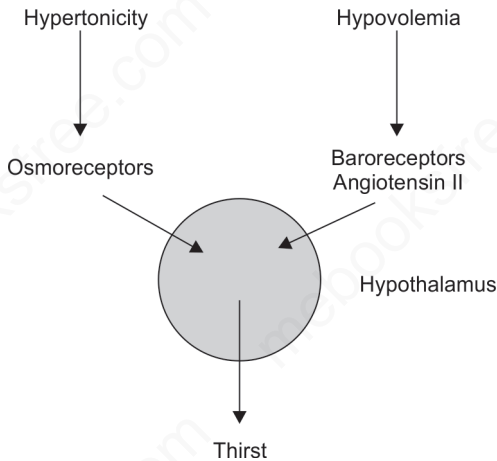

Fig. 13.7: Thirst control

Reward Center

- ❑ Located along the course of the **medial forebrain bundle**, especially in the **lateral** and **ventromedial nuclei** of the hypothalamus.
- ❑ Less potent reward centers: Septum, Amygdala, certain areas of the thalamus and basal ganglia, and extending downward into the basal tegmentum of the mesencephalon.

Punishment Centers

- ❑ **Most potent:** Central gray area surrounding the aqueduct of Sylvius (**PAG**) and extending upward into the periventricular zones of the hypothalamus and thalamus.
- ❑ **Less potent:** Amygdala and hippocampus.

Rage

Strong stimulation of the **punishment centers** (mainly *periventricular zone of the hypothalamus* and in the *lateral hypothalamus*) of the brain, causes the animal to:

I IMPORTANT**Sham rage reaction**

- ❖ Sham (false) rage is outburst of inappropriate pathological rage or, anger in response to mild peripheral stimulation.
- ❖ Shamrage is believed to originate from center in hypothalamus (caudal hypothalamus) and believes to occur due to release of hypothalamus from cortical control.
- ❖ Ablation of hypothalamus eliminates sham rage.
- ❖ Transection through the mid-brain, disconnecting the hypothalamus and brainstem, abolishes "sham rage." Removal of the cerebral hemispheres as long as the caudal hypothalamus remains intact produces sham rage reaction.

I IMPORTANT

Sham rage is a feature of decorticate, although it can be seen in high decerebrate rigidity.

I IMPORTANT

- ❖ The reflex responses activated by cold are controlled from the posterior hypothalamus.
- ❖ Those activated by warmth are controlled primarily from the anterior hypothalamus (preoptic nucleus), although some thermoregulation against heat still occurs after decerebration at the level of the rostral midbrain.

- ❑ Develops a defense posture, extend its claws, lift its tail, hiss, spit, growl, and develop piloerection, wideopen eyes, and dilated pupils. This pattern of behavior that is called *rage*.
- ❑ In the normal animal, the rage phenomenon is held in check mainly by inhibitory signals from the **ventromedial nuclei of the hypothalamus and cortex**. In addition, portions of the hippocampi and anterior limbic cortex, especially in the anterior cingulate gyri and subcallosal gyri, help suppress the rage phenomenon.

Temperature Regulation: Hypothalamus: The balance between heat production and heat loss determines the body temperature.

Different mechanisms of body heat production and heat loss are:

Body heat is produced by:	
Basic metabolic processes	
Food intake (specific dynamic action)	
Muscular activity	Major source
Body heat is lost by:	
% Loss in a nude person sitting inside at normal room temperature	
Radiation	60
Conduction to solid objects	3
Conduction to air	15
Convection	15 (same heat which is conducted to the air)
Evaporation	22

Temperature-Regulating Mechanisms: They include autonomic, somatic, endocrine, and behavioral changes.

The reflex and semi-reflex thermoregulatory responses in humans are:

Mechanisms activated by cold	
1. Shivering	2. Increased secretion of norepinephrine and epinephrine
3. Hunger	4. Decreased heat loss
5. Increased voluntary activity	6. Cutaneous vasoconstriction
7. Curling up	8. Horripilation

Mechanisms activated by heat

1. Increased heat loss	2. Cutaneous vasodilation
3. Sweating	4. Increased respiration
5. Decreased heat production	6. Anorexia
7. Apathy and inertia	

- ❑ Stimulation of the anterior hypothalamus causes cutaneous vasodilation and sweating, and lesions in this region cause hyperthermia, with rectal temperatures sometimes reaching 43°C (109.4°F).
- ❑ Posterior hypothalamic stimulation causes shivering, and the body temperature of animals with posterior hypothalamic lesions falls toward that of the environment.

Fever-Hyperthermia

A normal body temperature is ordinarily maintained, despite environmental variations, because the hypothalamic thermoregulatory center balances (set point) heat production and loss.

- Normal mean oral temperature (18–40 years) is 36.8 ± 0.4°C, with lowest levels at 6 A.M. (37.2°C) and highest levels at 4 to 6 P.M. (37.7°C).
- Rectal temperatures are generally 0.4°C higher than oral readings.
- Core temperature is the best single indicator of thermal status in humans.
- Core temperature monitoring (e.g., pulmonary artery, distal esophagus, tympanic membrane, or nasopharynx) is used to monitor intraoperative hypothermia, prevent overheating, and facilitate detection of malignant hyperthermia.
- PA is the most accurate site for core body temperature monitoring. Lower esophageal temperatures closely reflect core temperature.

Fever

- *An A.M. temperature of >37.2°C or a P.M. temperature of >37.7°C would define a fever.*
- Elevation of body temperature associated with an increase in the hypothalamic set point.
- Once the hypothalamic set point is raised, neurons in the vasomotor center are activated and vasoconstriction commences. The individual first notices vasoconstriction in the hands and feet.

I IMPORTANT**Effects Caused by Stimulation of Hypothalamus**

- ❖ **Posterior and lateral hypothalamus:** increases BP and HR and **insomnia. (Somnolence resulted from lesions of the caudal hypothalamus).**
- ❖ **Preoptic area:** Opposite effects (decrease HR and BP).
- ❖ **Mammillary bodies:** Feeding reflexes, such as licking the lips and swallowing.
- ❖ **Lateral hypothalamus:** Thirst and eating, but also increases the general level of activity of the animal, sometimes leading to overt rage and fighting.

I IMPORTANT**Effects Caused by Hypothalamic Lesions**

- ❖ **Lateral hypothalamus (Bilateral):** Decrease drinking and eating almost to zero, often leading to lethal starvation.
- ❖ **Ventromedial areas (Bilateral):** excessive drinking and eating as well as hyperactivity.

- When body temperature increases by 1°C to 2°C, shivering may begin. Shivering is not required if other heat conservation mechanisms raise blood temperature sufficiently.
- Reduction in pyrogens concentration or, antipyretics reset hypothalamic set point downward.

Hyperpyrexia

- A fever of >41.5°C (So, hypothalamic set point will also be increased)
- Develops in patients with severe infections but most commonly in patients with central nervous system (CNS) hemorrhages.
- In some rare cases, the hypothalamic set point is elevated as a result of local trauma, hemorrhage, tumor, or intrinsic hypothalamic malfunction (hypothalamic fever).

Hyperthermia

- An elevated body temperature in presence of a normal hypothalamic set point.
- *An unchanged (normothermic) setting of the thermoregulatory center (most important).*
- Hyperthermia occurs when mechanisms of heat loss have been impaired by drugs or, disease or, overwhelmed by environmental or, internal (metabolic) heat.
- Examples:
 - Heat stroke—Vigorous exercise in hot environment.
 - Malignant hyperthermia associated with anesthetic agents.
 - Drug-induced hyperthermia
- Differentiating between fever and hyperthermia is difficult and history is crucial.
- *The skin in hyperthermia is very hot but dry.*
- Hyperthermia does not respond to antipyretics.

LIMBIC SYSTEM

The word “limbic” means “border.” Originally, the term “limbic” was used to describe the border structures around the basal regions of the cerebrum, but according to the functions of the limbic system, the term limbic system has been expanded to mean the entire neuronal circuitry that controls emotional behavior and motivational drives.

- ❑ There is no universal agreement on the total list of structures, which comprise the limbic system.
- ❑ **The brain regions that constitute the limbic system are:**

Limbic system	
Limbic cortex	Cingulate gyrus Parahippocampal gyrus
Hippocampal formation	The dentate gyrus Hippocampus Subicular complex
Amygdala	
Septal area	
Hypothalamus	

I IMPORTANT

Kluver-Bucy syndrome

Kluver-Bucy syndrome results due to bilateral destruction of the temporal cortex (most common) along with amygdaloid body. It is characterized by visual agnosia, placidity, hypermetamorphosis, hyperorality and hypersexuality.

FUNCTIONAL CIRCUITRY OF LIMBIC SYSTEM

1. Papez circuit:

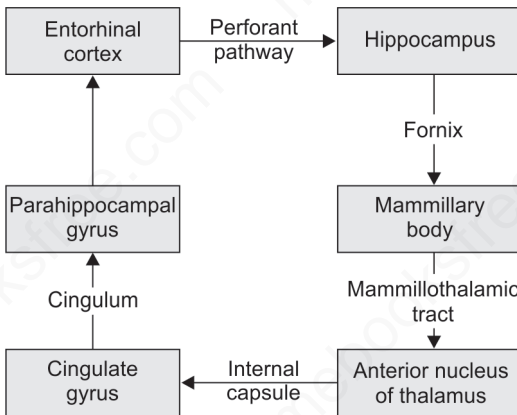

- 2. Circuits of amygdala:** Amygdala serves to integrate information processing between prefrontal/temporal association cortices and the hypothalamus. The amygdala has two major output pathways:
- a. Dorsal route via stria terminalis projects to the septal area and hypothalamus.
 - b. Ventral route via the ventral amygdalofugal pathway terminates in the septal area, hypothalamus and the medial dorsal thalamic nucleus.

I IMPORTANT

Korsakoff's psychosis

- ❖ Korsakoff's psychosis is caused by damage to mammillary bodies (most common), dorso-medial nucleus of thalamus and hypothalamus (diencephalic memory circuit).
- ❖ Hippocampus neurons number remains same. It is a syndrome associated with chronic impairment of recent and remote memory. Recent memory is characteristically more disturbed than remote memory. Immediate recall is usually preserved.

Functions of the limbic system:

Areas	Functions
Cingulate gyrus	Autonomic functions regulating heart rate and blood pressure as well as cognitive, attentional and emotional processing
Parahippocampal gyrus	Spatial memory
Hippocampus	Long-term memory
Amygdala	Anxiety, aggression, fear conditioning; emotional memory and social cognition
Hypothalamus	Regulates ANS and many others (discussed above)
Mammillary body	Memory
Nucleus accumbens	Reward, Addiction

MULTIPLE CHOICE QUESTIONS

CEREBRAL CORTEX AND DESCENDING PATHWAYS

RECENT MCQs

1. Which cells project to pial surface?
 - a. Axons of Betz cells
 - b. Martinotti cell
 - c. Fusiform cell
 - d. Stellate cell
2. Setting posture before planned movement:
 - a. Premotor cortex
 - b. Motor cortex
 - c. Frontal
 - d. Supplementary motor cortex
3. Pyramids are formed by:
 - a. Arcuate nucleus
 - b. Vestibular nuclei
 - c. Interstitial cells of Cajal
 - d. Lateral corticospinal tract
4. According to Herrington classification the decerebrate rigidity is characterised by all *except*:
 - a. Rigidity occurs in all muscles of the body
 - b. Increased in the rate of discharge of the gamma efferent neuron
 - c. Increased excitability of the motor neuron pool
 - d. Decerebration produces no phenomenon akin to spinal shock
5. The first reflex to return after recovery from spinal shock is:
 - a. Stretch reflex
 - b. Flexor reflex
 - c. Stepping reflex
 - d. Postural antigravity reflex
6. Effect of upper motor neuron on gamma motor neuron is:
 - a. Stimulatory
 - b. Inhibitory
 - c. Both
 - d. None

AIIMS/PGI/JIPMER

7. While doing a neurosurgery, the paracentral lobule was accidentally damaged. It will lead to which of the following? [AIIMS 00]
 - a. Hemiplegia
 - b. Monoplegia
 - c. Involvement of the perineum and lower limbs
 - d. Quadriplegia
8. Skilled voluntary movement is initiated at: [JIPMER 02]
 - a. Cerebral cortex (motor cortex)
 - b. Basal ganglia
 - c. Cortical association
 - d. Cerebellum
9. UMN includes: [PGI June 02]
 - a. Pyramidal cells
 - b. Peripheral nerves
 - c. Anterior horn cells
 - d. Glial cells
 - e. Schwann cells
10. True about lateral corticospinal tract:
 - a. Crossed [PGI Dec 06]
 - b. Uncrossed
 - c. Stops in midthoracic region
 - d. Crossed at midspinal level
 - e. Only 20% crossed
11. Which is not a medial pathway involved in maintenance of posture?
 - a. Reticulospinal tract [JIPMER 11]
 - b. Rubrospinal tract
 - c. Tectospinal tract
 - d. Vestibulospinal tract
12. Gamma motor neurons are mainly influenced by: [JIPMER 10]

- a. Tectospinal tract
- b. Vestibulospinal tract
- c. Reticulospinal tract
- d. Corticospinal tract

13. Corticospinal tract lesion leads to:

- a. Spasticity [PGI Nov 10]
- b. Extensor plantar response
- c. Cog-wheel rigidity
- d. Resting tremors
- e. Exaggerated tendon reflexes

14. Following are the features of corticospinal involvement except: [AI 03]

- a. Cog-wheel rigidity
- b. Spasticity
- c. Plantar extensor response
- d. Exaggerated deep tendon reflexes

15. Features of pyramidal tract lesion are all except: [AI 98, 94]

- a. Clasp knife rigidity
- b. Involuntary movements
- c. Positive Babinski sign

- d. Exaggerated reflexes and increased tone

16. The first reflex response to appear as spinal shock wears off in humans is:

- a. Tympanic reflex [AI 06]
- b. Withdrawal reflex
- c. Neck righting reflex
- d. Labyrinthine reflex

17. The maintenance of posture in a normal adult human being depends upon: [AI 06]

- a. Integrity of reflex arc
- b. Muscle power
- c. Type of muscle fibers
- d. Joint movements in physiological range

18. Function of vestibulospinal tract:

- a. Facilitates flexors [JIPMER 15]
- b. Facilitates extensors
- c. Inhibits flexors
- d. Inhibits extensors

CEREBELLUM**RECENT MCQs****19. The function of the neocerebellum is:**

- a. Maintenance of equilibrium
- b. Servo-correction of voluntary movements
- c. Planning and programming of voluntary movements
- d. Maintenance of muscle tone

20. Not included in cerebellar nuclei:

- a. Dentate nuclei
- b. Emboliform nuclei
- c. Fastigial nuclei
- d. Caudate nuclei

21. Purkinje fibers are inhibitory for:

- a. Deep cerebellar nuclei

- b. Climbing fiber
- c. Basket cells
- d. Spinocerebellar tracts

22. Vestibulo-ocular reflex is concerned with:

- a. Archicerebellum
- b. Flocculonodular lobe
- c. Neocerebellum
- d. Occipital lobe

23. True about spinocerebellar tract is:

- a. Equilibrium
- b. Smoothens and coordinates movement
- c. Learning induced by change in vestibulo-ocular reflex
- d. Planning and programming

AIIMS/PGI/JIPMER

24. Cells present in cerebellar cortex are all except: [AIIMS Nov 08]

- a. Purkinje b. Bipolar
c. Granule d. Golgi

25. Cerebellar connection to other parts of the brain is projected through which cell? [AI 94]

- a. Golgi cells b. Basket cells
c. Purkinje cells d. Oligodendrocytes

26. Flocculonodular lobe has direct connection with: [AI 98]

- a. Red nucleus
b. Inferior olivary nucleus
c. Vestibular nucleus
d. Dentate nucleus

27. Which one of the following clearly states the role of cerebellum in motor performance? [AIIMS May 04]

- a. Planning and programming of movement
b. Convert abstract thought into voluntary action

- c. Initiation of skilled voluntary action
d. Smoothens and coordinates ongoing movements

28. True about cerebellum: [PGI Dec 04]

- a. Cerebral cortex have mostly inhibitory effects
b. Co-ordination
c. Planning of motor movements
d. Decreased tone
e. Excitatory effect from deep nuclei

29. Which of the following does not carry proprioceptive impulses? [JIPMER 11]

- a. Olivocerebellar tract
b. Tectocerebellar tract
c. Spinocerebellar tract
d. Cuneocerebellar tract

30. Lesions of the lateral cerebellum cause all of the following except: [AI 10]

- a. Incoordination
b. Intention tremor
c. Resting tremor
d. Ataxia

BASAL GANGLIA**RECENT MCQs**

31. Neurotransmitter involved in nigrostriatal pathway is:

- a. Serotonin
b. Dopamine
c. Cholinergic
d. Adrenergic

32. Globus pallidus, putamen are present in:

- a. Pons
b. Basal ganglia
c. Thalamus
d. Cerebellum

AIIMS/PGI/JIPMER

33. Nucleus of basal ganglia: [PGI Dec 04]

- a. Dentate b. Thalamus
c. Caudate d. Red nucleus

34. The efferent fiber bundle of the substantia nigra transmits dopamine to one of the following areas:

[AIIMS Nov 04]

- a. Thalamus
b. Corpus striatum
c. Tegmentum of pons
d. Tectum of midbrain

35. Glutamate as a neurotransmitter is synthesized mainly in which part of basal ganglia? [AI 12]

- a. Globus pallidus interna
- b. Globus pallidus externa
- c. Subthalamic nucleus
- d. Putamen

36. Which of the following acts as the major neurotransmitter in substantia nigra? [AIIMS June 97]

- a. Dopamine
- b. Noradrenaline
- c. Acetylcholine
- d. Serotonin

37. Which of the following clearly states the role of basal ganglia in motor function? [PGI Dec 05]

- a. Planning
- b. Skilled function
- c. Coordinate function
- d. Smoothens

38. Functions of basal ganglia include:

- a. Gross motor [PGI June 02]
- b. Skilled movements
- c. Emotions
- d. Maintenance of equilibrium
- e. Coordination of movements

39. Which of the following is most prone to hypoxic injury? [PGI Dec 00]

- a. Thalamus
- b. Hippocampus
- c. Caudate nucleus
- d. Cerebellum

HYPOTHALAMUS AND LIMBIC SYSTEM

RECENT MCQs

40. Which of the following nucleus controls the circadian rhythm?

- a. Supraoptic nucleus
- b. Paraventricular nucleus
- c. Suprachiasmatic nucleus
- d. Premammillary nucleus

41. Daily rhythm regulation:

- a. Dorsomedial b. Ventromedial
- c. Supraoptic d. Suprachiasmatic

42. Diurnal variation of ACTH depends on:

- a. Suprachiasmatic nucleus
- b. Supraoptic nucleus
- c. Ventrolateral nucleus
- d. Thalamus

43. Osmoreceptors are located in:

- a. Supraoptic nuclei
- b. Paraventricular nuclei

- c. Anterior hypothalamus
- d. Lateral hypothalamus

44. Vasopressin induced thirst is:

- a. Subfornical nuclei
- b. Posterior hypothalamus
- c. Osmoreceptors
- d. Pretectal nucleus

45. Thirst is activated by:

- a. Increased Angiotensin II level
- b. Extracellular hyperosmolarity
- c. Increased ANP levels
- d. Increased Renin levels

46. Satiety centre is located at:

- a. Ventromedial nucleus of hypothalamus
- b. Dorsomedial nucleus of hypothalamus
- c. Peritrigonal area
- d. Lateral nucleus

47. The primary motor area for shivering is:

- a. Cerebrum
- b. Red nucleus
- c. Ventromedial anterior hypothalamus
- d. Dorsomedial posterior hypothalamus

48. Function of preoptic nucleus of hypothalamus:

- a. Temperature regulation
- b. Thirst
- c. GI stimulation
- d. Satiety centre

49. Main mechanism in thermoregulation-heat loss is:

- a. Radiation
- b. Evaporation
- c. Conduction
- d. Convection

50. Reward centre is:

- a. Insula
- b. Medial forebrain bundle
- c. Hypothalamus
- d. Preoptic nucleus

51. True about experimental sham rage is: [AI 12]

- a. Occurs in decorticate animals
- b. Is goal directed
- c. Is caused by removal of hypothalamus
- d. Appears slowly and goes slowly

52. Window of limbic system:

- a. Hypothalamus
- b. Hippocampus
- c. Amygdala
- d. Cingulate gyrus

53. Functions of limbic system:

- a. Emotion
- b. Movement
- c. Higher function
- d. Consciousness

54. Limbic system is concerned with:

- a. Control of emotions, food habits
- b. Sexual behavior
- c. Autonomic functions
- d. All of the above

55. Korsakoffs psychosis is lesion of:

- a. Thalamus
- b. Subthalamic nuclei
- c. Hippocampus
- d. Mammillary body

56. Klüver-Bucy syndrome is due to the lesion in which of the following structure:

- a. Amygdala
- b. Hippocampus
- c. Hypothalamus
- d. Temporal lobe

AIIMS/PGI/JIPMER

57. All of the following are known functions of hypothalamus except:

[AI 97, AIIMS Dec 95]

- a. Temperature regulation
- b. Increased in heart rate with exercise
- c. Food intake
- d. Hypophyseal control

58. Part of hypothalamus which is involved in sexual behavior? [AI 12]

- a. Preoptic area
- b. Supraoptic area
- c. Lateral hypothalamus
- d. Posterior hypothalamus

59. Injection of hypertonic saline in which region of hypothalamus produces intense thirst? [AIIMS Dec 94]

- a. Posterior region
- b. Paraventricular
- c. Preoptic
- d. Supraoptic

60. Drinking can be induced by:

[AIIMS May 04]

- Electrical stimulation of the posterior hypothalamus
- Osmotic stimulation of supraoptic nucleus
- Lesions in the paraventricular nucleus
- Neuronal lesion of the preoptic nucleus

61. Without external cue, the sleep-wake cycle in humans:

[AI 12]

- Unchanged
- Continues with cycle length of > 24 hours
- Continues with cycle length of < 24 hours
- Continue with cycle length of > 12 hours

62. The physiological effect in unacclimated person suddenly exposed to cold is:

[AIIMS May 01]

- Tachycardia
- Shift of blood from shell to core
- Non-shivering thermogenesis
- Hypertension

63. In human being, the least useful physiological response to low environmental temperature is:

[AI 06]

- Shivering
- Vasoconstriction
- Release of thyroxine
- Piloerection

64. Non-shivering thermogenesis in adults is due to:

[AI 02]

- Thyroid hormone
- Brown fat between the shoulders
- Noradrenaline
- Muscle metabolism

65. The first physiological response to high environmental temperature is:

- Sweating [AI 05]
- Vasodilatation
- Decreased heat production
- Non-shivering thermogenesis

66. Heat loss from the body depends mostly on:

[AI 94]

- Thermoregulatory center
- Warning of air during inspiration
- On the environmental temperature
- Radiation and evaporation

67. Sweating a result of exertion is mediated through:

[PGI June 99]

- Adrenal hormones
- Sympathetic cholinergic
- Sympathetic adrenergic
- Parasympathetic cholinergic

68. Under physiological conditions heat acclimatization is accomplished A/E:

[AIIMS Dec 98]

- Decreased renal blood flow
- Increased urine sodium
- Increased aldosterone secretion
- Excessive sweating

69. A 10 degree decrease in temperature causes decrease in cerebral metabolic rate by:

[AIIMS Nov 02]

- | | |
|--------|--------|
| a. 10% | b. 30% |
| c. 50% | d. 70% |

70. Emotional effect to a physical stimulus is given by:

[JIPMER 03]

- | | |
|---------------|----------------|
| a. Amygdaloid | b. Cortex |
| c. Cerebellum | d. Hippocampus |

71. Structure of brain involved in emotion:

[PGI Dec 04]

- Neocortex
- Limbic system
- Thalamus
- Hippocampus
- Basal ganglia

FUTURE TRENDS

72. Which of the following body parts is represented most laterally and inferiorly within the primary motor cortex?
- Face
 - Hand
 - Neck
 - Abdomen
73. Which component of the basal ganglia plays the major role in the control of cognitive (memory-guided) motor activity?
- Globus pallidus
 - Substantia nigra
 - Caudate nucleus
 - Putamen
74. Which structure is an important pathway for communication between the limbic system and the brainstem?
- Mamillothalamic tract
 - Anterior commissure
 - Indusiumgriseum
 - Medial forebrain bundle
75. Fine motor movement of the index finger can be elicited by stimulation of which of the following brain areas?
- Primary motor cortex
 - Lateral cerebellar hemisphere
 - Premotor cortex
 - Supplemental motor area

ANSWERS WITH EXPLANATIONS

1. **Ans. b. Martinotti cell** >> a. Axons of Betz cells

Martinotti cell is a small multipolar cell, present throughout cortex. The cell has small dendrites but axon is directed towards pial surface, where it ends in a more superficial layer. Pyramidal cell axon also extends towards pial surface.

2. **Ans. a. Premotor cortex**

(Ref. Ganong's Physiology 24th edn. pp 245)

Concerned with setting posture at the start of a planned movement and with getting the individual prepared to move.

Supplementary motor area appears to be involved primarily in organizing or planning motor sequences.

3. **Ans. d. Lateral corticospinal tract**

(Ref. Ganong's Physiology 24th edn. pp 242)

About 80% (average) of the corticospinal fibers cross the midline in the medullary pyramids to form the lateral corticospinal tract.

4. **Ans. a. Rigidity occurs all muscles of the body**

(Ref. Ganong's Physiology 24th edn. pp 249)

Hyperactivity in extensor muscles (not all muscle) in all four extremities, which is called decerebrate rigidity.

The hyperactivity is produced by the excitatory input to γ -motor neurons, which indirectly activate α -motor neurons (via Ia spindle afferent activity). This is called the gamma loop.

5. **Ans. b. Flexor reflex**

(Ref. Ganong's Physiology 24th edn. pp 250)

"The first reflex response to appear as spinal shock wears off in humans is often a slight contraction of the leg flexors and adductors in response to a noxious stimulus."

6. **Ans. c. Both**

(Ref. Ganong's Physiology 24th edn. pp 246)

UMN includes both pyramidal and extrapyramidal system. Pontine reticulospinal neurons are primarily excitatory and medullary

reticulospinal neurons are primarily inhibitory.

7. Ans. c. Involvement of the perineum and lower limbs

(Ref. Ganong's Physiology 24th edn. pp 246)

Paracentral area is the medial surface of motor cortex and sensory cortex. The body parts which are located on medial surface are leg and foot.

8. Ans. c. Cortical association

(Ref. Ganong's Physiology 24th edn. pp 242, Fig. 16.1)

Commands for voluntary movement originate in cortical association areas.

9. Ans. a. Pyramidal cells

(Ref. Ganong's Physiology 24th edn. pp 243)

Lower motor neurons refer to the spinal and cranial motor neurons that directly innervate skeletal muscles. Upper motor neurons are those in the cortex and brainstem that activate the lower motor neurons.

10. Ans. a. Crossed

(Ref. Ganong's Physiology 24th edn. pp 242)

About 80% (average) of corticospinal fibers cross the midline to form the lateral corticospinal tract. The remaining 20% make up the ventral corticospinal tract, which does not cross the midline until it reaches the level of the spinal cord at which it terminates.

11. Ans. b. Rubrospinal tract

(Ref. Ganong's Physiology 24th edn. pp 246)

The medial brainstem pathways, which work in concert with the ventral corticospinal tract, are the pontine and medullary reticulospinal, vestibulospinal, and tectospinal tracts.

12. Ans. c. Reticulospinal tract

(Ref. Ganong's Physiology 24th edn. pp 246)

The pontine and medullary reticulospinal tracts project to all spinal levels. They are involved in the maintenance of posture and in modulating muscle tone, especially via an input to γ -motor neurons.

13. Ans. b. Extensor plantar response

(Ref. Richard S. Snell's Clinical Neuroanatomy 7th edn. pp 182)

Babinski's (extensor plantar response) sign is a feature of pyramidal tract (corticospinal) tract lesion. All other options are caused by extrapyramidal lesion.

As the pyramidal tracts normally tend to increase muscle tone and the extrapyramidal tracts inhibit muscle tone, the balance between these opposing effects will be altered, producing different degrees of muscle tone. So, pure pyramidal tracts lesion produces hypotonia.

14. Ans. a. Cog-wheel rigidity

(Ref. Richard S. Snell's Clinical Neuroanatomy 7th edn. pp 182)

Cog-wheel rigidity is a feature of extrapyramidal lesion.

As discussed in above question; spasticity and exaggerated deep tendon reflexes are also not seen in pure pyramidal tract lesion. But single best exclusion is option a.

15. Ans. b. Involuntary movements

(Ref. Richard S. Snell's Clinical Neuroanatomy 7th edn. pp 182)

Involuntary movement is not a feature of pyramidal tract lesion.

16. Ans. b. Withdrawal reflex

(Ref. Ganong's Physiology 24th edn. pp 250)

The first reflex response to appear as spinal shock wears off in humans is often a slight contraction of the leg flexors, which is a part of withdrawal reflex.

17. Ans. a. Integrity of reflex arc

(Ref. Ganong's Physiology 24th edn. pp 247)

Stretch reflex is fundamental to posture control. The major factor in posture control is by a change in the threshold of the stretch reflex.

18. Ans. b. Facilitates extensors

(Ref. Ganong's Physiology 24th edn. pp 246)

It activates motor neurons to antigravity muscles (e.g. proximal limb extensors) to control posture and balance.

19. Ans. c. Planning and programming of voluntary movements

(Ref. Ganong's Physiology 24th edn. pp 257)

Spinocerebellum, by comparing plan with performance, smoothes and coordinates movements.

Neocerebellum for planning and programming.

20. Ans. d. Caudate nuclei

(Ref. Ganong's Physiology 24th edn. pp 255)

Caudate nucleus is a part of basal ganglia.

21. Ans: a. Deep cerebellar nuclei

(Ref. Ganong's Physiology 24th edn. pp 255)

The input from the Purkinje cell to the deep nuclei is inhibitory; however, the deep nuclei output is always excitatory.

22. Ans. b. Flocculonodular lobe

(Ref. Ganong's Physiology 24th edn. pp 257)

The reflex is controlled by vestibulocerebellum (or the flocculonodular lobe).

23. Ans. b. Smoothens and coordinates movement

(Ref. Ganong's Physiology 24th edn. pp 257)

Spinocerebellum: smoothens and coordinates movements.

Neocerebellum: planning and programming of movement.

24. Ans. b. Bipolar

(Ref. Ganong's Physiology 24th edn. pp 255)

25. Ans. c. Purkinje cells

(Ref. Ganong's Physiology 24th edn. pp 255)

Purkinje cells are the output nucleus of cerebellum.

26. Ans. c. Vestibular nucleus

(Ref. Ganong's Physiology 24th edn. pp 257)

Vestibulocerebellum (or flocculonodular lobe) has vestibular connections and is concerned with equilibrium and eye movements.

27. Ans. d. Smoothens and coordinates ongoing movements >> a. Planning and programming of movement.

(Ref. Ganong's Physiology 24th edn. pp 257)

[Explained in Q. 23]

28. Ans. b. Co-ordination, c. Planning of motor movements, d. Decreased tone, e. Excitatory effect from deep nuclei

Cerebellar disease produces hypotonia.

[Check Q. No. 19, 21, 23 for explanation]

29. Ans. b. Tectocerebellar tract

(Ref. Ganong's Physiology 24th edn. pp 257)

Tectospinal is for auditory and visual impulses via inferior and superior colliculi.

30. Ans. c. Resting tremor

(Ref. Ganong's Physiology 24th edn. pp 258)

Intention tremor occurs in a cerebellar disease; resting tremor seen in Parkinson's disease.

31. Ans. b. Dopamine

(Ref. Ganong's Physiology 24th edn. pp 251)

32. Ans. b. Basal ganglia

(Ref. Ganong's Physiology 24th edn. pp 251)

33. Ans. c. Caudate

(Ref. Ganong's Physiology 24th edn. pp 250)

34. Ans. b. Corpus striatum

(Ref. Ganong's Physiology 24th edn. pp 250)

The connections between the parts of the basal ganglia include a dopaminergic nigrostriatal projection from the substantia nigra pars compacta to the striatum and a corresponding GABAergic projection from the striatum to substantia nigra pars reticulata.

35. Ans. c. Subthalamic nucleus

(Ref. Ganong's Physiology 24th edn. pp 251)

Projections from subthalamic nucleus to Globus pallidus are glutaminergic.

36. Ans. a. Dopamine

[Explained in Q. 34]

37. Ans. a. Planning, b. Skilled function, c. Coordinate function

(Ref. Ganong's Physiology 24th edn. pp 252)

Basal ganglia are involved in the planning and programming of movement.

38. Ans. b. Skilled movements, e. Coordination of movements

(Ref. Ganong's Physiology 24th edn. pp 252)

Two important capabilities of the brain in controlling movement are (1) to determine how rapidly the movement is to be performed and (2) to control how large the movement will be.

39. Ans. b. Hippocampus

(Ref. Neuropathology by Richard A. Prayson and Textbook of Pharmacology by Seth)

Most sensitive neurons in adult are Pyramidal cell of CA1 region of hippocampus (Sommer's sector), Purkinje cell of cerebellum and striatal neurons. Most resistant to hypoxic damage are brainstem and spinal cord. Irreversible damaged occurs if there is no O₂ supply for >5 min.

40. Ans. c. Suprachiasmatic nucleus

(Ref. Ganong's Physiology 24th edn. pp 352)

Many endogenous body activities have rhythmic fluctuations that are approximately 24 h in length; that is, they are circadian. This rhythm is controlled by suprachiasmatic nucleus.

41. Ans. d. Suprachiasmatic

[Explained in Q. 40]

42. Ans. a. Suprachiasmatic nucleus

(Ref. Ganong's Physiology 24th edn. pp 352)

ACTH is secreted in irregular bursts throughout the day and plasma cortisol tends to rise and fall in response to these bursts. This is an example of circadian rhythm.

43. Ans: c. Anterior hypothalamus

(Ref. Ganong's Physiology 24th edn. pp 666)

"Vasopressin secretion is regulated by osmoreceptors located in the anterior hypothalamus."

44. Ans. None

(Ref. Ganong's Physiology 24th edn. pp 666)

Vasopressin does not induce thirst. AgII can stimulate subfornical organ for stimulation of thirst.

45. Ans: b. Extracellular hyperosmolarity > a. Increased Angiotensin II level > d. Increased Renin levels

(Ref. Ganong's Physiology 24th edn. pp 276)

Drinking is regulated by plasma osmolality and extra-cellular fluid (ECF) volume in much the same fashion as vasopressin secretion.

Increase renin can also induced thirst indirectly.

46. Ans. a. Ventromedial nucleus of hypothalamus

(Ref. Ganong's Physiology 24th edn. pp 275)

Satiety centre: Ventromedial nucleus of hypothalamus.

Hunger centre: Lateral nucleus of hypothalamus.

47. Ans. d. Dorsomedial posterior hypothalamus

(Ref. Ganong's Physiology 24th edn. pp 285)

Response to cold environment is controlled by posterior hypothalamus.

48. Ans. a. Temperature regulation

(Ref. Ganong's Physiology 24th edn. pp 285)

Preoptic nucleus is for thermoregulation (response to Hot), GnRH secretion.

49. Ans. a. Radiation

(Ref. Ganong's Physiology 24th edn. pp 284 & Guyton-Physiology-12th edn. pp 890)

Radiation is responsible for 60% thermoregulation-heat loss.

50. Ans. b. Medial forebrain bundle

(Ref. Guyton-Physiology-12th edn. pp 735)

[Detail in text]

51. Ans. a. Occurs in decorticate animals

(Ref. Guyton-Physiology-12th edn. pp 735)

Sham rage is believed to originate from center in hypothalamus (caudal hypothalamus) and believes to occur due to release of hypothalamus from cortical control (decorticate). Ablation of hypothalamus eliminates sham rage.

52. Ans. c. Amygdala

(Ref. Guyton-Physiology-12th edn. pp 737)

53. Ans. a. Emotion, > c. Higher function

(Ref. Guyton-Physiology-12th edn. pp 738)

Amygdala controls emotions.

54. Ans. d. All of the above

(Ref. Guyton-Physiology-12th edn. pp 738)

[Detail functions of different parts is given in text]

55. Ans. d. Mammillary body

(Ref: Neuropsychol Rev. 2012;22:72-80)

Most common involved structure is mammillary body.

56. Ans. d. Temporal lobe

(Ref. Guyton-Physiology-12th edn. pp 738)

When the anterior temporal cortex is ablated bilaterally, the amygdalas are almost invariably damaged as well. Destruction of temporal lobe is the most common cause of Klüver-Bucy syndrome occurs.

57. Ans. b. Increased in heart rate with exercise

(Ref. Ganong's Physiology 24th edn. pp 285)

ANS is controlled by hypothalamus. But HR increase during exercise is mainly controlled by medulla.

58. Ans. a. Preoptic area

(Ref. Guyton-Physiology-12th edn. pp 735)

The most anterior (medial preoptic area is main) and most posterior portions of the hypothalamus.

59. Ans. c. Preoptic

(Ref. Ganong's Physiology 24th edn. pp 285)

Osmoreceptors are located in the anterior hypothalamus (preoptic nucleus). Osmoreceptor can only detect the NaCl injection and stimulates thirst centre.

60. Ans. None >> b. Osmotic stimulation of supraoptic nucleus

(Ref. Ganong's Physiology 24th edn. pp 285)

Osmotic stimulation of preoptic nucleus can produce thirst. But in this question, no options are matching. Single best choice option b. Because osmoreceptors are located near to supraoptic area.

61. Ans. b. Continues with cycle length of > 24 hours

(Ref. Berne & Levy Physiology, 6th Bruce M Koeppen, pp20)

The cycle becomes 24.2 hours in absence of external cues (light).

62. Ans. b. Shift of blood from shell to core

(Ref. Ganong's Physiology 24th edn. pp 285)

Sudden exposure to cold environment produces skin vasoconstriction throughout the body. This shifts the blood from shell to core. This is caused by stimulation of the posterior hypothalamic sympathetic centers.

63. Ans. d. Piloerection

(Ref. Guyton-Physiology-12th edn. pp 895)

Piloerection means hairs "standing on end." Sympathetic stimulation causes the arrector pili muscles attached to the hair follicles to contract, which brings the hairs to an upright stance. This is not an important mechanism in human beings.

64. Ans. c. Noradrenaline

(Ref. Brain Res Bull. 1984 Feb;12:151-60)

Nonshivering thermogenesis was originally defined as a cold-induced increase in heat production not associated with the muscle activity of shivering. Recent research shows it to be a metabolic process located primarily in brown adipose tissue and controlled by the activity of the sympathetic nervous supply of this tissue. Another stimulus to sympathetic nervous activity, the ingestion of food, promotes diet-induced thermogenesis in brown adipose tissue.

65. Ans. b. Vasodilatation

(Ref. Guyton-Physiology-12th edn. pp 895)

First response is vasodilation followed by sweating.

66. Ans. d. Radiation and evaporation

[Explained in Q. 49]

67. Ans: b. Sympathetic cholinergic

(Ref. Front Biosci (Schol ed);2:685-696)

The sympathetic nerves distributed to sweat glands consist of large numbers of cholinergic terminals and a few adrenergic terminals. The effect of these adrenergic terminals in causing sweating is minimal given that exogenous administration of adrenergic agents will cause only minimal sweating relative to acetylcholine administration, the latter of which is the primary neurotransmitter causing sweating.

68. Ans. b. Increased urine sodium

(Ref. Guyton-Physiology-12th edn. pp 895)

There is decrease in NaCl in both sweat and urine.

69. Ans. d. 70%

(Ref. Lee's Synopsis of Anaesthesia by N.J.H David et al. pp 292)

With each fall of 1°C, metabolism is reduced by 6.7%.

70. Ans. a. Amygdaloid

(Ref. Guyton-Physiology-12th edn. pp 738)

Amygdala controls emotions.

71. Ans. b. Limbic system d. Hippocampus

(Ref. Guyton-Physiology-12th edn. pp 738)

72. Ans. a. Face

The face region of the motor cortex is most inferior and lateral in the territory of the middle cerebral artery, whereas the lower limb is in the paracentral lobule in the territory of the anterior cerebral.

73. Ans. c. Caudate nucleus

The caudate nucleus is involved in the basal ganglia circuits that control memory-guided motor activity.

74. Ans. d. Medial forebrain bundle

The medial forebrain bundle extends from the septal and orbitofrontal regions of the cerebral cortex downward through the

center of the hypothalamus to the brainstem reticular area. This structure serves as an important communication system between the limbic system and the brainstem.

75. Ans. a. Primary motor cortex

A large area of the primary motor cortex is dedicated to activating the muscles

that control the movement of the fingers. Stimulation of the primary motor cortex usually results in very discrete contractions of small groups of muscles. Stimulation of the premotor cortex results in the contraction of large groups of muscles and stimulation of the supplemental motor area results in bilateral movements.

Higher Functions and Special Senses

CEREBRAL DOMINANCE

- ❑ The vertebrate cerebrum (brain) is formed by two cerebral hemispheres that are separated by a groove, the medial longitudinal fissure.
- ❑ The brain is organized with certain specialized functions lateralized to each hemisphere.
- ❑ This hemisphere is concerned with categorization and symbolization has often been called the **dominant hemisphere**.
- ❑ However, it is clear that the other hemisphere is not simply less developed or “nondominant;” instead, it is specialized in the area of spatiotemporal relations.
- ❑ Consequently, the concept of “cerebral dominance” and a dominant and nondominant hemisphere has been replaced by a concept of complementary specialization of the hemispheres, one for sequential-analytic processes (**the categorical hemisphere**) and one for visuospatial relations (**the representational hemisphere**).
- ❑ The categorical hemisphere is concerned with language functions.

I IMPORTANT

- ❖ **Right-handed person:** In 96% of individuals, the left hemisphere is the dominant or categorical hemisphere, and in the remaining 4%, the right hemisphere is dominant.
- ❖ **Left-handed person:** In 70% cases, the left hemisphere is the categorical hemisphere, in ~15% of individuals, the right hemisphere is the categorical hemisphere and, in 15%, there is no clear lateralization.

THE OTHER DIFFERENCES BETWEEN TWO HEMISPHERES ARE:

	Dominant hemisphere (categorical hemisphere)	Nondominant (representational hemisphere)
Functions	<ul style="list-style-type: none"> • Spoken and written language • Mathematical skill • Analytical ability, reasoning, scientific skills 	<ul style="list-style-type: none"> • Visuospatial orientation • Recognition of face, image • Music, art awareness • Three dimensional awareness • Imagination, insight

Contd...

Contd...

	Dominant hemisphere (categorical hemisphere)	Nondominant (representational hemisphere)
Symptoms due to damage	<ul style="list-style-type: none"> • Aphasia • Dyscalculia 	<ul style="list-style-type: none"> • Astereognosis • Agraphia, dysgraphia • Agnosias • Unilateral neglect • Anosognosia

- ❑ Hemispheric specialization is related to handedness. Handedness appears to be genetically determined.
- ❑ It is interesting that learning disabilities such, as dyslexia, an impaired ability to learn to read, are 12 times as common in left-handers as they are in right-handers, possibly because some fundamental abnormality in the left hemisphere led to a switch in handedness early in development.

ELECTROENCEPHALOGRAPH (EEG)

- ❑ In 1924, Berger made the first EEG recording in man. Using the EEG, he was also the first to describe the different waves or rhythms, which were present in the normal and abnormal brain, such as the alpha wave rhythm (8-12 Hz), also known as Berger's wave.
- ❑ **Sources of EEG:** It is due to the constantly shifting/fluctuating dipole between the dendrites of the cortical cells and the cell bodies

Various Types of Waves in the EEG

Wave in EEG	Features
Alpha Rhythm	<ul style="list-style-type: none"> • Frequency: 8-13 Hz (alpha rhythm of most adults ranges between 9.5 and 10.5 Hz) • Location: Posterior dominant but may extending to central and temporal regions. • Morphology: Rhythmic, regular, waxing and waning. • Amplitude: Generally 20-100 μv. The alpha rhythm is often of slightly higher voltage over the right hemisphere. There should be little (less than 1 Hz) or no difference in the frequency of the alpha rhythm between the left and right hemispheres. • Reactivity: Awake and in a quiet, resting state of cerebration. Best seen with eyes closed, attenuates with eye opening. The posterior alpha rhythm is temporarily blocked by an influx of light (eye opening), other afferent stimuli, and mental activities.

Contd...

I IMPORTANT

The EEG recorded from the scalp is a measure of the summation of dendritic postsynaptic potentials (EPSP and IPSP) rather than action potentials.

I IMPORTANT

- ❖ **Origin of alpha waves:** It is believed that the alpha waves result from spontaneous feedback oscillation in diffuse thalamocortical system, possibly including the reticular activating system in the brainstem as well.
- ❖ **Origin of delta waves:** Transection of the fiber tracts from the thalamus to the cerebral cortex, which blocks thalamic activation of the cortex and thereby eliminates the alpha waves, nevertheless does not block delta waves in the cortex. Therefore, delta waves can occur strictly in the cortex independent of activities in lower regions of the brain.

I IMPORTANT**Alpha block (also called arousal response/alerting response/desynchronization)**

The alpha rhythm can be made to disappear by focused attention, by mental concentration and by sensory stimulation. This is known as alpha block. Or, we can say, when the awake person's attention is directed to some specific type of mental activity, the alpha waves are replaced by asynchronous, higher-frequency but lower-voltage beta waves.

I IMPORTANT

The frequency of the alpha rhythm is decreased by:

- ❖ Low blood glucose
- ❖ Low body temperature
- ❖ Low levels of glucocorticoid hormones
- ❖ High PaCO₂
- ❖ Hyponatremia
- ❖ Vitamin B12 deficiency
- ❖ Acute intoxication with alcohol, amphetamines, barbiturates, phenytoin, and antipsychotics.

Contd...

Wave in EEG	Features
Beta rhythm	<ul style="list-style-type: none"> • Frequency: Greater than 13 Hz, common 18-25 Hz, less common 14-16 Hz, and rare 35-40 Hz • Location: Mostly fronto-central but somewhat variable. • Amplitude: Usually range 5-20 μv. Can be mildly different (<35%) in amplitude between the two hemispheres, which may be caused by differences in skull thickness. • Morphology: Usually rhythmic, waxing and waning, and symmetric. • Reactivity: Awake person with eyes open and alert.
Theta rhythm	<ul style="list-style-type: none"> • Frequency: 4 to 8 Hz • Location: Parietal and temporal regions in children. They also occur during emotional stress in some adults, particularly during disappointment and frustration • Theta waves also occur in many brain disorders, often in degenerative brain states.
Delta waves	<ul style="list-style-type: none"> • Frequencies less than 3.5 Hz • Voltagess two to four times greater than most other types of brain waves. • They occur in very deep sleep, in infancy, and in serious organic brain disease. • Delta waves also occur during deep slow-wave sleep
Gamma rhythm	<ul style="list-style-type: none"> • Frequency at 30-80 Hz • Seen when an individual is aroused and focuses attention on some-thing, this causes 'binding' in neurons.
Mu Rhythm	<ul style="list-style-type: none"> • Normal rhythm with an amplitude similar to alpha rhythm: with a frequency 7-11 Hz. Mu rhythm attenuates with contralateral extremity movement, the thought of a movement.
Lambda rhythm	<ul style="list-style-type: none"> • Lambda activity is found in the occipital regions in the normal waking EEG. • Lambda, which occurs in 65% of the population, is normal and appears to represent an evoked response to visual stimuli produced by the rapid shifts of images across the retina.
Breach rhythm	<p>Breach wave is a sharply focal 6-11 Hz pattern associated with a defect in the skull, resulting from surgery or an accident. This rhythm is of higher amplitude than alpha rhythm (generally exceeding 80 μ volts)</p>

SLEEP**Two Types of Sleep: NREM and REM**

Over the course of a period of sleep, NREM and REM sleep alternate cyclically. The function of alternations between these two types of sleep is not yet understood, but irregular cycling and/or absent sleep stages are associated with sleep disorders. For example, instead of entering sleep through NREM, as is typical, individuals with narcolepsy enter sleep directly into REM sleep.

I IMPORTANT

Polysomnography is the study of sleep.

Polysomnographic recordings consist of:

- ❖ EEG (Electroencephalography)
- ❖ EMG (Electromyography)
- ❖ EOG (Electrooculography)

Differences between Two Types of Sleep

Physiological process	NREM (Slow wave sleep)	REM (paradoxical sleep)
Time spent	75–80% of total sleep duration	20–25% of total sleep duration
Brain activity	Decreases from wakefulness	Increases in motor and sensory areas, while other areas are similar to NREM
Heart rate, BP, Blood flow to brain, respiration	Decreases from wakefulness	Increases and varies compared to NREM
Sympathetic nerve activity	Decreases from wakefulness	Increases significantly from wakefulness
Muscle tone	Similar to wakefulness	Absent in all muscle except facial and extra-ocular muscles.
Body temperature	Is regulated at lower set point than wakefulness; shivering initiated at lower temperature than during wakefulness	Is not regulated; no shivering or sweating; temperature drifts toward that of the local environment
Sexual arousal	Occurs infrequently	Greater than NREM
EEG	Depending on the stages of sleep (given below)	Rapid, low-voltage beta like EEG activity, which resembles that seen in the awake (paradoxical sleep).

Contd...

I IMPORTANT

- Sleep spindles (sigma waves):
- ❖ Indicate the onset of stage II sleep
 - ❖ The defining features of stage II sleep
 - ❖ First appear at 6 to 8-week infant

Contd...

Physiological process	NREM (Slow wave sleep)	REM (paradoxical sleep)
EEG		P-G-O (ponto-geniculo-occipital) spikes (cholinergic) is seen.
Dreams	Non-recallable dream	Recallable dream (so called dream)

Stages of NREM Sleep

Recent stage	Old stage	% of total sleep duration	Features
N1	Stage 1	2-5%	Low amplitude, high frequency EEG activity
N2	Stage 2	45-55%	Sleep spindles (alpha-like 10-14/sec, 50 μv amplitude), K complexes
N3	Stage 3	10-15%	Low frequency, increased amplitude
	Stage 4		Maximum slowing (least frequency), large waves (rhythmic slow waves, synchronized)

Typical EEG Recording of Different NREM Stages (Fig. 14.1)

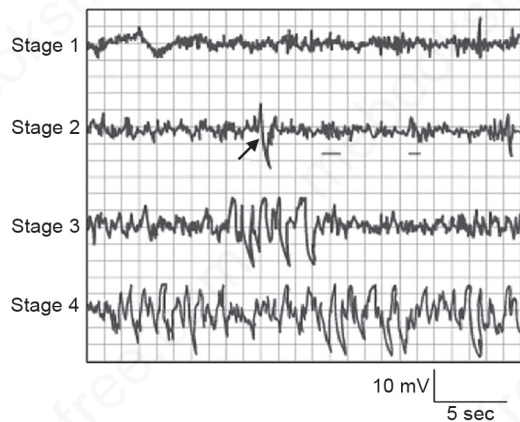

Fig. 14.1: EEG in NREM sleep. K-complex has been shown by an arrow

I IMPORTANT

- ❖ Total sleep time decreases with age
- ❖ Percentage of stage-4 (NREM) decreases with age.
- ❖ Percentage of REM increases towards morning.
- ❖ Percentage of stage-4 (NREM) decreases towards morning.
 - All the stages of sleep are reversible except the stage from REM to awake state

Genesis of Sleep

Model of sleep (Fig. 14.2): wakefulness and REM sleep are at opposite extremes. Balance between different neurotransmitter produces sleep-wakefulness.

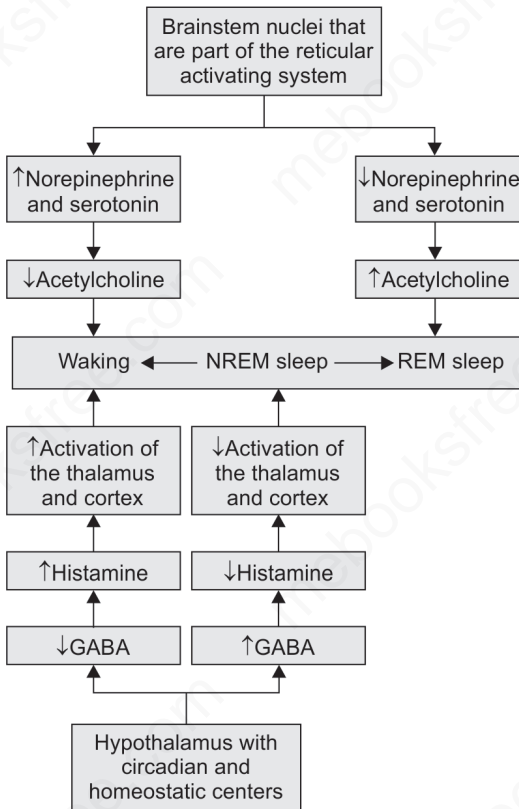

Fig. 14.2: A model of how alternating activity of brainstem and hypothalamic neurons may influence the different states of consciousness.

Awake state: Increase activity of norepinephrine- and serotonin-containing neurons (locus ceruleus and raphe nuclei) and reduced level of activity in acetylcholine-containing neurons (pontine reticular formation). Reduced GABA release and increase histamine release is also there.

REM state: The reverse of the above pattern leads to REM sleep.

NREM sleep: Increased release of GABA and reduced release of histamine increases NREM sleep. Also more balance in the activity of the aminergic and cholinergic neurons.

Metabolite homeostatic theory (Fig. 14.3): According to this theory:

I IMPORTANT

Percentage of REM out of total sleeping time

- ❖ Premature infants = 80%
- ❖ Full-term neonates = 50%
- ❖ 20-65 years = 25%
- ❖ After 65 years, it decrease (in elderly = 15%)

I IMPORTANT

- ❖ **Serotonin: Old concept**— necessary to obtain and maintain behavioral sleep (permissive role on sleep).
- ❖ **Serotonin: Recent concept**— suggests that during waking serotonin may complement the action of noradrenaline and acetylcholine in promoting cortical responsiveness and participate to the inhibition of REM-sleep effector neurons in the brainstem (*inhibitory role on REM sleep*).

I IMPORTANT

Cortical ach: Greatest during REM sleep >> waking and reduced during non-REM (NREM) sleep.

I IMPORTANT

- ❖ Sleep wake cycle follows a circadian pattern. Normally the cycle is synchronized to the 24 hrs period of the environmental light-dark cycle through direct input from intrinsically photosensitive ganglion cells in the retina to the SCN.
- ❖ Bilateral destruction of SCN results in loss of most of the endogenous rhythm including this sleep wake cycle, which becomes an averages 24.15 less in humans.
—(Harrison's Principles of Internal Medicine 19th Edn. Pp184)

- ❑ Accumulation of metabolites in cerebral cortex, stimulates the GABAergic neurons in basal forebrain.
- ❑ GABAergic neurons in turn stimulates ventrolateral preoptic area, sleep promoting areas of hypothalamus

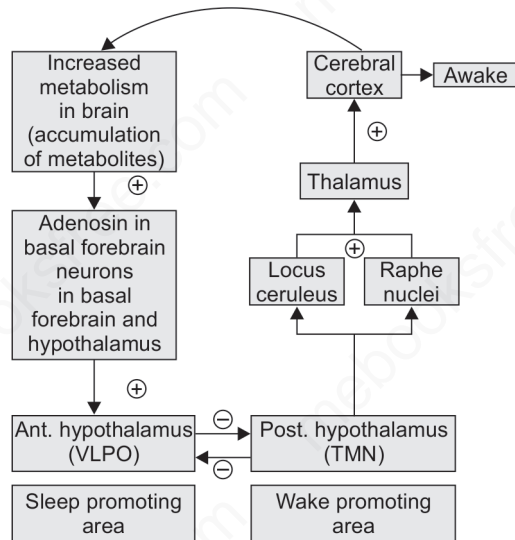

Fig. 14. 3: Metabolite homeostatic theory of sleep

I IMPORTANT

- ❖ **Sleep terrors:** This disorder occurs primarily in young children during the first few hours of sleep during NREM stage N3 sleep. The child often sits up during sleep and screams, **exhibiting autonomic arousal with sweating, tachycardia, large pupils**, and hyperventilation. The individual may be difficult to arouse and rarely recalls the episode on awakening in the morning.
- ❖ **Nightmare** is an unpleasant dream that can cause a strong emotional response from the mind, typically fear but also despair, anxiety and great sadness.

Sleep Disorder

NREM sleep disorder	
Sleepwalking (somnambulism)	Stage III and IV (stage N3) can occur during REM sleep also.
Somniloquy (sleep talking)	Stages I and II mainly but can possible in all.
Bruxism	Stages I and II mainly (stage II > I). May be in REM and stage III and IV
Nocturnal enuresis	All stages of NREM and REM <i>except</i> stage I (max during stage II)
Night terrors	Transition from stage III to stage IV (Stage N3)
REM sleep disorder	
Narcolepsy	REM sleep
Nightmare	REM sleep

LEARNING AND MEMORY

Learning is acquisition of the information that makes this possible and **memory** is the retention and storage of

that information. The two are obviously closely related and should be considered together.

Types of Memory (Flowcharts 14.1A and B)

Two major types:

- ❑ Implicit or, non-declarative memory:
 - Does not require conscious or, awareness
 - Does not usually involve hippocampus.
 - Example remembering how to brush your teeth
- ❑ Explicit or, Declarative memory: Memory of words, rules, and language
 - Associated with consciousness or, at least awareness
 - Dependent on the hippocampus
 - Example recalling first day in college

Implicit memory is subdivided into four types:

- ❑ Procedural memory includes skills and habits, which, once acquired, become unconscious and automatic.
- ❑ Priming is facilitation of recognition of words or objects by prior exposure to them. An example is improved recall of a word when presented with the first few letters of it (Name a fruit with GR... GRAPE).
- ❑ Associative learning is related to classical and operant conditioning in which the organism learns about the relation of one stimulus to another (check below).
- ❑ Non-associative learning includes habituation and sensitization and is dependent on various reflex pathways. Here the organism learns about a single stimulus.

The different parts of brain areas involved in processing and formation of implicit memory is given in Flowchart 14.1A.

Explicit memory is sub-divided into two types:

- ❑ Episodic memory for events
- ❑ Semantic memory for facts (e.g. words, rules, and language).

The different parts of brain areas involved in processing and formation of Implicit memory is given in Flowchart 14.1A.

I IMPORTANT

Memory storage

❖ Although the hippocampus stores spatial memories and the amygdala fear memories, the repository for most memories in the mammalian brain is thought to be **neocortex**.

Flowcharts 14.1A and B: Parts of brain areas involved in processing and formation of Implicit and explicit memory

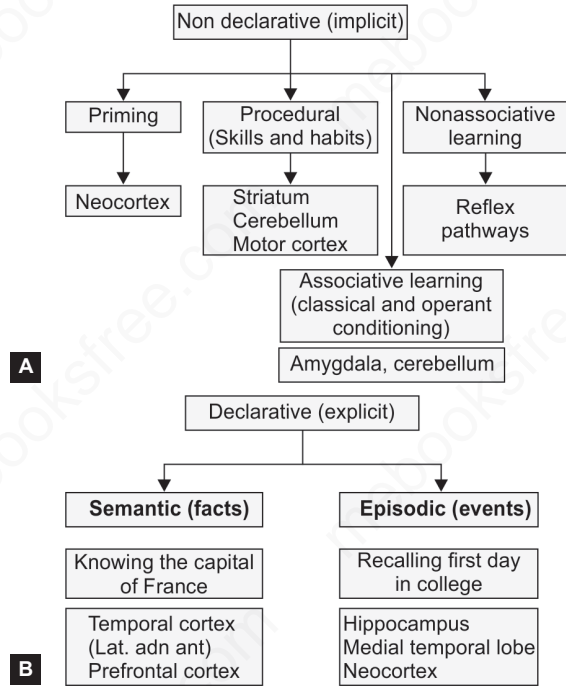

Classical Conditioning (Pavlov's Classic Experiments)

Pavlov's experiment on dog is the shows the typical classical conditioning in which the organism learns about the relation of one stimulus to another (bell and meat).

Look Figure 14.4 and Flowchart 14.2 carefully to understand the experiment.

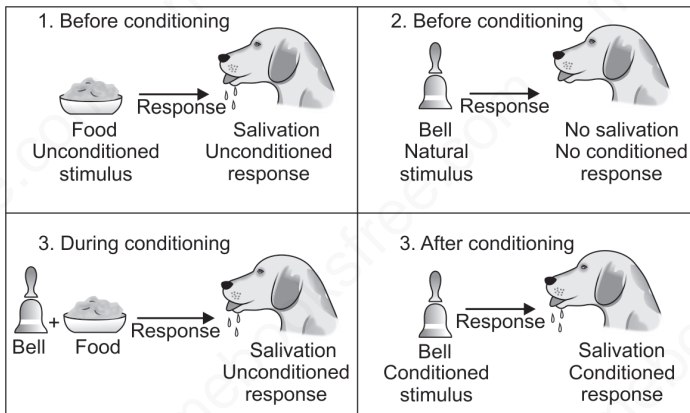

Fig. 14.4: Classical conditioning. Dog learn to salivate in response to bell but only when two stimuli (bell and meat) are given repeatedly and when bell precedes the meat

Flowchart 14.2: Result of Pavlov's experiment

Before conditioning	
Unconditioned stimulus (US): Meat	Salivation (innate response)
Neutral stimulus (NS): Bell	No salivation
During conditioning (repeated pairing)	
Bell (NS) + US (meat)	Salivation
After conditioning	
Bell: NS becomes condition stimulus (CS)	Salivation

Operant Conditioning

- ❑ Also called trial-and-error learning.
- ❑ Discovered by Edgar Thorndike and systematically studied by B.F. Skinner.
- ❑ Here the organism learns the relationship between an action and an outcome (behavior).

Explicit Memory and Many Forms of Implicit Memory Involve

1. **Working memory (recent memory):** It is a form of short-term memory that keeps information available, usually for very short periods, while the individual plans action based on it. Capacity is 7 ± 2 'chunks' of informations and duration of storage is 18–20 secs only.
2. **Short-term memory:** Which lasts seconds to hours, during which processing in the *hippocampus* and elsewhere lays down long-term changes in synaptic strength.
3. **Long-term memory:** Which stores memories for years and sometimes for life. During short-term memory, the memory traces are subject to disruption by trauma and various drugs, whereas long-term memory traces are remarkably resistant to disruption.

Neural Basis of Memory

The key to memory is alteration in the strength of selected synaptic connections. There is no 'memory cell' in the brain.

- ❑ Synaptic change can be in the form of:
 1. Post-tetanic potentiation
 2. Habituation
 3. Sensitization
 4. Long-term potentiation (LTP)
 5. Long-term depression (LTD)

I IMPORTANT

Mechanisms of:

- ❖ **Short-term memory:** a temporary memory trace in a circuit of reverberating neurons. Another possible explanation of short-term memory is presynaptic facilitation or inhibition.
- ❖ **Long-term memory:** actual structural changes, at the synapses, and these enhance or suppress signal conduction. The changes are:
 - Increase in vesicle release sites for secretion of transmitter substance.
 - Increase in number of transmitter vesicles released.
 - Increase in number of presynaptic terminals.
 - Changes in structures of the dendritic spines that permit transmission of stronger signals.
- ❖ **Short-term memory to long-term memory conversion occurs in hippocampus.**

1. **Postsynaptic potentials:** Occurs after a brief (tetanizing) train of stimuli in the presynaptic neuron. The tetanizing stimulation causes Ca^{2+} to accumulate in the presynaptic neuron to such a degree that the intracellular binding sites that keep cytoplasmic Ca^{2+} low are overwhelmed. This enhancement lasts up to 60 seconds.
2. **Habituation:** It is a simple form of learning in which a neutral stimulus is repeated many times. The first time it is applied and it is novel, and evokes a reaction (the orienting reflex or “what is it?” response). However, it evokes less and less electrical response as it is repeated. Eventually, the subject becomes habituated to the stimulus and ignores it. This is associated with decreased release of neurotransmitter from the presynaptic terminal because of decreased intracellular Ca^{2+} .
3. **Sensitization:** is in a sense the opposite of habituation.
4. **Long-term potentiation (LTP):** It is a rapidly developing persistent enhancement of the postsynaptic potential response to presynaptic stimulation after a brief period of rapidly repeated stimulation of the presynaptic neuron.
5. **LTD:** It is the opposite of LTP.

Details of Long-term Potentiation (LTP)

Mechanism of short-term to long memory formation.

- ❑ In hippocampus, the cell bodies of the pyramidal neurons lie in a single densely packed layer. This layer is divided into several distinct regions, the major ones being CA1 and CA3. “CA” refers to Cornu Ammon, a Latin name for Ammon’s horn—the ram’s horn that resembles the shape of the hippocampus.
- ❑ The dendrites of pyramidal cells in the CA1 region form a thick band (the stratum radiatum), where they receive synapses from Schaffer collaterals, the axons of pyramidal cells in the CA3 region (Fig. 14.5).
- ❑ Much of the work on LTP has focused on the synaptic connections between the Schaffer collaterals and CA1 pyramidal cells. Electrical stimulation of Schaffer collaterals generates excitatory postsynaptic potentials (EPSPs) in the postsynaptic CA1 cells.

- ❑ If the Schaffer collaterals are stimulated only two or three times per minute, the size of the evoked EPSP in the CA1 neurons remains constant. However, a brief, high-frequency train of stimuli to the same axons causes LTP, which is evident as a long-lasting increase in EPSP amplitude.
- ❑ *LTP also occurs at many other synapses, both within the hippocampus and in a variety of other brain regions, including the cortex, amygdala, and cerebellum.*

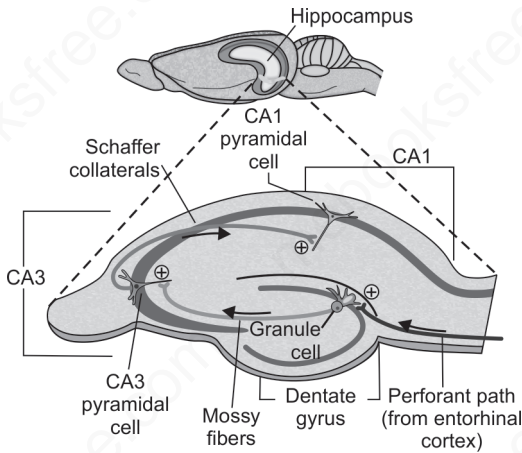

Fig. 14.5: LTP in Hippocampal (Rat brain)

Mechanism of LTP

- ❑ Long-term potentiation (LTP) is a rapidly developing persistent enhancement of the postsynaptic potential response to presynaptic stimulation after a brief period of rapidly repeated stimulation of the presynaptic neuron.
- ❑ Unlike post-tetanic potentiation, it is initiated by an increase in intracellular Ca^{2+} in the postsynaptic rather than the presynaptic neuron.
- ❑ There are two forms in the hippocampus: Mossy fiber LTP, which is presynaptic and independent of N-methyl-D-aspartate (NMDA) receptors; and Schaffer collateral LTP, which is postsynaptic and NMDA receptor-dependent.
- ❑ The basis of mossy fiber LTP is unsettled, although it appears to include cAMP and I_h , a hyperpolarization-activated cation channel.

I IMPORTANT

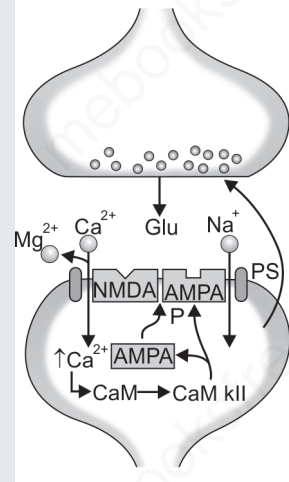

Fig. 14.6: Mechanism of LTP

- ❑ Glutamate (Glu) released from the presynaptic neuron binds to AMPA and NMDA receptors in the membrane of the postsynaptic neuron (Fig. 14.6).
- ❑ The depolarization triggered by activation of the AMPA receptors relieves the Mg^{2+} block in the NMDA receptor channel, and Ca^{2+} enters the neuron with Na^+ . The increase in cytoplasmic Ca^{2+} activates calmodulin (CaM), which in turn activates Ca^{2+} /calmodulin kinase II (CaM kII).
- ❑ The kinase phosphorylates the AMPA receptors (P), increasing their conductance, and moves more AMPA receptors into the synaptic cell membrane from cytoplasmic storage sites.

SPECIAL SENSES: VISION

The eye consists of three layers. The function of the three layers:

1. Sclera: Protective
2. Uvea: Vascular (nutritive)
3. Retina: Light-sensitive neural layer

The retina lines the post 2/3rd of the choroids.

- ❑ Contains visual receptors (rods and cones)
- ❑ **Macula lutea:** Yellowish spot in retina near posterior pole of eye.
- ❑ **Fovea centralis:** Center of macula lutea; produces sharpest vision (rod-free portion of the retina)
- ❑ **Optic disk:** optic nerve leaves the eye and the retinal blood vessels enter it. No visual receptors (blind spot).

Neuronal Arrangement in Retina (Fig. 14.7)

- ❑ **Receptor cells:** Rods and cones
- ❑ **Bipolar cells:** Provide pathway for impulses from photoreceptors to ganglionic cells.
- ❑ **Ganglion cells:** The axons of ganglion cells converge and form the optic nerve.
- ❑ Horizontal cells connect receptor cells to the other receptor cells in the outer plexiform layer.
- ❑ Amacrine cells connect ganglion cells to one another in the inner plexiform layer via processes of varying length and patterns.
- ❑ **Horizontal cells and amacrine cells:** Modify impulses.

Features of the photoreceptors (Fig. 14.8): Each rod and cone is divided into an outer segment, an inner segment with a nuclear region, and a synaptic zone. The saccules and disks in the outer segment contain photosensitive compounds (photo pigment, e.g. Rhodopsin), those react to light to initiate action potentials in the visual pathways.

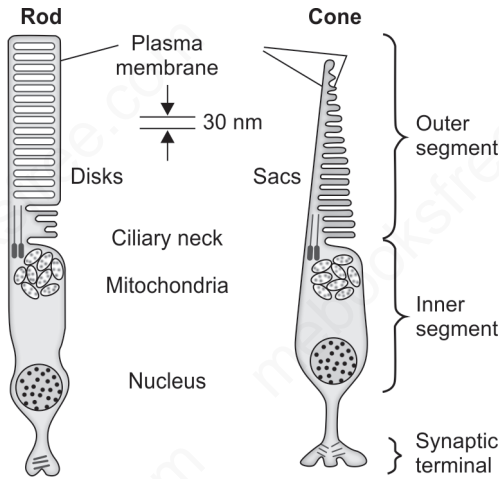

Fig. 14.8: Schematic diagram of a rod and a cone

There are certain functional differences between rod and cone photoreceptors. They are:

Rods	Cones
<ul style="list-style-type: none"> • High sensitivity, specialized for night vision • High amplification • Low acuity • Low temporal resolution • Slow response, long integration time • More sensitive to scattered light 	<ul style="list-style-type: none"> • Lower sensitivity, specialized for day vision • Less amplification • High acuity • High temporal resolution • Fast response, short integration time • Less sensitive to scattered light

IONIC BASIS OF PHOTORECEPTOR POTENTIALS (PHOTOTRANSDUCTION)

- Na^+ channels in the outer segments of the rods and cones are open in the dark, so current flows from the inner to the outer segment. This is known as 'dark current'.

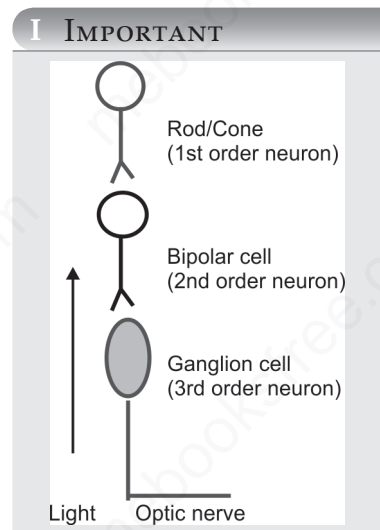

Fig. 14.7: Basic circuit in retina

- ❑ Current also flows to the synaptic ending of the photoreceptor. The $\text{Na}^+ - \text{K}^+$ pump in the inner segment maintains ionic equilibrium.
- ❑ Release of synaptic *transmitter (glutamate)* is steady in the dark.

When light strikes the outer segment, rhodopsin (11-cis-retinal + opsin) dissociates into all trans retinal and opsin separates out. Separated opsin produces some reactions inside receptors cell (Fig. 14.9) which ultimately leads to close some of the Na^+ channels, and the result is a *hyperpolarizing receptor potential*. The hyperpolarization reduces the release of synaptic transmitter, and this generates a signal in the bipolar cells that ultimately leads to *action potentials in ganglion cells*. The action potentials are transmitted to the brain.

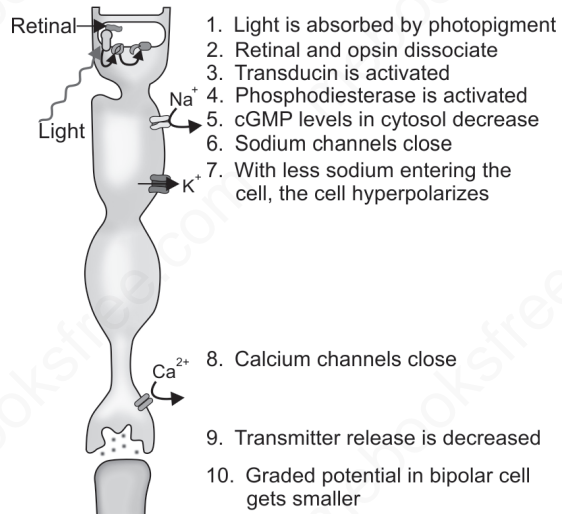

Fig. 14.9: Phototransduction mechanisms. Mechanisms of phototransduction have been numbered sequentially

I IMPORTANT

- ❖ Receptor potential is hyperpolarizing type (exception) in rods and cones rather than depolarizing type.
- ❖ Action potential is generated in ganglion cells of retina only. Other cells (bipolar, horizontal cells and amacrine) produce local potential.

Color Vision

Two complementary theories of color vision are:

1. **Trichromatic theory:** Young and Helmholtz
2. **Opponent process theory:** Ewald Hering

Trichromatic theory: According to this theory, three types of cones are preferentially sensitive to blue, green, and red:

1. S (short wavelength) cone: Peak wave length 420–440 nm

2. M (medium wavelength) cone: Peak wave length 534–555 nm
3. L (long wavelength) cone: Peak wave length 564–580 nm

Overall balance of activity in S, M, and L cones determines our perception of colour.

Opponent process theory: According to this theory, visual system interprets color in an antagonistic way: red vs green, blue vs yellow, black vs white. Activation of one member of this pair inhibits the activity in the other.

SPECIAL SENSES: OLFACTION (SMELL)

- ❑ Olfactory epithelium in humans covers an area of 10 cm² in the roof of the nasal cavity near the septum.
- ❑ The human olfactory epithelium contains 50 million *bipolar olfactory sensory neurons* interspersed with glia-like supporting (sustentacular) cells and basal stem cells.
- ❑ The olfactory epithelium is said to be the place in the body where the nervous system is closest to the external world.
- ❑ Each olfactory neuron has a short, thick dendrite that projects into the nasal cavity where it terminates in a knob containing 6–12 cilia.
- ❑ The cilia contains specific receptors for odorants (odorant receptors).
- ❑ The axons of the olfactory sensory neurons pass through the cribriform plate of the ethmoid bone and enter the olfactory bulbs.
- ❑ In the olfactory bulbs, the axons of the olfactory sensory neurons (*first order nerve*) contact the primary dendrites of the **mitral cells** and **tufted cells** (Fig. 14.10) to form anatomically discrete synaptic units called **olfactory glomeruli**.
- ❑ These mitral cells and tufted cells (**second order neurons**) **directly** project to the olfactory cortex without any relay to thalamus (exception).

I IMPORTANT

Colour Blindness:

- ❖ **Trichromats:** Normal person with three cones is trichromat. Weakness of one of the cones leads to:
 - *Red* cones weak: *Protanomaly*
 - *Green* cones weak: *Deuteranomaly*
 - *Blue* cones weak: *Tritanomaly*
- ❖ **Dichromats:** Have only two functional types of cones. Absent of:
 - *Red* cones: *Protanopia*
 - *Green* cones weak: *Deuteranopia*
 - *Blue* cones weak: *Tritanopia*

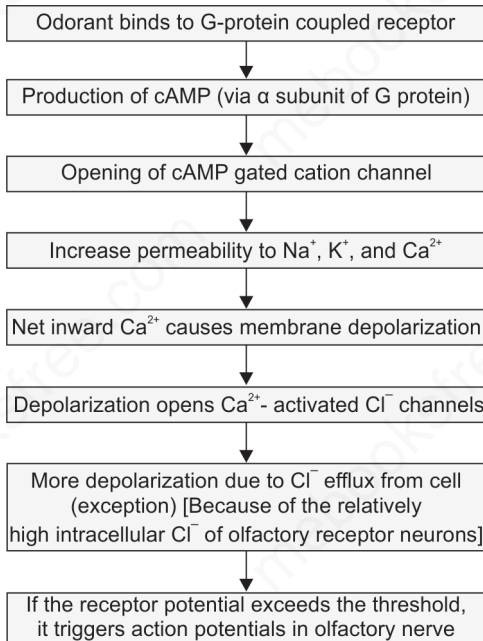
Flowchart 14.3: Signal transduction in an odorant receptor**I IMPORTANT**

- ❖ Odorant binds to a specific olfactory receptor protein in the cilium of an olfactory receptor cell (bipolar cell).
- ❖ Olfactory transmission to cerebral cortex requires only two neurons because the second order neurons (Mitral/ Tufted cell) directly project to the olfactory cortex without any relay to thalamus (exception).
- ❖ Ca^{2+} is the main ion for receptor depolarization in olfaction.

SPECIAL SENSES: GUSTATION (TASTE)**Taste Buds (Fig. 14.11)**

- ❑ The specialized sense organ for taste (gustation) consists of ~10,000 taste buds, which are ovoid bodies measuring 50 to 70 μm .
- ❑ There are four morphologically distinct types of cells within each taste bud: basal cells, dark cells (type I taste cells), light cells (type II taste cells), and intermediate cells (type III taste cells).
- ❑ The apical ends of taste cells have microvilli that project into the taste pore, a small opening on the dorsal surface of the tongue where taste cells are exposed to the oral contents.

Basic Taste Modalities

- ❑ Humans have five established basic tastes: sweet, sour, bitter, salt, and umami.
- ❑ It is used to be thought that the surface of the tongue had special areas for each of the first four of these sensations, but it is now clear that all tastants are sensed from all parts of the tongue and adjacent structures.

I IMPORTANT

- In humans, the taste buds are located in the mucosa of the epiglottis, palate, and pharynx in the walls of papillae of the tongue.
- ❖ Fungiform papillae are most numerous near the tip of the tongue
 - ❖ Circumvallate papillae are prominent structures arranged in a V on the back of the tongue
 - ❖ Foliate papillae are on the posterior edge of the tongue.
 - ❖ Each fungiform papilla has up to 5 taste buds, while each vallate and foliate papilla contain up to 100 taste buds.

I IMPORTANT

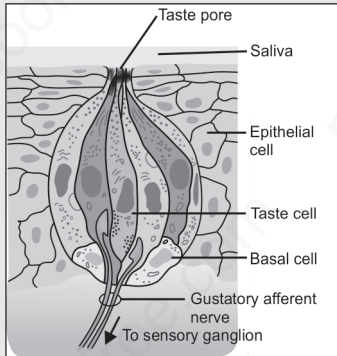

Fig. 14.11: Structure of a taste bud

- ❑ Afferent nerves to the NTS contain fibers from all types of taste receptors, without any clear localization of types.
- ❑ The fifth taste sense, umami, was recently added to the four classic tastes. It is triggered by glutamate and particularly by the monosodium glutamate (MSG) used so extensively in Asian cooking. The taste is pleasant and sweet but differs from the standard sweet taste.

Receptors for five basic tastes

The receptors for the five modalities of taste are two major types:

1. Ligand-gated channels (ionotropic receptors): Salt and sour tastes
2. GPCRs (metabotropic receptors): Sweet, bitter and umami taste

Salt-sensitive taste: Mediated by a Na^+ -selective channel (ENaC).

Sour taste: Mediated by H^+ ions permeable to ENaCs.

Other 3 primary tastes are G protein coupled receptors. They are:

- **Umami taste:** Mediated by glutamate acting on a metabotropic glutamate receptor.
- **Bitter taste:** Mediated by the T2R family of G protein-coupled receptors.
- **Sweet taste:** It may be dependent on the T1R3 family of G protein-coupled receptors which couple to the G protein gustducin.

SPECIAL SENSES: HEARING

Organ of Corti

- ❑ Located on upper surface of basilar membrane of inner ear (inside endolymph).
- ❑ The structure contains group of hearing receptor cells (hair cells)
- ❑ The hair cells are arranged in four rows:
 - Three rows of **outer hair cells: modulation of sound.**
 - One row of **inner hair cells: transducers of sound.**
- ❑ There are 20,000 outer hair cells and 3,500 inner hair cells in each human cochlea.

Electrical Response Generation in Hair Cell

- ❑ The resting membrane potential of the hair cells is about -60 mV (compared to perilymph) and -150 mV in comparison to endolymph.
- ❑ When the shorter stereocilia are pushed toward the longest cilia, the tip links (Fig. 14.12) are stretched.
- ❑ The tip links tie the tip of each stereocilium to the side of its higher neighbor, and at the junction are cation channels in the higher process that appear to be mechanically sensitive.
- ❑ So, stretching of tip links opens the mechanosensitive cation channels.
- ❑ K^+ (most abundant cation in endolymph) and Ca^{2+} enter via the channel and produce depolarization (the membrane potential is decreased to about -50 mV).
- ❑ Depolarization of hair cells causes them to release a neurotransmitter, probably glutamate, which initiates depolarization of neighboring afferent neurons.

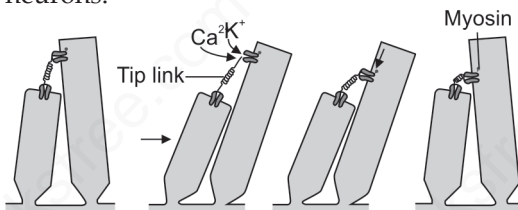

Fig. 14.12: Schematic representation of the role of tip links in the responses of hair cells. The cation channel moved down by a molecular motor (myosin)

I IMPORTANT

An electrical potential of about $+80$ millivolts exists all the time between endolymph and perilymph, with positivity inside the scala media and negativity outside. This is called the **endocochlear potential**, and it is generated by continual secretion of positive potassium ions into the scala media by the stria vascularis.

MULTIPLE CHOICE QUESTIONS

EEG, SLEEP AND MEMORY

RECENT MCQs

1. What are the EEG waves recorded for parieto-occipital region with subject awake and eye closed?

- a. Alpha waves
- b. Beta waves
- c. Delta waves
- d. Theta waves

2. Alpha rhythm on EEG seen in:

- a. Awake state
- b. Mental work
- c. Light sleep
- d. Deep sleep

3. Bruxism occurs in which phase of sleep?

- a. NREM 2
- b. NREM 3
- c. REM sleep
- d. NREM 4

4. Associative learning:

- a. Associated with consciousness
- b. Includes skills and habits
- c. Relation of one stimulus to another
- d. Facilitation of recognition of words

5. Pavlov's experiment on dogs shows:

- a. Conditional response
- b. Unconditioned response
- c. Procedural memory
- d. Familiarity

6. Salivation of a dog when food is given along with bell is?

- a. Conditioned reflex
- b. Reinforcement

- c. Habituation
- d. Innate reflex

7. Striatum damage affects priming:

- a. Procedural memory
- b. Short-term memory
- c. Long-term memory
- d. Explicit memory

8. Vomiting centre is situated in the:

- a. Hypothalamus
- b. Amygdala
- c. Pons
- d. Medulla

9. Vomiting centre:

- a. Area postrema
- b. Suprachiasmatic
- c. Medial nuclei
- d. Lateral nuclei

AIIMS/PGI/JIPMER

10. Human brain is more intelligent than monkey's brain due to: [PGI June 03]

- a. Larger brain
- b. Increased convolutions
- c. Increased brain area compared to body surface area
- d. More blood supply

11. Neurophysiological defects present in right lobe involvement all, except:

[AIIMS May 09]

- a. Visuo spatial defect
- b. Anosognosia
- c. Dyscalculia
- d. Dysgraphia

12. Left lobe of brain is mainly responsible for: [AIIMS May 12]

- a. Special recognition
- b. Written and spoken language
- c. Agnosia
- d. Music perception

13. Buerger waves (alpha waves) of EEG have the rhythm per sec of: [PGI 04]

- a. 0-4
- b. 4-7
- c. 8-13
- d. 13-30

14. Key regulators of sleep are located in: [AI 09]

- a. Hypothalamus
- b. Thalamus
- c. Putamen
- d. Limbic cortex

15. Alpha-wave in EEG is seen in: [PGI 96]

- a. Sleep
- b. REM sleep
- c. Awake state
- d. Mental work

16. Alpha-rhythm is seen in: [PGI 97]

- a. Sleep with eyes closed with mind wandering
- b. Mental activity
- c. Awake with eyes open
- d. REM sleep

17. Delta waves are seen in:

- a. Deep sleep [AI 07, AIIMS May 14]
- b. REM sleep
- c. Awake state
- d. Stage I NREM sleep

18. EEG rhythm recorded from the surface of the scalp during REM sleep:

- a. Alpha
- b. Beta [AIIMS 96]
- c. Delta
- d. Theta

19. Sleep waves in hippocampal area is: [AI 98]

- a. Delta waves
- b. Theta waves
- c. Beta waves
- d. Alpha waves

20. Beta waveforms in electroencephalogram designate which of the following states of the patient:

- a. Deep anaesthesia [AIIMS Nov 05]
- b. Surgical anaesthesia
- c. Light anaesthesia, eyes closed, relaxed
- d. Awake/alert state

21. Nightmare is seen in: [AI 00]

- a. REM sleep
- b. Stage II NREM sleep
- c. Stage IV NREM sleep
- d. Stage I NREM sleep

22. Which one of the following phenomena is closely associated with slow wave sleep?

- a. Dreaming
- b. Atonia
- c. Sleep walking
- d. Irregular heart rate

23. Slow wave sleep associated with: [PGI Dec 06]

- a. Dreams
- b. Cardiac arrhythmia
- c. Penile tumescence
- d. Delta activity

24. The normal adult human electroencephalogram (EEG):

- a. Will not show high frequency waves during stage 3 sleep
- b. Shows alpha rhythm when a person is awake but inattentive
- c. Has lower frequency waves during mental activity
- d. Is predominated by large amplitude waves during REM sleep

25. The processing of short-term memory to long-term memory is done in:

- a. Prefrontal cortex [AI 07]
- b. Hippocampus
- c. Neocortex
- d. Amygdala

26. Events occurring in the past one week is an example of: [AIIMS Nov 09]

- a. Recent memory
- b. Remote memory
- c. Working memory
- d. Delayed memory

SPECIAL SENSES

RECENT MCQs

27. Bitter taste is mediated by action of:

- a. Guanylyl cyclase
- b. G protein
- c. Tyrosine kinase
- d. Epithelial Na⁺ chain

28. The receptors/buds responsible for carrying bitter taste sensation are situated:

- a. At the tip of the tongue
- b. Just behind the tip
- c. At the sides
- d. At the posterior aspect

29. Photoreceptors on exposure to dark release:

- a. Acetylcholine
- b. Glutamate
- c. Adrenaline
- d. Epinephrine

30. Which are first order neuron in optic pathway?

- a. Bipolar cells
- b. Ganglionic cells
- c. Cells of lateral geniculate body
- d. Astrocytes

31. Second order neuron:

- a. ON (optic nerve)
- b. MGB

- c. LGB
- d. Layer of retina

32. Ganglion cell—order of neuron:

- a. 1st
- b. 2nd
- c. 3rd
- d. 4th

33. Transducin is required for:

- a. Small
- b. Hearing
- c. Small
- d. Vision

34. The rod receptor potential differs from other sensory receptors in that it shows:

- a. Depolarization
- b. Decreased negativity
- c. Increased conductance of sodium
- d. Hyperpolarization

35. The blobs of the visual cortex are associated with:

- a. Ocular dominance
- b. Orientation
- c. Color processing
- d. Saccadic eye movements

36. Amacrine cells secrete:

- a. Acetylcholine
- b. Glutamate
- c. Adrenaline
- d. Noradrenaline

AIIMS/PGI/JIPMER**37. Rods and cones differ in all except:***[AIIMS May 09]*

- a. Signal transduction
- b. Light sensitivity
- c. Wavelength
- d. Acuity

38. Initiation of visual impulse is associated with:*[AI 09]*

- a. Condensation of opsin with vitamin A aldehyde
- b. Photoisomerization and hydrolysis of visual purple
- c. NADP
- d. NAD

39. During the dark phase of visual cycle, which form of vitamin A combines with opsin to make Rhodopsin:*[AIIMS Nov 04]*

- a. All trans-retinaldehyde
- b. All trans-retinol
- c. 11-cis-retinaldehyde
- d. 11-cis-retinol

40. Relative color and luminosity of photoreceptive input under changing light conditions are regulated and maintained by:*[AIIMS 03]*

- a. Muller cells
- b. Amacrine cells
- c. Ganglion cells
- d. Retinal astrocytes

41. The only neurons in retina showing action potential are:*[PGI May 04]*

- a. Rods and cones
- b. Bipolar cells

- c. Amacrine cells
- d. Ganglion cells
- e. Color vision

42. Visible range of electromagnetic spectrum of human eye:*[PGI June 04]*

- a. 370-740 nm
- b. 740-1140 nm
- c. 200-370 nm
- d. 370-570 nm
- e. 370-770 nm

43. For color vision, which is true?*[AIIMS May 09]*

- a. Independent of wavelength of light
- b. Depends on intensity discrimination
- c. Involves opponent color cells
- d. Minimum at fixation point

44. Protonopes have defect in identifying red color:*[AIIMS May 02]*

- a. Red
- b. Blue
- c. Green
- d. Black

45. Any spectral color can be matched by a mixture of three monochromatic lights (red, green, blue) in different proportions. If a person needs more of one of the color for matching than a normal person, then he has a color anomaly. More red color is needed in the case of:*[AI 02]*

- a. Deuteranomaly
- b. Tritanomaly
- c. Protanomaly
- d. Tritanopia

FUTURE TRENDS

46. Olfactory receptor cells belong to which of the following groups of cells?
- Bipolar neurons
 - Modified epithelial cells
 - Multipolar neurons
 - Pseudounipolar neurons
47. Visual contrast is enhanced due to lateral inhibition by which retinal cells?
- Amacrine cells
 - Bipolar cells
 - Ganglion cells
 - Horizontal cells
48. Which lobe of the cerebral cortex contains the small bilateral cortical area that controls voluntary fixation movements?
- Frontal
 - Limbic
 - Occipital
 - Parietal
49. Which of the following sensory systems has the smallest range of intensity discrimination?
- Auditory
 - Gustatory
 - Olfactory
 - Somatosensory
50. Which of the following molecules moves from the endolymph into the stereocilia and depolarizes the hair cell?
- Calcium ions
 - Sodium ions
 - Hydrogen ions
 - Potassium ions
51. Which of the following retinal cells have action potentials?
- Amacrine cells
 - Bipolar cells
 - Ganglion cells
 - Horizontal cells
52. Which type of papillae is located in the folds along the lateral surfaces of the tongue?
- Circumvallate
 - Foliate
 - Fungiform
 - Fungiform and circumvallate
53. The primary auditory cortex lies primarily in which lobe of the cerebral cortex?
- Limbic lobe
 - Occipital lobe
 - Parietal lobe
 - Temporal lobe

ANSWERS WITH EXPLANATIONS

1. Ans. a. Alpha waves

(Ref. Ganong's Physiology 24th edn. pp 233)

Alpha rhythm is most marked in the parietal and occipital lobes and is associated with decreased levels of attention.

2. Ans. a. Awake state

(Ref. Ganong's Physiology 24th edn. pp 233)

Alpha wave is seen when the person is awake, in a quiet, resting stage of cerebration. Mental work (focused attention) will convert alpha to beta wave.

Light sleep converts alpha to theta wave.

3. Ans. a. NREM 2

(Ref. Kaplan and Sadock's Synopsis of Psychiatry: By Benjamin J. Sadock et al. and Harrison's Principles of Internal Medicine 19th Edn. Pp184)

Bruxism occurs in both stage I and stage II. But more common in stage II.

4. Ans. c. Relation of one stimulus to another

(Ref. Ganong's Physiology 24th edn. pp 290)

In associative learning, the organism learns about the relation of one stimulus to another.

5. Ans. a. Conditional response

(Ref. Ganong's Physiology 24th edn. pp 292)

In Pavlov's classic experiments, the salivation normally induced by placing meat in the mouth of a dog was studied. A bell was rung (conditioned stimulus; CS) just before the meat was placed in the dog's mouth (unconditioned stimulus; US), and this was repeated a number of times until the animal would salivate when the bell was rung even though no meat was placed in its mouth. In this experiment, the unconditioned stimulus (meat placed in mouth) normally produces a particular innate response (salivation). After the CS and US had been paired a sufficient number of times, the CS produced the response originally evoked only by the US. An immense number of somatic, visceral, and other neural changes can be made to occur as conditioned reflex responses.

6. Ans. d. Innate reflex

(Ref. Ganong's Physiology 24th edn. pp 292)

For condition reflex to occur, a bell should ring just before the meat was placed in the dog's mouth, and this should be repeated a number of times until the animal would salivate when the bell rings even though no meat was placed in its mouth. Placing food will cause salivation (innate reflex) whether the bell is there or not.

7. Ans. a. Procedural memory

(Ref. Ganong's Physiology 24th edn. pp 290)

Procedural memory includes skills and habits, which, once acquired, become unconscious and automatic. Striatum is responsible for this type of learning and memory.

8. Ans. d. Medulla

(Ref. Front Neuroendocrinol. 1994 Dec;15: 301-20)

The area postrema (AP) has been implicated as a chemoreceptor trigger zone for vomiting (emesis) for over 40 years. The AP is located on

the dorsal surface of the medulla oblongata at the caudal end of the fourth ventricle. It is one of the so-called circumventricular organs that serve as an interface between the brain parenchyma and the cerebrospinal fluid (CSF)-containing ventricles. The AP lacks a specific blood-brain diffusion barrier to large polar molecules (i.e., a "blood-brain barrier") and is thus anatomically positioned to detect emetic toxins in the blood as well as in the CSF.

The NTS (nucleus of the solitary tract) may serve as the beginning of a final common pathway by which different emetic inputs trigger vomiting.

9. Ans. None [Explained above]**10. Ans. a. Larger brain**

(Ref. Curr Opin Neurobiol. 2009 Feb;19: 6-11)

The human brain is 4.8 times the size for a hypothetical monkey of the same body weight.

There are two consequences of an increase in size. The first is that there is an increase in the number of specialized sub-regions, for example in the visual areas and in parietal cortex. The second is that there are consequential changes in the microstructure. The maximum spine density of layer III pyramidal neurons in the prefrontal cortex is 70% greater in the human than in the monkey brain. All these changes in large brain are responsible for intellectual functions.

11. Ans: c. Dyscalculia

(Ref. Ganong's Physiology 24th edn. pp 296)

Mathematical calculation is a skill of left hemisphere (categorical hemisphere).

12. Ans. b. Written an spoken language

(Ref. Ganong's Physiology 24th edn. pp 296)

The categorical hemisphere is concerned with language functions, but hemispheric specialization is also present in monkeys,

so it antedates the evolution of language. In 96% of right-handed individuals, who constitute 91% of the human population, the left hemisphere is the dominant or categorical hemisphere, and in the remaining 4%, the right hemisphere is dominant.

13. Ans. c. 8-13

(Ref. *Review of clinical electroencephalography* by G.R. Shamsaei, pp 10)

In 1924, Berger made the first EEG recording in man. Using the EEG, he was also the first to describe the different waves or rhythms which were present in the normal and abnormal brain, such as the alpha wave rhythm (8-12 Hz), also known as Berger's wave.

14. Ans. a. Hypothalamus

(Ref. *Ganong's Physiology 24th edn.* pp 237)

15. Ans. c. Awake state [Explained in Q. no. 2]

16. Ans. a. Sleep with eyes closed with mind wandering

(Ref. *Review of clinical electroencephalography* by G.R. Shamsaei, pp10)

Alpha wave: Best seen with eyes closed and under conditions of physical relaxation and relative mental inactivity. Blocked or attenuated by attention, especially visual, and mental effort.

So, in the question, the best option is a. When mind is still wandering, alpha wave can be seen.

17. Ans. a. Deep sleep

(Ref. *Review of clinical electroencephalography* by G.R. Shamsaei, Pp10)

Delta begins to appear at this stage. It increases in stage III and more than 50% delta activity is seen in stage IV sleep.

18. Ans. b. Beta

(Ref. *Review of clinical electroencephalography* by G.R. Shamsaei, pp 10)

REM sleep is defined by

- Rapid eye movements
- Muscle atonia
- EEG "desynchronization" (compared to stages 3 and 4 sleep).

EEG desynchronization: The EEG background activity changes from that seen in slow wave sleep (stage III or IV) to faster and lower voltage activity (theta and beta), resembling wakefulness.

19. Ans. b. Theta waves

(Ref. *Review of clinical electroencephalography* by G.R. Shamsaei, pp 10)

Theta wave is seen in cortex (human) and hippocampus (in non-human mammals).

20. Ans. d. Awake/alert state

(Ref. *Ganong's Physiology 24th edn.* pp 233)

When attention is focused on something, the alpha rhythm is replaced by an irregular 13–30 Hz low-voltage activity, the beta rhythm.

21. Ans. a. REM sleep

(*Harrison's Principles of Internal Medicine* 19th Edn. Pp 184)

Nightmare: REM sleep

Night terrors: NREM stage N3

22. Ans. c. Sleep walking >> a. Dreams

(*Harrison's Principles of Internal Medicine* 19th Edn. Pp184)

Dreams occur in both NREM and REM sleep. Dreams in REM are recallable dreams. Sleep-walking is a disorder of NREM stage N3.

23. Ans. d. Delta activity >> a. Dreams

(*Harrison's Principles of Internal Medicine* 19th Edn. Pp 184)

[Explained in Q. Nos. 17, 24]

24. Ans. a. Will not show high frequency waves during stage 3 sleep >> b. Shows alpha rhythm when a person is awake but inattentive

(Ref. Review of clinical electroencephalography by G.R.Shamsaei Pp10)

Alpha rhythm diminished or, attenuates in focused attention.

Stage 3 sleep will never show high frequency waves.

25. Ans. b. Hippocampus

(Ref. Guyton-Physiology-12th edn. pp 726)

When hippocampus is removed (treatment of epilepsy), after removal, these people have virtually no capability for storing verbal and symbolic types of memories (declarative types of memory) in long-term memory, or even in intermediate memory lasting longer than a few minutes.

26. Ans. a. Recent memory

(Ref. Memory: From Mind to Molecules by Squire and Kandel 2009)

Memory:

Working memory: Sec to min

Recent memory: Min/week/months

Remote: Months-years

27. Ans. b. G protein

(Ref. Ganong's Physiology 24th edn. pp 225)

Salt-sensitive taste is mediated by a Na⁺-selective channel (ENaC).

Sour taste is mediated by H⁺ ions permeable to ENaCs.

Other 3 primary tastes are G protein couple receptors. They are:

- ❑ Umami taste is mediated by glutamate acting on a metabotropic glutamate receptor
- ❑ Bitter taste is mediated by the T2R family of G protein-coupled receptors;

- ❑ Sweet taste may be dependent on the T1R3 family of G protein-coupled receptors which couple to the G protein gustducin.

28. Ans. d. At the posterior aspect

(Ref. Ganong's Physiology 24th edn. pp 225)

Bitter taste buds are located primarily in the posterior aspect of tongue.

29. Ans. b. Glutamate

(Ref. Ganong's Physiology 24th edn. pp 192)

The neurotransmitter from photoreceptor cells is glutamate.

30. Ans. a. Bipolar cells

(Ref. Molecular Vision 2008;14:706-720 and Concept and challenge in retinal biology by H Klob, H ripps)

First order neuron: Rods and cones

Second order neuron: Bipolar cell

Third order neuron: Ganglion cell.

But, in this question, we have to choose bipolar cell as answer.

31. Ans. a. ON (optic nerve)

(Ref. Molecular Vision 2008;14:706-720)

According to recent trends, 2nd order neurons are bipolar cells.

32. Ans. c. 3rd

(Ref. Molecular Vision 2008;14:706-720)

33. Ans. d. Vision

(Ref. Ganong's Physiology 24th edn. pp 192)

Transducin is the G-protein present in rods and cones, responsible for visual transmission.

34. Ans. d. Hyperpolarization

(Ref. Ganong's Physiology 24th edn. pp 192)

Phototransduction is hyperpolarization of the receptor cells.

During dark: Photoreceptor cells are depolarized.

When light falls on retina: Hyperpolarization of photoreceptor cells.

35. Ans. c. Color processing

(Ref. Ganong's Physiology 24th edn. pp 194)

Layers 2 and 3 of the cortex contain clusters of cells about 0.2 mm in diameter that, unlike the neighboring cells, contain a high concentration of the mitochondrial enzyme cytochrome oxidase. The clusters have been named blobs. They are concerned with color vision.

36. Ans. a. Acetylcholine

(Ref. Ehinger and Lindberg-Bauer 1976, Miller, Dacheux et al 1977)

The major neurotransmitters contained in amacrine cells are GABA and glycine. Other less common neurotransmitters released by amacrine cells are downline and acetylcholine.

Cholinergic Amacrine cell are know as STARBURST cell, which are more in number than dopamine producing cell. Dopamine acts as a neuromodulator in retina.

37. Ans. a. Signal transduction

(Ref. Ganong's Physiology 24th edn. pp 194)

Mechanism of phototransduction is almost similar in rods and cones.

38. Ans. b. Photoisomerization and hydrolysis of visual purple

[Detail process in text]

39. Ans. c. 11-cis-Retinaldehyde

(Ref. Ganong's Physiology 24th edn. pp 191)

40. Ans. b. Amacrine cells

(Ref. Guyton-Physiology-12th edn. pp 636)

In a sense, then, many or most amacrine cells are interneurons that help to analyze visual signals before they ever leave the retina.

41. Ans. d. Ganglion cells

(Ref. Ganong's Physiology 24th edn. pp 191)

The eye is unique in that the receptor potentials of the photoreceptors and the electrical responses of most of the other neural elements in the retina are local, graded potentials, and it is only in the ganglion cells that all-or-none action potentials (AP) transmitted over appreciable distances are generated.

42. Ans. a. 370-740 nm

(Ref. Guyton- Physiology-12th edn. pp 636)

43. Ans. c. Involves opponent color cells

(Ref. Guyton- Physiology-12th edn. pp 636)

44. Ans. a. Red

(Ref. Guyton-Physiology-12th edn. pp 636)

45. Ans. c. Protanomaly

(Ref. Guyton- Physiology-12th edn. pp 636)

Normal person with three cones is trichomat. Weakness of one of the cones is known as anomaly. Red cones weak: Protanomaly; Green cones weak: Deuteranomaly; Blue cones weak: Tritanomaly.

46. Ans. a. Bipolar neurons

The receptor cells for the smell sensation are bipolar nerve cells derived originally from the central nervous system itself.

47. Ans. d. Horizontal cells

There appear to be many types of amacrine cells and at least six types of functions. In a sense, amacrine cells begin the analysis of visual signals before they leave the retina.

However, horizontal cells, which are always inhibitory, have lateral connections between photoreceptors and bipolar cells. This lateral connection provides the same phenomenon of lateral inhibition that is important in all other sensory systems, helping to ensure transmission of visual contrast.

48. Ans. a. Frontal

A bilateral premotor cortical region of the frontal lobes controls voluntary fixation movements. A lesion of this region makes it difficult for a person to “unlock” their eyes from one point of fixation and then move them to another point.

49. Ans. c. Olfactory

Concentrations that are only 10 to 50 times above threshold values will evoke maximum intensity of smell, which is in contrast to most other sensory systems of the body, where the range of intensity discrimination may reach 1 trillion to 1.

50. Ans. d. Potassium ions

Although most cells in the nervous system depolarize in response to sodium entry, hair cells are one group of cells that depolarize in response to potassium entry.

51. Ans. c. Ganglion cells

Only ganglion cells have action potentials. Photoreceptors, bipolar cells, amacrine cells, and horizontal cells all appear to operate through graded potentials.

52. Ans. a. Circumvallate

Foliate papillae are located in the folds along the lateral surfaces of the tongue, fungiform papillae are located in the anterior part of the tongue, and circumvallate papillae are located in the posterior part of the tongue. The papilla of Vater empties pancreatic secretions and bile into the duodenum

53. Ans. d. Temporal lobe

Most of the primary auditory cortex is in the temporal lobe, but the association auditory cortices extend over much of the insular lobe and even onto the lateral portion of the parietal lobe.

SECTION

6

Renal System

C H A P T E R

15. Renal Physiology

CHAPTER

15

Renal Physiology

Functional Anatomy

- ❑ The functional unit of the kidneys is the nephron. Each human kidney contains ~1.2 million nephrons.
- ❑ The nephron consists of a renal corpuscle, proximal tubule, loop of Henle, distal tubule, and collecting duct system.
- ❑ The renal corpuscle consists of glomerular capillaries and Bowman's capsule.
- ❑ Total length of nephron segments (In mm) = 45 – 65 [Proximal tubule = 15 mm, Distal tubules (DT) = 5 mm, Collecting duct (CD) = 20]
- ❑ **Proximal tubules (PT):** Divided into following parts: Proximal convoluted tubules (PCT) and proximal straight tubules (PST).
- ❑ **The loop of Henle includes:** Descending thin limb (DTL), ascending thin limb (ATL), and thick ascending limb (TAL).
- ❑ **The connecting tubule** is the segment between distal convoluted tubules (DCT) and CD. Connecting tubule cells are unique in that they produce and release renal kallikrein.
- ❑ **CD has following portion:** Cortical collecting duct (CCD), outer medullary collecting duct (OMCD) and inner medullary collecting duct (IMCD).
- ❑ The collecting duct is composed of two cell types: **principal (P) cells and intercalated (I) cells.**

Difference between Proximal Tubular Cell and Distal Tubular Cell

PCT	CD
Brush border present	No brush border
Carbonic anhydrase (type IV) present in luminal membrane	No carbonic anhydrase (type IV) in luminal membrane
Cytoplasmic carbonic anhydrase (type II) present	Cytoplasmic carbonic anhydrase (type II) present

I IMPORTANT

Based on ultrastructure PT is divided into three segments:

- ❖ S1 segment: 1st part of PCT
- ❖ S2 segment: 2nd half of PCT and 1st half of PST
- ❖ S3 segment: 2nd half of PST

I IMPORTANT

- ❖ S3 segment of both the nephron is located in corticomedullary junction. This S3 segment is most vulnerable to hypoxic injury.

I IMPORTANT

Two types of cells in CD & DCT:

P (Principal) cell is responsible for:

- ❖ Na⁺ reabsorption
- ❖ K⁺ secretion
- ❖ H₂O Absorption

I (Intercalated) cell: two types

- ❖ Alpha: acid secretion
- ❖ Beta: HCO₃⁻ secretion

Contd...

I IMPORTANT

- ❖ *Gap junctions (electrical coupling) are located along the lateral cell membrane of PCT but not in CD.*
- ❖ **Acetazolamide** inhibits both type IV and type II variety of carbonic anhydrase. So, it has primary action on PCT and secondary action on CD.

I IMPORTANT

- ❖ Weight of kidney = 300 Gm
 - ❖ **Renal Blood Flow:**
- | | |
|------------|---------------|
| Total | 1260 mL/min |
| Cortical | 5 mL/Gm/min |
| Outer Med. | 2.5 mL/Gm/min |
| Inner Med. | 0.6 mL/Gm/min |
- ❖ Low blood flow through medulla is necessary for maintenance of hyperosmolar renal medulla.

I IMPORTANT

- ❖ **Renal plasma flow (RPF)** = 700 mL/min
- ❖ **Effective renal plasma flow (ERPF)**, which is the plasma flow measured by PAH clearance = 625 mL/min (less than actual plasma flow).

I IMPORTANT

- ❖ **O₂ Consumption of Kidney**
- | | |
|------------|-------------------|
| Total | 18 mL/min |
| Cortex | 9 mL/100 gm/min |
| Inner Med. | 0.4 mL/100 gm/min |
- ❖ (Artery-Venous) O₂ Diff. = 14 mL/L

Contd...

PCT	CD
Has 'leaky' tight junctions (TJ)	Has 'tight' tight junction
Para cellular transport possible via 'leaky TJ	Para cellular transport NOT possible

TYPES OF NEPHRON

- ❑ Nephrons may be subdivided into cortical and juxtamedullary types.
- ❑ *The glomerulus of each cortical nephron and juxtamedullary nephron is located in the region of the cortex*
- ❑ Cortical nephron maximally extend upto outer medullary segment.
- ❑ Juxtamedullary nephron extends deep into the medulla.

Difference between Two Types of Nephrons

Cortical nephron	Juxtamedullary nephron
85% of the nephrons	15% of the nephrons
Short loop of Henle	Long loop of Henle: Responsible for counter-current multiplier
Peritubular capillary network is short	Peritubular capillary forms vasa recta : Responsible for counter-current exchanger
Blood flow is large (5 mL/gm/min)	Blood flow is less (0.6 mL/gm/min)
PO₂ is 50 mm Hg	PO₂ is 15 mm Hg
O ₂ Consumption is high (9 mL/100 gm/min)	O ₂ Consumption is low (0.4 mL/100 gm/min)
O₂ extraction ratio is very less (0.17)	O₂ extraction ratio is large (0.83)

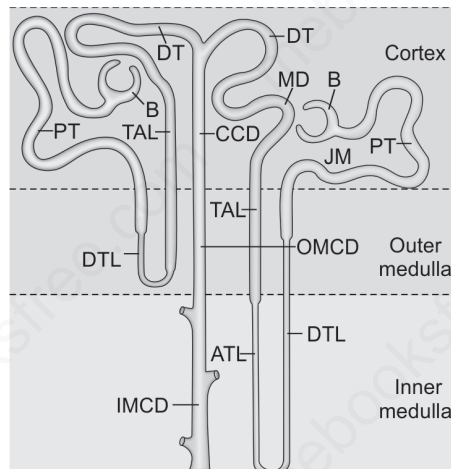

Fig. 15.1: Types of nephron and their parts (see text for description)

GLOMERULAR FILTRATION

Glomerular Membrane (GBM)

The barriers through which filtration has to take place

- ❑ **Glomerular endothelial cell layer:** (Fenestrated capillary with a gap of 70–90 nm in between endothelium cells)
- ❑ **Basement membrane:** A gel-like acellular meshwork of glycoproteins and proteoglycans.
- ❑ **Visceral epithelial layer of Bowman's capsule:**
 - The visceral epithelial cell is called a podocyte.
 - Each podocyte has many foot processes, which interdigitate to form filtration slits.
 - The slits are approximately 25 nm wide and each is closed by an extremely thin processes called **slit diaphragms** which bridge the slits between the pedicels.
 - Slit diaphragms are widened versions of the tight junctions and adhering junctions.
 - Slit diaphragm is composed of several proteins, including nephrin (NPHS1), NEPH-1, podocin (NPHS2), α -actinin 4 (ACTN4), and CD2-AP.

Genetic Mutation of these Proteins Results in Glomerular Disease in Human

Gene	Protein	Disease	Inheritance
NPHS1	Nephrin	Congenital nephrotic syndrome of the Finnish type	AR
NPHS2	Podocin	Steroid-resistant nephrotic syndrome	AR
CD2AP	CD2AP	Sporadic FSGS	n/a
ACTN4	Alpha Actinin 4	FSGS	AD
LAMB2	Laminin Beta 2	Pierson's syndrome	AR
COL4A5,3,4	Collagen IV alpha 5	Alport's syndrome	X-linked
ITGA3	Integrin alpha 3	Congenital nephrotic syndrome	AR

Glomerular Membrane Permeability Depends on

- ❑ **Size of particle:** Neutral substances which are < 4 nm are freely filtered; > 8 nm are not filtered. Between 4 nm and 8 nm, the permeability is inversely proportional to the diameter.

I IMPORTANT

Examples of freely filterable substances: Na^+ , K^+ , Cl^- and HCO_3^- , urea, creatinine, glucose, amino acid, organic acid (ketone body), inulin, PAH, insulin, myoglobin.

Not freely filterable: Albumin and other plasma protein, lipid soluble substances transported in plasma with proteins.

I IMPORTANT

Examples of freely filterable substances: Na^+ , K^+ , Cl^- and HCO_3^- , urea, creatinine, glucose, amino acid, organic acid (ketone body), Inulin, PAH, insulin, myoglobin.

Not freely filterable: Albumin and other plasma protein, lipid soluble substances transported in plasma with proteins.

I IMPORTANT

Measuring GFR (mGFR): to detect early damage

❖ **Clearance of exogenous substances:** Inulin, iothexol, $^{51}\text{Cr-EDTA}$, ^{125}I -iothalamate, $^{99\text{m}}\text{Tc}$ -diethylenetriaminepenta-acetic acid (DTPA)

– **Evaluation:** Precise and accurate, but costly, time-consuming.

❖ **Clearance of endogenous blood substances**

– **Serum creatinine:** Insufficiently sensitive for detection of chronic renal disease (CRD)

– **Creatinine clearance:** No longer recommended due to errors in urine collection

Exception: Patients with highly abnormal muscle mass or vegetarian diet

– **Serum cystatin C:** More sensitive than serum creatinine for detection of GFR reduction in the range 70–40; better than creatinine in children.

- ❑ Charge of the particle: Since the filtration membrane are negatively charged, filtration of positively charged particles is facilitated whereas negatively charged particles are repelled.
- ❑ **Electron microscopy demonstrates presence of anionic sites (negative charge) in all three layers of GBM.**

GLOMERULAR FILTRATION RATE (GFR)

- ❑ $\text{GFR} = 125 \text{ mL/min}$ or 180 lit/day
- ❑ The rate of filtration in all capillaries, including the glomeruli, is determined by the hydraulic permeability of the capillaries, their surface area, and the net filtration pressure (NFP) acting across them, given as follows:

Rate of filtration = Hydraulic permeability \times Surface area \times NFP

- ❑ Because it is difficult to estimate the area of a capillary bed, a parameter called the **filtration coefficient (K_f)** is used to denote the product of the hydraulic permeability and the area. $K_f = 12.5 \text{ ml/min/mm Hg}$.

$$\text{GFR} = K_f \times \text{NFP}$$

- ❑ The NFP is the algebraic sum of the hydrostatic pressures and the osmotic pressures resulting from protein—the oncotic, or colloid osmotic pressures—on the two sides of the capillary wall. There are four pressures to consider: two hydrostatic pressures and two oncotic pressures. **These are the Starling forces.**

$$\begin{aligned} \text{NFP} &= [(P_{\text{GC}} - P_{\text{BS}}) + (\pi_{\text{BS}} - \pi_{\text{GC}})] \\ &= [(60 - 18) + (0 - 32)] \text{ mm Hg} \\ &= 10 \text{ mm Hg} \end{aligned}$$

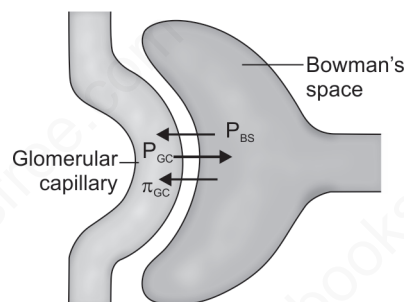

Fig. 15.2: Forces involved in glomerular filtration
GC = Glomerular capillary, BS = Bowman's space,
P = Hydrostatic pressure, π = Oncotic pressure

REGULATION OF GFR

Regulation is done by:

- ❑ Blood pressure: Autoregulation
- ❑ Resistance of afferent and efferent arterioles
 - **Autoregulation:** Constant maintenance of renal blood flow or, GFR over the span of renal perfusion pressure (pressure in renal artery minus pressure in renal vein) from 80 to about 170 mm Hg (Fig. 15.3).
 - **Mechanisms of autoregulation:**
 - **Myogenic mechanism**—contraction or relaxation of arteriolar smooth muscle in response to changes in vascular pressures; mediated by Ca^{++}
 - **Tubule glomerular feedback (TGF) mechanism**—mediated by macula densa cells (described later).

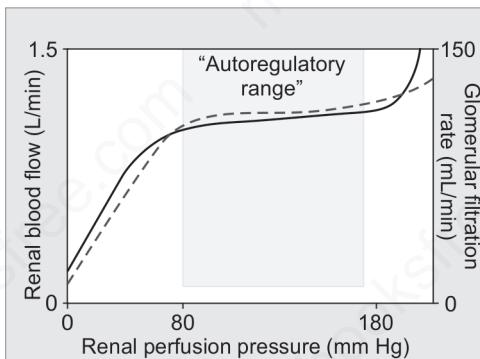

Fig. 15.3: Renal autoregulation

- ❑ **Role of afferent and efferent arterioles resistance on GFR and RPF (renal plasma flow):**

		RPF	GFR	FF
Afferent arterioles	Constriction	Decrease	Decrease	Normal
	Dilation	Increase	Increase	Normal
Efferent arterioles	Constriction	Decrease	Biphasic effect. Moderate constriction: slight increase in GFR, severe constriction: decrease in GFR	Increased or decrease
	Dilation	Increase	Decrease	Decrease

I IMPORTANT

❖ **FF: Filtration fraction**

❖ Normal FF = $(\text{GFR}/\text{RPF}) = 0.16$ to 0.2

I IMPORTANT**Mesangial cells**

Located in two sites:

❖ **Glomerular mesangial cells:**

Lying between glomerular capillary loops. These are contractile cells and play a role in regulation of glomerular filtration. When these relaxes, the GFR increases: PGE₂, ANP, cAMP and Dopamine causes dilation (relaxation) of mesangial cells.

❖ **Extraglomerular mesangial cells (Lacis cells):**

These form part of the juxta-glomerular apparatus. Secrete glomerular basement membrane and it is an anti-inflammatory cell.

Note

- ❑ Afferent arterioles constriction reduces GFR. However, the effect of efferent arteriolar constriction depends on the severity of the constriction; modest efferent constriction raises GFR, but severe efferent constriction (more than a threefold increase in resistance) tends to reduce GFR.

Effect of angiotensin II on kidney

- **Direct effects** of AngII on Na⁺ reabsorption in the renal tubules. Very low concentrations of AngII stimulate Na⁺/H⁺ exchange in the proximal tubule; increases Na⁺, Cl⁻, and bicarbonate reabsorption.
- **Release of aldosterone** from the adrenal cortex: Aldosterone acts on the distal and collecting tubules to cause retention of Na⁺ and excretion of K⁺ and H⁺
- **Altered renal hemodynamics:** AngII reduces renal blood flow by directly constricting the renal vascular smooth muscle. (Efferent > Afferent).
- **Effect on GFR:** AngII variably influences glomerular filtration rate (GFR) via several mechanisms:
 - Constriction of the afferent arterioles, tends to reduce GFR
 - Contraction of mesangial cells, tends to reduce GFR
 - Constriction of efferent arterioles tends to increase GFR
 - The outcome of these opposing effects depends on the physiological state. Normally, GFR is slightly reduced by AngII; however, during renal artery hypotension, the effects of AngII on the efferent arteriole predominate and AngII increases GFR. Thus, blockade of the renin-angiotensin system may cause acute renal failure in patients with bilateral renal artery stenosis or in patients with unilateral stenosis who have only a single kidney.

JUXTAGLOMERULAR APPARATUS

Components are:

1. **Juxtaglomerular cells (JG cell):**
 - These are modified smooth muscle cells in the tunica media of the afferent arteriole.
 - The cells have renin-containing granules (**granular cells**).
 - Renin is an aspartyl protease (enzyme).
2. **Macula densa:**
 - They are specialized tubular epithelium of **thick ascending limb** of loop of Henle.
 - It marks the beginning of DCT.

- Macula densa cells are the chemoreceptor cells, which regulate tubuloglomerular feedback mechanism.
- 3. **Lacis cells** or extraglomerular mesangial cells (Goor-maghtigh or Polkissen cells).

Three pathways control renin secretion from JG cells predominantly:

- ❑ **Macula densa pathway:** Increased NaCl reabsorption by macula densa cells (releases adenosine) inhibits renin release, while decreased NaCl flux (releases prostaglandin) stimulates renin release. Adenosine, acting via the A1 adenosine receptor to inhibits renin release.
- ❑ **Intra-renal baroreceptor pathway:** The intrarenal baroreceptors are located within JG cells. They sense renal afferent arteriolar pressure. Lowering of afferent arterioles pressure (renal artery stenosis) leads to degranulation of JG cells (increases renin secretion).
- ❑ **Beta-adrenergic receptor pathway** is mediated by the release of NE from postganglionic sympathetic nerves; activation of beta1 receptors on juxtaglomerular cells enhances renin secretion.

TUBULOGLOMERULAR FEEDBACK (TGF)

- ❑ To perform the function of autoregulation, the kidneys have a feedback mechanism that links changes in NaCl concentration at the macula densa with the control of renal arteriolar resistance.
- ❑ Decreased macula densa NaCl causes dilation of afferent arterioles and increased renin release.
- ❑ **The sensor for TGF is the macula densa.** It senses the amount of Na⁺ and Cl⁻ in it.
- ❑ The Na⁺ and Cl⁻ enter the macula densa cells via the Na-K-2Cl cotransporter in their apical membranes.
- ❑ The increased Na⁺ and Cl⁻ causes increased Na-K-ATPase activity and the resultant increased ATP hydrolysis. ATP hydrolysis causes more adenosine to be formed in macula densa cell.
- ❑ Adenosine acts via adenosine A1 receptors on the macula densa cells to increase their release of Ca²⁺ to the vascular smooth muscle in the afferent arterioles. This causes afferent vasoconstriction and a resultant decrease in GFR.
- ❑ Opposite mechanism is seen in case of decrease NaCl in macula densa (Flowchart 15.1).

I IMPORTANT

Although a change in NaCl transport is a key modulator of the macula densa pathway, the pathway depends more on the luminal concentration of Cl⁻ than Na⁺.

I IMPORTANT

Stimuli for increase renin release:

- ❖ Renal hypoperfusion and hypotension (most potent)
- ❖ Sympathetic stimulation
- ❖ Decrease NaCl in macula densa.
- ❖ Renal ischaemia triggers the release of renin

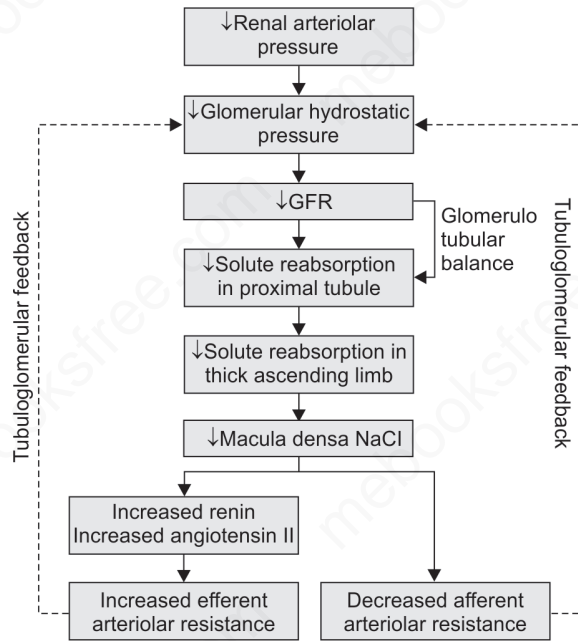
Flowchart 15.1: Tubuloglomerular feedback mechanism and glomerulo-tubular balance**GLOMERULOTUBULAR BALANCE (Flowchart 15.1)**

- ❑ An increase in GFR causes an increase in the reabsorption of solutes, and consequently of water, primarily in the proximal tubule, so that in general, the percentage of the solute reabsorbed is held constant.
- ❑ This balance between glomerulus and PCT is known as glomerulotubular balance.
- ❑ A cause of glomerulotubular balance is the increased oncotic pressure in the peritubular capillaries.
- ❑ When the GFR is high, there is a relatively large increase in the oncotic pressure of the plasma leaving the glomeruli via the efferent arterioles and hence in peritubular capillary.
- ❑ This increases the reabsorption of Na^+ from the tubule.

CLEARANCE

- ❑ *Clearance is the volume of plasma per unit time from which all of a specific substance is removed.*
- ❑ Clearance for a substance 'A' is defined as that volume of plasma that is required to contain that much amount of the substance A which is present in one minute's urine. *Its unit is mL/min*

Let us take the particularly important example of a polysaccharide named **inulin**.

- ❑ It is not found normally in the body, but we will administer it intravenously to a person at a rate sufficient to maintain **plasma concentration constant at 4 mg/L**.
- ❑ **Urine** collected over a 1-h period has a **volume of 0.1 L** and **urinary inulin concentration of 300 mg/L**; thus, inulin excretion equals $0.1 \text{ L/h} \times 300 \text{ mg/L}$, or 30 mg/h.
- ❑ How much plasma had to be completely cleared of its inulin to supply this 30 mg/h in urine? That will be the clearance of inulin in this case.
- ❑ We simply divide 30 mg/h by the plasma concentration, 4 mg/L, to obtain the volume cleared—7.5 L/h. In other words, we are calculating the inulin clearance (C_{In}) from the measured urine volume per time (V), urine inulin concentration (U_{In}), and plasma inulin concentration (P_{In}):

$$C_{\text{In}} = (U_{\text{In}} \times V) / P_{\text{In}}$$

So, the formula of clearance:

$$C = \frac{UV}{P} = \frac{\text{Amount in urine}}{\text{Plasma concentration}}$$

$$\left(\frac{\text{Filtration} + \text{Secretion} - \text{Absorption}}{\text{Plasma concentration}} \right)$$

Where, C = clearance

U = concentration of the substance in the urine

V = urine flow

P = concentration of the substance in the plasma

- ❑ If clearance is measured for a substances, which is not absorbed or, not secreted in tubules (e.g., Inulin), then:

Clearance =

$$\frac{\text{Amount in urine}}{\text{Plasma concentration}} = \frac{\text{Filtration amount}}{\text{Plasma concentration}}$$

filtration rate = GFR

- ❑ So, Clearance of Inulin gives GFR (125 mL/min)
- ❑ **The dynamics of PAH transport (Fig. 15.4):** Clearance of *paraaminohippuric acid* (PAH) gives renal plasma flow (625 mL/min)
 - Secretion of PAH occurs by active transport mechanisms.

I IMPORTANT

- ❖ If there is secretion of a substance in renal tubules, but no absorption, then: Clearance of the substance \gg GFR
- ❖ If there is absorption of a substance in renal tubules, but no secretion, then: Clearance of the substance \ll GFR
- ❖ Depending on the above properties: $C_{\text{PAH}} \gg C_{\text{K}^+} \gg C_{\text{Cr}} \gg C_{\text{In}} \gg C_{\text{Urea}} \gg C_{\text{Na}^+} \gg C_{\text{Glucose}}$

I IMPORTANT

Tubular reabsorption:

❖ **The tonicity of tubular fluid at various segments:**

- At the end of PCT: Isotonic
- As it goes down the descending limb: Hypertonic
- As it goes up the ascending limb: It first, isotonic, then hypotonic. At the top of ascending limb, it is hypotonic.

I IMPORTANT

❖ **Filtered Load:** of any substance in glomerulus is = (GFR × Plasma Concentration of substance)

❖ **Reabsorption rate** = (Filtered load - Excretion rate)

I IMPORTANT**Example:**

Plasma glucose is 400 mg/dL, GFR = 125 ml/min, T_m of glucose is 375. What is the excretion rate of glucose?

- ❖ Conc. of glucose 400 mg/dl = 4 mg/ml.
- ❖ Filtered load glucose = (125 × 4) = 500 mg/min.
- ❖ T_m (maximum absorbed theoretically) = 375 mg/min.
- ❖ So, excreted = (500 - 375) = 125 mg/min

- The filtered load of PAH is a linear function of the plasma level, but PAH secretion increases as P_{PAH} rises only until a maximal secretion rate (T_m_{PAH}) is reached. When P_{PAH} is low, C_{PAH} is high; but as P_{PAH} rises above T_m_{PAH}, C_{PAH} falls progressively. It eventually approaches the clearance of inulin (C_{In}), because the amount of PAH secreted becomes a smaller and smaller fraction of the total amount excreted.
- Because of these above reasons, if PAH concentration is high, C_{PAH} will give falsely lower RPF than actual.

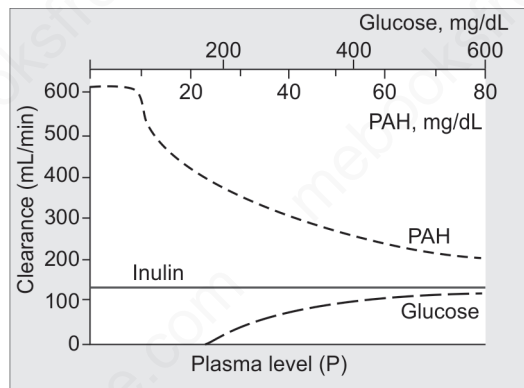

Fig. 15.4: Clearance of inulin, glucose, and PAH at various plasma levels of each substance

TUBULAR REABSORPTION AND SECRETION OF DIFFERENT SUBSTANCES IN NEPHRON

SODIUM REABSORPTION

- ❑ It occurs in all parts of the tubule except the thin descending part.
- ❑ It is active reabsorption except in thin ascending portion (where it is passive).
- ❑ **The various mechanisms in different parts of the tubule are:**

PCT	
	<ul style="list-style-type: none"> • Major: Sodium entry is coupled to the secretion of hydrogen ions, via the NHE3 antiporter. • Additional sodium enters in symport with glucose (SGLT), amino acids, phosphate, citrate and lactate. • All the sodium (100%) is transported to the interstitium linked via the basolateral Na,K-ATPase (directly or, indirectly).

Contd...

Contd...

PST	Cl ⁻ driven Na ⁺ transport (Para cellular pathway)
DTL	No reabsorption. Permeable to only H ₂ O
ATL	Passive (paracellular pathway)
TAL	<ul style="list-style-type: none"> • The major transporter in the thick ascending limb is the Na-K-2Cl symporter (NKCC). • Loop diuretics such as furosemide inhibit NKCC. • The cells here contain potassium channels that recycle potassium from the cell interior to the lumen (ROMK channel; lumen becomes positive) and to the interstitium.
	<ul style="list-style-type: none"> • Some sodium also moves para-cellularly in response to the lumen positive potential. • Mutations in NKCC have been described in Bartter's syndrome.
DCT	<ul style="list-style-type: none"> • The apical membrane contains the Na-Cl symporter (NCC), which is the target for inhibition by thiazide diuretics. • Mutation of NCC leads to Gitelman's syndrome.
CD	<ul style="list-style-type: none"> • Sodium reabsorption is via apical sodium channels (ENaC)-P cell. • Gain-of-function mutations of ENaC is seen in patients with Liddle syndrome.

I IMPORTANT

- ❖ Out of the total filtered load of Na⁺, 99.4% is reabsorbed: 65% in PCT; 25% in Henle; 10% in DCT/CT.
- ❖ **Aldosterone** increases the number of open ENaC and also by increasing the number of Na⁺-K⁺ ATPase on baso-lateral membrane of P cell.
- ❖ ENaC can be blocked by either triamterene or amiloride diuretics.
- ❖ **Atrial natriuretic peptide** (ANP) also inhibits ENaC, causing natriuresis and diuresis.

Atrial natriuretic peptide (ANP) and brain natriuretic peptide (BNP):

- **Secretion:** ANP by the cardiac atria and BNP by the cardiac ventricles.
- **Stimulus for Secretion:** Rise in BP and an increase in ECF volume.
- **Actions:**
 - Both ANP and BNP *reduce blood pressure* by decreasing total peripheral resistance and enhancing urinary excretion of NaCl and water and increasing capillary permeability.
 - Both *dilate afferent* arterioles and *constrict efferent* arterioles but *relax mesangial cells*. Therefore, ANP and BNP produce a modest *increase in GFR with little change in RBF*.
 - Both Inhibit reabsorption of NaCl by the MCD and inhibit ADH-stimulated water reabsorption *across the CD*.
 - Both reduce the secretion of ADH from the posterior pituitary. ANP induces a more profound natriuresis and diuresis than BNP does.

Contd...

- In the brain, ANP is present in neurons (hypothalamus). In general, the effects of ANP in the brain are opposite to those of angiotensin II, and ANP-containing neural circuits appear to be involved in lowering blood pressure and promoting natriuresis.

I IMPORTANT

- ❖ Vasopressin (ADH) acts on aquaporin-2. This action is mediated via vasopressin V2 receptor, cyclic adenosine 5-monophosphate (cAMP) and protein kinase A.
- ❖ Unlike the other aquaporins, this aquaporin-2 is stored in vesicles in the cytoplasm of principal cells. Vasopressin causes rapid insertion of these vesicles into the apical membrane of cells.

WATER REABSORPTION

- ❑ Water reabsorption is passive, following the osmotic gradient.
- ❑ The total glomerular filtered load is approximately 180 L/day.
- ❑ Out of this, the amount of urine output can vary from 500 mL (osmolality of 1400 mosm/L) to 23.3 Litres (osmolality of 30 mosm/L).
- ❑ Water reabsorption is facilitated by water channels (aquaporins).
- ❑ There are various types of aquaporins in kidney:

Type	Site
Aquaporin 1	Luminal membrane of PCT
Aquaporin 2	Luminal membrane of CD
Aquaporin 3	Basolateral membrane of CD
Aquaporin 4	Basolateral membrane of MCD

- ❑ The % of water reabsorption in the various segments is as follows:
 - PCT: 60-70%
 - Loop of Henle: 15%
 - Distal Tubule: 20%
 - DCT: 5%
 - CD: 15% (CCD 10%, MCD 4.7%) in presence of ADH. in absence of ADH, water absorption in CD is 2% only.

Obligatory and Facultative Water Absorption

Obligatory	Facultative (Optional)
Total 85% (PCT 65%, DTL 15%)	15-18% from CD
Irrespective of osmolality of blood	Depends on blood osmolality (body water)
Independent of ADH	Depends on ADH

FREE WATER CLEARANCE

Urine concentrating ability can be looked at in two ways.

- ❑ We can determine what the urine osmolality (or specific gravity) is compared to the plasma, or the U_{OSM}/P_{OSM} ratio. In people, a maximal value is about 4 to 5, a value that might be observed in a dehydrated, otherwise healthy, individual.
- ❑ Or, we can calculate *free water clearance* (or *free water production*). How much solute-free water per unit time the kidneys save or eliminate in the urine; abbreviated C_{H_2O} . C_{H_2O} is calculated from the following equation: $C_{H_2O} = V - C_{OSM}$

Where, V is the urine flow rate. C_{OSM} (Osmolar clearance) is defined as $(U_{OSM} \times V)/P_{OSM}$. If we factor out V in above equation we get: $C_{H_2O} = V(1 - U_{OSM}/P_{OSM})$

Where, C_{H_2O} = free water clearance, OSM = osmolality, U = urine, P = Plasma and V is the urine flow rate. From equation, we see that:

- ❑ A normal 70-kilogram human must excrete about 600 mOsmol of solute each day and plasma osmolality is 300 mOsmol/L. Then excreting urine that is isosmotic to plasma, we would need to excrete 2.0 L H_2O /d. In this situation $C_{H_2O} = 0$ (zero).
- ❑ If the U_{OSM}/P_{OSM} ratio is >1 (when urine is osmotically concentrated), C_{H_2O} is **negative**. It is produced in water deprivation (ADH release from the pituitary is stimulated) or SIADH.
- ❑ If U_{OSM}/P_{OSM} ratio = 1 (when urine isosmotic to plasma), then C_{H_2O} is **zero**. It is produced during treatment with a loop diuretic.
- ❑ If U_{OSM}/P_{OSM} ratio is <1 (when osmotically dilute urine), then C_{H_2O} is **positive**. It is produced with high water intake (in which ADH release is suppressed), central diabetes insipidus (in which pituitary ADH is insufficient), or nephrogenic diabetes insipidus (in which the collecting ducts are unresponsive to ADH).

GLUCOSE REABSORPTION

- ❑ Glucose is reabsorbed by **secondary active transport**. All the glucose is reabsorbed in proximal tubules (**SGLT2 in PCT**, S1, S2 segment and **SGLT1 in PST**, S3 segment).

I IMPORTANT

- ❖ Loop diuretics (furosemide): C_{H_2O} is Zero. So, produces isotonic urine.
- ❖ Thiazide diuretics: decreases C_{H_2O} (in ADH absence) and C_{H_2O} not affected (in presence of ADH).
- ❖ Water diuretics (V2 antagonist, Lithium): Increases (positive) C_{H_2O}
- ❖ FUROSEMIDE blocks both positive (in ADH absence) and negative (in ADH presence) free water clearance.
- ❖ THIAZIDE decreases positive free water clearance but does not affect negative free water clearance.

I IMPORTANT

- ❖ Dapagliflozin, canagliflozin (SGLT2 inhibitor) used in type II DM.
- ❖ Mutation of SGLT2: familial renal glycosuria.

- ❑ The TmG (**Transport maximum** for glucose *i.e.* the maximum rate of absorption of glucose by the tubule) is 375 mg/min in males and 300 mg/min in females.
- ❑ The actual value of **renal threshold** is much less than this; it is 200 mg/dL in arterial and 180 mg/dL in venous blood.
- ❑ This deviation in the renal threshold (from the calculated predicted value) is called **SPLAY (Fig. 15.5)**. The reason for splay is heterogeneity of nephrons (*i.e.* not all nephrons have TmG of 375 mg/min); further, not all nephrons are maximally active simultaneously.

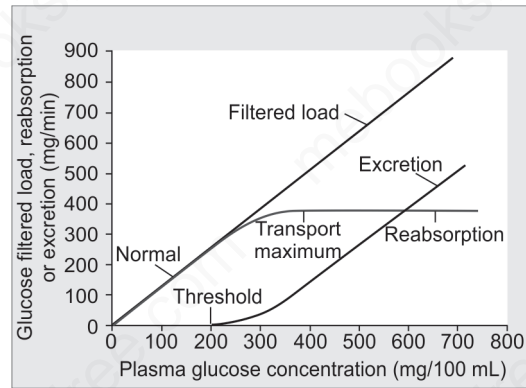

Fig. 15.5: Splay effect. The threshold is reached before the transport maximum (splay)

Transport Maximum (Tm)

- For most substances that are *actively reabsorbed or secreted*, there is a limit to the rate at which the solute can be transported, often referred to as the transport maximum.
- This limit is due to saturation of the specific transport systems involved when the amount of solute delivered to the tubule (referred to as tubular load) exceeds the capacity of the carrier proteins and specific enzymes involved in the transport process.
- **Tm of substances actively reabsorbed:** Glucose: 375 mg/min, lactate: 75 mg/min, plasma proteins: 30 mg/min, urate: 15 mg/min, amino acid: 1.5 mM/min.
- **Tm of substances actively Secreted:** PAH—80 mg/min, creatinine—16 mg/min.
- **Substances actively reabsorbed but NO Tm:** Na⁺

POTASSIUM: REABSORPTION AND SECRETION

- ❑ K^+ is the only electrolyte that is reabsorbed as well as secreted.
- ❑ 65% of the K^+ is reabsorbed in PCT, 25% in loop and < 10% reaches the distal nephron.
- ❑ Active reabsorption in PCT; secreted in DCT (Maximum secretion). K^+ secretion is decreased when the amount of Na^+ reaching the DCT is small.
- ❑ K^+ secretion is also decreased when the H^+ secretion is increased.
- ❑ In DCT, Na^+ is reabsorbed and K^+ and H^+ compete for their secretion for the amount of Na^+ reabsorbed.
- ❑ For K^+ and H^+ , remember the terms 'hypokalemic alkalosis and hyperkalemic acidosis'.

HYDROGEN SECRETION

- ❑ Occurs in PCT, DCT and CD

Mechanisms in PCT (Fig. 15.6)

- **Na^+H^+ exchanger (secondary active transport):**
Maximum acid secretion in tubules occurs via this transporter.
- For each H^+ that is secreted, effectively 1 Na^+ and 3 HCO_3^- is reabsorbed in blood **indirectly** by basolateral $Na-HCO_3$ symporters and $Cl-HCO_3$ antiporters. In both cases, the movement of bicarbonate is down its electrochemical gradient (*i.e.*, the exit step is **passive**).
- Symport with sodium is the dominant means of extruding bicarbonate in the proximal tubule and is particularly interesting because the efflux of sodium is active transport here (up its electrochemical gradient).
- But, the secreted H^+ in PCT **does not acidify** the urine; it only helps in the reabsorption of Na^+ and HCO_3^- .
- Since the secreted H^+ in the PCT is quickly handled, the secretion of H^+ in PCT can be called a high-capacity, low-gradient system *i.e.* the capacity is high but the acidification is not there.

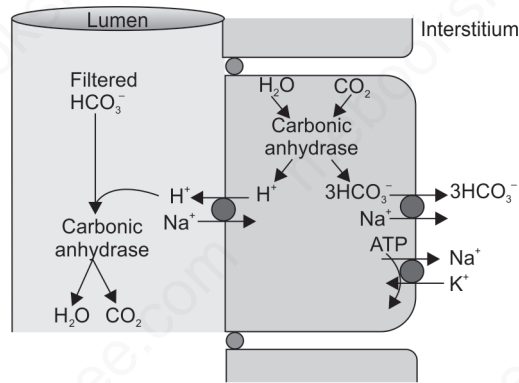

Fig. 15.6: Acid secretion in PCT

I IMPORTANT

Net acid excretion = Excreted titratable acids + excreted NH_4^+ - Excreted HCO_3^-

❖ **Titratable acid** is measured in the clinical laboratory by titrating the urine with a strong base (NaOH) and measuring the number of milliequivalents of OH needed to bring the urine pH back to the pH of the blood (usually 7.40). It represents the amount of hydrogen ions that are excreted combined with urinary buffers, such as phosphate, creatinine, and other bases. The largest component of titratable acid is normally phosphate, that is, H_2PO_4 .

Mechanism in DCT/CD

- ❑ ATP-driven proton (H^+) pump (H-ATPase) and H^+ - K^+ ATPase.
- ❑ *The secreted H^+ here helps to acidify the urine.*
- ❑ H^+ secretion here can be called a low-capacity, high-gradient system, i.e. the capacity is low but the acidification is significant.
- ❑ **Factors affecting acid secretion:**
 - Intracellular PCO_2 : When PCO_2 is high, acid secretion is increased.
 - K^+ depletion: This increases acid secretion.
 - If carbonic anhydrase is inhibited, acid secretion is decreased.
 - Aldosterone: This increases Na^+ reabsorption and increases K^+ and H^+ secretion

Note: *Hypokalemia tends to cause alkalosis and vice versa. Hyperkalemia tends to cause acidosis and vice versa.*

Urinary Buffers

Limiting pH of urine = 4.5 (this corresponds to 1000 times concentration of H^+ in urine)

Type of buffer	PK	Sites
Bicarbonate	6.1	In PCT, it is mostly bicarbonate buffer
Phosphate	6.8	In DCT/CD
Ammonia	9.0	Both PCT and DCT

Buffer Systems in Blood

Buffer systems in the body can be classified as follows depending on their functional capacity:

- **Bicarbonate buffer** forms 53% of the buffering in whole body.
 - Plasma HCO_3^- 35%
 - RBC HCO_3^- contributes 18%
- **Non-bicarbonate buffers** form remaining 47% of the buffering in the whole body.
 - Hemoglobin and oxyhemoglobin 35%
 - Plasma proteins 7%
 - Organic phosphate 3%
 - Inorganic phosphate 2%

Hemoglobin exists in the RBC as weak acid as HHb and its potassium salt (KHb).

I IMPORTANT

- ❖ **Most important** buffer in human body or, human plasma (ECF): **Bicarbonate buffer**.
- ❖ **Most important** intracellular buffer (ICF): **Protein** (Hb acts like ECF buffer)
- ❖ **Most important** buffer in RBC: **Hemoglobin** (acts like ECF buffer)
- ❖ *Protein is the **major (most abundant)** intracellular buffer and since intracellular volume is 2/3rd of total body fluid, protein may be considered the most abundant buffer in body.*

Hormones that Regulate Tubular Reabsorption in Kidney

Hormone	Major stimulus	Site of action	Effect
Angiotensin II	Renin increase	PT > TAL, DT, CD	Increase NaCl and H_2O absorption
Atrial natriuretic peptide (ANP) and BNP	Increase ECF volume	CD > DT (Medullary CD main)	Decrease NaCl and H_2O absorption
Aldosterone	Increase AgII and increase K^+	CD > DT > TAL (Cortical CD main)	Increase NaCl and H_2O absorption
Antidiuretic hormone (ADH)	Increase plasma osmolality	CD > DT (Medullary CD main)	Increase H_2O absorption
Dopamine	Increase ECF volume	PT	Decrease NaCl and H_2O absorption
Parathyroid hormone (PTH)	Decrease Ca^{++}	PT, DT (PT main-converts active Vit.D₃ also)	Decrease PO_4 reabsorption (PT), increase Ca^{++} reabsorption (DT)

COUNTER CURRENT MECHANISM

It is the process by which renal medullary interstitial fluid becomes hyperosmotic. It has two parts:

1. Counter current multiplier:

- The major factors that contribute to Multiplier:
 - TAL (thick): Active transport of Na^+ , K^+ , Cl^-
 - CD: Active transport of ions (Na^+)

- MCD: Facilitated diffusion of urea: 40-50%
- ATS (thin segment): Diffusion of NaCl: little role

2. Counter current exchanger (vasa recta)

Steps Involved in Countercurrent Multiplier System

- ❑ **Step 1:** First, assume that the loop of Henle is filled with fluid with a concentration of 300 mOsm/L, the same as that leaving the proximal tubule (Fig. 15.7).
- ❑ **Step 2:** Active absorption of NaCl by TAL, establishes a 200-mOsm/L concentration gradient between the tubular fluid (200 mOsm/L) and the interstitial fluid (400 mOsm/L). *This 200 mOsm/L is the maximum gradient that can be established by TAL.*
- ❑ **Step 3:** Absorption of water (Osmosis) in the DTL established an osmotic equilibrium (400 mOsm/L) between DTL and interstitium.
- ❑ **Step 4:** Additional flow of fluid into the loop of Henle from the proximal tubule (300 mOsm/L), which causes the hyperosmotic fluid previously formed in the descending limb (400 mOsm/L) to flow into the ascending limb.
- ❑ **Step 5:** Additional ions are pumped into the interstitium, until a 200 mOsm/L osmotic gradient is established, with the interstitial fluid osmolarity rising to 500 mOsm/L.
- ❑ **Step 6:** Then, once again, the fluid in the descending limb reaches equilibrium with the hyperosmotic medullary interstitial fluid due to water absorption in DTL.
- ❑ **Step 7:** These steps are repeated over and over, with the net effect of adding more and more solute to the medulla in excess of water; with sufficient time, this process gradually traps solutes in the medulla and multiplies the concentration gradient established by the active pumping of ions out of the thick ascending loop of Henle, eventually raising the interstitial fluid osmolarity to 1200 to 1400 mOsm/L.

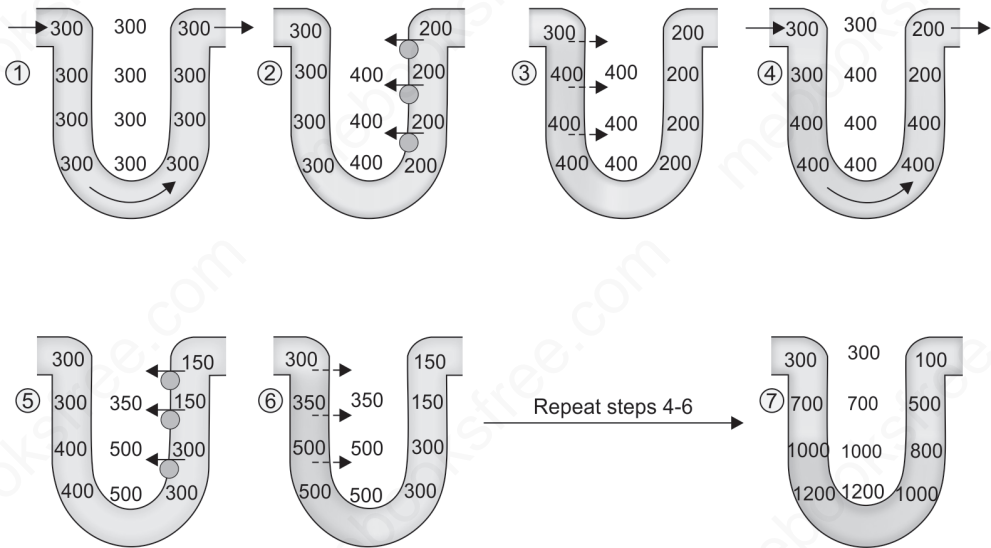

Fig. 15.7: Countercurrent multiplier system in the loop of Henle

Countercurrent Exchange in the Vasa Recta (Fig. 15.8)

- Plasma flowing down the descending limb of the vasa recta becomes more hyperosmotic because of diffusion of water out of the blood and diffusion of solutes from the renal interstitial fluid into the blood.

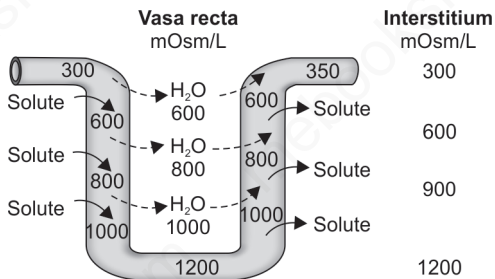

Fig. 15.8: Countercurrent exchange

- In the ascending limb of the vasa recta, solutes diffuse back into the interstitial fluid and water diffuses back into the vasa recta.
- Thus, although there is a large amount of fluid and solute exchange across the vasa recta, there is little net dilution of the concentration of the interstitial fluid at each level of the renal medulla because of the U-shape of the vasa recta capillaries, which act as countercurrent exchanger.

I IMPORTANT

- ❖ When maximally concentrated urine is excreted, the osmolality of the medullary interstitial fluid is ~1200 mOsm/kg H₂O at the papilla. Of this value, 50% (~600 mOsm/kg H₂O) tonicity is attributed to sodium (Na⁺: 300 mOsm/Kg) and chloride (Cl⁻: 300 mOsm/Kg) both and 40-50% (500-600 mOsm/kg H₂O) to urea.
- ❖ **So, the single most important substance for medullary tonicity is UREA.**

- Thus, the vasa recta do not create the medullary hyperosmolarity, but they do prevent it from being dissipated.

Important Points of Countercurrent Mechanism

- The longer the loop of Henle, the greater can be the medullary interstitial osmotic gradient created; thus, the length of the loop of Henle determines the concentration ability.
- Once the interstitial osmotic gradient is established by the counter current multiplier, **it is maintained by the counter current exchange mechanism of the vasa recta.**
- The counter current multiplier mechanism is **active** whereas the counter current exchange mechanism is **passive**.
- Once the medullary interstitial osmotic gradient is established, water can move from the collecting duct in the presence of ADH.
- Note that in the cortical collecting duct segment, the urine can at best be concentrated up to isotonicity only; as it moves down the medulla collecting duct, the urine can be concentrated up to the maximum limit determined by the maximum gradient existing in the medullary interstitium.

Miscellaneous: Endocrine Functions of Kidney

- The kidneys produce three hormones: 1,25-dihydroxychole-calciferol, renin, and erythropoietin.
- **Source of Erythropoietin (EPO):** In adults, about 85% from the kidneys and 15% from the liver. It is also found in spleen, salivary glands, brain, and uterus.
 - **In kidney:** Erythropoietin is produced by interstitial cells in the peritubular capillary bed
 - **In liver:** Perivenous hepatocytes.
- **Stimulus for EPO Secretion:** Usually hypoxia (main), cobalt salts, androgens and catecholamines via an adrenergic mechanism. Alkalosis facilitates secretion of this hormone in high altitude.
- **Function of EPO:** Erythropoietin increases committed stem cells in the bone marrow; increase RBC production.
- **Metabolism of EPO:** The principal site of inactivation of erythropoietin is the liver, and the hormone has a half-life in the circulation of about 5 hrs.

MULTIPLE CHOICE QUESTIONS

GLOMERULAR FILTRATION

RECENT MCQs

1. Filtration pressure in glomeruli of kidney:

- a. 10 mm of Hg b. 6 mm of Hg
c. 15 mm of Hg d. 2.0 mm of Hg

2. A negatively charged molecule is filtered with more difficulty compared to a positive one because:

- a. Presence of negatively charged sialoproteins on the filtering membrane
b. Negatively charged molecules are larger
c. Positively charged proteins on filtering membrane
d. Urine is acidic

3. GFR is determined by the following:

- a. Bowman capsule pressure
b. Hydrostatic pressure
c. Plasma oncotic pressure
d. All of the above

4. Glomerular filtration rate is increased when:

- a. Plasma oncotic pressure is increased
b. Glomerular hydrostatic pressure is decreased
c. Tubular hydrostatic pressure
d. Increased renal blood flow

5. GFR increases if:

- a. Efferent arteriole constricts
b. Efferent arteriole dilates
c. Afferent arteriole constricts
d. Afferent arteriole dilates

6. GFR is measured by:

- a. Creatine clearance
b. Inulin clearance

- c. PAH clearance
d. Creatinine clearance

7. Used to measure GFR:

- a. Inulin b. PAH
c. Hippurate d. D₂O

8. Inulin clearance is equal to:

- a. 55 mL/min
b. 625 mL/min
c. 125 mL/min
d. 40 mL/min

9. Relaxation of mesangial cells of kidney is brought about by:

- a. cAMP b. Endothelin
c. PGF₂ d. Vasopressin

10. Which of the following relaxes mesangial cells in glomerulus?

- a. Dopamine
b. Histamine
c. AT III
d. PDGF

AIIMS/PGI/JIPMER

11. All of the following structures lie in the renal medulla, except: [AIIMS Nov 08]

- a. Juxtaglomerular apparatus
b. Loop of Henle
c. Collecting duct
d. Vasa Recta

12. Juxtaglomerular apparatus lies in relation to: [AIIMS May 07]

- a. Proximal convoluted tubule
b. Ascending loop of Henle
c. Descending loop of Henle
d. Glomerulus

13. Macula densa is present in:

- a. Collecting tubule
- b. Proximal convoluted tubule
- c. Distal convoluted tubule
- d. Loop of Henle

14. In a normal person at resting condition GFR is: [PGI June 03]

- a. 125 mL/min
- b. 90 mL/min
- c. 60 mL/min
- d. 150 mL/min

15. In humans, effective renal blood flow is: [AIIMS 93]

- a. 425
- b. 525
- c. 625
- d. 725

16. Which of the following does not form a filtration barrier in nephrons? [AI 95]

- a. Podocytes
- b. Mesangium
- c. Endothelial cell
- d. Basement membrane

17. In renal disease albumin is first to appear in urine because: [AIIMS 04]

- a. Of its high concentration in plasma
- b. Has molecular weight slightly greater than the molecules normally getting filtered
- c. High albumin: globulin ratio
- d. Tubular epithelial cells are sensitive to albumin

18. Which of the following is freely filtered by kidney across glomerular capillaries? [PGI Nov 09, Dec 07]

- a. Albumin (across glomerular capillaries)
- b. Globulin
- c. Creatinine
- d. HCO_3^-
- e. Glucose

19. Best test for GFR is with: [PGI Dec 99]

- a. Inulin
- b. Hippuric acid
- c. Creatinine
- d. PAH

20. Two substances that can probably be used to determine nitration fraction are: [PGI 98]

- a. Insulin and mannitol
- b. Urea and diodrast
- c. PAH and phenol red
- d. Inulin and PAH

21. A substance is present in concentration of 2 mg% in the afferent arteriole and zero mg% in the efferent. True about the substance is: [AIIMS May 02]

- a. It is free filtered in glomerulus
- b. Secreted in cortical nephron
- c. Absorbed in PCT
- d. Impermeable in loop of Henle

22. All of the following statements about renal physiology are true, except: [AI 09]

- a. Distal tubule always receives hypo-osmotic solution
- b. The kidneys receive 5% of the cardiac output
- c. GFR is controlled by resistance in afferent and efferent arterioles
- d. The Glomerulus receives capillaries from the afferent arteriole

23. Which of the following statements about renal function is not true? [AIIMS Nov 11]

- a. Oncotic pressure of filtrate is equal to glomerular capillaries
- b. If afferent arteriole is vasoconstricted, then pressure in glomerular capillaries will fall
- c. The hydrostatic pressure of peritubular capillaries determine the glomerulotubular balance
- d. Ureteric obstruction increases the hydrostatic pressure of Bowman's space and reduces the GFR

TUBULAR TRANSPORT

RECENT MCQs

24. Inulin like secretion is seen with:

[Dec 2016]

- a. MIBG
- b. DTPA
- c. Gadolinium
- d. ^{99}Tc

25. Renin is secreted from which of the following cell:

[Dec 2016]

- a. JG apparatus
- b. Macula densa
- c. Endothelial cell
- d. Mesangial cell

26. Active reabsorption of amino acids exclusively seen in:

[Dec 2016]

- a. PCT
- b. DCT
- c. TAL
- d. CD

27. Maximum Na^+ absorption through which channel:

[Dec 2016]

- a. Na-H exchanger
- b. Na-K ATPase
- c. NKCC
- d. Na Cl

28. Main function of DCT cells:

[Dec 2016]

- a. Acidification of urine
- b. Water absorption
- c. Amino acid reabsorption
- d. HCO_3^- reabsorption

29. Plasma glucose is 400 mg/dL, GFR = 125 mL/min, T_m of glucose is 375. What is the excretion rate of glucose?

[Dec 2016]

- a. 25
- b. 125
- c. 225
- d. 375

30. Hypotonic fluid is given in:

[Dec 2016]

- a. Diabetes insipidus
- b. Cardiac tamponade
- c. Embolism
- d. MI

31. Where in the kidney does active reabsorption of sodium ions occur?

- a. Collecting duct
- b. Distal tubule
- c. Ascending limb of Henle
- d. All of the above

32. Mechanism by which water is reabsorbed from proximal convoluted tubule is:

- a. Active transport
- b. Passive transport
- c. Facilitated diffusion
- d. Osmosis

33. Proximal convoluted tubule has which type of aquaporins?

- a. Aquaporin 1
- b. Aquaporin 2
- c. Aquaporin 5
- d. Aquaporin 9

34. Glucose is transported in renal tubular cells by:

- a. K symport
- b. K^+ antiport
- c. Na antiport
- d. Na^+ cotransport

35. Over half of the potassium that appears in the urine of a patient, who has ingested some potassium salts, is derived from:

- a. Glomerular filtrate
- b. Secretion by the distal tubule
- c. Reabsorption in the proximal tubule
- d. Secretion by the loop of Henle

36. Which of the following product is primarily filtered with little secretion or reabsorption in renal tubules?

- a. Sodium b. Creatinine
c. Glucose d. Amino acids

37. Substrate which is both secreted and filtered:

- a. Uric Acid b. Glucose
c. Urea d. Na⁺

38. Which one of the following substances, actively transported by the tubular cells, has the highest Tubular Transport Maximum?

- a. Plasma protein b. Hemoglobin
c. Glucose d. Sodium

39. Aldosterone mainly acts upon:

- a. PCT b. Loop of Henle
c. Glomerulus d. Collecting duct

40. Most important buffer system present in the distal convoluted tubule:

- a. Bicarbonate b. Phosphate
c. Protein d. Ammonia

41. Bicarbonate is absorbed:

- a. Activity in PCT
b. Actively in DCT
c. Indirectly in PCT
d. Actively in DCT

42. What is the clearance of a substance, if its concentration in plasma is 10 mg%, concentration in urine is 100 mg% and urine flow is 2 mL/min?

- a. 0.2 mL/min b. 0.2 mL/min
c. 2 mL/min d. 20 mL/min

43. The plasma clearance value of glucose in a diabetes mellitus patient will be:

- a. Zero
b. Equal to that of inulin clearance
c. Greater than that of PAH clearance
d. Greater than zero

AIIMS/PGI/JIPMER

44. Which of the following statement is true? [AIIMS May 11, Nov 08]

- a. Fluid coming from the descending limb of loop of Henle is hypotonic
b. Descending limb of loop of Henle is permeable to solutes
c. If clearance of a substance is greater than GFR, then tubular secretion must be present
d. Clearance of a substance is always more than GFR if there is tubular secretion.

45. The principal site of absorption of sodium is: [AI 00]

- a. Proximal convoluted tubule
b. Distal convoluted tubule
c. Loop of Henle (thick portion)
d. Collecting duct

46. All of these are correct of renal physiology except: [PGI June 02]

- a. Sodium absorption occurs in DCT
b. Potassium is both secreted and absorbed in tubules
c. Glucose is reabsorbed in DCT
d. Hb is not excreted as it is a large molecule
e. Amino acids are reabsorbed in CD

47. In the presence of vasopressin, the greatest fraction of filtered water is reabsorbed which part of the nephron: [AI 03]

- a. Proximal tubule b. Distal tubule
c. Loop of Henle d. Collecting duct

48. Maximum absorption of water takes place in: [AI 01]

- a. Proximal convoluted tubule
b. Distal convoluted tubule
c. Collecting duct
d. Loop of Henle

49. Which one of the following statements regarding water reabsorption in the tubules is true? [AI 05, UP-08]

- The bulk of water reabsorption occurs secondary to Na^+ reabsorption
- Majority of facultative reabsorption occurs in proximal tubule
- Obligatory reabsorption is ADH dependent
- 20% of water is always reabsorbed irrespective of water balance

50. Vasopressin acts by: [PGI Dec 98]

- Water transport across collecting duct
- Water absorption at medullary ducts
- Water secretion at loop of Henle
- Water transport at PCT

51. The main site of bicarbonate reabsorption is: [AIIMS Nov 07, 97, AI 05]

- Proximal convoluted tubule
- Distal convoluted tubule
- Cortical collecting duct
- Medullary collecting duct

52. Not absorbed from the PCT: [AIIMS Nov 10]

- Na^+
- Phosphate
- HCO_3^-
- H^+

53. Which of the following occurs along with glucose transport into a cell?

- Sodium symport [AI 95, 96]
- Sodium anteport
- Potassium transport
- Amino acid transport

54. A/E-are absorbed in the DCT: [AIIMS June 97]

- Water
- Potassium
- Chloride
- Sodium

55. Potassium is maximally absorbed in which part of nephron? [JIPMER 03]

- Proximal convoluted tubules
- DCT
- Collecting ducts
- Loop of Henle

56. In a healthy individual on a normal diet, which of the following ion is completely absorbed in tubules? [JIPMER 11]

- Na^+
- K
- Cl^-
- HCO_3^-

57. Following cells are responsible for acid secretion in kidney: [JIPMER 02]

- I cells
- P cells
- Mesangial cell
- Pericytes

58. The principal site of acidification of urine is: [AI 00]

- Distal convoluted tubule
- Proximal convoluted tubule
- Loop of Henle
- Collecting duct

59. The tubuloglomerular feedback is mediated by: [AI 06]

- Sensing of Na^+ concentration in the macula densa
- Sensing of CP concentration in macula densa
- Sensing NaCl concentration in the macula densa
- Opening up of voltage gated Na^+ channels in afferent arteriole

60. According to myogenic hypothesis of renal autoregulation, the afferent arterioles contract in response to stretch induced by: [AIIMS Nov 05]

- NO release
- Noradrenaline release
- Opening of Ca^{2+} channels
- Adenosine release

61. Least clearance is for among these:

[JIPMER 04]

- a. Glucose
- b. Inulin
- c. Urea
- d. Creatinine

62. What is implied, if a drug has more renal clearance than the GFR?

[AIIMS June 00]

- a. Drug is reabsorbed in the tubules
- b. Drug is secreted in the tubules
- c. Drug is excreted in bile
- d. Drug is neither secreted, nor resorbed

63. The renal plasma flow (RPF) of a patient was to be estimated through the measurement of Para Amino Hippuric acid (PAH) clearance. The technician observed the procedures correctly but due to an error in the weighing inadvertently used thrice the recommended dose of PAH. The RPF estimated is likely to be:

[AI 03]

- a. False-high
- b. False-low
- c. False-high or false-low depending on the GFR
- d. Correct and is unaffected by the PAH overdose

COUNTER CURRENT MECHANISM

RECENT MCQs

64. Minimum urine osmolality that can be achieved by human kidney:

- a. 100 mOsm/L
- b. 80 mOsm/L
- c. 50 mOsm/L
- d. 20 mOsm/L

65. Normal range of urine osmolality (mOsm/L):

- a. 50-1400
- b. 100-1400
- c. 200-1000
- d. 300-1200

66. Maximum osmotic gradient is found in:

- a. Outer medulla
- b. Inner medulla
- c. Outer cortex
- d. Inner cortex

AIIMS/PGI/JIPMER

67. The high sodium content of the filtrate in renal medulla is because:

[AIIMS Nov 00]

- a. At the loop of Henle, there is counter current mechanism
- b. Increased blood flow to vasa recta
- c. Increased excretion of Na^+ from PCT
- d. Increased absorption of Na from PCT

68. The prime driving force for counter current multiplier system is:

[AI 06]

- a. Medullary hyperosmolarity
- b. Reabsorption of Na^+ in thick ascending limb
- c. Action of ADH via aquaporin channels
- d. Urea recycling

69. Renal medullary hyperosmolarity is due to:

[PGI June 04, 03]

- a. Increased Na^+
- b. Increased K^+ content
- c. Increased glucose
- d. Increased urea
- e. Increased potassium

70. Loop of Henle handles the following ions *except*:

[PGI June 97]

- a. Na^+
- b. K^+
- c. Cl^-
- d. Urea

71. Urinary concentrating ability of the kidney is increased by: [AI 05]

- a. ECF volume contraction
- b. Increase in RBF
- c. Reduction of medullary hyperosmolarity
- d. Increase in GFR

72. Hypertonic urine is excreted due to absorption of water in: [AIIMS Feb 97]

- a. Collecting ducts
- b. DCT
- c. Ascending part of loop of Henle
- d. Descending part of loop of Henle

73. Elimination of waste product from a normal person requires minimal amount of urine of: [PGI Dec 98]

- a. 100 mL
- b. 500 mL

- c. 100 mL
- d. 2000 mL
- e. 200 mL/min

74. Which of the following is not a component of countercurrent multiplier mechanism? [AIIMS NOV 2014]

- a. Thick ascending loop of Henle
- b. Collecting duct
- c. Vasa recta
- d. Thin descending loop of Henle

75. Which of the following is not a component of countercurrent mechanism? [AIIMS May 2015]

- a. Thick ascending loop of Henle
- b. Collecting duct
- c. Vasa recta
- d. Thin ascending loop of Henle

MISCELLANEOUS

RECENT MCQs

76. Renin is secreted by:

- a. Juxtaglomerular cells
- b. Macula densa
- c. Mesangial cells
- d. Glomerulus

77. Which of the following is most important in sodium and water retention?

- a. Renin-angiotensin system
- b. ANP
- c. BNP
- d. Vasopressin

78. Which causes raised angiotensin in blood?

- a. Increased blood volume
- b. Raised cardiac output
- c. Decreased blood pressure
- d. Increased sympathetic tone

79. Physiologically inactive form is:

- a. Angiotensin I
- b. Angiotensin II
- c. Angiotensin III
- d. Angiotensin IV

80. Erythropoietin is secreted from:

- a. Juxtaglomerular cells
- b. Macula densa
- c. Interstitial cells
- d. Glomerulus

81. Endocrine functions associated with kidney include all of the following except:

- a. Erythropoietin secretion
- b. Natriuretic peptide secretion
- c. 1,25 hydroxy D3 Formation
- d. Renin secretion

AIIMS/PGI/JIPMER**82. Renin is secreted by:** [AIIMS May 07]

- a. PCT
- b. DCT
- c. Collecting duct
- d. Juxtaglomerular apparatus

83. A/E one results in increased secretion of Renin: [AIIMS Dec 97]

- a. Renal ischemia
- b. Decreased amount of Na in DCT
- c. Decreased amount of Na⁺ in PCT
- d. Narrowing of afferent arterioles

84. True about function of angiotensin II: [PGI Nov 10]

- a. Constriction of afferent arteriole
- b. Autoregulation of GFR
- c. Secreted from endothelial
- d. Release aldosterone
- e. Increased sodium and water reabsorption

85. Angiotensin II causes all of the following except: [AIIMS May 11, AI 09]

- a. Stimulation of thirst
- b. Aldosterone secretion
- c. Increased ADH secretion
- d. Vasodilation

86. Several hormones regulate the tubular reabsorption of water and electrolytes at different sites in the nephron. Which of the following combination is correct? [AIIMS Nov 03]

- a. Angiotensin in distal tubule
- b. Aldosterone in collecting ducts

- c. ADH in proximal tubule
- d. ANP in loop of Henle

87. Erythropoietin level are increased by: [AI 98]

- a. Decrease PO₂
- b. Decrease PCO₂
- c. Decrease Hb
- d. Decrease pH

88. Which of the following hormone is not secreted by the kidney? [AI 07]

- a. Renin
- b. Angiotensin I
- c. Erythropoietin
- d. 1, 25 DHCC

89. Kidney produces: [PGI Nov 09]

- a. Vasopressin
- b. Erythropoietin
- c. Renin
- d. Angiotensinogen
- e. 25 hydroxy vit D

90. The most sensitive index for renal tubular function is: [AIIMS Nov 99]

- a. Specific gravity of urine
- b. Blood urea
- c. GFR
- d. Creatinine clearance

91. All of the following are the actions of ANP except:

[AIIMS Nov 2015]

- a. Contraction of mesangial cells
- b. Inhibition of Na⁺ reabsorption at PCT
- c. Inhibition of Na⁺ reabsorption at medullary collecting duct
- d. Dilate afferent arterioles

FUTURE TRENDS

92. The clearance of substances X, Y, and Z are studied at different concentrations in the blood (diagram below).

Which of the following statements best characterizes substance Y?

- Secreted
- Filtered
- Filtered and reabsorbed
- Filtered and secreted

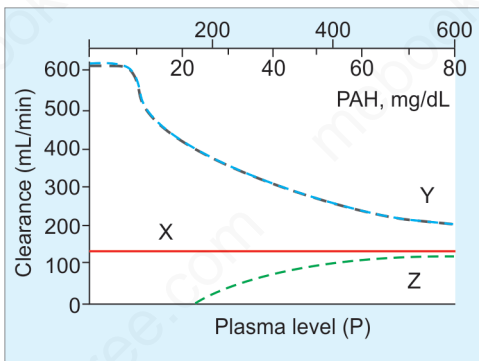

93. Relation between the plasma glucose level (P_G) and amount of glucose reabsorbed (T_G) has been shown in the following diagram. The difference between the ideal and actual graph (point X) indicate:

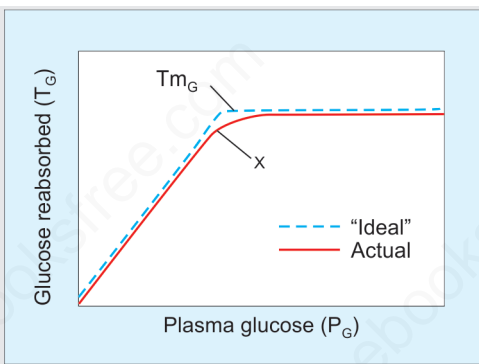

- Effective renal glucose absorption
- Transport maximum of glucose

- Glomerulotubular balance
- Splay effect

Choose the appropriate nephron site in the diagram below, for the Questions 94-97:

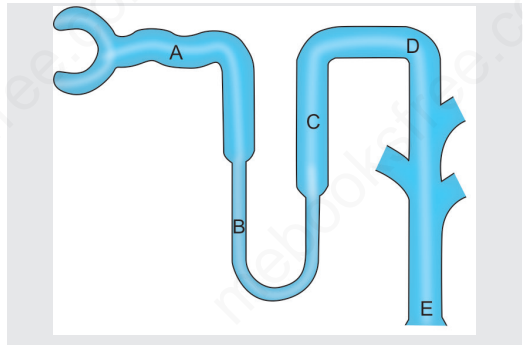

94. In a patient with severe central diabetes insipidus caused by a lack of anti-diuretic hormone secretion, which part of the tubule would have the lowest tubular fluid osmolarity?

- B
- C
- D
- E

95. In a person on a very low potassium diet, which part of the nephron would be expected to reabsorb the most potassium?

- A
- B
- C
- D

96. Which part of the nephron normally reabsorbs the most water?

- A
- B
- C
- D

97. In a normally functioning kidney, which part of the tubule has the lowest permeability to water during anti-diuresis?

- A
- B
- C
- D

Use the following clinical laboratory test results for questions 98 and 99:
Urine flow rate = 1 mL/min

Urine inulin concentration = 100 mg/mL
Plasma inulin concentration = 2 mg/mL
Urine urea concentration = 50 mg/mL
Plasma urea concentration = 2.5 mg/mL

98. What is the glomerular filtration rate (GFR)?

- a. 25 mL/min b. 50 mL/min
c. 100 mL/min d. 125 mL/min

99. What is the net urea reabsorption rate?

- a. 0 mg/min b. 25 mg/min
c. 50 mg/min d. 75 mg/min

ANSWERS WITH EXPLANATIONS

1. Ans. a. 10 mm of Hg

(Ref. Guyton-Physiology-12th edn. pp 318, 13th edn. pp 470)

Net filtration pressure is 10 mm Hg (average pressure in glomerular capillary).

Note: According to Ganong's Physiology: "The net filtration pressure (PUF) is 15 mm Hg at the afferent end of the glomerular capillaries, but it falls to zero." But here the question is not about afferent end; it's the average pressure. So, better answer is 10 mm Hg.

If question mention afferent arterioles level; go for 15 mm Hg.

2. Ans. a. Presence of negatively charged sialoproteins on the filtering membrane

(Ref. Ganong's Physiology 24th edn. pp 646)

"Sialoproteins in the glomerular capillary wall are negatively charged, and the negative charges repel negatively charged substances in blood."

3. Ans. d. All of the above

(Ref. Ganong's Physiology 24th edn. pp 646)

"The factors governing filtration across the glomerular capillaries are the size of the capillary bed, the permeability of the capillaries, and the hydrostatic and osmotic pressure gradients across the capillary wall."

4. Ans. d. Increased renal blood flow

(Ref. Ganong's Physiology 24th edn. pp 646)

Increase blood flow to the capillary, increases glomerular hydrostatic pressure.

5. Ans. d. Afferent arteriole dilates >> a. Efferent arteriole constricts

(Ref. Guyton-Physiology-12th edn. pp 318, 13th edn. pp 471)

Efferent arterioles constriction has biphasic effect on GFR. Moderate constriction increases GFR a little, but severe constriction decreases GFR.

Afferent dilation always increases GFR.

6. Ans. b. Inulin clearance

(Ref. Ganong's Physiology 24th edn. pp 645)

Inulin clearance is equal to GFR.

Inulin clearance = GFR = 125 mL/min

PAH clearance = RPF = 625 mL/min

Creatinine clearance: No longer recommended due to errors in urine collection.

7. Ans. a. Inulin

(Ref. Ganong's Physiology 24th edn. pp 645)

8. Ans. c. 125 mL/min

(Ref. Ganong's Physiology 24th edn. pp 645)

9. Ans. a. cAMP

(Ref. Ganong's Physiology 24th edn. pp 646)

PGE₂, ANP, cAMP and Dopamine causes dilation (relaxation) of mesangial cells.

10. Ans. a. Dopamine

(Ref. Ganong's Physiology 24th edn. pp 646)

11. Ans. a. Juxtaglomerular apparatus

(Ref. Ganong's Physiology 24th edn. pp 646)

The macula, the neighboring lacis cells, and the renin-secreting juxtaglomerular cells in the afferent arteriole form the juxtaglomerular apparatus. This apparatus is always present in cortex of kidney.

12. Ans. b. Ascending loop of Henle

(Ref. Ganong's Physiology 24th edn. pp 641)

The thick end of the ascending limb of the loop of Henle between its afferent and efferent arterioles forms macula densa. This macula densa along with lacis cell and JG cells forms the juxtaglomerular apparatus.

13. Ans. d. Loop of Henle

(Ref. Ganong's Physiology 24th edn. pp 641 and Raff's Medical Physiology A Systems Approach, 2011, pp 403)

"Macula densa cells, which are specialized thick ascending limb epithelial cells."

14. Ans. a. 125 mL/min

(Ref. Ganong's Physiology 24th edn. pp 645)

15. Ans. c. 625

(Ref. Ganong's Physiology 24th edn. pp 645)

Inulin clearance = GFR = 125 mL/min

PAH clearance = RPF = 625 mL/min (effective renal plasma flow)

Actual renal plasma flow = 700 mL/min.

16. Ans. b. Mesangium

(Ref. Ganong's Physiology 24th edn. pp 646)

17. Ans. b. Has molecular weight slightly greater than the molecules normally getting filtered

(Ref. Ganong's Physiology 24th edn. pp 646)

Albumin has low molecular weight in comparison to other major plasma protein. When the negative charges in the glomerular wall are dissipated, and albumin appears in urine even without an increase in the size of the "pores" in the membrane.

18. Ans. c. Creatinine d. HCO_3^- , e. Glucose

(Ref. Guyton-Physiology-12th edn. pp 318, 13th edn. pp 470)

Examples of freely filterable substances: Na^+ , K^+ , Cl^- and HCO_3^- , urea, creatinine, glucose, amino acid, organic acid (ketone body), inulin, PAH, insulin, myoglobin.

19. Ans. a. Inulin

(Ref. Ganong's Physiology 24th edn. pp 645)

Clearance of exogenous substances: Inulin, iothexol, ^{51}Cr -EDTA, ^{125}I -iothalamate, $^{99\text{m}}\text{Tc}$ -diethylenetriaminepenta-acetic acid (DTPA) gives exact measurement of GFR.

Creatinine clearance: No longer recommended due to errors in urine collection. But theoretically it gives a falsely higher value of GFR.

20. Ans. d. Inulin and PAH

(Ref. Ganong's Physiology 24th edn. pp 647)

Filtration fraction is the ration of GFR and RPF.

Inulin clearance = GFR = 125 mL/min

PAH clearance = RPF = 625 mL/min

So, FF = 0.2 = 20%

21. Ans. b. Secreted in cortical nephron >> a. It is free filtered in glomerulus

(Ref. Ganong's Physiology 24th edn. pp 641)

The substances here must have to be secreted in tubules.

Even if the substance is freely filterable, maximum filtrations that can possible in glomerulus is 20% of total plasma flow.

Remember all freely filterable substance are not zero concentration in renal vein.

22. Ans. b. The kidneys receive 5% of the cardiac output

(Ref. Ganong's Physiology 24th edn. pp 570)

Kidneys receive 20-23% of total cardiac output.

23. Ans. a. Oncotic pressure of filtrate is equal to glomerular capillaries

(Ref. Ganong's Physiology 24th edn. pp 647)

Oncotic pressure of glomerular capillary is ~32 mm Hg, but oncotic pressure of Bowman's space is 0 mm Hg as there is no proteins in filtrate.

Although oncotic pressure of peritubular capillary is the main determinant of Glomerulotubular balance, hydrostatic pressure also helps in the process.

24. Ans. b. DTPA

(Ref. J Nucl Med-1976-Barbour-317-20)

- ❑ Determination of glomerular filtration rate (GFR) requires the utilization of a substance that is freely filtered by the glomerulus and is neither secreted nor reabsorbed by the renal tubule. Inulin, a fructose polysaccharide exhibits these characteristics.
- ❑ Radioactive iothalamate (¹²⁵I) is a suitable replacement for Inulin.
- ❑ Chelating agent such as DTPA (diethylenetriaminepentaacetic acid) shows close correlation with inulin.

25. Ans. a. JG apparatus

(Ref. Ganong's Physiology 24th edn. pp 641, 25th 699)

26. Ans. a. PCT

(Ref. Ganong's Physiology 24th edn. 25th 680)

Near complete reabsorption of filtered amino acids occurs in proximal tubule via Na⁺ amino co-transporter system (secondary active transport).

27. Ans. b. Na-K ATPase

(Ref. Clin J Am Soc Nephrol; 2014, pp.1)

- ❑ All Na absorption in the PCT is driven directly or indirectly by the action of the basolateral Na,K-ATPase (basolateral location).
- ❑ Quantitatively, apical Na/H exchange mediated by NHE (Na⁺ H⁺ exchanger) is the most important reabsorptive mechanism.
- ❑ So, 100% Na⁺ reabsorption linked to Na-K-ATPase but if we have to choose max luminal transporter, then NHE is the answer.

28. Ans. a. Acidification of urine

(Ref. Ganong's Physiology 24th edn. 25th 712)

- ❑ Acidification of urine occurs in distal tubules (DCT) and collecting ducts, where H⁺ secretion is relatively independent of tubular H⁺ ion concentration.
- ❑ Water absorption in DCT is negligible.

29. Ans. b. 125

(Ref. Ganong's Physiology 24th edn. 25th 679)

Conc. of glucose 400 mg/dL = 4 mg/mL.

So, if GFR = 125.

Total amount of filtered glucose = 125 × 4 = 500 mg/min.

T_m = 375 mg/min. So, excreted = (500-375) = 125

30. Ans. a. Diabetes insipidus

(Ref. Ganong's Physiology 24th edn. 25th 679)

In Diabetes insipidus hypotonic fluid is lost. Most patients with diabetes insipidus (DI) can drink enough fluid to replace their urine losses.

31. Ans. d. All of the above

(Ref. Ganong's Physiology 24th edn. pp 649)

Na⁺ is actively transported out of all parts of the renal tubule except the thin portions of the loop of Henle.

32. Ans. d. Osmosis >> b. Passive transport

(Ref. Ganong's Physiology 24th edn. pp 652)

Water move rapidly out of the tubule along the osmotic gradients set up by active transport of solutes, and isotonicity is maintained.

33. Ans. a. Aquaporin 1

(Ref. Ganong's Physiology 24th edn. pp 652)

Aquaporin-1 is localized to both the basolateral and apical membrane of the proximal tubules.

34. Ans. d. Na⁺ cotransport

(Ref. Ganong's Physiology 24th edn. pp 650)

Glucose, amino acids, and bicarbonate are reabsorbed along with Na⁺ in the early portion of the proximal tubule.

35. Ans. b. Secretion by the distal tubule

(Ref. Ganong's Physiology 24th edn. pp 659)

Much of the filtered K⁺ is removed from the tubular fluid by active reabsorption in the proximal tubules, and K⁺ is then secreted into the fluid by the distal tubular cells. So, the person who has ingested K⁺ salt, the main K⁺ in urine is coming from secretion.

36. Ans. b. Creatinine

(Ref. Ganong's Physiology 24th edn. pp 650)

Creatinine is freely filterable at glomerulus with little secretion at PCT.

Na⁺ = 99.4% is reabsorbed, Glucose and amino acids = 100% reabsorbed.

37. Ans. a. Uric Acid

(Ref. Raff's Medical Physiology A Systems Approach, 2011, pp 656)

Urate (uric acid): Freely filterable. Almost all the filtered urate is reabsorbed early in the PCT; however, further on in the proximal tubule, urate undergoes active tubular secretion. Then, in the straight portion, some of the urate is once again reabsorbed. The total rate of tubular reabsorption is nor-

mally much greater than the rate of tubular secretion, so the mass of urate excreted per unit time is only a small fraction of the mass filtered.

Urea: Absorbed from medullary collecting duct by facilitated diffusion and diffuse back into thin ascending limb of loop of Henle. So, it is not active secretion but passive diffusion of urea.

38. Ans. c. Glucose

(Ref. Guyton-Physiology-12th edn. pp 331, 13th edn. pp 479)

T_m for Glucose = 375 mg/dL, plasma proteins = 30 mg/min. Na⁺ = does not have T_m.

39. Ans. d. Collecting duct

(Ref. Guyton-Physiology-12th edn. pp 342, 13th edn. pp 491)

Aldosterone: CD > Distal tubules > TAL

40. Ans. d. Ammonia

(Ref. Ganong's Physiology 24th edn. pp 681)

Phosphate and ammonia buffer works in distal tubules. But ammonia buffer has more capacity than phosphate. In chronic acidosis, secretion of ammonia increases in distal tubule to a high level.

41. Ans. c. Indirectly in PCT

(Ref. Raff's Medical Physiology A Systems Approach, 2011, pp 475)

Bicarbonate reabsorption in PCT lumen occurs indirectly via active secretion of H⁺ ion. In basolateral membrane HCO₃⁻ occurs passively. [Detail in text part]

42. Ans. d. 20 mL/min

(Ref. Ganong's Physiology 24th edn. pp 643)

In this problem:

Urine Conc. (U) = 100 mg% = 1 mg/mL

Urine flow (V) = 2 mL/min

Plasma conc. (P) = 10 mg% = 0.1mg/mL

So, Clearance = (UV/P) = 20 mL/min

43. Ans. d. Greater than zero

(Ref. Ganong's Physiology 24th edn. pp 643)

Clearance = (Urinary amount/Plasma conc)

In non-diabetic person, clearance of glucose is Zero as no glucose appears in urine.

In diabetic person, it will be positive (more than zero).

44. Ans. c. If clearance of a substance is greater than GFR, then tubular secretion must be present

(Ref. Ganong's Physiology 24th edn. pp 643)

Option C and D looking similar!!!

If Clearance \gg GFR, then secretion must be present. But, secretion does not mean, that clearance would be more than GFR always. Because if reabsorption occurs in a different segment of nephron after secretion, clearance may be low also. So, option D is not always correct.

45. Ans. a. Proximal convoluted tubule

(Ref. Ganong's Physiology 24th edn. pp 648)

Na⁺ absorption: Normally 60% proximal tubule, 30% thick ascending limb of the loop of Henle, 7% in the distal convoluted tubule and 3%, collecting ducts.

46. Ans. c. Glucose is reabsorbed in DCT, d. Hb is not excreted as it is a large molecule. Amino acids are reabsorbed in CD

(Ref. Ganong's Physiology 24th edn. pp 650)

Glucose and amino acid absorption is 100% in proximal tubule. Free Hb is easily excreted in glomerulus.

47. Ans. a. Proximal tubule

(Ref. Ganong's Physiology 24th edn. pp 653)

Water absorption in proximal tubules is 60-70% of the total filtrate volume (this is independent of vasopressin).

Vasopressin increases water permeability of collecting duct. In absence of this hormone,

CD absorbs only 2% of total filtrate. But in presence of vasopressin CD absorbs ~15% of total filtrate. So, whether vasopressin is present or, not maximum water is absorbed from proximal tubules only.

48. Ans. a. Proximal convoluted tubule

(Ref. Ganong's Physiology 24th edn. pp 653)

49. Ans. a. The bulk of water reabsorption occurs secondary to Na⁺ reabsorption

(Ref. Ganong's Physiology 24th edn. pp 653)

Water absorption in PCT is maximum among any parts of nephron. In PCT water is absorbed by osmosis gradient set up by active transport of Na⁺ and other solutes.

50. Ans. a. Water transport across collecting duct, b. Water absorption at medullary ducts

(Ref. Ganong's Physiology 24th edn. pp 653)

ADH acts on collecting duct.

51. Ans. a. Proximal convoluted tubule

(Ref. Raff's Medical Physiology A Systems Approach, 2011, pp 475)

Proximal tubule reabsorbs 80–90% of the filtered bicarbonate. The thick ascending limb of Henle's loop reabsorbs another 10%.

52. Ans. d. H⁺

(Ref. Raff's Medical Physiology A Systems Approach, 2011, pp 475)

H⁺ is secreted in PCT not absorbed.

53. Ans. a. Sodium symport

(Ref. Ganong's Physiology 24th edn. pp 650)

54. Ans. NONE > b. Potassium

(Ref. Ganong's Physiology 24th edn. pp 659)

Although K⁺ is also absorbed in DCT, secretion of K⁺ may exceed K⁺ absorption in this segment.

55. Ans. a. Proximal convoluted tubules

(Ref. Ganong's Physiology 24th edn. pp 659)

56. Ans. d. HCO_3^-

(Ref. Ganong's Physiology 24th edn. pp 649)

57. Ans. a. I cells

(Ref. Ganong's Physiology 24th edn. pp 679)

58. Ans. d. Collecting duct > a. Distal convoluted tubule

(Ref. Ganong's Physiology 24th edn. pp 679)

Acidification occurs in distal tubules and collecting duct. But CD is more important.

59. Ans. c. Sensing NaCl concentration in the macula densa

(Ref. Ganong's Physiology 24th edn. pp 679)

Macula densa sense both Na^+ and Cl^- but Cl^- is more important.

60. Ans. c. Opening of Ca^{2+} channels

(Ref. Ganong's Physiology 24th edn. pp 563)

Stretch on smooth muscle (afferent arterioles) opens Ca^+ channel, which causes contraction of afferent arterioles.

61. Ans. a. Glucose

(Ref. Ganong's Physiology 24th edn. pp 643)

In non-diabetic person, clearance of glucose is Zero as no glucose appears in urine.

62. Ans. b. Drug is secreted in the tubules

(Ref. Ganong's Physiology 24th edn. pp 643)

If Clearance \gg GFR, then secretion must be present.

63. Ans. b. False-low

(Ref. Ganong's Physiology 24th edn. pp 651)

At high concentration of PAH, secretory mechanism of PAH at PCT is saturated. After complete saturation, clearance of PAH falls. [Detail Figure. 15.4 in text].

64. Ans. c. 50 mOsm/L

(Ref. Ganong's Physiology 24th edn. pp 654)

In humans, the urine osmolality may be as low as 30 mOsm/kg of H_2O and the maximum osmolality of urine may reach 1400 mOsm/kg of H_2O .

65. Ans. a. 50-1400

(Ref. Ganong's Physiology 24th edn. pp 654)

[Explained above.]

66. Ans. b. Inner medulla

(Ref. Ganong's Physiology 24th edn. pp 654)

There is a gradient of osmolality from the cortex to tip of medulla.

67. Ans. a. At the loop of Henle, there is countercurrent mechanism

(Ref. Ganong's Physiology 24th edn. pp 654)

The countercurrent mechanism is a urine concentrating mechanism operated in renal medulla.

68. Ans. b. Reabsorption of Na^+ in thick ascending limb

(Ref. Guyton-Physiology-12th edn. pp 351, 13th edn. pp 483)

The major factors that contribute to the buildup of solute concentration into the renal medulla are as follows:

- ❑ Active transport of sodium ions and co-transport of potassium, chloride, and other ions out of TAL into the medullary interstitium
- ❑ Active transport of ions from CD into the medullary interstitium.
- ❑ Facilitated diffusion of large amounts of urea from the inner MCD into the medullary interstitium
- ❑ Diffusion of only small amounts of water from the medullary tubules into the medullary interstitium.

69. Ans. a. Increased Na⁺, d. Increased Urea

(Ref. Guyton-Physiology-12th edn. pp 351, 13th edn. pp 483)

[Explained above]

70. Ans. d. Urea

(Ref. Raff's Medical Physiology A Systems Approach, 2011, pp 656)

There is back diffusion of urea in ascending thin limb of loop of Henle. Here the question 'Loop of Henle handles' means active handling, not passive diffusion.

71. Ans. a. ECF volume contraction

(Ref. Raff's Medical Physiology A Systems Approach, 2011, pp 654)

ECF volume contraction is a stimulus for ADH release, and aldosterone secretion. Both of which concentrate urine.

72. Ans. a. Collecting ducts

(Ref. Raff's Medical Physiology A Systems Approach, 2011, pp 654)

Final concentration of urine is determined by water reabsorption at CD.

73. Ans. b. 500 mL

(Ref. Guyton-Physiology-12th edn pp 350, 13th edn. pp 487)

A normal 70-kilogram human must excrete about 600 milliosmoles of solute each day. If maximal urine concentrating ability is 1200 mOsm/L, the minimal volume of urine that must be excreted, called the obligatory urine volume, calculated as $600/1200 = 500$ mL.

74. Ans. c. Vasa recta

(Ref. Guyton-Physiology-12th edn. pp 351, 13th edn. pp483)

The question is about countercurrent multiplier. Counter current Mechanism: Two parts: 1. Counter current Multiplier and 2. Counter current exchanger (Vasa Recta).

[Explained in Q. No 68]

75. Ans. d. Thin ascending loop of Henle

(Ref. Guyton-Physiology-12th edn pp 351, 13th edn. pp 483)

Here the question is about countercurrent mechanism.

76. Ans. a. Juxtaglomerular cells

(Ref. Ganong's Physiology 24th edn. pp 641)

77. Ans. a. Rennin angiotensin system

(Ref. Raff's Medical Physiology A Systems Approach, 2011, pp 458)

Control of Na⁺ balance is the major mechanism for controlling ECF volume. "Sodium reabsorption is controlled by a combination of signals that affect transport proteins in the renal tubules. The main controlling signals come from renal sympathetic nerves and the RAS-aldosterone hormonal system."

78. Ans. c. Decreased blood pressure>> d. Increased sympathetic tone

(Ref. Raff's Medical Physiology A Systems Approach, 2011, pp 455)

Option c and d both are stimuli for renin secretion. Renin converts angiotensinogen to angiotensin I. **Renal hypoperfusion are potent stimuli to renin.**

79. Ans. d. Angiotensin IV

(Ref. Goodman & Gilman's The Pharmacological Basis of Therapeutics, Chapter 28)

AngI is <1% as potent as AngII. AngIII and AngII have qualitatively similar effects; both stimulate aldosterone secretion with equal potency, but AngIII is only 25% and 10% as potent as AngII in elevating blood pressure and stimulating the adrenal medulla, respectively.

Angiotensin III produces the hexapeptide sometimes called angiotensin IV, which is also said to have some activity.

80. Ans. c. Interstitial cells

(Ref. Ganong's Physiology 24th edn. pp 677)

- ❑ In adults, about 85% of the erythropoietin comes from the kidneys and 15% from the liver.
- ❑ Erythropoietin is produced by interstitial cells in the peritubular capillary bed of the kidneys and by perivenous hepatocytes in the liver.

81. Ans. b. Natriuretic peptide secretion

(Ref. Ganong's Physiology 24th edn. pp 670)

The kidneys produce three hormones: 1,25-dihydroxychole-calciferol, renin, and erythropoietin. Natriuretic peptides, substances secreted by the heart.

82. Ans. d. Juxtaglomerular apparatus

(Ref. Ganong's Physiology 24th edn. pp 641)

83. Ans. NONE >> c. Decreased amount of Na⁺ in PCT

(Ref. Raff's Medical Physiology A Systems Approach, 2011, pp 453)

Stimuli for renin release:

- ❑ Renal hypoperfusion and hypotension
 - ❑ Sympathetic stimulation
 - ❑ Decrease NaCl in macula densa.
 - ❑ Renal ischemia triggers the release of renin
- So, NaCl amount in PCT is not a direct stimulus for renin. But decrease NaCl in PCT also delivers low NaCl to distal tubules (macula densa). This can stimulates renin.

84. Ans. a. Constriction of afferent arteriole, b. Autoregulation of GFR, d. Release aldosterone, e. Increased sodium and water reabsorption

(Ref. Ganong's Physiology 24th edn. pp 672)

[Detail explanation in text]**85. Ans. d. Vasodilation**

(Ref. Ganong's Physiology 24th edn. pp 672)

It is one of the most potent vasoconstrictor in body.

86. Ans. b. Aldosterone in collecting ducts

(Ref. Ganong's Physiology 24th edn. pp 672)

[Detail explanation in text]**87. Ans. a. Decrease PO₂**

(Ref. Ganong's Physiology 24th edn. pp 672)

The usual stimulus for erythropoietin secretion is hypoxia, but secretion of the hormone can also be stimulated by cobalt salts and androgens.

88. Ans. b. Angiotensin I

(Ref. Ganong's Physiology 24th edn. pp 670)

[Explained in Q. No 78]

89. Ans. b. Erythropoietin, c. Renin, e. 25 hydroxy vit D

(Ref. Ganong's Physiology 24th edn. pp 670)

90. Ans. a. Specific gravity of urine

(Ref. Encyclopedia of urology By B. Fey et al.)

Specific gravity of urine and urea concentration of urine are most valuable test for tubular function.

91. Ans. a. Contraction of mesangial cells, b. Inhibition of Na⁺ reabsorption at PCT.

(Ref. Guyton-Physiology-12th edn. pp 342, 13th edn. pp 490)

Both a and b are wrong.

ANP causes relaxation of mesangial cell and has no action on PCT reabsorption. But ANP may have some indirect action on PCT. So, better choice a.

[Detail explanation in text]

92. Ans. d. Filtered and secreted.

X-Inulin, Y-PAH, Z-glucose or amino acids.

93. Ans: d. Splay effect

The difference between actual and ideal curve is splay effect.

94. Ans. d. Point E

In the absence of ADH, the late distal tubule and CD are not permeable to water. Therefore, the tubular fluid, which is already dilute when it leaves the loop of Henle (about 100 mOsm/L), becomes further diluted as it flows through the late distal tubule and CD as electrolytes are reabsorbed. Therefore, the final urine osmolarity in the complete absence of ADH is less than 100 mOsm/L.

95. Ans. a. Point A

About 65% of the filtered K^+ is reabsorbed in the proximal tubule, and another 20% to 30% is reabsorbed in the loop of Henle. Although most of the daily variation in K^+ excretion is caused by changes in potassium secretion in the distal and CD, only a small percentage of the filtered K^+ load can be reabsorbed in these nephron segments.

96. Ans. a. Point A

The proximal tubule normally absorbs ~65% of the filtered water, with much smaller percentages being reabsorbed in the DTL

and in the distal and collecting tubules. The TAL is relatively impermeable to water and therefore reabsorbs very little water.

97. Ans. c. Point C

The TAL is relatively impermeable to water even under conditions of maximal antidiuresis.

98. Ans. b. 50 mL/min

GFR is equal to inulin clearance, which is calculated as the urine inulin concentration (100 mg/mL) \times urine flow rate (1 mL/min) plasma inulin concentration (2 mg/mL), which is equal to 50 mL/min.

99. Ans. d. 75 mg/min

The net urea reabsorption rate is equal to the filtered load of urea (GFR [50 mL/min] \times plasma urea concentration [2.5 mg/mL]) - urinary excretion rate of urea (urine urea concentration [50 mg/mL] \times urine flow rate [1 mL/min]). Therefore, net urea reabsorption = (50 mL/min \times 2.5 mg/mL) - (50 mg/mL \times 1 mL/min) = 75 mg/min.

SECTION

7

Gastrointestinal System

C H A P T E R

16. Gastrointestinal Physiology

CHAPTER

16

Gastrointestinal Physiology

STRUCTURE–FUNCTION RELATIONSHIP

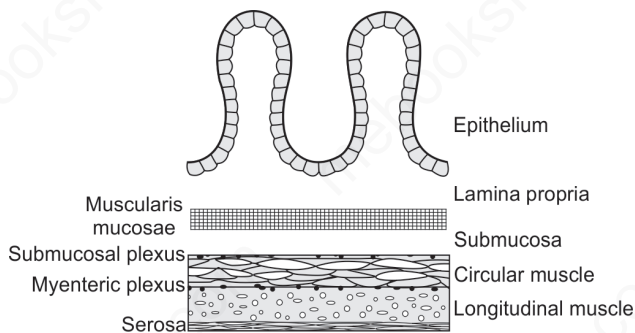

Fig. 16.1: The general histology of the wall of the GI tract, seen in transverse cross section

- ❑ **The mucosa** consists of three components (Fig. 16.1):
 1. **Epithelium**—secretes fluid and electrolytes, enzymes, or mucus into the lumen.
 2. **Lamina propria**—consists primarily of connective tissue. Blood vessels and lymph nodes are found within this layer.
 3. **Muscularis mucosae**—contractions of this layer change the shape of the mucosa, producing ridges and valleys that alter the absorptive or secretory area.
- ❑ **The submucosa** consists primarily of collagen and elastin loosely woven into a connective tissue that contains some glands and the larger blood vessels. It also contains network of nerves called the submucosal plexus or Meissner's plexus.
- ❑ **The smooth muscle** responsible for motility of the GI tract is found in an inner, circular layer and an outer, longitudinal layer. Between the circular and longitudinal muscle layers is the second nerve network, called the myenteric plexus or, Auerbach's plexus.

I IMPORTANT

- ❖ The entire epithelium of the small intestine is replaced every 3–6 days, making it one of the fastest growing tissues of the body.

I IMPORTANT

- ❖ *Segmentation is the predominant motility in fed state.*

I IMPORTANT

- ❖ MMC (migrating motor complex) is the main motility in fasting stage

I IMPORTANT

- ❖ **BER starts from mid portion of stomach. (A site along the greater curvature in the proximal body serves as the dominant pacemaker to entrain the rest of the stomach).**

Some Important Points of Small Intestine Structure

- ❑ Finger like projection Villi ~1mm and 20-40 villi per mm² area.
- ❑ Villi are covered by layer of columnar cell, which possess a brush border (microvilli).
- ❑ Brush border lined by glycocalyx.
- ❑ Between villi are intestinal gland known as Crypts of Lieberkuhn. They are simple tubular gland and do not penetrate muscularis mucosa.
- ❑ **The crypt cells**
 - Are the **proliferative cells of the intestine.**
 - Capable of **secreting fluid and electrolytes.**
 - Some cells differentiate into **mucus-secreting goblet cells.**
 - A few cells migrate to the bottom of the crypts and become **Paneth cells** which secretes **defensing (antibiotic natural)** and **guanylin**, regulates Cl-secretion in testine.

GASTROINTESTINAL MOTILITY**Types of Motility**

- ❑ Electrical activity: BER (basic electric rhythm)
- ❑ Mechanical activity:
 - Fed state motility:
 - Peristalsis (mass movement is a modified peristalsis in large gut)
 - Segmentation (Haustriation is a modified segmentation in large gut)
 - Fasting state motility: MMC (migrating motor complex)

BER (BASIC ELECTRIC RHYTHM)

The smooth muscle of the GIT shows a spontaneous, rhythmic *fluctuation in their membrane potentials* (between -65 mV and -45 mV); this is called *basic electrical rhythm or, BER.*

- ❑ **Site:** BER is present throughout GIT *except* the *esophagus* and *proximal* portion of the *stomach.*
- ❑ **Cause:** BER caused by pacemaker cells, called the *interstitial cells of Cajal.*
- ❑ **Location of the cells of Cajal:**
 - **Stomach and small intestine:** outer circular muscle layer near the myenteric plexus (Upper part of GIT-Upper circular. Lower part-Lower circular muscle).

- **Colon:** Submucosal border of the outer circular muscle layer

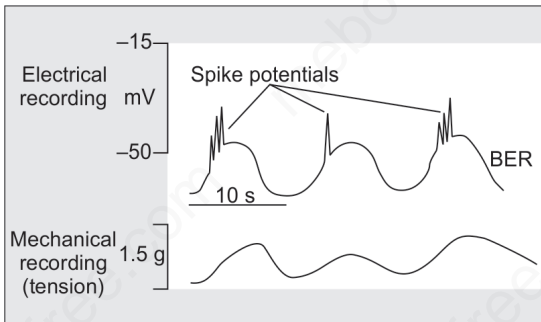

Fig. 16.2: Basic electrical rhythm (BER) of gastrointestinal smooth muscle: Morphology, and relation to muscle contraction

I IMPORTANT

❖ Rate of BER in different parts of GIT:

Site	Rate of BER
Stomach	4/min
Duodenum	12/min (maximum)
Proximal jejunum	11-12/min
Distal ileum	8/min
Caecum	2/min (minimum)
Sigmoid	6/min

- ❑ **Function:** *BER never causes contraction but coordinates different types of contractions like peristalsis and other “motor activity” of the GIT. The spike potentials superimposed on the most depolarizing portions of the BER waves cause contraction and increases muscle tension (Fig. 16.2). The depolarizing phase of these spike potentials is due to Ca^{+2} influx and their repolarization phase is due to K^{+} efflux.*
- ❑ **Factors affecting BER:** *Acetylcholine increases the number of spike potentials (and thus increases muscle tension) whereas epinephrine decreases the number of spike potentials (and thus decreases muscle tension). So, force of contraction depends on spike potential frequency not the amplitude (Fig. 16.3).*

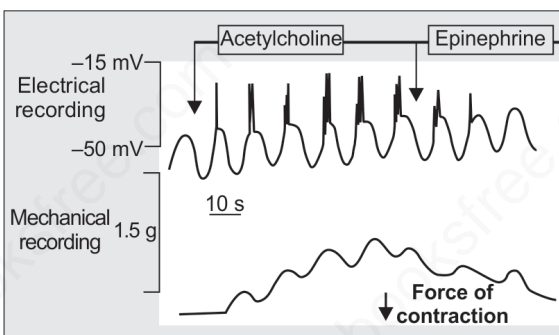

Fig. 16.3: Basic electrical rhythm (BER) of gastrointestinal smooth muscle: Stimulatory effect of acetylcholine and inhibitory effect of epinephrine

I IMPORTANT

- ❖ The peristalsis wave moves from an oral to caudal direction and helps in moving the contents of the GIT at a rate of 2–25 cm/s.

PERISTALSIS

- ❑ This is a reflex contraction of the gut wall to stretch (e.g. by food). It is present throughout the GIT (**from the esophagus to the rectum**). Stretching the gut wall causes a wave of contraction and relaxation, viz. an area of circular contraction behind the stretch and an area of relaxation in front of it.
- ❑ **Cause/mechanism:** Peristalsis occurs due to the integrated activity of the intrinsic system *i.e.* the enteric nervous system; however, the input from the extrinsic autonomic nervous system can increase/decrease it. If a segment of intestine is removed and the cut ends are joined in their original position, peristalsis still occurs. However, if the ends are reversed and then joined, peristalsis does not occur.
- ❑ **Possible sequence of events:** Stretch → releases *serotonin*, which stimulates the myenteric plexus. From the myenteric plexus, cholinergic neurons go two directions: (i) In a retrograde direction to activate neurons that release *substance P and acetylcholine* these cause the *contraction*. (ii) In an anterograde direction to activate neurons that release *NO, VIP and ATP* these cause the *relaxation* in front of the stimulus.

MASS MOVEMENT

- ❑ Special type of peristalsis observed in colon only.
- ❑ Occurs 3-4 times per day after meal, each contraction last for 3 min. Strong mass movement initiate after morning meal.
- ❑ Mass movement is more prominent in infant.
- ❑ Starts due to distension of colon and propagate like contraction ring.
- ❑ Mass movement forces the fecal matter into rectum and rectum distension initiate defecation reflex.
- ❑ **Mass movement initiated by:**
 - Gastrocolic or, duodenocolic reflex
 - Intense stimulation of parasympathetic nerve
 - Distension of colon
- ❑ **Mass movement abolished by:**
 - Destruction of Auerbach's plexus. Although the proximal part of colon is innervated by extrinsic nerve (vagus). It is relatively autonomous.

I IMPORTANT

- ❖ Post-prandial motility of colon (Gastrocolic reflex) is maximum in Sigmoid colon >> Transverse colon

- Distal part of colon is more depended on extrinsic innervation (vagus). So, movement of this region is abolished after injury to nerve.

SEGMENTATION

- ❑ This is the predominant motor activity in the fed individual and divides the bowel into segments, which accounts for the name segmentation given to this pattern. This is a nonpropulsive movement occurs in a to and fro manner, that's why it is also known as pendulous movement.
- ❑ Segmentation contractions move chyme in both directions, which allow greater mixing with the secretions of the intestines. Unlike peristalsis, segmentation actually can slow progression of chyme through the system.
- ❑ Segmentation involves contractions of the circular muscles in the digestive tract, while peristalsis involves rhythmic contractions of the longitudinal muscles in the GI tract.

MIGRATING MOTOR COMPLEX (MMC)

The motor and electrical activities of smooth muscle in GIT that *occur* during *fasting* (between periods of digestion) are called *migrating motor complex* or *MMC*. They are so called because the motor activity starts from the *stomach* and migrates *to* the *distal ileum*.

- ❑ **Control:** **Motilin** hormone controls MMC. Motilin secreted by Mo cell of stomach and duodenum, jejunum, ileum and colon. Maximum duodenum-Jejunum.
- ❑ **Function:** This is not fully clear. There is an increase in pancreatic and gastric secretion well as bile flow during each MMC. The function of MMC may be to *clear the contents* of the stomach and small intestine in between the meals. On taking *food*, *MMC stops* immediately and is replaced by peristalsis and other forms of BER and spike potentials.

GASTRIC EMPTYING

- ❑ *The main pathways regulating these processes are predominantly neural and consist of vagovagal reflexes.*

I IMPORTANT

- ❖ **Segmentation contractions occur in the large intestine and small intestine.**
- ❖ **Start from:** Both duodenum and ileum start segmentation simultaneously in response to local distension.
- ❖ **Rate of segmentation:** Is similar to BER rate (12 in duodenum and so).

I IMPORTANT

- ❖ **MMC rate:** During the period of **fasting**, MMCs move down the GIT at a regular rate of approximately **5 cm/min**. They are completely **inhibited** by a **meal**; they **resume 90–120 minutes after the meal** and **occur at interval** of about **90 minutes** till the next meal.

I IMPORTANT

Hormone:

- ❖ Stimulates gastric emptying is **Gastrin**.
- ❖ Inhibits gastric emptying are CCK, secretin and gastric inhibitory peptide (GIP).

I IMPORTANT

- ❖ CCK may act as a hormone not only to inhibit gastric emptying but also to stimulate vagal afferent fiber discharge to produce a vagovagal reflex-mediated decrease in gastric emptying.

I IMPORTANT

- ❖ **The most rapidly emptying substance in stomach is isotonic saline.** Both hypo- and hypertonic saline empty more slowly.
- ❖ The addition of **calories**, especially in the form of lipids, or **acid** further slows emptying. Of the food groups, **fat is emptied at the slowest rate.**

- ❑ Regulation of gastric emptying is done by receptors present at the upper intestine. The receptors respond to physical property (osmolality of food) and chemical composition (H⁺/Lipid). Receptor activation triggers various neural and hormonal mechanisms that inhibit gastric emptying.

Factors that affects gastric emptying: After a normal mixed meal, the stomach may contain 1500 mL of solids, ingested liquids, and gastric juice that take ~3 hrs to empty into the duodenum.

1. In general, the greater the volume, the more rapidly the contents empty. Distension of stomach triggers neural reflex and gastrin release, which increases motility.
2. Liquids empty more rapidly than solids, and solids must be reduced in size to particles of 2 mm to 3 mm or less for emptying to occur.
3. Type of food:
 - Carbohydrate rich food causes rapid gastric emptying.
 - Protein causes slower emptying and **fat** causes **slowest** emptying.
4. Duodenal factors:
 - Distension of duodenum, acidity of content (pH < 4) and high or, low osmolality of chyme (fat/protein products) via *enterogastric reflex* inhibits gastric emptying. *This reflexes are especially sensitive to the presence of irritants and acids in the duodenal chime.*

HORMONAL CONTROL OF INTESTINAL MOTILITY

- ❑ **Increase motility:** CCK, motilin, VIP, gastrin, serotonin and ghrelin.
- ❑ **Decrease motility:** Secretin, glucagon and hydrogen sulfide.
 - The main action of motilin is to stimulate the motility of stomach and small intestine (during fasting stage) but its potency is half of that of CCK.
 - So, CCK is the major hormone for intestinal motility.

Hormone	Major effect on intestine
Gastrin	Stimulates gastric emptying. Increase intestinal contraction but less clear effect on intestinal transit time.
CCK	Increases intestinal contraction, mixing of intestinal content and increase transit
Motilin	Increase transit (fasted motility)
VIP	Increase duodenal contraction and increase transit.

I IMPORTANT

Pancreatic polypeptide:

- ❖ PP cells are found in the periphery of pancreatic islets.
- ❖ There is a clear PP response to the ingestion of a meal.
- ❖ *The nutrients that stimulate gastrin and CCK secretion also stimulate PP secretion.*

Ref. Shackelford's Surgery of the Alimentary Tract By C.J. Yeo et al.

GASTROINTESTINAL HORMONES

	Gastrin	CCK-PZ	Secretin	GIP
Site	G-cells (antrum is the major site) Low levels present in: vagus nerve, pituitary corticotrophs, fetal pancreatic islets and colon	I-cells of proximal two-thirds of the small intestine	S-cells-upper small intestine	K cells- proximal intestinal crypts
Actions	<ul style="list-style-type: none"> • Stimulates acid (main action) and pepsin. • Stimulates gastric motility. • Stimulates insulin. • Stimulates glucagon. • Acts as a growth factor to stimulate mucosal proliferation. 	<ul style="list-style-type: none"> • Stimulates pancreatic acinar cell enzymes secretion (Main). • Stimulates GB contraction • Relaxes sphincter of oddi • Inhibits gastric emptying. • Inhibits gastric acid secretion • Augments pyloric sphincter contraction. • May increase motility of SI and colon. • Augments secretin actions. 	<ul style="list-style-type: none"> • The major effect is the secretion of bicarbonate from biliary and pancreatic ductular cell and Brunner glands. • Inhibits gastric acid secretion. • Stimulate pyloric sphincter. • Increases bile flow. • Augments the actions of CCK 	Stimulates insulin release from pancreas which is the only physiological action of this hormone
Stimulating factors	<ul style="list-style-type: none"> • Peptides (most potent) • Distension of stomach • Calcium • GRP (Gastrin releasing peptide) 	<ul style="list-style-type: none"> • Peptides (most potent) • Fatty acid (but NOT Triglyceride). Fat should be in a digestible form. • Carbohydrates are ineffective 	<ul style="list-style-type: none"> • Acid is the most potent stimulus. • Protein digestive products. 	This is the only GI hormone stimulated by 3 types of food— glucose, fat and amino acid

GIP is glucose-dependent insulinotropic polypeptide (gastric inhibitory polypeptide—old name)

GASTROINTESTINAL SECRETION

	Volume (in L/day)	Osmolality mOsm/L	pH	Na ⁺ (mEq/L)	K ⁺ (mEq/L)	Cl ⁻ (mEq/L)	HCO ₃ ⁻ (mEq/L)
Plasma	3	300	7.4	150	5	110	24
Saliva	1.5	100 Hypotonic	6-8	15	20-30	15	30
Gastric Juice	1-2	300 Isotonic	1.5-3.5	50-90	5-30	130	0
Pancreatic juice	0.5-1	300 Isotonic	8-9	140	5-10	75	90-115
Bile	0.5-1	300 Isotonic	7-9	145	5-10	100	35
Small intestine	1-3	Isotonic	7-9	120-140	10-20	80	20-40
Colon	0.2	Isotonic	7.5-8.0	60	30	40	0

Ref. Fluid and electrolyte balance; By Norma Metheny and Harrison's Principle of Internal Medicine.

I IMPORTANT

- ❖ Most **alkaline** fluid is pancreatic juice and most **acidic** fluid is gastric juice.
- ❖ **Maximum K⁺ concentration** is seen in **large (colonic)** fluid followed by Saliva. But maximum amount (concentration × volume) of **K⁺ secreted** per day in salivary secretion.
- ❖ **Least K⁺ concentration** or, content in bile << pancreas << gastric

I IMPORTANT

- ❖ **Maximum Na⁺ concentration** in **bile > pancreatic > small intestinal secretion.**
- ❖ **Maximum Cl⁻ concentration** is seen in **stomach > bile.**
- ❖ **Maximum HCO₃⁻ secretion** is by **pancreas > ileum**

BILE SECRETION

- ❑ Secreted by liver- 500 mL per day
- ❑ Maximum absorption in **terminal ileum** and undergo **enterohepatic circulation.** (Occurs **5-12 times per day**)
- ❑ Mechanism for the secretion of bile by the hepatocytes: The secretion of bile is the result of the active secretion of osmotically active compounds by hepatocytes into the canalicular space followed by the passive movement of water through the tight junctions. These osmotically active compounds include organic (bile acids, glutathione, glutathione-conjugated compounds, and glucuronide-conjugated substances) and inorganic anions (bicarbonate and chloride).
- ❑ Because bile acids are the major solutes in bile, they are considered the major osmotic driving force in the generation of bile flow.
- ❑ Concentration of bile occurs in the gallbladder (5 fold, max up to 20 fold). Most of this gallbladder absorption is caused by active transport of Na⁺ through the gallbladder epithelium, and this is followed by secondary absorption of Cl⁻, water, and most other diffusible constituents.

Expulsion of Bile

- ❑ The gallbladder begins to contract rhythmically within 30-min of a meal.
- ❑ The principal stimulus is hormonal, although it is stimulated by vagal activity also.

- ❑ The **major stimulus** for gallbladder contraction is **CCK** released by fat and protein digestion products within the lumen of the duodenum.
- ❑ CCK has two actions that result in bile expulsion: It contracts the smooth muscle of the gallbladder and relaxes the sphincter of Oddi.
- ❑ **Secretin** stimulates **water and HCO₃⁻** secretion into the bile and augment GB contraction induced by CCK.
- ❑ GIP has no effect on GB contraction.

SALIVARY SECRETION

- ❑ Saliva secreted in the acini is isotonic, with concentrations of Na⁺, K⁺, Cl⁻, and HCO₃⁻ that are close to those in plasma.
- ❑ The salivary duct cells modify the composition of the saliva by extracting Na⁺ and Cl⁻ and adding K⁺ and HCO₃⁻.
- ❑ The ducts are relatively impermeable to water. Therefore, *at low salivary flows*, the saliva that reaches the mouth is hypotonic, slightly acidic (low pH), low Na⁺, Cl⁻ and HCO₃⁻ but rich in K⁺.
- ❑ When salivary *flow is rapid*, there is less time for ionic composition to change in the ducts.
- ❑ Saliva is closer to isotonic, with high pH and higher concentrations of Na⁺ and Cl⁻ and HCO₃⁻ (HCO₃⁻ secretion is selectively stimulated when saliva secretion is stimulated) but lowest concentration K⁺ during this time.
- ❑ About 1.5 liter of saliva is secreted per day and its pH is about 7.0.

Regulation of Saliva Production

- ❑ Saliva production is unique in that it is increased by both parasympathetic and sympathetic activity. Parasympathetic activity is more important, however.
- ❑ Parasympathetic cause high volume, watery enzyme rich secretion.
- ❑ Sympathetic cause small amount of thick viscous mucous secretion.

I IMPORTANT

- ❖ **Choleretics** are substances that increase hepatic bile secretion. The most important choleretics are **bile salt**.

I IMPORTANT

- ❖ **Cholagogue** causes GB contraction. Most potent cholagogue is **CCK. Fatty acid and amino acid** in duodenum cause release of CCK, which cause GB contraction.

I IMPORTANT

- ❖ GB bile is slightly acidic (pH 6.5) in comparison to liver bile (pH 7.4).

I IMPORTANT

- ❖ Saliva contains the digestive enzyme ptyalin (salivary alpha amylase), which has a minor role in starch digestion. It also contains mucin which is a glycopeptide that lubricates the food.

GASTRIC SECRETIONS

Gastric Cell Types and Their Secretions

- ❑ Parietal cells (*oxyntic cell*), located in the body, secrete HCl and intrinsic factor.
- ❑ Chief cells (*peptic cell*), located in the body, secrete pepsinogen.
- ❑ G cells, located in the antrum, secrete gastrin.
- ❑ Mucous neck cells in oxyntic gland, which secrete mainly mucus.

Stimuli for Gastric Secretion (Fig. 16.4)

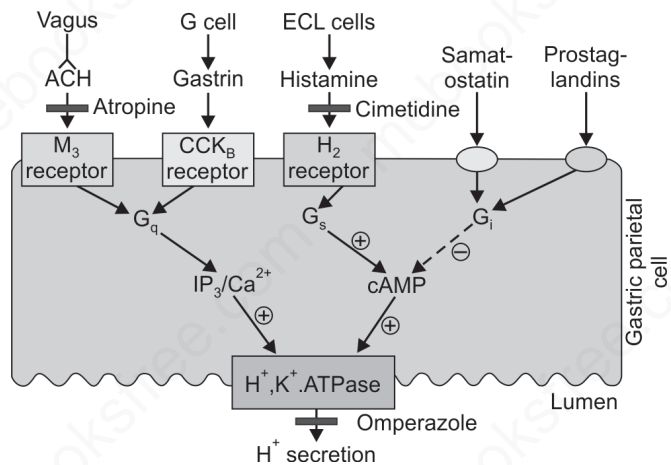

Fig. 16.4: Regulation of acid secretion in parietal cell

1. **Vagal stimulation:** Increases H^+ secretion by a direct pathway and an indirect pathway.
 - In the direct path, the vagus nerve innervates parietal cells and stimulates H^+ secretion directly. The neurotransmitter at these synapses is ACh, the receptor on the parietal cells is muscarinic (M_3).
 - In the indirect path, the vagus nerve innervates G cells and stimulates gastrin secretion, which then stimulates H^+ secretion by an endocrine action. The neurotransmitter at these synapses is GRP (not ACh).
 - Atropine, a cholinergic muscarinic antagonist, inhibits H^+ secretion by blocking the direct pathway only, not the indirect pathway.

2. **Gastrin:** Is released in response to eating a meal.
 - Stimulates H^+ secretion by interacting with the cholecystokinin B (CCK_B) receptor on the parietal cells (direct action).
 - Stimulates the release of histamine from ECL cell. Histamine causes acid secretion (indirect action). **Indirect action is the major pathway of acid secretion by gastrin.**
3. **Histamine:** Is released from enterochromaffin-like (ECL) cells in the gastric mucosa and diffuses to the nearby parietal cells.
 - Stimulates H^+ secretion by activating H_2 receptors on the parietal cell membrane.

Inhibition of Gastric H^+ Secretion

1. **Low pH (<3.0):** In the stomach inhibits gastrin secretion and thereby inhibits H^+ secretion.
2. **Somatostatin:** Inhibits gastric H^+ secretion by a direct pathway and an indirect pathway.
 - In the direct pathway: Somatostatin binds to receptors on the parietal cell that are coupled to adenylyl cyclase via a G_i protein, thus inhibiting adenylyl cyclase.
 - In the indirect pathway: Somatostatin inhibits release of histamine and gastrin, thus decreasing H^+ secretion indirectly.
3. **Prostaglandins:** Inhibit gastric H^+ secretion by activating a G_i protein, inhibiting adenylyl cyclase and decreasing cAMP levels.
4. The presence of food, protein breakdown products, irritant in upper intestine (reverse enterogastric reflex).

Phases of Acid Secretion

- ❑ Basal or interdigestive secretion is that which occurs in the absence of all gastrointestinal stimulation. Basal secretion is equal to about 10% of the maximal response to a meal. In humans, basal secretion shows a circadian rhythm, *with the highest acid output in the evening and the lowest in the morning.*
- ❑ The stimulation of acid secretion is divided into the **cephalic (20-30%), gastric (60-70%), and intestinal phases (10%).**

I IMPORTANT

❖ **Acting at H_2 receptors, histamine is the dominant physiological mediator of acid secretion.**

I IMPORTANT

❖ Secretin, gastric inhibitory peptide, vasoactive intestinal polypeptide also have slight to moderate effects in inhibiting gastric secretion.

Phases	Stimuli	Stimulator at parietal cell
Cephalic	Chewing, swallowing etc. stimulate (before food enters the stomach)	Vagus (parasympathetic)
Gastric	Distension stimulates	Local vagovagal reflexe
	Digested proteins stimulate	Gastrin-histamine
Intestinal	Distension stimulates endocrine cell which secretes	Entero-oxyntin
	Digested proteins stimulates	Circulating amino acids
All phases	Gastrin and ach stimulates ECL cell	Histamine

PANCREATIC SECRETION

Composition of pancreatic secretion

- High volume
- Virtually the same Na^+ and K^+ concentrations as plasma
- Much higher HCO_3^- concentration than plasma.
- Much lower Cl^- concentration than plasma.
- Isotonicity
- Pancreatic lipase, amylase, and proteases
- Regardless of the flow rate, pancreatic secretions are isotonic.

I IMPORTANT

- ❖ **At low flow rates**, the pancreas secretes an isotonic fluid that is composed mainly of Na^+ and Cl^- .
- ❖ **At high flow rates**, the pancreas secretes an isotonic fluid that is composed mainly of Na^+ and HCO_3^- .

Stimulation of Pancreatic Secretion

- Secretin:** Act on the pancreatic ductal cells to increase HCO_3^- secretion.
- CCK:** Acts on the pancreatic acinar cells to increase enzyme secretion (amylase, lipases, proteases). Also potentiates the effect of secretin on ductal cells to stimulate HCO_3^- secretion.
- Ach (via vago vagal reflexes):** Stimulates enzyme secretion by the acinar cells and, like CCK, potentiates the effect of secretin on HCO_3^- secretion.

ABSORPTION OF NUTRIENTS IN GIT

Absorption of Carbohydrate

- The transport of most hexoses is dependent on Na^+ in the intestinal lumen.
- Glucose and galactose** both uses the same transporter SGLT-1. SGLT-1 transports either glucose or, galactose along with Na^+ from intestinal lumen to cells (Secondary active transport).

- ❑ **Fructose** is absorbed by facilitated diffusion from the intestinal lumen into the enterocytes by GLUT 5. This process is Na^+ independent.
- ❑ For all glucose, galactose and fructose GLUT 2 is the basolateral transporter (i.e. for transport from cell into the interstitium and thence to the capillaries).
- ❑ The maximal rate of glucose absorption from the intestine is about 120 g/h.

Absorption of Protein

- ❑ **Amino acids:** At least 7 different transport systems transport amino acids into enterocytes. Five of these are Na^+ dependent cotransporter and two of these five also require Cl^- . In two systems, transport is independent of Na^+ .
- ❑ **Di- and tripeptides:** are also transported into enterocytes by a transporter known as PepT1 (or peptide transporter 1). PepT1 is a cotransporter that transports di/tripeptides along with H^+ instead of Na^+ .
- ❑ Absorption of protein antigens, particularly bacterial and viral proteins, takes place in large **microfold cells or M cells**, which are specialized intestinal epithelial cells that overlie aggregates of lymphoid tissue (Peyer's patches).
- ❑ Only 2–5% of the protein in the small intestine escapes digestion and absorption.

Absorption of Fat

- ❑ Lipids enter the enterocytes by passive diffusion.
- ❑ Long chain fatty acids are transported by fatty acid transporter protein FATP4 (not simple diffusion).
- ❑ On a moderate fat intake, 95% or more of the ingested fat is absorbed.

Absorption of Iron

- ❑ Almost all iron absorption occurs in the duodenum.
- ❑ Most of the iron in the diet is in the ferric (Fe^{3+}) form, whereas it is the ferrous (Fe^{2+}) form that is absorbed.
- ❑ Fe^{3+} is converted to Fe^{2+} by ferric reductase (this enzyme activity is inherent to DMT1 transporter).
- ❑ **DMT1** transports Fe^{2+} into the enterocytes. This DMT is a proton (H^+ ion) coupled metal ion transporter also known as **Nramp2** transporter that is specific for Fe^{2+} and other divalent cations Zn, Mn, Co, Cd, Cu, Ni, Pb.

I IMPORTANT

Absorption of nutrients in GIT

- ❖ Nutrients are absorbed along the entire length of small intestine, with the following exceptions:
 - **Folate and iron are only absorbed in duodenum (maximum) and proximal jejunum.**
 - **Bile salt and cobalamin are maximally absorbed in distal ileum. Very small amount can be absorbed in upper intestine also.**
- ❖ Bile salts are absorbed by Na -dependent co-transport.

I IMPORTANT

- ❖ Calcium is best absorbed in proximal small intestine by Vit.D dependent carrier protein TRPV6. Mg^{+2} also absorbed in the same site by TRPV6 and TRPV7. Calbindin is an intracellular protein which helps in calcium absorption (buffers intracellular Ca^{2+}).

I IMPORTANT

- ❖ **Carbohydrate, proteins and lipids are maximally absorbed in duodenum, somewhat less in jejunum and much less in ileum.**

I IMPORTANT

- ❖ All fat-soluble vitamins A, D, E, and K absorption occurs with micelles formation. So, maximum absorption occurs in upper small intestine (duodenum max).
- ❖ All water-soluble vitamins are absorbed in the upper small intestine, except vitamin B12 which is absorbed in the ileum.

- ❑ Some of the absorbed Fe^{2+} is stored as ferritin inside enterocyte and the remainder is transported out of the enterocytes by a basolateral transporter named **ferroportin 1**.
- ❑ **Hephaestin (Hp)** is associated with ferroportin 1. It is not a transporter itself, but it facilitates basolateral transport.
- ❑ In the plasma, Fe^{2+} is converted to Fe^{3+} and bound to the iron transport protein **transferrin**.

Absorption of Water

- ❑ The daily fluid load approximates 9 L in normal adults.
- ❑ Small intestinal absorption is 7000 mL (78%): Jejunum 5 to 6 L daily and ~2 L in Ileum.
- ❑ Colonic absorption 1900 mL (21%)
- ❑ Stool 100 mL (1%)

Dietary Fiber

- ❑ Dietary fiber obtained from plant food, most of them polysaccharide residing in cell walls.
- ❑ Resistant to digestion by the endogenous enzymes of gastrointestinal tract.
- ❑ Dietary fibers are:
 - Carbohydrate- pectin, cellulose, hemicellulose
 - Noncarbohydrate- lignin

Functions

- ❑ A high fiber meal is bulky in relation to caloric content. It stimulates the softness and frequency of fecal matter.
- ❑ Post-prandial glycemia is reduced.
- ❑ Reduced blood cholesterol level.
- ❑ Protect from colonic cancer. Reduced incidence of diverticulitis, irritable bowel syndrome.

I IMPORTANT

- ❖ Vitamin B12 absorption and folate absorption are Na^+ independent, but all seven of the remaining water-soluble vitamins (thiamin, riboflavin, niacin, pyridoxine, pantothenate, biotin, and ascorbic acid) are absorbed by carriers that are Na^+ cotransporters..

Short-chain fatty acids (SCFAs):

- Two- to five-carbon weak acids.
- About 60% of this total is acetate, 25% propionate, and 15% butyrate.
- Produced in the colon by the action of colonic bacteria on complex carbohydrates, resistant starches, and other components of the dietary fiber, that is, the material that escapes digestion in the upper gastrointestinal tract and enters the colon.

Contd...

Contd...

- They are absorbed from colon by specific transporters present in colonic epithelial cells. SCFAs also promote the absorption of Na^+ .
- **Functions:**
 - Significant contribution to total caloric intake.
 - They exert a trophic effect on the colonic epithelial cells, combat inflammation, and maintain acid-base equilibrium.

CONTROL OF FOOD INTAKE AND METABOLIC RATE

Regulation of Food Intake

The hypothalamus contains:

- ❑ Hunger centers (feeding center): Lateral hypothalamic (LH) nuclei
- ❑ Satiety centers: Ventromedial hypothalamic (VMH) nuclei
- ❑ The paraventricular and arcuate nuclei of the hypothalamus also play a major role in regulating food intake.
- ❑ Arcuate nuclei are the sites in the hypothalamus where multiple hormones released from the gastrointestinal tract and adipose tissue converge to regulate food intake, as well as energy expenditure.

Neurons and Neurotransmitters in the Hypothalamus (Fig. 16.5)

Two groups of neurons in the arcuate nuclei control appetite and energy expenditure:

1. Pro-opiomelanocortin (POMC) neurons that produce α -melanocyte-stimulating hormone (α -MSH) and cocaine- and amphetamine-related transcript (CART)
2. Neurons that produce the OREXIGENIC substances neuropeptide Y (NPY) and agouti-related protein (AGRP).
 - α -MSH (from POMC) acts on melanocortin receptors (MCR4) in neurons of the paraventricular nuclei. Activation of these receptors (MCR4) activates sympathetic system through NTS. The net effect is reduces food intake while increasing energy expenditure.

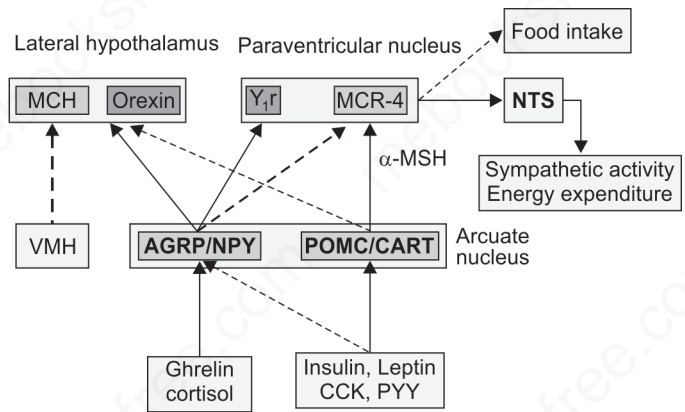

Fig. 16.5: Control of energy balance by hypothalamic neurons and peripheral signal controlling them (Solid arrow: stimulatory signal; broken arrow: inhibitory signal)

- AGRP is a natural antagonist of MCR-4 (α -MSH inhibitor) and activator of NPY receptor (Y_{1r}) on paraventricular neurons. The net result is stimulation of appetite.
- Melanin-concentrating hormone (MCH) and the orexins (also known as hypocretins) are expressed by distinct subsets of inter-mingled neurons in the LH (feeding center). Both of these peptides are orexigenic (see Fig. 16.5).
- The exact sites targeted by MCH and orexin neurons to induce feeding remain to be determined but both of these neurons are influenced by AGRP and POMC neurons of arcuate nucleus.
- **Peripheral factors:** Insulin, leptin and cholecystokinin (CCK) are hormones that inhibit AGRP-NPY neurons and stimulate adjacent POMC-CART neurons, thereby reducing food intake.
- Ghrelin, a hormone secreted from the stomach, activates AGRP-NPY neurons and stimulates food intake

I IMPORTANT

- ❖ Variations in BMR among different persons are related mainly to differences in the amount of skeletal muscle and body size.
- ❖ Skeletal muscle, even under resting conditions, accounts for 20–30% of the BMR.

I IMPORTANT

- ❖ BMR is closely proportional to lean body mass. In terms of lean body mass, difference of BMR between men and women largely disappear.
- ❖ BMR is directly proportional to body surface area.

Summary of neurotransmitters and hormones that influence feeding and satiety centers in the hypothalamus:

Decrease feeding (Anorexigenic)	Increase feeding (Orexigenic)
<ul style="list-style-type: none"> • α-melanocyte-stimulating hormone • Leptin 	<ul style="list-style-type: none"> • Melanin-concentrating hormone (MCH) • Orexins A and B

Contd...

Contd...

• Serotonin	• Neuropeptide Y (NPY)
• Norepinephrine	• Agouti-related protein (AGRP)
• Corticotropin-releasing hormone	• Endorphins
• Insulin	• Galanin
• Cholecystokinin (CCK)	• Amino acids (glutamate and γ -aminobutyric acid)
• Glucagon-like peptide (GLP)	• Cortisol
• Cocaine- and amphetamine-regulated transcript (CART)	• Ghrelin
• Peptide YY	• Endocannabinoids

Leptin

- ❑ Peptide hormone released from white adipose tissue. It is also produced by cardiomyocytes and vascular smooth muscle cells (VSMC).
- ❑ When the amount of adipose tissue increases (signaling excess energy storage), the adipocytes produce increased amounts of leptin, which is released into the blood (**so, high level in obesity**).
- ❑ **Leptin sends anorexigenic (see Fig. 16.5) signals** for the hypothalamus to decrease fat storage. Thus, leptin is an important means by which the adipose tissue signals the brain that enough energy has been stored and that intake of food is no longer necessary.
- ❑ In most obese humans, however, plasma leptin levels increase in proportion with increasing adiposity (*Obesity is associated with leptin resistance*).
- ❑ Leptin expression increases after food intake (**postprandial**) and decreases during fasting and diabetes.
- ❑ Leptin may be a link between body weight and onset of puberty (**leptin regulates the circadian rhythms of the gonadotrope**). Leptin plays a *permissive role* in this process, as leptin-deficient individuals fail to enter puberty.
- ❑ Leptin also stimulates thermogenesis.
- ❑ Leptin also enhances immune response, and regulates inflammation, coagulation, fibrinolysis, and platelet aggregation.

- ❑ The leptin acts via Janus Kinase-Signal transducer and activator of transcription-3 (**JAK-STAT3**) pathway.
- ❑ Leptin circulates in the blood at a level of 5 to 15 ng/mL in lean individuals. This level may reach up to 50 ng/mL in obese individuals.

Ghrelin

- ❑ **Ghrelin is an orexigenic signal (appetite stimulant) for the hypothalamus (see Fig 16.5).**
- ❑ It is produced mainly by the stomach (main), pancreas and adrenal glands in responses to changes in nutritional status.
- ❑ Circulating ghrelin levels increase **preprandially** (peak just before eating) and decrease after a meal.
- ❑ It increases synthesis and/or release of central orexins, including NPY and cannabinoids, and suppresses the leptin action.

Peptide YY

- ❑ Highest concentrations in enteroendocrine cells in the distal ileum and colon, mainly in the basal crypts of L cells.
- ❑ Fat is the major stimulant but other nutrients (e.g., carbohydrate) and bile acids also stimulate secretion.
- ❑ Acts as a satiety factor (anorexigenic).
- ❑ **Know as ileal brake because it controls transit of a meal through ileum.**
- ❑ Inhibits gastrointestinal motility, pancreatic, and gastric secretion.

BASAL METABOLIC RATE

- ❑ The minimum energy expenditure for the body to exist
- ❑ Experimentally, the metabolic rate determined at rest in a room at a comfortable temperature in the thermoneutral zone, 12–14 hours after the last meal is called the basal metabolic rate (BMR).
- ❑ Accounts for about 50–70% (average 60%) of the daily energy expenditure in most sedentary persons.
- ❑ The BMR normally averages about 65–70 calories per hour in an average 70-kilogram man.
- ❑ The maximum metabolic rate reached during exercise is said to be 10 times the BMR.

Conditions or, factors affecting BMR:

Decrease BMR	Increased BMR
• Sleep (10%)	• Hyperthyroidism (100%)
• Prolonged starvation (40%)	• Fever (120% for every 10°C rise)
• Hypothyroidism (30–40%)	• Growth hormone (20%)
• Obesity, anorexia	• Male (5–10% higher than female)
• Hypogonadism	• Pregnant woman (15% in 2nd trimester)
• Addison's disease	• Testosterone (10–15%)
• Immobilization	• Cushing's syndrome (slight), acromegaly
• Hypothalamic disorder	• Pheochromocytoma, polycythemia
	• Paget's disease
	• Cancer, heart failure, asthma

MULTIPLE CHOICE QUESTIONS

GASTROINTESTINAL MOTILITY

RECENT MCQs

1. BER produced by: [Dec 2016]

- a. Smooth muscle at cardiac end of stomach
- b. Antral G cell
- c. Interstitial cells of Cajal
- d. Myenteric plexus

2. Which of the following movement has housekeeping role in GIT? [Dec 2016]

- a. MMC
- b. Segmentation
- c. Mixing movement
- d. Peristalsis

3. Function of myenteric plexus: [Dec 2016]

- a. Absorption
- b. Secretion
- c. Basal output
- d. Motility

4. Mixing waves of stomach:

- a. Originates in body of stomach
- b. Originates in fundus of stomach
- c. Originates at incisura angularis
- d. Originates in any part of stomach

5. Which of the following does not simulate enterogastric reflex?

- a. Products of protein digestion in the duodenum
- b. Duodenal distension
- c. H⁺ ions bathing duodenal mucosa
- d. Hormones

6. Gastric emptying is mainly regulated by:

- a. Neural reflexes
- b. Enteric reflexes
- c. Local hormones produced in stomach
- d. Local hormones produced in duodenum

7. Migrating motility complex:

- a. Occurs upon arrival of food in the stomach
- b. Begins in the lower part of the small intestine
- c. Are initiated by pacemaker cells in the intestine
- d. Occurs at a rate of 5 cm per minute from the stomach

8. Gastric emptying sequence into duodenum:

- a. Fat > protein > carbohydrate
- b. Fat < carbohydrate < protein
- c. Protein < fat < carbohydrate
- d. Protein > fat > carbohydrate

9. In infants, defecation often follows a meal. The cause of colonic contractions in this situation is:

- a. Gastroileal reflex
- b. Enterogastric reflex
- c. Increased circulating levels of CCK
- d. Gastrocolic reflex

10. Mass movement of the colon would be abolished by:

- a. Extrinsic denervation
- b. Distension of the colon
- c. Gastrocolic reflex
- d. Destruction of Auerbach's plexus

11. Major regulator of interdigestive myoelectric complexes:

- a. VIP
- b. GIP
- c. Motilin
- d. Neurotensin

12. Intestinal motility is increased by:

- a. Secretin
- b. Gastrin
- c. CCK
- d. Motilin

13. Slow waves/BER maximum in:

- a. Stomach b. Ileum
c. Colon d. Rectum

14. Stimulation for gastric emptying:

- a. Secretin b. CCK
c. Gastrin d. Distension

AIIMS/PGI/JIPMER**15. Pacemaker of the GIT is located in:**

[PGI June 98]

- a. Cardiac end of stomach
b. Pyloric end of stomach
c. Central control of CBD origin
d. Fundus of stomach

16. Enterogastric reflex is stimulated by all except:

[PGI Dec 98]

- a. Alkaline content of small intestine
b. Hyperosmolarity of chyme
c. Distension of duodenum
d. None

17. Which of the following is TRUE regarding gastric emptying?

[AIIMS Dec 98, AI 95]

- a. Decreased by CCK
b. Decreased by gastrin
c. Increased by secretin
d. Decreased by insulin

18. Chyme is propelled forward in small intestine by:

[PGI June 98]

- a. Segmentation
b. Haustrations
c. Migratory motor complexes (MMC)
d. Peristalsis

19. All of the following statements are true for 'Intestinal motility' except:

[AI 07]

- a. Does not depend on gastric motility
b. Increased by distension
c. Increased by acetylcholine
d. Increased by cholecystokinin

20. Maximum postprandial motility is seen in:

[AIIMS May 11, Nov 08]

- a. Ascending colon
b. Transverse colon
c. Descending colon
d. Sigmoid colon

21. Longest transit time in GIT is seen in:

[PGI Dec 97]

- a. Stomach
b. Jejunum
c. Colon
d. Ileum

22. While doing sigmoidoscopy, if the rectum is inflated with gas increased peristalsis is seen:

[AIIMS May 01]

- a. Whole colon b. Proximal colon
c. Distal colon d. Whole intestine

GASTROINTESTINAL HORMONES**RECENT MCQs****23. Following are gastrointestinal hormones except:**

- a. CCK-PZ b. GIP
c. Motilin d. Chymotrypsin

24. Gastrin:

- a. Is a hormone secreted by pepsinogen cells
b. Is a polypeptide
c. Is released in cephalic phase
d. Cause gastric juice secretion at a rate of 500-700 mL/hr

25. Which one of the following is the primary site of production of gastrin?

- a. Pylorus
- b. Antrum
- c. Pancreas
- d. Small intestine

26. Which causes antral gastrin release?

- a. Antral distension
- b. Acid
- c. Secretin
- d. Calcitonin

27. Motilin is secreted by cells in:

- a. Stomach
- b. Duodenum/ileum
- c. Pancreas
- d. Liver

28. I cells of duodenum secrete:

- a. Secretin
- b. Gastrin
- c. CCK
- d. Motilin

29. Paneth cells in the mucosa of the small intestine secrete:

- a. Lysozyme
- b. Bioactive peptides and bioamines
- c. Bicarbonate
- d. Pepsin and rennin

AIIMS/PGI/JIPMER

30. Which of the following statements, regarding 'secretin' is least correct?

[AI 08]

- a. Increases bicarbonate rich secretion
- b. Inhibit gastric acid secretion
- c. Increases gastric acid secretion
- d. Causes contraction of pyloric sphincter

31. All are true about secretin except:

[PGI June 08]

- a. Inhibits gastric emptying
- b. Increases bicarbonate rich pancreatic secretion
- c. Potentiates action of CCK
- d. Increases bile salt and bile acids
- e. Increases bile secretion

32. True about secretin is: [PGI June 99]

- a. Increased gallbladder contraction and HCO_3 rich pancreatic fluid
- b. Increased gastrin secretion
- c. Gastric hypermotility
- d. Increase enzyme rich pancreatic fluid

33. All are actions of CCK except: [AI 99]

- a. Relax lower esophageal sphincter
- b. Increased pancreatic secretion
- c. Increased gastric secretion
- d. Causes GB contraction

34. Fat in the duodenum lumen: [AI 00]

- a. Stimulates gallbladder contraction
- b. Inhibits gallbladder contraction
- c. Inhibits CCK secretion
- d. Releases secretin

35. Gallbladder contraction is stimulated by: [AI 98]

- a. Gastrin
- b. Secretin
- c. Vagus
- d. Cholecystokinin

36. All of the following are trypsin inhibitors, except: [AI 08]

- a. Alpha-1 antitrypsin
- b. Alpha-1 antiproteinase
- c. Enterokinase
- d. Egg-white

GASTROINTESTINAL SECRETIONS

RECENT MCQs

37. All of the following are actions of secretin *except*: [Dec 2016]
- Increase secretion of gastric acid
 - Alkaline secretion from Brunner glands
 - Increases bile flow
 - Augments the actions of CCK
38. Gastric mucosal barrier stabilized by: [Dec 2016]
- Bicarbonate
 - Trefoil peptides
 - Prostaglandins
 - Acid
39. Which of the following is an inhibitor of gastric acid secretion? [Dec 2016]
- Ach
 - Gastrin
 - Histamin
 - Secretin
40. Myenteric plexus is present in:
- Muscularis externa
 - Submucosa
 - Mucosa
 - Serosa
41. Rennin is present in:
- Gastric juice
 - Liver
 - Kidney
 - Lung
42. Intrinsic factor of castle is secreted by which of the following cells in gastric glands?
- Chief cell
 - Parietal cell
 - Enterochromaffin cells
 - B cells
43. Parietal cell secretes:
- Mucus
 - Pepsinogens
 - Gastrin
 - Intrinsic factor
44. Cephalic phase of gastric secretion:
- 20%
 - 70%
 - 10%
 - 100%
45. In the stomach, H^+ ions are secreted in exchange for:
- Na^+
 - K^+
 - Ca^+
 - Cl^-
46. Minimum sodium is secreted in which of following:
- Saliva
 - Bile
 - Duodenal secretion
 - Stomach
47. Salivary amylase is activated by:
- Na^+
 - K^+
 - HCO_3^-
 - Cl^-
48. Gastric secretions are increased by all of the following *except*:
- Somatostatin
 - Histamine
 - Vagal stimulation
 - Gastrin
49. Which inhibits gastric secretion?
- Secretin
 - High gastric pH
 - Insulin
 - Calcium
50. Gastric secretion is increased by all *except*:
- Histamine
 - Acetylcholine
 - Gastrin
 - HCl

51. Cephalic phase of gastric secretion:

- a. On food entering stomach
- b. On food entering intestine
- c. On seeing food
- d. On stress

52. Gastric acid decreased by:

- a. Secretin
- b. Vagal stimulation
- c. Proteins in gastric fluids
- d. Gastric antral distension

53. HCl secretion in gastric phase is increase by:

- a. Pepsinogen
- b. CCK
- c. Gastrin
- d. Secretin

54. Secretion of bile into bile canaliculus is by:

- a. Osmotic gradient
- b. Facilitated diffusion
- c. Active transport across the membrane
- d. Simple diffusion

AIIMS/PGI/JIPMER**55. Normal gastric juice contains all except:** [AI 95]

- a. Na^+
- b. K^+
- c. Ca^{++}
- d. Mg^{2+}

56. HCl secretion is stimulated by:

- a. Secretin [PGI June 01]
- b. Somatostatin
- c. Histamine
- d. Gastrin
- e. VIP

57. Highest concentration of potassium is in: [AIIMS Nov 09]

- a. Bile
- b. Pancreatic juice
- c. Terminal ileal secretions
- d. Rectal fluid

58. Maximum potassium ions secretion is seen in: [AIIMS May 09]

- a. Saliva
- b. Gastric secretions
- c. Jejunal secretions
- d. Colonic secretions

59. Most important stimulant for bile secretion is: [Jipmer 99, AIIMS 97, AI 97]

- a. Cholecystokinin
- b. Secretin
- c. Bile acid
- d. Bile salt

60. Bilirubin is secreted by:

[AIIMS May 95]

- a. Bile salts
- b. Bile pigments
- c. Secretin
- d. CCK

61. Maximum contraction of gallbladder is seen with: [PGI June 2K]

- a. CCK
- b. Secretin
- c. Gastrin
- d. Enterogastrone

62. Which of the following secretions has a very high pH? [AI 06]

- a. Gastric juice
- b. Pancreatic juice
- c. Bile in gallbladder
- d. Saliva

ABSORPTION OF NUTRIENTS

RECENT MCQs

63. Vit. D increases absorption of calcium in intestine with the help of which of the following protein? [Dec 2016]

- a. Calbindin b. Calreticulin
c. Calsequestrin d. Calmodulin

64. Vit. B12 mainly absorb from: [Dec 2016]

- a. Terminal ileum b. Duodenum
c. Jejunum d. Stomach

65. The mechanism involved in the absorption of glucose from the small intestine is:

- a. Passive diffusion
b. Facilitated diffusion
c. Secondary active cotransport with sodium
d. Actively by insulin dependent uptake

66. Intestinal absorption is faster for:

- a. Hexoses
b. Disaccharides
c. Oligosaccharides
d. Polysaccharides

67. Fastest absorbing sugar in intestine:

- a. Glucose b. Sucrose
c. Maltose d. Mannose

68. Best absorbable monosaccharide:

- a. Glucose b. Mannose
c. Fructose d. Lactose

69. Amount of protein undigested in small intestine is:

- a. 1-5% b. 10-20%
c. 5-10% d. 25-30%

70. Gastric secretions are essential for absorption of:

- a. Cobalamin b. Fat
c. Thiamine d. Protein

71. Resection of which intestinal segment causes marked electrolyte imbalance?

- a. Duodenum b. Jejunum
c. Ileum d. Sigmoid

72. Which of the following is absorbed in the colon?

- a. Iron b. Proteins
c. Bile salts d. Electrolytes

73. Iron absorption takes place in which part of intestine?

- a. Duodenum b. Ileum
c. Jejunum d. Colon

AIIMS/PGI/JIPMER

74. Iron is actively absorbed in:

- a. Stomach [AIIMS May 07]
b. Duodenum and proximal jejunum
c. Large intestine d. Ileum

75. The amount of water absorbed in the intestine in a day is: [AIIMS Dec 95]

- a. 5 lit. b. 1 lit.
c. 10 lit. d. 8 lit.

76. Maximum water reabsorption in the gastrointestinal tract occurs in:

- [AI 11, 10]
a. Stomach b. Jejunum
c. Ileum d. Colon

77. Receptor for absorption of Vit. B12 intrinsic factor complex is located in:

- [JIPMER 11, 10]
a. Ileum
b. Duodenum
c. Transverse colon
d. Descending colon

78. Vitamin B12 is absorbed in:

- [PGI June 97]
a. Duodenum b. Jejunum
c. Ileum d. Stomach

79. Short chain fatty acid produced by bacteria are maximally absorbed in:

[JIPMER 02]

- a. Duodenum b. Colon
c. Ileum d. Jejunum

80. Following constitute dietary fibres except:

[AI 99]

- a. Pectin b. Cellulose
c. Hemicellulose d. Riboflavin

81. True about dietary fiber: [PG1 Dec 07]

- a. Soluble fiber increases metabolism of sugar in GIT
b. Increase bulk of stool
c. Only soluble fibers are included in diet
d. Increase GI transit time
e. Not prevention against colonic cancer

82. True about high roughage in diet is:

- a. Decreases stool transit time [AI 00]
b. Increase stool transit time
c. Normalize stool transit
d. No effect on stool transit time

83. Which of the following plant components is not fermented by gastrointestinal microorganisms? [AI 09]

- a. Lignin b. Cellulose
c. Hemicellulose d. Pectin

84. Colonic bacteria, on digestion of dietary fibres would give:

[AIIMS Nov 01]

- a. Free radicals b. Glycerol
c. Butyrate d. Sucrose

85. Which of the following is not a function of gut flora? [AIIMS Nov 11]

- a. Fermentation of mucin
b. Production of vitamin K
c. Decreased proliferation of epithelial cells
d. Synthesis of short chain fatty acid

86. Gastric muscle was isolated and electrical, mechanical recording were done (given below). All of the following statements are true about the recording except:

[AIIMS Nov 2015]

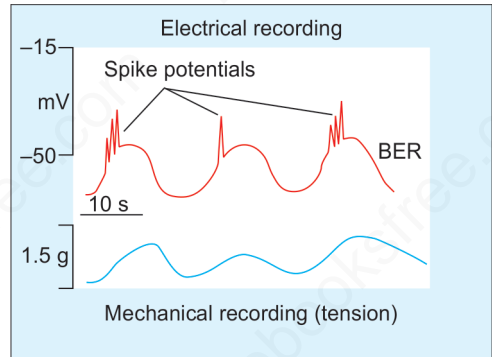

- a. Tension developed proportional to frequency of spike potential
b. Tension developed directly proportional to amplitude of spike potentials
c. Threshold voltage is -50 mv
d. Frequency is around 6/min

87. A small segment of mammalian small intestine was mounted over Dale's tissue bath and movement was recorded (given below). A substance was added at point X. Which of the following will correspond to X? [AIIMS Nov 2015]

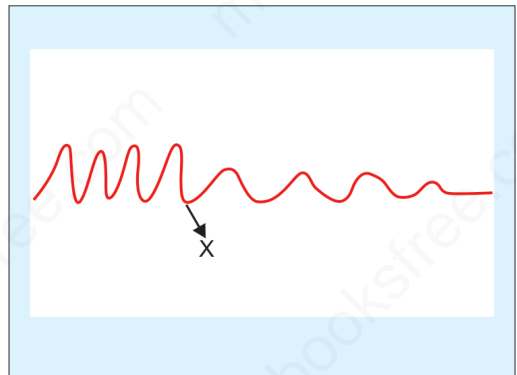

- a. Acetylcholine b. Adrenaline
c. KCl d. BaCl

CONTROL OF FOOD INTAKE AND METABOLIC RATE

88. Leptin level in obesity are:

- a. Low
- b. Normal
- c. High
- d. Fluctuating

89. Vast majority of obese individuals have increased levels of:

- a. Adiponectin
- b. Leptin
- c. Ghrelin
- d. Cortisol

90. Hormone responsible for stimulating appetite is:

- a. Ghrelin
- b. Obestatin
- c. Motilin
- d. Leptin

91. Hormone require during puberty:

- a. FSH
- b. Testosterone
- c. Leptin
- d. All of the above

92. Which hormone exhibits permissive action on puberty?

- a. Insulin
- b. GH
- c. GnRH
- d. Leptin

93. Which of the following reduces in insulin resistance?

- a. Leptin
- b. TNF alpha
- c. Resistin
- d. All of the above

94. BMR accounts for what percentage of daily energy?

- a. 10
- b. 25
- c. 50
- d. 70

95. BMR is decreased in:

- a. Hyperthyroidism
- b. Increased body temperature
- c. Cushing's syndrome
- d. Addison's disease

96. BMR is dependent on:

- a. Body weight
- b. Body surface area
- c. Amount of adipose tissue
- d. Amount of lean body mass

97. BMR closely related to:

- a. Body weight
- b. Body surface area
- c. Amount of adipose tissue
- d. Amount of lean body mass

FUTURE TRENDS

98. Chronic administration of which of the following types of drugs would lead to a sustained increase in serum gastrin levels?

- a. H₂ receptor antagonist
- b. Proton pump inhibitor
- c. Antacid
- d. Beta blocker

99. Which gastrointestinal motor activity is most affected by vagotomy?

- a. Secondary esophageal peristalsis
- b. Distension-induced intestinal segmentation
- c. Oral stomach accommodation
- d. Caudad stomach peristalsis

100. Removal of proximal segments of the small intestine results in a decrease in:

- a. Maximal acid output
- b. Gastric emptying of liquids
- c. Gastric emptying of solids
- d. Pancreatic enzyme secretion

101. A medical student presents to the emergency room with a two-day history of severe vomiting and orthostatic hypotension. What kind of metabolic abnormalities would you expect?

- a. Hyperkalemia, hyperchloremia, and metabolic alkalosis

- b. Normal serum electrolytes and metabolic acidosis
- c. Normal serum electrolytes and metabolic alkalosis
- d. Hypokalemic, hypochloremic, metabolic alkalosis

102. Acidification of the duodenum will:

- a. Decrease pancreatic secretion of bicarbonate
- b. Increase secretion of gastric acid
- c. Decrease gastric emptying
- d. Increase contraction of the sphincter of Oddi

ANSWERS WITH EXPLANATIONS**1. Ans. c. Interstitial cells of Cajal**

(Ref: Ganong's Review of Physiology 25th pp.496)

"Basic electrical rhythm (BER) is initiated by the interstitial cells of Cajal, stellate mesenchymal pacemaker cells with smooth muscle-like features".

2. Ans. a. MMC

(Ref: Ganong's Review of Physiology 25th pp.497)

MMC likely serve to clear the stomach and small intestine of luminal contents in preparation for the next meal. Thus they perform housekeeping functions.

3. Ans. d. Motility

(Ref: Guyton and Hall Physiology 13th Ed pp 799)

The myenteric plexus controls mainly the gastrointestinal movements, and the submucosal plexus controls mainly gastrointestinal secretion and local blood flow.

4. Ans. b. Originates in fundus of stomach

(Ref. Tortora's Principles of anatomy and physiology, 12th edn. pp 939)

Note: It is not a question of BER (slow wave). Although mixing movement is initiated by BER.

"Several minutes after food enters the stomach, gentle, rippling, peristaltic movements called mixing waves pass over the stomach every 15–25 seconds. These waves macerate food, mix it with secretions of the gastric glands, and reduce it to a soupy liquid called chime. **Few mixing waves are observed in the fundus**, which primarily has a storage function. As digestion proceeds in the stomach, more vigorous mixing waves begin at the body of the stomach and intensify as they reach the pylorus."

"As long as food is in the stomach, weak peristaltic constrictor waves, called mixing waves, begin in the **mid- to upper portions of the stomach** wall and move toward the antrum about once every 15–20 seconds. These waves are initiated by the gut wall basic electrical rhythm."...Guyton's Physiology.

[Also check the explanation of Q. No. 12]

5. Ans. d. Hormones

(Ref. Guyton-Physiology-12th edn. pp 786, 13th pp 451)

The enterogastric inhibitory reflexes are especially sensitive to the presence of irritants and acids in the duodenal chyme. Breakdown products of protein digestion also elicit inhibitory enterogastric reflexes. Finally, either hypotonic or hypertonic fluids (especially hypertonic) and distension of duodenum also elicit this inhibitory reflexes.

Hormones also control gastric motility, but not via enterogastric reflex.

6. Ans. a. Neural reflexes

(Ref. Berne & Levy Physiology, 6th edn. Bruce M Koeppen. pp 514)

The pathways regulating gastric motility processes are predominantly neural and consist of vagovagal reflexes initiated by extrinsic vagal afferent fibers that terminate in the muscle and mucosa.

CCK may act as a hormone not only to inhibit gastric emptying but also to stimulate vagal afferent fiber discharge to produce a vagovagal reflex-mediated decrease in gastric emptying.

"Powerful duodenal factors that inhibit stomach emptying is enterogastric nervous reflexes from the duodenum." ..Guyton's Physiology.

7. Ans. d. Occurs at a rate of 5 cm per minute from the stomach

(Ref. Ganong's Physiology 24th edn. pp 470)

MMC: occurs during fasting between periods of digestion. It initiates in stomach, moves with a speed of 5 cm/min (slow but strong contraction).

8. Ans. a. Fat > protein > carbohydrate

(Ref. Johnson's Essential Medical Physiology 3rd edn. 488)

Carbohydrate rich food causes rapid gastric emptying. Protein causes slower emptying and fat causes slowest emptying.

9. Ans. d. Gastrocolic reflex

(Ref. Guyton-Physiology-12th edn. pp 786, 13th pp 450)

Appearance of mass movements after meals is facilitated by gastrocolic and duodenocolic reflexes. Mass movement is more prominent in infant which leads to defecation often follows a meal.

10. Ans. d. Destruction of Auerbach's plexus

(Ref. Guyton-Physiology-12th edn. pp 786, 13th pp 450)

Motility is controlled by myenteric plexus or, Auerbach's plexus. So, destruction will lead to abolition of the motility.

11. Ans. c. Motilin

(Ref. Ganong's Physiology 24th edn. pp 470)

Interdigestive motility in small intestine is migratory motor complex, which is initiated and regulated by motilin.

12. Ans. c. CCK

(Ref. Shackelford's Surgery of the Alimentary Tract By CJ Yeo et al. 2012; pp 946)

The main action of motilin is to stimulate the motility of stomach and small intestine (during fasting stage) but its potency is half of that of CCK.

CCK is the major hormone for intestinal motility.

13. Ans. b. Ileum

(Ref. Ganong's Physiology 24th edn. pp 470)

"The rate of the BER is about 4/min in the stomach. It is about 12/min in the duodenum and falls to about 8/min in the distal ileum. In the colon, the BER rate rises from about 2/min at the cecum to about 6/min at the sigmoid."

14. Ans: c. Gastrin

(Ref: Guyton-Physiology-12th edn. pp 785, 13th pp 447)

Stomach wall stretch and the presence of certain types of foods in the stomach—particularly digestive products of meat—elicit release of a hormone called gastrin from the antral mucosa. This has potent effects to cause secretion of highly acidic gastric juice by the stomach glands. Gastrin also has mild to moderate stimulatory effects on motor functions in the body of the stomach.

15. Ans. b. Pyloric end of stomach

(Ref: Ganong's Physiology 24th edn. pp 470)

Pacemaker cells start appearing from mid portion of stomach and present throughout the small and large intestine. A site along the greater curvature in the proximal body serves as the dominant pacemaker to entrain the rest of the stomach. In the stomach and the small intestine, these cells are located in the outer circular muscle layer near the myenteric plexus; in the colon, they are at the submucosal border of the circular muscle layer.

From the above discussion, it is clear that pacemaker cells are not present in esophagus, cardiac and fundus parts of stomach. So, single best choice pyloric end of stomach.

16. Ans. a. Alkaline content of small intestine

(Ref. Guyton-Physiology-12th edn. pp 786, 13th pp 451)

(See Explanation of Q. No. 2)

17. Ans. a. Decreased by CCK

(Ref. Guyton-Physiology-12th edn. pp 785, 13th pp 446)

Stimulates gastric emptying: Gastrin.

Inhibits gastric emptying: CCK, secretin and gastric inhibitory peptide (GIP).

18. Ans. d. Peristalsis

(Ref. Ganong's Physiology 24th edn. pp 470)

Peristalsis and mass movement are propulsive movement.

Segmentation and haustrations are non-propulsive movement.

MMC is a fasting movement, not for propulsion of chyme.

19. Ans. a. Does not depend on gastric motility

(Ref. Ganong's Physiology 24th edn. pp 470)

Motility of stomach facilitates gastrocolic and duodenocolic reflexes. So, option A is not correct.

20. Ans. d. Sigmoid colon >> b. transverse colon

(Ref. Yamada Gastroenterology 5th pp 244)

"Eating elicits increased motor activity throughout the colon. Greater in the sigmoid than in the transverse colon, this increased activity is termed the gastrocolonic response."

21. Ans. c. Colon

(Ref. Johnson's Essential Medical Physiology 3rd edn. 488)

Longest transit time is in colon (~20 hours).

Transit time: esophagus- 4–8 sec, Stomach- 2–5 hours, Small intestine- 3–6 hours, Colon-10–59 hours.

22. Ans. c. Distal colon

(Ref. Ganong's Physiology 24th edn. pp 477, figure 28-8)

Distention produces passive tension due to stretching of the wall of the rectum, and additional active tension (contraction) develops in the smooth muscle of rectum.

23. Ans. d. Chymotrypsin

(Ref. Ganong's Physiology 24th edn. pp 455)

24. Ans. b. Is a polypeptide

(Ref. Ganong's Physiology 24th edn. pp 443)

G cells in the antral portion of the gastric mucosa produce gastrin. Gastrin is typically a polypeptide hormone.

25. Ans. b. Antrum

(Ref. Ganong's Physiology 24th edn. pp 443)

(Explained in Q. 21)

26. Ans. a. Antral distension

(Ref. Guyton-Physiology-12th edn. pp 776, 13th pp 410)

"Gastrin is secreted by the 'G' cells of the antrum of the stomach in response to stimuli associated with ingestion of a meal, such as distention of the stomach, the products of proteins, and gastrin releasing peptide, which is released by the nerves of the gastric mucosa during vagal stimulation."

27. Ans. b. Duodenum/ileum >> a. Stomach

(Ref. Ganong's Physiology 24th edn. pp 447)

Motilin is secreted by enterochromaffin cells and Mo cells in the stomach, small intestine, and colon.

Maximum in duodenum-jejunum.

28. Ans. c. CCK

(Ref. Ganong's Physiology 24th edn. pp 445)

"In addition to its secretion by I cells in the upper intestine, CCK is found in nerves in the distal ileum and colon. It is also found in neurons in the brain, especially the cerebral cortex, and in nerves in many parts of the body."

29. Ans. a. Lysozyme

(Ref. Johnson's Essential Medical Physiology 3rd edn. 531)

"A few cells migrate to the bottom of the crypts and become Paneth cells, whose functions are not entirely understood. Paneth cells contain lysozyme, a bacteriolytic enzyme, as well as immunoglobulin. This coupled with findings of degenerating bacteria and protozoa within their lysosomal elements suggest that Paneth

cells may regulate the microbiological flora in the gut."

30. Ans. c. Increases gastric acid secretion

(Ref. Ganong's Physiology 24th edn. pp 446)

Secretin increases the secretion of bicarbonate by the duct cells of the pancreas and biliary tract.

Secretin inhibits stomach emptying by contracting pyloric sphincter.

Although the secretion of secretin is increased by the products of protein digestion and by acid bathing the mucosa of the upper small intestine, it's a inhibitor of gastric acid secretion.

31. Ans. d. Increases bile salt and bile acids

(Ref. Ganong's Physiology 24th edn. pp 446)

Secretin increases the secretion of bicarbonate by the duct cells of the pancreas and biliary tract.

"Secretin also increases bile flow primarily by increasing the active secretion of chloride rich fluid by the bile ducts"... Ref. Blumgart's Surgery of the Liver, Pancreas and Biliary Tract: Expert Consult by WR Jarnagin

32. Ans. a. Increased gallbladder contraction and HCO₃ rich pancreatic fluid

(Ref. General Surgery by M Alex Jacocks pp 52 and Ganong's Physiology 24th edn. pp 446)

Secretin in physiological doses inhibits gastric motility. It can increase GB contraction also (text book has not mentioned with this point) and increases HCO⁻ rich pancreatic secretion.

33. Ans: c. Increased gastric secretion

(Ref. Ganong's Physiology 24th edn. pp 445)

It also inhibits gastric emptying and augments the contraction of the pyloric sphincter (prevent gastric emptying) but enhance the motility of the small intestine and colon.

"Cholecystokinin is a negative regulator of gastric acid secretion and postprandial release of gastrin in humans"... Ref. *Gastroenterology* 1994;107:1610-20

CCK transiently relaxes lower esophageal sphincter in response to gastric distension.

Ref. *Gut* 1997;40:575-581

34. Ans. a. Stimulates gallbladder contraction

(Ref. *Ganong's Physiology* 24th edn. pp 486)

Fatty acids and amino acids in the duodenum release CCK, which causes gallbladder contraction.

35. Ans. d. Cholecystokinin >> c. Vagal stimulation

(Ref. *Guyton-Physiology-12th edn. pp 803, 13th pp421*)

By far the most potent stimulus for causing the gallbladder contractions is CCK.

Vagal stimulation causes weak contraction of gallbladder.

36. Ans. c. Enterokinase

(Ref. *Ganong's Physiology* 24th edn. pp 455 and Jones et al., *Biochem.*, 2, 66, [1963])

A trypsin inhibitor is a type of serine protease inhibitor that reduces the biological activity of trypsin. Examples are α 1-antitrypsin, aprotinin, ovomucin (egg white), soybeans.

Enterokinase is a brush border hydrolyase, which converts trypsinogen to the active enzyme trypsin.

37. Ans. a. Increase secretion of gastric acid

(Ref. *Ganong's Review of Physiology* 25th pp.497)

It decreases gastric acid secretion.

38. Ans. b. Trefoil peptides

(Ref. *Ganong's Review of Physiology* 25th pp.457)

Trefoil peptides secreted by surface mucous cells that stabilize the mucus-bicarbonate layer.

39. Ans. d. Secretin

(Ref. *Ganong's Review of Physiology* 25th pp.497)

Secretin decreases gastric acid secretion.

40. Ans. a. Muscularis externa

(Ref. *Ganong's Physiology* 24th edn. pp 430)

Myenteric plexus is located in muscularis propria, which is the external muscle layer of GIT. The plexus is present in between the circular muscle and the longitudinal muscle of muscularis propria.

41. Ans. a. Gastric juice

(Ref. *Essentials of Food Science* by V Vaclavik, E W. Christian).

Rennin (note: Spelling) is a protein digestive enzyme present in the stomach of milk-fed calves.

42. Ans. b. Parietal cell

(Ref. *Guyton-Physiology-12th edn. pp 820, 13th pp 406*)

"Normal gastric secretions contain a glycoprotein called intrinsic factor, secreted by the same parietal cells that secrete hydrochloric acid. Intrinsic factor must be present for adequate absorption of vitamin B12 from the ileum."

43. Ans. d. Intrinsic factor

(Ref. *Guyton-Physiology-12th edn. pp 820, 13th pp 406*)

See above [Q. No. 36].

44. Ans. a. 20%

(Ref. *Guyton-Physiology-12th edn. pp 820, 13th pp 410*)

The stimulation of acid secretion is divided into the cephalic (20-30%), gastric (60-70%), and intestinal phases (10%).

45. Ans. b. K⁺

(Ref. Guyton-Physiology-12th edn. pp 796, 13th pp 409)

“The hydrogen ions are then actively secreted into the canaliculus in exchange for potassium ions: this active exchange process is catalyzed by H⁺, K⁺-ATPase.”

46. Ans. a. Saliva

(Ref. Fluid and electrolyte balance; by Norma Metheny and Harrison's Principle of Internal medicine, 19th edn. Table 98e-2)

Maximum Na⁺ concentration in bile > pancreatic > small intestinal secretion. Minimum Na⁺ is in saliva.

47. Ans. d. Cl

(Ref. Guyton-Physiology-12th edn. pp 809, 13th pp 427)

Salivary α-amylase is activated by chloride ions. It has an optimal pH of 6.7, and its action is inhibited by the acidic gastric juice when food enters the stomach.

“Chloride is the allosteric effector of vertebrate pancreatic and salivary α-amylases.”... Ref. The Journal of Biological Chemistry, 1996;271:23836-23841.

48. Ans. a. Somatostatin

(Ref. Guyton-Physiology-12th edn. pp 799, 13th pp 410)

Inhibitors: The presence of food, acid, protein breakdown products, irritant in upper intestine (reverse enterogastric reflex). Secretin, gastric inhibitory peptide, vasoactive intestinal polypeptide, and somatostatin: also have slight to moderate effects in inhibiting gastric secretion.

49. Ans. a. Secretin

(Ref. Guyton-Physiology-12th edn. pp 798, 13th pp 410)

Gastric acid is an inhibitor of further acid production.

Insulin: Parenteral insulin given in amounts sufficient to lower the blood sugar below 40 to 50 mg% stimulates gastric acid secretion within 1–2 hr in the vagally innervated stomach...Ref. JAMA 1963;183(12):1006-1007

Calcium stimulates gastrin release.

50. Ans. d. HCl

(Ref. Guyton-Physiology-12th edn. pp 799, 13th pp 410)

Explained in Q. 42.

51. Ans. c. On seeing food

(Ref. Guyton-Physiology-12th edn. pp 798, 13th pp 411)

The cephalic phase of gastric secretion occurs even before food enters the stomach. It is mediated via vagus (parasympathetic), so not seen during stress.

52. Ans. a. Secretin

(Ref. Guyton-Physiology-12th edn. pp 799, 13th pp 412)

Explained in Q. 42.

Proteins in gastric fluids and gastric antral distension release gastrin hormone, which stimulates acid secretion.

53. Ans. c. Gastrin

(Ref. Guyton-Physiology-12th edn. pp 798, 13th pp 411)

The stimuli for gastric phase of acid secretion are: local nervous secretory reflexes, vagal reflexes, gastrin-histamine stimulation.

54. Ans. c. Active transport across the membrane

(Ref. Ganong's Physiology 24th edn. pp 485)

The secretion of bile is the result of the active secretion of osmotically active compounds by hepatocytes into the canalicular space followed by the passive movement of water through the tight junctions. Bile

acids are the major solutes in bile, they are considered the major osmotic driving force in the generation of bile flow.

55. Ans. c. Ca⁺⁺

(Ref. Ganong's Physiology 24th edn. pp 433)

56. Ans. c. Histamine, d. Gastrin

(Ref. Ganong's Physiology 24th edn. pp 433)

The three agonists of the parietal cell are gastrin, histamine, and acetylcholine. Others option here are inhibitors.

57. Ans. d. Rectal fluid

(Ref. Fluid and electrolyte balance; By Norma Metheny and Harrison's Principle of Internal medicine 19th Table 98e-2)

Highest concentration: Colon-rectum

Highest secretion per day: Saliva

58. Ans. a. Saliva [Check Q. No. 51]

59. Ans. d. Bile salt

(Ref. Human Physiology: From Cells to Systems by Lauralee Sherwood 8th edn. pp 413)

Bile salts are the most potent stimulus for bile secretion.

60. Ans. a. Bile salts

(Ref. Johnson's Essential Medical Physiology 3rd edn. 524)

Bilirubin is secreted in bile. Bile secretion is stimulated by bile salt.

61. Ans. a. CCK [Explained in Q. No. 32]

62. Ans. b. Pancreatic juice

(Ref. Fluid and electrolyte balance; by Norma Metheny and Harrison's Principle of Internal medicine 19th Table 98e-2)

Detail explanation given in text.

63. Ans. a. Calbindin

(Ref: Boron and Boulpaep Medical Physiology 2nd pp 974)

The active transport of Ca²⁺ across the villous epithelial cells of the duodenum is transcellular and is under the control

of vitamin D. The uptake of Ca²⁺ across the apical membrane occurs through Ca²⁺ channels, driven by the electrochemical gradient between the lumen and the cell. Cytosolic Ca²⁺ then binds to a protein called calbindin, which buffers intracellular Ca²⁺. A Ca²⁺ pump and an Na-Ca exchanger on the basolateral membrane then extrude the Ca²⁺ from the cell into the interstitial fluid.

64. Ans. a. Terminal ileum

(Ref. Ganong's Review of Physiology 25th pp.484)

"Most vitamins are absorbed in the upper small intestine, but vitamin B12 is absorbed in the ileum."

65. Ans. c. Secondary active cotransport with sodium

(Ref. Ganong's Physiology 24th edn. pp 453)

SGLT-1 is responsible for uptake of dietary glucose from the gut, which is a co-transporter system.

66. Ans. a. Hexoses

(Ref. Ganong's Physiology 24th edn. pp 453)

Hexoses are rapidly absorbed across the wall of the small intestine. Poly-, oligo- and di-saccharides must be digested to monosaccharides prior to absorption.

67. Ans. a. Glucose

(Ref. Ganong's Physiology 24th edn. pp 453)

Hexoses are rapidly absorbed across the wall of the small intestine. Essentially all the hexoses are removed before the remains of a meal reach the terminal part of the ileum.

68. Ans. a. Glucose

(Ref. The Good Gut: By J Sonnenburg, E Sonnenburg)

Glucose is the fastest and best absorbing sugar from intestine.

69. Ans. a. 1-5%

(Ref. Ganong's Physiology 24th edn. pp 453)

Only 2-5% of the protein in the small intestine escapes digestion and absorption.

70. Ans. a. Cobalamin

(Ref. Ganong's Physiology 24th edn. pp 432)

The parietal cells secrete hydrochloric acid and intrinsic factor. Intrinsic factor is important for the later absorption of vitamin B12, or cobalamin.

71. Ans. b. Jejunum

(Ref. Raff's Medical Physiology A Systems Approach, 2011, pp 528)

Most of the fluid and electrolytes absorption occurs in jejunum.

72. Ans. d. Electrolytes

(Ref. Raff's Medical Physiology A Systems Approach, 2011, pp 528)

Among the option provided, electrolytes are absorbed in colon.

73. Ans. a. Duodenum

(Ref. Ganong's Physiology 24th edn. pp 459)

Almost all the iron absorption occurs in duodenum and small amount in proximal jejunum.

74. Ans. b. Duodenum and proximal jejunum

(Ref. Ganong's Physiology 24th edn. pp 459)

[Explained in Q. No. 65]

75. Ans. d. 8 lit.

(Ref. Raff's Medical Physiology A Systems Approach, 2011, pp 528)

The daily fluid load approximates 9 L in normal adults: Small intestinal absorption 7000 mL and colon absorption 1900 mL (21%); 100 mL excretion in stool.

76. Ans. b. Jejunum

(Ref. Raff's Medical Physiology A Systems Approach, 2011, pp 528)

Water absorption: Jejunum > ileum > colon.

77. Ans. a. Ileum

(Ref. Medical Physiology by WF Boron and EL Boulpaep 2nd edn. Chapter 45)

Cobalamin releases from the ingested proteins in stomach. Free cobalamin then binds to haptocorrin (formerly known as "R" type binder), a glycoprotein secreted by the salivary and gastric glands. The parietal cells of the stomach secrete a second protein, intrinsic factor (IF), crucial for the absorption of cobalamin. However, cobalamin and IF do not interact in the acidic milieu of the stomach. Rather, gastric acidity enhances the binding of cobalamin to haptocorrin. When this cobalamin-haptocorrin complex reaches the duodenum, the haptocorrin is degraded by pancreatic proteases and IF interacts with cobalamin in small intestine. Next step in the absorption of cobalamin is by binding of cobalamin intrinsic factor to specific receptor on apical membrane in ileum.

78. Ans. c. Ileum [Explained in Q. No. 69].**79. Ans. b. Colon**

(Ref. Ganong's Physiology 24th edn. pp 458)

Short chain fatty acids are 2-5 carbon weak acids that are produced and absorbed in colon.

80. Ans. d. Riboflavin

(Ref. Understanding Medical Physiology by RL Bijlani 3rd edn, pp 456)

Dietary fibres are: pectin, cellulose, hemicellulose and lignin

81. Ans. a. Soluble fiber increases metabolism of sugar in GIT, b. Increase bulk of stool

(Ref. Understanding Medical Physiology by RL Bijlani 3rd edn, pp 456)

Dietary fiber obtained from plant food, most of them polysaccharide residing in cell walls. They may be soluble or, insoluble.

A high fiber meal is bulky in relation to caloric content. It stimulates the softness and frequency of faecal matter (reduced transit time), Postprandial glycemia is reduced, Reduced blood cholesterol level, Protect from colonic cancer, Reduced incidence of diverticulitis, irritable bowel syndrome.

82. Ans. a. Decreases stool transit time

[Explained in Q. No. 73].

83. Ans. a. Lignin

(Ref. *Understanding Medical Physiology* by RL Bijlani 3rd edn, pp 456)

Resistant starch, most of the pectin and part of hemicellulose and cellulose are fermented by bacterial flora of the large intestine. Lignin is a noncarbohydrate dietary fiber not fermented by bacterial flora of colon.

84. Ans. c. Butyrate

(Ref. *Understanding Medical Physiology* by RL Bijlani 3rd edn, pp 456)

Short chain fatty acids (SCFA) are produced in the colon by the action of colonic bacteria on complex carbohydrates, resistant starches, and other components of the dietary fiber. SCFA are acetate, propionate, and butyrate.

85. Ans. c. Decreased proliferation of epithelial cells

(Ref. *Lancet* 2003;361:512-19)

Functions of colonic bacteria:

- Fermentation of nondigestible dietary residue and endogenous mucus
- Production short-chain fatty acids (SCFA) and vitamin K
- Absorption of ions
- Increase in epithelial cell proliferation (tropic effect of SCFA) and differentiation.
- Development and homeostasis of the immune system.

- Protection against pathogens (the barrier effect).

86. Ans. b. Tension developed directly proportional to amplitude of spike potentials

(Ref. *Ganong's Physiology* 24th edn. pp 470)

Tension does not depend on amplitude, it depends on frequency of spike potentials.

From x axis time scale, we can easily calculate the frequency (6/min here).

87. Ans. b. Adrenaline

(Ref. *Textbook of Practical Physiology*, by GK Pal, and P Pal, 2nd edn. ppc 424)

Adrenaline or, epinephrine decreases the force of intestinal contraction. All others option (BaCl, KCl, CaCl, Ach) increase the force of contraction.

88. Ans. c. High

(Ref. *Guyton and Hall Physiology* 13th pp 893)

In most obese humans, however, plasma leptin levels increase in proportion with increasing adiposity (Obesity is associated with leptin resistance).

89. Ans. b. Leptin

(Ref. *Guyton and Hall Physiology* 13th pp 893)

When the amount of adipose tissue increases (signaling excess energy storage), the adipocytes produce increased amounts of leptin, which is released into the blood (so, high level in obesity).

90. Ans. a. Ghrelin

(Ref. *Guyton and Hall Physiology* 13th pp 892)

Ghrelin is an orexigenic signal (appetite stimulant) for the hypothalamus.

91. Ans. d. All of the above

(Ref. *Guyton and Hall Physiology* 13th pp 893)

Apart from LH, FSH, testosterone, leptin play a permissive role in puberty onset.

92. Ans. d. Leptin

(Ref. Guyton and Hall Physiology 13th pp 893)

Leptin may be a link between body weight and onset of puberty (leptin regulates the circadian rhythms of the gonadotrope. Leptin play a permissive role in this process, as leptin-deficient individuals fail to enter puberty.

93. Ans. b. TNF alpha

(Ref. Endocrine. 2004;23:177-82)

Elevated TNF-alpha expression induces insulin resistance by down-regulating the tyrosine kinase activity of the insulin receptor and decreasing the expression of GLUT-4 glucose transporters.

In humans resistin is expressed primarily by macrophages and seems to be involved in the recruitment of other immune cells and the secretion of pro-inflammatory factors, including tumor necrosis factor (TNF) alpha.

94. Ans. d. 70

(Ref. Guyton and Hall Physiology 13th pp907)

BMR accounts for about 50 to 70% (average 60%) of the daily energy expenditure in most sedentary persons.

95. Ans. d. Addison's disease

(Ref. Textbook of Medical Biochemistry By S. Ramakrishnan pp498)

In Addison's disease BMR is subnormal while in Cushing's syndrome it is slightly increased.

96. Ans. d. Amount of lean body mass

(Ref. Guyton and Hall Physiology 13th pp 907)

Variations in BMR among different persons are related mainly to differences in the amount of skeletal muscle and body size. Skeletal muscle, even under resting conditions, accounts for 20 to 30% of the BMR.

97. Ans. d. Amount of lean body mass

(Ref. Biochemistry by D. Das pp 570)

BMR is closely proportional to lean body mass. In terms of lean body mass, difference of BMR between men and women largely disappear.

98. Ans. b. Proton pump inhibitor

Secretion of HCl by the parietal cell involves H-K-ATPase actively pumping H⁺ out of a cell in exchange for K⁺ entering the cell. Inhibition of pump activity leads to a prolonged increase in gastric pH and the removal of the inhibitory effect of low pH (<3.0) on gastrin release. The hypergastrinemia that develops may actually increase the number of parietal cells as a result of the trophic effects of the hormone.

99. Ans. c. Oral stomach accomodation

Orad stomach accommodation depends exclusively upon an intact vago-vagal reflex. Distension-induced contraction of gastrointestinal smooth muscle develops as the result of long (vago-vagal) and local (enteric nerves) reflexes. Secondary esophageal peristalsis, intestinal segmentation, and migrating motor complexes are unaffected by vagotomy, whereas caudad stomach peristalsis is decreased but not abolished by vagotomy.

100. Ans. d. Pancreatic enzyme secretion

Inflammation or removal of the upper small intestine leads to a decrease in pancreatic and hepatobiliary function. The proximal small intestine contains a number of "receptors" that monitor the physical (volume) and chemical (pH, fat content, caloric density, osmolality) composition of the chyme emptied from the stomach. Stimulation of these receptors releases hormones and activates neural reflexes that initiate pancreatic enzyme and bicarbonate secretion, stimulate gallbladder emptying, and provide feedback for inhibitory

regulation of gastric function (enterogastrone, enterogastric reflex). Removal of these reflexes decreases pancreatic secretion and gallbladder emptying and increases gastric emptying and acid output.

101. Ans. d. Hypokalemic, hypochloremic, metabolic alkalosis

Persistent vomiting will lead to low potassium (hypokalemia), low chloride (hypochloremia), and metabolic alkalosis. These abnormalities arise from two sources. First, gastric juice contains potassium and chloride in concentrations higher than found in the plasma. Loss of gastric juice through vomiting or drainage leads to depletions of these electrolytes from the plasma. Second, the metabolic abnormalities are exacerbated by the student's dehydration. Contraction of the vascular volume leads to orthostatic hypotension and the activa-

tion of renal mechanisms important for conserving volume. As a result, water, sodium, and bicarbonate are reabsorbed at the expense of increased potassium and hydrogen excretion.

102. Ans. c. Decrease gastric emptying

Acidification of the upper small intestine results in the inhibitory feedback regulation of gastric function. Secretin is released from the small intestine primarily in response to an increased delivery of hydrogen ions. Secretin is the primary stimulus for pancreatic secretion of water and bicarbonate. In addition secretin may serve as an enterogastrone, that is, a hormone involved in the inhibitory feedback regulation of gastric function. Cholecystokinin (CCK) is the hormone responsible for contraction of the gallbladder and relaxation of the sphincter of Oddi.

Endocrine & Reproductive System

CHAPTERS

- 17. Endocrine Physiology
- 18. Male & Female reproductive physiology
- 19. Special Topic: Exercise Physiology

CHAPTER

17

Endocrine Physiology

HORMONE CLASSIFICATION

Hormones can be divided into following major classes:

- ❑ **Amino acid derivatives** such as dopamine, catecholamine, and thyroid hormone.
- ❑ **Proteins and polypeptides:**
 - Anterior and posterior pituitary hormones,
 - Pancreas (insulin and glucagon)
 - Parathyroid gland (parathyroid hormone)
 - All hypothalamic releasing hormones except dopamine
 - Erythropoietin, ANP
 - Gastrin, CCK, secretin, leptin
 - HCG, HCS
- ❑ **Steroid hormones** such as cortisol and estrogen that are synthesized from cholesterol-based precursors.
- ❑ Vitamin derivatives such as retinoids (vitamin A) and vitamin D.

I IMPORTANT

As a rule, amino acid derivatives and peptide hormones interact with cell-surface membrane receptors. Steroids, thyroid hormones, vitamin D, and retinoids are lipid-soluble and interact with intracellular nuclear receptors.

Receptors for Hormones

Two major classes:

- ❑ **Membrane receptor:** Membrane receptors primarily bind peptide hormones and catecholamines.
- ❑ **Nuclear receptors:** Bind small molecules that can diffuse across the cell membrane, such as steroids and vitamin D.

Membrane Receptors Types (Fig. 17.1)

- ❑ Seven-pass transmembrane GPCRs (G protein Coupled receptor)
- ❑ Guanylyl cyclase receptor
- ❑ Tyrosine kinase receptors

- ❑ Cytokine receptors
- ❑ Serine kinase receptors

Mechanism of G Protein Coupled Receptor (GPCRs)

- ❑ **cAMP mechanism:** Hormone binds to a receptor in the cell membrane coupled to G protein. The G protein then activates (G_s) or inhibits (G_i) adenylate cyclase. Activated adenylate cyclase then catalyzes the conversion of adenosine triphosphate (ATP) to cAMP. cAMP activates protein kinase A, which phosphorylates specific proteins, producing highly specific physiologic actions.
- ❑ **IP_3 mechanism:** Hormone binds to a receptor in the cell membrane and via a G_q protein, activates phospholipase C. Phospholipase C liberates diacylglycerol and IP_3 from membrane lipids. IP_3 mobilizes Ca^{2+} from the endoplasmic reticulum. Together, Ca^{2+} and diacylglycerol activate protein kinase C, which phosphorylates proteins and causes specific physiologic actions.
- ❑ **Ca^{2+} calmodulin mechanism:** Hormone binds to a receptor in the cell membrane and, via a G protein, has two actions: it opens cell membrane Ca^{2+} channels and it releases Ca^{2+} from the endoplasmic reticulum. Together, these two actions produce an increase in intracellular $[Ca^{2+}]$. Ca^{2+} binds to calmodulin, and the Ca^{2+} calmodulin complex produces physiologic actions.

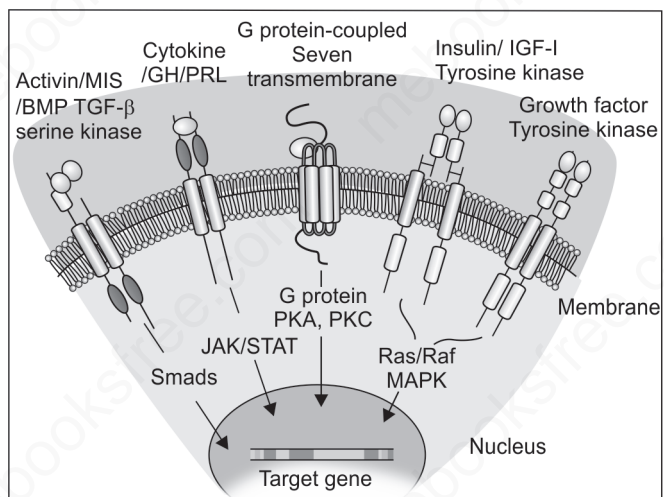

Fig. 17.1: Different types of membrane receptors (description is given in table on next page)

Membrane Receptor Family

Hormone receptor	Effector	Signaling pathway/ Second messenger
G protein coupled seven-transmembrane (GPCR)		
ACTH, TSH, LH, FSH, CRH, PTH, PTHrP, hCG, glucagon, calcitonin, beta-adrenergic , ADH (V2 receptor), MSH	G _s , adenylate cyclase	Stimulation of cAMP production
Alpha 2-adrenergic , somatostatin, Ach (M_2, M_4), AgII	G _i	Inhibition of CAMP production
TRH, GnRH, GHRH, Oxytocin, ADH (V1 receptor), Alpha 1-Adrenergic , Ach (M_1, M_3, M_5)	G _q	Phospholipase C, IP₃/DAG
Guanylyl cyclase receptor		
ANP, EDRF, nitric oxide, guanylin, urodilatin	Guanylyl cyclase	cGMP
Receptor tyrosine kinase		
Insulin, IGF-I	Tyrosine kinases	MAP kinases, PI 3-kinase; AKT
EGF, NGF	Tyrosine kinases, ras	Raf, MAP kinases, RSK
Cytokine receptor linked kinase		
GH, PRL	JAK , tyrosine kinases	STAT , MAP kinase, PI 3-kinase, IRS-1
Serine kinase		
Activin, TGF-beta, MIS	Serine kinase	Smads

(IRS: Insulin receptor substrates; MAP: Mitogen-activated protein; NGF: Nerve growth factor; PI: Phosphatidylinositol; RSK: Ribosomal S6 kinase; TGF: Transforming growth factor, STAT: Signal transducer and activator of transcription).

Ref: Harrison's 19th edition, Guyton 12th edition.

Note

- ❑ In addition to above actions, following hormone acts via **Ca₂⁺ channel activation**:
 - Glucagon, PTH, PTHrP, ACTH, MSH, GHRH, CRH.

Membrane Receptor of Steroid Hormone: Nongenomic Action

- ❑ Any action that does not directly influence gene expression (classical steroid receptors) but rather drives more rapid effects such as the activation of signalling cascades is known as nongenomic action.
- ❑ Most of the effects of estrogens are genomic, but some are so rapid (via MAP kinase) that it is difficult to believe they are mediated via production of mRNAs.
- ❑ **Example:**
 - Acute vasodilating effect of estrogen on coronary, cerebral artery via production of NO.

I IMPORTANT

Dopamine: 5 receptors. D1 and D5 acts by increasing cAMP (adenylyl cyclase) and D2, D3, and D4 acts by decreasing cAMP

I IMPORTANT

Hormone that acts through intracellular receptors: Depending on subcellular location. They may be: **Cytoplasmic:** Glucocorticoid (GR) > androgen receptors (AR) and progesterone receptor (**PR-B**). Mineralocorticoid receptor (MR) are partial cytoplasmic.

Nuclear: Thyroid hormone receptor (TR), estrogen receptor (ER α/β), progesterone receptor (**PR-A**), vit. D (VDR) and Vit. A (RAR)

I IMPORTANT**Orphan Receptors**

- ❖ An orphan receptor is a nuclear receptor that has a similar structure to other identified receptors but whose endogenous ligand has not yet been identified.
- ❖ Examples: Two "orphan" nuclear receptors (SF1 and DAX1) involved with normal gonadal differentiation and function in both sexes. Mutations in the orphan receptor Dax-1 cause congenital adrenal hyperplasia, and mutation of the orphan receptor SF-1 results in XY sex reversal and adrenal failure.

I IMPORTANT

- ❖ **Acidophilic cell in anterior pituitary:** Lactotrophs (10-30%) and somatotrophs (50%)
- ❖ **Basophilic cell in anterior pituitary:** Gonadotrope (20%), corticotrophs (10%) and thyrotropin (5%)

I IMPORTANT

- ❖ Corticotrophs appear first in foetus (6 weeks) > somatotrophs (8 weeks) > others (12 weeks).

- Neuronal discharge in the brain and feedback effects on gonadotropin secretion.
- ❑ Similar rapid effects of progesterone, testosterone, glucocorticoids, aldosterone, and 1,25-dihydroxy-cholecalciferol may also be produced by membrane receptors.

PITUITARY GLAND

- ❑ The anterior pituitary often is referred to as the "master gland".
- ❑ The anterior pituitary gland produces six major hormones: prolactin (PRL), growth hormone (GH), adrenocorticotrophic hormone (ACTH), luteinizing hormone (LH), follicle-stimulating hormone (FSH), thyroid-stimulating hormone (TSH)
- ❑ Pituitary hormones are secreted in a pulsatile manner.

Major Control of Pituitary Hormones

Hormone	Primary control	Secondary control
GH	NREM sleep is stimulatory —rise 90 min after sleep onset. (Peak-NREM stage 3 around 1 am–3 am) REM sleep is inhibitory.	Weak circadian effect (increased GH secretion at night)
CTH, cortisol	Circadian (peaks around 7–8.30 am)	Sleep inhibitory
TSH	Circadian (peaks around 2 am)	Sleep inhibitory
Prolactin	Sleep is stimulatory. Rise 60–90 min after sleep onset—Peak REM sleep. Peak 4–6 am	Circadian effect—sleep is more stimulatory when it occurs at night
LH and FSH	Sleep is stimulatory (REM). Peak early morning.	Circadian effect

Hypothalamic Control of Anterior Pituitary

There are six established hypothalamic releasing and inhibiting hormones:

1. Corticotropin-releasing hormone (CRH)
2. Thyrotropin-releasing hormone (TRH)

3. Growth hormone-releasing hormone (GRH)
4. Growth hormone-inhibiting hormone (GIH): Generally called somatostatin;
5. Gonadotropin-releasing hormone (GnRH)
6. Prolactin-inhibiting hormone (PIH): Chemically dopamine.

All these hormones are conducted, to the anterior pituitary through minute blood vessels called *hypothalamic-hypophyseal portal vessels*. In the anterior pituitary, these releasing and inhibitory hormones act on the glandular cells to control their secretion.

Posterior Pituitary Control

- ❑ Secretion from the posterior pituitary is controlled by neurons that originate in the hypothalamus (supraoptic and paraventricular nuclei) and terminate in the posterior pituitary.
- ❑ These tracts pass to the neurohypophysis (posterior pituitary) through the pituitary stalk (hypophyseal stalk).
- ❑ These nerve endings lie on the surfaces of capillaries, where they secrete two posterior pituitary hormones: (1) antidiuretic hormone (ADH), also called vasopressin, and (2) oxytocin.
- ❑ ADH is formed primarily in the supraoptic nuclei, whereas oxytocin is formed primarily in the paraventricular nuclei. Each of these nuclei can synthesize about one sixth as much of the second hormone as of its primary hormone.

I IMPORTANT

- ❖ A large nocturnal increase in gonadotropins is one of the hallmarks of puberty.
- ❖ In pubertal boys, the nocturnal rise of testosterone parallels the elevation of gonadotropins, whereas in pubertal girls, higher concentrations of estradiol occur during the daytime instead of the night time.

ADH Receptor

Type	Second messenger	Location	Actions
AVP R1A (V1)	IP3/calcium	Liver, vasculature, brain, kidney	Gluconeogenesis, release of factor VIII and Von-Willebrand factor, platelet aggregation, vasoconstriction
AVP R1B (V3)	IP3/calcium	Pituitary and brain	ACTH secretion in response to stress
AVP R2 (V2)- <i>main action</i>	cAMP	Receptor is present on basolateral membrane of collecting duct of kidney	Inserting aquaporins 2 (AQP2) channel on luminal membrane of CD Release of Von-Willebrand factor

I IMPORTANT**Cutting of Pituitary Stalk**

When stalk is cut above the pituitary gland but the entire hypothalamus is left intact:

- ❖ Decrease in all anterior pituitary hormones except prolactin.
- ❖ Posterior pituitary hormones continue to be secreted normally, after a transient decrease for a few days; they are then secreted by the cut ends of the fibers within the hypothalamus and not by the nerve endings in the posterior pituitary.

I IMPORTANT

Stage N3 sleep is enhanced in patients with hyperprolactinemia and in women who breast-feed and have high PRL levels compared with women who bottle-feed their infants.

I IMPORTANT

Fig. 17.2: Feedback control for prolactin. Dopamine is prolactin inhibitory factor (PIF) from hypothalamus, which inhibits prolactin secretion. Elevated thyrotropin releasing hormone may stimulate prolactin

PROLACTIN

- ❑ PRL secretion is *pulsatile* and follows a *bimodal pattern*. They are minimal around noon, increase somewhat during the afternoon, and the highest secretory peaks occurring during rapid eye movement sleep (REM).
- ❑ The primary effect of prolactin secretion may be stimulation of REM sleep.
- ❑ Peak serum PRL levels (up to 30 g/L) occur between 4:00 and 6:00 am.
- ❑ Morning awakenings and awakenings interrupting sleep are consistently associated with a rapid inhibition of PRL secretion.
- ❑ Sleep onset, irrespective of the time of day, has a stimulatory effect on PRL but the stimulatory effect of sleep on PRL secretion is greatest at night.
- ❑ The circulating half-life of PRL is about 50 min.

Factors stimulating prolactin secretion	Factors inhibiting prolactin secretion
Estrogen (pregnancy)- most potent	Dopamine (Fig. 17.2)
Breast-feeding	Bromocriptine (dopamine agonist)
Sleep (Peak 4–6 am)	Somatostatin
Stress	Prolactin (by negative feedback)
Strenuous exercise	
Hypoglycemia	
TRH (hypothyroidism)	
Dopamine antagonists	

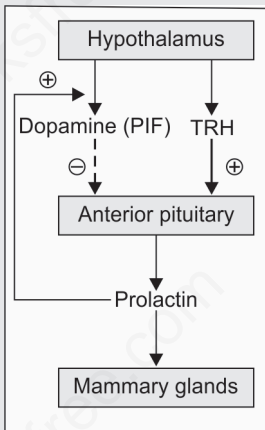
Actions of Prolactin

1. Stimulates milk production in the breast (**lactogenesis**)
2. Stimulates breast development (**mammogenesis**-in a supportive role with estrogen)
3. Induce and maintain lactation (**galactopoiesis**)
4. Inhibits ovulation by decreasing synthesis and release of gonadotropin-releasing hormone (GnRH)
5. Inhibits spermatogenesis (by decreasing GnRH)
6. Suppress sexual drive

GROWTH HORMONE (GH)

- ❑ GH is the most abundant anterior pituitary hormone, and GH-secreting somatotrophs cells constitute up to 50% of the total anterior pituitary cell population.
- ❑ Growth hormone is released in pulsatile fashion.

Factors stimulating GH secretion	Factors inhibiting GH secretion
Sleep (deep sleep-within an hour of onset)- maximum	Hyperglycemia
Stress	Somatomedins
Starvation	Somatostatin
Exercise	Obesity
Hypoglycemia	Pregnancy
Estrogen	
Ghrelin	

Feedback Control of GH (FIG. 17.3)

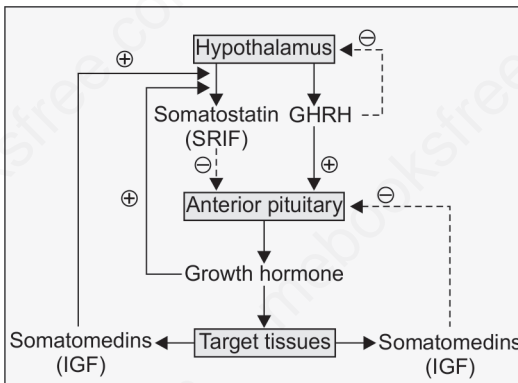

Fig. 17.3: Feedback control for growth hormone. Growth hormone releasing hormone (GHRH) from hypothalamus stimulates GH, while somatostatin inhibits it

Actions of Growth Hormone

- ❑ In the liver, growth hormone generates the production of somatomedins [insulin-like growth factors (IGF)], which serve as the intermediaries of several physiologic actions.
- ❑ The IGF receptor has tyrosine kinase activity, similar to the insulin receptor.

I IMPORTANT

- ❖ In contrast to the postnatal situation, the dominant regulator of IGF-1 production in the fetus is not growth hormone (GH), as GH receptors are generally expressed only at low levels in fetal tissues and appear to be induced by the peripartum glucocorticoid surge.
- ❖ Instead, fetal insulin, which in turn is predominantly under regulation by fetal glucose availability, is the primary driver of circulating fetal IGF-1.

Direct Actions of Growth Hormone

- ❑ ↓ Glucose uptake into cells (diabetogenic)
- ❑ ↑ Lipolysis
- ❑ ↑ Protein synthesis in muscle and ↑ lean body mass.
- ❑ ↑ Production of IGF
- ❑ GH promotes sodium, potassium, and water retention and elevates serum levels of inorganic phosphate

Actions of Growth Hormone via IGF

- ❑ ↑ *Protein synthesis in chondrocytes* and ↑ linear growth (pubertal growth spurt).
- ❑ ↑ Protein synthesis in muscle and ↑ lean body mass.
- ❑ ↑ Protein synthesis in most organs and ↑ organ size
- ❑ Anti-lipolytic

Hormones for fetal growth

- The main growth regulatory hormones are insulin, the insulin-like growth factors (IGFs), the thyroid hormones, glucocorticoids and possibly leptin.
- **Insulin:** Essential for normal fetal growth and most important hormone for foetal growth.
 - Insulin stimulates cellular uptake of glucose and amino acids, which increases their availability for tissue accretion. *It has little effect on tissue differentiation.*
- **IGF: IGF-2 is the primary growth factor for embryonic growth; the dominant fetal growth regulator in late gestation is IGF-1** produced by the fetal liver and other tissues.
- **Growth hormone: Appears to have little part in the control of fetal growth (influence after 36 wk gestation), unlike its role postnatally.**
- **Thyroid hormone:** Promotes terminal differentiation of fetal tissues closer to term (after 36 wk) and is important in mediating the prepartum maturational effects of the glucocorticoids that ensure neonatal viability.
- **Glucocorticoids:** Growth inhibitory in utero but essential for tissue differentiation in preparation for delivery. Their deficiency during late gestation leads to increased fetal body weight, conversely, cortisol infusion before term leads to IUGR in fetal sheep.

THYROID GLAND

- ❑ Thyroid gland, concerned with the production of thyroid hormone consists of multiple acini (follicles).
- ❑ Each spherical follicle is surrounded by a single layer of polarized epithelial cells and filled with proteinaceous material called colloid (Fig. 17.4).
- ❑ Colloid consists predominantly of the glycoprotein, thyroglobulin.
- ❑ When the gland is inactive, the colloid is abundant, the follicles are large, and the cells lining them are flat.
- ❑ When the gland is active, the follicles are small, the cells are cuboid or columnar, and areas where the colloid is being actively reabsorbed into the thyrocytes are visible as “resorption lacunae”.

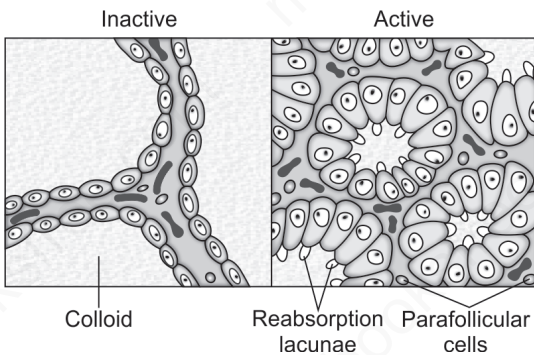

Fig. 17.4: Thyroid histology (thyroid follicle). The appearance of the gland when it is inactive (left) and actively secreting (right) is shown. Note the small, punched-out “resorption lacunae” in the colloid next to the cells in the active gland

Synthesis of Thyroid Hormones (Fig. 17.5)

1. **Thyroglobulin synthesis:** In the thyroid follicular cells, packaged in secretory vesicles, and extruded into the follicular lumen.
2. **Iodine trapping:** Na^+/I^- cotransporter actively transports I^- into the thyroid follicular cells. This step is inhibited by thiocyanate and perchlorate anions.
3. **Oxidation of I^- to I_2 :** Catalyzed by a peroxidase enzyme in the follicular cell membrane.

I IMPORTANT

- ❖ Thyroxine (T_4) and lesser amounts of triiodothyronine (T_3) are secreted by Follicular cell.
- ❖ Parafollicular cells secrete calcitonin.

4. **Organification of I₂:** Tyrosine residues of thyroglobulin react with I₂ to form monoiodotyrosine (MIT) and diiodotyrosine (DIT). *High levels of I₂ inhibit organification and, therefore, inhibit synthesis of thyroid hormone (Wolff-Chaikoff effect).*
5. **Coupling of MIT and DIT:** When two molecules of DIT combine, thyroxine (T₄) is formed. When one molecule of DIT combines with one molecule of MIT, triiodothyronine (T₃) is formed. More T₄ than T₃ is synthesized, although T₃ is more active.
6. **Stimulation of thyroid cells by TSH:** When the thyroid cells are stimulated, iodinated thyroglobulin is taken back into the follicular cells by endocytosis. Lysosomal enzymes then digest thyroglobulin, releasing T₄ and T₃ into the circulation.
7. Leftover MIT and DIT are deiodinated by thyroid deiodinase. The I₂ that is released is reutilized to synthesize more thyroid hormones. Therefore, deficiency of thyroid deiodinase mimics I₂ deficiency.
8. After synthesis of the thyroid hormones, each thyroglobulin molecule contains up to 30 thyroxine molecules and a few triiodothyronine molecules. In this form, the thyroid hormones are stored in the follicles in an amount sufficient to supply the body with its normal requirements of thyroid hormones for 2–3 months.
9. In the circulation, most of the T₃ and T₄ are bound to plasma proteins. It is the *free thyroid* hormones in plasma that are physiologically active and that feed back to inhibit pituitary secretion of TSH.

The Binding Proteins for Thyroid Hormones are:

	Plasma concentration (mg/dL)	Amount of circulating hormone bound (%)	
		T ₄	T ₃
Thyroxine-binding globulin (TBG)	2	67	46
Transthyretin (thyroxine-binding prealbumin, TBPA)	15	20	1
Albumin	3500	13	53

I IMPORTANT

Ariation of TBG

- ❖ In hepatic failure, TBG levels decrease, leading to a decrease in total thyroid hormone levels, but **normal levels of free hormone** (i.e., **clinically euthyroid**).
- ❖ In pregnancy, TBG levels increase, leading to an increase in total thyroid hormone levels, but normal levels of free hormone (i.e., **clinically euthyroid**).

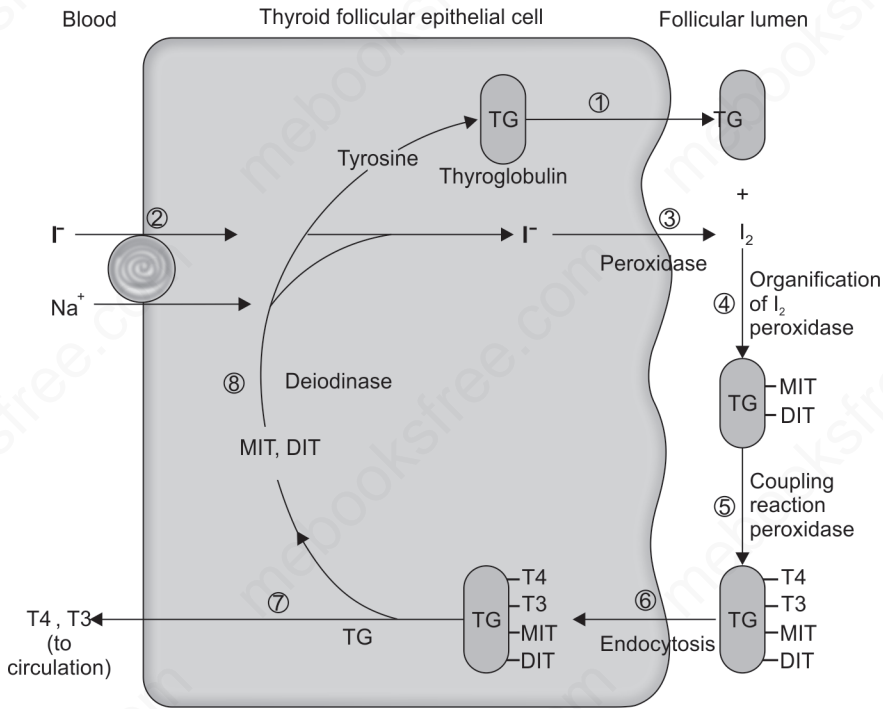

Fig. 17.5: Steps of thyroid hormone synthesis in acinar cell. Number written inside circles, indicates the stepwise sequence during thyroid hormone synthesis (described in text)

Secretion of Hormone by Thyroid Gland

- ❑ T_4 : 80 $\mu\text{g}/\text{day}$
- ❑ T_3 : 4 $\mu\text{g}/\text{day}$
- ❑ RT_3 : 2 $\mu\text{g}/\text{day}$
- ❑ MIT/DIT Nil

Note: TSH secretion: 110 $\mu\text{g}/\text{day}$

Conversion of T_4 to T_3 and Reverse T_3 (rT_3)

- ❑ In the peripheral tissues, T_4 is converted to T_3 by 5' iodinase (reverse T_3).
- ❑ T_3 is more biologically active than T_4 .
- ❑ rT_3 is inactive.

Thyroid hormone metabolism: Peripheral metabolism of thyroid hormones involves the sequential removal of iodine molecules, converting T_4 into the more active T_3 and inactivating thyroid hormones before their excretion (Fig. 17.6).

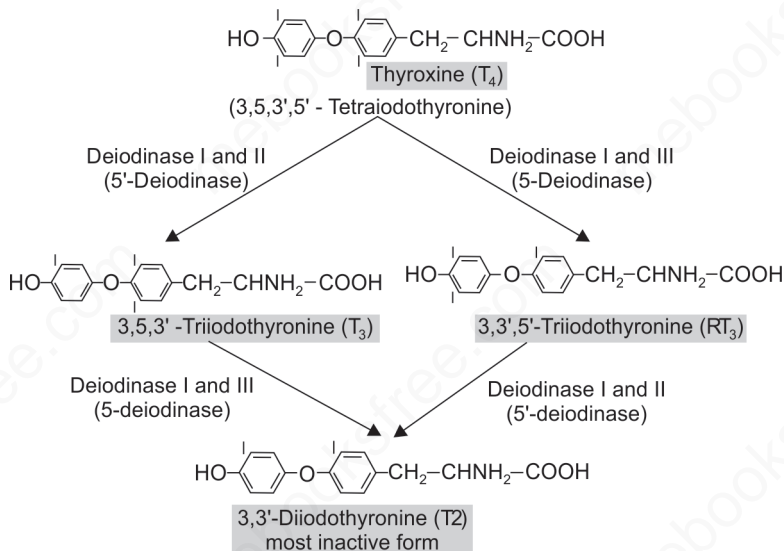

Fig. 17.6: Metabolism of thyroid hormones

From Figure 17.6 we have seen, that deiodinase I and II (5'-deiodinase) cause outer ring deiodination whereas Deiodinase I and III (5-deiodinase) cause inner ring deiodination.

Locations of various deiodinase enzymes are as follows:

Type of deiodinase enzymes	Tissue locations and effects
Type I deiodinase	<ul style="list-style-type: none"> Predominantly in liver, kidney, and thyroid Major source of circulating T_3 Primary site for clearance of plasma rT_3
Type II deiodinase	<ul style="list-style-type: none"> Primarily in human brain, anterior pituitary, and thyroid Important role in the local production of T_3 in tissues
Type III deiodinase	<ul style="list-style-type: none"> Predominantly in human brain, placenta, and fetal tissues It regulates intracellular T_3 levels by inactivating T_3 to T_2 more efficiently

Effect of Diet on Conversion of T_4 to T_3

- In fasted individuals, plasma T_3 is reduced by 10–20% within 24 h and by about 50% in 3 to 7 days, with a corresponding rise in RT_3 (Fig. 17.7).

- ❑ Free and bound T_4 levels remain essentially normal.
- ❑ During more prolonged starvation, RT_3 returns to normal but T_3 remains depressed.
- ❑ All these changes are to conserve calories by reducing tissue metabolism and are reversed promptly by refeeding.

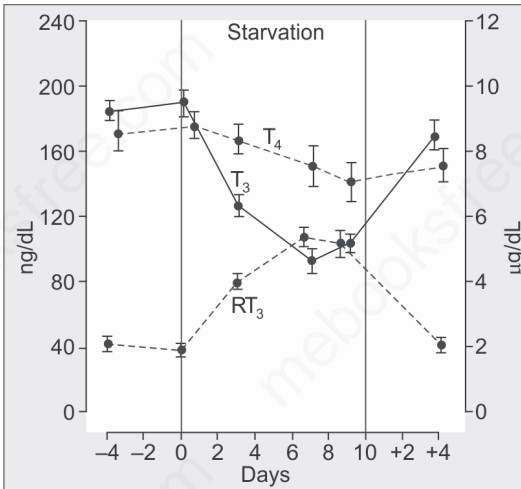

Fig. 17.7: Effect of starvation on plasma levels of T_4 , T_3 , and RT_3 in humans

Differences between T_3 and T_4

	T_4	T_3
Plasma concentration	8 ng/dL	0.15 ng/dL
Total Free concentration	2 ng/dL	0.3 ng/dL
% Bound form	99.98	99.8
% Free form	0.02	0.2
$T_{1/2}$ (Half-life)	Longer	Shorter
Binding with plasma protein	More	Less
Max ^m binding with	TBG (67%)	Albumin (53%)
Action	Slower	Much more rapid
Amount in colloid	More (25%)	Less (7%)
Amount in secretion	More (80 mg/d)	Less (4 mg/d)
'Reverse' form (inactive)	No RT_4	RT_3 is present
Potency	Less	3-5 times more potent
Binding to thyroid hormone nuclear receptors	Less	More

I IMPORTANT

Two myosin heavy chain (MHC) isoforms, α -MHC and β -MHC, produced by the heart α -MHC predominates in the atria in adults, and its level is increased by treatment with thyroid hormone. Conversely, expression of the α -MHC gene is depressed and that of the β -MHC gene is enhanced in hypothyroidism.

Actions of Thyroid Hormone

System	Effects of thyroid hormones
Effect on CVS	<ul style="list-style-type: none"> • T_3 in myocytes upregulates genes for α-myosin heavy chain (MHC), sarcoplasmic reticulum Ca^{2+} ATPase, β-adrenergic receptors, G-proteins, Na-K-ATPase, and certain K^+ channels. • The net result is increased heart rate, force of contraction and cardiac output. • Peripheral resistance decreases because of cutaneous vasodilation (in response to extra-heat production by thyroid hormones) • Increases levels of renal Na^+ and water absorption, expanding blood volume
Effect on CNS	<ul style="list-style-type: none"> • Maturation of the CNS (deficiency causes mental retardation). • Hyperthyroidism causes hyperexcitability and irritability. • Overall, cerebral blood flow, glucose and O_2 consumption by the brain are normal in adult hypothyroidism and hyperthyroidism
Effect on skeletal muscle	<ul style="list-style-type: none"> • Muscle weakness in hyperthyroidism (thyrotoxic myopathy) • This may be due in part to increased protein catabolism and effect on expression of the MHC genes in skeletal
Effect on growth	<ul style="list-style-type: none"> • Attainment of adult stature require thyroid hormone • Stimulate bone maturation as a result of ossification and fusion of the growth plates (In thyroid hormone deficiency, bone age is less than chronologic age). • Thyroid hormones act synergistically with GH and somatomedins to promote bone formation.
Effect on Basal metabolic rate (BMR)	<ul style="list-style-type: none"> • Calorigenic effect (increases heat production) • Oxygen consumption and BMR are increased by thyroid hormone in all tissues except the brain, gonads, lymph nodes, spleen and anterior pituitary.
Effect on metabolism	<ul style="list-style-type: none"> • Overall, metabolism is increased to meet the demand for substrate associated with the increased rate of O_2 consumption. • Glucose absorption from the gastrointestinal tract is increased. • Glycogenolysis, gluconeogenesis, and glucose oxidation (driven by demand for ATP) are increased. • Lipolysis increased (decrease fat store in boy and <i>increase</i> plasma free fatty acids level). • Thyroid hormones increase formation of low-density lipoprotein (LDL) receptors in the liver, resulting in increased hepatic removal of cholesterol from the circulation (<i>decrease</i> cholesterols, TG and phospholipids in plasma). • Protein synthesis and degradation are increased. The overall effect of thyroid hormone is catabolic.

I IMPORTANT

Thyroid hormones have marked effects on brain development. The parts of the central nervous system (CNS) most affected are the cerebral cortex and the basal ganglia.

ADRENAL GLANDS

Two Parts: Cortex and Medulla

- ❑ **Cortex consist of 3 layers (Fig. 17.8)**
 - Glomerulosa: 15% of gland weight
 - Fasciculata: 50% of gland weight
 - Reticularis: 7% of gland weight
- ❑ **Medulla: 28% of gland weight**

Synthesis of adrenocortical hormones:

- ❑ The zona glomerulosa produces **aldosterone**.
- ❑ The zona fasciculate produces **mostly glucocorticoids (cortisol)**.

- ❑ The zona reticularis produces **mostly androgens** (dehydroepiandrosterone and androstenedione).

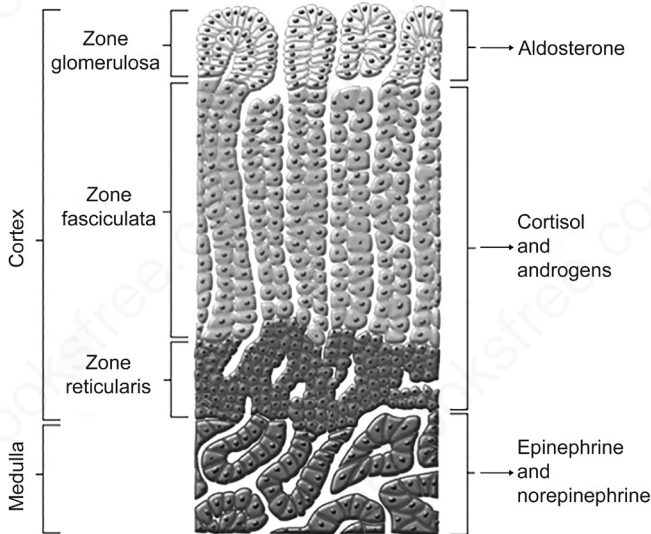

Fig. 17.8: Section through an adrenal gland showing both the medulla and the zones of the cortex, as well as the hormones they secrete

REGULATION OF SECRETION OF ADRENOCORTICAL HORMONES

Regulation Glucocorticoid Secretion (Fig. 17.9)

- ❑ Oscillates with a 24-hour periodicity (circadian rhythm). With peak levels in the morning (acrophase: 08:30 hour) and low levels in the evening (nadir phase: 00:15 hour).
- ❑ **Hypothalamic control:** Release of corticotropin-releasing hormone (CRH) occurs in response to endogenous or exogenous stress from paraventricular nucleus of hypothalamus. Corticotropin-releasing hormone stimulates the production, release, and processing of POMC, a prohormone synthesized in the anterior pituitary (Fig. 17.10). POMC is post-translationally cleaved to adrenocorticotropic hormone (ACTH).
- ❑ **Pituitary control:** Adrenocorticotropic hormone increases steroid hormone synthesis in all zones of the adrenal cortex by stimulating cholesterol desmolase (mainly zona fasciculata and zona reticularis) and increasing the conversion of cholesterol to pregnenolone.

I IMPORTANT

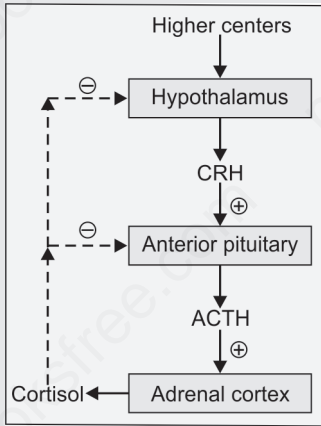

Fig. 17.9: Control of cortisol secretion. Corticotropin releasing hormone (CRH) from hypothalamus stimulates ACTH production

- ❑ **Negative feedback control:** Cortisol inhibits the secretion of CRH from the hypothalamus and the secretion of ACTH from the anterior pituitary.

POMC (Preproopiomelanocortin)

- CRH stimulates the production, release, and processing of POMC, a prohormone synthesized in the anterior pituitary (Fig. 17.10).
- POMC is post-translationally cleaved to adrenocorticotrophic hormone (ACTH); β -endorphin, an endogenous opioid peptide; and α -, β -, and γ -melanocyte-stimulating hormones (MSH).
- The predominant products of human corticotrophs are ACTH and β -lipotropin. Because final processing of POMC occurs in the secretory granule, β -lipotropin is secreted along with ACTH.
- Cleavage of β -lipotropin also occurs to some extent in human corticotrophs, so that some β -endorphin may also be released, particularly when ACTH secretion is brisk.

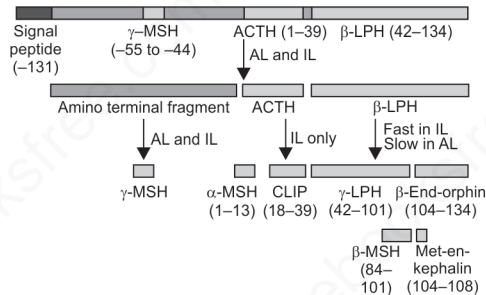

Fig. 17.10: POMC in pituitary cell. AL, anterior lobe; IL, intermediate lobe. Amino acids number are given in brackets

Actions of Glucocorticoids (Cortisol)

Overall, glucocorticoids are essential for the response to stress.

- ❑ Stimulation of protein catabolism and increased hepatic glycogenesis and gluconeogenesis.
- ❑ Anti-inflammatory effects:
 - Glucocorticoids induce the synthesis of lipocortin, an inhibitor of phospholipase A2.
 - Glucocorticoids inhibit the production of interleukin-2 (IL-2) and inhibit the proliferation of T lymphocytes.

- Glucocorticoids inhibit the release of histamine and serotonin from mast cells and platelets.
- ❑ Suppression of the immune response
 - Glucocorticoids inhibit the production of IL-2 and T lymphocytes, both of which are critical for cellular immunity.
- ❑ Maintenance of vascular responsiveness to catecholamines: Cortisol up-regulates α_1 receptors on arterioles, increasing their sensitivity to the vasoconstrictor effect of norepinephrine. Thus, with cortisol excess, arterial pressure increases.

Regulation of Aldosterone Secretion

Regulation of aldosterone secretion is under tonic control by ACTH, but is separately regulated by the renin-angiotensin system and by potassium.

- ❑ Actions of mineralocorticoids (aldosterone):
 - Renal Na^+ reabsorption (action on the principal cells of the late distal tubule and collecting duct)
 - Renal K^+ secretion (action on the principal cells of the late distal tubule and collecting duct)
 - Renal H^+ secretion (action on the α -intercalated cells of the late distal tubule and collecting duct)

Excessive aldosterone production (Primary aldosteronism or Conn's syndrome) will lead to (Fig. 17.11):

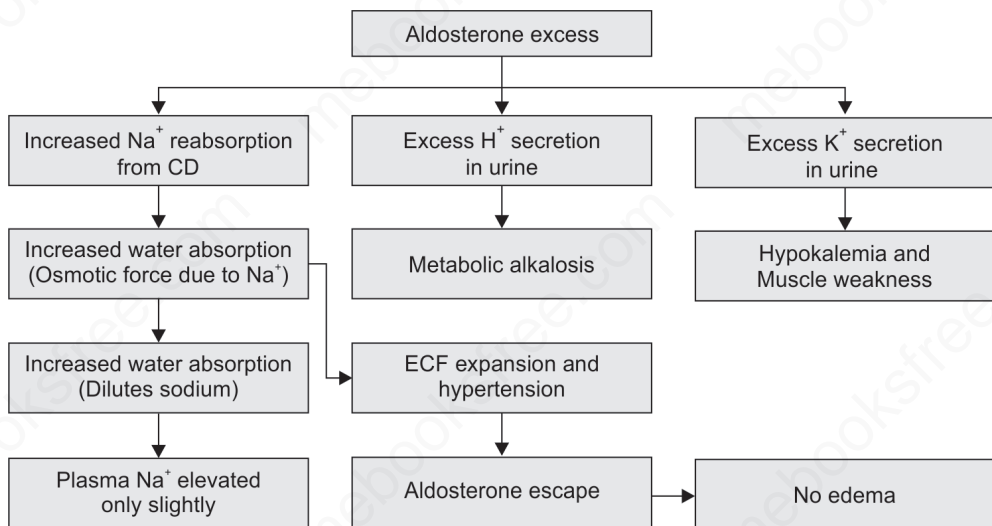

Fig. 17.11: Mechanisms of Conn's syndrome

Aldosterone Escape

- “Aldosterone escape”: Escape from the sodium-retaining effects of excess mineralocorticoids or, aldosterone in primary hyperaldosteronism.
- Administration of large doses of aldosterone typically causes an **initial decrease** in urinary sodium excretion, which leads to renal Na^+ retention. However, urinary Na^+ excretion **subsequently increases** to balance Na^+ intake **before detectable edema develops**. This phenomenon is termed ‘aldosterone escape’.
- This is the reason why edema formation is not a characteristic of primary hyperaldosteronism.

Mechanism of escape (Fig. 17.12)

- Volume expansion causes an increase in renal perfusion pressure, which decreases proximal Na^+ reabsorption and increases Na^+ delivery to the distal nephron. This increased delivery of Na^+ overrides the enhanced aldosterone mediated Na^+ reabsorption at the distal nephron. Which lead to excretion of both Na^+ and water (pressure natriuresis and diuresis).
- Volume expansion also increases levels of plasma ANP and therefore its inhibitory effect on Na^+ reabsorption in the collecting duct.
- But, in edematous disorders (Fig. 17.13) including cardiac failure and cirrhosis, however, normal aldosterone escape is impaired. Because in these condition there is stimulation of renin-angiotensin-aldosterone system (RAAS) and the sympathetic nervous system. In this setting, renal perfusion pressure and GFR decreases, which diminish the distal delivery of Na^+ to the sites of aldosterone and ANP hormone action in the CD. These processes lead to impaired aldosterone escape and blunt the actions of ANP hormone, resulting in edema formation.

Aldosterone Breakthrough

- ❑ Angiotensin converting enzyme (ACE) inhibitors and angiotensin receptor blockers (ARBs) are now widely used with beneficial effects, particularly in patients with hypertension and cardiac failure.
- ❑ However, since angiotensin II inhibits renin release, *a large increase in plasma renin activity* occurs with the administration of either ACE inhibitors or ARBs. Moreover, after several weeks of ACE inhibition or ARBs therapy, *plasma aldosterone returns to pretreatment levels* in up to 30–40% of patients.

This phenomenon has been termed *aldosterone breakthrough*.

- ❑ Those patients who demonstrate aldosterone breakthrough have a worse clinical prognosis than those who do not demonstrate aldosterone breakthrough.
- ❑ This deleterious effect could be due to the nongenomic effects of aldosterone, which are known to cause inflammation, fibrosis and oxidant injury.
- ❑ Direct renin inhibition, for instance with **aliskiren**, does not increase plasma renin activity, and therefore may not be associated with aldosterone breakthrough.
- ❑ Vitamin D has been shown to bind to the promoter region of the renin gene and downregulate renal mRNA expression of renin.
- ❑ Therefore direct renin inhibitors, vitamin D or a combination of the two could theoretically exert a renal and/or cardiovascular protective effect in patients receiving ACE inhibitor or ARB treatment who demonstrate aldosterone breakthrough.

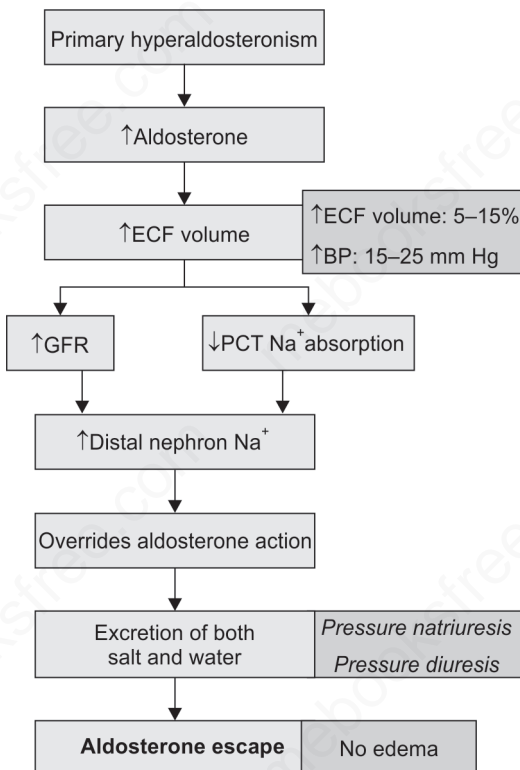

Fig. 17.12: Aldosterone escape mechanisms

Cardiac failure and cirrhosis

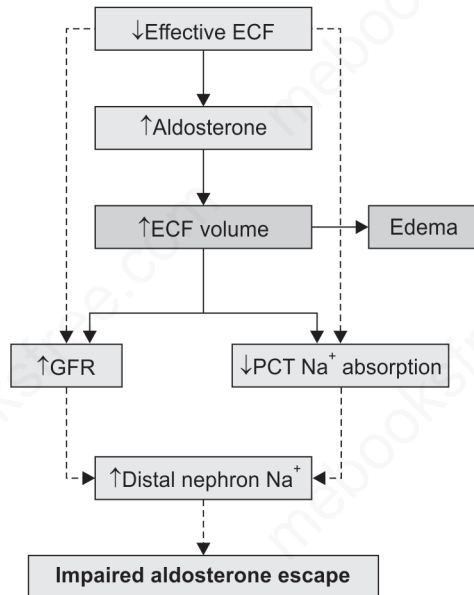

Fig. 17.13: Impaired aldosterone escape mechanisms in hyper-volemic states. Broke line indicates inhibitory pathway

ENDOCRINE PANCREAS

Organization of the endocrine pancreas (Fig. 17.14)

- ❑ The islets of Langerhans contain three major cell types; alpha, beta and delta
- ❑ Gap junction link beta cells to each other, alpha cells to each other, and beta cells to alpha cells for rapid communication.

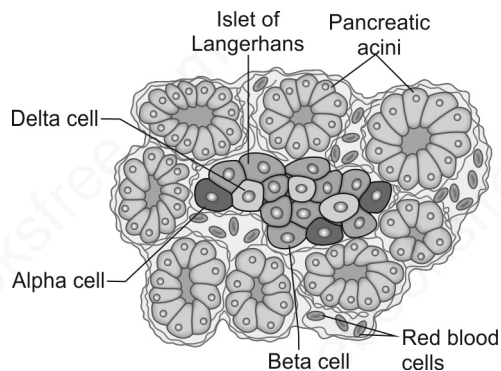

Fig. 17.14: Physiological anatomy of an islet of Langerhans in the pancreas

- ❑ The portal blood supply of the islets allows blood from the beta cells (containing insulin) to bathe the alpha and delta cells, again for rapid cell-to-cell communication.

Different types of cell in islets of Langerhans:

Type of cell	Location	Function
Beta (65–80%)	Center of the islets	Secrete insulin, C peptide and amylin
Alpha (15–20% of total islet cells)	Outer rim of islets	Secrete glucagon
Delta (3–10%)	Intermixed	Secrete somatostatin and gastrin
F cell or, PP cell (3–5%)	Intermix	Secretes pancreatic polypeptide
Epsilon cells (<1%)	Intermix	Ghrelin (<1%)
G cell	Foetal pancreas, intermix	Secretes gastrin

Insulin

- ❑ Contains an A chain and a B chain, joined by two disulfide bridges.
- ❑ Proinsulin is synthesized as a single-chain peptide.
- ❑ Within storage granules, a connecting peptide (**C peptide**) is removed by proteases to yield insulin.
- ❑ The C peptide is packaged and secreted along with insulin, and its concentration is used to monitor beta cell function in diabetic patients who are receiving exogenous insulin.

Regulation of Insulin Secretion

- ❑ Blood glucose concentration—is the major factor that regulates insulin secretion. An initial burst of insulin is followed by sustained secretion.
- ❑ ↑Amino acids (arginine, lysine, leucine), ↑fatty acids, glucagon, glucose, intestinal hormones (GIP, GLP-1, gastrin, secretin, CCK), β-keto acids, ach, glucagon, cAMP.

Mechanism of Insulin Secretion (Fig. 17.15)

- ❑ Glucose levels >3.9 mmol/L (70 mg/dL) stimulate insulin synthesis.
- ❑ Glucose, the stimulant for insulin secretion, binds to the GLUT2 receptor on the beta cells.
- ❑ Inside the beta cells, glucose is oxidized to ATP, which closes K⁺ channels in the cell membrane and leads to depolarization of the beta cells.

I IMPORTANT

- ❖ **Beef insulin** differs from human insulin by **three amino acids**, whereas the **pork insulin** differs from human insulin by a **single amino acid**.

I IMPORTANT

Increase adrenergic stimulation is a physiological defense mechanism in hypoglycemia. Adrenergic stimulation has dual effects on beta cells. α₂-adrenergic inhibition of insulin secretion is the main effect and β₂-adrenergic stimulation alone has little effect.

I IMPORTANT

Similar to the action of ATP, sulfonylurea drugs (e.g., tolbutamide, glyburide) stimulate insulin secretion by closing these K^+ channels.

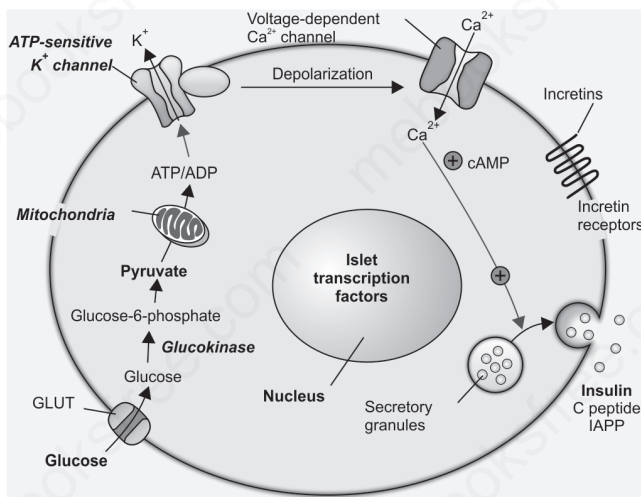

Fig. 17.15: Mechanism of insulin release in beta cell of pancreas

I IMPORTANT

Glucagon-like peptide 1 (GLP-1), the most potent incretin, is released from L cells in the small intestine and stimulates insulin secretion only when the blood glucose is above the fasting level.

I IMPORTANT

GLP-1 receptor agonist drugs (exenatide, liraglutide, dulaglutide) are used for the treatment of type II DM.

- ❑ Depolarization opens Ca^{2+} channels, which leads to an increase in intracellular $[Ca^{2+}]$ and then to secretion of insulin.
- ❑ **Incretins** are released from neuroendocrine cells of the gastrointestinal tract following food ingestion and amplify glucose-stimulated insulin secretion and suppress glucagon secretion.
- ❑ Incretin analogues, are used to enhance endogenous insulin secretion.

Insulin Receptor

- ❑ Found on target tissues for insulin.
- ❑ Tetramer with two α subunits and two β subunits.
- ❑ The α subunits span the cell membrane and have tyrosine kinase activity.
- ❑ When insulin binds to the receptor, tyrosine kinase auto-phosphorylates the β subunits. The phosphorylated receptor then phosphorylates intracellular proteins.
- ❑ The insulin-receptor complexes enter the target cells.
- ❑ Insulin down-regulates its own receptors in target tissues.

Therefore, the number of insulin receptors is increased in starvation and decreased in obesity.

Actions of Insulin

- ❑ *Insulin acts on the liver, adipose tissue, and muscle.*
- ❑ On adipose tissue:
 - Increase glucose uptake and converts them to TG
 - Insulin stimulates fat deposition and inhibits lipolysis

- Inhibits ketoacid formation in the liver because decreased fatty acid degradation provides less acetyl CoA substrate for ketoacid formation.
- Increase uptake of K^+
- ❑ On muscle:
 - It promotes formation of glycogen from glucose.
 - Insulin stimulates amino acid uptake into cells, increases protein synthesis, and inhibits protein degradation. Thus, insulin is anabolic.
 - Increases K^+ uptake into cells, thereby decreasing blood $[K^+]$.
- ❑ On liver:
 - It promotes formation of glycogen from glucose.
 - Insulin stimulates amino acid uptake, increases protein synthesis, and inhibits protein degradation.
 - It decreases gluconeogenesis.

I IMPORTANT

The half-life of insulin in the circulation in humans is about 5 min. The half-life of the insulin receptor is about 7 hrs.

Ca²⁺ HOMEOSTASIS

Overall Ca²⁺ Homeostasis (17.16)

- ❑ Total body calcium is around 1 kg (slightly >1 kg). This calcium is distributed in different compartment as follows:

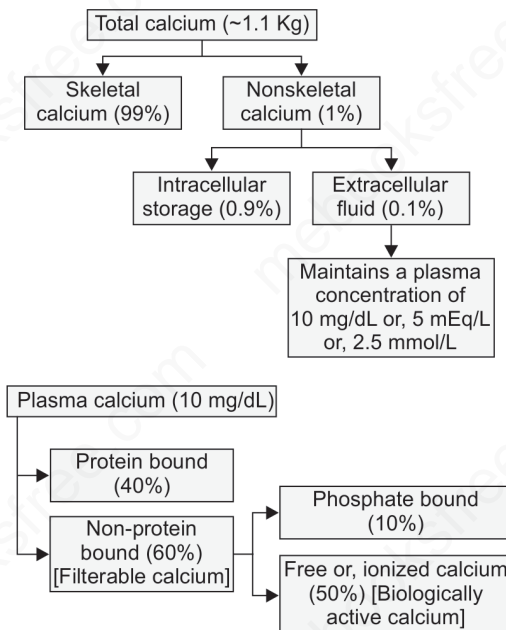

Fig. 17.16: Distribution of calcium in human body. Plasma calcium distribution into ionized calcium and un-ionized calcium is shown separately

I IMPORTANT**Positive Ca²⁺ balance**

❖ Is seen in growing children: Intestinal Ca²⁺ absorption exceeds urinary excretion, and the excess is deposited in the growing bones.

Negative Ca²⁺ balance

❖ Is seen in women during pregnancy or, lactation: Intestinal Ca²⁺ absorption is less than Ca²⁺ excretion, and the deficit comes from the maternal bones.

Hormones regulating calcium balance: Mainly three hormones regulates calcium balance. Their effects are as follows:

	PTH	Vitamin D	Calcitonin
Stimulus for secretion	↓ Serum [Ca ²⁺]	↓ Serum [Ca ²⁺] PTH ↓ Serum [Phosphate]	↑ Serum [Ca ²⁺]
Action on:			
Bone	↑ Resorption	↑ Resorption	↓ Resorption
Kidney	↓ P reabsorption (↑ urinary cAMP) ↑ Ca ²⁺ reabsorption	↑ P reabsorption ↑ Ca ²⁺ reabsorption	
Intestine	↑ Ca ²⁺ absorption (via activation of vitamin D)	↑ Ca ²⁺ absorption (calbindin D-28K) ↑ P absorption	
Overall effect on:			
Serum [Ca ²⁺]	↑	↑	↓
Serum [Phosphate]	↓	↑	

CAMP = Cyclic adenosine monophosphate

PTH AND ROLE IN CALCIUM BALANCE**I IMPORTANT**

Parathyroid glands are essential for life.

Secretion of PTH

- ❑ Is controlled by the serum Ca²⁺ binding to Ca²⁺ sensing receptors in the parathyroid cell membrane.
- ❑ *Secretion of PTH: Factors, which affects secretion of PTH, are given in the following table:*

PTH release is increased by	PTH release is decreased by
<ul style="list-style-type: none"> • Decreased serum Ca²⁺ (most important) • Mild decreases in serum Mg²⁺ • Hyperphosphatemia • Catecholamines 	<ul style="list-style-type: none"> • Increased serum Ca²⁺ • Severe decreases in serum Mg²⁺ • 1,25(OH)₂ D [Calcitriol]

- ❑ The second messenger for PTH secretion by the parathyroid gland is cAMP

PTH Receptor

Type	Second messenger	Location
PTH1R (hPTH/PTHrP)	cAMP (main) and IP3/calcium	Bone (osteoblast) and Kidney
PTH2R (hPTH2)	cAMP	Brain, placenta, pancreas and testis
CPTH		Osteocyte
<ul style="list-style-type: none"> Carboxyl-terminal PTH fragments (C-PTH), are generated by both direct secretion from parathyroids and catabolism of PTH operated by the Kupffer cells in the liver. C-PTH interacts with a putative C-PTH receptor. This way, C-PTH seems to exert specific effects on calcium homeostasis and bone metabolism, opposite to those of the synthetic agonist of PTH/PTHrP receptor 		
<p>Note: PTH receptor is not present in intestine. So, action of PTH on intestine is indirect (via Vit. D3).</p>		

Actions of PTH

Target organs/tissues	Actions of PTH
Bone	<ul style="list-style-type: none"> Fastest action is on bone. PTH increases bone resorption (brings both Ca²⁺ and phosphate from bone mineral into the ECF) Resorption of the organic matrix of bone is reflected in increased hydroxyproline excretion
Proximal tubule of Kidney	<ul style="list-style-type: none"> Inhibits renal phosphate reabsorption (phosphaturic effect) cAMP (second messenger of PTH) generated as a result of the action of PTH on the proximal tubule is excreted in the urine (increased urinary cAMP). Production of 1,25-dihydroxycholecalciferol (Calcitriol)
Distal tubule of Kidney	<ul style="list-style-type: none"> Increases renal Ca²⁺ reabsorption
	<ul style="list-style-type: none"> PTH increases the insertion of calcium channels in the apical membrane and facilitates the entry of calcium.
	<ul style="list-style-type: none"> Calbindin, a vitamin D-dependent calcium-binding protein facilitates the cytosolic diffusion of calcium from the apical influx to the basolateral efflux sites.
GIT (intestine)	<ul style="list-style-type: none"> Increases intestinal Ca²⁺ absorption indirectly by stimulating the production of 1,25-dihydroxycholecalciferol in the kidney

Mechanism of PTH Mediated Mobilization of Bone Calcium

- ❑ The inorganic phase of bone matrix is composed mainly of **hydroxyapatite**, which functions as a reservoir of calcium and phosphate ions.
- ❑ Osteoclastic activity induced by PTH is **indirectly** mediated through osteoblast activation.
- ❑ PTH binds to **PTH receptor (PTH1R)** in osteoblasts and stimulates the expression of RANKL expression on the cell surface.
- ❑ RANKL binds to **RANK, a cell surface protein on osteoclast precursors (Fig. 17.17)**.
- ❑ RANKL to RANK interaction causes differentiation and activation of inactive osteoclast into a mature osteoclast, leading to bone resorption.
- ❑ Another protein that participates in this sequence of events is **osteoprotegerin (OPG)**, a member of the TNF receptor superfamily, secreted by osteoblasts. Osteoprotegerin acts as a **natural antagonist of RANKL**, decreasing RANK–RANKL interaction (Fig. 17.18).
- ❑ Thus OPG causes suppression of bone resorption and hypercalcemia.

I IMPORTANT

Denosumab (drug) is a human monoclonal antibody that binds with high affinity to RANKL, mimicking the effect of OPG, and blocks osteoclast formation and activation. It increases BMD and decreases bone turnover.

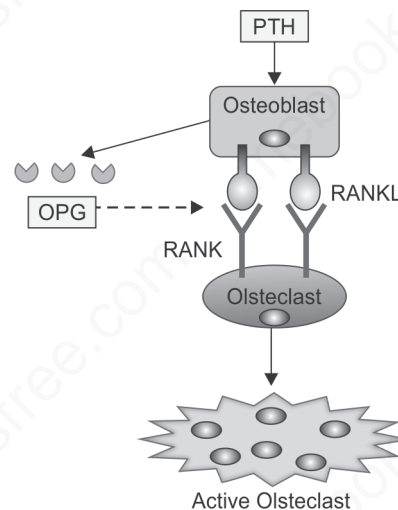

Fig. 17.17: PTH-mediated osteoclast differentiation. RANKL: receptor activator of nuclear factor- κ B ligand; OPG: osteoprotegerin. Broken arrow \rightarrow inhibitory; Solid arrow \rightarrow stimulatory signal

Some hormones involved in the regulation of bone metabolism:

Hormones	Actions
Estrogens and androgens	<ul style="list-style-type: none"> • Increase osteoblastic activity • Increase osteoclast apoptosis • Increase osteoprotegerin synthesis • Net decrease in bone loss
Growth hormone	<ul style="list-style-type: none"> • Stimulates osteoblast mediated bone synthesis and growth
Thyroid hormone	<ul style="list-style-type: none"> • Increases osteoclast mediated bone resorption
Glucocorticoids	<ul style="list-style-type: none"> • Increase apoptosis of osteoblast (Increase bone resorption) • Decrease osteoprotegerin synthesis

VITAMIN D METABOLISM AND ROLE IN CALCIUM BALANCE

- ❑ Provititamin D (7-dehydrocholesterol) in the skin is converted to cholecalciferol by ultraviolet (UV) light.
- ❑ Cholecalciferol and ergocalciferol (from plants) are transported to the liver where they undergo the first step in bioactivation the hydroxylation at C-25 to 25-hydroxyvitamin D (25(OH) D), the **major circulating form of vitamin D** (Fig. 17.18).
- ❑ The second hydroxylation step, at C-1, occurs in the kidney and results in the hormonally active 1,25(OH)₂D. This step is stimulated by PTH
- ❑ An increase in plasma calcium levels inhibits the hydroxylation at C-1 and favors hydroxylation at C-24, leading to the synthesis of an inactive metabolite of vitamin D (24,25(OH)₂D).

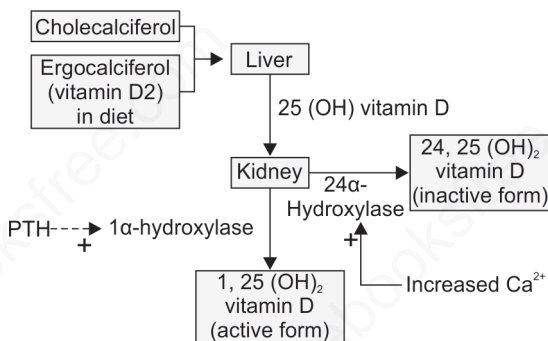

Fig. 17.18: Vitamin D metabolism. (+) sign indicates, stimulatory pathway

- ❑ Cholecalciferol, 25-hydroxycholecalciferol, and 24,25-dihydroxycholecalciferol are inactive.
- ❑ The active form of vitamin D is *1,25-dihydroxycholecalciferol (calcitriol)*.
- ❑ The production of 1,25-dihydroxycholecalciferol in the kidney is catalyzed by the enzyme 1α -hydroxylase (at PCT).

Actions of 1,25-dihydroxycholecalciferol (Calcitriol)

- ❑ Are coordinated to increase both Ca^{2+} and phosphate in ECF to mineralize new bone.
- ❑ *Increases intestinal Ca^{2+} absorption (indirect action)*. Vitamin D–dependent Ca^{2+} binding protein (calbindin) is induced by 1,25-dihydroxycholecalciferol.
- ❑ PTH increases intestinal Ca^{2+} absorption indirectly by stimulating 1α -hydroxylase and increasing production of the active form of vitamin D.
- ❑ *Increases intestinal phosphate absorption.*
- ❑ Increases renal reabsorption of Ca^{2+} and phosphate, analogous to its actions on the intestine.
- ❑ Increases bone resorption, which provides Ca^{2+} and phosphate from “old” bone to mineralize “new” bone.

CALCITONIN/ THYROCALCITONIN AND ROLE IN CALCIUM BALANCE

- ❑ Is synthesized and secreted by the parafollicular C-cells of the thyroid.
- ❑ Secretion is stimulated by an increase in serum Ca^{2+} greater than 9.5 mg %, CCK-PZ, glucagon, secretin, estrogen, dopamine and gastrin
- ❑ *Acts primarily to inhibit bone resorption by causing apoptosis of osteoclast.*
- ❑ Decreases renal formation of 1,25-dihydroxycholecalciferol.
- ❑ Increases Na^+ , Ca^{2+} , Cl^- and PO_4^{3-} excretion in urine.
- ❑ Inhibits intestinal calcium and phosphate absorption.
- ❑ Increases intestinal secretion of water and electrolytes.

HORMONE AND STRESS

Increased	Decreased
CRF, ACTH and cortisol (3-5times)	GnRH, gonadotropins, and gonadal steroid
Catecholamine	TSH and T3, T4
Vasopressin (ADH)	Insulin
Prolactin (it may decrease)	
GH (2-10 folds)	

CRF: Corticotropin releasing factor, GH: Growth hormone

HORMONAL CHANGES WITH AGING

Increased	Decreased
PTH, CCK	GH, aldosterone
LH (women), FSH	Testosterone, estradiol, LH (men)
Insulin, Nor-epinephrine	Calcitonin, melatonin
Cortisol	25 OH Vit. D
Prolactin	IGF-I, VIP

CCK: Cholecystokinin, VIP: Vasoactive intestinal peptide

I IMPORTANT**Hormone that remain unchanged or, Slightly Decrease During Aging**

Epinephrine, thyroid hormones T3 and T4, glucagon like peptide (GLP-I) and gastric inhibitory polypeptide (GIP).

MULTIPLE CHOICE QUESTIONS

HORMONE RECEPTOR

RECENT MCQs

1. Which is not a peptide hormone?

- a. Somatostatin b. Serotonin
c. Neuropeptide d. Enkephalin

2. Not a glycoprotein:

- a. FSH b. LH
c. TSH d. GH

3. Which of the following act through tyrosine kinase receptor?

- a. Insulin b. Glucagons
c. GH d. FSH

4. cAMP action mediates all *except*:

- a. Glucagon
b. Follicle stimulating hormone
c. Luteinizing hormone
d. Estrogen

5. All the following hormones have receptors on the plasma membrane of target tissues *except*:

- a. Thyrotropin b. Glucagons
c. Estradiol d. Epinephrine

6. Steroid receptor superfamily is present in:

- a. Vitamin D3 b. Insulin
c. Glucagon d. Thyroid

7. Endothelium derived relaxing factor (EDRF) induced vasodilatation is mediated by:

- a. Increased intracellular cGMP
b. Decreased intracellular cGMP
c. Increased extracellular cyclic Amp
d. Decreased intracellular cyclic Amp

AIIMS/PGI/JIPMER

8. Which of the following hormones is an example of a peptide hormone?

[AIIMS May 05]

- a. Parathormone b. Adrenaline
c. Cortisol d. Thyroxine

9. cAMP action mediates all *except*:

- a. Glucagon b. FSH *[PGI June 2K]*
c. LH d. Estrogen

10. All of the following use c-AMP as a second messenger *except*: *[AIIMS Nov 09]*

- a. Corticotropin b. Dopamine
c. Glucagon d. Vasopressin

11. cGMP is second messenger for which hormone(s)? *[PGI May 09]*

- a. Somatostatin
b. Atrial natriuretic factor
c. Angiotensin II
d. Antidiuretic hormone (ADH)
e. Nitric oxide (NO)

12. Receptors on cell membrane that activate ion channel after binding with agonists are: *[PGI June 03]*

- a. Nicotinic cholinergic
b. Muscarinic cholinergic
c. Opioid mu receptors
d. GABA_A
e. GABA_B

13. Intracellular receptors are found in:

[PGI June 06]

- a. Insulin b. Glucagon
c. Corticosteroids d. Androgen
e. Thyroxine

14. Which sets of hormones have nuclear receptor? [PGI Dec 08]

- Estrogen, thyroxin and glucagon
- Estrogen, thyroxin and TSH
- Estrogen, TSH and gonadotropin releasing hormone (GnRH)
- Retinoid acid, Thyroxin and luteinizing hormone (LH)
- Testosterone, cortisol and estrogen

15. Atrial natriuretic factor (ANF) is mediated by: [AIIMS Nov 01, June 97]

- Inositol phosphate
- DAG
- CyAMP
- CyGMP

16. CyAMP acts as a second messenger of: [AIIMS May 95, 94]

- FSH
- Thyroxine
- Growth hormone
- Insulin

17. All are second messengers except: [AIIMS Nov 08]

- Guanylyl cyclase
- cAMP
- IP₃
- DAG

18. Steroid receptors present at: [JIPMER 2011]

- Cell membrane
- Cytoplasm
- Nucleus
- All of the above

19. Secondary messengers include: [PGI June 02]

- cAMP
- IP₃
- Diacylglycerol
- GMP

20. Which one of the following acts as second messenger? [AIIMS May 06]

- Mg⁺⁺
- CT
- Ca⁺⁺
- PO₄³⁻

21. True about second messenger:

- Bind first messenger [PGI May 11]
- Integral protein
- Hormone secreted by stimulation of other hormones
- Substance that increase or decrease function
- Intracellular receptor

22. Steroid hormone receptors have attachment site for all except:

- Steroid hormone [AIIMS May 08]
- Transcription repressors
- Hormone responsive element
- Transcription activators

23. True about intracellular receptors: [PGI June 01]

- Mainly on nuclear surface
- Steroids act on them
- Estrogen does not act on it
- GH act on it

24. True about G protein coupled receptors is: [AIIMS May 08]

- G protein bind to hormones on the cell surface
- All the three subunits alpha, beta and gamma should bind to each other for G protein to act
- G protein acts as inhibitory and excitatory because of difference in alpha subunit
- G protein is bound to GTP in resting state

25. Various cells respond differentially to a second messenger (such as increased cAMP) because they have different:

- Receptors [AIIMS May 03]
- Enzymatic composition
- Nuclei
- Membrane lipid

26. Action of α -subunit of G protein is:

[AIIMS Nov 08]

- a. Breakdown of GTP to GDP
- b. Conversion of GDP to GTP
- c. Internalization of receptors
- d. Binding of agonist

27. Adrenaline, noradrenaline and dopamine act through:

[AIIMS Nov 06]

- a. Single-pass receptors
- b. Four-pass receptors
- c. Seven-pass receptor
- d. Ligand-gated channel

28. CAMP acts through:

[PGI Dec 06]

- a. Activation of protein kinase
- b. Activation of adenylate cyclase

- c. Increased Ca^{2+} release
- d. PIP3 pathway

29. Steroid receptor superfamily is present in:

[AIIMS Dec 98]

- a. Vitamin D3
- b. Insulin
- c. Glucagon
- d. Thyroid

30. The following hormone does not have any intracellular receptor:

[AI 01]

- a. Vitamin D3
- b. Cortisone
- c. Adrenaline
- d. Thyroxine

31. The hormone using an enzyme receptor for its action:

[AI 00]

- a. Insulin
- b. Steroid
- c. Oestrogen
- d. Thyroxine

PITUITARY**RECENT MCQs****32. Acidophils secrete:**

- a. GH
- b. TSH
- c. ACTH
- d. FSH

33. Secretion of all the following hormones are decreased in section of pituitary stalk except:

- a. Prolactin
- b. GH
- c. Vasopressin
- d. FSH

34. All are types of cells present in anterior pituitary except:

- a. Somatotropes
- b. Isotropes
- c. Gonadotropes
- d. Thyrotropes

35. GH secretion is:

- a. Greater in early morning
- b. Greater in evening
- c. Increases on prolonged fasting
- d. Stimulates B-cells of pancreas directly

36. Hypothalamus controls the hormone secretion of:

- a. Anterior hypophysis
- b. Posterior hypophysis
- c. Kidney
- d. Pineal gland

37. ADH formation site:

- a. Pituitary
- b. Hypothalamus
- c. Pineal
- d. None

38. Vasopressin is secreted by:

- a. Supraoptic
- b. Preoptic
- c. Paraventricular
- d. Posterior nucleus

AIIMS/PGI/JIPMER**39. Basophilic cells of pituitary secretes:**

[PGI Dec 02]

- a. Prolactin
- b. GH
- c. TSH
- d. ACTH
- e. LH

40. Posterior pituitary secretes:

[PGI Dec 01]

- a. Oxytocin
- b. Prolactin
- c. ADH
- d. FSH
- e. MSH

41. Hormone secreted by adenohypophysis are/is: [PGI June 03]

- a. Oxytocin
- b. TSH
- c. Gonadotropins
- d. Arginine vasopressin
- e. ACTH

42. Prolactin is secreted by: [JIPMER 11]

- a. Acidophil b. Basophil
- c. Chromophobe d. Herring bodies

43. Somatomedin mediates:

[AIIMS May 10, 09]

- a. Deposition of chondroitin sulfate
- b. Lipolysis
- c. Gluconeogenesis
- d. Decreased rate of glucose uptake by cells

44. Acromegaly is due to excess of:

[PGI Dec 99]

- a. Somatomedin b. Growth hormone
- c. Somatostatin
- d. Insulin

45. When NaCl is injected in the internal carotid artery, it causes release of ADH by acting on? [AIIMS Nov 01]

- a. Paramedian nucleus
- b. Anterior pituitary
- c. Paraoptic nucleus
- d. Supraoptic nucleus

46. Which of the pairs about vasopressin receptors is incorrect? [AIIMS Nov 10]

- a. V1-smooth muscles
- b. V2-collecting ducts
- c. V3-anterior pituitary
- d. V4-CNS

47. About ADH secretion all are true except:

[AIIMS 12]

- a. Secretion increased in early postoperative period
- b. Causes increased permeability of DCT
- c. Neurosecretion
- d. Level increased by low plasma osmolality

48. A/E are caused by accidental transection of pituitary stalk: [AIIMS June 97]

- a. Diabetes mellitus
- b. Polyuria
- c. Galactorrhea
- d. Diabetes insipidus

THYROID HORMONE

RECENT MCQs

49. Which is not an effect of T3 hormone?

- a. It increases the heart rate
- b. It increases the stroke volume
- c. It decreases the peripheral vascular resistance
- d. Decreases protein breakdown

50. In thyroid follicle for how long thyroxine is stored:

- a. 2-3 weeks b. 2-3 days
- c. 2-3 months d. 2-3 years

AIIMS/PGI/JIPMER

51. Thyroid hormones in blood is transported by: [PGI Dec 01]

- a. Albumin
- b. Globulin
- c. Prealbumin
- d. Transferrin
- e. Ceruloplasmin

52. Iodine uptake is seen in following organs:
[PGI Dec 03]

- a. Ovary
- b. Thyroid
- c. Parathyroid
- d. Salivary gland
- e. Mammary gland

53. Thyroxine injected to rat produces A/E:

- a. Increased lipolysis [PGI June 2K]
- b. Increased O₂ consumption
- c. Decrease BMR
- d. Increased myocardial contractility

ADRENAL GLAND

RECENT MCQs

54. Zona glomerulosa secretes:

- a. Aldosterone
- b. Cortisol
- c. Testosterone
- d. Catecholamines

55. Destruction of zona glomerulosa will deplete:

- a. Aldosterone
- b. Cortisol
- c. Testosterone
- d. Catecholamines

56. Which is not an action of cortisol?

- a. Stimulation of gluconeogenesis
- b. Increases liver and plasma proteins
- c. Mobilization of fatty acids
- d. Increases the number of eosinophils

57. Anti-inflammatory action of steroids due to:

- a. Inhibition of phospholipase A2
- b. Inhibition of cyclooxygenase
- c. Increased activity of lipo lipase
- d. Inhibition of lipoxygenase

58. Major adrenal androgen is:

- a. Testosterone
- b. 11-hydroxy derivative of androstenedione
- c. 17-ketosteroid dehydroepiandrosterone
- d. Cortisol

59. Excessive production of aldosterone results in:

- a. Metabolic acidosis
- b. Severe hypotension
- c. Potassium retention
- d. Depressed plasma renin

60. Which of the following increases during surgical stress?

- a. Cortisol
- b. Estrogen
- c. Insulin
- d. Gastrin

AIIMS/PGI/JIPMER

61. What is effect of cortisol on metabolism?
[PGI Dec 08]

- a. Neoglucogenesis
- b. Lipogenesis
- c. Proteolysis
- d. Protein anabolism in liver
- e. Glycolysis

62. During stress increased stimulation of cortisol release cause:
[PGI Dec 04]

- a. Neoglucogenesis
- b. Glycolysis
- c. Protein breakdown
- d. Glucose utilization
- e. Lipolysis

63. ACTH level is highest during:

- a. Early morning [PGI Dec 99]
- b. Evening
- c. Afternoon
- d. Night

64. Mineralocorticoid receptors are present in all of the following sites, except:

[AIIMS Nov 05, May 07, AI 11]

- a. Hippocampus
- b. Kidney
- c. Colon
- d. Liver

65. Hyperaldosteronism is associated with all except:

[AIIMS May 10]

- a. Hyponatremia
- b. Hypokalemia
- c. Hypertension
- d. Metabolic acidosis

66. Excess secretion of aldosterone causes all except:

[AIIMS Nov 08]

- a. Increased ECF
- b. Very high Na^+ in plasma
- c. Increased BP
- d. Natriuresis

67. Aldosterone synthesis is inhibited by:

[PGI June 03]

- a. Renin
- b. Endothelin
- c. Dopamine
- d. Endorphin
- e. Hyponatremia

68. Epinephrine action in liver:

- a. Glycogenolysis [PGI Dec 98]
- b. Gluconeogenesis
- c. Glycolysis
- d. Lipolysis

69. Which of the following hormones are increased due to stress during surgery, especially in DM?

[PGI Dec 00]

- a. Epinephrine
- b. GH
- c. Glucocorticoids
- d. Thyroxine

70. In stress which hormone is increased?

[PGI June 04]

- a. Insulin
- b. Vasopressin
- c. Adrenaline

71. Stress-induced hyperglycemia is due to:

[PGI June 02]

- a. Glucocorticoids
- b. GH
- c. Thyroxine
- d. Epinephrine
- e. Insulin

72. Stress induced hyperglycemia is mediated through which hormone?

[PGI Dec 05]

- a. Insulin
- b. Glucagon
- c. Thyroxine
- d. Epinephrine
- e. Cortisol

73. All of these cause hyperglycemia except:

[PGI June 02]

- a. GH
- b. Cortisol
- c. Catecholamines
- d. Insulin
- e. Glucagons

74. In surgical stress all hormone is increased except:

[PGI Nov 11]

- a. Adrenalin
- b. ACTH
- c. Epinephrine
- d. Cortisol
- e. Insulin

75. Reason of diurnal variation in eosinophil count:

[AI 12]

- a. Variation in environmental temperature
- b. Variation in cortisol levels
- c. Bone marrow depression during sleep/night
- d. Increased physical activity

PANCREATIC HORMONE

RECENT MCQs

76. C-peptide occurs in:

- a. Proinsulin
- b. Glucagon
- c. Parathormone
- d. Thyroxine

77. Insulin increases the entry of glucose into:

- a. All tissues
- b. Renal tubular cells
- c. The mucosa of the small intestine
- d. Skeletal muscle

78. Insulin is essential for glucose entry in:

- a. Muscle
- b. Cortical neurons
- c. Renal tubular cells
- d. Beta cells of pancreas

79. Glucose increases plasma insulin by a process that involves:

- a. GLUT1 b. GLUT2
- c. GLUT3 d. SGLT1

80. Glucose transporter involved in insulin stimulated glucose transport is GLUT:

- a. 1 b. 2
- c. 3 d. 4

81. Increased ratio of insulin to glucagon causes:

- a. Decreased levels of cyclic AMP
- b. Decreased levels of lipoproteins lipase
- c. Decreased amino acid synthesis
- d. Enhanced lipolysis in adipose tissue

82. Which of the following compound antagonizes the actions of insulin?

- a. Neuropeptide Y
- b. Growth hormone
- c. Substance P
- d. Vasoactive intestinal peptide

83. Half life of insulin is:

- a. 1-2 min b. 4-6 min
- c. 0-12 min d. 12-16 min

84. How many parts are there in insulin receptor?

- a. 1 b. 2
- c. 3 d. 4

AIIMS/PGI/JIPMER

85. Following hormones are produced by endocrinal part of pancreas:

[PGI June 01]

- a. Insulin
- b. Somatostatin
- c. Glucagons
- d. Bombesin
- e. Pancreatic polypeptide

86. Insulin is/are secreted by:

[PGI May 11]

- a. Pancreas
- b. Islets of Langerhans
- c. Liver
- d. Heart
- e. Intestine

87. Glucagon is secreted by:

[PGI Nov 10]

- a. Alpha cell b. Beta cell
- c. Delta cell d. G cell
- e. C cell

88. Insulin is secreted along with the following molecule in a 1:1 ratio:

[PGI June 06]

- a. Pancreatic polypeptide
- b. Glucagon
- c. GLP-1
- d. Somatostatin
- e. C peptide

89. Insulin mediated glucose uptake occurs through:

[Jipmer 11, AIIMS Nov 09]

- a. GLUT1 b. GLUT2
- c. GLUT3 d. GLUT4

90. Insulin acts on glucose metabolism by:

[PGI June 00]

- a. Increase permeability of glucose across cell membrane
- b. Increase permeability across cell membrane against glucose gradient
- c. Increase permeability of renal cells
- d. Increase glucose transport to brain

91. Glucose transporter in myocyte:

[AIIMS Nov 09]

- a. GLUT1 b. GLUT2
- c. GLUT3 d. GLUT4

92. Not done by insulin:

[AIIMS May 10, 09]

- a. Glycogen synthesis
- b. Glycolysis
- c. Lipogenesis
- d. Ketogenesis

93. Rapid infusion of insulin causes:

[AIIMS May 10]

- a. Hyperkalemia b. Hypokalemia
- c. Hyponatremia d. Hyponatremia

94. Insulin secretion is/are increased by all except:

[PGI Nov 10]

- a. Gastrin b. Secretin
- c. VIP d. GIP
- e. CCK

95. Insulin secretion is decreased by:

[PGI June 03]

- a. Glucagon
- b. Glucose
- c. Adrenaline
- d. Vagal stimulation

96. Insulin secretion seen in: [PGI June 04]

- a. Glucose
- b. Vagal stimulation
- c. Acetylcholine
- d. Adrenaline
- e. Calmodulin

97. In a seriously ill patient, addition of amino acids in diet results in a positive nitrogen balance. The mechanism for this is:

[AIIMS May 08]

- a. Increased growth hormones secretion
- b. Enhanced rate of gluconogenesis
- c. Increased absorption of amino acids from diet
- d. Increased secretion of insulin

98. After a meal rich in carbohydrate, insulin secretion is stimulated by:

[JIPMER 03]

- a. CCK b. Serotonin
- c. VIP d. GLP-1 (7-36)

99. In fetus the insulin secretion begins by:

[AIIMS May 05]

- a. 3rd month b. 5th month
- c. 7th month d. 9th month

100. Amylin is secreted by which cells of the islet of langerhans:

[AI 11, 12]

- a. Beta cells b. Alpha cells
- c. Delta cells d. Gamma cells

101. Human insulin differs from beef insulin by how many number of amino acid residues?

[AI 95]

- a. 1 b. 2
- c. 3 d. 4

CALCIUM METABOLISM

RECENT MCQs

102. Calcium absorption is increased by:

- a. Proteins b. Bile
c. Acid d. Phosphates

103. Site of 25-hydroxylation of cholecalciferol:

- a. Kidney b. Skin
c. Liver d. Lung

104. Increased calcium levels lead to:

- a. Increased 1, 25
b. Increased 24, 25
c. Decreased calcitonin
d. Increased parathormone

AIIMS/PGI/JIPMER

105. Active form of vitamin D is:

[AIIMS May 07]

- a. Cholecalciferol
b. 24, 25 (OH)₂ Vit-D
c. 1, 25 (OH)₂ Vit-D
d. 25-OH Vit-D

106. Calcium absorption is from:

[PGI Dec 99]

- a. Proximal small intestine
b. Distal ileum
c. Middle small intestine
d. Ascending colon

107. True of the following: [PGI June 01]

- a. Calcium reabsorbed in DCT
b. 90% calcium excreted by glomerulus
c. Parathormone (PTH) promotes absorption of Ca⁺⁺ from intestine
d. PTH promote action of calcitonin

108. True statement about calcium:

[PGI Dec 04]

- a. Absorbed in upper small intestine
b. Absorbed in lower small intestine
c. Absorption increased by alkaline pH
d. Absorption increased by acidic pH

109. Which of the following organ is not involved in calcium metabolism?

[PGI May 10, Dec 01]

- a. Lung b. Liver
c. Spleen d. Skin
e. Kidney

110. Parathyroid hormone is responsible for all actions except:

[PGI Dec 97]

- a. Absorption of phosphorous increase
b. Vit D absorption increases
c. Mobilizes calcium from bone
d. Increase intestinal absorption of calcium

111. In tetany hyperexcitability is due to:

[PGI June 04]

- a. Low Ca⁺⁺ causes increase permeability to Na⁺
b. Prevent K⁺ release
c. Prevent Na⁺ and K⁺ release
d. Decrease Ca⁺⁺ produce generation of AP

112. Hypocalcemia due to calcitonin is by:

[PGI Dec 99]

- a. Increased excretion in kidney
b. Decreased bone resorption
c. Decreased intestinal absorption
d. Decreased renal reabsorption

113. Which of the following is considered the active form of calcium? [AI 08]

- a. Ionised calcium
b. Albumin bound calcium
c. Phosphate bound calcium
d. Protein bound calcium

114. Which of the following organs is not involved in calcium homeostasis?

- a. Kidneys b. Skin [AI 06]
c. Intestines d. Lungs

115. Calcitonin is secreted by: [AI 06]

- a. Thyroid gland
b. Parathyroid gland
c. Adrenal glands

116. Osteoclasts are inhibited by: [AI 05]

- a. Parathyroid hormone
b. Calcitonin
c. 1,25-dihydroxycholecalciferol
d. Tumor necrosis factor

117. Osteoclast has specific receptor for: [AIIMS May 03]

- a. Parathyroid hormone

- b. Calcitonin
c. Thyroxin
d. Vit D3

118. Which of these can cause hypocalcemia? [AIIMS May 02]

- a. Thyroxine b. Calcitonin
c. Parathyroid hormone
d. Cholecalciferol

119. Which of the following would you expect to find in a patient whose diet has been low in calcium for 8 weeks?

[AIIMS Nov 07]

- a. Increased phosphate levels
b. Raised calcitonin levels
c. Increased parathormone secretion
d. Activation of 24-25 dihydroxycholecalciferol

FUTURE TRENDS

120. The graph below demonstrates diurnal variation in the plasma level of:

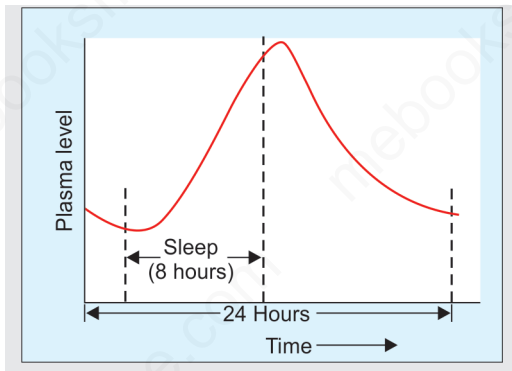

- a. Insulin
b. Parathyroid hormone
c. Cortisol
d. Estrogen

Match each of the patients described in questions 121–123 with the correct set of plasma values listed in the table below. Normal values are as follows: plasma aldosterone concentration, 10 ng/dL; plasma cortisol concentration, 10 mg/dL; plasma potassium concentration, 4.5 mEq/L.

terone concentration, 10 ng/dL; plasma cortisol concentration, 10 mg/dL; plasma potassium concentration, 4.5 mEq/L.

	Aldosterone concentration	Cortisol concentration	Potassium concentration
A	10.0	2.0	4.5
B	2.0	2.0	6.0
C	40.0	30.0	2.0
D	40.0	10.0	2.0
E	40.0	10.0	4.5

121. A patient with Addison's disease:

- a. A b. B
c. C d. D

122. A patient with Conn's syndrome:

- a. A b. B
c. C d. E

123. A patient on a low-sodium diet:

- a. A b. B
c. C d. D

ANSWERS WITH EXPLANATIONS

1. Ans. b. Serotonin

(Ref. Ganong's Physiology 24th edn. pp 281)

Somatostatin is a polypeptide hormone.

2. Ans. d. GH

(Ref. Ganong's Physiology 24th edn. pp 54)

TSH, FSH, LH, hCG are glycoprotein hormone. GH is a protein hormone.

3. Ans. a. Insulin

(Ref. Ganong's Physiology 24th edn. pp 51)

Insulin, IGF-I, epidermal growth factor (EGF), platelet-derived growth factor (PDGF), monocyte colony-stimulating factor (M-CSF), Nerve growth factor (NGF), GH and PRL act via tyrosine kinase receptor.

4. Ans. d. Estrogen

(Ref. Williams Textbook of endocrinology 12th edn.)

Estrogen acts via nuclear receptor. [Check text for detail concept on steroid receptor].

5. Ans. c. Estradiol [Check Q. no. 4].**6. Ans. a. Vitamin D3, d. Thyroid**

(Ref. Williams Textbook of endocrinology 12th edn.)

All steroid, thyroid, Vit. D and retinoids includes in steroid hormone superfamily.

7. Ans. a. Increased intracellular cGMP

(Ref. Ganong's Physiology 24th edn. pp 564)

Endothelial cells produce endothelium-derived relaxing factor (EDRF), a substance that is now known to be nitric oxide (NO). NO and ANP hormone act via increasing intracellular cGMP.

8. Ans. a. Parathormone

(Ref. Ganong's Physiology 24th edn. pp 368)

9. Ans. d. Estrogen [Check Q. no. 4].**10. Ans. d. Vasopressin (single best choice)**

(Ref. Ganong's Physiology 24th edn. pp 666)

Vasopressin receptor V1 and V3 acts via IP3/calcium pathway. V2 acts via cAMP.

11. Ans. b. Atrial natriuretic factor, e. Nitric Oxide (NO) [Check Q. no. 7].**12. Ans. a. Nicotonic cholinergic, d. GABA_A**

(Ref. Ganong's Physiology 24th edn. pp 133)

Nicotinic cholinergic and GABA_A are ionotropic receptor (they are ion channel). Other receptors in the options are G-protein coupled receptor; known as metabotropic receptor.

13. Ans. c. Corticosteroids, d. Androgen, e. Thyroxine

(Ref. Williams Textbook of endocrinology 12th edn.)

14. Ans. e. Testosterone, cortisol and estrogen

(Ref. Biochimica et Biophysica Acta 2005:1745:382-389 & Williams Textbook of endocrinology 12th edn.)

Cortisol receptor shuttle between cytoplasm and nucleus.

Steroid hormone receptors location:

- ❑ **Cytoplasmic:** Glucocorticoid (GR) > androgen receptors (AR) and progesterone receptor (PR-B). Mineralocorticoid receptor (MR) are partial cytoplasmic.
- ❑ **Nuclear:** Thyroid hormone receptor (TR), estrogen receptor (ER α/β), progesterone receptor (PR-A), Vit. D (VDR) and Vit. A (RAR).

15. Ans. d. CyGMP [Check Q. no. 7].**16. Ans. a. FSH**

(Ref. Harrison's Principles of Internal Medicine 19th edn. pp4000)

[Check Text for detail of receptors]

17. Ans. a. Guanylyl cyclase

(Ref. Ganong's Physiology 24th edn. pp 51)

Guanylyl cyclase helps in generation of cGMP (second messenger).

18. Ans. d. All of the above [Check Text for detail of receptors]

Some of the steroid hormones have receptors on cell membrane also like oestrogen, progesterone, testosterone.

19. Ans. a. cAMP, b. IP₃, c. Diacylglycerol, d. GMP

(Ref. Harrison's Principles of Internal Medicine 19th edn. pp 4000)

20. Ans. c. Ca⁺⁺

(Ref. Harrison's Principles of Internal Medicine 19th edn. pp 4000)

21. Ans. d. Substance that increase or decrease function

(Ref. Ganong's Physiology 24th edn. pp 51-55)

First messenger binds to cell surface receptor, which in turn produces second messenger.

22. Ans. b. Transcription repressors

(Ref. Harper's 30th edn, pp 445)

Transcriptional repressors are proteins that bind to specific sites on DNA and prevent transcription of nearby genes.

23. Ans. b. Steroids act on them

(Ref: Williams Textbook of endocrinology 12th edn.)

[Check Q. no. 14].

24. Ans. c. G proteins act as inhibitory and excitatory because of difference in alpha subunit

(Ref. Ganong's Physiology 24th edn. pp 51-55)

25. Ans. b. Enzymatic composition

(Ref. Endocrinology: An Integrated Approach by S Nussey and S Whitehead 2001)

When ligand binds with cell surface receptors, second messenger is produced. Second messenger in turn activates enzymes inside the cells, which cause phosphorylation or, *dephosphorylation* of different enzyme, ion channels or structural. This causes alteration of cell function.

That's why we can understand why the same second messenger (cAMP) has different actions on different cells.

26. Ans. a. Breakdown of GTP to GDP

(Ref. Ganong's Physiology 24th edn. pp 53)

27. Ans. c. Seven-pass receptor

(Ref. Harrison's Principles of Internal Medicine 19th edn. pp 4000)

All the hormones in the question act via cell surface receptor which is a seven-pass membrane receptor.

28. Ans. a. Activation of protein kinase

(Ref. Ganong's Physiology 24th edn. pp 51)

cAMP acts via activation of protein kinase, which phosphorylates other proteins in cell.

29. Ans. a. Vitamin D₃, d. Thyroid

(Ref. Williams Textbook of Endocrinology 12th edn.)

All steroid, thyroid, Vit. D and retinoids include in steroid hormone superfamily.

30. Ans. c. Adrenaline

(Ref. Harrison's Principles of Internal Medicine 19th edn. pp 4000)

Adrenaline has membrane receptor.

31. Ans. a. Insulin

(Ref. Harrison's Principles of Internal Medicine 19th edn. pp 4000)

Insulin acts via tyrosine kinase pathway.

32. Ans. a. GH

(Ref. Ganong's Physiology 24th edn. pp 379)

- ❑ **Acidophilic cell:** Lactotroph (10-30%) and Somatotroph (50%)
- ❑ **Basophilic cell:** Gonadotrope (20%), Corticotrope (10%) and Thyrotrope (5%)

33. Ans. a. Prolactin

(Ref. Guyton-Physiology-13th edn. pp 552)

Normally prolactin is under the inhibitory control from hypothalamus. Destruction of pituitary stalk leads to release of prolactin producing cell; leads to increase prolactin.

34. Ans. b. Isotropes

(Ref. Ganong's Physiology 24th edn. pp 379)

35. Ans. c. Increases on prolonged fasting

(Ref. Ganong's Physiology 24th edn. pp 385)

GH is under weak circadian effect. Increased GH secretion occurs at night. (Peak around 1-3 am).

Stimulated by fasting, hypoglycemia, exercise, protein meal, stress, pyrogen, sleep, estrogen and androgen.

36. Ans. a. Anterior hypophysis

(Ref. Ganong's Physiology 24th edn. pp 280)

Hypothalamus controls anterior pituitary hormones. Posterior pituitary hormones synthesize in hypothalamus.

37. Ans. b. Hypothalamus

(Ref. Ganong's Physiology 24th edn. pp 277)

Supraoptic and paraventricular nuclei synthesize ADH hormone, which travel along the axons of these neurone and secreted from posterior pituitary.

38. Ans. a. Supraoptic >> c. Paraventricular

(Ref. Ganong's Physiology 24th edn. pp 275)

ADH: Supraoptic >> Paraventricular
Oxytocin: Paraventricular >> Supraoptic.

39. Ans. c. TSH, d. ACTH, e. LH

(Ref. Ganong's Physiology 24th edn. pp 379)

Explained in Q. No. 32.

40. Ans. a. Oxytocin, c. ADH

(Ref. Ganong's Physiology 24th edn. pp 274)

41. Ans. b. TSH, c. Gonadotropins, e. ACTH

(Ref. Ganong's Physiology 24th edn. pp 377)

42. Ans. a. Acidophil

(Ref. Ganong's Physiology 24th edn. pp 379)

43. Ans. a. Deposition of chondroitin sulfate

(Ref. Ganong's Physiology 24th edn. pp 384)

Somatomedin (IGF) causes increase protein synthesis in chondrocytes and increase linear growth (pubertal growth spurt).

44. Ans. b. Growth hormone

(Ref. Ganong's Physiology 24th edn. pp 382)

45. Ans. c. Paraoptic nucleus

(Ref. Ganong's Physiology 24th edn. pp 667)

Osmoreceptors located in the anterior hypothalamus (preoptic nucleus), which are stimulated by NaCl injection (increase osmolality). Osmoreceptors have stimulatory action on thirst centre and ADH secreting supraoptic nucleus.

46. Ans. d. V4-CNS

(Ref. Ganong's Physiology 24th edn. pp 667)

[Detail explanation in text]

47. Ans. d. Level increased by low plasma osmolality

(Ref. Ganong's Physiology 24th edn. pp 667)

[Explanation in Q. No. 45]

48. Ans. a. Diabetes mellitus

(Ref. Ganong's Physiology 24th edn. pp 667)

ADH deficiency produces DI and polyuria. Loss of inhibitory control on lactotropes leads to hyperprolactinemia (galactorrhea).

49. Ans. d. Decreases protein breakdown

(Ref: Ganong's Physiology 24th edn. pp 312)

Thyroid hormones increases cardiac output by the direct action, as well as that of catecholamines, on the heart and stroke volume.

Thyroid hormones cause enough extra heat production, which in turn activates heat-dissipating mechanisms. Peripheral resistance decreases because of cutaneous vasodilation.

The muscle weakness may be due in part to increased protein catabolism.

50. Ans. c. 2-3 months

(Ref: Guyton-Physiology- 13th edn. pp 566)

After synthesis of the thyroid hormones, each thyroglobulin molecule contains up to 30 thyroxine molecules and a few triiodothyronine molecules. In this form, the thyroid hormones are stored in the follicles in an amount sufficient to supply the body with its normal requirements of thyroid hormones for 2 to 3 months.

51. Ans. a. Albumin, b. Globulin, c. Prealbumin

(Ref: Ganong's Physiology 24th edn. pp 305)

Thyroxine-binding globulin (TBG), transthyretin (thyroxine-binding prealbumin, TBPA) and albumin are the thyroid hormone binding proteins.

52. Ans. b. Thyroid, d. Salivary gland, e. Mammary gland

(Ref: Ganong's Physiology 24th edn. pp 304)

Apart from thyroid gland, iodine uptake is also seen in salivary glands, gastric mucosa, placenta, ciliary body of the eye, choroid plexus, mammary glands, and certain cancers derived from these tissues.

53. Ans. c. Decrease BMR

(Ref: Ganong's Physiology 24th edn. pp 312)

BMR increases in response to thyroid hormone.

54. Ans. a. Aldosterone

(Ref: Ganong's Physiology 24th edn. pp 338)

55. Ans. a. Aldosterone

(Ref: Ganong's Physiology 24th edn. pp 338)

56. Ans. d. Increases the number of eosinophils

(Ref: Ganong's Physiology 24th edn. pp 350)

Cortisol decreases circulating basophils, eosinophils and lymphocytes. All other cell count increases in cortisol treated person.

57. Ans. a. Inhibition of phospholipase A2

(Ref: Ganong's Physiology 24th edn. pp 349)

Glucocorticoids induce the synthesis of lipocortin, an inhibitor of phospholipase A2.

58. Ans. c. 17-ketosteroid dehydroepiandrosterone

(Ref: Ganong's Physiology 24th edn. pp 348)

The major adrenal androgen is the 17-ketosteroid dehydroepiandrosterone, although androstenedione is also secreted.

59. Ans. d. Depressed plasma renin

(Ref: Ganong's Physiology 24th edn. pp 348)

Prominent feature of prolonged mineralocorticoid excess are Na^+ reabsorption and K^+ depletion due to prolonged K^+ diuresis. H^+ is also lost in the urine (alkalosis). Na^+ is retained initially, but the plasma Na^+ is elevated only slightly if at all, because water is retained with the osmotically active sodium ions. Extra Na^+ increases ECF volume and the blood pressure rises and suppressed RAS system.

60. Ans. a. Cortisol

(Ref: Indian J Endocrinol Metab 2011 Jan-Mar; 15:18-22)

Cortisol increases 3–5 times during major stress in body. Other hormones that increases during stress are CRF, ACTH, Catecholamine, Vasopressin (ADH), Prolactin (it may decrease) and GH (2–10 times).

61. Ans. a. Neoglucogenesis, c. Proteolysis

(Ref. Ganong's Physiology 24th edn. pp 349)

Protein catabolism and increased hepatic glycogenesis and gluconeogenesis.

It promotes mobilization of fatty acids from adipose tissue. This increases the concentration of free fatty acids in the plasma.

62. Ans. a. Neoglucogenesis, c. Protein breakdown, e. Lipolysis

(Ref. Ganong's Physiology 24th edn. pp 349)

Explained in Q. No. 61.

63. Ans. a. Early morning

(Ref. Harrison's Principles of Internal Medicine 19th edn. pp 2310)

Peak level observed at 8.30 am in the morning, nadir is reached around midnight.

64. Ans. d. Liver

(Ref. Oxford Textbook of Endocrinology and Diabetes 2nd edn. pp 26 by John A.H. Wass, Paul M. Stewart)

Mineralocorticoid receptors are present in kidney, colon, salivary gland and sweat gland. It was also isolated from hippocampus of brain.

65. Ans: d. Metabolic acidosis

(Ref. Ganong's Physiology 24th edn. pp 348)

[Detail explanation in text]

66. Ans. b. Very high Na⁺ in plasma

(Ref. Ganong's Physiology 24th edn. pp 348)

Na⁺ level is slightly high.

67. Ans. c. Dopamine, e. Hypernatremia

(Ref. Ganong's Physiology 24th edn. pp 348)

Renin, endorphin and endothelin stimulates aldosterone biosynthesis.

Hypernatremia is an inhibitor for aldosterone synthesis via RAS system suppression.

Dopamine (also bromocriptine) has direct inhibitory role on aldosterone biosynthesis.

68. Ans. a. Glycogenolysis, b. Gluconeogenesis, d. Lipolysis

(Ref. Ganong's Physiology 24th edn. pp 341)

Epinephrine and norepinephrine both cause glycogenolysis and lipolysis.

69. Ans. a. Epinephrine, b. GH, c. Glucocorticoids

(Ref. RSSDI Textbook of Diabetes Mellitus by BB Tripathy pp1081)

Surgery and general anesthesia in DM patient stimulate a neuroendocrine stress response with the release of corticotropin (ACTH) and cortisol, growth hormone, catecholamines, and to varying degrees, glucagons.

70. Ans. b. Vasopressin, c. Adrenaline

(Ref. Indian J Endocrinol Metab. 2011 Jan-Mar;15:18-22)

[Explained in Q. No. 60]

71. Ans: a. Glucocorticoids, b. GH, d. Epinephrine, e. Insulin

(Ref. <http://dx.doi.org/10.1155/2014/486403>)

The causes of hyperglycemia during critical illness are attributed to the increased hepatic glucose production and impaired glucose consumption by peripheral tissues as well as insufficient pancreatic insulin production. In addition, the production and accumulation of counter regulatory hormones, such as glucagon, cortisol, catecholamines, and growth hormone, will increase lipolysis, protein breakdown, and impair glucose usage by peripheral tissues.

72. Ans. a. Insulin, b. Glucagon, c. Thyroxine, d. Epinephrine, e. Cortisol

(Ref. <http://dx.doi.org/10.1155/2014/486403>)

[Explained in Q. No. 71]

73. Ans. d. Insulin

(Ref. Ganong's Physiology 24th edn. pp 319)

74. Ans: e. Insulin

[Explained in Q. No. 69]

75. Ans: b. Variation in cortisol levels

(Ref. Ganong's Physiology 24th edn. pp 350)

Cortisol decreases eosinophil level in blood. So, eosinophil count is low in the morning (high cortisol) and high in midnight (low cortisol level).

76. Ans. a. Proinsulin

(Ref. Ganong's Physiology 24th edn. pp 318)

Preproinsulin contains a signal peptide of 23-amino acid signal peptide removed as it enters the endoplasmic reticulum. The remainder of the molecule is **pro-insulin**. This peptide contains A, B chains and the **connecting peptide (C peptide)**. Separation of C peptide produces insulin.

77. Ans. d. Skeletal muscle

(Ref. Ganong's Physiology 24th edn. pp 319)

Skeletal and cardiac muscle, adipose tissues contain GLUT4, which is stimulated by insulin.

78. Ans. a. Muscle

[Explained in Q. No. 77]

79. Ans. b. GLUT2

(Ref. Ganong's Physiology 24th edn. pp 320)

GLUT2 is the pancreatic beta cell sensor for glucose. Rise of blood glucose stimulates this GLUT.

80. Ans. d. 4

[Explained in Q. No. 77]

81. Ans. a. Decreased levels of cyclic AMP

(Ref. Ganong's Physiology 24th edn. pp 319 and 329)

Glucagon acts via increase in intracellular cAMP. So, in high insulin glucagon ration, cAMP level in the cell decreases.

Insulin causes activation of lipoprotein lipase and inhibition of hormone-sensitive lipase. Because of this there is increased fatty acids synthesis in adipose tissue.

Insulin also increases amino acid uptake and protein synthesis in muscles.

Normal insulin-glucagon molar ratio on a balanced diet is approximately 2.3.

82. Ans. b. Growth hormone

(Ref. Ganong's Physiology 24th edn. pp 332)

Human growth hormone makes clinical diabetes worse, and 25% of patients with growth hormone-secreting tumors of the anterior pituitary have diabetes.

83. Ans. b. 4-6 min

(Ref. Ganong's Physiology 24th edn. pp 318)

The half-life of insulin in the circulation in humans is about 5 min.

The half-life of the insulin receptor is about 7 h.

84. Ans. d. 4

(Ref. Ganong's Physiology 24th edn. pp 316)

Insulin receptor contains 4 subunits: 2 alpha, 2 beta.

85. Ans. a. Insulin, b. Somatostatin, c. Glucagons, e. Pancreatic polypeptide

(Ref. Ganong's Physiology 24th edn. pp 316)

Bombesin is a 14 amino acid peptide isolated from amphibian skin which was found to have stimulatory effects upon gastric and pancreatic secretions, release of gastrointestinal hormones, gallbladder contraction and bronchoconstriction.

86. Ans. a. Pancreas, b. Islets of Langerhans

(Ref. Ganong's Physiology 24th edn. pp 316)

87. Ans. a. Alpha cell

(Ref. Ganong's Physiology 24th edn. pp 316)

88. Ans. e. C peptide

(Ref. Ganong's Physiology 24th edn. pp 318)

Normally, 90–97% of the product released from the B cells is insulin along with equimolar amounts of C peptide. The rest is mostly pro-insulin.

89. Ans. d. GLUT4

(Ref. Ganong's Physiology 24th edn. pp 319)

[Explained in Q. no. 77].

90. Ans. a. Increase permeability of glucose across cell membrane

(Ref. Ganong's Physiology 24th edn. pp 318)

In muscle, adipose, and some other tissues, insulin stimulates glucose entry into cells by increasing the number of GLUT4. This is a type of facilitated diffusion along the concentration gradient.

Brain glucose entry does not depend on insulin. [Check annexure for GLUT in brain].

91. Ans. d. GLUT4

(Ref. Ganong's Physiology 24th edn. pp 320)

[Check annexure for all GLUT types].

92. Ans. d. Ketogenesis

(Ref. Ganong's Physiology 24th edn. pp 323)

93. Ans. b. Hypokalemia

(Ref. Ganong's Physiology 24th edn. pp 319)

Insulin causes K^+ to enter cells, with a resultant lowering of the extracellular K^+ concentration. Infusions of insulin and glucose significantly lower the plasma K^+ level in normal individuals and are very effective for the temporary relief of hyperkalemia in patients with renal failure.

94. None

(Ref. Ganong's Physiology 24th edn. pp 319)

All the options given here can stimulate insulin release.

Stimuli for insulin release: Glucose, Mannose, Amino acids (leucine, arginine), Intestinal hormones (GIP, GLP-1, gastrin, secretin, CCK), β -Keto acids, Ach, Glucagon, cAMP.

VIP is also a powerful stimulator for insulin release.

95. Ans. c. Adrenaline

(Ref. Ganong's Physiology 24th edn. pp 327)

Catecholamines have a dual effect on insulin secretion; they inhibit insulin secretion via α 2-adrenergic receptors and stimulate insulin secretion via β -adrenergic receptors. The net effect of epinephrine and norepinephrine is usually inhibition.

96. Ans. a. Glucose, b. Vagal stimulation, c. Acetylcholine

(Ref. Ganong's Physiology 24th edn. pp 319)

[Explained in Q. no. 95]

97. Ans. d. Increased secretion of insulin

(Ref. Ganong's Physiology 24th edn. pp 319)

Amino acids (leucine, arginine, others) are stimulus for insulin release. Insulin stimulates the incorporation of amino acids into proteins (positive nitrogen balance).

98. Ans. d. GLP-1 >> a. CCK

(Ref. Pharmacol Rev. 2008; 60: 470–512)

The insulin secretory response of incretins, called the incretin effect, accounts for at least 50% of the total insulin secreted after oral glucose.

There are two incretins, known as glucose-dependent insulinotropic peptide (GIP) and glucagon-like peptide-1 (GLP-1), that are responsible for the above functions.

Possible CCK also has some role in glucose induced insulin release.

99. Ans. a. 3rd month

(Ref. American Dietetic Association Guide to Gestational Diabetes Mellitus by Alyce M. Thomas. pp 14)

The production of insulin in the fetal pancreas begins in the first trimester, at approximately 11 or 12 weeks of gestation. It is excreted in the fetal urine and is found in amniotic fluid by the 12th week of pregnancy.

100. Ans. a. Beta cells

(Ref. Harrison's Principles of Internal Medicine 19th edn. pp 2402)

101. Ans. c. 3

(Ref. Pharmacology for Health Professionals by BJ Bryant 3rd edn pp 704)

Beef insulin differs from human insulin by three amino acids, whereas the pork insulin differs from human insulin by a single amino acid.

102. Ans. a. Proteins >>c. Acid

(Ref. Ganong's Physiology 24th edn. pp 458)

Ca²⁺ absorption is also facilitated by protein. It is inhibited by phosphates and oxalates because these anions form insoluble salts with Ca²⁺ in the intestine. Magnesium absorption is also facilitated by protein.

Acid load can also increase Ca⁺⁺ absorption.

103. Ans. c. Liver

(Ref: Ganong's Physiology 24th edn. pp 366)

25-Hydroxylation in liver.

1 α hydroxylation in kidney.

104. Ans. b. Increased 24, 25

(Ref. Ganong's Physiology 24th edn. pp 366)

1 α -hydroxylase, is regulated in a feedback fashion by plasma Ca²⁺ and PO₄³⁺. When the plasma Ca²⁺ level is high, little 1,25-dihydroxycholecalciferol is produced, and the kidneys produce the relatively inactive metabolite 24,25-dihydroxycholecalciferol instead.

105. Ans. c. 1, 25 (OH)₂ Vit-D

(Ref. Ganong's Physiology 24th edn. pp 366)

Active form is 1,25-dihydroxycholecalciferol (calcitriol).

106. Ans. a. Proximal small intestine

(Ref. Ganong's Physiology 24th edn. pp 364)

Calcium is best absorbed in proximal small intestine by Vit.D dependent carrier protein TRPV6.

107. Ans. a. Calcium reabsorbed in DCT, c. Parathormone (PTH) promotes absorption of Ca⁺⁺ from intestine

(Ref. Ganong's Physiology 24th edn. pp 365)

98–99% of the filtered Ca²⁺ is reabsorbed. About 60% of the reabsorption occurs in the proximal tubules and the remainder in the TAL and the distal tubule. Distal tubular reabsorption depends on the TRPV5 channel, and is regulated by parathyroid hormone.

108. Ans. a. Absorbed in upper small intestine, d. Absorption increased by acidic pH

(Ref. Ganong's Physiology 24th edn. pp 365)

109. Ans. a. Lung, c. Spleen

(Ref. Ganong's Physiology 24th edn. pp 366)

- ❑ Skin: Synthesis of previtamin D₃ from 7-dehydrocholesterol
- ❑ Liver: Conversion of vitamin D₃ to 25-hydroxycholecalciferol
- ❑ Kidney: 1 α -hydroxylase enzymes produces active form of vit. D₃.

110. Ans. a. Absorption of phosphorous increase, b. Vit D absorption increases

(Ref. Ganong's Physiology 24th edn. pp 369)

PTH decreases phosphorus absorption from kidney. It increases Ca⁺⁺ absorption from GIT via formation of vit. D₃

111. Ans. a. Low Ca⁺⁺ causes increase permeability to Na⁺

(Ref. Ganong's Physiology 24th edn. pp 368)

Normally, Ca^{++} remains attached in the ECF mouth of voltage gated Na^+ channel. In hypocalcaemia, Ca^{++} detached from the channel; leading to increase permeability of the channel. Increase Na^+ permeability leads to hyperexcitability of nerve.

112. Ans. b. Decreased bone resorption

(Ref. Ganong's Physiology 24th edn. pp 370)

Calcitonin inhibits osteoclast.

113. Ans. a. Ionised calcium

(Ref. Ganong's Physiology 24th edn. pp 364)

It is the free, ionized calcium in the body fluids that is active and vital second messenger necessary for blood coagulation, muscle contraction, and nerve function.

114. Ans: d. Lungs

[Check Q. No. 109].

115. Ans. a. Thyroid gland

(Ref. Ganong's Physiology 24th edn. pp 370)

In mammals, calcitonin is produced by the parafollicular cells of the thyroid gland, which are also known as the clear or C cells.

116. Ans. b. Calcitonin

[Check Q. No. 112].

117. Ans. b. Calcitonin

(Ref. Ganong's Physiology 24th edn. pp 373)

PTH and vit. D receptors are present on osteoblast. This osteoblast stimulates the development of osteoclast.

Calcitonin has receptor directly on osteoclast and causes inhibition of osteoclast.

118. Ans. b. Calcitonin

(Ref. Ganong's Physiology 24th edn. pp 370)

The Ca^{2+} lowering hormone has been named calcitonin, which inhibits osteoclast.

119. Ans. c. Increased parathormone secretion

(Ref. Ganong's Physiology 24th edn. pp 369)

Circulating ionized calcium acts directly on the parathyroid glands in a negative feedback fashion to regulate the secretion of PTH. Low calcium diet leads to hypocalcemia, which stimulates PTH release.

PTH causes hypophosphatemia.

In presence of hypocalcemia, serum calcitonin level decreases and active form of vit. D increases with decrease in inactive form of vit. D_3 (24,25 dihydrocholecalciferol).

120. Ans. c. Cortisol

Cortisol is the only hormone that has a diurnal variation, as shown in the graph accompanying the question. Plasma cortisol levels rise sharply during sleep, peaking soon after awakening, and sinking to a low level approximately 12-h later.

121. Ans. b. Set B

Secretion of adrenal cortical hormones is deficient in patients with Addison's disease. Consequently, low plasma levels of both aldosterone and cortisol would be reported. As a result of the low plasma levels of aldosterone, plasma potassium concentration would be increased.

122. Ans. d. Set E

Patients with Conn's syndrome have tumors of the zona glomerulosa that secrete large amounts of aldosterone. Consequently, plasma levels of aldosterone are elevated, causing hypokalemia. The secretion of cortisol from the zona fasciculata is normal.

123. Ans. d. Set D

Aldosterone secretion is elevated when dietary sodium intake is low, but cortisol secretion is normal. Although aldosterone increases the rate of potassium secretion by the principal cells of the collecting tubules, this effect is offset by a low distal tubular flow rate.

Consequently, there is little change in either potassium excretion or plasma potassium concentration.

MALE REPRODUCTIVE PHYSIOLOGY**Regulation of Testes (Fig. 18.1)**

- ❑ **Hypothalamic control-GnRH:**
 - Arcuate nuclei of the hypothalamus secrete GnRH into the hypothalamic-hypophysial portal blood. GnRH stimulates the anterior pituitary to secrete FSH and LH.
- ❑ **Anterior pituitary-FSH and LH:**
 - FSH acts on the sertoli cells to maintain spermatogenesis. The sertoli cells also secrete inhibin, which is involved in negative feedback of FSH secretion.
 - LH acts on the Leydig cells to promote testosterone synthesis. Testosterone acts via an intratesticular paracrine mechanism to reinforce the spermatogenic effects of FSH in the sertoli cells.

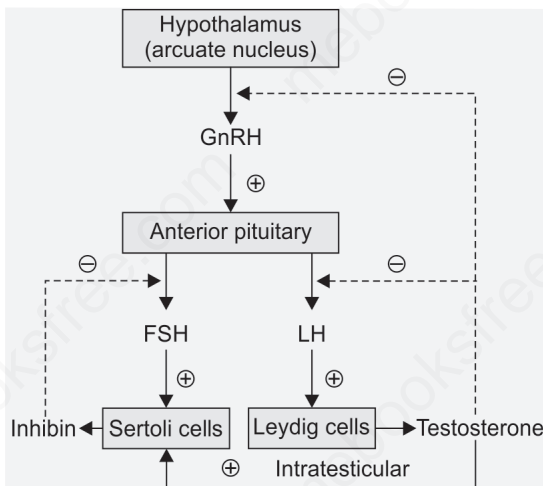
**Fig. 18.1:** Control of male reproductive hormones

❑ **Negative feedback control-testosterone and inhibin:**

- Testosterone inhibits the secretion of LH by inhibiting the release of GnRH from the hypothalamus and by directly inhibiting the release of LH from the anterior pituitary. Inhibin (produced by the Sertoli cells) inhibits the secretion of FSH from the anterior pituitary.

I IMPORTANT

5 α -reductase inhibitors (finasteride) may be used to treat benign prostatic hyperplasia because they block the activation of testosterone to dihydrotestosterone in the prostate.

Synthesis of Testosterone

- ❑ Testosterone is the major androgen synthesized and secreted by the Leydig cells.
- ❑ Leydig cells do not contain 21 β -hydroxylase or 11 β -hydroxylase (in contrast to the adrenal cortex) and, therefore, do not synthesize glucocorticoids or mineralocorticoids.
- ❑ LH (in a parallel action to ACTH in the adrenal cortex) increases testosterone synthesis by stimulating cholesterol desmolase, the first step in the pathway.
- ❑ Accessory sex organs (e.g., prostate) contain 5 α -reductase, which converts testosterone to its active form, dihydrotestosterone.

Actions of testosterone	Actions of dihydrotestosterone
<ul style="list-style-type: none"> • Differentiation of epididymis, vas deferens, and seminal vesicles. • Pubertal growth spurt • Cessation of pubertal growth spurt (epiphyseal closure) • Libido • Spermatogenesis in Sertoli cells (paracrine effect) • Deepening of voice • Increased muscle mass • Growth of penis and seminal vesicles • Negative feedback on anterior pituitary. 	<ul style="list-style-type: none"> • Differentiation of penis, scrotum, and prostate • Male hair pattern • Male pattern baldness • Sebaceous gland activity • Growth of prostate

I IMPORTANT

FSH and Testosterone both are required for spermiation. But FSH is the main hormone for spermiation. The main role of Testosterone in spermatogenesis is spermiation process.

Spermatogenesis (Fig. 18.2)

The process of germ cell development in the male from the primordial germ cells, through spermatogonia, spermatocytes, spermatids, to the mature *haploid* spermatozoa is known as spermatogenesis.

- ❑ This process begins during adolescence.
- ❑ The estimated number of spermatids formed from a single spermatogonium is 512

- ❑ In humans, it takes an average of 74 days to form a mature sperm from a primitive germ cell

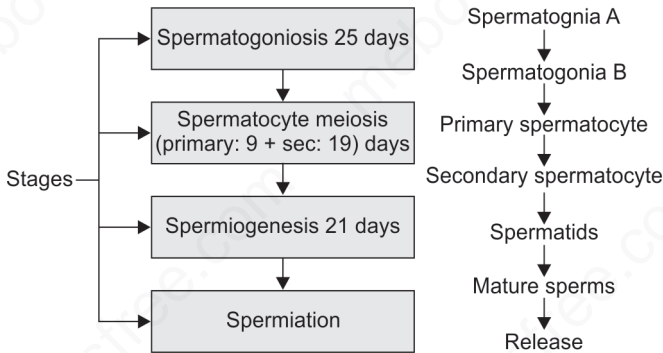

Fig. 18.2: Steps in spermatogenesis

- ❑ **Spermiation:** The spermatids mature into spermatozoa in deep folds of the cytoplasm of the Sertoli cells. The process of release of mature spermatids from the sertoli cell after maturation is known as spermiation. FSH is the main hormone, which cause cytoskeletal organization of protein necessary for release of sperm. Testosterone is also needed for ectoplasmic specialization formation.

Changes in Sperm inside Epididymis

- ❑ Spermatozoa leaving the testes are not fully mobile.
- ❑ **Acquire motility** (forward progressive motility) during their passage through **the epididymis**.
- ❑ Motility in epididymis, involves activation of a unique protein called *CatSper* in the sperm tail. This protein is a Ca^{2+} ion channel that permits cAMP-generalized Ca^{2+} influx.
- ❑ **Storage:** The epididymal transit time is 12 to 26 days.
- ❑ **Sperm Maturation:** Sperm gain the ability to fertilize as evidence by pregnancy result after MESA (micro-epididymal sperm aspiration).
- ❑ **Gain motility:** Progressive increase in forward motility.
- ❑ Maturation of acrosome.
- ❑ Decreased cytoplasm and cell volume.
- ❑ Ability to bind to zona pellucida (gain receptors for zona pellucida).
- ❑ Molecular reorganization of the plasma membrane: Lipids (stabilization of plasma membrane) and Proteins (shedding as well as acquisition of new proteins).

I IMPORTANT

Role of hormones in spermatogenesis:

- ❖ Testosterone:
 - Spermiogenesis
 - Spermiation (main role)
- ❖ FSH:
 - Sertoli cell proliferation up to pachytene spermatocytes stage.
 - Spermatogenesis and Meiosis

I IMPORTANT

Estrogen: Estrogen content of rete testis fluid is very high.

- ❖ Fluid resorption and concentration of spermatozoa. If this does not occur, the sperm entering the epididymis are diluted in a large volume of fluid, and infertility results.
- ❖ Acrosome biogenesis

I IMPORTANT

The **capacitation** of the spermatozoa that occurs in the female genital tract (starts from cervix and ends in isthmus of FT) **enhances the ability (hypermotility)** of the sperm cell to fertilize the ovum.

Capacitation and Acrosomal Reaction

- ❑ Capacitation is the process of hyperactive sperm motility. It's a complex changes that transform the sperm from nonfertilizing to potentially fertilizing cells.
- ❑ In the capacitated state, spermatozoa can then respond to molecular signals provided by the oocyte and it's associated investments (cumulus cells, zona pellucida) and undergoes the acrosome reaction.
- ❑ Capacitation correlates with cholesterol *efflux* from the sperm plasma membrane, increased membrane fluidity and modulations in intracellular ion concentrations (Ca^{2+} , K^+ , Na^+ and HCO_3^-), *hyperpolarization* of the sperm plasma membrane and increased protein tyrosine phosphorylation.
- ❑ **Site of capacitation:** Start at cervix (when sperm is deposited in vagina) and completed in isthmus.
- ❑ **Acrosome reaction (AR)** is essential for zona binding and penetration by spermatozoon occurs inside the ampulla of the fallopian tube. It is an irreversible exocytotic event leading to the release of hydrolytic enzymes that aid penetration of the zona pellucida and to the acquisition of properties by the sperm head plasma membrane that permit fusion with the oocyte.

I IMPORTANT

Speed of sperm: 3 mm/min through the female genital tract. Sperms reach the uterine tubes 30–60 min after copulation. In some species, contractions of the female organs facilitate the transport of the sperms to the uterine tubes, but it is unknown if such contractions are important in humans.

Semen

- ❑ Contains sperms and the secretions of the seminal vesicles, prostate, Cowper's glands, and, probably, the urethral glands.
- ❑ An average volume per ejaculate is 2.5–3.5 mL after several days of abstinence.

Composition of human semen

Specific gravity: 1.028, **pH:** 7.35–7.50, **Sperm count:** Average about 100 million/mL

Other components

From seminal vesicles

(Contributes 60% of total volume)

- Fructose
- Phosphorylcholine
- Ergothioneine
- Ascorbic acid
- Flavins
- Prostaglandins

From prostate (contributes

20% of total volume)

- Spermine
- Citric acid
- Cholesterol
- Phospholipids
- Fibrinolysin
- Fibrinogenase
- Zinc
- Acid phosphatase

Buffer in semen

Phosphate bicarbonate

Other

Hyaluronidase

(Does not contain thrombin or prothrombin)

Coagulation and Liquefaction of Semen

- ❑ Semen **coagulates** soon after ejaculation due to clotting factors produced by the **seminal vesicles** and forms a gelatinous mass. *Semenogelin* is the major protein for this coagulation.
- ❑ The coagulated semen **liquefies** after 15–60 min due to proteolytic enzymes produced in the **prostatic secretions**, including seminin, plasminogen activators, and PSA.
- ❑ This coagulation permits coating of the sperm with nutrients and factors that contribute to fertilization (e.g., capacitation factor) and also permits deposition of the sperm near the vaginal os.
- ❑ The subsequent liquefaction allows sperm to swim out of the coagulum and into the cervix and uterus.
- ❑ This coagulation process, while similar to blood coagulation, is unique to semen and is not inhibited by sodium citrate or heparin and does not involve prothrombin, fibrinogen, or the hematologic clotting factors.
- ❑ The main protein products forming the fibrous coagulum are semenogelin I and II, which are produced in the seminal vesicles.

FEMALE REPRODUCTIVE PHYSIOLOGY

Mammals other than primates do not menstruate, and their sexual cycle is called an estrous cycle. It is named for the conspicuous period of “heat” (estrus) at the time of ovulation, normally the only time during which the sexual interest of the female is aroused.

Menstrual Cycle

The reproductive system of women, unlike that of men, shows regular cyclic changes.

In humans and other primates, the cycle is a menstrual cycle. The length of the cycle is an average of 28 days. By convention, the first day of bleeding (menses) is called day 1 of the menstrual cycle.

The menstrual cycle includes both the ovarian and uterine (endometrial) cycles. The ovarian and uterine cycle can be divided into the following phases:

Ovarian phases	Uterine (endometrial) phase	Events
Follicular phase (Days 1–14)	Menstrual phase (Days 1–5)	<ul style="list-style-type: none"> Withdrawal of the hormonal support of the endometrium at this time causes necrosis and menstruation. Low estrogens and progesterone
	Proliferative phase (Days 6–14)	<ul style="list-style-type: none"> This phase is dominated by the effects of estrogen, which include the replacement of the endometrial cells lost during menses
Ovulation (Day 14)		Characterized by the LH surge, which actually induces ovulation
Luteal phase (Days 15–28)	Secretory phase (Days 15–28)	Dominated by the elevated plasma levels of progesterone, which, along with the secreted estrogen, prepares the uterus for implantation

I IMPORTANT

Primitive germ cells differentiate into a mature egg (ovum) through a series of steps called **Oogenesis**. Oogonia are the stem cells from which ova are derived. The oogonia proliferate by mitosis to form primary oocytes followed by primordial follicle.

- ❖ Oogenesis starts during early embryonic development.
- ❖ In male, Spermatogenesis starts during adolescent.

Ovarian and uterine changes occur parallel during this menstrual cycle. They are as follows:

OVARIAN CYCLE (FIG. 18.3)

- ❑ From the time of birth, there are many primordial follicles under the ovarian capsule. Each contains an immature ovum. During follicular phase of menstruation, primordial follicle developed into mature graafian follicle.
- ❑ Follicular development occurs by the following steps under the influence of FSH:

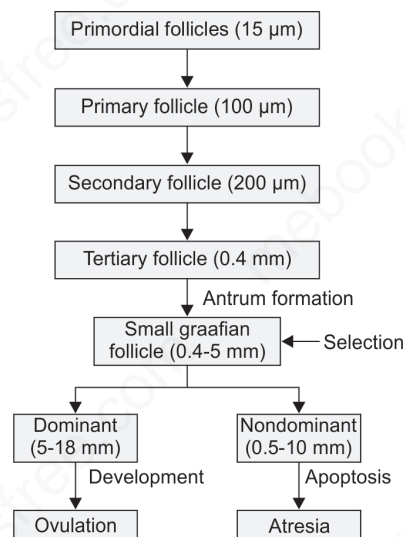

I IMPORTANT

- ❖ Meiosis in females begins in mid-gestational fetal life.
- ❖ In males, on the other hand, meiosis is initiated at or around puberty.

Fig. 18.3: Follicular development inside ovary during follicular phase. In a broad sense, there are two types of follicles: preantral (primordial, primary, secondary, tertiary) and antral (graafian, preovulatory). The development of preantral and antral follicles is gonadotropin independent and gonadotropin dependent, respectively.

- ❑ The structure of a maturing ovarian (graafian) follicle is shown in Figure 18.4. The primary source of circulating estrogen is the granulosa cells of this graafian follicle; however, the cells of the theca interna of the follicle are necessary for the production of estrogen.

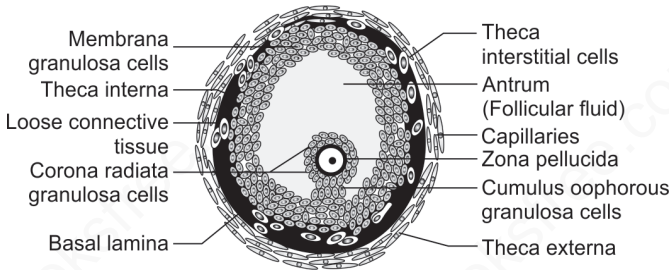

Fig. 18.4: Histological architecture of graafian follicle. Note the outer theca cell and inner layer of granulosa cell. Just before ovulation size of this follicle around 20 mm

- ❑ At about the 14th day of the cycle, the distended follicle ruptures, and the ovum is extruded into the abdominal cavity (**ovulation**).
- ❑ Ruptured follicle fills with blood (**corpus hemorrhagicum**), which later on converted into yellowish, lipid rich **corpus luteum** (Fig. 18.5).
- ❑ This initiates the **luteal phase** of the menstrual cycle, during which the luteal cells secrete estrogen and progesterone.

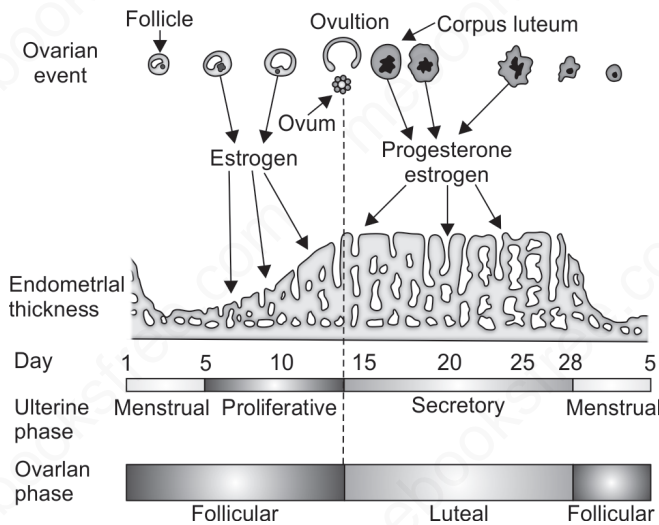

Fig. 18.5: The endometrial (uterine) cycle and ovarian cycle

I IMPORTANT

Ovulation and polar body:

- ❖ First polar body extrusion occurs during telophase I of 1st meiotic division.
- ❖ First polar body extrusion occurs before ovulation but around 20-hour after onset of LH surge.
- ❖ Once the first polar body is extruded, ovulation occurs.

I IMPORTANT

- ❖ Following extrusion of first polar body, 2nd meiotic division commences arresting at metaphase II stage (3-hour before ovulation).
- ❖ Extrusion of polar body is taken as an indication of oocyte nuclear maturity and potential for fertilization.

I IMPORTANT

If pregnancy occurs, the corpus luteum persists. If pregnancy does not occur, the corpus luteum begins to degenerate about 4 days before the next menses (24th day of the cycle) and is eventually replaced by scar tissue, forming a **corpus albicans**.

I IMPORTANT

Minor bleeding from the ruptured follicle into the abdominal cavity may cause peritoneal irritation and fleeting lower abdominal pain ("mittelschmerz").

I IMPORTANT

- ❖ A surge in LH secretion triggers ovulation.
- ❖ The primary trigger for LH surge is rise in estradiol.
- ❖ LH surge peaks ~12 hours after its initiation and lasts for ~48 hours.
- ❖ The peak concentration of LH during the surge is ~3-fold greater than the concentration before the surge.

I IMPORTANT

Ovulation occurs:

- ❖ 24–36 hours (Ganong's Physiology) or, 34–36 (Dutta's Obstetrics) after the onset of LH surge
- ❖ About 9 hours (Ganong's Physiology) or, 10–12 hours (Dutta's Obstetrics) after the LH peak
- ❖ About 83 hours after estradiol rise
- ❖ About 24–36 hours of estradiol peak
- ❖ About 8 hours of progesterone rise

Uterine cycle: Refers to cyclic changes in the endometrium during active reproductive period. These cyclic changes are brought about by the cyclic production of oestrogens and progesterone by the ovaries.

□ Proliferative phase (estrogen phase):

- FSH secretion is slightly elevated during this phase, causing proliferation of granulosa cells of ovaries, which produces *estrogen* (Fig. 18.6).
- New endometrium then regrows (stromal cells and epithelial cells proliferate) under the influence of estrogens from the developing follicle.
- Increase endometrium thickness continue from 5th to the 14th days of the menstrual cycle (Fig. 18.5).
- Before ovulation, uterine glands are also enlarged. The endometrial glands, especially those of the cervical region, secrete thin, stringy mucus.

□ Ovulation:

- When estrogens rise above a certain level, they no longer inhibit the release of LH and FSH. Instead, they stimulate the release of LH and FSH (negative feedback loop to positive feedback loop) (Fig. 18.6).
- This causes a surge in the release of LH and FSH. Only the LH surge is essential for the induction of ovulation and formation of the corpus luteum.

□ Luteal phase (progestational phase):

- After **ovulation**, the endometrium becomes more highly vascularized and slightly edematous under the influence of estrogen and progesterone from the corpus luteum.
- Once formed, the luteal cells are stimulated by LH to secrete considerable progesterone and some estrogen. Progesterone inhibits LH secretion (negative feedback).
- Progesterone causes marked swelling and secretory development of the endometrium (Fig. 18.5).
- The uterine glands become coiled and tortuous and they begin to secrete a clear fluid.
- In addition, the cytoplasm of the stromal cells increases, lipid and glycogen deposits (**subnuclear vacuolation**) increase greatly in the stromal cells, and the blood supply to the endometrium further increases.

❑ **Menstruation:**

- Progesterone from corpus luteum inhibits the secretion of LH and contributes to the demise of the corpus luteum, because the corpus luteum depends on LH for its continued stimulation.
- When the corpus luteum regresses, lower plasma levels of progesterone (and estradiol) no longer support the endometrium.
- Foci of necrosis appear in the endometrium, and these coalesce. In addition, spasm and degeneration of the walls of the spiral arteries take place, leading to spotty hemorrhages that become confluent and produce the menstrual flow.
- At the end of menstruation, all but the deep layers of the endometrium have sloughed.

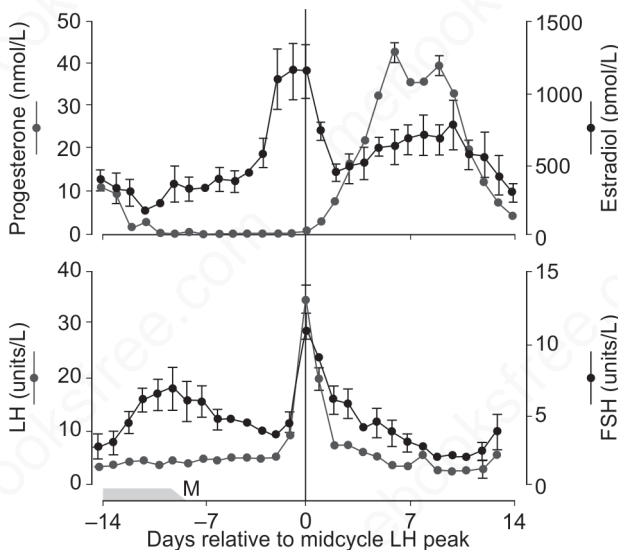
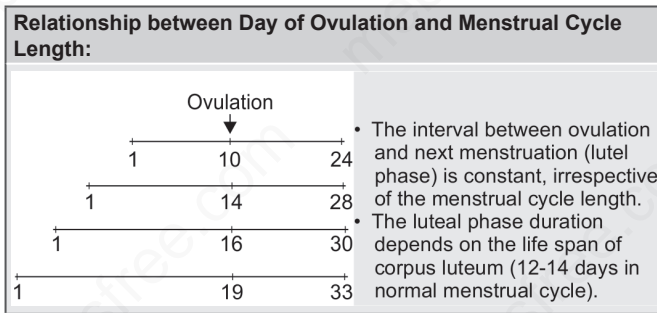

Fig. 18.6: Hormonal changes during the menstrual cycle

I IMPORTANT

Normal Menstruation:

- ❖ Menstrual blood is predominantly arterial, with only 25% of the blood being of venous origin.
- ❖ It contains tissue debris, prostaglandins, and large amounts of fibrinolysin.
- ❖ Usual duration of the menstrual flow is 3–5 days
- ❖ Blood lost normally about 30 mL (average). Loss of more than 80 mL is abnormal.

I IMPORTANT

- ❖ High estrogen should be present at least for two days for positive feedback effect.
- ❖ When circulating levels of progesterone were high, the positive feedback effect of estrogen was inhibited.
- ❖ In primates, there is evidence that both the negative and the positive feedback effects of estrogen are exerted in the mediobasal hypothalamus.

I IMPORTANT

- ❖ FSH is slightly elevated during follicular phase, leading to increased estrogen secretion from granulosa cell.
- ❖ Corpus luteum produces high progesterone during luteal phase.
- ❖ Midcycle LH, FSH peak is due to positive feedback effect of estrogen.

I IMPORTANT**Feedback by Inhibin and Activin:**

The inhibins inhibit FSH secretion by the gonadotrophs of the anterior pituitary. Activin stimulates FSH release, which is independent of GnRH.

I IMPORTANT

- ❖ In follicular phase, HIGH frequency, low amplitude GnRH favours LH synthesis.
- ❖ In luteal phase, SLOW frequency, high amplitude GnRH favours FSH synthesis.

Hormonal Control of Female Sexual Cycle

- ❑ Pulsatile release of GnRH from the hypothalamus (every 60 to 90 minutes) triggers a corresponding pulsatile release of LH and FSH from the gonadotrophs of the anterior pituitary to secrete FSH and LH, which stimulate ovarian cells to secrete estrogens and progestins.
- ❑ LH and FSH bind to specific receptors on the surface of their target cells. The theca cells of the follicle have LH receptors, whereas the granulosa cells have both LH and FSH receptors.
- ❑ Ovarian steroids (estrogens and progestins) exert both negative and positive feedback on the hypothalamic-pituitary axis.
- ❑ **Negative feedback by ovarian steroids:** Throughout most of the menstrual cycle, the estrogens and progestins feedback negatively on both the hypothalamus and the gonadotrophs of the anterior pituitary. The net effect is to reduce the release of both LH and FSH. The estrogens exert negative feedback at both low and high concentrations, whereas the progestins are effective only at high concentrations.
- ❑ **Positive feedback by ovarian steroids:** Although ovarian steroids feed back negatively on the hypothalamic-pituitary axis during most of the menstrual cycle, they have the opposite effect at the end of the follicular phase. Levels of estrogen, mainly estradiol, rise gradually during the first half of the follicular phase of the ovarian cycle and then steeply during the second half (Fig. 18.6). After the estradiol levels reach a certain threshold for a minimum of 2 days the hypothalamic-pituitary axis reverses its sensitivity to estrogens; that is, estrogens now feed back positively on the axis. This switch to positive feedback promotes the LH surge.
- ❑ The gonadotropin surge (LH) causes ovulation and luteinization. Luteinization in the granulosa cells of the follicle causes these cells to secrete progesterone rather than estradiol.
- ❑ As the luteal phase of the menstrual cycle begins, circulating levels of LH and FSH rapidly decrease. This fall-off in gonadotropin levels reflects negative feedback by three ovarian hormones—estradiol, progesterone, and inhibin.

- ❑ Moreover, as gonadotropin levels fall, so do the levels of ovarian steroids. Thus, immediately after ovulation we see more or less concurrent decreases in the levels of both gonadotropins and ovarian hormones.
- ❑ Later, during the luteal phase, the luteal cells of the corpus luteum gradually increase their synthesis of progesterone, estradiol and inhibin (Fig. 18.6).
- ❑ By ~48 hours before onset of the menses, the pulsatile rhythm of LH secretion has decreased to one pulse every 3 to 4 hours. As a result, circulating levels of LH slowly fall during the luteal phase. During the late luteal phase, the gradual demise of the corpus luteum leads to decreases in the levels of progesterone, estradiol, and inhibin. After the onset of menstruation, the hypothalamic-pituitary axis returns to a follicular-phase pattern of LH secretion (i.e., a gradual increase in the frequency of GnRH pulses).

OVARIAN STEROIDS: ESTROGEN AND PROGESTERONE

- ❑ Starting from cholesterol, the ovary synthesizes estradiol, the major estrogen, and progesterone, the major progestin.
- ❑ Estrogen biosynthesis requires two ovarian cells (theca and granulosa cells) and two gonadotropins (LH and FSH), whereas progestin synthesis requires only a single cell.
- ❑ The superficial theca cells and theca-lutein cells can take up cholesterol and produce the adrenal androgens, but they do not have the aromatase necessary for estrogen production (Fig. 18.7).
- ❑ However, the deeper granulosa cells and granulosa-lutein cells have the aromatase, but they lack the 17α -hydroxylase and $17,20$ -desmolase necessary for making the adrenal androgens.
- ❑ Another difference between the two cell types is that (in the follicle) the superficial theca cell is near blood vessels and is hence a source of LDL cholesterol. The granulosa cell, conversely, is far from blood vessels and instead is surrounded by LDL-poor follicular fluid. Thus, in the follicular stage, the granulosa cells obtain most of their cholesterol by de novo synthesis.

- ❑ However, after formation of the corpus luteum, the accompanying vascularization makes it possible for the granulosa-lutein cell to take up LDL cholesterol from the blood and to thus synthesize large amounts of progesterone.
- ❑ A final difference between the two cell types is that theca cells have LH receptors, and granulosa cells have both LH and FSH receptors.
- ❑ Because of their unique physiological properties, neither the theca/theca-lutein cells nor the granulosa/granulosa-lutein cells can make estrogens by themselves. According to the two-cell, two-gonadotropin hypothesis, estrogen and progesterone synthesis occurs in the following steps (Fig. 18.7):

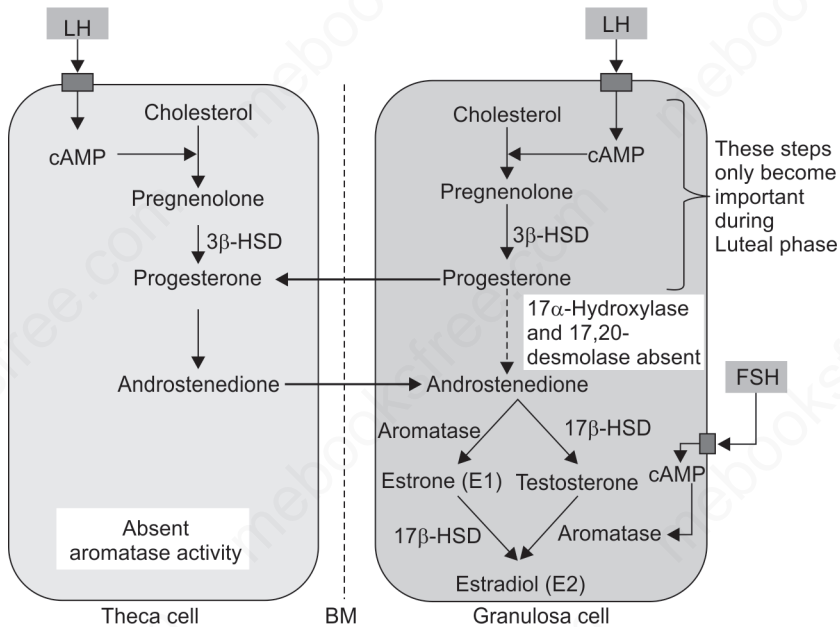

Fig. 18.7: Two-cell, two-gonadotropin model

- ❑ LH primes the theca cell to convert cholesterol to androstenedione. Because the theca cell lacks aromatase, it cannot generate estradiol from this androstenedione. Instead, the androstenedione diffuses to the granulosa cell, whose aromatase activity has been stimulated by FSH. The aromatase converts the androstenedione to estradiol.
- ❑ After ovulation, LH acts on the cells of the corpus luteum.

- ❑ In the luteal phase, the vascularization of the corpus luteum makes LDL (cholesterol) available to the granulosa cells. Thus, both the theca and the granulosa cells can produce progesterone, the major product of the corpus luteum.
- ❑ For production of 17α -hydroxyprogesterone (17α -OH progesterone), some of the progesterone diffuses into the theca cell, which has the 17α -hydroxylase activities needed for converting the progesterone to 17α -hydroxyprogesterone.
- ❑ The theca cell can also generate the androstenedione, which diffuses into the granulosa cell for estradiol synthesis.

Comparison of Estrogen and Progesterone:

	Estrogen	Progesterone
Natural form	17β -estradiol (E2), estrone (E1), and estriol (E3)	Progesterone: C21 steroid And 17α -hydroxyprogesterone (small amount)
Secreted from	Granulosa cells of follicles, corpus luteum and placenta	Corpus luteum, placenta, and ovarian follicle (little amount)
Circulating forms	2% free 60% bound to albumin 38% bound to sex hormone-binding globulin (SHBG)	2% free 80% bound to albumin 18% bound to corticosteroid-binding globulin
Metabolism and excretion	In the liver, E1, E2, E3 converted to glucuronide and sulfate conjugates. All these compounds excreted in the urine	In liver converted in the liver to pregnanediol, which conjugated to glucuronic acid and excreted in the urine
Receptors	Intranuclear location (ER α/β)	Intracytoplasmic: PR-B Intranuclear: PR-A
Effects on the Female Genitalia	<ul style="list-style-type: none"> • Growth of the ovarian follicles. • Proliferation of endometrium. • Increases motility and decrease secretion of uterine tubes. • Increased excitability of uterine smooth muscle. • Clear, watery, copious mucous secretion from cervix which is elastic (spinbarkeit) 	<ul style="list-style-type: none"> • Secretory effect on endometrium (tortuous gland) • Decrease motility and increased secretion of uterine tubes • Decreasing excitability of uterine smooth muscle but increases RMP. • Scanty, thick mucous secretion from cervix.
Female Secondary Sex Characteristics	<ul style="list-style-type: none"> • Enlargement of breasts (Growth of duct and stroma), uterus, and vagina (pubertal changes). • Female distribution of fat 	Breast enlargement (lobules and alveoli)
Effects on Endocrine Organs	<ul style="list-style-type: none"> • Increased secretion of angiotensinogen and thyroid-binding globulin • They cause epiphyseal closure in humans 	Large doses of progesterone inhibit LH secretion and potentiate the inhibitory effect of estrogens, preventing ovulation.

Contd...

Contd...

	Estrogen	Progesterone
Effects on the Central Nervous System	<ul style="list-style-type: none"> • Increase libido in humans via direct effect on hypothalamus. • Proliferation of dendrites on neurons and the number of synaptic knobs • Increase BMR slightly 	Progesterone is thermogenic and is probably responsible for the rise in basal body temperature at the time of ovulation
Other effects	<ul style="list-style-type: none"> • Salt and water retention • Fluidic secretion from sebaceous gland (prevent acne) • Plasma cholesterol-lowering action (decrease LDL, increased HDL) • Vasodilation by increasing the local production of NO 	<ul style="list-style-type: none"> • Natriuresis by blocking aldosterone action • Stimulates respiration (decreases alveolar PCO₂) • Increase plasma LDL and decreases HDL

I IMPORTANT

- ❖ SHBG also known as testosterone-binding globulin (TBG).
- ❖ TBG not only bind estradiol, but also TBG levels are twice as high in women as they are in men. Estrogens (including birth control pills) stimulate the synthesis of SHBG.

I IMPORTANT

- The estradiol secretion rate:
- ❖ 36 µg/day (133 nmol/day) in the early follicular phase
 - ❖ 380 µg/day just before ovulation
 - ❖ 250 µg/day during the midluteal phase.
 - ❖ In men is about 50 µg/day (184 nmol/day)

I IMPORTANT

- ❖ In men, the plasma progesterone level is approximately 0.3 ng/mL (1 nmol/L).
- ❖ In women, the level is approximately 0.9 ng/mL (3 nmol/L) during the follicular phase of the menstrual cycle.

INHIBINS AND ACTIVINS

- ❑ Inhibins are produced by:
 - Granulosa cells of the follicle
 - Pituitary, brain, adrenal gland, kidney, bone marrow, corpus luteum, and the placenta.
- ❑ FSH specifically stimulates the granulosa cells to produce inhibins. Inhibins in turn inhibit FSH production by gonadotrophs through a negative feedback loop.
- ❑ Estradiol may stimulate inhibin production through an intraovarian mechanism.
- ❑ Just before ovulation, after the granulosa cells acquire LH receptors, LH also stimulates the production of inhibin by granulosa cells.
- ❑ The activins are produced in the same tissues as the inhibins, but they stimulate, rather than inhibit FSH release from pituitary cells.

- Inhibins are dimeric glycoproteins consisting of an α subunit linked through disulfide binding with either a β_A or β_B subunit. The resulting $\alpha\beta_A$ heterodimer is referred to as inhibin A, whereas the $\alpha\beta_B$ protein constitutes inhibin B.

- Inhibin A predominant form produced during the late follicular and luteal phases of the normal menstrual cycle, whereas inhibin B is the predominant form during the early and mid follicular phases of the cycle.
- Inhibin A predominantly secreted by corpus luteum whereas inhibin B is predominantly produced by granulosa cells.

RELAXIN: A PLEIOTROPIC HORMONE

- ❑ Relaxin is a peptide hormone of about 6000 Da belonging to the insulin family. Like insulin, relaxin is composed by two disulfide-linked chains, termed the A and B chains, the B chain bearing the receptor interaction site.
- ❑ It attains the highest plasma levels during pregnancy. In this condition, relaxin is also produced by the decidua, placenta and breast.
- ❑ In nonpregnant women it is produced by the corpus luteum and endometrium during the secretory but not the proliferative phase of the menstrual cycle.
- ❑ In males, relaxin is synthesized in the prostate and released in the seminal fluid.
- ❑ An additional source of relaxin has recently been identified in the heart atria.
- ❑ Function of relaxins are:
 - Induction of collagen remodeling and consequent softening of the tissues of the birth canal in view of delivery;
 - Inhibition of uterine contractile activity
 - Stimulation of growth and differentiation of the mammary gland.

I IMPORTANT

Women have less body hair and more scalp hair, and the pubic hair generally has a characteristic flat-topped pattern (female escutcheon). Estrogen determines this pattern. However, growth of pubic and axillary hair in both sexes is due primarily to androgens rather than estrogens.

I IMPORTANT

- ❖ Gonadal steroids (i.e., testosterone in boys, estradiol in girls) are the major hormone for bone growth and osseous maturation.

Summary of Hormonal Control (Fig. 18.8)

Fig. 18.8: Hormonal control of menstrual cycle: Feedback loops

PUBERTY

- ❑ Between early childhood and ~8–9 years of age (prepubertal stage): *undetectable serum level of luteinizing hormone (LH) and sex hormones (estradiol in girls, testosterone in boys).*
- ❑ **1–3 years before the onset of clinically evident puberty: low serum levels of LH during sleep become demonstrable.**
- ❑ This sleep-entrained LH secretion occurs in a pulsatile fashion and reflects endogenous episodic discharge of hypothalamic gonadotropin-releasing hormone (GnRH).
- ❑ *Nocturnal pulses of LH continue to increase in amplitude and, to a lesser extent, in frequency as clinical puberty approaches. By midpuberty, LH pulses become evident even during the daytime and occur at approximately 90–120 min intervals.*
- ❑ The increasing secretion of hypothalamic GnRH in a pulsatile fashion underlies the onset of pubertal development.
- ❑ Loss-of-function mutations of the *KISS1 R*—also known as *GPR54*—gene (the gene encoding a G-protein-coupled receptor whose ligand is kisspeptin) cause an autosomal recessive form of hypogonadotropic hypogonadism, whereas gain-of-function mutations of the gene are associated with precocious puberty.

I IMPORTANT

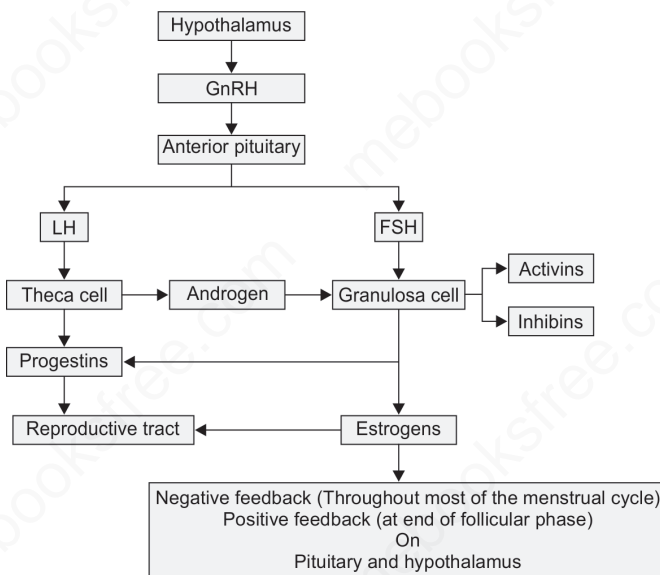
The “GnRH pulse generator” is regulated by multiple neuropeptides:

- **Stimulatory:** Glutamic acid, kisspeptin, and neurokinin-B
- **Inhibitory:** γ -aminobutyric acid, preproenkephalin, and dynorphin.

GnRH secretion is also regulated by factors produced by the glial cells, such as transforming growth factor α .

I IMPORTANT

- *GnRH is the major hormone responsible for the onset and progression of puberty. Pulsatile release (not continuous) is essential for puberty.*

I IMPORTANT

- ❖ Gonadal steroids (i.e., testosterone in boys, estradiol in girls) are the major hormone for bone growth and osseous maturation.

- *Estrogens, rather than androgens, are responsible for the process of bone maturation that ultimately leads to epiphyseal fusion and cessation of growth.*

- Estrogen determines the acceleration of bone elongation at puberty, epiphyseal closure, harmonic skeletal proportions, the achievement of peak bone mass, and the maintenance of bone mass.
- Estrogens also mediate the increased production of growth hormone, which along with a direct effect of sex steroids on bone growth, is responsible for the *pubertal growth spurt*.

MULTIPLE CHOICE QUESTIONS

MALE REPRODUCTIVE SYSTEM

RECENT MCQs

1. Blood-testis barrier is formed by:

- a. Sertoli cells b. Leydig cells
c. Epididymis d. Vas deferens

2. Testosterone production is mainly contributed by:

- a. Leydig cells
b. Sertoli cells
c. Seminiferous tubules
d. Epididymis

3. Sperm acquires motility in:

- a. Seminal vesicle b. Testes
c. Epididymis d. Ejaculatory duct

4. Sperm maturation takes place in:

- a. Vas deferens
b. Seminiferous tubules
c. Epididymis
d. Female genital tract

5. Spermatogenesis is mostly controlled by:

- a. Inhibin b. FSH
c. LH d. GnRH

6. PGs in semen are secreted by:

- a. Prostate b. Seminal vesicle
c. Sperms d. Testes

7. Velocity¹ of human sperm:

- a. 1–3 mm/min b. 4–6 mm/min
c. 6–9 mm/min d. 10–13 mm/min

8. Semen is released by:

- a. Epididymis b. Testes
c. Vas deferens d. Prostate

9. The principal steroid secreted by testis is:

- a. Testosterone
b. Dihydrotestosterone
c. Androstenedione
d. Dehydroepiandrosterone

10. Mullerian inhibiting substance (MIS) is produced by:

- a. Stroma b. Sertoli cells
c. Leydig cells d. All of the above

AIIMS/PGI/JIPMER

11. Sertoli cells in the testis have receptors for: *[AIIMS Nov 07, AI 04]*

- a. FSH b. LH
c. Inhibin d. GnRH

12. Spermatogenesis is maintained by which hormones? *[PGI Dec 08]*

- a. Testosterone b. FSH
c. LH d. Prolactin
e. Gonadotropin releasing hormone (GnRH)

13. Capacitation of sperms takes place in: *[AIIMS May 10, 09]*

- a. Seminiferous tubules
b. Epididymis
c. Vas deference
d. Uterus

14. Which of the following organs secretes zinc in large amount in man? *[AIIMS May 06]*

- a. Seminal vesicle b. Prostate
c. Epididymis d. Vas deferens

15. Sertoli cells play a key role in which of the following process? [AI 09]

- a. Spermiogenesis
- b. Testosterone secretion
- c. Secretion of seminal fluid
- d. Production of germ cells

16. Spermatogenesis occurs at: [AI 08]

- a. Body temperature
- b. Temperature lower than core body temperature
- c. Temperature higher than core body temperature
- d. Temperature does not play a role

MENSTRUAL CYCLE

RECENT MCQs

17. Which of the following is not seen in human?

- a. Estrous cycle
- b. Menstrual cycle
- c. Endometrial cycle
- d. Ovarian cycle

18. Ovulation in a women with 28-day cycle:

- a. Just before LH surge
- b. Just after corpus leuteal maturation
- c. Due to progesterone rise
- d. 14 days prior to menstruation

19. The interval between ovulation and LH surge:

- a. 12–24 hours
- b. 24–48 hours
- c. 72 hours
- d. 72–96 hours

20. Increased LH secretion just before ovulation is due to:

- a. Positive feedback by progesterone
- b. Positive feedback by estrogen
- c. Positive feedback by FSH
- d. Positive feedback by relaxin

21. Positive feedback action of estrogen for inducing luteinizing hormone surge is associated with which of the following steroid hormone ratios in peripheral circulation?

- a. High estrogen: low progesterone
- b. Low estrogen: high progesterone
- c. Low estrogen: low progesterone
- d. High estrogen: high progesterone

22. There is a mid-cycle shift in the basal body temperature (BBT) after ovulation in women. This is caused by:

- a. FSH-peak
- b. LH-peak
- c. Oestradiol
- d. Progesterone

23. Corpus leuteum starts regressing after how many days of ovulation:

- a. 5 days
- b. 10 days
- c. 24 days
- d. None

24. Corpus luteum in pregnancy is maintained by which hormone:

- a. Progesterone
- b. Oestrogen
- c. LH
- d. FSH

25. Luteal phase dominant hormone:

- a. Estrogen
- b. Progesterone
- c. Prolactin
- d. Oxytocin

26. In post-ovulatory phase thickness of endometrium is because of:

- a. Progesterone b. Oestrogen
- c. FSH d. LH

27. Ovary produces all *except*:

- a. Gonadotropin b. Testosterone
- c. Estrogen d. Inhibin B

28. True about estrogen production in menstrual cycle:

- a. Only by theca cells
- b. Only by granulosa cells
- c. Both theca and granulosa cells
- d. None of the above

29. Estrogen is secreted by:

- a. Granulosa cells
- b. Theca luteal cells
- c. Theca interna
- d. Theca externa

30. Two cell two gonatotropin hypothesis is:

- a. FSH and LH inhibits the release of estrogen and progesterone
- b. FSH acts on granulosa cell and LH on theca cells
- c. FSH stimulates estrogen while LH inhibits estrogen
- d. FSH feedback inhibits hypothalamus, while LH feedback inhibits pituitary

31. The type of estrogen found in highest concentration in adult female is:

- a. Estrone b. Estriol
- c. Estradiol d. None

32. Estrogen is secreted during pregnancy, mostly by:

- a. Maternal ovary
- b. Fetal ovary
- c. Pituitary
- d. Hypothalamus

33. Secretion of estrogen is maximum at:

- a. Just before menopause
- b. At puberty
- c. At menstruation
- d. Before ovulation

34. Following pubertal change is not due to estrogen:

- a. Vaginal comification
- b. Pubic and axillary hair growth
- c. Cervical mucus production
- d. Menstruation

35. Estrogen Beta receptors are found on:

- a. Uterus
- b. Blood vessels
- c. Ovary
- d. Vagina

36. False about estrogen action:

- a. Stimulates secondary sex characters in female
- b. Stimulates osteoclasts
- c. Decreases LDL
- d. Increases blood coagulability

37. Source of progesterone during normal menstrual cycle:

- a. Corpus luteum
- b. Stroma
- c. Surface epithelium of ovary
- d. Endothelium cell

38. Progesterone has how many carbons?

- a. 18 b. 19
- c. 20 d. 21

39. Action of progesterone:

- a. Increased sensitivity of uterus to oxytocin
- b. Inhibits LH secretion
- c. Decrease in body temperature
- d. Causes proliferative changes in uterus

40. Subnuclear cytoplasmic vacuolization is seen in which stage of menstrual cycle?

- a. Proliferative phase
- b. During menstruation
- c. Secretory phase
- d. None

41. 17 OH steroid:

- a. Androgen
- b. Progesterone
- c. Estrogen
- d. Testosterone

42. FSH and LH both are inhibited by:

- a. Cortisol
- b. Aldosterone
- c. Estrogen
- d. Progesterone

43. Inhibin is secreted by:

- a. Ovarian follicle
- b. Stroma
- c. Surface epithelium of ovary
- d. Corpus luteum

44. Hormone with no change in levels in menstrual cycle:

- a. Activin
- b. Inhibin
- c. FSH
- d. GnRH

45. Common precursor of mineralocorticoids, glucocorticoids and sex steroids:

- a. Pregnenolone
- b. alpha-hydroxyprogesterone
- c. Dehydrotestosterone
- d. Deoxycortisol

46. Aromatase produces estrogen from:

- a. Progesterone
- b. Cortisol
- c. Aldosterone
- d. Androgen

47. Beta HCG is secreted by:

- a. Ovary
- b. Pituitary
- c. Corpus luteum
- d. Placenta

48. Function of oxytocin:

- a. Milk ejection
- b. Milk secretion
- c. Ovulation
- d. Maintenance of pregnancy

AIIMS/PGI/JIPMER

49. Ovulation is associated with sudden rise in: [AIIMS May 04]

- a. Prolactin
- b. Testosterone
- c. LH
- d. Oxytocin

50. Corpus luteum is maintained by:

[AI 97]

- a. Progesterone
- b. LH
- c. FSH
- d. Estrogen

51. Follicular stimulating hormone receptors are present on:

[AIIMS May 06, May 02]

- a. Theca cells
- b. Granulosa cells
- c. Leydig cells
- d. Basement membrane of ovarian follicle

52. The laboratory report shows values of gonadotropin and ovarian hormones of the blood sample taken, on day 20 of the menstrual cycle of a young woman. Whether her cycle was ovulatory or not may be validly assessed by the reported serum level of:

[AIIMS Nov 02]

- a. FSH
- b. LH
- c. Oestradiol
- d. Progesterone

53. Which of the following statements can be regarded as primary action of inhibin? [AI 05]

- a. It inhibits secretion of prolactin
- b. It stimulates synthesis of estradiol
- c. It stimulates secretion of TSH
- d. It inhibits secretion of FSH

54. Progesterone is produced by: [AI 95]

- a. Granulosa luteal cells
- b. Theca cells
- c. Stroma of ovary
- d. Sertoli cells

55. Hormones exclusively secreted by placenta: (PGI 03)

- a. HCG
- b. Estrogen
- c. HPL
- d. PRL

FUTURE TRENDS

56. The hormone primarily responsible for development of ovarian follicles prior to ovulation is:

- a. Chorionic gonadotropin
- b. Estradiol
- c. Follicle-stimulating hormone
- d. Luteinizing hormone

57. Administration of estrogens in women will:

- a. Limit the growth of ovarian follicles
- b. Produce cyclic changes in the vagina and endometrium
- c. Cause cervical mucus to become thicker and more acidic
- d. Produce glandular proliferation in the breast

58. Progesterone:

- a. Is secreted by the corpus luteum
- b. Secretion by the placenta increases at week 6 of gestation
- c. Plasma levels increase during the menses

d. Plasma levels decrease subsequent to ovulation

59. Assuming a regular menstrual cycle of 30 to 32 days, ovulation would be expected to occur between:

- a. Days 12 and 14
- b. Days 16 and 18
- c. Days 18 and 20
- d. Days 22 and 24

60. Which of the following treatments is most likely to elicit an early surge of luteinizing hormone (LH) in a normal nonpregnant 21-year-old woman? An injection of:

- a. Estradiol 10 days after the onset of menses
- b. Progesterone 10 days after the onset of menses.
- c. Estradiol 20 days after the onset of menses
- d. Progesterone 20 days after the onset of menses

ANSWERS WITH EXPLANATIONS

1. Ans. a. Sertoli cells

(Ref. Ganong's Physiology 24th edn. pp 403)

Cytoplasmic process from sertoli cells along with tight junction forms blood testis barrier.

2. Ans. a. Leydig cells

(Ref. Ganong's Physiology 24th edn. pp 402)

The interstitial cells of Leydig secrete testosterone into the bloodstream.

3. Ans. c. Epididymis

(Ref: Ganong's Physiology 24th edn. pp 404)

Acquire motility (forward progressive motility) during their passage through the epididymis.

4. Ans. d. Female genital tract

[Check Q.No 2].

5. Ans. b. FSH

(Ref. Trends Endocrinol Metab 1995 Apr;6: 95-101)

Both FSH and T exert synergistic actions on germ cells, but T has a specific action on the later stages of spermatid maturation. FSH, by its ability to stimulate Sertoli cell mitosis during testicular development, can influence the spermatogenic capacity of the adult testis.

6. Ans. b. Seminal vesicle

(Ref. Ganong's Physiology 24th edn. pp 405)

[Detail composition given in text]

7. Ans. a. 1-3 mm/min

(Ref. Ganong's Physiology 24th edn. pp 405)

Human sperms move at a speed of about 3 mm/min through the female genital tract.

8. Ans. c. Vas deferens

(Ref. Ganong's Physiology 24th edn. pp 406)

Contraction of the smooth muscle of the vasa deferentia and seminal vesicles in response to stimuli in the hypogastric nerves leads to ejaculation or, release of sperm.

Semen is produce by seminal vesicle (main component).

9. Ans. a. Testosterone

(Ref. Ganong's Physiology 24th edn. pp 402)

Testosterone is the main androgen produce by testis.

The testosterone metabolite dihydrotestosterone induces the formation of male external genitalia and male secondary sex characteristics.

10. Ans. b. Sertoli cells

(Ref. Ganong's Physiology 24th edn. pp 402)

Sertoli cell secretes androgen binding proteins, inhibin and MIS.

11. Ans. a. FSH

(Ref. Ganong's Physiology 24th edn. pp 405)

Sertolic cell has receptors for FSH.

Leydig cell has receptors for LH.

12. Ans. a. Testosterone, b. FSH, c. LH, e. Gonadotropin releasing hormone (GnRH)

(Ref. Trends Endocrinol Metab 1995 Apr;6: 95-101)

Main hormone for spermatogenesis is FSH>>Testosterone.

LH maintains testosterone production and GnRH regulates LH and FSH production.

13. Ans. d. Uterus

(Ref. Ganong's Physiology 24th edn. pp 404)

Capacitation starts in cervix and ends at the level of isthmus of fallopian tube.

14. Ans. b. Prostate

(Ref. Ganong's Physiology 24th edn. pp 405)

[Detail composition given in text]

15. Ans. a. Spermiogenesis

(Ref. Ganong's Physiology 24th edn. pp 404)

Maturation from spermatids to spermatozoa depends on androgen acting on the Sertoli cells in which the developing spermatozoa are embedded. FSH acts on the Sertoli cells to facilitate the last stages of spermatid maturation.

16. Ans: b. Temperature lower than core body temperature

(Ref. Ganong's Physiology 24th edn. pp 405)

Spermatogenesis requires a temperature considerably lower than that of the interior of the body. The testes are normally maintained at a temperature of about 32°C. They are kept cool by air circulating around the scrotum. When the testes are retained in the abdomen sterility result.

17. Ans. a. Estrous cycle

(Ref. Ganong's Review of Physiology 25th pp 403)

"Mammals other than primates do not menstruate, and their sexual cycle is called an estrous cycle. It is named for the conspicuous period of 'heat' (estrus) at the time of ovulation, normally the only time during which the sexual interest of the female is aroused."

18. Ans. d. 14 days prior to menstruation

(Ref. Ganong's Review of Physiology 25th pp 399)

In a 28 days cycle, at about the 14th day of the cycle, ovulation occurs. After ovulation, the ruptured follicle forms the corpus luteum (CL), which survive for another 14 day if pregnancy does not occurs. Complete regression of CL leads to loss of hormonal support for the endometrium which marked the onset of next menstruation.

19. Ans. b. 24–48 hours

(Ref. Ganong's Review of Physiology 25th pp 408)

At 36–48 hours before ovulation, the estrogen feedback effect becomes positive, and this initiates the burst of LH secretion (LH surge) that produces ovulation. Ovulation occurs about 9 hours after the LH peak.

20. Ans. b. Positive feedback by estrogen

[Check explanation of above question]

21. a. High estrogen: low progesterone

(Ref. Ganong's Review of Physiology 25th pp 409)

High estrogen should be present at least for two days for positive feedback effect. When circulating estrogen was increased about 300% for 24 h, only negative feedback was seen; but when it was increased about 300% for 48 h or more, LH surge is seen.

When circulating levels of progesterone were high, the positive feedback effect of estrogen was inhibited. In primates, there is evidence that both the negative and the positive feedback effects of estrogen are exerted in the mediobasal hypothalamus.

22. Ans. d. Progesterone

(Ref. Ganong's Review of Physiology 25th pp 402)

The cause of the temperature change at the time of ovulation is probably the increase in progesterone secretion, since progesterone is thermogenic.

23. Ans. b. 10 days

(Ref. Ganong's Review of Physiology 25th pp 399)

If pregnancy does not occur, the corpus luteum begins to degenerate about 4 days before the next menses (24th day of the cycle).

24. Ans. c. LH

(Ref. Ganong's Review of Physiology 25th pp 399)

A burst of LH secretion is responsible for ovulation and the initial formation of the corpus luteum. LH secretion must continue for the functioning of corpus luteum.

During pregnancy: hCG produced by the developing conceptus maintains steroidogenic function of the corpus luteum until ~ 9th week of gestation, at which time placental function is well established. If not rescued by pregnancy, the hormone-producing cells of the corpus luteum degenerate and leave behind a fibrotic corpus albicans. So, in this particular question, NONE is the correct answer. But single best choice would be LH.

25. Ans. b. Progesterone

(Ref. Ganong's Review of Physiology 25th pp 403)

26. Ans. a. Progesterone

(Ref. Ganong's Review of Physiology 25th pp 407)

Progesterone stimulates the stroma and glandular components (inhibits epithelial cell proliferation) of the endometrium and thus induces secretory changes in the endometrium. The epithelial cells exhibit a marked increase in secretory activity.

27. Ans. a. Gonadotropin

(Ref. Ganong's Review of Physiology 25th pp 406)

28. Ans. b. Only by granulosa cells

(Ref. Ganong's Review of Physiology 25th pp 404)

A unique aspect of estradiol synthesis is that it requires the contribution of two distinct cell types: the theca and granulosa cells within the follicle. Although the contribution of both cell is required, Estrogen is actually produced by granulosa cell.

29. Ans. a. Granulosa cells

(Ref: Ganong's Review of Physiology 25th pp 404)

The granulosa cells make estradiol when provided with androgens, and it appears that the estradiol they form in primates is secreted into the follicular fluid.

30. Ans. b. FSH acts on granulosa cell and LH on theca cells

(Ref. Ganong's Review of Physiology 25th pp 404)

Theca interna cells have many LH receptors, and LH converts cholesterol to androstenedione. The theca interna cells supply androstenedione to the granulosa cells. The granulosa cells make estradiol when provided with androgens, and it appears that the estradiol they form in primates is secreted into the follicular fluid.

31. Ans. c. Estradiol

(Ref: Ganong's Review of Physiology 25th pp 404)

E1 (estrone): Main form in postmenopausal women

E2 (estradiol): Main form during reproductive age group

E3 (estriol): Main form during pregnancy

32. Ans. a. Maternal ovary

(Ref. Ganong's Review of Physiology 25th pp 404)

During first 6–12 weeks of pregnancy, corpus luteum of maternal ovary is the major source of estrogens.

33. Ans. d. Before ovulation

(Ref. Ganong's Review of Physiology 25th pp 404)

The estradiol secretion rate is 36 µg/day (133 nmol/day) in the early follicular phase, 380 µg/day just before ovulation, and 250 µg/day during the midluteal phase. Highest level of estrogen is seen during pregnancy.

34. Ans. b. Pubic and axillary hair growth

(Ref. Ganong's Review of Physiology 25th pp 405)

In women, less body hair and more scalp hair, and the shape of pubic hair is under the influence of estrogen. Growth of pubic and axillary hair in both sexes is due primarily to androgens rather than estrogens.

35. Ans. c. Ovary

(Ref. Ganong's Review of Physiology 25th pp 406)

ER α is found primarily in the uterus, kidneys, liver, and heart, whereas ER β is found primarily in the ovaries, prostate, lungs, gastrointestinal tract, hemopoietic system, and central nervous system (CNS).

36. Ans. b. Stimulates osteoclasts

(Ref. Ganong's Review of Physiology 25th pp 383)

Estrogens prevent osteoporosis by inhibiting the osteoclasts.

37. Ans. a. Corpus luteum

(Ref. Ganong's Review of Physiology 25th pp 406)

Progesterone is a C21 steroid secreted by the corpus luteum, the placenta.

38. Ans. d. 21

(Ref. Ganong's Review of Physiology 25th pp 406)

39. b. Inhibits LH secretion

(Ref. Ganong's Review of Physiology 25th pp 407)

Large doses of progesterone inhibit LH secretion and potentiate the inhibitory effect of estrogens, preventing ovulation.

40. Ans. c. Secretory phase

(Ref. Guyton and Hall Physiology 13th ed pp1045)

Subnuclear vacuolization is due to the cytoplasmic glycogen deposits, which starts on 16th day of menstrual cycle.

41. Ans. b. Progesterone

(Ref. Guyton and Hall Physiology 13th Ed pp1043)

Small amounts of another progestin, 17- α -hydroxyprogesterone, are secreted along with progesterone and have essentially the same effects.

21-carbonsteroids: Progesterone, deoxycorticosterone, aldosterone, and cortisol.

19-carbonsteroids: Dehydroepiandrosterone or androstenedione. They have androgenic activity and are precursors to the estrogens.

18-carbonsteroids: Estrogens.

42. Ans: c. Estrogen

(Ref. Ganong's Review of Physiology 25th pp 407)

Estrogens decrease FSH secretion. Under some circumstances, they inhibit LH secretion (negative feedback). The feedback effects of progesterone are complex and are exerted at both the hypothalamic and pituitary levels. Large doses of progesterone inhibit LH secretion.

43. Ans. a. Ovarian follicle

(Ref. Ganong's Review of Physiology 25th pp 390)

Inhibins are produced by: Granulosa cells of the follicle.

44. Ans. a. Activin (J Clin Endocrinol Metab. 1996;81:3328-34).**45. Ans. a. Pregnenolone**

(Ref. Ganong's Review of Physiology 25th pp 357)

46. Ans. d. Androgen

(Ref. Ganong's Review of Physiology 25th pp 383)

Progesterone converted into androstenedione (androgens) and enters into granulosa cell for synthesis of estrogens.

47. Ans. d. Placenta

(Ref. Ganong's Review of Physiology 25th pp 412)

The placental gonadotropin in humans is called human chorionic gonadotropin (hCG).

48. Ans. a. Milk ejection

(Ref. Ganong's Review of Physiology 25th pp 412)

49. Ans. c. LH

(Ref. Ganong's Review of Physiology 25th pp 402)

A surge in LH secretion triggers ovulation, and ovulation normally occurs about 9 h after the peak of the LH surge at midcycle.

50. Ans. b. LH

(Ref. Ganong's Review of Physiology 25th pp 408)

A burst of LH secretion is responsible for ovulation and the initial formation of the corpus luteum. LH secretion must continue for the functioning of corpus luteum.

51. Ans. b. Granulosa cells

(Ref. Ganong's Review of Physiology 25th pp 404)

Granulosa cells have many FSH receptors, and FSH facilitates their secretion of estradiol by acting via cAMP to increase their aromatase activity.

52. Ans. d. Progesterone

(Ref. Ganong's Review of Physiology 25th pp 383)

Predominant progesterone is produced by corpus luteum during luteal phase of menstrual cycle.

53. Ans. d. It inhibits secretion of FSH

(Ref. Ganong's Review of Physiology 25th pp 390)

The gonads secrete other polypeptides, including inhibin, a polypeptide that inhibits follicle-stimulating hormone (FSH) secretion.

54. Ans. a. Granulosa luteal cells

(Ref. Ganong's Review of Physiology 25th pp 383)

Theca luteal cell is the major source of progesterone. Granulosa luteal cell produces small amount of progesterone.

55. Ans. c. HPL

(Ref: Knobil and Neil Reproductive physiology, 4th edition Table 40.1)

Confusion here is about HCG. Major source of HCG is placenta (syncytiotrophoblast >cytotrophoblast). But gonadotrope can also secrete HCG. Foetal kidney and foetal pituitary are other source of HCG. Pathologically, some advanced malignancy secrete HCG.

56. Ans. c. Follicle-stimulating hormone

FSH stimulates development of the theca and granulosa cells of the follicles before ovulation.

57. Ans. b. Produce cyclic changes in the vagina and endometrium

Estrogens cause the mucus secreted by the cervix to become thinner and more alkaline and to exhibit a fernlike pattern upon drying. Estrogens can stimulate growth of ovarian follicles, the smooth muscle of the uterus, and the uterine vascular system. Growth of the glandular elements of the breast is stimulated by progesterone; growth of the ductal elements is stimulated by estrogen.

58. Ans. a. Secreted by the corpus luteum

Progesterone is secreted by the corpus luteum.

The plasma level of progesterone rises steadily throughout pregnancy after the placenta takes over production at about 12 weeks of gestation. The plasma level of progesterone is low during the menses and remains low until just prior to ovulation. It rises substantially after ovulation, owing to secretion by the corpus luteum.

59. Ans. b. Days 16 and 18

The interval between ovulation and next menstruation (luteal phase) is constant, irrespective of the menstrual cycle length. The luteal phase duration depends on the

life span of corpus luteum (12–14 days in normal menstrual cycle).

60. Ans. a. Estradiol 10 days after the onset of menses

The stimulus for the ovulation-inducing surge of LH secretion is the rising level of plasma estradiol during the follicular stage of the cycle. Ten days after the onset of menses (day 10 of the cycle) is the mid-follicular stage and an injection of estradiol would elicit an early surge. Estradiol given 20 days after the onset of menses (midluteal stage) does not elicit an LH surge, because the high plasma concentrations of progesterone block the facilitative effect of estradiol on LH secretion.

**CARDIORESPIRATORY CHANGES
DURING EXERCISE****Oxygen Consumption in Exercise: VO_{2max}**

- As exercise intensity increases, oxygen consumption increases until maximal oxygen consumption is reached (VO_{2max}).
- VO_{2max} is the point at which there is no further increase in oxygen uptake occurs despite further increases in workload.
- When workload exceeds the VO_{2max} , the energy for increased workload provided by nonaerobic processes, which results in a rapid buildup of lactic acid.

WHO Grading of Exercise

Level	% of VO_{2max}	Heart rate per min
Mild	<25	<100
Moderate	25–50	100–125
Heavy	51–75	126–150
Very heavy (severe)	>75	>150

I IMPORTANT

Skeletal muscle accounts for about 20% of cardiac output. During extreme physical exertion, more than 80% of cardiac output can be directed to contracting muscles.

Muscle Blood Flow during Exercise

- At rest, skeletal muscle blood flows may be 1–4 mL/min per 100 g. Blood flow can increase ~25 fold with maximal vasodilation or active hyperemia.
- Blood flow can increase even before start of exercise (psychic stimulation).
- Causes of increase blood flow during exercise are:
 - **Intramuscular vasodilation (50%):** Caused by the direct effects of increased muscle *local vasoactive metabolites* (Adenosin, K^+ , CO_2 and lactic acid) which cause dilation of arterioles and precapillary sphincter.

- **Moderate increase in arterial blood pressure (30%):** The increase in pressure not only forces more blood through the blood vessels but also stretches the walls of the arterioles and further reduces the vascular resistance.
- **Adrenergic sympathetic vasoconstrictor nerve:** secretes NE, can decrease muscle blood flow. But sympathetic system secretes large amount of E and NE from adrenal medulla. The epinephrine *excites more beta-adrenergic* (vascular beta2-adrenoceptors produce vasodilation) receptor to produce muscle vasodilation.
- **Cholinergic sympathetic vasodilator nerve:** No convincing evidence in human skeletal muscle.

Distribution of Cardiac Output (CO) during Heavy Exercise Situation (Fig. 19.1)

- Working muscle receives 71% of cardiac output.
- Skin blood flow is also increased to meet the thermoregulatory demands of exercise.
- The absolute amount of *coronary muscle blood flow increases* although the % of CO remains relatively constant.
- The absolute amount of *cerebral blood flow remains constant (autoregulation)*, which means that the % of CO distributed to brain decreases.
- Both *renal and splanchnic blood flow decreases* as exercise intensity increases.

I IMPORTANT

Muscle Metabolic Systems in Exercise

- ❖ The amount of ATP present in the muscles (stored ATP), even in a well-trained athlete, is sufficient to sustain maximal muscle power for only about 3 seconds.
- ❖ New ATP formed continuously by:
 - Phosphocreatine-creatine system: 8 to 10 seconds
 - Glycogen lactic acid system: 1.3 to 1.6 minutes
 - Aerobic system: Unlimited time (as long as nutrients last)

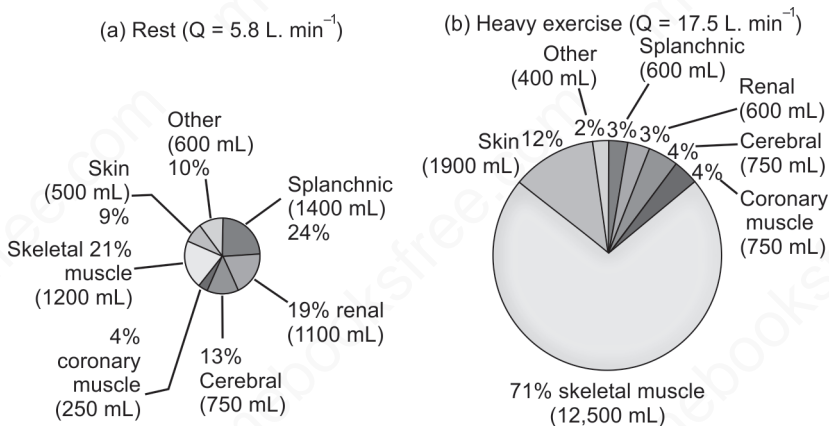

Fig. 19.1: Distribution of cardiac output during heavy exercise as comparison to resting stage

CHANGES IN VENTILATION

Mild to Moderate Exercise

- Due to increased ventilation the total amount of O_2 entering the blood therefore increases from 250 mL/min at rest to values as high as 4000 mL/min.
- And the amount of CO_2 removed from each unit of blood is increased, and CO_2 excretion increases from 200 mL/min to as much as 8000 mL/min.
- *Increase in ventilation is proportional to O_2 consumption and CO_2 output, up to a maximum and .*
- This proportional increase in ventilation easily compensates the fall in venous blood PO_2 (from 40 to 25 mm Hg) or, the rise in venous blood PCO_2 .
- So, the arterial blood PO_2 , PCO_2 and pH remains normal up to moderate grade of exercise (Fig. 19.2). (Peripheral chemoreceptors not stimulated).

I IMPORTANT

- ❖ The arterial blood PO_2 , PCO_2 and pH remains normal up to moderate grade of exercise.
- ❖ During severe exercise arterial PO_2 still remains constant or, increase slightly. PCO_2 and pH fall in this condition.

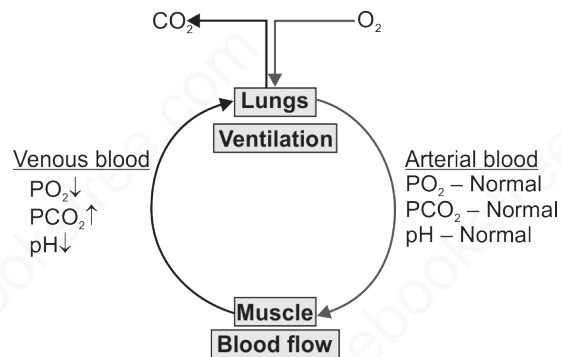

Fig. 19.2: Changes in arterial and venous blood gas composition during exercise

During Severe Exercise

- Above the moderate level of exercise, O_2 consumption levels off and the blood lactate level continues to rise.
- Buffering of the increased amounts of lactic acid liberates more CO_2 , and this further increases ventilation.
- With increased production of acid, the increases in ventilation and CO_2 production remain proportional, so alveolar and arterial CO_2 change relatively little (isocapnic buffering).

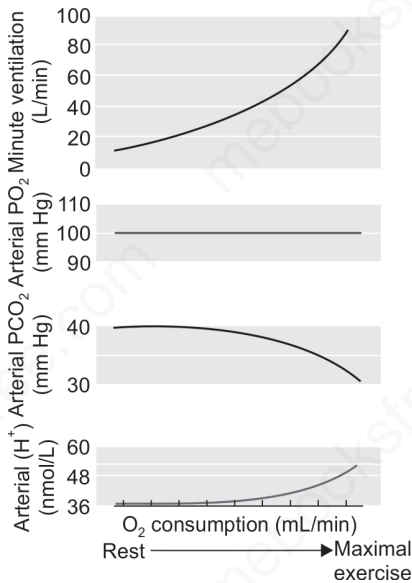

Fig. 19.3: Effect of exercise on minute ventilation, arterial oxygen and carbon dioxide partial pressures, and arterial H^+

- But with further accumulation of lactic acid, the increase in ventilation outstrips CO_2 production and alveolar PCO_2 falls, as does arterial PCO_2 .
- PO_2 of arterial blood remain constant or, slightly increased even during severe exercise (see Fig. 19.3).

Causes of Increased Ventilation during Exercise

Ventilation increases abruptly with the onset of exercise (1), which is followed after a brief pause by a further, more gradual increase. Ventilation abruptly decreases when exercise ceases (2).

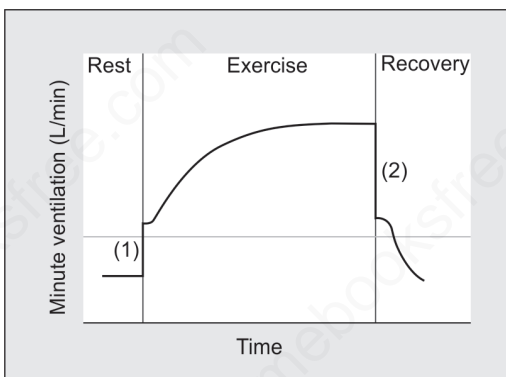

Fig. 19.4: Changes in ventilation during exercise

I IMPORTANT

Average arterial PCO_2 levels (and H^+ ions) are not altered significantly until exercise is sufficiently strenuous to produce increased levels of lactic acid. PO_2 remains almost constant even during strenuous exercise.

I IMPORTANT

Abrupt increase in ventilation at start of exercise is due to psychic stimuli and stimulation of respiratory centre from proprioceptors of muscles and joints.

Abrupt Increase (Phase 1)—Neural Response

- Due to psychic stimuli and afferent impulses from proprioceptors in muscles, tendons, and joints. The increase is due mostly to an increase in the depth of respiration.

Gradual Increase

- **During moderate exercise:** due to increase in body temperature and increases in plasma K^+ level, which may stimulate the peripheral chemoreceptors (arterial pH, PCO_2 , and PO_2 remain constant during moderate exercise).
- **During severe exercise:** Lactic acid buffered by HCO_3^- produces CO_2 . There is also increase sensitivity of respiratory centre to CO_2 also. So, during this time increased CO_2 and increased H^+ ions are stimuli for increased ventilation.

CHANGES IN CARDIOVASCULAR SYSTEM

- **Cardiac output:**
 - Displays a rectilinear increase and plateaus at maximal exercise. The initial increase in cardiac output reflects an increase in SV and HR.
 - SV increases rectilinearly initially and then plateaus at ~40–50% of VO_{2max} (see Fig. 19.5)
 - HR increases in a rectilinear fashion and plateaus at maximal exercise.

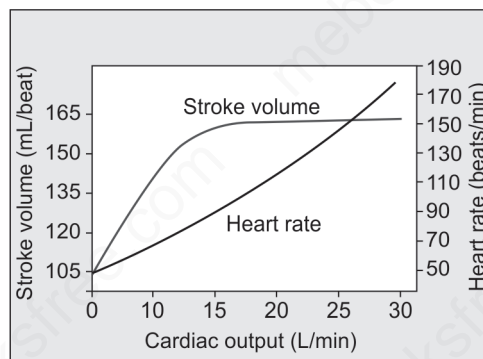

Fig. 19.5: Changes in SV and HR during exercise

- EDV increases largely because of the increase VR by the active muscle pump and the increased sympathetic venoconstriction.

- ESV decreases because of augmented contractility of the heart, which ejects more blood from the ventricle and leaves less in the ventricle.
- TPR decreases in a negative curvilinear pattern and reaches its lowest level at maximal exercise.
- Decreased resistance reflects maximal vasodilation in the active tissue in response to the need for increased blood flow that accompanies.
- **Blood pressure response:**
 - **SBP:** increases rectilinearly and plateaus at maximal exercise. Caused by the increased CO, which outweighs the decrease in resistance.
 - **DBP:** remains **relatively constant** or **decrease** at high levels of exercise. Constant because of the balance of vasodilation in the vasculature of the active muscle and vasoconstriction in other vascular beds.
 - **MAP:** increase because of increased systolic BP.
- **Right shift of oxygen-Hb dissociation curve:** due to release of large quantity of CO₂, other acids (H⁺) and increase body temperature. During strenuous exercise 2,3-DPG also increases. Conflicting results emerges in comparison of 2,3-DPG level in trained and untrained individual.

Cardiovascular Responses to Static Exercise (Isometric Exercise)

- Depends on the intensity of contraction, provided the contraction is held for a specified time period.
- **Cardiac output:** increases owing to an increase in heart rate, with the magnitude of the increase dependent upon the intensity of exercise.
- **Stroke volume:** remains relatively **constant** during low-intensity contractions and decreases during high-intensity contractions.
- **Heart rate:** increases during static exercise.
- The magnitude and the rate of the increase in HR depend on the intensity of contraction. The greater the intensity, the greater the HR response.
- **TPR:** remain **constant or, increase** (high intensity) during static exercise.
- **Rapid increase in both SBP and DBP occurs.** Since both SBP and DBP increase, there is a *marked increase in MAP.*

I IMPORTANT

- ❖ **Isometric contraction:** as no external work is done, therefore mechanical efficiency is nil and 100% energy expenditure is disappeared as heat.
- ❖ **Isotonic contraction:** mechanical efficiency in is ~25% of the energy expenditure and rest 75% is degraded as heat.

Difference between Isotonic (Dynamic) and Isometric (Static) Exercise

Isotonic exercise: (iso = same and tonic = tone), the tension in the muscle remains same whereas its length changes (decreases during contraction).

Examples:

- Lifting weight from ground
- Walking and running.

Isometric exercise: The length of the muscle remains same but tension developed (iso = same, metric = measure, i.e. length). External work done in this type of exercise is zero (Work = force × distance).

Examples:

- When we try to push a wall, contraction of arm muscle.
- Contraction of postural muscle (anti-gravity muscle).

	Isotonic (aerobic/ dynamic)	Isometric (static)
Cardiac output	Linearly increases	Modest gradual increase
Stroke volume	Increases initially: plateaus at 40–50% VO_{2max}	Relatively constant at low work loads; decrease at high work loads
Heart rate	Linearly increases	Marked increase
SBP	Linearly increases	Marked steady increase
DBP	Shows little or no change or, decrease	Marked increase
MBP	Small increase	Marked increase
TPR	Decreases	Remain same/increase

MULTIPLE CHOICE QUESTIONS

AIIMS/PGI/JIPMER

1. Initial hyperpnoea in exercise is because of:

- a. Hypercapnoea
- b. Hypoxemia
- c. Lactic acidosis
- d. Stimulation of cortex and proprioceptors

2. In moderate exercise tachypnea is due to stimulation of which receptors:

- a. Proprioception
- b. J-receptor
- c. Lung receptor
- d. Baro receptor

3. Isometric contraction occurs in which of the following muscle?

- a. Respiratory muscle
- b. Extra-ocular muscle
- c. Antigravity muscle
- d. GIT muscle

4. The cardiac output (CO) of a well trained athlete is 5.5 L/min. On exercise CO reaches to:

- a. 12 L/min
- b. 28 L/min
- c. 35 L/min
- d. 55 L/min

5. A person who is running, the main source of energy he will be using in 1st min is:

- a. Glucose
- b. Glycogen
- c. Fat
- d. Phosphagen

6. In isometric exercise the following changes occurs except:

- a. Increase muscle tone
- b. Staircase phenomenon

- c. Summation of contraction
- d. Relaxation heat

7. During mild to moderate exercise, heart rate increases. The change is:

- a. There is greater decrease in atrial systole than atrial diastole
- b. There is greater decrease in ventricular systole than ventricular diastole
- c. There is greater decrease in ventricular diastole than ventricular systole
- d. None of the above

8. Exercise causes which of the following? [AIIMS Nov 07]

- a. Increased blood flow to the muscle after half minute
- b. Increase in cerebral blood flow due to increase in systolic blood pressure
- c. Increase in body temperature
- d. Decreased O₂ consumption

9. Which of the following is TRUE regarding physiological changes in the brain during moderate exercise? [AI 08]

- a. Blood flow is decreased
- b. Blood flow is increased
- c. Blood flow remains unaltered
- d. Blood flow initially increases and then decreases

10. In moderate exercise the respiratory rate is increased due to response of: [AI 98]

- a. Proprioception receptors in the joints
- b. Increased PCO₂ in arterial blood
- c. Increased PO₂ in arterial blood
- d. J-receptor stimulation

11. The main cause of increased blood flow to exercising muscles is:

[AIIMS 10, AI 09]

- Raised blood pressure
- Vasodilatation due to local metabolites
- Increased sympathetic discharge to peripheral vessels
- Increased heart rate

12. All are true regarding blood supply increase in muscles during exercise, except:

[AIIMS Nov 12]

- Decreased beta-adrenergic stimulation
- Local metabolites
- Increased arterial pressure
- Cholinergic stimulation

13. A/E are the features of exercise:

[AIIMS June 99]

- Left shift of Hb-O₂ dissociation curve
- Increase blood supply to muscle
- Increase stroke volume
- Increase O₂ extraction

14. In isometric exercise all are increased except:

[AIIMS May 07]

- Heart rate
- Cardiac output
- Mean arterial pressure
- Systemic vascular resistance

15. Aerobic capacity is increased by:

[AIIMS May 94]

- Prolonged exercise routine
- Strenuous exercise
- Regular 3 minutes exercise
- Spurt of exercise

16. Physiological changes during severe exercise are:

[PGI Dec 03]

- Hyperventilation in the beginning
- Hyperkalemia
- Decreased PaO₂
- Decreased PaCO₂
- Decreased H₂CO₃

17. In exercising muscle, true about metabolism is:

[PGI Dec 98]

- Same in aerobic and anaerobic
- Fatty acids used mainly
- Glycogen and creatine kinase used anaerobically
- All of the above

18. Exercise is also prescribed as an adjuvant treatment of depression. Most probably acts by:

[AIIMS May 05]

- Increasing pulse pressure
- Improving hemodynamics
- Rising epinephrine level
- Inducing good sleep

FUTURE TRENDS

19. Which of the following sources can produce the greatest amount of ATP per minute over a short period of time?

- Aerobic system
- Phosphagen system
- Glycogen-lactic acid system
- Phosphocreatine system

20. Olympic athletes who run marathons or perform cross-country skiing have

much higher maximum cardiac outputs than non-athletes. Which of the following statements about the hearts of these athletes compared to non-athletes is most accurate?

- Stroke volume in the Olympic athletes is about 5% greater at rest
- % increase in heart rate during maximal exercise is much greater in the Olympic athletes

- c. Maximum cardiac output is only 3% to 4% greater in the Olympic athletes
- d. Resting heart rate in the Olympic athletes is significantly higher

21. Which of the following athletes is able to exercise the longest before exhaustion occurs?

- a. One on a high-fat diet
- b. One on a high-carbohydrate diet

- c. One on a mixed carbohydrate-fat diet
- d. One on a high-protein diet

22. If muscle strength is increased with resistive training, which of the following conditions will most likely occur?

- a. Decrease in the number of myofibrils
- b. Increase in mitochondrial enzymes
- c. Decrease in the components of the phosphagen energy system
- d. Decrease in stored triglycerides

ANSWERS WITH EXPLANATIONS

1. Ans. d. Stimulation of cortex and proprioceptors

(Ref. Ganong's Physiology 25th edn. pp 666)

Hyperpnea or hyperpnoea is increased depth and rate of breathing at the start of exercise is presumably due to psychic stimuli and afferent impulses from proprioceptors in muscles, tendons, and joints. O_2 , CO_2 , pH of blood remain normal up to moderate grade of exercise.

2. Ans. a. Proprioception

(Ref. Ganong's Physiology 25th edn. pp 666)

See explanation of Question number 1.

3. Ans. c. Antigravity muscle

(Ref. Medical Physiology for Undergraduate Students by Indu Khurana 1st edn. pp. 76)

Contraction of muscles, which help in maintaining posture against gravity, is an example of isometric contraction.

4. Ans. c. 35 L/min

(Ref. Guyton-Physiology 13th edn. pp 1093)

- ❑ Cardiac output (CO) in a young man at rest 5.5 L/min
- ❑ Maximal CO during exercise in a young untrained man = 23 L/min

- ❑ Maximal CO during exercise in an male marathoner average = 30 L/min (may be up to 35–40 L/min)

5. Ans. b. Glycogen

(Ref. NASM's Essentials of Sports Performance Training By Clark, Lucett & Kirkendall)

Immediate source is CP ...but it sustained for few sec. So, during 1min run, other source is used. "The major sources of energy in the 100-m sprint are creatine phosphate (first 4–5 sec) and then anaerobic glycolysis using muscle glycogen as the source of glucose." ... Harper's Biochemistry.

Exercise duration for energy systems and supplies used

Estimated time	Energy system used	Energy supply used
1–4 seconds	Anaerobic	ATP in muscle
4–20 seconds	Anaerobic	ATP + CP
20–45 seconds	Anaerobic	ATP + CP + muscle glycogen
45–120 seconds	Anaerobic and lactic	Muscle glycogen
120–240 seconds	Anerobic and anaerobic	Muscle glycogen + lactic acid
Over 240 seconds	Anerobic	Muscle glycogen + fatty acids

6. Ans. d. Relaxation heat

(Ref: *Medical Physiology for Undergraduate Students by Indu Khurana 1st edn. pp.84*)

Relaxation heat is the typical feature of isotonic contraction.

- ❑ **Resting heat:** Resting heat is the heat generated when the muscle is at rest, i.e. not contracting. Resting heat is the external manifestation of the basal metabolic process of the muscle.
- ❑ **Recovery heat:** Recovery heat refers to the heat produced in excess of resting heat following muscle contraction. It continues for about 30-min of the cessation of muscle contraction. This heat is generated by the metabolic processes, that restore the muscle to its precontraction state.
- ❑ **Relaxation heat:** This is the extra heat, in addition to the recovery heat, which is produced during relaxation of the **isotonically** contracted muscle.

7. Ans. c. There is greater decrease in ventricular diastole than ventricular systole

(Ref: *Ganong's Physiology 25th edn. pp 542*)

Check the variation of cardiac cycle during increased heart rate in the following table.

	Heart rate 75/min	Heart rate 200/min
Duration of cardiac cycle	0.80 sec	0.30 sec
Duration of ventricular systole	0.27 sec	0.16 sec
Duration of ventricular diastole	0.53 sec	0.14 sec
Duration of action potential	0.25 sec	0.15

So, it is obvious from the above table that the duration of diastole decreases much more than systole duration.

8. Ans. c. Increase in body temperature

(Ref: *Ganong's Physiology 24th edn. pp 636*)

Muscle blood flow increases even before start of exercise.

Cerebral blood flow remains constant.

9. Ans. c. Blood flow remains unaltered

(Ref: *Ganong's Physiology 24th edn. pp 636*)

The absolute amount of cerebral blood flow remains constant, which means that the % of CO distributed to brain decreases.

10. Ans. a. Proprioception receptors in the joints

(Ref: *Ganong's Physiology 24th edn. pp 636*)

Detail explanation in text.

11. Ans. b. Vasodilatation due to local metabolites

(Ref: *Guyton-Physiology-12th edn. pp. 1063, 13th edn. pp 98*)

Detail explanation in text.

All options in this question are responsible for increased blood flow to muscle. But most important one is option b.

12. Ans. a. Decreased beta-adrenergic stimulation

(Ref: *Guyton-Physiology-12th edn. pp 1063, 13th edn. pp 98*)

There is increased beta adrenergic stimulation, not decrease. Increased adrenergic drive causes vasodilation (vascular beta₂-adrenoceptors produce vasodilation).

Option d: it is also not important for increase muscle blood flow in human. But among the provided options, a is the single best.

13. Ans. a. Left shift of Hb-O₂ dissociation curve

(Ref: *Guyton-Physiology-13th edn. pp 357*)

There is right shift of OHDC curve during exercise.

14. Ans. d. Systemic vascular resistance

(Ref: *Circulation 1979;59:651-654*)

Detail explanation in text.

SV remains constant. TPR does not change significantly during low workload. All others option in the questions, increases markedly.

15. Ans. a. Prolonged exercise routine

(Ref: *Healthy Living: Endurance Exercise (Aerobic) by AHA*)

The American Heart Association (AHA) recommends that adults get at least 150 minutes (2½ hours) of moderate to vigorous activity per week. Thirty minutes a day five days a week is an easy goal to remember. Some people will be able to do more. It is important to set realistic goals based on your own health and ability.

Three minutes exercise will not increase aerobic capacity. Strenuous exercise is not recommended.

16. Ans. a. Hyperventilation in the beginning, b. Hyperkalemia, d. Decreased PaCO₂

(Ref. Ganong's Physiology 24th edn. pp 636)

Detail explanation in text.

17. Ans. c. Glycogen and creatine kinase used anerobically

(Ref. Guyton-Physiology-12th edn pp 1063, 13th edn. pp 98)

Muscle contracting under low oxygen conditions produced lactate at the expense of glycogen.

18. Ans. c. Rising epinephrine level

(Ref. Prim Care Companion J Clin Psychiatry 2004;6:104-111)

Proposed mechanisms for the exercise-depression relationship:

- **Thermogenic hypothesis:** rise in core body temperature following exercise is responsible for the reduction in symptoms of depression.
- **Endorphin hypothesis:** exercise releases β-endorphins, which reduced symptoms.
- **Monoamine hypothesis:** exercise leads to an increase in the availability of brain neurotransmitters (e.g. serotonin, dopamine, and norepinephrine) that are diminished with depression.
- **Distraction hypothesis:** distraction from worries and depressing thoughts.

19. Ans. b. Phosphagen system

Over a short period of time the phosphagen system can produce 4 moles of ATP/min. The phosphagen system comprises the ATP

and phosphocreatine system combined. However, when a person runs a long distance race, such as a 10-km race, the phosphagen system can supply energy for 8 to 10 seconds only. The glycogen-lactic acid system supplies energy can produce 2.5 moles of ATP per minute and the aerobic system, which consists of metabolism of glucose, fats, and amino acids, can produce 1 mole of ATP/min.

20. Ans. b. % increase in heart rate during maximal exercise is much greater in the Olympic athletes

Stroke volume is much higher at rest in the Olympic athlete and heart rate is much lower. The heart rate can increase approximately 270% in the Olympic athlete during maximal exercise, which is a much greater percentage than occurs in a non-athlete. In addition, the maximal increase in cardiac output is ~30% greater in the Olympic athlete.

21. Ans. b. One on a high-carbohydrate diet

An athlete on a high-carbohydrate diet will store nearly twice as much glycogen in the muscles compared to an athlete on a mixed carbohydrate-fat diet. This glycogen is converted to lactic acid and supplies four ATP molecules for each molecule of glucose. It also forms ATP 2.5 times as fast as oxidative metabolism in the mitochondria. This extra energy from glycogen significantly increases the time an athlete can exercise.

22. Ans. b. Increase in mitochondrial enzymes

During resistive training muscle hypertrophy and several changes occur. There will be an increase in the number of myofibrils and up to a 120% increase in mitochondrial enzymes. As much as a 60% to 80% increase in the components of the phosphagen energy system can occur, and up to a 50% increase in stored glycogen can occur. Also, as much as a 75% to 100% increase in stored triglycerides can occur.