

# **Underground Aqueducts Handbook**



# Taylor & Francis

Taylor & Francis Group

<http://taylorandfrancis.com>



# Underground Aqueducts Handbook

Edited by  
**Andreas N. Angelakis**  
**Eustathios Chiotis**  
**Saeid Eslamian**  
**Herbert Weingartner**



**CRC Press**

Taylor & Francis Group

Boca Raton London New York

---

CRC Press is an imprint of the  
Taylor & Francis Group, an **informa** business

Cover courtesy of Chapter 11 author Mathias Döring.

CRC Press  
Taylor & Francis Group  
6000 Broken Sound Parkway NW, Suite 300  
Boca Raton, FL 33487-2742

© 2017 by Taylor & Francis Group, LLC  
CRC Press is an imprint of Taylor & Francis Group, an Informa business

No claim to original U.S. Government works

Printed on acid-free paper  
Version Date: 20160915

International Standard Book Number-13: 978-1-4987-4830-8 (Hardback)

This book contains information obtained from authentic and highly regarded sources. Reasonable efforts have been made to publish reliable data and information, but the author and publisher cannot assume responsibility for the validity of all materials or the consequences of their use. The authors and publishers have attempted to trace the copyright holders of all material reproduced in this publication and apologize to copyright holders if permission to publish in this form has not been obtained. If any copyright material has not been acknowledged please write and let us know so we may rectify in any future reprint.

Except as permitted under U.S. Copyright Law, no part of this book may be reprinted, reproduced, transmitted, or utilized in any form by any electronic, mechanical, or other means, now known or hereafter invented, including photocopying, microfilming, and recording, or in any information storage or retrieval system, without written permission from the publishers.

For permission to photocopy or use material electronically from this work, please access [www.copyright.com](http://www.copyright.com) (<http://www.copyright.com/>) or contact the Copyright Clearance Center, Inc. (CCC), 222 Rosewood Drive, Danvers, MA 01923, 978-750-8400. CCC is a not-for-profit organization that provides licenses and registration for a variety of users. For organizations that have been granted a photocopy license by the CCC, a separate system of payment has been arranged.

**Trademark Notice:** Product or corporate names may be trademarks or registered trademarks, and are used only for identification and explanation without intent to infringe.

---

#### Library of Congress Cataloging-in-Publication Data

---

Names: Angelakis, Andreas N. (Andreas Nikolaos)  
Title: Underground aqueducts handbook / Andreas N. Angelakis [and three others], editors.  
Other titles: Aqueducts handbook  
Description: Boca Raton : CRC Press, 2017. | Includes bibliographical references and indexes.  
Identifiers: LCCN 2016020940 | ISBN 9781498748308 (alk. paper)  
Subjects: LCSH: Aqueducts. | Hydraulic structures. | Water-supply engineering. | Irrigation canals and flumes. | Groundwater.  
Classification: LCC TD398 .U43 2017 | DDC 628.1/5--dc23  
LC record available at <https://lccn.loc.gov/2016020940>

---

Visit the Taylor & Francis Web site at  
<http://www.taylorandfrancis.com>  
and the CRC Press Web site at  
<http://www.crcpress.com>

---

# Contents

Preface.....	ix
Editors.....	xi
Contributors.....	xiii

## **SECTION I Introduction**

<b>Chapter 1</b> Underground Aqueducts: Types, Definitions, and General Conclusions.....	3
<i>Eustathios D. Chiotis</i>	

## **SECTION II Europe**

<b>Chapter 2</b> Roman Underground Hydraulic Structures in Dalmatia, Croatia.....	19
<i>Katja Marasović, Snježana Perojević, and Jure Margeta</i>	
<b>Chapter 3</b> Roman Underground Aqueducts in Germany.....	37
<i>Constantin Canavas</i>	
<b>Chapter 4</b> Updated Appraisal of Ancient Underground Aqueducts in Greece.....	43
<i>Panagiota Avgerinou, Eustathios D. Chiotis, Stella Chrysoulaki, Panos Defteraios, Theodora Evangelou, Nikos M. Gigourtakis, George Kakes, Yiannis Kourtzellis, Panagiotis Koutis, Nikos Mamassis, Maria Pappa, Giorgos Peppas, and Anna I. Strataridaki</i>	
<b>Chapter 5</b> The Aqueduct of Eupalinos on Samos, Greece, and Its Restoration.....	63
<i>Costas Zambas, George Dounias, and George Angistalis</i>	

## **SECTION III Africa**

<b>Chapter 6</b> The Past and Present of Underground Aqueducts in Algeria.....	83
<i>Najet Aroua and Abdelkrim (Krimo) Dahmen</i>	
<b>Chapter 7</b> The Water Supply History of Underground Aqueducts in Egypt.....	99
<i>Abdelkader T. Ahmed and Mohamed H. Elsanabary</i>	
<b>Chapter 8</b> Qanāt Evolution and Use in Libya.....	109
<i>Abdulgader Abufayed</i>	

## **SECTION IV Middle East**

- Chapter 9** Iranian Qanāts: An Ancient and Sustainable Water Resources Utilization..... 123  
*Saeid Eslamian, Alireza Davari, and Mohammad Naser Reyhani*
- Chapter 10** Spring Tunnels (Niqba’): The Jerusalem Hills Perspective, Israel..... 151  
*Azriel Yechezkel and Amos Frumkin*
- Chapter 11** Qanāt Fir’aun: An Underground Roman Water System in Syria and Jordan ..... 173  
*Mathias Döring*
- Chapter 12** The Aqueducts of the Sultanate of Oman: Sustainable Water-Supplying Systems Irrigating Oases Cities ..... 197  
*Fairouz Megdiche-Kharrat, Rachid Ragala, and Mohamed Moussa*
- Chapter 13** Aqueducts in Saudi Arabia..... 211  
*Abdulaziz M. Al-Bassam and Faisal K. Zaidi*
- Chapter 14** Qanāts of Syria..... 229  
*Josepha I. Wessels*
- Chapter 15** Groundwater Structures throughout Turkish History ..... 241  
*Zekâi Şen*
- Chapter 16** Aflaj Al Emarat: History and Factors Affecting Recharge, Discharge, and Water Quality, United Arab Emirates ..... 261  
*Zeinelabidin E. Rizk and Abdulrahman S. Alsharhan*
- Chapter 17** *Qanāt* and *Falaj*: Polycentric and Multi-Period Innovations: Iran and the United Arab Emirates as Case Studies ..... 279  
*Rémy Boucharlat*

## **SECTION V Eurasia**

- Chapter 18** Ancient Aqueducts and the Irrigation System in Armenia ..... 305  
*Marine Nalbandyan*
- Chapter 19** Evolution of the Qanāt (Kahriz) Systems in the Arid Countries of the Caucasus and Central Asia..... 323  
*Alovsat Guliyev*

<b>Chapter 20</b> Ancient Water Mining in Tunnels and Wells in West Central Asia.....	333
<i>Renato Sala</i>	

## **SECTION VI Asia**

<b>Chapter 21</b> Underground Aqueducts in Japan .....	363
<i>Chikaosa Tanimoto and Iwanai Shimada</i>	

<b>Chapter 22</b> Managing Drought through Qanāt and Water Conservation in Afghanistan .....	385
<i>Saifullah Khan and Saeid Eslamian</i>	

<b>Chapter 23</b> Utilization and Contribution of Underground Aqueducts in the Turpan Oasis of China.....	403
<i>Gofur Nuridin Tolmbok</i>	

<b>Chapter 24</b> Traditional Methods of Groundwater Abstraction and Recharge along the Windward Side of the Foothills of the Western Ghats of India.....	415
<i>Darren Crook, Sudhir Tripathi, and Richard Jones</i>	

<b>Chapter 25</b> Historical Development of Qanāts: Underground Aqueducts in Pakistan.....	425
<i>Saifullah Khan, Mahmood-Ul-Hasan, and Muhammad Ishaque Fani</i>	

<b>Chapter 26</b> Underground Aqueduct and Water Tunneling Development in Thailand.....	449
<i>Vilas Nitivattananon, Dollachet Klahan, Visnu Charoen, and Yin Mon Naing</i>	

## **SECTION VII Americas**

<b>Chapter 27</b> Puquios and Aqueducts in the Central Andes of South America .....	465
<i>Kevin Lane</i>	

<b>Chapter 28</b> The Ancient Hydraulic Catchment Systems of the Tepeaca-Acatzingo Archaeological Zone, Puebla, Mexico .....	475
<i>Miguel Medina Jaen, Norma G. Peñaflores Ramírez, and Jay E. Silverstein</i>	

## **SECTION VIII Past, Present, and Future Trends**

<b>Chapter 29</b> Underground Aqueducts: Past, Present, and Future Trends.....	491
<i>Josepha I. Wessels, Sotirios Vardakos, Herbert Weingartner, Saeid Eslamian, and Andreas N. Angelakis</i>	

<b>Index</b> .....	511
--------------------	-----



# Taylor & Francis

Taylor & Francis Group

<http://taylorandfrancis.com>

---

# Preface

The rapid technological progress in the twentieth century created a disregard for past water supply management and sustainability. In the future, urbanization will continue to increase, and 80%–90% of the future world growth (~145,000 inhabitants/day) will be in urban areas. Thus, new specific water supply technologies need to be developed, based on sustainable principles, for serving different sizes of cities and peri-urban regions. Also, many unresolved problems related to the water management principles, such as collection and transportation of water by underground infrastructures, their durability, cost effectiveness, and sustainability issues, will be intensified to an unprecedented degree, especially in the developing world.

Traditional underground hydro-technologies presented major achievements globally in the scientific field of underground aqueducts throughout the millennia. This book provides valuable insights into various underground hydraulic works, for example, qanāts (which are referred to with a particular local term in various regions of the world), tunnels, and various types of inclined galleries, with and without shafts, which transfer ground and/or surface water from an area, usually mountainous, to the lowlands—sometimes several kilometers away for use. Management issues of their characteristics of durability, adaptability to the environment, and sustainability are also considered. In addition, a comparison of the water technological developments in several civilizations has been made. These technologies are the underpinning of modern achievements in underground aqueduct engineering practices. It is the best proof that “the past is the key for the future.”

This book focuses on the technological developments and management practices related to worldwide underground aqueduct technologies throughout the millennia. Paradigms of these technologies and management practices presented in this book (not widely known among engineers) may have some importance for water engineering even today. The hydraulic features of several categories of underground aqueduct technologies in numerous parts of the world are presented and discussed in this book. Finally, an attempt has been made to clarify the distinctive categories of such technologies through their historical development. In addition, potential future trends of underground aqueducts are considered including the possibility of combining old technologies with today’s available infrastructure (e.g., Tunnel boring machine).

About 66 authors from several disciplines and from 4 continents and 26 countries have collaborated on this book. The disciplines include archaeology, hydrology, history, engineering, life sciences, health sciences, environmental sciences, biology, and geosciences. The geographical coverage is very wide, and it is divided into 8 parts and 29 Chapters as follows:

Part I. Introductory (one)

Part II. Europe (Germany, Croatia, and Greece)

Part III. Africa (Algeria, Egypt, and Libya)

Part IV. Middle East (Iran, Israel, Jordan, Oman, Saudi Arabia, Syria, Turkey, and United Arab Emirates)

Part V. Eurasia (Armenia, Azerbaijan, and Kazakhstan)

Part VI. Asia (Afghanistan, China, India, Japan, Pakistan, and Thailand)

Part VII. Americas (Chile, Peru, and Mexico)

Part VIII. Past, Present, and Future Trends

Finally, we appreciate the efforts and contributions of the authors who have written about the labors of humankind to bring hydraulic works to the people and cities. We also acknowledge the assistance

of the CRC Press staff, particularly of Joseph Clements and Melisa Sedler, for their professional efficiency, fruitful cooperation, useful guidance, and helpful contribution for 15 months.

**Andreas N. Angelakis**

*National Agricultural Research Foundation*

**Eustathios D. Chiotis**

*Institute of Geology and Mineral Exploration of Greece*

**Saeid Eslamian**

*Isfahan University of Technology*

**Herbert Weingartner**

*University of Salzburg*



---

# Editors

**Andreas N. Angelakis** is a water resources engineer at the National Agricultural Research Foundation (N.AG.RE.F.), Institute of Crete, Greece, and technical consultant to the Hellenic Union of Municipal Enterprises for Water Supply and Sewerage. The areas of his interest include environmental engineering, aquatic wastewater management systems, treated wastewater renovation and reuse, and water and wastewater technologies in ancient civilizations. He has authored/coauthored more than 450 publications and over 3000 SCH (Scholar) citations, with i10-index 58. He is a distinguished fellow and honorary member of the International Water Association (IWA), member of the IWA Strategic Council, president of IWA Specialist Group on Water and Wastewater in Ancient Civilizations, past president of EurEau and the EurEau Working Group on Water Reuse, and honorary member of the Hellenic Water Association. For more, visit <http://www.a-angelakis.gr/>.

**Eustathios D. Chiotis** (1943–) graduated in 1966 from the mining and metallurgy department at the National Technical University of Athens (NTUA), Athens, Greece. He earned his MSc and DIC degrees at the Imperial College, London, both in mineral exploration (1974–1975) and petroleum engineering (1975–1976). He presented his PhD thesis at the NTUA in 1990 on “The Thermo-Mechanical State of the Lithosphere in the Aegean Sea, Greece.” His areas of interest include mineral exploration and mining, petroleum engineering and geophysics, geothermal energy, and drilling and archaeometry. He served as director of geophysics at the Public Petroleum Corporation of Greece, Athens, and director of mineral resources evaluation at the Institute of Geology and Mineral Exploration of Greece, Athens. He has published papers on plate tectonics and the lithospheric structure in the Aegean Sea, oil exploration, archaeometry, and ancient aqueducts (<https://independent.academia.edu/Chiotis>).

**Saeid Eslamian** is a full professor of hydrology and water resources engineering in the Department of Water Engineering at Isfahan University of Technology, Iran, where he has been working since 1995. He earned his PhD at the University of New South Wales, Australia, under the supervision of Professor David Pilgrim. His research focuses mainly on water resources planning and management and statistical and environmental hydrology in a changing climate. Formerly, he was a visiting professor at Princeton University, New Jersey and ETH Zurich, Switzerland. He has started a research partnership with McGill University, Montreal, Canada since 2014. Dr. Eslamian has contributed to more than 500 publications in journals, books, and technical reports. He is the founder and chief editor of both *International Journal of Hydrology Science and Technology* (Scopus, Inderscience) and *Journal of Flood Engineering*. He has written more than 100 book chapters and books and has become the editor of several handbooks published by CRC Press (Taylor & Francis Group) that include a three-volume *Handbook of Engineering Hydrology* (2014), *Urban Water Reuse Handbook* (2015), and a three-volume *Handbook of Drought and Water Scarcity* (2016).

**Herbert Weingartner** is an associate professor in the Department of Geography and Geology at the University of Salzburg, where he is the head of the Landscape and Sustainable Development research group. His PhD thesis was entitled “Geomorphology of the Tennengebirge Mountains/Salzburg” and his 1990 post-doctoral thesis was entitled “Physical Geography of the Island of Thasos/Greece. His research areas of interest are physical geography, landscape ecology, human impact on alpine ecosystems, and sustainable development. He has published on various questions of physical geography, human impact on alpine environments, sustainable development, and qanats (<http://www.lasd.at>).



# Taylor & Francis

Taylor & Francis Group

<http://taylorandfrancis.com>

---

# Contributors

**Abdulgader Abufayed**

Civil Engineering Department  
College of Engineering  
University of Tripoli  
Tripoli, Libya

**Abdelkader T. Ahmed**

Civil Engineering Department  
Aswan University  
Aswan, Egypt

**Abdulaziz M. Al-Bassam**

Geology and Geophysics Department  
College of Science  
King Saud University  
Riyadh, Saudi Arabia

**Abdulrahman S. Alsharhan**

Middle East Geological and  
Environmental Est  
Dubai, United Arab Emirates

**Andreas N. Angelakis**

National Agricultural Research Foundation  
Iraklion, Greece

**George Angistalis**

Egnatia Odos SA  
Thessaloniki, Greece

**Najet Aroua**

Polytechnic School of Architecture and  
Urbanism of Algiers  
Algiers, Algeria

**Panagiota Avgerinou**

Ephorate of Antiquities of West Attika, Piraeus  
and Islands  
Ministry of Culture and Sports  
Athens, Greece

**Rémy Boucharlat**

CNRS  
University Lyons 2  
Paris, France

**Constantin Canavas**

Faculty of Life Sciences  
Hamburg University of Applied Sciences  
Hamburg, Germany

**Visnu Charoen**

Bangkok Metropolitan Administration  
Bangkok, Thailand

**Eustathios D. Chiotis**

Institute of Geology and Mineral Exploration  
Athens, Greece

**Stella Chrysoulaki**

Ephorate of Antiquities of West Attika, Piraeus  
and Islands  
Ministry of Culture and Sports  
Athens, Greece

**Darren Crook**

University of Hertfordshire  
Hatfield, United Kingdom

**Abdelkrim (Krimo) Dahmen**

Institute of Architecture  
Saad Dahlab Blida University  
Blida, Algeria

**Alireza Davari**

Water Engineering Department  
Tarbiat Modares University  
Tehran, Iran

**Panos Defteraios**

Department of Civil Engineering  
National Technical University of Athens  
Athens, Greece

**Mathias Döring**

Technische Universität Darmstadt  
Adenstedt, Germany

**George Dounias**

Civil Engineering Department  
Imperial College  
London

and

Edafos—Engineering Consultants S.A.  
Athens, Greece

**Mohamed H. Elsanabary**

Civil Engineering Department  
Port Said University  
Port Said, Egypt

**Saeid Eslamian**

Department of Water Engineering  
Isfahan University of Technology  
Isfahan, Iran

**Theodora Evangelou**

Ephorate of Antiquities of West Attika, Piraeus  
and Islands  
Ministry of Culture and Sports  
Athens, Greece

**Muhammad Ishaque Fani**

Institute of Social Sciences and Distance  
Education  
Bahauddin Zakariya University  
Multan, Pakistan

**Amos Frumkin**

Institute of Earth Sciences  
The Hebrew University  
Jerusalem, Israel

**Nikos M. Gigourtakis**

Department of History and Archaeology  
University of Crete  
Crete, Greece

**Alovsat Guliyev**

Institute of Soil Science and Agrochemistry  
of the Azerbaijan National Academy of  
Science  
Baku, Azerbaijan

**Mahmood-Ul-Hasan**

Department of Geography  
University of Peshawar  
Peshawar, Pakistan

**Miguel Medina Jaen**

Dirección de Salvamento Arqueológico  
Instituto Nacional de Antropología e Historia  
México City, Mexico

**Richard Jones**

University of Exeter  
Exeter, United Kingdom

**George Kakes**

Archaeological Ephorate of Lesvos  
Ministry of Culture and Sports  
Athens, Greece

**Saifullah Khan**

Institute of Social Sciences and Distance  
Education  
Bahauddin Zakariya University  
Multan, Pakistan

**Dollachet Klahan**

Metropolitan Waterworks Authority  
Bangkok, Thailand

**Yiannis Kourtzellis**

Archaeological Ephorate of Lesvos  
Ministry of Culture and Sports  
Athens, Greece

**Panagiotis Koutis**

Ephorate of Antiquities of West Attika, Piraeus  
and Islands  
Ministry of Culture and Sports  
Athens, Greece

**Kevin Lane**

McDonald Institute for Archaeological  
Research  
University of Cambridge  
Cambridge, United Kingdom

**Nikos Mamassis**

Department of Civil Engineering  
National Technical University of Athens  
Athens, Greece

**Katja Marasović**

Faculty of Civil Engineering Architecture and  
Geodesy  
University of Split  
Split, Croatia

**Jure Margeta**

Faculty of Civil Engineering Architecture and  
Geodesy  
University of Split  
Split, Croatia

**Fairouz Megdiche-Kharrat**

High Agronomic Institute of Chott Mariem  
ISA-IRESA Research Unit Doctoral School  
of Agronomy and Environment  
University of Sousse  
Sousse, Tunisia

and

Université Paris-Sorbonne (Paris IV)  
Paris, France

**Mohamed Moussa**

Laboratory of Sciences of the Desert and  
Combating Desertification  
Institute of Arid Regions  
Médénine, Tunisia

**Yin Mon Naing**

Asian Institute of Technology  
Bangkok, Thailand

**Marine Nalbandyan**

The Institute of Geological Sciences of the  
National Academy of Sciences  
Yerevan, Armenia

**Mohammad Naser Reyhani**

Department of Water Engineering  
Isfahan University of Technology  
Isfahan, Iran

**Vilas Nitivattananon**

Urban Environmental Management Field of  
Study  
School of Environment, Resources and  
Development  
Asian Institute of Technology  
Bangkok, Thailand

**Maria Pappa**

Archaeological Ephorate of Lesvos  
Ministry of Culture and Sports  
Athens, Greece

**Norma G. Peñaflores Ramírez**

Dirección de Salvamento Arqueológico  
Instituto Nacional de Antropología e Historia  
México City, Mexico

**Giorgos Peppas**

Ephorate of Antiquities of West Attika, Piraeus  
and Islands  
Ministry of Culture and Sports  
Athens, Greece

**Snježana Perojević**

Mediterranean Centre for Built Heritage  
Faculty of Architecture  
University of Zagreb  
Zagreb, Croatia

**Rachid Ragala**

Department of Geography and Planning  
Laboratory Analysis and Social mathematics  
Center CNRS-EHESS  
Paris-Sorbonne University Abu Dhabi  
Université Paris-Sorbonne (Paris IV)  
Paris, France

**Zeinelabidin E. Rizk**

Institute of Environment, Water and Energy  
Ajman University of Science and Technology  
Ajman, United Arab Emirates

**Renato Sala**

Laboratory of Geoarchaeology  
Faculty of History, Archeology and  
Ethnology  
Al-Farabi Kazakh National University  
Almaty, Kazakhstan

**Zekâi Şen**

Turkish Water Foundation  
Libadiye Caddesi  
Istanbul, Turkey

**Iwanai Shimada**

Expressway Research Institute  
Japan Expressway Authority  
Tokyo, Japan

**Jay E. Silverstein**

Departments of Anthropology and Literatures  
and Languages of Europe and the Americas  
University of Hawaii, Manoa  
Honolulu, Hawaii

**Anna I. Strataridaki**

Faculty of Education  
University of Crete  
Crete, Greece

**Chikaosa Tanimoto**

Department of Global Architecture  
Graduate School of Engineering  
Osaka University  
Osaka, Japan

**Gofur Nuridin Tolmbok**

Karez Study Society of Xinjiang Uyghur  
Autonomous Region China  
Xinjiang, China

**Sudhir Tripathi**

University of Hertfordshire  
Hatfield, Hertfordshire

**Sotirios Vardakos**

WSP/Parsons Brinckerhoff  
Chicago, Illinois

**Herbert Weingartner**

Department of Geography and Geology  
University of Salzburg  
Salzburg, Austria

**Josepha I. Wessels**

Center for Resolution of International Conflict  
Department of Political Science  
University of Copenhagen  
Copenhagen, Denmark

**Azriel Yechezkel**

Geography Department  
The Hebrew University  
Jerusalem, Israel

**Faisal K. Zaidi**

Geology and Geophysics Department  
College of Science  
King Saud University  
Riyadh, Saudi Arabia

**Costas Zambas**

C. Zambas Office  
Athens, Greece

# *Section I*

---

## *Introduction*



# Taylor & Francis

Taylor & Francis Group

<http://taylorandfrancis.com>



---

# 1 Underground Aqueducts

## *Types, Definitions, and General Conclusions*

*Eustathios D. Chiotis*

### CONTENTS

1.1	Historical Review of the Early Underground Aqueducts .....	3
1.2	Classification and Terminology of Underground Aqueducts .....	4
1.2.1	Review of Representative Underground Aqueducts .....	4
1.2.2	Proposed Classification Scheme .....	5
1.2.3	Remarks on the Proposed Classification Scheme .....	6
1.3	Diffusion of Terminology versus Diffusion of Qanāt Invention .....	7
1.4	Underground Aqueducts as a Response to Holocene Aridification .....	7
1.4.1	Holocene Aridification and Early Hydraulic Societies .....	7
1.4.2	The Foggaras in the System of Fossil Aquifers in Sahara .....	8
1.4.3	Qanāts in the Western Desert in Egypt and Aflaj in the Peninsula of Oman .....	10
1.5	General Conclusions .....	11
	Acknowledgments .....	13
	References .....	13

### 1.1 HISTORICAL REVIEW OF THE EARLY UNDERGROUND AQUEDUCTS

The underground aqueducts combine all types of water resources and miscellaneous types of waterworks, both of which cover a broad spectrum. Common types of water resources are springs, rivers, and streams (perennial or ephemeral); lakes (natural or artificial); and the aquifers (recharged or fossil unconfined or artesian). Critical environmental factors are precipitation, evaporation and proximity to mountains, which usually constitute both a better recharge area and the source of eroded porous sediments, proper as water reservoirs.

The underground structure can be a net of natural karstic pipes interconnected and enlarged artificially; a tunnel without shafts; a shafts-and-gallery array, with the shafts commonly vertical or inclined, as in the Gadara Aqueduct in Jordan (Döring 2016, figure 11.7) along a gallery; or a tunnel accessed from horizontal adits, as in the Tatsumi Aqueduct in Japan (Tanimoto and Shimada 2016).

Examined in terms of expertise, the underground aqueducts require technical skills on sinking wells and tunneling, as well as hydrogeological perception, which depends on the local environmental conditions.

Variable geo-climatic conditions usually lead to different hydraulic engineering works (Bagg 2007, 29). As expressed by Wilkinson (2003, 45), water-supply systems are sensitively engineered to suit local hydrogeological conditions.

Empirical knowledge of the groundwater circulation was originally gained at the springs, as in Sahara Oases springs, in the excavation of spring chambers of ritual function in the Minoan Crete (Evans 1935, 139) or in spring tunnels, as in Israel.

Irrigation channels were the first large-scale hydraulic engineering works, which gradually incorporated tunneling as well. In the lower Euphrates valley, irrigation appears to have been tried out very early, probably in the Halaf period (6000–5100 BC). The quite complete network that has been discovered in the area of Mari of the third millennium BC seems to figure among the earliest known (Geyer and Monchambert 2015, 11).

Tunneling techniques have been gradually developed in burial chambers, mining, irrigation, land reclamation, such as the Etruscan cuniculi, and waterworks.

Dating aqueducts, particularly the earlier ones, is usually uncertain, and because of that, tracing the evolution and transfer of hydraulic techniques are often based on uncertain assumptions or in the projection of current state in the past, without the required archaeological evidence.

However, some typical cases are well documented and can serve as milestones. Among them is the short tunnel at Mycenae in Greece for the underground connection of the fortified palace with a hidden water channel at the end of the 13th c. BC; similar structures existed in Israel, at Gibeon and Megiddo, which are dated to the Iron Age (Bagg 2012, 258–261). Archaeological research has revealed shafts-and-gallery systems in southeastern Arabian Peninsula, modern-day United Arab Emirates (UAE) and Sultanate of Oman, which are dated to the early centuries of the first millennium BC. Furthermore, it seems that the Assyrians were the first to construct long straight tunnels for the transportation to urban centers of surface water from rivers or lakes, artificial or natural. The cultivation of the “fertile crescent” would not be possible without the irrigation works because of low precipitation, but Egypt was favored by the natural flooding of the Nile. A challenging project for water supply to Nineveh was accomplished between 702 BC and 688 BC, including a tunnel excavated through a topographic high (Bagg 2007, 33). The long Naguib Tunnel, which can be traced for some kilometers, is ascribed to the Assyrian King Asarhaddon (681–669 BC) on the basis of inscription on the rocks *in situ* (Bagg 2007, 32).

The construction of the famous aqueduct of Eupalinos started in c. 550 BC (Kienast 1995, 187) and consists of three sections, a horizontal central tunnel and two shaft-and-gallery end sections (Zambas et al. 2016). Most likely, it was preceded by the Aegina and Megara underground aqueducts (Graeber 1905, 558), which were of the shaft-and-gallery type.

Early invention of underground aqueducts has been recorded in the process of adaptation of communities to natural decline of precipitation and springs, in the turn of the second to the first millennium BC. Thus, areas rich in water in the first half of the Holocene were gradually transformed into deserts in Libya and Western Egypt, with few oases near springs. Subsequently, the decline of the springs forced the invention of underground aqueducts, the foggaras in Libya, where outcrops of fossil aquifers were the last refugia for settlements. In the Peninsula of Oman, the Hajar Mountains were similarly the last refugia, thanks to their higher precipitation, which could support irrigation in narrow zones at the foothills of the mountain belt by means of underground aqueducts (*aflaj*), a topic extensively treated by Boucharlat (2016).

In the sixth century BC, underground aqueducts started in Greece, a region of mild Mediterranean climate, owing to a combination of urbanization and a climatic shift. Large surface aqueducts supplied the Hellenistic cities in Asia Minor, and this technology was further improved, spread, and enhanced in the Roman period.

## 1.2 CLASSIFICATION AND TERMINOLOGY OF UNDERGROUND AQUEDUCTS

### 1.2.1 REVIEW OF REPRESENTATIVE UNDERGROUND AQUEDUCTS

Some representative types of underground aqueducts are summarized in Table 1.1, with particular emphasis on the origin of water and the type of underground waterworks, in order to demonstrate the wide variability and complexity of possible combinations.

**TABLE 1.1**  
**Selection of Underground Aqueduct Types**

Origin of Water	Underground Waterworks	Comments
Surface water (rivers, springs, and lakes)	<ol style="list-style-type: none"> <li>1. Assyrian tunnels</li> <li>2. Aini falaj fed from springs: Oman-UAE</li> <li>3. Horizontal tunnel combined with shafts-and-gallery end sections: Eupalinos aq., Greece</li> </ol>	<ol style="list-style-type: none"> <li>1. Fed from river: Wilson (2008, 290)</li> <li>2. Al-Ghafri et al. (2003, 29)</li> <li>3. Supplied from spring: 550 BC (Zambas et al. 2016)</li> </ol>
Dry valleys (wadi)	Shallow tunnels: Ghaili falaj at Al Madam	Cero 2012, 134; UAE, Iron Age II
Karstic aquifers	Spring tunnels in Israel	8th c. BC (Yechezkel and Frumkin 2016)
Lake	Shafts-and-gallery drainage tunnel aqueduct (Etruscan cuniculi)	6th c. BC at the latest (Izzet 2007, 195)
Capturing at the level of the phreatic water table	Aegina and Megara in Greece in the shaft-and-gallery technique	6th c. BC (Avgerinou et al. 2016)
Capturing below the water table	Hadrianic aqueduct of Athens in Greece, in the shaft-and-gallery technique	125–140 AD (Avgerinou et al. 2016)
Confined aquifers	<ol style="list-style-type: none"> <li>1. Corinth aqueduct at the Peirene spring</li> <li>2. Caesarea of Mauretania, Algeria</li> <li>3. Kharga Oasis (Egypt) (Wuttmann 2001)</li> <li>4. Fazzan Oasis (Libya) (Wilson 2005)</li> </ol>	<ol style="list-style-type: none"> <li>1. Hill (1964)</li> <li>2. Leveau (2012, 157)</li> <li>3. Fossil water in artesian springs and wells and/or galleries within the aquifer</li> </ol>
Deep aquifers in arid areas	Xinjiang in China, in the shafts-and-gallery technique	Hu et al. (2012, 216)
Shallow aquifers in arid areas	Chain of shafts without a gallery	Sala (2016)

### 1.2.2 PROPOSED CLASSIFICATION SCHEME

A classification scheme of the various aqueducts is proposed below (Table 1.2) based on hydrogeological criteria and the following principles.

First, it should be clarified that the term aqueduct is applied, both in a strict sense for hydraulic structures simply conveying surface waters and in a broad sense for underground waterworks tapping and conveying groundwater as well. The distinction between them will be the first classification criterion.

Second, a class of groundwater infiltrating galleries\* will be distinguished under the generic name *shafts-and-gallery*† *aqueducts tapping groundwater*. It will be further subdivided into subclasses A, B, and C (Table 1.2), based on hydrogeological criteria and the water capturing mode in particular.

Third, the regional terms applied traditionally in various countries, such as qanāts, foggaras, aflaj, and karez, have inherited special connotations, which imply meaningful differences; as Boucharlat notes (2016) “Qanāt, a word of Arabic root, is the most frequently term used...in Iran while the Persian word karez, kārīz is spread only in the Eastern part of Iran and more frequently

\* Boucharlat (2001, 158) proposed the French term “galerie de captage” as a general term, including qanāts.

† According to Wilson (2008), the shafts-and-gallery tunneling technique, which is associated by many authors with the Persian qanāts, was developed earlier in the Assyrian Empire in the construction of long-distance artificial canals supplying water usually from distant rivers. Assyrians crossed intervening ridges by means of tunnels several hundred meters or even several kilometers long. The Assyrian king Assurnasirpal II (884–859 BC) dug a canal 19.5 km long from the Upper Zab River to supply Nimrud, which passed under a rock ridge at Negoub via a tunnel 7 km long, dug between pairs of vertical shafts. The system supplied water to the city of Nimrud and irrigated the fields around it (Wilson 2008, 290). It is suggested that the alternative term “qanāt technique” may cause confusion that the aqueducts dug by means of the “qanāt technique” are qanāts, which obviously is not the case.

**TABLE 1.2**  
**Classification of Aqueducts on the Basis of Hydrogeological Criteria**

Aqueduct Class	Subclasses	Typical Cases
Single infiltrating gallery	Spring tunnels without wells infiltrating along the water table	Spring tunnels of Israel (figure 6 in Yechezkel and Frumkin 2016)
<i>Shafts-and-gallery aqueducts tapping groundwater</i>	A. Shafts-and-gallery infiltrating along the water table B. Shafts-and-gallery in open or confined aquifer infiltrating from mother wells C. Infiltrating gallery and wells dug within open aquifer below the phreatic water table or within a confined aquifer	Aegina and Megara aqueducts in Greece and Aflaj Al Gheli in UAE Daudi falaj (figure 7 in Rizk and Alsharhan 2016), Iranian qanāts (figure 1 in Al-Bassam and Zaidi 2016), and Xinjiang qanāt Foggaras in the Kharga Oasis in Egypt, Fazzan Oasis foggaras in Libya, Algerian foggaras (figure 3 in Aroua and Dahmen 2016), Ghaili falaj at Al Madam, and Hadrianic aqueduct of Athens (figure 4.6 in Avgerinou et al. 2016)
Aqueducts sensus strictus	Any combination of surface or underground structures for water conveyance, including shafts-and-gallery sections, above the water table	Assyrian tunnels, Aini falaj, Eupalinos' aqueduct, and most of the Roman aqueducts

in Afghanistan". Therefore, the local terms should be maintained for local use but not merged or transferred out of context to other regions. Apparently, the diffusion model of qanāts is to some degree the result of **terminology diffusion**.

### 1.2.3 REMARKS ON THE PROPOSED CLASSIFICATION SCHEME

The first subclass of Table 1.2, the spring tunnels (Figure 10.6), "are quarried into the ground of an active spring in order to enrich the water flow, for a few dozens of meters long" (Porath 2014, 66). The spring tunnels were developed in Israel since the eighth century BC (Yechezkel and Frumkin 2016).

The distinction of the subclasses A, B, and C is based on the configuration of the gallery with regard to the water table or the aquifer, which implies a different mode of water capturing. Type A aqueducts follow the top layer of open water table; galleries of type B cross the aquifer over a short distance only at the mother wells (Figures 9.3, 9.5 and 17.13); and those of type C with the infiltrating section wholly dug within the aquifer (Figure 4.6, initial section). Hydraulic structures above the water table are considered conveyance aqueducts sensus strictus.

For the drainage of water while digging aqueducts at or below the water table or within the aquifer, a special tunneling technique is required for groundwater removal; digging starts from the surface and continues upstream, as in the case of the Algerian foggaras (Remini et al. 2010), the Raschpëtzer aqueduct of Luxembourg (Kayser and Waringo 2003) and the Hadrianic aqueduct of Athens (Avgerinou et al. 2016, figure 4.7).

The role played by the mother wells in arid areas can be clarified in terms of water quality, thanks to the systematic work in the UAE (Rizk and Alsharhan 2016), where the Eastern Mountains occupy only 5% of the total area of the UAE but receive about 30% of the total annual rainfall. The water quality rapidly deteriorates on both sides away from the water divide, which is actually the central line of the recharge area. Therefore, the aflaj mother wells, in Aflaj Al Daudi, start near the water-divide line that connects high peaks of the Eastern Mountain Ranges, where rainfall is the highest in the country (figure 16.7 in Rizk and Alsharhan 2016).

Once the mother well has located water of acceptable quality, it is brought to the surface along the shortest route to avoid mixing with water of higher salinity, present further away from the divide.

Mother well is also an essential component of the Iranian qanāts. *The initial step in building a qanāt is digging the mother well deep into the water table. ... The main, or mother, well, is generally excavated in the mountains, penetrating deep into the water table* (Eslamian et al. 2016).

Some mother wells are exceptionally deep, rarely exceeding 300 m in depth; however, 100 m seems more common among the deep wells. It can be reasonably assumed that at these depths, the target is a confined (artesian) aquifer of good water quality.

As noted by Wilkinson (2003, 47) deeper wells have been dug for the supply of drinking water for humans and animals. However, digging such deep wells is a high-risk project and an impressive technical achievement, which should be credited to Iran in the latest stages of qanāt development.

### 1.3 DIFFUSION OF TERMINOLOGY VERSUS DIFFUSION OF QANĀT INVENTION

As noticed by Leveau (2015, 149), the German Archaeologist Grewe merged the Roman aqueducts with qanāts. Indeed, Grewe (2003, 9) supported that the invention of the iron made possible the production of proper tools for tunneling, so that the first tunnels were dug at the beginning of the first millennium BC. Furthermore, Grewe assumed that since about this time, qanāts were built in ancient Persia, which were the model of the Roman aqueducts, an assumption which is not tenable presently.

It should be reminded, in this regard, that the end segments of the Eupalinos' aqueduct on Samos, Greece, were constructed in the shafts-and-gallery technique, since 550 BC (Figure 5.4). In addition, in the blind horizontal tunnel of the same aqueduct, the water pipeline was installed in a lateral inclined gallery, dug again using the same technique (Zambas et al. 2016, figures 5.6 and 5.7).

Bagg (2005–2006, 402)—in his review of the book edited by P. Briant “Irrigation et drainage dans l'Antiquité, qanāts et canalisations souterraines en Iran, en Égypte et en Grèce”—without taking into account hydrogeological conditions, underlines a priori that “characteristic of the qanāts is the applied construction technique: the gallery is constructed in parts, whereby the horizontal stretch is dug between two vertical shafts.”

Various definitions of qanāts, emphasizing the shafts-and-gallery characteristic as their diagnostic feature, paved the way for the logical error that any shafts-and-gallery aqueduct is a qanāt.

An essential and crucial technical feature of qanāts is omitted in some definitions, and this feature is that “a qanāt is a subterranean aqueduct engineered to collect groundwater from a mother well,” as underlined by Lightfoot (2000, 215).

In this fashion of considering any shafts-and-gallery aqueduct as qanāt, the Raschpötzer aqueduct has been also characterized as qanāt (Kayser and Waringo 2003, 278); however, there is neither a single mother well nor an indication of Persian influence, the climate is far from arid, and the aqueduct captures water all along its course from a confined sandstone aquifer.

The aqueducts of Palermo are also considered as qanāts (Lofrano et al. 2003, 1664), introduced after the Arab conquest of Sicily in 827 AD; however, they are geologically and technically similar to the ancient aqueducts of Syracuse bored more than a millennium earlier (Wilson 2001, 12).

Another certainty in the diffusion model of qanāts is that the African foggaras are also qanāts, an impression created perhaps from the similar patterns in satellite images. However, there is no convincing indication of Iranian influence in the development of foggaras in the Libyan Desert.

### 1.4 UNDERGROUND AQUEDUCTS AS A RESPONSE TO HOLOCENE ARIDIFICATION

#### 1.4.1 HOLOCENE ARIDIFICATION AND EARLY HYDRAULIC SOCIETIES

It is believed that the earliest hydraulic systems with irrigation works were developed in sedentary societies, commonly called hydraulic societies, under environmental limitations mitigated by means of technology.

Mesopotamia, the land between the rivers Tigris and Euphrates, modern Iraq, is considered as the place where the first hydraulic civilization arose. It is worth noting that the rivers carry a great deal of silt that gradually raises them above the surrounding plains, until they overflow their banks in devastating floods (Headrick 2009, 18). It is often supported that the hydraulic cultures of Egypt and the Indus Valley were inspired by the example of nearby Mesopotamia and that in China, Mexico, and Peru, three different agricultural systems developed quite independently of outside influences (Headrick 2009, 20).

Brooks (2006, 29) advanced an environmental model for the emergence of the first hydraulic societies in the Afro-Asiatic monsoon belt and northern South America during the sixth and early fifth millennia BP. He emphasized that “this was a period of profound climatic and environmental change in these regions and globally, characterized by a weakening of the global monsoon system and widespread aridification in regions that today contain the bulk of the world’s warm deserts.”

Hydroclimate reconstructions for South and Central Asia show that precipitation from both monsoon and westerly sources that feed rivers of the western Indo-Gangetic Plain decreased since approximately 5000 years ago. This drying of the Indus region supports the hypothesis that adaptation to aridity contributed to social complexity and urbanization (Giosana et al. 2012).

The Indus Civilization is one of the classic early complex societies of the Bronze Age. The urban development in the Indus Valley was based on the surplus food production in the fertile soil of the river-irrigated plains. The surplus was stored in granaries, two of which have been exposed, one at Mohenjo Daro and another at Harappa. As vividly described by Khan et al. (2016), the Indus Valley Civilization had an early canal irrigation system and the inhabitants of Mohenjo Daro were masters in constructing wells with tapering bricks that were strong enough to dig deep wells.

In Sahara, particularly in Fazzan in Libya, and in Egypt, there are indeed indications that a sociocultural change evolved as a response to enhanced aridity, which resulted in migration of population in environmental refugia characterized by the presence of surface water, as in the Oases in Libyan Sahara and the Western Desert of Egypt, which are still supplied from fossil water, the last remnants of rich aquifers charged in the Early Holocene.

Geomorphological and palaeoenvironmental surveys conducted in parts of the Lake Megafezzan Basin in Libya, in the frame of the Desert Migrations Project, studied younger palaeolake sediments deposited in the Holocene. Sediment exposures in the Wadi al-Hayat suggest that a period of aridity and associated aeolian activity was followed by a lacustrine interval that terminated about 3 kyr BP (Drake et al. 2009, 175).

It is noted by Brooks (2006, 35) that the earliest evidence of settlement in the Wadi al-Hayat and the Garamantian civilization “clearly appears to be the end result of a process of adaptation to increasingly scarce water resources and ultimately a response to the final disappearance of surface water around 3000 years BP. The desiccation of Fazzan led to population agglomeration, increased territoriality, social stratification, an increasing focus of human activity on specific locations, sedentism, and technological innovation, leading to the emergence of a complex urban society.”

In the Algerian Sahara, the first archaeological traces of sedentary settlements around lakes could date back to the Neolithic era, whereas underground water structures are attested since the early antiquity and the Romans introduced further hydraulic techniques in the North (Aroua and Dahmen 2016).

#### 1.4.2 THE FOGGARAS IN THE SYSTEM OF FOSSIL AQUIFERS IN SAHARA

The Libyan foggaras are fed from the North-Western Sahara Aquifer System, which is shared by Algeria, Tunisia, and Libya. It consists of two major groundwater aquifers, the Continental Intercalaire and the Complexe Terminal, which extend over an area of more than one million km<sup>2</sup> (OSS 2004, 3). In Algeria, “the northern side of the Gurara is supplied from the Western Erg aquifer, while the areas surrounding the Tadmout are served by the Continental Intercalaire aquifer, where



water table becomes close to the surface (figure 6.3 in Aroua and Dahmen 2016). In Libya, the foggaras are hosted in the Continental Intercalaire Aquifer, which in most of the Fazzan basin outcrops at the surface (OSS 2004, 61) and is apparently used to supply the Megafezzan Lake with water. It still maintains groundwater, which is tapped by means of foggaras, located apparently preferentially at sites of dried springs to capture water from lower horizons of the aquifer, and when the tapped layers dry again, then the foggara is dug a few meters deeper.

In Algeria, in the Saharan basin of the Grand Erg Occidental, the Continental Intercalaire Aquifer is for the major part unconfined, and thus, it is easily accessible by means of foggaras and wells (OSS 2004, 58). The Algerian foggaras described by Remini and Achour (2008) are dug below the undisturbed (static) phreatic water table, and they are therefore excavated by means of a special technique starting from the entrance of the gallery (Remini and Achour 2008, 31–34).

Therefore, Algerian foggaras of this type, the foggaras in Fazzan, and the “qanāts” of the Kharga Oasis in Egypt are classified in class C in Table 1.2 because of water infiltration along their gallery, which is dug within the aquifer, whereas in typical qanāts, the gallery is simply the transportation route of water tapped at the mother well.

Wilson and Mattingly (2003) and Wilson (2005) have established the existence of some 550 foggaras or qanāts in the Wadi al-Ajal, Fazzan, and numerous others in different parts of the Fazzan Basin in Libya. They are dated from the last centuries BC to early centuries AD and appear to have been used perhaps until the early Middle Ages (seventh to eleventh centuries) but probably not beyond this. It is argued by Wilson that “foggara technology was introduced from Egypt in the second half of the first millennium BC and enabled the development of an agricultural society in Fazzan, which spread north to the fringes of the Garamantian world, to southern Tunisia and the southern Aurès Mountains in the Roman period.” This assumption, however, seems to be rather an unnecessary complication, given the long and widespread tradition of foggaras in Libya.

The Garamantes, the people who flourished in the region of Fazzan in Libya, in the period between c. 1000 BC and c. AD 700, brought important developments to the central Sahara. Already in the Early Garamantian phase, *ca.* 1000–500 BC, they developed settlements situated in strategic and defensible locations. It is supported that this early stage was sustained by an economy based on an irrigated cultivation system due to the use of underground wells and channels known as foggaras (González Rodríguez 2014, 29). However, this assumption of so early introduction of foggaras is not based on direct dating, and possibly, the irrigation in this period was still based on springs or shallow wells, as at Brayk in Figure 8.2.

In Fazzan, there is a repeated pattern of settlements in wadis associated with foggaras and cemeteries on hills—the latter ones were due to mortuary rituals and habits (González Rodríguez 2014, 321). The foggaras start from the hills and are fed from fossil aquifers, which still maintain water at depths accessible by wells, up to a couple dozens of meters deep.

Research of the Desert Migrations Project led by David Mattingly has established in the Fazzan area numerous foggara irrigation systems in the Wadi al-Ajal, which were constructed in the Garamantian period and allowed the development of oasis agriculture that enabled the emergence of a Garamantian state. The general dating of the foggaras to the Classic Garamantian period (*ca.* 1–400 AD) is suggested by their spatial association with settlement sites.

Closer direct dating of the foggara systems was attempted in the Taqallit promontory, where excavations included four locations. Several foggaras of the Taqallit area had complex systems of tributary branches in their upstream sections and splitting channels visible in the downstream portions.

In the area of Taqallit, it was concluded that the foggaras are later than drum cairns, which probably belong to the Early Garamantian (*ca.* 1000–500 BC) and Proto-urban Garamantian (*ca.* 500–1 BC) phases. Therefore, it is not excluded that the foggaras here originated earlier in the Proto-urban phase (Mattingly et al. 2009, 130).

There are, however, areas in the Libyan Sahara, such as the Oasis Fewet, some 10 km southwest of Ghat, with hydrogeologic conditions more favorable, where even today the water table is rather shallow. Radiocarbon datings indicate that the area was still fed by a river from at least 4200–2700 BP. In the periods 1930s and 1940s, the local population relied on 34 wells in shallow aquifers and 12 springs, which were surrounded by large pools full of clean water. In the excavations of the Fewet Oasis, no foggaras were located, and the well discovered inside the Garamantian village of Fewet indicates that the water table was far closer to the surface than it is today (Castelli et al. 2005, 75).

It is therefore suggested that the foggaras and the oasis settlements were developed in areas of originally shallow water table, which immersed in the process of climatic change and was therefore tapped with underground aqueducts.

### 1.4.3 “QANĀTS” IN THE WESTERN DESERT IN EGYPT AND AFLAJ IN THE PENINSULA OF OMAN

Wuttmann (2001) excavated the hydraulic works at the Kharga Oasis associated with the giant sandstone aquifer of fossil water, the Nubian Sandstone, the recharge of which ceased after the last humid episode. Three periods of habitation are documented at the oasis, namely Persian, Ptolemaic, and Roman. Water is captured from tunnel or trench walls or from artesian wells; the tunnels are referred to as qanāts, although they were actually infiltrating galleries and tapped water all along their length, like the foggaras.

It is noted that the water potential of the area was already exploited in artesian springs since the Neolithic times. A Neolithic settlement in the Kharga Oasis, which was absolutely dated between 4800 BC and 4200 BC, tapped an artesian spring. Under the strong climatic pressure at the end of the Middle Holocene, an artificial well was dug at the site of the spring, excavated to a depth of 2.6 m (Briois et al. 2012, 178–179).

Two stages of “qanāts” are dated at the oasis. One was the shallow “qanāts” 6 m deep dated in the Persian period. After drying up of the gallery, a new one was dug 4 m deeper, which was further deepened by 1–2 m in the Roman period. The water percolates on the walls of a shallow tunnel or a trench or rises close to the surface in artesian wells (Wuttmann 2001, 117).

Gallery networks have experienced many changes at the Kharga Oasis; the short and shallow galleries were gradually lengthened and deepened to follow the declining reservoirs. It is therefore indicated that at the Kharga Oasis, all types of hydraulic works were locally developed under strong climatic pressure. Starting with tapping artesian springs, the next steps sequentially were digging shallow or deeper artesian wells and excavating open trenches in the aquifer, short spring tunnels, shallow, and then deeper galleries along a chain of shafts. This evolutionary trend is enhanced by the remark of Institut Français D’archéologie Orientale-Le Caire (IFAO) that: “While it is likely that the technique of the qanāt has its origins on the Iranian plateau and was introduced by the Achaemenid conquerors, it is nevertheless the case that the structures of Ain Manawir are the only ones to have been effectively dated to that period” (IFAO: Douch, <http://www.ifao.egnet.net/archeologie/douch/>).

Wilson (2008, 291) considers the above aqueducts as Iranian qanāts, but he equally notes that no qanāt in Iran has yet been shown to be of Achaemenid date and that the earliest securely dated qanāts belong to the Achaemenid period in the Kharga Oasis in Egypt.

Furthermore, the view that there are so far no proven ancient qanāts in Iran (Boucharlat, 2001, 157) has not been seriously disputed so far. As concluded by Boucharlat (2016), “the hypothesis of radial diffusion from a unique center does not match with the archaeological evidence. The *qanāt* and *falaj* may well be a polycentric invention at different periods in different geographical contexts, especially for the first period, the first millennium BC.” Boucharlat finally concludes schematically that “the first generation of shafts-and-gallery aqueducts was very likely polycentric during varied periods of the first millennium BC. Much later the second generation might have been actually implemented in Iran around the middle of the first millennium AD and was soon spread elsewhere.”



It is noted that if the above “qanāts” in the Kharga Oasis in Egypt are considered in the broader context of the Libyan Sahara, they are similar to the Libyan foggaras, both in geological and structural terms. The settlement in the Kharga Oasis in Egypt during the Persian rule could simply indicate the Iranian control of the desert caravan routes in Egypt and not necessarily the transfer of technology, for which there is not sufficient archaeological evidence that the Iranians possessed in this period. The Neolithic settlements at Oases in Sahara near artesian springs, the extensive outcropping aquifers of fossil water, the potential of shallow artesian wells and foggaras, and the gradual aridification since the Middle Holocene were critical conditions for the early and independent development of groundwater tapping aqueducts near Oases in the Northern Africa. In particular, the early irrigation in Fazzan, not necessarily from foggaras, is supported by archaeological evidence that the Early Garamantian period (1000–500 BC) saw the establishment of planned settlements (González Rodríguez 2014, 319). Apparently, the innovation of underground aqueducts in the Libyan Desert and the Peninsula of Oman was induced in the process of adaptation, thanks to the favorable hydrogeological conditions, namely the fossil aquifers in the Libyan Desert and the recharged aquifers at the flanks of the Hajar Mountains.

It is concluded that in the process of declining precipitation and increasing aridity in Africa and the Arabian Peninsula, nature enforced pressure for the technological adaptation, and this was faced with aflaj in the Peninsula of Oman in the Iron Age, with the so-called qanāts in the Kharga Oasis in Egypt in the middle of the first millennium BC, and with the foggaras in Libya.

## 1.5 GENERAL CONCLUSIONS

Early underground aqueducts were developed in areas exposed to aridification in the aftermath of the climatic change in the Middle Holocene. The decline of the water resources was gradual, so that Oases were maintained with springs and streams at favorable spots, some of which are still active. It is now widely accepted that underground aqueducts of the shafts-and-gallery technique were in use in the Peninsula of Oman in wadis since the turn of the first to the second millennium BC (Boucharlat 2016). The favorable factor in this area is the mountain belt of Hajar with higher precipitation, sufficient to feed aquifers, temporary streams, and springs near the foothills.

Since about the same era, sedentary settlements developed in the Fazzan basin in the Libyan Desert (González Rodríguez 2014) and aqueducts of the shaft-and-gallery technique, the foggaras, occurred in the second half of the first millennium BC (Mattingly et al. 2009). Under similar conditions the foggaras in the Kharga Oasis in Egypt occurred, already in the fifth century BC. In both cases, the foggaras tapped extensive fossil artesian aquifers, which outcrop in Maghreb and the Oases of the Western Desert in Egypt. Once the springs at Oases dried, underground digging started to tap the aquifer in various forms, at artesian wells, open trenches, spring tunnels, and finally shafts-and-gallery aqueducts.

This evolutionary trend in waterworks is clearly apprehended by Aroua and Dahmen (2016) in Algeria, where “starting from elementary ground water techniques such as the development of water sources or small dikes, autochthonous people developed underground structures like the *chegga*, a trench which can reach several meters depth and continues as a short tunnel. A more sophisticated underground aqueduct is the *foggara*, or *ifli* in Berber.” Furthermore, since the Fazzan project in Libya, the presence of foggaras in the Maghreb is reported to the second century BC, but due to more recent dating the limit tends to reach the fourth century BC (Aroua and Dahmen 2016).

Groundwater draining galleries (*puquios*) occur also in Nasca, in the South-central Andean region, which is one of the driest areas in Peru and South America and where precipitation averages 4 mm a year. Water comes from the adjacent highlands down onto seasonal rivers and streams. Two types of *puquios* have been identified—trench and gallery (Figure 28.2); however, these are not mutually exclusive. Gallery *puquios* are the hydraulic-type technology, most analogous to the Old-World *qanāts* or filtration galleries. There is a dispute on the age of *puquios*, but currently, the general consensus based on settlement site association is that of a pre-Hispanic origin, with

subsequent Spanish and Republican modifications. Yet, the fact that doubts persist should alert us to the need for further research on this topic (Lane 2016).

It is interesting to note the conceptual geometrical similarity of the helicoidal wells of puquios (Lane 2016, figure 27.5) with the step wells in the Indus Valley (Khan et al. 2016, figure 25.3).

Ancient hydraulic catchment systems exist also in Mexico, at the Tepeaca-Acatzingo Archaeological zone. “Filtration galleries (*galerías filtrantes*) are generally believed to have been constructed between the Spanish conquest of Mexico in the sixteenth century and the first half of the twentieth century. However, important pre-Hispanic population centers in the same area also developed systems for the collection of water by exploiting the hydrographic properties of the sedimentary geology of the region. The continuity and periodization of elaboration of water collection systems in this area, which had their origin in prehistoric times and which climaxed with the post-conquest construction of extensive networks of *galerías filtrantes*, is poorly understood. In the area Tepeaca-Acatzingo, located 30 km east of the city of Puebla, at an average altitude of 2220 masl the geology favors a rapid infiltration of rainwater and drainage hydrography is primarily through underground features. Given these geological and hydrographic conditions, the ancient people of the area had to devise techniques for capturing the water available in the subsoil required for both domestic consumption and for agricultural development, especially in the dry season when the shortage of surface water was critical” (Jaen et al. 2016).

The polycentric invention of early shafts-and-gallery aqueducts, as inferred by Boucharlat, is a natural and well-established development, motivated by adaptation for survival in hostile environmental changes. It is therefore further confirmed that the small-scale prehistoric systems probably constituted an example of “human niche construction” (Wilkinson 2012, 155).

As Boucharlat (2016) concludes “the first generation of shafts-and-gallery aqueducts was very likely polycentric during varied periods of the first millennium BC. Much later the second generation might have been actually implemented in Iran around the middle of the first millennium AD and was soon spread elsewhere.”

It is therefore implied that hydraulic techniques related to underground aqueducts, in the first millennium BC or in the first centuries AD, particularly in the Hellenistic and the Roman periods, preceded Persian qanāts of the second generation.

Historical records referring to Iranian qanāts quoted by Eslamian et al. (2016) date in the after-Islam period. Their repeated arguments in favor of early spread of qanāts in the Achaemenid period return mainly to the assumption of Goblot (1979) that qanāts spread from Urtu, the “qanāts” of the Oasis of Kharga in Egypt, which are rather foggaras than qanāts, and the text by Polybius; all these arguments are reasonably disputed by Boucharlat (2016).

The late occurrence of the second generation of shafts-and-gallery aqueducts in Iran around the middle of the first millennium AD is in harmony with the increasing evidence that the diffusion of qanāts started later than what it was believed a few decades ago. Thus, the underground water transfer system at Ayn Zubaydah Al Aziziyah in Saudi Arabia, which comprises a network of stone-lined galleries and shafts, was completed in 801 AD (Al-Bassam and Zaidi 2016).

The qanāt systems in Israel, for which dating assumptions in the past ranged from the late sixth century BC to the early seventh century AD, are currently dated on the basis of archaeological excavations to the Early Islamic period, late seventh to ninth centuries AD, (Porath 2014, 68).

In Syria, where a declining precipitation occurs from west to east, a network of qanāts was developed in valleys in the east. “There are many sites, often related to the qanāts or established nearby, and all date to the Byzantine period” (Geyer 2002, 78).

Kamash, who defines qanāt as a subterranean gallery that taps an aquifer (2006, 79), concludes that the evidence seems to point to the fact that qanāts were present in the Near East by the late Roman period and that there is no positive evidence to suggest that qanāts were in the area in the pre-Roman period (2006, 84).

Based on the above, it is concluded that there is no evidence for the diffusion of qanāts from Iran to the Near East in the Achaemenid period (538/532 to 332 BC). However, Wessels (2016), despite

supporting that Qanāts in Syria are nearly all of Roman or Byzantine origin, assumes that “the Persian influence in technology transfer and advancement must have been substantial and Syria’s proximity to the Persian Empire suggests that the technology of qanāts was first introduced during the expansion of this civilization.”

The chapter on the underground waterworks of West-Central Asia, on the basis of rich soviet literature, provides the first complete list of “*karez*,” which were diffused from Iran. The earliest historical reference of a *karez*-qanāt was recorded during the tenth century AD in the Kopet Dag, but some authors suspect an earlier Achaemenid start of the building tradition (Sala 2016).

Thus, despite the evidence for the diffusion of shafts-and-gallery aqueducts in the first millennium BC in many areas, the view of the Achaemenid diffusion is still a recurring assumption in the literature. A typical scenario is that the invention of qanāts occurred in Urtu Land, from where it spread to Iran. As quoted by Eslamian et al. (2016), the ancient Iranians made use of the water that the miners wished to get rid of and founded a basic system named qanāt to supply the required water to their farmlands. Furthermore, Eslamian et al. (2016) invoke that according to Goblot, this innovation that took place in Urtu Land was later introduced in the neighboring areas such as the Zagros Mountains (Goblot 1979) and that, as Goblot believes, the influence of Medians and Achaemenians made the technology of qanāt spread from Urtu to all over the Iranian plateau. However, it is clear from the detailed account of the hydraulic developments in Urtu by Nalbandyan (2016) that water supply was based on canals and dams exploiting surface waters and there is no single reference to qanāts. This fact was already underlined by Salvini (2001); however, it is hoped that the additional evidence provided this time by Nalbandyan will be convincing at last.

The evolutionary trend of the underground aqueducts in ancient Greece, as recorded in the chapters 4 and 5 on the basis of recent research, is continuous and indigenous. The obvious source of technological influence are the Laurion Mines in Attica, where the silver recovery from lead ores started already in the 4rd millennium BC (Kakavogiannis and Koursoumis 2013). Even the Hadrianic aqueduct of Athens, built totally underground in the Roman period (125–140 AD), is designed on the basis of mining principles, in striking contrast with the rest Roman surface aqueducts in Greece. Affinities of the ancient Greek aqueducts can be traced in Magna Graecia and Etruria, but in no case in Iran.

## ACKNOWLEDGMENTS

I acknowledge with great pleasure and gratitude the fruitful and courteous cooperation of Dr. Rémy Boucharlat, of the Laboratoire Archéorient (MSH Maison de l’Orient et de la Méditerranée), for his transfer of knowledge and expertise, for the exchange of thoughts and concepts, and for advising me to be careful while making assumptions. I am also grateful to Professor Henning Fahlbusch for his comments on my manuscript and his valuable guidance on ancient hydraulic technology. My thanks are also addressed to Abdelkrim Dahmen, of the Institute of Architecture at the Saad Dahlab Blida University in Algeria, for kindly explaining details of the functional *foggaras* in Algeria; to Kevin Lane, of the University of Cambridge, for introducing me to the pre-Hispanic hydraulic systems of Nasca and his brilliant composition of contradictory views on *puquios*; and finally to W. D. Schram, Utrecht, the Netherlands (<http://www.romanaqueducts.info>) for his supply of rare publications. Last but not the least, I express my gratitude and appreciation to all the authors of the chapters 4, 5, 10, 13, 15, 16, 17, 20, 21, 26 and 27 who accepted my invitation and honored me with their excellent and fruitful cooperation.

## REFERENCES

- Al-Bassam, A.M. and Zaidi, F.K. 2016. Aqueducts in Saudi Arabia. In *Underground Aqueducts Handbook*, eds. A.N. Angelakis, E.D. Chiotis, S. Eslamian, and H. Weingartner, pp. 211–228, Boca Raton, FL, CRC Press.
- Al-Ghafri, A., Inoue, T., and Nagasawa, T. 2003. Daudi Aflaj: The Qanats of Oman. *Proceedings of the Third Symposium on Xinjiang Uyghor*, China, 29–36, Chiba University, Japan.

- Al-Ghafri, A. 2004. Water distribution management of aflaj irrigation systems of Oman, PhD Thesis, Hokkaido University, Sapporo, Japan.
- Aroua, N. and Dahmen, A. 2016. Past and present of underground aqueducts in Algeria. In *Underground Aqueducts Handbook*, eds. A.N. Angelakis, E.D. Chiotis, S. Eslamian, and H. Weingartner, pp. 83–98, Boca Raton, FL, CRC Press.
- Avgerinou, P., Chiotis, E.D., Chrysoulaki, S., Evangelou, T., Koutis, P., Peppas, G., Defteraios, P., et al. 2016. Updated appraisal of ancient underground aqueducts in Greece. In *Underground Aqueducts Handbook*, eds. A.N. Angelakis, E.D. Chiotis, S. Eslamian, and H. Weingartner, pp. 43–62, Boca Raton, FL, CRC Press.
- Bagg, A. 2005–2006. Book review, *Archiv für Orientforschung* 51:402–405. ed. Briant, *Irrigation et drainage dans l'Antiquité, qanats et canalisations souterraines en Iran, en Égypte et en Grèce*, Collège de France, Paris, 192 pp, Thotm editions, 2001 (Persika 2).
- Bagg, A. 2007. Wer wird den Kanal graben? – Kanalbauten und Wasserwirtschaft im alten Vorderen Orient. In *von der Cura Aquarum bis zur EU – Wasserrahmenrichtlinie, Fünf Jahre DWhG*, ed. C. Ohlig, 29–37, Siegburg, DWhG.
- Bagg, A. 2012. Die Anfänge des Tunnelbaus: Wasserbauliche Anlagen im antiken Jerusalem. In *Wasserwirtschaftliche Innovationen im archäologischen Kontext Von den prähistorischen Anfängen bis zu den Metropolen der Antike*, eds. F. Klimscha, R. Eichmann, C. Schuler, und H. Fahlbusch, 257–266, Rahden/Westf, Leidorf.
- Boucharlat, R. 2001. Les galeries de captage dans la péninsule d'Oman au premier millénaire avant J.-C.: questions sur leurs relations avec les galeries du plateau iranien. In *Irrigation et drainage dans l'Antiquité, qanats et canalisations souterraines en Iran, en Égypte et en Grèce*, ed. P. Briant, 157–183, Collège de France, Paris.
- Boucharlat, R. 2016. *Qanat and falaj*, polycentric and multi period innovations: Iran and the United Arab Emirates as case-studies. In *Underground Aqueducts Handbook*, eds. A.N. Angelakis, E.D. Chiotis, S. Eslamian, and H. Weingartner, pp. 279–301, Boca Raton, FL, CRC Press.
- Briant, P. 2001. Polybe X.28 et les qanats: le témoignage et ses limites. In *Irrigation et drainage dans l'Antiquité, qanats et canalisations souterraines en Iran, en Égypte et en Grèce*, ed. P. Briant, 15–40, Collège de France, Paris.
- Briois, F., Midant-Reynès, B., Marchand, S., Yann Tristant, T., Wuttmann, M., De Dapper, M., Lesur, J., and Newton, C. 2012. Neolithic occupation of an artesian spring: KS043 in the Kharga Oasis, Egypt, *Journal of Field Archaeology*, 37:178–191.
- Brooks, N. 2006. Cultural responses to aridity in the Middle Holocene and increased social complexity, *Quaternary International*, 151:29–49.
- Castelli, R., Cremaschi, M., Gatto, M.-C., Liverani, M., and Mori, L. 2005. A preliminary report of excavation in Fewel, Libyan Sahara, *Journal of African Archaeology*, 3:69–102.
- Cerro, C. 2012. Some evidence of crisis and abandonment at the end of the Iron Age in Al Madam I-Thuqaibah, Sharjah. In *Fifty Years of Emirates Archaeology*, eds. D.T. Potts and P. Hellyer, 132–139, Motivate Publishing, London.
- Córdoba, J.M. 2013. New perspectives about Iron Age and the oasis culture in the Oman Peninsula. Two conclusive seasons at al Madam (Sharjah, UAE), *Isimu*, 16:139–151.
- Döring, M. 2016. Qanat Fir'aun – an underground Roman Water System in Syria and Jordan. In *Underground Aqueducts Handbook*, eds. A.N. Angelakis, E.D. Chiotis, S. Eslamian, and H. Weingartner, pp. 173–196, Boca Raton, FL, CRC Press.
- Drake, N., White, K., Salem, M., Armitage, S., El-Hawat, A., Francke, J., Mark Hounslow, M., and Parker, A. 2009. DMP VIII: Palaeohydrology and palaeoenvironment, *Libyan Studies*, 40:171–178.
- Eslamian, S., Davari, A., and Reyhani, M.N. 2016. Iranian Ganats: An Ancient and Sustainable Water Resources Utilization. In *Underground Aqueducts Handbook*, eds. A.N. Angelakis, E.D. Chiotis, S. Eslamian, and H. Weingartner, pp. 123–150, Boca Raton, FL, CRC Press.
- Evans, A. 1935. *The Palace of Minos at Knossos*, Vol IV, Part II, MacMillan, London, 1018 pp.
- Geyer, B. 2002. Expansion and Decline of Syria's Arid Margin, *The Arab World Geographer/Le Geographe du monde arabe*, 5:73–84 (Toronto).
- Geyer, B. and Monchambert, J.-Y. 2015. Canals and water supply in the lower Euphrates valley, *Water History*, 7:11–37. doi:10.1007/s12685-014-0108-4.
- Giosan, L., Clift, P.D., Macklin, M.G., Fuller, D.Q., Constantinescu, S., Durcan, J.A., Thomas S., et al. 2012. Fluvial landscapes of the Harappan civilization. doi:10.1073/pnas.1112743109.
- Goblot, H. 1979. Les qanats: une technique d'acquisition de l'eau (Vol. 9). Editions de l'Ecole des Hautes Etudes en Sciences Sociales, Paris.

- González Rodríguez, M. 2014. Death is another country. Mortuary rituals and identity in Fazzan, Libya. PhD Thesis, University of Leicester.
- Graeber, F. 1905. Die Wasserleitung des Peisistratos und die Wasserversorgung des alten Athen, *Zentralblatt der Bauverwaltung*, 25:557–560 (Berlin, Verlag W. Ernst & Sohn).
- Grewe, K. 2003. Wasserversorgung aus Qanaten - Qanate als Vorbilder im Tunnelbau. In *Internationales Frontinus-Symposium*, Walferdange, Luxemburg. Schriftenreihe der Frontinus-Gesellschaft 2005, 26:9–24.
- Headrick, D.R. 2009. *Technology: A World History*. Oxford University Press, New York.
- Hill, B.H. 1964. The Springs: Peirene, Sacred Spring, Glauke, Corinth, 1:1–235, American School of Classical Studies at Athens, Greece.
- Hu, W.J., Zang, J.B., and Liu, Y.Q. 2012. The qanats of Xinjiang: Historical development, characteristics and modern implications for environmental protection, *Journal of Arid Land*, 4:211–220.
- IFAO (INSTITUT FRANÇAIS D'ARCHÉOLOGIE ORIENTALE-LE CAIRE), Douch, <http://www.ifao.egnet.net/archeologie/douch/>
- Izzet, V. 2007. *The Archaeology of Etruscan Society*. Cambridge University Press, Cambridge.
- Jaen, M.M., Peñaflores Ramírez, N.G., and Silverstein, J.E. 2016. *The Ancient Hydraulic Catchment Systems of the Tepeaca-Acatzingo Archaeological Zone*. Pueblo, Mexico. In *Underground Aqueducts Handbook*, eds. A.N. Angelakis, E.D. Chiotis, S. Eslamian, and H. Weingartner, pp. 475–487, Boca Raton, FL, CRC Press.
- Kakavogiannis, E. and Koursoumis, S. 2013. Localiazation, recording and mapping of ancient mining shafts in the peninsula of Laurion (in Greek), *Αρχαιολογική Εφημερίς, Η εν Αθήναις Αρχαιολογική Εταιρεία*, Athens, Greece, 77–102.
- Kamash, Z. 2006. Water Supply and Management in the Near East, 63 BC–AD 636. PhD Thesis, Magdalen College/Institute of Archaeology, University of Oxford, <http://www.romanaqueducts.info/aquaportal/kamash2006.htm>
- Kaysers, P. and Waringo, G. 2003. Die unterirdische Wasserleitung der Raschpëtzer, ein Monument antiker Ingenieurbaukunst aus Luxemburg. 'Wasserversorgung aus Qanaten – Qanate als Vorbilder im Tunnelbau', vol. 26, Internationales Frontinus-Symposium, Schriftenreihe der Frontinus-Gesellschaft, Walferdange, Luxemburg, pp. 277–292.
- Khan, S., Ul-Hasan, M., and Fani, M.I. 2016. Historical Development of Qanats/Underground Aqueducts in Pakistan. In *Underground Aqueducts Handbook*, eds. A.N. Angelakis, E.D. Chiotis, S. Eslamian, and H. Weingartner, pp. 425–448, Boca Raton, FL, CRC Press.
- Kienast, H.J. 1995. Die Wasserleitung des Eupalinos auf Samos. In *Kommission bei R. Habelt*, 215 pp, DAI, Bonn.
- Lane, K. 2016. *Puquios and Aqueducts in the Central Andes in South America*. In *Underground Aqueducts Handbook*, eds. A.N. Angelakis, E.D. Chiotis, S. Eslamian, and H. Weingartner, pp. 465–474, Boca Raton, FL, CRC Press.
- Leveau, P. 2012. D'Alexandrie d'Égypte à Caesarea de Maurétanie: transfert de technologie hydraulique et diffusion d'un nouveau modèle urbain. In *Entre Afrique et Égypte: relations et échanges entre les espaces au sud de la Méditerranée à l'époque romaine*, ed. S. Guéron, pp. 157–175, Paris, Ausonius Éditions, Scripta Antiqua 49.
- Leveau, P. 2015. Qanâts, hyponomoi, cuniculi et specus: une contribution à l'histoire des techniques hydrauliques. In *La technologie gréco-romaine. Transmission, restitution et médiation*, eds. P. Fleury, C. Jacquemard, et S. Madeleine, pp. 149–176, University of Caen, Normandie.
- Lightfoot, D.R. 2000. The origin and diffusion of qanats in Arabia: New evidence from the northern and southern peninsula, *The Geographical Journal*, 166:215–226.
- Lofrano, G., Carotenuto, M., Maffettone, R., Todaro, P., Sammataro, S., and Kalavrouziotis, I.K. 2013. Water collection and distribution systems in the Palermo Plain during the Middle Ages, *Water*, 5:1662–1676. doi:10.3390/w5041662.
- Mattingly, D., Lahar, M., and Wilson, A. 2009. DMP V: Investigations in 2009 of cemeteries and related sites on the west side of the Taqallit Promontory, *Libyan Studies*, 40:95–131.
- Nalbandyan, M. 2016. Ancient Aqueducts and Irrigation System in Armenia. In *Underground Aqueducts Handbook*, eds. A.N. Angelakis, E.D. Chiotis, S. Eslamian, and H. Weingartner, pp. 305–322, Boca Raton, FL, CRC Press.
- OSS (Observatoire du Sahara et du Sael), 2004. *The North-Western Sahara Aquifer System: Hydrogeology*, Vol II, OSS, Tunis, Tunisie, 153 pp.
- Porath, Y. 2014. When the Qanat Systems were introduced to the Holy Land? In *Cura Aquarum in Israel II – Water in Antiquity*, Vol 21, eds. C. Ohlig and T. Tsuk, pp. 65–69, Siegburg, DWHG.
- Remini, B. and Achour, B. 2008. Les foggaras du Grand Erg Occidental Algerien, *Larhyss Journal*, 7:21–37.



- Remini, B., Achour, B., et Kechad, R. 2010. La foggara en Algérie: un patrimoine hydraulique mondial, *Revue des sciences de l'eau*, 23:105–117. doi:10.7202/039903ar.
- Rizk, Z.E. and Alsharhan, A.S. 2016. Aflaj Al Emarat: History and factors affecting recharge, discharge and water quality, United Arab Emirates. In *Underground Aqueducts Handbook*, eds. A.N. Angelakis, E.D. Chiotis, S. Eslamian, and H. Weingartner, pp. 261–278, Boca Raton, FL, CRC Press.
- Sala, R. 2016. Ancient water mining by tunnels and wells in West Central Asia. In *Underground Aqueducts Handbook*, eds. A.N. Angelakis, E.D. Chiotis, S. Eslamian, and H. Weingartner, pp. 333–359, Boca Raton, FL, CRC Press.
- Salvini, M. 2001. Pas de qanats en Urartu ! In *Irrigation et drainage dans l'Antiquité, qanats et canalisations souterraines en Iran, en Égypte et en Grèce*, ed. P. Briant, pp. 143–155, Collège de France, Paris.
- Tanimoto, C. and Shimada, I. 2016. Underground aqueducts in Japan. In *Underground Aqueducts Handbook*, eds. A.N. Angelakis, E.D. Chiotis, S. Eslamian, and H. Weingartner, pp. 363–384, Boca Raton, FL, CRC Press.
- Wessels, J.I. 2016. Qanats of Syria. In *Underground Aqueducts Handbook*, eds. A.N. Angelakis, E.D. Chiotis, S. Eslamian, and H. Weingartner, pp. 229–240, Boca Raton, FL, CRC Press.
- Wilkinson, T.J. 2003. *Archaeological Landscapes of the Near East*. University of Arizona Press.
- Wilkinson, T.J., Bouchard, R., Ertsen, M.W., Gillmore, G., Kennet, D., Magee, P., Rezakhani, K., and De Schacht, T. 2012. From human niche construction to imperial power: long-term trends in ancient Iranian water systems, *Water History*, 4:155–176. doi:10.1007/s12685-012-0056-9.
- Wilson, R.J.A. 2001. Aqueducts and water supply in Greek and Roman Sicily: The present *status quaestionis*, Cura Aquarem in Sicilia. In *Proceedings of the Tenth International Congress on the History of Water Management and Hydraulic Engineering in the Mediterranean Region*, ed. G.C.M. Jansen, Syracuse, May 1998, pp. 5–36, Peeters, Leuven.
- Wilson, A.I. and Mattingly, D.J. 2003. Irrigation technologies: Foggaras, wells and field systems. In *The Archaeology of Fazzan, Vol 1: Synthesis*, ed. D.J. Mattingly, pp. 235–278, Society of Libyan Studies, London.
- Wilson, A.I. 2005. Foggara irrigation, early state formation and Saharan trade: The Garamantes of Fazzan, *Schriftenreihe der Frontinus Gesellschaft*, 26:223–234 (Walferdange).
- Wilson, A.I. 2008. Hydraulics engineering and water supply. In *Oxford Handbook of Engineering and Technology in the Classical World*, ed. J.P. Oleson, pp. 285–318, Oxford University of Press, New York.
- Wuttmann, M. 2001. Les qanats de Ayn-Manâwîr (oasis de Kharga, Égypte). In *Irrigation et drainage dans l'Antiquité, qanats et canalisations souterraines en Iran, en Égypte et en Grèce*, ed. P. Briant, pp. 15–40, Collège de France, Paris.
- Wuttmann, M., Briois, F., Midant-Reynes, B., and Dachy, T. 2012. Dating the end of the Neolithic in an Eastern Sahara Oasis: Modeling absolute chronology, *Radiocarbon*, 54:305–318.
- Yechezkel, A. and Frumkin, A. 2016. Spring tunnels (Niqba'): The Jerusalem hills perspective. In *Underground Aqueducts Handbook*, eds. A.N. Angelakis, E.D. Chiotis, S. Eslamian, and H. Weingartner, pp. 151–172, Boca Raton, FL, CRC Press.
- Zambas, C., Dounias, G., and Angistalis, G. 2016. The aqueduct of Eupalinos on Samos, Greece and its restoration. In *Underground Aqueducts Handbook*, eds. A.N. Angelakis, E.D. Chiotis, S. Eslamian, and H. Weingartner, pp. 63–80, Boca Raton, FL, CRC Press.

# *Section II*

---

*Europe*



# Taylor & Francis

Taylor & Francis Group

<http://taylorandfrancis.com>



---

# 2 Roman Underground Hydraulic Structures in Dalmatia, Croatia

*Katja Marasović, Snježana Perojević, and Jure Margeta*

## CONTENTS

2.1	Introduction—Roman Dalmatia.....	19
2.2	Water Resources of Dalmatia .....	20
2.2.1	Water Resources and Hydrogeological Properties .....	20
2.2.2	Morphology .....	21
2.2.3	Climate .....	22
2.2.4	Flows.....	22
2.3	Roman Aqueducts in Dalmatia.....	22
2.3.1	Navalia (Novalja).....	23
2.3.2	Cissa (Caska).....	23
2.3.3	Aenona (Nin) .....	23
2.3.4	Iader (Zadar).....	24
2.3.5	Asseria .....	25
2.3.6	Scardona (Skradin) .....	26
2.3.7	Burnum .....	26
2.3.8	Salona (Solin).....	27
2.3.9	Diocletian’s Palace (Split).....	27
2.3.10	Tilurium (Gardun).....	28
2.3.11	Epidaurum (Cavtat).....	28
2.4	Underground Section of Diocletian’s Palace Aqueduct.....	29
2.5	Underground Section of Navalia Aqueduct.....	31
2.6	Conclusion .....	35
	Acknowledgment .....	35
	References.....	35

## 2.1 INTRODUCTION—ROMAN DALMATIA

Dalmatia is a region of Croatia that occupies its southernmost part between the Adriatic Sea and the neighboring Republic of Bosnia and Herzegovina. It covers around 12,260 km<sup>2</sup>, that is, about 22% of Croatia’s surface, with a population of around 860,000, or 20% of Croatia’s population. During the Roman Empire, Dalmatia was by its surface 7.5 times larger and spread between the Raša River in Istria in the west, Pannonia in the north, the Drina River in the east, and the Mata River in Albania in the south. In the Bronze Age, this whole area was inhabited by the Illyrians. The Greeks colonized the Adriatic islands in the fourth century BC, and in the third century BC, they spread onto the coast. The Romans gradually infiltrated first as protectors of the Greeks and later through direct conflicts with the Illyrians in order to take over the whole territory. They finally succeeded

when in AD 6–9 they put down the rebellion of the great Illyrian chieftain Bato and then a period of peace and prosperity began. Towns that demonstrated loyalty to Rome were granted the status of colonies. They all had town walls, public buildings, water supply systems, sewage, and all other facilities like any other town of Empire. During the rule of Augustus and Tiberius, a whole road network was built, departing from Salona, the capital and the largest city of the Roman province of Dalmatia, which is thought to have had a population of 60,000. Besides Salona, large urban centers that enjoyed the status of agrarian colonies were Iader (Zadar), Salona (Solín), Aequum (Čitluk near Sinj), Naroná (Vid near Metković), and Epidaurus (Cavtat). The agricultural areas surrounding the towns were divided into lots  $710 \times 710$  m, distributed to Roman colonizers. In such a way, this originally Illyrian area was gradually Romanized. The economy of the Roman province of Dalmatia consisted mostly of agriculture and farming but also of fishing, maritime affairs, and crafts. The Dalmatian inland (present-day Bosnia and Herzegovina) was known for its iron, lead, and silver mines.

## 2.2 WATER RESOURCES OF DALMATIA

### 2.2.1 WATER RESOURCES AND HYDROGEOLOGICAL PROPERTIES

The area of Dalmatia belongs to the Croatian karst littoral area, mostly occupying the entire Croatian Adriatic basin. The Croatian Littoral karst abounds in various karst forms but also in water phenomena, both underground and surface waters. Some of them, such as permanent karst springs and abundant aquifers of clear water, have important social, economic, and ecological values. Their existence was crucial for the permanent settlement and development of urban centers on the Croatian Littoral as well as of Roman settlements. Their function is the same today and will remain such in the future.

In the area of Dalmatia, there are several permanent water flows, namely rivers Cetina, Jadro, Krka, Zrmanja, and Neretva that flows from Bosnia and Herzegovina (Figure 2.1). There are no



FIGURE 2.1 Water flows of Dalmatia.

natural lakes, and the aquifer are typical karst aquifers that feed surface water springs. Besides these permanent surface flows, during the winter rainy period, there are a number of smaller surface water flows that mostly dry out in the spring and disappear underground. That is why, the aforementioned rivers are the only permanent water sources in this area.

In the area of Dalmatian, water resources mostly consist of limestone, dolomites and marl Mesozoic, and Eocenic limestone and very few areas of Permian limestone. Deposits in the basin are flysch sediments of Eocene, clasts from the Trias, and Paleocene marl. The youngest layers are Quaternary diluvial karst field sediments of predominantly silty sandstone structure with a different portion of carbonate rock karst fragments.

Mesozoic and Eocenic limestones are mostly well-permeable rocks, with the function of a main aquifer. Depending on the presence of the dolomite and marl components, the permeability of limestone decreases into middle to fairly permeable rocks. Classic sediments of Eocenic flysch, clasts from the Trias, and Paleocene marls are impermeable rocks. They create hydrogeological barriers that form aquifers, and at permeable areas, there are springs, as is the case with rivers Jadro, Zrmanja, Ombla, and a number of smaller water sources.

Islands in Croatia generally do not have surface waters. The only fresh water besides rainwater are fresh water lenses below the islands – the fresh water floating on the seawater. Such underground waters are particularly characteristic of some Dalmatian islands such as Pag, Silba, Brač, Vis, and Hvar. Vertically and quickly, surface waters penetrate through the karst into the sea level, where they fill the aquifer beneath the island during rainy periods. In dry periods, the accumulated water on the rim of the island is gradually discharged, depending on the permeability of perimetral geological layers. If the littoral karst cracks are filled, draining is slower, resulting in underground waters conservation at some locations throughout the year. If a shaft or well is dug up to sea level and several meters deeper, water can be scooped up. A similar phenomenon is also present in hinterland aquifers (Hrvatske vode 2009).

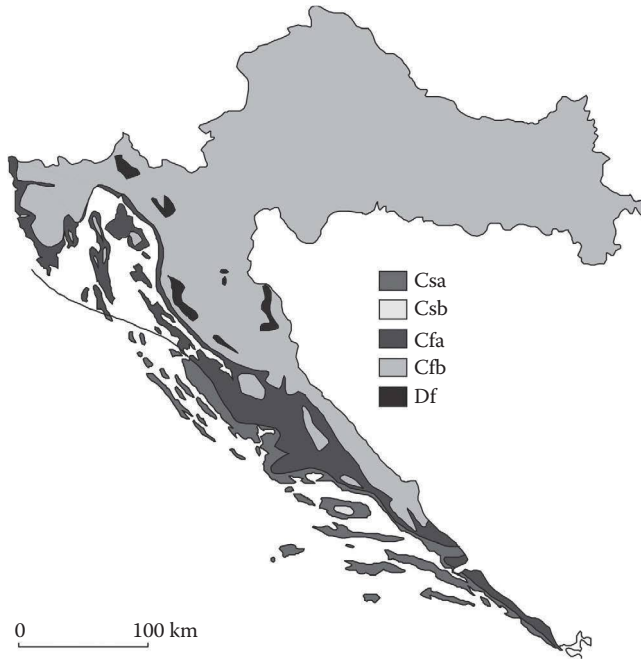
The area of the Adriatic basin is characterized by pronounced fragmentation and present tectonic activity, leading to changes in structural features of the system of faults and crevices. This is indicated by constant trembling in this area. All together, this affects the circulation of underground flows, which in a lesser or greater extent constantly changes. Moreover, bringing surface sediment constantly into deeper layers and cracks leads to their filling, which also affects the direction of flow and size of water filtration, particularly in dry periods of the year, when the aquifer is at its lowest level. Over time, sediments increased, and in Roman times, they were supposedly somewhat smaller than today. Characteristics of the entire basin were also different, which is why the amount of net rainfall and the amount of surface outflow were different.

It may therefore be assumed that the abundance of water resources slowly but constantly changes and that it was not the same in Roman times.

### 2.2.2 MORPHOLOGY

The Adriatic basin spreads from the littoral to the peaks of the littoral Dinarides, stretching along the Adriatic Littoral at a lesser or greater distance from it. The littoral mountains are more than 1000 m high, covered with snow during the winter, which in the spring supplies the water resources.

The fields and the elevations stretch in the northwest–southeast direction. The elevated parts of the relief are solid carbonate rocks (limestone and dolomite), with all elements of karst morphology (ponors, pits, caves, karren, sinkholes, dry valleys, steep slopes, and other). Morphological depressions are mostly built of dusty-clay sediments of different types and ages. Terrace-like sediments are partly formed. Within the depressions, mostly along the rims, flows and ponors can be seen. Short-term outflows appear only in the event of intensive rainfall. The plateaus also show subsidence in classical sediments of karst fields.



**FIGURE 2.2** Climate in Croatia according to Köppen classification. (From Šegota, T. and Filipčić, A., *Geoadria*, 8/1, 17–37, 2003. With Permission.)

### 2.2.3 CLIMATE

The climate is typically Mediterranean. It is characterized by cool, wet winters and dry, hot summers. Rainfall, and thus, water, appears when least needed. That is why permanent but rare water sources were the most reliable resources for water supply.

According to the Köppen climate classification, which besides the basic expression of climate takes into account the native vegetation (Figure 2.2), the area of Dalmatia mostly belongs to climate C, that is, moderately warm rainy climate. It is a climate whose mean temperature of the coldest month is not below  $-3^{\circ}\text{C}$  and at least 1 month has a temperature above  $10^{\circ}\text{C}$ . The coastal area belongs to moderately warm Csa climate, that is, Mediterranean climate with hot summers. It is a moderately warm climate of dry summer period, with air temperature in the hottest month  $T > 22^{\circ}\text{C}$ . The basin, that is, the interior area toward the Dinarides, would also belong to the moderately warm climate C but perhaps closer to category Cfa than to category Csa. This category of moderately warm wet climate with hot summers does not have an extremely dry period, and each month has more than 60 mm of rainfall, with air temperature in the warmest month  $T > 22^{\circ}\text{C}$ .

### 2.2.4 FLOWS

Owing to such geological, hydrogeological, and climatic features, the capacities of water resources in Dalmatia are very variable, seasonal, and also shorter. The flow of rivers and springs changes rapidly and significantly depends on the intensity of rainfall.

## 2.3 ROMAN AQUEDUCTS IN DALMATIA

In the area of present-day Dalmatia, eleven Roman aqueducts have been established until the present, namely nine that belonged to urban areas and two that belonged to military camps. They will be described according to their position, from north to south (Figure 2.3).



**FIGURE 2.3** Roman aqueducts of Dalmatia: (1) Navalia, (2) Cissa, (3) Aenona, (4) Jader, (5) Asseria, (6) Scardona, (7) Burnum, (8) Salona, (9) Diocletian's Palace, (10) Tilurium, and (11) Epidaurum.

### 2.3.1 NAVALIA (NOVALJA)

The Roman port Navalia was situated in a bay in the northwest of Pag island, at the site of present-day Novalja. In order to supply their ships with drinking water, the Romans built a 4 km long aqueduct, of which 1000 m was dug as a tunnel in bedrock. Along with the aqueduct of Diocletian's Palace in Split, existence of the tunnel makes it unique in the area of the Roman province of Dalmatia and will be described in more details in Section 2.5.

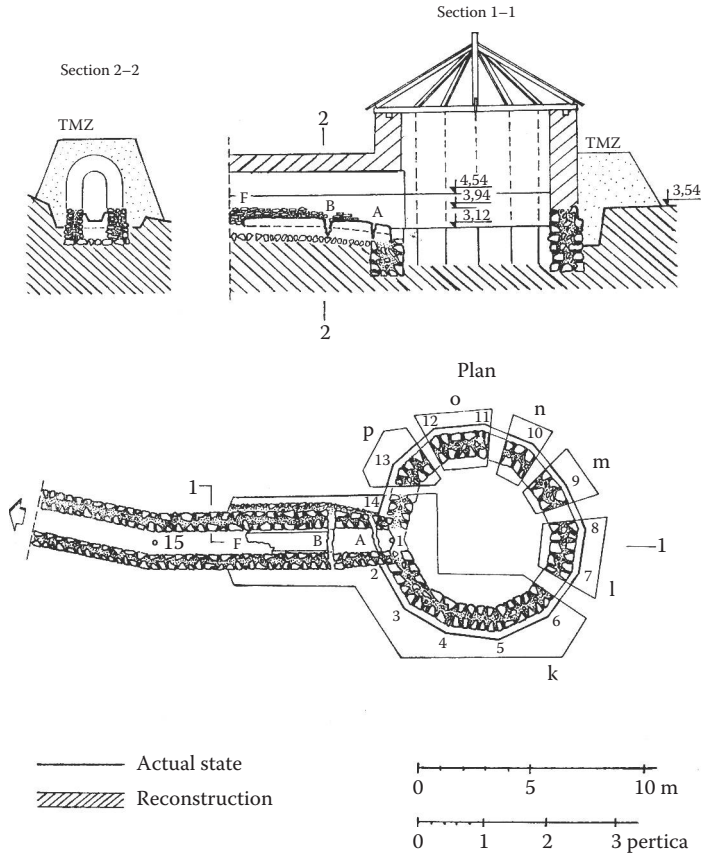
The Navalia aqueduct was supplied with water from the Škopalj spring. It was discovered in the first half of the nineteenth century, and in the beginning of the twentieth century, it was reused by laying a water pipe into the channel. The water was then pumped from the spring by pumps powered by a windmill, a motor since 1929, and electric energy since 1949. It is no longer in use today (Ilakovac 2008).

### 2.3.2 CISSA (CASKA)

The largest Roman settlement on Pag island was Cissa, present-day Caska. The remains found until the present are parts of the town's defensive walls, houses, and a 12 km long aqueduct system. From the spring, in the area of Kolan to Roman Cissa, the route of the aqueduct followed terrain contour lines, occasionally cut into the terrain and at some places mounted on the bridges with arches. The route segment across the Novalja field valley was presumably done by a siphon. Only lower parts of the channel were found, and it may be determined that it was only 18 cm wide (Ilakovac 1982).

### 2.3.3 AENONA (NIN)

First, an Illyrian (Liburnian) settlement, and later, Roman Aenona, present-day Nin, was situated on a peninsula in the lagoon of the bay of Nin, in the Zadar hinterland. It was granted the status of



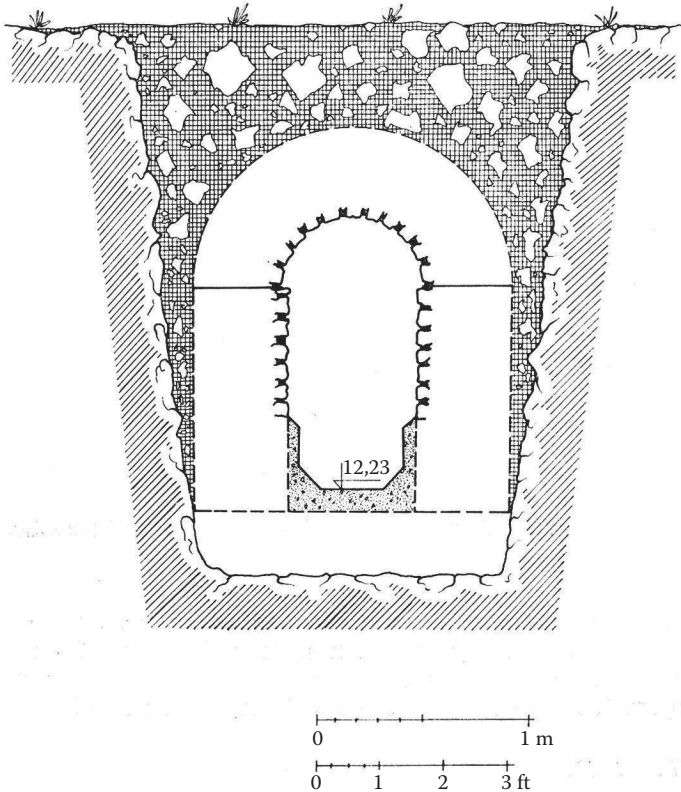
**FIGURE 2.4** Polygonal water intake of Aenona aqueduct. (From Ilakovac, B. *Rimski akvedukti na području sjeverne Dalmacije, Liber, Zagreb/Arheološki muzej*, 1982. With Permission.)

a Roman town during Augustus (Suić 1976), and this is presumably when its aqueduct was built. Remains of the aqueduct were for the first time noticed in 1955, after which systematic archaeological excavations were carried out.

The aqueduct of Aenona was supplied with water from Boljkovac spring, about 3.5 km from the town, with minimum summer capacity of 100 L/s. Its spring yielded remains of a polygonal water intake (*castellum fontis*) (Figure 2.4) and a channel leading the water toward Nin. At the 23rd meter of the channel, there is a double lock and the beginning of the second parallel channel, supplying a mechanic device with water. The gravity channel of the Aenona aqueduct followed the terrain contour lines, a greater part of which was executed as a “superficially-dug channel,” while its lesser part was completely cut in the rock. Because of small level difference between the spring and the town, a longitudinal slope of the channel was extremely gentle and varied from 0.077‰ to 0.095‰. The channel was 80–86 cm wide (the widest of all aqueduct channels of Roman Dalmatia) (Ilakovac 1982).

**2.3.4 IADER (ZADAR)**

Liburnian Iadera, Roman Iader, present-day Zadar, was the second largest town in Roman Dalmatia, right after Salona. As early as the first century BC, it was a *municipium*, and during Augustus, it became *Colonia Iulia Iader*. The name of the city represents a hydronym that denotes an abundance of water sources in the Zadar peninsula. Despite this, standards of such an urban center required the construction of the aqueducts that would supply the town with water in sufficient quantities and



**FIGURE 2.5** Aqueduct channel of Jader aqueduct. (From Ilakovac, B. *Rimski akvedukti na području sjeverne Dalmacije*, 1982. With Permission.)

under appropriate pressure. That is why two aqueducts were built, both at the end of the first century AD, during the reign of Emperor Trajan. The older one, 40,35 km long, was supplied with water from the Biba spring near Lake Vrana about 40 masl. The channel is 60 cm wide and the longitudinal slope is between 0.64‰ and 2.54‰ (Figure 2.5). On the aqueduct route, a valley about 5 km long and about 36 m deep was bridged over by a siphon. Remains of the siphon made of stone pipe 35 cm of inner diameter were found, and beside it, there was a lead pipe of inner diameter around 15 cm (thickness of walls 2 cm), which is why Ilakovac concludes that the stone siphon did not function due to large pressure and had to be replaced very soon by a lead siphon. The second aqueduct in Zadar was supplied with water from Botina spring and was 3.4 m long to the point where it joined the older aqueduct. The level difference of 26.4 m is solved with a longitudinal slope of as much as 7.76‰. The width of the channel is only 21 cm. Owing to a number of subsequent construction interventions on both springs, remains of Roman water intakes are not possible to find (Ilakovac 1982).

### 2.3.5 ASSERIA

Liburnian Asseria developed on a natural promontory, dominating the area east of Benkovac. In the first century, it became a Roman *municipium*. Excavations yielded remains of massive walls with towers and the city gate, the forum, and several houses. (Suić 1976). In the seventh century, it shared the fate of other towns of Roman Dalmatia that were abandoned due to Avar incursions (Čače 2003). Asseria is nowadays a significant archaeological site.

Ilakovac presumes that the Asseria aqueduct was supplied with water from Bunar Čatrnja. Several modest remains that could have belonged to the aqueduct route were found, according



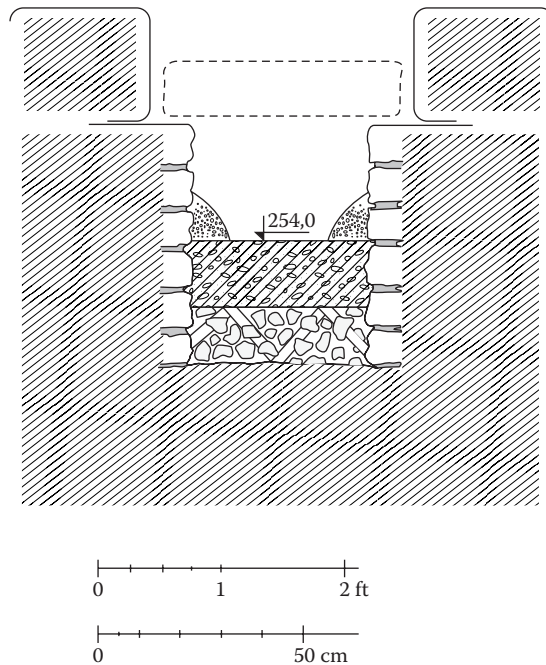
to whose position, he concludes that the route was linear, without winding, approximately 4 km long. Two stone blocks of the gravity channel with a gutter 19.5 cm wide were found. Ilakovac also describes remains of a high masonry support, only 56 cm wide, considered to be made in order to avoid making a siphon or to reduce the difference in height and pressure in the siphon on one part of the route where the valley had to be spanned (Ilakovac 1982).

### 2.3.6 SCARDONA (SKRADIN)

Little city of Skradin, Roman Scardona, is located in the Šibenik hinterland at the right bank of the Krka river, exactly on the point to which the river is navigable. Originally, Liburnian, under the Roman rule, became the seat of the court of justice (*conventus iuricus*). Remains of the Roman aqueduct can be seen east of Skradin, above the road that leads to Skradinski buk. It has not been studied until the present, but it was supposedly about 6 km long, with water being drawn above the falls of Skradinski buk (Ilakovac 1982).

### 2.3.7 BURNUM

The military camp Burnum was founded in the beginning of the first century, at a strategic position, some 100 m above the Krka River, which before the construction of the aqueduct must have made the water supply of the castrum fairly difficult. According to Ilakovac, the construction of the aqueduct is dated to 20 AD and ceased to function in 536–537 AD. During 1973–1974, systematic archaeological excavations were carried out, in the course of which the route was entirely defined, and it was concluded that the water was drawn from Glib spring in Plavno polje. Owing to the complexity of the terrain configuration, the route partly passed across cuts and trenches through the rocks, up to 9 m deep, with the channel 1 Roman foot wide (approximately 30 cm). At favorable segments, the channel was 42 cm wide and 30 cm high (Figure 2.6), passing above the ground, and its remains



**FIGURE 2.6** Aqueduct channel of Burnum aqueduct. (From Ilakovac, B. *Rimski akvedukti na području sjeverne Dalmacije, Liber, Zagreb/Arheološki muzej, Zadar, 1982. With Permission.*)



were later used as roads or perimeter walls. The overall length of the aqueduct is 32.6 km, the level difference is 171 m, the average longitudinal slope is 5.24‰, and capacity is 168 L/s. Approximately at the middle of the aqueduct route, remains of a large reservoir 138 × 25 m were found, laid parallel with the channel south of it. This reservoir is commonly named *ribnjak* (fishpond) (Ilakovac 1982).

### 2.3.8 SALONA (SOLIN)

Even during Caesar's lifetime (before 27 BC), the Illyrian town of Salona was granted the status of a Roman colony and became the capital of Illyricum and later of the Roman province of Dalmatia. The aqueduct of Salona was built at the end of the first century BC during Augustus (Katić 1999). It drew water from the Jadro River spring, 3 km east of Roman Salona, at elevation 33.50 masl. The minimum summer flow of the spring is 3.5 m<sup>3</sup>/s, and the maximum winter flow is 60 m<sup>3</sup>/s (Bonacci 2012). The channel route follows terrain contour lines. It is partly buried underground, partly semi-buried in the slope, and partly laid on masonry support. The average longitudinal channel slope is 2‰, and the overall length from the spring to Porta Cesarea is 4.7 km. The channel 60–80 cm wide and 105–120 cm high was built up of large stone slabs (floor, sidewalls, and cover) and simple stone masonry (Figure 2.7). Large segments of the Solin aqueduct channel were destroyed in the twentieth century, owing to intensive exploitation of marl in that area (Margeta 2015).

### 2.3.9 DIOCLETIAN'S PALACE (SPLIT)

Simultaneously with the construction of Diocletian's Palace, its aqueduct was built, too (by 305 AD), which, alike the Solin aqueduct, drew water from the Jadro River spring. The overall length of Diocletian's aqueduct is 9.5 km. It consisted of a 7.1 km long channel laid on the ground, 600 m on bridges (Figure 2.8), 100 m in cuts, and 1.7 km in tunnels, which will be dealt with in more details in Section 2.4. The longitudinal slope of the channel varies from 0.65‰ to 2.66‰; the channel is 60 cm wide and 120 cm high, covered by the vault of 30 cm in radius. According to the hydraulical calculation, the channel capacity in Roman times was 715 L/s. The aqueduct was in use until the seventh century, when it was destroyed by the Avars. At the end of the nineteenth century, it was reconstructed and used for the water supply of the city of Split that developed from Diocletian's



FIGURE 2.7 Aqueduct channel of Salona aqueduct.



**FIGURE 2.8** Aqueduct bridge of the Diocletian's Palace aqueduct. (From Marasović, K. et al. Water supply system of Diocletian's palace in Split - Croatia. In *IWA Regional Symposium on Water, Wastewater and Environment: Traditions and Culture*, ed. I.K. Kalavrouziotis and A.N. Angelakis, pp. 163–173, 2014. With Permission.)

Palace. More than half of its original route is still in use. Nowadays, the Roman channel capacity is 470 L/s, somewhat less than one third of the overall water supply of the Split basin with a population of approximately 300,000 inhabitants (Marasović et al. 2014).

### 2.3.10 TILURIUM (GARDUN)

Tilurium (present-day Gardun) was first an Illyrian (Delmat) hillfort and afterward a castrum of the VII Roman legion that arrived in Dalmatia at the beginning of the first century. By ruling of Emperor Claudius, it became the only colony in the interior of the province of Dalmatia. Remains of the Tilurium aqueduct have not been found until the present, but an inscription from 147 to 171 AD mentions that members of the VIII cohort built a water tower “*turrem ad aquam tollendam fecit*” (Zaninović 2011).

### 2.3.11 EPIDAURUM (CAVTAT)

The Roman colony of Epidaurum was founded in the first century BC at the site of present-day Cavtat situated on a peninsula, 11 km southeast of Dubrovnik. In order to serve the city with water, a 23.6 km long aqueduct was built in the first century, whose route followed the northern rim of the large Konavle field. This field was named after the aqueduct channel (canale - Konavle). Its construction is related to P. Cornelius Dolabella, who was governor of Dalmatia from AD 14 to 20, that is, during the reigns of Augustus and Tiberius. The first recordings about the aqueduct were brought by Sir Arthur Evans, who, at the end of the nineteenth century, visited the surroundings of Dubrovnik.

The aqueduct drew water from the Vodovađa spring (Sv. Ivan) at elevation 321 masl, and its route follows the terrain contour lines. The channel is 45 cm wide and 60 cm high, covered by the vault of 33 cm in radius. The channel is mostly half buried in the slope, and at some places, it was laid on a masonry support. The first 3 km have longitudinal slope of 3%–4%, after which it varies from 0.07% to 0.38%. Before the town, it suddenly loses height and is supposed to have accessed the peninsula by means of a siphon across a narrow isthmus. It further went on along the ridge of the

peninsula, that is, the main decumanus and ended with a large cistern and nymphaeum, which have been preserved only in fragments (Kovačić 2015).

## 2.4 UNDERGROUND SECTION OF DIOCLETIAN'S PALACE AQUEDUCT

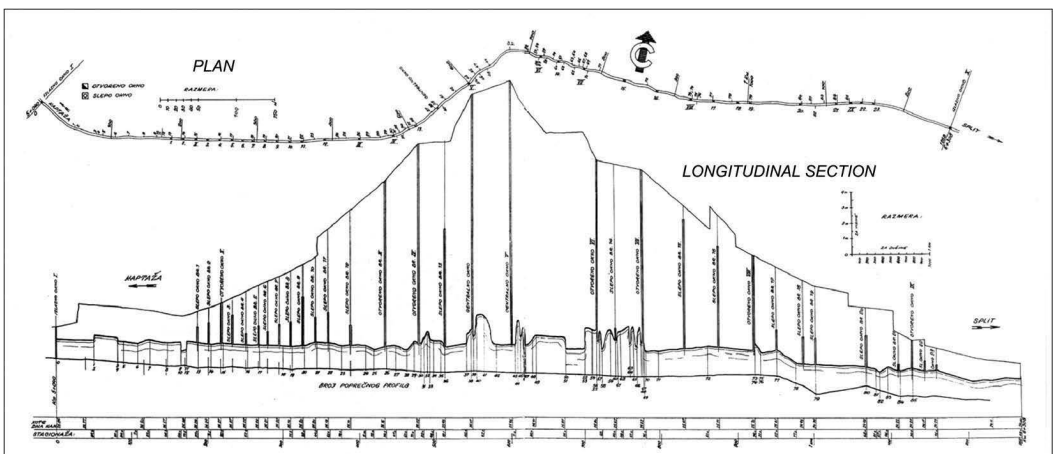
As previously said, 1.7 km of the 9.5 km of Diocletian's Palace Roman aqueduct channel was laid underground in three tunnels. The first one 287 m long is at 3000 m from the spring, the second 120 m long at 4650 m, and the third 1268 m long at 5040 m from the spring (Figure 2.9). Unlike the first two that supply Split with water even today, the third is no longer in use from 2004. Therefore, it is possible to visit it today. The authorized water company releases small amounts of water into the channel, so that its masonry channel and marl vaults do not dry up and therefore collapse.

The tunnel was dug in marl, and its profile varies, which is related to natural marl layers that form the vault (Figure 2.10). The masonry channel 60/120 cm in section was laid in the tunnel and is largely preserved with the original red plaster (Figure 2.11). The route of the tunnel winds and does not follow a straight line, so it can be assumed that the builders followed the marl layers, avoiding those of solid limestone, which is typical for the Split peninsula.

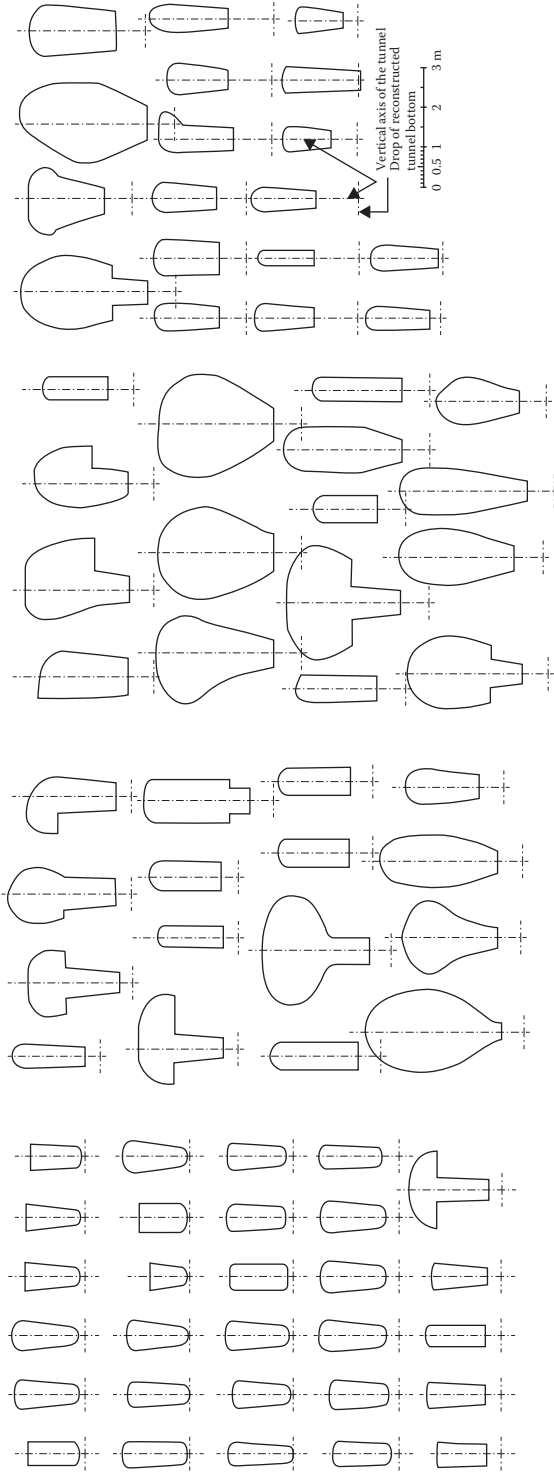
There are 32 vertical shafts on the tunnel route, which were used for its digging. Once the vertical shaft was dug to the channel alignment, the digging of the horizontal tunnel pipe began in two directions, and the shaft served for taking out the material. In this way, more working spots were opened during the digging of the tunnel, which significantly accelerated its construction.

The shafts have a square plan, with a cross section of 80 × 80 cm, enclosed in stone, and every 1.5 m in height have a horizontal strip along the rim that probably served for leaning the wooden platform or wooden ladder used by workers to climb down into the tunnel (Figure 2.12). Of the 32 shafts, 23 are closed and 9 are open. The majority of shafts were closed already in Roman times, so as to prevent objects and animals from falling inside. Those that remained open served for aeration of the aqueduct channel. These openings are presently closed with concrete slabs for security reasons.

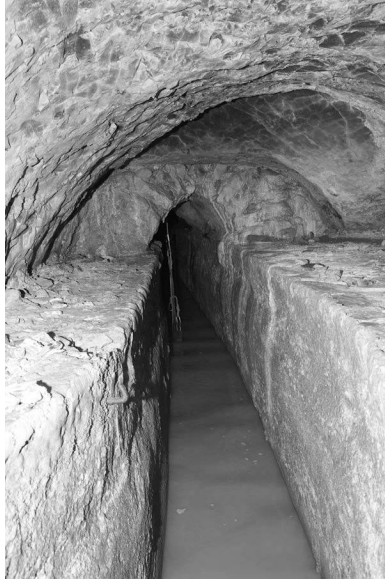
Shafts were densely placed at the beginning and at the end of the tunnel, while toward the middle, they were sparsely arranged. At the beginning, 5 m high shafts are arranged at a distance of at least 12 m, while in the middle of the route, the shafts 16–18 m high are at a distance of more than 100 m. The original Roman staircase for descending into the tunnel was preserved around the 17 m high central shaft (Figure 2.13). Staircase served for inspection and maintenance of the tunnel.



**FIGURE 2.9** Plan and longitudinal section of the “Ravne njive” tunnel. (From Katanić, N. and Gojković, M., *Građa za proučavanje starih kamenih mostova i akvedukata u Hrvatskoj*, JZZSK/RZZZSK SR Hrvatske, Beograd/Zagreb, 1972. With Permission.)



**FIGURE 2.10** Cross sections of “Ravne njiwe” tunnel. (From Katanić, N. and Gojković, M., *Građa za proučavanje starih kamenih mostova i akvedukata u Hrvatskoj*, JIZZSK/RZZZSK SR Hrvatske, Beograd/Zagreb, 1972. With Permission.)



**FIGURE 2.11** “Ravne njive” tunnel. (Courtesy of T. Bartulović.)



**FIGURE 2.12** Vertical shaft of “Ravne njive” tunnel. (Courtesy of T. Bartulović.)

It may be concluded that the construction of the Ravne Njive tunnel was the most demanding section of the aqueduct of Diocletian’s Palace.

## 2.5 UNDERGROUND SECTION OF NAVALIA AQUEDUCT

Of the 4 km long Roman aqueduct of Navalia, 1042 m of the channel went underground (Figure 2.14). The tunnel was cut in bedrock. The average width of the channel is about 60 cm, and its height varies from 120 to 220 cm (Figure 2.15).



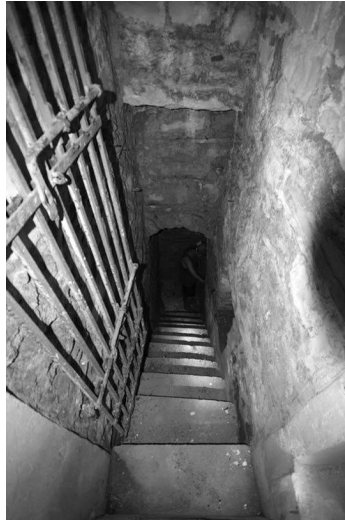


FIGURE 2.13 Staircase of “Ravne njive” tunnel.

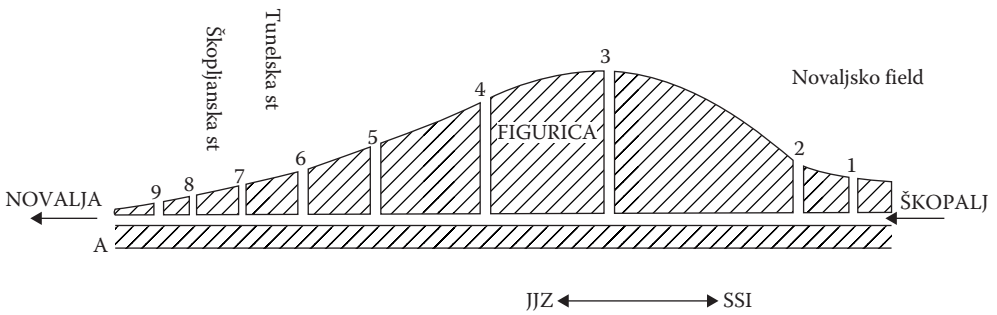
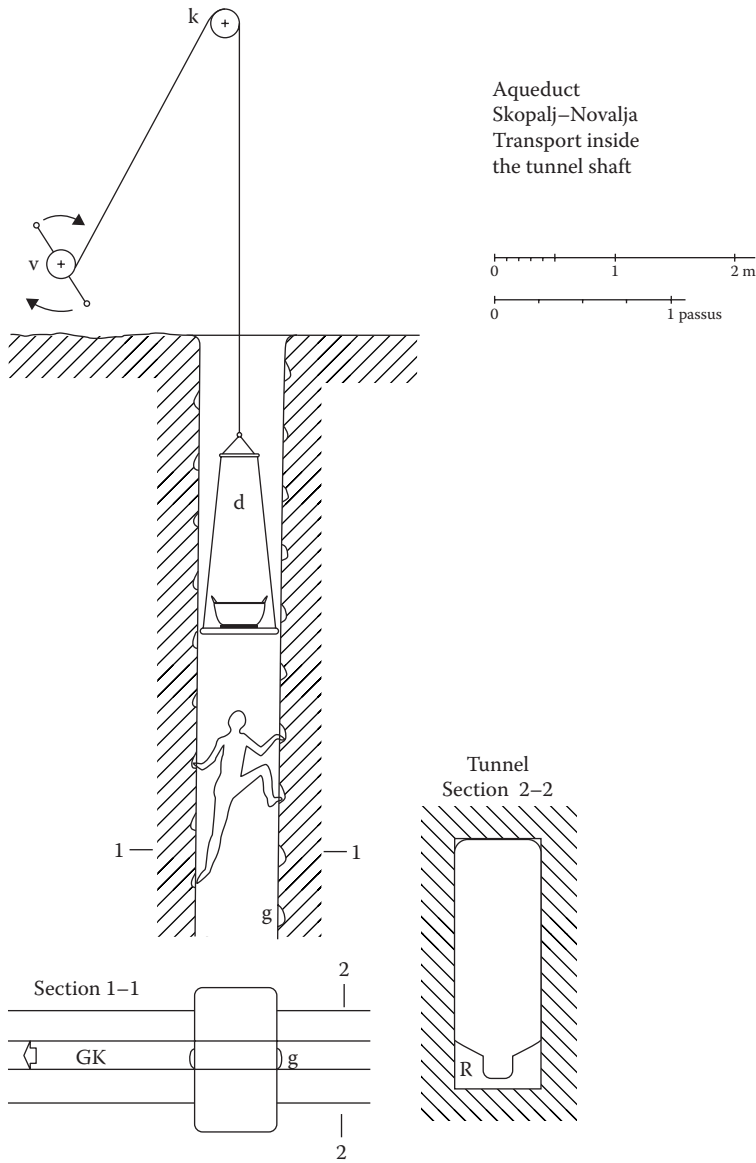


FIGURE 2.14 Longitudinal section of Navalia aqueduct tunnel. (From Ilakovac, B. VAMZ, 3.s., XLI, 129–166, 2008. With Permission.)



FIGURE 2.15 Navalia aqueduct tunnel. (From Ilakovac, B. VAMZ, 3.s., XLI, 129–166, 2008.)



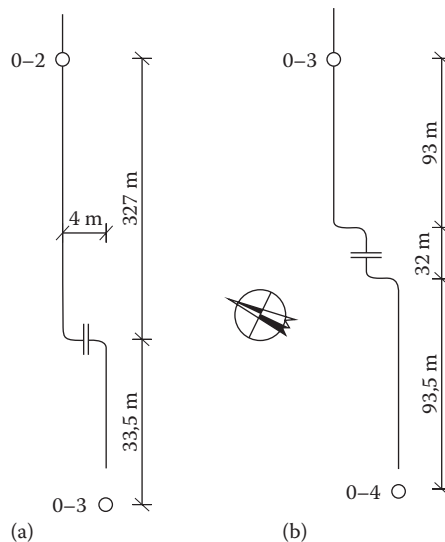
**FIGURE 2.16** Vertical shaft and aqueduct channel of Navalia aqueduct tunnel. (From Ilakovac, B. *VAMZ*, 3.s., XLI, 129–166, 2008. With Permission.)

The tunnel has nine vertical shafts made for digging a tunnel (Figure 2.16). They have a square cross section: the smallest is  $100 \times 50 \text{ cm}^2$ , and the largest is  $128 \times 76 \text{ cm}^2$ . Only shaft 7 has a circular cross section, 90 cm in diameter. The shafts are 5–44 m high, which is the height of the seventh shaft. Cuts that served as stairs for climbing can still be seen in their walls. In the course of the aqueduct reconstruction in the beginning of the twentieth century, Austrian engineers had the shaft openings walled and covered with large stone slabs (Figure 2.17).

The tunnel walls also show traces of tools used for digging, which indicate positions where certain segments were joined. The builders obviously traced the route of the tunnel very precisely, because certain segments of the tunnel were joined perfectly. However, at the junction between the



**FIGURE 2.17** Shaft no. 7 of Navalja aqueduct tunnel. (From Ilakovac, B. *VAMZ*, 3.s., XLI, 129–166, 2008. With Permission.)



**FIGURE 2.18** Deviation of Navalja aqueduct tunnel. (From Ilakovac, B. *VAMZ*, 3.s., XLI, 129–166, 2008. With Permission.)

second and third and between the third and fourth shafts, the channels missed each other for more than 4 m, which were subsequently adjusted (Figure 2.18).

As the rock in which the tunnel was dug is not compact, builders came across various cracks and even smaller caves, and the tunnel had to be walled. Roman bricks and roof tiles (*tegulae*) were used for this purpose. Some of them bear the mark of the Roman brickworks AFAESONIAF (Auli Faesoni Africani).

After the fall of the Roman Empire, the aqueduct was abandoned and was discovered only after the beginning of the nineteenth century, when a child fell into the tunnel. It is nowadays accessible, because the Novalja Town Museum has been built above it and in its basement is the entrance to the tunnel that is walkable along its entire length (Ilakovac 2008).



## 2.6 CONCLUSION

After the Romans finally overcame the resistance of the Illyrians in the first century, they finally conquered entire Dalmatia and gradually introduced all achievements of the Roman civilization. Among other things, they built aqueducts in nearly all urban centers. Most of the aqueducts were built in the first century. Unfortunately, only lesser parts of these structures have been preserved until today, and consequently, only a lesser number have been systematically studied and elaborated. For instance, the route of the Salona aqueduct is defined, thanks to the scientific project that is under way (Margeta 2015). Roman aqueduct of Diocletian's Palace in Split is only one still in function.

We can conclude that all 11 aqueducts were well adapted on the one hand to the water requirements and on the other to the location and elevation of water intake. The capacity determined the available hydraulic gradient and size of the channel. Approximately 400 L/inhab.d was the specific water consumption taken into account for the required capacity. Standard Roman practice was applied in the construction of these structures. The main building material was mostly stone, which is found here in abundance. Only two of the eleven aqueducts have a tunnel segment, which is logical, considering the limestone terrain dominant in Dalmatia. Expectantly, the best preserved aqueducts are the underground ones, such as Diocletian's and the Pag aqueduct. Both were reconstructed more than 100 years ago and have been used until recently; this speaks of the quality of the applied solution. Both underground aqueducts were built with similar technology and are of similar size, although the required capacity was different. Size was adapted to meet the needs for human maintenance activities. The available space was small and work was obviously difficult and presented a health risk for the workers. These structures possessed standard elements of underground aqueducts, free height in channels, fine ventilation, and shafts for inspection and clearing. Based on available facts, it may be concluded that aqueduct builders carefully thought about the water taken for water supply. Although hydraulically more appropriate solutions were available, those that guaranteed secure water quality were applied. This is best proved by the fact that a significant part of the same springs is still used nowadays.

## ACKNOWLEDGMENT

This material is based on work primarily supported by the Croatian Scientific Foundation under HRZZ Research Project IP-11-2013.

## REFERENCES

- Bonacci, O. 2012. Hidrološka analiza odvođenja vode iz krškog izvora rijeke Jadro. *Hrvatske vode*, 20, 79–80.
- Čače, S. 2003. Aserija u antičkim pisanim izvorima. *Asseria*, 1, 7–43.
- Hrvatske vode. 2009. Površinske vode. In *Strategija upravljanja vodama*, ed. D. Biondić, pp. 9–19.
- Ilakovac, B. 1982. *Rimski akvedukti na području sjeverne Dalmacije*, Liber, Zagreb/Arheološki muzej, Zadar.
- Ilakovac, B. 2008. Roman aqueducts on the island of Pag. *VAMZ*, 3.s., XLI, 129–166.
- Katanić, N. and Gojković, M. 1972. *Grada za proučavanje starih kamenih mostova i akvedukata u Hrvatskoj*, JIZZSK/RZZSK SR Hrvatske, Beograd/Zagreb.
- Katić, M. 1999. Salonitanski vodovod. In *Dioklecijanov akvedukt*, ed. J. Belamarić, Ministarstvo kulture Republike Hrvatske/Konzervatorski odjel – Split, Split, pp. 58–63.
- Kovačić, L. 2015. *Antički vodovod Vodovađa - Cavtat / Roman aqueduct Vodovađa - Cavtat*.
- Marasović, K., Perojević, S. and Margeta J. 2014. Water supply system of Diocletian's palace in Split - Croatia. In *IWA Regional Symposium on Water, Wastewater and Environment: Traditions and Culture*, ed. I.K. Kalavrouziotis and A.N. Angelakis, Hellenic Open University, Patras, pp. 163–173.
- Margeta, J. 2015. *Raport on scientific project: Roman Water Systems of City of Salona and Diocletian's Palace and Their Impact on Urban Sustainability (RWSCSDP) First year*.
- Suić, M. 1976. *Antički grad na istočnoj obali Jadrana*.
- Šegota, T. and Filipčić, A. 2003. Köppenova podjela klima i hrvatsko nazivlje. *Geoadria*, 8/1, 17–37.
- Zaninović, M. 2011. Tilurium, Aequum i Osinium arheološko-povijesna povezanost. In *Zbornik u čast Emilija Marina*, Kačić, pp. 499–508.



# Taylor & Francis

Taylor & Francis Group

<http://taylorandfrancis.com>

---

# 3 Roman Underground Aqueducts in Germany

Constantin Canavas

## CONTENTS

3.1 Roman Underground Aqueducts in Germany .....	37
3.2 The Eifel Aqueduct.....	38
3.3 The Aqueduct of Mainz (Mogontiacum).....	39
3.4 Heiliger Pütz (Drove Mountain, Düren in North Rhineland) .....	39
3.5 Further Underground Aqueducts.....	39
3.6 Roman Qanāts.....	39
3.7 The Aqueduct in the Ruwer Valley (Trier).....	40
3.8 The Underground Waterline of Vienna .....	40
3.9 Conclusions.....	41
References.....	41

## 3.1 ROMAN UNDERGROUND AQUEDUCTS IN GERMANY

Aqueducts dating from the imperial Roman period were constructed in the territory of present-day Germany since the first century AD. Some of them—at least partially—were constructed as underground channels. The underground character enabled a better protection of the water transfer from weather influences, as well as from destructive human interventions (Hodge 1992).

In general, underground Roman aqueducts have been much less studied than the spectacular overground ones (Leveau 2008, 145, 2015, 166). During the recent years, both kinds of sources, archaeological excavations (e.g., in France and in Germany) and new assessments of the historical records, have shifted the focus of research toward underground water networks.

Two major controversially discussed issues should be mentioned at the beginning of the present overview. One is related to the terminology—especially to the criteria of characterizing an underground channel as a *qanāt* or a *qanāt*-like aqueduct. Major features of the *qanāt* are the perpendicular manhole shafts in regular distances to each other (e.g., 10–15 m), which permit the descending from the ground surface to the underground channel between the mother well and the outlet—some hundred meters or several kilometers away from the mother well, which guarantees the water supply. The debate involves the re-assessment of the historical record (mainly the *History* by Polyvius, who, in book *Antiochus the Great In Media*, Chapter 28, describes campaigns in Media, Minor Asia in 209/208 BC and refers to underground water-carrying constructions dating back to the Achaemenid period) and the different translations provided by philologists and historians for the terms concerning these constructions. Several issues and criteria for defining or recognizing a *qanāt*, a *hyponomos*, or other old type of underground channel (such as the Etruscan *cuniculus*) have been analyzed critically and discussed, for example, during the colloquium on irrigation and drainage in the antiquity held in Collège de France (Briant 2001). Since major researchers define these constructions differently, later channels such as the Roman underground aqueducts in Italy, Gaul, and Rhineland are eventually described on the basis of different terms—depending also on the author’s assumptions concerning typology and construction technique. Thus, Goblot recognizes a *qanāt* as a water-capturing technique that follows mining tradition and experience (Goblot 1979); according to those recognition patterns,

underground aqueducts gathering water from superficial sources should not be called *qanāt*. Grewe distinguishes further between *qanāt* and tunnels constructed by the counter-excavation technique (Grewe 2008, 322–323). For the *qanāt* technique, he refers to an Arabic text by an Iranian mathematician of the eleventh century AD, al-Karājī, in which geometrical survey of constructing *qanāt* is described both theoretically and practically. Grewe summarizes the *qanāt* procedure as follows: “The planned route of the tunnel is laid across any intervening elevation in a line that allows the shafts to be as shallow as possible. [...] Next the shafts were staked out and sunk. After reaching a precisely calculated depth below ground, a straight connection was driven between the central shaft and the two adjoining shafts. The excavated spoil was transported to the surface in leather bags or baskets lifted by winches” (Grewe 2008, 323). According to Grewe, the counter-excavation technique should have appeared by the sixth century BC: “In this procedure the tunnel is driven from two sides in an attempt to meet in the middle of the mountain to be perforated” (Grewe 2008, 323). This also includes the option to dig from two adjacent shafts, with the attempt to meet in the middle of the distance separating them. From textual reports, it may be deduced that both techniques were applied in constructing Roman underground tunnels (Grewe 2005, 11). In his critical commentary, Leveau underlines the fact that this distinction is mainly based on certain assumptions concerning the transmission of ancient Greek treatises on applied geometry and survey, for example, *Dioptra* by Heron of Alexandria, first century AD, and indicates possible misunderstandings in the transmission and the perception of Heron’s text (Leveau 2015, 171–176). He makes the point that such distinctions eventually overestimate text-based transmission of scientific knowhow in relation to archaeological evidence (Leveau 2015, 168–170).

The other major debate concerns the origin and the diffusion of the *qanāt* pattern—or its independent development at several geographical regions. Generally, the term would be attributed to the Asian (Iranian) pattern. Grewe considers the Iranian *qanāt* as a model for the Roman underground tunnels (Grewe 1998, 2005, 9, 17; Briant 2001; Leveau 2008, 144, 2015, 154), and others are more critical with respect to the Iranian origin and the diffusionist hypothesis—especially when questionable and scarce historical sources or questionable transmission lines and interpretations of scientific treatises are used to fill the lacunae of the archaeological evidence.

Typical Roman underground aqueducts in Germany with well-established archaeological record are the Eifel aqueduct conceived for the water supply of Colonia (Cologne/Köln), the aqueduct of Mogontiacum (Mainz), the tunnel at the Drove Mountain (“Heiliger Pütz”), and the aqueduct in the Ruwer valley near Waldrach used for supplying the Roman Colonia Augusta Treverorum (Trier) with water. Further, two aqueducts in the Moselle region, at Mehring and Pölich, and tunnels located at Brey (Koblenz), Retterich (Mayen), and Miesenheim (Mayen) should be mentioned. In 2005, an underground aqueduct tunnel was excavated in Alt-Inden/Düren in Rhineland.

### 3.2 THE EIFEL AQUEDUCT

The Eifel aqueduct in its latest phase was perhaps the longest one in the north regions of the Roman Empire. Archaeological evidence has revealed some 100 km of mostly underground channels bringing water from sources in the Eifel region to the urban area of Colonia Claudia Ara Agrippinensium (present-day Cologne/Köln). Considering some additional springs, the total length of channels could reach 130 km. Field survey and excavation research have revealed aqueduct parts that correspond to use in several periods. The oldest one should be the waterline A in the Hürther valley, dating from the first century AD. As a whole, it should have been in use from the first up to the fifth century AD. The dating has been established on the basis of a few coins, which imply that a part of the aqueduct in the first century AD already existed. The poor ceramic finds only imply that another part was constructed in the second century (Haberey 1971, 99). Among the constructions revealed by archaeological research, there are shafts (entrances to the tunnel system used for cleaning and repairing), several elaborate intermediate basins for water cleaning, and bridges for the overground

channels over valleys. In a later period of use, a second channel was constructed in a less depth, parallel to some parts of the older one. The water provided by the aqueduct has been estimated between 10,000 m<sup>3</sup>/d and 20,000 m<sup>3</sup>/d. Detailed documentation is provided by W. Haberey (1971) and K. Grewe (1986, 2004, 74–81).

### 3.3 THE AQUEDUCT OF MAINZ (MOGONTIACUM)

The aqueduct of Mainz dates from the second half of the first century AD and was presumably built to provide the Roman legions in Mainz (Mogontiacum) with water, estimated up to 7000 m<sup>3</sup>/d, from the springs of Finten (Fontanetum). Its length was 9 km, with 6 km underground channels and 3 km on arches. The remains of these arches (58 pillars) are known as “Römersteine” (Roman stones). Further foundations of the aqueduct are still visible and accessible for visit at some places, but most of the structures are lost—presumably, they were reused as building material during the Middle Ages (Lamberth 1983; Frontinus-Gesellschaft 1988; Dolata 2007).

### 3.4 HEILIGER PÜTZ (DROVE MOUNTAIN, DÜREN IN NORTH RHINELAND)

The underground tunnel between the water source Heiliger Pütz at the Drove Mountain near Düren (North Rhineland) and Soller is the longest tunnel north of the Alps. The tunnel has a length of 1660 m and is constructed in the rocks of the Drove Mountain at a maximal depth of 26 m. The vertical shafts are not in a straight line; moreover, the distance between them varies: the ones at the beginning and at the end of the tunnel are considerably closer to each other than the shafts in the middle part of the tunnel. The plausible explanation provided by Grewe implies that the ancient surveyor suggested to the builders to use the calculated horizontal distance between the shafts as a measure for their depth (Grewe 2004, 81–86). Thus, the depth of the tunnel and the distance between two shafts increase from the ends toward the central part of the tunnel from 8 m to 26 m. Grewe underlines the current assumption that the elaborate underground structure was presumably used to supply just a small Roman settlement (*villa rustica*) with water (Grewe 2008, 328).

### 3.5 FURTHER UNDERGROUND AQUEDUCTS

Further tunnels are located at Brey near Koblenz, at Retterich near Mayen, and at Miesenheim (Mayen).

Some shafts of the tunnel at Brey were reported as “devil’s holes” already in 1885. During World War II, parts of the tunnel were used as refuge by civilians. The excavated length is 75 m. Six vertical shafts in a distance of 5–10 m from each other have been traced. Today, the bed of the tunnel is 4.0–4.5 m below the ground surface. Its quadratic cross section measures approximately 1.2 × 1.2 m to 2.0 × 2.0 m (Grewe 1998; Haberey 1971, 148). Parts of the tunnel can be visited.

A similar, but deeper, tunnel (9 m deep vertical shaft) has been found at Retterich near Mayen. Traces of small niches for the lamps have been found on the walls of the tunnel (Haberey 1971, 146).

Another underground tunnel was discovered in an old mine at Miesenheim (Mayen); because of mining activities in modern times, several parts of the underground aqueduct have been destroyed (Haberey 1971, 146; Bemann 1988).

### 3.6 ROMAN QANĀTS

Some Roman aqueducts in Germany are described by scholars explicitly as *qanāts* or *qanāt*-like tunnels. These include two underground aqueducts in the Moselle region (Trier-Saarburg), one at Mehring and another one at Pölich, as well as an underground aqueduct excavated at Alt-Inden (Düren, North Rhineland) in 2005.

In the cases of Mehring and Pölich, B. Kremer assumes that the Romans have developed the *qanāt* technique further by transforming it into the counter-excavation technique. Without further argumentation, he assumes the latter technique as having been applied in Mehring and Pölich and uses the term *qanāt* for the tunnel, apparently because of the existence of the vertical shafts (Kremer 1999, 2005). The first (modern) report on the tunnel at Pölich dates from 1888. After several excavation campaigns, the tunnel has been studied in a length of 430 m. Twelve round vertical shafts—including the mother well (shaft)—with a diameter of 1.2–1.8 m have been traced up to now. The tunnel has a height of 1.2 m and a width of 0.55 m. Timber used as support in the tunnel was dated through dendrochronology back to 206 AD (Päffgen 2006, 140 n. 11). Parts of the tunnel can be visited (Gilles 2008).

The other Roman *qanāt* in the Moselle valley is in the north of Mehring. It was used for the water supply of a Roman *villa rustica* in the second to third century AD, as in the case of “Heiliger Pütz.” The tunnel was first mentioned in 1855. Up to now, some 106 m of the tunnel have been excavated—including 10 vertical shafts. The height is 1.20 m and the width is between 50 cm and 60 cm (Kremer 1999).

A further *qanāt*-like underground aqueduct was traced in 2005 in conjunction with the excavation of a Roman *villa rustica* at Alt-Inden (Düren, North Rhineland). The aqueduct has a length of 500 m, from which 300 m are underground. Beside the mother well, some 27 vertical shafts with a diameter of 2 m, in a distance of 5–17 m from each other (mostly 10 m), have been traced up to now. Four further prospection shafts have also been found near the mother well. The water-capturing part of the tunnel extended up to 20 m from the mother well. In the subsequent water-carrying part of the aqueduct, clay tubes with a diameter of 15 cm, as well as their fittings, have been found. Timber supports and covering were also used. There is no mention in the literature whether these elements were introduced from the beginning into the underground aqueduct (Päffgen 2006, 135–142).

### 3.7 THE AQUEDUCT IN THE RUWER VALLEY (TRIER)

The aqueduct in the Ruwer valley near Waldrach was used for supplying the Roman town Colonia Augusta Treverorum (present-day Trier) with water. The aqueduct has a length of 13 km and dates from the second century AD. It was fed by the river Ruwer and ran mostly underground in the Ruwer valley, bringing water to Colonia Treverorum, with a flow rate up to 25,000 m<sup>3</sup>/d. When deep valleys had to be crossed, the channel was continued on bridge constructions. The underground channel is not a tunnel but a stone water channel built from square sandstone blocks to a width of 74 cm and a height of 96 cm. From traces on the sidewalls, an average water level of 60 cm can be deduced (Frontinus-Gesellschaft 1988, 79). Many parts of the water channel are freely accessible and serve today as exhibition of Roman water technology ([www.ruwer.eu](http://www.ruwer.eu)).

### 3.8 THE UNDERGROUND WATERLINE OF VIENNA

A Roman aqueduct construction in Central Europe that could be compared to the aqueduct of the Ruwer valley is the waterline of Vienna. The aqueduct was constructed of sandstone in a small depth under the earth surface and had a length of 17 km. Actually, the goal of the aqueduct was to bring spring water from the Vienna Woods into what was to become the Roman legionary garrison Vindobona—a place that in the second century AD should have offered living place, urban infrastructure (e.g., water supply), and services to a total of c. 30,000 persons, including c. 6000 legionaries. The waterline was first uncovered and studied at the beginning of the twentieth century (Kubitschek et al. 1908). It consists mainly of a U-form stone construction with an inner waterproof cement-like layer and stone cover. The height of the channel is 60 cm and its width is 50 cm. The estimated average flow rate should have been c. 4300 m<sup>3</sup>/d. Several wooden or stone wells in the

settlement area have been discovered; some of these wells, as well as parts of the waterline, are accessible for touristic visits (Saki-Oberthaler and Ranseder 2009, 15–19).

### 3.9 CONCLUSIONS

Underground aqueducts constructed in Germany during the imperial Roman period have been found at several places, typically in the regions of Eifel, Moselle, and Rhineland. Some of them were used for the water supply of large towns, such as Colonia (present-day Cologne/Köln), Mogontiacum (present-day Mainz), and Colonia Augusta Treverorum (present-day Trier). Others were presumably used for supplying small Roman *villae rusticate* with water. The spectrum of construction type varies from underground tunnels (some of them are comparable to *qanāt*) to covered water channels, constructed by using stone plates just under the ground surface. Parts of these aqueducts have been arranged accordingly (including supply of information tables on site) and are today accessible to the public ([www.romanaqueducts.info/index.html](http://www.romanaqueducts.info/index.html)).

### REFERENCES

- Bemmann, M. 1988. Eine römische Wasserleitung in der Gemakrung Miesenheim, Stadt Andernach, Kreis Mayen-Koblenz. *Archäologische Funde aus der Pellenz* 3. Nickenich (Koblenz).
- Briant, P. (ed.) 2001. *Irrigation et drainage dans l'Antiquité: qanâts et canalisations souterraines en Iran, en Egypte et Grèce*. Paris: Thotm Éditions.
- Dolata, J. 2007. Tonröhre und Ziegelstempel: baugeschichtliches Fundmaterial zur Wasserversorgung im römischen Mainz. *Schriftenreihe der Deutschen Wasserhistorischen Gesellschaft* 11–1:87ff.
- Frontinus-Gesellschaft, B. 1988. *Die Wasserversorgung Antiker Städte*, vol III.
- Gilles, K.-J. 2008. Pölich, Kreis Trier-Saarburg. Römische Wasserleitung. In *Führer zu archäologischen Denkmälern des Trierer Landes*, ed. Rheinisches Landesmuseum Trier, Trier.
- Goblot, H. 1979. *Les qanats. Une technique d'acquisition de l'eau*. Paris: Mouton.
- Grewe, K. 1986. *Atlas der römischen Wasserleitungen nach Köln*. Darmstadt: von Zabern.
- Grewe, K. 1998. *Licht am Ende des Tunnels: Planung und Trassierung im antiken Tunnelbau (Light at the end of the tunnel: Planning in old tunnel building)*. Mainz: von Zabern.
- Grewe, K. 2004. Der Römerkanal und andere historische Technikbauten der Eifel. *Schriftenreihe der Frontinus-Gesellschaft* 25:73–99.
- Grewe, K. 2005. Wasserversorgung aus Qanaten – Qanate als Vorbilder im Tunnelbau. *Schriftenreihe der Frontinus-Gesellschaft* 26:9–24.
- Grewe, K. 2008. Tunnels and canals. In *The Oxford Handbook of Engineering and Technology in the Classical World*, ed. J. P. Oleson, pp. 319–336. Oxford: Oxford University Press.
- Haberey, W. 1971. *Die römischen Wasserleitungen nach Köln. Die Technik der Wasserversorgung einer antiken Stadt*. Düsseldorf: Rheinland Verlag.
- Hodge, A. T. 1992. *Roman Aqueducts & Water Supply*. London: Duckworth.
- Kremer, B. 1999. Wasserversorgung aus dem Tunnel. Der römische Qanat von Mehring. *Funde und Ausgrabungen im Bezirk Trier* 31:37–50.
- Kremer, B. 2005. Antike Wassergewinnung an der Mosel. Der römische Qanat von Pölich. *Schriftenreihe der Frontinus-Gesellschaft* 26:127–141.
- Kubitschek, W., Novalski de Lilia, J., and Proksch, A. 1908. Die Römische Wasserleitung nach Wien. Wien: *Jahrbuch der Altertumskunde* 2.
- Lamberth, W. 1983. Die römische Wasserversorgung in Rheinhessen. *Schriftenreihe der Frontinus-Gesellschaft* 6:25.
- Leveau, P. 2008. Conduire l'eau et la contrôler: L'ingénierie des aqueducs romains. In *Archéologie et histoire des technologies du monde romain*, ed. M. Molin, pp. 132–164. Paris: De Boccard.
- Leveau, P. 2015. Qanâts, hyponomoi, cuniculi et specus: une contribution à l'histoire des techniques hydrauliques. In *La technologie gréco-romaine. Transmission, restitution et médiation*, eds. P. Fleury, C. Jacquemard, and S. Madeleine, pp. 149–176. Caen: Presses universitaires de Caen.
- Päffgen, B. 2006. Eine römische Wasserleitung in Qanatbauweise in Inden, Kr. Düren. *Schriftenreihe der Frontinus-Gesellschaft* 27:135–142.
- Saki-Oberthaler, S. and Ranseder, C. 2009. *Wasser in Wien. Von den Römern bis zur Neuzeit*. Wien: Museen der Stadt Wien – Stadtarchäologie.





# Taylor & Francis

Taylor & Francis Group

<http://taylorandfrancis.com>



---

# 4 Updated Appraisal of Ancient Underground Aqueducts in Greece

*Panagiota Avgerinou, Eustathios D. Chiotis, Stella  
Chrysoulaki, Panos Defteraios, Theodora Evangelou,  
Nikos M. Gigourtakis, George Kakes, Yiannis Kourtzellis,  
Panagiotis Koutis, Nikos Mamassis, Maria Pappa,  
Giorgos Peppas, and Anna I. Strataridaki*

## CONTENTS

4.1 Introduction .....	43
4.2 The Archaic Underground Aqueduct in Megara .....	44
4.3 Underground Structures for the Water Supply in Ancient Piraeus.....	48
4.4 Underground Evidence on the Tunneling Technique in the Hadrianic Aqueduct of Athens.....	50
4.5 The Roman Aqueduct of Fundana-Knossos.....	54
4.6 The Underground Structures of the Roman Aqueduct of Mytilene .....	56
4.7 Review of Other Aqueducts and Concluding Remarks .....	59
References.....	61

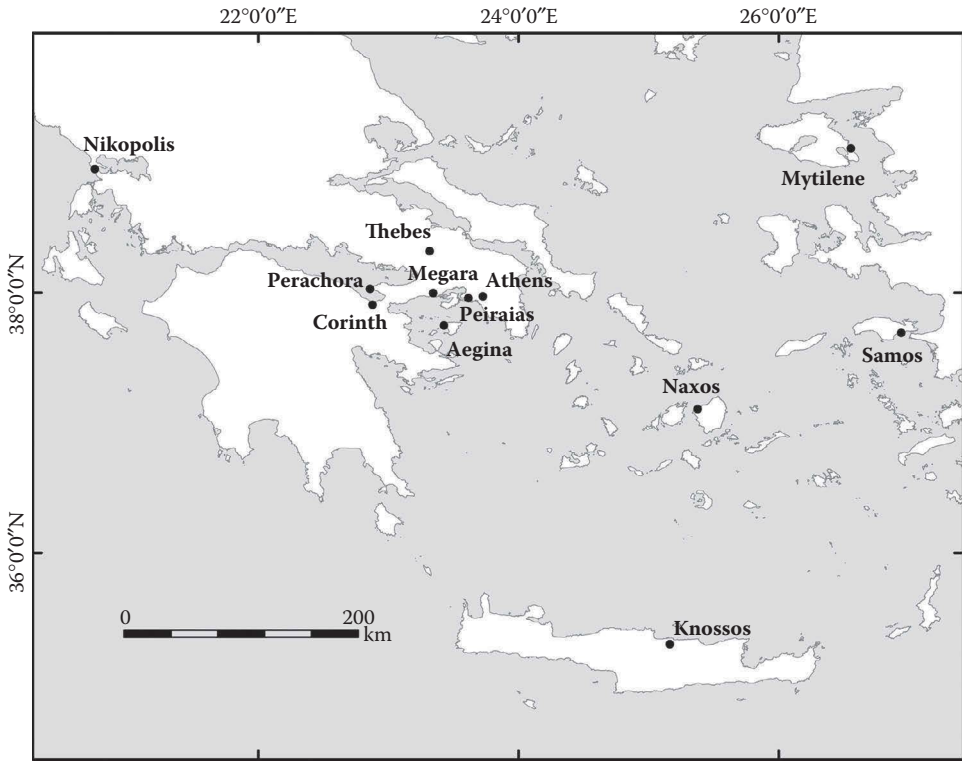
## 4.1 INTRODUCTION

Eustathios D. Chiotis

The first aqueducts in Greece were constructed in Crete for the water supply from springs of the Minoan Palace at Knossos by means of stone-built surface conduits, in the second millennium BC. Minoans were also familiar with groundwater harvesting at springs, where they used to excavate spring chambers not only for improved water capturing but also for the construction of fountains and the performance of ritual functions. Such a typical combination occurred at the so-called caravanserai near the Knossos Palace, impressive for its frescos and the elaborate water management system. Therefore, the Minoan Crete is considered the cradle of the hydraulic tradition in Greece.

Mycenaeans further developed hydraulics and introduced short tunnels, the most impressive of which is the underground connection of the fortified palace at Mycenae with a hidden water channel in a trench, at the end of the 13th c. BC. Short tunnels of the Mycenaean Era, tapping springs, have also been excavated at the Boeotian Thebes (Keramopoulos 1917, 327–329). However, the major efforts of hydraulic engineering in the Mycenaean period were devoted to the construction of large drainage and irrigation waterworks. Particularly impressive are the drainage works developed in the Copais Basin circa in 1300 BC, “fully justifying the claim that here we have the first hydraulic civilization in Europe” (Knauss 1995, 83).

Two drought periods in Greece in the late eighth and the fourth century BC (Camp 1979, 1982) motivated the development of long aqueducts, constructed by means of either surface-cut and covered channels, as in the Peisistratean and Acharnian aqueducts, or the shafts-and-gallery technique, as in the aqueducts of Aegina and Megara.



**FIGURE 4.1** Ancient aqueducts of Greece mentioned in this chapter.

Early underground aqueducts occurred in Greece in the sixth century BC, including the famous tunnel of Eupalinos on the island of Samos and the aqueducts of Aegina and Megara. The important innovation of the Aegina and Megara aqueducts is that they tap groundwater and thanks to that they are sustainable in the centuries. Thus, the Aegina, Megara, Hemyttos, and Hadrianic aqueducts were put again in operation in the nineteenth or the twentieth century AD. By contrast, the typical Roman aqueducts that transported surface water along a line of channels, galleries, and water bridges on arcades, such as the aqueducts at Nikopolis, Corinth, Knossos, and Mytilene, ceased supplying water soon after they were abandoned.

It is noted that the shafts-and-gallery tunneling technique (Wilson 2008, 290), which is arbitrarily associated by many authors with the Persian qanāts, was applied in Greece earlier than the Achaemenid Empire (538/532 to 332 BC), which is credited with the development and diffusion of qanāts. In addition, the Greek shafts-and-gallery aqueducts capture groundwater mostly all along their course in temperate areas, whereas the Iranian qanāts are typically fed from the spot of mother wells in arid areas and their galleries are excavated dry.

The most significant aqueducts in Greece with an underground section are summarized in Table 4.1 below, and the towns they supplied are shown in Figure 4.1. Only few representative ones are further discussed in more detail below.

## 4.2 THE ARCHAIC UNDERGROUND AQUEDUCT IN MEGARA

Panagiota Avgerinou

The ancient town of Megara was located in a fertile region, with easy and rapid access to two fortified ports, Nisaea on the Saronic Gulf and Pagae on the Gulf of Corinth. The town was extended over the two fortresses of Alkathos and Karia. Megara flourished from the eighth to seventh century BC,

**TABLE 4.1**  
**Most Significant Aqueducts in Greece with Underground Segments**

Aqueduct	Origin of Water	Technique	Construction Date	Length, ~ km
<b>Aegina</b>	Phreatian WT <sup>a</sup>	S&G <sup>b</sup>	6th c. BC	N/A
<b>Megara, Attica</b>	Phreatian WT	S&G	6th c. BC	N/A
<b>Eupalinian, Samos</b>	Spring	Tunnel, S&G	Middle of 6th c. BC	2.5
<b>Naxos</b>	Spring	PU <sup>c</sup>	Late 6th BC	11
<b>Peirene, Corinth</b>	Spring and CA <sup>d</sup>	S&G	6th c. BC (?)	N/A
<b>Thebes (Tachi)</b>	Springs	S&G	Classical	N/A
<b>Thebes (Kolonaki)</b>	Springs and CA	S&G	Classical (?)	N/A
<b>Hymettos, Athens</b>	Springs and phreatian WT	S&G	4th c. BC (?)	N/A
<b>Perachora, Loutraki</b>	CA	IG <sup>e</sup>	Hellenistic	N/A
<b>Nikopolis, Epirus</b>	Springs	PU	Augustan period (27 BC–14 AD)	70
<b>Knossos, Crete</b>	Spring	PU	Roman (2nd c. AD)	10.1
<b>Hadrianic, Athens</b>	Spring and phreatian WT	S&G, partly below the WT	125–140 AD	20
<b>Hadrianic, Corinth</b>	Springs	PU	2nd quarter of 2nd c. AD	85
<b>Mytilene, Lesbos</b>	Springs	PU	2nd half of the 2nd c. AD	33

<sup>a</sup> WT = Water table

<sup>b</sup> S&G = Shaft-and-gallery

<sup>c</sup> PU = Partly underground

<sup>d</sup> CA = Confined aquifer

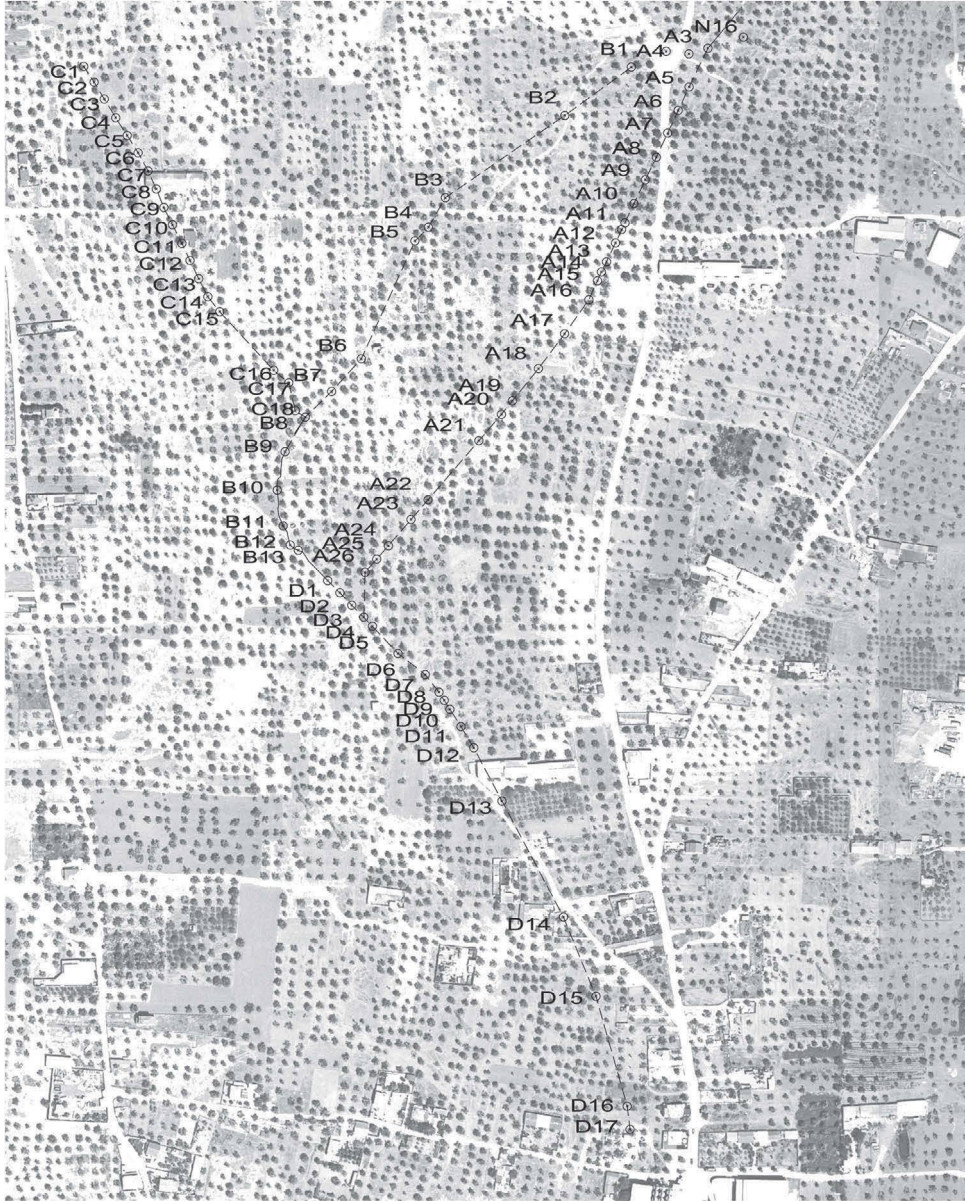
<sup>e</sup> IG = Inclined gallery

developing significant commercial and colonizing activities. The first colony was founded in Sicily (Megara Hyblaea, 728 BC), and this was followed by other colonies in the next century in Propontis, the most important being Byzantium (660 BC).

During the sixth century BC, ambitious men grabbed the opportunity to seize great power unconstitutionally in the name of the oppressed by aristocratic regimes and became tyrants. They won the favor of the people and strengthened their hold by providing basic necessities as benefits of their regime. The expanding population and increased settlement size, coupled with new wealth and economic development, required new solutions to the problem of water supply. Tyrants recognized that an abundant supply of water was one of the things that pleased people and laid out great water projects. Impressive constructions of hydraulic engineering were made, which disengaged the towns from the sources in close proximity and raised new expanded limits in the supply of water. Along with other Greek cities, Megara experienced the tyranny of Theagenes, which was followed by the troubled periods of “moderate regime” or oligarchy and “radical democracy,” as they are called in ancient sources. In the context of this background, the remarkable Megarian Eupalinos, the first hydraulic engineer whose name has been preserved by the literary tradition, armed with intellectual tools, accomplished one of the finest engineering achievements of ancient times. He was employed by the tyrant Polykrates in Samos, and he designed an ingenious system, the famous Eupalinian aqueduct in Samos. Moreover, he endowed his hometown with the famous “Theagenes Fountain” erected in the center of Megara\* (Gruben 1965; Helner 2009).

An ordinary stone conduit channeled the water to the fountain from an underground aqueduct located around 1500 m away in the North of the modern town of Megara, at the site Orkos or Ambatzades (Avgerinou 2015). The underground part of aqueduct incorporated four long roofed gallery branches A, B, C, and D, extending from SW to NE (Figure 4.2). The galleries have different

\* Extended bibliography is given by Avgerinou (2015).

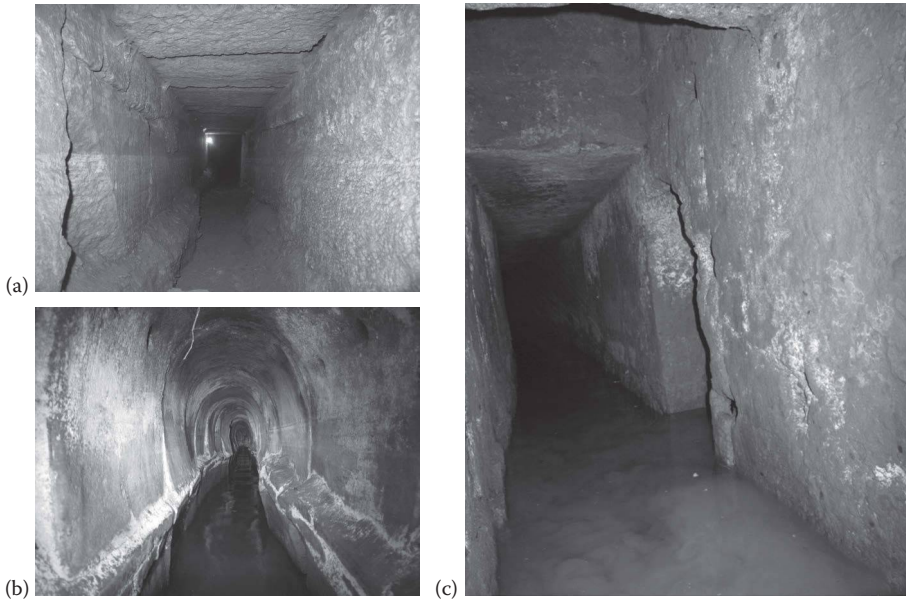


Surveyor: Ierotheos Valtas

0 25 50 100 200 m

**FIGURE 4.2** The course of the underground aqueduct in Megara projected on Ktimatologio air photos. The spots indicate the vertical well-like shafts arranged in four branches underlain by tunnels. (By permission of Avgerinou, P., *Water supply facilities in megara during the archaic and classical period*, in *Actes du colloque de Mangalia MÉGARE, Nouvelles recherches sur Mégare et les cités de la Propontide et du Pont-Euxin*, Juillet 8–12, 2012, A. Robu et I. Bîrzescu (eds.), Éditions de Boccard, Paris, France, pp. 279–313.)





**FIGURE 4.3** (a) View of the underground conduit of Branch D, lined with masonry. (b) Terracotta conduit of Branch A. (c) The junction of Branches D and A. (By permission of Avgerinou, P., *Water supply facilities in megara during the archaic and classical period*, in *Actes du colloque de Mangalia MÉGARE, Nouvelles recherches sur Mégare et les cités de la Propontide et du Pont-Euxin*, Juillet 8–12, 2012, A. Robu et I. Bîrzescu (eds.), Paris, France, pp. 279–313.)

technical features and are supposed to be functionally linked to each other (Figure 4.3b). The entire system is a complicated construction, which required high skillfulness and expertise. Thus, it is ascertained that a great water supply project exists and remains almost unchanged since antiquity.

Branch D seems to be the first and the main arm of the aqueduct. Seventeen access shafts leading to the bottom of the tunnel have been preserved and are observed on the ground over a length of 546 m. They have been covered by square stone slabs of average dimensions  $0.65 \times 0.65$  m. The gallery bottom is about 6.10 m below the surface and about 58 m above the sea level.

The biggest part of the tunnel of Branch D seems to have been hewn in hard conglomerate rock. The sides and the roof were left uncovered with coarse and uneven surface, probably for reasons of economy of material and time. In the spots where the conglomerate was liable to fall, the side walls and the roof were covered with elaborate masonry. Two kinds of masonry are distinguished, both of local shelly limestone, without binding mortar in joints (Figure 4.3a). Thus, in the northern part of Branch D, over a length of about 31 m, the side walls have been covered with rectangular single massive slabs. All slabs are of identical dimensions  $1.00 \times 0.60 \times 0.05$  m and have been placed vertically with the largest dimension upward. A well-shaped narrow channel 0.26 m in width was curved along the center of the rocky floor for water transport.

In addition, the southern part of Branch D had been dressed by rectangular or square stone blocks, which formed a pseudo-isodomic stonework. The roof consisted of either large horizontal stone slabs or corbelled slabs. In this part, the water was conveyed through a terracotta pipeline composed of segments that were inserted into each other with cemented joints of a wider mid-segment diameter of 0.20 m. Every segment had been decorated with four parallel engraved lines at both ends.

These differences in masonry and pipes may reflect construction methods of different worker gangs. Several groups of builders might have worked simultaneously in different stretches of the course of Branch D of the aqueduct.

The long-term viability of Branch D implies many centuries of activity and many repairs. Thus, it seems that some points had required repairs and complementary constructions during centuries, both in the part with exposed conglomerate rock and in the part with masonry. In most of the cases, these secondary constructions are fragmentary, supporting walls built by rubble masonry. Dissimilarities in width and height are detected along the branch, which confirm the aqueduct's long period of use. It is worth noting that Branch D was in working order until 1936, supplying water to the citizens of Megara (Benardis 2010).

Despite the fact that the research is still in progress, the first data show that Branch D was constructed in the sixth century BC. It belongs to a bunch of archaic underground aqueducts dispersed over a wide area of other Greek cities. Apart from the widely known Eupalinian aqueduct in Samos, the Peisistratean aqueduct in Athens, the Flerio aqueduct in Naxos island (Labrinoudakis et al. 2010), the aqueduct in Aegina island, and the aqueduct in the ancient port of Larnaka, Cyprus (<http://www.hydraproject.net/gr/>), are dated to the second half of the sixth century BC. Furthermore, taking into consideration the identification of Eupalinos' lifespan with the original construction of Megara aqueduct, we can accept that aqueducts in both Samos and Megara were studied, designed, and implemented by him.

Branch A is oriented to SW-NE and its total length is 1 km. Twenty six access shafts are visible today, with an average distance between them of 15–17 m (Figure 4.2). The technical features of Branch A are characterized by the presence of terracotta drums coating the sides of the access shafts, 0.90 m in diameter. In the tunnel bottom, there is a terracotta conduit that is about 1 m high, 0.40 m wide, and has wall thickness of 0.04 m. It consists of couples of large U-shaped terracotta sections, inverted and laid symmetrically with mortared joints. At junction point there are inserted usually one, and in some cases two or three rows of fired bricks that connected the long edges of the sections. Thus, they form an elliptical terracotta conduit (Figure 4.3c).

A similar pipeline that had been built simultaneously with the fortification wall of the ancient town was recently investigated. This means that the pipeline is dated, like the city wall, to the late fifth or to the early fourth century BC (Zoridis 1985). Moreover, sections of a conduit of the same type have been linked to the Acharnian aqueduct dated in the fourth century BC, designed for the water supply of Athens (Chiotis and Marinos 2012; Kassotaki 2003). This dating is also consistent with the construction of wells with terracotta rings, which were fully developed in the wells in Plato's Academia in the fourth century BC. Therefore, Branch A can be dated to the fourth century BC and was probably reconstructed after the Peloponnesian War simultaneously with the south fortification wall of the town.

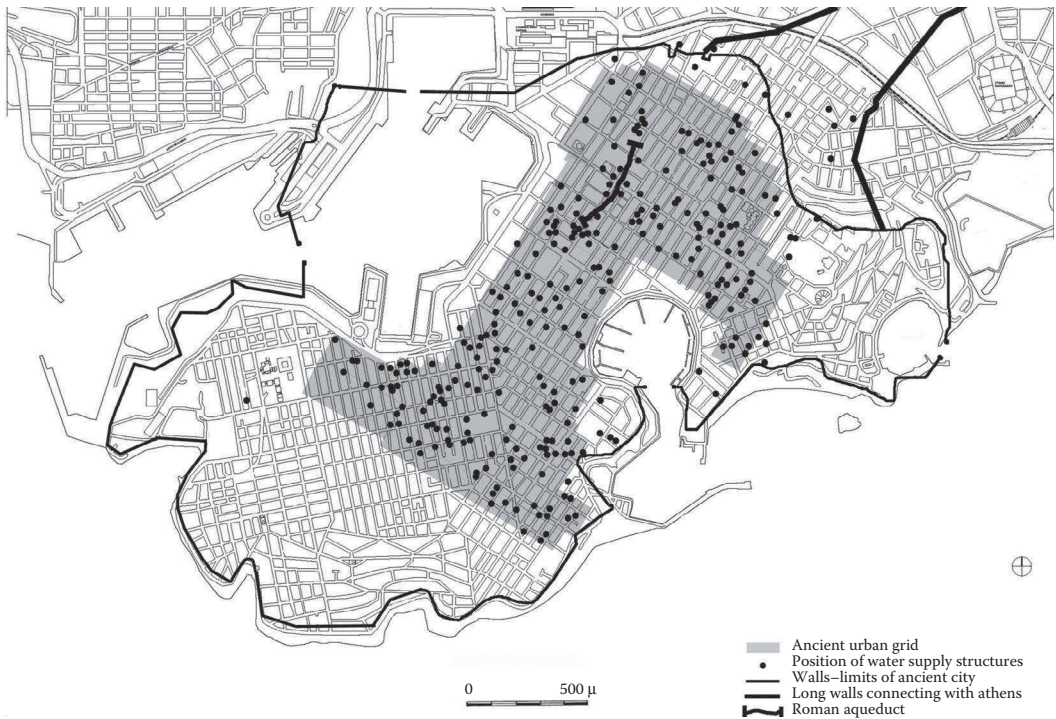
The research of Branches B and C is still ongoing.

### 4.3 UNDERGROUND STRUCTURES FOR THE WATER SUPPLY IN ANCIENT PIRAEUS

Stella Chrysoulaki, Theodora Evangelou, Panagiotis Koutis, and Giorgos Peppas

Piraeus was the major port of ancient Athens since the middle of the fifth century. According to urban planning conducted by Hippodamus from Miletus, it was built at that time. The conception of the new city and its organization into a single grid captures the sense of proportion and fairness that were fundamental components of the Athenian democracy. Since its final destruction and abandonment after two major invasions, by the Romans in 86 BC and the Goths in 396 AD, Piraeus' natural harbors gave Athens the opportunity to develop in maritime and trade (History of Piraeus: Garland 2001; Πανώγος 1995; Steinhauer 2012).

Underground structures for water supply in ancient Piraeus traced over time in the majority of excavations that revealed parts of the urban grid of the ancient city. Research over bibliographic references (von Eickstedt 1991, 121–133, plan 3-III/2, catalog 194–237) and the Archaeological Service's archives indicate (Figure 4.4) a total of 368 excavated sites within their limits, from which 330 ancient wells and 388 cisterns have been found. These include 115 wells and cisterns revealed in the recent excavations for the extension of the underground railway (Metro).



**FIGURE 4.4** Map showing position of ancient water supply structures over modern urban grid. (Courtesy of A. Bendermacher-Gerousis and G. Peppas.)

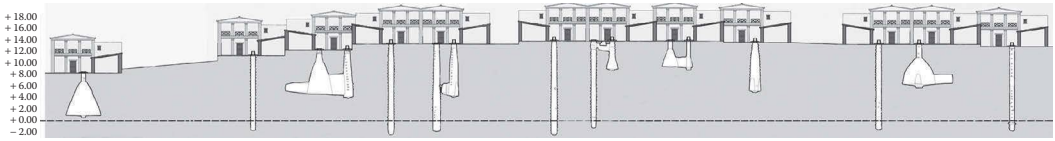
Since the discovery of the first water supply structures, the Archaeological Service has fended for their study, and where applicable, their preservation. Today, individual cisterns, wells, and tunnels are kept visible to the public inside three of the largest sites of Piraeus configured in archaeological parks.

Recent multidisciplinary research<sup>\*</sup> concluded that since the city's construction phase in the late fifth century BC, the inhabitants made efforts to obtain safe water by drilling wells to investigate the aquifer. This was the initial attempt to ensure drinking water for each house, following the example of Athens. These wells have a typical diameter of 0.80 m and rectangular cavities carved in the walls in two facing rows as "taps" for vertical access. Wells have a depth up to 18 m from the surface of the modern city, at an altitude ranging from  $-1.42$  to  $-4.95$  m. (The water table appears today at an altitude of  $+3$  m above sea level.)

Overexploitation of the poor aquifer due to drought, siege conditions, and other events, combined with increased safe water needs as the population grew, depleted water reserves. For ensuring adequate amount of water, the only solution was to store rainwater in underground reservoirs. Thus, the houses and their yards served as water collectors by using various technical solutions: the roof slope, pipeline, and draining networks. Smaller conical cisterns and bell-shaped cisterns (diameter from 2.80 to 6.14 m) were carved into natural rock and coated with hydraulic plaster, inside which led a shaft at least 2–3 m deep. At the bottom's center, there was a pit to collect the sediment and to manage the vessel that was used for pumping (Figure 4.5).

In the late Classical Era, luxurious houses resulting from the combination of more than one house were built. Moreover, given that in terms of statics, bell-shaped cisterns could not expand

<sup>\*</sup> For an extended view of the subject on Piraeus in Greek, refer to <https://efadyat.wordpress.com>—*Αρχαία Συστήματα Υδρευσης*—and in English, refer to <https://efadyat.wordpress.com/2015/04/16/16th-cura-aquarum-in-greece/>



**FIGURE 4.5** Hypothetical representation of typical house blocks and underground water structures in section. (Courtesy of A. Bendermacher-Gerosis and G. Peppas.)

and opening new ones was not an option as the space on the surface was inadequate for extra mouths, dead-end tunnels were drilled in existing cisterns to increase capacity. Moreover, in some cases, even five cisterns that used to belong to different houses were joined together. Some of the wells were still used at that time, as it is evident from connecting tunnels linked to cisterns that functioned as overflows.

Toward the end of their period of use, systems that at earlier times were formed by combining individual cisterns were isolated by diaphragm walls, owing to either the cessation of their use or fragmentation of the house.

At the end of the Hellenistic period until the early Roman period, the vast majority of these systems was abandoned and used as debris deposits. This was probably the city's rebuilding phase after its destruction by Sulla in 87–86 BC.

Villas of the Roman period, public baths, and thermes needed much larger quantities of water. Besides, the engineering of large-scale projects had now become possible.

The existence of an aqueduct was always suspected by scholars. They had included a map showing an aqueduct entering the city and crossing it from north to south. Constructions resembling an aqueduct were first identified in 1992 under Piraeus' modern central avenue (Steinhauer 2012, 105–106).

At the same axle, during the recent excavation for the construction of Metro central station, we now revealed a section of the aqueduct of about 95 m in length. This includes, beside the central tunnel conduit, three wells and two earlier cisterns that were used for entering. The duct is trapezoidal in section, with a slight decrease upward, and has an average width of 0.85 m and height of 1.80 m. The distance between the entrances is 26–34 m. Tunnel drilling began from each well toward both opposite directions.

Unlike Hadrian's aqueduct of Athens, Piraeus' aqueduct seems to have stopped working and has been abandoned. The entering wells were revealed filled with dump material, dating back to the late Roman period. The abandonment of such a major public project can only be attributed to a large-scale disaster, most likely the invasion of the Goths in 396 AD.

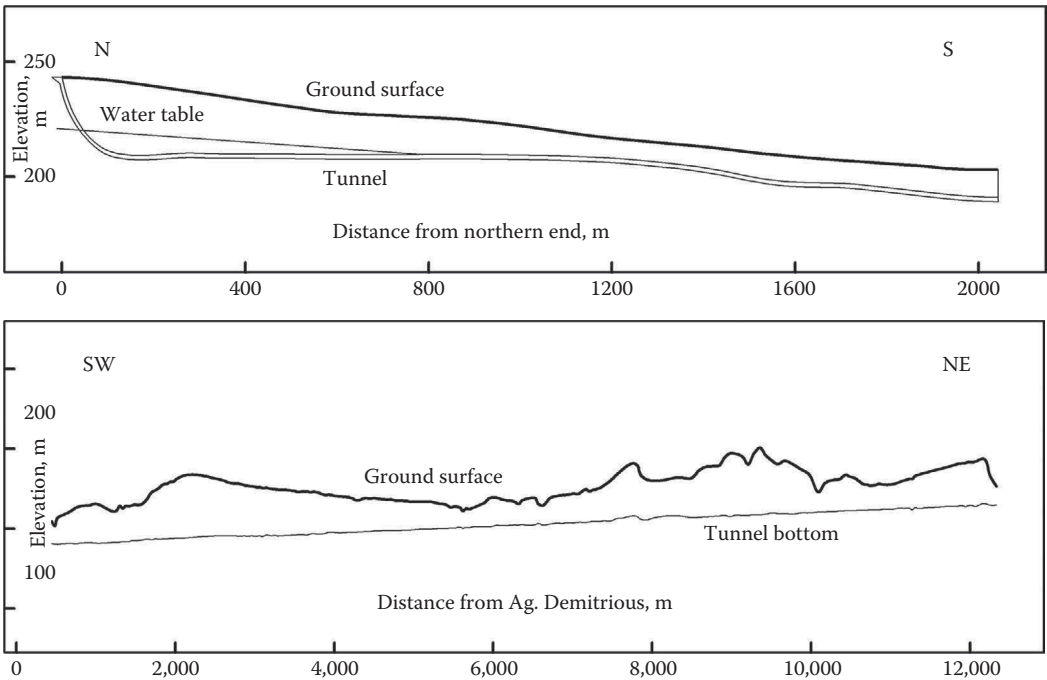
#### 4.4 UNDERGROUND EVIDENCE ON THE TUNNELING TECHNIQUE IN THE HADRIANIC AQUEDUCT OF ATHENS

Panos Defteraios, Eustathios D. Chiotis, and Nikos Mamassis

The construction of the Hadrianic aqueduct of Athens, abbreviated as HAA below, a benefaction of the Roman Emperor Hadrian to the city of Athens, started most likely in 125 AD and was completed in 140 AD. Other significant Roman aqueducts in Greece have been built at Nikopolis, Corinth, Mytilene, Knossos, Samos, and elsewhere. They are impressive for the water bridges on arcades and the tunnels crossing mountains for the delivery of water from distant springs.

The HAA differs significantly from the rest Roman aqueducts in being totally underground (Angelakis et al. 2014, 99), from the foothill of Mount Parnis to Lycabettus Hill in Athens, over a





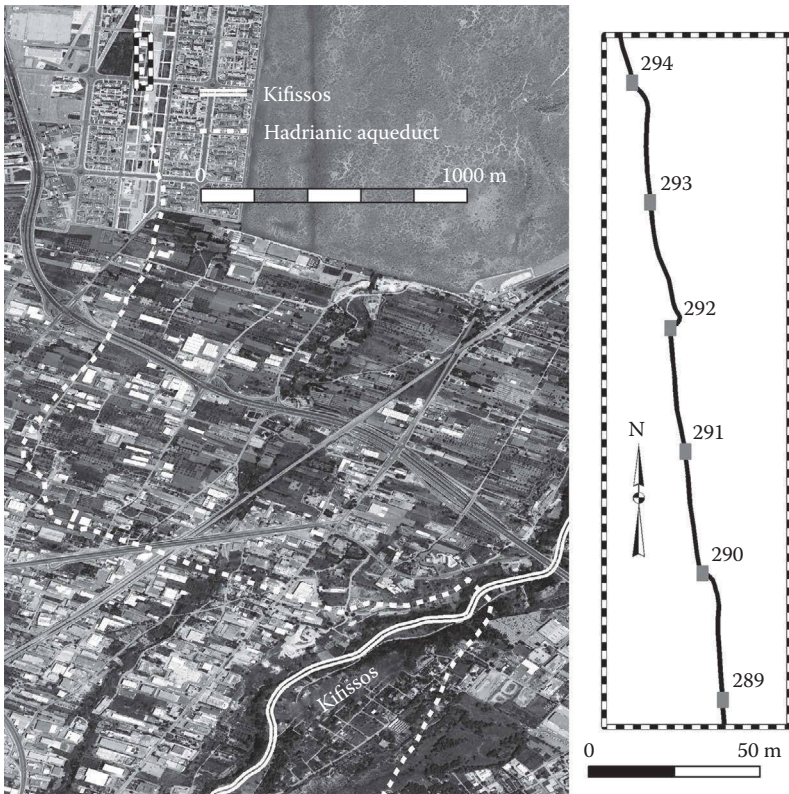
**FIGURE 4.6** Section along the northern part of the Hadrianic aqueduct, depicting the ground surface, the undisturbed water table, the inclined gallery, and the aqueduct tunnel. Below: longitudinal section along the Hadrianic tunnel from Ampelokipoi (SW) to Pyrna-Kalyftaki, Kifissia (NE); the chainage from Agios Dimitrios (Ampelokipoi) is projected versus the surface elevation in meters.

distance of circa 20 km. Because of insufficient surface waters in Attica, HAA was designed to capture groundwater, following the Greek tradition of the Aegina and Megara Archaic aqueducts. The initial section of the aqueduct was dug up to 10 m below the undisturbed water table (Figure 4.6). It is therefore supported that the HAA is an aqueduct of the Roman period designed in the Greek tradition of tunnels, harvesting groundwater in dry areas.

The HAA used to tap water from all possible sources, that is, springs at the Parnis foothills, groundwater below the water table, and perched aquifers, wherever available. Over most of its length, it runs at or below the water table (Chiotis and Marinos 2012).

It is noted that 316 wells are depicted along the tunnel in older sections, with the first ones near Agios Dimitrios, Ampelokipoi. Based on these sections, the following depth distribution is estimated: 21 wells (6.7%) are shallower than 10 m, 118 (37.3%) range between 10 m and 20 m, 113 (35.8%) between 20 m and 30 m, and 64 wells (20.2%) are deeper than 30 m, with the deepest one being 41.4 m deep.

The most prolific section of the HAA is the northernmost section, shown in Figure 4.7, at the lower part of a talus cone, covering impermeable layers of clayey sediments. Despite the present disconnection from springs, the HAA supplies water, which at shaft no. 275 was measured at 0.086 m<sup>3</sup>/s. The continuous infiltration of groundwater flowing from the wells and the tunnel walls is presently obvious; it is locally associated with incrustation of calcite, particularly in the roofed sections of loose sediments. Artificial roof support consists usually of prefabricated terracotta pieces, either of orthogonal plates or of curved bricks. The average tunnel section is 0.50 m wide and 1.20 m high; however, the height can locally reach 2 m or even more (Figure 4.8).



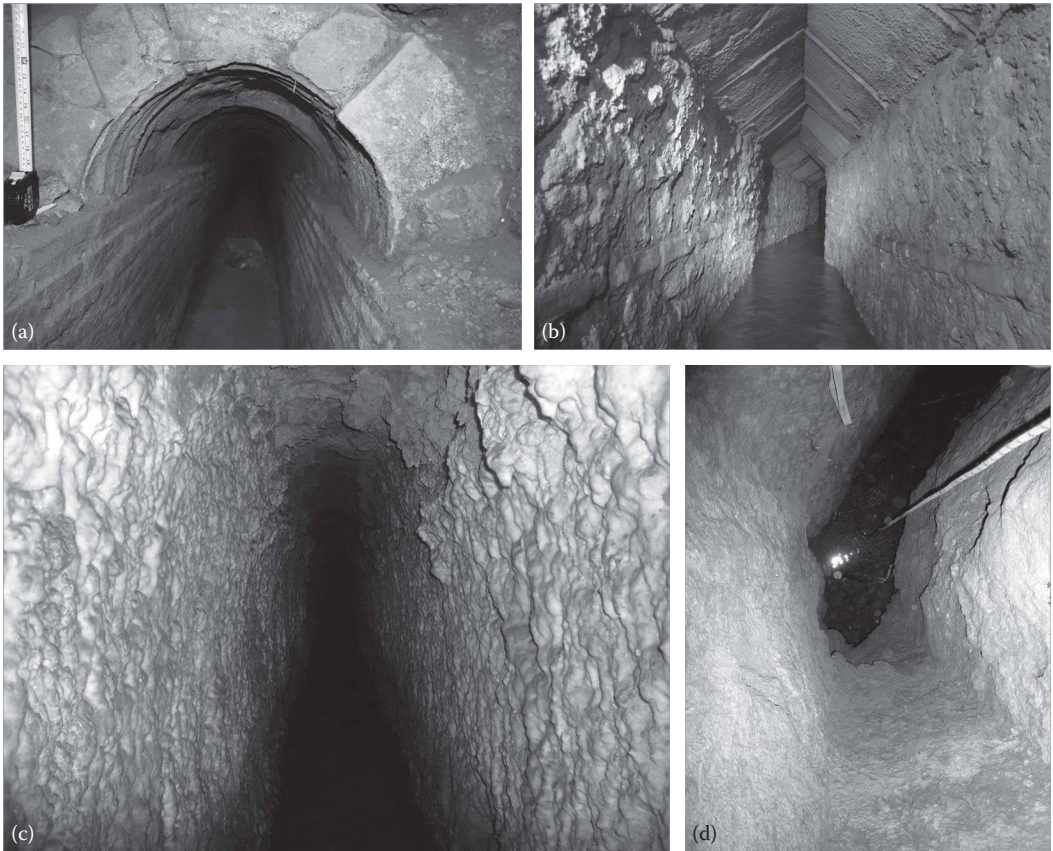
**FIGURE 4.7** The northern route of the Hadrianic aqueduct projected on the Ktimatologio air photos on the left and detailed plan of some wells with S-shaped deviations on the right. (Courtesy of E. Chiotis and P. Defteraios.)

Underground research\* revealed new evidence regarding the tunneling technique applied. Shafts, at regular distances of circa 35–40 m, were dug first; they were then connected at their bottom by tunnel sections driven upstream.

The correction of course deviations from the planned geometry of the tunnel is of special interest. Tunneling used to start at the bottom of a shaft and was directed to the bottom of the next one upstream, as indicated by S-shaped curved paths necessary to meet the next shaft (Figure 4.7). When the lateral deviation was small and the tunnel section passed higher or lower than the shaft bottom, then the tunnel was enlarged vertically to pass at the scheduled elevation, as in the case of wells 270 and 277; in this case, there was an elevation difference on both sides of the wells. The larger section of the tunnel occurred downstream when the tunnel crossed the shaft too high and vice versa. In cases of both lateral and vertical deviations, the tunnel followed an inclined S-shaped path toward the targeted bottom of the adjacent shaft upstream (Figure 4.8d).

It is therefore concluded that before tunneling, an accurate topographical survey was conducted, which determined the locations of the shafts and their depth; any deviation from this plan was

\* National Technical University of Athens, EYDAP, and the Ephorate of Antiquities of East Athens, coordinated by Professor D. Koutsoyiannis, E. Nestoridi, and I. Gourtzioumi, respectively, cooperated on this project, part of P. Defteraios's continuing doctoral research, supervised by Prof. N. Mamassis. Underground survey was accomplished by the Urban Speleology team (<http://urbanspeleology.blogspot.gr>) of the Speleologists Bourbouli G., Defteraios P., Georgopoulos P., Glarakis A., Tsakanikas I., Tsalikoglou T., and Tsekouras A. P. Defteraios expresses his warm and sincere thanks to all of them.



**FIGURE 4.8** Tunnel roof support types: (a) Brick vaulting, (b) corbelled terracotta plates, (c) calcite incrustations on tunnel walls, and (d) S-shaped deviation at the rectangular well 297. (Courtesy of P. Defteraios.)

corrected and absorbed in the section between two adjacent shafts. It was achieved in this way to reach the targeted point on Lycabettus Hill in Athens at the proper inclination and pass successfully the tunnel below streams and particularly the Kifissos River, dipping continuously downstream. The tunnel followed a U-turn at the area across the Kifissos River, as shown in the Figure 4.7, to gain the necessary route for smooth dip. The section of the ancient tunnel below the river used to pass a few meters below the riverbed in antiquity and survived until 1930, when it was eroded during a torrential rainfall; it was then replaced with an iron pipe encased in concrete.

Upstream tunneling implies that the starting point was at the surface, for the natural flow of the water during the tunneling stage. The obvious starting point for the northern part of the HAA was near the Kifissos River, where the tunnel reached the ground surface before diving below the river. This would also facilitate water supply to the aqueduct from the river, a plausible possibility, for which, however, there is no evidence.

It is noted that similar S-paths have been recorded in the Roman aqueduct of Raschpëtzer in Luxemburg, where again the tunnel was excavated upstream. Furthermore, this aqueduct is dated by means of dendrochronology in 130 AD, which apparently falls in the period of the Emperor Hadrian (Kayser and Waringo 2003, 281).

The intertemporal sustainability of many ancient Greek hydraulic works is strongly demonstrated in the case of the Hadrianic aqueduct. The HAA was reused almost 1700 years after its construction as the main water supply of the city of Athens. Indeed, in the second half of the nineteenth



century, the aqueduct was repaired and reused for Athens' water supply. After the construction of the Marathon Reservoir and a new tunnel in 1931, the ancient structure was demoted to a secondary water source for Athens' hydrosystem.

#### 4.5 THE ROMAN AQUEDUCT OF FUNDANA-KNOSSOS

Anna I. Strataridaki and Nikos M. Gigourtakis

In the Roman period, the city of Knossos was supplied with water from the Fundana spring through an aqueduct about 10.1 km long.

The significance of the Fundana water spring—located 10 km southeast of the modern city of Heraklion—is high, owing to its ample water yield,\* which has been utilized since antiquity until today, in order to meet the water needs of the city.

The Fundana spring (WGS84 geographical coordinates: 35° 15' 31.67"N, 25° 11' 12.51"E) is located on the west slope of the Kounaviano Gorge. At 200 m elevation, an aqueduct was constructed from the spring to the city of Knossos. The aqueduct was constituted of surface sections and of an underground straight-line tunnel (Figure 4.9).

This aqueduct was reused during the Egyptian rule in Crete (1830–1840), after a reconstruction of damaged sections. It was in this period that the construction of the grand double-bridge aqueduct with many arches began at the site of Hagia Irene (Figure 4.10). From there, the aqueduct continued its route to Heraklion.



FIGURE 4.9 Map of the Fundana-Knossos aqueduct. (Courtesy of N.M. Gigourtakis.)

\* In 1843, it has been estimated that the total water flow from Fundana to Heraklion was about 250 *massoures*. One *massoura* amounts to less than 3 L/min (Spanakis 1981, 91).



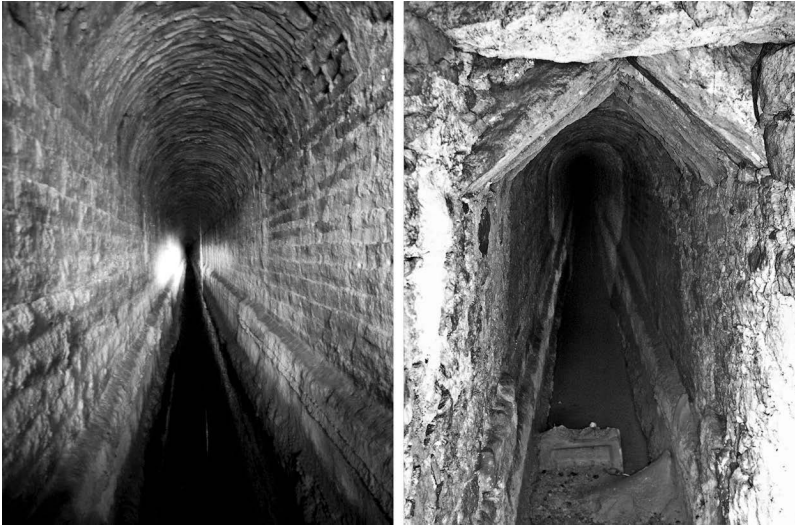
**FIGURE 4.10** The grand double-bridge aqueduct at Hagia Irene. (Courtesy of M. Chalkiadakis.)

Our survey revealed sections of the Roman aqueduct, which is preserved only partially today. As shown in Figure 4.9, the sections of the surface channel follow the ground slope. A small bridge with one arch—dated probably from the Roman times—is located near the Fundana spring, so the water would be transferred above the river Vathys Potamos (Deep River in Greek). From this location and following a route at constant dip, the aqueduct curved around hills and ground depressions to reach a point near and south of the village of Skalani. At this location, the aqueduct changed to an underground tunnel. The tunnel, 1150 m long, headed westward and reached its end, as it came out of a hill; from there, it continued as a surface channel northward to the city of Knossos, where today only a few fragments exist.

The surface channel was built on a stone wall, about 1.5 m tall. The stones were elongated and placed in rows and were held together with a lot of mortar. The actual water-carrying channel was built on the top of this wall in a U-shaped form, and its interior was covered with good-quality hydraulic mortar, 0.03 m thick. The width of the channel was 0.40 m, its depth was 0.40 m, and the supporting walls were 0.50 m thick. The channel was probably covered with big rectangular stones, which would have been easy to remove for cleaning purposes. At several points of the channel, the base of the Roman wall is well preserved, whereas the wall structure that was added during the Egyptian rule is clearly visible.

The tunnel is 1.90 m high and 0.75 m wide and has a vaulted or corbelled roof. On the ground surface, the water channel, 0.55 m wide, is preserved and is covered with a layer of mortar 0.10 m thick, along with calcite deposits. The tunnel walls were constructed with large bricks built in rows; the bricks have a visible dimension of 0.30 m and are 0.045 m thick, and there are thick mortar layers in between. On the base of the tunnel side walls, elongated limestones were built. The roof was either vaulted, made of perfectly matched curved bricks in vertical position (Figure 4.11a), or composed of corbelled stone plates (Figure 4.11b). It is very probable that shafts existed originally, which later were blocked with soil; today, unfortunately, it is impossible to trace them from on the ground.\* The tunnel had been opened up at one end, as it constitutes a straight-line construction. The entrance point (A in Figure 4.9) is located at elevation of 178 m (WGS84 geographical coordinates:

\* It is very probable that cave research undertaken by specialists in the interior of the tunnel will reveal the existence of shafts. During the Egyptian rule, when the tunnel was cleaned, workers had died of suffocation. For relevant sources, see Stratiradaki et al. (2009). This could have been caused by the probable covering of the shaft with soil.



**FIGURE 4.11** Sections of the underground tunnel. (Courtesy of N.M. Gigourtakis.)

**TABLE 4.2**

**The Key Sites along the Course of the Roman Aqueduct of Mytilene, Shown in Figure 4.12**

- |   |  |
|---|--|
| 1. Great Lake                               | 12. Water channel                          |
| 2. Springs of Tsigos, St. Demetrius         | 13. Kamaroudia (water bridge)              |
| 3. Anerayda (water bridge)                  | 14. Prineri Katifori (water channel)       |
| 4. Thyridia (water bridge)                  | 15. Tunnel's entrance                      |
| 5. Paspalas (water bridge with single arch) | 16. Fanos (shaft)                          |
| 6. Paspalas (water bridge with four arches) | 17. Tunnel's exit (?)                      |
| 7. Springs of Hagioi Aggelli                | 18. Moria (water bridge)                   |
| 8. Sutzak (water channel)                   | 19. Roman quarry (water channel)           |
| 9. Kousteri (water bridge)                  | 20. Kourtzi thermal springs (water bridge) |
| 10. Vrysoudia (water bridge)                | 21. Castellum divisorium (?)               |
| 11. Larissees Petres (water channel)        |  |

35° 16' 38.21"N, 25° 11' 16.06"E), whereas the exit point of the underground tunnel (B in Figure 4.9) lies at elevation of 176 m (geographical coordinates: 35° 16' 40.52"N 25° 10' 31.31"E) (Table 4.2).

Nowadays, the construction of the underground tunnel is preserved in excellent condition without any soil filling.\*

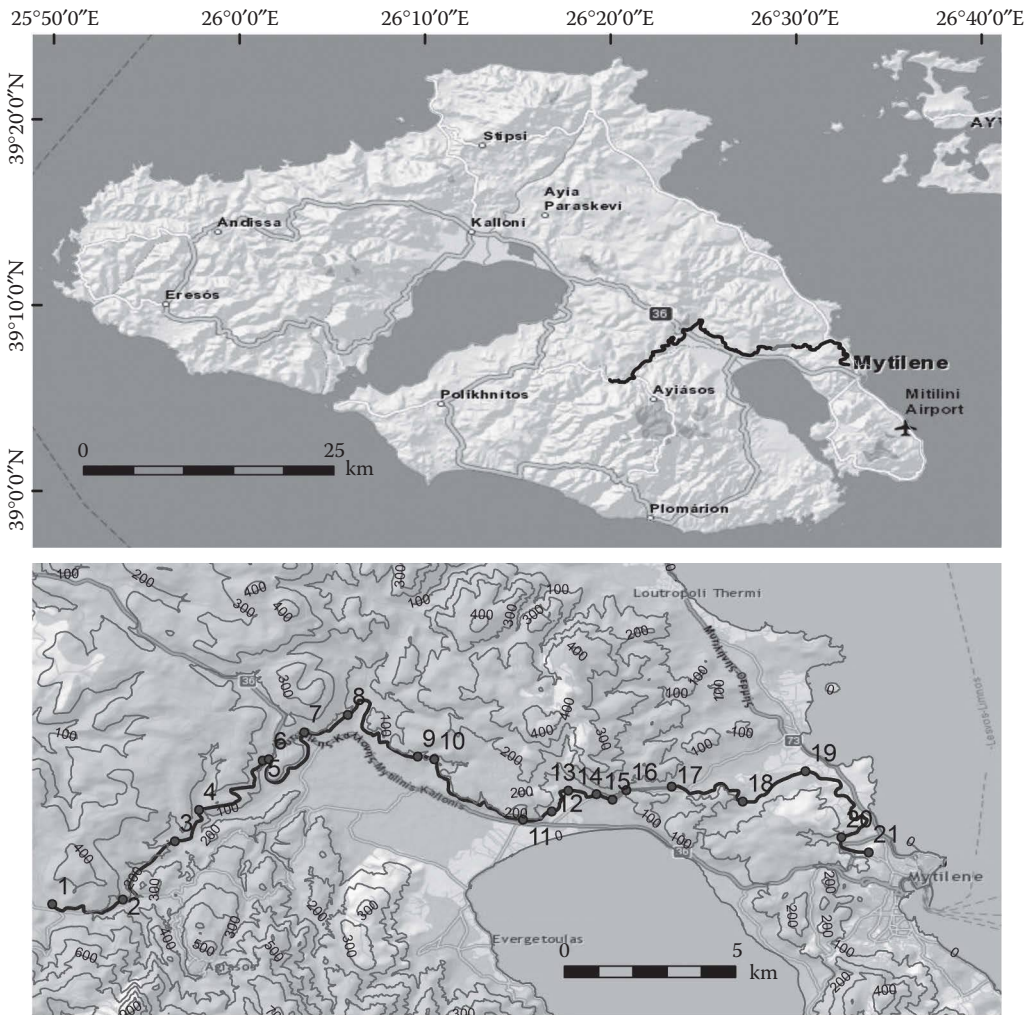
#### **4.6 THE UNDERGROUND STRUCTURES OF THE ROMAN AQUEDUCT OF MYTILENE**

Yiannis Kourtzellis, Maria Pappa, and George Kakes

The aqueduct of the ancient city of Mytilene is a superb work of antiquity, dated to the second half of the second century AD. Its construction intended to cover the increased water demand of a spacious Roman city, whose glory was compared, by the ancient writers, to that of Rhodes and Ephesus (Ovid, *Odes*, I, 7, 1; Horace, *Epistles*, I, 11, 7).

\* The Municipal Water Supply and Sewerage Service of Heraklion has blocked the entrance to the tunnel with a metallic door.

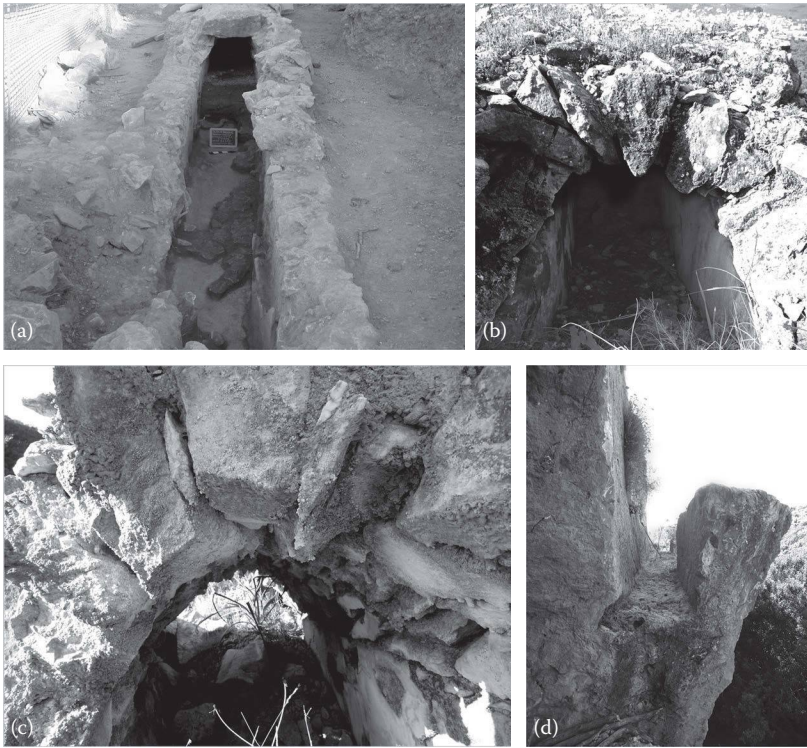




**FIGURE 4.12** The course of the Roman aqueduct of Mytilene. (Preliminary plan projected on ESRI’s global maps [<http://www.arcgis.com/home/search.html?q=imagery&t=content>], by Courtesy of Y. Kourtzellis.)

The aqueduct’s surface water sources are located at the Tsigos, St. Demetrius location (1 and 2), at the foothills of Mount Olympus. A central vaulted channel was constructed to transfer the water from the sources to the city by natural flow. The total length of the aqueduct is estimated to be about 33 km (Figure 4.12). In order to maintain the appropriate slope, the channel crossed rocks of different lithology (mostly limestones and ophiolites), following the smoothest route (Παπακωνσταντίνου et al. 2015, 15). Up to now, nine water bridges are already known. Among the aqueduct’s water bridges, the one in Moria stands out (Kourtzellis et al. 2016). The channel’s features are adapted to the terrain topography and to the geological formations. It can be said in general that it consists of a waterproof rectangular section, vaulted at the top, 0.60–0.65 m wide, and 0.85–0.90 m high. Its inner walls are covered with a 0.02–0.05 m thick mortar, lined with a thin, off-white, hydraulic plaster layer (Figure 4.13).

Some sections of the channel are carved into the hill’s rocky slopes, such as at Vrysoudia (10), Larissees Petres (11), and Kourtzi thermal springs (20); at other locations, built and carved walls are combined, such as at Kourtzi thermal springs (20) and Sutzak (8), whereas elsewhere, the channel is exclusively masonry-built, such as at the sites Anerayda (3) and Kamaroudia (13).



**FIGURE 4.13** The aqueduct’s channel. (a) At Prineri Katifori. (b) At the Roman quarry. (c) Detail of the channel’s vaulted top. (d) At Kourtzi thermal springs. (By permission of Y. Kourtzellis.)

Although the channel’s visible carved parts, mostly on the limestone rock of Larissee Petres (11), are the best known and impressive ones, the central channel’s route to a larger extent is underground and is built in a covered trench. The depth of the channel depends on landscape’s morphology and the need to secure the appropriate slope for water flow (Παπακωνσταντίνου et al. 2015, 10–17). Of the underground parts of the aqueduct, of particular interest is a section that was detected only in 2013. The channel, after the location “Prineri Katifori” (14), continues its route to the SE. This section must have been particularly crucial for the work progress since the engineers had to cross a large rocky mass, aptly known as “Fanos.” The selected solution was to pass the channel underground in a masonry-built tunnel, like the tunnels of the Hadrian’s aqueduct in Corinth (Lolos 1997, 289–290). The tunnel’s entrance was recently detected; however, its exit remains unknown (approximately at 15). The length of the tunnel is estimated from 800 m to 1 km, and its exit is at a distance of approximately 40 m from the location known as “Tsesmes tis Batzakenas” (17).

At a distance of about 320 m from the vaulted tunnel entrance, an impressive vertical shaft (putei) has been revealed and brought to light (site 16 in Figure 4.12). The altitude of the surviving wall of the shaft (SE side) is estimated to be 95.59 m above sea level. The floor of the previously visible channel section is traced at an elevation of 58.97 m. Therefore, the estimated total depth of the shaft is 37.79 m (Kourtzellis et al. 2016). Currently, the shaft’s interior is visible at a depth of 6.62 m (Figure 4.14). The lower part is filled with earth, tree branches, and so on. The masonry-built walls consist of freestones of various sizes and origin (limestone, schist, and so on) and are bound with a strong whitish lime mortar. The maximum preserved dimensions of the shaft are  $2.54 \times 2.24$  m and internal dimensions are  $1.32 \times 1.14$  m, while the walls’ thickness varies between 0.46 m and 0.78 m. The inner SE side of the shaft is hewn with three, still discernible, superimposed, 0.09 m deep,





**FIGURE 4.14** The upper part of vertical shaft at the geographic area of Moria, with the characteristic name “Fanos.” (By permission of Y. Kourtzellis.)

horizontal incisions (1.20 m between each other). These were, in all probability, used to fix wooden elements in order to reinforce the walls with timbering or facilitate access to the shaft bottom.

Nevertheless, one can see traces of other shafts in the area; however, their exposure requires systematic excavations. These vertical shafts were necessary to provide natural lighting and fresh air to the underground tunnel. For these reasons, they were known as “fanoi” that is, light shafts or roof lights (Kourtzellis et al. 2016).

#### 4.7 REVIEW OF OTHER AQUEDUCTS AND CONCLUDING REMARKS

Eustathios D. Chiotis

A few more underground aqueducts deserve special reference, including the unique aqueduct of the Peirene fountain at Corinth, the Hymettos-National Garden aqueduct, the double aqueduct at Thebes, and the aqueduct near the Heraion sanctuary of Perachora.

At the Peirene spring of Corinth, the first human interventions with stone-built and rock-cut structures date probably to the eighth and seventh centuries BC (Robinson 2011, *ixx*). Behind the Roman fountain façade, a network of branching rock-cut supply tunnels has been revealed, thanks to long and painstaking excavations of the American School, directed by Hill (1964). The tunnels, of an overall length about 1 km or more, were excavated within an elongated, sinuous sandstone aquifer (Robinson 2011, Plate D).

In the course of tunneling, access shafts were constructed at intervals, as required for ventilation and earth removal. The Corinthians tunneled into the bedrock to increase water yield, literally mining water from the native rock (Robinson 2015). The shafts-and-gallery underground structure advanced gradually from a simple spring tunnel into a complicated aqueduct over centuries since at least the sixth century BC. It has nothing in common with the *qanāts*, either in the origin of water or in the geometry of the tunnel. It is a good example of long interventions adapted to local hydrogeological conditions by applying the local hydrological and mining tradition.

The Hymettos-National Garden aqueduct is of the shafts-and-gallery type, with wells up to circa 15 m deep. Part of it was first described by Ziller as the ancient Royal Garden aqueduct (1877, 112); another section of the same aqueduct is known near the Agios Thomas church, at Goudi.

Judeich (1905, 34 and 186) misidentified the Royal Garden aqueduct as part of the Peisistratean one which is immensely different in construction. Recent excavations uncovered new sections of the actual Peisistratean aqueduct and confirmed that both the central supplying line and the distribution branches consist of terracotta pipelines installed in a shallow covered trench (Lygouri-Tolia 2000). The construction of the Peisistratean aqueduct was accomplished in the last quarter of the sixth century BC and supplied for the first time the Agora of Athens. It is therefore supported (Chiotis and Chioti 2012, 429) that the shafts-and-gallery waterworks in the National Garden belong to a different aqueduct, which postdates the Peisistratean one. The National Garden Hymettos aqueduct catches underground water from clastic sediments of the Hymettos talus cones and continues currently to water the National Garden, although it is not supplied presently by any spring.

The Thebes aqueducts at Tachi and Kolonaki (Table 4.1) are also of the shaft-and-gallery type, with the peculiarity that at the second aqueduct, over the main tunnel, there is locally a secondary one, apparently tapping perched aquifers.

Another unusual Hellenistic hydraulic structure at the flat area of Heraion of Perachora near Corinth is composed of an inclined gallery dipping 27°. It is 70 m long excavated trough marl, which covers a sandstone aquifer crossed at the bottom of the gallery, where three short horizontal tunnels are ramified. Three shafts of oblong rectangular section meet the short tunnels and they apparently served for the uplift of water (Tomlinson 1969). An extended form of this type of structure is the Hellenistic aqueduct on the Island of Rhodes, which is composed of a network of tunnels accessed by means of inclined galleries (Voudouris et al. 2013).

It is also worth mentioning the first Roman aqueduct in Greece at Nikopolis in Western Greece, near the bay of Actium, where Augustus defeated the combined navies of Mark Anthony and Cleopatra in 31 BC. The city of Nikopolis (Victory City in Greek) was built by Augustus like a trophy as a monument to his victory of Actium. The aqueduct constituted a major symbol of Romanization in the urban and rural environment. It is about 70 km long and only a section circa 500 m long is underground. The water was supplied from karstic springs of high capacity (Doukellis et al. 1995).

Finally, the Hadrianic aqueduct of Corinth, which supplied water from the Stymphalian Springs along a route circa 85 km long, included three tunnels; the longest of them is 1070 m in length and its apex lies at a maximum of circa 80 m below the surface. It is fully described by Lolos (1997), who studied the literary evidence, the course, the construction, the repairs, and the history of the aqueduct; he also compiled an excellent catalog of the numerous Roman aqueducts in Greece.

With the exception of the HAA, which is totally underground for tapping groundwater, all the rest described Roman aqueducts in Greece transport spring water and have a limited underground section up to 1 km long, in general, in order to cross a hill and maintain the straight course. In the Mytilene aqueduct, in particular, there is convincing evidence that the tunnel was constructed in the shaft-and-gallery technique.

In conclusion, early urban centers in the Minoan Crete since the first half of the second millennium BC, being in communication with the “hydraulic civilizations” in the Middle East, constituted the cradle of hydraulic tradition in Greece and developed various hydraulic works and surface aqueducts supplied from springs.

The Mycenaean Kingdoms focused their interest mainly on impressive drainage and irrigation waterworks.

The nucleation of city-states since the eighth and seventh centuries BC was accompanied in the sixth century BC by the development of large-scale underground aqueducts and tunnels, the most renowned of which is the Eupalinian aqueduct in Samos, to which Chapter 5 is devoted in this handbook.

Infiltration galleries in the shaft-and-gallery technique were constructed in Greece since the sixth century BC, before the Achaemenid Empire, to which the qanāts were commonly credited. It is therefore supported that Greece, in close connection with the Greek colonies and the Etruscans in Italy, acted collectively as an independent “hydraulic province” since the sixth century BC.

Boucharlat concludes in this handbook, Chapter 17, that “schematically the first generation of shafts-and-gallery aqueducts was very likely polycentric during varied periods of the first millennium BC. Much later the second generation might have been actually implemented in Iran around the middle of the first millennium AD and was soon spread elsewhere.” It is inferred implicitly that neither the Archaic nor the Hellenistic and the Roman hydraulic technologies were influenced by the posterior Iranian qanāts.

## REFERENCES

- Angelakis, A.N., Mamassis, N., Dialynas, E., and Defteraios, P. 2014. Urban water supply, wastewater, and stormwater considerations in ancient Hellas: Lessons learned, *Environment and Natural Resources Research*, 4(3). doi:10.5539/enrr.v4n3p95.
- Avgerinou, P. 2015. Water supply facilities in Megara during the Archaic and Classical Period. In *Actes du colloque de Mangalia MÉGARE, Nouvelles recherches sur Mégare et les cités de la Propontide et du Pont-Euxin*, Juillet 8–12, 2012, ed. A. Robu et I. Bîrzescu, Éditions de Boccard, Paris, pp. 279–313.
- Benardis, M. 2010. *Ψήγματα Μεγαρικών-Μυθολογικά, ιστορικά, Δήμος Μεγάρων*, Megara, Greece, pp. 205–215.
- Camp, J.McK. II. 1979. A drought in the late eighth century BC, *Hesperia*, 48:397–411.
- Camp, J.McK. II. 1982. Drought and famine in the 4th century BC, *Hesperia Supplements* 20, *Studies in Athenian Architecture, Sculpture and Topography*, 9–17.
- Chiotis, E.D. and Chioti, L.E. 2012. Water supply of Athens in antiquity. In *Evolution of Water Supply Through the Millennia*, eds. A.N. Angelakis, L.W. Mays, D. Koutsoyiannis, and N. Mamassis, IWA Publishing, London, pp. 407–442.
- Chiotis, E.D. and Marinos, P.G. 2012. Geological aspects on the sustainability of ancient aqueducts of Athens, *Bulletin of the Geological Society of Greece*, 46:16–38, [http://www.geosociety.gr/images/news\\_files/EGE\\_XLVI/2\\_CHIOTIS\\_p16-38.pdf](http://www.geosociety.gr/images/news_files/EGE_XLVI/2_CHIOTIS_p16-38.pdf).
- Doukellis, P.N., Fouache, É., and Dufaure, J.-J. 1995. Le contexte géomorphologique et historique de l’aqueduc de Nicopolis. *Bulletin de Correspondance Hellénique*, 119:209–233.
- von Eickstedt, K.-V. 1991. *Beiträge Zur Topographie des Antiken Piräus*, Η εν Αθήναις Αρχαιολογική Εταιρεία, Athens, Greece.
- Garland, R. 2001. *The Piraeus from the Fifth to the First Century B.C.*, Classical Press, Bristol, 2nd ed.
- Gruben, G. 1965. *Das Quellhaus von Megara, ArchDelt 19A, 1964 (1965)*, Ministry of Culture, Athens, Greece, pp. 37–41.
- Helner, N. 2009. Η «Κρήνη του Θεαγένους» στα Μέγαρα, Ιστορία και Αρχιτεκτονική ενός μνημείου του 5ου αι. π.Χ., Εκδόσεις Νάστου.
- Hill, B.H. 1964. *The Springs: Peirene, Sacred Spring, Glauke, Corinth*, 1:1–235, American School of Classical Studies at Athens, Greece.
- HYDRRIA Project, The aqueducts and the water wisdom of the ancient town of Larnaca, Cyprus <http://www.hydrriaproject.net/en/cases/cyprus/importance.html> (accessed January, 27, 2016).
- Judeich, W. 1905. *Topography von Athen*, C.H. Beck’sche Verlag, München, Germany.
- Kassotaki, E. 2003. Αστικό οδικό δίκτυο: η “Οδός Γ” στο Οικόπεδο Μακρυγιάννη. In *Η πόλη κάτω από την πόλη*, 2nd edn, eds. L. Parlamas and N. Stabolidis, Ίδρυμα Ν.Π. Γουλανδρή, Μουσείο Κυκλαδικής Τέχνης, Athens, Greece, pp. 54–57.
- Kaysers, P. and Waringo, G. 2003. Die unterirdische Wasserleitung der Raschpétzer, ein Monument antiker Ingenieurbaukunst aus Luxemburg. ‘Wasserversorgung aus Qanaten – Qanate als Vorbilder im Tunnelbau’, vol. 26, *Internationales Frontinus-Symposium*, Schriftenreihe der Frontinus-Gesellschaft, Walferdange, Luxemburg, pp. 277–292.
- Keramopoulos, A.D. 1917. About Thebes (excavations and topography). *ArchDelt*, 3:1–503 (Ministry of Culture, Athens).
- Knauss, J. 1995. Technical and historical aspects of the unfinished ancient drainage tunnel at the outmost north-eastern corner of the Kopais-Basin. In *Proceedings of the Second International Conference on Boeotian Studies (1992)*, vol. 2.1, ed. A. Christopoulou, Εταιρεία Βοιωτικών Μελετών, pp. 83–95.
- Kourtzellis, Y., Pappa, M., and Kakes, G. 2016. The roman aqueduct of Mytilene. In *Great waterworks in Roman Greece: Aqueducts and Monumental Fountain structures*, ed. G.A. Aristodemou, Archaeopress, Archaeology Series, Oxford, England.
- Labrinoudakis, V., Sfyroera, A., and Bilis, Th. 2010. Συντήρηση και Ανάδειξη του Αρχαίου Υδρογωγείου Νάξου και του Ιερού των Πηγών στις Μέλανες. National and Kapodistrian University of Athens.

- Lolos, Y. 1997. The Hadrianic Aqueduct of Corinth (With an Appendix on the Roman Aqueducts in Greece). *Hesperia*, 66:271–314.
- Lygouri-Tolia, E. 2000. Evangelismos Station. In *The City under the City*, eds. L. Parlama and N. Stambolodis, Τόρυμα Ν.Π. Γουλιανδρή, Μουσείο Κυκλαδικής Τέχνης, Athens, Greece, pp. 208–217.
- Panagos, H.T. 1948. *Piraeus: Economic and Historical Research from Antiquity until the End of the Roman Empire*, Athens, Greece.
- Παπακωνσταντίνου, Α., Κουρτζέλλης, Ι., Παππά, Μ., Κακές, Γ. 2015. Εφαρμοσμένη Γεωπληροφορική και Γεωοπτικοποίηση στην Αρχαιολογία. Μελέτη της πορείας του ρωμαϊκού υδραγωγείου Μυτιλήνης. In *Archaeological research in the Digital Age. Proceedings of the 1st Conference on Computer Applications and Quantitative Methods in Archaeology Conference - Greek Chapter (CAA-GR)*, eds. C. Papadopoulos, E. Paliou, A. Chrysanthi, E. Kotoula, and A. Sarris, Rethymno, Crete, 6–8 March 2014, Institute for Mediterranean Studies- Foundation of Research and Technology (IMS-FORTH), Rethymno, Greece, pp. 10–17.
- Robinson, B.A. 2011. *Histories of Peirene: A Corinthian Fountain in Three Millennia*, ASCSA, Princeton, NJ, 386 p.
- Robinson, B.A. 2015. Mining and Moving Water at Corinth, Cura Aquarum in Athens, Abstracts.
- Spanakis, S. 1981. Η ύδρευση του Ηρακλείου 829–1939 (The Water supply to Heraklion 829–1939), Technical Chamber of Greece, Department of Eastern Crete, Heraklion, Greece, 91 p.
- Steinhauer, G.A. 2012. Ancient Piraeus. In *Piraeus*, eds. G.A. Steinhauer, M.G. Malikouti, V. Tsokopoulos, and V. Ganiatsas, Center of Shipping and Culture, Piraeus, Greece.
- Strataridaki, A.I., Chalkiadakis, E.G., and Gigourtakis, N.M. 2009. The history of the Fundana spring aqueduct and its significance for the water supply of Heraklion city (Crete) through the ages. In *IWA Speciality Conference: 2nd International Symposium*, May 28–30, Bari, Italy.
- Tomlinson, R.A. 1969. Perachora: The remains outside the two sanctuaries, *BSA*, 64:155–258.
- Voudouris, K.S., Christodoulakos, Y., Steiakakis, E., and Angelakis, A.N. 2013. Hydrogeological characteristics of Hellenic aqueducts-like Qanats. *Water*, 5:1326–1345. doi:10.3390/w5031326.
- Wilson, A.I. 2008. Hydraulics engineering and water supply. In *Oxford Handbook of Engineering and Technology in the Classical World*, ed. J.P. Oleson, Oxford University Press, Oxford, UK, pp. 285–318.
- Ziller, E. 1877. Untersuchungen über die antiken Wasserleitungen Athens, *Mitteil. Deutsch. Arch. Inst., Athen. Abteilung*, 2:107–131.
- Zoridis, P. 1985. *Ancient Walls of Megara Archaeological Newspaper*, pp. 217–236, Athens.

---

# 5 The Aqueduct of Eupalinos on Samos, Greece, and Its Restoration

*Costas Zambas, George Dounias, and George Angistalis*

## CONTENTS

5.1	Introduction .....	63
5.2	A Brief Description of the Aqueduct.....	64
5.2.1	The Head Spring and Cistern .....	66
5.2.2	The First Part: From Spring to Tunnel .....	66
5.2.3	The Second Part: The “Amphistomon” Tunnel .....	67
5.2.4	The Third Part: From the Tunnel to the City.....	75
5.3	Recent Restoration Works .....	75
5.4	Further Discussion.....	78
	Bibliography .....	79

## 5.1 INTRODUCTION

The famous archaic aqueduct on Samos dated from the sixth century BC has been in the limelight ever since it was discovered in the late nineteenth century. Worldwide attention is drawn on the unique tunnel that was bored from both ends, without the use of guiding shafts, by applying geometry and mathematics. The interest and the search for the tunnel were fueled by Herodotus’ (485–421/415 BC) clear description of its main features and the great importance he attributed to it. The aqueduct is described in unsurpassed detail by Herman Kienast (1995, 2005). Most of the archaeological information in this note comes from Kienast’s publications. The monument is included in the World Heritage List of UNESCO since 1992 and was declared an International Tunneling Landmark by the International Tunneling Association in 2015 (<http://www.eupalinos-tunnel.gr/>).

The head spring of the Eupalinos aqueduct was first identified in 1853 by the French Archaeologist Victor Guérin (1856), who produced an accurate drawing of the area. He investigated only a small length of the first part of the aqueduct from the spring onward.

The discovery of the tunnel and the first attempt to clean it and even to restore it to working order were made in 1882, as presented by Stamatiades (1884) and Fabricius (1884). Fabricius was the first to study in some depth the unearthed works and to produce a fairly accurate map of the aqueduct, although he pictured the tunnel as a straight line.

The first accurate mapping of the accessible parts of the aqueduct was prepared much later by Wolfgang Kastenbein (1960), without any further cleaning. The tunnel was cleaned by the German Archaeological Institute (DAI), headed by Ulf Jantzen, between fall of 1971 and fall of 1973 (Jantzen et al. 1973a, b), so that there was full access along the main tunnel, as well as access to all but a few parts of the water-flowing trench. Further cleaning and support works were carried out on the access trench from the spring to the tunnel and from the tunnel to the city, until 1977 and additional ones on. A detailed mapping was prepared after the excavation works by DAI, allowing for the first time an in-depth study of the whole aqueduct. The meticulous exhaustive studies by Ulf Jantzen and mainly by Herman Kienast, Architect Archaeologist of DAI, led to a detailed description of the

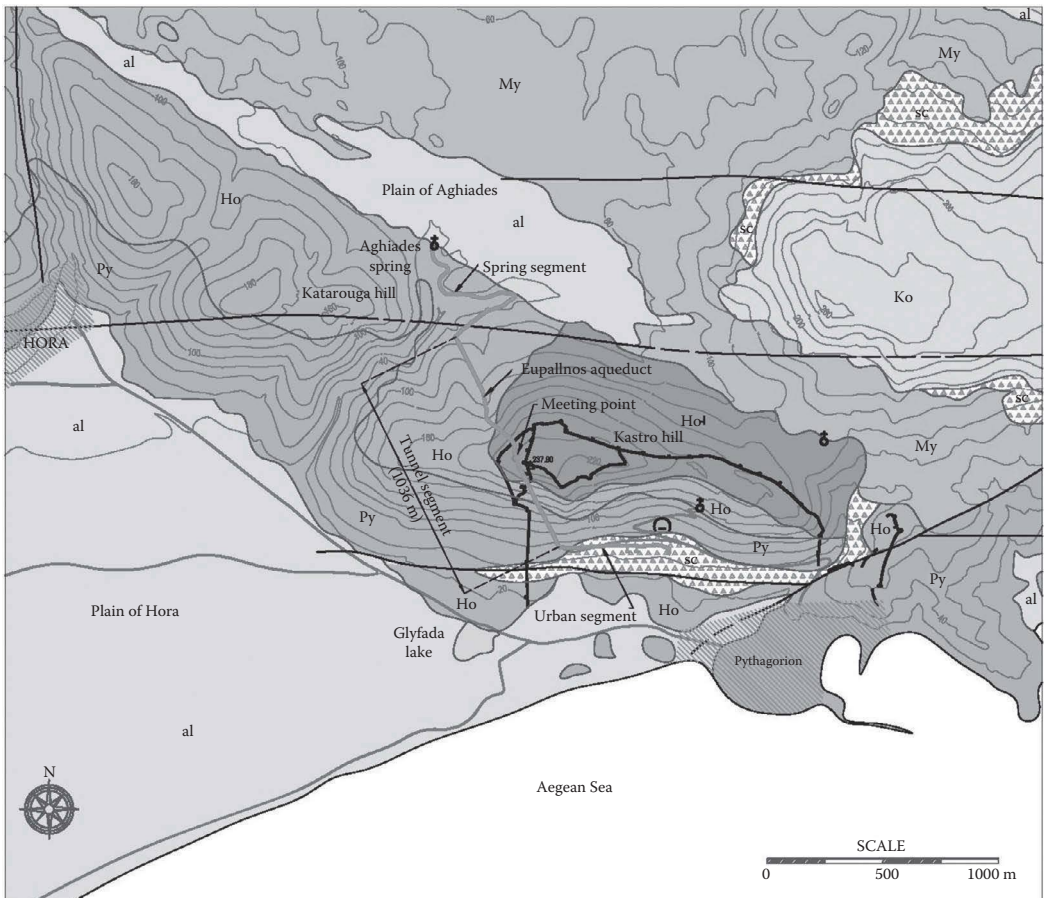


works that fill the reader and the visitor of the monument with awe and admiration for this achievement of the ancient Greek engineering. According to Kienast (1995, 2005), the aqueduct was in operation for approximately 1100 years.

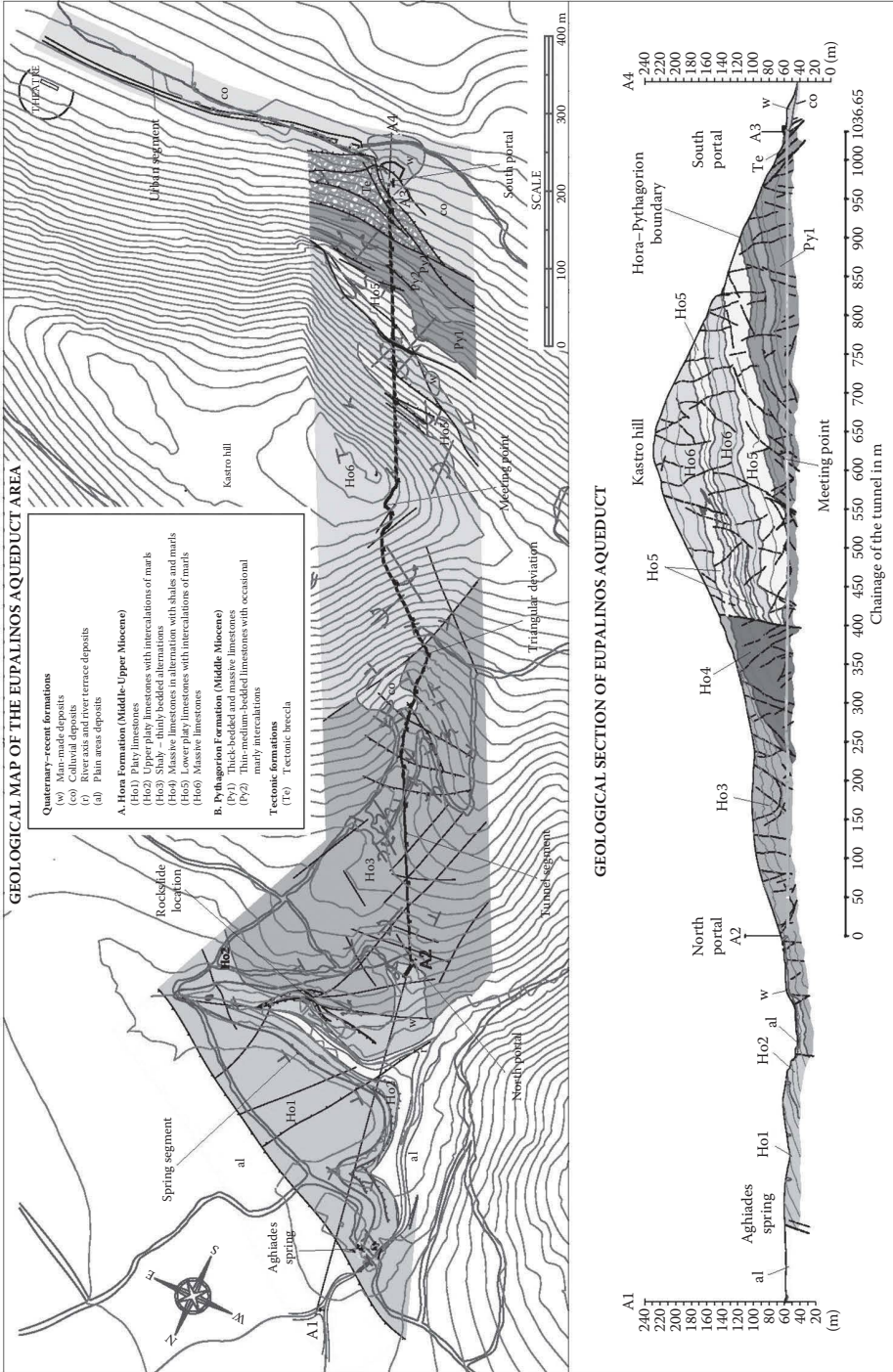
A major program, including restoration and conservation works, that provided additional information toward the better understanding and appreciation of this engineering marvel was carried out between 2013 and 2015.

## 5.2 A BRIEF DESCRIPTION OF THE AQUEDUCT

The aqueduct can be separated in three parts from the head spring and collector cistern at Ayiades to the city of Pythagorion. Figure 5.1 shows the outline of the aqueduct on the geological map of the broad area. Figure 5.2 presents the geological map and a longitudinal geological section of the central tunnel segment aqueduct. The first part from spring to the tunnel is 890 m long, constructed as either an open trench or an underground excavation, using the shafts-and-gallery method. The second part is the famous 1036 m long tunnel under the ancient fortification of the Kastro hill, where the water flowed in a deep trench. The third part from the tunnel to the city has a length of more than 1000 m and was built by the shafts-and-gallery method.



**FIGURE 5.1** Geological map of the Eupalinos aqueduct broad area. (From Lyberis, E. et al. The geology of Eupalinos Aqueduct, Samos Island, Greece, *2nd Eastern European Tunnelling Conference*, 28 September–1 October, Athens, Greece, 2014. With Permission.)



**FIGURE 5.2** Geological map and long section of the Eupalinos aqueduct. (From Lyberis, E. et al. The geology of Eupalinos Aqueduct, Samos Island, Greece, 2nd Eastern European Tunnelling Conference, 28 September–1 October, Athens, Greece, 2014. With Permission.)

The reader is encouraged to acquire the concise guide “The aqueduct of Eupalinos on Samos” by H. Kienast, Greek Ministry of Culture, Archaeological Receipts Fund, 2005, for illustrations that will assist the understanding of the following descriptions.

### 5.2.1 THE HEAD SPRING AND CISTERN

At Ayiades, under the chapel of Aghios Ioannis, there is the archaic cistern, half cut in rock and half formed by a thick masonry wall. Its roof is made of stone slabs supported on 15 stone pillars, as shown in Figure 5.3. The cistern is fed by the spring through two openings on the NW corner and is used to feed the aqueduct through an overflow opening on its SE corner. There are unverified reports on the exact location of the spring and its link to the cistern (Stamatiades 1884), but no recent excavations have been performed. Kienast (1995) assumes that the spring that was initially considered by Eupalinos was located approximately 4 m higher than its present level. He bases this assumption on excavations made 4 m higher in the stream bed for what could have been an attempt to form a collector tank and on the observations on the deepening of the water-flowing trench in the tunnel. The potential of the original spring is not easy to measure accurately owing to modern water wells opened in the broad area. Kienast (1995) estimates the present potential at 400 m<sup>3</sup> per day or 4.6 L/s.

### 5.2.2 THE FIRST PART: FROM SPRING TO TUNNEL

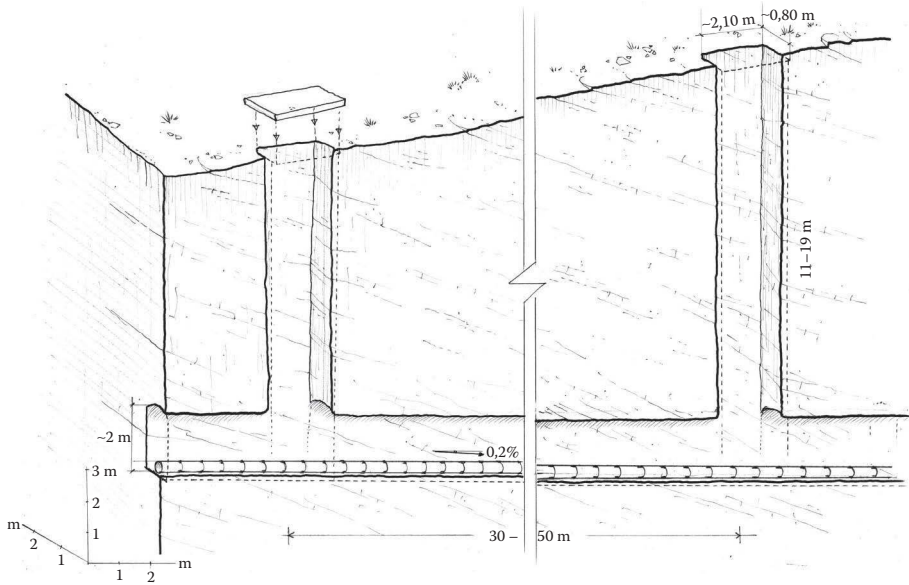
The first part of the aqueduct has a total length of 890 m. For the first 740 m, an open trench was dug and then covered by thick slabs and backfilled with soil. Later, it was locally covered by a dry masonry vault. This trench undulates following the ground morphology in order to keep a minimum excavation depth. The trench had a width of 60–70 cm and a depth of 2–5 m, depending on the ground morphology. A lower depth was used in the stream crossings, resulting in free space, with a height of 1.2 m. The excavation walls were overall stable, but locally, they were supported by masonry. According to the findings, inspection and cleaning manholes must have been located at distances of approximately 30–50 m.

The last 150 m, till the connection to the trench of the main tunnel, were excavated underground by using deep guide shafts spaced every 30–50 m. A sketch of the shafts-and-gallery method of construction, according to Kienast’s description, is given in Figure 5.4. At this part, an initial shallow excavation of the trench and a subsequent deepening are apparent. The free height of the trench is up to 6 m. According to Kienast (1995), the deepening is the only logical explanation for this excessive free height.



**FIGURE 5.3** The interior of the cistern. The mineral and organic deposits on the surface of the pillars indicate the variation of the water level.





**FIGURE 5.4** The shafts-and-gallery technique in the first part of the aqueduct. (Drawing by G. Thomas.)

This first part of the aqueduct joins the trench excavated from within the tunnel almost perpendicularly.

The water used to flow through ceramic pipes of approximately 25 cm internal diameter, wall thickness of 2–2.5 cm, and segment lengths of 71–73 cm. The top part of the pipes was cut and removed later in order to assist the cleaning operations.

The elevation of the ceramic pipe invert next to the head cistern was 52.96 masl (above sea level), and at the joint with the tunnel proper, it was 51.21 m, giving the first part an inclination of 0.2% (Kienast 1995).

### 5.2.3 THE SECOND PART: THE “AMPHISTOMON” TUNNEL

The expression “αρξόμενον ἀμφίστομον” (started from both portals) used by Herodotus places particular significance and singularity to the tunnel already in antiquity. Hero of Alexandria probably bases his method for solving the practical mathematical problem of how “to dig through a mountain in a straight line when the portals of the tunnel on the mountain are given” on the Eupalinos tunnel (Burns 1971).

A plan of the central part of the aqueduct is presented in Figure 5.5, showing the main features of the tunnel.

This central part of the aqueduct has a length of 1036 m. A more or less horizontal-access tunnel  $1.8 \times 1.8$  m (minimum height 1.6 m and maximum width 2.3 m) was bored from both ends at an elevation of approximately 55.2 m ASL, under the Kastro hill. The maximum overburden of the tunnel is 175 m.

The water flowed in ceramic pipes placed on the floor of a trench excavated on the eastern side of the tunnel. The width of the trench is approximately 0.6 m and its depth, from the tunnel floor, ranges from 4 m on the north portal to 8.5 m on the south portal. According to Kienast, this trench was already constructed, almost throughout the tunnel, approximately 4 m higher, when the elevation of the head spring was lowered by 4 m, owing to geological reasons or inadequate initial testing. It had therefore to be deepened using a variety of methods, mainly shafts-and-gallery or open-trench method. Parts of the already opened trenches were backfilled when the shafts-and-gallery technique was used for the deepening of the water route. This is roughly portrayed in Figure 5.6.

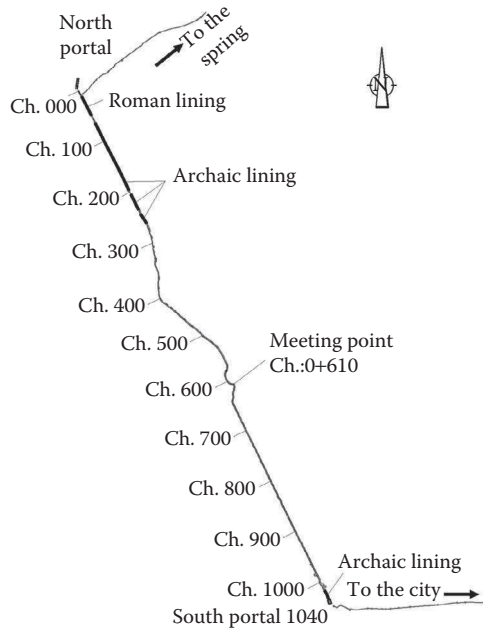


FIGURE 5.5 Plan of the Eupalinos tunnel. (Based on Tokmakides, 2009.)

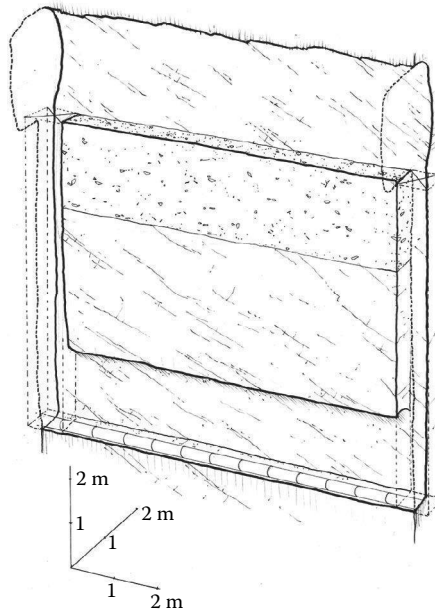
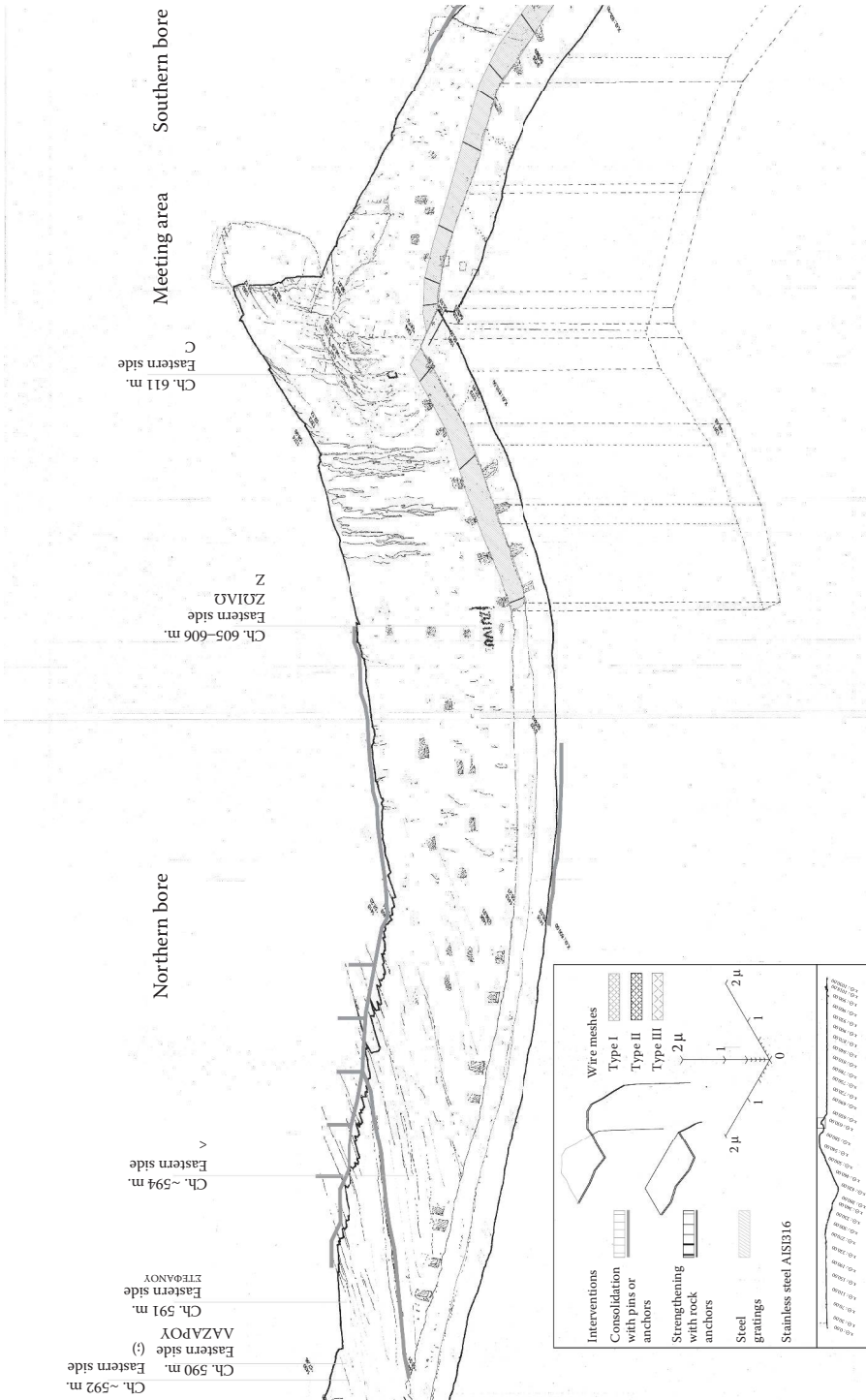


FIGURE 5.6 Stages of trench excavation near the south portal. (Sketch by G. Thomas.)

Following Kienast’s reported elevations, the average inclination of the water pipes in the tunnel is 0.36%. There is a clear indication though of increasing inclination going down the tunnel. The average inclination for the northern segment of the tunnel, up to the meeting point, is nearly 0.3% and that of the southern segment is close to 0.43%.

The two bores met under the highest point of the hill at a distance approximately 610 m from the north portal and 425 m from the south portal. The meeting area of the northern and the southern bores is shown in Figure 5.7. The plan is published for the first time here and is a part of the



**FIGURE 5.7** The meeting area of the two bores of the tunnel. (From Zambas, C. et al. Study for the restoration of the Aqueduct of Eupalinos. Samos Island. Unpublished Study in Greek. Egnatia Odos SA, Thessaloniki, Greece, 2010. Architectural surveying by C. Zambas, G. Thomas, Eir. Doudoumi based on the topographical one by P. Tokmakides. Drawing: handmade by Eir. Doudoumi. Modified in grayscale for this edition. With Permission.)

architectural and structural survey performed for the study for the restoration of the monument (Zambas et al. 2010) and is based on the recent topographical survey (Tokmakides 2009). The tunnel was presented in axonometric plans in scale 1/50, including sections in 1/25, in which besides the geometry and the state of preservation, the ancient red marks and inscriptions, the ancient cuttings, the later additions, and all the data of the monument are recorded.

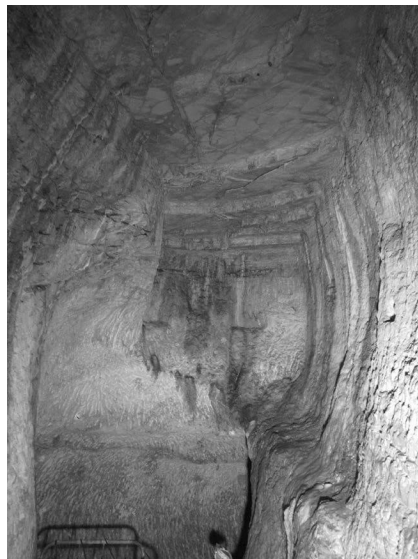
The southern bore was straight, but the northern bore diverged from the straight line, probably in order to find more stable ground conditions, and then came back to meet the southern bore at an angle, because a face-to-face meeting was highly improbable. To ensure the meeting, the height of the northern bore was increased gradually to engulf the southern bore. The north face and the south face at the meeting point are shown in Figures 5.8 and 5.9.

Most of the access tunnel is unsupported, with the exception of the first 260 m from the north portal and the first 20 m from the south portal that are supported by masonry lining, which was constructed either initially (Archaic) or at a later stage (Roman). The same holds true for the water-flowing passage, where masonry lining was locally applied. The archaic lining is of high aesthetic value, mainly at the tunnel but also in the trench. Large stone blocks perfectly hewn were transported inside and were assembled without mortar in an admirable way (Figures 5.10 through 5.12).

As part of the restoration needs, detailed mapping of the lining was recently made, as shown in Figure 5.13.

The tunnel suffered from a series of problems attributed mainly to the adverse geological conditions. A detailed geological and geotechnical mapping was performed (Edafos Engineering Consultants SA 2009) in order to improve our understanding of the tunnel behavior. The main problems were the distortion of parts of the lining due to the applied earth pressures (e.g., at Ch. 135, Figure 5.14), the locally unstable roof showing signs of progressive enlargement (e.g., at Ch. 531, Figure 5.15), unstable roof conditions and debris accumulated on top of the Roman lining, inadequate drainage due to blocking of the original paths, and so on.

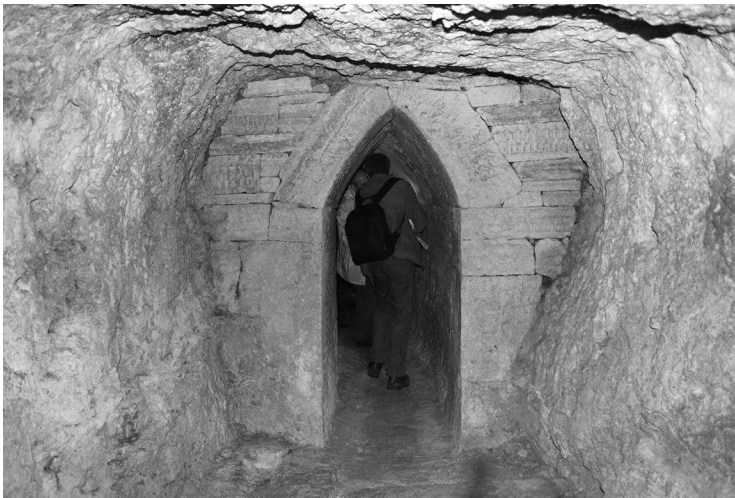
Starting from the beginning of the last section of archaic lining at Ch. 242 till its end at Ch. 263, the miners coming from the north turned around  $9^\circ$  to the east. Then they turned back  $9^\circ$  to the west till they came back to the intended axis. Then they turned  $18^\circ$  away from the initial axis to the west



**FIGURE 5.8** The face of the north bore at the meeting point. At the bottom of the picture is the south bore eastside. The face of the south bore is at the bottom-left corner.



**FIGURE 5.9** The south face at the meeting point. The marks of the two miners working side by side are visible. The north bore emerges at the left side of the picture.



**FIGURE 5.10** The portal of the archaic lining at Ch. 198 looking north.

to form the other much larger “triangle (Figure 5.5, Ch. 400).” As described by Kienast, they then followed a series of corrections till they met the south bore.

The questions that come up immediately to someone’s mind, also addressed by Kienast and a number of other investigators, are as follows:

- (a) Why they decided to turn the excavation direction?
- (b) Why they turned the excavation to the east?
- (c) Why they turned the excavation back to the west?
- (d) Why they turned the excavation again  $18^\circ$  to the west?

These diversions cannot be attributed to errors and were most probably triggered by the difficult conditions created by the combination of the weak geological unit and the encountered water.





**FIGURE 5.11** The archaic lining between Ch. 245 and Ch. 263, with the characteristic treatment of the surfaces of the stone blocks.

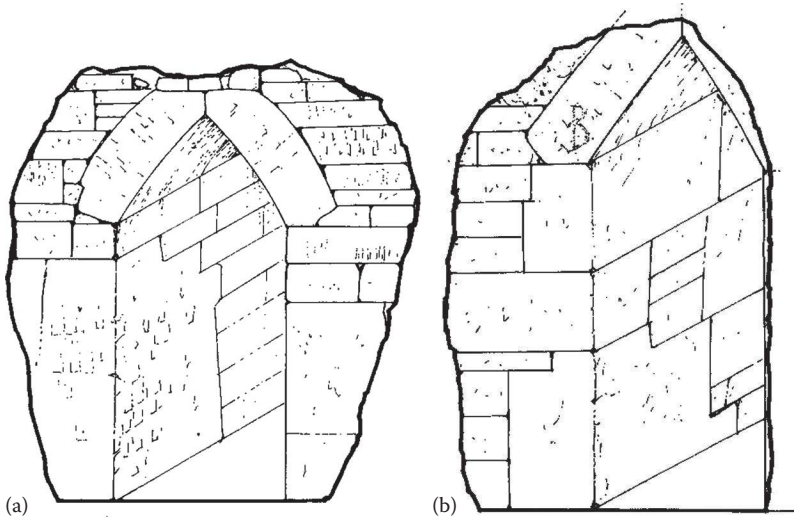


**FIGURE 5.12** Perfectly fitting and beautifully curved archaic masonry lining.

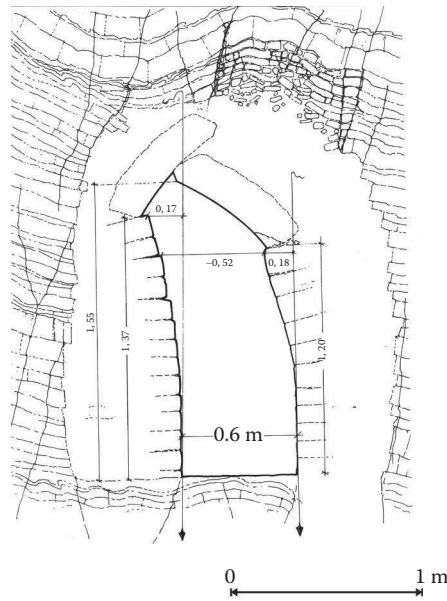
It seems as if they followed a trial-and-error approach, first turning to the east and then—since conditions did not improve—to the west.

To answer question (a), someone has to observe that the tunnel's masonry lining ends exactly at the point of the third turn—that is,  $18^\circ$  to the west—at Ch. 263. From Ch. 263 onward, the geotechnical conditions improved and there was no need for the very arduous construction of the tunnel's masonry lining. Therefore, the most probable answer to question (a) is that the miners turned the excavation direction because they were looking to meet better ground conditions.

No definite answers exist for questions (b), (c), and (d). The 20 m long tunnel section that starts from the first  $9^\circ$  turn to the east and ends to the second  $9^\circ$  turn to the west is supported with the previously mentioned masonry lining. One can assume that this first attempt to meet



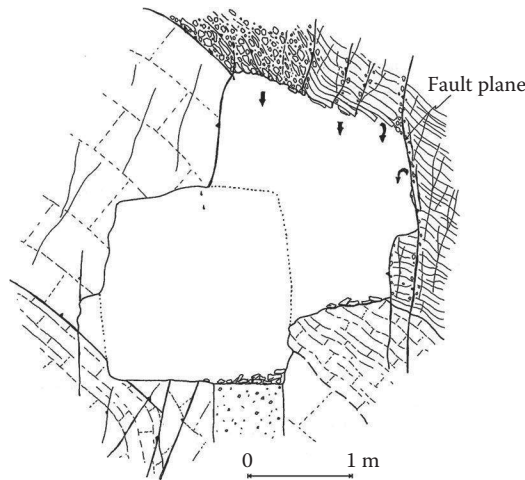
**FIGURE 5.13** The support masonry lining made of large stone blocks (a) Ch. 198 and (b) Ch. 263. (From Zambas, C. et al. Study for the restoration of the Aqueduct of Eupalinos. Samos Island. Unpublished Study in Greek. Egnatia Odos SA, Thessaloniki, Greece, 2010. Surveying by C. Zambas. Drawing by G. Thomas. With Permission.)



**FIGURE 5.14** Heavily stressed archaic lining near Ch. 135. (From Lyberis, E. et al. The geology of Eupalinos Aqueduct, Samos Island, Greece, *2nd Eastern European Tunnelling Conference*, 28 September–1 October, Athens, Greece, 2014. With Permission.)

better ground conditions had been unsuccessful. If this holds true, the second and the third turns were the attempts to correct the previous deviation and to meet the long-sought good ground conditions.

In theory, boring perpendicular to the dip direction of the strata has clear advantages in tunneling, since it minimizes the formation of side sliding blocks and goes faster through water-bearing



**FIGURE 5.15** Instability on the roof and the wall in thin-bedded horizons due to folding and faulting near Ch. 531 (From Lyberis, E. et al. *The geology of Eupalinos Aqueduct, Samos Island, Greece*, 2nd Eastern European Tunnelling Conference, 28 September–1 October, Athens, Greece, 2014. With Permission.)

strata. There appears to be no better direction achieved with respect to the layering of the rock following their turning to the west. In any case, they had then to turn back to the east. Therefore, turning in order to get a better direction with respect to the dip direction of the beds is not a very plausible explanation.

The most probable explanation is that they tried to drive away from the water-bearing strata and maybe to find an overall stronger and more solid rock. It is very clear that the water was causing great problems and they were forced because of that to give an upward slope of approximately 6% to the floor in order to be able to drain the excavation face.

An interesting question is: was this turning eventually worthwhile or the ground conditions would have improved in any case, had they kept on the straight excavation? The ground conditions definitely improved by moving away from the faulted and folded rock mass, but in retrospect, the same could have been achieved by turning to the east or even by staying at the original alignment for a little longer. Based on the surface geological mapping, had they maintained their first turn 9° to the east, they would have met much earlier the crossing of the fault at Ch. 400, beyond which conditions were overall more stable. Also eventually, the additional length required for this triangular deviation meant losing both time and money.

In any case, those miners—by doing all these manipulations to the underground excavation direction of the tunnel—proved that they had some understanding of geological conditions and they possessed an advanced applied geometrical knowledge, allowing successive corrections.

The systematic red marks and writings left on the walls of the tunnel by the constructors have been used to form assumptions as to the methods used in order to draw and measure the route of the tunnel (Kienast 1995).

The tunnel was used as a refuge from the seventh century AD and onward, after the aqueduct was abandoned, most probably owing to the inability to maintain it. A cistern at Ch. 675 of the tunnel, the walls forming doors near the southern portal, and many artifacts are clear indications of habitation. More interesting findings as to the habitation of the tunnel were unearthed during the recent restoration works.

The present northern entrance to the tunnel was formed in 1884 by building a retaining wall to support the eastern side and a stone staircase to decent from the surrounding deposits to the level of the tunnel.



The southern entrance is now through a small monumental building erected in 1884 and a narrow stone staircase with large uneven steps. The building stands on the remains of an ancient structure, and the inspection of the staircase shows that parts of it may have been very old. It was clearly reconstructed in 1884 by using some old stone blocks and following probably existing constraints that led to the unevenness of the steps.

### 5.2.4 THE THIRD PART: FROM THE TUNNEL TO THE CITY

From the tunnel to the city, the aqueduct was constructed using the method well established in the Greek world, the shafts-and-gallery method. Some 620 m after the tunnel, there is a cistern that unfortunately is ruined to the ground, and beyond that, there are findings that strongly support that the aqueduct was running to the center of the city. No ceramic pipes have been found in that third part of the aqueduct. It is reasonable to assume that they were initially placed but then removed at a much later stage, when the water must have flown on the bottom of the trench.

There are 24 discovered guide shafts, plus one that can be reasonably assumed, that opened at distances between 20 m and 26 m, although near the tunnel, they are much closer. The typical section of the shafts is 0.6 m across the axis of the aqueduct and 1.6 m along the axis, in order to provide better guiding for the digging of the connecting galleries. The typical dimensions of the underground excavation are 0.6 m width and 2.0 m height, excavated in conglomerates. The thickness of the overburden (roof) rock is very small and is occasionally missing, turning the excavation into an open one. This necessitated the construction of a roof or a complete lining of the excavation in unstable ground. The shafts were initially level with the ground covered by masonry blocks.

From the tunnel to the cistern, under the ancient theatre, there is an elevation difference of 465 m, corresponding to an average inclination of 0.75%, double that of the tunnel section. Clearly, this gradual increase of the slope of the aqueduct from the start to the end was intentional and not forced by the ground morphology. One explanation is that it reflects what was considered good practice at that time; may be the intention was to limit the settling of sediment, as mentioned by Kienast. Another explanation may be that after the lowering of the head spring elevation, they limited the slope of the initial part in order to keep a high elevation, suitable both for limiting the excavation depth and for reaching the upper parts of the city.

### 5.3 RECENT RESTORATION WORKS

Following the cleaning that finished in 1973, the conditions within parts of the tunnel started deteriorating in places where geological formations were weak and/or were heavily disturbed by faults. The need for additional restoration and support measures was evident. Following an initiative report by Egnatia Odos SA,\* a study was undertaken by a multidisciplinary group of scientists in 2009 in order to investigate in detail the geological conditions, identify critical stability problems, repair and maintain the lining, improve the stability of the tunnel roof and walls in critical areas, improve the safety of the visitors, and enhance the viewing of the monument by appropriate lighting.†

---

\* Prepared by G. Angistalis, S. Raptopoulos, and D. Kaltsas on 2008.

† The studies were undertaken by a multidisciplinary group, consisting of Dr C. Zambas office, Civil Engineers and Architects, specializing in ancient monuments, who acted as the team coordinator, Prof. K. Tokmakides, Aristotle University of Thessaloniki (AUTH), and P. Tokmakides Surveyors, Prof. G. Tsokas, Geophysicist, AUTH (Papadopoulos et al. 2014), EDAFOS S.A., Geotechnical and Geological Studies and V. Konstantinides & Associates, Electrical Engineers. G. Angistalis, O. Kouroumli, and D. Kaltsa of Egnatia Odos S.A. were the supervisors of the studies. A study on the conservation and protection of the ancient marks and writings, the masonry linings, the rock surfaces, and so on was also done by K. Papastamatiou from the Directorate of Conservation of Ancient and Modern Monuments of the Greek Ministry of Culture. Valuable assistance during the studies was provided by the Archaeological Ephorate section, headed by Maria Viglaki.

The study was approved by the Central Archaeological Council of Greece, and the interventions began in 2013.\*

The main tasks of the project were the restoration, conservation, and enhancement of the monument. The main works for the restoration of the monument were:

- Consolidation and support of the vulnerable parts of the rock surfaces with grouting, rock anchors, and fine wire mesh made of stainless steel. Various sizes of rock anchors and three types of wire mesh were used, according to the severity of the instabilities.
- Support of the vulnerable thin platy rock slabs of the roof with pins, injections, and sealing of open joints.
- Consolidation and support of rock surfaces not visible from the tunnel with rock anchors, steel mesh, and shotcrete mantle.
- Restoration of the Roman and Byzantine masonry lining by cleaning, filling open joints with mortar, and maintaining damaged masonry blocks. This was a part of the conservation works.
- Restoration of the dry stone masonry of the archaic linings was done at three parts of the lining, approximately 6 m long each. The lining at these places was badly damaged and/or distorted, and the width of the passage was reduced. There, the top part of the lining was dismantled and the stone blocks were repaired with mortar and titanium reinforcements and were reassembled. The rock above the lining was supported by rock anchors and concrete lining reinforced with stainless steel.

The main works for the enhancement of the monument were:

- Coverage of the trench with heavy-duty removable gratings made of stainless steel. The gratings enlarge the floor space available for the movement of the visitors and permit them to see and understand the main purpose for the construction of the tunnel, which is the ceramic pipe at the bottom of the trench.
- For enhancement, linear and spot LED lights illuminate the tunnel and the trench as a whole and locally the places of specific interest, such as the red inscriptions.
- Construction of protective canopies made of stainless steel as an additional protective measure for the safety of the visitors, at places where the height of the tunnel is very large due to progressive roof collapses or there are fault zones filled with unstable gauge material.
- Drainage of the water and partial coverage of the floor where water is concentrated.

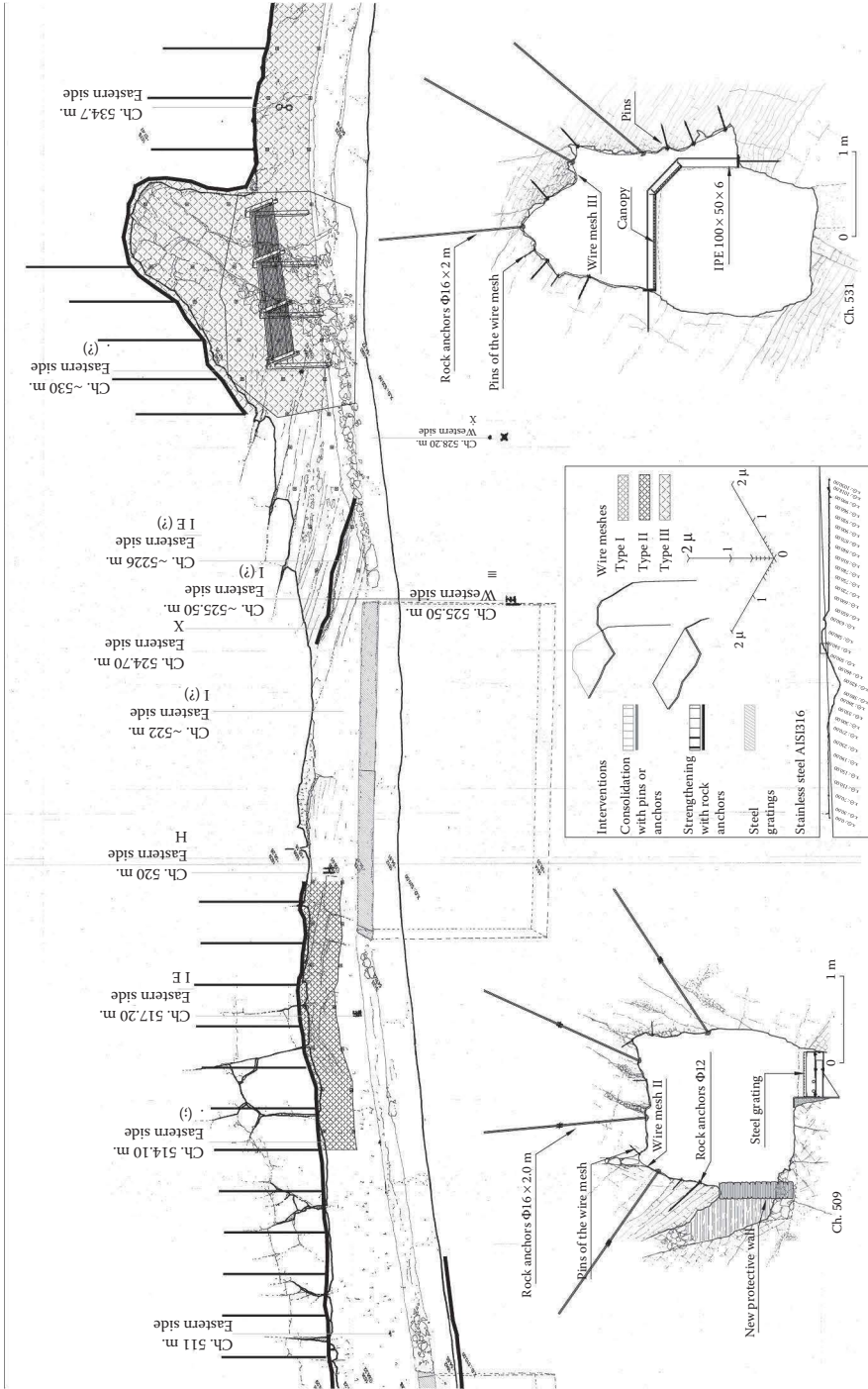
Indicatively, the works for a part of the tunnel are presented in Figure 5.16.

Figures 5.17 and 5.18 show a part of the archaic lining before and after the restoration works.

Following the restoration, the whole tunnel could be visited safely and is properly illuminated. The complete record of the recent restoration works is under preparation.

---

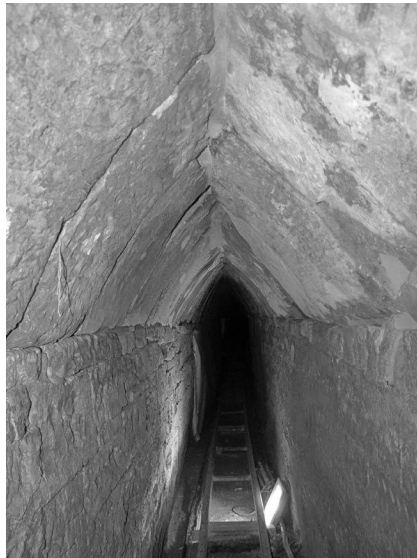
\* The construction was undertaken by EDRATEC SA (represented by A. Tampakopoulos). The restoration works lasted from 2013 to 2015 and were supervised by the Directorate for the Restoration of Ancient Monuments, headed by D. Svolopoulos via P. Hadjimitros, head of the constructions section, and A. Kalfas, V. Soulis, G. Soras, and S. Spyropoulou supervisors. EDAFOS SA and Dr C. Zambas office in cooperation with Dr K. Papantonopoulos acted as technical consultants for the duration of the works. The Directorate for Conservation of Ancient and Modern Monuments was working in parallel implementing their 2010 study. The local Ephorate headed by P. Hatzidakis assisted in the works, providing quick inspections, supervising the archaeological excavations, and advising the contractor. The necessary limited archaeological excavations were performed under the supervision of M. and P. Viglaki, Archaeologists.



**FIGURE 5.16** The part of the northern bore between Ch. 510 and Ch. 540 of the tunnel with characteristic interventions of the restoration project. (From Zambas, C. et al. Study for the restoration of the Aqueduct of Eupalinos. Samos Island. Unpublished Study in Greek. Egnatia Odos SA, Thessaloniki, Greece, 2010. Architectural surveying by C. Zambas, G. Thomas, Eir. Doudoumi based on the topographical one by P. Tokmakides. Drawing: handmade by G. Thomas and electronic by Eir. Doudoumi. Modified in grayscale for this edition. With Permission.)



**FIGURE 5.17** The support masonry lining between Ch. 178 and Ch. 183 before the intervention.



**FIGURE 5.18** The support masonry lining between Ch. 178 and Ch. 183 after the intervention.

#### 5.4 FURTHER DISCUSSION

The Eupalinos aqueduct on Samos will never cease to amaze all people involved in its study. Furthermore, it seems that it still keeps some secrets to be discovered by future investigators. It is unique in the sense that almost the whole of the aqueduct exists in a good state and additional restoration works should be undertaken for the first, from the spring to the tunnel, segment and the third, from the tunnel to the city, segment.

The construction difficulties and the solutions adopted based on the geometrical and surveying skills of its engineer, together with the high standards followed for the lining of the tunnel and the trench, make it a unique monument worldwide.

The aqueduct was in operation for nearly 1100 years. This type of aqueduct suffers very little by the earthquakes and floods that very much affect the surface aqueducts such as the long Roman aqueduct of Samos. The increased needs for water in the Roman times necessitated the construction of a 15 km long surface aqueduct, bringing water to the city and the large baths from the large Zastano spring at Imvrassos stream (Dimitriou 2003). The potential of the Zastano spring is 1250 m<sup>3</sup> per day, much larger than the 400 m<sup>3</sup> per day of the Ayiades spring. Furthermore, the water from other large Imvrassos springs might have been used to enhance the flow. A large number of low and high bridges were built to cross the streams, some of them still visible but in ruins. The age of the Roman aqueduct is not known, but it can be safely assumed that the two aqueducts coexisted for some time. It is not known if the Eupalinos aqueduct was abandoned in favor of the larger Roman aqueduct owing to its maintenance requirements or whether they were both abandoned when Samos went through a long period of decline and later the Roman aqueduct was repaired and put back to operation. Dimitriou (2003) notices that the Roman aqueduct had undergone extensive repairs, including local realignments, dated long after the abandonment of the Eupalinos aqueduct.

The recent investigations will allow the archaeologists to better date the time at which the tunnel was used as a refuge. Clearly, at such times, the ability to maintain large public projects is questionable.

The Eupalinos aqueduct was well known for its technical and mathematical aspects. The recent study has brought forward the importance of the aqueduct as a geological monument as well. While crossing under the Kastro hill, even the untrained eye will recognize and appreciate the variability of the rock, the tectonics, and the on-going geological processes such as the creation of many forms of stalactites.

One cannot avoid thinking that with proper continuing maintenance, this underground aqueduct could have been operational to the present day.

## BIBLIOGRAPHY

- Angistalis, G. and Kouroumli Arend, O. 2014. Outline of the Restoration Designs of Eupalinos Tunnel, Samos Island, Greece. *2nd Eastern European Tunnelling Conference*, 28 September–1 October 2014, Athens, Greece.
- Burns, A. 1971. The Tunnel of Eupalinus and the Tunnel Problem of Hero of Alexandria. *Isis*, 62(2):172–185.
- Dimitriou, T. 2003. The Roman Aqueduct of Samos, Intellectual Institution of Samos “Nikolaos Dimitriou,” Library of scientific publications (in Greek).
- Edafos Engineering Consultants SA. 2009. Final Geotechnical and Geological Design (part of the Final Design for the Restoration and Enhancement of the Eupalinos Tunnel at Pythagorion, Samos). Unpublished Study in Greek. Egnatia Odos SA. Thessaloniki. Greece.
- Fabricius, E. 1884. Altertümer auf der Insel Samos. *Mitteilungen des Deutschen Archäologischen Institutes in Athen*, 9:165–192.
- Guérin, V. 1856. Description de l’île de Patmos et de l’île de Samos, Paris, France.
- Jantzen, U., Felsch, R. C. S., Hoepfner, W., and Willers, W. D. 1973a. Samos 1971, *Archäologischer Anzeiger*, 72 ff.
- Jantzen, U., Felsch, R. C. S., and Kienast, H. 1973b. Samos 1972, *Archäologischer Anzeiger*, 401 ff.
- Kastenbein, W. 1960. Untersuchungen am Stollen des Eupalinos. *Archäologischer Anzeiger*, 75:178–198.
- Kienast, H. 1995. Die Wasserleitung des Eupalinos auf Samos, DAI, Samos XIX, Bonn.
- Kienast, H. 2005. *The Aqueduct of Eupalinos on Samos*, Translation from German by David Hardy, Archaeological Receipts Fund, Directorate of Publications, Athens, Greece.
- Lyberis, E., Dounias, G., Ntouriopi, A., Sotiropoulos L., and Angistalis, G. 2014. The Geology of Eupalinos Aqueduct, Samos Island, Greece, *2nd Eastern European Tunnelling Conference*, 28 September–1 October, Athens, Greece.
- Meissner, B. 1976. Das Neogen von Ost-Samos, Sedimentationsgeschichte und Korrelation. *Neues Jahrbuch für Geologie und Paläontologie - Abhandlungen*–, 152(2):161–176.

- Papadopoulos, N., Tsokas, G., Sarris, A., Tsourlos, P., and Vargemezis, G. 2014. Ground based archaeological prospection: Case studies from Greece, *First Break*, 32:73–80.
- Stamatiades, E. I. 1884. *About the Eupalinos Tunnel on Samos*, Hegemon Press, Samos, Greece.
- Tokmakides, K. 2009. Surveying the Eupalinian Aqueduct in Samos Island, *22nd CIPA Symposium*, October 11–15, Kyoto, Japan.
- Zambas, C., Thomas, G., and Doudoumi, E. 2010. Study for the Restoration of the Aqueduct of Eupalinos. Samos Island. Unpublished Study in Greek. Egnatia Odos SA, Thessaloniki, Greece.

## *Section III*

---

*Africa*





# Taylor & Francis

Taylor & Francis Group

<http://taylorandfrancis.com>

---

# 6 The Past and Present of Underground Aqueducts in Algeria

*Najet Aroua and Abdelkrim (Krimo) Dahmen*

## CONTENTS

6.1	Introduction .....	83
6.2	The Early Environmental History of the Algerian Sahara.....	84
6.3	Physiography, Climate Variability, and Hydrogeology .....	84
6.4	The Oasis Vital Equation.....	85
6.5	The Underground Aqueduct Systems in Algeria.....	86
6.5.1	The <i>Chegga</i> System .....	86
6.5.2	The Gurara–Tuat–Tidikelt System.....	87
6.5.3	The M’Zab System .....	89
6.6	Related Technology and Ethic .....	91
6.6.1	Underground Aqueduct Technology.....	91
6.6.2	Water-Related Ethic.....	92
6.7	Present State of Underground Aqueduct in Algeria .....	93
6.7.1	Urban Growth and Irrigation.....	93
6.7.2	Rehabilitation Strategy .....	94
6.8	Conclusions.....	95
	Acknowledgment .....	95
	References.....	95

## 6.1 INTRODUCTION

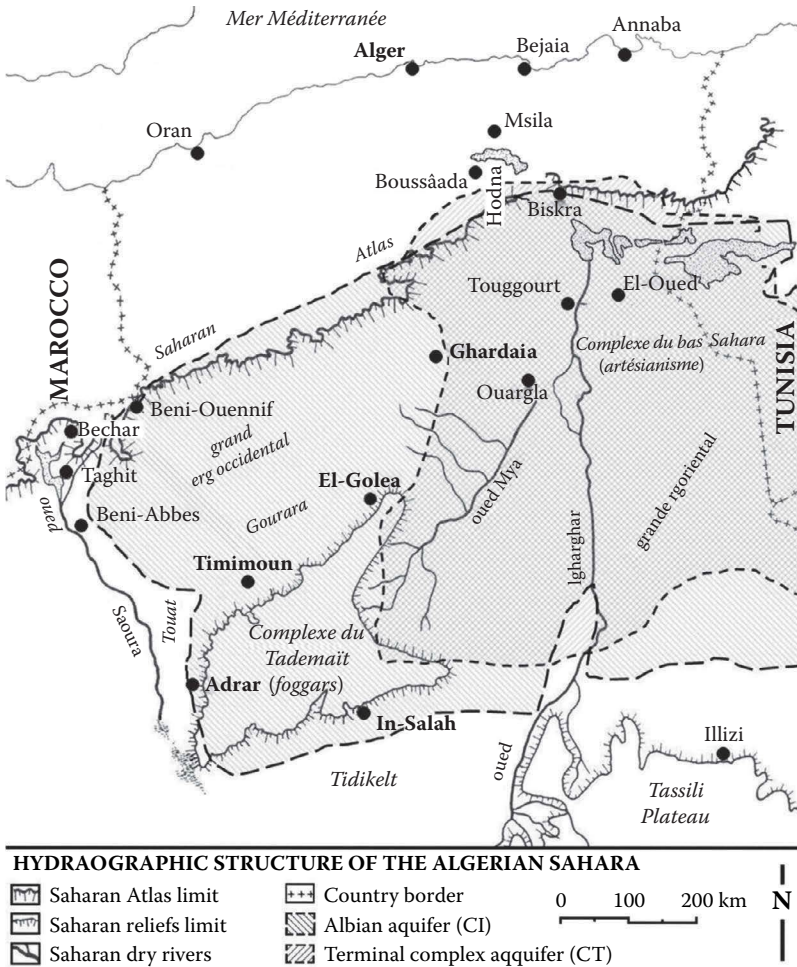
Biodiversity and life in general can expect surprising outcome within the Sahara desert, a drought-ridden country in the middle of Africa. Many secrets, including groundwater, are buried under dunes. The climate change did paradoxically favor agriculture and subsequently sedentary lifestyle by 4000 BP (Côte 2014). This date also corresponds to the beginning of the last aridity cycle (Rognon 1989). During that long adaptation period, inhabitants developed ingenious techniques to capture groundwater, according to the local physiography and hydrogeology, such as underground aqueducts, which are more generalized in the arid zones in Algeria, where underground aqueducts used to supply many oases across the Algerian Sahara in the regions of Bechar-Tindouf, Gurara-Tuat-Tidikelt, the M’Zab valley, the Ahaggar Southernmost, and around the Hodna lake. The Gurara-Tuat-Tidikelt, the M’Zab Valley, and the *Chegga* system in some places around the Hodna Lake may constitute the most relevant functional cases in Algeria.

## 6.2 THE EARLY ENVIRONMENTAL HISTORY OF THE ALGERIAN SAHARA

Oases supplied by underground aqueducts are cited in old manuscripts relayed by a number of Arab historians and geographers, either by locals or while traveling across the Algerian Sahara, most likely from the eleventh century onward (Hassani 2012). Some geographers, such as *al-Idrissi*, *Ibn Khaldun*, and *al-Wazzan*, became famous, as their works were published, while others remain unknown, as their manuscripts have not been systematically studied yet. Later, after the French colonization (in 1830), some explorers on official duty or great travelers did penetrate that wide desert. They did leave some valuable descriptive studies well illustrated with drawings and photographs on the regional water supply system and especially the original underground aqueduct technology. This chapter also refers to recent studies launched by academics and the National Sahara Watershed Agency among others.

## 6.3 PHYSIOGRAPHY, CLIMATE VARIABILITY, AND HYDROGEOLOGY

The general landscape of Algeria shows separate parallel physical units with variable altitude from North to South, even though the Sahara cannot be delimited properly (Dubief 1953). As shown in Figure 6.1, the Algerian Sahara is limited in north by the Saharan Atlas mountains, in west by the



**FIGURE 6.1** Map of the hydrographic structure of the Algerian Sahara. (From Dahmen A., *Major hydraulic systems in Algeria*, Yazd, Iran, 141–154, 2015.)

Atlantic Sea beyond Morocco, and in east by the Libyan Desert. The southern border seems to be endless and extends to Senegal, Niger, and Chad.

The Sahara is divided into two major streaming courses, in accordance with the general topography. The eastern course includes the Wadi-Righ and partially the Great Eastern Erg draining northern toward the lower Sahara around Chott Melghigh, following the Igharghar fossil river course. The western course starts south of the Moroccan Great Atlas, including the western border of the Great Western Erg, and continues southward up to the Reggane depression, following the course of the Saoura river.

The desert soil is mainly clayey and partly stony in general and subsequently more sensitive to the sun's drying effect. The high level of the atmospheric drought does result in the high evaporating capacity and then the emergence of salt water on the surface (Dubief 1953; Guemari 2008). The regional physiography seems to be hostile to the flora development, since it is mainly composed of sandy and stony wide areas called *erg* and *reg*, respectively.

Apart from the man-made oasis ecosystem, the local flora hardly grows, since water resources are very rare. Yet, the Sahara rivers called *wad* are often dry. They run and even overflow irregularly after rainfall events (Daumas 1845; Dubief 1953). Actually, the general topography and the climate conditions are mainly impacted by the drying effect of the wind North-Northeast, which also controls the temperature and the rainfall repartition (an average of 150 mm/yr Northern and 100 mm/yr Southern) (Martin 1908; Dubief 1953; Vial and Vial 1974). Since then, the country mainly depends on floods to replenish the natural underground reservoirs (Dubief 1953). With this regard, shallow and deep aquifers constitute the ultimate supplying resource within the wide desert. The shallow water table contained in the alluvium is replenished by rainwater, which is used for irrigation and drinking water supply, while the terminal continental aquifer (CT) and the intercalary continental aquifer (CI) (the fossil aquifers, 800–1500 m deep) are contained in the sand and sandstone layers (Dubief 1953; Despois et Raynal 1975; Guemari 2008; Côte 2014).

#### 6.4 THE OASIS VITAL EQUATION

First archaeological traces of sedentary settlements around lakes could date back to the Neolithic Era (de Planhol 1968; Côte 2014). Many carving and painting rocks show the fauna and flora mutation through millenaries and how the Sahara lifestyle has accommodated when climate changed definitively arid and hyperarid. The water technology progress combined with the local hydrogeological conditions made this adaptation possible within oases.

The oasis, as known nowadays, would be the ultimate survival formula settled in the ninth and tenth centuries, enhancing both trade activities and roads security (Hassani 2012; Côte 2014). According to the water origin and use, various kinds of oasis can be notified in Algeria. For example: (a) the oasis located at the edge of the two great ergs, where palm groves planted at the bottom of an artificial basin named "*ghut*" are self-irrigated by capillarity, as in El-Oued oasis; (b) the oases located essentially around the Tademaït Plateau, which is supplied by underground aqueducts generally named "*foggara*" such as Timimoun; (c) the oases located mainly in Wadi-Righ and irrigated by the artesian wells; (d) the oases of the southern slopes of the Saharan Atlas irrigated by canals diverted from a river such as Laghouat; (e) the oases served by water sources in various places such as in the Ziban region; and (f) the oases located along a riverbed such as Djanet.

Their location results from a spatial logic system, combining hydrogeological and physical items with travel amenities across the oases network. Successive Muslim governing dynasties in the Maghreb (*al-Murabitun* and *al-Muwahidun* particularly) did endeavor to maintain and develop the existing oases, in addition to finding and populating others to connect coastal and continental cities with the so-called *Bilad Sudan* and Timbuktu in Mali (Hassani 2012). After Côte (2014) and Hassani (2012), it seems that *Bilad Sudan* used to design the African country from East to West without distinction of frontiers. The oases have been settled on the rivers banks or near expected groundwater, making best use of underground aqueducts that would have been notably developed starting from

the tenth century (Hassani 2012). Despite the great depth of the water level, some oases did grow and became famous in so far as cultural and trade centers such as *Tamentit*, *Timimun*, *Ouargla*, *In-Salah*, *Timmi* (Adrar), and *Ghardaya* in the M'Zab Valley.

Within that arid zone, groundwater used to be captured through underground aqueducts to supply the increasing population and irrigate the numerous palm groves and gardens all around. Even then, autochthonous people were not favorable to settle new agglomerations close to one another to avoid the overexploitation of groundwater and then the drawdown of the table (Hassani 2012). According to the oasis size and the plant density, resulting local climate affects the temperature and the humidity as much as the wind breeze force, which in turn reduces the evaporation rate of water (Riou 1990). The main objective was to maintain that famous oasis vital equation based on the close relationship between water resources, palm groves, and build environment locally named *tin/timmil aïn* and *ghaba* and *qu'sar*, respectively (Martin 1908).

## 6.5 THE UNDERGROUND AQUEDUCT SYSTEMS IN ALGERIA

In Algeria, underground water structures are attested since the early antiquity through various regions. The Romans introduced further hydraulic techniques in the North since the beginning of the first century. Their achievements are more urban and concern both drinking water supply and wastewater disposal. There are 39 aqueducts related to the Roman period; a good part of them have underground parts such as in Caesarea (Cherchell), Tipasa, and Madauros (M'daourouch) (Leveau 2010). Other underground aqueducts are attributed to the Ottomans, such as in Algiers since the sixteenth century. (Aroua 2002; Ouzidane 2013). The French administration contributed to repair part of the existing aqueducts and achieved various hydraulic structures, including underground aqueducts (Beau 1937). After independence, great works have been achieved; the most important one is the 700 km long underground aqueduct, being presently used to supply water from In-Salah to the southernmost main city of Tamanrasset (MRE 2016).

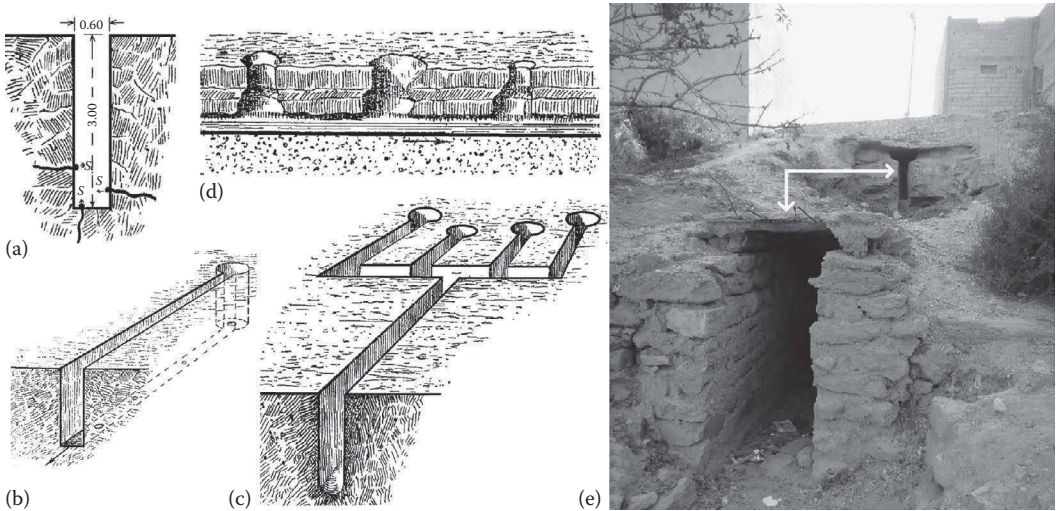
From elementary groundwater techniques such as the development of water sources or small dikes, autochthonous people developed underground structures such as the *chegga*, a trench that can reach the depth of several meters and continues as a short tunnel. It belongs to different places through northern Algeria but mainly around the *Chotts* in the highlands (Moulias 1927; Despois 1953). A more sophisticated underground aqueduct is the *foggara*, or *ifli* in Berber. Underground aqueducts have various equivalent designations worldwide. *Foggara* (pl. *faggagir*) that is used in Algeria could have been derived from *faqira* (pl. *faqirate* or *faquair*) that designates the water releasing in a channel (based on Al-Munjid dictionary, Beirut 1956, p. 622).

The *foggara* is exclusively noticed in the regions of Gurara, Tuat, and Tidikelt, surrounding the Tademait Plateau as a *foggara*-based irrigation zone. Since the Fazzan project, its presence in the Maghreb is reported to the second century BC (Mattingly et al. 1997; Wilson and Mattingly 2003). Due to more recent dating operations achieved more recently and communicated by Prof. Mattingly, the limit tends to reach the fourth century BC. Some *foggaras'* kinds are located in the Ahaggar region. They are more likely featured as covered and uncovered canals, with shafts eventually diverting water from the riverbed shallow aquifer. Some local traditions in the oasis of Djanet in the Tassili Plateau report that they have been achieved once. The technique was abandoned after they were destroyed by the floods (Capot-Rey 1953).

### 6.5.1 THE CHEGGA SYSTEM

The technique is well attested in various places in both Saharan and northern regions. The *chegga* is a simple uncovered trench that taps on the riverbed or starts from a dried-up water source. With the digging advancing upward, it may continue as a subterranean gallery with access shafts. It is witnessed by early French sources in various places such as around Tlemcen and the south of Medea (Ville 1869). This system appears more concentrated around the Hodna Lake, where it used to be





**FIGURE 6.2** Different chegga types in Zab-Dhahrawi (Biskra) in the early twentieth century, and Eddis (Msila) today. (a) Section on a chegga with three water emergences; (b) A chegga with four water emergences in alignment, including one shaped like a well; (c) A rake scheme chegga gathering four simple items; (d) The “natural foggara” of Ayn-Mothi water source at Bouchagroun; (e) A dry chegga below the street mosque in Eddis. (From Flamand, G.B.M., *Compte Rendu de la Campagne 1907–1908*, Heintz, Alger, p. 166, 1908, [http://jubilotheque.upmc.fr/fonds-geolreg/GC\\_000021\\_001/document.pdf?name=GC\\_000021\\_001\\_pdf.pdf](http://jubilotheque.upmc.fr/fonds-geolreg/GC_000021_001/document.pdf?name=GC_000021_001_pdf.pdf); Dahmen 2015. With Permission.)

dug up to the middle of the twentieth century (Despois 1953). It also existed far from inhabited areas, serving exclusively for agricultural irrigation.

The *chegga* can be shaped in different schemes. It can be a simple open trench or developed from one or more water sources in a linear or ramified scheme, as shown in Figure 6.2. In the Zab-Dhahrawi near Biskra, Flamand, who witnessed more than 150 sources, also noticed various *chegga* forms and even a water source as a natural gallery, with shafts looking like an underground aqueduct (Flamand 1908). In Eddis, the *chegga* structures have largely dried up since the nineties of the twentieth century after the administration dug a deep well for drinking water supply.

Given its elementary technique, the *chegga* is a simple structure that might be in use largely through the Maghreb, without any relevant need to search how it might be introduced (Cornet 1953). This suggests that the technique might have been in use since the early antiquity in different places. Indeed, various names derived from the *chegga* do exist in different regions, such as Oran and Annaba on the Mediterranean coast, Tebessa and Tlemcen on the side frontiers, and Ouargla in the Sahara. Furthermore, the system might have been a transitional form, advancing autochthonous to master underground structures.

### 6.5.2 THE GURARA–TUAT–TIDIKELT SYSTEM

As shown in Figure 6.1 upper section, the Gurara–Tuat–Tidikelt (5) covers the southeastern edge of the Great Western Erg (northern) and the areas surrounding the Tadmaït Plateau (about 600 m altitude) from the north, west, and south. The Great Western Erg is a large high-dunes area (20–40 m high). In Arabic, *Erg* (or *erq*, pl. *uruq*) literally designs a vein. It receives seasonal spring and autumn rainfall (Dubief 1953). Autochthonous people used to design the whole region of Gurara–Tuat–Tidikelt as the Tuat (Martin 1908).

The region integrates two wilayats: Adrar and Tamanrasset. In Algeria, the *wilaya* (pl. *wilayat*) is the administrative spatial unity, bringing together a number of municipalities.



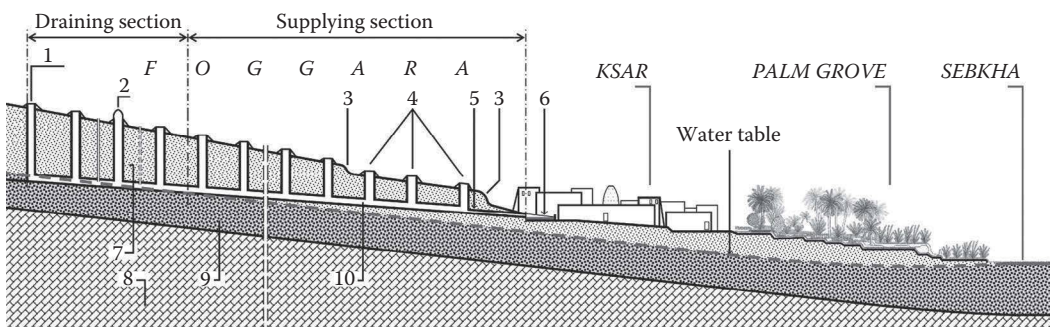
Adrar has been first divided into Gurara, Tuat, and Tidikelt and cited by historians as being excessively hot, sandy, and windy; however, it is rich in water resources, trees, and palm groves (Mohamad ben abdel Karim ben abd el-Haq from the eleventh century cited by Hassani 2012). Gurara would mean “*quarara*” that designs the fixed stay in Arabic. The genuine name in the ancient sources as Ibn-Khaldoun and al-Wazzan is *Tigurarin* in Berber, which would be derived from *Agrur*, a camp or an inhabited place (Mammeri 1984, 11). Tuat would be “the inhabited location,” while Tidikelt would mean “the hand palm,” a flat land.

The northern side of the Gurara is supplied from the Western Erg aquifer, while the areas surrounding the Tadmaït are served by the Continental Intercalaire aquifer, where water table becomes close to the surface. The supply system is organized preferentially according to the local topography in order to receive drained water by gravity (Daumas 1845). The underground aqueducts technology was based on a relatively simple process but was certainly very expensive in terms of labor. Actually, this technology could be developed only if labor was available, since fieldwork objectives were to determine the table line, dig wells, and galleries; build sharing conducts and storage basins; and ensure and maintain the whole system running.

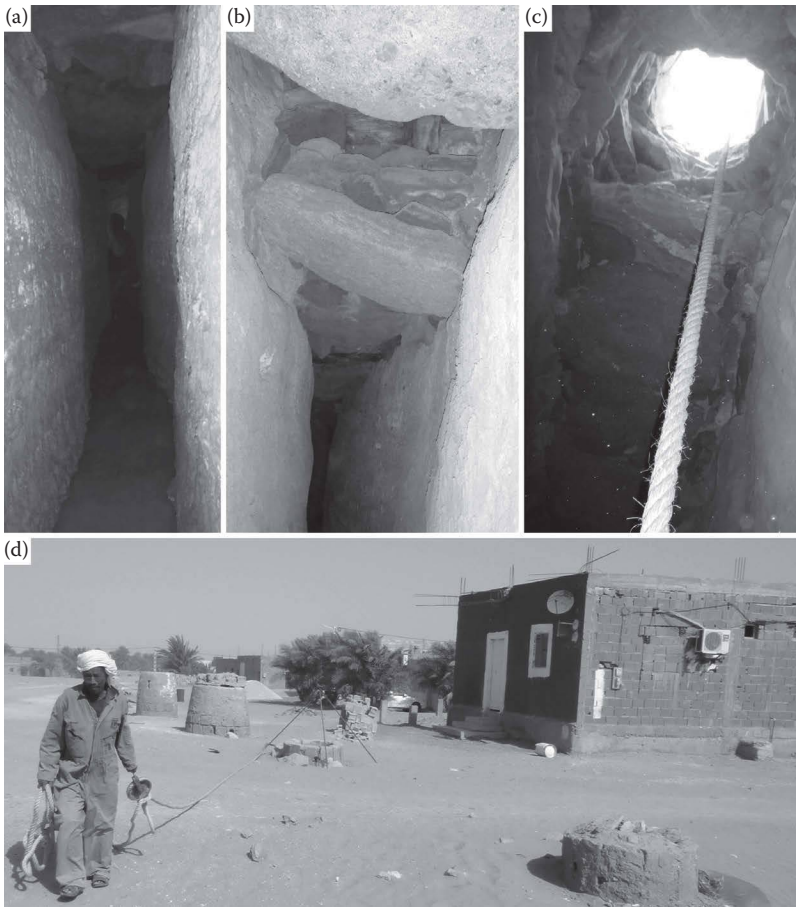
The entire process (design, building, and maintenance) has been tested and codified across the time and concerns two main gallery sections: first, upstream gallery being in contact with the water table and ventilated by wells; second, downstream gallery located above the water level, bringing drain water to the surface (Merzougui 2003; Remini 2008; Kerroumi 2014). The related organizing principle is to arrange the water system and the agglomeration together with the palm grove, successively from up to downstream and to determine the low slope gradient (less than 1%) in parallel to the water flow, as shown in Figure 6.3. (El-Faïz 2005; Garcier and Bravard 2008; Remini 2008). To facilitate the water running and avoid infiltration, the slope gradient is more important in the second section downstream (Merzougui 2003). The role of these wells is to ventilate and extract cuttings and allow access to galleries when necessary (Ville 1872). As shown in Figure 6.4, on the surface, they are surrounded by a small protecting stone wall near the inhabited area or by a ring of spoil in the non-urbanized area (Ville 1872; Remini 2008; Messaitfa undated).

The Tuat counts hundreds of foggaras (Ben Naoun 2001). The succession of shafts designates the underground gallery course. The gallery section linking two successive shafts is called *anfadh*. After the traditional law, the distance between two foggaras is counted in *quama* that represents two extended arms of length about 2 m (Remini 2008). The gallery can be several kilometers long (0.4–14 km): 50–80 cm large and 90–150 cm high. Wells are 1–40 m deep and 0.5–1 m large and spaced about 20–30 m from each other (www.unesco.org).

The emerging section of the gallery named *aghussru* is sometimes covered by flat stones; it connects the gallery to the *kesria*, a triangular basin where the flow is diverted into the canals through a stony distributor called *Mechta*, literally the comb. To control the water repartition between



**FIGURE 6.3** The foggara-based oasis organization. Legend, (1) Last shaft, (2) Bordj-el-foggara (gauging shaft), (3) Escarpment, (4) Shafts, (5) Aghussru, (6) Kesria, (7) Permeable layer, (8) Impermeable layer, (9) Aquifer, and (10) Gallery. (From Dahmen A., *Major Hydraulic Systems in Algeria*, Yazd, Iran, 141–154, 2015.)

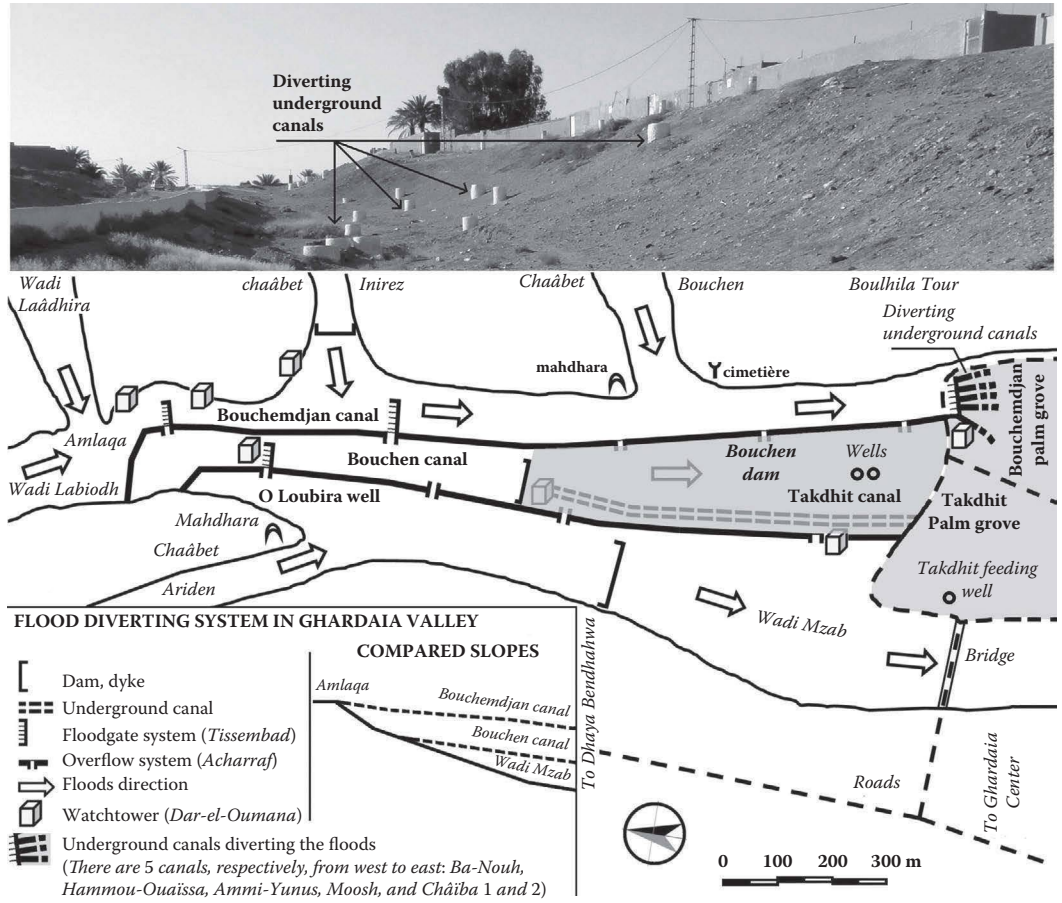


**FIGURE 6.4** Huddi foggara in Gasbet-el-Kef, north Timimoun. (a) The gallery 200 m upstream, (b) Stone-built shaft from the gallery cover, (c) Shaft with the hanged rope to get into the gallery, and (d) Abderrahman Al-Maghili, the foggara expert (*khabir*), getting back the rope after the gallery visit. (From Dahmen 2015.)

beneficiaries, the water partition is achieved by a gauging tool, locally named *louh* or *chegfa* (literally “piece of wood”) or *hallafa* or *kayl al-asfar*. This piece is made of terracotta or copper (since resistant to corrosion) and has some differentiated holes sized in a way so that it enables the different combinations, depending on each attributed part (Remini 2008). Then water is brought through channels that are increasingly narrow, called *segua*, toward the storage basin, locally named *majen*, located at the entrance of palm groves and gardens partitioned in small units called *guemun*. This basin is sized in a way so that it fills in 1 day (24 h) (Bisson 1999; Ben Naoun 2001; Remini 2008).

### 6.5.3 THE M’ZAB SYSTEM

The M’Zab Saharan valley is located about 600 km far from Algiers, between the high steppe lands Southwest and the vast Sahara. Even if the climate is arid, the valley is served by a northern limestone plateau situated 250–750 m high. The maximum rainfall amount does not exceed 100 mm per year. However, given the waterproof stone plateau, the seasonal floods arrive to the M’Zab valley through the rivers *M’Zab*, *Metlili*, *Seb-Seb*, *N’sa*, and *Zeghrir*. They flow so fast that they prevent both evaporation and infiltration. This river network is called Chebka. Water infiltrates the valley, which supplies for seven oases, including Ghardaïa, the capital. Each oasis has its particular hydraulic system. This section presents the Ghardaïa system.

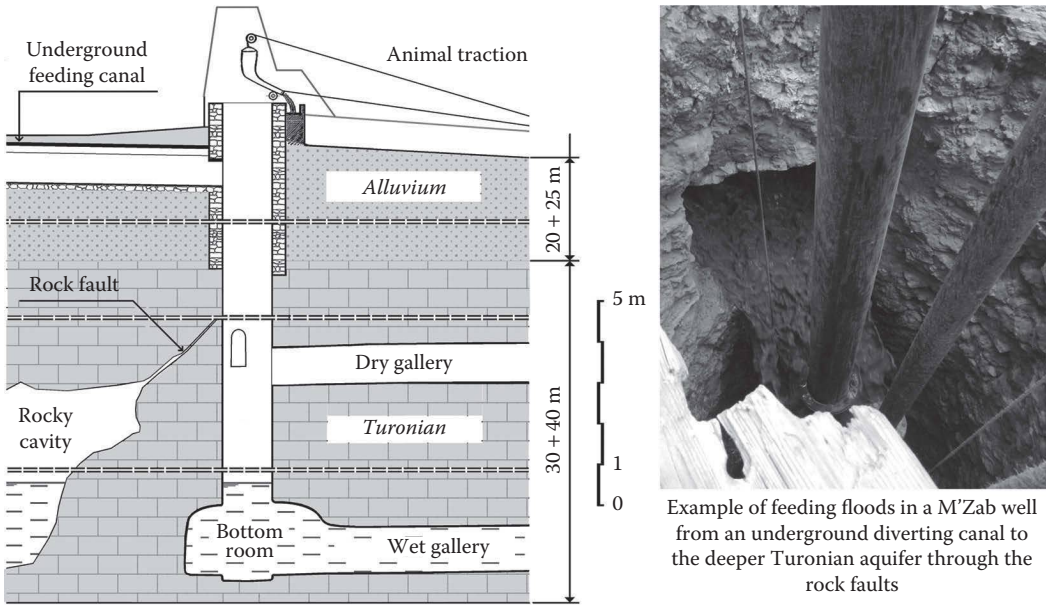


**FIGURE 6.5** Flood-diverting system in the Ghardaïa valley. (From Dahmen A., *Major Hydraulic Systems in Algeria*, Yazd, Iran, 141–154, 2015.)

The basic rule is to take the biggest benefit from the seasonal floods. As seen in Figure 6.5, water is diverted into gardens by canals. Once the gardens are irrigated, the floods are diverted through the canals to feed the deeper aquifer by a group of wells. After this, water is retained in a dam called *bouchen* and behind the dykes to infiltrate the aquifer. If there is any additional flood, it is simply diverted back to the river.

The wells reconstitute water during the rest of the year. They are of three categories. Alluvium wells are short (20–25 m depth) and water-scarce. They give water only during 6–30 months. Permanent wells, called *warwara*, catch from a deeper aquifer in the Turonian layer, which arrives up to 55 m depth (Charlet 1905). They can give water continuously, without exceeding a flow limit. The third category is of those wells that give water continuously without flow limits. They are called *tameh-rit*. Some wells of the last two categories serve as feeding wells when they meet major rock faults connected to the layer caves. They also have a larger bottom room and horizontal galleries dug in various depths in order to reinforce water catchment, as shown in Figure 6.6.

Some of these galleries are connected, so that they draw an underground network, enhancing wells capacity mutually. As the floods are not frequent enough, the M’Zab system uses dams, dykes, canals, and wells to optimize and master the water resources. This is achieved by direct irrigation when floods occur and direct filling into the deep aquifer, reinforcing infiltration. Canals, dams, and dykes are equipped with an overflow system called *acharra*, which diverts exceeding water back to the river in order to prevent water devastation threats. They are also equipped with a range of



**FIGURE 6.6** Cross section of a basic *Tamehrit* feeding well, with the horizontal galleries and the bottom room. The picture shows a feeding well, receiving floods from an underground canal during September 2015. (From Dahmen A., *Major Hydraulic Systems in Algeria*, Yazd, Iran, 141–154, 2015.)

floodgates called *tissembad* to control the rate of flow. In the past, the diverting canals were uncovered. Owing to the successive sand deposits, they have been covered, so they appear like a *foggara*. The M’Zab system uses two types of subterranean tunnels: the diverting canals to share the floods and the well galleries to feed the aquifer and restitute water by extraction.

## 6.6 RELATED TECHNOLOGY AND ETHIC

The longevity and prosperity of oasis heavily depended on the development of agronomy and hydrology knowledge, as much or more than available labor was required to dig and maintain different existing types of wells, specifically those associated with underground aqueducts. After El-Faïz, it seems that hydraulic engineering developed in the Maghreb is mainly based on the fieldwork experience in order to comply with the local physical and hydrogeological conditions (El-Faïz 2005). Yet, both the jurisprudence and related technology are based on the professional experience and the local knowledge at the same time.

### 6.6.1 UNDERGROUND AQUEDUCT TECHNOLOGY

In the Tuat, building activities consist first of digging the mother well upstream in order to evaluate the water level. A deep table is more appreciated, since the risk of drying up is supposed to be less important (Ville 1872). If the water availability is confirmed, work starts over from downstream by digging and connecting wells through galleries (Based on Ville 1872). The gallery level is conducted to an exit point downward, so that water flows naturally by gravitation. In the Gurara, the gallery starts downstream from a dried-up source and continues upward (Cornet 1953). To build galleries, two workers proceed from opposite directions until the gallery becomes draining (Ville 1872; Remini 2008). The same method has been used in Iran (Semsar Yazdi and Khaneiki 2010). Building materials are locally extracted from either palm groves or basement rocks. Stonecutting is used to build the gallery walls, while palm trunks associated with a straw and clay mortar are used



to consolidate its ceiling (www.unesco.org). After Berbrugger, similar method and materials were to be used to build the artesian wells (Berbrugger 1862).

Maintenance service may be similar and common to all oases supplied with underground aqueducts. They consist of controlling and cleaning galleries from deposit sediments or collapse stones and cover the well's mouth to preserve against sandy winds. In summer, each inhabitant has to contribute actively to the maintenance of the whole system, according to the local custom called *al-fridha*, literally “the duty” (Remini 2008).

As soon as a reduced flow is detected, another well is built a few meters away (about 15–20 m) (Martin 1908). The strategy can also consist either of lowering the floor level or of extending the gallery length (the process is called *tarha*, literally “extension”) or of digging a new network under the first one. Yet, a number of underground aqueducts (2–6) can be interconnected and intersected on the surface (the process is called *kra'*, literally “leg”) (Remini 2008). New palm-groves and garden parcels are subsequently rearranged at a lower topographic level to benefit from the gravity effect (Bisson 1999).

### 6.6.2 WATER-RELATED ETHIC

Starting from the notable development of the underground aqueducts in the country, probably by the time of al-Malik al Mansur between the eleventh and the twelfth centuries (Remini 2008), underground aqueducts-related jurisprudence consecrated the very precious water resource and codified the related technology and governance. Until now, specific law books are jealously preserved by local notables, who ensured their application and transmission across generations. In the Gurara-Tuat-Tidikelt, the oasis governance belongs to a group of elected notables called *djamaa*, who meet once a week *extra muros* to make general decisions and give advices, including those on water issues (Daumas 1845; Hassani 2012).

Since groundwater constitutes the main available resource, the law articles concern related technology (material and tools, building code, protecting perimeter, etc) more than the management (repartition, price, debit, etc) and ethical issues (slave labor status, working organization, local knowledge transfer, etc). Scholars have precisely defined the protecting perimeter diameter and discussed damages aspects and prohibition rules according to the general local context. Yet, they ordered to release some cubits around the well, depending on its nature and use (if ancient or new and if used for animal watering or irrigation). The maximum radius (about 225–250 m) concerned the drinking water source (Salama 2013).

The protecting perimeter called *harim al-ma'* or *harim al-foggara* is an original legal operating concept synthesizing both water sacredness and hygiene concern (Aroua 2014). In general, there is no common distance, but in the Tuat region, it has been identified to a distance of 80 m (Grandguillaume 1973). However, since 1996, a local law proclaimed by the Wali (Adrar Governor) has fixed the *harem* distance to 10 m from each side (decision n° 426—June 22, 1996). This perimeter also serves to circumscribe and preserve the private property (even collective) and associated rights, in addition to prohibiting any new wells within that perimeter (Salama 2013). The prohibition was sometimes pronounced against the extension of the underground aqueducts far from the oasis as far as it could aggravate the local vulnerability face to enemies and natural risks (Daumas 1845; Ben Naoun 2001).

Each associated owner having contributed to finance or carried out the underground aqueducts is granted a water volume, depending on the commitment rate, as evaluated by the accounting responsible called *al-hassab* (literally “the calculator”). In the Tuat, water used to be shared referring to the eighth unit until now (Hassani 2012). This unitary share is equivalent to 0,0416 L/s. It is locally called *t'men*. It would be evaluated compared to the grain of caroub, locally named *habba* or *habba zrig* (Remini 2008; Remini and Achour 2013). *T'men* is the local pronunciation of *thumun* (1/8) in Arabic. However, other measures are being used such as *al-majen* (the storage basin content), or *a'sba'* (the finger), or *al-ûd* (the stick), or *al-kharga* (the hole) (Benhamza 2013). The unit part can

also be calculated on time such as in Tamantit, called *nouba* (Benhamza 2013). Whatever the number of beneficiaries may be, one part is devoted to public institutions (such as mosques and schools) as a free and permanent donation (Remini 2008).

The operation is witnessed by shareholders and can take one day for a small foggara and up to 3 days for the biggest one. Each part is notified on the underground aqueducts register called *zeman* by the person in charge, namely *al-kiyal*, who is appointed by the notables (Martin 1908; Remini 2008). This register is also used to inventory living underground aqueducts and collect taxes (D'Eu 1903). Between two counting operations, the number of underground aqueducts may change. Some could be added or dried up or invaded by the sand or willingly damaged by the enemy. In the oasis of *Zaouiet Kounta* (Adrar), a register dating back to 1670 grants some of them by one of the following mentions: "died long time ago," "died 25 years ago," "the water level is slightly lower than the garden land level," "cleaned out in (date)," and "cannot be cleaned" (Martin 1908).

It is interesting to notice that scholars in charge of water law are farmers themselves. Some of them did actively contribute to dig wells in order to promote the agricultural activity, which is supposed to be their main purpose (Hassani 2012). This reinforces the realism and the relevance of the water-related jurisprudence, and subsequently, its ability to deal with fieldwork inquiries, which are inspired by the Islamic philosophy (Aroua 2014). The water jurisprudence has also hardly contributed to reinforce the solidarity between users, despite the strict social hierarchy. In the M'Zab valley, the clerical group legislates within their own city, subordinating the soil appropriation to the individual water property. This is what used to be until 1882, when the M'Zab region had been annexed by the French colonial government. The water legislation followed in the M'Zab valley has arisen from the Ibadite religious school that was well adapted to the local natural conditions, connecting water to soil property and enhancing social participation. The Ibadite Code is fundamentally similar to the Malikite and the Hanafite schools regarding water issues, as they all consider and incorporate pre-Islamic practices and ethic principles in order to protect water resources and ensure social equity. Furthermore, the law applied by *al-Qadi* (the judge) results from both religious considerations and expert consultations. Yet, the water-related jurisprudence or "*Fiqh al-Ma*" is quite contextualized and is designated as a pragmatic and realistic jurisprudence. Indeed, many manuscripts indicate a permanent concern with the ecological approach connecting humans with environmental components (Based on Aroua 2014).

## 6.7 PRESENT STATE OF UNDERGROUND AQUEDUCT IN ALGERIA

Starting from the nineteenth century, the trade dynamic did change its ways and means for the benefit of the navigation, causing the gradual decline of oases and then the underground aqueducts purpose (Côte 1983). However, their worrying present state may go back to the seventies, when the Algerian government decided to develop the Sahara region with the same strategy used in North, without sufficient adaptation to the local conditions. The process was intensified even more in the eighties by enlarging the irrigated perimeters dedicated to the cereal production (Othmane and Kouzmine 2013). The government objectives were to introduce a new demographic and economic balance across the country and to ensure the self-reliance at the same time (Spiga 2005; Othmane and Kouzmine 2013). However, the method and means used did not lead to the expected results, especially in the Gurara-Tuat-Tidikelt (Othmane and Kouzmine 2013).

### 6.7.1 URBAN GROWTH AND IRRIGATION

Since last decades, southern cities of Algeria have grown rapidly to phagocytose oases. Besides, they extend in a disharmonious and anarchic way so that the autochthonous people do not even recognize them as their own. Neither the architecture nor the urban design is culturally specific and adapted to the local environment. Moreover, migrants did found refuge in ancient settlements where hygiene facilities are no longer insured. Actually, "the slave road" became the "migrant road."



Therefore, the M'Zab valley is nowadays threatened by a serious water crisis, which may be aggravated by climate change. Moreover, it is now encircled by a number of precarious settlements that suffer unprecedented wastewater diffusion. Even located under such a dry climate, the valley is facing increasing flooding events, causing human and material damages. At the same time, palm groves have been widely settled through the whole Sahara and more specifically in the Gurara-Tuat-Tidikelt, which is irrigated by both traditional underground aqueducts and new drilling pumps (Kerroumi 2014). Actually, the extraction technology of hydrocarbons has well supported the hydraulic business in the wide arid Sahara. Since the 1960s, groundwater is captured from very important depth. As a result, the drinking water supply has been improved and more irrigated cultures have been developed. However, it has contributed to dry up the underground aqueducts and endangered both palm groves and built environments. Yet, the more water is dispensed, the more effluent discharging increases and threatens the groundwater and, more generally, the natural ecosystem. While the whole region faces natural risks such as silting, scarcity, and high temperatures, a significant volume of water is drilled from the deep fossil aquifer. Water is, therefore, introduced within the ruling water cycle regardless either the local ecosystem or the population demands. Yet, the most critical risk that oases and southern cities are facing is related to wastewater and environmental pollution, since there is neither sufficient natural outlet (they sometimes have been replaced by the underground aqueducts' wells) nor sewage treatment system (Remini 2008). Therefore, the Algerian Sahara would be in danger of water excess, since nowadays, the extracted volume exceeds the required volume (Côte 1998, 2014). As a result, the groundwater level becomes seriously declined and contaminated and even salted, while many underground aqueducts are being dried up (Côte 2014). The underground aqueducts shareholders often protest against the use of deep wells dug near the galleries. They always claim to respect the related buffer zone (Othmane and Kouzmine 2013). This shows that the decision proclaimed in 1996 did not have a significant impact.

### 6.7.2 REHABILITATION STRATEGY

Autochthonous people used to rehabilitate the underground aqueduct by extending the gallery upstream or moving down the gallery (Merzougui 2003). When the foggara dries just because of a lack of maintenance, it can be revived. Since 2011, more than 60 foggaras have been revived with public budget, through the different districts of the Gurara-Tuat-Tidikelt region. The information is reported from the Adrar hydraulic services. Actually, the region is nowadays dotted with many inactive underground aqueducts, designating successive historical steps of the land use and settlement (Marouf 1999). It seems that process cannot be carried out anymore, mainly owing to the lack of skilled labors (Remini 2008). Actually, it is quite difficult to restore a dead underground aqueduct if not based on a new groundwater strategy, considering the necessary protecting perimeter and the water flow monitoring (Merzougui 2003; Khadraoui 2007). Some of them have been restored with either local or international financial support, so that the "Oases supplied by *foggara* and *ksour* of the Great Eastern Erg" have been included on the World Heritage Tentative List in 2002 (<http://whc.unesco.org>). Otherwise, M'Zab valley has been inscribed on the World Heritage List in 1982, regardless of its hydraulic system (Icomos 1982).

Given the uncontrolled urbanization within the palm grove area, and after the 2008 devastating floods, a major part of the hydraulic system has been damaged. A restoration plan is conducted under the auspices of the Ministry of Culture to repair the system up to the diverting canals downward, with the participation of the traditional governing system of the ksar related to water issues called *Umana es-Ayl*. Owing to the safeguard heritage law, the project has to be developed in four steps: (a) a general survey and emergency actions, (b) collecting the data and historical sources, (c) the evaluation of the state of conservation, and (d) the restoration project. At present, the project study has been achieved and adopted by the Ministry of Culture since early 2014. The fieldworks are expected to be launched by the beginning of 2016. The project consists of a general site survey and an evaluation of damages and related pathologies within the built structures, especially

in the stone-built subterranean canals. The project proposes to repair the damages by using the traditional building mode, which remains in use in the valley. The built water structures are based on stone masonry; stones are held together by using a mortar based on a mixture of lime and sand. The project also recommends the use of cement in case it has been already used in previous restorations.

More generally, the underground aqueducts' original heritage is dealing with intrinsic issues due to the water loss (by infiltration), as well as the location of the gallery compared with the aquifer flow direction, in addition to the interfering phenomenon between new wellbores and underground aqueducts. In this respect, some modern technical measures have been proposed to support the rehabilitation strategy (such as sealing the gallery to avoid any infiltration, reducing the water flow, discharging the sand by air or water pressure system, and simply increasing the intake of water from other wells) (Khadraoui 2007). Since the whole oasis ecosystem is naturally intended to evolve any rehabilitation, strategy should be based on the global approach dealing with water and cultural issues, including traditional agricultural practices and modern integrated water management principles.

## 6.8 CONCLUSIONS

The underground water structures obviously indicate a key evolution in human history. Their development has advanced the local know-how and enhanced the rise of a new era. In these arid zones, water becomes available for use at the due time and the desired space. Nevertheless, the global water cycle and the urban water cycle have become risky today. By the past, groundwater gave life to the oasis; today, due to a lack of organisation and management, it becomes a threat sometimes. In the same way, the old migration movements have contributed to the underground aqueducts development. Today, however, the increasing demography participates in the environment endangering. In Algeria, oases supplied by underground aqueducts and underground aqueducts themselves are nowadays endangered from human polluting activities and climate change, pushing favorable isohyets northerly. After the Observatoire du Sahara et du Sahel (OSS 2002), there were 1000 underground aqueducts in the Tuat-Tidikelt in 1960 and only 807 in 1999. The flow decreased by 29%. In 2011, the number of living underground aqueducts was decreased nearly half compared with that in 1960 (from 498 to 271), while the number of dead ones has been multiplied by almost 5 (from 59 to 286) (Benhamza 2013). In 2015, the Water Resources National Agency inventoried 1492 foggaras, including 781 dried-up ones and positioned already 195,034 shafts by GPS (Ansari 2015). Some famous underground aqueducts are still in service within the Gurara-Tuat-Tidikelt, such as *al-Meghiyer* in Timimun (9000 m long, 879 wells), *Tufrin* (12 km long, 770 wells), *el-Gara* (6 km long, 500 wells), *Igreni S'ghira* (8 km long, 1200 wells), *al-K'bira* (14 km long, 1700 wells), *Awlad Ali* (9 km long, 1500 wells), and *Bendraou* (6500 m long, 438 wells) (Remini 2008). But how long they will exist?

## ACKNOWLEDGMENT

We are grateful to L. Behlouli for his technical input on regional hydrogeology and present state of underground aqueducts. We also express our thanks to the Adrar hydraulic services and the south-west regional office of the National Water Resources Agency.

## REFERENCES

- Agence Nationale des Ressources Hydriques. 2008. *Réhabilitation d'une foggara. Ksar Ait Messaoud, Commune de Reggane, Wilaya d'Adrar*. Fiche technique, Adrar (Algeria), pp. 14 (in French).
- Al-Munjid dictionary. 1956. Dar-el-Machreq, Beirut, Lebanon (in Arabic).
- Ansari T. 2015. *Mapping living heritage: the foggara of Adrar, Algeria*, in the IWA Workshop on Evolution of Qanat and Relevant Hydraulic Technologies, 8–10 November. Yazd-ICQHS, Iran, pp. 166–180.

- Aroua N. 2002. *Approvisionnement en eau et assainissement à Alger à l'époque othomane*, In Proceedings of the 38th International Congress on the History of Medicine 1–6 September 2002, Istanbul, Nil Sari & al Editors, pp. 963–975 (in French).
- Aroua N. 2014. *Traditional qanat related jurisprudence in Algeria*, Water Science & Technology: Water Supply, p. 8 (IWA Publishing). doi:10.2166/ws.2014.076.
- Beau (Le) G. 1937. *Exposé de la situation générale de l'Algérie en 1936*. Heintz, Algiers, Algeria, p. 843 (in French).
- Benhamada S. 2007. *Al-ma wa al-insan fi al-andalus khilal al qarn 7 wa 8 hidjri (Water and men in Al-Andalus during XIIIth and XIVth centuries)*. Dar a'talia l'tibaa' wa nachr publisher, Beyrouth, Lebanon, p. 292 (in Arabic).
- Benhamza M. 2013. *Aperçu hydrogéologique et hydroclimatiques sur le système de captage traditionnel dans eaux souterraines "foggara" dans la région d'Adrar*. Magister thesis. University of Annaba, Algeria, 123 p + Annexes (in French).
- Ben Naoun A. 2001. *Les commerces caravaniers à travers les récits hagiographiques*. In *La route des caravanes*, Centre national de recherché préhistoriques, anthropologiques et historiques (CNROAH), Algiers, Algeria, pp. 41–46 (in French).
- Berbrugger A. 1862. *Les puis artésiens des oasis méridionales de l'Algérie*. Bastide Libraire Editor, France, p. 136 (in French).
- Bisson J. 1999. *Gurara*. In 21 Gland-Hadjarien, Edisud (21), Aix-en-Provence, pp. 3188–3198 (in French).
- Capot-Rey R. 1953. *Recherches géographiques sur les confins algéro-libyens*. In *Travaux de l'Institut de Recherches Sahariennes (IRS)*, Algiers, t. 9, pp. 33–73 (in French).
- Charlet (Lt.) 1905. *Les palmiers du Mzab*. In: *Bulletin de la Société de Géographie d'Alger et de l'Afrique du Nord [BSGAAN]*. Algiers, Zamith & Cie, pp. 11–87 (in French).
- Cornet A. 1952. *Essai sur l'hydrogéologie du Grand erg occidental et des régions limitrophes. Les foggaras*. In: *Travaux de l'Institut de Recherches Sahariennes*, t.8, pp. 71–121 (in French).
- Côte M. 2014. *Le Sahara. Barrière ou pont*, Ed. Presse Universitaire de Provence (PUP), France, p.157 (in French).
- Côte M. 1998. *Des oasis malades de trop d'eau?* In *Sécheresse*, 9(2), AUF et les éditions John Libbey Eurotext. pp. 123–130.
- Côte M. 1983. *L'espace algérien, les premisses d'un aménagement*, Ed. Office des Publications Universitaires (OPU), Algeria, p. 278 (in French).
- D'Eu (Colonel). 1903. *In-Salah et le Tidikelt. Journal des opérations. Instructions sur la conduite des colonnes dans les régions sahariennes*, Librairie militaire Chapelot R. & Cie Publisher, Paris, p. 147 (in French).
- Dahmen A. 2015. *Major hydraulic systems in Algeria*. In: *Proceedings of the IWA Workshop on Evolution of Qanat and Relevant Hydraulic Technologies*, Yazd, Iran, 141–154.
- Daumas. 1845. *Le Sahara algérien: études géographiques, statistiques et historiques sur la région au sud des établissements français en Algérie*, Langlois et Cie Publisher, Paris, France, p. 339 (in French).
- Daumas 1853. *Moeurs et coutumes de l'Algérie. Tell-Kabylie-Sahara*, Librairie Hachette Cie Publisher, Paris, France, p. 394 (in French).
- De Planhol X. 1968. *Les fondements géographiques de l'histoire de l'Islam*, Ed. Flammarion. Publisher, Evreux, Paris, France, p. 442 (in French).
- Despois J. 1953. *Le Hodna. Algérie*, Presses universitaires de France, Paris, France, p. 410 (in French).
- Despois J. and Raynal R.1975. *Géographie de l'Afrique du Nord-Ouest*, Ed Payot, Paris, France, p. 570 (in French).
- Dubief J. 1953. *Essai sur l'hydrologie superficielle au Sahara*, Gouvernement Général de l'Algérie. Service de la colonisation et de l'hydrologie Publisher, Algiers, Algeria, p. 457 (in French).
- El-Faïz M. 2005. *Les maîtres de l'eau. Histoire de l'hydraulique arabe*, Ed. Actes Sud, France, p. 363 (in French).
- Flamand G.B.M. 1908. *Compte Rendu de la Campagne 1907–1908*, Heintz, Alger, p. 166, [on line], [http://jubilotheque.upmc.fr/fonds-geolreg/GC\\_000021\\_001/document.pdf?name=GC\\_000021\\_001\\_pdf.pdf](http://jubilotheque.upmc.fr/fonds-geolreg/GC_000021_001/document.pdf?name=GC_000021_001_pdf.pdf) (in French).
- Garcier R. and Bravard J.-P. 2008. *Qu'est-ce qu'une oasis. Réflexions géographiques sur un objet limite*, p. 19, <http://www.garcier.net/wp-content/uploads/2008/07/29.-Garcier-Bravard.pdf> (in French).
- Guemari F. 2008. *Etude des systèmes traditionnels de captage des eaux d'irrigation dans les oasis de la Vallée du Mzab. Cas des oasis de Metlili, El-Ateuf, Guerrara, Beni Izguen, Berriane et Bounoura*. Magister thesis, University of Ouargla, Algeria, p. 86 (in French).
- Grandguillaumee. G. 1973. *Régime économique et structure du pouvoir: le système des foggara du Touat*. In: *Revue de l'Occident musulman et de la Méditerranée*, 13–14, pp. 437–457 (in French).

- Hassani M. 2012. *Mawsu'at tarihk wa thaquafat al-mudun al-jazairiya (Encyclopedia of the history and culture of Algerian cities)*. Vol 2. *Mudun al-janub*. Dar al-Mahkama Publisher, Algiers, Algeria, p. 256 (in Arabic).
- ICOMOS (International Council on Monuments and Sites). 1982. The Mzab Valley Advisory body Evaluation. Unesco, Paris. [http://whc.unesco.org/archive/advisory\\_body\\_evaluation/188.pdf](http://whc.unesco.org/archive/advisory_body_evaluation/188.pdf).
- Kerroumi B. 2014. *La mutation des oasis à foggara: le renouveau agricole et le déclin de la production traditionnelle en Algérie*. In RCJT/CJTG Vol. 1(2), Université Laurentine, Dépt Géographie, Ontario V, pp. 6–12 (in French).
- Khadraoui A. 2007. *La foggara dans les oasis du Tuat-Gurara et de Tidikelt. Définition- Proposition de réhabilitation et de sauvegarde*. Note, Agence du bassin hydrographique Sahara Publisher, Algeria, p. 10 (in French).
- Leveau P. 2010. *L'alimentation hydraulique des villes de la méditerranée romaine: Assurer l'abondance et créer les pénuries*. In: Actes des Vèmes Rencontres Internationales Monaco et la Méditerranée, Gestion durable et équitable de l'eau douce en Méditerranée. Mémoire et traditions, avenir et solution, Monaco 2009, pp. 69–97 (in French).
- Marouf N. 1999. *Lecture de l'espace oasien*. Ed. Sindbad. France, p. 281 (in French).
- Martin A.G.P. 1908. *Les oasis sahariennes. Gurara-Touat-Tidikelt*. L'Imprimerie Algérienne, Algeria, p. 406 (in French).
- Mattingly D. J., Al-Mashai M., Balcombe P., Chapman S., Coddington H., Davison J., Kenyon D., Wilson A. I., and Witcher R. 1997. *The Fezzan Project 1997: methodologies and results of the first season*. Society of Libyan Studies, 28:11–25 (London).
- Merzougui B. 2003. *Etude du tarissement des foggaras dans la wilaya d'Adrar. Foggara du Ksar Ikki-Lahmer*, Agence nationale des ressources hydriques, Direction régionale Sud-Ouest, Algeria, p. 53, [www.anrh.dz](http://www.anrh.dz) (in French).
- Messaitfa K. Undated. *La foggara: un système d'irrigation original*, Algeria, p. 5, <http://www.amistimimou.free.fr> (in French).
- Ministry of Water Resources (MRE) 2016. *Transfert In Salah-Tamanrasset*. [http://www.mre.dz/index\\_fr.php?action=transfert&id=43](http://www.mre.dz/index_fr.php?action=transfert&id=43) (in French).
- Moulias D. 1927. *L'organisation hydraulique des oasis sahariennes*, Carbonel, Alger, Algeria, p. 305 (in French).
- Nedjah N., Hamdaoui O., and Laskri N. 2011. *Protection des eaux souterraines de la région d'Adrar des infiltrations d'eaux usées par application du lagunage naturel*. In Revue des Energies Renouvelables, ICESD'11 Adrar, Algeria, pp. 227–232 (in French).
- Observatoire du Sahara et du Sahel (OSS). 2002. *Système aquifère du Sahara septentrional*. OSS Publisher, Tunisia, Vol. 2, pp. 156 + Annexes (in French).
- Othmane T. and Kouzmine Y. 2013. *Bilan spatialisé de la mise en valeur agricole au Sahara algérien. Mythes, réalisations et impacts dans le Touat-Gurara-Tidikelt*. In Cybergeo: European Journal of Geography, doct 632, 29 p, <http://cybergeo.revue.org/25732> (in French).
- Ouzidane K.D. 2013. *Les aqueducs à souterazi de la Régence d'Alger*, in : e-Phaïtos, Journal of the History of the Technology, 2:73–84 (in French).
- Remini B. 2008. *La Foggara*, Ed Office des Publications Universitaires, Algiers, Algeria, p. 132 (in French).
- Remini B., Achour B., Ouled Belkhir C., and Baba Amar D. 2012. *The Mzab foggara: an original technique for collecting the water rising*. Journal of Water and Land Development 16(I–VI):49–53. Committee for Land Reclamation and Environmental Engineering in Agriculture of Polish Academy of Sciences and Institute of Technology and Life Sciences in Falenty (Polonia), [www.itep.edu.pl](http://www.itep.edu.pl)
- Remini B. and Achour B. 2013. *Les foggaras de l'Ahaggar. Disparition d'un patrimoine hydraulique*. In Larhyss Journal n°14, University of Biskra, Algeria, pp. 149–159 (in French).
- Rognon P. 1989. *Biographie d'un désert, le Sahara*, l'Harmattan, Paris, France, p. 348 (in French).
- Riou C. 1990. *Bioclimatologie des oasis*. In Dollé V. and Toutain G. *Les systèmes agricoles oasiens*. Montpellier, France, CIHEAM, pp. 207–220 (in French).
- Salama A. 2013. *Qadhaya al-ma'inda al-Arab quadiman. Mina al-Jahiliya ila al-quarn al-sabi' achar (17 milady)*. Ed. Dar al-Wafa Publisher, Alexandria, Egypt, p. 560 (in Arabic).
- Spiga S. 2005. *Aménageurs et migrants dans les villes du Grand Sud Algérien*. In Autrepert 36, Institut de recherche pour le développement (IRD) Publisher, France, pp. 81–103 (in French).
- Semsar Yazdi A.A. and Khaneiki M.L. 2010. *Veins of desert. A review of the technique of qanat/falaj/karez*. International center on qanats and historic hydraulic structures (ICQHS), Iran Water Resources Management Organization (IWRMO) Publisher, Iran, p. 310.
- Vial Y. And Vial M. 1974. *Sahara milieu vivant*. Ed. Hatier, Paris, France, p. 224 (in French).

- Ville L. 1872. *Exploration géologique du Beni Mzab, du Sahara et de la région des steppes de la province d'Alger*, Imprimerie Nationale Publisher, Paris, France, 540 p + Annexes (in French).
- Ville M. 1869. *Notice sur les gites minéraux et les matériaux de construction de l'Algérie*. Dunod, Paris, France, p. 70 (French) [online] <http://biblio.univ-alger.dz/jspui/bitstream/1635/32/1/24887.pdf>.
- Wilkinson J.C. 1990. *Muslim land and water law*. Journal of Islamic Studies, 1(1):57–72, Oxford Centre for Islamic Studies (in Arabic).
- Wilson A.I. and Mattingly D.J. 2003. *Irrigation technologies: foggaras, wells and field systems*. In: The Archaeology of Fazzan, 1, Synthesis, Society of Libyan studies (D. J. Mattingly, Ed.), London, UK, 454 p, pp. 235–278.
- Zella L. and Smadhi D. 2006. *Gestion de l'eau dans les oasis algériennes*. Larhyss Journal, 5:149–156, University of Biskra, Algeria (in French).

---

# 7 The Water Supply History of Underground Aqueducts in Egypt

*Abdelkader T. Ahmed and Mohamed H. Elsanabary*

## CONTENTS

7.1	Introduction .....	99
7.2	Aqueducts in Ancient Egypt.....	100
7.3	The Tunneling and Shaft Digging Technique of EA .....	104
7.4	The Hydrological and Hydraulic Properties of EA .....	104
7.5	EA Feed Resources.....	105
7.6	The Sustainability of the Water Supply.....	105
7.7	Water Quality and Management of Aqueducts.....	106
7.8	Conclusions.....	106
	References.....	106

## 7.1 INTRODUCTION

Egypt lies in the northeastern corner of Africa and occupies a total area of approximately 1 million km<sup>2</sup>. The surface topography of Egypt is characterized by a vast desert plateau separated in the middle by the Nile valley and its delta, which occupy about 5% of the total country area. The Nile River is the main source of water in Egypt as it supplies around 97% of its renewable water resources; however, there are some places in Egypt that depend on underground aqueducts either coming from the Nile or groundwater aquifers. The main aquifer is known as the Nubian Sandstone Aquifer System (NSAS) in the Western Desert of Egypt; it contains roughly 150,000 billion m<sup>3</sup> of water. However, Egypt's access for this aquifer has been so far limited to only three main access points in the Western Desert oases (PBC 2011). The evaluation of groundwater resources of NSAS indicated that 1020 million m<sup>3</sup>/yr of groundwater can be exploited in the New Valley Oases in Egypt. At present, only about 600 million m<sup>3</sup>/yr of groundwater is being used for irrigation. Centuries ago, NSAS was the source of many springs. In recent generations, hundreds of wells were tapped to this very large aquifer system that caused lowering of the water level. Nowadays, most water in the area is drawn from wells, whereas springs have disappeared. The second main area of groundwater resources in Egypt is Sinai Peninsula at the northeastern corner of Egypt. There are some natural springs such as Ain Furtaga in the southern province of Sinai and Ain EL Gudeirat in the sedimentary plateau of North Sinai (La Moreaux and Tanner 2015).

This chapter chronicles use of the aqueduct technique in Egypt. It discusses the hydrogeological properties of Egyptian aqueducts (EA) and the impacts of climatic change on them. Furthermore, this chapter discusses the hydrologic properties of the aquifer, such as local origin of water, flow rate, evaporation, and/or infiltration loss of water, and digging techniques. Finally, this chapter also provides an overview of the water quality and management of these aqueducts and the sustainability of the aqueduct water supply.



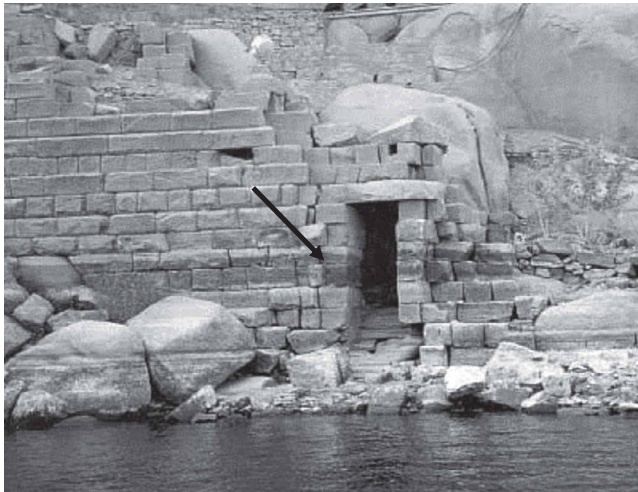
## 7.2 AQUEDUCTS IN ANCIENT EGYPT

An aqueduct is described as a watercourse constructed to convey water. It is considered as an important innovation in water supply and management. The term *aqueduct* is used for any system of pipes, ditches, canals, tunnels, and other structures used for conveying water. The term often also refers particularly to a bridge on a man-made watercourse. Ancient Egyptians used aqueducts like other ancient civilizations such as Greek, Roman, and Persian. The simplest aqueducts are small ditches cut into the earth. Aqueducts sometimes run for some or their entire path through tunnels constructed underground. These tunnels were at a lower level than the reservoir, and they were often several kilometers in length. The technique relied on a gravity hydraulic system of mobilization, transport, and distribution of water without using any additional energy that may have negative impacts on both climate and environment. Historically, ancient societies have constructed aqueducts to supply large cities with drinking water and to irrigate crops. The aqueduct was called Qanāt in the Middle East regions, which probably originated from Arabic or Persian language. These aqueducts or Qanāts were large underground galleries that collected and conveyed groundwater (Cartwright 2012).

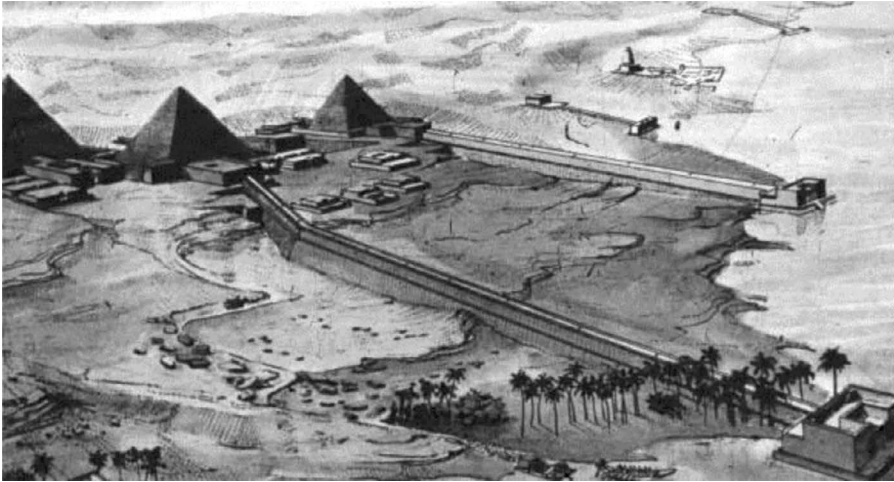
During the period 550–331 BC, when the Persian Empire rule extended from the Indus to the Nile, the aqueduct technology spread throughout the empire. The Achaemenid rulers provided a major incentive for aqueduct builders and their heirs by allowing them to retain profits from newly constructed aqueducts for five generations. As a result, thousands of new settlements were established and others expanded. To the west, aqueducts were constructed from Mesopotamia to the shores of the Mediterranean, as well as southward into parts of Egypt. The Persians introduced aqueducts to Egypt around 500 BC (WH 2015). The simplest, most primitive form of aqueduct was used in early Egypt. It consisted of nothing more than an open canal dug between the Nile River and the pyramids where water moved by gravity alone. There are also some places in Egypt especially oasis and desert regions that used aqueducts for conveying groundwater or springs to surface use for both irrigation and drinking purposes.

Ancient Egyptian, Pharaohs, conveyed Nile River water to their temples via underground aqueducts. For example, in the Edfu temple, which was built by Ptolemy III *ca.* 57 BC, beyond the great hypostyle hall is a second, smaller one, which leads to a well called the chamber of the Nile where the priests obtained pure holy water. The well brings water from the Nile in spite of the fact that the temple is away from the Nile by 1 km. The similar arrangement was found at Dendera temple (TEW 2015). An example of underground intakes conveying Nile water inside the temples is shown in Figure 7.1.

Moreover, open and underneath causeways or aqueducts are common to all pyramids that were built by the pharaohs close to the banks of the Nile. Aqueducts transferred Nile water into the base of the



**FIGURE 7.1** The entrance of Nile water to underneath aqueducts for a temple site.



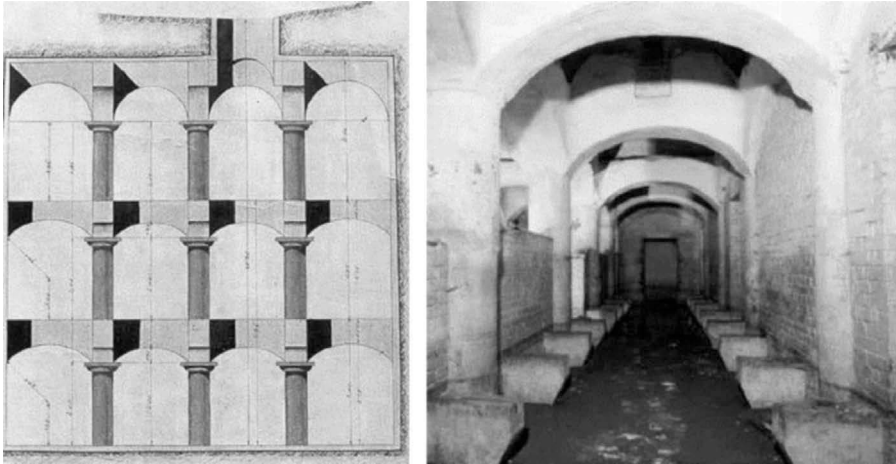
**FIGURE 7.2** Drawing shows the open and underneath causeways in the Giza pyramid site. (From Earthmilk Ancient Energy (EAE). 2015. Precisely Cut Wells, Shafts, and Underground Channels Connecting the Pyramids to the Nile River, accessed at 2015, <http://earthmilkancientenergy.com/ch4.htm>. With Permission.)

pyramid (see Figure 7.2). They are connected to the base of the pyramid and the Nile bed with a large opening to the sky structure and huge stone doors that open and close inside the Nile River. Inside the Giza pyramids, there were openings and passageways to an enormous underground cavern of the size of a football field under the pyramids. There were also shafts and aqueducts. When the Nile flowed beside the pyramids, the opening here was deep under the surface of the river, and the enormous chamber would fill up with water, directly underneath the pyramids, as shown in Figure 7.3 (EAE 2015).

Romans depended greatly on the technique of conveying groundwater and surface water by aqueducts. In Alexandria, Egypt, thousands of years ago, Romans brought fresh water to the city in a large and deep channel called cistern, cut by men through the desert to the Nile as shown in Figure 7.4. Every year, in late August and throughout September, the Nile River, which rises considerably at this time of the year, flows through this canal to fill all the wells of the city for the whole year, and the wells outside the city, which are used for watering the gardens and for drinking (Empereur 1998).



**FIGURE 7.3** Deep holes in the Giza pyramid site with connection to underground horizontal passageways. (From Earthmilk Ancient Energy (EAE). 2015. Precisely Cut Wells, Shafts, and Underground Channels Connecting the Pyramids to the Nile River, accessed at 2015, <http://earthmilkancientenergy.com/ch4.htm>. With Permission.)



**FIGURE 7.4** Roman cistern in Alexandria city. (From Tour Egypt Website (TEW). 2015. “Horus Temple”, accessed at 2015, <http://www.touregypt.net/edfut.htm#ixzz3pVpWqfyx>. With Permission.)



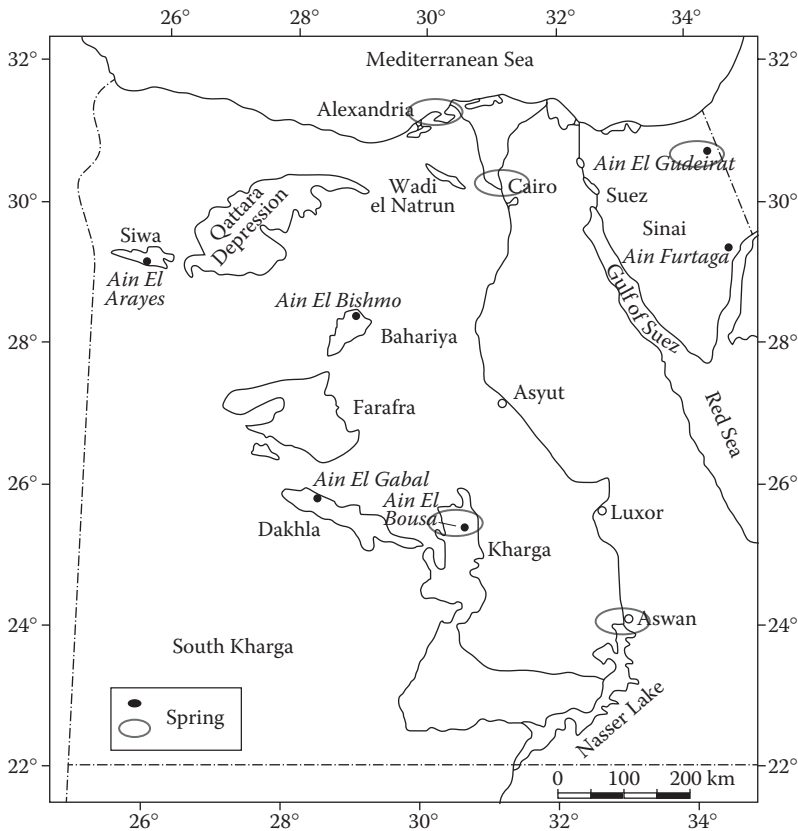
**FIGURE 7.5** The ruins of Ain Umm Dabadib, the Kharga Oasis. (From Dunn, J. 2011. Ain Umm Dabadib in the Kharga Oasis of Egypt. <http://www.touregypt.net/featurestories/dabadib.htm>. With Permission.)

In Ain Umm Dabadib in the Western Desert, Egypt, there are many ancient aqueducts (Figure 7.5). The aqueducts were discovered in 1905, whereas a tunnel or aqueduct had been cleared out by villagers from Kharga. The aqueduct was still flowing with some 30–35 gal/min of water at that time. It was measured 1.5 by 0.75 m and was cut through solid sandstone rock to a depth of 40 m. It led to a tunnel measuring about 1.5 m high and 60 cm wide at the top. Nowadays, these aqueducts are still intact, snaking north from the town to the water source in the escarpment. They are by far the best example of such elaborate aqueducts in the Kharga Oasis. Along the route, every few meters, is an air vent and access hole, which permitted maintenance of the underground galleries. This was necessary because they were always filled with sand, which had to be cleared out. An extensive 14.3 km twisting and turning underground system of galleries was created. Five main aqueducts run parallel to each other with manholes for maintenance along each of them. The longest of these is the westerly one, stretching some 4.6 km. The one to the north runs 2.9 km and is 53.5 m deep. It has 150 shafts spaced about 19–20 m apart. It descends about 1 m for every 2.5 m in length. Combined, the builders excavated some 4875 m<sup>3</sup> of earth, digging 600–700 vertical shafts, and cut and moved over 20,000 m of solid rock (Dunn 2011).

In Wadi El Gudeirat in the northeastern part of Sinai, there is a spring called Ain El Gudeirat. Ain El Gudeirat issues from the lowermost part of the highly cracked limestones at a daily rate of 1500 m<sup>3</sup>. The spring water flows in a small aqueduct or channel constructed centuries ago, is used currently to irrigate several hundred acres of olive trees, and is a source of water supply for the local villagers (La Moreaux and Tanner 2015).

Moreover, Shams (2014) reported that a chronological aqueduct system in the high mountains of Sinai Peninsula was recently rediscovered. In 1970s, the present sinaitic site of Farsh Abu Alwan or the anciently known Farsh Shammaa was archaeologically surveyed without a direct reference to the aqueduct system *in situ*. Scientifically, it is an argumentative and unique aqueduct system in terms of chronology, location (region), site (local setting), water source, size, and household utility. It is the only discovered aqueduct across the Sinai, connecting the Near East and North Africa.

In Egypt and many places worldwide, the underground water sometimes introduces itself by exploding springs. These springs gave the ancient people the idea of using aqueducts, such as the aqueducts in Sinai and Western Desert. There are six natural springs in Egypt that are typical examples for Sinai and the Western Desert: Ain Furtaga in the southern Precambrian province of Sinai Peninsula, Ain El Gudeirat in the sedimentary plateau of North Sinai, and Ain El Bishmo, Ain El Bousa, and Ain El Gabal in the Western Desert Oases of Bahariya, Kharga, and Dakhla. The springs in the Western Desert discharge from the NSAS. The sixth spring, Ain El Arayes, is in the Siwa Oasis (La Moreaux and Tanner 2015). A map for locations of the above mentioned springs and aqueducts in Egypt is shown in Figure 7.6.



**FIGURE 7.6** A map for locations of above mentioned springs and aqueducts in Egypt. (Modified from La Moreaux, P. E. and Tanner, J. *Springs and Bottled Waters of the World*. Springer, the Netherlands, 2015. With Permission.)



### 7.3 THE TUNNELING AND SHAFT DIGGING TECHNIQUE OF EA

The construction techniques of the aqueducts have remained almost unchanged for 2000 years: The process begins with the digging of the vertical shafts, which are then linked by the underground canal (Sun et al. 2009). The ancient Egyptians developed techniques for cutting soft rocks with copper saws and hollow reed drills, both surrounded by an abrasive, a technique probably used first for quarrying stone blocks and later in excavating temple rooms inside rock cliffs (Lane 2015). An aqueduct, for instance, was used to supply water to the Kharga Oasis by about 525 BC. The aqueduct is constructed as a series of well-like vertical shafts, connected by a gently sloping tunnel. The aqueduct taps into subterranean water in a manner that efficiently delivers large quantities of water to the surface without the need for pumping: The water drains by gravity, typically from an upland aquifer. The main difference between an aqueduct tunnel and just an aqueduct is that an aqueduct is entirely a water collecting system, dug at or below the groundwater level, whereas an aqueduct tunnel mainly transports water captured elsewhere. Aqueducts are commonly excavated close to their destination, usually for agricultural irrigation and/or for domestic water supply (De Feo et al. 2013).

### 7.4 THE HYDROLOGICAL AND HYDRAULIC PROPERTIES OF EA

De Feo et al. (2013) stated that ancient Egyptian hydraulic engineering is renowned for the construction of a navigable channel linking the Red Sea and the Nile delta. They developed river ports along the Nile, for example Memphis and Thebes. There are direct underground connections from the pyramids to the Nile, as shown in Figure 7.7 and previously in Figure 7.2. In fact, all the Egyptian pyramid complexes were filled with wells, shafts, and huge cut holes that interconnected underground. There is an underground chamber with an auditorium of 100 ft below the pyramids on the Giza plateau. In addition to a 7 ft wide and hundreds of feet long rectangular channel, which received water from the Nile to fill the chamber, ancient Egyptians used a system of holes, shafts, and deep wells that permeated and moved water around and into the pyramids using simple water hydraulics and Bernoulli's principle of moving fluids (Brown 2015).



**FIGURE 7.7** Aerial view of organized system of wells and shafts, the Giza Plateau. (From Brown, J. 2015. Ancient Energy Research Center 2285 Eagle Drive, Suite A Pagosa Springs, CO, accessed at 12/08/2015 <http://earthmilkancientenergy.com/ch4.htm>. With Permission.)

## 7.5 EA FEED RESOURCES

Compared with Middle East and Africa, the ancient Egyptians did not rely mainly on the usage of groundwater reserves due to the presence of the Nile River. However, some usage of well water was proved (Cookson-Hills 2014). Shahin (1991) considered wells, aqueducts, and groundwater wells as supplementary usage rather than substitutive of the riparian irrigation. The aqueduct technology was brought to Egypt during the Persian invasion in the *ca.* fifth century BC (Wuttmann et al. 2000). However, an ancient example of underground aqueducts from groundwater has been found in the Bahariya oasis in Egypt. It was proved in ancient Egypt that a chamber in a tomb of that period had been shifted to avoid interfering with the aqueduct. The water supply of Mersa Matruh in the northwest region of Egypt still depends on an old aqueduct feeding from groundwater in the oolitic limestone in the west of the town. The rate of flow of water in the aqueduct is controlled by the level of the underground water table (Kobori 1973).

In the Bahariya oasis, the irrigation started from local Manâwîr, as shown in Figure 7.8. Approximately 2000 of the so-called pre-Roman and Roman wells including ruins have been found around the oases. Till 1960, in the settlement of Umm Dabadib, the northern part of the El Kharga depression, there was cultivated land, mainly dates irrigated by an aqueduct feeding from groundwater. The first well is 30 m deep into the water table and at an altitude of about 80 m, whereas the cultivated land lies at an altitude of about 50 m (Kobori 1973).

## 7.6 THE SUSTAINABILITY OF THE WATER SUPPLY

Revitalization of traditional water harvesting and supply techniques such as aqueducts is crucial for sustainable water utilization. Therefore, the United Nations and other organizations encourage their use in arid/semiarid areas. Boustani (2008) considered aqueduct as a water management system, which was used to provide a reliable supply of water to human settlements or for irrigation in hot, arid/semiarid climates. Aqueducts exploit groundwater as a renewable resource. Hence, aqueducts are environmentally sustainable water harvesting and conveyance techniques through which groundwater can be obtained without causing damage to the underground aquifer in the arid/semiarid regions.



**FIGURE 7.8** Manâwîr in the Bahariya oasis. (From Kobori, I. *Orient*, 9, 43–66, 1973. With Permission.)



## 7.7 WATER QUALITY AND MANAGEMENT OF AQUEDUCTS

In prehistoric times, people searched for pure water supplies. In that era, the only available water quality standards were the natural properties of water such as taste, temperature, smell, and appearance. Using chemicals to purify water was unknown to ancient people, but they had other ways. First they used settling basins. It was like a pool. The basins would slow the water down. As it slowed, the impurities or the loads dropped out of it. That would remove some of the sand and other impurities. Instead of a settling basin, some aqueducts had zigzags built into it to help settle water down. These zigzags caused the water to slow down, which would unload impurities. They also purified water by aerating it. The water in the aqueducts was exposed to air and ventilation throughout its journey via the vertical shifts, or aboveground parts of the aqueducts (Aicher 2015).

Earliest water treatment records come from Sanskrit and Egyptian inscriptions. The earliest Egyptian record of water treatment is in *ca.* 1500 BC; the Egyptians first discovered the principle of coagulation. They applied the chemical alum for suspended particle settlement. Pictures of this purification technique were found on the wall of the tomb of Amenophis II and Ramses II. Then in *ca.* 500 BC, Hippocrates, known as the Father of Medicine, treated water by boiling it to improve the water taste and then filtering it through a cloth bag (Angelakis et al. 2012).

In addition, in order to keep water clean and healthy, the ancient people managed the water usage; they divided aqueduct water to consequent stations. The first station lies at the starting point of the aqueduct beside the source and used for collecting the drinking water. This was the first permitted use of water. After drinking outlet facilities, bathing places were built for men and then for women and children. The aqueduct then reached the garden where a special distribution system of small canals was developed to distribute the irrigation water (Ahmed 2015).

## 7.8 CONCLUSIONS

The conclusions of this work could be summarized as follows:

1. In ancient Egypt, an example of underground aqueducts from groundwater has been found in the Bahariya oasis; however, the aqueduct technology was used abundantly in Egypt during the Persian invasion in the *ca.* fifth century.
2. Compared with Middle East and Africa, the ancient Egyptians did not rely mainly on the usage of groundwater reserves due to the presence of the Nile River. However, some usage of well water was proved in the Western Desert and Sinai region.
3. Ancient Egyptians conveyed Nile River water to their temples and cities via underground aqueducts.
4. Ancient Egyptians used water treatment processes since *ca.* 1500 BC; they discovered the principle of coagulation and applied the chemical alum for suspended particle settlement.

## REFERENCES

- Ahmed, A. T. 2015. Water quality for irrigation and drinking water use of Aflaj in Oman. *Water Science & Technology: Water Supply*, 15(2):421–428.
- Aicher, P. 2015. Watering Ancient Rome, <http://www.pbs.org/wgbh/nova/ancient/roman-aqueducts.html>.
- Angelakis, A. N., Mays, L. W., Koutsoyiannis, D., and Mamassis, N. (Eds.). 2012. *Evolution of Water Supply throughout the Millennia*. IWA Publishing, London, UK.
- Boustani, F. 2008, September. Sustainable water utilization in arid region of Iran by qanats. *Proceedings of the World Academy of Science, Engineering and Technology*, 33:213–216.
- Brown, J. 2015. Ancient Energy Research Center 2285 Eagle Drive, Suite A Pagosa Springs, CO, <http://earth-milkancientenergy.com/ch4.htm> (retrieved 12/08/2015).
- Cartwright, M. 2012. Aqueduct. *Ancient History Encyclopedia*, last modified September 1, 2012, <http://www.ancient.eu/aqueduct/>.

- Cookson-Hills, C. 2014. Hydraulic technology in Egypt. In *Encyclopaedia of the History of Science, Technology, and Medicine in Non-Western Cultures*, pp. 1–4, Springer, the Netherlands.
- De Feo, G., Angelakis, A. N., Antoniou, G. P., El-Gohary, F., Haut, B., Passchier, C. W., and Zheng, X. Y. 2013. Historical and technical notes on aqueducts from prehistoric to medieval times. *Water*, 5(4):1996–2025. Springer-Verlag Berlin Heidelberg New York.
- Dunn, J. 2011. Ain Umm Dabadib in the Kharga Oasis of Egypt. <http://www.touregypt.net/featuresstories/dabadib.htm>.
- Empereur, J.-Y. 1998. *Alexandria Rediscovered*. British Museum Press, ISBN 0-7141-1921-0.
- Kobori, I. 1973. Some notes on diffusion of qanat. *Orient*, 9:43–66.
- La Moreaux, P. E. and Tanner, J. 2015. *Springs and Bottled Waters of the World*. Springer, the Netherlands.
- Lane, K. S. 2015. Tunnels and underground excavations, accessed at 2015 <http://www.britannica.com/technology/tunnel#toc72434>.
- Plan Bleu Centre (PBC). 2011. National study Egypt: Water use efficiency and economic approach, [http://planbleu.org/sites/default/files/publications/efficience\\_eau\\_egypte\\_en.pdf](http://planbleu.org/sites/default/files/publications/efficience_eau_egypte_en.pdf).
- Earthmilk Ancient Energy (EAE). 2015. Precisely Cut Wells, Shafts, and Underground Channels Connecting the Pyramids to the Nile River, accessed at 2015, <http://earthmilkancientenergy.com/ch4.htm>.
- Tour Egypt Website (TEW). 2015. “Horus Temple”, accessed at 2015, <http://www.touregypt.net/edfut.htm#ixzz3pVpWqfyx>.
- Shahin, M. 1991. *Assessment of groundwater resources in Egypt*. Hydraulic and Environmental Engineering, Delft, the Netherlands.
- Shams, A. A. 2014. Rediscovered-new Qanat system in the High Mountains of Sinai Peninsula, with Levantine reflections. *Journal of Arid Environments*, 11(110):69–74.
- Sun, Q., Tao, W., Kobori, I., and Liang, L. 2009. Case Study V: Karez in the Turpan Region of China. In *Seeing Traditional Technologies in a New Light Using Traditional Approaches for Water Management in Drylands*, United Nations Educational, Scientific and Cultural Organization (UNESCO), Paris, France.
- Water History (WH). “Qanats” accessed at 2015 <http://www.waterhistory.org/histories/qanats/>.
- Wuttmann, M., Gonon, T., and Thiers, C. 2000. The Qanats of ‘Ayn Manâwîr Kharga Oasis, Egypt. *Journal of Achaemenid Researches*, 11:1–11. <http://www.achemenet.com/pdf/jasr/jasr2000.1.pdf>.



# Taylor & Francis

Taylor & Francis Group

<http://taylorandfrancis.com>

---

# 8 Qanāt Evolution and Use in Libya

*Abdulgader Abufayed*

## CONTENTS

8.1	Introduction .....	109
8.2	Evolution of Qanāt Systems' Use in Libya .....	110
8.3	Use of Qanāt Systems in the Fezzan Region of Libya.....	111
8.3.1	Qanāt Systems of the Wadi Al-Ajall Subregion of Fezzan in Libya .....	112
8.3.2	Qanāt Systems Use in the Murzuk Depression Subregion .....	112
8.3.3	Qanāts Presently in Use in Libya.....	113
8.3.4	Qanāt Design and Construction.....	116
8.3.5	Qanāt Systems Management.....	116
8.4	Future of Qanāt Systems in Libya .....	117
8.5	Conclusions .....	117
	Acknowledgment .....	118
	References.....	118

## 8.1 INTRODUCTION

Qanāts have been the major source of water supply for domestic and agricultural uses in some regions in Libya. These regions are characterized by arid and semiarid climatic conditions, absence of surface water sources with year-round flows, such as rivers and lakes, and availability of good quality water near the naturally sloping ground surface and close to potentially fertile areas. Archaeological evidence indicates that the first underground hydraulic works, in fact qanāts in Libya, appeared around 500 BC (English 1968; Mattingly et al. 1999; Werner and Savage 2004; Wilson 2009). Their use was favored in arable areas with no surface water resources and where groundwater table was high, and sloping topography allowed free surface downstream flow from the water source. Water flowing from qanāts was regularly and reliably protected from pollution and heat and was made less prone to the adverse effects of natural disasters such as earthquakes and floods and insensitive to the levels of precipitation.

Qanāt systems' use was especially favored in central and southern Libya. This hyperarid and remotely located region consisted of numerous oasis villages and towns whose sustainability has relied directly on fossil groundwater. Despite its extensive use historically, available data and information on qanāt systems' use in Libya are limited to some parts of the Fezzan region, southwest of Libya (Figure 8.1). The objective of this chapter is, therefore, to describe the historical evolution of qanāt use in Libya with a special focus on the Fezzan region. This chapter is basically a compilation of data and information collected from local experts (Ahmed et al. 2016) and from surveying the literature available on the subject.

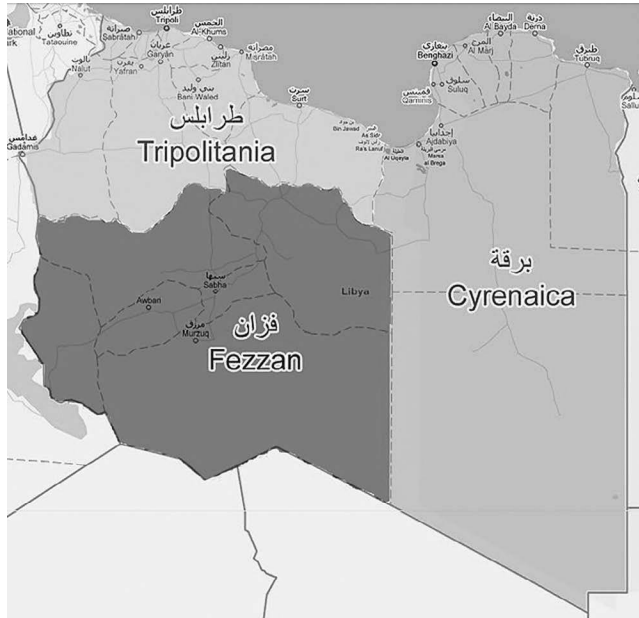


FIGURE 8.1 Fezzan region, Libya.

## 8.2 EVOLUTION OF QANĀT SYSTEMS' USE IN LIBYA

Qanāt systems' use in Libya has been very extensive, the most highly developed use anywhere outside Iran (Wilson 2009). Evolution of qanāt systems in Libya took place over a very long time period starting from the sixth century BC all the way to the eleventh and twelfth centuries AD (English 1968; Wilson 2009; Remini et al. 2014b). It was introduced by one of the three sources: (a) from Persia via Egypt in the second half of the first millennium BC, (b) during contact with the Roman world, or (c) during the spread of Islam in North Africa including the Sahara region in the seventh century (English 1968; Wilson 2009; Mostafaiepour 2010). The spread of Islam brought with it new water supply technologies while adopting, making use of, and developing existing technologies it came in touch with worldwide. More recently, a fourth assumption set by Mattingly et al. (1999) was that qanāts were developed by the Garamantes, the local residents of Fezzan from which they spread westward to Tunis and Algeria. This assumption is contested, however, by reports of records that qanāts were spread from Libya to Algeria and Morocco under the second Almwrauid sultan in the beginning of the twelfth century (Nachtigal 1974; Mostafaiepour 2010; Remini et al. 2014b). A fifth assumption was that qanāts were developed by local indigenous inhabitants of the region—other than the Garamantes—“whose prosperity has enticed the envy of the Garamantes thousands of years ago” (Nachtigal 1974).

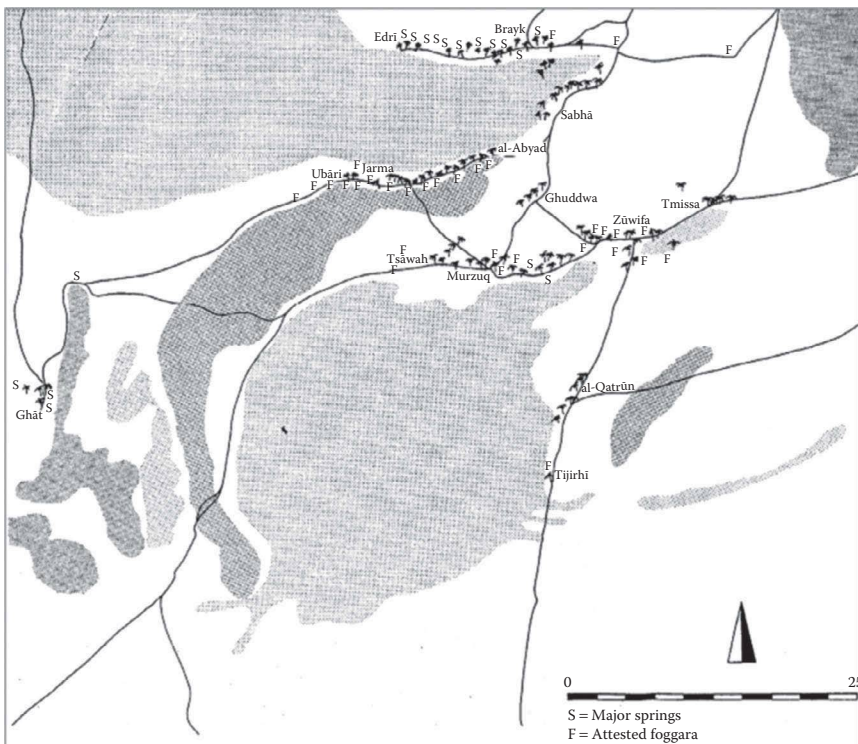
It is plausible that qanāts were introduced by each of the five sources proposed above, but to different regions or subregions of Libya and at different times. The impacts of Islam have been most pronounced, however, as they were the latest, long lasting, and widest, geographically covering all regions of Libya.

Extensive use of qanāt systems, locally called foggara, appears to have lasted until the early ninth to the twelfth centuries; the Muslim geographer Al-Idrisi recorded the existence of these systems in the region in the twelfth century (Nachtigal 1974; Werner 2004; Wilson 2009). Increased withdrawals to meet the demands of the growing settlements coupled with dwindling recharge led to a continued decline in the water tables in the aquifers supplying the qanāts. As a result, qanāts were abandoned gradually; qanāt shafts were transformed into wells driven by humans and animals with

applications declining gradually as early as the fourth century AD (Werner 2004; Wilson 2009). Qanāt systems' disappearance was accelerated by the collapse of the North-South trans-Saharan trade in the fourth or fifth centuries AD and supply of labor needed for qanāt construction and maintenance. Most of the qanāts have filled-in shafts, but they escaped nature's forces and are still traceable; many of the filled-in shafts are also traceable through the green shrubs and trees growing out of them, thanks to the water available readily by capillary motion.

### 8.3 USE OF QANĀT SYSTEMS IN THE FEZZAN REGION OF LIBYA

According to the limited references available, qanāt systems were most abundant in the southern regions of Libya: the Kufra and Fezzan regions and Ghadames (Jones 1966; English 1968; Nachtigal 1974; Mattingly et al. 1999; Mattingly and Wilson 2003; Boualem and Rabah 2012; Mattingly et al. 2015). They were most abundant in the Fezzan region as it is hyperarid with large volumes of fossil groundwater available near the ground surface (Figure 8.2). This region is characterized by three main bands of oasis aligned approximately east to west in the direction of the Wadi Ash-Shati in the north, Wadi al-Ajaal, and Wadi Berjouj, and the Murzuk depression in the south. The Wadi Ash-Shati system, extending westward from the city of Sebha, the traditional capital of the Fezzan region, relied on springs flowing naturally from water reservoirs. The Wadi al-Ajaal system relied traditionally on the qanāt system, which played a pivotal role in the subregions settlements' development and sustainability. This is also the case for the Wadi Berjouj or the Murzuk depression system. Qanāt systems in this subregion tap aquifers below the foot of the escarpment at the southern edge of the wadis and lead it down to the depression in the wadi center.



**FIGURE 8.2** Spread of qanāt systems in the Fezzan region, Libya. (From Mattingly, D. J. and Wilson, D. Farming the Sahara: The Germanian Contribution in Southern Libya. In *Arid Lands in Roman Times, Papers from International Conference*, M. Liverani, ed., Rome, July 9–10, 2001, Firenze, Italy, pp. 37–50, 2003. With Permission.)



### 8.3.1 QANĀT SYSTEMS OF THE WADI AL-AJAAL SUBREGION OF FEZZAN IN LIBYA

Use of the qanāt systems in the Wadi al-Ajaal subregion dates back probably to about 600 BC (English 1968; Mattingly et al. 1999; Werner and Savage 2004; Wilson 2009). Large-scale qanāt systems occurred along the entire length of the Wadi al-Ajaal running approximately north from the alluvium at the foot of the escarpment toward the center of the oasis belt. They were constructed to convey the near-surface water available at the escarpment a distance varying between 1 and 3 km to irrigate arable low lands in the valleys.

Mattingly and Wilson (2003) estimated a total of 600 qanāts in this subregion extending 100 km underground with a total of about 100,000 vertical shafts placed regularly at an average depth of 10 m, but sometimes reaching 45 m. General vertical height and width of these bricked and cemented qanāts were 60 cm and 150 cm, respectively. The total length of qanāts' spread within the 130 km length of the Wadi al-Ajaal corridor was estimated to be 20,000 km (Werner 2004). Al-Idrisi, a twelfth century Arab geographer, noted the existence of qanāts in this subregion, whereas Nachtigal noted that traces of 200 qanāts still existed, some of which were used until recently with two qanāts still operating in 1968 (Nachtigal 1974). Nachtigal also indicated that qanāts were spread from here westward.

A group of well-preserved qanāts northwest of Zincheera near Germa, the historical capital of the Germantes of Fezzan, was recorded by Mattingly et al. (1999) where they were traceable to within 100 m of the escarpment base. The description provided by Mattingly et al. of qanāts (F1 and F2 in Figure 8.3) is summarized below.

This qanāt is constructed a little to the north of the cultivated fields northwest of Zincheera. It becomes traceable in a gravelly terrain, initially as a line of gravel rings about 9–10 m in diameter, and then as a pair of parallel banks with a depression in between. The qanāt runs some 875 m northward and then it becomes untraceable in dense cultivation.

This qanāt seems to originate in a large *possibly mother well* located northwest of Zincheera. This well is 26.7 m deep with a channel that is about 1 m high at its bottom. A line of shafts is still clearly visible amid modern cultivation north of this well.

### 8.3.2 QANĀT SYSTEMS USE IN THE MURZUK DEPRESSION SUBREGION

A large number of qanāt systems were traced in the Murzuk depression subregion named locally as-Sharqiya that comprises several linearly located oasis depressions including the settlements of Umm al-Aranib, Hummaira, Al-Badr, Misquin, Zawaila, and Tmissah (Figure 8.2). In Al-Badr, at least 15 qanāts running north to south feed into an extensive area of field systems on the edge of a depression. Another qanāt group (about five in number) runs south to north into the same depression in the village of Hummaira, south of Al-Badr. A larger group of about 20 channels runs into the oasis of Misquīn. Although abandoned long ago, traces of these qanāts are still visible everywhere in the wadi (dry river), looking like evenly spaced dots linking the escarpment to the farmland (Figure 8.4). The description provided by Mattingly et al. (2015) of the Zawaila qanāt system is summarized below.

Two qanāt groups, each comprising about 10–15 qanāt systems, flowed from north to south (Figure 8.5), irrigating low-lying ground about 2 km to the south of the settlement (ZUL015). The cultivated area was estimated to be in excess of 100 ha. The first group (ZUL013) was about 1.3 km long, whereas the second group (ZUL014) was about 1.7 km long.

It is probable that wells and qanāts have been used in combination to irrigate the extensive garden area. Traces of an extensive field system (ZUL007) covering an area of at least 630 ha, divided into roughly square plots, are found, many of them with traces of a centrally positioned well. It is highly probable that these wells were developed to combat falling water table and supplement qanāt flows. Water from the wells was lifted using shaduf (a well sweep); at a later stage, water was lifted from wells using the *dalw* (a self-dumping bucket) drawn by camel power.

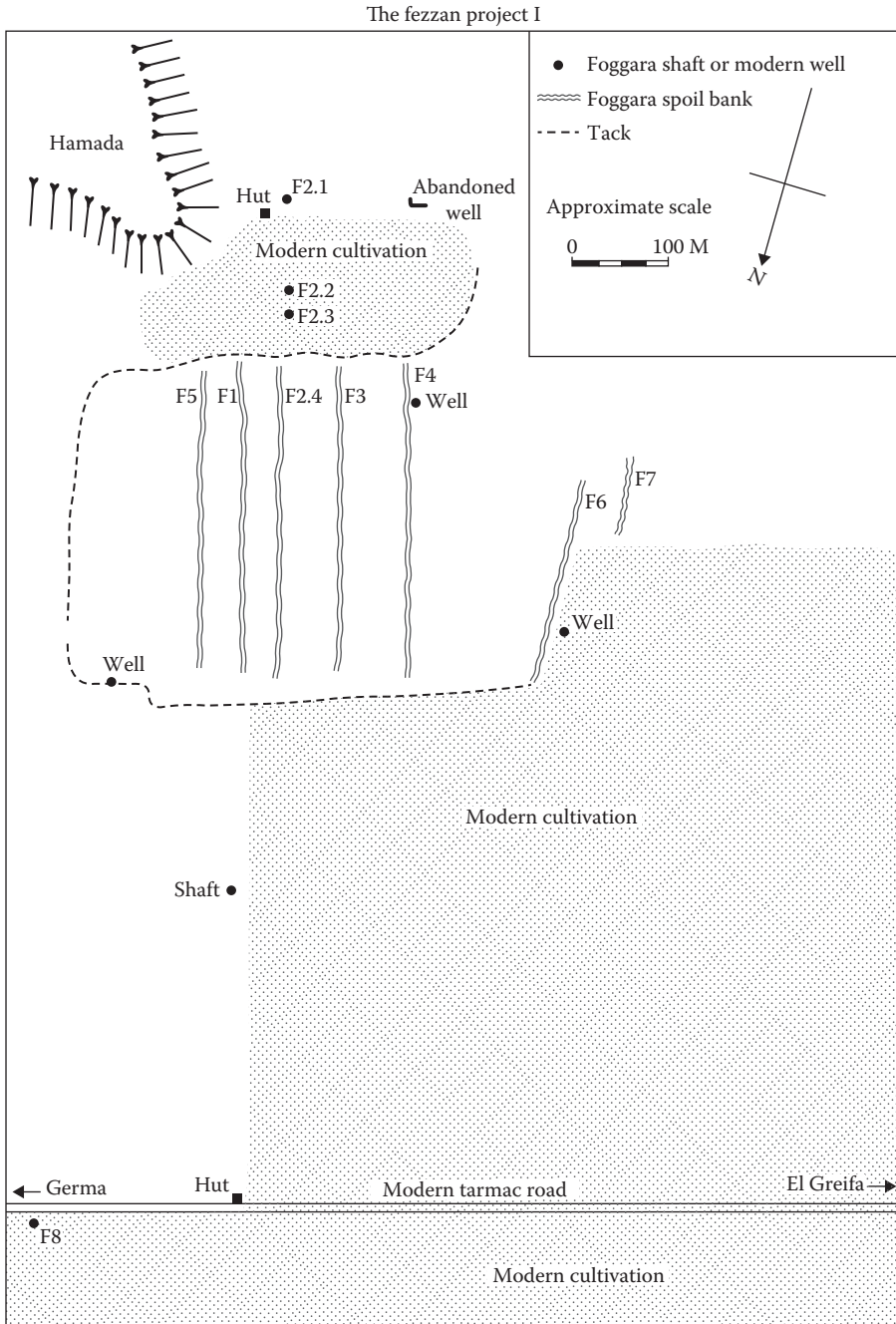


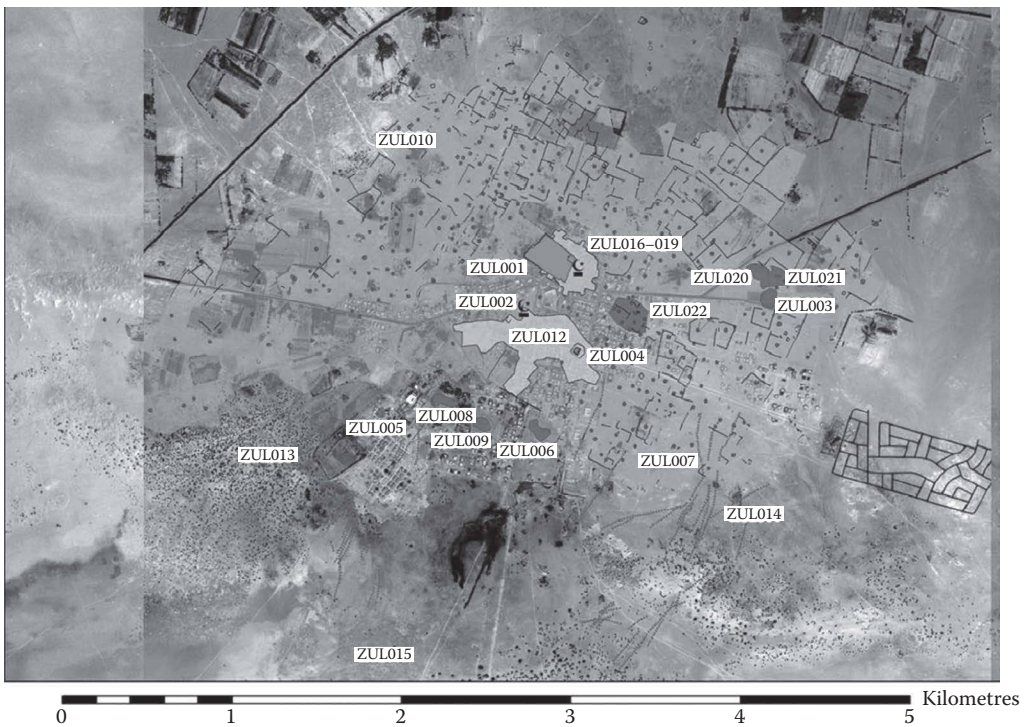
FIGURE 8.3 Qanāt systems at Zinchecra, Wadi al-Ajaal, Fezzan, Libya.

### 8.3.3 QANĀTS PRESENTLY IN USE IN LIBYA

The latest qanāts still in existence (Azzaaz and as-Swainya and al-jadida) are located on a wadi northwest of the town of al-Fuqaha along with six springs. The as-Swainya al-jadida qanāt, delivering less than 250 L/s with a total dissolved solid (TDS) concentration of about 600 mg/L, consists of 13 shafts (manfas), all of which have been covered to prevent filling in with sand



**FIGURE 8.4** Traces of qanāts, south of Zawaila. (From <https://www.google.com/maps/@26.2117237,14.8766837,350723m/data=!3m1!1e3>. With Permission.)



**FIGURE 8.5** Groups of qanāts, south of Zawaila.



**FIGURE 8.6** Water storage and delivery at the outlet of as-Sawainya Al-Jadida qanāt, Al-Fuqaha.

(GWA 1996; Ahmed et al. 2016). The qanāt is presently operated by the family of Mohamed Yosuf; its water is used mostly for irrigating palm trees. The flow is collected periodically using a concrete reservoir and delivered through a pipe control using a gate valve at the downstream (Figure 8.6). The Azzaaz qanāt is in a relatively better state with seven shafts still unfilled including the mother well, (Figure 8.7) whereas other shafts filled in partly or fully. Water flow is significantly higher (less than about 1 m<sup>3</sup>/s) and a TDS concentration of about 250 mg/L. Water from the two qanāts is utilized for irrigation of small family plots with mostly palm trees, vegetables, and fodder crops (Figure 8.8). Farmers share the water according to a 17 day cycle. The daily subcycle is divided into morning and afternoon shifts only. Night flow is collected



**FIGURE 8.7** Shafts of the Azzaaz qanāt, al-Fuqaha.





**FIGURE 8.8** Plots irrigated by qanāt waters, al-Fuqaha.

in the basin for use during the day shift. Each shift or more is utilized by a farmer with water directed to the next farmer through a main water transmission channel.

The drilling of many wells in the region has had a detrimental effect on the qanāts; water flows decreased dramatically, and oasis palms have dried up. The once green meadows of the oasis are turning into sand dunes.

Other qanāts may still be in operation in Libya. A total of 32 *operating* foggaras were reported by Boualem and Rabah (2012). The actual number of qanāts presently in operation is not known; however, it is probably very small (Jones 1966; Nachtigal 1974; Boualem et al. 2012).

#### 8.3.4 QANĀT DESIGN AND CONSTRUCTION

Qanāt construction required many skills including the identification of water source, track selection, alignment, manual digging of shafts, and properly sized and sloped water conveyance channels as well as operation and maintenance. Availability of proper equipment necessary to implement these works was a prerequisite.

Data on materials of construction of qanāts in the Fezzan region are scarce. The qanāts in Wadi al-Ajaal were built with a cemented brick (Werner and Savage 2004). It is likely that enforcing of shafts and channels or canals was practiced except where local soils were strong and not susceptible to erosion and structural failure.

#### 8.3.5 QANĀT SYSTEMS MANAGEMENT

Management of qanāt systems in the Fezzan region prior to the introduction of Islam remains to be investigated, although it is clear that they were managed efficiently as proved by the sustainability of the *many* qanāt systems' dependent settlements until very recently. With the coming of Islam, highly sophisticated water management systems were developed based on the *shari'a* regulations that were applied to all water supply systems including the qanāt systems. According to these regulations, water uses were prioritized: human and animal drinking preceding agriculture. Public uses such as mosques, bathing, and ablution were also guaranteed in the form of specific quantities of water. Finally, wild animals and birds were allocated a portion of the water resources available.

Traditionally, qanāt water was apportioned by volume or by time; the latter being the most common practice. A water cycle of a specified length (days) was set for the qanāt that varied according to total number of water shares owned by all users. The cycle was divided based on the users' shares

into many time subdivisions, which may be further divided into fractions smaller than a second at times. A user's share could increase or decrease if the *owner* bought or sold parts of his water property. An apportionment was timed usually by a water clock (a ceramic or metallic bowl with a small hole in its bottom).

A dedicated water administration existed for management of qanāt systems; all water transactions and activities were documented in a water register (*Zimam*). The management team included a *wakeel* (director), *amin* (secretary), *katib* (writer), *muhassib* (calculator), *mujarree* (monitor), *wallaje* (maintainer), and a water clock man. The number of staff varied with the size and complexity of the water resource and number of users (Abufayed 2006).

It is clear that qanāt systems were more than simple water supply systems; they were a matrix binding the community through social, economic, and cultural traditions and practices. They provided water efficiently, making life possible in very harsh environments, brought people together, and formed a base for sustainable social development and economic growth.

Information and data on qanāt construction, operation, maintenance, ownership, and water allocation are scarce. It is most likely that the main course of the qanāt is publicly *community* owned along with the major distribution courses, whereas individual courses in land plots are owned by individuals or families.

Although little proof is available, it is expected that the locations of settlements and agricultural areas evolved in response to qanāt water course directions, water availability, and quality along the watercourse. Despite their pivotal role in the development of Libya in general and the Fezzan region settlements in particular, qanāt systems' evolution and utilization remain relatively unknown. More research is needed to uncover this important technology and its applications throughout Libya's regions. Data and information generated will contribute to a better understanding of qanāt technology development and transfer worldwide.

#### 8.4 FUTURE OF QANĀT SYSTEMS IN LIBYA

Qanāt use in Libya has declined markedly in the past 2–3 centuries with only a few qanāts still in operation; the major reasons for this decline are as follows:

1. Considerable efforts and costs associated with periodical qanāt maintenance and lack of skilled labor to perform such efforts.
2. Declining qanāt discharges due to repeated droughts.
3. Migration of rural population where qanāts were used in search of better job opportunities.
4. Introduction of simple drilling and pumping technologies that were preferred by individual farmers in favor of collective limited volume qanāt systems; this reason is by far the most detrimental on the qanāt systems viability.

The relatively high water table continues to support modern urban settlements and agricultural projects in the Fezzan region where qanāt systems once flourished, but now pumps and pipes have replaced the network of qanāts or animal-driven water supply systems. Large-scale earth moving equipment used for executing these projects has rapidly destroyed a large fraction of the surface traces of qanāts throughout the Fezzan region. Unless special care is taken to save the few *surviving* qanāts urgently, they are likely to diminish soon due to lack of maintenance and lack of economic competitiveness.

#### 8.5 CONCLUSIONS

Qanāt systems were used extensively as the main method of irrigation in the arid southern regions of Libya for more than 2500 years. This ingenious technology may have been transferred earlier from Persia via Egypt and later from Arabia with the introduction of Islam. These systems played



an important role in the development and prosperity of many oasis communities until, perhaps, two centuries ago. The number of qanāts in operation decreased dramatically because of declining aquifer water levels, rising maintenance costs, and the introduction of more efficient motorized pumps with very few qanāt systems still in operation.

Traces of thousands of kilometers of abandoned qanāts, seen as long dotted lines linking escarpments to valleys everywhere in the Fezzan region, will continue to remind us of the intensive efforts put into constructing and maintaining these qanāts and their pivotal role in sustaining countless communities for thousands of years.

Interest in studying qanāt evolution and development is rising in response to the large gap in data and information on this historically significant technology. Results from qanāt research will add yet another proof that the rise and fall of civilizations resulted as much from availability of water resources as it did from the way these resources were managed. It is ironic, however, that our interest in qanāt evolution is rising at the time when their use and their very existence are coming to a sad end. It is hoped that such research will not only uncover invaluable knowledge on qanāt technology and socioeconomics but also identify new methods for their preservation and keeping them functional and competitive with modern technologies.

## ACKNOWLEDGMENT

The author wishes to acknowledge the assistance of Mr. Ahmad S. Ahmad and Mr. Mohamed Yosuf, a local expert and head of the Yosuf family, the present owner and benefactor of the as-Sawainya al-Jadida, al-Fuqaha, and his son Ihmeed for providing photos and basic data on the qanāts of al-Fuqaha, Libya.

## REFERENCES

- Abufayed, A. 2006. Water Management Practices in Islam: The Example of the Historic City of Ghadames. In *1st International Conference on Water and Wastewater in Ancient Civilizations*, A. Angelakis and D. Koutsoyiannis, eds., National Agricultural Research Foundation, Iraklio, Greece, October 28–30, 2006, pp. 295–304.
- Ahmed, S. A., Yosuf, M., and Yosuf, I. M. 2016. Local experts, al Fuqaha, Libya, (personal communication, Feb. 2016).
- Boualem, R. and Rabah, K. 2012. The Foggara in the Arab World. *Geographia Technica*, No. 1, 1–7.
- English, P. W. 1968. The Origin and Spread of Qanats in the Old World. *Proceedings of the American Philosophical Society*, 112(3):170–181.
- General Water Authority (GWA). 1996. Preliminary Report on Water Resources of alFuqaha, Unpublished Report, Tripoli, Libya. <https://www.google.com/maps/@26.2117237,14.8766837,350723m/data=!3m1!1e3>.
- Jones, J. R. 1966. Groundwater Exploration and Development in Libya. *Water Well Journal*, 20(2):13–16.
- Mattingly, D. J., ElMashai, M. I., Balcombe, P., Chapman, S., Coddington, H., Davison, J., Kenyan, D., Wilson, A., and Withcher, R. 1999. *The Fezzan Project I: Research Goals, Methodologies, and Results of the 1997 Season*. Dutch Archaeological Institute, Preliminary Report, pp. 175–197.
- Mattingly, D. J., Sterry, M., and Edwards, M. D. 2015. *The Origins and Development of Zuwila, Libyan Sahara: An Archaeological and Historical Overview of an Ancient Oasis Town and Caravan Centre*. Azania: Archaeological Research in Africa, pp. 1–49. doi:10.1080/0067270X.2014.980126.
- Mattingly, D. J. and Wilson, D. 2003. Farming the Sahara: The Germanian Contribution in Southern Libya. In *Arid Lands in Roman Times, Papers from International Conference*, M. Liverani, ed., Rome, July 9–10, 2001, Firenze, Italy, pp. 37–50.
- Mostafaeipour, A. 2010. Historical Background, Productivity and Technical Issues of Qanats. *Water History*, 2:61–80.
- Nachtigal, G. 1974. *Sahara and Sudan: Volume I: Tripoli and Fezzan Tibesti or Tu* (Ger). Translated by Alan Fisher and Humphry Fisher, C Hurst & Co, London, UK.
- Remini, B., Achour, B., and Kechad, R. 2014a. The Sharing of Water in the Oases of Timimoun, Heritage Cultural Declining. *Larhyss Journal*, 18:7–17. ISSN 1112 3680.

- Remini, B., Kechad, R., and Achour, B. 2014b. The Collecting of Groundwater by the Qanats: A Millennium Technique Decaying. *Larhyss Journal*, 20:259–277.
- Werner, L. and Savage, T. 2004. Libya's Forgotten Desert Kingdom. *Aramco World*, 55(3):8–13.
- Wilson, A. I. 2009. Foggaras in Ancient North Africa: Or How to Marry a Berber Princess. In *Contrôle et distribution de l'eau dans le Maghreb antique et médiéval*, Collection de l'École française de Rome, 426, Rome, Italy, pp. 19–39.v



# Taylor & Francis

Taylor & Francis Group

<http://taylorandfrancis.com>

# *Section IV*

---

*Middle East*



# Taylor & Francis

Taylor & Francis Group

<http://taylorandfrancis.com>

---

# 9 Iranian Qanāts

## *An Ancient and Sustainable Water Resources Utilization*

*Saeid Eslamian, Alireza Davari, and  
Mohammad Naser Reyhani*

### CONTENTS

9.1	Introduction .....	124
9.1.1	Sustainability .....	125
9.1.1.1	Principles of Sustainable Groundwater Development .....	126
9.1.1.2	Long-Term Conservation of Groundwater Resources .....	126
9.2	History .....	126
9.2.1	Elamites and Assyria ( <i>ca.</i> 1400–550 BC) .....	127
9.2.2	Achaemenian Empire ( <i>ca.</i> 550–330 BC) .....	127
9.2.3	Seleucidian Era (312–250 BC) .....	127
9.2.4	Parthian Era (250 BC–150 AD) .....	127
9.2.5	Sassanid Era (226–650 AD) .....	128
9.2.6	After Islam (from 621 AD to Ilkhanid Era) .....	128
9.2.7	Ilkhanid Era .....	128
9.2.8	Safavid Era .....	129
9.2.9	Dynasty of Qajar .....	129
9.2.10	Period of Pahlavi .....	129
9.2.11	Time of the Islamic Republic .....	130
9.3	Global Distribution of Qanāts .....	131
9.4	Geographical Distribution of Qanāts in Iran .....	132
9.4.1	The Province of Yazd .....	133
9.4.2	The Province of Semnan .....	134
9.4.3	The Province of Khorasan .....	134
9.4.4	The Province of Kerman .....	134
9.4.5	The Province of West Azarbayjan .....	134
9.5	The Nature of Qanāts .....	134
9.5.1	Goals of Construction of Qanāts .....	136
9.5.2	Prerequisite Conditions for the Creation of Qanāts .....	136
9.5.3	Qanāt Construction .....	137
9.5.4	Types of Qanāt .....	137
9.5.4.1	Qanāt Type According to Length .....	138
9.5.4.2	Qanāt Type According to Discharge .....	138
9.5.4.3	Qanāt Type According to Depth .....	138
9.5.5	Maintenance .....	139



9.6	Structure .....	139
9.6.1	Techno-Physical Structure of Qanāt.....	139
9.6.1.1	Structural Feature .....	139
9.6.1.2	Gallery .....	140
9.6.2	Boneh as the Social Structure of Qanāt: What Is Boneh?.....	141
9.6.2.1	Advantages of the Boneh System.....	142
9.6.2.2	Disadvantages of the Boneh System.....	143
9.6.3	Qanāt as a Technique to Adapt to the Climate Change.....	144
9.7	Qanāts are a Means of Sustainability .....	144
9.7.1	Linking Qanāt to Sustainable Development Goals .....	145
9.7.2	Social .....	146
9.7.3	Culture .....	146
9.7.4	Economic .....	146
9.7.5	Environmental .....	146
9.7.6	Community Development.....	146
9.7.7	Water Conservation .....	147
9.7.8	The Tension between a Sustainable Unequal System and the Modern System .....	147
9.8	Summary and Conclusions .....	148
	References.....	149

## 9.1 INTRODUCTION

Water, the most precious commodity in deserts, is the single most natural resource that determines the suitability of a habitat for the living organisms. Throughout the arid Middle East and North Africa, water shortages have become increasingly acute. Population growth, combined with agricultural expansion and intensification, has heightened demand for domestic, industrial, and agricultural (especially irrigation) water use. Local surface and subsurface water resources are no longer sufficient to meet these burgeoning needs throughout the region (Ahmadi et al. 2010). Domestic water supply is so short that it is rationed in a number of Middle-Eastern cities, and, as the region's cities continue to grow, it is likely that urban water demand will also grow (Gupta and Onta 1997). In rural areas, irrigation water is increasingly scarce. A scarcity of irrigation water will force small farmers off the land and increase food imports across the Middle East (Gupta and Onta 1997).

Groundwater has always been considered a readily available source of water for domestic, agricultural, and industrial use. In many parts of the world, groundwater extracted for a variety of purposes has made a major contribution to the improvement of the social and economic circumstances of human beings (Eslamian 2014). Management strategies have been focused on the development of groundwater resource, while projects of various types and scales have been developed and managed in response to the growing demand for water by communities and industries. Despite bringing many benefits, with the increase in demand, this resource is being overexploited in many areas, resulting in a permanent depletion of the aquifer system and associated environmental consequences such as land subsidence and water quality deterioration.

Moreover, with changes in land use and a vast increase in the quantities and types of industrial, agricultural, and domestic effluents entering the hydrological cycle, a gradual decline in water quality is observed owing to surface and subsurface pollution.

To meet growing demands for water, governments and other investors in the Middle East have abandoned traditional, sustainable (but less productive) water supply systems in favor of modern, less sustainable (but more productive) hydraulic systems. In river valleys, modern dams have been constructed to trap surface water. Where surface water is not available, modern pumping technologies that provide access to previously unknown or inaccessible groundwater reservoirs are being

used extensively. One of the most striking examples of this shift in water technologies has been the case of qanāts. These ancient, gravity-flow water supply systems, which have provided dependable, renewable supplies of water to Middle-Eastern towns and villages for millennia, are being rapidly replaced by a more productive but less sustainable water technology, deep wells. On the Iranian plateau, an important heartland of qanāt-watered settlement, this change in water technology is draining aquifers, altering the distribution of towns and villages, and transforming the lifeworld of Iranian villagers (Eslamian et al. 2015).

As history has evolved, the development and management of water resources have occurred in numerous ways, with qanāts representing potentially one of the greatest hydrologic achievements of the ancient world. In fact, qanāts may be considered the first long-distance water transfer system. Qanāts are an ancient water transfer system found in arid regions, wherein groundwater from mountainous areas, aquifers, and, sometimes, rivers is used. Considered as the oldest, biggest achievement of human engineering, these systems cover extensive regions, including, for example, Japan and Mexico. Central Iran is exceptionally in the plateau regions of Iran; water obtained in this way from the subsurface is used for domestic and agricultural purposes. The adoption of the qanāt technique was instrumental in transforming the entire arid Middle East world into oases of date palms and other crops. This region is well known for its qanāts features, because the most splendid qanāts exist throughout this region, many of which are still active; these play a vital role in water supply in today's context (Behnia 1988).

Mass migration to cities, availability of high-yielding water extraction technologies, and lack of funding to maintain the existing qanāts have resulted in the decline of the share of qanāts in supplying water to rural communities in many Middle-Eastern countries. The climatic change and its impact on regional water resources have also led to decline of water tables (Yin, 2003). This resulted in overexploitation of groundwater resources due to excessive issuance of permits for deep wells and caused many qanāts to dry up. As such, the community distribution of water rights that has been provided and protected by qanāts over many centuries is now being replaced by demands, from individual farmers, for deep-well permits. This has led to growing inefficiencies in irrigation water uses in a region affected by severe droughts and water scarcity.

In this sense, after a brief review of qanāt structure, the advantages of qanāts in sustainable provision of quality water in arid and semi-arid regions are reviewed and emphasized. The aim of this review is to demonstrate that this ancient system of water supply should not only be protected as a great human heritage but also be reconsidered as part of a sustainable groundwater management agenda in arid and semi-arid rural areas.

### 9.1.1 SUSTAINABILITY

Sustainable development, as presently understood, has its origin in the World Conservation Strategy (IUCN, 1980). This strategy set out some now widely accepted principles of environmental sustainability and identified three essential life-support systems: soil, air, and water. The sustainable development concept was subsequently promoted to a high level of international prominence in the report *Our Common Future* (WCED 1987), known as the Brundtland Report. It defined sustainable development as “development which meets the needs of the present without compromising the ability of future generations to meet their own needs.”

Water resources projects are sustainable, if water of sufficient quantity and quality at acceptable prices is available to meet the demands and quality standards of the region now and in the future, without causing the environment to deteriorate (Plate 1993).

Water resources come from systems such as rivers, lakes, wetlands, and aquifers. The planning for utilization of these resources must be considered in association with their functions in the hydrological cycle and their interactions with the physical, chemical, and biological processes in terrestrial ecosystems. Planning and decision making for groundwater development are continuous dynamic processes.

When one addresses the question of sustainable development, the objectives and concerns of development will change over time and the development planning must adjust with the changing conditions. Short-term socioeconomic gains may have to be traded with long-term sustainability, with its varied dimensions. This again is not an easy task because of the complex interactions involved and the difficulties of specifying various non-commensurate criteria.

### **9.1.1.1 Principles of Sustainable Groundwater Development**

The goal of environmentally sound and sustainable development of water resources is to develop and manage them in such a way that the resource base is maintained and enhanced over the long term. Groundwater development begins typically with a few pumping wells, and initially, the groundwater management practice, in many cases, is geared to facilitate usage and development. As development progresses with more and more drilled wells scattered over the basin, issues such as overexploitation, equitable sharing of water, and degradation of water quality become apparent in many basins. Thus, the emphasis of groundwater management practice has to be changed, so that the available resource is utilized in an efficient, sustainable, and equitable manner, contributing to the economic and social well-being of the broader community. A sustainable groundwater development depends on the understanding of processes in the aquifer system, quantitative and qualitative monitoring of the resource, and the interaction with land and surface water development. The following key principles reflect different aspects of concern in the evolution of sustainability in groundwater development:

1. Long-term conservation of groundwater resources
2. Protection of groundwater quality from significant degradation
3. Consideration of environmental impacts of groundwater development

### **9.1.1.2 Long-Term Conservation of Groundwater Resources**

Groundwater development must be sustainable on a long-term basis, which implies that the rate of extraction should be equal to or less than the rate of recharge. When the rate of extraction is higher than the rate of recharge, a continual lowering of water level or potentiometric level is expected, and this situation has to be carefully considered for some specific cases. A continual lowering of the water table will steadily increase the pumping cost and then, at a certain level, it would no longer be economical to pump for many uses such as agricultural production. An assessment of the natural recharge is thus a basic prerequisite for an efficient groundwater resources development planning. At the initial stage of development, conventional water-balance studies based on the classical theory of a hydrological budget and soil moisture balance are conducted to estimate the groundwater recharge. However, with the availability of hydrogeological data and monitoring information as development progresses, the long-term availability of a resource for development is assessed, based on the dynamic response of the groundwater system. As the requirement of sustainable development is attached with the quantity aspect of groundwater availability and the related economic consequences, the operational concern will be to limit the anticipated decline of the water table or potentiometric level (Gupta and Onta 1997). This restriction may also be related to the environmental consequences of development, as stressed in the subsequent principles.

## **9.2 HISTORY**

Iran is known as the birthplace of qanāt. With an average annual rainfall of 250 mm, it is composed of vast regions, with less than 100 mm annual rainfall, in the east and center, and small areas with up to 1400 mm annual rainfall, in the west and north (Motiee et al. 2006). In such circumstances, an efficient use of subsurface water resources became vital. In this sense, around 800 BC, Persians mastered a groundwater exploitation technology (Goblot 1979; Behnia 1988) in form of man-made

underground water channels titled Kanehat (now called Kariz or Qanāt). This technology was then spread to other Middle-Eastern countries, China, India, Japan, North Africa, and Spain and from there to Latin America (Salih 2006).

### 9.2.1 ELAMITES AND ASSYRIA (CA. 1400–550 BC)

Henry Goblot explored the genesis of this technology for the first time. He stipulated in his book entitled “Qanāt; a Technique for Obtaining Water” that during the early first millennium before Christ (Elamites and Assyria period), for the first time, some small tribal groups gradually began immigrating to the Iranian plateau, which experienced less precipitation than that of the territories these groups came from. They came from somewhere with a lot of surface streams, so their agricultural techniques used to require more water, which was out of proportion to the water available in the Iranian plateau. Therefore, they had no option but to fasten their hope on the rivers and springs that originated in the mountains. They faced two barriers: the first was the seasonal rivers, which were out of water during the dry and hot seasons, and the second was the springs, which drained out the shallow groundwater and fell dry during the hot seasons. The ancient Iranians made use of the water that the miners wished to get rid of and founded a basic system named qanāt to supply the required water to their farmlands. According to Goblot, this innovation took place in Urartu and later was introduced in the neighboring areas such as Zagros Mountains (Goblot 1979). Goblot believes that the influence of Medians and Achaemenians made the technology of qanāt spread from Urartu (in the western north of Iran and near the present border between Iran and Turkey) to all over the Iranian plateau.

### 9.2.2 ACHAEMENIAN EMPIRE (CA. 550–330 BC)

It was an Achaemenian official ruling that in case someone succeeded in constructing a qanāt and bringing groundwater onto the surface in order to cultivate or in renovating an abandoned qanāt, the tax he was supposed to pay the government would be waived, not only for him but also for his successors up to five generations. During this period, the technology of qanāt was in its heyday, and it even spread to other countries. For example, according to Darius’s order, Silaks, the naval commander of the Persian army, and Khenombir, the royal architect, managed to construct a qanāt in the oasis of Kharagha’ in Egypt. “Beadnell” believes that the qanāt construction dates back to two distinct periods. In Egypt, some qanāts were constructed by the Persians for the first time, and later, Romans dug up some other qanāts during their reign in Egypt from 30 BC to 395 AD.

Boucharlat confirms the introduction of qanāt in Egypt at the time of Achaemenian, though he underlines the differences between them and the original Persian qanāts. He writes, “recent excavations both in Egypt and Libya have provided evidence of underground galleries dated to Persian period (mid-fifth century BC). The most reliable document confirming the existence of qanāts at Achaemenian period has been written by Polibius who stipulates that: “the streams are running down from everywhere at the base of Alborz mountain, and people have transferred too much water from a long distance through some subterranean canals by spending much cost and labor.”

### 9.2.3 SELEUCIDIAN ERA (312–250 BC)

During Seleucidian era, which began after the occupation of Iran by Alexander, it seems that the qanāts were abandoned. May be, this situation has something to do with the origin of the occupiers who had no idea on how the system of qanāt works and how they should be treated (Semsar Yazdi 2006).

### 9.2.4 PARTHIAN ERA (250 BC–150 AD)

According to the historical records left from the ancient times, the Parthian kings did not care about the qanāts the way the Achaemenian kings and even Sassanid kings used to do. Polybius

(Greek historian, 203–120 BC) recorded how Arsac III, one of the Parthian kings, tried to demolish the qanāts and so cut off the water supply in order to halt the advance of Antiochus toward the lost Parthian capital of Hecatompylos. Arsac destroyed some qanāts in order to make it difficult for Seleucidian Antiochus to advance further while fighting him (Beaumont 1971).

### 9.2.5 SASSANID ERA (226–650 AD)

The historical records left from this time indicate a perfect regulation on both water distribution and farmlands. All the water rights were recorded in a special document, which was referred to in case of any transaction. The lists of farmlands—whether private or governmental—were kept at the tax department. During this period, there existed some official rulings on qanāts, streams, construction of dam, operation and maintenance of qanāt, and so on. The government proceeded to repair or dredge the qanāts that were abandoned or destroyed by any reason and to construct the new qanāts, if necessary. A document written in Pahlavi language pointed out the important role of qanāts in developing the cities at that time.

### 9.2.6 AFTER ISLAM (FROM 621 AD TO ILKHANID ERA)

In Iran, the advent of Islam that coincided with the overthrow of the Sassanid dynasty brought about a profound change in religious, political, social, and cultural structures. However, the qanāts stayed intact, because the economical infrastructures such as qanāts were of great importance to the new government.

As an instance, M. Lombard reports that the Moslem clerics who lived during Abbasid era such as Abooyoosuf Ya'qoob (death 798 AD) stipulated that whoever could bring water to the idle lands for cultivation, his tax would be waived and he would be entitled to the same lands cultivated. Therefore, this policy did not differ from that of the Achaemenians, who did not get any tax from the people who revived the abandoned lands. Arabs' supportive policy on the qanāts was so successful that even the holy city of Mecca gained a qanāt.

There are also other historical texts that prove that the Abbasids were concerned about qanāts. For example, according to the “Incidents of Abdollah bin Tahir's Time” written by Gardizi, in the year 830 AD, a terrible earthquake struck the town of Forghaneh and reduced many homes to rubble. The inhabitants of Neyshaboor used to come to Abdollah bin Tahir in order to request him to intervene, for they bickered over their qanāts and found the relevant instruction or law on qanāt as a solution neither in the prophet's quotations nor in the clerics' writings. Therefore, Abdollah bin Tahir managed to bring together all the clergymen from throughout Khorasan and Iraq to compile a book entitled “Alghani” (the book of qanāt). This book took up all the rulings on qanāts that could be of use to whoever wanted to judge a dispute over this issue.

Ms. Lambton quotes Moeen al-din Esfarzi, who has written the book *Rowzat al-Jannat* (the garden of paradise), that Abdollah bin Tahir (from Taherian dynasty) and Ismaeel Ahmed Samani (from Samani dynasty) had several qanāts constructed in Neyshaboor. Later, in the eleventh century, a writer named Nasir Khosrow acknowledged all those qanāts by the following words:

“Neyshaboor is located in a vast plain at a distance of 40 Farsang (~240 km) from Serakhs and 70 Farsang (~420 km) from Mary (Marv) ... all the qanāts of this city run underground,” and it is said that a traveler who was offended by the people of Neyshaboor has complained that “what a beautiful city Neyshaboor could become if its qanāts would flow on the ground surface and instead its people would live underground.”

### 9.2.7 ILKHANID ERA

In the thirteenth century, the invasion of Mongolian tribes to Iran reduced many qanāts and irrigational systems to ruin, and many qanāts were deserted and dried up. Later, in the era

of Ilkhanid dynasty, especially at the time of Ghazan Khan and his Persian minister Rashid Fazl-Allah, some measures were taken to revive the qanāts and irrigational systems. There is a book entitled *AlVaghfiya Al-Rashidiya* (Rashid's deeds of endowment) that names all the properties located in Yazd, Shiraz, Maraghe, Tabriz, Isfahan, and Mowsel that Rashid Fazl-Allah had donated to the public or religious places. This book mentions many qanāts running at that time and irrigating a considerable area of farmlands. At the same time (fourteenth century), another book entitled *Jame' alKheyrat* was written by Seyyed Rokn al-Din on the same subject as that of Rashid's book.

### 9.2.8 SAFAVID ERA

In the Safavid era (fifteenth and sixteenth centuries), the problem of the shortage of water intensified and led to the construction of many water reservoirs and qanāts. Sharden, the French explorer who made two long journeys to Iran at the time of Safavid, reports, "the Iranians rip the foothills in search of water, and when they find any, by means of qanāts they transfer this water to a distance of 50 or 60 km or sometimes further downstream. No nation in the world can compete with the Iranians in recovering and transferring groundwater. They make use of groundwater in irrigating their farmlands, and they construct qanāts almost everywhere and always succeed in extracting groundwater."

### 9.2.9 DYNASTY OF QAJAR

The dynasty of Qajar ruled Iran from the sixteenth century to the early eighteenth century. According to Goblot, the time of Qajar can be considered as the heyday of qanāts, for the qanāts could flourish. Agha Mohammad, Khan the founder of Qajar dynasty, chose Tehran as his capital city, the city where there was no access to a reliable stream of surface water and it had to rely on the groundwater. The rich supply of groundwater and suitable geological-topographical conditions of Tehran allowed this city to house many qanāts, whose total discharge amounted to 2000 L/s. Haj Mirza Aghasi (ruling between 1834 and 1848), the prime minister of the third king of Qajar dynasty, encouraged and supported qanāt construction throughout the country<sup>4</sup>. Jaubert de Passa, who surveyed the situation of irrigation in Iran, reports a population of 50,000 in Hamedan, 200,000 in Isfahan, and 130,000 in Tehran in the year 1840. Then, he claims that in these cities, life is indebted to the qanāts, which are being constructed in a simple but powerful manner. In a nutshell, the period of Qajar, which lasted about 1.5 century, witnessed lots of endeavors to revive the qanāts.

### 9.2.10 PERIOD OF PAHLAVI

Period of Pahlavi began in 1921, when Reza Shah came to power, and ended in 1979 with his son's overthrow in the wake of Islamic revolution. However, the process of qanāt construction and maintenance continued during this time, but in sum, the commercialist trends inflicted some damages on this irrigational system. Unfortunately, most of the Iranian scholars had a low opinion of the traditional technology during the period of Pahlavi. They assumed that the only way out from the economical crisis is to belittle the traditional methods to pave the way for the modern technologies. Even some of the scholars and politicians tried to exaggerate the technical defects in traditional methods to convince public opinion to get rid of them in any way.

In the face of such a paradigm, a county that was responsible for the qanāts was set up by Reza Shah. At that time, most of the qanāts of the country belonged to the landlords. In fact, feudalism was the prevailing system in the rural regions. The peasants were not entitled to the lands they worked on, but they were considered just the users of the lands. They had to pay the rent of the land and water to the feudals. The feudal, who were at a high financial level, could afford to finance all



the activities required to maintain the qanāts. According to the report of Safi Asfiya, who was in charge of supervising the qanāts of Iran in the former regime, in the year 1942, Iran enjoyed 40,000 qanāts, with a total recharge of 600,000 L/s or 18.2 billion m<sup>3</sup>/year.

This period faced the advent of the new technology of pumped well, which was unconditionally welcomed by the government on one hand, and experienced a reformative program declared by the former Shah on the other hand. These two issues, which are described in the next parts of the paper, played an important role in phasing out the system of qanāt.

In 1946, the Independent Foundation on Irrigation was set up by the government for the first time, aiming at the construction of dams and meteorological stations, implementation of irrigational projects, supply of drinking water, and harvesting of surface runoffs. Suffice to say, a widespread conflict between the pumped wells and the qanāts broke out, in which final loser was the system of qanāt was the loser.

In 1959, a reformative program named as White Revolution was declared by the former Shah. One of the articles of this program addressed the land reform that let the peasants take ownership of a part of the feudals' lands. In fact, the land reform dashed the lords' hope. They lost their motivation for investing more money in the construction or repair of the qanāts, which were subject to the land reform law. On the other hand, the peasants could not come up with the money to maintain the qanāts, so a lot of qanāts gradually got deserted. The pumped wells had a negative impact on the qanāts, owing to their overexploitation of the groundwater. These changes that occurred in Mohammad Reza Shah's reign inflicted a great damage on the qanāts of the country, so that many qanāts vanished forever.

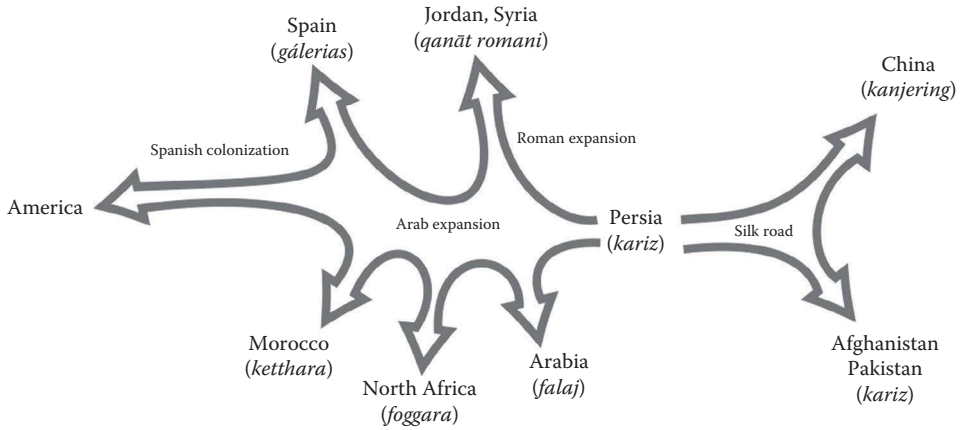
In the year 1963, the Ministry of Water and Electricity was established in order to provide the rural and urban areas of the country with sufficient water and electricity. Later, this ministry was renamed as the Ministry of Energy. Three years later, in 1966, the parliament passed a law to protect the groundwater resources. According to this law, the Ministry of Water and Electricity was allowed to ban drilling of any deep and semi-deep wells wherever the surveys showed that the water table was dropping because of overpumping. This law as well as the law of water nationalization that was approved in 1968, and eventually, the law of fair distribution of water passed (in 1981) after the Islamic revolution, emphasized the definition of the restricted and free areas for drilling. In the restricted areas, drilling any wells (except for drinking and industry) were prohibited in order to prevent the continuous depletion of groundwater, so the rest of the qanāts had a better chance to survive.

### 9.2.11 TIME OF THE ISLAMIC REPUBLIC

After the Islamic revolution, a special attention was given to the qanāts. For the first time, in 1981 a conference on qanāt was held in Mashhad, during which the different options to mitigate the problem were explored. The organization of Jihad Sazandegi took responsibility for the rehabilitation of qanāts and subsidized their shareholders. Now, the same organization, which was renamed as "Ministry of Jihad Agriculture," is responsible for the qanāts and continues to grant some funds to the stakeholders to maintain their qanāts.

In the years 1984–1985, the Ministry of Energy took census of 28,038 qanāts whose total annual discharge was 9 billion cubic meters. In the years 1992–1993, the census of 28,054 qanāts showed a total discharge of 10 billion m<sup>3</sup>. Ten years later, in 2002–2003, the number of qanāts was reported as 33,691, with a total discharge of 8 billion m<sup>3</sup> (Javan et al. 2006).

According to the last report published by the Iran Water Resources Management organization, in the years 2011–2012, there exist 41,109 qanāts over the country, whose total discharge is 4.66 billion m<sup>3</sup>. The increase in the number of registered qanāts in the earlier records is due to enhancing the accuracy of monitoring operations, so that the small qanāts with low discharge are included by these operations.



**FIGURE 9.1** Expansion of qanāt from Iran to different parts of the world. (From Salih, A. Qanāts a unique groundwater management tool in arid regions: The case of Bam region in Iran, in *International Symposium on Ground Water Sustainability (ISGWAS)*, Alicante, Spain, pp. 79–87, 2006. With Permission.)

Construction of qanāts expanded from Persia to the East, along the silk route to China, and subsequently spread to India, Saudi Arabia, North Africa, Cyprus, the Canary Islands, and Spain (Lambton 1989). Around 750 BC, Arab Muslims constructed qanāts in Africa as well as the Yafoga qanāt in Madrid. Around 550 BC, the design concepts of qanāts were taken by the Iranian army to Egypt and then subsequently to Oman and Saudi Arabia about 525 BC. Spaniards extended qanāts to Mexico in 1520 AD, and from there, they came into use in Los Angeles. Pika, in Chile, utilized qanāts in 1540 AD. Qanāts can be traced in China to 120 BC, but there is no evidence currently available that indicates their presence in ancient society in Turkistan, and particularly in Tourfan, where well diggers have all been from the Khorasan Province of Iran (Figure 9.1). Qanāt technology was introduced into Eastern Asia around 280 AD. Japanese qanāts, which are generally located across Narva, the former capital of Japan and are termed Manboo (Munbu), appear to have been derived from the Persian word (Manbae), which means “reservoir” (Goblot 1979).

### 9.3 GLOBAL DISTRIBUTION OF QANĀTS

Records of scientists and researchers indicate that 34 countries of the world benefit from the use of qanāts; the list of countries includes (Baboli & Labaf Khaniki, 2000): (a) Asia: Iran, Jordan, Afghanistan, United Arab Emirates, Bahrain, Pakistan, China, Oman, Palestine, Cambodia, India, and Yemen; (b) Africa: Algeria, Tunisia, Sahara, Libya, Morocco, and Egypt; (c) Europe: Germany, England, Spain, Italy, Czechoslovakia, Cyprus, France, and Sicily; and (d) the Americas: Peru, Chile, and Mexico (Figure 9.2).

They were the focal point of the formation of civilization in various parts of the world. The communities whose main source of water had been qanāts made their utmost endeavors concerning promotion of exploitation and management of such an amazing technology. Since the introduction of pumped wells, many of the qanāts have been phased out. However, in some countries such as Iran, Oman, Afghanistan, Pakistan, China, and Azerbaijan, some qanāts are still operational and supply a considerable amount of water to the agricultural sector. At present, according to existing reports, some countries, for example, Iran, Afghanistan, Pakistan, Oman, and China, enjoy active qanāts. It is quite possible that there are running qanāts in some other countries. Some accurate information in terms of the situation of qanāts has so far been received in the following countries: China, Tunisia, Algeria, Morocco, Egypt, Spain, Italy, Afghanistan, Pakistan, and Sultanate of Oman.



dig qanāts, with the result that consumption of underground water has lasted for many centuries (Figure 9.2).

The north and western provinces of Iran are not so dependent on qanāts for their surface water resources. However, the south, central, and eastern provinces have 24,411 qanāts, forming 74% of domestic qanāts in Iran, with approximately 6 billion m<sup>3</sup> of annual discharge. The following criteria describe the priorities for the selection of sites for qanāts in Iran during past centuries:

- Desert regions
- Rainfall scarcity: Maximum annual rainfall hardly exceeds 250 mm. Some areas receive an annual average precipitation of less than 100 mm, and there are some locations that record only 50 mm of rainfall
- Lack of permanent rivers
- Remoteness of the seas and oceans

Some optimum conditions for digging qanāts in the East include:

- High mountains with convenient slopes and a plain at the foot of the mountains
- Noticeable aquifers with acceptable water quality
- Diligent people
- Fertile lands that have limited agricultural potential owing to a shortage of water

Water and its resources are development key for Iran. Therefore, the qanāts as a main water resource are very valuable natural resources in arid zone in Iran. There are some 22,000 qanāt units in Iran, comprising more than 170,000 miles of underground channels. The qanāt innovation belongs to Iranian and has developed in other countries over the world (Kardavani 1997). Moreover, the Greek historian Polybius in the second century BC described a qanāt that had been built in an Iranian desert “during the Persian ascendancy.”

Inside qanāts, there are wonders unbelievable to modern world. According to the Iranian Ministry of Energy, the number of qanāts in Iran is about 36,300. The average length of these qanāts is about 6 km and the average depth of all shaft wells of a qanāt, together, is approximately 4 km.

There are about 22,000 qanāts in Iran, although their number has diminished as the time passed. This reduction in number is a consequence of digging deep wells. There are still a considerable number of qanāts in Iran that are still in use. These qanāts are about 274,000 km long. Qanāts are stretched all over Iran country, particularly in the arid and semi-arid zones. The provinces that benefit from qanāts are described in the following sections.

#### 9.4.1 THE PROVINCE OF YAZD

Yazd, in the center of Iran, relies extensively on qanāt water, owing to its average annual rainfall of 60 mm and lack of permanent rivers. Shirkoh mountain's water deposits feed the aquifers with adequate potential resources, so that the Yazd-Adriatic alluvial basin benefits from considerable water deposits. Consumption of underground water delivered by the qanāts has been the only method for centuries, because Yazd is an ancient city. Qanāts more than 1000 years old are still active. Yazd Province is proud that it still has numerous running qanāts, particularly the mountainous ones. According to the census in 2001, there are 3091 qanāts with an annual discharge of 339 million cubic meters in Yazd. According to the total discharge of the underground water of the province, that is, 1403 million cubic meters, some 24% comes from qanāts and the rest is supplied by deep and semi-deep wells and springs.

### 9.4.2 THE PROVINCE OF SEMNAN

Shah-rud qanāt is considerable, owing to its discharge in this province, which exceeds 250 L/s, with a mother well enjoying 60 m of depth. It is to be noted that this qanāt is the only source of water in the town.

### 9.4.3 THE PROVINCE OF KHORASAN

Bidokht and Saleh Abbad are the two well-known active qanāts in Gonabad. Bidokht enjoys a mother well of 350 m depth and a discharge of 150 L/s, irrigating 150 hectares of the agricultural lands. Keikhosro is another qanāt in Gonabad with a mother well of 400 m depth, according to Mr. Saed-lu. Mr. kurus believes that the biggest qanāt gallery in Gonabad is 70 km long. This is probably the one with a mother well of 140 m depth, according to Mr. Saad-lu. It is believed that the sanabad qanāt in Mashhad is 1200 years old and dates back to pre-Islamic era.

### 9.4.4 THE PROVINCE OF KERMAN

There is no unanimity regarding the longest qanāt in Kerman. For instance, Hashu-eieh, located in Baghein (31 km long, with 22 L discharge), is the longest qanāt, according to the authorities of the regional water organization. Mr. Safi Nejad believes that the Kerman qanāt, which is 40 km long, has a mother well of 120 m depth, has a discharge of 20 L/s, is considerable. Mr. Petroshevski has recorded the Mahan qanāt, which is 50 km long, and Dr. Bastani Parizi believes that there is a qanāt in Kerman that is about 42 km long and has a mother well of 145 m depth. The most splendid qanāt of the province is called pa-ye-kam, located on the outskirts of Bam, with a length of 4600 m, 4000 m of which is the wet zone. The mother well is 47 m deep. In Bam and Narmashir, Rashidi qanāt in Barvat and Fazl-Abbad date back to Rashid-Al-Din Fazlolah's Children and Gardun qanāt precedes Mongols. Chupar is another qanāt that date back to Annahita.

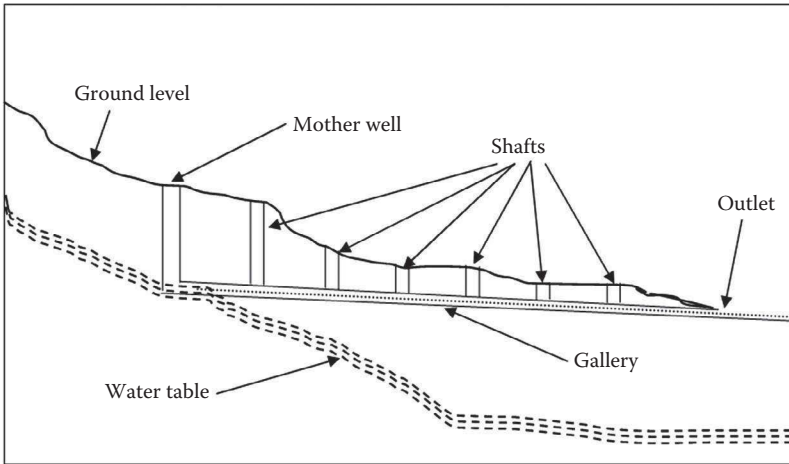
### 9.4.5 THE PROVINCE OF WEST AZARBAYJAN

The longest qanāt of Bostan—Abbad is Dagh—Cheshmeh is located in a village named Estyar. It is 8000 m long, and its mother well is 20 m deep. Vakil and Cheshmeh Armanistan qanāts are the longest ones in Azar shahr. They both enjoy a length of 6000 m and the mother wells are 15 m and 30 m deep, respectively. The deepest recorded mother well of the region (115 m) belongs to Hassan Abbad and Bareh-khuni of Mamaghan. Kalantar qanāt in Tabriz and is more than 10,000 m long.

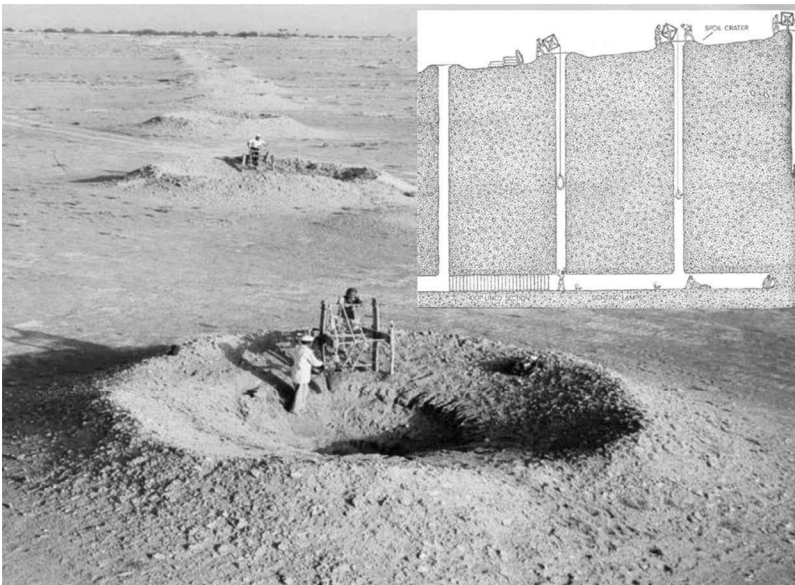
## 9.5 THE NATURE OF QANĀTS

A qanāt is a system of water supply that consists of an underground tunnel connected to the surface by a series of shafts, which use gravity to bring water from the water table to the surface (Figure 9.3). Qanāts are usually dug where there is no surface water, and these were originally invented by Iranians. The main, or mother, well is generally excavated in the mountains, penetrating deep into the water table. Water runs down a slightly sloping tunnel, gradually increasing in volume, until it emerges near farms or communities. Water from qanāts is brought to the surface, where the soil has been enriched by sediments from alluvial fans (Figure 9.4). Cultivated land and settlement sites are situated downward from the point where the water surfaces. The immediate outlet, mazhar, is the point where people take water, and it is generally located in the main square of a village. The water outlet point is very important; it is well kept and cemented and water use





**FIGURE 9.3** The structure of a qanāt system.



**FIGURE 9.4** Digging the tunnel and shafts of a qanāt (Yazd Province, Iran.)

is monitored. A tunnel, or payab, channels water under the residential area to the cultivated land. A sloping corridor with steps leads from the surface to the payab. The first payab is located in the main square and is used for taking drinking water. A network of smaller payabns runs from the main payab.

Qanāts are also known as “Karez” (Afghanistan), “Galeria” (Spain), “Khotara” (Morocco), “Aflaj” (Arabian Peninsula), “Foggara” (North Africa), “Kanerjing” (China), and “Auon” (Saudi Arabia/Egypt), reflecting the widespread dissemination of the technology across ancient trading routes and political maps.



### 9.5.1 GOALS OF CONSTRUCTION OF QANĀTS

The goals of construction of qanāts have been to provide hygienic drinking water and irrigation for agriculture. The availability of water has resulted in prosperity, both socially and economically. The purposes of qanāts include (Motiee et al. 2006):

1. To supply fresh water to arid zones
2. To allow the population to live in desert areas (e.g., Kavirs)
3. To allow the development of saline and alkaline lands
4. To harmonize population distribution in arid and semi-arid zones
5. To store water by ab anbar; an ab anbar is a traditional qanāt-fed reservoir for drinking water in Persian antiquity
6. To provide cooling in desert climate (Motiee et al. 2006): Qanāts used in conjunction with a wind tower can provide cooling as well as water supply. A wind tower is a chimney-like structure positioned above the house to catch the prevailing wind. The tower catches the wind, driving a hot, dry breeze into the house; the flow of the incoming air is then directed across the vertical shaft from the qanāt. The air flow across the vertical shaft opening creates a lower pressure and draws cool air up from the qanāt tunnel, mixing with it. The air from the qanāt is drawn into the tunnel at some distance away and is cooled both by contact with the cool tunnel walls and water and by the giving up of latent heat of evaporation as water evaporates into the air stream. In dry desert climates, this can result in a greater than 15°C reduction in the temperature of air coming from the qanāt; the mixed air still feels dry, so the basement is cool and only comfortably moist (not damp). Wind tower and qanāt cooling have been used in desert climates for over 1000 years
7. To store ice: In 400 BC, Persian engineers had already mastered the technique of storing ice in the middle of summer in the desert. The ice was brought in during the winters from nearby mountains in large quantities and stored in specially designed, naturally cooled refrigerators called yakhchal (meaning ice pits). A large underground space with thick insulated walls was connected to a qanāt, and a system of wind catchers was used to draw cool subterranean air up from the qanāt to maintain temperatures inside the space at low levels, even during hot summer days. As a result, the ice melted slowly and ice was available all year round
8. To drive underground water mills: In cases where the gradient is steeper, underground waterfalls may be constructed with appropriate design features (usually linings) to absorb the energy with minimal erosion. In some cases, the water power has been harnessed to drive underground mills. There are significant advantages of a qanāt water delivery system, including that it allows water to be transported long distances in hot dry climates, without losing a large proportion of the source water to seepage and evaporation. Qanāts are constructed as a series of well-like vertical shafts connected by gently sloping tunnels. This technique taps the subterranean water in a manner that efficiently delivers large quantities of water to the surface without need for pumping

The water drains rely on gravity, with the destination lower than the source, which is typically an upland aquifer. The rate of flow of water in a qanāt is controlled by the level of the underground water table. Thus, a qanāt cannot cause significant drawdown in an aquifer, because its flow varies directly with the subsurface water supply. When properly maintained, a qanāt is a sustainable system that provides water indefinitely.

### 9.5.2 PREREQUISITE CONDITIONS FOR THE CREATION OF QANĀTS

The natural conditions considered while digging a qanāt include regional climate, hydrologic environment, topography, and soil texture (Behnia, 1988). These four elements play vital roles in

a successful qanāt digging procedure where there are suitable regional conditions due to precipitation, available transmissive aquifers, and available canal gradients. Soil texture must also be considered, because both very hard and very soft soils sometimes disturb the performance. Most qanāts are constructed in arid zones, owing to the scarcity of surface waters, with the shortage of water being fulfilled through the digging of qanāts, providing access to an aquifer (Farshad and Zinck 1997). No doubt, the aquifer can supply the necessary water if the aquifer source water region receives sufficient precipitation. Consequently, adjacent slopes of mountains that receive sufficient rain, permeable soils, and gentle slopes are the optimum places for qanāt digging (Beaumont 1989).

### 9.5.3 QANĀT CONSTRUCTION

Traditionally, qanāts were built by a group of skilled laborers, muqannīs, with hand labor. The profession historically paid well and was typically handed down from father to son. The critical, initial step in qanāt construction is identification of an appropriate water source. The search begins at the point where the alluvial fan meets the mountains or foothills; water is more abundant in the mountains because of orographic lifting, and excavation in the alluvial fan is relatively easy. The muqannīs follow the track of the main water courses coming from the mountains or foothills to identify evidence of subsurface water such as deep-rooted vegetation or seasonal seeps. A trial well is then dug to determine the location of the water table and determine whether a sufficient flow is available to justify construction. If these prerequisites are met, then the route is laid out aboveground (Motiee et al. 2006).

Equipment must be assembled. The equipment is straightforward: containers (usually leather bags), ropes, reels to raise the container to the surface at the shaft head, hatchets and shovels for excavation, lights, spirit levels or plumb bobs, and string. Depending on the soil type, qanāt liners (usually fired clay hoops) may also be required. Although the construction methods are simple, the construction of a qanāt requires a detailed understanding of subterranean geology and a degree of engineering sophistication. The gradient of the qanāt must be carefully controlled; too shallow a gradient yields no flow and too steep a gradient will result in excessive erosion, collapsing the qanāt.

In addition, misreading the soil conditions leads to collapses, which at best require extensive rework and at worst can be fatal for the crew.

Construction of a qanāt is usually performed by a crew of 3–4 muqannīs. For a shallow qanāt, one worker typically digs the horizontal shaft, one raises the excavated earth from the shaft, and one distributes the excavated earth at the top.

The crew typically begins from the destination to which the water will be delivered into the soil and works toward the source (the test well). Vertical shafts are excavated along the route and separated at a distance of 20–35 m. The separation of the shafts is a balance between the amount of work required to excavate them and the amount of effort required to excavate the space between them, as well as the ultimate maintenance effort. In general, the shallower the qanāt, the closer the vertical shafts. If the qanāt is long, excavation may begin from both ends at once. Tributary channels are sometimes also constructed to supplement the water flow.

The qanāt's water-carrying channel is 50–100 cm wide and 90–150 cm high. The channel must have a sufficient downward slope so that water flows easily. However, the downward gradient must not be so great as to create conditions under which the water transitions between supercritical and subcritical flows; if this occurs, the waves that are established result in severe erosion and can damage or destroy the qanāt. In shorter qanāts, the downward gradient varies between 1:1000 and 1:1500, while in longer qanāts, it may be almost horizontal. Such precision is routinely obtained with a spirit level and string.

### 9.5.4 TYPES OF QANĀT

Qanāts are categorized on the basis of their length, discharge, and depth, as described in the following subsections (Behnia 1988).

#### 9.5.4.1 Qanāt Type According to Length

The length of qanāts depends on the district and geography of the area. Extended qanāts consist of longer galleries and deeper mother wells, and vice versa—short-distance qanāts have shorter galleries and shallower mother wells. Extended qanāts were usually created because of a regional scarcity of annual rainfall and gentle slopes, while shorter qanāts benefited regions with more rainfall and steep gradients. The water table may be hundreds of meters below ground surface.

Short qanāts are usually established on mountain slopes with steep slopes and extend over tens of kilometers. For example, in Tehran, which receives significant rainfall, the galleries are much shorter and the mother wells are shallower than Yazd, where very little annual rainfall occurs.

#### 9.5.4.2 Qanāt Type According to Discharge

Qanāts with permanent discharge are those with long galleries and rich underground water basins running through deep galleries rather than through the surface. Qanāts with seasonally varying discharge are fed by shallow and, sometimes, poor-quality aquifers. They are basically dependent on seasonal rainfalls, and their discharge varies.

The discharge of water produced by a qanāt depends on several factors, including the spatial extent of the aquifer, type of aquifer, and soil strata (e.g., sand seam, fractured limestone, and buried riverbed conglomerate). Each will hold its own volume of water per hectare, and each rock type will allow the water to drain at a fixed rate (Sankaran Nair 2004).

#### 9.5.4.3 Qanāt Type According to Depth

Qanāts are divided into two categories on the basis of their gallery depth (Behnia 1988).

*Deep qanāts:* If the low-permeability layer of the soil is at a great depth, the qanāts are called deep qanāts, and the mother wells are usually more than 30 m deep, although some are hundreds of meters in depth. Three qanāts in the Province of Khorasan in Iran are examples of this traditional hydraulic technology, with mother wells more than 300 m deep and galleries 35 km long.

*Shallow qanāts:* These are employed when the low-permeability layer of the soil is not as deep and where the depth of the mother wells does not exceed 30 m.

Classification of qanāts according to the following five criteria is given as follows:

- Length and depth of qanāt
  - Short qanāts
  - Long qanāts
- Topography
  - Mountainous qanāts
  - Semi-mountainous qanāts
  - Plain qanāts
- Geographical situation
  - Successive qanāts
  - Parallel qanāts
  - Converging qanāts
- Qanāt discharge
  - Fluctuating qanāts
  - Constant qanāts
- Source of qanāt flow
  - Normal qanāt
  - Qanāt–spring
  - Qanāt–river
  - Qanāt–well

### 9.5.5 MAINTENANCE

Qanāt routes need to be regularly cleaned and maintained. They are subject to damage and destruction by flash floods. To prevent shafts from being filled with sand, they are covered by stone slabs or other objects. Moqannies carry castor-oil lamps to test the ventilation underground. If the air does not keep the flame alight, another shaft is sunk. They clear the deposited sediments formed by minerals at the bottom of the aqueducts (Mostafaeipour 2010).

## 9.6 STRUCTURE

A typical qanāt system is described in the following subsections.

### 9.6.1 TECHNO-PHYSICAL STRUCTURE OF QANĀT

In terms of physical functioning and structure, qanāt can be described as gently sloping subterranean tunnels that connect wells over long distances (English 1968). In other words, the physical system of qanāt contains a set of well-like vertical shafts, or a chain of wells, connected by sloping horizontal tunnels. Qanāts tap subterranean water in a manner that efficiently delivers large quantities of water to the surface, without the need for pumping. The water drains by relying on gravity, with the destination being lower than the source. Qanāt allows water to be transported long distances in hot, dry climates without losing a large proportion of the source water to seepage and evaporation. Qanāts are relatively insensitive to levels of precipitation; a qanāt typically delivers a relatively constant flow, with only gradual variations from wet to dry years, and as they rely on seepage into the tunnel, qanāts deliver groundwater in sustainable quantities. Making the physical structure of a qanāt is a highly skilled operation in the way that the trade of the qanāt makers (muqannīs) was often hereditary in rural Iran (Reed & Lambton 1954)

#### 9.6.1.1 Structural Feature

The methods used today for building qanāts in Iran are not greatly different from the system devised thousands of years ago (Saffari 2005). The building project begins with a careful survey of the land. A qanāt system is usually dug in the slope of a mountain or hillside.

The qanāt includes some wells and one gallery, with slope less than earth's surface, which drains water from saturation layer or river or wetland by gravity. Figure 9.5 shows all parts of qanāt. The qanāt becomes a ditch near its destination. The depth of qanāt reaches 30 m (the record is about 60 m) and can cover distances of many kilometers (the longest Iranian qanāt is 70 km long). A qanāt, once built, can exist for a long time, but agriculture with qanāts is extremely labor-intensive. It is not only difficult to dig an underground canal, but it also needs a visit every spring to clean it out. Here, some of important elements of a qanāt are presented, and these are demonstrated by Figure 9.5.

Description of a qanāt and the technologies used to build such a system have been well documented since early times. The building process of qanāts has changed very little since that time. Qanāts have been constructed by the hand labor of skilled workers, called muqannīs, who have mastered a great understanding of geology and engineering. A qanāt system, as depicted by Figure 9.5, consists of the following components (Beaumont 1971; Motiee et al. 2006).

*Mother well:* This is the initial step in building a qanāt. A mother well (with a width of approximately 0.8–1.0 m) is dug deep into the water table. As qanāts lead water by the force of gravity, the mother well is usually constructed on alluvial depositions at the bed of mountains and hills. This phenomenon has the advantage of reaching the water at a place and depth that are usually protected from outside contamination. To reach the water table and locate the place of the mother well, the qanāt builders had to go through a trial-and-error process by digging a few boreholes. If one of these trial wells could reach the

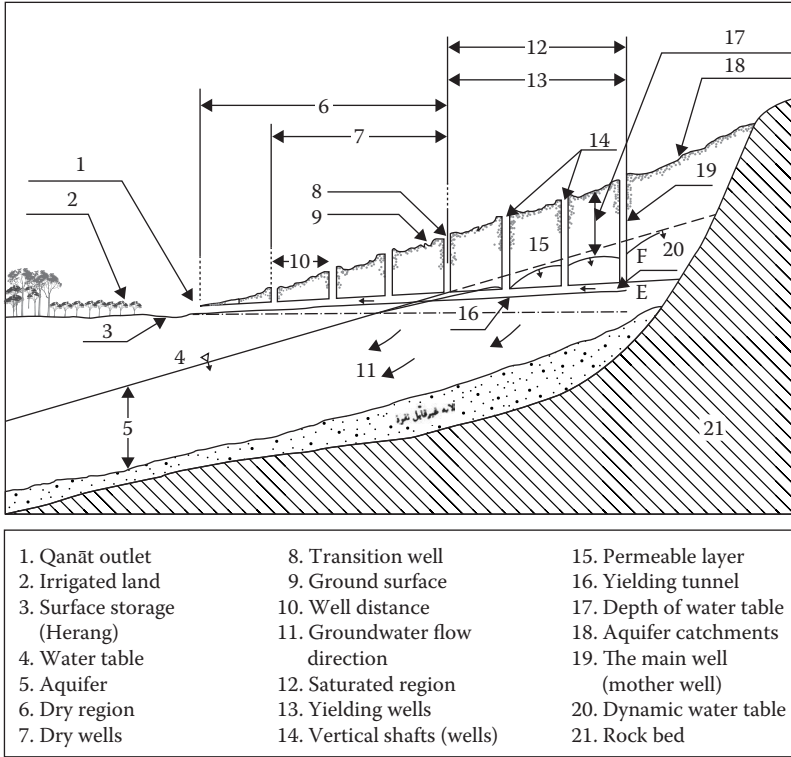


FIGURE 9.5 Physical structure of a qanāt system.

water at a height that provided an acceptable slope for water flow toward the qanāt outlet, it was selected as the mother well. The deepest mother well among qanāts, more than 300 m, belongs to the 2700-year-old Gonabad qanāt in Khorasan Razavi province in Iran (Boustani 2008).

*Outlet:* It is the place where water is emerged to the surface. There are often several candidate positions for the exit point of water. The final location is determined with respect to a number of factors such as the proximity to the points of water consumption (villages, farmlands, etc.) and the slope it makes when connected to the mother well.

9.6.1.2 Gallery

Once the mother well and the outlet are located, the muqannīs start to build the gallery, which is a slightly sloped tunnel. The job is started from the outlet toward the mother well. The choice of the slope is a trade-off between erosion and sedimentation. Highly sloped tunnels are subject to more erosion, as water flows at a higher speed. On the other hand, less sloped galleries need frequent maintenance, owing to the problem of sedimentation. As seen in most of the qanāts, the slope is around 0.5%. The cross section of the gallery is elliptical, with a height of 1.2–2.0 and width of 0.8–1.0 m. In some advanced qanāts, the bed of the tunnel is sealed by a hard material such as mortar. In addition, in loose soils, to avoid roof and wall collapse, baked clay rings are employed.

On the basis of the distance between the outlet and the mother well, the length of the gallery could vary from a few hundred meters to several kilometers. The longest gallery among the qanāts in Iran, for example, about 120 km, belongs to Zarach qanāt in Yazd province (Molle et al. 2004).

*Shafts:* These are a series of vertical wells built along the gallery between the destination point (water outlet) and the mother well to facilitate the removal of soil and to provide ventilation and access for muqannīs while they are building the gallery. The shafts are built 20–50 m apart from each other, and their depth increases toward the mother well. These wells are protected even after the gallery is fully built, as they provide access to qanāt for cleaning and maintenance purposes.

*Farm:* The farm is a cultivated area that is less elevated than the exit point of the qanāt, irrigated by the water coming out of the qanāt. The extent of the cultivated area depends on several factors such as the qanāt discharge, soil quality, soil permeability, and local climatic conditions. If the water flowing from the qanāt is insufficient, the water is stored in a pool to increase the volume and head of water, so that it can be delivered to the land at a higher flow rate and thus irrigate the farms. The irrigation cycle differs from area to area but is usually between 12 and 15 days.

*Dry zone:* It is a portion of the gallery between the wet zone and the appearance.

*Wet zone:* It is referred to the infiltrating walls inside the gallery of a qanāt. The discharge rate is directly dependent on the wet zone.

---

1. Qanāt outlet	12. Saturated region
2. Irrigated land	13. Yielding wells
3. Surface storage (Herang)	14. Vertical shafts (wells)
4. Water table	15. Permeable layer
5. Aquifer	16. Yielding tunnel
6. Dry region	17. Depth of water table
7. Dry wells	18. Aquifer catchment
8. Transition well	19. The main well (mother well)
9. Ground surface	20. Dynamic water table
10. Well distance	21. Rock bed
11. Groundwater flow direction	

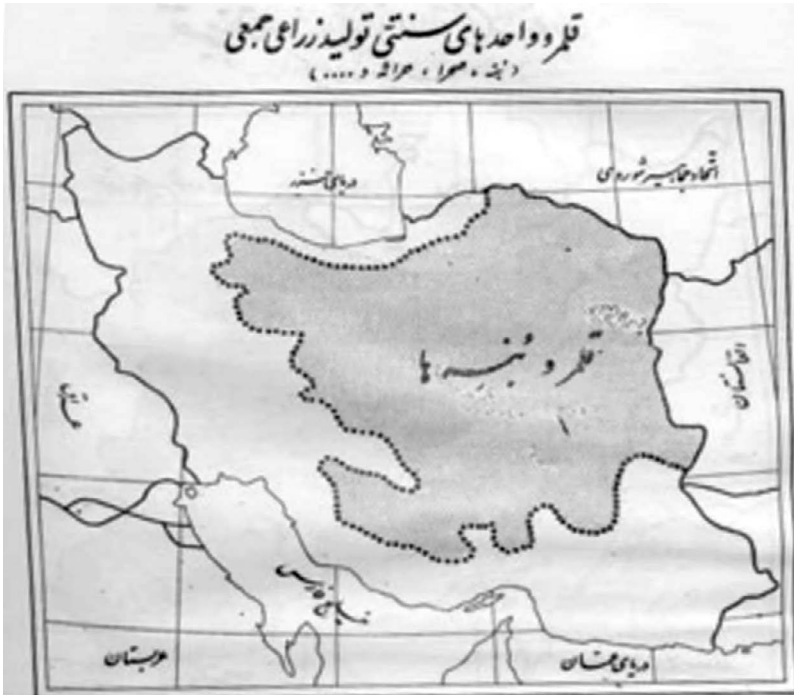
---

It should be noted that an irrigation cycle is a water management order, according to which the shareholders take turns for irrigating their farms. For example, if the irrigation cycle is 12 days, every farmer has the right to take his share just once every 12 days.

### 9.6.2 BONEH AS THE SOCIAL STRUCTURE OF QANĀT: WHAT IS BONEH?

Like all traditional resource management systems, qanāt also has a wider sociocultural aspect. In fact, qanāt is a remarkable social phenomenon and cannot be viewed just as an engineering wonder (Balali 2009). The qanāt system has to be closely linked to the local community's ability to plan and manage its own water resources, especially for agriculture (Ibid). The social institution on which qanāt depends to operate properly is Boneh. This system is known by various names, depending on the region of Iran. In the areas around Iranian capital, Tehran, the system is called Boneh. In the eastern parts of Iran, it is called Sahra, and in the central regions, the term Harasseh is used (Jomehpour 2009). This system is similar to other ancient social traditions connected to water around the world such as Minga in the Andean region and Nafir system in Sudan. Scholars have defined this typical qanāt-based collective system in different ways. Hooglund describes it as “a communal system under which the arable land of a village was organized into units farmed cooperatively by teams of sharecroppers” (Hooglund 2014). Another definition is collective organization of production management, common in the central and eastern provinces, in the qanāt regions (Jomehpour 2009). In addition, Balali defines the system as “an agricultural unit on which some farmers have the right to work cooperatively” (Balali 2009). Some scholars have described Boneh





**FIGURE 9.6** Map 4, Realm of Boneh (gray part) in Iran. (From Balali, M. R., *Towards Reflexive Land and Water Management in Iran: Linking Technology, Governance and Culture*, Wageningen Universiteit, 2009. With Permission.)

as a cooperative lifestyle, more than just a management system (Farshad and Zinck 1997), and also “a social hierarchy which defines roles and responsibilities” (Jomehpour 2009). In fact, Boneh was developed as a system of collective ownership and management of qanāt water, along with some participatory practices (Habashiani 2011). This social system has been the result of millennia of human adaptation to water scarcity, in which villagers share the management and ownership of water resources through a complex sharing ethics among local stakeholders. Boneh, as a collective production unit, has been determining the traditional rural social structure, before modernization of the agriculture and water management. These two technical and social phenomena, qanāt and Boneh, along with relevant value systems, were the main characteristics of the land and water management in pre-modern Iranian rural society (Balali 2009) (Figure 9.6).

#### 9.6.2.1 Advantages of the Boneh System

One of the major functions of Boneh was the efficient use of productive land and qanāt’s water (Balali 2009). It is said that the main advantage of this system was to solve the problem of land fragmentation. In this traditional cooperative system, by implementing production plans for the entire village and by combining the cultivators into teams, the over-fragmentation of lands and the grazing problems could be overcome and field size was expanded (Habashiani 2011). In addition, to achieve the highest land fertility, cultivation of Bonehs was systematically rotated (Jomehpour, 2009). Promoting strong collaborative work among agricultural communities was another benefit of the Boneh system (Jomehpour 2009). It strengthened the socioeconomic position of the peasants (Balali 2009). Everybody worked and lived under the management and authority of a lord, who owned the arable lands in village. The duty of each farmer was perfectly specialized: some were usually in charge of plowing and preparing the field, some were responsible only for irrigation, and some were involved in seeding, protecting, and harvesting (Kuros and Labbaf Khaniki 2007).

A measure of social mobility was evident within the hierarchy of a Boneh. Boneh members could be promoted according to some regulations; as a result, their rights and social status were raised. A normal member of a Boneh (Barzgar) could be promoted to the position of irrigator (Abyar), the highest position in a Boneh (Safinejad 1989). In this system, if a Barzgar could ensure his qualifications for a higher position, he could be promoted to the irrigator's position and even to the landlord's representative (Habashiani 2011). Moreover, the irrigators who headed the Bonehs did their best to compete with one another by optimizing irrigation. In doing so, they could increase their production, which was of great importance to the lord. The better an irrigator could manage his team, the more he could produce and the more valuable he was to the lord. The irrigator had to put in considerable effort to satisfy the lord's expectation; otherwise, he had the risk of losing his position (Kuros & Labbaf Khaniki 2007).

Efficient management of water, the scarcest input of agriculture, resulted from the Boneh system (Balali 2009). This efficiency had two reasons. First, the traditional system of land ownership and tenure and the socioeconomic organization of Boneh were well adapted to the optimal use of the qanāt system (Ehsani 2006). Farmlands of landlords had no value without qanāts; consequently, cleansing a qanāt was the landlords' responsibility; so, they tended to clean up qanāts (Lahsaeizadeh 2002). If a qanāt needed repairing, the lord did not hesitate to call in the qanāt practitioners and finance the whole project (Habashiani 2011). Qanāts were carefully protected, and qanāt maintenance was a professional job for a class of villagers within the rural agrarian structure. The second reason for irrigation efficiency within the Boneh system was that irrigators had professional expertise in irrigation. Irrigators were chosen from a large number of farmers, since irrigators had to go through different stages of membership of Boneh and should have proven their abilities in cultivation and harvest. There were also some "hidden competitions to achieve the irrigator position" (Safinnegad 1979). Interaction among farmers in the system of Boneh was so efficient that there was some excess water left, by which more land could be irrigated (Habashiani 2011). No agricultural unit was short of water in a Boneh system, and the benefits and costs were always kept in balance (Farshad & Zinck 1997).

The likelihood of various interrelated activities that enabled communities to mitigate a range of risks was another advantage of the Boneh system. This advantage of Boneh resulted in a traditional integrated farming system that was a complex system of unified activities, which included three main components: crop farming, animal husbandry, and handicraft production. The output of one activity might become the input to another one. In this way, the primary farm products were increased constantly, either for autoconsumption or for sale. Functional integration and temporal distribution of the activities ensured that all family members participated full time all year around. The large variety of products generated helped mitigate all kinds of risk, from climatic (drought and late frost) to economic (market price fluctuations and product scarcity). Such integration was the end result of an enduring co-evolution between ecosystem and social system (Balali 2009).

### 9.6.2.2 Disadvantages of the Boneh System

In terms of class stratification, Boneh was also a pattern of class division or stratification among the peasants in virtually every village. The Boneh system reflected a person's social and economic status in the village. Within the Boneh system, like many indigenous systems everywhere in the world, upper castes were entitled to privileged rights (Habashiani 2011). The heaviest jobs were allocated to the lowest member of Boneh, and the easiest work was awarded to the highest member. Boneh members did not have independence in cultivation, since the type and the amount of cultivation depended on the lord's wishes. Indeed, the landlords could command all the Bonehs of a village under their ownership and management. All the needs of Bonehs were supplied by the landlord's power and funds; consequently, local rules and customs supported the landlord's interests (Safinnegad 1979). According to this discriminatory stratification, the products were not distributed among the peasants and the lord very fairly. In the old regime of landlord and peasants, product division was based on the system of ownership over productive factors of water and land (Safinnegad 1979).

The final shares of the Boneh members depended on their position in the system. Usually, the head of Boneh received more than the others, and in the end, farmers received a smaller share than all other members did (Habashiani 2011). When the lord provided the peasants with land, water, plowing ox, and seed, he could appropriate one-fifth of the crop for himself. As a result, a big group of peasants had to content themselves with the rest. Besides, other external people who gave services to the farmers during a year, such as the carpenter, mason, blacksmith, and barber, also shared in the rest (Balali 2009). The basic character of the pre-land reform agricultural regime in Iran was often criticized. Briefly defined, according to this old hierarchy, a minority of owners derived profit from farming by exploiting the labor of the majority of villagers (Hooglund 2014). Some critics have pointed out other shortcomings. The lack of individual freedom and the conservative functioning of the system that emphasized existing sociotechnical arrangements instead of innovation (Kiddie 1968) are among them. Recognition of these disadvantages can help us identify the difficulties of applying this traditional system to a practical model in modern contexts.

### 9.6.3 QANĀT AS A TECHNIQUE TO ADAPT TO THE CLIMATE CHANGE

The archeological findings prove that the climate change in ancient times broke out at a relatively high pace. Adaptation to environmental conditions is a very common strategy for human communities. The communities once living on the banks of permanent rivers in the central plateau of Iran could come to terms with the intensifying drought and then embraced a change in their civilization and culture. In a nutshell, the shrinking surface water bodies drove the communities to turn to the technique of qanāts, which caused a substantial change in their production system. The change in the production system gave rise to some major modifications in the economic structures, in order to better adapt to the new condition, and such modifications accordingly brought about a transformation in social and cultural structures, ranging from political foundations to social styles, art, literature, education, and so on.

Qanāt seems to have been invented spontaneously in order to enhance the level of human's adaptation to the changing environmental conditions. Invention of qanāt could have taken place in different geographical places that enjoyed similar conditions simultaneously and independently. Of course, one cannot deny some reliable historical records that mention the model of geographical diffusion of qanāt, but this model could not prevail over the model of multicluster genesis, according to which qanāt came into existence at the same time in different places under similar climatic circumstances. The human response to climate change and aggravating water scarcity took the shape of qanāt invention, which helped ancient communities shift from surface water to groundwater resources.

## 9.7 QANĀTS ARE A MEANS OF SUSTAINABILITY

Groundwater is an important natural resource with high economic value and sociological significance. It is important that this resource be utilized in such a manner that a permanent depletion of the resource in both quantity and quality aspects is avoided and that any other environmental effect such as land subsidence and sea water intrusion in coastal areas are restrained within acceptable limit. In most of the aquifer systems, unplanned and uncontrolled water withdrawal, waste disposal, and pollution have already led to situations of excessive stress and water shortage. In some cases, the adverse consequences could be so severe that remediation would be difficult and the future use of the resource will be permanently constrained. In some other cases, there may still be an opportunity for corrective measures, and it may be desirable to consider sustainable management as an option for development planning in the future (Zarabadi and Haeri 2011).

The key principles in the evolution of sustainability in groundwater development are addressed as: (a) providing sustainable water use; (b) protecting groundwater resources from degradation, that is, sustaining quality; and (c) controlling environmental impacts of development, that is, sustaining

environmental diversity (Gupta and Onta 1994). The basic need is to understand the functioning of the groundwater system, as development progresses, through monitoring and evaluation and to adjust the utilization pattern spatially as well as in time as need arises to sustain this resource on a long-term basis for future generations. In this regard, mathematical models provide a quantitative framework to synthesize data obtained from monitoring of the groundwater system and play a significant role in assessing the system's behavior when subjected to future stresses and changing conditions.

However, not only technical factor but also institutional and social acceptances are important in addressing sustainability. In order to achieve these factors, the authorities concerned should have adequate and properly trained manpower to monitor and evaluate the system response and should take the responsibility to transferring this knowledge and understanding of the system's performance through proper means to groundwater users and the community. The resource planners and decision makers should recognize groundwater as an important component of water resources and the environment, and it is required that necessary regulations are implemented for the protection of the resource.

By the end of 2015, the United Nations adopted a new global development agenda as a follow-up to the Millennium Development Goals. To this end, the UN member states are now engaged in a debate on defining universal Sustainable Development Goals, as decided by the 2012 Rio+20 Summit. According to the final declaration of that summit, these goals should "address and incorporate in a balanced way all three dimensions of sustainable development and their interlinkages" and should "be coherent with and integrated into the United Nations development agenda beyond 2015." The linkage of qanāt to sustainability and sustainable development covers a vast field of social and environmental issues (Boltz et al. 2013). In the following subsections, these features of qanāts are presented as their coverage on sustainable development goals and other pillars of sustainability (Griggs et al. 2013):

### 9.7.1 LINKING QANĀT TO SUSTAINABLE DEVELOPMENT GOALS

GOAL 2: End hunger, achieve food security and improved nutrition, and promote sustainable agriculture

- Ensure sustainable food production systems and implement resilient agricultural practices that increase productivity and production and that help maintain ecosystems

GOAL 6: Ensure availability and sustainable management of water and sanitation for all

- Improve water quality by reducing pollution
- Substantially increase water-use efficiency and ensure sustainable withdrawals and supply of freshwater to address water scarcity
- Support and strengthen the participation of local communities in improving water and sanitation management

GOAL 10: Reduce inequality within and among countries

- Ensure enhanced representation and voice for developing countries in decision making in global international economic and financial institutions, in order to deliver more effective, credible, accountable, and legitimate institutions

GOAL 11: Make cities and human settlements inclusive, safe, resilient, and sustainable

- Reduce the adverse per capita environmental impact of cities, which including by paying special attention to air quality and municipal and other waste management
- Support positive economic, social, and environmental links between urban, peri-urban, and rural areas by strengthening national and regional development planning
- Increase by [x]% the number of cities and human settlements adopting and implementing integrated policies and plans toward inclusion, resource efficiency, mitigation, and adaptation to climate change, resilience to disasters, develop, and implement, in line with the forthcoming Hyogo Framework, holistic disaster risk management at all levels

**GOAL 12: Ensure sustainable consumption and production patterns**

- Achieve the sustainable management and efficient use of natural resources
- Achieve the environmentally sound management of chemicals and all wastes throughout their life cycle, in accordance with agreed international frameworks, and significantly reduce their release to air, water, and soil, in order to minimize their adverse effects on human health and the environment

**9.7.2 SOCIAL**

Culture, as the human communities' engine, is a reflection of inner secrets and human thoughts. Every culture is a mirror of human adaptation to the environment; these findings answer the economical, technological, and political changes in a long run. Large parts of the social system in areas that rely on qanāts were directly or indirectly related to this phenomenon. In such regions, the importance and value of people were judged according to their "ownership rights to the amount of "water." No matter how small a share was in this aspect, the person was held in high esteem (Kheirabadi 2000). In cities too, this was held as social hierarchy, as the vicinity of a person's premises (that is, whether it was upstream or downstream in relation to the qanāt) was a factor to be considered. Reliance on the qanāt has brought about social cooperation in many fields. This order is noticed in the agricultural sphere, such as the method of water distribution.

**9.7.3 CULTURE**

One phenomenon in the cultural aspect relative to qanāts in Iran constitute the beliefs that people had and the traditions that revolved around such beliefs. For instance, it was a notion that qanāts were either "male" or "female" (Habashiani 2011). Majority of the qanāts were known to be the former, whereas a minority were the latter. These qanāts were coupled or paired off, in such that marriage ceremonies were performed as a ritual, in addition to sacrifices made. All these qanāts were held as being sacred (Balali 2009).

**9.7.4 ECONOMIC**

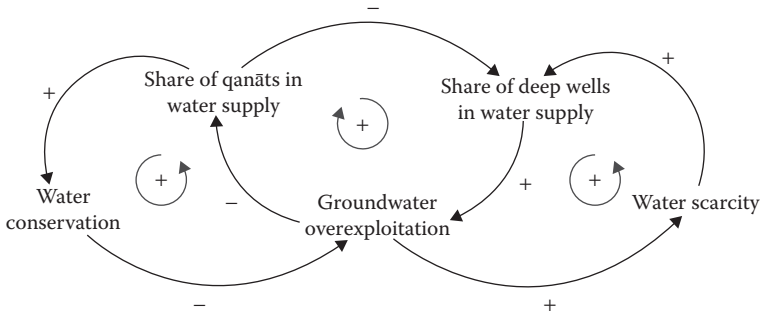
Qanāt is one of the best choices for proper and reasonable use of underground water resources. As improvement of industry and agriculture and establishment of human communities, small towns, big cities, and other various activities are dependent on water, qanāt can trigger the improvement in agriculture and industry as the most adaptable and efficient method of utilization with the least production price, and consequently, economic growth happens.

**9.7.5 ENVIRONMENTAL**

Qanāt as an environmental, traditional water technology plays an important role in environmental development in dry and hot cities, which reflects constructive adaptation of human and environment. Thus, our ancestors always tried to establish a friendly relation with the nature and environment, but with the advent of new technologies and their deconstructive functions, the mutual respect between human and nature has been distorted (Nasiri and Mafakheri 2015).

**9.7.6 COMMUNITY DEVELOPMENT**

From a community development point of view, construction and utilization of qanāts could well engage the local population, foster participatory decision making, and provide employment opportunities. It also empowers rural communities to assume responsibility for management and distribution of their water resources (Motiee et al. 2006).



**FIGURE 9.7** Casual loop diagrams (CLD) of trade-offs between qanāts and deep wells. (From Nasiri, F. and Mafakheri, M. S., *Environ. Syst. Res.*, 4, 1–5, 2015. With Permission.)

In summary, Figure 9.7 presents the trade-off between using qanāt systems and deep wells via a casual loop diagram.

**9.7.7 WATER CONSERVATION**

The rate of water flow in qanāt directly depends on the groundwater natural flow, preventing over-exploitation of the tapped aquifer. Thus, conservation of the aquifer is another advantage of qanāts. In addition, evaporation losses are small, as the sealed water-transferring channel of qanāt is placed underground, which also reduces water loss from seepage. In areas with low-yielding aquifer, where digging deep wells is not a feasible choice, qanāt can well serve the irrigation needs. A hybrid well can also be utilized in such circumstances, which is a qanāt-like gallery attached to a deep well to increase the well yield (Nasiri and Mafakheri 2015). As such, qanāt is a sustainable water supply system that can indefinitely provide water by preserving subsurface water tables (Motiee et al. 2006).

However, the main barrier to maintaining this share would be the increasing water scarcity due to inefficient farming or irrigation practices (represented by a reinforcing/positive causal loop of relationships on the left side of Figure 9.7, which encourages the farmers to seek access to a higher number of deep wells, which in turn results in overexploitation of groundwater resources and drying of the remaining qanāts (represented by a reinforcing/positive causal loop of relationships on the right side of Figure 9.7. In this sense, availability of qanāts as an alternative means of water supply contributes to the sustainability of rural communities and optimal management of water resources (Zheng et al. 2011) in the Middle-East region that is under the adverse effects of climate change, with severe droughts and widespread water shortages.

**9.7.8 THE TENSION BETWEEN A SUSTAINABLE UNEQUAL SYSTEM AND THE MODERN SYSTEM**

The rate of flow of water in a qanāt is controlled by the level of the underground water table. Thus, a qanāt cannot drain an aquifer, because its flow varies directly with the subsurface water supply. When properly maintained, a qanāt is a sustainable system that provides water to settlements indefinitely. Qanāts exploit groundwater as a renewable resource. The self-limiting features of qanāts that make them a sustainable technology can, however, be their biggest drawback, particularly when they are compared with the range of technologies available today. The rapidly increasing demand for water generated by population growth and agricultural expansion in the modern Middle East cannot be accommodated by qanāts (Habashiani 2011).

By contrast, deep wells can draw water from permanent aquifers on demand, without regard to rates of recharge. The technology, therefore, enables people to exploit their water resources in an unsustainable fashion. The ability of deep wells, and motorized pumps, to withdraw water in excess



of an aquifer's recharge rate makes this modern technology very attractive in the short term. As a result, however, water is fast becoming a non-renewable resource in areas where deep wells are used.

A tension can be identified between two sides of the above division. This challenge can be described as a tension between environmental sustainability and modern social justice. The conflict between traditional water sustainability and modern social justice in the case of the qanāt system and its alternatives can be summarized based on the different economic infrastructures of the two systems. In this way, the water paradigm shift in Iran has been a transformation from feudalistic land and water law to individualistic/capitalistic arrangements (Habashiani 2011). One can see that despite some abusive dimensions in the old system, it had many positive points. Furthermore, the new system of egalitarian agriculture was not actually very equal. Although the new system diminished the old environmental sustainability, it could not create an egalitarian agriculture.

## 9.8 SUMMARY AND CONCLUSIONS

Qanāts are considered a great human heritage, contributing to sustainable management of groundwater. Qanāts are renewable water supply systems that have sustained agricultural settlement on the Iranian plateau for millennia. By their very nature, qanāts have encouraged sustainable water use. Their major limitations are that they are expensive to build and produce relatively small amounts of water. As a result, few qanāts are being built today. Instead, qanāts are being replaced by deep wells, which produce more water to meet the current demand and support more intensive patterns of land use.

In the course of history, qanāts have had many ups and downs. Sometimes, the qanāts as well as the qanāt constructors were supported and encouraged by the governments, and sometimes, they were deserted. Even when the qanāts were destroyed for some military purposes, they would start flourishing as soon as the political situation got stable. The risks that are threatening the qanāts today differ from those in the past. In other words, in the past, the political and military crises had a negative effect on the qanāts; however, the qanāts could recover as soon as the crises were over.

However, the present risks are quite different and more destructive. The present risks are acting environmentally, so it is not very easy to handle them. Therefore, it is a must for the governments and nations throughout the world to think more of the new legislations about the protection of groundwater resources against any kind of overexploitation. Qanāt civilization is rooted in this ancient hydraulic structure. Over the past 3000 years, the system of qanāt has underlain many technological, social, moral, economical, and legal principles that have formed an important part of our culture. These principles evolved into the present state by being passed from generation to generation. The present generation is supposed to build on these principles, behind which there are 3000 years of history, not to forget about them.

Qanāts have effective roles in a variety of economic, economy of architecture, environmental, sociocultural, and managerial functions in the field of sustainable development of agriculture, so that the life in these regions is widely dependent on qanāts. As a result, according to recent droughts and increasing need of water in dry and semi-dry regions of Iran, qanāt, as the most important element of continuing life in these regions, must be considered by authorities. Fundamental and executive measures should be taken for more use of qanāt in these regions.

For this purpose and for restoration of traditional qanāts, it is crucial to emphasize on the applied researches, approve executive rules for fundamental preservation, rehabilitate and restore qanāts, inform and educate the society about the importance and value of qanāts, promote agricultural and industrial activities in desert areas based on modern irrigation methods of qanāts in order to increase economic and financial efficiency, and adapt and implement appropriate policies in order to change consumption pattern in arid regions.

## REFERENCES

- Ahmadi, H., Samani, A. N., & Malekian, A. (2010). The Qanat: A living history in Iran. In *Water and Sustainability in Arid Regions* (pp. 125–138). Springer.
- Baboli, Y. M., & Labaf Khaniki, M. (2000). The role of qanat in karizi civilisation. In *Proceedings of an International Conference in Qanats* (Vol. 1). Water Company of Yazd, Iran.
- Balali, M. R. (2009). *Towards Reflexive Land and Water Management in Iran: Linking Technology, Governance and Culture*. Wageningen Universiteit (Wageningen University).
- Beaumont, P. (1971). Qanat systems in Iran. *Hydrological Sciences Journal*, 16(1), 39–50.
- Beaumont, P. (1989). The qanat: A means of water provision from groundwater sources. *Qanat, Kariz, and Khattara*, 13–31.
- Behnia, A. (1988). *Qanat, Construction and Maintenance* (46 p). Iran: Tehran University.
- Boltz, F., Turner, W. R., Larsen, F. W., Scholz, I., & Guarín, A. (2013). Post 2015: Reconsidering sustainable development goals: Is the environment merely a dimension. DIE Briefing Paper.
- Boustani, F. (2008). Sustainable water utilization in arid region of Iran by qanats. In *Proceeding of World Academy of Science, Engineering and Technology* (Vol. 33, pp. 213–216).
- English, P. W. (1968). The origin and spread of qanats in the Old World. *Proceedings of the American Philosophical Society*, 170–181.
- Eslamian, S. (2014). *Handbook of Engineering Hydrology: Environmental Hydrology and Water Management*. CRC Press.
- Eslamian, S., Davari, A., & Reyhani, M. N. (2015). *Qanat, the Symbol of Sustainability*.
- Farshad, A., & Zinck, J. A. (1997). Indigenous knowledge and agricultural sustainability. *ITC Journal*, 3.
- Goblot, H. (1979). *Les qanats: une technique d'acquisition de l'eau* (Vol. 9). Editions de l'Ecole des Hautes Etudes en Sciences Sociales.
- Griggs, D., Stafford-Smith, M., Gaffney, O., Rockstrom, J., Ohman, M. C., Shyamsundar, P., ... Noble, I. (2013). Policy: Sustainable development goals for people and planet. *Nature*, 495(7441), 305–307. doi:10.1038/495305a.
- Gupta, A. D., & Onta, P. R. (1994). Groundwater management models for Asian developing countries. *International Journal of Water Resources Development*, 10(4), 457–474.
- Gupta, A. D., & Onta, P. R. (1997). Sustainable groundwater resources development. *Hydrological Sciences Journal*, 42(4), 565–582.
- Habashiani, R. (2011). *Qanat: A Sustainable Groundwater Supply System*. James Cook University.
- Hamidian, A., Ghorbani, M., Abdolshahnejad, M., & Abdolshahnejad, A. (2015). Qanat, traditional eco-technology for irrigation and water management. *Agriculture and Agricultural Science Procedia*, 4, 119–125.
- Hooglund, E. J. (2014). *Land and Revolution in Iran, 1960–1980*. Austin, TX: University of Texas Press.
- IUCN. (1980). *World Conservation Strategy: Living Resource Conservation for Sustainable Development*. Gland, Switzerland: IUCN.
- Javan, M., Hassanli, A. M., & Shahrokhnia, M. A. (2006). The ancient qanats of Iran. In *Proceedings 1st IWA International Symposium Water and Wastewater Technologies in Ancient Civilizations, National Agricultural Research Foundation* (pp. 28–30), Iraklio.
- Jomehpour, M. (2009). Qanat irrigation systems as important and ingenious agricultural heritage: Case study of the qanats of Kashan, Iran. *International Journal of Environmental Studies*, 66(3), 297–315.
- Kardavani, P. (1997). Iran, the origin of qanat and its spread in the world. *Geographical Research*. doi:10.1890/1540-9295(2006)4[309:IFNISA]2.0.CO;2.
- Kheirabadi, M. (2000). *Iranian Cities: Formation and Development*. Syracuse, NY: Syracuse University Press.
- Kuros, G. R., & Labbaf Khaniki, M. (2007). *Water and Irrigation Techniques in Ancient Iran*. Iranian National Committee on Irrigation and Drainage.
- Lambton, A. K. S. (1989). The origin, diffusion and functioning of the qanat. In *Qanat, Kariz and Khattara* (pp. 5–12). London, UK: School of Oriental and African Studies.
- Mostafaeipour, A. (2010). Historical background, productivity and technical issues of qanats. *Water History*, 2(1), 61–80.
- Motiee, H., Mcbean, E., Semsar, A., Gharabaghi, B., & Ghomashchi, V. (2006). Assessment of the contributions of traditional qanats in sustainable water resources management. *Water Resources Development*, 22(4), 575–588.
- Nasiri, F., & Mafakheri, M. S. (2015). Qanat water supply systems: A revisit of sustainability perspectives. *Environmental Systems Research*, 4(1), 1–5.
- Plate, E. J. (1993). Sustainable development of water resources: A challenge to science and engineering. *Water International*, 18(2), 84–94.

- Reed, H. A., & Lambton, A. K. S. (1954). *Landlord and Peasant in Persia*. JSTOR.
- Safinnegad, J. (1979). *Traditional Irrigation Systems in Iran*.
- Salih, A. (2006). Qanats a unique groundwater management tool in arid regions: The case of Bam region in Iran. In *International Symposium on Ground Water Sustainability (ISGWAS)* (pp. 79–87). Alicante, Spain.
- Sankaran Nair, V. (2004). Etymological conduit to the land of qanat. Electronic Document Available at: [www.boloji.com Environment](http://www.boloji.com/Environment), 24.
- Semsar Yazdi, A. A. (2006). A survey of the historical evolution of Qanats in Iran. In *Water and Development Information for Arid London-A Global Network (G-WADI) Meeting on Water Harvesting* (pp. 20–22).
- WCED. (1987). *Our Common Future* ('Brundtland report'). USA: Oxford University Press.
- Yin, Y. Y. (2003). Methods to link climate impacts and regional sustainability. *Journal of Environmental Informatics*, 2(1), 1–10.
- Zarabadi, Z. S., & Haeri, N. (2011). Qanat as the sustainable sign in during time. *International Journal of Academic Research*, 3(5), 425–429.
- Zheng, C., Yang, W., & Yang, Z. F. (2011). Strategies for managing environmental flows based on the spatial distribution of water quality: A case study of Baiyangdian Lake, China. *Journal of Environmental Informatics*, 18(2), 84–90.

---

# 10 Spring Tunnels (Niqba')

## *The Jerusalem Hills Perspective, Israel*

*Azriel Yechezkel and Amos Frumkin*

### CONTENTS

10.1	Historical Background .....	152
10.1.1	Development of Water Systems in Israel.....	152
10.1.2	Roofing Water Facilities through Ancient History.....	153
10.2	Geomorphology and Climate of the Studied Area .....	153
10.2.1	Geomorphological Properties .....	153
10.2.2	Climate .....	155
10.3	Hydrogeological Background .....	156
10.3.1	Perched Springs—The Origin of Spring Tunnels .....	156
10.3.2	Annual and Seasonal Fluctuations of Discharge in Perched Springs .....	156
10.4	Spring Tunnels .....	157
10.4.1	Description of the Phenomenon and Its Importance.....	157
10.4.2	Types of Spring Tunnels.....	158
10.4.3	Spring Tunnels Setting .....	160
10.4.4	Related Improvements and Associated Water Facilities .....	161
10.4.5	Environmental and Social Conditions That Accelerated Spring Tunnel Development.....	162
10.4.6	Challenges in Dating Spring Tunnels.....	162
10.4.6.1	Complexity of Dating a Spring Tunnel .....	162
10.4.6.2	Currently Accepted Age of Spring Tunnels.....	162
10.5	Findings from Selected Spring Tunnels.....	162
10.5.1	Joweizeh Spring Tunnel.....	162
10.5.1.1	Dating the Water System—Proto-Aeolic Capital .....	163
10.5.1.2	Attempting Radiometric Dating of Flowstone.....	164
10.5.2	Gibeon Spring Tunnel .....	164
10.5.3	Suba Cave Water System.....	165
10.5.4	Nebi Samuel Spring Tunnel.....	166
10.5.5	Beitin Spring Tunnel .....	167
10.6	Discussion and Conclusions.....	168
	Acknowledgments.....	169
	References.....	169

## 10.1 HISTORICAL BACKGROUND

### 10.1.1 DEVELOPMENT OF WATER SYSTEMS IN ISRAEL

The first development of water systems in Israel was at Atlit Yam, on Israel's northern shore (Galili and Nir 1993, 267). On this site, the first well was found, dated to the end of the Pre-Pottery Neolithic period (6100–5500 BC). Well drilling continued on the Chalcolithic period, evidenced by a well found in Lahav (Burton and Levy 2012, 138). During the Early Bronze Age, fortified cities rose for the first time, concentrating large number of people. This allowed development of new methods for producing water because of the manpower involved in urban settlements. In Tel Arad, a great unplastered reservoir was used to collect runoff water from all over the city (Amiran and Ilan 1996, 106).

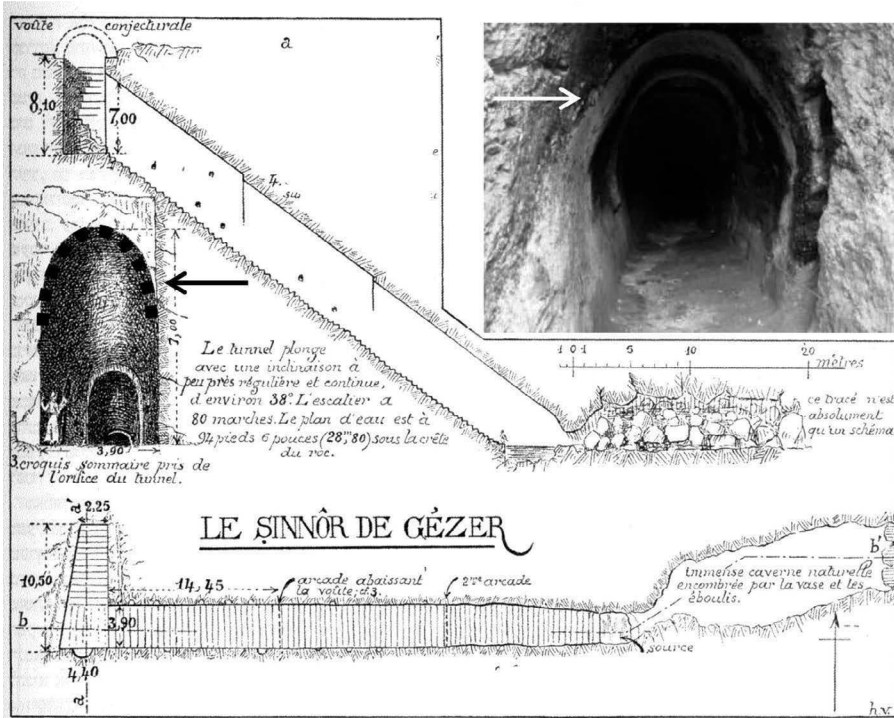
During the Middle Bronze Age (2200–1550 BC), springs were included within the walls of cities (e.g., Tel Dan and Tel Kabri, see Kempinski 1992, 76). The most complex water system from this period was discovered in Jerusalem. It includes a tunnel that brought water from the Gihon Spring to a pool protected by a massive fortress. In addition, during this period, we have witnessed a new kind of water system—a carved, complex shaft tunnel, which was hewn downward into the groundwater. An example of such system can be seen at Tel Gezer (Macalister 1912, 256; Warner 2014, 6). During the Late Bronze Age (1550–1200 BC), we have witnessed for the first time the existence of large, plastered reservoirs filled by runoff water (Hazor—Yadin 1975, 123; Ta'anach—Lapp 1969, 33).

During the Iron Age 2 (1000–586 BC), water technology development reached a peak. Complicated and impressive water systems were found in Gibeon, Jerusalem, Hazor, Megiddo, Arad, Beit Shemesh, Be'er Sheva, and more. The main achievement of this period was to bring external water, from springs or runoff, into the city. This required exceptional engineering capability, good knowledge of hydrology and geology, recruitment of manual labor, excavation of thousands of cubic meters of rock, construction of retaining walls and staircases, plaster of large spaces, and more. In Hazor and Megiddo, it is possible that before building the water system, land in the city was expropriated, which indicates strong centralized government. At Megiddo, the people identified a water source outside the city, and by carving a shaft and an underground tunnel, they managed to channel the water to the bottom of the shaft and into the city. This testifies the high ability of measurement and navigation underground.

Water systems at Hazor and Gibeon did not aim their way to a water source outside of town but to the regional impermeable layer. This indicates an understanding that water gathers on layers spread regionally around the residential area and not in a single place or spring. Hezekiah's Tunnel is the first example in the ancient world of quarrying a long hidden water tunnel, from two different directions, without intermediate shafts, apparently under an approaching Assyrian campaign (Frumkin and Shimron 2006, 235).

During the Hellenistic period, water technology developed and long aqueducts were built for the first time in Israel—some as open channels (Jericho—Netzer and Garbrecht 2002, 367), some as hewn tunnels or built vaults (Akko—Frankel 2002, 83–86), and some with terracotta pipes (Sebaste—Frumkin 2002a, 267).

In the Roman period, there was another peak in technological development and water supply systems because of the engineering achievements of the Roman world. Romans were the first to use massive concrete vaults and arches in their building projects, building impressive aqueducts to many Roman cities throughout the empire in general and in Israel in particular. Some of these aqueducts are preserved until today along tens of kilometers, with minimal gradients, often using tunnels to shorten the route (Frumkin 2015a, 170). For example, Channel A, of the high aqueduct to Caesarea Maritima, used an underground 6.5 km long tunnel to catch groundwater and divert it along an impressive arched aqueduct to the city. Because the aqueduct had to overcome a “Kurkar” ridge before reaching the shore line, a 442 m long tunnel was hewn from both sides of the ridge by using 15 shafts for ventilation and measurements (Porath 2002, 112). The total gradient of Channel A is 16 cm per km, one of the lowest-gradient Roman aqueducts (Olami and Peleg 1977, 132).



**FIGURE 10.1** Water system at Gezer. Middle Bronze Age ceiling hewn as a barrel-shaped vault. (Based on Vincent, L.H. *Jérusalem recherches de topographie, d'archéologie et d'histoire- tome premier*, Librairie Victor Lecoffre, Paris, France, 1912, p. 158, figure 36. With Permission.)

### 10.1.2 ROOFING WATER FACILITIES THROUGH ANCIENT HISTORY

During our study, we noticed that the roofing method for water facilities changes through history. Here, we offer a chronological typology for roofing methods and use this typology to date spring tunnels. During the Middle Bronze Age, the ceilings of water tunnels were hewn barrel-shaped vaults (e.g., Gezer—Figure 10.1) (Warner 2014, 2), and open channels were roofed with big unprocessed stones (boulders) (e.g., Jerusalem, see Reich and Shukron 2002, 3). In the Late Bronze Age, in a large water reservoir at Hazor, two forms of roofing are identified: a false arch vault, built of large stones without a keystone, and a barrel-shaped hewn vault (Ben Tor 1989, 18 Plan V). During the Iron Age 2, we have witnessed two forms of roofing water facilities: horizontal stone slabs (e.g., Arad, see Herzog 1997, 211, figure 61) and, for the first time, a tunnel with a square-cut hewn ceiling, at Hezekiah's Tunnel, Jerusalem (Figure 10.2), and in a water tunnel in Gibeon. Confirmation that a square-cut hewn ceiling began in the Iron Age 2 and is typical of this area and period was found in tunnel VI in Jerusalem (Figure 10.3) (Frumkin and Shimron 2006, 234).

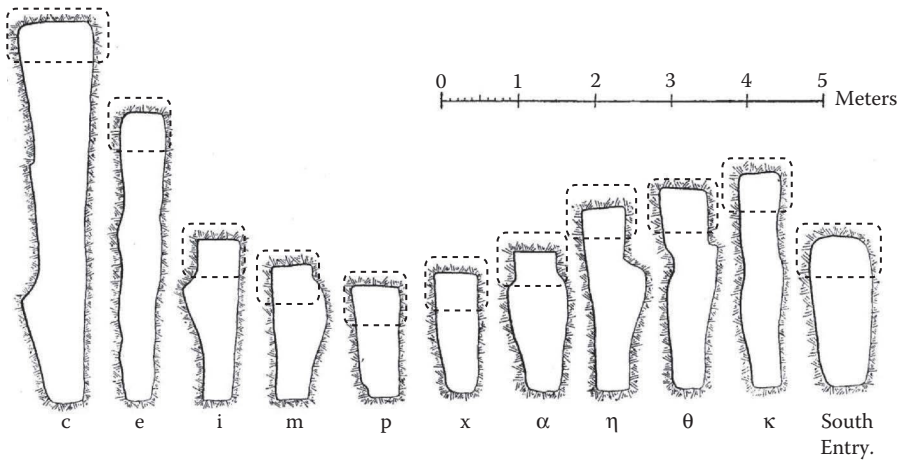
The spring tunnels presented below became feasible owing to the hydrogeological and engineering knowledge developed in urban water installations.

## 10.2 GEOMORPHOLOGY AND CLIMATE OF THE STUDIED AREA

### 10.2.1 GEOMORPHOLOGICAL PROPERTIES

The studied area is within the Jerusalem hills (Figures 10.4 and 10.5), which are part of the Judean mountains, of the central mountain range of Israel. Its boundaries form a triangle between Jerusalem





**FIGURE 10.2** Hezekiah's Tunnel from the Iron Age 2. A square-cut hewn ceiling. (Based on Vincent, L.H. *JERUSALEM SOUS TERRE- les recnentes fouilles D'OPHEL*, Horace Cox, London, UK, 1911, figure 29. With Permission.)



**FIGURE 10.3** Tunnel VI at Jerusalem carried water from the Gihon Spring to the bottom of Warren's Shaft (Frumkin and Shimron 2006, 234), and it predated Hezekiah's Tunnel. This tunnel had a hewn barrel-shaped vault ceiling. At a later stage, the ceiling was raised and cut in a square style. (Photography by Frumkin.)

and the lowland hills in the West. Owing to several processes of folding, uplift, and erosion, the Judea Group of Albian, Cenomanian, and Turonian age is exposed in the Jerusalem hills (Sheffer et al. 2010, 4). The Mt. Scopus Group rocks of Senonian-Paleocene age overly the Judea Group rocks (Flexer et al. 1989, 350).

An erosional surface (termed the "Judean peneplain," see Frumkin 1992, 169), cuts the Judea- Mt. Scopus Groups, forming the skyline of the Jerusalem hills.

The Jerusalem hills are dissected by several valleys of ephemeral streams (wadies), such as Sorek and Refaim. These streams have formed seven major branches, in a dominantly east-west direction. Outcrops of hard limestone and dolomite commonly slope steeply (Kisalon, Aminadav, Veradim,

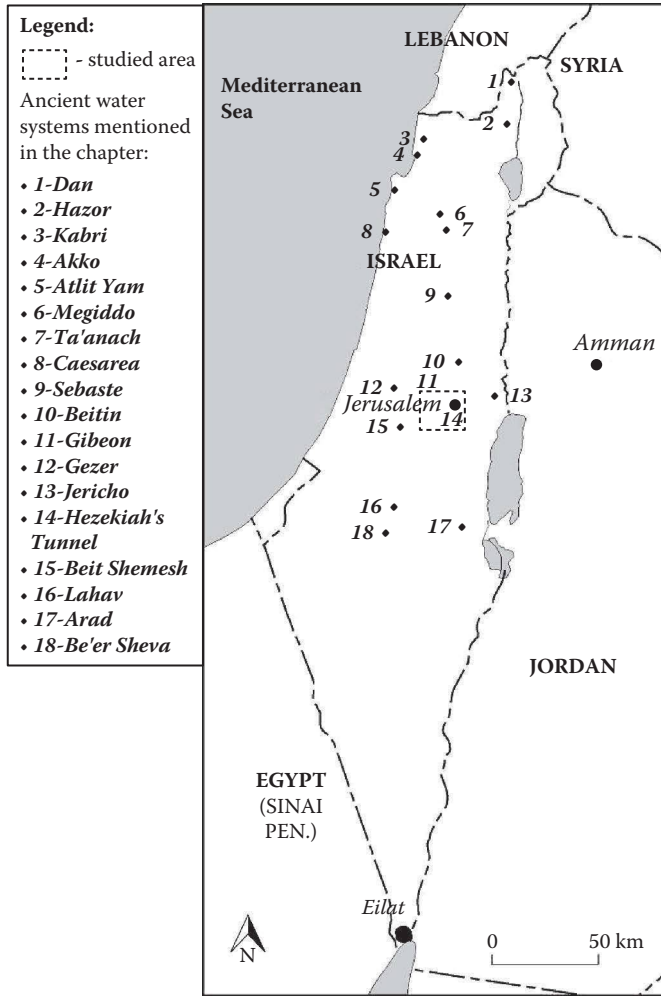


FIGURE 10.4 General map of Israel.

and Bina formations), while outcrops of marl and chalk are rounded and soft (Moza, Beit Meir, Kfar Shaul formations, etc.). In the Jerusalem hills, Karst phenomena such as caves are common in soluble cretaceous carbonate rocks (Frumkin and Fischhendler 2005, 459, figure 1; Frumkin 2013, 60).

**10.2.2 CLIMATE**

Jerusalem mountains are in the dry Mediterranean climatic region (Csa) (Goldreich 2003, 13). The summer is hot and dry (Gvirtzman 2002, 14), and the rainy season lasts from October to May (Goldreich 2003, 63). Evaporation is high (due to high temperatures), causing negative effective precipitation over the entire year and positive effective precipitation only from December to February, when most precipitation falls (Gvirtzman 2002, 21; Goldreich 2003, 55). Rainfall is usually characterized by intense showers derived from cold fronts associated with Cyprus lows (Goldreich 2003, 26).

Temperature at Jerusalem hills averages 23°C and 8°C in the hottest and coldest months (August and January), respectively (Goldreich 2003, 101). Average annual precipitation is about 550 mm (Goldreich 2003, 67). Most precipitation is lost to evapotranspiration, and only 33% of the multi-annual precipitation infiltrates and recharges the aquifers (Dafny 2009, 104).

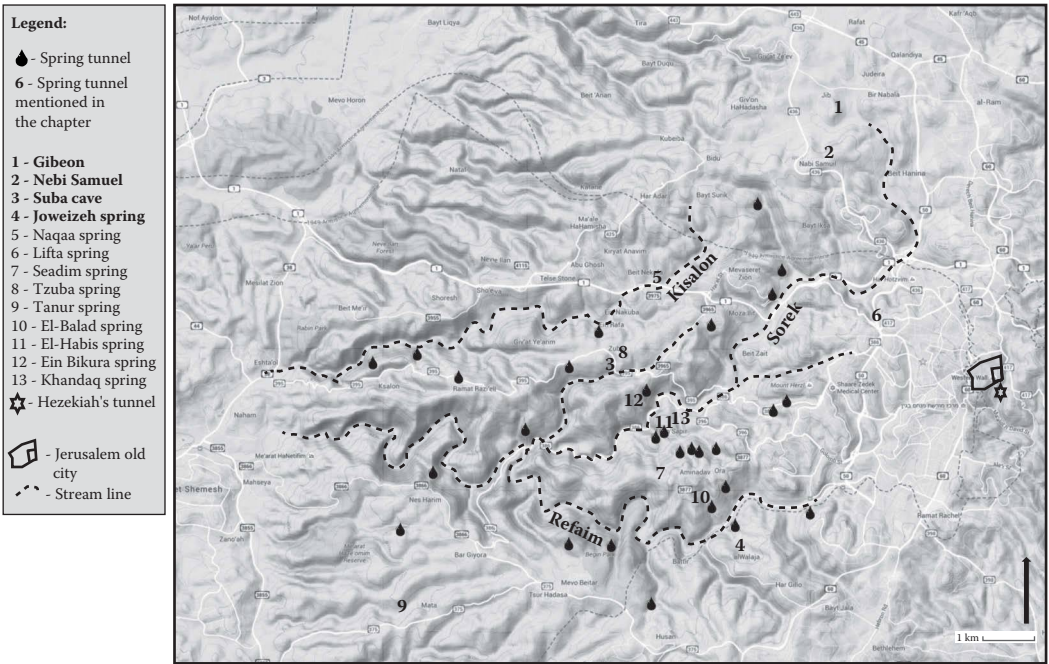


FIGURE 10.5 Studied area map of Jerusalem hills.

During the Holocene, that is, from the beginning of human settlement in permanent communities, there were a number of climatic changes in Israel (Frumkin et al. 1999, 680; Enzel et al. 2003, 272). Issar and Zohar (2012, 152) connected between the effect of climate change on water facilities and technology development in the Jerusalem area.

### 10.3 HYDROGEOLOGICAL BACKGROUND

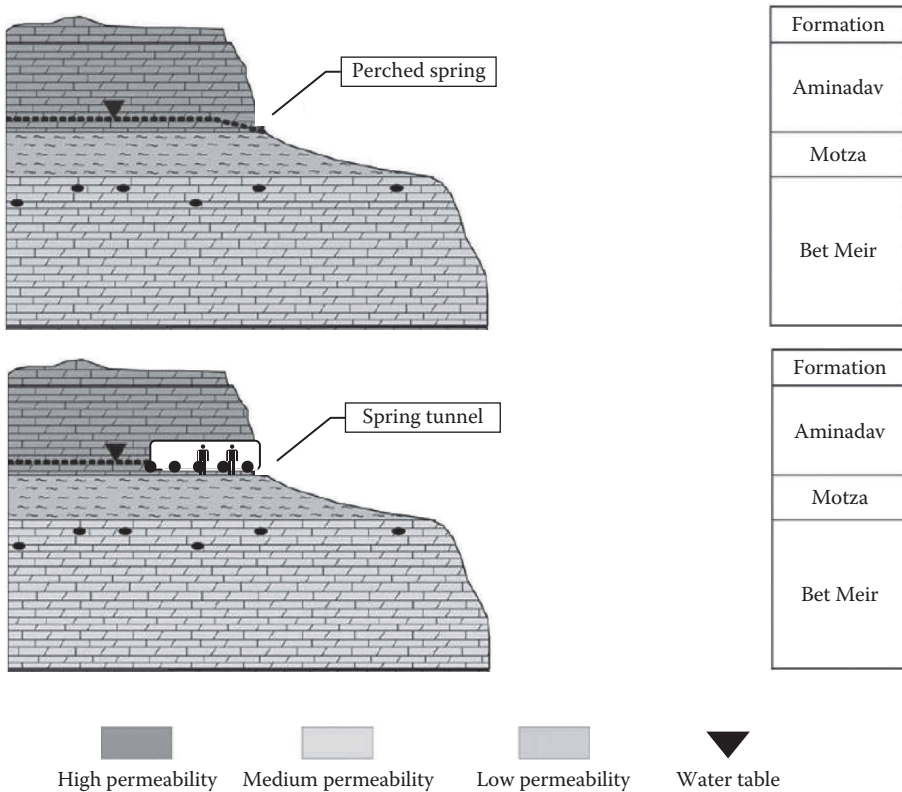
#### 10.3.1 PERCHED SPRINGS—THE ORIGIN OF SPRING TUNNELS

A perched spring is formed at the exposed interface between an aquifer and an underlying aquiclude layer (Figure 10.6). In some cases, a perched aquifer will not only feed a local spring, but water can seep down deeper, feeding additional perched springs or the regional aquifer. Many parameters affect the quantity and quality of water coming out from these springs. These include quantity and distribution of rainfall and the infiltration percentage (affected by soil moisture, evaporation and transpiration, runoff, etc.). Additional parameters are the size of the recharge area, the unsaturated zone depth, the characteristics of the soil and rock, and geological–geomorphological aspects (such as fractures and karst). In general, spring water quality in the Jerusalem hills is high, owing to the relatively slow infiltration and the length of seepage time through the rock.

Perched springs are very common in the Judea and Samaria hills. The larger springs discharge approximately  $100,000 \text{ m}^3\text{yr}^{-1}$  (Weiss and Gvirtzman 2007, 766 Table 1). A significant portion of the perched springs have low discharge rates, amounting to less than  $10,000 \text{ m}^3\text{yr}^{-1}$  (Cohen and Peyman 2011, Appendix 2), owing to their limited recharge area.

#### 10.3.2 ANNUAL AND SEASONAL FLUCTUATIONS OF DISCHARGE IN PERCHED SPRINGS

Burg (1998, 175) suggested that the perched springs in karstic carbonate areas (e.g., Jerusalem hills) have two sets of flow: slow matrix flow and quick flow in cracks and fissures. The first system feeds the springs through summer and the second feeds the springs through winter.



**FIGURE 10.6** Perched spring and spring tunnel. (Based on Peleg, N. and Gvirtzman, H. *Journal of Hydrology* 388, 13–27, 2010, figure 3. With Permission.)

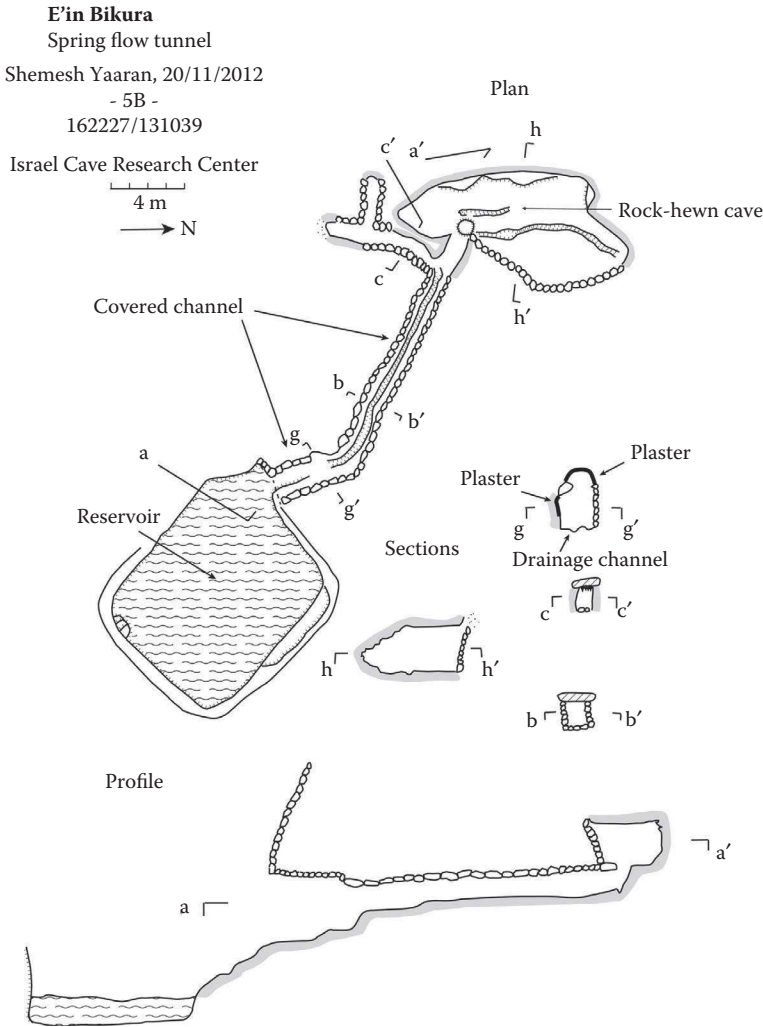
Our study of regional perched springs discharge was conducted on 36 perched springs in the mountains of Jerusalem and was based on photographs of the reservoirs of these springs over a period of 10 years. We have noticed that perched springs fed by a karstic aquifer were more affected by the fluctuations in annual precipitation than springs fed by non-karstic aquifers (Yechezkel 2015, 97). This is consistent with other studies (Peleg and Gvirtzman 2010, 24; Peleg et al. 2012, 782; Fiorillo 2009, 290).

## 10.4 SPRING TUNNELS

### 10.4.1 DESCRIPTION OF THE PHENOMENON AND ITS IMPORTANCE

Numerous perched springs in the Jerusalem hills emanate today from ancient tunnels, excavated sub-horizontally deep into the rock at the source of the spring. This technological development of the perched spring could achieve two goals: The first is to enhance spring discharge by increasing the saturated rock-air interface. The second is to renew the discharge of a spring that had dried out by tunneling into the retreating saturated zone. These excavations in the rock or earth are termed here spring tunnels (Hebrew: Niqba') (Figures 10.6 and 10.7).

Most spring tunnels we know are based on perched springs, while some of them have a karstic element (depending on the lithology of the aquifer). Spring tunnels can also be found carved into a karstic spring that is not perched, such as Ras Al Ein in Nablus (Frumkin 2015b). Quarrying spring tunnel is based on deep hydrogeological understanding: Water is perched on an aquiclude layer underground and can be reached by horizontal excavation from the surface and not just by digging vertically. The main significance of the spring tunnel is to develop water resources and increase the



**FIGURE 10.7** Ein Bikura Spring tunnel—plan and sections. Israel Cave Research Center.

economic security of rural agricultural communities. Perhaps, it even affected the distribution of habitation sites in different periods.

**10.4.2 TYPES OF SPRING TUNNELS**

Depending on the topography, water level, and geology, we can identify two forms of spring tunnels.

1. Rock-hewn tunnel, cut directly to the bedrock, was excavated where a perched spring was seeping from a steep rocky slope. This is important from a technical and perhaps also from a chronological aspect (below). The width of a hewed spring tunnel is commonly less than 1 m but sometimes reach 4 m and more (e.g., El-Balad spring, Figure 10.8). Some of these tunnels are hewn partly in bedrock. In these cases, there is a built roof above a rock-carved tunnel (e.g., El-Habis spring, Figure 10.9)
2. Covered channel, dug where the water table was close to the surface and the mild topography did not allow excavation directly into the bedrock. First, an open channel was dug from the surface to the perched water layer. Later, the channel was covered using different





**FIGURE 10.8** El-Balad spring. A hewn spring tunnel, 4 m wide. (Photography by Yechezkel.)



**FIGURE 10.9** El-Habis spring. A hewn spring tunnel roofed with stone slabs. (Photography by Yechezkel.)

methods—stone slabs, barrel vault, pointed vault, and so on. When the spring tunnel was dug in loose sediment, casement walls were built to prevent collapse. The walls were constructed from either uncarved fieldstones (e.g., Lifta Spring and Naqaa Spring, Figure 10.10) or ashlar (e.g., Seadim Spring, Tzuba Spring, and Tanur Spring, Figure 10.11). Not all covered water channels are spring tunnels. Some were used only to carry water from one place to another. Therefore, we must investigate each water facility separately.

In many places, the terrain above the roofing was leveled by fillings of dirt, rocks, and soil. Subsequently, the area above the spring tunnel was restored as an agricultural area (Ron 1985, 155). Sometimes, the spring tunnel character changes as one moves inward, from a covered channel to





**FIGURE 10.10** Naqaa spring. A built spring tunnel from field stones, roofed with stone slabs, and a drainage ditch. (Photography by Yechezkel.)



**FIGURE 10.11** Tanur spring. A built spring tunnel from perfectly carved ashlar. (Photography by Yechezkel.)

a rock-hewn tunnel. In some cases, this reflects the additional stage(s) of pursuit after the receding groundwater level (Ron 1985, 154).

### 10.4.3 SPRING TUNNELS SETTING

As noted, most spring tunnels are associated with perched springs. From a hydrological and/or climatic standpoint, spring tunnels may be found in areas where freshwater is scarce. These issues are met at hundreds of springs in Judea and Samaria, on the central mountain range of Israel. We suggest that spring tunnels may have originated in Israel.

### 10.4.4 RELATED IMPROVEMENTS AND ASSOCIATED WATER FACILITIES

Increasing the saturated rock-air interface to increase spring discharge could be facilitated by quarrying at the end of the tunnel a large hall (Figure 10.7), by quarrying a twisting tunnel with sharp angles (e.g., Joweizeh Spring, Figure 10.12), or by splitting the tunnel into several branches.

In some spring tunnels, we can identify several points where water is emanating from the rock, along the tunnel. In the bottom of many spring tunnels, a drainage ditch was hewn with a small cross section, for times when discharge decreased. In long spring tunnels, sometimes, vertical shafts were constructed, connecting the tunnel with the surface, probably used as entry points, which facilitated easier access for excavation or maintenance. In some cases, a small shallow pool was dug at the output of the tunnel to filter the water before entering the main storage pool.

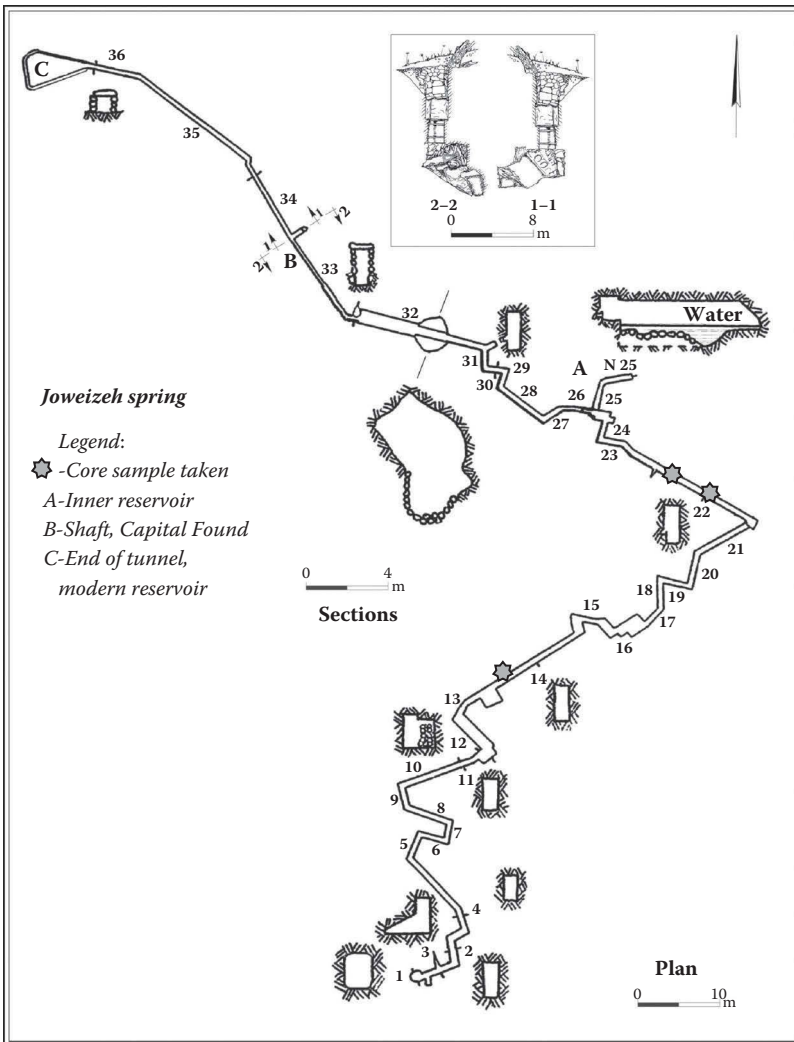


FIGURE 10.12 Joweizeh spring—plan and sections. (From Ein Mor, D. and Ron, Z. *New Studies in the Archaeology of Jerusalem and Its Region*, 85–109, 2013. [Hebrew], figure 3. With Permission.)

#### 10.4.5 ENVIRONMENTAL AND SOCIAL CONDITIONS THAT ACCELERATED SPRING TUNNEL DEVELOPMENT

The most common type of settlement in the Jerusalem hills from ancient times to the Ottoman period is a small agricultural rural village. As perched springs are the only perennial water resources in this area, it is clear that increasing the discharge by spring tunnels was an important hydrogeological invention. It contributed to both the deployment of settlements in ancient times and their long-term resilience. In addition, since these springs are mostly located in mountain slopes, in many cases, the spring tunnel supplied water for irrigation agriculture, called “Shlachin” (Ron 1985, 149), based on gravity water channels. The high density of spring tunnels in a small area (Figure 10.5) indicates that these water resources were used as the basis for small agricultural villages. The scope of work needed for initial development is quite limited for most spring tunnels. It could rely on a small number of people for a season or two, such as for constructing cisterns. In some spring tunnels, one can identify that a large amount of work was done, possibly reflecting government-funded projects (such as Joweizeh spring and irrigated system of Khandaq spring) (Ein Mor and Ron 2013, 105; Ron 1985, 168).

#### 10.4.6 CHALLENGES IN DATING SPRING TUNNELS

##### 10.4.6.1 Complexity of Dating a Spring Tunnel

Various potential methods may be attempted to date a hydraulic structure/facility. Among them are stratigraphic dating of an archaeological excavation; dating hydraulic plaster and petrographic tests; dating with architectural typologies such as roof shape; and radiometric dating of calcium carbonate spring deposits. In practice, dating a specific spring tunnel is difficult for the following reasons: (a) Only few archeological excavations have been performed in spring tunnels. (b) The agricultural rural sector is not always represented in the archaeological record. (c) Dating plaster of water facilities in general and in spring tunnels in particular is complicated. Plaster is used mainly for sealing, so it was rarely used in spring tunnels, which were dug to increase the saturated rock-air interface.

##### 10.4.6.2 Currently Accepted Age of Spring Tunnels

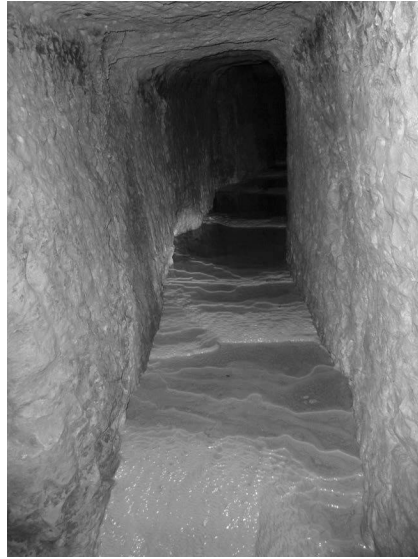
Several researchers have suggested that spring tunnels were first hewed in Israel during the Iron Age/Persian Period (Edelstein et al. 1983, 19; Ron 1985, 169; Shiloh 1992, 282; Issar and Zohar 2012, 161). This claim rarely relies on archaeological excavations of spring tunnels or on radiometric dating. Frumkin (2002b, 23) noted that the water source that feeds the water system in Gibeon, dating to the Iron Age, is a spring tunnel. Apart from this, many spring tunnels are associated with a high degree of probability to the Roman period (Patrich and Amit 2002, 10; Bull 1965, 227; Frumkin 2015b; Mazar 2002, 233; Zissu and Weiss 2008; Gibson et al 1991, 38). Because substantial evidence for dating the initial use of spring tunnels has hardly been presented, we analyze below a few selected cases.

### 10.5 FINDINGS FROM SELECTED SPRING TUNNELS

#### 10.5.1 JOWEIZEH SPRING TUNNEL

Joweizeh Spring (Figure 10.12) is a few kilometers southwest from Jerusalem, toward the Refaim Valley, near the village of Walaja. This is the longest spring tunnel known in Jerusalem hills and Israel. The tunnel is hewn into the hard dolomite rock from the Aminadav formation and its path is twisting in sharp angles. The tunnel itself has two main parts, a built section and a hewn section. The total length of the tunnel is approximately 233 m.

The built section is accessed from a modern pool built on the surface. The first section of the built tunnel is approximately 30 m long, 60 cm high and 40 cm wide. Its walls are built of fieldstones covered with stone slabs (Markus and Ben Joseph 1983, 55). At the end of this section, a shaft connects it to the surface (described in detail later). The next section is 13 m long, approximately 1.5 m



**FIGURE 10.13** Joweizeh spring. Ceiling was cut in a square style. Notice the flowstone layers at the floor. (Photography by Yechezkel. With Permission.)

high and is built mainly from big ashlar. This part ends with a massive blocking wall, probably built as support against soil collapse. In its southern corner, there is a small breach, through which one can squeeze into the hewn part of the tunnel. A large vaulted hewn room leads into a narrow tunnel draining several small discharge points. This hewn part of the tunnel is more than 187 m long, 0.9–1.8 m high, and 0.6–1.5 m wide. The cross section is rectangular, and the walls and ceiling are carved in a professional way (Figure 10.13).

Along 124.5 m of the tunnel, there is a hewn and plastered drainage channel, approximately 10 cm wide and about 20 cm above the floor level of the main tunnel (Ein Mor and Ron 2013, 98). This channel probably led water during times of low discharge and is covered, like the floor of the tunnel, with a very thick layer of calcite flowstone. A short branch, 5 m long, splits from the main tunnel to the east. The floor level of this branch is lower by 1 m from the main tunnel floor, which makes this branch a small reservoir, may be for emergencies (Markus and Ben Joseph 1983, 57). The tunnel continues with sharp curves and angles up to  $130^\circ$  and ends with two small branches, each draining its own discharge point.

#### 10.5.1.1 Dating the Water System—Proto-Aeolic Capital

After the discovery of this unique spring tunnel, a survey was conducted by Israel Cave Research Center in 1983 for mapping and measurements. During this survey, Frumkin noticed a carved stone that was stuck in the shaft described above (Markus and Ben Joseph 1983, 61). Only during a survey conducted in 2012, Ein Mor identified that the item is an architectural, monolithic, large capital, carved in a Proto-Aeolic style (Ein Mor and Ron 2013, 98). The quality of finish of the carving is excellent. Ein Mor and Ron suggest that this item served as half of the monumental entrance of the rock-cut water system.

So far, 27 Proto-Aeolic capitals have been found in the region of the Israel kingdom, 11 in the region of the Judea kingdom, and a few more in Transjordan. The capitals found in the kingdom of Israel are dated mainly to the ninth century BC (Lipschits 2011, 205) and those in Judea and Jordan date back to the late eighth century or the beginning of the seventh century BC (Lipschits 2011, 212–213).

The weight of the capital and the vast dimensions indicate that it is located close to its original location. Based on the parallels found, the researchers dated the capital and consequently the

associated tunnel to the Iron Age 2 period and more precisely to the end of the eighth or beginning of the seventh century BC. The engineers' skills and the impressive quarrying over more than 187 m leave no doubt that this is a state-funded water system. As noted in the introduction, knowledge of engineering and hydrology existed during the Iron Age 2, evidenced in water projects around the country. The nearest water system, geographically and chronologically, is the 530 m long Hezekiah's Tunnel.

Ein Mor and Ron suggest that there may have existed a nearby palace or estate similar to the one found at Ramat Rachel. They also note the possibility that the water system was built before the Iron Age.

#### 10.5.1.2 Attempting Radiometric Dating of Flowstone

We drilled three cores for radiometric dating in the bottom of the spring tunnel (Figure 10.14). In the first core, there was stratification of flowstone overlying a piece of rock. Since it was not proved to be bedrock and could mean perhaps that it was a stone fallen from the ceiling, this sample was not used for dating. At the second core, the stratification of the flowstone was interrupted. The third core had uniform stratification of flowstone till bedrock to the depth of 30 cm. This sample was dated using U-Th at the Israel Geological Survey laboratories to 14,026–10,455 yr BP. This date is too ancient, indicating that the closed system assumption was violated, and Uranium was added during the years (Ford 2003, 556; Shopov 2003, 282).

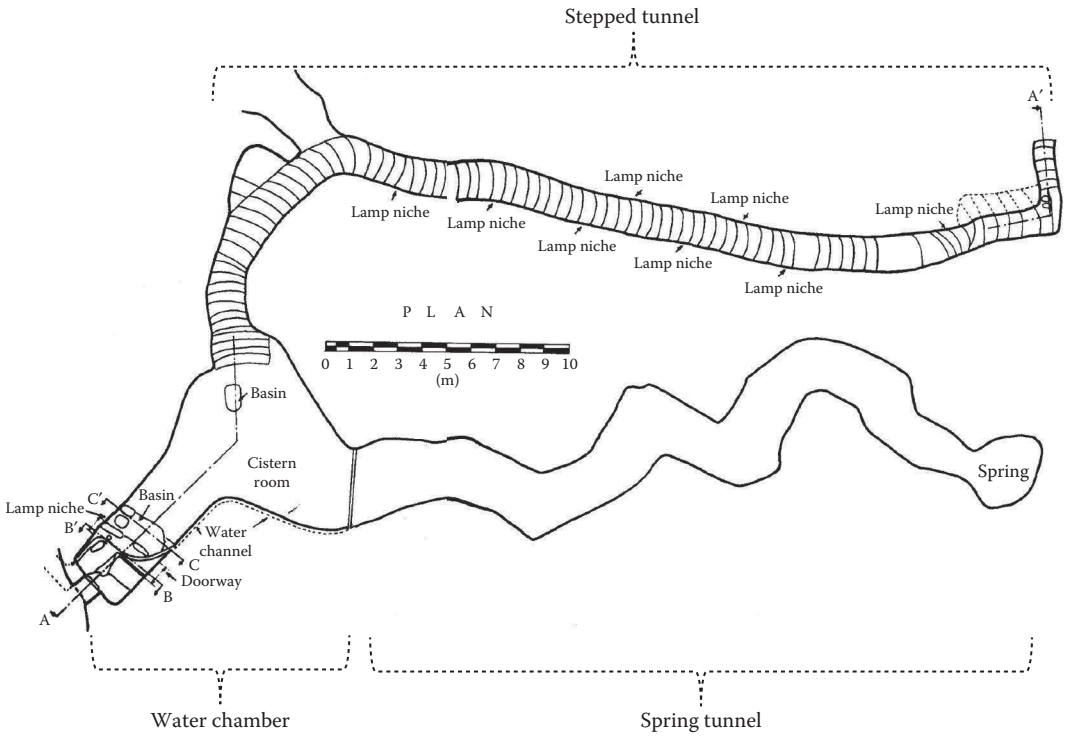
### 10.5.2 GIBEON SPRING TUNNEL

Tel al-Jib, north of Jerusalem, is identified with the Biblical city of Gibeon. During the Iron Age, two water systems were constructed in Tel al-jib. One is a tunnel leading from the city to a reservoir room fed by a spring tunnel and the other is a large, deep, round shaft descending to the perched aquifer. Pritchard (1961, 1962) exposed both during two seasons of digging. We discuss here only the first system.

From the entrance hall, built within the Iron Age fortifications, you enter an inclined stepped tunnel approximately 45 m long (Pritchard 1961, 5). This tunnel does not intersect ancient layers. At the beginning, the tunnel is covered with stone slabs, soon becoming entirely hewn in the bedrock. The tunnel ends in a large reservoir chamber (12 m length and 3 m width). The chamber was supposedly open toward the surface in times of peace, but during times of war, a built stone wall 75 cm



**FIGURE 10.14** Joweizeh spring. Drilling a core at the bottom of the spring tunnel. (Photography by Yechezkel.)



**FIGURE 10.15** Gibeon water system and spring tunnel—plan. (Based on Pritchard, J.B. *The Water System of Gibeon*, The University Museum, Philadelphia, PA, 1961, figure 3. With Permission.)

thick prevented the entrance from outside the city. This wall was not preserved, but one can detect its rock-hewn foundation course.

A 47.5 m long hewn spring tunnel feeds water to the reservoir (Figure 10.15). There are nine turns in the spring tunnel, possibly reflecting pursuit after receding water (Ein Mor and Ron 2013, 103), or that the diggers had followed some karstic fissures in the limestone bedrock (Cole 1980, 25; Shiloh 1992, 282 footnote 21; Tsuk 2000, 125). A narrow channel was carved in the tunnel floor in order to maintain water flow during low discharge.

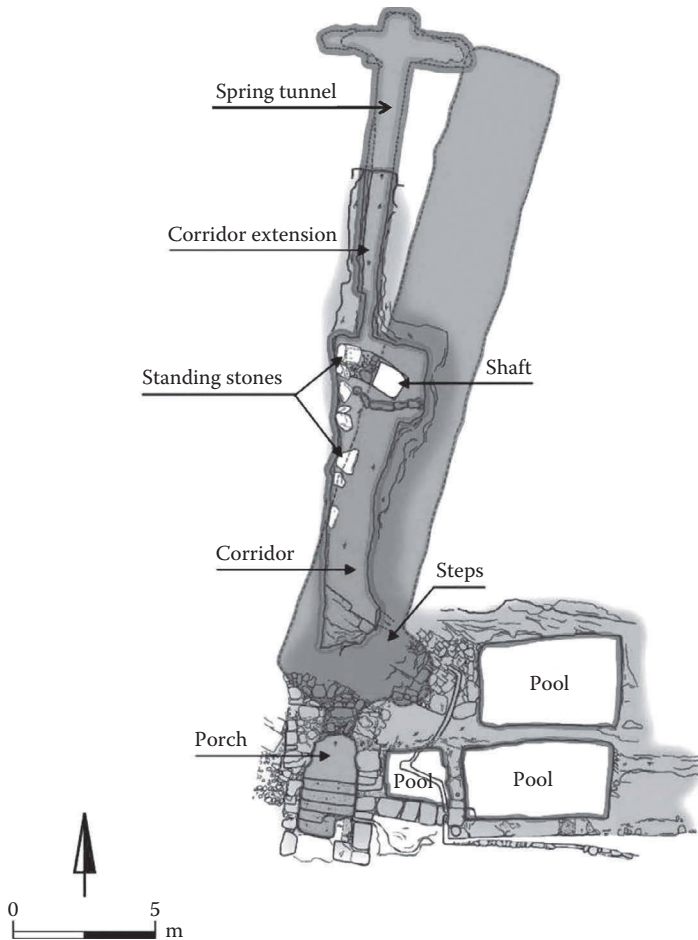
There are many different opinions in research regarding the relationship between the water systems in Gibeon, even though there is a consensus that both date to the Iron Age (Wright 1963, 211; Cole 1980, 27–29; Shiloh 1992, 291; Tsuk 2000, 127).

### 10.5.3 SUBA CAVE WATER SYSTEM

During 2003 and 2005–2006, Gibson (2009, 45) uncovered a sophisticated water system southwest of Kibbutz Tzuba, 9.5 km from Jerusalem. The water system, which was named by Gibson “Suba cave,” or “Cave of John the Baptist,” contains the following components: a spring tunnel, shaft, reservoir, canals, and pools (Figure 10.16). The entire system is fed by a spring tunnel directed S-N that is 11.5 m long and 0.5–1.0 m wide and is hewn in a rectangular cross section. The northern end of the tunnel was hewn in bedrock, with branches to the east and west in the form of a cross-like plan, while the southern part of the spring tunnel was open to the sky.

As explained earlier, splitting the tunnel was aimed to increase the saturated rock-air interface. Water lines high above the floor may indicate periods of more significant discharge. Today, only a small amount of water runs in the tunnel during winter. Water from the spring tunnel is directed





**FIGURE 10.16** Suba cave—plan. (From Gibson, S., *The Suba water system as a clay-production plant in the Iron Age II*. In *Eretz Israel 29*, ed. J. Aviram, A. Ben-Tor, I. Ephal, Y. Aviram, S. Gitin, and R. Reich, pp. 45–55, The Israel Exploration Society, Jerusalem, 2009, figure 3. With Permission.)

both to a plastered reservoir through a shaft and to several small pools by shallow canals. Gibson assumes that these pools were evaporation ponds that were used for ceramic industry.

This water system, which begins with a spring tunnel, is well dated to the Iron Age 2, by several independent lines of evidence: (a) indicative hydraulic plaster from the reservoir, (b) speleothems accumulated over the plaster of the reservoir U-Th dated to ~598 BC, (c) several complete vessels from the Iron Age 2, and (d) charcoal found inside one of the pools dated by carbon-14 to 770–400 BC.

#### 10.5.4 NEBI SAMUEL SPRING TUNNEL

Nebi Samuel, located NW of Jerusalem, is identified since medieval times as the burial place of Samuel the Prophet (Magen and Har-Even 2007, 38). Examination of 211 ceramic sherds collected during an archaeological survey resulted in negligible amount of sherds from the Iron Age 1 and from the Persian period, 36% potsherds from Iron Age 2, 15% from the Hellenistic period, 8% from the Roman period, 25% from the Byzantine period, and 15% from the Muslim period (Finkelstein 1993, 233).

Around the mosque of Nebi Samuel, built on the ruins of a Crusader castle, some archaeological excavations revealed no remains from the Iron Age 1. However, numerous Iron Age 2 pottery vessels were found, which dated to the seventh-eighth century BC, including handles with “Lamelech” stamps that are commonly attributed to King Hezekiah (Magen and Har-Even 2007, 40). Apart from that, the site was inhabited in the Persian, Hellenistic, Byzantine periods and later.

The spring tunnel: On the northern part of the site, a spring discharges from two small caves (Yechezkel 2003, 11; Yechezkel and Yechezkel 2008, 24). The most significant flow comes out from a hewn spring tunnel 10 m long and approximately 0.6 m wide. The cross section of this tunnel is rectangular (Figure 10.17), it branches in the middle, and there is a shaft in the ceiling. Water runs through a small pit before being collected in a pool approximately 2 × 2 m in size. The pool also collects water from the second cave.

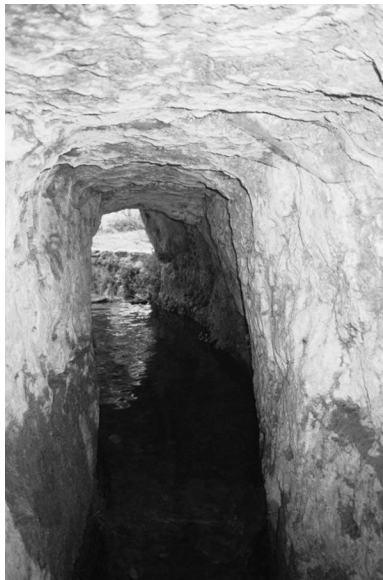
No excavations or surveys were done near the spring. We suggest that the spring tunnel is ancient and began to be used in Iron Age 2 for two reasons:

First reason is the technical characteristics of the spring tunnel. It is entirely hewn and resembles other water facilities and/or spring tunnels dated to the Iron Age. As noted, Hezekiah’s Tunnel, the Joweizeh spring tunnel, the Gibeon spring tunnel, and the Suba cave spring tunnel were quarried similarly, with a rectangular cross section and had similar dimensions.

Second, the main period represented by ceramic sherds at the site above the spring is from the eighth-seventh century BC (36%). We have seen earlier in this chapter that there was considerable hydrogeological knowledge at that time. The dating of the “Lamelech” handles found in the site is consistent with the accepted chronological dating of Hezekiah’s Tunnel and the dating proposal of both the Joweizeh spring tunnel and the Suba cave spring tunnel. Most likely, the original residents of “Nebi Samuel” also made use of this important water source.

### 10.5.5 BEITIN SPRING TUNNEL

Although this site is slightly beyond the natural boundaries of Jerusalem hills, north in the Benjamin hills, its geological-geomorphological properties and historical–archeological context are similar to the springs described above.



**FIGURE 10.17** Nebi Samuel spring tunnel. Ceiling was cut in a square style. (Photography by Yechezkel.)

Most opinions tend to identify the village “Beitin,” north of Ramallah, with Beth-El, mentioned many times in the Bible (Albright 1928, 9). Several seasons of archaeological excavations were conducted by Albright and Kelso between 1934 and 1960 (Kelso 1961, 16). The excavations uncovered findings from the Early Bronze Age up to the Byzantine period.

The spring of Beitin is at the southern edge of the site. A large pool drains water from a long covered channel more than 90 m long. It is hard to identify the original characteristics of the channel because it was recently coated with concrete.

The channel drains a hewn spring tunnel 15 m long. The spring tunnel line is not straight and has two zigzags. The far edge of the tunnel was enlarged to a small hewn hall, whose walls and floor are covered with thick flowstone. Rapid flowstone deposition rate is indicated by modern items such as pieces of iron and tree roots embedded in the flowstone. Erlich (2013, 99) assumes that from the western corner of the hall, the spring tunnel continued into the Bronze Age city area. If true, this continuation is now clogged and filled with mud and stone. Forty meters north of the hall, at the end of the purported extension of the spring tunnel, within the Bronze Age city limits, a deep ancient well was discovered. Erlich proposes that the well is the head of the water system, and the spring tunnel started from this well during the Late Bronze Age or Iron Age 1.

We drilled three cores for radiometric dating in the bottom of the tunnel, in and near the small hewn hall. The first core consisted of a very thin layer of flowstone, followed by 45 cm of plastic gray marl. The second core was composed of 19 cm layers of flowstone above 19 cm of gray marl. The third core had 12 cm of disturbed flowstone layers overlying gray and plastic marl. All three cores were unsuitable for dating because of the marl and dirt.

## 10.6 DISCUSSION AND CONCLUSIONS

When did the innovation of a spring tunnel occur? During the Iron Age 2, man had reached a peak in his abilities regarding water engineering, hydrological and hydrogeological knowledge, engineering capability, planning, and execution. This is reflected in highly sophisticated urban water systems. There is no doubt that city dwellers and government engineers during this period had the capability to measure height and distance difference between a spring outside the city and a certain point in the city and translate this information to construct a massive shaft coupled with a covered tunnel in order to reach precisely the source of the water. Moreover, in some water systems, such as in Hazor and Gibeon shaft, they did not even try to reach a water source outside the city but rather to reach the perched aquifer below the city. Hezekiah’s Tunnel is the world’s most ancient long hewn tunnel, constructed without any communication and ventilation shafts. This complicated engineering task was apparently executed by a small team of workers and under pressure of an approaching Assyrian siege.

In light of these considerations, we compare spring tunnels with Iron Age water systems. The technical competence required for excavating a spring tunnel, including a long one, is much less than the technical ability and the hydrological knowledge that existed during the Iron Age 2.

In recent years, as a result of new surveys and excavations, we can re-establish and claim that spring tunnels began to appear during the Iron Age 2 period, as we have seen in the Joweizeh spring, spring tunnel of Suba cave, the Gibeon spring, and perhaps also the spring tunnel at Nebi Samuel.

The evidence of spring tunnels from the Iron Age, which are the basis of prime agricultural or industrial enterprises, matches the results of the archaeological survey conducted in the Judean hills. The data of the Jerusalem hills’ archaeological survey from the Bronze Age to the Persian period show that rural settlement reached an unprecedented peak in the eighth and seventh centuries BC during Iron Age 2 (Broshi and Finkelstein 1992, 56; Faust 2005, 102). Hundreds of rural sites were found in the hills around Jerusalem, most of which are farms, as well as a few villages and satellite towns.

Based on this evidence, the presence of spring tunnels, and the flourishing of small agricultural sites on the countryside around Jerusalem during the Iron Age 2, we offer two alternative models for the development of the first spring tunnel:

1. It is likely that some of the manual labor for quarrying Hezekiah's Tunnel came from the rural area around Jerusalem. During excavation, some workers noticed water dripping from the walls of the tunnel. This observation taught them that it is possible to increase the discharge of a water source by increasing the saturated rock-air interface. From this point, the way to a local experiment and excavation of a spring tunnel is short. Recall that in ancient times, it was difficult to draw water from deep sources and bring large quantities of water to farmlands. This forced ancient farmers who lived in mountains to exploit water resources in mountains areas, even small perched springs. This model assumes a flow of labor, ideas, and information between the municipal/governmental sector and the rural sector.
2. While quarrying Hezekiah's Tunnel, the workers noticed water emanating from the walls. They realized that they were increasing the discharge of the spring by increasing the hewn space and passed this information to the municipal government. As a result, it was decided to develop state-funded spring tunnels in two springs near Jerusalem: One, Suba cave water system, for ceramic industry, and the second, Joweizeh spring, as a national irrigated garden. The conventional dating of Hezekiah's Tunnel to the end of the eighth century BC and the dating of the spring tunnels described above fit this theory.

It is important to emphasize that the two models proposed above suggest local technological development rather than importing knowledge from various countries such as Persia, as claimed previously (Issar and Zohar 2012, 161).

In this study, for the first time, an attempt was made to date flowstone radiometrically in spring tunnels. Although the attempt was unsuccessful for flowstone under continuous flow of water, the method proved to be applicable in other water systems, such as dating dripping stalactites in Hezekiah's Tunnel (Frumkin et al. 2003, 169). Further attempts should be made to date spring tunnels that are not regularly flooded with water, by U-Th dating of dripstone speleothems. Perhaps, additional Iron Age spring tunnels are hidden in the hills of Jerusalem. We expect that these spring tunnels are hewn in bedrock and have a rectangular cross section.

## ACKNOWLEDGMENTS

We would like to thank Dr. Raphael Yechezkel (AY's father) to help translating this article from Hebrew; Dr. Miryam Bar-Matthews from the Israel Geological Survey for dating the samples from the spring tunnels; And Zeev (Z'abo) Erlich, Shemesh Ya'aran, Reuel Kasel, Eran Meeiri, Iftach Raanan, Gideon Goldberg, Oded Hulzinger, and Elyashiv Videberg for their help in drilling cores in the spring tunnels.

## REFERENCES

- Albright, W.F. 1928. A trial excavation in the mound of Bethel. *Bulletin of the American Schools of Oriental Research* 29:9–11.
- Amiran, R. and Ilan, O. 1996. *Early Arad- The Chalcolithic and Early Bronze IB Settlements and the Early Bronze II City: Architecture and Town Planning*, Vol. II. Jerusalem, Israel: Israel Exploration Society.
- Ben Tor, A. 1989. *Hazor III–IV: An Account of the Third and Fourth Seasons of Excavations*. Jerusalem, Israel: Israel Exploration Society.
- Broschi, M. and Finkelstein, I. 1992. The population of Palestine in Iron Age II. *Bulletin of the American Schools of Oriental Research* 287:47–60.

- Bull, R.J. 1965. Appendix 4. Water sources in the Vicinity. In *Shechem: The Biography of a Biblical City*, ed. G.E. Wright, 214–228. New York: McGraw-Hill.
- Burg, A. 1998. Geochemistry and hydrology of perched carbonate aquifers in northern and central Israel. PhD Thesis, Hebrew University of Jerusalem, Israel (Hebrew).
- Burton, M.M. and Levy, T.E. 2012. Chalcolithic social organization reconsidered: Excavations at the Abu Hof Village, Northern Negev, Israel. *Journal of the Israel Prehistoric Society* 42:137–192.
- Cohen, A. and Peyman, D. 2011. *Springs Survey in the Judean Mountains—Analyzing Water Balance and Quality*. Jerusalem, Israel: Israel Nature and Parks Authority (Hebrew).
- Cole, D. 1980. How water tunnels work. *Biblical Archaeologist Review* 6(2):8–29.
- Dafny, E. 2009. Groundwater flow and solute transport within the Yarqon-Taninim aquifer, Israel. PhD Thesis, Hebrew University of Jerusalem, Israel (Hebrew).
- Edelstein, G. Gat, Y., and Gibson, S. 1983. Food production and water storage in the Jerusalem Region. *Qadmoniot: A Journal for the Antiquities of Eretz-Israel and Bible Lands* 16(1):16–23 (Hebrew).
- Ein Mor, D. and Ron, Z. 2013. “Golot Hakoteret”: a royal spring tunnel from Iron Age in Nahal Refaim area. *New Studies in the Archaeology of Jerusalem and Its Region* 7:85–109 (Hebrew).
- Enzel, Y. Bookman, R. Sharon, D. Gvirtzman, H. Dayan, U. Baruch, Z., and Stein, M. 2003. Late Holocene climates of the Near East deduced from Dead Sea level variations and modern regional winter rainfall. *Quaternary Research* 60:263–273.
- Erlich, Z. 2013. The “Midrash” Tunnel, in Beitin. *Bemaabe Hahar* 2:91–100 (Hebrew).
- Faust, A. 2005. The Settlement of Jerusalem’s Western Hill and the City’s Status in Iron Age II Revisited. *Zeitschrift des Deutschen Palästina-Vereins* 121(2):97–118.
- Finkelstein, I. 1993. En-Nebi Samwil. In *Archaeological Survey of the Hill Country of Benjamin*, ed. I. Finkelstein, and Y. Magen, 333–334. Jerusalem, Israel: Israel Antiquities Authority (Hebrew).
- Fiorillo, F. 2009. Spring hydrographs as indicators of drought in a Karst environment. *Journal of Hydrology* 373:290–301.
- Flexer, A. Gilat, A. Hirsch, F. Honigstein, A. Rosenfeld, A., and Rueffer, T. 1989. Late Cretaceous evolution of the Judean Mountains as indicated by ostracodes. *Terra Nova* 1(4):349–358.
- Ford, D. 2003. Paleoenvironments: Speleothems. In *Encyclopedia of Caves and Karst Science*, ed. J. Gunn, 555–558. New York: Fitzroy Dearbon.
- Frankel, R. 2002. The Hellenistic aqueduct of Akko-Ptolemais. In *The Aqueducts of Israel*, ed. D. Amit, J. Patrich, and Y. Hirschfeld, 82–87. Portsmouth: Rhode Island.
- Frumkin, A. 1992. Karst origin of the upper erosion surface in the northern Judean Mountains, Israel. *Israel Journal of Earth Sciences* 41:169–176.
- Frumkin, A. 2002a. The water-supply network of Samaria-Sebaste. In *The Aqueducts of Israel*, ed. D. Amit, J. Patrich, and Y. Hirschfeld, 267–277. Portsmouth: Rhode Island.
- Frumkin, A. 2002b. The hydrogeology of Israel and water supply in antiquity. In *The Aqueducts of Israel*, ed. D. Amit, J. Patrich, and Y. Hirschfeld, 21–24. Portsmouth: Rhode Island.
- Frumkin, A. 2013. Caves and Karst Hydrogeology of Jerusalem, Israel. In *Proceedings of the 16th International Congress of Speleology*, Vol. 3, ed. M. Filippi, and P. Bosak, 60–65. Czech Republic: Brno.
- Frumkin, A. 2015a. Shafts and survey errors of ancient tunnel engineering in Jerusalem and Caesarea water systems, Israel. In *Proceedings of International Congress of Speleology in Artificial Cavities, Hypogea 2015*, ed. M. Parise, C. Galeazzi, R. Bixio, and C. Germani, 170–177. Italy: Roma.
- Frumkin, A. 2015b. The underground water system of Ma’abarta-Flavia Neapolis (Hellenistic – Roman Shechem). *Geoarchaeology*.
- Frumkin, A. Carmi, I. Gopher, A. Ford, D.C. Schwarcz, H.P., and Tsuk, T. 1999. A Holocene millennial-scale climatic cycle from a Speleothem in Nahal Qanah Cave Israel. *The Holocene* 9(6):677–682.
- Frumkin, A. Shimron, A., and Rosenbaum, J. 2003. Radiometric dating of the Siloam Tunnel, Jerusalem. *Nature* 425:169–171.
- Frumkin, A. and Fischhendler, I. 2005. Morphometry and distribution of isolated caves as a guide for phreatic and confined paleohydrological conditions. *Geomorphology* 67:457–471.
- Frumkin, A. and Shimron, A. 2006. Tunnel engineering in the Iron Age: Geoarchaeology of the Siloam Tunnel, Jerusalem. *Journal of Archaeological Science* 33:227–237.
- Galili, E. and Nir, Y. 1993. The submerged Pre-Pottery Neolithic water well of Atlit-Yam, northern Israel, and its palaeoenvironmental implications. *The Holocene* 3(3):265–270.
- Gibson, S. 2009. The Suba water system as a clay-production plant in the Iron Age II. In *Eretz Israel* 29, ed. J. Aviram, A. Ben-Tor, I. Ephal, Y. Aviram, S. Gitin, and R. Reich, 45–55. Jerusalem: The Israel Exploration Society.

- Gibson, S. Ibbs, B., and Kloner, A. 1991. The Sataf Project of landscape archaeology in the Judean Hills: a preliminary report on four seasons of survey and excavation (1987–1989). *Levant* 23:29–54.
- Goldreich, Y. 2003. *The Climate of Israel: Observation, Research and Application*. New York: Kluwer Academic & Plenum Publishers.
- Gvirtzman, H. 2002. *Israel Water Resources, Chapters in Hydrology and Environmental Sciences*. Jerusalem, Israel: Yad Ben-Zvi Press (Hebrew).
- Herzog, Z. 1997. Arad— The Arad Fortress. Tel Aviv, Israel: Hakibbutz Hameuchad Publishing House (Hebrew).
- Issar, A.S. and Zohar, M. 2012. The Impact of climate changes on the evolution of water supply works in the Region of Jerusalem. In *Evolution of Water Supply through the Millennia*, ed. A.N. Angelakis, L.W. Mays, D. Koutsoyiannis, and N. Mamassis, 147–168. London, UK: IWA Publishing.
- Kelso, J.L. 1961. The Fourth Campaign at Bethel. *Bulletin of the American Schools of Oriental Research* 164:5–19.
- Kempinski, A. 1992. Dan and Kabri- a note on the planning of two cities. In *Eretz Israel* 23, ed. E. Stern, and T. Levi, 76–81. Jerusalem: The Israel Exploration Society (Hebrew).
- Lapp, P.W. 1969. The 1968 Excavations at Tell Ta'anek. *Bulletin of the American Schools of Oriental Research* 195:2–49.
- Lipschits, O. 2011. The Origin and Date of the Volute Capitals from the Levant. In *The Fire Signals of Lachish: Studies in the Archaeology and History of Israel in the Late Bronze Age, Iron Age, and Persian Period in Honor of David Ussishkin*, ed. I. Finkelstein, and N. Na'aman, 203–225. Winona Lake, IN: Eisenbrauns.
- Macalister, R.A.S. 1912. *The Excavations of Gezer 1902–1905 and 1907–1909*, Vol. I. London, UK: John Murray.
- Magen, Y. and Har-Even, B. 2007. Persian Periods Stamp Impressions from Nebi Samwil. *Tel Aviv* 34:38–58.
- Markus, M. and Ben Joseph, S. 1983. Joweizeh Spring- The longest spring tunnel in the Judean Mountains. *Nikrot Zurim* 8:54–63 (Hebrew).
- Mazar, A. 2002. A survey of the aqueducts to Jerusalem. In *The Aqueducts of Israel*, ed. D. Amit, J. Patrich, and Y. Hirschfeld, 210–242. Portsmouth: Rhode Island.
- Netzer, E. and Garbrecht, G. 2002. Water channels and a royal estate of the late Hellenistic period in Jericho's western plains. In *The Aqueducts of Israel*, ed. D. Amit, J. Patrich, and Y. Hirschfeld, 366–379. Portsmouth: Rhode Island.
- Olami, Y. and Peleg, Y. 1977. The Water Supply System of Caesarea Maritima. *Israel Exploration Journal* 27(2/3):127–137.
- Patrich, J. and Amit, D. 2002. The aqueducts of Israel: An introduction. In *The Aqueducts of Israel*, ed. D. Amit, J. Patrich, and Y. Hirschfeld, 9–20. Portsmouth: Rhode Island.
- Peleg, N. and Gvirtzman, H. 2010. Groundwater flow modeling of two levels perched karstic leaking aquifers as a tool for estimating recharge and hydraulic parameters. *Journal of Hydrology* 388:13–27.
- Peleg, N. Morin, E. Gvirtzman, H., and Enzel, Y. 2012. Rainfall, spring discharge and past human occupancy in the eastern Mediterranean. *Climatic Change* 112:769–789.
- Porath, Y. 2002. The water-supply to Caesarea: a re-assessment. In *The Aqueducts of Israel*, ed. D. Amit, J. Patrich, and Y. Hirschfeld, 104–129. Portsmouth: Rhode Island.
- Pritchard, J.B. 1961. *The Water System of Gibeon*. Philadelphia, PA: The University Museum.
- Pritchard, J.B. 1962. *Gibeon, Where the Sun Stood Still*. Princeton, NJ: Princeton University Press.
- Reich, R. and Shukron, E. 2002. Channel II in the City of David, Jerusalem: Some of its technical features and their chronology. In *Cura Aquarum in Israel*, ed. C. Ohlig, Y. Peleg, and T. Tsuk, 1–6. Deutsche Wasserhistorische Gesellschaft (DWhG), Siegburg, Germany.
- Ron, Z. 1985. Development and management of irrigation systems in mountain regions of the Holy Land. *Transactions of the Institute of British Geographers* 10(2):149–169.
- Sheffer, N.A. Dafny, E. Gvirtzman, H. Navon, S. Frumkin, A., and Morin, E. 2010. Hydrometeorological daily recharge assessment model (DREAM) for the Western Mountain Aquifer, Israel: Model application and effects of temporal patterns. *Water Resources Research* 46:1–16.
- Shiloh, Y. 1992. Underground water systems in the land of Israel in the Iron Age. In *The Architecture of Ancient Israel from the Prehistoric to the Persian Period*, ed. A. Kempinski, and R. Reich, 275–293. Jerusalem, Israel: Israel Exploration Society.
- Shopov, Y. 2003. Dating of Karst landforms. In *Encyclopedia of Caves and Karst Science*, ed. J. Gunn, 281–283. New York: Fitzroy Dearbon.
- Tsuk, T. 2000. Ancient water systems in settlements in Eretz Israel. Ph. D. Thesis, Tel Aviv University, Israel (Hebrew).
- Vincent, L.H. 1911. *JERUSALEM SOUS TERRE- les recnentes fouilles D'OPHEL*. London, UK: Horace Cox.



- Vincent, L.H. 1912. *Jérusalem recherches de topographie, d'archéologie et d'histoire- tome premier*. Paris, France: Librairie Victor Lecoffre.
- Warner, D.A. 2014. Is there a light at the end of the Tunnel? Excavations of the Tel Gezer water system. Preliminary results of the 2010–12 seasons. In *Cura Aquarum in Israel II*, ed. C. Ohlig, and T. Tsuk, 1–8. Deutsche Wasserhistorische Gesellschaft (DWhG), Siegburg, Germany.
- Weiss, M. and Gvirtzman, H. 2007. Estimating ground water recharge using flow models of perched karstic aquifers. *Ground Water* 45(6):761–773.
- Wright, G.E. 1963. Book review: Water supply of Gibeon. *Journal of Near Eastern Studies* 22:210–211.
- Yadin, Y. 1975. *Hazor, the Rediscovery of a Great Citadel of the Bible*. London, UK: Weidenfeld and Nicolson.
- Yechezkel, A. 2003. *Springs in the Mountain*. Jerusalem, Israel (Hebrew).
- Yechezkel, A. 2015. Perched springs and spring tunnels in the hills of Jerusalem: Hydrological and chronological aspects. Master Thesis, Hebrew University of Jerusalem, Israel (Hebrew).
- Yechezkel, A. and Yechezkel, D. 2008. *Springs in the Mountain—The Full Guide for Perched Springs in the Hills of Jerusalem*, 2nd edn. Jerusalem, Israel (Hebrew).
- Zissu, B. and Weiss, D. 2008. En Qobi. Hadashot Arkheologiyot- Excavations and Surveys in Israel 120 (February). [http://www.hadashot-esi.org.il/Report\\_Detail\\_Eng.aspx?id=703&mag\\_id=114](http://www.hadashot-esi.org.il/Report_Detail_Eng.aspx?id=703&mag_id=114)

---

# 11 Qanāt Fir'aun

## *An Underground Roman Water System in Syria and Jordan*

*Mathias Döring*

### CONTENTS

11.1	Climate, Geology, and Settlement History .....	173
11.2	The Hellenistic Gadara Aqueduct Qanāt Turāb .....	175
11.3	Urban Development and Water Requirements .....	176
11.4	The Long-Distance Water Transport System Qanāt Fir'aun .....	177
11.4.1	Field Research .....	177
11.4.2	The Overground Section from Dille to Adra'a (Syria).....	179
11.4.3	Circumvention of the Wādī eš-Sallāla .....	182
11.4.4	Through the Plateaus around Abila.....	182
11.4.5	Route Correction in the Wādī Samar .....	184
11.4.6	The Unfinished Qanāt Fir'aun.....	184
11.5	Water from Dion and Muzerib.....	187
11.6	Measurement.....	189
11.7	Tunneling .....	189
11.8	Construction Errors .....	193
11.9	Dating .....	194
11.10	The Aqueduct System in Comparison .....	194
	References.....	195

### 11.1 CLIMATE, GEOLOGY, AND SETTLEMENT HISTORY

The most northerly part of Jordan—part of the Roman province of Syria—is made up of highland lying between 350 m and 550 m above sea level. The edges of the highland are jagged and the deeply incised valleys descend in the west to the Jordan, 200 m below sea level, and in the north to its largest tributary, the Yarmuk (Figure 11.1). These two rivers are the only ones that retain their flow throughout the year; all others have a periodic characteristic. At the edge of the Jordan Rift Valley, a winter rainfall of 350–500 mm makes crop farming possible. Further east, where rainfall is lower and does not exceed 200 mm, this crop farming is replaced by pasture farming. The evaporation of 2200 mm and the low capacity of the springs indicate a significant water deficit. An additional factor is the wide variation (between 200 mm and 900 mm)\* in annual rainfall, which would destabilize any water supply system without storage capacity.

Limestone from the Cretaceous period (with an age of *ca.* 80 million years), with layers of flint, runs through the Jordanian earth to a depth of over 200 m. The limestone is frequently overlaid with basalt from the Hauran volcanic area. Groundwater deposits between marly clay layers flow into the springs.†

---

\* Irbid: Precipitation 1954–2006: 420 mm/a; 1938–2005: 476 mm/a (280–890 mm/a), Evaporation 2179 mm/a (Obeidat et al. 2008, p. 429, fig. 3).

† Wolfahrt 1962, pp. 445–478, in particular fig. 5, 8; Bender 1968; Obeidat et al 2008, tab. 1; El-Naser et al. 1998, pp. 25 ff.

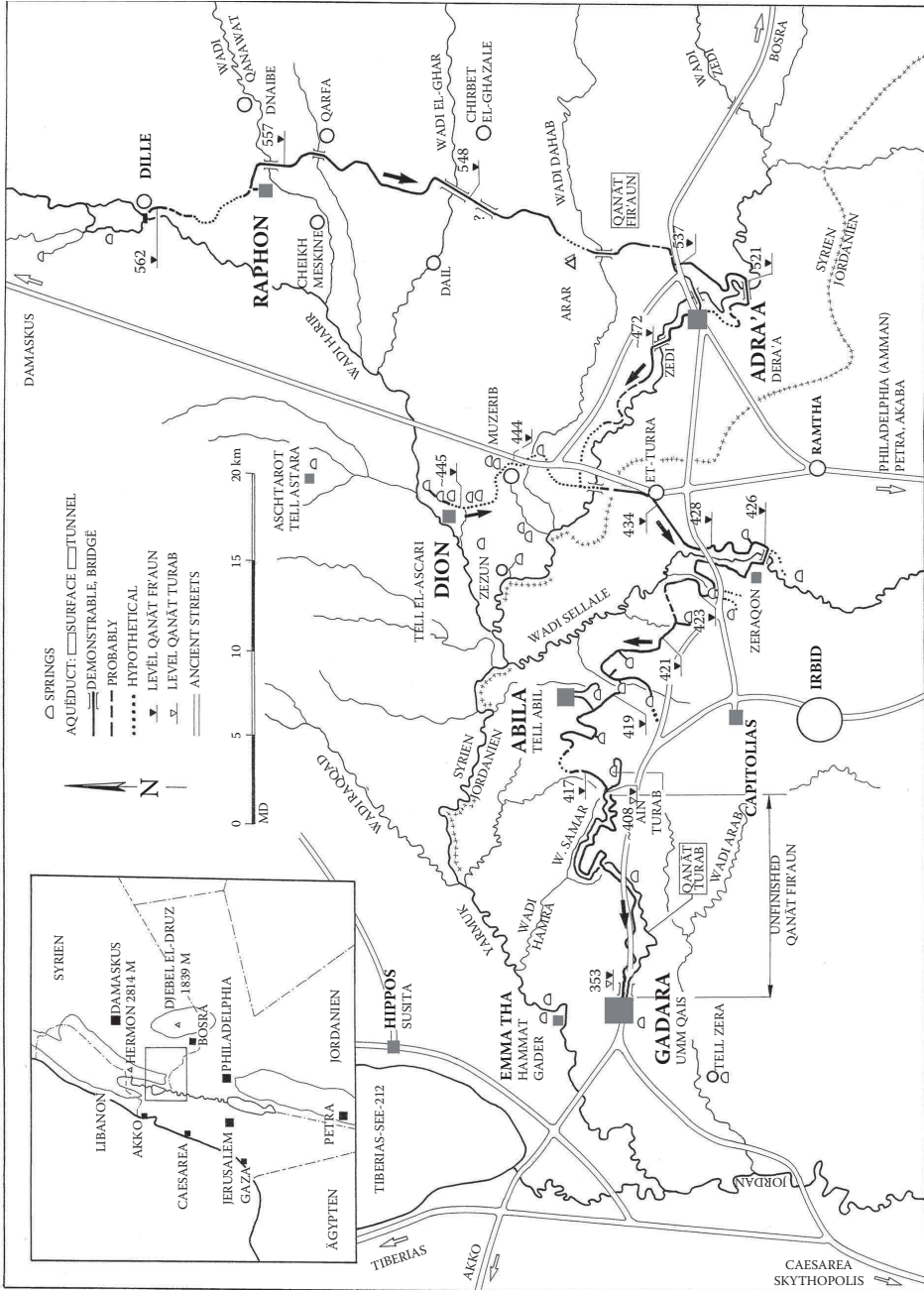


FIGURE 11.1 The aqueducts Qanāt Turāb and Qanāt Fir'aun.

Fortified settlements dating back to the early Bronze Age have been discovered. These were followed by the Iron Age, and from the third century BC, the Hellenic-style settlements, one of which was Gadara.\* The roads followed the same course that the roads of the highland follow today. West of Adra'a, the road that led from the north of the later Roman province Arabia via Abila and Gadara to the Mediterranean ports intersected with the caravan routes and the later pilgrim routes from Aleppo and Damascus over Philadelphia (today Amman), Petra, Medina, and Mecca into Yemen.† After 64/63 BC, when the region fell to Rome, some cities in Transjordan developed into important trade areas. In the first century BC, these became a trade confederation under Roman protection, with far-reaching administrative autonomy. In the first years, Gadara was the main city of the Decapolis.‡

The positive economic development, which was mainly due to Rome's need for oriental goods, did not only affect Gadara but also the other Decapolis cities of Abila (today Tell ābil) and Adra'a. An additional factor was the founding of the Roman province Syria with the capital city Antioch, the Roman annexing of the Nabatean area, the creation of the province of Arabia, and the founding of the new capital city Bosra (106 AD). An additional impetus arose after the visit of the Emperor Hadrian (129–130 AD), who spent the winter in Gerasa and probably also visited Gadara, Abila, and Adra'a. A similar effect was probably created by the visit of the Emperor Marcus Aurelius (175 AD). A regular construction boom followed in the early third century.§

The decline of Gadara began with the attack of the Sassanids in 613/14, plague epidemics, and the heavy earthquake of 747. The important trade city dwindled to a few insignificant villages in a wide-reaching expanse of rubble.

## 11.2 THE HELLENISTIC GADARA AQUEDUCT QANĀT TURĀB

In peacetime, the water requirements of Hellenic cities averaged around 20 L per person per day.¶ For the needs of Gadara, which was the largest city of the region in the early first century, over 100 cisterns within the city\*\* and a few springs, including the Ain Umm Qais, were sufficient.†† The economic upturn led to a rise not only in the number of inhabitants but also in the number of cattle and pack animals and the amount and size of caravans stopping in Gadara, so that the new water requirements could only be fulfilled by a continual supply system. For this purpose, an underground aqueduct in hellenistic style with a 15 cm terracotta pipeline conduit was created in the first century BC.‡‡ The 30 km long tunnel,§§ named Qanāt Turāb, was built by about 700 short construction shafts and runs near to the surface, as is often the case in Hellenic settlement areas. The water comes from the Turāb spring, with a discharge of about 4 L/s.¶¶ Because of leaking along the line, not more than 2–3 L/s (200 m<sup>3</sup>/d) are useful in the town.

An exception is the *ca.* 600 m long tunnel section that crosses the watershed range between the Wādīs Hamra and el-'Arab. The tunnel section lays up to 72 m below ground, making construction

\* Around 211 BC, Polybios mentions Gadara as Seleucid military base (Weber 2002, p. 60, annotation 419).

† Mittmann 1999.

‡ Hoffmann 2002, p. 101. The number of towns is uncertain, at the beginning presumably 10, up to 18 later.

§ Weber 2002, pp. 75 f.

¶ In case of a siege, Garbrecht 2001, p. 40 estimates the minimum demand to be between 7 L/P•d and 13 L/P•d.

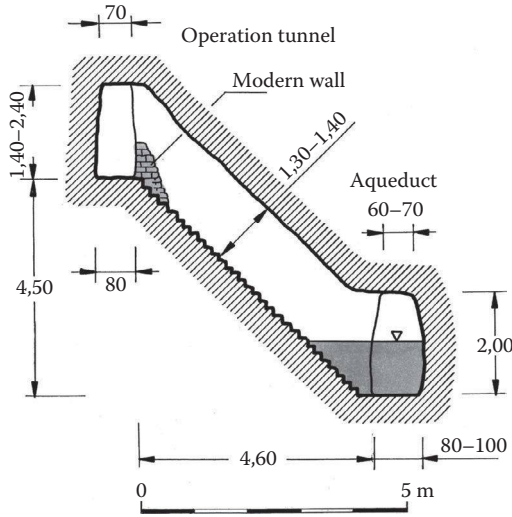
\*\* Keilholz 2007, p. 34. In 2009, Keilholz found more than 100 cisterns having a capacity between 9.5 m<sup>3</sup> and 580 m<sup>3</sup> just in the center of Gadara. In this way, the supply of around 2200 inhabitants could be assured.

†† The spring of Ain Umm Qais (average discharge according to Obeidat et al. 2008, tab. 1: 1,1 L/s, 91 m<sup>3</sup>/d, 1960–84) is situated much lower than the town. Thus, the water was carried up with the help of pack animals.

‡‡ Kerner/Krebs/Michaelis 1997.

§§ All length specifications between 19 km and 22 km, mentioned in previous literature so far (e.g., refer to Kerner 2004), are not realistic.

¶¶ Water Authority of Jordan/BGR 1996, refer also to: Wolfahrt 1962, pp. 445–478, in particular fig. 5, 8; Obeidat et al. 2008, tab. 1. The data vary up to 10%.



**FIGURE 11.2** Qanāt Turāb: Construction tunnels and the aqueduct beneath the watershed range of the Wādīs Hamra and el-'Arab.

shafts impossible. Here, a service gallery was built, from which one could reach the aqueduct tunnel by using small steps (Figure 11.2).

In a later construction phase, the transregional pipeline, the Qanāt Fir'aun, was joined up with this supply system, about 1.6 km west of Ain Turāb. In order to incorporate what was now a much greater amount of water, the pipe was probably removed and the tunnel was covered with hydraulic plaster.

### 11.3 URBAN DEVELOPMENT AND WATER REQUIREMENTS

The increase in water requirements that accompanied the economic and population growth of the first to the third century AD can be attributed to the increase in caravan trade.\* Another very significant factor was the expansion of the urban infrastructure with the adoption of the Roman water culture† with wells, thermal springs, and representative water games.

Water supply was now no longer related to the number of people but to the overall water requirements. In cities based on the Roman model, these lay at around 300–400 L/inhab.d and more. Such quantities could not be delivered by pipeline, even for small cities. Therefore, Roman aqueducts are almost always canals for large amounts of water.‡

For animals and public buildings, which made up the largest part of the water usage, a lower quality of water was acceptable. Spring water was not the only option. Apart from these, in the large cities, cisterns continued to be used for drinking water, while aqueducts were used to supply utility water.§

\* The caravans move only in limited sections on a long-distance route, nothing but the goods covered the full distance. The goods were reloaded in larger towns such as Gadara, where the resting animals caused a considerable water consumption.

† Weber 2002, pp. 142 ff. The water losses amounting to 10%–30% also increased with the rising demand.

‡ Contrary to pipelines, open channels cannot be operated under pressure. Thus, their routing is much more difficult to plan, since they have to follow the contour lines of the landscape.

§ In very large towns such as Rome or Antioch, there were aqueducts for supplying drinking water (in Rome e.g., the Aqua Appia, Marcia, Anio Vetus) and other aqueducts for supplying service water fed from rivers or lakes (Rome: Aqua Anio Novus, Traiana, Alsietina).

Working on a basis of 400 L/inhab.d for Gadara in the second and third centuries AD, it can be calculated that the requirements for utility water were at least 12,000 m<sup>3</sup>/d. The spring Ain Umm Qais, the cisterns, and the Qanāt Turāb were by no means able to supply these amounts. The neighboring cities of Abila und Adra'a were in a similar situation.

## 11.4 THE LONG-DISTANCE WATER TRANSPORT SYSTEM QANĀT FIR'AUN

Until the beginning of the Roman time, a short aqueduct had led water with a pipe aqueduct from the spring Ain Quelbe to the city of Abila,\* while Adra'a's water supply was provided by several wells and springs.† By the beginning of the first century AD, a future problem for the three Decapolis cities manifested itself—water deficit as a result of economic improvement. It is therefore likely that an aqueduct in Roman style was conceived as a joint project from the start.‡ As the largest and more exposed city, it is likely that Gadara led the enterprise.

Because it was mostly utility water that was required, the use of surface water did not present any problems. The planners had to take into account that in summer, when the nearby rivers ran dry and spring capacity was reduced, a dam would be required as a reservoir, which was not possible with cisterns.

The following scenario was possible for the supply of water:

- Delivery from around ten springs east of the Ain Turāb for Gadara and Abila. In the summer, these could provide less than 600–800 m<sup>3</sup> per day.§
- An additional delivery channel from the big springs around Muzerib and Dion in Syria (discharge in summer: 8,200 m<sup>3</sup>/h, 2,300 L/s).
- An additional delivery of water from the Wādī Harir/Syria. Although this has abundant water in the winter months, it does not reach the level required for a conduit until 40 km north of Adra'a and has no or very little water in the summer months. However, the topography here would permit a dam to be constructed.

As the field research and radiocarbon dating show, the first three options listed above were planned, built gradually, and then connected to Qanāt Fir'aun. The underground sections of this aqueduct (Figure 11.1), which, together with the side pipes ran to over 100 km, represented one of the most significant engineering constructions of Roman antiquity (Table 11.1).

### 11.4.1 FIELD RESEARCH

The existence of a second water supply system was already posited during the early archaeological works in Gadara and Abila. These hypotheses are based on the older reports, sketches, and maps of the nineteenth century.¶ However, because no indications of an aqueduct could be found to the west of Adra'a, the theory was questioned from various directions.\*\* More recent findings then seemed to confirm the old hypotheses,†† although the course of such a water transport system to the Jordanian-Syrian border was not established.

\* Mare 1995, p. 729, 2004, p. 503, here the line was called *Lower Aqueduct*.

† Schumacher 1897, pp. 123 f. The findings in close proximity to the springs point out to an ancient usage. The discharge is unknown.

‡ Other solutions would have been selected for ensuring a separate supply of the towns.

§ Water Authority of Jordan/BGR 1996; Obeidat et al. 2008; El-Naser et al. 1998.

¶ Wetzstein 1860, pp. 123–125; Merill 1881, p. 296; Schumacher 1886, pp. 123–126; 1897, p. 125; 1915, p. 136; Heber-Percy 1896; Rindfleisch 1898, p. 21; Steurnagel 1927, pp. 13; 35 f; Palestine map 1915, M. 1:168.960, plates 7; 11; et al.

\*\* Schumacher 1897, p. 184; et al.

†† Mare 1995, p. 729; Weber 1991, 2002; Kerner 2002, pp. 129–136, 2004; Bienert 2004; Häser 2004; et al.



**TABLE 11.1**  
**The Dekapolis Aqueducts, Technical Dates**

Qanāt Turāb	Length	30.3	km	Tunnel
	Minimum slope	0.6	‰	
Qanāt Fir'aun	Dille – Adra'a	50.8	km	Surface
	Adra'a – Abū el-Qantara	15.4	km	Tunnel and surface
	Dion – Abū el-Qantara	14.5	km	Surface
	Abū el-Qantara – Wadi Samar	61.5	km	Tunnel
	Wadi Samar – Gadara	26.1	km	Tunnel, unfinished
	Branch lines	8.8	km	Tunnel
	Total	177.1	km	
	Minimum slope	0.2	‰	
	Qanāt Turāb, cross section	1.50 × 1.00	m	Tunnel
Qanāt Fir'aun, cross section	2.30 × 1.20	m	Tunnel	
Discharge	Qanāt Turāb, conduit	4–6	L/s	
	Qanāt Turāb, channel	<250	L/s	
	Qanāt Fir'aun, channel	250–320	L/s	

The theory of a transregional water supply system became more concrete, after the author's investigation of the Bronze Age settlement Hirbet ez-Zeraqōn at the Wādī eš-Sallāla, the largest southern tributary of the Yarmuk, around 40 km east of Gadara (Figure 11.1). Three deep shafts here and a set of steps that had previously received little attention had hitherto been identified as a possible water supply system for Zeraqōn.\* However, it soon became clear that these could by no means be dated to the third century AD. Work of this scale on the limestone with its flint layers could not have been carried out with bronze tools. The roomy cross section and the plaster—fragments of which were still in evidence—on the walls indicated that this was a Roman aqueduct.

Like Qanāt Turāb, the tunnel was built using a large number of construction shafts. However, in contrast to Qanāt Turāb, these constructions shafts were up to 70 m deep and rather than vertical, as was common practice,† they descended at an angle of under 40°–45° and were equipped with steps—a technology that had probably been adopted from the Persian cultural area.‡ In order to protect the water in the tunnel, the shafts had been walled up and filled from outside during construction. There was therefore nothing to find, other than the already identified entrances.

Given the lack of large antique settlements in the proximity of Zeraqōn, a tunnel of these dimensions could be part of only a long-distance water transport system. Because it was a channel with an open water level, the only possible recipients for the water were those cities that could be reached by a declining angle. Therefore, the author used topographical maps and the Roman method of tunnel construction§ to develop hypothetical routes in both directions, extending from Zeraqōn. The result confirmed that Adra'a, Abila, and Gadara lay at a suitable height for the aqueduct.

The hypothesis of an aqueduct of such unusual dimensions led to a project, of which the first task was to establish the course of the tunnel. The project area was 10 × 40 km<sup>2</sup> and not easily charted; it was expected that collapsed or still open construction shafts would be the only indications of a tunnel. With the help of a hypothetical route, it was possible to find around 200 shafts, some of which

\* Mittmann 1994.

† The qanāt technique exported into the Mediterranean at the very latest during the Hellenistic period of time, that is, the tunnel driving starting from construction shafts at the opposite side, was applied for almost all larger tunnel constructions up to the twentieth century for shortening the building time.

‡ Monadjem 1980. In Ancient Persian Qanāts, inclined shafts were used for extracting water as well as for providing access to underground mills.

§ Slope 1‰, coverage 70 m.



**FIGURE 11.3** Entrance into a construction shaft at 'Alcāl.

permitted entrance into the aqueduct (Figure 11.3). Although the tunnel was repeatedly accessible for long sections, it could not be traversed along the entire length. Piles of earth beneath collapsed construction shafts, dammed up rain water, and lack of oxygen continually served to block the way. However, any collapsed sections were hardly found.

#### 11.4.2 THE OVERGROUND SECTION FROM DILLE TO ADRA'A (SYRIA)

The aqueduct system consists of a main conduit and at least 14 conduits leading to and from this. The main conduit begins at the Syrian village Dille\* at Wādī Harir at a height of about 562 m above sea level (Figure 11.4), which is frequently referred to in the older literature. Here, a hill in the middle of the valley enabled the building of a previously undiscovered dam with two dams of basalt masonry. Significant parts of the 5–6 m high, angled west dam remain (Figure 11.5), but from the lower east dam, only the foundation, made from *opus caementicium*, the Roman concrete, can still be found. The 3 km<sup>2</sup> reservoir, which could hold around 6 million m<sup>3</sup> of water,† enabled the periodic flows to be balanced, so that the aqueduct guaranteed a daily supply of up to 20,000 m<sup>3</sup> throughout the year.‡

Over time, the pacifying of the flow led to an accumulation of mud in the lake, increasingly affecting its function. The consequence was a marshification§ of the entire surrounding area. In 1951, the west dam,¶ which had hitherto remained intact, was broken through, the marsh was dried out, and the area was used for agriculture.

\* Stationing preliminary (km 0: Dille/Syria; km 154: Gadara). The aboveground aqueduct section in Syria was basically found by means of satellite photos and older literature, preliminary altitude indications.

† Surface area and capacity were generated on the basis of satellite photos.

‡ Following a hypothetical management plan of the dam for several variants of inflow, capacity, and draw-off.

§ Wetzstein 1860, p. 123.

¶ According to information provided by local residents. The erosion gully in the former storage space furnishes impressive proof of the thick sediments.

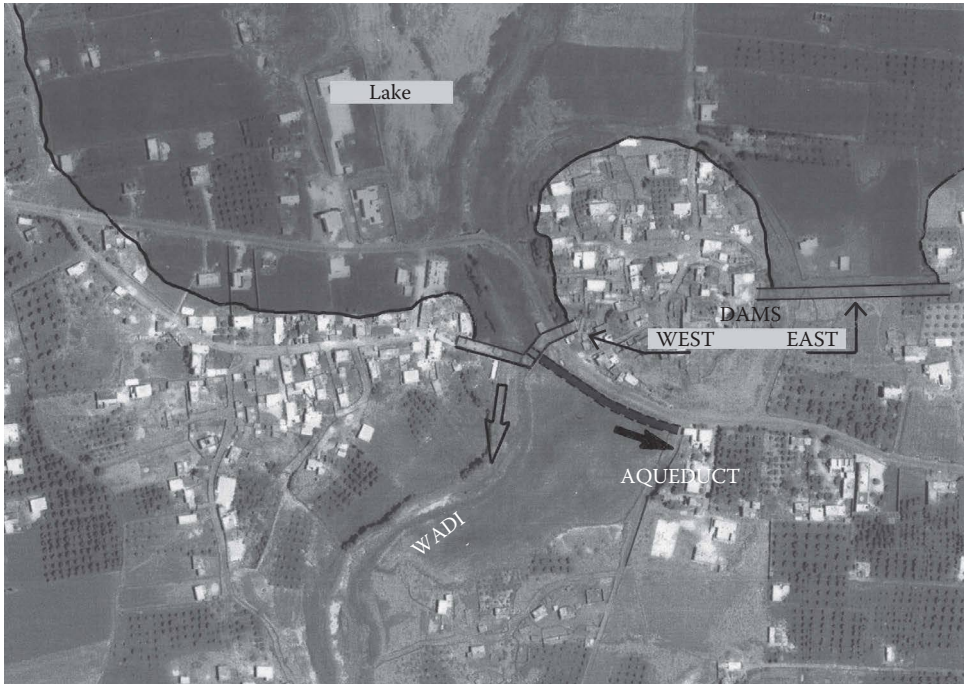


FIGURE 11.4 Dille with both dams. (Copyright and courtesy of Google.)



FIGURE 11.5 The west dam made from basalt blocks.

As is clearly shown by satellite images, several large constructions, walled-up tunnel sections, and foundations were found along the following, 35 km long section. One example is the *ca.* 140 m long bridge over Wādī Qanawāt (Figure 11.6), of which the middle section has collapsed. A long strip foundation has been attached to the southern side of this. A quadratic structure next to the bridge may have been a small fort. Sixteen kilometer further in south, an aqueduct section running for several kilometers has been almost completely preserved (Figure 11.7)\*.

\* This refers to the section mentioned by Wetzstein 1860, p. 123.



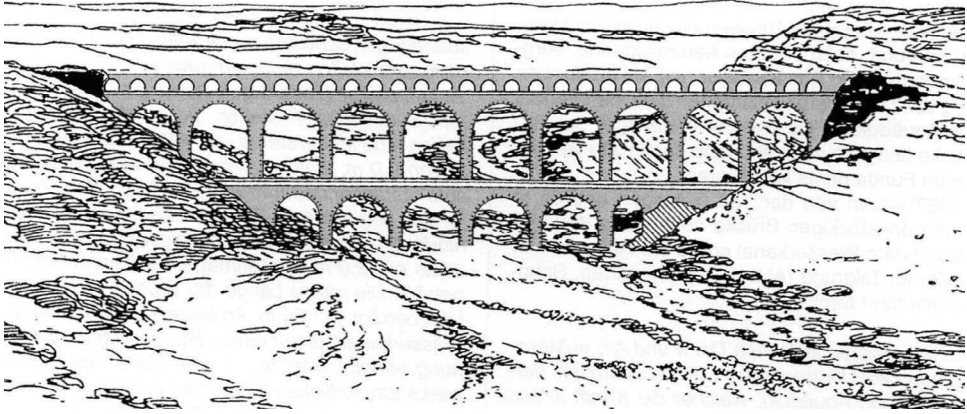
**FIGURE 11.6** Aqueduct bridge over the Wādī Qanawāt. The middle section has collapsed.



**FIGURE 11.7** Aqueduct near Kheurbet Rhazâlê.

South of Adra'a, of which the old city, el-Kerak', received its water from a secondary conduit,\* the main conduit crossed over the Wādī ez-Zēdi on a 138 m long and 35 m high bridge. The bridge, named *Dschisr el-Mēsari'*, consisted of three levels and could be reconstructed using sketches made in the nineteenth century (Figures 11.1 and 11.8). The main conduit of the aqueduct ran south and

\* The balustrades of the bridge were renewed in the twentieth century such that the pressure line described by Wetzstein 1860, p. 124 f, and outlined by Schumacher 1886, p. 124, does not exist anymore. However, the riser made of clay and covered with *opus caementicium* with an inner diameter of 18 cm, leading to the fortified historical center of Adra'a (Kerak) for providing a thermal bath, still exists *in situ*.



**FIGURE 11.8** Aqueduct bridge south of Adra'a, an attempted reconstruction.

west around Adra'a, crossed the Wādī ez-Zēdi again around 3 km west of the city,\* and reached the Roman bridge (now destroyed) on the old Damascus-Philadelphia (Amman) trade route.† Here, where a secondary channel from Muzerib may also have been incorporated, the aqueduct crossed the Wādī ez-Zēdi for a fourth time toward the south.

#### 11.4.3 CIRCUMVENTION OF THE WĀDĪ EŠ-SALLĀLA

Some kilometers north of et-Turra, the aqueduct entered the 85 km long tunnel system up to Gadara. There were several construction shafts in the area, one of which permitted access to the 14 m deep water channel. All construction shafts in the following 4 km wide, intensively farmed hill land up to Wādī eš-Sallāla had been filled in. However, as shown clearly on a satellite image taken in autumn, the abnormalities in the land structure and plant cover remained. These lie at a distance of 40 m from one another—the chain created by the construction shafts. It runs in a straight line toward a rock face, which has been eroded by the Sallāla river. Here, the aqueduct is visible about 25 m below the plateau and 80 m above the river.

In order to cross the steep-sided valley, the usual practice of leading the aqueduct far into the upper reaches of the river was followed. It crossed the valley at Hirbet ez-Zeraqōn on a 17 m high and 105 m long bridge (now collapsed).‡ Several springs (especially the Ain Guren§) were incorporated en route.

A second tunnel system (in Figure 11.9 construction phase II) was found about 1 km west of the bridge. This became necessary when the tunnel used in construction phase I had to be abandoned, owing to later fissuring and a large landslide that had apparently been caused by the tunnel construction.

#### 11.4.4 THROUGH THE PLATEAUS AROUND ABILA

The tunnel then turns back toward the north. It crosses under the mountain ridge of el-Muġhaiyyir and reaches the area of Ain Rahūb.¶ This area, around the most abundant spring in the region,

\* The water channel presented by Schumacher 1897, p. 125, fig. 26, with only 25 cm depth is the rest of the channel walls. In the twentieth century, the area was flooded by a reservoir.

† Wetzstein 1860, p. 124; Schumacher 1915, p. 136.

‡ The exact routing in the section from Adra'a to et-Turra is not yet clarified in detail.

§ Böser/Otto 1996 considered the construction to be a road bridge, although Wetzstein 1860, p. 124, already assumed it to be an aqueduct bridge (“*kanâtir fōḵ kanâtir*” = arches standing one above the other). The road planum lacking on both sides and the following underground channels on both sides clearly prove that it is an aqueduct bridge.

¶ Spring discharge <0.2 L/s/<0.7 L/h.



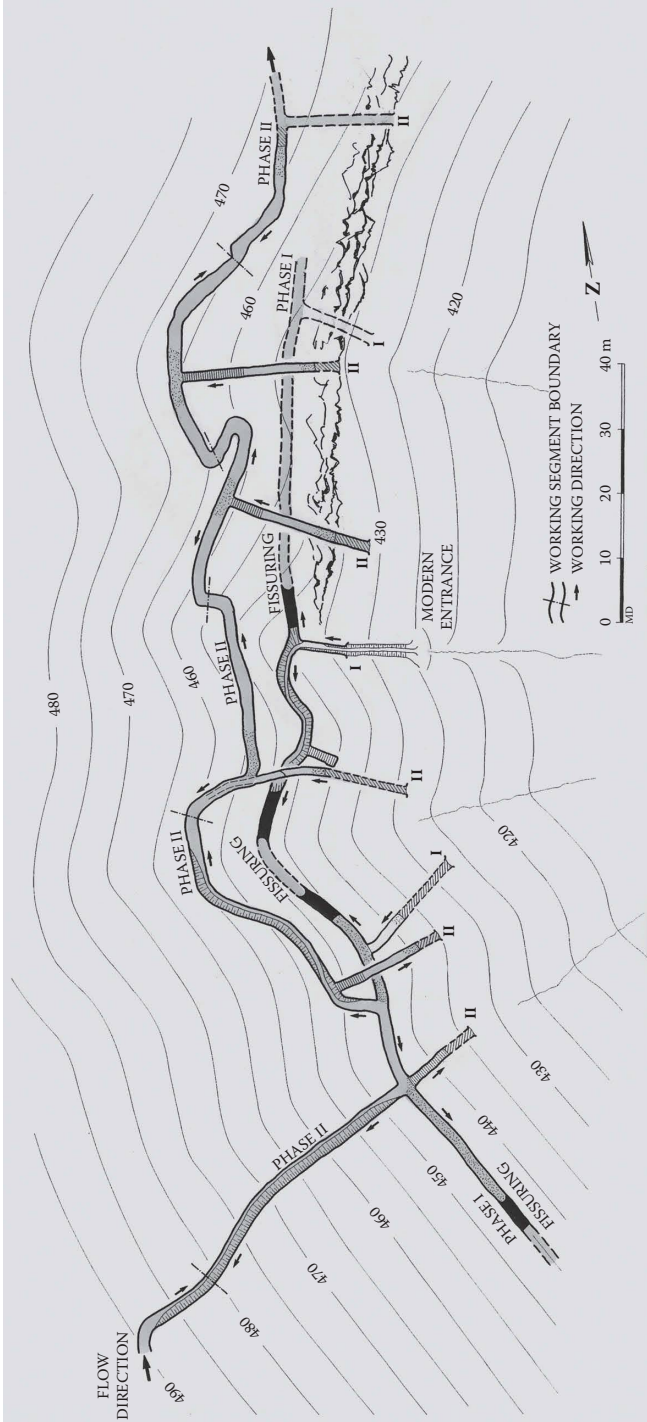


FIGURE 11.9 The Zeraqon tunnel system.



has been inhabited since the Neolithic age. The aqueduct crosses beneath the Wādī Rahūb, which comes from the south. A 550 m long secondary pipeline from the Ain Mucallaqa spring and the Ain Rahūb spring itself fed into the aqueduct, which then runs along the west side of the valley, back toward the north. In the area around the spring, several tunnel fragments were identified. These tunnel sections, some of which are separated from one another, had been abandoned after a short stretch. Tunnel sections of three levels were also found, which make strikingly clear how difficult it was to peg the route out underground. Here, a spiral staircase that cut from the *in situ* limestone and permits access to the aqueduct is unique.

In the following 30 km long section, the path runs into plateaus, which are often several kilometers wide and extend far toward the north. Here, the risk of crossing through these was taken.\* Because of the great depth, the distance between the construction shafts was extended to over 200 m, which led to great problems with orientation underground. While the course along the valleys remained relatively well oriented toward its goal, in almost every section, search tunnels were necessary in order to find the tunnel being dug from the opposite end. This extended the length of the tunnel to around 35% more than what a direct route would have measured (Figure 11.10).

In 'Alcāl and Barashda, water from further springs,† a qanāt, and from the 1.5 km long diversion conduit from the Ain Khurayba were incorporated.‡ Near the Ain Qelbe, which had already supplied Abila with water before the construction of the aqueduct, the first of at least two but possibly three exit channels into the city began.§ Further, input channels for springs followed at Hubrās (Ain Balat)¶ and Yubla village, where a narrow feed tunnel ran, the source for which was no longer identifiable.

#### 11.4.5 ROUTE CORRECTION IN THE WĀDĪ SAMAR

At Kufr Sum, the aqueduct, as shown by several prominent construction shafts, crosses the drainage divide between the Wādīs Quneida and Samar. Although the decline remains relatively constant (0.2‰) until this point, it increases abruptly beneath the mountain ridge to almost 4‰. This indicates a change in plan, for no decline change was necessary to connect the tunnel to the Qanāt Fir'aun section leading on to Gadara on the other side of the Wādī Samar (Figure 11.11). The fact that this did not take place could be attributed to the many significant construction errors in the last 26 km of this section as far as Gadara.

A stopgap solution for the water transport to Gadara was found by connecting the tunnel to the Qanāt Turāb. Although this had a smaller diameter, after the pipeline was removed and the tunnel was plastered and widened in some places, it was able to carry at least most of the water to the Decapolis cities. For this solution, the Qanāt Fir'aun tunnel, coming from the north, needed to be sunk further down, so that it could cross beneath the Wādī Samar about 1 km west of the Ain Turāb spring at a depth of 5 m. Here, access to the aqueduct was enabled by steps. The water was fed into the Qanāt Turāb directly to the west of this and reached Gadara after 26 km.

#### 11.4.6 THE UNFINISHED QANĀT FIR'AUN

The last 26 km long section of Qanāt Fir'aun is unfinished. Its course can be traced by following the many construction shafts 8–40 m above Qanāt Turāb. It begins around 11 m above the conjunction between the Qanāt Fir'aun and Qanāt Turāb and is also led up to the city mount of Gadara,

\* Spring discharge 7.8 L/s (28 m<sup>3</sup>/h) (Water Authority of Jordan/BGR 1996; Margane et al. 2006)

† Older aerial views show numerous still-open construction shafts (filled up nowadays) in this section.

‡ 'Alcāl: Ain es-Sukkar (Brandenburg 1914, pp. 10 f), Khurayba: Ain el-Chrebi (spring discharge 4.8 L/s/17 m<sup>3</sup>/h) and Ain Barashda (spring discharge 0.3 L/s/1 m<sup>3</sup>/h) (Water Authority of Jordan/BGR 1996; Obeidat et al. 2008, Tab. 1).

§ This section could not be explored.

¶ Owing to the deep location of the Ain el-Qēlbi (spring discharge 10 l/s, 36 m<sup>3</sup>/h [Water Authority of Jordan/BGR 1996]), any water could not be fed into the Qanāt Fir'aun.

Downloaded by [ETH BIBLIOTHEK (Zurich)] at 09:18 13 January 2017

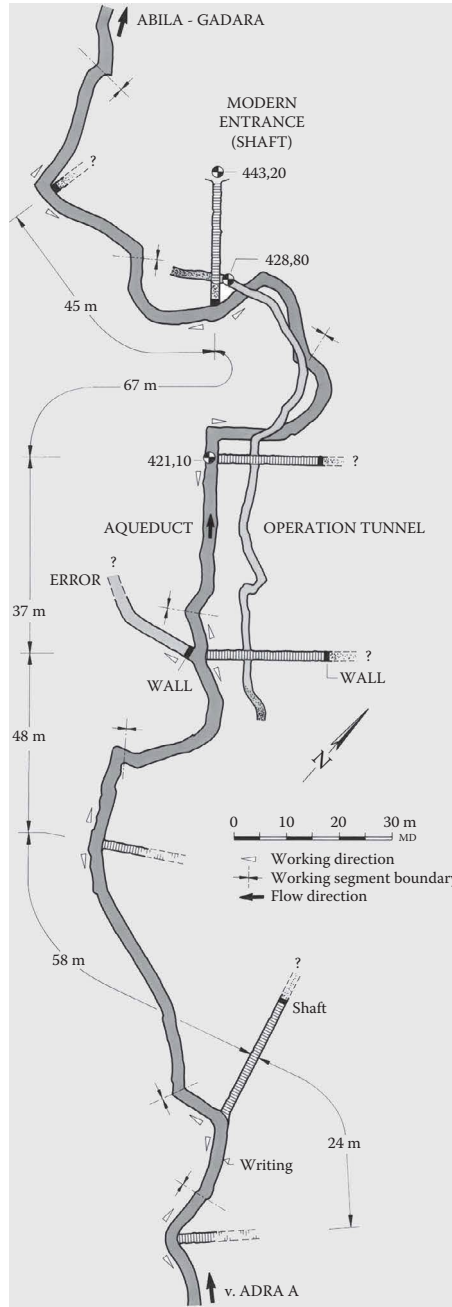


FIGURE 11.10 Outline of a tunnel section with construction tunnels near 'Alcāl.

which it crosses with a length of around 300 m as a so-called *upper tunnel*. It ends shortly before the large nymphaeum in the center of the city.

The construction method, tunneling technique, and dimensions correspond to those of the Qanāt Fir'aun, and it was clearly conceived as the continuation of this tunnel as far as Gadara (Figure 11.12). However, work came to a halt in the preliminary construction phases and no internal work was undertaken. Thus, the rock excavation was not smoothed over, and—except in a few short

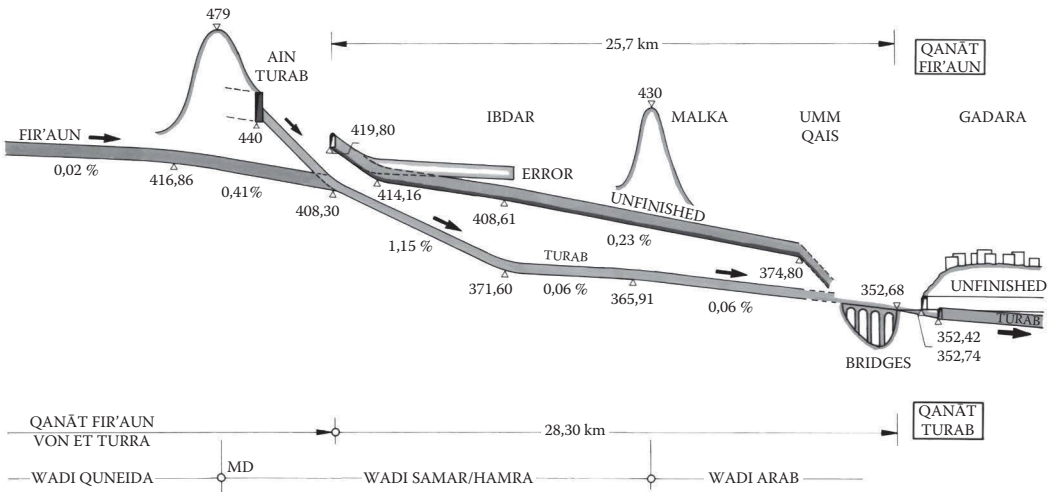


FIGURE 11.11 Both aqueducts between Ain Turāb and Gadara.

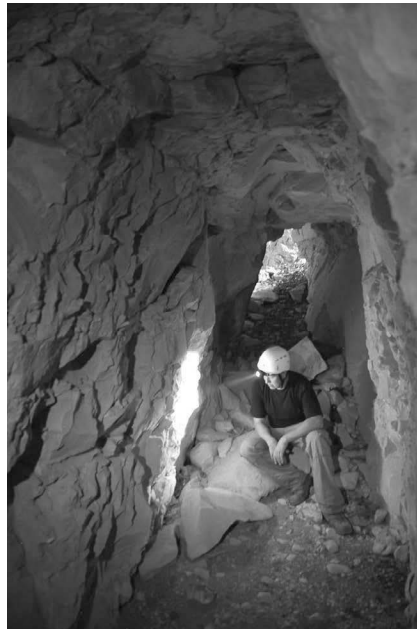


FIGURE 11.12 In the “Unfinished Section” at Malka.

sections—plaster has not been applied. There are also several uncorrected errors in measurement and construction, the scale of which has not been found for the Qanāt Fir’au.

Already at the beginning, the tunnel floor had to be deepened, either because the initial placing had been too shallow or because the plans had been changed. The difference between the first and the second tunnel floors is greater than the entire tunnel height, so that a second tunnel had to be constructed beneath the first, and then somewhat further west, a third tunnel, even lower one, was attempted (Figure 11.13). Orientation difficulties in the same area are reflected by a chaotic tunnel course that turns twice in a circle. No satisfactory explanation for how this occurred could be found.



**FIGURE 11.13** Errors in height calculation: Above, the tunnel that was laid too high.

The unfinished section crossed the Wādī Hamra/Wādī el-'Arab watershed with a vertical distance of over 39 m above Qanāt Turāb. The crossing is marked on both sides by two round construction shafts—the only two vertical shafts—with a diameter of around 5 m.

Beyond the drainage divide, the Qanāt Turāb runs parallel to the mountain contours. The unfinished section, however, takes the shortest route through the south-reaching mountains, with a depth of first 20 m and then, further west, 6–10 m. Several construction shafts, which in the west run increasingly close to the road to Gadara, indicate the tunnel route. In Gadara, the aqueducts can be accessed from the cellars of some houses, and several construction shafts are visible. Here, the course of the Qanāt Turāb runs south of the main road, while parts of the unfinished section keep to the north. A basin of about 200 m in front of the old city was crossed by two bridges laid next to one another.

## 11.5 WATER FROM DION AND MUZERIB

Right from the start, the question arose as to which possibilities for additional water procurement were given in Gadara after the springs south of the Yarmuk River had been recognized as being insufficient, owing to their discharge of less than 20 L/s in total. Contrary to the Hellenistic aqueducts, the Roman ones are open systems, whose outflow does not depend on the water consumption but on the inflow. On the basis of the sinter height on the walls of the aqueduct tunnel, an outflow of 200–300 L/s could be reconstructed—a volume that was only available in Dion (Tell al-Ašcarī) and Muzerib.

Consequently, the attention was focused on the springs of Muzerib and Dion. Here, the largest springs of South Syria emerge, whose discharge (19,000 m<sup>3</sup>/h, 5,300 L/s) exceeds the discharge of all other springs within reach of the aqueduct by more than 200-fold (Figure 11.14).

As a result, the concept was complemented with the new variant—orientation of the Qanāt Fir'aun toward Muzerib and Dion—thus requiring research work on the hydrogeology of South Syria and

Section	L/s				
	50	100	150	200	250
Turāb–Gadara	≤6				
Rahūb–Gadara	≤25				
Dille–Adra'a	≤50				
Dion–Muzerib	≥250–300				

**FIGURE 11.14** Qanāt Fir'aun: Water availability.

the undisturbed hydrogeological situation before the beginning of modern water procurement. In the midst of the twentieth century, the FAO/Rome had examined this situation, which probably came very close to the ancient situation, by means of the spring discharges.

According to this, the eight springs accessible from an aqueduct provide a total volume of approximately 8200 m<sup>3</sup>/h (2300 L/s)—a volume that is not available anywhere in the greater region of South Syria and North Jordan (Figure 11.15). Thanks to the beginning of the aqueduct to Gadara in Dion and Muzerib, the following can be explained:

- The large cross section of the aqueduct
- The walls plastered up to 1.80 m in height
- The marked water levels
- The sinter deposits in Qanāt Fir'aun and Qanāt Turāb
- The exceptional construction effort for the environment of the Wādī eš-Sallāla
- The extensive reconstruction of the aqueduct after the rock slide in Zeraqōn
- The construction of the second bridge in the Wādī eš-Sallāla
- The channel profile on the bridges in the Wādī eš-Sallāla and before Gadara



**FIGURE 11.15** Ain Rouajdat spring near Dion in October 2010.

This assumption is confirmed by the width of the aqueduct before and after the water discharge north of et-Turra. Since the hydraulic connections were not known in the ancient Roman world, the aqueduct was dimensioned on the basis of geometrical analogies. Thus, twice the width was necessary for providing twice the volume of water. If this approach is applied to the Qanāt Fir'aun, the bridges in the Wādī eš-Sallāla and before Gadara with a channel width of 1.20 m compared with the bridge *Dschisr Mesari* near Adra'a (width of 50 cm) would have been dimensioned for approximately two-and-a-half times the volume of water—a volume that could be delivered only by the springs at Dion and Muzerib.

Evidence for the initial orientation of the water supply line toward Dion is given by the route in the Syrian-Jordan border region, which is directly orientated toward Muzerib. The ample discharge of the springs is proven by the 14 mills with 37 grinding stages driven with the help of these springs near Tell šhāb. Around 1900, nothing but a section of only 2.5 km in length belonging to the aqueduct from Dion to et-Turra of about 19 km in length was still existing north of Dion.\*

## 11.6 MEASUREMENT

In the first and second centuries AD, sufficient experience for the construction of a tunnel by using the traditional technique with vertical shafts was available. The direction and height could be reliably calculated using plumb line. The sloping shafts of the Qanāt Fir'aun made transport easier but are likely to have made measurement much more difficult. It is likely that, because of the frequent repositioning of the instruments necessary here and the resulting imprecision, the barometric level and plumb line were used only at shallow points. For greater depths, it can be assumed that the route was geometrically pegged using triangulation, as known from Pythagoras, Hipparchos of Nicaea, Menelaus of Alexandria, and Hero. In contrast, route pegging from the foot of the construction shaft appears to have been carried out by eye. This is the only means of explaining the sometimes-significant deviations to the side, which also occur in the shorter construction sections.

The supra-regional measurements must have been carried out with particular precision, as the unusually small difference in elevation and the low decline of less than 1 m/km gave very little margin for error. The antique method of construction remains an open question. A particularly important question is how the difference in elevation was maintained over greater distances, which would have led to serious errors, had the earth curvature not been accounted for. This is equivalent to 2 m for a distance of only 6 km and over 30 m for a 20 km stretch. According to the current stand of research, the construction could only have taken place by using the Dioptra, unit lengths, and correction factors for the earth curvature and refraction (deviation of the view near the horizon).

## 11.7 TUNNELING

The research findings indicate that the tunneling was undertaken in the following stages: First, the construction shafts were dug out, at a distance of between 20 m and 200 m from one another and with a depth of between 5 m and 70 m (Figure 11.16). In order to reduce the chance of miscalculating the elevation, it appears that when working with great depths and unstable land surface, horizontal construction tunnels in the half depth were used as a measurement basis. Examples of these were found beneath the drainage divide of Wādī Hamra/Wādī Arab and at Al-āl.

From the foot of the shaft, the tunneling was carried out by using pilot tunnels (Figure 11.17). These arched toward one another from the opposite direction, both on the same side. It was hoped that this method would prevent one tunneling team from missing the other tunneling team working toward it from the other construction shaft. This was not always the case, as many examples show. After the two tunnel ends had met up with one another, the cross section was widened out to the full diameter and the differences in width and height were evened out. The tunnel floor was built only

\* Schumacher 1897, p. 167.



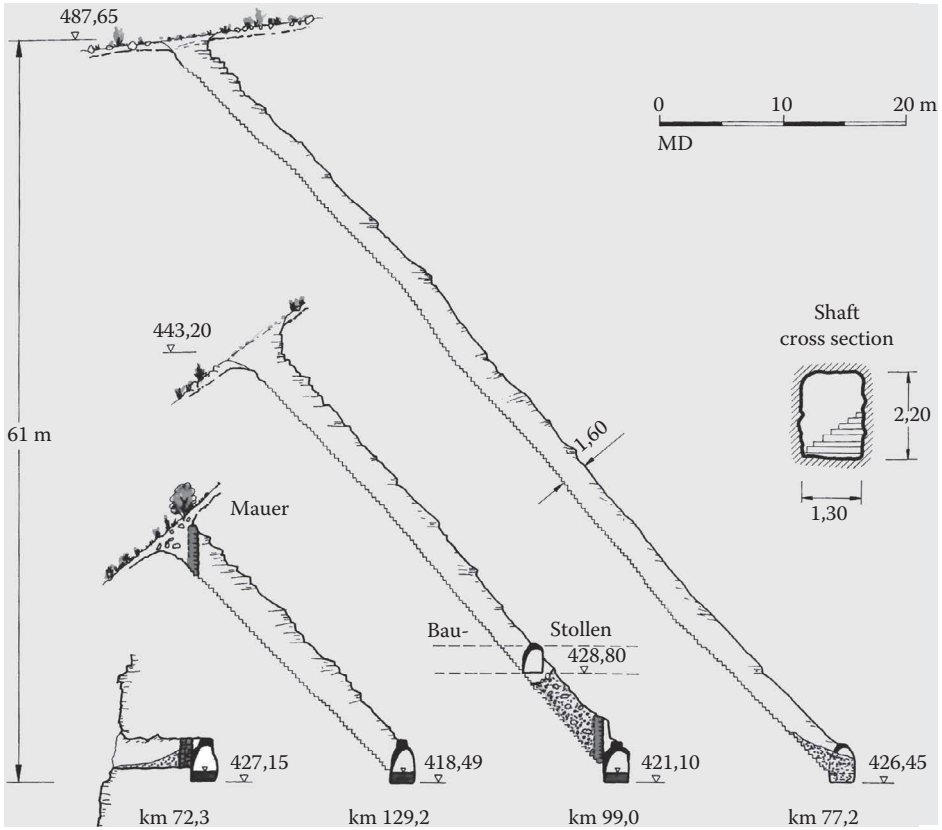


FIGURE 11.16 Construction shafts.

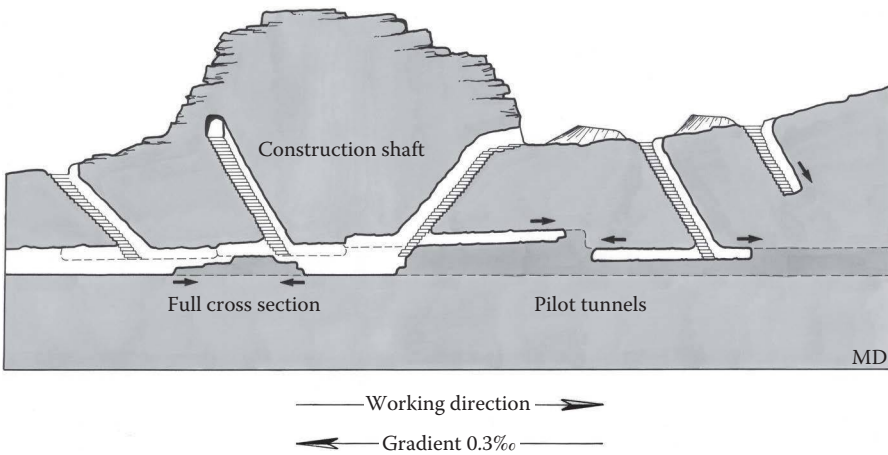


FIGURE 11.17 Tunneling stages.

when a longer tunnel section made it possible to devise a decline of only 2–3 cm/100m. It is likely that the winding route, which rarely permitted a sight line of over 20 m, was a significant obstruction here.

The largest segment of the tunnel system was mined out using hammer and chisel. Quadratic moil chisels were used (Figure 11.18). Their characteristic traces in the unplastered sections of the



**FIGURE 11.18** Mark left by a quadratic moil chisel.

tunnel reveal not only the direction in which the tunneling was carried out but also whether the worker was right-handed or left-handed.

In some parts of the massive, solid limestone in Qanāt Fir'aun, the traces of a rough instrument can be seen (Figure 11.19). These run almost parallel over the side walls. A 3–4 cm wide flat chisel, the traces of which are still recognizable, was used to chip at the rock. Excavated stones of 8–15 cm were found in the tunnel, making it likely that an instrument held in a clamp and operated with great force was used here. This could have been a half-mechanical “tunneling machine,” which consisted of an iron bar, beam, or tree trunk wedged either vertically or diagonally in the tunnel. The instrument had a vertical pivoted arm, and the chisel was fastened to the end of this, so that it could also be banged directly under the tunnel roof with a heavy hammer.

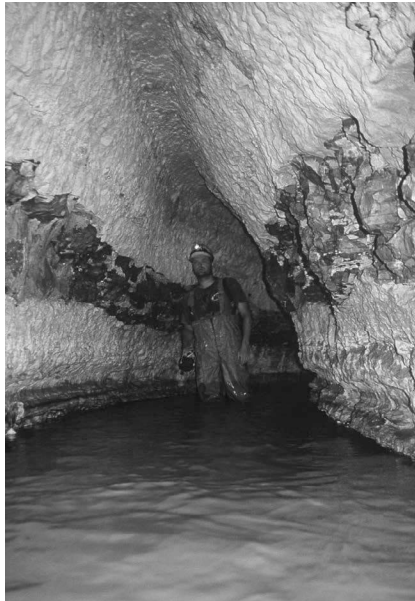
For long stretches of the Qanāt Fir'aun tunnel, the walls have been plastered to up to 1.80 m above the floor, while the Qanāt Turāb has been plastered up to the ceiling (Figure 11.20–11.22). Ground charcoal was mixed with plaster for this, so that the mixture was *hydraulic*, that is, impermeable and leak proof. Thus, the plaster corresponds to the Roman *opus signinum*, which was usually used for such purposes. In other sections, where the rock was denser, plaster was not used.



**FIGURE 11.19** Excavation traces on the side wall of an unfinished secondary tunnel.



**FIGURE 11.20** Plastered tunnel near Abila.



**FIGURE 11.21** Aqueduct without sealing near 'Alcāl.

Water rich in calcium carbonate leaves calcite sintering on the tunnel walls. These decrease as the flow path continues. However, in the tunnel section of Qanāt Fir'aun, these increase from east to west. These appears to confirm that east of the Wādī eš-Sallāla, where there is no sinter at all, surface water with a low calicum content flowed from the volcanic region of the Hauran foreland. The calicum content increased with the calcium-rich spring water from the Jordanian highland.

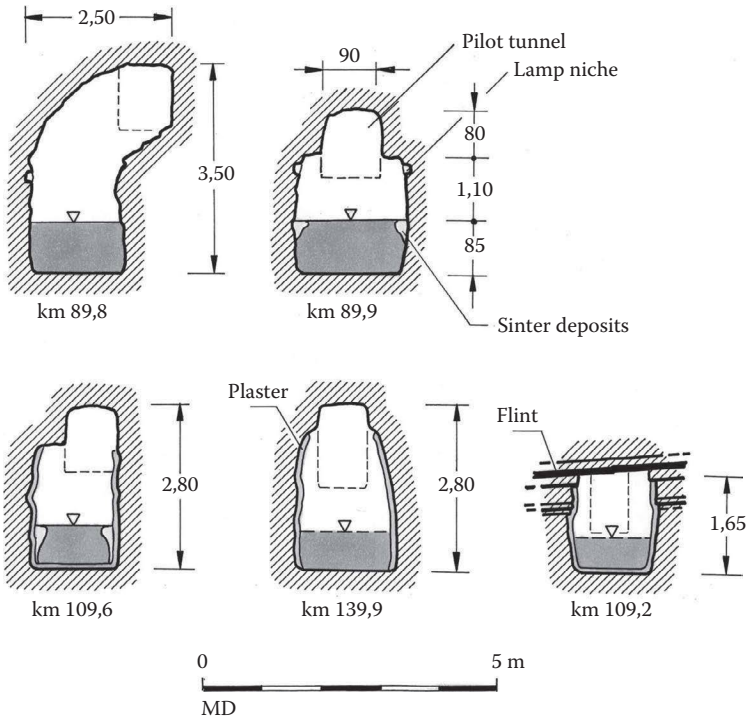


FIGURE 11.22 Cross sections of the Qanāt Fir'aun tunnel.

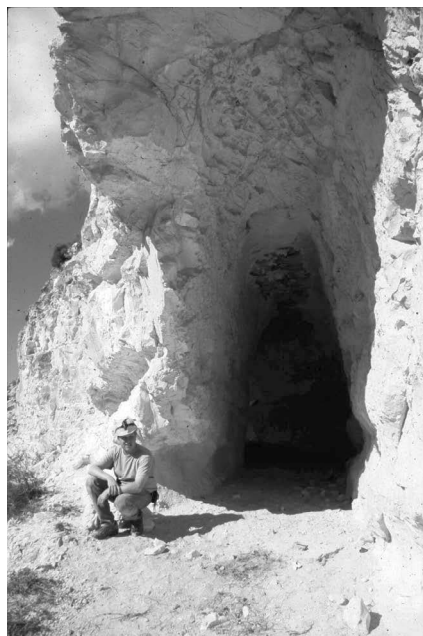
This development is particularly striking west of the Ain es-Sukkar spring at 'Alcāl (Figure 11.1), where strong sintering can be seen on the inside walls of the feed tunnel and the main tunnel. The deposit pattern shows that the source capacity of the spring was highly erratic, while the flow in the main tunnel was relatively steady. This confirms that the reservoir at Dille was large enough to supply water throughout the year.

The water depth in the main tunnel was 40–60 cm, meaning that a flow of *ca.* 20,000–25,000 m<sup>3</sup> per day could be calculated for the Wādī eš-Sallāla–Abila section.

### 11.8 CONSTRUCTION ERRORS

Despite the use of search tunnels, almost every construction section has stretches deviating from the original orientation. As long as the tunneling teams digging from either end managed to meet one another, corrections could be undertaken. When the tunneling teams missed one another, the situation became more difficult. Here, lateral tunnels leading to the original course had to be dug (Figure 11.11). In the unfinished section of the Qanāt Fir'aun, beneath a valley basin, a 200 m long search tunnel, led in loops, was necessary to locate the tunneling that was being carried out from the opposite direction. To avoid water turbulence that could have led to heavier calcium deposits occurring later, all curves were rounded. At another point, the tunnel had been laid too close to the slope surface, which led to later fissuring and landslides (Figures 11.13 and 11.23). Routes had to be moved deeper beneath the mountain to avoid these weak points.

In order to avoid the problem of still-standing water, where the tunnel course had been re-directed further downward, new tunnel construction had to be undertaken. However, course deviations upward, reflected in ledges in the tunnel roof, did not create any problems. The tunnel floor was simply altered in order to maintain the necessary decline.



**FIGURE 11.23** Landslide, probably caused by a tunnel laid too close to the surface.

## 11.9 DATING

The key for dating the Qanāt Fir'aun beyond the spring of Ain Turāb toward the east proves to be  $^{14}\text{C}$  type analyses of the charcoal contained in the *opus signinum*. Its construction seems to have been started immediately after having rebuilt the Qanāt Turāb. A distinction between several construction phases dating from the midst of the first and the early second centuries AD—the period of economic prosperity of the cities of the Decapolis—could be made. These phases of construction were gradually combined with each other.

However, the time of origin of the uncompleted part is uncertain. Broken fragments found near Ibdar indicate the Roman time. It appears to be the oldest construction phase of the Qanāt Fir'aun, which was built immediately in the early first century AD. During the construction phase, the builders could already have recognized that the uncompleted was useless, owing to its construction defects, and consequently, they stopped working on it. As a replacement, the tunnel of the Qanāt Turāb, running underneath, was covered with mortar. In this way, it was prepared to take the water from the Qanāt Fir'aun. The Syrian Qanāt Fir'aun Dille, Adra'a, was built in the middle of the second and was working until to the twelfth century.

## 11.10 THE AQUEDUCT SYSTEM IN COMPARISON

On the whole, the Qanāt Fir'aun, inclusive of all secondary supply lines, proved to be a complex aqueduct system of more than 200 km in length, presumably supplying the Decapolis cities of Adra'a, Abila, and possibly Raphon, apart from Gadara. While Abila and Gadara could rely on the springs of the Hauran, carrying abundant amounts of water all year round, Raphon and Adra'a had to create an annual storage reservoir—owing to a lack of sufficient springs—with the help of the reservoir near Dille in order to bridge the 8 months of summerly dry season.

The extent and complexity of the aqueduct system of approximately 207 km length can measure up to the outstanding hydraulic engineering buildings of large ancient metropolises (Table 11.2). Its unique features are its tunnel sections of approximately 106 km (Fir'aun) and 30 km (Turāb) length,

**TABLE 11.2**  
**Significant Ancient Aqueducts and Water Tunnels**

Important Aqueduct Systems	Construction Time	Length (km)	Discharge (L/s)
Gadara aqueduct (conduit)	First century BC	30	4
Campi Flegrei, Serino	First century BC	106	1000
Nîmes, Pont du Gard	19 BC	50	250
Rome, Anio Novus	52 AD	86	1800
Lyon, Gier	First and second centuries AD	86	175
Decapolis aqueduct	First and second centuries AD	207	250
Carthage	Before 162 AD	132	200
Side	Second century AD	30	3000
Byzantium, Valens	380	242	1500
Large Water Tunnels			Number of Shafts
Samos, Eupalinus	Sixth century BC	1	None
Gadara aqueduct (channel)	First century BC	30	~700
Bologna, Reno	30 BC	18	?
Rome, Anio Novus	38–52 AD	9	~250
Lago Fucino-Emissar	44–54 AD	5.7	41
Dekapolis aqueduct	First and second centuries AD	~106	~2900

which none of the approximately 1400 Roman water supply line were even near to achieve. The subterranean section of 42 km length between the Wādī eš-Sallāla and the Wādī Quneida, having a decline of 0.2‰ (20 cm/km), and undercrossings of up to 3 km wide plateaus with curved line layout at a depth of 40–60 m testify the remarkable surveying works.

Thus, the construction is not only the most complex ancient water supply system of the Levant but also joins the top group of all Hellenistic-Roman hydraulic engineering buildings to which the pressure line of Pergamon, the urban Roman Aqua Anio Novus/Claudia, or the water lines of Carthage, Antioch, Aspendos, Lyon, or Byzantium, for instance, are attributable.

## REFERENCES

- Bender, F., *Geologie von Jordanien*. Bundesanstalt für Bodenforschung, Vol. 7: Beiträge zur regionalen Geologie der Erde (Berlin 1968).
- Bienert, H. D., The Underground Tunnel Systems in Wādī ash Shellalah, Northern Jordan. *Men of Dikes and Canals. Orient Archäologie* 13, 2004, pp. 43–56.
- Böser, W., Otto, J. Topographisch-fotogrammetrische Bauaufnahme einer antiken (römischen ?) Talbrücke im Bereich Hirbet ez-Zeraqōn/Jordanien. Hochschule für Technik, Fachbereich Geoinformationswesen - Fachhochschule Karlsruhe, Geodätische, Photogrammetrische und Kartographische Berichte II/1996, pp. 77–79.
- Brandenburg, E., *Bericht über eine Reise in Syrien und Palästina*. Berlin 1914.
- Döring, M., Römische Wasserversorgungstunnel im Norden Jordaniens. *Zeitschrift des Deutschen Palästinavereins* 121/2005, pp. 130–139, plate 9.
- Döring, M., Вода для Гадары: римский водопровод на севере Иордании. *Гидросооружения* 2/2008, pp. 12–17.
- Döring, M., Qanat Fir'ūn – Documentation of the 100 Kilometres Aqueduct-Tunnel in Northern Jordan. *Annual of the Department of Antiquities of Jordan* 53/2009, pp. 153–165. 2012.
- El-Naser, H., Nuseibeh, M.-F., Assaf, K.-K., Kessler, S., Ben-Zvi, M., *Overview of Middle East Water Resources. Water Resources of Palestinian, Jordanian and Israeli Interest*. US Geological Survey 1998.
- Garbrecht, G., *Die Wasserversorgung von Pergamon*. Deutsches Archäologisches Institut, *Altertümer von Pergamon I, Stadt und Landschaft* 4/2001.



- Häser, J., Ancient Tunnel Systems in Northern Jordan. *Studies in the History and Archaeology of Jordan* VIII/2004, pp. 155–159.
- Heber-Percy, A., Moab, Amon and Gilead. London 1896.
- Hoffmann, A., Topographie und Stadtgeschichte von Gadara/Umm Qais. *Gadara-Gerasa und die Dekapolis*, Mainz 2002, pp. 98–124.
- Keilholz, P., Die Zisternen der antiken Stadt Gadara (Umm Qais, Jordanien). *Schriften der Deutschen Wasserhistorischen Gesellschaft* 9/2007, pp. 195–228.
- Kerner, S., Gadara – Schwarzweiße Stadt zwischen Adjlun und Golan. *Gadara-Gerasa und die Dekapolis*. Mainz 2002, pp. 125–136.
- Kerner, S., The Water Systems at Gadara and other Decapolis Cities of Northern Jordan. *Men of Dikes and Canals. Orient Archäologie* 13, 2004, pp. 187–195.
- Kerner, S., Krebs, H., Michaelis, D., Water Management in Northern Jordan: The Example of Gadara Umm Qais. *Studies in the History and Archaeology of Jordan* VI/1997, pp. 265–270.
- Mare, W. H., The Technology of the Hydrological System at Abila of the Decapolis. *Studies in the History and Archaeology of Jordan* 1995, pp. 727–736.
- Margane, A., Borgstedt, A., Subah, A., Hajali, Z., Almomani, T., Delineation of Groundwater Protection Zones for the Rahoub Spring. Technical Report N° 7 of the German-Jordanian Cooperation-Groundwater Resources Management. Berlin 2006.
- Merill, S., East of the Jordan. London 1881.
- Mittmann, S., Hirbet ez-Zeraqōn. Eine Stadt der frühen Bronzezeit in Nordjordanien. *Archäologie in Deutschland* 2/1994, pp. 10–15.
- Mittmann, S., Römerstraßen in Nordwestjordanien und ihr Nachleben in der Kreuzfahrerzeit. *Zeitschrift des Deutschen Palästinaverains* 115–1/1999, pp. 24–44, Tafeln 3–6.
- Monadjem, H., Ghanat, eine uralte Bewässerungstechnik. Graz 1980.
- Obeidat, M. M., Ahmad, F. Y., Hamouri, N. A., Massadeh, A. M., Athamneh, F. S., Assessment of nitrate contamination of karst springs, Bani Kanana, northern Jordan. *Revista Mexicana de Ciencias Geológicas* 25, 3/2008, pp. 426–437.
- Rindfleisch, G., Die Landschaft des Haurān in römischer Zeit und in der Gegenwart. *Zeitschrift des Deutschen Palästinaverains* XXI/1898, pp. 12–15, Tafel 1.
- Schumacher, G., Across the Jordan: being an Exploration and Survey of Part of Hauran and Jaulan. London 1886.
- Schumacher, G., Das südliche Basan. *Zeitschrift des Deutschen Palästinaverains* XX/1897, pp. 67–185 ff.
- Schumacher, G., Unsere Arbeiten im Ostjordanlande VII. *Zeitschrift des Deutschen Palästinaverains* XXXVIII/1915, pp. 136–149.
- Steuernagel, C., Der 'Adschlūn. Nach den Aufzeichnungen von Dr. G. Schumacher. Leipzig 1927.
- Water Authority of Jordan/BGR, Groundwater Resources of Northern Jordan, Vol. I: Rainfall, spring discharge and baseflow, Part 2: Spring discharge in northern Jordan, Appendix 5. Amman 1996.
- Weber, T. M., Gadara of the Decapolis. Preliminary report on the 1990 Season at Umm Qeis. *Annual of the Department of Antiquities of Jordan* 35/1991, pp. 223–235.
- Weber, T. M., Gadara – Umm Qēs I: Gadara Decapolitana, Untersuchungen zur Topographie, Geschichte, Architektur und der Bildenden Kunst einer "Polis Hellenis" im Ostjordanland. *Abhandlungen des Deutschen Palästinaverains* XXX, 2002.
- Wetzstein, J., Reisebericht über Hauran und die Trachonen. Berlin 1860.
- Wolfahrt, R., Zur Geologie und Hydrogeologie des Irbid-Distriktes. *Geologisches Jahrbuch*. 79/1962, pp. 445–478.

---

# 12 The Aqueducts of the Sultanate of Oman

## *Sustainable Water-Supplying Systems Irrigating Oases Cities*

*Fairouz Megdiche-Kharrat, Rachid Ragala, and Mohamed Moussa*

### CONTENTS

12.1	Introduction .....	197
12.2	The Sultanate of Oman.....	198
12.2.1	Geographical Presentation.....	198
12.2.2	The Geological Provinces .....	198
12.2.3	The Climate .....	198
12.2.4	The Water Resources.....	198
12.2.5	Historical Presentation .....	199
12.3	The Aqueducts of Oman.....	199
12.3.1	Description and Classification of Aqueducts .....	199
12.3.2	The Aqueducts Inscribed in the World Heritage List.....	200
12.3.3	Management System of Aqueducts .....	200
12.3.3.1	The Administration Structure.....	200
12.3.3.2	Ownership and Various Stakeholders.....	201
12.3.3.3	Water Rights and Shares Distribution .....	201
12.3.3.4	The Irrigation Scheduling.....	201
12.4	Nizwa and Its Aqueducts.....	202
12.4.1	The City of Nizwa: General Presentation.....	202
12.4.2	Aqueducts in Wilayat Nizwa .....	203
12.4.3	The Main Underground Aqueduct of the City of Nizwa: Falaj Daris .....	206
12.4.3.1	Presentation and Physical Data.....	206
12.4.3.2	Falaj Daris within People's Everyday Lives .....	206
12.5	Common Issues and Problems of Aqueducts .....	208
12.6	Conclusions.....	208
	Acknowledgments.....	209
	References.....	209

### 12.1 INTRODUCTION

Almost half of the world's land area has arid and semi-arid climates, where rainfall is rare and irregular. Besides, 60% of these lands are in the developing countries (Singh et al. 1990 cited in Al-Ghafri 2012, 192). Despite the low availability of water, civilizations exist there since thousands of years. Man succeeded to fetch and supply water necessary for his subsistence from surface sources or from beneath the ground, which made his settlement possible in harsh conditions as those in the lands of Oman. Indeed, Oman is characterized by little and irregular rainfall, very high

temperature, and low humidity in the interior of the country. Talking about settled life in Oman, Costa (1983, 275) writes, “Where life is hard and difficult, sometimes reduced to pure survival, the *objet d’art* tends to be absent: this, of course, does not mean that in those areas art is absent. Aesthetic values, taste and imagination find their ways of expression in the building styles, in the design and decoration of tools and weapons, in the patterns of weaving and basketry; they are also expressed in the design of the hydraulic works.” By hydraulic works, Costa means those systems that made settlements possible in the territory of Oman, throughout history: the aqueducts named locally *aflaj* (plural of *falaj*).

## 12.2 THE SULTANATE OF OMAN

### 12.2.1 GEOGRAPHICAL PRESENTATION

Oman is situated in the Southeast of the Arabian Peninsula. It has a total area of approximately 309,500 km<sup>2</sup> and opens onto the Gulf of Oman and the Arabian Sea, with a coastline that reaches 1700 km (Hawley 2005, 70). Oman shares borders with the United Arab Emirates on the North and Northwest parts, the Kingdom of Saudi Arabia on the West side, and the Republic of Yemen in the Southwest of the country.

Oman presents large landscape sets that can be classified into four families: plains of gravel or loess (silt clay and limestone), the deserts of sand, *sebkha*, and mountain ranges (Hawley 2005, 69). The country is also characterized by its numerous wadis. The shape, nature, and location of these dry rivers result from the geologic and climatic specifications of the country (El-Baz 2002).

### 12.2.2 THE GEOLOGICAL PROVINCES

Oman can be divided into four distinct geologic areas. The first region is the chain of Al-Hajar Mountains in the North, which forms a belt characterized by the largesse of its folds. The second region is at the center of the country; it shows rocky plateaus covered with flat sedimentary layers. The third region is the Dhofar Mountains in the South, which consist of calcareous layers and steep coastal cliffs. The fourth region comprises the sand plains of the Rub’ al Khali in the West side and those of Wahiba in the central part of the country (El-Baz 2002).

### 12.2.3 THE CLIMATE

Oman has an arid climate characterized by clear skies across the year, light winds, winters with moderate temperatures, and very hot dry summers. The sun shines on Oman 10 h/d as annual average, except on the mountains and on the Dhofar region in the South of the country. The average humidity ranges from 40% in desert regions to 60% in the North of the country to reach 70% in the South. Rainfall is very low across the country, except in the Southwestern part and the Northern Mountains, where it goes over 300 mm yearly (El-Baz 2002). According to the Ministry of Regional Municipalities and Water Resources (MRMWR), rainfall occurs in *Al-Jabal Al-Akhdar* twice a year: in the summer, after the area is affected by the Southeastern wind coming from the Indian Ocean, and in winter, when the area is affected by the Northeastern wind from the Gulf (MRMWR 2008, 18).

### 12.2.4 THE WATER RESOURCES

According to MRMWR, Oman has two types of water resources: conventional resources that count 84% and nonconventional resources that represent only 16% (MRMWR 2014). Natural water resources come from surface water (rainfall), springs, and groundwater. Non-natural resources include desalinated water and treated wastewater. The different resources and their importance in supplying the country with water are shown in Table 12.1.

**TABLE 12.1**  
**Various Water Resources and Their Importance in the Supply of Oman**

Type of Water Resource	%
Groundwater	78
Desalinized water	13
Surface water	6
Treated wastewater	3

Source: Ministry of Regional Municipalities and Water Resources, MRMWR, Water Resources, 2014, [http://mrmwr.gov.om/new/en/Page.aspx?id=82&li=8&Type=W\\_Sec&Slide=false](http://mrmwr.gov.om/new/en/Page.aspx?id=82&li=8&Type=W_Sec&Slide=false)

### 12.2.5 HISTORICAL PRESENTATION

Archeological evidences have demonstrated that human settlements have existed since prehistoric times on the lands of Oman. The site of Al Watiya (near the capital Muscat), from the Stone Age, is the oldest in the east of the Arabian Peninsula, dating back to 10,000 years; then, successive human settlements were established around the country, mainly in the North and Northeastern parts, from the forth millennium BC to the Islamic eras (Arab and Abdelhalim 2010, 87). In the first millennium BC, a human colony settled in the Northwestern part of the country and built the city of Izki, which was the residence of Pade, a king of Qade. Today, Izki is a large oasis city located about 35 km Northeastern side from the city of Nizwa, which was founded in the Islamic Period (Schreiber 2004 cited in Al-Salimi and Korn 2010, 38).

The land of Oman is mentioned in the writings of Arab geographers of the Middle Age, who emphasize the role Oman played in the navigation and commerce, thanks to its strategic location, which allowed sailors and merchants to build close relations with China, India, and the east coast of Africa. They also describe the landscape panoramas that this land offers, as well as the urban aspects of its cities and customs of its inhabitants. Ibn Hawqal (990, 27–30 cited in Arab and Abdelhalim 2010, 18) talks about Oman in his book *Surat al Ardh* (image of the earth). He mentions that this land has many palm groves and produces a variety of fruits such as bananas and pomegranates and that its climate is warm; despite this, it slightly snows on the peaks of some of its mountains.

## 12.3 THE AQUEDUCTS OF OMAN

Aqueducts in Oman are important water-supplying mechanisms for people, specifically in rural communities. They are called locally *aflaj* and are classified into three types. The results of the national *aflaj* inventory project conducted by the Ministry of Regional Municipalities, Environment and Water Resources in the period from 1997 to 1999 show that there are 4112 systems distributed throughout the regions of Oman, of which 3017 are still operational (MRMWR 2008, 10). As inventoried in 2001, 2900 km of surface canals and tunnels irrigate about 17,600 ha of cropped area (MRMEWR 2001 cited in Al-Ghafri 2012, 194).

### 12.3.1 DESCRIPTION AND CLASSIFICATION OF AQUEDUCTS

Omani aqueducts are commonly defined as tunnels. These tunnels bring water from where it concentrates in the ground and lead it to the surface. However, in terms of their physical structure, these systems are classified into three different types: *ghaili*, *dawoodi*, and *aini* (Al-Marshudi 2007, 34). Table 12.2 gives the percentage of each of these types from the total number of inventoried

**TABLE 12.2**  
**Percentage of Each Type of Aqueduct from the Total Number of**  
**Inventoried Aqueducts (Percentage 1) and from the Total Number**  
**of Dry Ones (Percentage 2)**

Type of Aqueduct	Percentage 1 (%)	Percentage 2 (%)
<i>Ghaili aflaj</i>	49	54
<i>Aini afaj</i>	28	15
<i>Dawoodi aflaj</i>	23	31

Source: Al-Ghafri, A. 2012. Sultanate of Oman. In *Qanāt in Its Cradle: Situation of Qanāt (Kariz, Karez, Falaj) in the World*, (A. A. Semsar Yazdi, and M. Labbaf Khaneiki, Eds.). Shahandeh Publication, Tehran, Iran, pp. 191–273, 201–2016)

aqueducts in Oman. Costa (1983, 275) distinguishes the three types of aqueducts according to their different methods of water extraction: “channeling surface flow, tapping springs, and draining water-soaked.” The first type, commonly called *ghaili*, diverts flow from wadi or river into a man-made channel to bring the water to the nearby plantations (Al-Marshudi 2007, 34). The second type, named *aini*, transports water from one or more natural springs to places of use. In most cases, the *aini falaj* is entirely above the ground, but it may also be partly subterranean (Costa 1983, 276). The third type, known as *dawoodi*, brings water from underground aquifers. The underground aqueduct (*dawoodi falaj*) originates from one or more mother well (*Umm Al-Falaj*). To describe this water-supplying system, Costa states, “The depth of the mother well depends of course on the location of the water source and can vary considerably, from a few meters to 50 m or more. From the point where the water is tapped, a tunnel is excavated in which the water flows at a gradient of from 1% to 3% until it meets the ground surface where it continues, generally as an open channel, to where it is required” (Costa 1983, 276).

In Oman, about 25% of the inventoried aqueducts are dry systems. Table 12.2 gives the percentage of dried aqueducts from each type.

### 12.3.2 THE AQUEDUCTS INSCRIBED IN THE WORLD HERITAGE LIST

In July 2006, five Omani aqueducts were added in the World Heritage List by the World Heritage Committee (under UNESCO) during its 30th session held in the Republic of Lithuania. These aqueducts are of different types: four of them are underground aqueducts (*dawoodi aflaj*) and the fifth one brings water from a natural spring in the mountain (*aini falaj*). They are *Falaj Daris* and *Falaj Al-Khatmeen* in Wilayat Nizwa, *Falaj Al-Malaki* in Wilayat Izki, *Falaj Al-Mayssar* in Wilayat Al Rustaq, and *Falaj Al-Jeela* in Wilayat Sur (MRMWR 2008, 16–42). This inscription also includes locations and surrounding environments of aqueducts such as ancient monuments, buildings, farms, industries, and other on-site activities (MRMWR 2008, 10).

### 12.3.3 MANAGEMENT SYSTEM OF AQUEDUCTS

#### 12.3.3.1 The Administration Structure

In Oman, the aqueduct is managed by an administration headed by a *wakil*. Its structure consists of a director (*wakil*), assistants (*arif*, generally two: one for underground services and the other for above-ground services), a banker (*qabidh*), a crier (*dallal*), and expert workers (*bayadir*) (MRMWR 2009, 23; see also Sutton 1984 and Wilkinson 1977 cited in Al-Ghafri et al. 2003a, 148). The *wakil* is recommended by the water shareholders and then assigned by the *sheik* of the community.

His duty is to look after the overall system (the budget, solving conflicts...etc.). The *arif* watches over the irrigation timing allocated to farmers; the *qabidh* controls the aqueduct's income (from benefit shares and allocated lands) (Al-Ghafri et al. 2003a, 149).

### 12.3.3.2 Ownership and Various Stakeholders

Omani aqueducts are both governmental and private water-supplying systems. Smaller aqueducts are sometimes owned by single families, but larger ones can count hundreds of owners, mostly farmers (Al-Ghafri et al. 2003b, 29). In general, there are two kinds of water ownerships: a public ownership, which consists of using the water for domestic purpose such as drinking, washing clothes, and also for livestock drinking, and a private ownership, which concerns the water used for irrigation (MRMWR 2009, 25). For large aqueducts, there are four types of private ownership: (a) Owning land and water, (b) owning land and renting water; (c) owning water and renting land, and (d) renting both land and water (Al-Ghafri et al. 2003b, 30).

### 12.3.3.3 Water Rights and Shares Distribution

Laws and water rights are determined since the construction of the system. Rarely, they can be updated for the benefit of the aqueduct and only in a way that does not affect owners' rights (MRMWR 2009, 39). Water is distributed to various stakeholders according to the number of shares each one owns. This number depends on the sizes of the owned lands and/or the contribution in the construction of the system itself (Al-Ghafri et al. 2003b, 29). For the majority of aqueducts, shares are distributed by irrigation timing (1 *baddah* counts 12 h and 1 *athar* is equal to 30 min). Water can also be divided through spatial solutions; as seen in Figure 12.1, the water divider of *Falaj Al-Khatmeen* separates the water for government's benefit from the water for local farmers' benefit. Farmers rely commonly on water clepsydra to estimate *athar*. Besides, in the recent past, they used a complex sundial system in the daytime and a stars system (that differs from winter to summer) in the nighttime. Nowadays, farmers in Oman use the modern watch to get their rights from the water supplied by local aqueducts.

### 12.3.3.4 The Irrigation Scheduling

Water shares are distributed to farmers according to an irrigation cycle or rotation called *dawaran*. It consists of the number of days' interval between two successive irrigations for the same farmer. The irrigation rotation differs from one aqueduct to another, depending mainly on the number of shares and shareholders, the agricultural land sizes, and the flows of the water. Each day is divided



**FIGURE 12.1** Water divider of Falaj Al-Khatmeen: It separates the water for the government's benefit from the water for the local farmers' benefit. (Courtesy of Megdiche-Kharrat 2015.)



into two timings (*baddah*): a daytime *baddah* and a nighttime *baddah* (Al Amri et al. 2014, 130). The *baddah* starting time and length differ according to seasons (summer, spring and autumn, or winter) and used methods (traditional, *goroobi*, or *zawali*) (Al-Ghafri et al. 2003a, 164). In traditional method, the night *baddah* is counted from sunset to sunrise and the day *baddah* from sunrise to sunset. In *goroobi* and *zawali* methods, the two *baddah* are equal in time, regardless seasons, and they both count 12 h. Farmers use the modern watch to switch from night *baddah* to day *baddah*. In *goroobi* method, the starting time of *baddah* differs from one season to another. In this method, the watch is set to 12:00 am at sunset every day. However, in *zawali* method, the day *baddah* always starts at 6:00 am (Al-Ghafri et al. 2003a, 163). During irrigation, the timing units that are mostly used are *athar* (30 min), half-*athar* (15 min), and quarter-*athar* (7 min 30 s).

## 12.4 NIZWA AND ITS AQUEDUCTS

### 12.4.1 THE CITY OF NIZWA: GENERAL PRESENTATION

Wilayat Nizwa is the regional capital of the Ad Dakhiliyah governorate. It covers 13 small cities, of which Nizwa is the largest. The city of Nizwa is located in the North of Oman, about 180 km away from Oman's capital, Muscat. It is situated at the foothill of the Al-Hajar mountains, at around 600 m altitude and near Al-Jabal Al-Akhdar (a 2000 m altitude mountain), where rainfall can reach 325 mm yearly (El-Baz 2002). This region is dominated by the mountains, which stretch from Northwest to Southeast in the Northern part of Oman over a distance of about 700 km; the width of these mountains varies from 30 to 70 km. They show outcrops with steep slopes and peaks, reaching 3000 m above sea level. A network of wadis goes down from these mountains to join Northward the plain of Al-Batinah and Southward the interior of the country. The area is conducive to the establishment of oases. They disperse at the foothills of the mountains and are irrigated mainly by underground aqueducts (*dawoodi aflaj*). Houses and palm groves at the foothill of a rocky outcrop at Wadi Nizwa are shown in Figure 12.2.

Nizwa also has the distinction of being an Arab-Islamic city without ramparts. It is famous for its round-shaped fort, a military construction built by Sultan Ibn saif, the second Imam of the Yaruba dynasty, in 1668 (Hawley 2005, 46). At that time, Nizwa was the political center of Oman and remained so for centuries (Scholz 2004b cited in Al-Salimi et Korn 2010, 45).



**FIGURE 12.2** Houses and palm groves at the foothill of a rocky outcrop at Wadi Nizwa. (Courtesy of Megdiche-Kharrat 2012.)

Al-Maqudissi, Arab geographer from the tenth century, presents Nizwa in his book *Ahsan Attaquacim* (the best partitions) as a large town in the mountains, with clay and mud buildings. He describes the city's mosque, which is implanted in the middle of the souk and is flooded by runoff water during the winter when the river overflows. He also mentions that its inhabitants drink water from wells and rivers (Al-Maqudissi 999, 93 cited in Arab and Abdelhalim 2010, 18). Nowadays, the mosque and souk are still in the same place, implanted in the trajectory of a wadi and where people gather daily or weekly to exchange local products. Local farmers selling goats at Nizwa's weekly livestock market (on Friday, very early in the morning) are shown in Figure 12.3.

#### 12.4.2 AQUEDUCTS IN WILAYAT NIZWA

Nizwa is known to be an oasis city irrigated by aqueducts capturing runoff water and draining water from sources and aquifers. Wilayat Nizwa counts 134 systems, from which 111 are still active (MRMWR 2014). A number of inventoried aqueducts by type in this region are shown in Table 12.3. The underground aqueduct *Falaj Daris*, in Nizwa, is the largest of its type in the Ad Dakhiliyah governorate, followed by *Falaj Al-Khatmeen* in a neighbor village named Birkat Al-Mouz.

The distribution of aqueducts in the administrative area of Wilayat Nizwa that includes some neighborhood villages and that of the mountain Al-Jabal Al-Akhdar are shown in 3D perspective in Figure 12.4. Analyzing the following maps of Figure 12.5a, b, the relationship of the linear



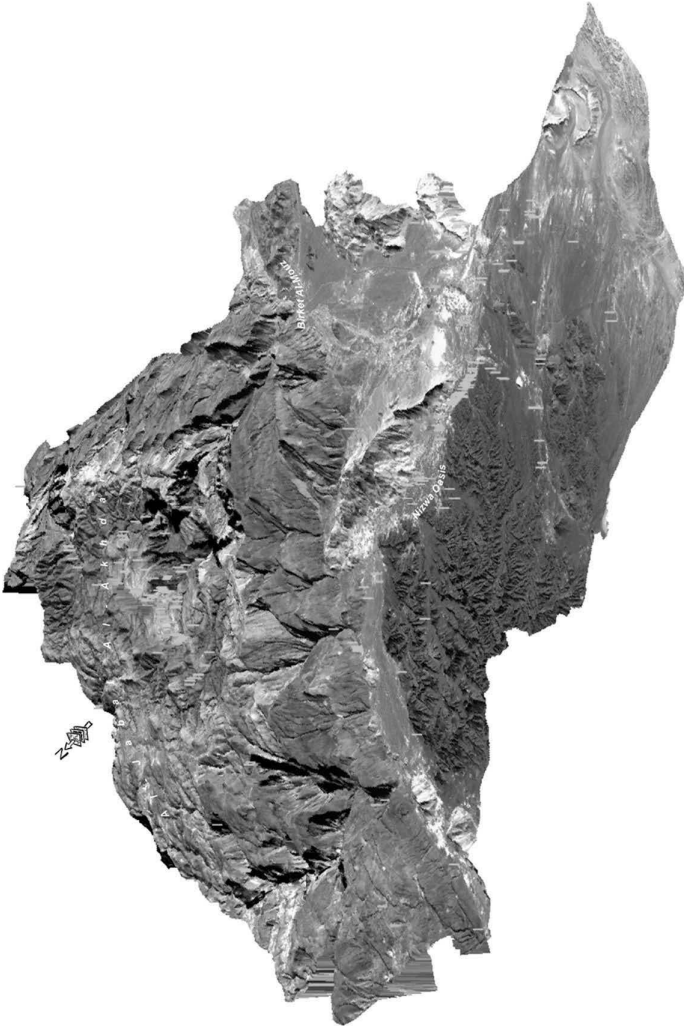
**FIGURE 12.3** Local farmers selling goats at Nizwa's weekly livestock market. (Courtesy of Megdiche-Kharrat 2015.)

**TABLE 12.3**

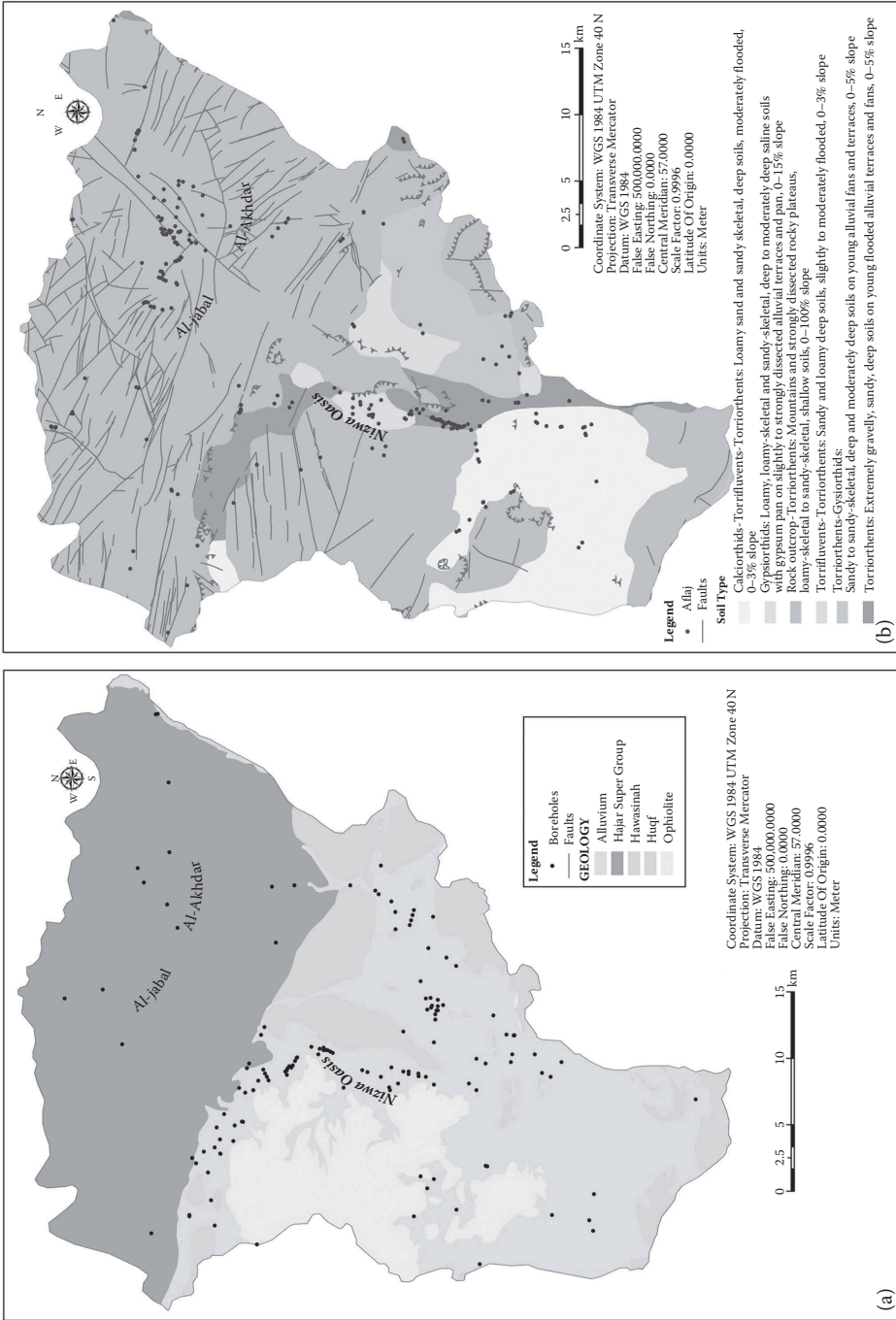
#### The Aqueducts in Wilayat Nizwa: Number by Type and General Condition

Type	Number	Total Number	Active	Dried
<i>Ghaili aflaj</i>	26	134	111	23
<i>Aini afaj</i>	75			
<i>Dawoodi aflaj</i>	33			

Source: Ministry of Regional Municipalities and Water Resources, MRMWR, Water Resources, 2014, [http://mrmwr.gov.om/new/en/Page.aspx?id=82&li=8&Type=W\\_Sec&Slide=false](http://mrmwr.gov.om/new/en/Page.aspx?id=82&li=8&Type=W_Sec&Slide=false)



**FIGURE 12.4** Wilayat Nizwa (Governorate of Nizwa): Geolocalization of aqueducts (aflaj) in 3D perspective view SW-NE. (Courtesy of Ragala and Megdiche-Kharrat.)



**FIGURE 12.5** Wilayat Nizwa (Governorate of Nizwa): (a) Geology, boreholes, and faults and (b) aqueducts (afraj), soil types, and faults. (Courtesy of Ragala and Megdiche-Kharat.)

distribution of aqueducts and boreholes was observed in two main zones in the study area. A very well correlation between aqueducts' density and the general direction of the tectonic discontinuities (fault zones) is observed in the Al-Hajar Mountains' (rocky mountains') area at the Northeastern part of Nizwa oasis (Figures 12.4 and 12.5a, b) into Al-Hajar super group geological formations. The hydrogeological recharge of the groundwater and the aqueducts is explained by the secondary porosity of the fractured rocky system.

In addition, along the left bank of Wadi Nizwa, the linear distribution of the aqueducts is very well correlated with a probable fault zone covered by recent alluvial formations. The hydrogeological connection with the groundwater recharge is due to the high porosity of the sandy alluvial deposits of the Nizwa oasis.

Unlike Al-Hajar Mountains, the city and the oasis of Nizwa occupy a favorable environment characterized by sandy and loamy deep soil, slightly to moderately flooded and with low slope (less than 3%). Moreover, the south and north valleys are characterized by gravelly, sandy, and deep soils on young flooded alluvial terraces and alluvial fans, with slope less than 5%.

Concerning the boreholes, the logic of their spatial distribution is generally different from those of aqueducts (*afraj*). In fact, their location is mostly concentrated in alluvial areas, without presence of faults, related with deeper and different aquifers type than the aqueducts.

This proves that the aqueducts and boreholes, in this arid environment, were constructed under a very good knowledge and macro-field observations by the local population. This testifies an ancestral knowledge in hydrogeological, soil, and agricultural fields.

### 12.4.3 THE MAIN UNDERGROUND AQUEDUCT OF THE CITY OF NIZWA: FALAJ DARIS

#### 12.4.3.1 Presentation and Physical Data

*Falaj Daris* was built about 400 years ago, when the city was ruled by the *Imam Sultan Ben Saif Al-Yaarabi*. This underground water-supplying system irrigates the quarter *Al-Alaya* in Nizwa. Fed by many wadis, mainly wadi *Al-Abyadh*, *Falaj Daris* brings water from a water table underneath the foothill of *Al-Jabal Al-Akhdar* and passes through the houses of *Al-Alaya* to reach the agricultural areas adjacent to the *wadi* (MRMWR 2008, 16).

The former *wakil* of *Falaj Daris*, Sheik Nasser Al-Kharousi, asserts that this aqueduct was named Daris (from Arabic *Darasa*, which means to step on), because its construction led to the loss of many other underground aqueducts such as *Falaj Al-Muhaidith*, *Falaj Al-Maara*, and *Falaj Al-Dausmed*.

This underground aqueduct has two branches, a main long branch (starting from the shaft considered as the mother well, called locally *Umm Al-falaj*, as shown in Figure 12.6) and a shorter branch. They both meet in the shaft called *Fardhat Al-Mutaqa*. The physical characteristics of this aqueduct are presented in Table 12.4.

#### 12.4.3.2 Falaj Daris within People's Everyday Lives

The water supplied by the underground aqueduct *Falaj Daris* serves the agricultural area and also the domestic needs of the inhabitants of *Al-Alaya* (Figure 12.7). Indeed, before it irrigates the diverse plantations (mainly palm trees and some seasonal crops), it passes between houses to be a part of people's everyday lives and habits. In the early morning, the users of this aqueduct bring their drinking water from the *shariaa*, the first opening after which the canal of the aqueduct appears under the sunlight. Some kids gathering near the *shariaa* in a public garden named after this aqueduct are shown in Figure 12.8. People can also access the channel near their houses for various domestic activities (mainly washing dishes and clothes). Some small cabins are built over the channel for bathing. In hot season, kids play and swim in the canals of the open-sky part of the aqueduct.



**FIGURE 12.6** The mother well, Umm Al-Falaj, of the underground aqueduct Falaj Daris in Nizwa (Oman). (Courtesy of Megdiche-Kharrat 2015.)

**TABLE 12.4**  
**Physical Characteristics of the Underground Aqueduct *Falaj Daris* in Nizwa, Oman**

Name	<i>Falaj Daris</i>
Code	F0500
City	Nizwa (Al-Alaya quarter)
Age	About 400 years
Name of administrator ( <i>wakil</i> )	Mr. Said Al-Syabi
Total length	7990 m
Number of branches	2
Length of large branch/depth of source	1700 m/17.5 m
Length of small branch/depth of source	1900 m/16 m
Location of the mother well ( <i>Umm Al-Falaj</i> )	40 Q 0555526 East
UTM coordinates	2542635 North
Altitude	559 m
Location of the shaft <i>Fardhat Al-Mutaqa</i>	40 Q 0556102 East
UTM coordinates	2541360 North
Altitude	548 m
Location of the <i>shariaa</i> (first surface opening)	40 Q 0556328 East
UTM coordinates	2540632 North
Altitude	542 m
Water flow	2000 L/s
Electric conductivity	477 $\mu$ S/cm
Temperature	29°C
pH	7.3
Irrigation area	171.5502 ha
Total demand area	238.2642 ha

*Source:* Data from Ministry of Regional Municipalities and Water Resources, MRMWR, *Aflaj Oman in the World Heritage List*. Muscat, Oman, pp. 16–18, 2008; UTM data are courtesy of Megdiche-Kharrat.





**FIGURE 12.7** Water of the underground aqueduct Falaj Daris temporarily affected (for a few seconds). (Courtesy of Megdiche-Kharrat 2015.)

## 12.5 COMMON ISSUES AND PROBLEMS OF AQUEDUCTS

Nowadays, the aqueducts of Oman are facing some issues resulting from environmental and socio-economical changes. Indeed, the successive droughts led to a lowering in the water table, which affected negatively the water flow in many underground aqueducts (*dawoodi aflaj*). This has direct impact on the nature of crops and the area of cultivated lands. Besides, these lands are inter alia menaced by urban expansion and rural population displacement for new job opportunities since the rise of fossil energy. The irrigation efficiency of the aqueducts was also affected by deep wells and boreholes dug near freshwater sources or mother wells. In addition, new harmful behaviors have been noticed among communities of users, such as wasting fresh water in washing cars and using some chemical products while cleaning clothes or bathing in the channels, despite authority's prohibition. As seen in Figure 12.8, the water is temporarily affected in the main channel of the underground aqueduct *Falaj Daris* in Nizwa.

## 12.6 CONCLUSIONS

Aqueducts are sustainable and environment-friendly water acquisition systems adopted frequently in arid and semi-arid regions. The climate of Oman is hot and dry; thus, this technique of water-supplying galleries for agriculture expanded throughout the country (mainly in the Northern and Eastern parts). In 2001, 3017 operational aqueducts were inventoried, showing a total length of tunnels and canals equal to 2900 km. They are mostly managed as private common ownership system. Nowadays, no more aqueducts, specifically the underground ones, are being constructed. However, the communities of users, despite their new aspirations and the continuous social and economic changes facing them, are still preserving their heritage through a controlled management of the system. The nearly 400-year-old underground aqueduct *Falaj Daris* is one of the five Omani aqueducts inscribed in the World Heritage List. Among many others, this system subsisted for centuries and continues to provide fresh water for various stakeholders, insuring the sustainability of the resource. In terms of landscape issues, it is spectacularly integrated and taken as a chronic part within the urban expansion and the continuous extension of the town's layout. Within the context of global water crisis and inequity in access to fresh water among communities worldwide,



**FIGURE 12.8** Kids gathering at the edge of the surface channel of the underground aqueduct Falaj Daris passing by a public garden. (Courtesy of Megdiche-Kharrat 2015.)

underground aqueducts must be protected and revived. Already, many actions have been taken by governments, such as in Oman, and organizations to protect this heritage. However, still many efforts are needed to surpass the problems that may menace the survival of these systems and to raise awareness among people and local communities about their importance. They represent a crucial knowledge, which is the result of hundreds of years of practice and expertise.

## ACKNOWLEDGMENTS

The authors thank all those who helped in this research, with special thanks to experts from the Ministry of Regional Municipalities and Water Resources (MRMWR) of Oman, Dr. Abdullah Al-Ghafri and Sheik Nasser Al-Kharousi.

## REFERENCES

- Al Amri, S., Al Ghafri, A., and Abd Rahman, N. 2014. Water Management of Falaj Al Khatmain in Sultanate of Oman. *Journal of Earth Science and Engineering* 4:127–133.
- Al-Ghafri, A., Inoue, T., and Nagasawa, T. 2003a. Irrigation scheduling of Aflaj of Oman: Methods and its modernization. In *Proceedings of UNU-UNESCO-ICARDA International Workshop in Alexandria, Egypt*, 21–25 September 2002, pp. 147–166. Tokyo: The United Nations University.
- Al-Ghafri, A., Inoue, T., and Nagasawa, T. 2003b. Daudi Aflaj: The Qanat of Oman. In *Proceedings of the Third Symposium on Xinjiang Uyghor*, China, 11 November 2003 pp. 29–36. Chiba, Japan: Chiba University.
- Al-Ghafri, A. 2012. Sultanate of Oman. In *Qanat in Its Cradle: Situation of Qanat (Kariz, Karez, Falaj) in the World*, (A. A. Semsar Yazdi, and M. Labbaf Khaneiki, Eds.). Shahandeh Publication, Tehran, Iran, pp. 191–273.
- Al-Marshudi, A. S. 2007. Institutional arrangement and water rights in aflaj system in the Sultanate of Oman. In *Proceedings of the International History Seminar on Irrigation and Drainage*, 2–5 May 2007, Tehran, Iran, pp. 31–42. Tehran: IRNCID-ICID.
- Al-Salimi, A., Gaube, H., and Korn, L. 2010. *Islamic Art in Oman* (2nd ed.). Al Royal Press & Publishing House, Muscat, Oman.
- Arab, M. S. and Abdelhalim, R. M. (dir.) 2010. *Oman fi Et-Tarikh*. Ministry of Information. Muscat, Oman.
- Costa, P. M. 1983. Notes on Traditional Hydraulics and Agriculture in Oman. *World Archeology* 14/3:273–295.

- El-Baz, F. 2002. *Wadis of Oman: Satellite Image Atlas*. Office of the Advisor to His Majesty The Sultan for Cultural Affairs, Sultanate of Oman, Muscat, Oman.
- Hawley, D. 2005. *Oman*. Stacey International, London, UK.
- Ministry of Regional Municipalities and Water Resources, MRMWR. 2008. *Aflaj Oman in the World Heritage List*. Muscat, Oman: MRMWR.
- Ministry of Regional Municipalities and Water Resources, MRMWR. 2009. *Experimental Project for Archiving Ownerships and Norms and Sunan and Data Related to Aflaj*. Muscat, Oman: MRMWR.
- Ministry of Regional Municipalities and Water Resources, MRMWR. 2014. *Water Resources*. [http://mrmwr.gov.om/new/en/Page.aspx?id=82&li=8&Type=W\\_Sec&Slide=false](http://mrmwr.gov.om/new/en/Page.aspx?id=82&li=8&Type=W_Sec&Slide=false).

---

# 13 Aqueducts in Saudi Arabia

*Abdulaziz M. Al-Bassam and Faisal K. Zaidi*

## CONTENTS

13.1	Introduction.....	211
13.2	Origin of Qanāts: Diffusion or Isolated Inventions?.....	212
13.3	Qanāts in Saudi Arabia.....	214
13.3.1	Qanāts at Al-Ula.....	217
13.3.2	Qanāts at Al-Jawf.....	218
13.3.3	Ayn Zubaydah Al Aziziyah.....	218
13.3.4	The Layla Lakes.....	220
13.3.5	Darb Zubaydah Al Aziziyah.....	220
13.3.6	The Zamzam Well.....	222
13.3.7	Well of Ayn Haddaj.....	224
13.4	Conclusion.....	225
	Acknowledgment.....	226
	References.....	226

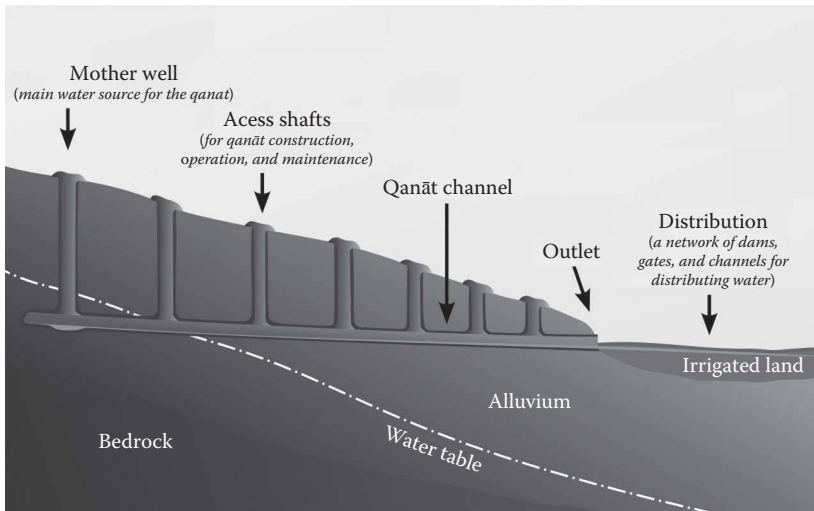
## 13.1 INTRODUCTION

The Arab region is one of the most arid regions of the world and is characterized by low rainfall and very high temperatures. Nevertheless, agricultural practices have been common in these regions since time immemorial, thanks to the centuries-old practices of building underground water canals tapping the aquifers and bringing the groundwater to the surface under the influence of gravity. These aqueducts or subterranean water tunnels have played a significant role in agricultural development and human settlement in the arid and semi-arid regions of the old world (English 1968). The technique essentially consisted of constructing subsurface water channels or canals in the alluvium and bed rock, directing water from the mountain aquifers and springs to semi-arid and arid valleys and plains for agricultural activities and community use (Lightfoot 2000).

These aqueducts have been addressed by various vernacular names in different regions. They are referred to as Qanāt/Kariz in Iran; Kahriz in Iraq; Falaj/Aflaj in the UAE and Oman; Ghayl/Miyan in Yemen; Qanāt Romani in Syria; Foggara in Egypt, Libya, and Algeria; Kriga in Tunisia; and Khattara in Morocco (Lightfoot 2000; Boualem and Rabah 2012). Outside the Arab region, they are referred to as Karez in Afghanistan, Pakistan, Azerbaijan, and Turkmenistan; Kanerjing in China; Galleria in Spain; and Mambo in Japan (Mays 2010; Fattahi 2015).

Many workers have cited that aqueducts in Saudi Arabia are known as Ain (singular) or Auyoun (plural) (Hussain et al. 2008; Remini and Kechad 2012; Remini et al. 2014; Fattahi 2015); however, the term actually is a misnomer. Ain literally means spring. This terminology of aqueducts being referred to as Ain in Saudi Arabia seemed to have originated from the fact that some of these spring sites were the source of water for the aqueducts. The aqueducts are referred to as qanāt in Saudi Arabia as well. In fact, the word qanāt is of Arabic origin; the plural is referred to as “qanwat” and is an indication of the Arabic origin of this technique of groundwater supply rather than the Persian origin, which has been deeply imbedded in the literatures available on qanāt.

Qanāts have been providing water for agricultural and domestic activities for centuries across the globe, especially in the arid and semi-arid regions. Based on the available literature, qanāts



**FIGURE 13.1** Sketch of a typical qanāt system. (Image source: Samuel Bailey; [https://commons.wikimedia.org/wiki/File:Qanāt\\_cross\\_section.svg](https://commons.wikimedia.org/wiki/File:Qanāt_cross_section.svg). With Permission.)

exist in more than 50 countries, with Iran having the maximum number of functional aqueducts (Remini et al. 2014). Qanāts basically consist of underground channels that are 50–80 cm wide and 90–150 cm high, with length varying from several hundred meters to more than 100 km. Their discharge rates may vary from 1 to 500 L/s (Mostafaeipour 2010). They have a gradient gentler than that of the ground to tap water table from the highlands or springs. Across the length of the channel, there are a series of vertical shafts at intervals ranging from 10 to 140 m to remove the excavated material, channel aeration, and operation and maintenance (Fattahi 2015). Aerially, the qanāt system appears like a line of circular craters extending from the foothills across the desert to the greener regions of irrigated settlement (News & Events 2016). Figure 13.1 shows the diagrammatic sketch of a typical qanāt. The popularity of the aqueducts in the arid and semi-arid regions of the Middle East was due to several reasons. First, they did not require any source of power other than gravity to transfer the water from its source in the aquifers to the agricultural fields/gardens/human settlement. Second, since these aqueducts were subterranean, evaporation losses due to the high temperatures in the region could be minimized and also the water was safe from surface pollution. Finally, the supply of water to these aqueducts was dependent on the volume of aquifers' recharge, their proper operation, and maintenance, which led to a sustainable source of water supply for years (Haeri 2003). This system is believed to be one of the most environment-friendly methods of groundwater abstraction in arid regions, as it is based on the passive tapping of water table by gravity, without disturbing the natural water balance (Balali et al. 2009).

## 13.2 ORIGIN OF QANĀTS: DIFFUSION OR ISOLATED INVENTIONS?

A widely believed concept for the diffusion of qanāt technology, as put forward by many workers (English 1968; Beaumont 1971; Potts 1990; Lightfoot 2000; Ahmadi et al. 2010), is that qanāts originated in Persia, and from there, they spread to the different parts of the world, including Peninsular Arabia, along the existing trade route. In fact, Lightfoot (2000) in his paper suggested three trade routes for the transfer of qanāt technology from Iran to Peninsular Arabia, namely the northern trade route (from Persia to Mesopotamia and Syria to the Levant), the central trade route (from the eastern gulf coast to the oases regions of Central Saudi Arabia and finally to the settlements around the holy city of Makkah, close to the Red Sea coast), and the southern route (from Iran to Oman and finally to Yemen). However, archeological evidences from parts of the UAE, Oman, Saudi Arabia,

and Libya present a completely different picture and are contrary to this widely accepted route of diffusion of qanāt technology. The concomitant age of aqueducts at some locations suggests that the qanāts were more of a polycentric invention (Boucharlat 2015) in response to man's adaptation to the arid environment prevailing in these regions, whereas the older age of qanāts at some locations than those at Persia suggests a reverse trajectory.

Evidences of human settlements from southeastern Arabia, which began shortly after 1100 BC, have been reported (Magee 1999; Magee et al. 1998, 2002). Qanāt systems dating back to the Iron Age (1000–600 BC) have been discovered at several locations in the UAE (Tikriti 2002, Cordoba 2002). The use of qanāts for water supply must have been in response to the increasing aridification in the region, and the entire socioeconomic condition corresponding to that period must be dependent on them (Magee 2003). Excavations carried out in the city of Al-Ain in the UAE have shown the existence of qanāts since the beginning of the Iron Age (1300–300 BC) and precedes the earliest known qanāts in Persia by several centuries and rebuts the commonly accepted notion of origin of qanāts (Tikriti 2002). Several aflaj in the UAE belonging to the Iron Age have been discovered and are now a part of the UNESCO world heritage sites. Based on extensive surveys, excavations, and C<sup>14</sup> dating, Magee (2005) concluded that the irrigation through qanāt technology was contemporaneous with the establishment of human settlement across various sites in southeastern Arabia. The oldest-known qanāts in Peninsular Arabia have been discovered from Oman. The Iron Age aflaj was discovered at Maysar in the Sultanate of Oman by the Germans. These aflaj were constructed for providing water supply to the communities living in the north of Maysar during the early Iron Age (Yule 1999). More than 4000 aflaj in the Sultanate of Oman have been recorded, of which more than 3000 are still active (Sulaimani et al. 2007).

Between the eighth and fourth centuries BC, large portions of the human settlement across the Arabian Peninsula transformed into modern societies flourishing on agriculture and trade. Important cities such as Dedan (Al-Ula), Tayma, and Dumat Al Jandal flourished along the northern caravan route. In the oasis of Al-Ula, existence of qanāts has been reported, which are believed to be constructed during the Lyhanite dynasty of Dedan, sometime in between the sixth and fourth centuries BC (Nasif 1980). Evidences of human settlements in Dumat-Al-Jandal in the Al-Jawf province of Saudi Arabia dates back to the early Bronze Age, and the presence of qanāts and groundwater wells belonging to the seventh or sixth century BC has been reported by Nasif (1987a). This points to an age similar to those of the oldest Persian qanāts, and the Persian origin of qanāts and their later diffusion to Peninsular Arabia do not hold true.

The mid-Holocene period corresponding to 5000–7000 years before present has been widely regarded as a warm period (Jones et al. 1998; Hughes and Diaz 1994; Kerwin et al. 1999; Brooks 2006) characterized by changes in global precipitation patterns, which mainly affected the Middle East and Northern Africa. The regions of Saharan Africa and Peninsular Arabia have been subjected to an ongoing desertification process since then (Wellbrock et al. 2012). The changes in global climate patterns during this period have been linked with the evolution of complex societies in order to adapt to the changing environmental conditions, especially the aridity (Brooks 2006; Sandweiss 1999). The prevailing humid conditions before the mid-Holocene, particularly in the Sahara and peninsular Arabia and their considerable decline starting from the mid-Holocene to a more or less present-day situation, forced the societies inhabiting these regions to adapt to the changing climate (Brooks 2006). The fact that changes in the climatic conditions must have led to the collapse of civilizations and the emergence of new settlements around eleventh century BC, depending on groundwater as their main source of water supply, can be deciphered from the fact that before the period of warming and corresponding increase in aridity through the mid-Holocene, societies depended on surface water canals for irrigation and domestic use. The presence of surface water canals was an indication that there was a perennial source of water supply.

Increasing aridity during the late second and early first millennium BC and the simultaneous development of qanāts are the evidences of man's adaptation to the harsh environment and are also supported by the evidence from Al-Fezzan in Libya (Mattingly 2004). Evidences from the farming



systems in Wadi Al-Ajal during the period of Garamantes (500 BC–500 AD) showed the presence of underground channels termed *Foggaras* and were similar to the *qanāts* found in Arabian Peninsula and Persia (Mattingly 2004). This region was unlikely to be in contact with either Arabia or Persia until the end of the first millennium BC and counters any hypothesis of a connection between the Achaemenid Empire and the spread of *qanāt* technology. Rather, the development of this technology was a parallel process in different geographical areas, mainly as an adaptive response to the extreme aridity, which brought about a change in the global climate after the mid-Holocene.

Based on the archeological excavations in Oman, the UAE, it is certain that the first *aflaj* in southeast Arabia came into existence several centuries before their first occurrence in Iran. Seven *aflaj* belonging to the Iron Age have been discovered in the UAE alone (Tikriti 2002), whereas a *qanāt*-dependent settlement from Tepe Yahya, southeastern Iran, reveals an age of 800 BC (Magee 2005), which is approximately 200 years after the *qanāts* were discovered from the UAE in southeastern Arabia.

These observations refute the generally accepted historical trajectory of *qanāt* technology, which states that *qanāt* irrigation systems were first invented in Iran in the eighth century BC (English 1968; Lightfoot 2000), from where these was transferred to Arabia and the rest of the Middle East during the period of the Achaemenid Empire (538–332 BC). In fact, the observation from the UAE and Oman suggest an inverse trajectory of *qanāt* diffusion, from Peninsular Arabia to Persia. The development of *qanāts* of Al-Ula and Dumat Al Jandal in Saudi Arabia and Al-Fezzan in Libya can surely be considered an isolated innovation triggered by the hydrological stress created by the prevailing climatic conditions.

### 13.3 QANĀTS IN SAUDI ARABIA

Evidences of the existence of *Qanāts* in Saudi Arabia have been found in Al Qatif, Al Khobar, and Al Hasa in the Eastern region; Al Asyah, Al Kharj, Al Layla-Al Aflaj, and Yabrin in the Central region; Ain Zubaydah, Ain Zarqa (Lightfoot 2000), and *qanāts* of Al-Ula in the Western region; and Al-Jawf in the Northern region (Nasif 1980, 1987a).

The presence of *qanāt* in Saudi Arabia has been centered on the presence of natural springs such as those in Al Qatif, Al Hasa, and Al Kharj; Al Layla-Al Aflaj; or those in Western Saudi Arabia, notable among which is the Ain Zubaydah *qanāt*. Al Layla in central Saudi Arabia, for instance, is an example where a single spring-fed lake, covering an area of 4 km<sup>2</sup>, existed and *qanāts* were developed around the lake (Ritter and Meckelein 1980).

Zamzam well in Makkah deserves a special mention here, owing to its historical and religious significance. Although it is not a *qanāt*, it has been a source of water supply in Makkah for around 4000 years ([www.sgs.com.sa](http://www.sgs.com.sa)). Similarly, the well of Ayn Haddaj that is believed to be the largest well in Peninsular Arabia and a source of water for agricultural activities in Tayma (northwestern Saudi Arabia) for over 2500 years has also been mentioned here. Figure 13.2 shows the location of all the *qanāts* and wells in the Arabian Peninsula, which has been discussed in this chapter.

Al Hasa region in the eastern province of Saudi Arabia is an oasis and is believed to be the oldest center of human settlement in the Arabian Peninsula, thanks to the availability of water and natural springs in the region. A system of irrigation known as *Saih* existed in the region where water flowed from large springs into an extensive network of canals known as *masqas* (Hecht 2011). During the late 1960s, a number of springs were integrated into the present Al-Hassa Irrigation and Drainage Authority, which was completed in 1971 (Hussain 1982) and was the largest irrigation network in the country (Abderrahman 1988). Figure 13.3 shows the satellite image of these irrigation canals in Al Hasa oasis.

Abraq Farzan, which was an artesian spring and supplied water to a series of *qanāts* in Al Kharj, belonged to the early Islamic period (Schiettecatte et al. 2013). It was fed by an open-air canal leading into a *qanāt*, which is still visible from the surface. It consists of a series of shafts or vertical

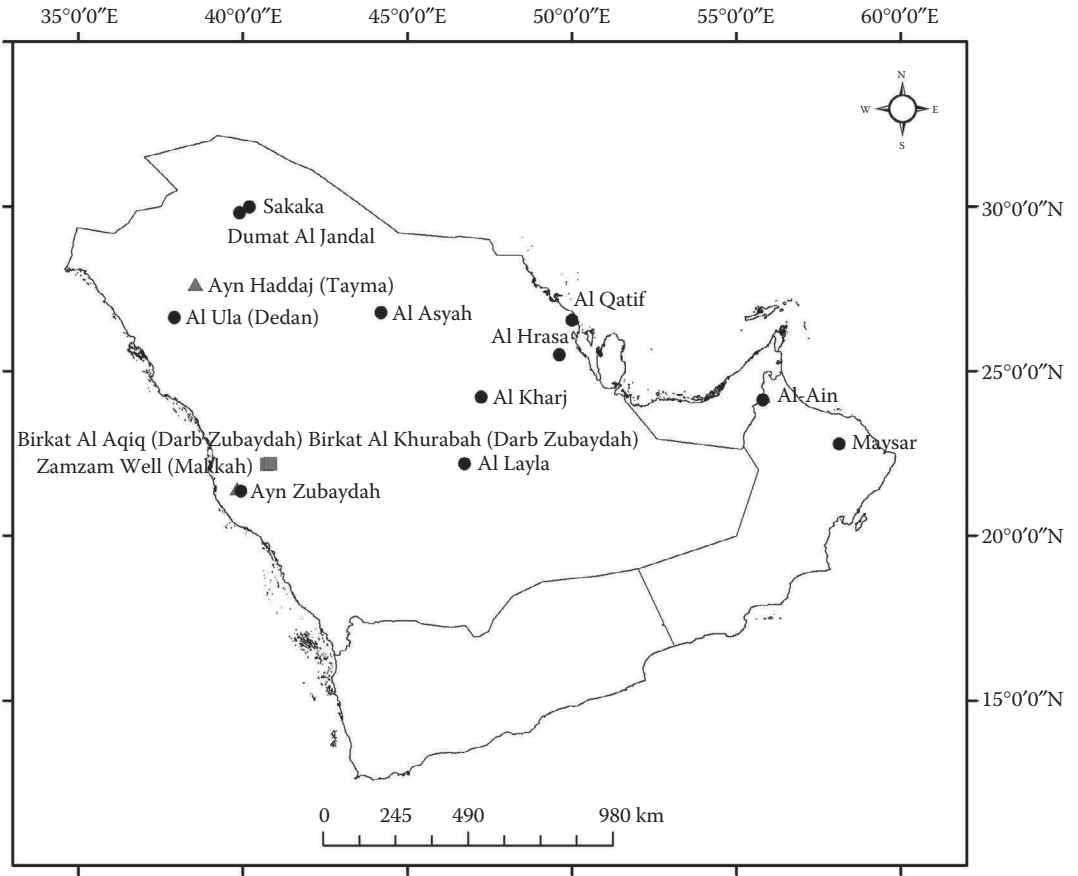


FIGURE 13.2 Location of the qanāts and wells in Peninsular Arabia discussed in this chapter.

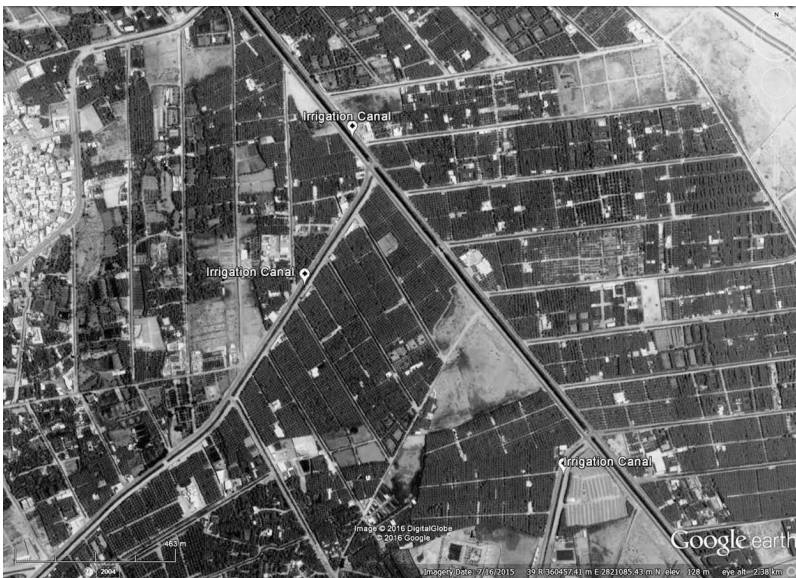


FIGURE 13.3 The network of irrigation canals in Al Hasa. The source of the water in these canals is the Al Asfar Lake, situated in the northeast of Al Hasa, Eastern Saudi Arabia.

Downloaded by [ETH BIBLIOTHEK (Zurich)] at 09:18 13 January 2017



**FIGURE 13.4** Satellite image of the qanāt system in Al Kharj, Central Saudi Arabia.

wells about 3 m in diameter and approximately 11 m apart and was in use until the early part of the twentieth century (Philby 1920). Figure 13.4 shows the satellite image of the qanāt in Al-Kharj. However, with the increase in groundwater demands and improvement in drill technology, many of the qanāts became defunct. In the oasis of Qatif, buried ruins of qanāt have been discovered. These qanāts were in use until the 1940s but were later replaced by deep wells (Kobori 1973). Qanāts also existed in the Ayn Ibn Fuhayd (Al Asyah) governorate in the Qassim province of Saudi Arabia, dating back to the early Islamic period (<http://alsahra.org>). Figure 13.5 shows the aerial image of the qanāts in the Ayn Ibn Fuhayd area, and Figure 13.6 shows the field photographs of the same qanāts.



**FIGURE 13.5** Satellite image of the qanāt system in Al Asyah, Al Ayn Ibn Fuhayd governorate, Central Saudi Arabia.



**FIGURE 13.6** Field photographs of the vertical shafts and qanāts in Al Ayn Ibn Fuhayd governorate. Photo Credit: Omar Lafouza.

In the following section, we describe some of the important places in the kingdom of Saudi Arabia, where qanāts and historical groundwater wells existed, some of which are still in use.

### 13.3.1 QANĀTS AT AL-ULA

Dadān, al-ʿUla, was one of the principal settlements of northern Arabia during the first millennium BC and was located northeast of the present town of Al-Ula. It was the hub of communication network, connecting southern Arabia with Egypt, Syria, and Mesopotamia along the ancient Incense Route. The town was the capital of the kingdom of Dadān during the first half of the first millennium BC, later becoming the center of the dynasty of the Lihyanite kingdom, before its collapse during the first century BC (Al-Said 2011). The people of the region flourished owing to the ingenuity of their trade and innovations in agricultural practices. A whole network of underground aqueducts was reported in the region by Nasif (1980), in the absence of which the entire area would have remained deserted. Al-Nasif concludes that the Lihyanite inscriptions found at Al-Ula indicates that these qanāts were built sometime in between the sixth and fourth centuries BC. Four qanāts, namely Zuhra, Salihiyah, Salimiyyah, and Fath, have been studied by Nasif. All these qanāts drew water from the Al Udhyab area. The lengths of the qanāts were around 3 km and the slope was 0.43%. Since the alluvial sediments present in the region were very friable, the roofs and the walls of the qanāts were lined with the compact sandstones found in the region. However, the instability of these surrounding sandstones was also a threat to the proper functioning of the qanāts, as they would block the underground channels, especially after heavy rainfall events. All these qanāts were primarily used for irrigation purpose. These qanāts were functional till the 1980s, but owing to the extensive damage caused to the qanāts by the heavy rains, it was not possible for the qanāt owners to

renovate them, and instead, this gave way to the exploitation of groundwater by bore wells operated by diesel pumps (Nasif 1980).

### 13.3.2 QANĀTS AT AL-JAWF

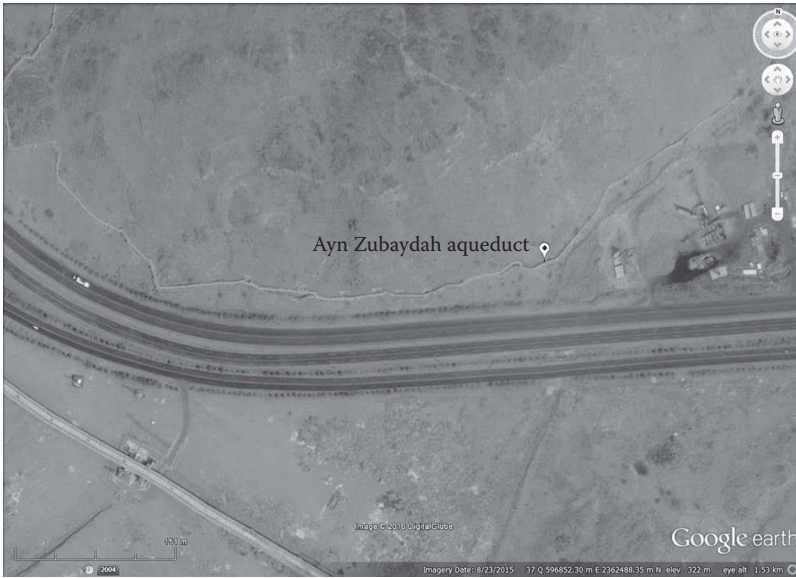
Evidences of qanāts at Dumat Al Jandal and Sakaka have been reported by Nasif (1987a, 1987b). Dumat Al Jandal is located in the Al-Jawf province of Saudi Arabia, near the southern end of Wadi Al-Sirhan, which is about 50 km from the city of Sakaka. It was an important destination along the Incense Road since the tenth century BC (Wellbrock et al. 2012). Mention of caravans arriving in Assyria from Tayma and Saba is present in the Assyrian texts from the eighth century BC, suggesting that the trade route must have passed through “*Adummatu*,” the Assyrian name for Dumat Al Jandal (Charloux and Loreto 2013). The presence of a large number of wells close to a nearby wadi indicates the presence of shallow groundwater as the main source of water supply in the region, which was used for irrigation as well as domestic purposes. The wells and qanāts of Dumat Al Jandal have been studied by Thomas et al. (2013) and Marcolongo (2013). Exploration of the wells by Thomas et al. (2013) made it possible to discover the qanāts, as the surface expression of these qanāts are not very well preserved. As described by Charloux and Loreto (2013), some wells at Dumat Al Jandal have staircase integrated in their masonry, which leads to opening at regular heights, providing access for the maintenance of the wells and the qanāt system. Although the qanāt system at Dumat Al Jandal has not been dated so far, the presence of water flowing through these qanāts has been mentioned during the time of Prophet Mohammad (peace be upon him [pbuh]) (Charloux and Loreto 2013). No evidence of the use of surface runoff has been reported (Wellbrock et al. 2012), thereby giving an indication that the region was dependent on groundwater supplies since its early human occupation.

In the Sakaka region of Al-Jawf province, a well referred to as Bir Saisara was believed to be the main source of groundwater, serving the underground network of qanāt (Nasif 1987a). This well is elliptical in shape. It has a diameter of 8 m and 7 m along the long and short axes, respectively; a depth of 15 m; and spiral staircases. These spiral staircases led to a rectangular opening, which was believed to be the access point for the qanāt; however, it could not be physically confirmed by Nassif. According to information provided by the locals of the region to Nasif (1987a), the qanāt originating from this well was about 1.5 km in length and the tunnel was about 0.75 m wide and approximately 2 m in height. Although the exact age of this qanāt has not been confirmed, based on the similarity between the shafts of Bir Saisara and the shafts of the well of Al Jib in Palestine, a speculative age of late seventh century or early sixth century BC has been suggested (Pritchard 1961).

### 13.3.3 AYN ZUBAYDAH AL AZIZIYAH

Ayn Zubaydah Al Aziziyah is an integrated underground water transfer system that had been a source of water supply to Makkah and the surrounding holy sites for over more than 1200 years. It is located in Numan Wadi (valley) east of Makkah city and comprises a network of stone-lined galleries, which can be accessed by stone-lined shafts spread along the gallery network for the purpose of cleaning and maintenance (Mokhtar 2008). The construction of the qanāt started in the eighth century AD and was completed in 801 AD (Khurshid 2012). Figure 13.7 shows the aerial image of the aqueduct. Figure 13.8 shows the field photograph of the Ayn Zubaydah canal. The spring and the aqueduct originating from the spring are named after its founder Zubaydah Al-Abassid, the wife of Caliph Haroon Al-Rasheed, who lived in Baghdad from 760 to 820 AD. Seeing the water scarcity in Makkah, Queen Zubaydah ordered the construction of a qanāt that could bring water from the valleys in vicinity of Makkah to the holy sites. After detailed survey by engineers, two sites were suggested to bring water to Makkah. One was in wadi Hunayn and the other was in wadi Numan. Owing to frequent rainfall in this region, the water table was relatively shallow, thereby facilitating





**FIGURE 13.7** Satellite image of the Ayn Zubaydah aqueduct, approximately 9 km southeast of the holy mosque in Makkah, Western Saudi Arabia.



**FIGURE 13.8** Field view of the Ayn Zubaydah canal. (Photo Credit: hussam11; <http://static.panoramio.com/photos/1920x1280/26876585.jpg>. With Permission.)

the construction of the qanāt. Wadi Hunayn was the first to be exploited, where the groundwater was brought to large storage tanks near the holy site in Makkah. However, owing to the continuous use of this water, the groundwater levels declined and the focus shifted to Wadi Numan. Queen Zubaydah bought the land in the wadi and supported the development of the qanāt.

The qanāt that spans over a length of 27 km, starting from Wadi Numan to the Aziziyah district in Makkah, consisted of 130 wells/kharazah, and its water was dammed by a natural underground dam just east of Arafat. For this reason, it was not much affected by years of drought. Four to five dug wells were constructed in Wadi Numan, which were approximately 35 m deep and marked the beginning of Ayn Zubaydah qanāt. The water from all these wells was collected in one well through tunnels. This mother well was known as the Ummiyah. The water from this mother well to the city



of Makkah was transferred through the qanāt. The slope of the qanāt ensured that the water flowed naturally under the influence of gravity. To maintain the gradient, the qanāt was above the ground at some places and underground at others. For the maintenance and aeration of the qanāt, vertical access wells known as kharazah were constructed at every 50 m. The kharazah and the qanāt were lined with mortar made of lime and stones to make it waterproof and prevent the absorption of water. The gradient of the qanāt throughout its length is about 1 in 3000, which in itself is an architectural wonder. From Wadi Numan, the qanāt moves toward the plains of Arafat. At the Jabal Al Rahmat in Arafat, the qanāt is about 10 ft above the ground. There were three tanks near the Jabal Al Rahmat, which could be filled with water brought from the qanāt, providing freshwater supply to the pilgrims during the Hajj season. From Arafat, the qanāt heads north and is mostly underground as it passes through Wadi Uranah to finally reach Muzdalifah, where the qanāt takes the shape of well, providing water to the pilgrims in Muzdalifah and Mina.

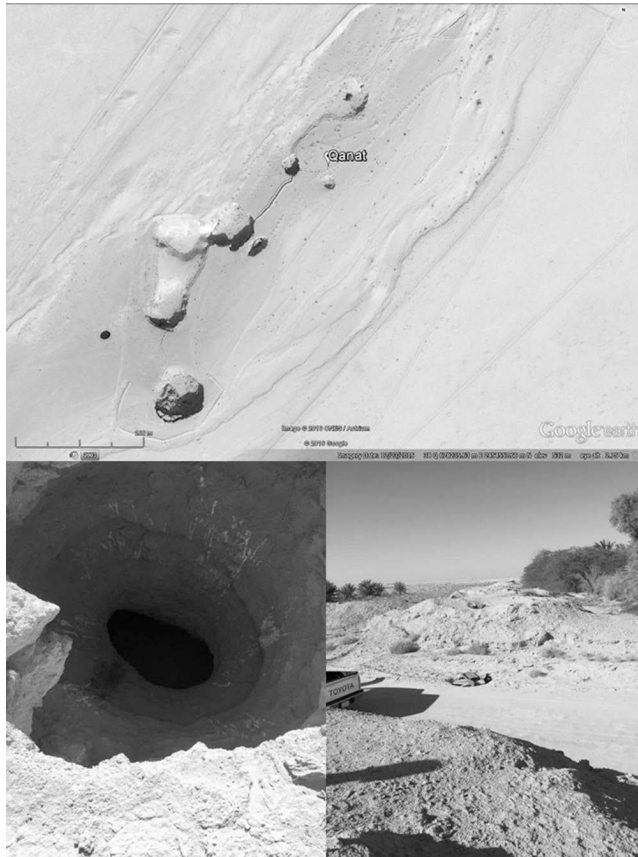
The qanāt was functional until the 1920s, when floods in Makkah filled the qanāt with sand and gravel, thereby obstructing the flow of water. It was in 1928 when King Abdulaziz invited engineers from Egypt to renovate and restore the functioning of the qanāt. The system that was robust and built with great technical expertise provided over 40,000 m<sup>3</sup> of water per day and remained functional until 1974 (Hussain et al. 2008). Parts of this qanāt system were later damaged, and at present, the length of the existing part is around 18 km (Hussain et al. 2008). Owing to inadequate operations and maintenance, coupled with growing water demand and the advent of new pumping techniques, the groundwater levels declined and the supply of water to Ayn Zubaydah was cut off, and the qanāt became dry.

#### 13.3.4 THE LAYLA LAKES

Layla is the main town of the Al-Aflaj oasis in the Ar Riyadh province, approximately 330 km south of the city of Riyadh, and is famous for its sinkholes. These sinkholes were deep enough to intercept the water table and formed lakes, which existed until the mid-1980s (Kempe and Dirks 2008). These lakes were the natural outlets for deeper aquifers, and a series of qanāts were built from these lakes to carry water to the fields and date farms in the north. The water used from these lakes were sustainable, as the water flowing through the qanāts under the influence of gravity was only consumed. Date farming in the regions has been carried out since centuries by using the water that flowed through these qanāts. Depending on the presence of a reliable water source, these subterranean channels or qanāts were constructed from their source (lakes in the present case) to the area required for irrigation. A vertical well or shaft was constructed approximately every 20–30 m across these qanāts to remove the excavated material during the construction of the qanāt; maintenance and operation of the qanāt after its construction; and the aeration of water flowing through these qanāts (Thompson 2013). The qanāts of Layla are only of historic interest now, as the lakes that were the source of water for these qanāts have dried up, owing to the water table falling below the level of the deepest sinkholes. Figure 13.9 shows the satellite image and field photographs of the qanāts in Al Layla.

#### 13.3.5 DARB ZUBAYDAH AL AZIZIYAH

The approximately 1400 km long Kufi pilgrimage route, known as the Darb Zubaydah, was the most important pilgrimage route connecting the holy city of Makkah from Kufa, a city in Iraq about 170 km south of Baghdad. Although parts of the Darb Zubaydah were in use in the pre-Islamic era, a permanent route for the Mesopotamians traveling to Makkah was established during the reign of the Abbasid caliph, Haroon Al-Rasheed. Like Ayn Zubaydah, this pilgrimage route is also named after the wife of Haroon Al-Rasheed, Queen Zubaydah bint Ja'far, who took keen interest in the welfare of the pilgrims traveling to Makkah from Iraq. In fact, the hardships involved in the travel due to dust storms and scarcity of water prompted Queen Zubaydah to improve the facilities along



**FIGURE 13.9** Satellite image and the field photographs showing the vertical shafts and the qanāt in Al Layla, Central Saudi Arabia (Photo Credit: Mufleh Al-Dossari.)

this important route. Markers and milestones were installed, and the route was developed with stations that had fresh water pools, dams, palaces, houses, and pavement. The distances between these stations were normally 12–30 km, depending on the terrain, and the distance pilgrims could traverse in a day (Caudill 2006). The route started from Kufa in Iraq, entering Saudi Arabia near Rafha, moving on to Mahd Ad Dahab, and finally meandering through different valleys to reach Taif and Makkah. The most striking and remarkable feature of this ancient pilgrimage route was the presence of the *birqats* or freshwater pools alongside other facilities. The artificial water works present along the Darb Zubaydah is an excellent example of man’s adaptation to the harsh environment. Since there are few groundwater springs or oases in this part of the Arabian Peninsula, the roads were made usable by constructing large reservoirs with cisterns, in the drainage basin or along the water flow path in the wadi, which could tap the water during flash floods. The drainage basins were properly maintained in order to protect the cistern and the main reservoir from being destroyed by the force of moving water. Normally, the cisterns and reservoirs were constructed away from the main wadi course. They used to tap the overflow water, which filled the depressions. The cisterns were connected to a secondary filter tank, where all the sediments were allowed to settle down before the water was allowed to collect in the main pool. Mention of three freshwater pools, Birqat Al Aqiq and Birqat Al Khurabah, approximately 95 km to the north east of city of Taif, and Birqat Al Madiq, situated some 38 km northeast of Makkah, on this important pilgrimage route can be found in the literature (Caudill 2006). Figure 13.10 shows the satellite image and field photograph of Birkat Al-Aqiq, whereas Figure 13.11 shows the satellite image and field photograph



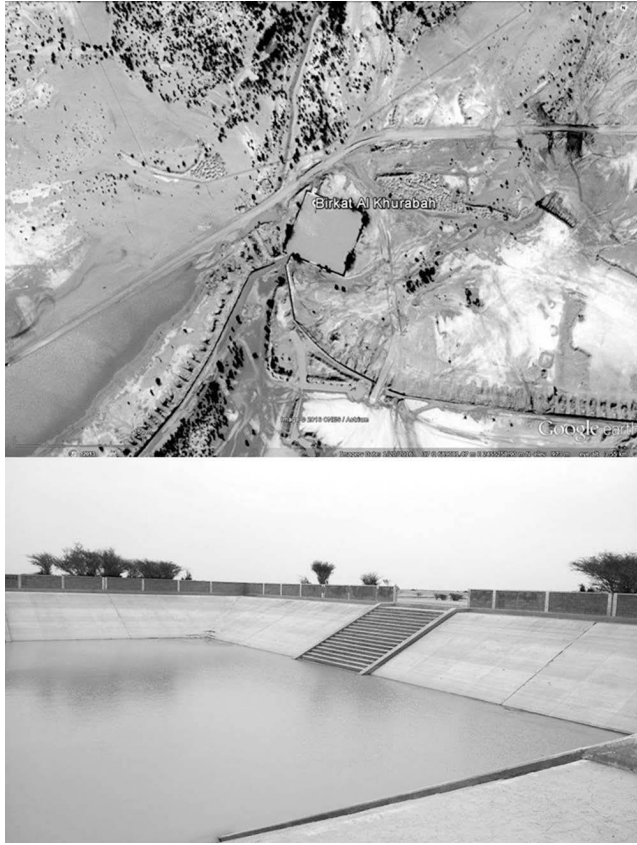
**FIGURE 13.10** Satellite image and field photograph of Birkat Al Aqiq on Darb Zubaydah, approximately 130 km northeast of the holy mosque in Makkah, Western Saudi Arabia. (Photo Credit: Ibn e Bakhtiar; <http://static.panoramio.com/photos/1920x1280/89512875.jpg>. With Permission.)

of Birkat Al-Khurabah. The Darb Zubaydah was a remarkable success, with its birqats standing as a testimony of the vision of its creators and a remarkable feat of hydrological engineering.

### 13.3.6 THE ZAMZAM WELL

Although there is no qanāt built from the Zamzam well, a special mention must be given to it, as the well has been supplying water for over 4000 years, except for a few periods when it was dry or buried under sand. It was the first and the most ancient source of water supply in Makkah and is located in the holy mosque, about 20 m east of the Ka’ba, the cubical structure at the center of the holy mosque in Makkah, regarded as the house of God and in the direction that Muslims across the globe should face while performing their prayers.

According to Islamic belief, the well is the site of a spring that miraculously emerged from a barren valley between the hills of Safa and Marwa, where Prophet Ibrahim (pbuh), under Allah’s command, had left his wife Hajar and their infant son Ismail (pbuh). In her desperate search for water, Hajar ran seven times back and forth between the two hills of Safa and Marwa in the scorching heat to look for water for Ismail (pbuh), who was thirsty. Allah sent Angel Gabriel, who rubbed the ground, causing the spring to appear. On finding the spring and fearing that it might run out of water, Hajar enclosed it in sand and stones (Shil and Abdul-Wahid 2002). The origin of the word Zamzam takes its route from the phrase Zomē , meaning “stop flowing,” a command that was



**FIGURE 13.11** Satellite image and field photograph of Birkat Al Khurabah on Darb Zubaydah, approximately 135 km northeast of the holy mosque in Makkah, Western Saudi Arabia. (Photo Credit: Ibn e Bakhtiar; <http://static.panoramio.com/photos/large/89514264.jpg>. With Permission.)

repeatedly used by Hajar in order to stop the spring water from flowing. The area around the spring, which was later converted into a well, became a resting place for caravans and is regarded as the first site of permanent settlement in Makkah, the birthplace of Prophet Muhammad (pbuh). The well continued to be a source of water supply for the settlements in Makkah, but by the fifth century AD, it was no longer in use as it was completely buried under sand and its landmarks were hidden completely. It was later rediscovered by Abdul-Mutallib, the grandfather of Prophet Mohammed (pbuh) in the sixth century AD. He built a cistern beside it and used to fill it with water along with his son, so that the pilgrims could benefit from the stored water. The well during that time was simple, surrounded by a fence of stones, and had two cisterns: one for drinking and one for ablution. In the era of the Abbasid caliph Al-Mansur, that is, 771 AD, a dome was built above the well and it was tiled with marble. In 1417, during the time of the Mamluks, the mosque was damaged by fire and required restoration. Further restoration took place in 1430 AD and again in 1499 AD, when the marble was replaced (Shil and Abdul-Wahid 2002).

In the recent times, the most extensive restoration took place to the dome, during the era of the Ottoman Sultan Abdul Hamid II, in 1915 AD. For the ease of the pilgrims during tawaf (the circumambulation around the Ka'ba), the building housing the Zamzam was moved away and is now pumped in the eastern part of the mosque.

The Zamzam well was excavated by hand and is about 30 m deep and 1.08–2.66 m in diameter. It taps groundwater from the wadi alluvium and some from the bedrock. Originally, water from the

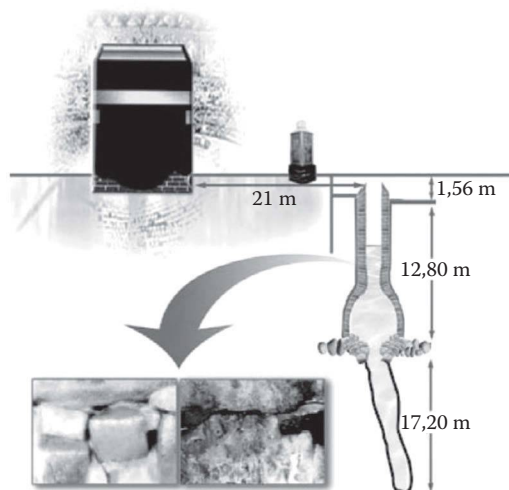
well was drawn via ropes and buckets, but today, the well is in a basement room, from where electric pumps draw the water, which is available throughout the Masjid al-Haram.

Hydrogeologically, the well is in the Wadi Ibrahim. The upper half of the well is in the sandy alluvium of the valley, lined with stone masonry, except for the top 1 m, which has a concrete “collar.” The lower half of the well is in the bedrock. In between the alluvium and the bedrock, there is a 50 cm thick section of weathered permeable rocks, which provide the main water entry into the well. Water in the well comes from precipitation in Wadi Ibrahim, as well as from the runoff from the local hills ([www.sgs.gov.sa](http://www.sgs.gov.sa)). Figure 13.12 shows the structure of the Zamzam well and its distance from the holy Ka’ba.

The keen interest of King Abdulaziz and King Abdullah bin Abdulaziz in improving the facilities at the two holy sites in Saudi Arabia led to the formation of the Zamzam Studies and Research Center (ZSRC) at the Saudi Geological Survey to maintain the quality and quantity of Zamzam water. A series of studies to define, quantify, and monitor the water source and provide the information needed to manage and sustain supplies in the face of increasing demand by residents and pilgrims have been effectively taken up by the center (ZSRC 2016).

### 13.3.7 WELL OF AYN HADDAJ

A special mention must also be given to the Haddaj well in Tayma region of northwestern Saudi Arabia. Tayma lies on the ancient trade route between Yathrib (Medina) and Dumah. The Haddaj well is believed to be the largest well in Peninsular Arabia and dates back to the mid-sixth century BC. It was built more than once throughout its history. All of Tayma was buried during the fifth century BC, and the well was not in use for many centuries, till it was restored to its functional state by Suleiman al-Gonaim. In the recent times, it was renovated by King Saud bin Abdulaziz in 1953, when pumps were added to the well to increase production (Arabian Rock Art Heritage 2016). The source of this well is a spring known as Ayn Haddaj. The water from the well has been used for irrigation purposes, and the well still supplies water to the nearby wells through a system of canal. The well basically worked on a pulley system, where water was pulled up by camels or oxen and then was put into channels, which carried them all the way to the farms. Figure 13.13 shows the image and the field photograph of Ayn Haddaj.



**FIGURE 13.12** Diagrammatic sketch of the position and structure of the Zamzam well in the holy mosque at Makkah, Western Saudi Arabia. (Image Source: <http://www.thekeytoislam.com/theme/images/g-zamzam-well.jpg>. With Permission.)





**FIGURE 13.13** Satellite image and the field photographs of the well of Ayn Haddaj in Northwestern Saudi Arabia. (Photo Credit: jamaan alathly; <http://static.panoramio.com/photos/1920x1280/115000422.jpg>. With Permission.)

### 13.4 CONCLUSIONS

Based on the evidence of the Iron Age qanāts from Oman, the UAE, and Saudi Arabia, the hypothesis of diffusion of qanāt technology from Persia to Arabian Peninsula does not hold any longer. In fact, the presence of qanāts as old as 3000 years suggests that the technology for building qanāts was transferred from southeastern Arabia to Persia.

The climatic shifts during the mid-Holocene affected the entire Arabian Peninsula and Saharan Africa and triggered not only the sedentary lifestyle of the humans but also their agriculture practices. Evidences of the simultaneous growth of settlement through the Iron Age in southeastern, southwestern, and northern Arabia were an indication of man's adaptation to this climatic shift. Groundwater as a source of water supply for domestic and agricultural use became common only after this period of continuous aridity. Qanāts, which relied on the availability of groundwater, came into existence during this time, and their existence should be considered more as polycentric inventions in response to climate change after the mid-Holocene period of warming. Qanāts from Al Ula and Dumat Al Jandal in the northern part of Saudi Arabia belong to this period, where the shallow aquifers (mostly Quaternary alluvial aquifers) must have been the source of groundwater, resulting in the sustenance of the settlements.

Although there are no qanāts originating from their source, owing to the religious and historic significance, the wells of Zamzam in Makkah and Ayn Haddaj in Tayma have also been mentioned here. Both the wells are still in use and date back to 4000 years and 2500 years respectively.

The technology involved in the construction of the qanāts, which allow the transfer of water from natural groundwater springs or by intercepting the groundwater table along hill slopes and allow the water to flow under the influence of gravity to areas of water demand through mostly underground and sometimes over-the-ground channels, should be considered as a feat of hydrological engineering. The distance of these qanāts along which the water could flow and the fact that they were built



at a time when the modern techniques of leveling, survey, and global positioning were not available make them one of the most advanced scientific treasures of the human history. It was also a very sustainable technique of groundwater usage, as there was no artificial pumping involved and only the water that could flow naturally through the qanāts was available to the community.

Although the information about the qanāts of Saudi Arabia has been painstakingly recorded by numerous workers and travellers, a more systematic approach of documenting, dating, and preserving the qanāts is required. Efforts must be made to rejuvenate some of these existing qanāts. Unit for Ain Zubaida Rehabilitation and Ground Water Research at King Abdulaziz University in Jeddah is one such effort for rejuvenating the Ayn Zubaydah canal. The need of the hour is to devise ways to go back to this traditional yet highly sustainable technique of groundwater distribution to minimize the water stress, especially in the arid regions of the world, for a greener future.

## ACKNOWLEDGMENT

The authors would like to thank the SGS Chair for Natural Hazards and King Saud University for providing the necessary research facilities.

## REFERENCES

- “Arabian Rock Art Heritage.” Tayma -. Accessed February 3, 2016. <http://saudi-archaeology.com/sites/tayma/>.
- “2015”. من الزلفي الى الاسياح (3): القنوات المائنة (القطانم) في النباح. Accessed February 10, 2016. <http://alsahra.org/?p=13341>.
- Abderrahman, W. 1988. Water management plan for the Al-Hassa irrigation and drainage project in Saudi Arabia. *Agricultural Water Management* 13:185–194.
- Ahmadi, H., A.N. Samani, and A. Malekian. 2010. The Qanat: A living history in Iran. In *Water and Sustainability in Arid Regions*, ed. G. Schneier-Madanés and M. Courel, p. 126. the Netherlands: Springer.
- Al-Said, S.F. 2011. Recent epigraphic evidence from the excavations at Al-ʿUla reveals a new king of Dadān. *Arabian Archaeology and Epigraphy* 22:196–200.
- Balali, R.M., J. Keulartz, and M. Korthals. 2009. Reflexive water management in arid regions: The case of Iran. *Environmental Values* 18:91–112.
- Beaumont, P. 1971. Qanat systems in Iran. *Hydrological Sciences Journal* 16:39–50.
- Boualem, R. and K. Rabah. 2012. The foggara in the Arab world. *Journal of Geographia Technica* 1:1–7.
- Boucharlat, R. 2015. Le falaj ou qanāt, une invention polycentrique et multipériode. [http://archeorient.hypotheses.org/4692?lang=fr\\_FR](http://archeorient.hypotheses.org/4692?lang=fr_FR).
- Brooks, N. 2006. Cultural responses to aridity in the Middle Holocene and increased social complexity. *Quaternary International* 151:29–49.
- Caudill, M.A. 2006. *Twilight in the Kingdom: Understanding the Saudis*. Greenwood Publishing Group, Westport, CT.
- Charloux, G. and R. Loreto. 2013. *Dūmat al-Jandal. 2800 years of History in the Kingdom of Saudi Arabia*, p. 18. Riyadh, Saudi Commission for Tourism and Antiquities-EADS Airbus Group.
- Cordoba, J. 2003. Villages of shepherds in the Iron Age . The evidence of Al Madam (AM1 Thuqaibah, Sharjah, UAE). In *Archaeology of the United Arab Emirates*, D. Potts, H. Al Naboodah, P. Hellyer, eds., 173–180, Trident Press, London.
- English, P.W. 1968. The origin and spread of qanats in the Old World. *Proceedings of the American Philosophical Society* 112:170–181.
- Fattahi, M. 2015. OSL dating of the Miam Qanat (KĀRIZ) system in NE Iran. *Journal of Archaeological Science* 59:54–63.
- Garbrecht, G. 1983. Ancient water works—lessons from history. *Impacts of Science on Society* 1:10 (UNESCO).
- Haeri, M.R. 2003. Kariz (Qanat); an eternal friendly system for harvesting groundwater. In *Adaptation Workshop*, New Delhi, India.
- Hecht, G. 2011. *Entangled Geographies: Empire and Technopolitics in the Global Cold War*, p. 217. MIT Press., Cambridge, MA.

- Hughes, M.K. and H.F. Diaz. 1994. Was there a 'Medieval Warm Period', and if so, where and when? *Climatic Change* 26:109–142.
- Hussain, I., O.S. Abu-Rizaiza, M.A.A. Habib, and M. Ashfaq. 2008. Revitalizing a traditional dryland water supply system: the karez in Afghanistan, Iran, Pakistan and the Kingdom of Saudi Arabia. *Water International* 33:333–349.
- Hussain, Z. 1982. Problems of irrigated agriculture in Al-Hassa, Saudi Arabia. *Agricultural Water Management* 5:359–374.
- Jones, P.D., K.R. Briffa, T.P. Barnett, and S.F.B. Tett. 1998. High-resolution palaeoclimatic records for the last millennium: Interpretation, integration and comparison with General Circulation Model control-run temperatures. *The Holocene* 8:455–471.
- Kempe, S. and H. Driks. 2008. Layla Lakes, Saudi Arabia: The world-wide largest lacustrine gypsum tufas. *Acta Carsologica* 37:7–14.
- Kerwin, M., J.T. Overpeck, R.S. Webb, A. DeVernal, D.H. Rind, and R.J. Healy. 1999. The role of oceanic forcing in mid-Holocene northern hemisphere climatic change. *Paleoceanography* 14:200–210.
- Khurshid, K. 2012. Ayn Zubaydah flows down memory lane. *Arab News*, June 30.
- Kobori, I. 1973. Some notes on diffusion of qanat. *Orient* 9:43–66.
- Lightfoot, D.R. 2000. The origin and diffusion of qanats in Arabia: New evidence from the northern and southern peninsula. *The Geographical Journal* 166:215–226.
- Magee, P. 1999. Settlement patterns, politics and regional complexity in the southeast Arabian Iron Age. *Paléorient* 24:49–60.
- Magee, P. 2005. The chronology and environmental background of Iron Age settlement in Southeastern Iran and the question of the origin of the Qanat irrigation system. *Iranica Antiqua* 40:217–231.
- Magee, P. 2003. New chronometric data defining the Iron Age II period in southeastern Arabia. *PSAS* 33:6–7, Archaeopress, Oxford, UK.
- Magee, P., Grave, P., Al-Tikriti, W.Y. et al. 1998. New evidence for specialised ceramic production and exchange in the southeast Arabian Iron Age. *Arabian Archaeology and Epigraphy* 9:236–245.
- Magee, P., Thompson, E., Mackay, A. et al. 2002. Further evidence of desert settlement complexity: Report on the 2001 excavations at the Iron Age site of Muweilah, Emirate of Sharjah UAE. *Arabian Archaeology and Epigraphy* 13:133–156.
- Marcolongo, B. 2013. The Geo-archaeological Survey of Dûmat Al-Jandal and Al-Jawf Area, 2011 Survey Campaign. Report, Saudi Commission for Tourism & Antiquities.
- Mattingly, D.J. 2004. Surveying the desert: From the Libyan valleys to Saharan oases. *British School at Athens Studies*, 163–176.
- Mays, L.W. 2010. *Ancient Water Technologies*. Berlin, Germany: Springer Science & Business Media.
- Mokhtar, T.A. 2008. Assessing the potential of in-gallery seismic shots in exploring buried structures of 'Ain Zubaidah using acoustic wavefield modeling. *Earth Sciences* 19:1–20.
- Mostafaeipour, A. 2010. Historical background, productivity and technical issues of qanats. *Water History* 2:61–80.
- Nasif, A.A. 1987a. An ancient water system in Sahārā, Al-Jawf, Saudi Arabia. *Proceedings of the Seminar for Arabian Studies*, 127–135.
- "News & Events." International Center on Qanats. Accessed February 10, 2016. <http://icqhs.org/SC.php?type=static>.
- Pritchard, J.B. 1961. *The water system of Gibeon*, University Museum Monograph, UPenn Museum of Archaeology, Pennsylvania.
- Nasif, A.A. 1987b. The Ancient Qanât System of Dûmat al-Jandal, Al-Jauf, Saudi Arabia. *Ages* 2:61–70.
- Nasif, A.A. 1980. Qanats at al-'Ula. *Proceedings of the Seminar for Arabian Studies*, 10:75–79.
- Philby, H. St JB. 1920. Southern Najd. *Geographical Journal*, 55:161–185.
- Potts, D.T. 1990. *The Arabian Gulf in Antiquity: From Prehistory to the Fall of the Achaemenid Empire*, Vol. 2. Clarendon Press, Oxford, UK.
- Remini, B. and R. Kechad. 2012. The foggara in the Arab world. *Journal of Geographia Technica* 1:1–7.
- Remini, B., R. Kechad, and B. Achour. 2014. The collecting of groundwater by the qanats: a millenium technique decaying. *Larhyss Journal* 20:259–277.
- Reza, B.M., J. Keulartz, and M. Korthals. 2009. Reflexive water management in arid regions: the case of Iran. *Environmental Values* 18(1):91–112.
- Ritter, W. and W. Meckelein. 1980. Did Arabian oases run dry? *Desertification in Extremely Arid Environments* 95:73–92.
- Sandweiss, D.H., K.A. Maasch, and D.G. Anderson. 1999. Transitions in the mid-Holocene. *Science* 283:499–500.

- Schiettecatte, J., A. Al-Ghazzi, G. Charloux, et al. 2013. The oasis of al-Kharj through time: First results of archaeological fieldwork in the province of Riyadh (Saudi Arabia). *Proceedings of the Seminar of Arabian Studies* 43:285–308 (Oxford, Archaeopress).
- Shil, M.I. and Abdur-Rahman, A. 2002. Historic Places: The Well of Zamzam. <http://web.archive.org/web/20080223204039/http://www.islamonline.net/English/hajj/2002/01/stories/article4.shtml> (accessed February 10, 2016).
- Sulaimani, A., Z. Khalid, T. Helmi, and H. Nash. 2007. The social importance and continuity of falaj use in northern Oman. In *International History Seminar on Irrigation and Drainage Tehran-Iran* May 2–5 pp. 277–293.
- Thomas, M., O. Testa, and P. Courbon. 2013. Les puits et qanâts de Dûmat al-Jandal. *Spelunca*, 43–47.
- Thompson, A. 2013. *Origins of Arabia*. Routledge, London, UK.
- Tikriti, W.Y. 2002. The south-east Arabian origin of the falaj system. In *Proceedings of the Seminar for Arabian Studies*, 117–138 (Brepols).
- Wellbrock, K., P. Voß, and M. Grottker. 2012. The evolution of water management methods in north-western Arabia and the south-ern Levant from the Neolithic Age through Antiquity. *DWhG-Zehn Jahre waserhistorische Forschungen und Berichte* 29.
- Yule, P. 1999. *Studies in the Archaeology of the Sultanate of Oman*. Leidorf, Rahden.
- “ZSRC (Zamzam Studies and Research Centre).” Earth Science. Accessed February 2, 2016. <http://www.sgs.org.sa/English/earth/pages/zamzam.aspx>.

---

# 14 Qanāts of Syria

Josepha I. Wessels

## CONTENTS

14.1	Introduction.....	229
14.2	The History of Qanāts in Syria.....	230
14.3	Geographical Distribution, Ecology, and Types of Qanāts of Syria.....	232
14.4	Irrigation Management at Syrian Qanāt Sites.....	234
14.5	Challenges and Threats to Qanāts in the Twentieth and Twenty-First Centuries.....	235
14.6	Rehabilitation of Qanāts in Syria between 2000 and 2004.....	236
14.7	A Bleak Future for Qanāts in the Syrian Warzone.....	237
14.8	Conclusions.....	237
	References.....	238

## 14.1 INTRODUCTION

This chapter describes the history, development, and distribution of Syrian qanāts, also called “*Qanāt Romani*” in the vernacular Syrian Arabic dialect.

The Syrian qanāts are part of a long history of hydraulic systems that can be found in Syria. The most famous hydraulic systems in Syria are the large waterwheels, called *Noria*, of which most can be found in the city of Hama; they formed a major tourist attraction in the past. Next to the lifting devices and water wheels, Syria has a wide variety of ancient dams and aboveground hydraulic structures that carry water over long distances through the desert (Calvet and Geyer 1992; Geyer 1990). The *Noria* of Hama dates from the fifth century AD and were built in the Late Roman period. Calvet and Geyer (1992) found a mosaic from that period in the city of Apamea at the Orontes river that depicts a similar waterwheel (Calvet and Geyer 1992). The majority of Syria’s hydraulic structures in the desert can be linked to the forts of the “*Strata Diocletiana*,” a major road network built by the Roman Emperor Diocletian (284–305 AD), connecting the Eastern fortifications built by the Romans such as the fort of Qasr al Hayr al Gharbi (Calvet and Geyer 1992; Geyer 1990). One of the earliest dam systems is the water infrastructure in Ras Shamra, which dates from the time of Ugarit and places these hydraulic structures in the twelfth century BC. Both Calvet and Geyer (1992, 1987) claim that it is thus likely that dams and water-capturing systems existed in Syria as early as the Bronze Age (thirteenth century BC). However, the majority of water-harvesting and supply systems in Syria were developed to carry water above ground and qanāts, and underground water technologies were introduced at a later date.

The qanāts in Syria are nearly all of Roman and Byzantine origin, and in contemporary Syria, less than 5% of the original number of qanāt systems and tunnels during the Roman and Byzantine era are still in active use (Wessels 2008a). Most of those remaining qanāts are short, not longer than 3–5 km, and often dug in groundwater-rich aquifers. There are three main types of qanāts in Syria: first, there are *spring-based* qanāts that are dug in calcareous karstic solid rock near mountainous areas, generally found in the western part of Syria. Second, Syria has *infiltration-based* qanāts dug in alluvial plains of a relatively flat surface, such as in the dry areas in the middle and east of Syria. Finally, Syria has *river-based* qanāts, generally dug in the alluvial plain of a main river such as the Euphrates or the Barada rivers.

Based on a literature review and a national survey done between 2000 and 2004, this chapter gives an overview of the historical background, evolution, and status of contemporary qanāts in Syria.\* Furthermore, this chapter highlights important interventions and efforts carried out to rehabilitate qanāts between the years 2000 and 2004. The chapter concludes with a reflection on the impact of the current war in Syria and the implications for the future of qanāts, in particular.

In many countries in the Middle East and North African region, qanāts are in active use, among others in parts of rural Syria. Although Syrian qanāts do not contribute much to a country's total daily needs, the tunnels continue to play a significant role in those communities that derive most of their local water from qanāts. However, qanāts in Syria are rapidly drying up and are being abandoned by rural communities.

In the beginning of the nineties, the American geographer Professor Dale Lightfoot studied qanāts in various countries to examine the role of qanāts in a modern world, among others in Syria (Lightfoot 1996). He identified two causes of abandonment: environmental abandonment and cultural abandonment. Environmental abandonment refers to biophysical causes such as earthquakes, falling water tables after introduction and expansion of irrigation systems, and the tunnel silting up with calcareous deposits, reducing seepage. Especially, lengthy qanāts are prone to irreparable damage by floods and earthquakes (Lightfoot 1996). Cultural abandonment occurred when the routine maintenance ceased because of adoption of newer technologies and the subsequent socio-political changes in land use patterns, combined with the Syrian land reform in the late 1950s (Lightfoot 1996). Off-farm income and migration as exit option also potentially draw qanāt users away from the villages (Lightfoot 1996). Similar scenarios are occurring in Pakistan, Iran, Oman, Morocco, and many other countries where qanāts are still in use (Kobori 1982; Lightfoot 1996; Safadi 1990). With the abandonment of qanāts, a large proportion of the traditional knowledge is also rapidly lost, which results, in turn, in a definite abandonment.

## 14.2 THE HISTORY OF QANĀTS IN SYRIA

To reconstruct the history of qanāts in Syria, much of our information relies on secondary sources. Dating qanāts is virtually impossible, as historical documents and inscriptions rarely mention the actual construction (Lightfoot 1996). Most dating is thus done through circumstantial evidence. Studies in the Achaemenid history suggest that the qanāt technology originated in Northern Persia some 3000 years ago. The establishment of the Achaemenid Empire seems to have enabled the spread of the technique further west and eastward (Briant 2001; Goblot 1979; Lambton 1989; Lassoe 1953; Weisgerber 2003; Wilkinson 1977). Until today, archaeological evidence lacks to sustain a comprehensive theory, the diffusion, and scientific debates center around the role of the Persian Empire in the spread of the technique (Briant 2001; Wutmann et al. 2000). Notwithstanding, the Persian influence in technology transfer and advancement must have been substantial, and Syria's proximity to the Persian Empire suggests that the technology of qanāts was first introduced during the expansion of this civilization.

There are clear indications that qanāts have certainly been used during Roman-Byzantine eras, as much circumstantial evidences such as potsherds, coins, and oil lamps found in qanāt tunnels tend to indicate this direction (Caponera 1973; Kobori 1982, 1990; Lightfoot 1996; Wessels 2008a). Until today, Syrians themselves refer to the tunnels as *qanāt Romani* in their vernacular language (Kobori 1982; Lightfoot 1996). According to Goblot (1979), qanāt technology had already been transferred to Syria during the *ca.* second century BC, placing the introduction of the technology to Syria with the Greek civilization (Lightfoot 1996). As found by Lightfoot (1996) and further corroborated by Wessels (2012, 2009, 2008a) and Kamash (2009), many of the qanāts in contemporary Syria

---

\* This chapter is partly based on my PhD thesis with permission.



**FIGURE 14.1** Byzantine oil lamp found in the Qanāt of Shallalah Saghirah, summer 2000. (Reprinted with permission from Wessels, J.I. To cooperate or not to cooperate? Collective action for rehabilitation of traditional water tunnel systems (qanāts) in Syria, PhD Thesis, Vossius Press, Amsterdam, the Netherlands, 2008a, p. 114.)

are found near Roman-Byzantine settlements such as Qara, Khanasser (Anasartha),\* Amsareddi, Qdeym, Taibe, Andarin, and Palmyra, featuring masonry inside the tunnels, indicating Roman-Byzantine origin (Kamash 2009; Wessels 2008a). Proof of the use during the Byzantine period has been found during the renovation efforts carried out in Shallalah Saghirah in the year 2000 by Wessels (2008a, 2008b). As illustrated in Figure 14.1, inside the qanāt tunnel of Shallalah Saghirah, several Byzantine crosses inscribed on the walls and an original oil lamp that was dated during the time of Emperor Justinianus (*ca.* sixth century AD) were found (Wessels 2008a; Mouterde and Poidebard 1945). More archaeological research is still needed to explore the exact relationship with a potential Persian or even Greek introduction of qanāt technology in Syria.

The development of qanāts greatly influenced settlement patterns in Syria. In Greek and Roman times, the qanāts in Syria played a vital role in the further expansion of the empire and development of thriving cities such as Palmyra in the Syrian desert. With the foundation of the Byzantine Empire, the Syrian province saw some prosperous periods, both politically and economically. In Northern Syria, settlements grew out to be centers of religion, science, philosophy, and arts. Most of these settlements were provided with water from qanāts or hand-dug wells. Having overcome the Byzantine forces at Yarmuk, the Arabs overtook the country in 636 AD, along with Iran and Egypt. The Omayyads (661–750) made Syria and Damascus the center of the Muslim Empire (Cotillon 1993). The state ruled by the Omayyads was highly centralized, and with the inherited qanāts from previous empires, Syria became the most prosperous province of any Islamic caliphate, and agricultural production flourished (Goblot 1979; Kobori 1990; Lightfoot 1996). The building and

\* Kamash (2009) dates the qanāt of Khanasser based on an inscription on a large basalt lintel some 400 m north of the qanāt shafts and at the eastern extremity of the ruined site in Khanasser (Anasartha), which she describes as follows: “*It is natural in this universe for things to roll to the plains from the summits and for dry to follow humid: by divine good will, fallen from this source, out of this rock came the power to exhale vapors, offering a salutary remedy suitable for passers-by. Having discovered an abundant source, Gregorios worked on its capture, which extended easily to his homeland the stream of life and prevention against illnesses. All this work was carried out in [the year of] the 12th indiction.*” Source: Mouterde and Poidebard (1945):207–208. “*It is thought that Gregorios must be Gregorios Abimenes, a rich Arab, who in AD 604 restored the city gates and possibly the citadel at Hanaser. This dates the inscription securely to this period.*” Source: Kamash (2009):82.



diffusion of qanāts after the Islamic Empire most probably continued, owing to continued contacts with Persians and the historic spread of Islam (Lightfoot 1996).

Qanāts must be constantly repaired to maintain water flow, and local populations have continuously altered the shape and construction of qanāts. In some cases, qanāts lay abandoned for years and were reused by new settlers such as Bedouin groups or other migrants. Some qanāts were reused and altered during the French Mandate (Lightfoot 1996). In the twentieth century, qanāt building slowed down, except for some occasional attempts in the Ghouta Oasis of Damascus (Goblot 1979; Lightfoot 1996).

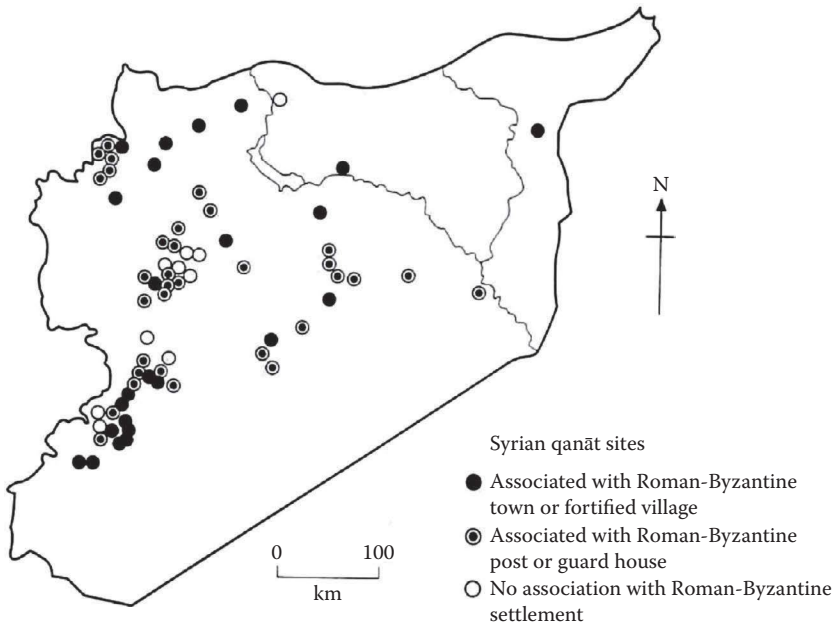
### 14.3 GEOGRAPHICAL DISTRIBUTION, ECOLOGY, AND TYPES OF QANĀTS OF SYRIA

Rainfall, evapotranspiration, topography, morphology, and hydrogeology determine the locations and original discharge of the qanāts in Syria (Lightfoot 1996). Qanāts are mainly located near alluvial aquifers of major rivers and penetrating alluvial fans at the foot of mountainous areas. These piedmonts and alluvial plains provide ideal circumstances for the construction and digging of successful qanāts. All qanāts in Syria are found at or below the 500 mm rainfall isohyet and almost 90% are within 25 km of uplands (Lightfoot 1996). Most qanāts can be found in arid alluvial plains at the margins of highland areas or rivers (Lightfoot 1996). Alluvial aquifers are the shallowest and most widespread water bodies in the Middle East (Beaumont et al. 1989). Owing to topographical and geological diversity, the Syrian qanāts vary considerably in type and construction. In Syria, we can generally distinguish three main types of Syrian qanāts:

1. *Spring-based*: Dug in calcareous karstic solid rock near mountainous areas
2. *Infiltration-based*: Dug in alluvial plains or piedmonts of relatively flat surface
3. *River-based*: Dug in the alluvial plain of a main river

In total, 44 locations in Syria containing flowing 101 qanāts were identified in the year 2000 based on a survey following and updating the extensive work carried out by Prof. Dale Lightfoot in 1994. The survey that was carried out in 2000 confirmed Lightfoot's conclusion that most Syrian qanāts' locations seem to be related to the presence of Roman-Byzantine sites (see Figure 14.2).

Syria can be divided in three regions of flowing qanāts: Northwest, Southwest, and Middle Syria. The other regions also have qanāts, but there were no reports of active use at the time of investigation. Five qanāt sites in the North-West region were identified (Membey, Harim, Salquin, Armanaz, and Khirbet Martin). In 1994, only the qanāts of Membey were reported to be dry. In 2001, all five sites, except Harim, had dried up. An additional five sites, not recorded previously, were identified, where water was present (Shallalah Saghirah, Jdain, al Qubayji, Marata Es-Shelf, and Mou'allaq). Only the qanāt of Shallalah Saghirah was flowing. In all other sites, cleaning had taken place with support from the Directorate of Irrigation of Aleppo province, during the nineties. Of the 10 identified qanāt sites in the Northwest, only 2 are still flowing: Shallalah Saghirah and Harim. In Harim, the Directorate of Irrigation undertakes regular cleaning of the open irrigation canals. Complete renovation of these irrigation canals took place in 1995. In 1999, no cleaning had taken place since decades in Shallalah Saghirah. In Middle Syria, 17 sites were recorded. Of these 17 sites, 11 were dry, 3 had static water, and 3 were flowing. The three flowing sites are Arak, Taybeh, and Breij. The most active site is Breij, where the users perform regular cleaning of the open sections. They tried to clean the tunnel in the beginning of the 1990s but stopped after a while when they found asbestos pipes installed by the government in the 1970s. In 1993, the Irrigation Directorate of the Aasi Basin (Homs) conducted a study and sent a proposal for renovation but nothing happened. In Taybeh, water is still flowing, but the users' community replaced the qanāt at the outlet in 1979 with a diesel-operated pump. In Southwest Syria, 10 sites were re-identified and 7 more were discovered. Of the total 17 sites, 6 were dry, 1 flowed only in winter, and 10 were flowing. The most active qanāt



**FIGURE 14.2** Distribution of qanāts in Syria and the presence of Roman-Byzantine sites. (From Lightfoot, D.R. *J. Arid Environ.*, 33, 321–336, 1996, <http://www.waterhistory.org/histories/syria/syria2.jpg>. With Permission.)

region in Syria is the South-West region. This is most likely due to the favorable biophysical and environmental factors, a long uninterrupted history of social organization related to the qanāts, and a policy of regional government support in the Awaj/Barada basin.

The variety of qanāts in Southwest Syria is high. While the qanāts in Northwest Syria are short and often spring-based, the qanāts in Middle Syria are long and based on infiltration. Southwest Syria contains river-based qanāts, mainly around the city of Damascus, and various spring- and infiltration-based qanāts. Further differences are due to the rainfall zone, morphology of the surroundings, soil type, and the available groundwater resources. Northwest Syria has higher rainfall and is hilly and mountainous, while Middle Syria, the *Badia*, is a dry steppe with a graduate slope and the soil is sandy and limestone. The Southwest of Syria is mountainous, and in the West, where the anti-Lebanon mountains and Qalamoun range run parallel, this dry highland provides excellent surroundings for qanāt construction. The yearly snowfall in both the Qalamoun and the anti-Lebanon ranges ensures a good supply of recharge into both the alluvial plains and the underlying geology. This is most probably why the concentration of qanāts is so high. In the eastern part of Southwest Syria, the boundary of the steppe runs along the mountain range. Here, longer infiltration-based qanāts can be found, such as those in Dmayr. In turn, the locations of qanāts in Syria, as in other qanāt countries (Beaumont et al. 1989; Wilkinson 1977), greatly influenced settlement patterns and traditional field systems. The village and town sites, as well as the amount of irrigated land, are determined by qanāt construction. Depending on the estimated flow, cycles, local morphology, and soil types, the amount of land to be irrigated was designated at the time of construction. Seasonal climatic variation causes variability of irrigated land size, with the smallest surface irrigated during summer time, when the qanāts provide a base flow. At some sites, such as Dmayr, users have agreed to a special summer-and-winter irrigation cycle. The effect of global climate change on qanāts has not been investigated properly, but farmers do report a decrease in rainfall over the past decades as the main cause for the drying up of qanāts. However, this must be

seen in perspective of the increase in water demand due to population growth, the introduction of pump wells, and subsequent overexploitation of the aquifers, resulting in lower groundwater tables.

#### 14.4 IRRIGATION MANAGEMENT AT SYRIAN QANĀT SITES

Qanāt irrigation systems know a complex organization of cycles and rights, based on time, volume, and discharge (Beaumont et al. 1989; Lightfoot 1996; Wessels 2008a, 2008b, 2009, 2012; Wilkinson 1977). In Syria, much of these systems remained partially intact at flowing qanāt sites. Three main rights to use qanāt water can be distinguished: the right to drink, the right to use the water domestically, and the right to irrigate (Wessels 2008a, 2008b, 2009, 2012). The right to drink and use water to wash before prayer is free to everyone who visits the qanāt (outlet). This is based on the so-called Islamic *Law of Thirst*, which states that all people and animals must be allowed to drink water. The right to use the water for domestic purposes is also free but generally confined to those living in close proximity of the qanāt outlet. Irrigation rights are not free and are confined to certain families and groups. According to Islamic law, water cannot be owned unless it is stored and measured (Bulloch and Darwish 1993; Caponera 1973; Métral 1982; Vincent 1995). Islamic law distinguishes between rivers, springs, and wells (Bulloch and Darwish 1993), as well as the spring category that applies to qanāts. Natural springs are free for all to use. Those who have “uncovered a spring and caused it to flow” own the discovered spring communally. If a spring is uncovered on someone’s private land, ownership is not disputed, but Islamic law obliges the owner(s) to offer water free of charge to others (Bulloch and Darwish 1993; Métral 1982; Vincent 1995). It is difficult to establish who actually uncovered the spring at qanāt sites in Syria, but those families and groups who have the right to use the qanāt water for irrigation define the users’ communities that own the qanāt.

The irrigation rights are bound to a complex system of timeshares and cycles. Each qanāt user has the right to irrigate for a certain period at a designated time. His or her water share is measured in time and sometimes in volume when the qanāt has an irrigation reservoir. For each qanāt, the total of timeshares is arranged in a rotation cycle or period of irrigation called “*addan*.” For example, Dmayr has three qanāts: Drasia qanāt, Maitaroun qanāt, and Mukabrat qanāt. The addans are 26, 28, and 16 days, respectively. It is not clear what process defines the length of the addan. Many qanāt users did not remember and explained that the very first families originally owned each day. This would mean that in Dmayr, there were originally 26, 28, and 16 user families for each respective qanāt. With the qanāts dated somewhere in the *ca.* second century AD, it is unlikely that this is the case. Another possible explanation is that the soil and crops require this particular cycle of irrigation for it to be fertile. In any case, the length of the addan is rarely changed. The lengths of the timeshares, however, do change and are subject to inheritance, division, and sale. Another measurement that is observed to regulate qanāt use is the use of irrigation reservoirs or “*birkeh*” in Arabic.

If a qanāt gives sufficient water, the flow and thus irrigation practices will continue for 24 h/d. However, when a decrease in flow is observed and there is not enough pressure for water to reach the outermost lands, the users will build a collection reservoir to regulate the flow. The reservoir is then opened for a specified amount of hours per day. The collected body of water will then provide enough pressure so that the water reaches the outer borders of the irrigated land.

Different types of ownership of qanāts systems exist. Full ownership of a qanāt in Syria consists of the land where the underground tunnel is situated, connected are the rights to use the water of the qanāt and the land irrigated by the water of the qanāt. Property rights in Syria are characterized by a co-existence of the customary law *urf* and the formal legal system of the state “*qanun*” (Rae et al. 2002). The customary laws are largely based on Islamic principles on property and land tenure, stemming from nineteenth century’s Ottoman practices (Métral 1982).

Full ownership or “*mulk*” refers to owning the land and its resources and having the right to use and transfer, either as a gift, settling it as an endowment *waqf*, or giving it to relatives or descendants (Vincent 1995). In Syria, state land is called *amlak ed-dawlah*, and in 1952, the state ordered that

*mewat* land be re-classed as *amlak ed-dawlah* (Rae et al. 2002). All qanāts in Syria are either *mulk* or *amlak ed-dawlah*. Although qanāts in other countries can be part of *waqf*, when solely owned by a religion-based institution such as a mosque or church, such full ownership in Syria was not found. However, partial *waqf* in qanāt sites was found, where the full ownership was *mulk* of a large group of different families, as well as monasteries and mosques. *Mulk* qanāt ownership can thus be divided in land owned by one related family or tribal group and land that is owned by several, not necessarily related, families and groups.

There are regulations and laws that protect the tunnel of the qanāt system. The main traditional law to prevent qanāts from drying out is the so-called “*harim*” principle, where no water well can be sunk within a specified distance from another water project (Beaumont et al. 1989; Caponera 1973; Vincent 1995). In Syria, *harim* is a defined boundary around the qanāt tunnel, source area, or outlet in which it is forbidden to drill wells or dig another qanāt. The exact definitions of the boundaries vary from site to site, but the range is between 1 km and 5 km, depending on the local conditions. In Syria specifically, the *harim* rule is barely implemented on the existing qanāt sites. In Dmayr and the Qalamun region, some communities still apply the rule. In the Damascene countryside, the *harim* is defined at 1 km<sup>2</sup> around the source of any qanāt with a discharge of 10 L/s. For example, in Dmayr, when the Ministry of Tourism wanted to build a hotel resort with health spa supplied by one of the sulfuric qanāt springs in its vicinity, the local farmers’ association and qanāt users managed to stop the construction based on *harim*. Apart from the customary laws and rules, the national water legislation does not have any reference to qanāts in particular. Most of the qanāts are regarded as springs underneath private or community lands, thus implying private or community ownership or under the control of the Directorate of Antiquities. The local or regional governments do not pay specific attention to qanāts or qanāt maintenance, apart from those in Southwest. Since the late eighties, the Syrian government allocated a certain budget on a yearly basis to maintain qanāts, where necessary, in this region.

#### 14.5 CHALLENGES AND THREATS TO QANĀTS IN THE TWENTIETH AND TWENTY-FIRST CENTURIES

Industrialized overexploitation, land reform, and migration have often been identified as main causes for falling groundwater tables (Beaumont 1989, 1993; Kobori 1982; Lightfoot 1996; Safadi 1990; Vincent 1995). The competition between pumps and qanāts for water resources had thus been identified as a major challenge to the existence of qanāts. Since the introduction of the new pumped well technology in the 1960s in the Middle East, Ehlers and Saidi (1989) reported that *The change from qanāt irrigation to water exploitation by means of motor pumps and large dams has had tremendous effects on the fragile ecology of the arid highlands of Iran*. Molle et al. (2003) reports that in the Assadabad region that Ehlers and Saidi studied in Iran, the numbers of wells were 39 in 1962, 439 in 1969, and a staggering 1386 in 1979; all qanāts dried up. Between the 1960s and the 1980s, qanāts in Iran symbolized backwardness, as opposed to the promising future of diesel pumps (Ehlers and Saidi 1989; Molle et al. 2003). Similarly, in Syria, the rapid drying up of qanāts corresponds to the introduction of tube wells (Lightfoot 1996; Wessels 2008a, 2008b; Wessels and Hoogeveen 2008).

The most vivid example of drying qanāts is the case of the many dried-up qanāts around the city of Homs. After the land reform in 1958, the allocation of land to formerly landless families gave households the opportunity to exploit the water resources underneath the land. The farmers had enough capital to buy drilling and pump equipment, and there were no restrictions. The Ministry of Public Works and Water Resources did issue a law (no. 208) to prohibit digging of wells in certain areas, such as the Ghouta Oasis, but these were completely ineffective (Naito 1985). On the surface, it seems that the contemporary abandonment of qanāts is related mostly to a combination of falling groundwater tables due to overexploitation, a high rate of migration of the users’ population, and the poor existence of a traditional regime to regulate use and ownership. Qanāts must be

regularly cleaned and maintained to ensure water flow (Beaumont et al. 1989; Goblot 1979; Kobori 1990; Lightfoot 1996; Wilkinson 1977). Lack of collective maintenance is strongly related to the decline of qanāts. Types of ownership and leadership have a profound impact on collective action. Communal ownership seems to be beneficial for the maintenance of qanāts, but state leadership appears to initiate collective action crucial to maintaining regular upkeep.

#### 14.6 REHABILITATION OF QANĀTS IN SYRIA BETWEEN 2000 AND 2004

Several initiatives and efforts were taken in the beginning of the twenty-first century to rehabilitate qanāt systems in Syria. These various renovation efforts are described extensively in several reports and academic articles (Wessels 2003, 2008a, 2008b, 2005, 2009, 2012; Wessels and Hoogeveen 2008). A research project by the International Center for Agricultural Research in the Dry Areas based in Aleppo, Syria, and led by the author, was carried out to renovate the qanāts in Khanasser Valley, specifically the one in the village of Shallalah Saghirah. Subsequent renovations followed for the qanāt of the Monastery of Deir Mar Yaqoub in Qara and the qanāts of Dmayr. The pilot renovation that took place in Shallalah Saghirah (Wessels 2008a, 2008b) proved to be a successful intervention, whereby the flow gained considerably after the renovation intervention in the summer of 2000. In 2010, this particular qanāt was still in active use. However, the introduction of electricity in the year 2004 at this location had also introduced the use of electrical pumps to draw groundwater from the same aquifer as the Shallalah Saghirah qanāt. Hence, the threat of lowering groundwater tables loomed over the qanāt of Shallalah Saghirah (Figure 14.3). Renovation efforts were also carried out in the community of Dmayr, executed by the leadership of the local farmers' association. The renovation works were carried out under the auspices of the Directorate of Irrigation of the Damascus countryside. A major advantage of this renovation effort was the strong organization of the local farmers' association with a long history of cooperation. The final renovation was carried out and concluded in Qara, near the Qalamoun Mountains. This renovation effort was carried out by knowledgeable traditional qanāt cleaners from Ma'aloula and it was proven to be successful as well.



**FIGURE 14.3** Author next to an open channel of the qanāt in the village of Shallalah Saghirah. (Reprinted with permission of the photographer J.I. Wessels copyright 2000.)



However, again in 2010, overexploitation and the introduction of a deep well by the local monastic community severely threatened the flow of the qanāts that were on the verge of drying up.

### 14.7 A BLEAK FUTURE FOR QANĀTS IN THE SYRIAN WARZONE

Qanāts in Syria are facing a very bleak future. The decline of the use of these sustainable water supply systems started in the second half of the twentieth century, in sync with modern technological advancements. The introduction of pump wells, cars, changing economy, the widespread modernization of communication technology, television, and mobile phone technology deeply affected rural livelihoods in Syria. These developments coincided with the widespread introduction of pump wells, which threatened many qanāts in Syria. Ironically, this modern technological development caused a major negative effect on the most sustainable manner of groundwater use in arid areas. After a period of thousands of years, sustainable water systems such as qanāts were suddenly declining and drying up rapidly. This trend continued in the seventies and eighties, until the severe decline of qanāt use in the year 2000.

Between 2000 and 2010, the use of qanāts in Syria gradually declined, except in the water-rich areas of the northwestern mountains and the water-rich province of Quneitra, bordering Israel. The Syrian uprisings, the brutal crackdown by the Syrian regime, and consequent widespread violence and destruction has reduced the country to a total warzone, in which qanāts are used as storage tunnels for weaponry and are destroyed by aerial bombardments. Villages that were dependent on qanāts have been abandoned by civilians, such as the village of Shallalah Saghirah. Caught up in the middle of a frontline, Syrians are not able to maintain their livelihoods and certainly will not be able to maintain the upkeep of those qanāts that are still in use. One out of two Syrians has been displaced by the war. This means a massive demographical shift nationwide. The protraction of the Syrian war begs a very dark future for the survival of Syrian qanāts; we could be witnessing the swan song for these feats of engineering. We can only hope for an imminent peace in Syria in order for the Syrian people and their legacy of ancient water works to survive.

### 14.8 CONCLUSIONS

The history of civilization and the emergence and diffusion of qanāts in Syria are intertwined. Growth and expansion of the Persian, Greek, Roman, and Byzantine empires in Syria were only possible by the implementation of elaborate and technologically advanced structures and technology of water supply. Qanāts are part of this carefully designed and advanced infrastructure. Underground aqueducts have been built in Syria since at least the last 2000 years and qanāts have been able to provide water in some of the driest parts of Syria. The growth of the eastern Roman desert city of Palmyra was only possible because of the expansive system of underground water tunnels and aqueducts that provided the population with water. In the second half of the twentieth century, the introduction of diesel-powered pump wells, land reform, and a general shift in agricultural production technologies resulted in a first blow to the existence of qanāts in Syria. Climatic changes and falling groundwater tables due to overexploitation deepened the threats to qanāts and resulted in a rapid drying up of the underground tunnels and popular abandonment. With it, generations of knowledge and engineering expertise were also lost. Renovation efforts followed in the 1990s throughout the first decade of the twenty-first century. These efforts proved to be successful at a local level; however, at a national level, the future for qanāts remained bleak. The outbreak of the popular Syrian uprisings against the Assad regime in March 2011 and the subsequent widespread violence, mass atrocities, and aerial bombardments on Syrian cities, towns, infrastructure, and heritage, including qanāts and their communities, caused even more abandonment of the qanāts, which are consequently drying up. Unless a peaceful solution to the Syrian war at a national level is found, we are currently witnessing the swan song of qanāts in Syria. The only hope is that after the Syrian war, reconstruction efforts will also be directed toward restoring the remaining qanāts for future generations.



## REFERENCES

- Beaumont, P. 1993. *Drylands, Environmental Management and Development*. London: Routledge.
- Beaumont, P., M. Bonine, and K. McLachlan, eds. 1989. *Qanat, Kariz and Khattara: Traditional Water Systems in the Middle East and North Africa*. Wisbech: Middle East and North African Studies (Menas) Press.
- Briant, P. 2001. *Irrigation et drainage dans l'Antiquité, qanats et canalisation souterraine en Iran, en Égypte et en Grèce*, séminaire tenue au Collège de France sous la direction de Pierre Briant Paris: Collège de France, Thotm éditions.
- Bulloch, J. and A. Darwish. 1993. *Coming Conflicts: Water Wars in the Middle East*. London: St. Edmundsbury Press.
- Calvet, Y. and B. Geyer. 1987. L'eau dans l'habitat, Ras Shamra. In *Ougarit III: le centre de la ville*, pp. 129–156, sous la direction de Marguerite Yon, RSO III, Paris.
- Calvet, Y. and B. Geyer. 1992. *Barrages antiques de Syrie*, Collection de la Maison de l'Orient méditerranéen n° 21, série archéologique 12, Lyon.
- Caponera, D.A. 1973. Water laws in Moslem countries. *FAO Irrigation and drainage papers*. Rome: FAO.
- Cotillon, J. 1993. *Water from Dams in Syria*. Paris, France: ICOLD.
- Ehlers, E. and A. Saidi. 1989. Qanats and pumped wells: The case of Assad'abad, Hamadan. In *Qanat, Kariz and Khattara: Traditional Water Systems in the Middle East and North Africa*, eds. P. Beaumont, M. Bonine, and K. McLachlan, pp. 89–112. Wisbech: Middle East and North African Studies (Menas) Press.
- Geyer, B., ed. 1990. Techniques et pratiques hydro-agricoles traditionnelles en domaine irrigué: approche pluridisciplinaire des modes de culture avant la motorisation en Syrie, Actes du Colloque de l'IFAPO, Damas 1987, Bibliothèque Archéologique et Historique 136, vol. 2. Paris, France: P. Geuthner.
- Goblot, H. 1979. *Les Qanats, une technique d'acquisition de l'eau*. Paris: École des Hautes Études en Sciences Sociales, Centre de Recherches Historiques.
- Kamash, Z. 2009. *Water supply and management in the near East 63 BC-AD 636*. PhD diss., University of Oxford [data-set]. York, UK: Archaeology Data Service [distributor]. doi:10.5284/1000172.
- Kobori, I. 1990. Les qanat en Syrie. In *Techniques et pratiques hydro-agricoles traditionnelles en domaine irrigué*, vol. 2, ed. B. Geyer, pp. 321–328. Paris: Librairie Orientaliste Paul Geuthner.
- Kobori, I. 1982. *Case Studies of Foggara Oases in the Algerian Sahara and Syria*. Tokyo, Japan: University of Tokyo, Department of Geography.
- Lassoe, J. 1953. Reflections on modern and ancient waterworks. *Journal of Cuneiform Studies* 7:5–26.
- Lightfoot, D.R. 1996. Syrian qanat Romani: History, ecology, abandonment. *Journal of Arid Environments* 33:321–336.
- Métral, F. 1982. Le droit de l'eau dans le code civil Ottoman de 1869 et la notion de domaine public. In *L'homme et l'eau en Méditerranée et au proche orient, vol. II: Aménagements hydrauliques, état et législation*, ed. J. Métral, P. Sanlaville, and F. Métral, pp. 125–142. Lyon: GIS-Maison de L'Orient, Presse Universitaire de Lyon.
- Molle, F., T. Shah, and R. Barker. 2003. The groundswell of pumps: Multilevel impacts of a silent revolution. In *Proceedings of the ICID-Asia Meeting*, pp. 1–18. <http://www.iwmi.cgiar.org/assessment/files/pdf/publications/ConferencePapers/The%20pump%20revolution2.pdf>.
- Mouterde, R. and Poidebard, A. 1945. *Le limes de Chalcis, organisation de la steppe en haute Syrie Romaine*. Paris: Librairie Orientaliste Paul Geuthner.
- Naito, M. 1985. *Water Resource Management in the Oasis of Damascus: Man's Role in Changing Phases of Desertification*, Vol. 105. Stuttgart, Germany: Stuttgarter Geographischen Studien, pp. 103–104.
- Rae, J., G. Arab, T. Nordblom, K. Jani, and G. Gintzburger. 2002. Tribes, state and technology adoption in arid land management in Syria. In *Innovation in Natural Resource Management: The Role of Property Rights and Collective Action in Developing Countries*, ed. R. Meinzen-Dick, A. Knox, F. Place, and B. Swallow. Baltimore, MD: Johns Hopkins University Press.
- Safadi, C. 1990. La foggara, système hydraulique antique, serait-elle toujours concevable dans la mise en valeur des eaux souterraines en Syrie? In *Techniques et Pratiques Hydro-Agricoles Traditionnelles en Domaine Irrigué*, tome 2, ed. B. Geyer, pp. 285–293. Paris, France: Librairie Orientaliste Paul Geuthner.
- Vincent, L. 1995. *Hill Irrigation Water and Development in Mountain Agriculture*. London, UK: Intermediate Technology Publications.
- Weisgerber, G. 2003. The impact of the dynamics of qanats and afl aj on oases in Oman: Comparisons with Iran and Bahrain. In *Proceedings of the International Frontinus Symposium*, Walferdange, Luxemburg, 2–5 Oct.

- Wessels, J.I. 2012. Groundwater and qanats in Syria; Leadership, ownership and abandonment. In *Water, Cultural Diversity, and Global Environmental Change: Emerging Trends, Sustainable Futures?* eds. B.R. Johnston, et al. pp. 149–163. United Nations Educational and Scientific Organisation-International Hydrological Programme. Amsterdam, the Netherland: Springer Press.
- Wessels, J.I. 2009. Water crisis in the Middle East: an opportunity for new forms of water governance and peace. *Whitehead Journal of Diplomacy and International Relations* 10(2):131–141.
- Wessels, J.I. 2008a. *To cooperate or not to cooperate? Collective action for rehabilitation of traditional water tunnel systems (qanats) in Syria*. PhD Thesis. Amsterdam, the Netherlands: Vossius Press.
- Wessels, J.I. 2008b. Assessment of three collective renovations of traditional Qanat systems in Syria. In *What Makes Traditional Technologies Tick? A Review of Traditional Approaches for Water Management in Drylands*, eds. Z. Adeel, B. Schuster, and H. Bigas, pp. 11–20. Toronto: United Nations University International Network on Water, Environment and Health (UNU-INWEH).
- Wessels, J.I. 2005. Reviving ancient water tunnels in the desert—digging for gold? *Journal of Mountain Science* 2(4):294–305.
- Wessels, J.I. 2003. Qanats in Syria, ease the water shortage. *Waterlines* 22(2):8–11.
- Wessels, J.I. and Hoogeveen, R. 2008. Renovation of Byzantine Qanats in Syria as a water source for contemporary settlements. In *Handbook of Regenerative Landscape Design*, ed. R. France, pp. 237–263. Boca Raton, FL: CRC Press.
- Wilkinson, J.C. 1977. *Water and Tribal Settlement in South-East Arabia: A study of the Afl aj of Oman*. Oxford, UK: Clarendon.
- Wutmann, M., T. Gonon, and C. Thiers. 2000. The Qanats of Ayn-Manawir (Kharga Oasis, Egypt). In *Proceedings First International Conference on Qanats*, Yazd, Iran: ICQHS.



# Taylor & Francis

Taylor & Francis Group

<http://taylorandfrancis.com>

---

# 15 Groundwater Structures throughout Turkish History

*Zekâi Şen*

## CONTENTS

15.1	Introduction.....	241
15.2	Water History and Groundwater.....	242
15.2.1	Historical and Present-Day Hydraulic Principles.....	243
15.3	Historical Groundwater-Supply Structures.....	244
15.3.1	Hand-Dug Wells.....	244
15.3.1.1	Zamzam Well.....	245
15.3.2	Qanāts.....	246
15.3.3	Cisterns.....	248
15.3.4	Aqueducts.....	249
15.4	Historical Water Structures in Turkey and Istanbul.....	251
15.4.1	Hittite Period.....	251
15.4.2	Urartu Period.....	253
15.4.3	Ancient Greek, Byzantine, and Roman Periods.....	253
15.4.2	Seljukide and Ottoman Period.....	255
15.4.2.1	Fountains.....	255
15.5	Historical Evolution of Water Technology.....	257
15.6	Conclusions.....	259
	References.....	259

## 15.1 INTRODUCTION

Philosophically, “The origin of all matter is water,” said Thales. The largest constituent of the universe is hydrogen, which makes two of the three atoms in water (H<sub>2</sub>O). Scientists believe that liquid water is prerequisite to life, and we know with certainty that the first life forms flourished in the oceans. The Code of Hammurabi (1790 BC) for the State of Sumer lists several laws pertaining to irrigation that address negligence of irrigation systems and water theft (Hatami and Gleick, 1994).

Water, the most abundant compound on the surface of the earth, is necessary for the survival of all living beings. Not all the water present in its natural environments in the form of oceans, lakes, and groundwater are directly usable for drinking, agriculture, and livestock purposes. Generally, groundwater makes a considerable part of the total freshwaters available on the planet Earth. After polar ice caps and glaciers having their share as 78% in freshwaters, groundwater is the abundant source of freshwater, contributing about 12% to the total freshwater resources of the world. Subsurface water, except in the vicinity of recharge areas, is rarely found without dissolution of minerals from the host geological environment, through which it makes its way under the influence of hydraulic gradients.

The first history-bending transformation followed the invention and spread of cultivated agriculture and the herding of animals for food production, after a long prelude of foraging, hunting,

fowling, and fishing. This period lasted from the dawn of humankind until about 10,000 years ago, when some societies adopted agriculture as a means of subsistence, which was rapidly followed by digging wells, canals, and drains.

The earliest states evolved into militaristic empires that rose and fell in succession in many parts of the world. By the end of the Roman Empire, changing conditions in Europe and later the spread of Islam created a different world order, which capitalized on the accumulated knowledge of water management, especially the technology of irrigation in arid lands, the abstraction of groundwater, and the use of water-lifting devices. At that time, the earlier invention of the waterwheel (saqiya or noria) proved to be revolutionary. The waterwheel was modified for industrial purposes, in combination with trade in the context of merchant capitalism.

The earliest artificial irrigation civilizations emerged along the banks of the Nile, the Euphrates, the Indus, and the Yellow rivers. The great civilizations of Mesoamerica, however, depended on harvesting surface runoff, small rivers, lakes, and groundwater.

Water is the mainspring of civilization. This was recognized at the dawn of civilization in Mesopotamia and Egypt. Water was conceived as the source of all things, eternal and primeval. This early recognition of the link between water management and civilization is the subject of this chapter.

Civilizations (Sumerian, Hittite, Urartu, Hellenistic, Roman, Byzantine, Seljukide, and Ottoman) are constrained directly by the quality and quantity of available safe drinking and subsistence water. They are constrained indirectly by the influence of water on food, energy, transportation, and industry. Throughout history, human societies have found new means to secure availability of water where they settled. They have devised ingenious methods to harvest, transport, and store rainwater, spring water, groundwater, and even air moisture.

For more than five millennia, different civilizations had their cultural, social, economic, and environmental imprints in Asia Minor (Anatolia), or Asian Turkey, owing to its geopolitical position between the two continents, including upstream of the Euphrates and Tigris rivers at the upper Mesopotamian fertile soils, which coupled with convenient climatological features in four distinctive seasons. This provided opportunity for productive agriculture and food storage. On the other hand, in the Thrace peninsula, the European Turkey had one of the most historically significant old city, Constantinople, modern Istanbul, which is situated at naturally and magnificently prosperous small peninsula right at the south end of Bosphorus, where there has been continuous water deficit, because there are not sufficient local resources and the potential sources were far away, outside the city walls.

The age of water industry is pivotal for understanding how our modern water systems and paradigms are linked to earlier developments in water management technologies and practices. It is, therefore, the main purpose of this chapter to clarify the transformations in water systems, structures, and technologies during the historical periods by focusing on different civilizations that were active in the present-day Turkish territories.

## 15.2 WATER HISTORY AND GROUNDWATER

Water history may also unearth ancient water materials and technologies that could be suitable as durable and inexpensive substitutes for imported versions, such as ancient Egyptian and Roman mortars, and underground qanāts.

Easily available water resources sites have become the cradles of civilizations, and therefore, the most easily accessible and sustainable water resources are streams, creeks, rivulets, lakes, and rivers. Among these, the rivers are of prime importance, because their water is replenishable after each storm rainfall, and therefore, early settlers have preferred river sides as their urban areas. This is reflected by the fact that early civilizations were along the running waters such as the Euphrates, Tigris, Nile, Indus, and Yellow rivers. Food security is also dependent on the water availability, and therefore, early agricultural lands were also along the river sides.

Humankind is dependent on easily accessible water resources without water structures or with simple but genuine structures. Migrations, settlements, and, at times, sieges, fights, and migrations have taken place depending on the availability of water resources in addition to rational consumption and management strategies for survival and well-being. Throughout the history, water has been collected, transported, and allocated for various uses such as transportation along the rivers, agricultural products, and protection against enemy. Settlement potential subsistence and health care have been among the key concerns for sufficient amount and good quality of water, its distribution facilities, and seasonality.

Especially, along the rivers (the Nile, Euphrates, Tigris, and Indus), canal and drain systems expanded in the earliest riverside agrarian societies.

As explained by Postgate (1992) and Wilkinson (2003), canals in the Mesopotamia are the oldest evidence, and they were dug by removing silt from clogged channels, and over three millennia, canals achieved sufficient length to irrigate tracks of up to 25 km<sup>2</sup>.

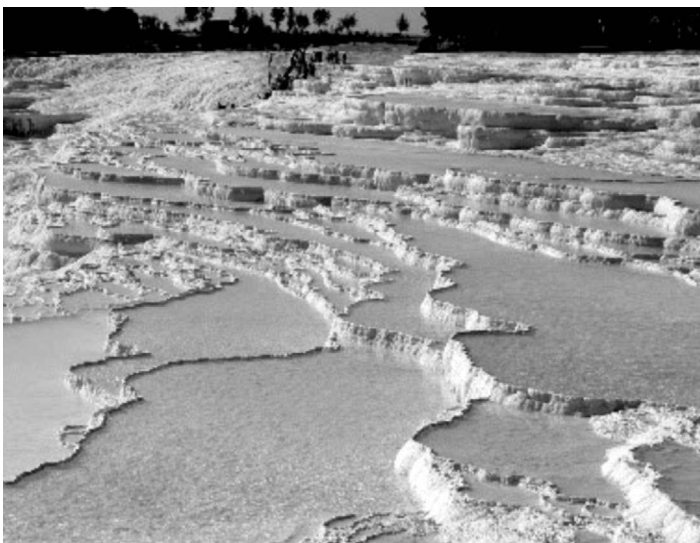
In arid and semi-arid regions, owing to the aridity prevalence and desertification, groundwater resources became the main water sources, especially for drinking water provisions. Groundwater outlets were natural springs, wells, and qanāts for local use, but the conveyance means were aqueducts, canals, stone pipes, inverted siphons, tunnels, bridges, cisterns, nymphaeum, sabils, and fountains. The groundwater is used for a set of purposes such as drinking water, because compared with surface-running water, the quality of groundwater is far better as a result of mineral solution. Hot spring groundwater outlets are used for healing purposes at centers of baths, for instance a Turkish bath. For centuries, hot springs are believed to possess medical curing properties among the people.

In Southwest Turkey, in the city of Denizli, groundwater springs that originate from a cliff next to the city have calcite-laden waters that lead to extraordinary landscape with petrified white rocks at Pamukkale, which means cotton palace, as shown in Figure 15.1.

This site was also famous during the Hellenistic period, with its town, Hierapolis, founded toward the end of second century BC. There are remains of baths, temple ruins, arches, nymphaeum, and a theater.

### 15.2.1 HISTORICAL AND PRESENT-DAY HYDRAULIC PRINCIPLES

The historical hydraulic and hydrological principles, assumptions, rules, and guides have remained in verbal (linguistically) information forms, which are converted into modern mathematical



**FIGURE 15.1** Calcite-laden groundwater-fed natural hot waters.



equations during the last 150 years. One can write linguistically the following points that have been used in the historical groundwater resources development.

1. Water flows from high elevation to lower parts, owing to gravitational force, without any energy consumption. This is the main principle based on which irrigation canals and aqueducts are constructed (Section 15.3.4).
2. The groundwater heads are at cliffs or hills, where spring outlets exist, but they are far away from suitable locations for settlement, and therefore, transportation routes are constructed especially in the forms of aqueducts (Section 15.3.4).
3. In arid and semi-arid regions, owing to high evaporation, transportation routes were in the form of qanāts, which lead groundwater to consumption areas along underground tunnels. In the long run, the qanāts system is not only economical but also sustainable for irrigation and agriculture purposes (Section 15.3.2).
4. The groundwater flow was known to depend on grain size of sediments, and, therefore, the tunnels in qanāts are filled in with courser material than the surrounding host geological formations. The qanāts are constructed mainly along the valleys where Quaternary sediments are deposited (Section 15.3.2).
5. The idea of gravitational force and coarse grain material preference impels the verbal interpretation of Darcy (1856) law, which states that the groundwater velocity is directly proportional to hydraulic gradient (gravitation force) and high permeability (coarse material) (Section 15.3.2).
6. The principle of U-tube was also known, because inverted siphons were used in some historical water structures such as the most famous ones in Southwest Turkey, Antalya city, and Aspendos as remnants from Roman period. This principle was known verbally as “water finding its own level” (Kessener, 2001) (Section 15.4.3).
7. Water balance towers are used as pressure relieves, again based on the principle of U-tube, and hence, the pressure on water structures is reduced (Section 15.4.2).
8. In arid and semi-arid regions or in surface-water-extinct areas, the best sites are located in rather low elevations such as valleys (wadis in arid region, Şen, 2008) for groundwater abstraction, where hand-dug wells are constructed. Since the demand was not much, the water was hauled by hand and bucket-type gadgets. However, as the demand increased, hand haulages were supported by shadofs (Section 15.3.1).
9. Other early gadgets for raising water from lower to higher places were spirals (Archimedean), waterwheels (shadof), and also animal power and bucket fixed leathers. Apart from the human power, animal power was also used as supportive energy (Section 15.5).

### 15.3 HISTORICAL GROUNDWATER-SUPPLY STRUCTURES

After the identification of groundwater potential locations, each civilization was engaged to transport these sources to consumption centers. For this purpose, various means were used, as will be explained in the following subsections.

#### 15.3.1 HAND-DUG WELLS

Any vertical excavation on the earth’s surface is a water well, provided that the purpose is to extract groundwater from the zone of saturation for domestic, agricultural, industrial, or any other similar uses. Wells should have shapes that simplify the groundwater movement toward the well storage. The choice of shape and dimensions of well depends on the topography, piezometric level, and subsurface geological conditions of the surrounding aquifer, regional climate, and rainfall and recharge possibilities, as well as their quantities.

For thousands of years, hand-dug well procedures remained the same at the primitive stage, and wells were dug in dry streambeds, so that the surface water from nearby streams could also contribute through the sand layers as filters. Early men were nomadic, and therefore, needed water temporarily, and they did not care for well casing, because it was unnecessary and not worth of losing time. Initially, hand-dug wells did not have more than a few meters' depth. The diameter of the well was enough for a man to enter to continue digging as water level dropped due to dry year effects.

The main instruments used in the excavation of a large-diameter well are the picks and shovels. Mostly, these wells are dug by hand and therefore are known as hand-dug wells. The minimum size of diameter is about 1 m, which gives comfort for one person to work in the well digging. The larger will be the diameter, the more will be the storage of well, and hence, at the time of need, large quantities can be abstracted initially, without difficulty. These wells cannot be deep, and the maximum depths observed in practice are about 80 m. They are mostly dug in unconfined aquifers, and the actual depth of a large-diameter well at any time is a function of the groundwater table elevation. Initially, when the well reaches the groundwater table, the aquifer is penetrated for about 1–2 m and the water is abstracted. Regional drop in the water table may require additional digging, as necessary. In this way, the maximum depth is limited by the underlying impermeable non-fractured crystalline rocks. Applications of large-diameter wells in the Middle Eastern countries and in India indicate that they are mostly dug in Quaternary deposits of wadi alluviums, which are underlain by weathered rocks and fractured media, before penetration into solid rocks. Figure 15.2 shows a typical large diameter well.

#### 15.3.1.1 Zamzam Well

Zamzam is the most functional hand-dug well since about 4000 years from Sumerian period, starting from circa 1900 BC, with Prophet Abraham (peace be upon him). Today, it serves Muslims in Makkah Al-Mukharramah. Its waters originate as daily intensive evaporation from the Red Sea and humidity-laden air movement toward the inlands, and at Taif city heights (more than 2000 m above mean sea level), the rainfall is generated mostly orographically, leading to groundwater recharge



FIGURE 15.2 A large diameter well.

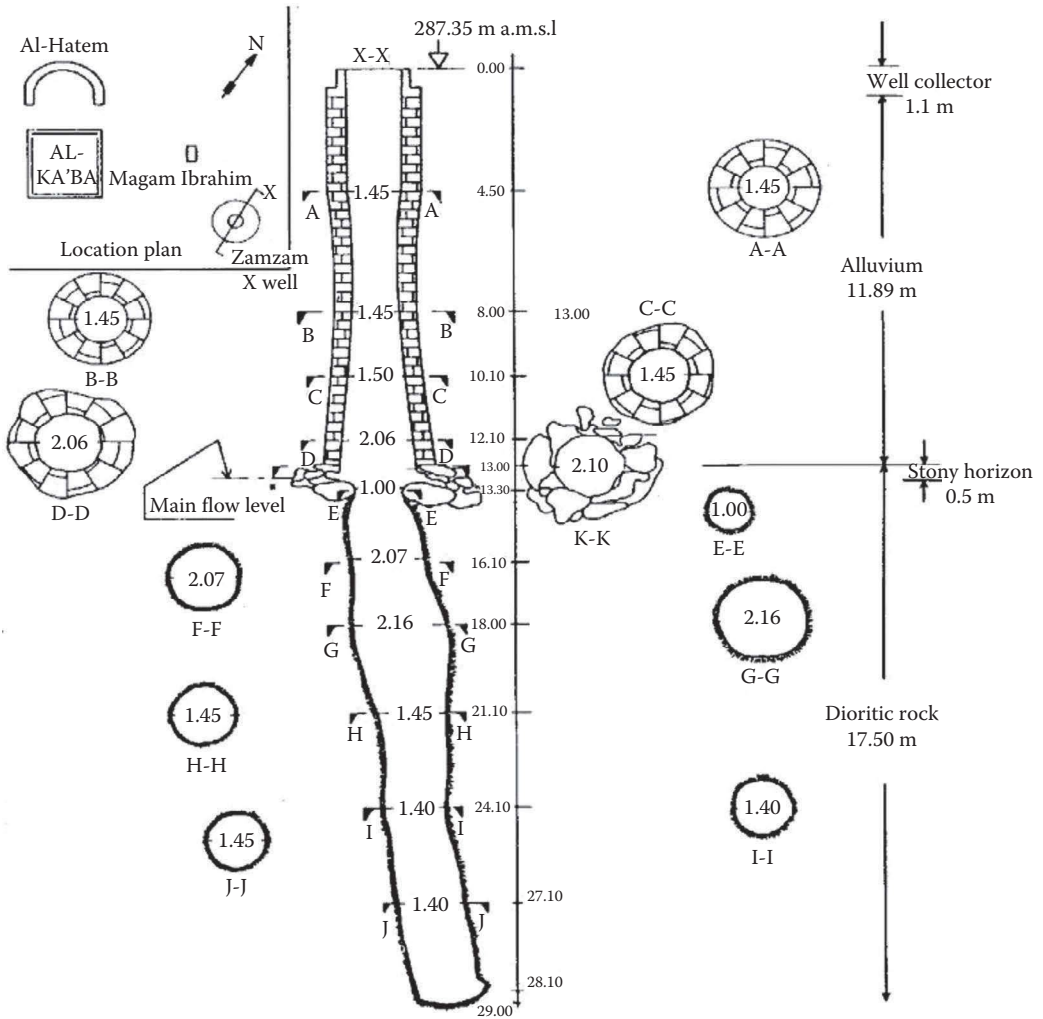


FIGURE 15.3 Vertical section of the Zamzam well.

(Şen, 2006). The well location is in the Wadi Ibrahim, main course drainage basin with very specific subsurface structure that leads all groundwater to flow toward the well location.

The vertical section of the Zamzam well is given in Figure 15.3. Its total depth is 30.5 m, with about 18 m penetration into the dioritic and granodioritic rocks. The section within the alluvium is lined with masonry, which plays the role of an artificial barrier for the horizontal groundwater entrance into the well.

### 15.3.2 QANĀTS

During the first millennium BC, the development of artificial irrigation technique by means of underground aqueducts was introduced. This type of aqueduct is commonly called qanāt, keriz, foggara, or khettara, depending on the development of tunneling technology, well digging, and land surveying. In this ingenious hydraulic structure, groundwater is abstracted from a mother well and transferred via underground tunnels over long distances to irrigate fields and supply towns in some of the most arid places in the world (Lightfoot, 1997).

The invention of qanāts has long been thought to have taken place in Iran, but recent evidence suggests that the oldest documentation is in Southeast Arabia, around 3100–3000 BC. By 2300 BC,

qanāts technology had spread rapidly in the arid zone, extending from Pakistan to the Egyptian desert. It spread later as far as China and Spain (Kobori, 1973).

Şen (2014) has explained the significance of these groundwater structures from hydrogeology point of view. A system of wells connected together by a gallery that brings water from the foothills to the plains is called “Qanāts,” as shown in Figure 15.4. The main groundwater-carrying part of the system is the gallery, which penetrates with a small gradient deep into the aquifer.

The first stage in the construction of a qanāt is to dig large-diameter exploratory wells through the alluvium. These wells are about 300–400 m apart and may reach down to 100 m depth, and they have large diameter of at least 75 cm. The gradient of qanāts is taken usually around 1:1500. Figure 15.4 indicates excavation stages and other views of a qanāt. Qanāts appear to have various local names in different countries. For instance, in Saudi Arabia, they are known as iyn (or iyun in plural) shat-at-ir in Marocco; foggariur in Algeria; falaj (or aflaj in plural) in Oman; shariz in Yemen; and karez in Pakistan, Iraq, and Afghanistan.

Qanāts are constructed as gently sloping tunnels in the alluvial fills or fans. The tunnel collects the groundwater seepage and carries it down the slope, until it appears as surface water near the exploitation center above the water table. The widespread usages of qanāts in arid or semi-arid regions are due to the following facts:

1. The groundwater flows due to the gravitational force, and thus, there is no need for extra power source.

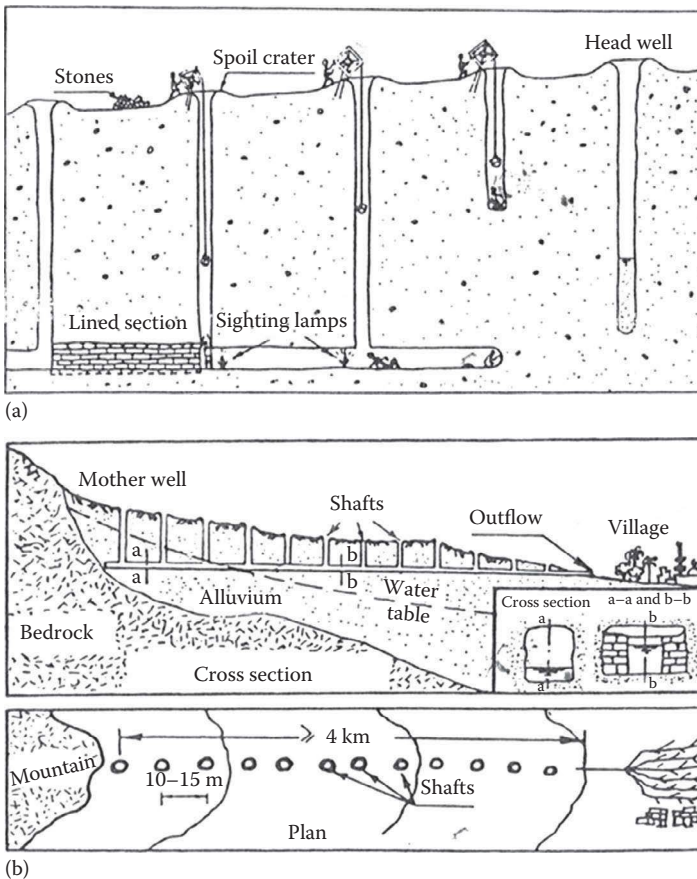


FIGURE 15.4 Qanāts (a) excavation stages and (b) longitudinal section.

(Continued)



(c)

**FIGURE 15.4 (Continued)** Qanāts (c) Areal view of well series of different qanāts in Iran (From Mousavi, A., Qanāts: an early irrigation system in West Asia. In *Qanāts of Bam: A Multidisciplinary Approach*, ed. M. Honari, A. Salamat et al. UNESCO Tehran Cluster Office, Tehran, Iran, pp. 87–97, 2006. With Permission.)

2. The evaporation losses are at the minimum level, because the flow takes place completely in the subsurface.
3. It provides a dependable and sustainable water supply for local domestic and agricultural lands for long duration. For instance, Iyn Zubaydah qanāts system was constructed mainly for water supply to the pilgrims in the holy places of Makkah city in year about 750 AD, and it is functioning even today.
4. The groundwater flow is safe guarded against pollution. A detailed account of qanāts construction in the arid zones is given by Amin et al. (1983), in addition to their hydrologic importance, maintenance, and specific properties.

Qanāts transfer underground water to the surface from aquifers near mountainous or flat regions through one or more man-made tunnels. Water flows inside the tunnels with a gentle slope that provides gravitational flow to underground water (Mostafaeipour, 2010).

### 15.3.3 CISTERNS

There are alternatives for water supply purposes as a result of rainwater harvesting. According to the climate pattern, where there is not much evaporation during autumn, winter, and spring seasons, the water is collected in these open ditches (cisterns). On the other hand, such water collections in ditches are another means of groundwater recharge. Water is directly available in these ponds, instead of groundwater haulage, which requires extra force and power. Such structures are like distilling ponds, and water remains clean, especially on the surface. These cisterns in Istanbul date back to Byzantine period, but they have continued to their functions during Ottoman times. The construction techniques of these large artificial surface depressions are characteristic of the Roman period. Of the seven pre-Ottoman wells discovered in Istanbul, five date from the pre-Byzantine period and only two date from the Byzantine period (Figure 15.5).

Another Roman water structure is the covered cistern from the Byzantine period, which was a remnant from the Roman era. According to Roman architect Vitruvius, “If the ground is hard or if the veins lie too deep, the water supply must be obtained from roofs or higher ground, and





**FIGURE 15.5** Open cistern.



**FIGURE 15.6** Covered cistern.

collected in cisterns.” The cisterns are like precipitation tanks, where water is rested for immediate use (Figure 15.6).

Cisterns have, almost during all periods of the history, played a key part in Turkey (Öziş, 1982). Covered and open cisterns in Istanbul, from the fourth to eighth centuries, with side lengths in the order of 150–250 m, are extraordinary examples of antique cisterns (Forchheimer and Strzygowski, 1893).

#### 15.3.4 AQUEDUCTS

In early times, when there was no possibility of water haulage and pressurized pipe constructions, the water sources at far distances could be transported by open channels, which are not adjunct to the earth surface only, but the valleys are crossed over by bridges that carried water canals at their heads canals. These constructions are referred to as aqueducts, which provided the spring



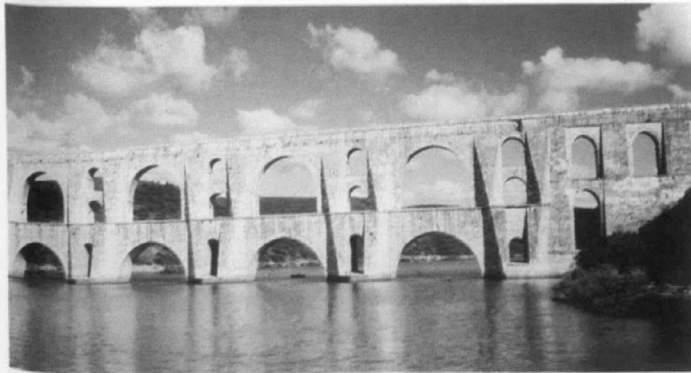


**FIGURE 15.7** Bozdoğan (Valens) aqueducts.

groundwater flow from the source to demand locations by only gravitation force. Aqueducts are in the form of bridges, with arches on the top of series of columns. In Istanbul and its vicinity, the aqueducts are remnants from Roman period from the fourth century, and they are standing even today, at least in parts. The most famous one lies within the city, and it is known as the Valens (Bozdoğan) (Figure 15.7).

Another important aqueduct type is the Kırıkkemer aqueduct, which is significant because of its architecture and engineering styles, and small part of this structure was constructed in Byzantine ages.

Another debatable aqueduct is over the Alibey Stream in Istanbul, and it is referred to as the Mağlova aqueduct. Some Europeans claim that this aqueduct is a late Byzantine monument, and its name is Justinian aqueduct. However, this claim is entirely wrong according to proof of many researchers (Çeçen, 1988; Necipoğlu, 2005; Pierpont, 2007). Arch type, wall thickness, and muqarnas on the wall indicate that it is one of the brilliant structures of Architect Sinan, from Ottoman period (Figure 15.8).



**FIGURE 15.8** Mağlova aqueduct (From Çeçen, K., *Istanbul'da Sinan tarafından yapılan su tesisleri* [Water Structures by architecture Sinan in Istanbul]. Atatürk Cultural, Language and History High Commission Publication, Ankara, Turkey, pp. 19–20, 1988. With Permission.)

## 15.4 HISTORICAL WATER STRUCTURES IN TURKEY AND ISTANBUL

The earliest powerful states appeared in Egypt, Mesopotamia, Indus, and China. Owing to the necessity of a powerful central authority to manage the large water systems in these countries, they were also called “hydraulic civilizations.” On the other hand, it is quite natural that the need for large water works in less arid zones with suitable climate and lacking large rivers, such as Turkey and many other Mediterranean countries, came into existence quite later. The first powerful state in Asia Minor (Anatolia or Asian Turkey) was the Hittites, which dates from the second millennium BC, and those in other Mediterranean regions belong to later periods (Öziş et al. 2005). Table 15.1 indicates different water works of civilizations in Anatolia.

Old water structures in Western and Southern Anatolia (Turkey) and Istanbul are remnants rarely from the Hellenistic period but extensively from the Roman and early Byzantine periods. They are numerous from the first millennium BC to the first half of the first millennium AD. Figure 15.9 includes all the potential water structure remnant locations in Turkey by different civilizations.

Istanbul has been cradle of several civilizations, among which the most important ones are the Roman, Byzantium, and Ottoman periods, which cover more than four millenniums. Before these periods and even today, Istanbul is struggling for water resources augmentation.

### 15.4.1 HITTITE PERIOD

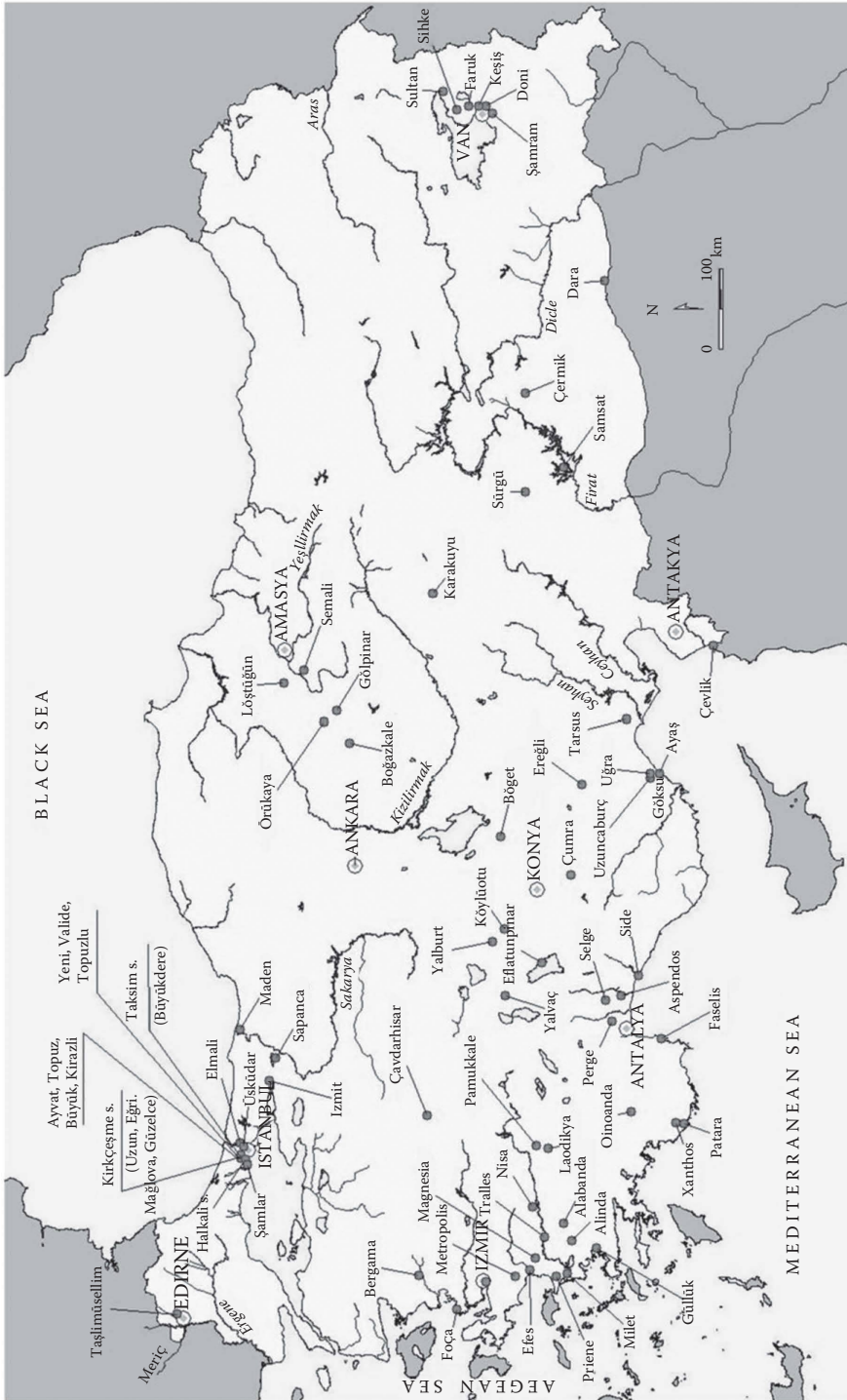
Water structures remnants of the Hittite period are in Central Anatolia, and they are the most ancient examples in Turkey, dating back to the second millennium BC. These are mainly wells, canals, and dams for water collection and distribution. As stated by Öziş (2015), the most ancient one is the Gürpınar dam near Alacahöyük, which is the main settlement area of the Hittite period.

In the second millennium BC, Hittites had the first examples of water structures in Turkey, especially in their capital, which was located at about 150 km east of Ankara, the capital of Modern Turkey.

**TABLE 15.1**  
**Civilization-Wise Water Structures in Turkey**

Civilization	Period	Water Works	Location
Hittite	Second millennium BC	Spring water collection chambers Conduits	Central Anatolia
Urartu	First millennium BC	Canals Dams Galleries	Eastern Anatolia
Hellenistic, Roman, and Byzantine	First millennium AD	Aqueducts Cisterns Tunnels Dams	Western and Southern Anatolia
Seljukide	Tenth-thirteenth century	Conveyance systems Irrigation systems	Different parts of Anatolia
Ottoman	Thirteenth-twentieth century	Aqueducts Fountains Sabils Dams	Different parts of Anatolia
Republic of Turkey	Since 1923	Modern water structures	All over Turkey

Source: (Öziş et al. 2005)



**FIGURE 15.9** Ancient hydraulic works location map in Turkey (From Özış, Ü., Water works through four millennia in Turkey. *Environmental Processes*, 2, 559–573, 2015. With Permission.)

Continuous water supply has been obtained by artificial ponds located at various places in and around the major settlement centers. The ponds are used not only for water haulages and supply directly from the surface runoff but also as artificial groundwater recharge units. The remnants of these ponds indicate that the largest one had  $100 \times 65 \text{ m}^2$ , with about 8 m depth. The entire pond sides were supported with limestone pavements against erosion, and the clay material was used for water tightness.

#### 15.4.2 URARTU PERIOD

In the Eastern Anatolia, near the Van Lake, Urartu civilization had a systematic water network with irrigation canals that are there almost from the beginning of the first millennium BC. During this period also, cisterns for rainwater harvesting and some minor qanāts were constructed for groundwater management.

The Urartians lived in central settlements around Van Lake, and they had developed hydraulic technologies for benefiting from water resources. They had fish-like monuments of the god of water, relating to irrigation activities. This mountainous area with semi-arid environment is distinguished by a complex network of streams and rivers connected with the lakes and watersheds, including head waters of the Tigris and Euphrates (Hofmann, 1978). Especially, open cisterns were built near settlement areas and castles. In some cases, long tunnels were dug in the rocks for water supply. Since the Van Lake water is not potable, Urartians constructed systematic water networks starting from the headwaters as springs at the feet of high hills, and through the canal and reservoir system, agricultural fields were watered, and finally, the waters reached the Van Lake (Harutyunyan, 2012). Another system was the construction of dams for water impoundment at high elevations, so that water could be distributed to the settlement centers easily by gravitational force. Their water systems were designed in such a manner that they could serve under severe climatological conditions.

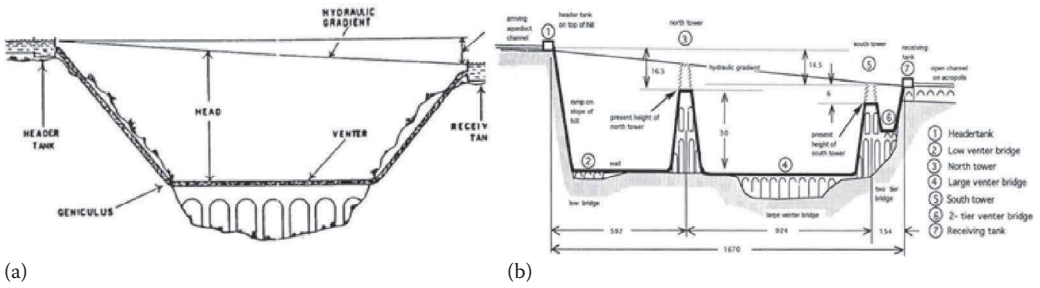
There was agricultural intensification during the period of the Urartian Kingdom, and water structures remain as the best interpretation of the evidence currently available. However, this should now be modified to note that such works were not necessarily conducted by the Urartian state itself and that they might have been intended to facilitate the intensification of both arable land and pastoral agriculture in the region (Çifci and Greaves, 2013).

#### 15.4.3 ANCIENT GREEK, BYZANTINE, AND ROMAN PERIODS

Old Greek, Roman, and Byzantine periods provided huge, long-distance, and original water structures as aqueducts, cisterns, inverted siphons, tunnels, and nymphaea. These civilizations with dominance of Roman and Byzantine periods followed each other, starting from the first millennium BC up to almost the first quarter on the second millennium AD. There are numerous water structures scattered especially in the Mediterranean, Aegean, and Marmara regions (Thrace peninsula, i.e., European Turkey), whereas water structures are dominant in Asian Turkey in Istanbul, also from Ottoman period. The materials used for water conveyance construction were mainly stone, clay, and lead, especially lead-pipe inverted siphons near Pergamon in the Aegean region (Öziş, 2015), in addition to rock-cuts (tunnels) and masonry (canals). However, inverted siphon of Aspendos is constructed from stone pipes. The general description of Aspendos water structure is given in a sketch by Kessener (2001).

The two most distinctive examples are from Antalya, where Aspendos structures and Istanbul. The location of Aspendos is about 12 km from the modern Mediterranean city of Antalya, at elevation of about 60 m above mean sea level. Among the ruins of Aspendos are aqueduct hydraulic towers (Figure 15.10).

As stated by Kessener (2001), today the skyline of Aspendos is dominated by the remnants of the façade of the nymphaeum from the second to third century BC, in addition to the monumental



**FIGURE 15.10** Aspendos inverted siphon: (a) general principles (Hodge, 1992) and (b) vertical dimension enlarged (Kessener, 2001).

entrance hall of the basilica. The location had its water supply by means of a Roman aqueduct channel composed of tunnels and bridges.

Constantinople was the most populated city during the Medieval Europe until the thirteenth century. As a new imperial capital of Eastern Roman Empire, the Byzantine water structures in and around the city started to rival the Western Roman city, Rome. The defense of the city, population increase, and various sieges rendered the water conditions in deteriorating manner, and therefore, the water supply needed to be supported from far distance springs, among which were Istranca Mountains, which are about 250 km away from the historical small peninsula of old city, Constantinople. The aqueducts that brought water from Istranca Mountain were the longest, of about 590 km of channels in the world, even today, with its remnants. The next longest aqueduct was about 520 km, near Rome City. The aqueduct in Istanbul ends within the city, and it is named as Aqueduct of Valans, with its 970 m length (see Figure 15.7, Section 15.3.4). The average height of Istranca Mountains is about 640 m above mean sea level, and Istanbul is at 30 m, which corresponds to the slope of  $(640-30)/250 \times 10^3 = 0.0024$ . However, the Roman aqueducts have the slope 0.007.

Cisterns from the fourth, fifth, and sixth centuries AD in Istanbul are in the forms of open ditches or covered ones, which are the early examples of cisterns. These were used for rainwater harvesting, which are also used today in many parts of the world, with modern water structure forms (Şen et al. 2012).

Water network for water supply to Istanbul city can be examined in two periods, pre-Ottoman (old Greek, Byzantine, and Roman) and Ottoman periods. This also reflects the water demand of the city through different civilizations in a continuous manner. Many researchers examined the historical water networks that ended in Istanbul (Çeçen, 1979, 1984, 1986, 1988; Eyice, 1989; Forchheimer and Strzygowski, 1893). In general, they mentioned that there are four water systems in Istanbul's history after the Christ. The first water supply line was constructed during the reign of Emperor Hadrian (117–138 AD), and later, Theodosius II (408–450 AD) extended it. The second extensive stage of water supply to Istanbul city took place during the reign of Emperor Constantine (324–337 AD), who constructed a series of aqueducts along 242 km from Istranca Mountains on the west-northern part of Thrace Peninsula. The third major-stage water supply system construction was due to Emperor Valens in 373 AD, and this system had been restored and enlarged by addition of Archilleus Baths and Yerebatan Sarayı (Basilica) Cistern, during the reigns of Justinian (527–565 AD) and Constantine (720–740 AD) (Çeçen, 1976). The last extensive work for water supply to Istanbul city was due to Theodosius (379–395 AD), who had a new water system line from Belgrad Forest at the northern corner of the Thrace Peninsula to city center.

In the course of the time, Roman water systems had been destroyed from earthquakes and various sieges, and therefore, nymphaeum gave rise to the idea that rather than bringing water to the city from far distances, it would be better and self-sufficient to construct water-capturing systems within the city walls, and hence, rainwater collection structures appeared as cisterns—rainwater-harvesting,



extensive open and covered cisterns (ditches). Byzantium (Istanbul) was the capital of Eastern Rome, and it had its own style of monumental structures, among which there was the need for water structures.

The cisterns were either in the form of extensively large open ditches or were covered in relatively small scales (see Section 15.3.3). They were constructed not only within the city walls but also outside, not far from the walls. These cisterns served as major water collection locations and water distribution centers.

Another type of water structure in Istanbul, dating from Roman and Byzantine times, was the ayazma or sacred spring. These were structures built over springs whose mineral water was regarded as sacred and was not used for domestic needs. Hence, they were not connected up to the city's water system.

Earlier damage and deterioration in the Roman period's water system were compounded still further by the Latin occupation in 1204, after which the water system became virtually unusable. When Istanbul passed into the hands of the Ottomans in 1453, major repairs and additions were made to the system.

## 15.4.2 SELJUKIDE AND OTTOMAN PERIOD

The eleventh and twelfth centuries showed Seljukide dominance, especially in the Central and Eastern Anatolia (Turkey). They constructed some small-scale surface water collection dams, aqums, and bends. Konya city as the capital of Seljukide Sultanates had various irrigation canal system, which combined at some places with remnants from the Hittite period.

Sultan Mehmed II, after the conquest of Istanbul in 1453, urged for repairs of the existing water systems from the Roman and Byzantium periods. In addition, a few new water supply lines were constructed at the same time as extensions to the late Roman period line. The most efficient water resources system expansion was done during the reign (1520–1476) of Sultan Süleyman the Magnificent. The famous architect Mimar Sinan examined the water structures of the Roman-Byzantine period and also the ones since the Ottoman conquest, and finally, he himself constructed various waterways and structures for the city (see Figure 15.8). He started with major reconstruction and enlargement of the Kırkçeşme system from the Roman period. He made use of surviving aqueducts and dams, following the former Roman supply line and using the ancient Valens aqueduct as the most comprehensive water supply project, undertaken by the Ottomans in Istanbul.

One of the most important water systems constructed during the Ottoman period is the introduction of modern dam concept and collection of surface waters behind them and then transportation to the city center by canals. At each side of the dam walls, there were sluices, over which the water flowed into basins and then to distribution chambers. The dams of this time were given the shapes either of straight or of bend or angled walls. These dams were constructed in Belgrad Forest area, which was also considered a potential water site during the Roman period. Aqueducts were in the form of arched bridges, which had been used since the Roman period to carry water across valleys and streams, dividing two areas of high ground, so that there was no need for water haulage.

Along the waterways, there were water level measurement towers, the internal structure of which in the Roman period remains unknown; however, in the Ottoman period, these were tower-like structures, known as su terazisi (water balance), serving to adjust water pressure and also to measure water for distribution purposes (see Figure 15.11).

Their height varied from 3 to 10 m, and they had a cistern at the summit, from which the water flowed into distribution pipes.

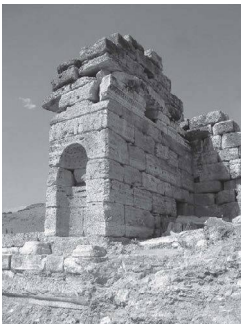
### 15.4.2.1 Fountains

These are specific for Ottoman period's water outlets, with the purpose of serving the community free drinking water. It is possible to name the Ottoman period as water fountain civilization. The construction purpose was mostly to gain the benevolence and trust of Allah (God). These were built

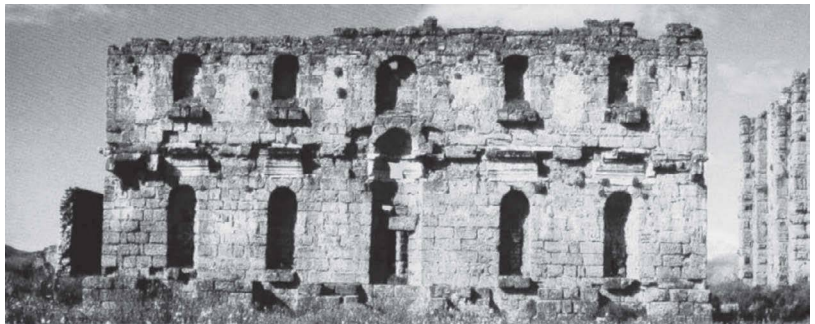




**FIGURE 15.11** Water balance towers.



(a)



(b)

**FIGURE 15.12** (a,b) Roman period nymphaeum.

with donation of wealthy people, and mostly, the distribution water had groundwater origin, either by wells or by springs. There were also such important water structures called nymphaea during Roman period, but they were very few and had monumental big structures. They were not intensively distributed to the points of needs, like Ottoman fountains. Figures 15.12 and 15.13 indicate examples from the Roman and Ottoman period structures.

Today, one of these is at the main building location of Istanbul University, to which water was carried by the aqueduct that was generally believed to have been built by Emperor Valens (364–378). The origins of the nymphaeum can be traced back to ancient Greece.

In Islam, water has been regarded as gift from Allah (God), and therefore, it should be shared freely. Muslims have regarded this as Allah's mercy and benevolence. Keeping this point in mind, wealthy people and those who were in domination started to provide free drinking water for street passers, and they constructed street water-drinking fountains at convenient places, which are also



**FIGURE 15.13** Ottoman period fountains.

referred to as “sabil.” Their main water resource was groundwater that came through the springs, and by conduits, water was brought to the sabil location.

## 15.5 HISTORICAL EVOLUTION OF WATER TECHNOLOGY

The technological period started widespread use of water-lifting devices such as the shaduf, the saqiya/noria, and the Archimedean screw (4400–2200 years ago). Water-lifting techniques refined during the first millennium BC were often associated with urban water supply, irrigation of gardens and orchards, digging canals for transport, or, on occasions, with ambitious irrigation works such as elaborate aqueducts, subterranean water abstraction, and delivery tunnels (*qanāts*). This mid-level technological leap also entailed a move to the use of water, wind, and animals as sources of energy (Fraenkel, 1986; Fraenkel and Thake, 2006).

One needs to consider only the history of water-lifting devices such as the saqiya, its transformation into the water mill, and its transmission from the Arab world to Europe, or the influence of European hydraulic engineering on countries such as India and Egypt. Among the earliest waterlifting devices was the shaduf, which depends on the principle of gravity to lift water from one level to another. As the groundwater table fell, the haulage become difficult. In order to solve this problem, innovative technologies entered the scene and the period of water-lifting devices started. The very first one is the shaduf (see Figure 15.14) and the Archimedean screw (see Figure 15.15).

Shadufs are also used in *qanāts*’ construction (see Figure 15.4, Section 15.3.2). In order to achieve this, a long branch is used as a pole, suspended asymmetrically, so that it can swing as a lever on an upright support frame built from mud. The shorter section (about one-fifth of the length of the pole) has a weighty stone or a lump of mud attached to its outer end. The longer section of the pole is attached by a rope to a bucket or to a waterproof basket. The rope is pulled down, so that the bucket or basket dips below the water level in a canal or well. When the rope is released, the

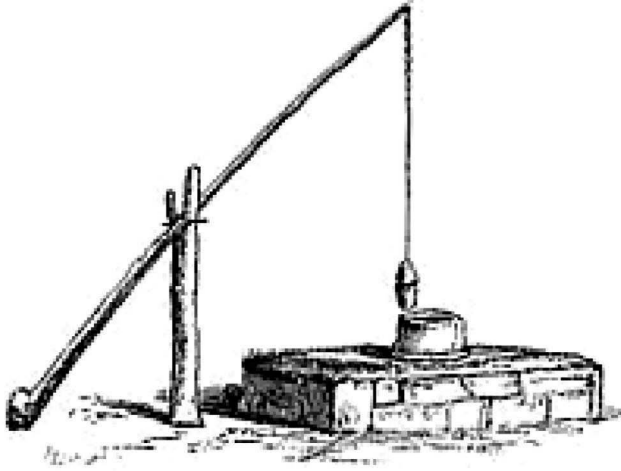


FIGURE 15.14 Shaduf.

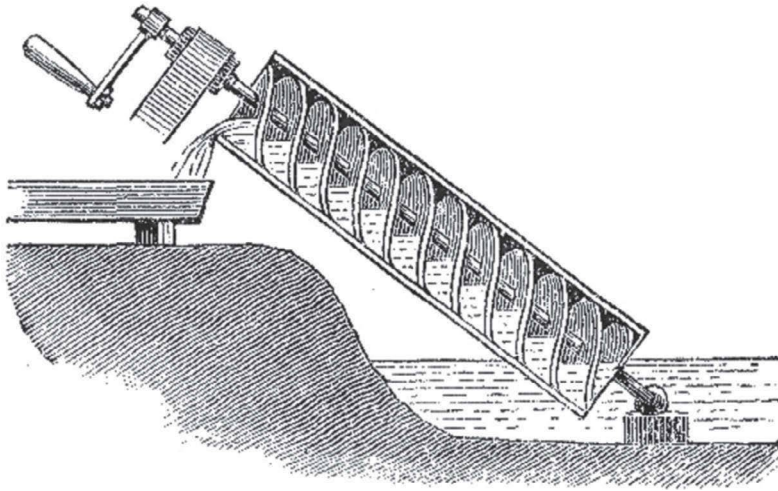
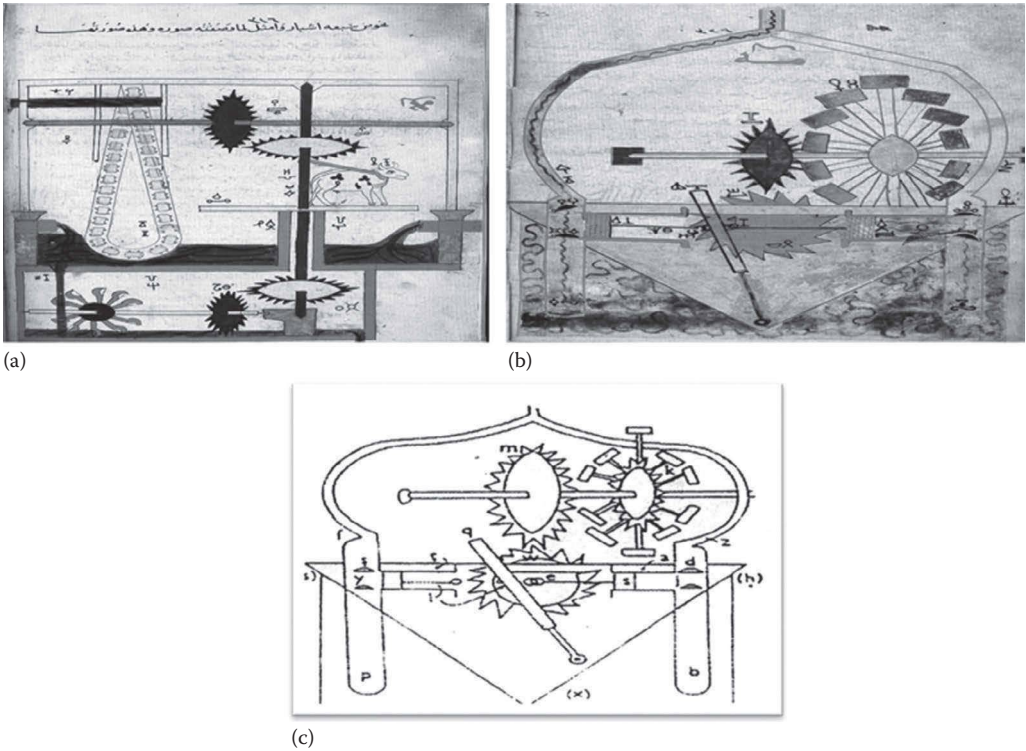


FIGURE 15.15 Archimedean screw.

stone or mud weight pulls the other end of the pole down and rises the water-filled bucket upward easily. The pole is then swung round and the bucket is emptied into a water channel at a higher level, which carries the water to the field plot (Bazza, 2006; Mays, 2008).

During the Seljukide period, famous Abo-l Iz Al-Jazari, who lived in the present-day Turkish town of Cizre, designed ingenious hydromechanical devices, which are the predators of the present-day hydraulic instruments. As inventor, after Archimedes (Old Greek, circa 200 BC), Heron (Old Greek, circa 50 AD), and Vitruvius (Roman, circa 70 BC) comes Abo-l Iz Al-Jazari (Seljukide, circa 1200 AD). Heron's original writings and designs have been lost, but some of his works were preserved in Arabic manuscripts. Abo-l Iz Al-Jazari has suggested the use of water power by suggesting piston, cylinder, and crank mill (Hill, 1974). Some of these devices are presented in Figure 15.16.



**FIGURE 15.16** Technological gadgets: (a) Abo-I Iz animal power, (b) Abo-I Iz water and wind power, and (c) Hill redraw of Abo-I Iz wind power.

### 15.6 CONCLUSIONS

Clearly, world history of water reveals how ideas and practices have spread in different directions at different times in a series of transcultural transmissions back and forth, with additions, modifications, and improvements that link humanity as a single water community.

Different civilizations contributed to significant water resources systems, structures, and technologies for impoundment, conveyance, and exploitation. The Anatolian Peninsula had Hittite, Urartu, Old Greek, Roman, Byzantium, Seljukide, and Ottoman, and now, modern Turkish Republic civilizations. Various water structure remnants and functions are available within Turkey, including the Hittite period in Central Anatolia, from the Urartu period in Eastern Anatolia, from the Hellenistic-Roman-Byzantine periods, as well as from the Seljukide and Ottoman periods, and finally Turkish Republic, with some of them still in use after so many centuries, even millennia. This makes Turkey one of the most outstanding open-air museums of the world in this respect.

### REFERENCES

Amin, M.I., Qazi, R. and Downing, T.E. 1983. Efficiency of infiltration galleries as a source of water in arid land. *Water International*, Elsevier, Netherlands, 8(4):158–165.

Bazza, M. 2006. Overview of the history of water resources and irrigation management in the Near East region. In *Water and Wastewater Technologies in Ancient Civilizations*, ed. A. N. Angelakis and D. Koutsoyiannis, Iraklio, Greece, National Agricultural Research Foundation, pp. 593–604.

Çeçen, K. 1979. *Sinan’s Water Supply System in Istanbul*, *Istanbul Water and Canalization*. Istanbul, Turkey: Department Publication.



- Çeçen, K. 1984. *İstanbul'da Osmanlı devrindeki su tesisleri* [Ottoman period water structures in Istanbul]. Istanbul Technical University Science and Technology Research Center, Istanbul, Turkey, No. 1, 292 p.
- Çeçen, K. 1986. *16. Yüzyılda Osmanlı'da Su Tesisleri* [Ottoman Water Structures in the 16th Century]. Istanbul Water and Canalization Department Publication, Istanbul, Turkey, 238 p.
- Çeçen, K. 1988. *İstanbul'da Sinan tarafından yapılan su tesisleri* [Water Structures by architect Sinan in Istanbul]. Atatürk Cultural, Language and History High Commission Publication, Ankara, Turkey, pp. 19–20.
- Çifci, A. and Greaves, A.M. 2013. Urartian irrigation systems: A critical review. *ANES* 50:191–214.
- Darcy, H. 1856. *Les Fontaines Publiques de la Ville de Dijon*, Victor Dalmont, Paris, France.
- Eyice, S. 1989. *İstanbul'un Bizans Su Tesisleri* [Byzantium Water Structures in Istanbul]. Istanbul, Turkey, STAD, 5:3–14.
- Forchheimer, P. and Strzygowski, J. 1893. Die byzantinischen Wasserbehälter von Konstantinopel. Wien, Beiträge zur Geschichte der byzantinischen Baukunst und zur Topographie von Konstantinopel, 270 s, 1893.
- Fraenkel, P.L. 1986. Water Lifting Devices, FAO Irrigation and Drainage Paper 43.
- Fraenkel, P.L. and Thake, J. 2006. *Water Pumping Devices: A Handbook*, 3rd edn, Practical Action Publishing, Rugby, UK.
- Harutyunyan, N. 2012. Water management and technologies in ancient Armenia. Central European University, Department of Environmental Sciences and Policy, Nador u. 9, H-1051 Budapest, Hungary.
- Hatami, H. and Gleick, P. 1994. Chronology of conflict over water in the legends, myths, and history of the ancient Middle East. In “*Water, War, and Peace in the Middle East*” *Environment*, Vol. 36, No. 3, pp. 6-on. Heldref Publishers, Washington, DC.
- Hill, R. 1974. *The Book of Knowledge of Ingenious Mechanical Devices*. Reidel, Dordrecht, the Netherlands.
- Hodge, T. 1992. *Roman Aqueducts and Water Supply*. Duckworth, London.
- Hofmann, J.K. 1978. Sociopolitical Implications of the Architecture of Northern Urartu and Urartian Written Sources. BSc. Thesis, Massachusetts Institute of Technology, Cambridge, MA.
- Kessener, P. 2001. The Aspendos Aqueduct, an outstanding example of Roman hydraulic technology. *Frontinus-Gesellschaft-Hefter*, 24:95–108.
- Kobori, I. 1973. Some notes on diffusion of qanats. *Orient*, 9:43–66.
- Lightfoot, D.R. 1997. Qanats in the Levant: Hydraulic technology at the periphery of early empires. *Technology and Culture*, 38(2):432–451.
- Mays, L.W. 2008. A very brief history of hydraulic technology during antiquity. *Environmental Fluid Mechanics*, 8(5–6):471–484.
- Mostafaeipour, A. 2010. Historical background, productivity and technical issues of qanats. *Water History*, 2(1):62–80.
- Mousavi, A. 2006. Qanats: an early irrigation system in West Asia. In *Qanats of Bam: A Multidisciplinary Approach*, ed. M. Honari, A. Salamat et al., UNESCO Tehran Cluster Office, Tehran, Iran, pp. 87–97.
- Necipoğlu, G. 2005. *The Age of Sinan, Architectural Culture in the Ottoman Empire*. Princeton University Press, Princeton NJ.
- Öziş, Ü. 1982. An outlook on ancient cisterns in Anatolia. In *International Conference on Rain Water Cistern Systems, Proceedings*, University of Hawaii, Honolulu, s.9–15.
- Öziş, Ü. 2015. Water works through four millennia in Turkey. *Environmental Processes*, 2:559–573. doi:10.1007/s40710-015-0085-3.
- Özis, Ü., Türkman, A., and Özdemir, 2005. Historical waterworks in Turkey. *Ninth International Water Technology Conference, IWTC9 2005*, Sharm El-Sheikh, Egypt, 291–309.
- Pierpont, A. 2007. *Sinan Diary—A Walking Tour of Sinan's Monuments*. Citlembik/Nettleberry Publications, Istanbul, Turkey.
- Postgate, J.N. 1992. *Early Mesopotamia: Society and Economy at the Dawn of History*. Routledge, London.
- Şen, Z. 2006. *Manevi ve Bilimsel Açılardan Zemzem Water* [Zamzam Water from Scientific and Spiritual Perspectives.] Turkish Water Foundation Press, İstanbul, Turkey, 154 p.
- Şen, Z. 2008. *Wadi Hydrology*. Taylor and Francis Group, CRC Publishers, Baco Raton, FL, 340 p.
- Şen, Z. 2014. *Practical and Applied Hydrogeology*. Elsevier, New York, 406 p.
- Şen, Z., Al Alsheikh, A., Al-Turbak, A.S., Al-Bassam, A.M., and Al-Dakheel, A.M. 2012. Climate change impact and runoff harvesting in arid regions. *Arabian Journal of Geosciences*. doi:10.1007/s12517-011-0354-z.
- Wilkinson, T.J. 2003. *Archaeological Landscapes of the Near East*. University of Arizona Press, Tucson, Arizona.

---

# 16 Aflaj Al Emarat

## *History and Factors Affecting Recharge, Discharge, and Water Quality, United Arab Emirates*

*Zeinelabidin E. Rizk and Abdulrahman S. Alsharhan*

### CONTENTS

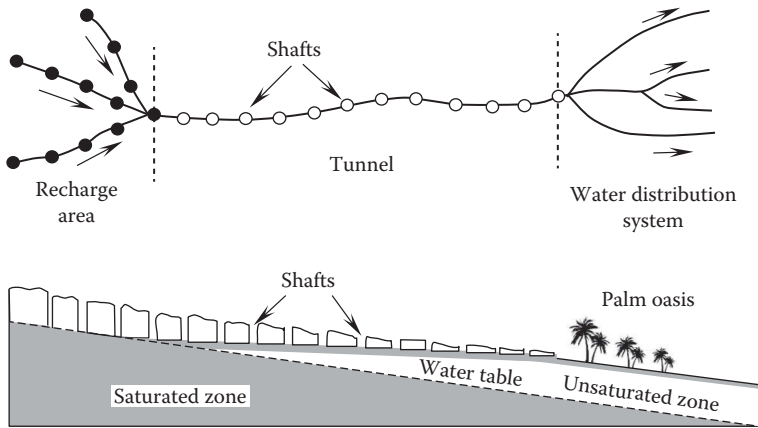
16.1	Introduction.....	261
16.2	Aflaj History .....	262
16.2.1	Aflaj Construction and Maintenance.....	263
16.2.1.1	Aflaj Construction.....	263
16.2.1.2	Aflaj Maintenance.....	265
16.2.2	Aflaj Administration.....	265
16.3	Aflaj Discharge .....	268
16.3.1	Climate.....	269
16.3.2	Geologic Setting .....	270
16.3.3	Human Activities .....	271
16.4	Aflaj Water Quality.....	272
16.5	Aflaj Water Use.....	272
16.6	Conclusions .....	274
	References.....	277

### 16.1 INTRODUCTION

Aflaj Al Emarat is an Arabic term referring to the falaj systems in the United Arab Emirates. Aflaj (plural of falaj) in Arabic means the division of an ownership into shares among those who have water rights. They vary in size from those that supply water to a small number of families to those that provide water for several thousands of people and several hundred palm gardens. The falaj systems of United Arab Emirates (UAE) have provided communities with water for irrigation and domestic purposes for the last 1500–2000 years (Alsharhan et al. 2001, 128).

The UAE is one of the Gulf states located in the Arabian Peninsula on the southeastern coast of the Gulf and the northwestern coast of the Gulf of Oman. The UAE is a federation that consists of seven emirates (Abu Dhabi, Dubai, Sharjah, Ajman, Fujairah, Ras Al Khaimah, and Umm Al Quwain) and was founded in 1971. The seven emirates were formerly known as the Trucial States, in reference to the treaty with Britain in the nineteenth century. The area was settled by a number of tribes along the coast and the interior. Coastal communities practiced fishing and pearl trade, while the interior inhabitants worked mainly in farming. Today, the UAE is a modern country with highly diversified economy. Abu Dhabi is the capital of the country, and Dubai is the second largest city.





**FIGURE 16.1** Map view and cross section in one of Aflaj Al Daudi in the UAE. (From Rizk, Z.S., *Arab. J. Sci. Eng.*, 23(1C), 3–25, 1998. With Permission.)

Aflaj are man-made streams, intercepting groundwater table through a single or several wells at the foot slopes of high mountains. They bring water to the surface at a lower level, without any mechanical devices with expenditure of fuel, for irrigation through a tunnel that has a slope gentler than the natural hydraulic gradient (Figure 16.1).

Boucharlat (2003) investigated the type of aquifers and concluded that Aflaj Al Emarat are shallow and tapped water from aquifers or base flow in dry wadis (valleys).

In the past, Aflaj represented the main arteries of life in Eastern UAE. At their outlets, palm oases have flourished (Figure 16.1), permanent communities were established, and an agricultural way of life was dependent on their water. Aflaj are part of the UAE's agricultural heritage, but recently, many aflaj have run dry because of low rainfall and excessive groundwater pumping at their mother well areas. However, a limited number of aflaj are still flowing and feeding palm oases.

The design, construction, and maintenance of aflaj are interesting issues, and ancient water distribution systems of historical aflaj still exist near Al Hili Archeological Garden in Al Ain City, in the eastern region of Abu Dhabi Emirate (Rizk 1998).

The arid climate that prevailed in the Arabian Peninsula during the last 6000 years has caused shortage of surface water sources and led ancient communities in Al Ain area of the UAE to introduce the aflaj system for groundwater exploitation. The vertical wells used for irrigation in the region during the Bronze Age were replaced by aflaj, which tapped groundwater in gently sloping tunnels since Iron Age. In addition to Al Ain, the discovery of aflaj systems in Bidaa Bint Saud (Al Tikriti 2015, 221) and Al Madam (Córdoba 2013, 142) areas indicates that aflaj were already well established in the UAE several centuries before the foundation of the Achemanean Empire (the First Persian Empire, 550–330 BC), to which the system was mistakenly attributed. Introduction of the aflaj system in Al Ain area was a revolution that led to the establishment of many settlements similar to the modern villages developed before the discovery of oil.

This chapter discusses the history of Aflaj Al Emarat and the factors affecting their discharge and water use.

## 16.2 AFLAJ HISTORY

Although aflaj are wasteful of water, they have the great advantage of deriving their water high up on the alluvial fan, where the supply is fresh and continuously replenished. Cressey (1958) considered the falaj as an idea of Persian origin, which dates back more than 2000 years, where the palace city of Persepolis is thought to have been supplied by qanāts at about 500 years BC. However, Al Tikriti (2015, 211), in his discussion on the history, engineering, and origin of Aflaj Al Emarat, claims that recent excavations

carried out in and around Al Ain city of the UAE demonstrated that standard aflaj, tapping water from mother wells sent deep into the ground, rather than those diverting surface water, have been in use in the region since the beginning of the Iron Age (1300–300 BC). This date precedes the earliest known qanāt in Persia by several centuries, and the cultural sites of Al Ain (Hafit, Hili, Bdaa Bint Saud, and Oases areas) were listed as World Heritage in 2011 under criteria (3–5). Al Tikriti (2015, 211) added that three falaj systems from the Early Iron Age period have been discovered at Hili and Bidaa Bint Saud, while four more dating to the same period are known today from the UAE (Figure 16.2).

At least five Iron Age aflaj have been found in the Al Ain area (Al Tikriti et al. 2015). At Hili 15, a falaj dating from around 1000 BC has been excavated, revealing surface channels, a shari'a with sluice gates still *in situ*, a cut-and-cover section, and two shafts (Jorgensen and Al Tikriti 1995, 2002). A nearby, fortified site was also found, which might have been the administrative center for controlling the falaj system. At Bida Bint Saud, north of Al Ain, two more Iron Age aflaj were discovered and an area of previously irrigated land has been identified. The shari'a of the first falaj was found at a depth of 3.8 m below the present ground surface, with steps descending from the northern side. Two further examples have been identified at Nahil and Al Jabeeb, north of Al Ain (Figure 16.2).

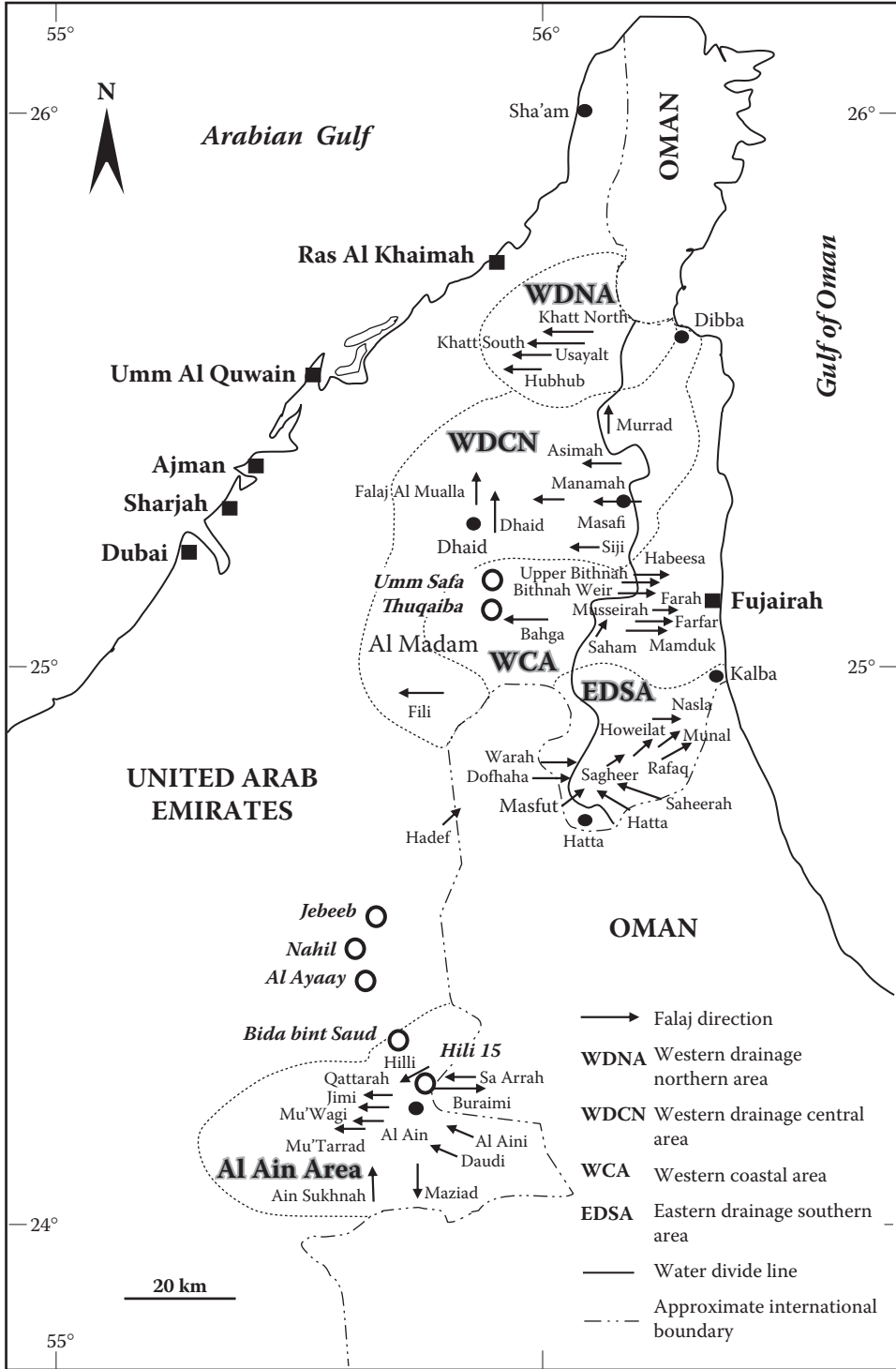
The Persian term karez, equivalent to the Arabic term qanāt (English 1997), is widely used in Southwest Asia. Some karez are present near Al Kharj and Al Qatif areas in Saudi Arabia (Lightfoot 2000). In Bahrain Islands, some of the surface canals or aqueducts are roofed with slabs of stone to keep out the sand. Similar structures are present in Yemen, where they are known as felledj. In Morocco, foggaras occur on both sides of the Atlas Mountains (Boualem and Rabah 2012). To the north, they are well developed near Marrakesh, where they are also known as khottara or rhattara (Lightfoot 1996). Aflaj are known, but have different names, in Iraq, Afghanistan (Parise 2012; Macpherson et al. 2015), China (Hu et al. 2012; Zheng 2014), and Central and West Asia (Beckers et al. 2013). Aflaj are also found throughout North Africa along the northern margin of the great Sahara. In the Fezzan, some 1127 km south of Tripoli, the Garamnates established a system of underground channels or foggara, which supported a rich agriculture in Roman times until the groundwater declined, and foggara were replaced by wells (Boualem and Rabah 2012). It seems that the system has reached Spain (Barnes and Fleming 1991), Sicily (Lofrano et al. 2013), and Greece on the northern coast of the Mediterranean (Beckers et al. 2013). Aflaj of more recent dates are also known in Japan and Peru.

## 16.2.1 AFLAJ CONSTRUCTION AND MAINTENANCE

### 16.2.1.1 Aflaj Construction

Aflaj are designed to bring groundwater to the surface through a tunnel that has a slope gentler than the natural hydraulic gradient. They vary in length, width, the quality and quantity of water they carry, and the nature of the ground through which they pass. The upper part of the falaj tunnel, below the groundwater table, serves as an infiltration gallery and may have several branches to increase flow.

The falaj consists of four parts: the mother well (Umm al Falaj), tunnel, shari'a, and surface channels. The mother well is the first step to start with while building a falaj. Before construction, an expert (Al Baseer, the farsighter) based on his experience selects a site for the mother well (Umm al Falaj). It is necessary to define the most suitable starting point, at which there is a plentiful supply of water at relatively shallow depth. For each falaj, there may be more than one mother well resembling upstream tributaries that carry water to the main stream (tunnel of the falaj; Figure 16.1). Once the mother well is dug and water is discovered, other nearby wells are also excavated and connected by tunnels in order to increase the overall water supply. The slope of the falaj tunnel is usually gentle and smoothly finished to ensure laminar flow of water, as a strong current could lead to erosion, which would flood the crops with silted water (ADACH 2011, 35). The slope of tunnel depends on the ground slope, rock type, and groundwater depth. The main tunnel of the falaj may reach a depth of 30 m but decreases gradually as the falaj approaches the land surface. Vertical shafts known as thuqab (plural of thuqba) are constructed at distance of 5–8 m between the mother well and irrigated



**FIGURE 16.2** Locations, directions, and discharge areas of the aflaj systems in the eastern region of the UAE, showing the Iron Age aflaj systems in Al Ain, Bida bent Saud, and Al Madam areas in bold italic font, based on the data from the *UAE National Atlas* (1993, 38), Rizk (1998, 9), Alsharhan et al. (2001, 131), and Al Tikriti (2015, 212). With Permission.

fields. The *thuqab* are dug to allow ventilation and remove debris. They can be used as access points to the tunnel, whenever maintenance is necessary. The *thuqab* heads are usually surrounded by a ring of baked clay and may be covered to prevent flooding and the influx of debris. The tunnel is extended by digging horizontally between shafts. Tunnels are chosen over open channels to reduce evaporation losses, especially when the channel would be long (channel lengths range from 3 to 20 km). The length of the *falaj* tunnels depends on the ease of drilling in the rock opposite the mountainous area (Wilkinson 1983). The width of the *falaj* tunnel is from 0.6 to 1.2 m, and the height varies between 0.9 m and 2.1 m. The *shari'a* is the first place where water comes on the surface and can be utilized. *Shari'a* resembles a river bank, where all people were allowed to collect water. *Falaj Al Mulla* in the Emirate of Umm Al Quwain has two “*Shari'as*”: one for men and the other for women (Humaid 2012). Both *Shari'as* are now dry because of heavy groundwater pumping in the *falaj* recharge area.

As a *falaj* intersects the ground surface, it splits into a number of distributary channels (called *Awamid*, the columns). These are narrow, deep, open, and cement-lined small channels that deliver water from the main tunnel of the *falaj* to farmlands and palm oases (Figure 16.1). In some cases, they are covered to reduce losses through evaporation.

The main construction problems concern either the presence of compact rocks that are hard to penetrate with hand tools or soft rocks that are liable to collapse. The Gulf tribes, Al Awamer, were renowned for their skill in detecting underground water and digging *aflaj*. More recently, more modern tools such as drill rigs and electrical power tools have solved many of these problems of hard rocks. In soft sediment, the tunnel may be lined with tiles about 1 m long and 12–24 cm wide, so that many thousands may be required for the construction of a single *falaj* tunnel.

### 16.2.1.2 Aflaj Maintenance

Historically, owners and users of *Aflaj* took great care in keeping the *aflaj* functional to ensure effective water provision to their fields. Cleaning and maintenance were undertaken regularly and whenever necessary. Al Areef is equivalent to the “*Falaj* Foreman.” He is in charge of the *falaj*'s physical structure and knows its weaknesses, assessing the method and timing of repairs and maintenance. In the largest systems, two people fulfill this role—one being responsible for the underground section and one for the aboveground part. *Falaj* maintenance is done by *bidars* (workers), who are supervised by Al Areef, and it involves cleaning the tunnel by removing roots and repairing minor collapses of roofing stones or walls (Alsharhan et al. 2001).

Whenever the flow of water through the *aflaj* decreased, the diggers and specialists would trace the *falaj* stream and carry out the necessary repair work. This would include removing gravel, dust, and dirt from the holes. Some of these holes could be up to 15 m deep. The cleaning operation of *aflaj* is called *Al-Mazad* (the auction). Specialists interested in cleaning the *aflaj* would submit a financial bid for the services. This public tender was then awarded to a preferred person or group. The cost of cleaning and repair was covered by selling *falaj* water (ADACH 2011).

## 16.2.2 AFLAJ ADMINISTRATION

*Aflaj* are a historically important adaptation of water use in dry environments, tapping groundwater and conducting it through channels, often covered, to the areas of cultivation. Usually, each *falaj* belonged to a single community, with the management of the water in the hands of that community (Sutton 1984; Al Amri et al. 2014). Every individual in that community had rights to the water for drinking and livestock. However, the use of *falaj* water in agriculture and irrigation remained in the hands of the traditional owners through inheritance or purchase. Such water was distributed according to time, but in many mountain villages, *falaj* owners obtained their shares as volumes of water. The time during which each owner could draw water was fixed, the amount of time varying from place to place, depending on the water supply and time of year. Funds for the maintenance of the *aflaj*, cleaning of channels, and repairing minor wall collapse were collected from the water rents, which in turn reflected the abundance of water and the type of agriculture.

In the past, the distribution of aflaj water in the UAE relied on experience and social norms. The task of distributing falaj water among the farm owners was assigned to a person called Al Areef (the knowledgeable one), who was chosen according to his social status, honesty, knowledge, and experience (ADACH 2011). Each falaj in Al Ain area had an Al Areef, but lately, the head of Aflaj Department in Al Ain Municipality was appointed Al Areef for all aflaj systems. Al Areef is responsible for water distribution in return for a share of the falaj water and also for the organization of falaj affairs, the ownership and rental of water rights, the arrangement for distribution of water according to such rights, the maintenance and sale of falaj property, and policy decisions on falaj repairs. The distribution of aflaj water depends on measurement of shade during the day and the movement of the moon and stars at night. The water is divided between participants according to determined irrigation needs on a 4- to 8-day frequency, according to a predetermined schedule and according to the nature of the soil. The time is fixed, but its length can be varied, depending on the water supply, rate of flow, and the time of year. The unit on which water distribution is founded depends on size of the falaj.

The flow of water among the farms was controlled by a series of Al Awamid (plural of Al Amid) or the sluices. The end of the subterranean tunnel opened up into a holding tank, which was linked to an interconnected network of smaller aboveground channels running through all of the palm gardens. The junctions between the main channel and the subchannels could be opened or closed by Al Amid, usually constructed with metal, rocks, or rags (ADACH 2011). When the time came for water to be distributed to a particular farm, Al Amid was opened, and at the end of the allotted period, it was closed. The holding tank or basin was always filled with water at night. Falaj preservation and repair was funded by those receiving water quotas by paying Al Areef or his aides an amount of money. Women used to go to falaj “shari’a” late at night to fill their jugs, as water at this time was particularly clean and pure. Those who found that their falaj water quota was inadequate could buy additional water by paying money to farm owners who were willing to sell or rent their quotas.

The Ministry of Environment and Water in the UAE now manages and monitors more than 40 active aflaj (Figure 16.2; Table 16.1). These aflaj are confined to the eastern mountain ranges and

**TABLE 16.1**

**Type, Length (m), Mean Velocity (m/s), Discharge in Liter per Second (L/s), Electrical Conductivity in Microsiemens per Centimeters (EC =  $\mu\text{S}/\text{cm}$ ), Total Hardness (TH = mg/L), and Sodium Adsorption Ratio (SAR) of Active Aflaj in the UAE (Illustrated in Figure 16.2). Based on the Data from the Ministry of Environment and Water, UAE**

No.	Falaj Name	Falaj Type	Falaj Length (m)	Falaj Mean Velocity (m/s)	Falaj Discharge (L/s)	EC ( $\mu\text{S}/\text{cm}$ )	TH (mg/L)	SAR	Current Status
<b>A. Eastern Drainage, Southern Area</b>									
1	Shadgah	Gheli		0.11	21.1				Dry
2	Hadf	Gheli		0.09	13.2				Dry
3	Nasla	Gheli		0.18	29.2				Dry
4	Rafaq	Gheli	2,500	0.23	38.5	1,700	262	7.2	Dry
5	Munnai	Gheli	500	0.02	10.4	780	177	3.2	Dry
6	Howeilat	Gheli	3,200	0.23	29.3	1,250	186	6.5	I.F.
7	Warah	Gheli	1,000	0.11	19.1	710	257	1.6	Dry
8	Masfut	Gheli	1,500	0.39	15.5	750	255	1.4	Dry
9	Dofdaha	Gheli	1,000	0.00	3.9	610	196	1.6	Dry

(Continued)

TABLE 16.1 (Continued)

Type, Length (m), Mean Velocity (m/s), Discharge in Liter per Second (L/s), Electrical Conductivity in Microsiemens per Centimeters (EC =  $\mu\text{S/cm}$ ), Total Hardness (TH = mg/L), and Sodium Adsorption Ratio (SAR) of Active Aflaj in the UAE (Illustrated in Figure 16.2). Based on the Data from the Ministry of Environment and Water, UAE

No.	Falaj Name	Falaj Type	Falaj Length (m)	Falaj Mean Velocity (m/s)	Falaj Discharge (L/s)	EC ( $\mu\text{S/cm}$ )	TH (mg/L)	SAR	Current Status
<b>A. Eastern Drainage, Southern Area</b>									
10	Sagheer	Daudi	1,500	0.06	9.1	700	295	0.5	Dry
11	Saheerah	Daudi	1,500	0.07	5.8	900	335	1.0	Dry
12	Hatta	Gheli							I.F.
<b>B. Western Drainage, North Area</b>									
13	Khatt (N)	Hadouri		0.17	20.8				I.F.
14	Khat (S)	Hadouri	1,000	0.57	23.9	2,250	335	8.5	I.F.
15	Hubhub	Daudi	500	0.39	38.3	2,760	384	9.6	B.F.
16	Usayhli	Daudi	3,500	0.21	6.8	2,200	319	8.7	Dry
<b>C. Western Drainage, Central Area</b>									
17	Fili	Gheli	5,000	0.06	8.9	1,020	180	6.4	Dry
18	Asimsah	Gheli	3,000	0.21	5.5	450	167	0.9	Dry
19	Murrad	Gheli	1,500	0.10	11.5	750	265	1.4	I.F.
20	Dhaid	Gheli	10,000	0.12	11.4	1,180	165	6.4	B.F.
21	Siji	Gheli	500	0.04	3.3	750	289	1.0	Dry
22	Mualla	Gheli	3,500	0.03	8.8	1,840	294	7.6	Dry
23	Mannama	Daudi	3,000	0.19	4.9	680	280	0.8	Dry
<b>D. East Coast Area</b>									
24	Farfar	Gheli	2,000	0.28	14.4	900	255	2.3	I.F.
25	Mudouk	Gheli	3,000	0.18	4.2	600	180	1.8	Active
26	Musseirah	Gheli	4,200	0.18	4.3		319	2.2	Dry
27	Habisah	Gheli	1,200	0.04	2.1	740	185	2.4	Dry
28	Bithna (L/B)	Gheli		0.99	79.4				I.F.
29	Bithna(R/B)	Gheli	500	0.15	18.8	1,050	319	2.2	I.F.
30	Sakamkam	Daudi	500	0.08	1.5	1,030	118	7.2	Active
31	Saham	Gheli	500	0.14	7.7	650	275	0.8	Active
32	Farah	Gheli	2,500	0.22	8.3	1,000	360	2.4	Active
33	Raheeb	Daudi	500	0.11	5.3				Active
34	Gamhour								Active
<b>E. Al Ain Area</b>									
35	Sukhana	Hadouri	3,000	0.21	27.3	10,940	2,132	17.4	
36	Maziad	Daudi	2,000	0.34	15.9	960	270	2.9	
37	Hilly	Gheli	4,000	0.19	24.4	750	200	2.5	
38	Daudi	Daudi	5,000	0.22	38.3	520	162	1.5	Active
39	Al-Ain	Daudi	6,000	0.26	47.5	620	182	1.9	Active
40	Buraimi	Daudi	9,000	0.11	22.7	380	142	1.1	Dry

I.F., intermittent flow; B.F., being fed.



the gravel plains flanking these mountains from the East and West. The falaj lengths range from 0.5 km (Falaj Khatt at Ras Al Khaimah) and 15 km (Falaj Al Daudi at Al Ain).

### 16.3 AFLAJ DISCHARGE

Water movement in aflaj channels is controlled by many factors, and the aflaj of high discharge are those oriented parallel to the direction of groundwater flow (Parks and Smith 1983).

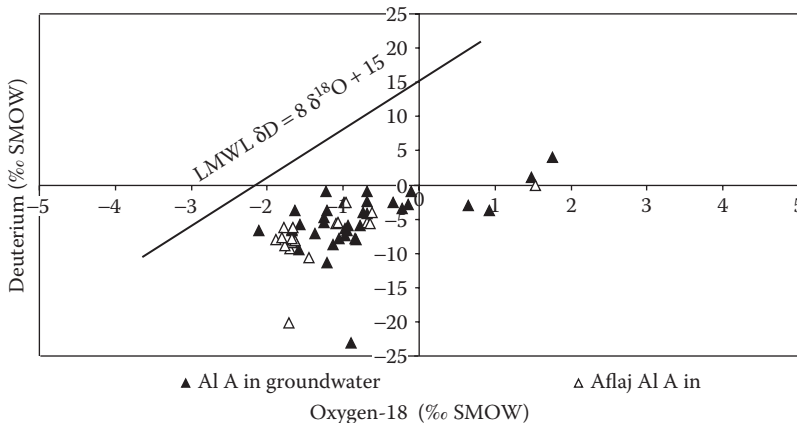
Aflaj recharge mechanisms depend on the source, which includes rainfall, groundwater, or natural springs. Discharge can vary from falaj to falaj, depending on the location of the main well, gradient, recharge area, nature of the aquifer, and the amount of seepage from the walls of the tunnel. Aflaj Al Emarat were classified on the basis of their discharge into Al Gheli, Al Daudi, and Al Hadouri or Al Aini (Al Adrous 1990).

Aflaj Al Gheli are located in the mountains or close to them, tap base flow in dry wadis, carry seasonal water, with discharge directly related to rainfall, and may become dry when the rainfall ceases. Despite their low discharge, water of Aflaj Al Gheli is renewable and has good quality (Wilkinson 1983, 177–194). Aflaj Al Emarat Al Siji, Masfut, and Masafi belong to this type (Figure 16.2; Table 16.1).

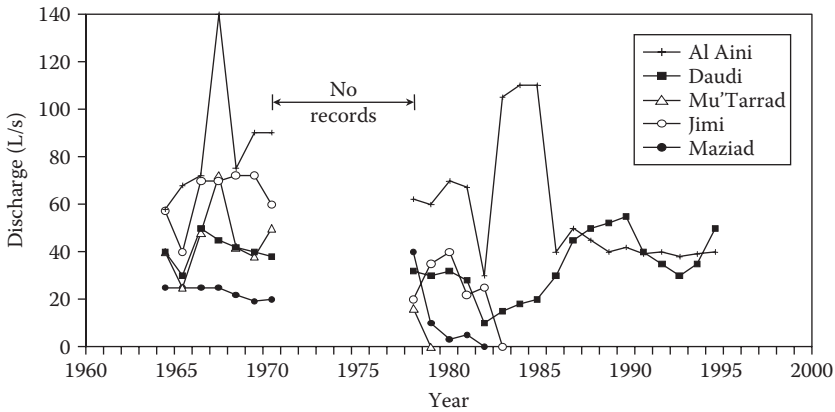
In contrast, aquifers are the main water source for Aflaj Al Daudi. Aflaj Al Daudi in Al Ain area used to have a large groundwater supply that maintained a permanent discharge throughout the year, with little change in their discharge rates. The gravel aquifer is the main source of recharge for Aflaj Al Daudi in Al Ain area (Rizk and Alsharhan 1999). The authors noticed a striking similarity of the stable isotopes of hydrogen ( $^2\text{H}$ ) and oxygen ( $^{18}\text{O}$ ) in 32 groundwater samples collected from the gravel aquifer and 17 water samples collected from Aflaj Al Daudi in Al Ain area (Figure 16.3). Aflaj Al Dhaid Al-Manama and Al Sarooj belong to this category.

Discharge of Aflaj Al Hadouri or Al Aini is commonly connected to springs or artesian aquifers (Table 16.1). Aflaj Al Hadouri arise from limestone to provide good-quality water and are reliable. However, where they emerge from ophiolites, the water is strongly alkaline and is usually connected with deep artesian aquifers, draining water that rises along fractures and fissures. Falaj Maddah in Fujairah and Falaj Bu Sukhnah in Al Ain belong to this category (Figure 16.2; Table 16.1).

Over the last 25 years, Aflaj Al Ain area has been placed under increasing stress from declining groundwater levels in the source or mother well areas (EAD 2006). Overexploitation of several aquifers, which represent the main source of recharge for Aflaj Al Daudi and Al Hadouri, Aflaj Al



**FIGURE 16.3** Stable isotopes ( $^2\text{H}$  and  $^{18}\text{O}$ ) in water samples from the gravel aquifer and Aflaj Al Daudi in Al Ain area, UAE. (From Rizk, Z.S. and Alsharhan, A.S., Application of natural isotopes for hydrogeologic investigations in United Arab Emirates, in *Proceedings of the Fourth Gulf Water Conference*, Manama, Bahrain, 1999, pp. 197–228. With Permission.)



**FIGURE 16.4** Falaj hydrographs in the Al Ain area for the period 1964–1996, based on the data from different sources. (From Rizk, Z.S., *Arab. J. Sci. Eng.*, 23(1C), 3–25, 1998; Rizk, Z.S. and Alsharhan, A.S., Water resources in the United Arab Emirates, developments in water science (50), in *Water Resources Perspectives: Evaluation, Management and Policy*, A.S. Alsharhan and W.W. Wood (eds.), Elsevier, Boston, MA, 2003, pp. 245–264. With Permission.)

Mu'Tarrad, Maziad, and Al Jimi in Al Ain area became dry in 1978, 1982, and 1983, respectively (Figure 16.4).

None of Aflaj Al Ain is currently working fully under natural flow conditions; rather, they are now largely supplemented from pumped groundwater from support wells and piped desalinated water from the Qidfa desalination plant in Fujairah (EAD 2006). However, active falaj systems are still found in other parts of the UAE. Rizk (1998) studied 33 aflaj in the eastern region of the UAE, and their natural flows in 1996 varied from 0.08 L/s to 89.7 L/s, with an average flow of 17 L/s (Table 16.1).

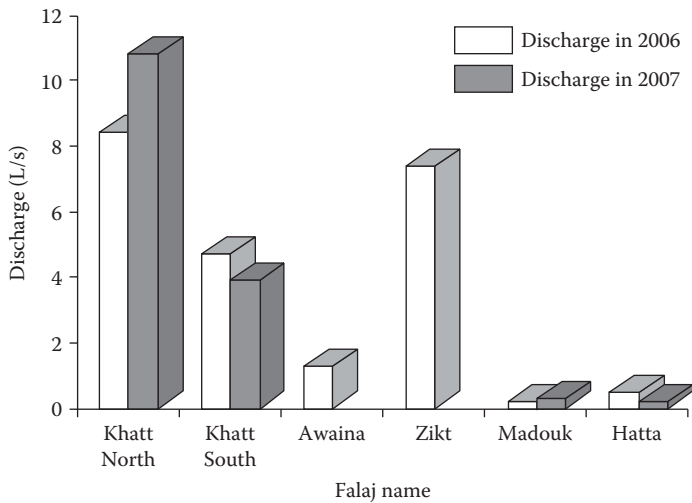
The discharge of active aflaj in the UAE was measured with an Ott 1205–1226 mini-current meter, which is equipped with an electronic revolution indicator (Rizk 1998). Every 10 cm across the falaj outlet, the number of revolutions in 40 s was counted at depths of 8 and 15 cm above the bottom. Flow velocities were obtained from rating tables provided with the instrument, according to the formula:  $V = 0.619 N + 0.017$ , where  $V$  is the velocity in meter per second, and  $N$  is the number of revolutions per second. The area of the outlet, which can be triangular, rectangular, or trapezoid, was measured by a staff. Discharge of each sector was then estimated by multiplying the average velocity by the area. Total falaj discharge is the sum of sector discharges. The accuracy of the used current meter is high, and expected errors do not exceed 2%–3%.

The discharge of the active aflaj in Northeastern UAE, measured in 2006 and 2007, is illustrated in Figure 16.5.

The factors affecting the discharge, water quality, and water use of Aflaj Al Emarat include climate, geologic setting, and human activities.

### 16.3.1 CLIMATE

The two principal wind systems affecting the climate of the UAE are the winter cyclonic depressions, which descend the Arabian Gulf from the north and northwest, and give rise to the cold northwesterly “Shamal” airflow, and the summer monsoonal low developed over the Rub’ al Khali desert. The Shamal winds blow all year, but their speeds increase during the period between March and April, to hit a top speed of 41 km/h (Alsharhan et al. 2001). The Shamal winds drive winter rain and cause Aflaj Al Gheli to flow in North and Northeastern UAE, while the summer monsoon leads to short rainstorms, causing flash floods in mountain areas and gravel plains.



**FIGURE 16.5** Discharge of the still active aflaj in Northeastern UAE. (From Rizk, Z.S. and Alsharhan, A.S., *Water Resources in the United Arab Emirates*, Ithraa Publishing and Distribution, Amman, Jordan, 2008, 624p. With Permission.)

The principal rain in the UAE falls between November and March and has the maximum intensity during February and March. About 90% of precipitation falls during winter and spring. The wettest months are February and March, when 60% of precipitation is received. February is the rainiest month, with an average 37.9 mm rainfall, while June is the driest month, with an average of 0.3 mm rainfall. During wet years, there may be as many as nine rainy days during the winter months, although rain for more than six days is not common. The mean annual rainfall for eastern mountains (160 mm) is higher than the UAE's mean annual rainfall (119 mm). Winter rainfall is generally light to moderate and is widespread in nature, being frontal, as the dry polar air masses meets the warm moist air of the Arabian Gulf. Summer rainfall occurs as heavy isolated events associated with the passage of retreating monsoon or as a result of convection, giving rise to lifting mechanism. This rain is confined to the mountains and gravel plains. The northern Oman Mountains in the UAE also provide a natural topographic high, forcing the air upward, ultimately producing orographic rainfall along the eastern coastal region.

The discharge of Aflaj Al Gheli depends mainly on rainfall. A plot of the total annual discharge of Aflaj Al Emarat, which are predominantly of the Al Gheli type, shows a direct correlation with the mean annual rainfall on the eastern mountain ranges and gravel plains (Rizk and Alsharhan 2008).

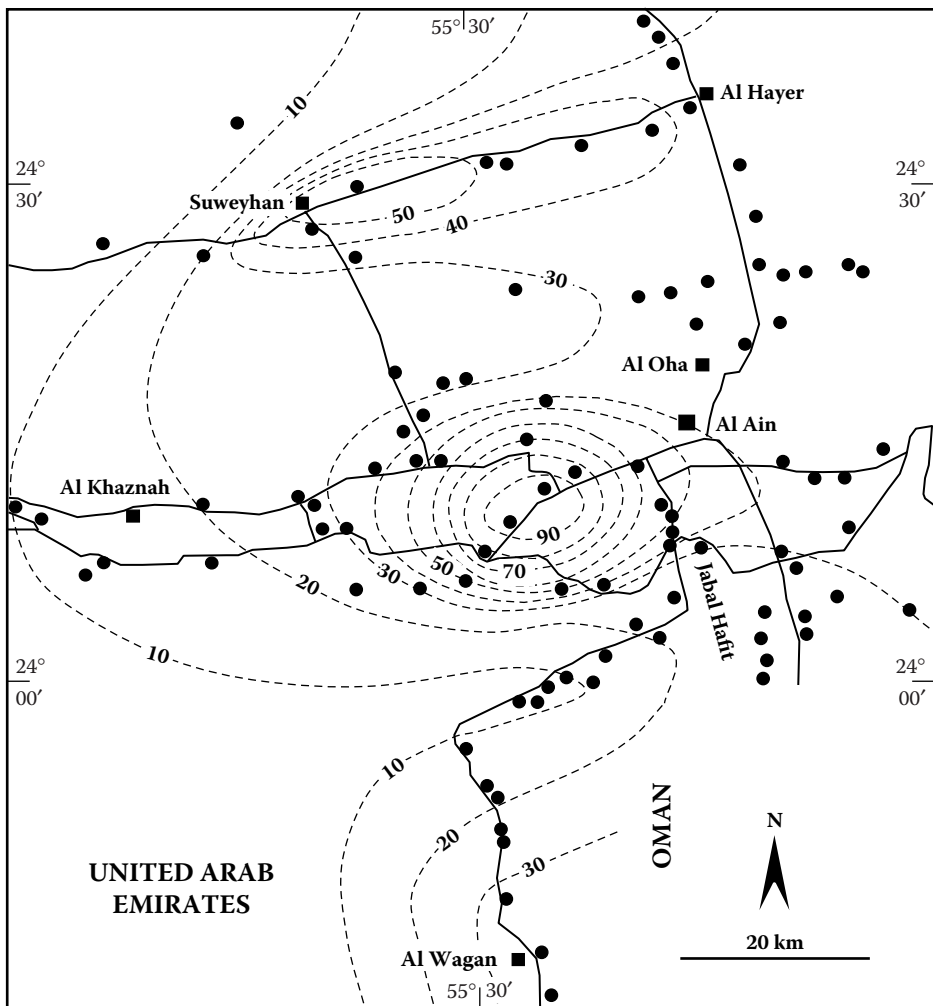
### 16.3.2 GEOLOGIC SETTING

The eastern mountains occupy only 5% of the total area of the UAE but receive about 30% of the total annual rainfall (Al-Shamesi 1993). For this reason, most of aflaj systems are confined to these mountains and the gravel plains are confined to the East and West (Figure 16.2). Geology is one of the main controls on the amount and quality of water flowing through aflaj channels or tunnels, according to their nature and design. The aflaj mother wells start near the water-divide line that connects high peaks of the eastern mountain ranges, where rainfall is the highest in the country, to ensure enough supply of water for sustaining aflaj discharge. From the water divide, aflaj move West in Ras Al Khaimah and Al Ain areas, East in Fujairah, and Northeast in Masfut area (Figure 16.2). A large number of alluvial fans coalesce together, forming flat, gently sloping gravel plains East and West of the mountains front. Both gravel plains are the most fertile areas in the UAE and witness intensive agricultural activities, served by several aflaj systems.

### 16.3.3 HUMAN ACTIVITIES

Irrigated agriculture is a major water consumer in the world. The annual recharge of natural aquifers in the UAE is estimated at 120 million m<sup>3</sup> (Khalifa 1995), while the groundwater pumping by the agricultural sector is only about one billion cubic meter per year. The number of water production wells of Abu Dhabi Emirate reached 43,503 wells in 2005 (World Bank 2005), and thousands of those wells are in Al Ain area. Excessive groundwater abstractions caused decline of groundwater levels and increase in groundwater salinity. Aflaj have suffered from the general lowering of the water table in the catchments source areas of Al Jaww plain to the East of Al Ain (EAD 2006). According to National Drilling Company (NDC 1994), the combined discharge of all aflaj has declined from 160,000 m<sup>3</sup>/year in 1964 to 100,000 m<sup>3</sup>/year in 1993.

The EAD (2006) reported 70 m decline in groundwater levels in Al Ain area during the 4500 years. The authors measured the depth of groundwater in Al Hili area as 90 m, next to 11 m old hand-dug well that once tapped the same aquifer in the past (Figure 16.6).



**FIGURE 16.6** Depth of groundwater, in meters, in the western gravel aquifer in Al Ain area in February 1995. Black circles represent data points. (From Garamoon, H.K., Hydrogeological and geomorphological studies on the Abu Dhabi—Al Ain—Dubai rectangle, United Arab Emirates, PhD Thesis, Ain Shams University, Cairo, Egypt, 130, 1996. With Permission.)

## 16.4 AFLAJ WATER QUALITY

The electrical conductivity (EC) of water samples collected from Aflaj Al Emarat varied between 450  $\mu\text{S}/\text{cm}$  in Falaj Asimah in Fujairah and 10,940  $\mu\text{S}/\text{cm}$  in Falaj Ain Sukhnah in Al Ain (Figure 16.7).

Generally, the EC of water samples is directly proportional to the total dissolved solids. The EC values are low in water samples collected from the aflaj draining ophiolite rocks, east of Al Ain and Fujairah areas, indicating low water salinity. In contrast, the EC values are relatively higher in water samples of the aflaj draining limestone rocks in Ras Al Khaimah and west of Al Ain areas.

The iso-EC contour map shows that the EC values of aflaj water are low near the water divide line of the eastern mountains and increase to the East and West, with increasing distance from this line (Rizk et al. 1997). The ECs of 98 groundwater samples measured by the authors from Northeastern UAE in 1996 are presented in Figure 16.7. The iso-EC contours show that the groundwater salinity also increases from the water divide toward the East and West.

A water sample from Falaj Ain Sukhnah in Al Ain area has an EC of 10,940  $\mu\text{S}/\text{cm}$ , which is an exceptionally high salinity for falaj water, but this particular falaj runs across the evaporite deposits of the Miocene Fars Formation, which flank Jabal Hafit from both side. Dissolution of these evaporites might be the reason for high salinity.

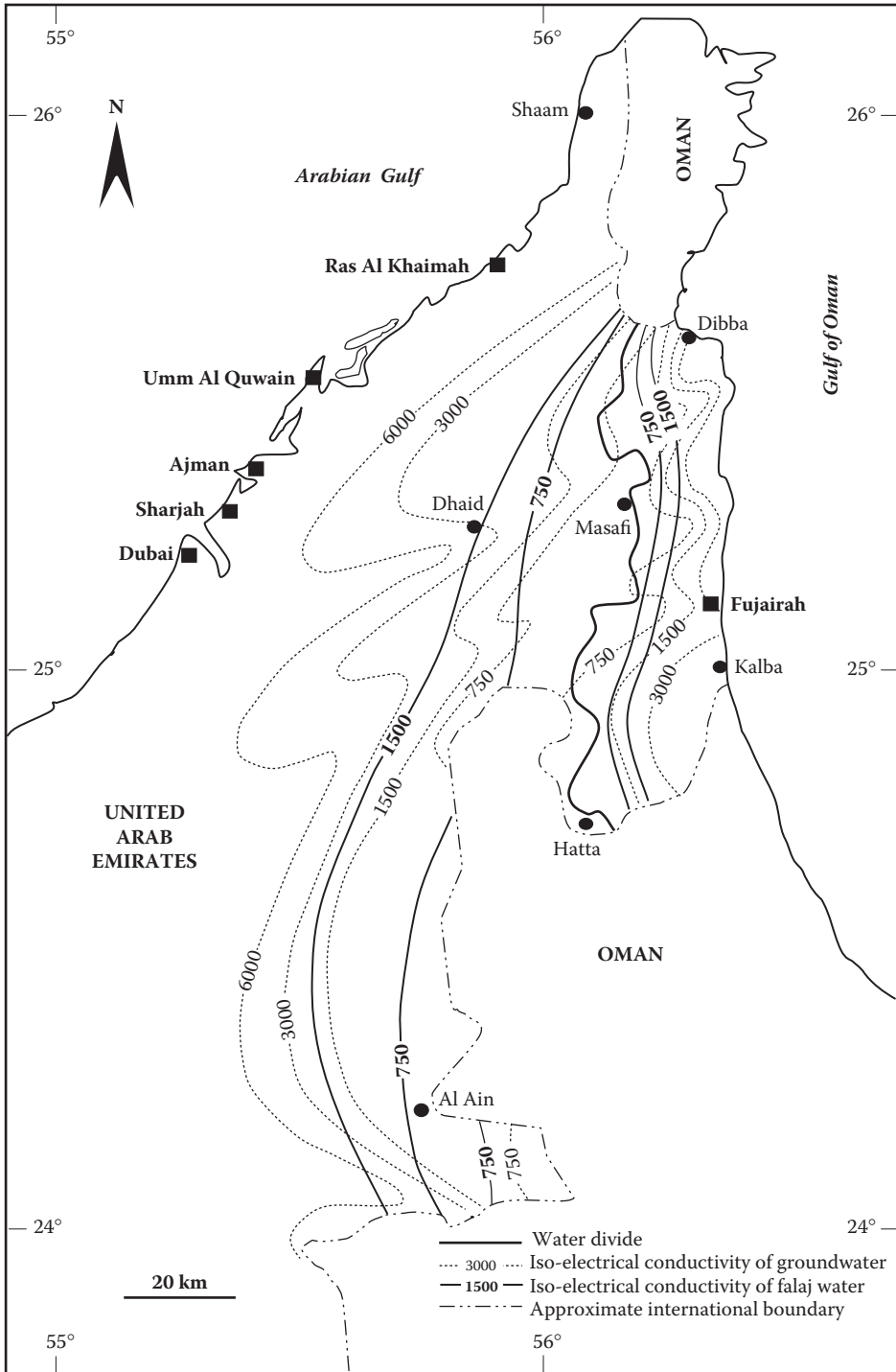
A plot of the EC ( $\mu\text{S}/\text{cm}$ ) versus falaj length shows that the EC of Aflaj Al Gheli, which are the dominant in the UAE, increases with increasing a falaj's length (Figure 16.8a). Examples are Falaj Asimah (Length [L] = 3 km and EC = 450  $\mu\text{S}/\text{cm}$ ), Falaj Fili (L = 5 km and EC = 1020  $\mu\text{S}/\text{cm}$ ), and Falaj Al Dhaid (L = 10 km and EC = 1180  $\mu\text{S}/\text{cm}$ ). The EC increases as a result of high natural evaporation rates from aflaj channels and interaction between water and the bedrock. The longer the channel, the larger the contact surface with the bedrock and higher its contribution to the salinity of the falaj water. This explains why old aflaj channels were designed very narrow and rather deep in order to minimize the natural evaporation from aflaj water. In Aflaj Al Daudi, the EC does not correlate with the falaj length (Figure 16.8b) because of the variation in rock type and source of water in these aflaj. Despite short length of its tunnel (0.5 km), Falaj Hubhub has a high EC (2760  $\mu\text{S}/\text{cm}$ ). In contrast, Falaj Al Aini is 6 km long and has a much lower EC (620  $\mu\text{S}/\text{cm}$ ).

Water of aflaj draining limestone rock has high concentration of calcium ion ( $\text{Ca}^{2+}$ ), while water of the aflaj draining ophiolite rocks has high concentration of magnesium ion ( $\text{Mg}^{2+}$ ). As aflaj water has a short residence time compared with groundwater, sodium ion ( $\text{Na}^+$ ) concentration in water of Aflaj Al Emarat is generally lower. Bicarbonate ion ( $\text{HCO}_3^-$ ) is high in most aflaj waters, especially in Aflaj Al Gheli. The  $\text{HCO}_3^-$  is also high in aflaj close to the water divide line. The sulfate ion ( $\text{SO}_4^{2-}$ ) level in Falaj Ain Sukhnah in Al Ain area is high, possibly because of the dissolution of gypsum ( $\text{CaSO}_4 \cdot 2\text{H}_2\text{O}$ ) from the evaporite deposits of the Miocene Fars Formation, through which the water of this falaj moves.

The plot of chemical analysis of water samples collected from Aflaj Al Emarat on Piper's diagram (1944) illustrates the appearance of most of the samples in the upper triangle of the diamond shape and points out to the dominance of Na–Mg and Cl– $\text{HCO}_3^-$  water types (Rizk and Alsharhan 2008). Water of Aflaj Al Emarat is enriched in  $\text{Mg}^{2+}$  and  $\text{Ca}^{2+}$ , which are dissolved from Mg-rich ophiolites and Ca-rich carbonate rocks, respectively (Figure 16.9).

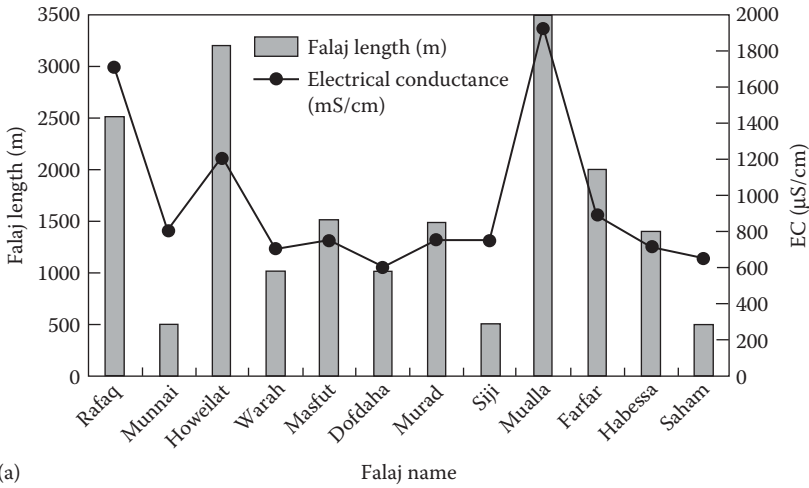
## 16.5 AFLAJ WATER USE

In the past, the falaj system represented an integral part of villagers' life. It provided water for all uses, and because the community depended on it, codes of social behavior have become established (Sutton 1984). One user does not pollute the system of another. For example, the uppermost access point in the settlement is set aside for the collection of drinking water, and no one should wash in, or otherwise dirty, the water above this point. Now, aflaj water use is limited to irrigation. To evaluate the suitability of aflaj water for irrigation, field-measured EC values were plotted versus

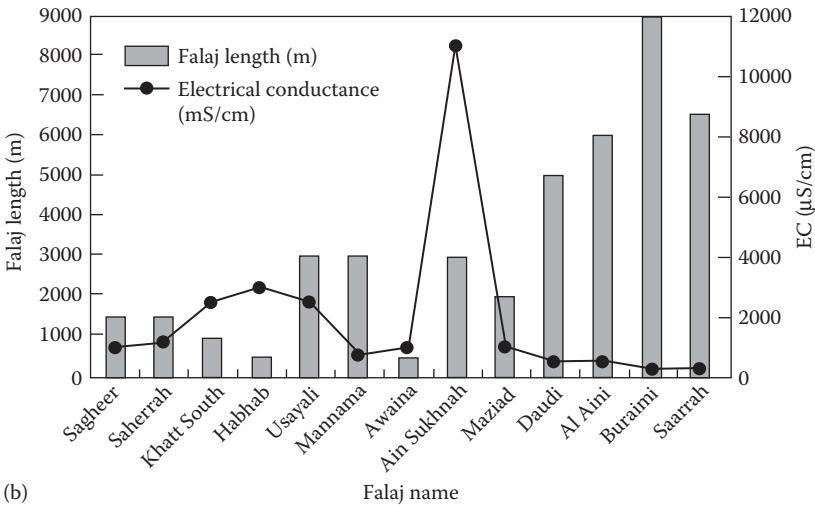


**FIGURE 16.7** Isoelectrical conductivity ( $\mu\text{S}/\text{cm}$ ) and isosalinity ( $\text{mg}/\text{L}$ ) contour map of groundwater and aflaj water in the eastern region of the UAE. (From Rizk, Z.S., *Arab. J. Sci. Eng.*, 23(1C), 3–25, 1998; Rizk, Z.S. and Alsharhan, A.S., *Water resources in the United Arab Emirates, developments in water science* (50), in *Water Resources Perspectives: Evaluation, Management and Policy*, A.S. Alsharhan and W.W. Wood (eds.), Elsevier, Boston, MA, 2003, pp. 245–264. With Permission.)





(a)



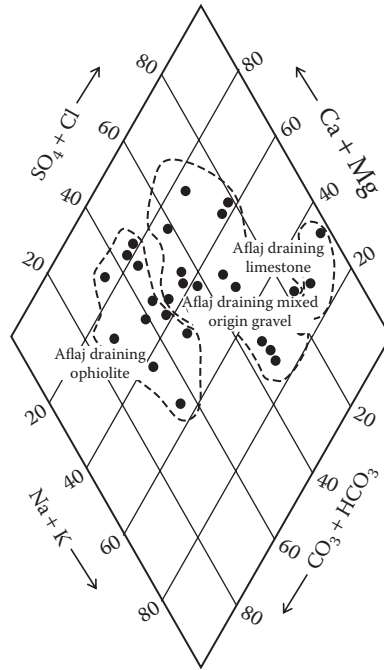
(b)

**FIGURE 16.8** Relationship between aflaj length (m) and EC ( $\mu\text{S}/\text{cm}$ ): (a) Aflaj Al Gheli and (b) Aflaj Al Daudi in the eastern region of the UAE. (From Rizk, Z.S., *Arab. J. Sci. Eng.*, 23(1C), 3–25, 1998; Rizk, Z.S. and Alsharhan, A.S., *Water resources in the United Arab Emirates, developments in water science* (50), in *Water Resources Perspectives: Evaluation, Management and Policy*, A.S. Alsharhan and W.W. Wood (eds.), Elsevier, Boston, MA, 2003, pp. 245–264. With Permission.)

calculated sodium adsorption ratios (SAR) on the US Salinity Laboratory Staff (1954) diagram (Figure 16.10; Table 16.1). Results show that the waters of Aflaj Al Emarat, except Khatt South and Hubhub (Table 16.1), are good to fair for irrigation purposes.

### 16.6 CONCLUSIONS

The discovery of aflaj systems in Al Ain, Bidaa Bint Saud, and Al Madam areas indicates that the aflaj were already well established in the UAE several centuries before the foundation of the Achemanean Empire, to which the system was mistakenly attributed. Standard aflaj tapping water from mother wells sent deep into the ground have been in use in the UAE since the beginning of the Iron Age. Five aflaj systems have been found in the Al Ain area. At Bida Bint Saud, north of Al Ain,



**FIGURE 16.9** Presentation of chemical analysis of Aflaj water in the eastern region of the UAE on the trilinear diagram. (From Rizk, Z.S., *Arab. J. Sci. Eng.*, 23(1C), 3–25, 1998; Rizk, Z.S. and Alsharhan, A.S., Water resources in the United Arab Emirates, developments in water science (50), in *Water Resources Perspectives: Evaluation, Management and Policy*, A.S. Alsharhan and W.W. Wood (eds.), Elsevier, Boston, MA, 2003, pp. 245–264. With Permission.)

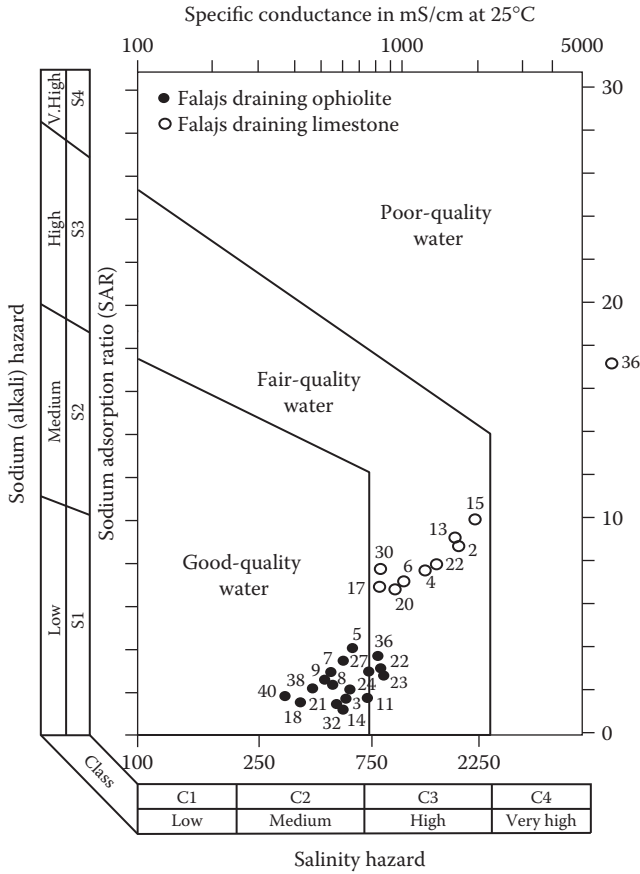
two more Iron Age Aflaj systems were discovered, and two more examples have been identified at Nahil and Al Jabeeb, north of Al Ain (Figure 16.2).

To avoid the confusion and misunderstanding in the definition and attribution of different aqueduct structures, E. D. Chiotis (Chapter 1) stated, “the regional terms applied traditionally in various countries, such as qanāts, foggaras, aflaj and others. have inherited special connotations which imply meaningful differences; therefore they should be maintained for local use but not merged or transferred out of context to other regions.” Chiotis (2015) proposed a classification system of aqueduct types based on clear hydrogeological criteria and in which the shafts-and-gallery tunneling technique is not considered as an exclusive feature of qanāts.

History of aflaj construction and maintenance in the UAE is well documented in the literature and were briefly described here. Aflaj administration in the past relied on experience and social norms and was assigned to Al Areef, who was chosen according to his social status, integrity, good reputation, honesty, knowledge, and experience.

Aflaj were classified based on geographic location and geologic setting but most importantly according to water source and discharge. Aflaj Al Gheli are directly recharged by rainwater, and their discharge is highly variable, depending on rainfall intensity. Despite their low discharge, water of Aflaj Al Gheli is renewable and has good quality. Aflaj Al Daudi obtain their water from shallow aquifers and maintain a permanent discharge throughout the year, with little change in their discharge rates. Aflaj Al Hadouri or Al Aini discharge is connected to springs or deep artesian aquifers, which are mainly limestone or ophiolite. Aflaj Al Hadouri drain water that rises along fractures and fissures, affecting such aquifers.

Aflaj Al Mu’Tarrad, Maziad, and Al Jimi in Al Ain area became dry in 1978, 1982, and 1983, respectively, as a result of groundwater overpumping in their recharge areas. The combined



**FIGURE 16.10** Evaluation of the suitability of aflaj water for irrigation in the UAE, based on EC ( $\mu\text{S}/\text{cm}$ ) and SAR values. See Table 16.1 for aflaj names. (From Rizk, Z.S., *Arab. J. Sci. Eng.*, 23(1C), 3–25, 1998; Rizk, Z.S. and Alsharhan, A.S., *Water resources in the United Arab Emirates, developments in water science* (50), in *Water Resources Perspectives: Evaluation, Management and Policy*, A.S. Alsharhan and W.W. Wood (eds.), Elsevier, Boston, MA, 2003, pp. 245–264; Rizk, Z.S. and Alsharhan, A.S., *Water Resources in the United Arab Emirates*, Ithraa Publishing and Distribution, Amman, Jordan, 2008, 624p. With Permission.)

discharge of Aflaj Al Ain has declined from 160,000  $\text{m}^3/\text{year}$  in 1964 to 100,000  $\text{m}^3/\text{year}$  in 1993. The discharge of active aflaj in the eastern region of the UAE, measured by the authors in 1996, varied from 0.08 L/s to 89.7 L/s, with an average of 17 L/s (Table 16.1).

The factors affecting discharge, water quality, and water use of Aflaj Al Emarat include climate, geologic setting, and human activities, particularly groundwater overpumping. The rainfall-driving mechanisms in the UAE are the cold northwesterly Shamal (north) airflow and the summer monsoon. The annual discharges of Aflaj Al Emarat, which belong mainly to Al Gheli type, show a direct correlation with the rainfall in the eastern mountains and gravel plains.

The EC of 98 groundwater samples and 33 aflaj water samples from northeastern UAE, measured by the authors in 1996, varied from 450 to 10,940  $\mu\text{S}/\text{cm}$  and averaged 2670  $\mu\text{S}/\text{cm}$ , with a general increase from the water divide line toward the East and West. The aflaj water has relatively better quality than surrounding aquifers, because water moving in aflaj channels or tunnels has less chance for reaction with surrounding aquifer matrix.

In the past, aflaj provided water for agricultural and domestic uses, but now, aflaj water use is limited to irrigation. Evaluation of aflaj water revealed that Aflaj Al Emarat, except Khatt South and Hubhub, are good to fair for irrigation purposes.

## REFERENCES

- ADACH (Abu Dhabi Authority for Culture and Heritage), 2011, Water Heritage in the UAE, Exhibition: Water (H2O = Life), September 19, 2011 to January 5, 2012, Abu Dhabi, United Arab Emirates, 44 p.
- Al Adrous, M.H., 1990, *Falajes of the Al Ain-First Edition*, Al Motanabi Publishing, Abu Dhabi, United Arab Emirates, 109 p (in Arabic).
- Al Amri, S., Al Ghafri, A., and Abd Rahman, N., 2014, Water management of Falaj Al Khatmain in sultanate of Oman, *Journal of Earth Science and Engineering* 4, 127–133.
- Al Shamesi, M.H., 1993, Drainage basins and flash flood hazards in Al Ain area, M. Sc. Thesis, UAE University, Al Ain, United Arab Emirates, 151 p.
- Alsharhan, A.S., Rizk, Z.S., Nairn, A.E.M., Bakhit, D.W., and Alhajari, S.A., 2001, *Hydrogeology of an Arid Region: The Arabian Gulf and Adjoining Areas*, Elsevier Publishing, Amsterdam, the Netherlands, 331 p.
- Al Tikriti, W., Al Tawalbeh, D., Al Nuaimi, A., Al Kaabi, A., and Omar, W., 2015, Filling a Blank: New Excavations at an early Islamic Site at Oud Al Toba/Muataredh in Al Ain, in *Proceedings of the Seminar for Arabian Studies*, volume 45, Al Ain, United Arab Emirates.
- Al Tikriti, W.Y., 2015, Origin and technique of the Falaj System: An evidence from the United Arab Emirates, Cultural Heritages of Water. In *The Cultural Heritages of Water in the Middle East and Maghreb*, First edition, ICOMOS, World Heritage Convention, France pp. 211–222.
- Barnes, M., and Fleming, D., 1991, Filtration gallery irrigation in the Spanish new world, *Latin American Antiquity* 2(1), 48–68.
- Beckers, B., Berking, J., and Schütt, B., 2013, Ancient water harvesting methods in the drylands of the Mediterranean and Western Asia, *Journal of Ancient Studies, Berlin* 2, 145–164.
- Boualem, R., and Rabah, K., 2012, The foggara in the Arab world, *Geographia Technica* 1, 1–7.
- Boucharlat, R. 2003, Iron Age water-draining galleries and the Iranian “Qanat.” In *Archaeology of the United Arab Emirates*, eds. D. T. Potts, H. Al Naboodah, and P. Hellyer. pp. 159–172.
- Chiotis, E.D., 2015, Underground aqueducts: Types and definitions. In *Underground Aqueducts Handbook*, eds. A.N. Angelakis, S. Eslamian, H. Weingartner, and E. Chiotis. CRC Press, Taylor & Francis Group, Boca Raton, FL, Chapter 1.
- Córdoba, J.M., 2013, New perspectives about Iron Age and the oasis culture in the Oman peninsula: Two conclusive seasons at al Madam (Sharjah, UAE), *Isimu* 16(2013), 139–152.
- Cressey, G.B., 1958, Qanats, karez, and foggaras, *Geographical Review* 48, 24–44.
- EAD (Environment Agency—Abu Dhabi), 2006, *Current Status of Aflaj in the Al Ain Area*, Environment Agency, Abu Dhabi, United Arab Emirates, 25p.
- English, P.W., 1997, Qanats and Lifeworlds in Iranian Plateau Villages: Middle Eastern Natural Environments, *Yale F and ES Bulletin* 103, 187–205.
- Garamoon, H.K., 1996, Hydrogeological and geomorphological studies on the Abu Dhabi—Al Ain—Dubai rectangle, United Arab Emirates. PhD Thesis, Ain Shams University, Cairo, Egypt, 277p.
- Hu, W.J., Zhang, J.B., and Liu, Y.Q., 2012, The qanats of Xinjiang: Historical development, characteristics and modern implications for environmental protection, *Journal of Arid Land* 4(2), 211–220.
- Humaid, R.K., 2012, Hydrogeology and Hydrogeochemistry of Aquifer Systems in the Um Al Quwain Emirate, UAE. Unpublished MSc Thesis, Ajman University of Science and Technology, Ajman, United Arab Emirates, 149p.
- Jorgensen, D.G., and Al Tikriti, W.Y., 1995, Man, water, and climate change in UAE since the Bronze Age [abs.] In Abstract for oral presentation at *Global Warming and Environmental Protection Workshop*, May 2–3, Abu Dhabi, United Arab Emirates, 3p.
- Jorgensen, D.G. and Al Tikriti, W.Y., 2002, A hydrologic and archeological study of climate change in Al Ain, United Arab Emirates. *Global and Planetary Change* 35(2002), 37–49.
- Khalifa, A.A., 1995, Surface water and Groundwater resources in UAE. In *Culture and Science Society, Meeting on Water Balance inn UAE*, Dubai, United Arab Emirates, 12p.
- Lightfoot, D.R., 1996, Moroccan Kheffara: Traditional irrigation and progressive desiccation, *Geoforum*, 21(2), 261–273.
- Lightfoot, D.R., 2000, The Origin and Diffusion of Qanats in Arabia: New Evidence from the northern and southern Peninsula, *The Geographical Journal* 166(3), 215–226.
- Lofrano, G., Carotenuto, M., Maffettone, R., Todaro, P., Sammataro, S., and Kalavrouzotis, I.K., 2013, Water Collection and Distribution Systems in the Palermo Plain during the Middle Ages, *Water* 5, 1662–1676.
- Macpherson, G.L., Johnson W.C., and Liu, H., 2015, Viability of karezes (ancient water supply systems in Afghanistan) in a changing world, *Applied Water Science*, KACST, Springer, DOI 10.1007/s13201-015-0336-5.

- NDC (National Drilling Company), 1994, Falajes of Al Ain Area, Ground Water Research Project, Abu Dhabi Emirate, United Arab Emirates.
- Parise, M., 2012, Underground Aqueducts: A first preliminary bibliography around the world. In *IWA (International Water Association) Specialized Conference on Water and Wastewater*, March 22–24, 2012, Technologies in Ancient Civilizations, Istanbul, Turkey.
- Parks, Y. P. and Smith, P. J., 1983, Factors affecting the flow of aflaj in Oman: A modeling study, *Journal of Hydrology* 65(4), 293–312.
- Piper, A.M., 1944, A graphic procedure in the geochemical interpretation of water analysis, *Transactions, American Geophysical Union* 25, 914–928.
- Rizk, Z.S., 1998, Aflaj of United Arab Emirates: Geological setting and hydrogeological characteristics. *Arabian Journal for Science and Engineering* 23(1C), 3–25.
- Rizk, Z.S. and Alsharhan, A.S., 1999, Application of natural isotopes for hydrogeologic investigations in United Arab Emirates. In *Proceedings of the Fourth Gulf Water Conference*, Manama, Bahrain, pp. 197–228.
- Rizk, Z.S. and Alsharhan, A.S., 2003, Water Resources in the United Arab Emirates, Developments in Water Science (50). In *Water Resources Perspectives: Evaluation, Management and Policy*, eds. A.S. Alsharhan and W.W. Wood. Elsevier, Boston, MA, pp. 245–264.
- Rizk, Z.S. and Alsharhan, A.S., 2008, *Water Resources in the United Arab Emirates*, Ithraa Publishing and Distribution, Amman, Jordan, 624p (in Arabic).
- Rizk, Z.S., Alsharhan, A.S., and Shindo, S.S., 1997, Evaluation of groundwater resources of United Arab Emirates. In *Proceedings of the Third Gulf Water Conference*, Muscat, Oman, pp. 95–122.
- Sutton, S., 1984, The falaj—A traditional cooperative system of water management, *Waterlines* 2(3), 8–11.
- UAE (United Arab Emirates) National Atlas, 1993, Remote Sensing Center, UAE University, Al Ain, United Arab Emirates, 188p.
- U.S. Salinity Laboratory Staff, 1954, Diagenesis and improvement of saline and alkali soils. In *Agricultural Handbook*, Volume 60. U.S. Department of Agriculture, Washington, DC, pp. 60–160.
- Wilkinson, J.C. 1983, The origins of the Aflaj of Oman, *Journal of Oman Studies* 6.1, 177–194.
- World Bank, 2005, Report on evaluation of water sector in the GCC countries, Challenges facing water resources and water management and the way ahead. In Arab Gulf Program for United Nations Development Organizations, 113p (in Arabic).
- Zheng, X., 2014, Current developmental impacts on the Qanats: Its challenge and maintenance in China, *Journal of Earth Science and Engineering* 4, 146–155.

---

# 17 *Qanāt* and *Falaj*: Polycentric and Multi-Period Innovations *Iran and the United Arab Emirates as Case Studies*

Rémy Boucharlat

## CONTENTS

17.1	<i>Qanāt/Kāriz</i> and <i>Falaj</i> .....	280
17.2	The First Evidence of <i>Falaj</i> in the UAE.....	282
17.2.1	Date of the Invention and Its Relation to the Revival of Human Settlement .....	287
17.2.2	The End of the Proto-Historic <i>Falaj</i> in SE Arabia and the Climatic Change .....	287
17.2.3	The Revival of the Deep <i>Falaj</i> in the Late First Millennium AD: Problems of Origin .....	288
17.3	Some Isolated Cases of Shafts-and-Gallery Aqueducts in the Mid-First Millennium BC in Egypt and Iran .....	289
17.3.1	Egyptian Oases.....	289
17.3.2	Fazzān .....	289
17.3.3	Bam .....	292
17.3.4	Doubtful Cases .....	293
17.4	The Dearth of Evidence of <i>Qanāt</i> in Pre-Islamic Iran.....	293
17.4.1	Iran—“The Land of the <i>Qanāt</i> ” .....	294
17.4.2	Polybius’ Text .....	295
17.4.3	Written Sources in the Late First Millennium AD .....	296
17.4.4	Exit of the Mining Theory .....	296
17.4.5	Exit of the <i>Qanāt</i> in Urartu and Assyria.....	296
17.4.6	Indirect Archaeological Clues for Late Pre-Islamic Shafts-and-Gallery Aqueducts in Iran: Extension and Change in the Pattern Settlement.....	296
	Acknowledgments.....	297
	References.....	298

This chapter deals with the ancient underground aqueducts in the United Arab Emirates (UAE) and Iran. Some regional cases in other countries will be occasionally mentioned when dealing with the questions of the chronology and diffusion of the earliest witnesses. All the documents and case studies presented here can be grouped under the generic term *shafts-and-gallery aqueducts* (as suggested by E. Chiotis in his introduction Chapter 1 in this volume, *tapping groundwater*). The last words of that definition aim at excluding the (partly or totally) subterranean aqueducts collecting water from springs, lakes, and dams. Conversely, the depth of the mother well cannot be used for making a distinction between the so-called Iranian *qanāt* and the other types of *qanāt* or *falaj*, as has been often assumed in hundreds of papers. As a matter of fact, the vocabulary used by the local people and hence by scholars in several countries, and the word *qanāt*, from Iran to Egypt via Syria,



is limited, and one cannot reduce this term to the aqueduct with a deep mother well tapping a deep aquifer.\* Therefore, *qanāt* for Iran and *falaj* for the UAE and the Sultanate of Oman are employed here in the broad meaning as defined above. Both of them encompass a large “family” of water catchments.

Leaving aside any hydrogeological aspect, the viewpoint of this chapter is first the technical skills and knowledge of the population digging underground galleries, as seen by an archaeologist. Therefore, the aims are: (1) to present the earliest evidence of underground galleries in the early first millennium BC in South-East Arabia; (2) to mention some mid-first millennium BC isolated cases, in Egypt and Iran, both in a very peculiar geological context; (3) to stress the lack of direct archaeological evidence in Iran and even of indirect evidence until the mid-first millennium AD; therefore, one cannot infer an Iranian influence on the other side of the Persian Gulf in antiquity; and (4) to assume from the written evidence the existence of *qanāt* tapping deep aquifers in Iran very likely in the mid-first millennium AD.

The hypothesis of radial diffusion from a unique center does not match with the archaeological evidence. The *qanāt* and *falaj* in their general meaning may well be a polycentric innovation in different geographical contexts at different periods, especially for the first period, the first millennium BC. For that period, there are generally short galleries capturing water from the shallow aquifer formed by seepage from the watercourse of a wadi. In the early first millennium AD, some countries continued (Egypt and Libya) or developed (Syria, Northern Iraq) rather simple and shallow underground galleries. At the same time, very likely in Iran, the improvement of knowledge, may be science and techniques, allowed the specialists to detect unsuspected and deeper water resources. These galleries of the “second generation” are well attested in the written sources in Iran and have been illustrated by thousands of *qanāt* from that time to nowadays, while shallow galleries are still in use. For this second “generation,” a diffusionist model may be reconstructed.

## 17.1 QANĀT/KĀRIZ AND FALAJ

The most common word used by local peoples and scholars for defining these galleries, *qanāt*, has been supposed to refer to a peculiar kind of water catchment, with a mother well dug deep under the surface, mainly on alluvial fans and piedmont afar from springs and rivers (Figures 17.1 and 17.2). Concerning the first examples of these underground aqueducts, all the studies until the end of the last century firmly attributed their invention to the Iranians in the early first millennium BC, following H. Goblot’s book (Goblot 1979). This position cannot be longer maintained.

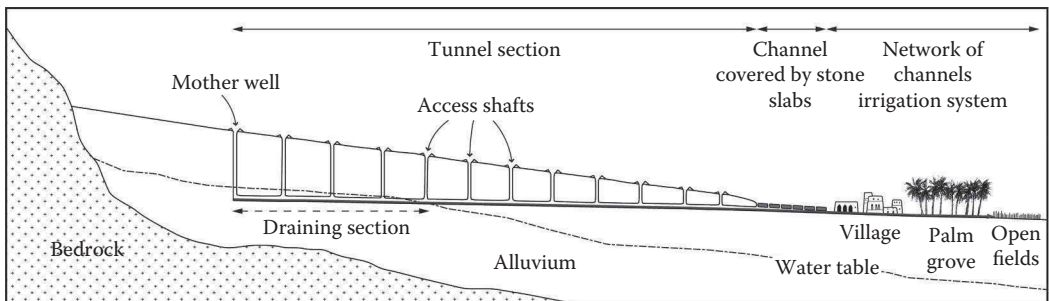
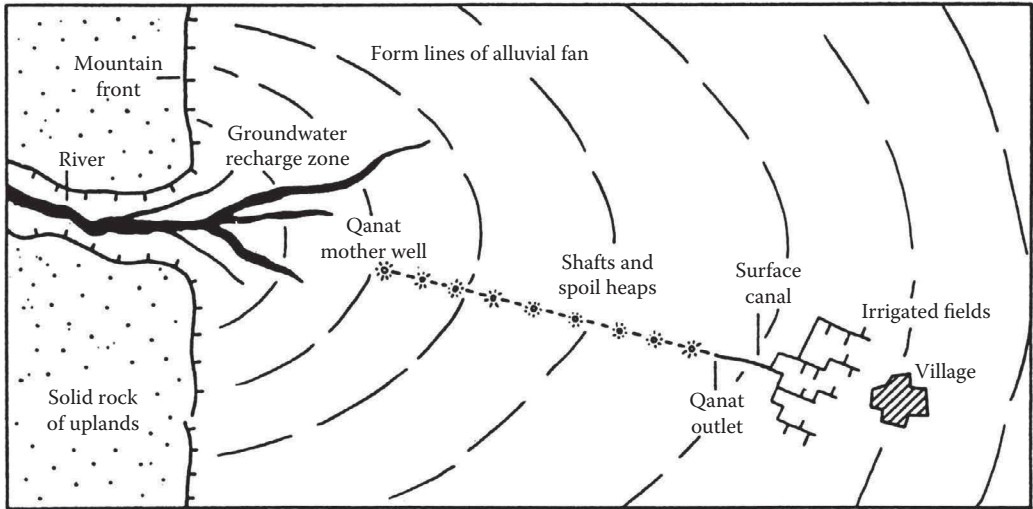


FIGURE 17.1 Section of a *qanāt*. (Courtesy of Charbonnier, 2014.)

\* The opposite position of Salesse (2001, 713) claiming for a restricted use of *qanāt* is only a wish. One cannot go against the common use by villagers and therefore the scholars in Syria or Egypt and even in Iran.



**FIGURE 17.2** Plan of a *qanāt* from alluvial fan. (From Beaumont, P., *The qanāt: A means of water provisions from groundwater sources*, in *Qanāt, Kariz & Khattaras: Traditional Water Systems in the Middle East and North Africa*, eds. P. Beaumont, M.E. Bonine, K. McLachlan, Menas Press, London, 1989, pp. 13–31, figure 3. With Permission.)

*Qanāt*, a word of Arabic root, is the most frequently term used...in Iran, while the Persian word *kārez*, *kāriz* is spread mainly in Eastern Iran and more frequently in Afghanistan. *Qanāt* and *kāriz* are used in the Iranian world by people, engineers, and scholars for any type of shafts-and-gallery aqueduct capturing groundwater; thus, these two words should be considered very generic terms. In a few cases, the anthropologist or the geographer studying a local network of galleries may obtain from the villagers a precision, a second term added for defining the type of water resource the *qanāt* catches. However, this secondary word changes with the region under consideration (see Section 17.4.1).

Similarly, on the other side of the Persian Gulf, the locals and the scholars used the generic term *falaj* (pl. *aftāj*), an Arabic word, but not *qanāt*. *Falaj* is basically “an organization for distributing water amongst those who have rights to it” (Wilkinson 1977, 74). The term has later been reduced to the aqueduct and its source. In the UAE and the northwestern part of the Gulf, Bahrain, Saudi Arabia, and Yemen, *falaj* is applied to any type of shafts-and-gallery aqueduct. In some more precise studies, a second term is added to better define the origin of the water resource. The *falaj ‘aini*, which define an aqueduct deriving a surface spring should be sorted out; the *ghaili falaj* usually a surface or underground diversion into a channel from a riverbed which is often deeply incised. It may also correspond to the catchment in the underflow of wadis. The third term, that is, the *dawudi* or *daudi falaj* (al-Ghafri et al. 2003, 2012, 196–197, and see below), completely fills the requirements of the *qanāt*, as it is usually considered by most of the scholars. *Falaj* is restricted to the Arabian Peninsula, while *qanāt* is spread over the rest of the Middle East, including Syria (*qanāt rumani*), reaching its western limit in Egypt. Further west, in Libya, Sahara, and Maghreb, *qanāt* is replaced by *foggara* and finally by *khettara* in Morocco.

Leaving aside the two last words, which belong to areas beyond the scope of this paper, one should consider *qanāt* or *kāriz* and *falaj* as comparable, because they are generic terms, regardless the geological and topographical contexts (which should offer a slope), the depth of water resource, and the length of the aqueduct, as some examples below clearly show. The two compelling components for an aqueduct to be called *qanāt* or (*ghaili*) *falaj* are the subterranean origin of the water resource and therefore the subterranean aqueduct for most part of the gallery, which necessarily should be reached by a series shafts for digging and maintaining the gallery. Beyond

this basic definition, the differences between different types are not envisaged here by modern knowledge; for instance, Laureano (2012) offers an interesting classification by ecosystems. In the following sections, the underground galleries are seen from the viewpoint of the ancient practitioners' knowledge and skills, allowing them to (a) detect groundwater from the surface at a few meters beneath it or conversely reaching an aquifer much deeper without visible signs on the surface for the common people and (b) be able to transport water on short distance with a series of shafts sometimes close to each other (5–10 m) or on several kilometers with shafts often at greater distance up to 50 m, while keeping a regular and very gentle gradient (maximum 1 or 2‰), in fact, nearly horizontal.

## 17.2 THE FIRST EVIDENCE OF *FALAJ* IN THE UAE

The pioneering paper by Wilkinson (1977) was the first serious attempt to better define the *falaj*. This scholar introduced the term *ghayl falaj* (or *ghaili falaj*) to distinguish the first two different types, as we have seen. Unfortunately, for clearly distinguishing the third type from the others, Wilkinson coined it *qanāt*, borrowing the term from the Iranian world, assuming that all the *qanāt* in these areas tap a deep aquifer.

Concerning the chronology, Wilkinson (1983, 182–184) infers from medieval and modern local texts and chronicles that the (*daudi*) *falaj* was already widely spread in some parts of NE Oman in the Imamate period (ninth century AD). Therefore, the technique could have been introduced during the Iranian domination of that area in the Sasanian period (third to early seventh century AD). Then, Wilkinson (1983, 185–189), taking into account the most recent archaeological results of that time, put the introduction of *falaj* to the eighth century BC, according to the date of the series of new settlements all along the western/southern piedmont of the Hajar mountain range. He attributed the introduction of the technique to the Achaemenid kings ruling Iran and the Middle East and may be part of the Oman Peninsula from the late sixth century BC but did not point to the discrepancy between this date and the eighth century BC, as suggested above.\*

In the same year, in the early 1980s, the first link between a newly found village dated to the Iron Age (first millennium BC) and the outflow of a *falaj* was evidenced on the southern piedmont of the mountain range at Maysar Site 42 (Weisgerber 1981), vaguely dated at that time from the middle of the first millennium BC. At that time, most of the scholars held (and many still hold) for an Iranian/Achaemenid origin, but they did not stress—except Potts (1990, 391–392)—the discrepancy between the historical (interpreted) sources focusing on the late sixth and fifth centuries BC and the date of the villages from the early first millennium BC. However, this last author (Potts 1990, 392) and others sought for a more ancient origin for the *falaj* in that area from the surface channels of the third and second millennia BC but still maintaining an Iranian origin (e.a. Cleuziou 2001). There is no ground either for such a technical evolution or for an external origin (Charbonnier 2014, 47).

The chronology of the early *falaj* was rapidly set, thanks to several excavations of villages totally depending of the *falaj*. Moreover, an example in Oman was dated by radiocarbon of the ninth century BC (Cleuziou 2001, 3 quoting I.D. Clark's PhD in Paris 6 University 1987, 173). The definitive evidence for such an early date for the *falaj* in the UAE is due to the painstaking fieldwork of W. Y. al Tikriti from 1983 until now. He published his first results in 2002 in Arabic and later an up-to-date English edition (al-Tikriti 2011). The author first discovered a series of small surface channels distributing water in several pieces of land, corresponding to small fields

\* Wilkinson pointed to a local tradition that mentions the presence of Persians under the rule of a Dara b. Dara b. Bahman, two Iranian names; the former could be the last Achaemenid king Darius III in the late fourth century BC defeated by Alexander.



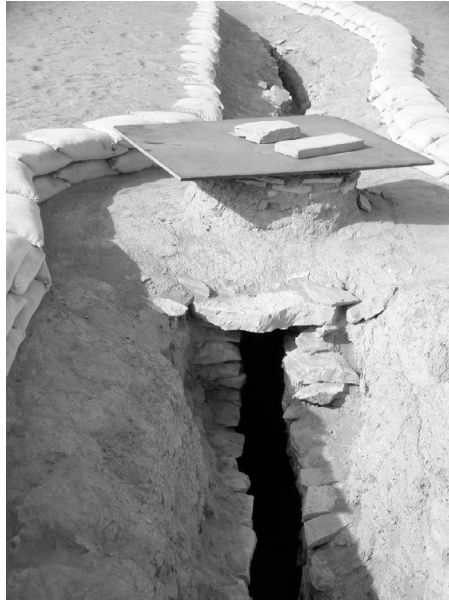
**FIGURE 17.3** *Falaj* Hili 15, Al Ain oasis, Abu Dhabi Emirate, UAE. Water distribution to secondary channels from the outlet of the main channel. (Courtesy of Boucharlat.)

in the Al Ain oasis (site Hili 15). These fields were probably related to a *shari'a*, a system of water distribution, consisting of several smaller channels provided with sluices (Figure 17.3) and with a large building, *ca.* 50 m aside, probably corresponding to a storage place and/or the seat of some authority (Boucharlat and Lombard 1985). From these fields, al Tikriti went upstream and cleared out a more important channel dug from the surface and covered by stones slabs (cut-and-cover technique). This channel went deeper and deeper over several hundreds of meters, still dug from the surface, reaching a depth of 3 m, but provided with a series of shafts (locally called *thugbah*, pl. *thugab*) for maintenance (Figure 17.4). The walls of the channel and those of the shafts are consolidated with sandstones in their upper part on a height of 1 m, while the lower part is dug in the compact soil and may have been deepened after a decrease of the water level (al-Tikriti 2011, 78). Later, a tunneled part was accidentally found at one point 500 m further toward the mountain range called Jebel Huglah or Mishterin (al-Tikriti 2011, Figure 55). The author noted in one area, “a concentration of acacia trees (*ghaff*) which is usually taken as an indication of high levels of groundwater” (al-Tikriti 2011, 81). This observation is important regarding the origin of water, very likely a shallow water table.

Other *aflāj* networks have been partly excavated by W. Y. al-Tikriti along the foot of the mountains between the piedmont and the huge sand dune field reaching the Coast.

Two *aflāj* have been found at Bida bint Saud, 14 km north of al Ain oasis, very likely beginning from a rocky outcrop present today in the middle of a sand dune field. The western *falaj* was partly excavated 1 km afar from the outcrop. It runs *ca.* 4 m below the ancient surface today, covered by several meters of sand. The excavator cleared out several shafts and some segments of the gallery, which is definitely a tunnel, and was not dug from the surface (al-Tikriti 2011, 92). Importantly, between two of the shafts, there is a large opening lined by stonewalls. A stone staircase gives access to the channel and a pool situated 3.80 m below the surface.\* The use of this access is clearly shown by sherds, including pieces of large jars. The *falaj* continues westward on 700 m marked by

\* This installation is very similar to medieval and modern ones in Iran and in other countries. In the centre of many towns and villages there is a vaulted staircase conducting to the subterranean channel several meters deep. These villages are situated onto the still subterranean aqueduct while the cultivated fields are located downstream from the outlet.



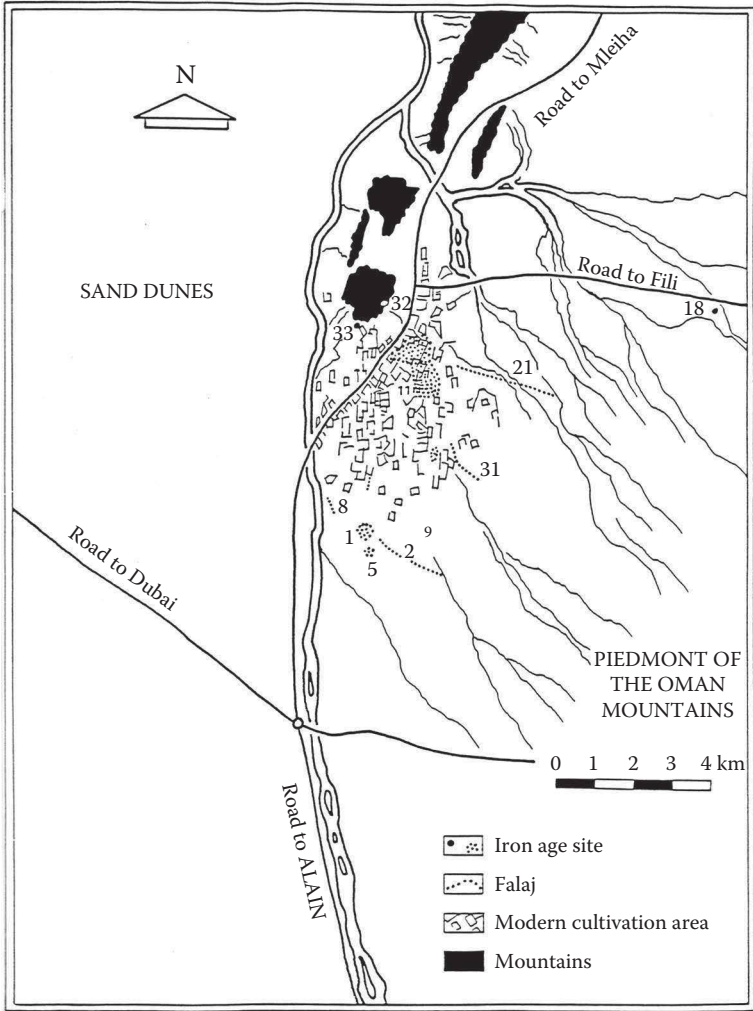
**FIGURE 17.4** *Falaj* Hili 15, Al Ain oasis, Abu Dhabi Emirate, UAE. One of the shafts opening on the gallery in a cut-and-cover section. (Courtesy of Boucharlat.)

the spoil heaps corresponding to the shafts, containing pottery sherds and fragments of grinding stones. It seems to end near a series of small mounds, probably corresponding to small houses and agricultural activities. At 150 m north of the *shari'a*, a large building with mudbrick walls includes a large pillared room in a building, as we know elsewhere in relationship with a *falaj* dated from the same period. Concerning the origin of this *falaj*, al-Tikriti (2002, 129, 2011, 99) suggested the northern tip of the outcrop and he noted that the water table is today 20 or 24 m below the surface but was at a higher level when the *falaj* was in operation. Consequently, the origin of the *falaj* was not very deep 3000 years ago.

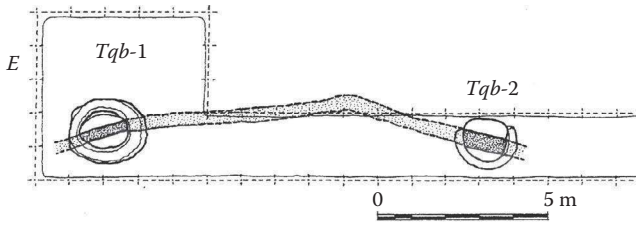
Apart from other shafts-and-galleries aqueducts excavated by al-Tikriti further north in the Abu Dhabi Emirate, a third example is worth mentioning in the Sharjah Emirate at al-Madam (Figure 17.5). Three channels 1 to 3 km long have been identified, thanks to the openings of the shafts that are still visible today but are completely filled up with sand. They run toward clusters of ancient houses, extending over several hectares. Near some houses made of mudbrick walls, the Spanish archaeologists brought to light a series of small fields carefully irrigated by small channels, very likely a palm grove that had the rows of regularly set small pits linked by narrow ditches (Córdoba 2013). Apart from the *aflāj*, there is a well 5 m deep near the fields. One of them has been investigated. The rather irregular layout of the gallery is probably due to an empiric digging technique (Figure 17.6). It also showed a tunnel abnormally 4 m high (Figure 17.7). A careful observation showed that the gallery was first 1.60 m high, which was then deepened 2.30 m to face the depletion of the water level (Figure 17.8). The flow slowly decreased and the gallery was partially silted; consequently, the *falaj* was abandoned.

The origin of the water resource has been found in the underflow of a series of usually dried wadis near the settlement, not farther in the piedmont, at short distance to the east of the settlement (at least 700 m for *falaj* AM2 and 2 km for AM21) at a point where a large shaft is very likely the mother well (Benoist et al. 1997, 64–65). The archaeologists demonstrated that the al-Madam underground galleries clearly belong to the *ghaili falaj* type (Mouton and Schiettecatte 2014, 38–45). It is tempting to consider the other excavated *aflāj* of that period that belong to the





**FIGURE 17.5** Al Madam, Sharjah Emirate, UAE. Map of the Iron Age village, the three *aflaj*, and the network of dry wadis to the East. (From Mouton, M., *Archaeological survey of the region of Al Madam: A preliminary report*, in *Archaeological Surveys and Excavations in the Sharjah Emirate, 1990 and 1992: A sixth Interim Report*, CNRS-Université Lyon 2, Lyon, France, 1992, pp. 3–10, Figure 1. With Permission.)



**FIGURE 17.6** Plan of a segment of the gallery AM21. (Copyright and courtesy of Cordoba.)





FIGURE 17.7 Al Madam high gallery. (Copyright and courtesy of Cordoba.)

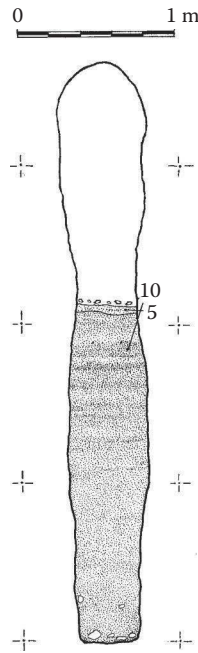


FIGURE 17.8 Al Madam, Sharjah Emirate, UAE. The *falaj* AM2. The gallery has been deepened to face the depletion of the water level. (Copyright and courtesy of Cordoba.)

same type, depending of shallow groundwater. Therefore, they were directly affected by the depletion of the rather poor water resource. This hypothesis (Boucharlat 2003, 162–172; Córdoba and Del Cerro 2005) is not accepted by al-Tikriti (2011, 130–132, 139), who argues against Boucharlat’s assumption and tends to consider that most of the Iron Age *aflāj* tap an aquifer. Charbonnier (2014, 50–67) keeps a balanced position while he stresses the importance of wells as an important water

resource besides the *falaj*. As a matter of fact, deep wells will be the unique water resource in the following periods on the very few sites located in a different area.

### 17.2.1 DATE OF THE INVENTION AND ITS RELATION TO THE REVIVAL OF HUMAN SETTLEMENT

The question of the date of these early *aflāj* is not disputed. Every excavated example is clearly linked to a settlement, and in three cases, together with a large building, each of them is securely dated from the Iron Ages II and, possibly, III. Iron Age II starts at the turn of the second and first millennia BC and ends around 600 BC. The chronology is based on a rather homogeneous pottery assemblage throughout the UAE and Oman, some distinctive types of copper objects and weapons, and a series of radiocarbon dates (Tables in Magee 2007, 87–88). Similar pottery sherds have been found by al-Tikriti around the outlet of Hili 15 *falaj* and in the small fields nearby, while other pottery sherds from a different date are absent. In the same way, Iron Age II sherds have been found in the *shari'a* of Bida bint Saud and around the spoil heaps around the shafts. No other pottery that Iron Age shards have been found, but a very few pieces of modern ceramic.

### 17.2.2 THE END OF THE PROTO-HISTORIC FALAJ IN SE ARABIA AND THE CLIMATIC CHANGE

Interestingly, there is a sharp decrease of the population, evidenced by the dramatic fall in the number of settlements and in their size after the period during the Iron Age III (600–300 BC). This evolution is visible by a distinctive new pottery assemblage that is hardly present in the *aflāj*. They were probably gradually abandoned because of the lowering of the water resource, as demonstrated in al-Madam, and were never reused. As already mentioned, the excavated *falaj* of al-Madam was dug 2.30 m deeper in a second phase, as it was probably the case for *falaj* Hili 15 in Al Ain, 100 km to the South. The strategy of deepening the soil of the cultivated fields and the palm tree fields to follow the lowering of the water table and the floor of the *falaj* is very traditional in the oases. It probably reached its limits during the Late Iron Age, and consequently, the villages were abandoned. As an example, the *falaj* AM2 in al-Madam was slowly silted up with successive layers, owing to a weak flow, showing that it was no longer cleaned and then abandoned.

The climatic change is often put forward for explaining the invention of the *falaj*. It is known that the end of the last humid period in that area (9000–6000 BP) was followed by a continuous aridity until our days but with a more marked arid period from the beginning of the first millennium BC (Magee 2007, 90 with reference). From more precise surveys in the now-dried Awafi lake in Ras al-Khaimah Emirate (Parker et al. 2006a, b), after the end of the humid period in 6000 Cal yr BP, the lake was maintained with a minor revival until 4200 Cal yr BP and then the lake basin dried up, turning into the present situation. As a result, there was a constant depletion of the groundwater. Consequently, the local population dramatically decreased from the third to the second millennium. The invention of the *falaj* was an adaptive response to the general aridity of the region. It lasted only for some centuries because of the continuous aridity of that period. Therefore, the *falaj* system of that time (not very deep) was unable to function any more, despite some deepening. Consequently, the channels capturing surface water or shallow groundwater were abandoned.

Before leaving the first millennium BC in SE Arabia, it should be noted that it is odd that the Iron Age *falaj* of the Oman Peninsula did not spread in the northwest part of the Persian Gulf. The earliest evidence is from the third to second century BC in Eastern province of Saudi Arabia. The type of resource seems to be artesian spring, as it is the rule in Bahrain (Lombard and Tengberg 2001, 178, Lombard pers. comm. 2015). Therefore, there were no direct heirs of the Omani *falaj* during the Iron Age. In the northern part of the Arabian Peninsula, shafts-and-gallery aqueducts are known by several examples of rather short galleries (usually 1.5–3 km), but date was still a matter of discussion some years ago (Nasif 1980, 1987. See Chapter 13).

### 17.2.3 THE REVIVAL OF THE DEEP *FALAJ* IN THE LATE FIRST MILLENNIUM AD: PROBLEMS OF ORIGIN

The *aflāj* built much later in al Ain oasis come to support the hypothesis which suppose that the shallow *falaj* was the sole technique in use in the first millennium BC. As noted by al Tikriti (2011, 55–66, 118–130), there were new *aflāj* in the Medieval period, that is, after one millennium gap from the Iron Age, as al-Tikriti stresses. The oldest one is located in the modern city center and dates from the Early Islamic Period, probably from the eighth to ninth century AD, according to the ceramic material and one radiocarbon date of  $1330 \pm 25$  BP.

More recent excavations since 2011 (al-Tikriti et al. 2015) come as a quite interesting confirmation of the Early Islamic occupation, as illustrated by other buildings and three *falaj*. It is remarkable that the Early Abbasid period settlement coincides with the evidence of the great period of *aflāj* in some parts of Oman (ninth to tenth century AD), according to textual evidence. These texts referring to that periods have been written later; however, there are records of the *falaj* rulings. There are also archaeological data, such as the coastal site of Suhar, showing a dramatic extension of the cultivated lands at that time (Wilkinson 1983, 181–184).

In al Ain, the building technique of the Islamic *falaj* is rather different from that of the Iron Age. Near the mosque, the channel is dug from the surface through 2 m of sand and compacted clay. The bottom of the gallery is 3–4 m deep in the excavated segments, and its height of more than 1.50 m allows the builders to work easily inside. As a matter of fact, the walls are carefully built up of baked bricks, as is the vaulted roof. In some places, it has been repaired with large stone slabs. Then, the trench is filled up to the ground. Technically, this lower end of this *falaj*, excavated along 175 m, belongs to the cut-and-cover technique, while the construction of the upper segments is unknown but is probably tunneled. It is interesting to mention that a mosque was built nearly at the same period close to the *falaj* and a well dug beside it could have given access to the gallery.

The origin of this *falaj* and of the aqueducts of ca. 20 modern period in Al Ain up to the early twentieth century is worth mentioning. Among half a dozen coming from the NE, such as the Hili 15 belonging to the Iron Age, another one, also called Hili, is 10 km long and its mother well goes at least 30 m deep. The other *aflāj* come from a different direction, from the SE higher piezometric surface. One of them is 7 km long and has a mother well 20 m deep (al-Tikriti 2011, 55–66 and Figure 30). The same author notes “Groundwater levels during the Iron Age were much closer to the surface than during the Islamic Period. Consequently, it is natural to see the *aflāj* constructed during the Islamic period at much greater depth” (al-Tikriti 2011, 132).<sup>\*</sup> The continuous aridification was compelling and demanded an adaptation. The new response took time to be found.

The chronological gap between the mid-first millennium BC and late first millennium AD is indicated by the lack of pottery sherds of the Bronze Age and the Iron Age in the recent excavations in the city center of al Ain (al-Tikriti et al. 2015). Besides, the current new survey of the whole al-Ain/Buraimi oasis (Power et al. 2015) confirms the Early Islamic occupation, in one case directly linked with a *falaj*. To be mentioned the excavations have also evidenced a very flimsy occupation, perhaps falling in the chronological gap (first to second century AD) and a little more important in the sixth to eighth century AD, therefore being very close to the Early Islamic period. However, there is still a huge chronological gap between the Iron Age and the Islamic period.

As a hypothesis for explaining the gap, we would assume that the Iron Age populations were unable to detect deeper water resource and transport it to their settlements. The revival after the gap is therefore better explained by the implementation of a new knowledge and technique, allowing to tap “hidden waters” (Landry 1990). They are often located much deeper and should be transported on longer distances (several kilometers or more than 10 km).

After the abandonment of the Iron Age villages in the western part of the Oman Peninsula, there was a dramatic decrease in population. A very few new sites were settled in the late first millennium BC at

<sup>\*</sup> The evolution continued, and today, the modern *aflāj*, including the recent ones, are dried up.

different locations where water was supplied by wells, not by *falaj*, with some exceptions in Central Oman (Mouton and Schiettecatte 2014, 77–99). It was only in the late Sasanian period that a resettlement was noticed in the northern part of the modern UAE and in Oman (Mouton and Schiettecatte 2014, 47–77). Tentatively, we suggest that the new knowledge and skills of the second generation of shafts-and-gallery aqueducts were introduced from Iran and implemented from the beginning of the Islamic period.

## 17.3 SOME ISOLATED CASES OF SHAFTS-AND-GALLERY AQUEDUCTS IN THE MID-FIRST MILLENNIUM BC IN EGYPT AND IRAN

### 17.3.1 EGYPTIAN OASES

The archaeological program carried out in the 1990s in the southern part of the Kharga oasis in southern Egypt in an arid environment has revealed a network of several subterranean channels called *qanāt* by the excavator (Wuttmann 2001). All of them are short, the maximum length being 400 m (Figure 17.9). Some are dug in tunnel, reaching the water that infiltrates from the walls, and in others, galleries are dug by vaulted trenches, when the aquifer is close to the surface (Figure 17.10) (Wuttmann 2001, 118; Gonon 2005, 54, Figure 10). The water resource consisted of several artesian springs, which were no longer under pressure after the prehistoric period, and of small separate reservoirs, resulting in tectonically uplifted limestone blocks. The life in the oasis lasted for seven centuries, between the fifth century BC and the second century AD, and was divided into two main periods, the Achaemenid (fifth to fourth centuries BC) and the following Ptolemaic periods and then the Roman period.

This case study is beyond the scope of this paper but is mentioned here because it falls—by coincidence, in my opinion—within the Achaemenid period, which has long been supposed to be the period on diffusion of that technique in the whole Middle East. Suffice to say that the geological context is very peculiar, totally unknown in Iran. It consists of the huge Nubian Reservoir, which was formed during the last humid period, which ended around 6000 years ago. This immense reservoir is beneath the sandstone plaque made of uplifted blocks of alternate strata of porous sandstone and clay layers in a faulted band. It was not refilled after the mid-Holocene humid period. When the level of a local reservoir went down, the floor of the channel was deepened. Therefore, the gallery should be easily accessible by large rectangular shafts (Figure 17.11). When the reservoir was exhausted, the *qanāt* was abandoned and a new one was dug about 100–150 m afar. Another observation makes these aqueducts very peculiar: the gradient is much more important than it should be (01.-02:1000); of the two provided examples, one is 0.7:100. Moreover, the digging technique seems rather empiric, with irregularities in the gradient or even steps, because two converging segments starting from two shafts did not exactly join (Gonon 2005). Because the technique implemented and the peculiar geological context of the Nubian plate, it would be wiser to call these aqueducts *foggara*, as they are called in the neighboring Fazzān instead of *qanāt* (see section 17.3.2).

The beginning of the village of the oasis is securely dated from the mid-fifth century BC by the artifacts and more precisely by *ostraca* (pottery sherds used as small tablets for registering contracts of selling or renting fields or crops or an amount of water). These *ostraca* usually mention the year of the Pharaoh or the Achaemenid king. Several of these *ostraca* actually are contracts of granting “days of water” (Chauveau 2001).

### 17.3.2 FAZZĀN

The implementation of such galleries elsewhere in the oasis is going to be demonstrated for the same period and certainly later in other Egyptian oases. The diffusion westward in the Garamantes region (Fazzān, Libya) is now demonstrated for the early Christian era (Classical Garamantian period 1–400 AD) and very likely at some time during the previous proto-urban Garamantian period (500–1 BC), in any case before any Roman influence (Wilson and Mattingly 2003, 261–265; Mattingly and Wilson 2007, 525; Mattingly et al. 2009, 110, 130). As in ‘Ayn Manawir, the construction technique seems to be rather empiric and the origin of water resource is not very deep (5–10 m,







**FIGURE 17.10** ‘Ayn Manawir, Kharga oasis, Egypt. A gallery dug from the surface, which is then vaulted in the upper part. (Courtesy of Boucharlat.)



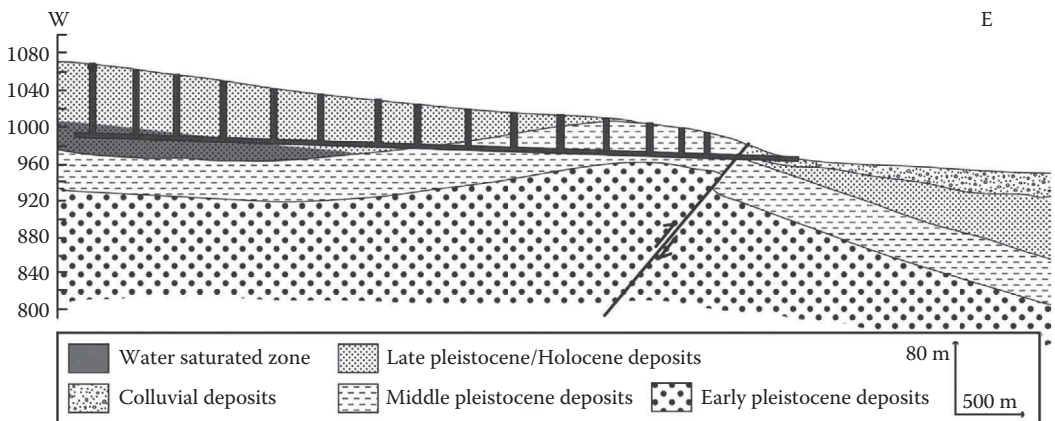
**FIGURE 17.11** ‘Ayn Manawir, Kharga oasis, Egypt. Series of restored shafts of the gallery MQ4. (Courtesy of Boucharlat.)



rarely more, from the present surface). Certainly at ‘Ayn Manawir and possibly at other sites, the water tables went down and were finally exhausted in the second to third century AD, because they were not rechargeable.\* This case seems to be restricted to the geological context of huge sandstone plaque from Egypt to Sahara. The origin of the technique remains unknown, but there is no reason to assume an origin from Iran, which hardly knew this technique at that time and certainly not in a similar geological context. For the time being, one may well consider the Egyptian *qanāt* and the Libyan *foggara* as local inventions, probably linked together, as an adaptive response to the need of water. It started in the mid-fifth century BC, according to the date of the earliest *ostraca*; however, there is absolutely no ground for connecting this innovation with the Persian domination.†

### 17.3.3 BAM

A second possible case is being under study in Bam oasis in Southeast Iran. The archaeological survey of this area was launched after the terrible earthquake of December 2003, which once more stroke this region. The use of *qanāt* in the past centuries is certain, tapping water in thick gravel layer of the piedmont down to 15 or 50 m of depth. The use of shafts-and-gallery aqueducts has been recently evidenced for the second half of the first millennium BC (again corresponding to the Achaemenid period and the following centuries). In one case, the channel is clearly a diversion of the underflow in a wadi and another one might be from a confined aquifer formed by the Bam scarp on the main tectonic fault. This case awaits for more precise study (Adle 2006).‡ It seems to be limited to this highly tectonic area, with a peculiar geological context (Figure 17.12). Therefore, we



**FIGURE 17.12** Bam oasis, Iran. An example of *qanāt* adapted to the seismic fault. (From Fouache, É., et al. Les régions de Bam et de Sabzevar (Iran): une évolution dans l’implantation des sites archéologiques et dans la gestion des ressources en eau compatible avec l’hypothèse d’une aridification croissante du climat entre 2500–1900 BC, Cahiers d’Asie Centrale 21/22, 559–572, 2013.)

\* The depletion of the aquifer *ca.* 0.50 m per century (Gonon 2005, 56) explaining the repeated digging of the floor of the galleries until the local small reservoir was exhausted.

† To be noted the beginning is dated almost one century after the conquest. Despite the total lack of evidence, the French archaeological expedition maintains the Achaemenid influence: “while it is likely that the technique of the *qanāt* has its origins on the Iranian plateau and was introduced by the Achaemenid conquerors, it is nevertheless the case that the structures of Ain Manawir are the only ones to have been effectively dated to that period.” <http://www.ifao.egnet.net/archeologie/douch/> accessed February 20, 2016.

‡ At the time of his untimely date (2015), Shahryar Adle was waiting for the results of three OSL dates. I owe this very general information to him. The results have been released since then. Unfortunately the dates represent a too wide array to be significant (Prof. Fouache pers. comm. July 2016).

should think of a local invention, as we suggest for the shafts-and-gallery aqueducts in the Nubian desert, although Bam is in a quite different environment.

### 17.3.4 DOUBTFUL CASES

The hypothesis of underground galleries around the archaeological site of Tepe Yahya, 200 km south of Kerman in South Iran, was put forward by Magee (2005). As in many others parts of Iran, in an arid environment, there are several *qanāt*; however, they are not used today. After a gap in the human occupation, from the second half of the second millennium BC, there was a modest resettlement in the Iron Age, probably from 800 BC. Magee suggests to connect this new settlement pattern with the introduction of *qanāt* (Magee 2005, 224–229). Currently, this is totally a guess, since there is absolutely no direct connection between these only surveyed small settlements and the *qanāt*, contrary to the situation in SE Arabia.\* Because of the 200-year lag between the appearance of the shafts-and-gallery aqueducts in SE Arabia and later their appearance in Iran—if there is any *qanāt* of that period—Magee (2005, 228) comes to the point to suggest a possible inversion of the influence, from the south to the north of the Persian Gulf. At the same time, he concludes that this adaptive innovation may well be polycentric, as it is very likely the case in the Nubian desert. The latter assumption is much more likely.

A recent paper by Fattahi (2015) suggests a quite earlier date for a shafts-and-gallery aqueduct called Miam Qanāt located in the Dasht-e-Bayaz fault, Northeast Iran, ca. 260 km south of Mashhad, not far from the famous deep Qanāt of Gonabad. The *qanāt* is built along a fault. A series of shafts are still visible from the ground and on the aerial photograph.† Five samples taken from different layers of a ring-shaped spoil heap have been analyzed by optically stimulated luminescence dating. Two samples come from the deepest layers, according to the section.‡ The date for the construction is  $4.4 \pm 0.8$  and  $3.79 \pm 05$  Ka (= between 5200 and 3300 years ago as a maximum chronological range) and a second date corresponds to a period of maintenance 1600 years later (Fattahi 2015, 62). Such an incredibly early date, which corresponds to the Bronze Age, remains to be confirmed by dating carefully selected samples. There is no information about the gallery, its depth, and the origin of water. Regardless its date, this case should be put in the general type of shafts-and-gallery aqueducts.

## 17.4 THE DEARTH OF EVIDENCE OF QANĀT IN PRE-ISLAMIC IRAN

Iran has long been considered, without question, as the unique cradle of the *qanāt* system and as the country that diffused the technique to the whole Middle East and later to China. This assumption rests upon a series of clues, which were neither verified nor enough discussed. It derives from some papers on the “Persian *qanāt*” produced by geographers (e.g., English 1968, one of the founding papers on the subject). The first synthesis was published after the death of Henri Goblots (1979), the author, and has been the “Bible” for the *qanāt*, its invention in Iran in the early first millennium BC, its diffusion by the Achaemenid empire, and then a rather schematic radial diffusion in the world. Regrettably, several of his unfounded assumptions—origin from mining technology in the eighth century in the Urartian kingdom and then its distribution in Iran and in the Achaemenid empire—are still widely spread and continuously diffused by renowned scholars and other specialists in the very first page of overviews on “*qanāt*” or handbooks on ancient water technology (English 1998, 188–189; Grewe 1998, 33, 2003, 9, 2008, 322–324; Hodge 2000, 35–38; Lightfoot 2000, 221; Lewis

\* In the 1970s, the American archaeological expedition at Tepe Yahya partially cleared out a shaft to establish a date, but without result (C.C. Lamberg-Karlovsky email December 17, 2001, pers. comm.).

† [https://www.researchgate.net/figure/283853100\\_fig2\\_Fig-2-a-Aerial-photograph-of-the-1968-Dasht-e-Bayaz-earthquake-ruptures-north-of](https://www.researchgate.net/figure/283853100_fig2_Fig-2-a-Aerial-photograph-of-the-1968-Dasht-e-Bayaz-earthquake-ruptures-north-of).

‡ The sediment grains in the gravel extracted when digging the shaft are not exposed for long to the daylight. They are rapidly covered by the content of the next bags of earth and gravel.

2001, 198–199; Mostafaeipour 2010, 61, 65; de Planhol 1992, 130–134, 2011, 564; Laureano 2012, 2). Very few authors expressed about the actual *qanāt* technique used by the Assyrians (Wilson 2008, 290–293) or about the date of the earliest galleries which could be much older than expected, in the late third millennium BC (Fattahi 2015). A few authors completely disagree with Goblot's theory for both the date and the origin of the (Boucharlat 2001, 2003, in press; Salesse 2001; Magee 2005; Leveau 2015, 169); the latter suggested a polycentric invention.

The main arguments in favor of this traditional Iranian hypothesis have been:

- The *qanāt* technique is very old in Iran and is widely and densely attested in pre-contemporary Iran, more than in any other country in the world. Iran has the longest and deepest *qanāt* network. The term *qanāt*, though of Arabic origin, is widely used for the Iranian shafts-and-galleries aqueducts.
- There is a unique but important written source of the second century BC (Polybius) that describes shafts-and-galleries aqueducts in Northern Iran. A much later text (early eleventh century AD) by a Persian-born scholar precisely described the various origins of water and the techniques for constructing a *qanāt*. It is considered as a confirmation of the high technological level of the Iranian engineers.
- According to Goblot's hypothesis, the invention of the *qanāt* derives from the mining technology in the kingdom of Urartu (corresponding to modern Northwestern Iran, Eastern Anatolia, and Armenia) between the ninth and the seventh centuries BC. From there, the Achaemenid empire would have implemented the *qanāt* in Iran (as would show Polybius' text) and then throughout the empire, which extended from Asia Minor, Levant, and Egypt to modern Pakistan, Afghanistan, and Central Asia.
- There are several cases of shafts-and-gallery aqueducts in the Egyptian and Libyan deserts, dated from the mid-first century BC at the earliest. Bam case is still of an uncertain type, as are a few other cases in the same country (see Section 17.3).
- Iran in the Late pre-Islamic period saw a dramatic population growth in several arid and semi-arid zones. While the implementation of a type of shafts-and-gallery aqueducts may well be an already known technique in some areas, the innovation of the deep *qanāt* could be an explanation for the extension of the irrigated fields and the occupation of new land in arid areas.

#### 17.4.1 IRAN—"THE LAND OF THE QANĀT"

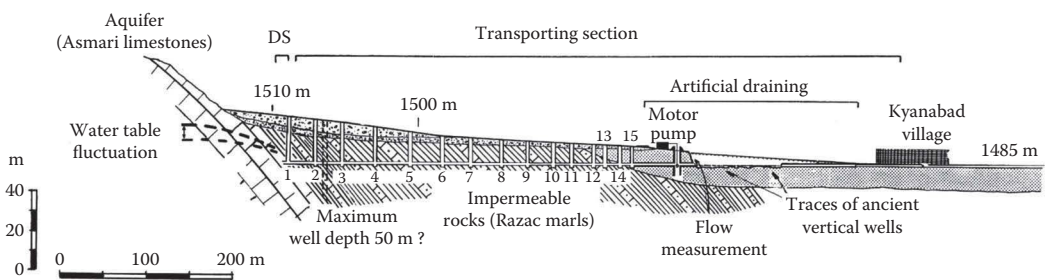
Apart from the allegedly geographical and chronological origin of the *qanāt* in Iran, the problem derives from the indistinct use of the term applied to any shafts-and-gallery aqueducts, the hazily use of measurements, and statistics extracted from here and there.\* Some exceptional examples of *qanāt* are often quoted, for instance, 80 km, but constituted of three branches for Zarch in Yazd province (Semsar et al. 2012, 12), 35 km long with a mother-well 300 m deep for Gonabad in NE Iran (de Planhol 2011, 566), or, for the same 28 km (or 70 km) long and between 350 and 400 m deep (Mostafaeipour 2010, 63, 69). These records hide the common reality. It is better to quote P. Beaumont, who noted that 36% of 2000 channels of 12 different *qanāt* systems he examined on the fringes of the Central Plateau are between 0.5 km and 2 km long and 81% are less than 5 km long. Only 16 channels are longer than 15 km (Beaumont 1971, 42–44, Figure 3; 1989, 23, Figure 2.5 and map 2.9, statistics accepted by de Planhol 2011, 567). Beaumont duly noted that in the 1950s, in the Varamin plain, south of Tehran, surface canals tapped water from the local

\* To give a very general idea, the modern *qanāt* in Iran amounts to 22,000 units, totalizing 272,000 km (Mostafaeipour 2010, 63) or 36,888 still active *qanāt* (Semsar Yazdi and Labbaf Khaneiki 2012, 13, Table Figure 4 shows the overwhelming predominance of *qanāt* in Iran in comparison with the neighbouring countries).

river, while 266 (subterranean) *qanāt* originated from alluvial aquifers (Beaumont 1989, 27). The mother well is generally far from the impressive depths often cited, generally less than 30 m, occurring between 10 m and 20 m in Qazvin-Tehran area (Beaumont 1971, 44, Figure 4). In the more arid area of Mahan in the Kerman basin, there are networks 15 km long, with mother well 30–50 m deep, and others 1.5–3 km long and 10–20 m deep (English 1989). Beaumont (1971, 46) clearly points that the deepest mother wells are located close to the foothills, where the water table is lowest, and the shallow ones are located downstream on the desert margin. In Qom, Lambton (1989) clearly states that there are *qanāt* that tap deep or semi-aquifers and *asman-nigar qanāt* highly depend on rainfall and are therefore not very deep.\* Apart from these regional cases, there are some other published concrete examples of a given *qanāt* network. For instance, the *qanāt* of Sargon near Shiraz in an area benefiting from 400 mm of annual rainfall, but only 160 mm in winter, is an example of the diversity (Dumas and Mietton 1998). It taps a 50 m deep perched aquifer in a karstic milieu. It is only 1 km long, with 20 shafts at 10–15 m interval through lacustrine alluvium and marl layers (Figure 17.13). In that case, the discharge varies a lot, depending on the season (low flow from July through October). As these examples testify, “Iranian *qanāt*” definitely belong to various origins of water resource and therefore different types of shafts-and-gallery aqueducts.

#### 17.4.2 POLYBIUS’ TEXT

The Greek historian reports a testimony about a system unknown to him, which he has not seen by himself. He describes a chain of “wells” linked, as he wrote, by a subterranean gallery located on the southern piedmont of the Alborz range, east of Tehran. Fighting against the Seleucid king Antiochos III at the end of the third century BC, the local ruler has filled up the wells in order to deprive the enemy of drinking water. Polybius adds that these Greek *hyponomoi* go back to the Persian kings, that is, the Achaemenids. This famous text raises many difficulties, as P. Briant demonstrated in his in-depth study (Briant 2001; comments Salesse 2001, 718–720). Apart from Polybius’ mistake about the function of the shafts, one of the main problems lies in the alleged equivalence of *qanāt* with Greek *hyponomos*. As a matter of fact, the Greek author mentions nothing about the origin of the water resource, which was very likely run-off, wadis, or superficial water tables. Nevertheless, shafts-and gallery aqueducts did exist in that part of Iran in the late third century BC. No corresponding archaeological witness of that time has been found so far (see below for some hints for a slightly later period).



**FIGURE 17.13** Modern sargon *qanāt* in Kyanabad, 10 km SW of Shiraz, Iran. DS: Draining section. (From Dumas, D. and Mietton, M., *Bulletin de l'Association de géographes français* 1998(2), 170–178, 1998, figure 1. With Permission.)

\* The word for shallow *qanāt* may change from one region to another. In Yazd area, the *qanāt* tapping shallow groundwater varying with seasons and annual changes and depending on the rainfall is called *qanāt havābīn* from Persian *havā* “weather” (Bonine 1982, 145).

### 17.4.3 WRITTEN SOURCES IN THE LATE FIRST MILLENNIUM AD

There is no direct archaeological evidence of the *qanāt* system until the modern period, but indirect hints of its existence for providing water can be inferred from the earliest occupation of villages and cities located in arid zones on the fringe of the Iranian desert. Many of them could have permanently existed only because of the *qanāt* as a unique or complementary water resource. Qom, Yazd, and others cities have been studied in this view. According to the *Ta'rikh Qom* (History of Qom), written and rewritten from the tenth down to the nineteenth century, some decades after the conquest the Ash'ari, Arabs repaired 20 *qanāt* (*kārez* in the text), which had fallen out of operation in the late Sasanian period (Lambton 1989); the type of *qanāt* is not specified. Likewise, from a description in a "Compilation of jurisprudence" written in Middle Persian around 620 AD, the term *katas* or *kahas* has been thought to be a *qanāt* (de Menasce 1966). Despite that it is 1.50 m deep, nothing clearly points to an actual subterranean channel, and the word is now translated by specialists as canal or channel.

The *qanāt*, including the type of gallery tapping an aquifer, sometimes very deep, was certainly widely in use before the early eleventh century, when the Persian engineer al-Karaji wrote his book, rendered in English, *The Extraction of Hidden Waters*, in 1017 AD (Mazaheri 1973; Landry 1990). Al-Karaji offers in the first part a comprehensive study of the geological environment and the various origins of water. In the second part, he offers all the necessary technical information for constructing a *qanāt*, which is the type that taps a deep refillable or a fossil aquifer.

According to the annals of several Iranian cities, written and rewritten between the tenth and the nineteenth centuries, there are several *qanāt* dating back to the beginning of every Iranian city. They are an essential condition for everyday life.

### 17.4.4 EXIT OF THE MINING THEORY

Technically, the channels for transporting the undesirable water from the mine galleries are more often than not on the surface. Moreover, the gradient has no importance in the mines, since the channels aim to evacuate surplus of water not to maintain a slow and permanent flow.

### 17.4.5 EXIT OF THE QANĀT IN URARTU AND ASSYRIA

Goblot mentions several examples of tunnels of that period in the Urartu kingdom and aqueducts and sophisticated hydraulic structures in the Assyrian empire to the west. None of the Urartian and Assyrian aqueducts and their tunnel segments dug into hills and rocky mountains originate from a mother well, but they originate from rivers springs, lakes, and manmade dams (Bagg 2000, 128–135 and definitively Salvini 2001).

### 17.4.6 INDIRECT ARCHAEOLOGICAL CLUES FOR LATE PRE-ISLAMIC SHAFTS-AND-GALLERY AQUEDUCTS IN IRAN: EXTENSION AND CHANGE IN THE PATTERN SETTLEMENT

None of the Iranian *qanāt* can be directly dated from the pre-Islamic period and even from the following centuries, despite some assumptions put forward time to time, especially for the Khorasan province, corresponding to the NE quarter of the country. Chronological clues cannot be found in the digging techniques, since the workers used very simple tools (e.g., pick, baskets, and ropes) in the past, until the mid-twentieth century. No chronological evidence can be inferred from the poor archaeological material which is very rarely found in the galleries.\* It could be of any date: objects

\* In Iran, *qanāt* networks usually last for long, sometimes several centuries, by a careful maintenance or by deepening the gallery or digging a new one near or below the old one. Therefore, the outlet yields material dating from the present time down to the construction period. Excavating an outlet would be certainly most rewarding for establishing a chronology.



fallen into a shaft from a date later than the initial digging, or conversely, objects lying in a settlement dragged down when the digging of a shaft went through the archaeological layers.\*

It is well known from textual sources and archaeological data that the Sasanian period (224–652 AD) corresponds to a dramatic extension of agriculture. From the former, we know that the kings sought to develop the economy to establish factories and encourage crops production. From the latter, we observe a considerable growth of settlement, both in extension and density. This is obvious in the Mesopotamian lowlands, thanks to the huge canal network, which is not explained in other geographical areas, including the arid zones. Several recent archaeological surveys have stressed the dramatic changes in the maps of settlements, which occur in these centuries.

Two selected cases in arid areas suffice to show this sharp evolution. The first one is located 400 km east of Tehran, in the Semnan province, on the southern piedmont of the Alborz range, not too far from the region where *qanāts* were reported by Roustaei (2012). He surveyed two piedmonts stretching over 10 km between the mountains and the desert Salty Plain. He noted a few sites from pre-history down to the mid-first millennium AD and then a sharp growth of human settlement in the Islamic period, from the eleventh century AD. Roustaei stresses that there is a shift of proto-historic settlements from near the often-dried wadis of the piedmont downward to the plain located near the still-visible *qanāt*. This shift seems to start from the Achaemenid period but is more important in the Sasanian period (Roustaei 2012, 207–217).†

The other example comes from the opposite part of Iran in the South in two small regions with arid climate and in nonperennial wadis with often brackish water. Recent archaeological surveys have showed a dramatic increase in the human settlement in the first half of the first millennium AD, tentatively from the Sasanian period (third to seventh centuries AD). In one valley, the settlements increased from 4 in the Achaemenid period up to 44 in the Sasanian period (Askari Chaverdi and Azarnoush 2004) (Figure 17.14a and b). In the other small region, the increase is even much sharper, from 2 Achaemenid sites to 47 Sasanian ones (Asadi et al. 2013) Such a dramatic increase in population demanded an extension of the necessarily irrigated cultivated lands. Moreover, despite the too large-scale published maps, it seems that many of the new settlements were established farther from the river running at the bottom of the valleys and more distantly from the secondary wadis; therefore, they needed water resource such as *qanāt*. These observations are still vague and remain indirect signs of an increased diversification of water resources, which may originate in the exploitation of underground water.‡

The precise types of *qanāt* implemented in Sasanian and Early Islamic Iran from the North to the South remain to be more precisely studied. Knowing from al-Karaji' Treatise that the *qanāt* tapping a deep aquifer was fully mastered before the eleventh century AD, we incline toward the argument that this type came in use in Iran, before the time of the Islamic conquest, that is, during the Sasanian period. From Iran, this more technical and scientific generation of *qanāt* disseminated in the Middle East and progressively beyond that region, toward the Maghreb and may be to Eastern Asia and to the East. Schematically, the first generation of shafts-and-gallery aqueducts was very likely polycentric during varied periods of the first millennium BC. Much later, the second generation might have been actually implemented in Iran around the middle of the first millennium AD and was soon spread elsewhere.

## ACKNOWLEDGMENTS

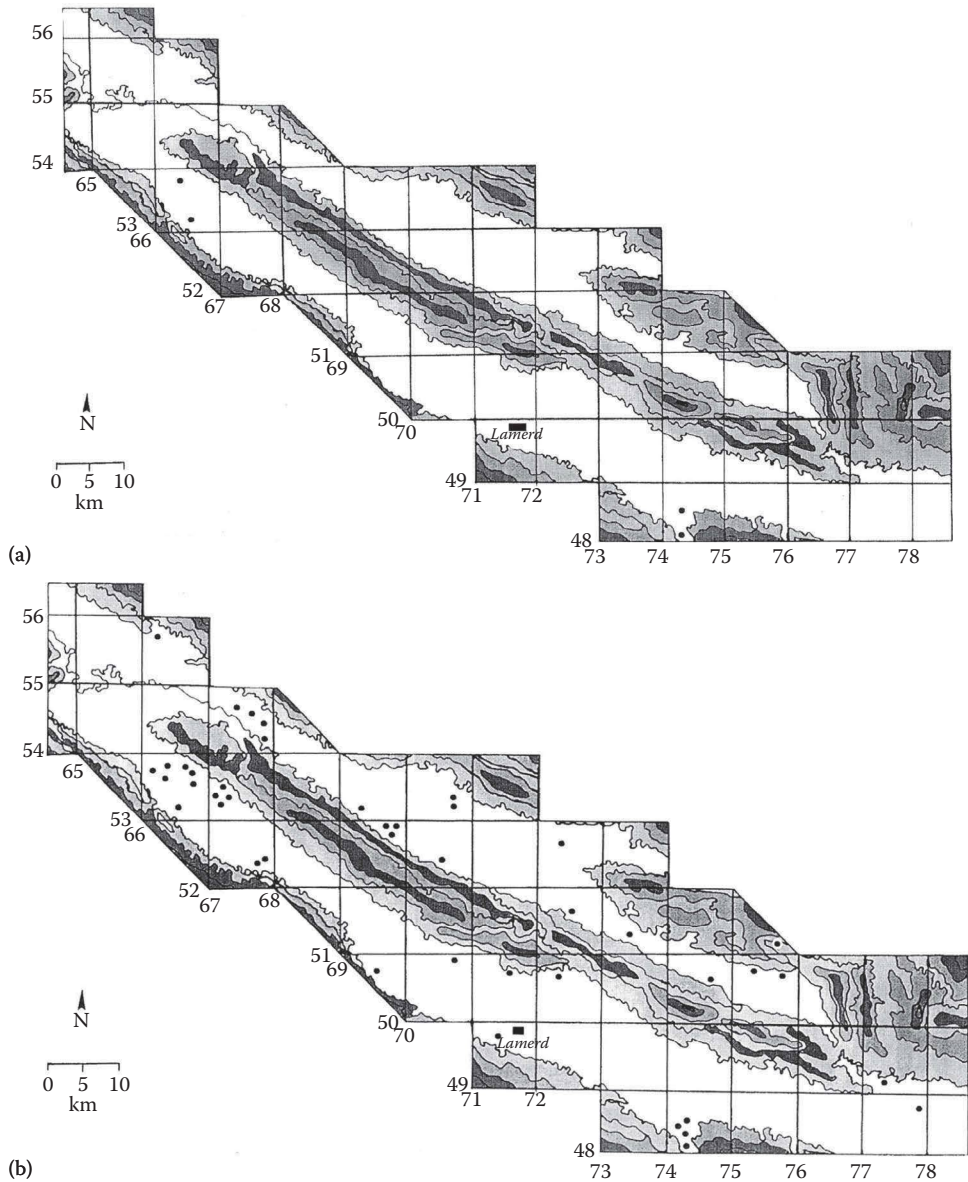
I warmly acknowledge the fruitful and enjoyable cooperation of Dr. E. Chiotis, the scientific editor of this Part, for his precious advices to an archaeologist totally ignorant about geology and hydrogeology. I am also grateful to Dr. Chiotis for providing many articles and references unavailable to me. The remaining mistakes and lacunae in the text are mine.

\* As we have seen, the Iron Age *aflāj* of the UAE constitute a different case, since the artifacts were exclusively of that period and were in their original position in the channels, the *shari'a*, and the fields located beyond the outlet.

† In assuming that the *qanāt* technique developed as early as the Achaemenid period, Roustaei clearly refers to Magee's hypothesis (2005) for the Iron Age in Tepe Yahya in SE Iran.

‡ For some more details, see Boucharlat, in press.





**FIGURE 17.14** Maps of Lamerd-Mohr valleys in South Iran. Settlement distribution (a) in the Achaemenid period and (b) in the Sasanian period. (From Askari Chaverdi, A. and Azarnoush, M., *Majalle-ye Bāstānshenāsi va Tārikh/Iranian J. Archaeol. History*, 36, 3–18, 2004, Figures pp. 11–12. With Permission.)

## REFERENCES

- Adle, C. 2006. Qanats of Bam: An archaeological perspective. Irrigation system in Bam, its birth and evolution from the prehistoric period up to modern times. In *Qanats of Bam. A Multidisciplinary Approach*, eds., M. Honari, A. Salamat, A. Salih, J. Sutton, J. Taniguchi, pp. 33–85. Tehran, Iran: UNESCO Tehran Cluster Office.
- al-Ghafri, A. 2012. Chapter 6—Sultanate of Oman. In *Qanat in Its Cradle. Situation of Qanat (Kariz, Karez, Falaj) in the World*, eds. A.A. Semsar Yazdi, M. Labbaf Khaneiki, pp. 191–273. Tehran, Iran: ICQHS.
- al-Ghafri, A., Inoue, T., Nagasawa, T. 2003. *Daudi Aflaj: The Qanats of Oman. Proceedings of the Third Symposium on Xinjiang Uyghor, China, Chiba (Japan)*, pp. 29–36.

- Asadi, A., Mousavi Kuhpar, S.M., Neyestani, J., Hojabri-Nobari, A. 2013. Sasanian and early Islamic settlement patterns north of the Persian Gulf. *Vicino Oriente* XVII: 21–38.
- Askari Chaverdi, A., Azarnoush, M. 2004. Barresi va bāstānshāxti-ye mohavatehā-ye bāstāni-ye paskarānehā-ye Khalij-e Fārs /Archaeological Survey in the Hinterland of Persian Gulf, Lamerd and Mohr district, Fars. *Majalle-ye Bāstānshenāsi va Tārikh/Iranian Journal of Archaeology and History* 36: 3–18.
- al-Tikriti, W. 2002. The south-east Arabian origin of the falaj system. *Proceedings of the Seminar for Arabian Studies* 32: 117–138.
- al-Tikriti, W. 2011. *Archaeology of the Falaj: A Field Study of the Ancient Irrigation Systems of the United Arab Emirates*. Abu Dhabi, United Arab Emirates: Department of Historic Environment (ADACH).
- al-Tikriti W., al-Neyadi, M., Tawalbeh D., al-Nuaimi A.R., al-Kaabi A., Oma W. 2015. Filling a blank: New excavations at an early Islamic Site at Oud Al Toba/Muataredh in ‘al- Ayn, UAE. *Proceedings of the Seminar for Arabian Studies* 45: 371–384.
- Bagg, A. 2000. *Assyrische Wasserbauten. Landwirtschaftliche Wasserbauten im Kernland Assyriens zwischen der 2.Hälfte des 2. und der 1.Hälfte des 1. Jahrtausends v. Chr.* (Baghdader Forschungen 24). Mainz.
- Beaumont, P. 1971. Qanat Systems in Iran. *Bulletin of the International Association of Scientific Hydrology* 16: 39–50.
- Beaumont, P. 1989. The qanat: A means of water provisions from groundwater sources. In *Qanāt, Kariz & Khattaras: Traditional Water Systems in the Middle East and North Africa*, eds. P. Beaumont, M.E. Bonine, K. McLachlan, pp. 13–31. London: Menas Press.
- Benoist, A., Córdoba, J., and Mouton, M. 1997. The Iron Age in al-Madam (Sharjah, UAE): Some notes on three seasons of work. *Proceedings of the Seminar for Arabian Studies* 27: 59–73.
- Bonine, M.E. 1982. From qanāt to kort: Traditional Irrigation Terminology and Practices in Central Iran. *Iran* 20: 145–159.
- Boucharlat, R. 2001. Les galeries de captage dans la péninsule d’Oman au premier millénaire avant J.-C.: Question sur leurs relations avec les galeries du plateau iranien. In *Irrigation et drainage dans l’Antiquité, qanāts et canalisations souterraines en Iran, en Egypte et en Grèce*, ed. P. Briant (Persika 2), pp. 157–183. Paris, France: Thotm.
- Boucharlat, R. 2003. Iron Age water-draining galleries and the Iranian qanāt. In *Archaeology of the United Arab Emirates: Proceedings of the First International Conference on the Archaeology of the United Arab Emirates*, eds. D. Potts, H. al-Naboodah, P. Hellyer, pp. 162–172 London: Trident Press.
- Boucharlat, R. in press. Irrigation in Southern Iran in the early 1st mill. AD. Some hypotheses about draining galleries. In *Water and Life in Arabia Conference*, ed. W.Y. al-Tikriti. Abu Dhabi, United Arab Emirates: Abu Dhabi Tourism and Culture Authority, Department of Historical Environment, Archaeology Section.
- Boucharlat, R., Lombard, P. 1985. The oasis of Al Ain in the Iron Age: Excavations at Rumeilah 1981–1983, Survey at Hili 14. *Archaeology in the United Arab Emirates* 4: 44–73.
- Briant, P. 2001. Polybe X. 28 et les qanāts: le témoignage et ses limites. In *Irrigation et drainage dans l’Antiquité, qanāts et canalisations souterraines en Iran, en Egypte et en Grèce*, ed. P. Briant (Persika 2), pp. 15–40. Paris, France: Thotm.
- Charbonnier, J. 2014. Groundwater management in Southeast Arabia from the Bronze Age to the Iron Age: A critical reassessment. *Water History* 7(1): 39–71.
- Chauveau, M. 2001. Les qanāts dans les ostraca de Manāwir. In *Irrigation et drainage dans l’Antiquité, qanāts et canalisations souterraines en Iran, en Egypte et en Grèce*, ed. P. Briant (Persika 2), pp. 137–142. Paris, France: Thotm.
- Cleuziou, S. 2001. Un système d’irrigation par gravité depuis les nappes souterraines dans la péninsule d’Oman au IIIe millénaire avant notre ère/An irrigation system using gravity to carry water from the underground water table in the Oman Peninsula during the IIIrd Millennium BC, In *Colloque International OH2 « Origines et Histoire de l’Hydrologie », Dijon, 9–11 mai 2001*. hydrologie.org/ACT/OH2/actes/06cleuziou.pdf (accessed February 12, 2016).
- Córdoba, J.M. 2013. New perspectives about Iron Age and the oasis culture in the Oman Peninsula. Two conclusive seasons at al Madam (Sharjah, UAE). *Isimu* 16: 139–151.
- Córdoba, J.M., Del Cerro, M.C. 2005. Archéologie de l’eau dans al Madam (Sharjah, Emirats Arabes Unis). Puits aflaj et sécheresse pendant l’âge du Fer. *Iranica Antiqua* 40: 515–532.
- Dumas, D., Mietton, M. 1998. Structure et fonctionnement du qanat de Sargon (Shiraz-Iran) (Structure and hydrological behavior of the Sargon qanat (Shiraz-Iran). *Bulletin de l’Association de géographes français* 1998(2): 170–178.
- English, P. 1968. The origin and spread of qanats in the old world. *Proceedings of the American Philosophical Society* 112: 170–181.

- English, P. 1989. The qanats of Mahan. In *Qanāt, Kariz & Khattaras: Traditional Water Systems in the Middle East and North Africa*, eds. P. Beaumont, M.E. Bonine, K. McLachlan. pp. 113–118. London: Menas Press.
- English, P. 1998. *Qanats and lifeworlds in Iranian Plateau villages*. *Yale F&ES Bulletin* 103: 187–205.
- Fattahi, M. 2015. OSL dating of the Miam Qanat (KĀRIZ) system in NE Iran. *Journal of Archaeological Science* 59: 54–63.
- Fouache, É., Francfort, H.-P., Cosandey, C., Adle, C., Bendezu-Sarmiento J. et Vahdati, A.A. 2013. Les régions de Bam et de Sabzevar (Iran) : une évolution dans l'implantation des sites archéologiques et dans la gestion des ressources en eau compatible avec l'hypothèse d'une aridification croissante du climat entre 2500–1900 BC. *Cahiers d'Asie Centrale* 21/22: 559–572.
- Goblot, H. 1979. *Les Qanāts: une technique d'acquisition de l'eau*, Paris-La Haye-New York: Mouton.
- Gonon, Th. 2005. Les Qanats d'Ayn Manawir (Oasis de Kharga, Egypte): Techniques de creusement et dynamique de l'exploitation d'une ressource épuisable de la Première Domination Perse au IIe siècle de l'Ere Commune. In *Wasserversorgung aus Qanaten—Qanate als Vorbilder im Tunnelbau, Walferdange, Luxemburg, Internationales-Frontinus-Symposium* Heft 26: 39–57.
- Grewe, K. 1998. *Licht am Ende des Tunnels. Planung und Trassierung im antiken Tunnelbau*. Mainz, Germany: von Zabern.
- Grewe, K. 2003. Wasserversorgung aus Qanaten—Qanate als Vorbilder im Tunnelbau. In *Wasserversorgung aus —Qanaten als Vorbilder im Tunnelbau, Walferdange, Luxembourg, Internationales-Frontinus-Symposium* Heft 26: 9–24.
- Grewe, K. 2008. Tunnels and Canals. In *The Oxford Handbook of Engineering and Technology in the Classical World* ed. J.P. Oleson, pp. 319–337. Oxford: Oxford University Press.
- Hodge, A.T. 2000. I.4. Qanats, In *Handbook of Ancient Water Technology*, ed. Ö. Wikander, pp. 35–38. Leiden, the Netherlands: Brill.
- Lambton, A.K.S. 1989. The qanats of Qum. In *Qanāt, Kariz & Khattaras: Traditional Water Systems in the Middle East and North Africa*, ed. P. Beaumont, M.E. Bonine, K. McLachlan, pp. 151–175. London: Menas Press.
- Landry, P. 1990. Eaux souterraines et qanāts d'après un livre arabe du XIe siècle. In *Techniques et pratiques hydro-agricoles traditionnelles en domaines irrigués. Approche pluridisciplinaire des modes de cultures avant la motorisation en Syrie*, ed. B. Geyer, pp. 271–283 (Bibliothèque Archéologique et Historique 136, vol. II), Beirut, Lebanon: IFPO.
- Laureano, P. 2012. Water catchment tunnels: Qanat, foggara, falaj. An ecosystem vision. In *IWA Specialized Conference on Water&Wastewater. Technologies in Ancient Civilizations*, pp. 22–24, March 2012, Istanbul, Turkey. [https://www.academia.edu/2267274/Water\\_catchment\\_tunnels\\_qanat\\_foggara\\_falaj.\\_An\\_ecosystem\\_vision](https://www.academia.edu/2267274/Water_catchment_tunnels_qanat_foggara_falaj._An_ecosystem_vision) (accessed February 10, 2016).
- Leveau, Ph. 2015. Qanāts, *hyponomoi*, *cuniculi* et *specus*: une contribution à l'histoire des techniques hydrauliques. In *La technologie gréco-romaine. Transmission, restitution et médiation*, eds. Ph. Fleury, C. Jacquemard, S. Madeleine, pp. 149–176. Caen, France: PUC.
- Lightfoot, D.R. 2000. The Origin and Diffusion of Qanats in Arabia: New Evidence from the Northern and Southern Peninsula, *The Geographical Journal* 166(3): 215–226.
- Lombard, P., Tengberg, M. 2001. Environnement et économie végétale à Qal'at al-Bahrēin aux périodes Dilmoun et Tylos. Premiers éléments d'archéobotanique. *Paleorient*, 27/1: 167–181.
- Lewis, M.J.T. 2001. *Surveying Instruments of Greece and Rome*. Cambridge: Cambridge University Press.
- Magee, P. 2005. The chronology and environmental background of Iron age settlement in Southeastern Iran and the question of the origin of the qanat irrigation system. *Iranica Antiqua* 40: 217–231.
- Magee, P. 2007. Beyond the desert and the sown: Settlement intensification in late prehistoric Southeastern Arabia. *Bulletin of the American Schools of Oriental Research* 347: 83–105.
- Mazaheri, A. 1973. *La Civilisation des eaux cachées. Traité de l'exploitation des eaux souterraines composé en 1017 par Karagi*. Nice, France: Université de Nice.
- Mattingly, D., Lahr, M., Wilson, A. 2009. DMP V: Investigations in 2009 of cemeteries and related sites on the west side of the Taqallit promontory. *Libyan Studies* 40: 95–131.
- Mattingly, D.J., Wilson, A.I. 2007. Concluding thoughts: Made in Fazzān. In *The Archaeology of Fazzān*, 3. *The excavations of C.M. Daniels*, ed. D.J. Mattingly (Society of Libyan Studies Monograph, 8) Tripoli, Libya: Department of Antiquities and Society of Libyan Studies.
- Menasce, J. de. 1966 Textes pehlevis sur les Qanats. *Acta Orientalia* 30(Copenhagen): 167–175.
- Mostafaeipour, A. 2010. Historical background, productivity and technical issues of qanats. *Water History* 2(1): 61–80.

- Mouton, M. 1992. Archaeological survey of the region of Al Madam: A preliminary report. In *Archaeological Surveys and Excavations in the Sharjah Emirate, 1990 and 1992: A sixth Interim Report*, pp. 3–10. Lyon, France: CNRS-Université Lyon 2 (reprint: *Sharjah Archaeology* 6, 1997, Sharjah).
- Mouton, M., Schiettecatte, J. 2014. *In the desert margins: The settlement process in ancient South and East Arabia* (Arabia Antiqua 9). Rome, Italy: “L’Herma” di Breitschneider.
- Nasif, A.A. 1980. Qanats at al-’Ula. *Proceedings of the Seminar for Arabian Studies* 10: 75–79.
- Nasif, A.A. 1987. An Ancient Water System in Satārā, Al-Jawf, Saudi Arabia. *Proceedings of the Seminar for Arabian Studies* 17: 127–135.
- Parker, A., Davies, C., Wilkinson, T.J. 2006a. The early to mid-Holocene moist period in Arabia: Some recent evidence from lacustrine sequences in eastern and south-western Arabia. *Proceedings of the Seminar for Arabian Studies* 36: 243–255.
- Parker, A.G., Preston, G., Walkington, H., Hodson, M.J. 2006b. Developing a framework of Holocene climatic change and landscape archaeology for the lower Gulf region, southeastern Arabia. *Arabian Archaeology and Epigraphy* 17: 125–130.
- de Planhol, X. 1992. Les galeries drainantes souterraines: Quelques problèmes généraux. In *Les Eaux cachées—Études géographiques sur les galeries drainantes souterraines*, ed. D. Balland (Publications du Département de Géographie de l’Université de Paris Sorbonne, 19), pp. 129–142. Paris, France: PUPS.
- de Planhol, X. 2011. Entry: Kāriz, *Encyclopaedia Iranica* XV(6): 564–583. [http://www.iranicaonline.org/articles/kāriz\\_1](http://www.iranicaonline.org/articles/kāriz_1) (accessed January 20, 2016).
- Potts, D.T. 1990. *The Arabian Gulf in Antiquity*, I. *From Prehistory to the Fall of the Achaemenid Empire*. Oxford: Clarendon Press.
- Power, T., al-Jawari, N., Sheehan, P., Strutt, K. 2015. First preliminary report on the Buraimi Oasis Landscape Archaeology Project. *Proceedings of the Seminar for Arabian Studies* 45: 233–252.
- Roustaie, K. 2012. Archaeological survey of the Shahroud area, northeast Iran: A landscape approach. *Archäologische Mitteilungen aus Iran und Turan* 44: 191–219.
- Salesse, E. 2001. Du nouveau à propos des galeries de captage émergentes. Quelques réflexions sur les actes du séminaire du Collège de France de mars 2000. Pierre Briant (éd.), *Irrigation et drainage dans l’Antiquité. Qanāts et canalisations souterraines en Iran, en Égypte et en Grèce (Séminaire du Collège de France, mars 2000)*. *Topoi*, 11: 711–736.
- Salvini, M. 2001. Pas de qanats en Urartu!. In *Irrigation et drainage dans l’Antiquité, qanāts et canalisations souterraines en Iran, en Égypte et en Grèce*, ed. P. Briant (Persika 2), pp. 143–155. Paris, France: Thotm.
- Semsar Yazdi, A.A., Labbaf Khaneiki, M. 2012. Foreword. In *Qanat in its Cradle. Situation of Qanat (Kariz, Karez, Falaj) in the World*, eds. A.A. Semsar Yazdi, M. Labbaf Khaneiki, pp. 8–20. Tehran, Iran: ICQHS.
- Weisgerber, G. 1981. Mehr als Kupfer in Oman. *Der Anschnitt* 33: 174–263.
- Wilkinson J.C. 1977. *Water and Tribal settlement in South-East Arabia*. Oxford: Clarendon Press.
- Wilkinson, J.C. 1983. The Origins of the Aflāj of Oman. *Journal of Oman Studies* 6(1): 177–194.
- Wilson, A.I. 2008. Hydraulic Engineering and Water Supply. In *The Oxford Handbook of Engineering and Technology in the Classical World*, ed. J.P. Oleson, pp. 285–318. Oxford: Oxford University Press.
- Wilson, A., Mattingly, D.J. 2003. Irrigation technologies: Foggaras, wells and field systems. In *The Archaeology of Fazzān*, 1. *Synthesis*, (Society of Libyan Studies Monograph, 5), ed. D.J. Mattingly, pp. 235–278. Tripoli, Libya: Department of Antiquities of Libya and Society of Libyan Studies.
- Wuttman, M. 2001. Les qanāts de ‘Ayn Manāwīr (oasis de Kharga, Égypte). In *Irrigation et drainage dans l’Antiquité, qanāts et canalisations souterraines en Iran, en Égypte et en Grèce*, ed. P. Briant (Persika 2), pp. 109–136. Paris, France: Thotm.



# Taylor & Francis

Taylor & Francis Group

<http://taylorandfrancis.com>

# *Section V*

---

*Eurasia*





# Taylor & Francis

Taylor & Francis Group

<http://taylorandfrancis.com>

---

# 18 Ancient Aqueducts and the Irrigation System in Armenia

*Marine Nalbandyan*

## CONTENTS

18.1	Introduction .....	305
18.2	Overview of the Development of Irrigation in Armenia in the Late Bronze Age.....	306
18.3	The Water Distribution System of Armenia in Pre-Urartian Period.....	308
18.4	The Hydraulic System in the Urartian Period .....	310
18.5	The History of Water System Construction and Water Use in Medieval Armenia.....	316
18.6	Summary and Conclusions .....	320
	References.....	320

## 18.1 INTRODUCTION

Every civilization, be it modern or ancient, has exploited water resources, with the main purpose of satisfying the everyday water needs. Armenia, with its several-thousand-year-old history, has a special position in creating and exploiting numerous irrigation and water supply systems for controlling the use of its water reserves.

The comprehensive excavations of sites in Urartu revealed Urartian citadels of all shapes and sizes but with unique characteristic and defining architectural feature, constant from site to site. One of the key architectural features of the Urartian citadels is the presence of multifunctional water systems, complex canal systems, cisterns, and drainage pipes.

Another significant type of water collection constructions date back to Urartian times, which are preserved until today. Large cisterns and water canals along and under the walls were used to ensure water supply to population of citadels. In some cases, the big tunnels were dug in the rocks for reaching to fresh-water sources. Generally, the cisterns used in Urartu period are characterized by rocky steps that go up to the castle and multifunctional cisterns at the ground floor.

The major irrigation constructions in ancient Armenia were connected with the “cult of water,” represented by astonishing monuments—*vishaps* (dragons). These are fish-like stone monsters (3–5 m long), attributed to the god of water. At the beginning of the twentieth century, archeologists discovered a number of *vishaps* in different parts of present-day Armenia. It was revealed that *vishaps* are closely connected with ancient irrigation systems.

Mt. Aragats irrigation system is designed for gathering water from the perennial snow reserves of the mountains rather than rivers. The general structure follows the natural relief of the mountainside to be used as water-collecting spots, dams, and canals. The network was upgraded to enhance the relief features to serve as an efficient irrigation mechanism. Two types of lakes were found. Water-collecting lakes or the main reservoirs located at the high slopes of the mountain, close to the summit, to collect melting water and source the main canals. The second type of lakes was located at lower levels, around the main canals and artificial dikes. Two types of channels were also observed in the area. The main channels ran from the connecting smaller artificial lakes and flowed into larger lakes that served to irrigate the lower lands. The secondary channels ran from primary channels to feed irrigation lands or flow into the lakes. A number of hydrotechnical constructions were also

found in the system, such as a large structure of ground and boulders lifted up to re-direct the water flow from natural stream into the irrigation channel. The construction and maintenance of such a complex water system indicates about the existence of densely populated area that required a political and economic stability.

## 18.2 OVERVIEW OF THE DEVELOPMENT OF IRRIGATION IN ARMENIA IN THE LATE BRONZE AGE

In the material culture of the Armenian highlands, a special place occupies the latest phase of the primitive culture development, falling in the period from the end of the fourteenth century BC to the beginning of the millennium BC. At this particular time, there were marked significant changes in the dominating sectors of the economy: in agriculture, cattle breeding, and crafts (Piotrovsky 1949; Martirosyan 1964, 1969). The study of the Late Bronze Age contributes to the recreation of the approximate picture of the tribal organization and revelation of the deep roots of Urartu and early Armenian nations' culture.

In Western Armenia, from Kars to Karina and Ordu, the review period monuments are also identified, indicating the presence of single large cultural center throughout the Armenian highland in the pre-period of the Late Bronze Age and Early Iron Age.

For the above-mentioned study of Armenian agriculture, the works of Martirosyan (1960, 1964), Khachatryan (1963, 1971, 1975), and Yesayan (1976) are very important, in which the authors, considering the numerous sources, depict the picture of the material culture of Armenia in the Late Bronze Age and Early Iron Age. At the southern slopes of Mt. Aragats, traces of extensive network of channels of water reservoirs and the remains of ancient building structures were found.

Kalantar revealed eastern part of the ancient Aragatsotn irrigation network: for it, there was drawn a visual map of the area, with the geographical location identified in the wake of the ancient canal and reservoirs (Kalantar 1937).

The field investigations on the southern slopes of Mt. Aragats have shown that when laying irrigation canal used for the existing of gullies, lopi and Maar, located in the coincident directions, as well as natural deepening of the earth's surface, can serve as a repository of meltwater. The existence of the same type of constructed canals, reservoirs, and irrigation facilities in the territory, Aragatsotn testifies the developed construction techniques in mountainous, rugged areas and the high level of agricultural production in that area before Urartu.

Four peaks of Aragats surround a huge ice cirque of about 200 m depth. In the vertex region and in the upper valleys traces of ancient lakes, there are relict glaciers, whose capacity reaches up to 5 m. These favorable conditions for introduction of agriculture on the basis of meltwater were used by the aborigines, owing to the laying of rationally crafted network of canals and reservoirs (Karapetyan 1979).

Yesayan (1976), while studying the irrigation agriculture in the northeastern area of Armenia, revealed a peculiar form of irrigation. As the main rivers of this region—the Agstev, with its tributaries, Bedal, Agartsil, Voskepar, etc.—as well as the rivers Hakhum, Tavush, Khndzorut, etc., flow in the deepest channels and places, sometimes breaking out into the valleys become shallow; this fact is made impossible by artificial water pumping. Moreover, they are abounding in water only in April and May, when the average monthly runoff is increased about 20 times, in comparison with the monthly average runoff into the rest of the year. In these circumstances, irrigation is performed by constructing channels derivable of the slopes in the small areas, as a result of which was created a peculiar terracing of irrigation areas (Yesayan 1976).

From the irrigation facilities of Van Kingdom, the channel of King Menua has a special reputation, with the length of 80 km, which supplies water from powerful sources, located 5 km to the south from the district Khoshay to Tushpa, the Urartu. Great difficulties were faced by carrying the channel through the gorge. In these places, on the edge of the gorge, huge supporting walls

were built with cyclopean masonry, with 20 m height, in the upper part of which passed canal bed. Sometimes, the bed carved into the rocks, was waste, and the cyclopean walls served as a retaining wall for the prevention of the slope collapse from the fast-flowing waters of the canal. From the canal, throughout the whole duration of its flow, small canals were allocated; some of them are now set in the motion of the water mill (Karapetyan 1979).

Menua, and subsequently his son Argishti I, also paid a great attention to the southern and northern shores of the lake Van, owing to which they became rich owners of agricultural and horticultural areas in the central parts of Van Kingdom.

In this connection, an undoubted interest represents Akhtamar inscription of Menua, narrating the fact that this Urartian ruler has a large role in the irrigation system of the southern coast of the lake Van. The inscription of Menua from Berkley (10 km northeast from the lake) indicates the conducting canal (Belck 1899).

The number of investigations (Melikishvili 1951, 1960; Harutyunyan 1957) indicates a well-established powerful irrigation activities of Menua. The fact that areas in the upper reaches of Aratsani of the city Manazkert had favorable conditions for the development of agriculture and also proves the fact that before our times, the population here was intensively engaged in agriculture and herding.

Successor of King Menua, his son Argishti I, was more actively engaged in irrigation works. At the fifth year of the reign of Argishti I, the military-administrative center of Erebuni was founded, and after 6 years—administrative-economic center Argishtikhinili was founded. Parallel to the construction, Argishtikhinili's powerful works for the irrigation canals on the left bank middle course of the river Araks were being deployed. About the significance of these events proves the reflection in Khorkhorian chronicles. The king left an inscription about the construction of the canal and over his estuary on the left bank of the large river rock Araks, in the southwest of Argishtikhinili. No less significant is the inscription of Argishti I of Sardarapat village near Armavir, where it is said: "... I have led four channels from the river, have broken vineyards and orchards ..." (Urartian cuneiform inscription [UCI], 136, 137). Large construction activities in Argishtikhinili were folded by the son Argishti I, Sarduri II (Martirosyan 1969). There should be noted an important fragment of inscription by Sarduri II from the western fortress Argishtikhinili, which refers to the breakdown of the new vineyard, orchard, and fields, which indirectly indicate irrigation (Harutyunyan 1966). Subsequently, the tradition of canals construction was continued by Rusa I, who appeared the last king of Urartu, which was still on the top of its military and economic power, as evidenced by the inscription by Rusa in the areas Rusakhinili (Toprakkale and Ulhu, to north of the lake Urmia). In the eighth century BC, irrigation canals and an artificial lake were built (Harutyunyan 1964). "Louvre tablet" of the Assyrian king Sargon II contains valuable information regarding the irrigation activities of Rusa I, the son of Sarduri, in the areas lying to the north of lake Urmia (Diakonov 1951). Irrigation facilities built in the region Archesha by Argishti II, the son of Rusa, refer to the period of gradual decline of Urartu (northern coast, northeastern by lake Van) (UCI, 285). Two inscriptions found near the villages of Chelebi Bagi and villages of Hagi (the area of Archesha) prove the creation of artificial lakes and water use of the lake for irrigation (UCI, 275). A great interest attaches to the inscription of Argishti II from Hagi, containing information about the city Taktumnia, where Urartian governor created an artificial lake, perhaps, on the basis of water resources of the river Aliala. The reverse side of the inscription reports that the town and the fields were supplied with water through a channel carried by an artificial lake, for which the river Kaliaala serves as a source (UCI, 276). Another area of the country Aza, for whose irrigation needs, the subsequent Urartu rulers cared, was the area Teishebaini—Karmir-Bloor. Intensive works were conducted by Rusa II, the son of Argishti. The evidence of this inscription is Zvartnots temple (Golenishev 1901). Taking into account the specified inscription, as well as the remains of Urartian city-Teishebaini, and the channel from the opposite right bank of the river Hrazdan,

Piotrovsky expresses the idea that the stella of Zvartnots was initially installed on the plain against Karmir-Bloor, and the text of the inscription show the construction of Urartians in the region where this inscription was found (Piotrovsky 1959).

Considering the above-mentioned details, the huge value of irrigation projects for the development of different types of agro-economic cultures in the Armenian highlands in the era of Urartu becomes obvious. The characteristic feature of Urartu state, in addition to military policy, had been a concern about the economic situation of the country, expressed in rather intensive irrigation activities.

### 18.3 THE WATER DISTRIBUTION SYSTEM OF ARMENIA IN PRE-URARTIAN PERIOD

At the beginning of the 1930s of the twentieth century, Professor A. Kalantar, studying the primal irrigation system of historical Aragatsotn in details, restored the arrangement, directions, and process of the canals, streams, and reservoirs, as well as of the construction of other structures (Kalantar 1937). Because of him, this system was discovered, which in old times irrigated the lands of Aragat through melting waters of Aragats highlands.

Professor A. Kalantar has discovered that the ancient inhabitants of Aragatsotn, in order to use irrigated agriculture, built a special network of canals from the summit lands of Aragatsotn to the cultivated lands, according to which reservoirs were built in the natural concavities, aiming to save melting snow water (Kalantar 2003).

Up to now, the remnants of cyclic masonry blocking the lower edges of reservoirs have been survived. Such kind of reservoir, for example, is Lake Qari, which occupies 1 ha area and has a depth of about 8 m. Through special structures, the water from the lake flowed in two stream, one of which is directed toward the southeast, later joining Arkashen valley, and the other to the southwest. The remaining traces of the area proofs, that once the Qari Lake's water had been moved to a cascade of reservoirs, which are built on the irrigation network streams. There are mentioned traces of ancient artificial dam in the southern edge of the lake (Shirmazan 1962). Thus, an entire system of canals, natural and artificial lakes, and reservoirs was created, which was spread in the southern slopes of Aragats, Arkashen, and rivers between Ambert. Based on the detailed study of the water network, Professor A. Khalantar came to the conclusion that it is a pre-Urartian building.

In 1969, long-term studies brought us to Metsamor hill, about a kilometer to the southwest from the inhabitations of Upper Zeyva, the opposite side of the lake of Ayghr, in 35 km to the west from Yerevan. A. Andjur in 1936 for the first time found out a stone that reflected the network of canals in the ancient pictographic graphs. The stone surface is quite widespread, but graph is 6 m long and 3 m wide. The comparison of stone carving with the ancient surviving maps is the main base to consider that they really reflect hydraulic system. The existence of such irrigation system with purposed distribution of artificial reservoirs and channels indicates the high level of agricultural culture and architecture. The Gegharot and Kasakh rivers are considered the eastern borders of the scheme map, and the western carvings speak about the Mastara downpour tubes. In the east, the first of canals, originating from Gegharot, nourishes the current Aragats (Ghaznafar), Vardablur (Shiraghala), Artashavan, Ohanavan, Karbi, inhabitation fields of Mughni, and then continues to the south.

The part of Aragatsotn irrigation system canals, which in ancient times stored the melting snow waters in the upper stream, are nowadays also considered as water suppliers and are filled with drinking water only during spring floods (Armenian Physical Geography 1971). There are several canals in the saved ones fro pre-Urartian period that are currently purposed to supply drinking water (Figure 18.1).

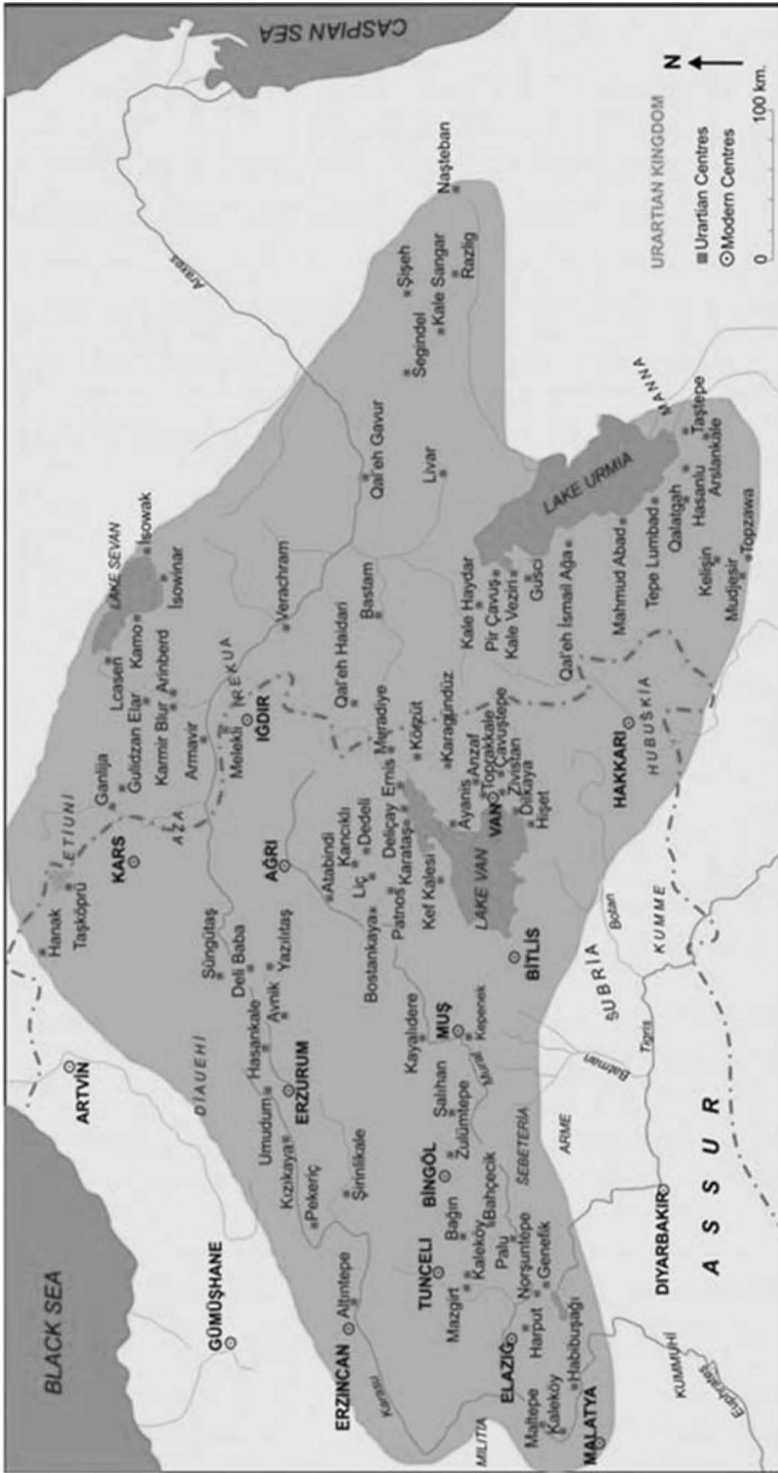


FIGURE 18.1 Scheme of Aragatsotn irrigation system in pre-Urartian period. (Courtesy of Professor A. Kalantar.)





**FIGURE 18.2** Scheme of stone carving. (Courtesy of Professor A. Kalantar.)

The following conclusions can be made according to the studies of ancient carved map of irrigation system found on the Zeyvayi hill and the territory covered by it:

1. The traces of ancient irrigation network discovered in Aragatsotn and still-existing water suppliers coincide with the stone carving, both by geographic distribution and the edges of reservoirs and by the number of building structures.
2. Long ago, before Urartian conquests, the irrigation system of Aragatsotn using melting snow waters had already stopped functioning. It is possible that Aragatsotn ancient irrigation was destroyed because of the invasions of nomadic tribes. The Urartian steles does not mention the canals, reservoirs, and structures of irrigation system, which were used on the basis of melting snow water supply. Urartians in the Ararat valley implemented the irrigated agriculture on the basis of another hydraulic network, on Echmiadzin, Shahari, and Sardarapat, which were fed by the melting snow water of Aragats, and also by the Hrazdan, Kasagh, and Araks rivers' water, and were permanent (Figure 18.2).

#### 18.4 THE HYDRAULIC SYSTEM IN THE URARTIAN PERIOD

Only little is known about the rise and fall of Urartu kingdom. The earliest appearance of the name Urartu is an Assyrian inscriptions around 1250 BC, indicating the geographical area between the lakes Van, Sevan, and Urmia, where today's frontiers of Turkey, Iran, and the USSR meet (Figure 18.1). Harassed by the Assyrian campaigns to the north, the Hurrian tribes living in the Armenian highlands amalgamated around 850 BC to form the kingdom of Urartu. Their first king was Arame, who gave his name to the Armenians, the successors of the Urartians. During the reigns of thirteen successive kings between 850 BC and 600 BC, during which they fought against the great power Assyria, Urartu rose to a leading position in the Near East but was declined and eventually fell in 595 BC, following an assault by the Scythians and Medes. The Urartian power reached at its peak during the period between 830 BC and 730 BC (Garbrecht 1988).

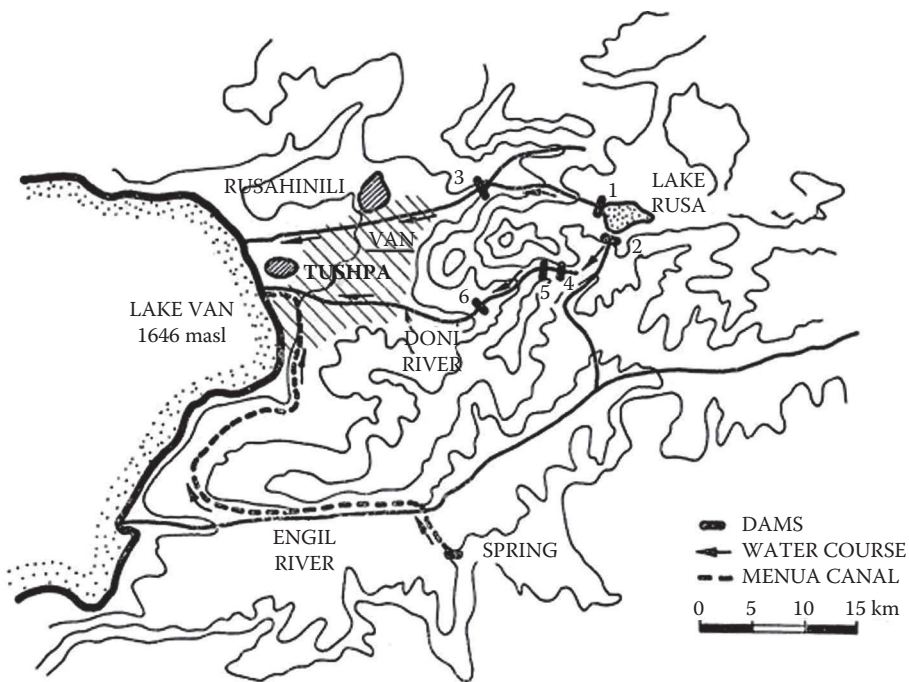
Before discussing the archaeological and textual evidence for the Urartian water management systems, first of all it is necessary to establish the physical characteristics of the region, as the rugged nature of the landscape inevitably placed limits on any settlement and agricultural activity that may have taken place there. In particular, understanding the ancient climate, rainfall patterns, and surface water hydrology of the region will be of most relevance to the subject of irrigation.

Pollen analyses from lake Van suggest that although there had been significant climate changes from 13,000 BC onward, from around 2000 BC, increasingly arid conditions led to a climate very similar to that of nowadays. The paleontological evidence from the second and first millennia BC suggests that there was also a fluctuation in the level of humidity at this time. After a short period of cold and humid climate, around 1000 BC, a warm and dry period followed, with a low peak of humidity around 850 BC. Therefore, although the climate in the region had fluctuated, both before the Urartian period and after it, the scientific evidence appears to suggest that the climatic conditions were very much similar to those that can be observed there today, and therefore, useful observations of the landscape can be made, which can inform our understanding of the physical environment in which the Urartian water management systems were developed.

If there is an aspect of life in the ancient Near East, which may be taken as a common factor between lands and cities so far removed in space and time such as Sumer, Urartu, Eridu, and Van, it is irrigation. This is a subject that needs more research, especially on the ground. There is also a link between Seton Lloyd's excavations at Eridu and in the Diyala region, his publication of Sennacherib's aqueduct, and his later interest in Urartu (Lloyd 1935).

Charles Burney mentioned (2011) that one can claim the first-hand knowledge only of the last, and without the first season's excavations at Beycesultan, he would scarcely have set out on his first archaeological survey in northern Anatolia (Burney 1956), followed by that in the Pontic region of Tokat and Amasya (Durbin 1971).

In Urartu, by good fortune, he was able to visit the newly undertaken excavations at the large site of Haftavan Tepe, the mound that dominates the Salmas plain at the northwest corner of Lake Reza'iyeh (Urmia). Although it is too early to see much of the results, he was able to make valuable suggestions concerning the building remains then coming to light. Since then, much more has been found, seven cultural periods being distinguished in the evidence from the first three seasons' excavations. Situated close to the Turkish frontier, Haftavan Tepe is no further from the Urartian capital at Van than Kayalidere (Burney 1970, 1972) (Figure 18.3).



**FIGURE 18.3** Water supply system of the ancient Urartian kingdom's capital, Tushpa.

Shortage of water can arise from growth in population or from decline in rainfall (or, more precisely, in annual precipitation, since in the highlands, the water supply depends so much on the melting snows). These are the stimuli to the digging of canals and reservoirs and the construction of dams and cisterns, the subject of much activity by successive Urartian kings. Among them, Menua (c. 810–786 BC) has left the greatest number of inscriptions; however, later kings of Urartu are also known to have been energetic irrigation engineers. There is perhaps a third factor encouraging such works, which may be termed political. A ruling dynasty could have no surer means of securing popularity than by the construction and maintenance of canals to bring water to the fields and gardens. It may not always have been a matter of life and death, but it could be the means of assuring an improved and reliable variety and quantity of food. When a city had first been founded or been rebuilt on a larger scale, with consequent increase in population, elaborate provision might be required to bring the necessary water supply from a considerable distance. No such problem was faced by the early Sumerian cities, where it was rather a matter of controlling floods from the Tigris or the Euphrates and of channeling water where it was a need from one or another of the two rivers. Traces of canals round Eridu could be more or less contemporary with the Ubaid levels, although the evidence seems inconclusive (Mallowan 1976). There was a period when Charles Burney was on the point of undertaking a survey of ancient canals in Iraq, a project planned in conjunction with a census of land, as suited, formerly suited, or unsuited for cultivation. External circumstances prevented this survey at that period. It would anyhow have been a hard task, owing to the difficulty of correlating traces of ancient canals with the evidence of pottery and other surface finds for the date of settlements along the canal banks (Adams 1965).

Concerning the work, it was subsequently (1957–1958) undertaken by the Diyala Basin Archaeological Project, in a restricted but nonetheless informative enclave of the Mesopotamian lowlands. This project showed how slow the changes in the patterns of settlement, total population, relationship of towns to villages, and character of irrigation can be traced by a correlation of archaeological evidence with the data and specialized expertise provided by geologists, soil scientists, botanists, and irrigation engineers; for the later periods, historians and Arabists had also to be consulted. The result has been the recognition of three main phases in the development of irrigation in the Diyala basin, the first being marked by numerous small channels, affecting little change in the natural environment, a phase ending with the decline of settled life to a nadir in the early first millennium BC. The second phase, beginning with a slow recovery in the Neo-Babylonian and Achaemenid periods, culminated in a highly sophisticated and centralized system of irrigation in the Sassanian period. Thereafter a steady decline came, which aggravated by the vulnerability of the Sassanian system to neglect and deliberate destruction (Konig 1955).

The Urartian inscriptions, bald as they generally are, include a significant proportion that records the digging of canals. Without locating traces on the ground, however, it is not easy to judge their scale.

The most famous of all Urartian canals was the one constructed by Menua to bring water from the Hogap valley to Van, which had not been the Urartian capital for more than 50 years; there are fourteen inscriptions and most of them are near the aqueducts, taking the canal across side valleys. Thus, the water was brought over 45 miles to Van (Inscriptions nos. 29a–e, 30a–i). Just in that place, the oldest surviving structure, the “Sardursburg,” at the foot of the west end of Van citadel rock, probably served to protect the local springs for the garrison’s water. Another district whose supply Menua improved was Ercis, on the northeast shore of Lake Van, where he dug a canal that ended in the River Dainali, probably the modern Zilan Dere, just to the west of Ercis (Inscription no. 33). He also seems to have irrigated the small but fertile plain at the northeast extremity of Lake Van, the district commanded by the fortress of Kurzut (Inscription no. 32).

One of the most interesting sites relating to the development of Urartian water facilities is Lake Aygir in the northwest of Van. Here, terracotta water pipes and stone channels were laid down in order to carry water out from the artificial lake. The excavator of Anzavurtepe, Kemal Balkan, has also made a mention of similar terracotta pipes and proposed that they were used to collect water for the citadel from the Kumocagi stream that runs some 2 km to the east of the site. A recently

discovered water reservoir to the east of Ayanis Fortress, 2002 m above the sea level, is also considered to have supplied water to the lower town and citadel of Ayanis by means of a system of stone pipes.

Since irrigating the arable lands around Lake Van (i.e., the Van, Muradiye, and Gürpınar plains) from the region's natural water body was not feasible, it was evidently necessary for Urartian kings from the reign of Minua onward to construct artificial reservoirs in order to irrigate the fertile soils of these areas. These kings then recorded their construction works by means of inscriptions that commemorated their great feats of construction (see Section 18.4). Examples of these artificial reservoirs include the Upper Anzaf dam built by King Minua to the east of Upper and Lower Anzaf Kale. This dam was fed by rain and spring meltwater from the nearby mountains and was evidently intended to supply water for the lands around the citadel (Cifci and Greaves 2013).

Four inscriptions record the construction of canals in the vicinity of Malazgirt (Manzikert), where there are large springs giving easily available sources for the irrigation of the open land of the upper Murat valley (Inscriptions nos. 34, 35, 36, 38).

Very probably, the traces of a small canal west of Bulanik, observed during the above-mentioned survey in 1964, may also be attributed to Menua. Storage of water by cisterns is also recorded in this reign (Inscription no. 39).

Using such type of water storage (cisterns) the planting of vineyards were irrigated, for instance, for one of the daughter of Manua King, Terraria (Inscription no. 40). Thus, there is a sample proving that despite the military preoccupations to east, west, and north, Menua found time to promote the economic strength of his expanding realm.

One of Minua's greatest engineering achievements was the construction of the Minua Canal (mMi-nu-a-i pi-li-e), which runs about 51 km from the Mount Baet area of the Artos Mountains to the city of Van. The water that feeds the canal begins as a spring in the village of Yukarı Kaymaz, which then forms a stream that runs to the Hogap (Engil) Çayı, and from there, it is then transported by an aqueduct over the Hogap into a canal that averages between 3.5 m and 4 m wide and is 1.5–2 m deep. The average flow of water is estimated to be between 3 m<sup>3</sup>/s and 3.5 m<sup>3</sup>/s. A managed water flow on this scale was greater even than that of the largest aqueducts in the city of Rome at the peak of its population in the first century AD. For the most part, the canal was carved into solid bedrock, and in areas of steep valleys and slopes at points, its walls can measure up to 11 m high.

The Minua Canal helped ensure the successful development of agriculture, horticulture, and viticulture in the central areas of the Urartian Kingdom and, remarkably, it is still in use today, approximately 2800 years after its construction.

An inscription found on Aktamar Island near the southern shore of Lake Van, which was clearly not *in situ*, states that Minua constructed canals in the territory of Aĭunikani, in Minuaĭinili, in Aiduni, and in the land of Uisini (Uishini) (Figure 18.4).

The city mentioned by the Assyrian king Sargon II in his eighth campaign was named as Uajais and it also appears in numerous Assyrian letters as the variants Uesi and Uasi. The city was evidently associated with the Urartian army, and Uajais was mentioned as a *nagu* (province) of Urartu by Sargon II. A damaged inscription of Minua from Qalatgah also mentions a city called Uise in an unknown context (CTU A 3–10 line 5). However, the great distance that lies between the find spot of the Akdamar inscription and the site of Qalatgah in northwestern Iran and the different written forms of Uisin, Uajais, or Uise cast some doubt on the idea that these names should be identified with a single city. It is therefore possible that there were actually two different cities, one named Uisini and the other known as Uajais or Uise. Therefore, one might accept a location for the latter in Qalatgah in the Ushnu Plain, and for the former, a location either on the eastern or on the southeastern shore of Lake Van basin in the vicinity of Geva has been suggested. However, it is also known that Urartian kings spoke about their various constructive works in the same context as in the case of Akdamar inscription, where Minua also mentions canals that he built in different locations such as Aĭunikani, Minuaĭinili, and Aiduni.



**FIGURE 18.4** Menua channel today (constructed in 805–785 BC).

Therefore, it is still possible that the city of Uajais/Uise or Uisini is located in northwest Iran at Qalatgah (Cifci and Greaves 2013).

Argishti I recorded his construction of four canals to bring water to an arid stretch of the Araxes valley, where he had founded two fortresses at Argishtihinili (Armavir-Blur). Vineyards and orchards were planted on land previously desert (Inscriptions nos. 90, 91). Sarduri II continued this dynastic tradition by planting a vineyard near Ercis, perhaps on the site of the one to be seen there today (Burney 1972).

In the following reign, Rusa I's achievements are recorded not in his own inscriptions but in Sargon II's well-known account of the fertility brought to the district of Ulhu by Rusa's canal, where the wealth of the neighborhood was gathered into the store city, or state magazines, of Ulhu, principally in the form of grain and wine. Although Rusa I had a residence there, it was evidently not a military stronghold. This function was reserved for a fortress called Sardurihurda.

On Mount Kishter, clearly sited to command the plain, Sargon II's account could support an identification of Ulhu with Haftavan Tepe. The Urartian building on the summit of the mound (Haftavn III) and the forts built on nearby hilltops indicate the importance of the Salmas plain in the eighth century BC, if perhaps less so, later in the Urartian period (Kleiss 1969b). Although the historical geography of Sargon II's eighth campaign might possibly be more easily reconstructable, if Ulhu was located in the Marand valley, the natural route for the Assyrian advance to Lake Van would have been via the Kotur valley, the route taken by the recently completed railway. This would mean that the Assyrian army must have passed very close indeed to the Salmas plain, making it improbable to escape unscathed. Indeed, the luridly detailed account of destruction by Sargon's troops seems to be reflected in the abandonment of the citadel and very probably the whole site of Haftavan Tepe throughout the seventh century BC and perhaps longer. The main center of Urartian power in the northwest of the Urmia region might subsequently, under Rusa II, have been moved north of Khoi, to the fortress of Bastam (Konig 1976).

Rusa II (c. 685–645 BC) seems to have been the founder of Rusahinili, the citadel of Toprakkale, as the center of his improvements to the capital of Van. To supply water to this citadel, he created the artificial lake, named "Lake of Rusa," with a canal to the new city, which also irrigated the vineyards, trees, and barley fields planted at the foot of Toprakkale (Inscription no. 126).

The two dams on Lake Rusa have not yet been examined or surveyed in more detail. From the elevation of the wing wall, however, it can be concluded that the crest of the dam 1 had an elevation





**FIGURE 18.5** Bottom sluice of Rusa Dam today (constructed 700 BC).

at least 10 m above the present level of the lake. This explains the necessity for the dam 2 to the south, which is located 7–8 m above the present level of the lake. More exact information about the dimension and elevation of the two dams can be obtained only from excavations and surveys. It can be estimated that the storage capacity of about 20 million m<sup>3</sup> available today must have been of the order of 100 million m<sup>3</sup> in Urartian times (Figure 18.5).

After the collapse of the large dam 1 on the northwestern lake outlet, a smaller one seems to have been built about 50 m upstream to replace it. As this substitute dam was last flooded and destroyed in 1891, after the winter with heavy snowfalls and rainy spring, probably the smaller replacing structure at the outlet was destroyed several times between 700 BC and 1891 and was every time rebuilt because of its importance for the water supply to the plain Tuspa-Rusahinili. The now-existing dam, 5.40 m in height, was constructed in 1952.

Approximately halfway between the lake and the king's residence at Rusahinili, there is another dam 3 (today called Faruk Bendi), whose design and construction technique suggest that it is not of Urartian but of late Roman origin. As there was hardly any need for this dam 3 and its storage capacity as long as the original large dam existed at the outlet of the lake, it is reasonable to assume that the Urartian dam 1 was not destroyed until late Roman times. After its destruction, the Faruk Bendi was thus intended to compensate for the storage lost in the lake (Garbrecht 1988).

One of the important type of water collection constructions date back to Urartian times, which are preserved until today, are the cisterns, which were usually built near settlements and castles.

At Toprakkale, a large cistern, fed by a small channel through a porthole entrance, was cut out of the solid rock. Similar plantations—vineyards, trees, orchards, and barley—were made possible, according to another inscription of Rusa II, by a canal constructed from the River Ildarunia by him, probably the modern Hrazdan (Lynch 1901). He may also have made the artificial outlet from Lake Sevan, which took advantage of the periodic rise in the level of the lake to augment the water drawn from the river. These irrigation works must surely be associated with the reorganization of the provincial administration implied by the foundation of Teishebaina (Karmir-Bloor) and the abandonment of Erebuni (Arin Berd). Comparable projects were probably carried out in other areas where the economic and political revival of Urartu in this reign is evident.



Cistern systems at Van castle and Tushpa city were built under different plans based on location conditions and functions. For example, vertically connected cistern system under the ground level of the Van castle and Tushpa city played very important function of water requirement, security, and communication, especially during the times when the city and castle were beleaguered by the enemy. Another type—the closed circular planned cistern system—was built within the Van castle by cutting the rocky ground and paving the way to door frames, cellars, etc. (Orhan et al. 2006).

The above record of irrigation works is attributable to Urartian kings in the period c. 810–645 BC, but it does not prove the factor that was the foremost in stimulating this activity, growth in population, decline in rainfall, or the political ambitions of successive Urartian kings. The evidence from different regions of Urartu seems conflicting, and knowledge at present is insufficient to allow any definitive conclusions.

The number of Urartian sites in the homeland around Lake Van is so great compared with the meager traces of occupation attributable to the second millennium BC that the population certainly must have increased in the years following the establishment of Van as the capital of the kingdom by Sarduri I (c. 840–830 BC). The construction of the Menua canal would have led to a population of 50,000 in Van itself, the city, and its garden suburbs, per a conservative estimate. Since the population in the nineteenth century AD exceeded that figure, there is no need to suggest a smaller population in the Urartian capital (Dyson 1969).

This might have reached its highest level under Rusa II, with the new areas brought under cultivation. Political security alone, however, might be thought an insufficient cause for a rapid rise in the settled population. A deterioration in the climate, with the advent of drier conditions, would have made irrigation canals and cisterns not merely political propaganda but also a matter of survival.

Patterns of settlement varied in different parts of Urartu. In the Mus plain, which is at present largely dependent on irrigation, there are some 25 prehistoric mounds, a few showing traces of Urartian occupation. An apparently obvious center thus seems to have been only thinly populated. Elsewhere, as in the frontier area of the Ushnu valley, the Urartian fortress of Kalatgar was built on a high spur, commanding the fertile plain, the destruction of whose settlements suggests punitive measures to discourage alliance with Assyria in this crucial region southwest of Lake Urmia. The excavations at Hasanlu strongly suggest a decline in population after the burning of the citadel by Menua (c. 800 BC) (Dyson 1969).

Haftavan Tepe seems to have reached its maximum population either just before the incorporation of the area into Urartu or, less probably, during the eighth century BC. Irrigation works around Ulhu, therefore, must have been intended to serve a large existing community rather than to attract incomers. Terracing, visible in the area of Tariria's vineyard beside her father Menua's canal leading to Van, could indicate pressure of population on available land, but alternatively, it could simply illustrate the extension of wine growing under royal patronage.

According to the works which presented of the Urartian irrigation systems and some comparative evidence, we can conclude that the irrigation system in Assyria can have some similarity to Urartian. It hardly needs to be said that the natural environment in Urartu is very different from that in Assyria or elsewhere in Mesopotamia. The long winters and relatively brief summers make the necessity for these elaborate provisions for water supply far from obvious, given the conditions of today. However, it would require only a modest deterioration in winter snowfall or in the rains of spring and autumn, or alternatively or additionally much hotter summers, to necessitate a careful conservation of freshwater and its canalization to large towns, sometimes from a great distance.

## 18.5 THE HISTORY OF WATER SYSTEM CONSTRUCTION AND WATER USE IN MEDIEVAL ARMENIA

The first exact information about the water systems construction of the Armenian sources relates to Zvartnots. The catholicos Nerses, the builder (641–661) during the construction of Zvartnots, also built a canal and supplied water to the newly built residence. In 783, it is said that Ukhtatur monk and

his brother Totlike brought drinking irrigation water for Talin town from Sarkapanu (Kostanyants 1913b). It was noticed correctly that “this could be both drinking and irrigation water that was reflected in the mention about the threat being taken away by the rulers” (Arakelyan 1958). In 867, there was a bloody fight between the villages Aruh and Kosh of the Aradatsotn province for the irrigation water. By the order of the Armenian commander Smbat, Vram’s son, named Gregory, came here, who called himself the slave of Smbat, equalizing the water between the above-mentioned villages and left a protocol on the wall of the Aruch monastery. Finally, he cursed and threatened those who broke the contract (Kostanyants 1913a). In 985, the Hayataghi ditch was built in Byurakan (Kostanyants 1913c).

After the victory against the Arab conquerors, favorable conditions were created for the reconstruction and further development of the economic and political life in the period of newly established kingdom of Bagratuni.

The Bagratuni kings had also realized huge activities of water system construction.

In 903, for Vanevan church, Smbat I (891–914) built a canal, which began from the village Unjork, located in the mountains of the monastery, and cutting off enough distance, reached Voskebak village, near the monastery (Barkhudaryan 1973).

Ashot III (953–977) built the conduit of the capital Ani, which begins from the foot of Alaja mountain, and Smbat II (977–990) built a big canal, whose water was used to fill the moats of northern side of Ani to irrigate orchards and operate mills. In 1031, under the reign of John Bagratuni king Hovhannes Smbat, Mr. Apirat prince renovated the canal built by Urartian, which was probably destroyed.

Water system construction activities were also led in Vaspurakan by Artsruni kings. Among them, Gagik Artsruni constructed his castles surrounds by parks. By his orders, artificial canals were constructed.

Tatev canal was one of the large and complex structures in water system of medieval Armenia. For adopting about 200 ha of uncultivated land in Tsakut village in the eastern side of Tatev monastery, on the left bank of Vorotan, water was needed. Using the water of Vorotan was impossible, because in the following area, the river entered the Harjik (Yayj) deep gorge, under the depth of 650, and around Halidzor about 800 m (Boramyan 1942).

According to the data given by Gregory Shirmazan, while taking the canal, there was 200 L of water per second, but in the thirteenth century, it was significantly destroyed and this reduced its water release. In 1294, the abbot of Tatev monastery completely renovated the canal (Divan 1960; Shirmazan 1960). After the renovation, the canal was in use till 1386, when the hordes of Tamerlane captured it in Syunik and destroyed it.

Water system construction activities have been done in Vayots Dzor.

It is known that according to the request of Sofia princess, the wife of Syunik prince Smbat, in 936, Gnde monastery was built, after which the population intended to build canal to irrigate the monastery lands and provide Gndevaz’s villagers with water. Although the Arpa river passed toward the village and the monastery, it was impossible to use it, because in that area the river ran over 400 m deep gorge. The total length of the canal is 24 km. From the ninth kilometer, the canal turns to the Arpa river basin, which is separated from the Dzknarats river by Zangezour mountain chain. Taking into account the scarcity and the canal’s length, two reservoirs were built on the appropriate places on it, to store water at nights (Shirmazan 1960). The canal was destroyed during the invasion of the Persian shah Abbas (Lalayan 1906b). Further, the canal was renovated again and operates until now.

Water system construction activities were also realized in the Gegharkunik province, the administrative center of which was Noratus. In 839, for irrigating the lands belonging to the church and making them more profitable, in 842, during the reign of Amir Vasak, a canal was constructed, which began from Gavaraget, situated on the eastern part of Geghama slopes (Lalayan 1906).

The remarkable rise of the Armenian economic life was interrupted in the second half of the eleventh century, when the country was attacked by the invasion of Seljuk Turks. During the

continuous invasions and wars, the emigration of Armenians to the other countries began. It led to the degradation of the agriculture. The canals and irrigation networks were destroyed. However, under the reign of Zakaryans, the feudal land relations, destroyed towns were being recovered. During the Bagratunyats kingdom period, the degraded agricultural structure was being restored; new canals and reservoirs were being built; and the horticulture, cotton, and rice cultivation were being developed (Virabyan 1975).

Talin is located in the western part of historical Aragatsotn. It is one of the oldest settlements in Armenia, about which the Armenian historians have records (Thovma 1985). In the early medieval town, Talin belonged to the Kamsarian ministers (Shirakatsi 1979; Toramanyan 1984).

The existence of Talin medieval water supply systems in the town is of great interest. Talin, being located in the southwestern slopes of Mt. Aragats, has a hilly and heavily rugged surface rich in stones. It is deprived from the natural water surfaces and rivers. Perhaps in the medieval Talin, a continental climate poor of rainfalls was prevalent, which was unfavorable for the development of agriculture. This fact proves the existence of ancient irrigation systems, whose tracks are still visible in many places.

However, still for millennia, for getting high and sustainable crop in the Armenian highlands, particularly in the Aragats highlands, the large volume of work had been done for storing and further using water stores gathered by sources, melting, and other precipitations. For this aim, an artificial reservoir was built and a number of ditches were removed. The artificial irrigation system constructions continued in the middle ages as well. Talin is also famous for its artificial structures. The ruins of the artificial reservoir included in Talin irrigation system are located in the deep gorge, about 1 km north of the village. The reservoir was built for storing and further using the flood water. The stronghold of the reservoir is about 80 m long, from which only 65 m currently remains. The dam stretches from the right to the left side of the gorge and continues to the right side of the hill slope. The size of the dam shortens on the hill slope and becomes equal to the area relief. The selected natural soil for the dam construction was firm and was composed of deep andesite-basalt precipitate, which reached to the surface.

The walls are built of technique midis layout and the height reaches 2 m. The internal and external faces of the dam walls are covered by the tufa big stones. Layout stones are well designed and have a  $70 \times 30$  cm<sup>2</sup> size, while more large blocks were used for the under rows than for the upper ones.

In the central part of the dam, the wall was curved directed to the mirror, which was intended to relieve water pressure. Opposite to it, the lower part of the right side of the dam was thinly attached, because the Blbul slope served as a natural reservoir for the dam. The stream rows gathered in the concavity, behind the dam, and captured a large area. Interestingly, for the water system construction for the reservoir area, a large amount of alumina has been moved. The amount of this alumina was taken, and thus, actually, the reservoir floor was deeper. The existence of alumina in the lateral incision and floor proves that the builders choose a waterproof layer for building the reservoir. Thus, judging the relationship between the dam and the reservoir area, the mirror of the artificial dam was too big. According to preliminary estimates, the reservoir had 58,000–60,000 m<sup>3</sup> of water draft (Asatryan 1989).

The reservoir water was used for irrigation of land in the surrounding areas of Talin. The system of water release of reservoir was on the left side of the dam, to the direction of the valley's natural channel. However, it is difficult to say of what kind was the water release system. This sector is completely destroyed. After releasing the irrigation water from the reservoir, it came out to the northern part of the inhabitation by the valley channel. By the bottom edges, artificial streams were dug for the irrigation of land situated in the west of Talin. The traces of above-mentioned streams are still maintained. This fact is also confirmed by the Talin relief. Releasing the water from the reservoir, it could flow only to western part of the settlements, where lands occupying 100 ha were situated, still being considered the best lands. By the water collected in the reservoir, it was possible to irrigate 100 ha of land twice a year, which is quite enough for obtaining high grain yield (Asatryan 1989).

On the other hand, the reservoir area has served as water regulation system, for defending the Talin churches and surrounding environment from floods caused by the natural disasters. As for the period of reservoir construction, it should be noted that the techniques and stones used for the dam construction are typical to the wall layout of early medieval ecclesiastical and civil buildings. Taking into account the fact that the construction of such large organizations has implemented powerful kings or ministers, it is possible that it was built by Kamsarians, not excluding the fact that the builders could be Bagratunys. By the use of reservoir, a huge income was stored.

In addition to the expansion of irrigation facilities, medieval Talin had separate drinking water supplier. In the northern part of Talin, not far from churches, the pipeline with six aqueducts was found. The pipe was pulled from the north-south axis. Such placement of the pipeline clearly demonstrates the water brought from the springs of Talin sources.

The Dashtadem (Internal Talin) castle water supplement system also has an interesting structure. The foundation of this castle relates to the foundation of Talin and refers to Kamsarian ministers. A huge underground basin carved into a huge mass of tuff is situated between the castle and the palace church. It has dimensions  $4 \times 3 \times 8 \text{ m}^3$  and  $100 \text{ m}^3$  displacement. The basin from the top is covered with three huge tuff slabs. There is a round, small hole on the surface of one slab, similar to the mouth of well, which is closed by the tufa lid. The slabs of basin were filled with soil and equalized to the ground surface. The inner walls of the basin were plastered with waterproof mortar. On the south wall of the underground basin, 1 m down from the ceiling, the edge of irrigation clay pipe feeding the basin was seen (Asatryan 1989).

Although the water supply with pipelines in Armenian highlands existed for a long time, it reached to the peak in the ancient and medieval periods. Excavations studied discovered the water supply systems of Artashat, Garni Ani, and Amberd. The above-mentioned settlements about the existence of water supply systems in Talin indicate the highly developed and widespread communal economy in the medieval Armenia.

The neighboring villages with the common means constructed canals; they define a stable sequence for the irrigation in their fields in the medieval Armenia. The inscription carved on the cross-stone erected in 1235 near the village Artsvanist, Martuni region, is the evidence of the fact, that according to which the villages of Artsvanist, whose ruins remain until now, were transferred to the Aluchalu canal. The ruins of the canal can be found today. The cross-stone is a boundary monument between the villages erected on the top of Vanevan monastery, on which a procedure or decision about the water use is written (Barkhudaryan 1964).

The canal construction was encouraged both in Eastern Armenia and in Iran. Here, the Mavat right is under use, according to which the new, unusable land obtained by the irrigation became the misappropriator's property. The Mavat right was especially given to the monasteries and the privileged class. The sardars were indifferent to the water system construction activities in the khanates of Yerevan and Nakhijevan, and very often, they organized and managed these khanates. The entire burden of water system construction was operated by the peasant masses.

There were officials, juvars, and mirabs who controlled the irrigation canals in the Armenian shops, who were rewarded by the rural communities. Mirabe was the supreme director of the irrigation system of the given mahal, who was assigned by the sardar for a year. His poor performance was causing great damage to the population and Khanian treasury, as the taxes were taken from the population according to the land fertility. Juvars' responsibilities included the maintenance of irrigation water in all parts of the canal, controlling the water use sequence between the villages. Usually each dyooz had his jolvar and any main stream was under the control of dyooz. The unit of water quantity was bah (one bah was equal to around 30 L/s of water) in medieval Armenia. The quantity of irrigation water was also summed by days, "sections, chapters," and so on.

Water system construction activities in Feudal Armenia were realized by the country's monasteries, rulers, communities, and individuals. The irrigation water use laws had great significance for the development of Armenian agriculture and were changed under the transformation of social relations.

## 18.6 SUMMARY AND CONCLUSIONS

Water was significant part of life of ancient societies inhabiting Armenia. It was a life source and cornerstone of civilization emergency and development in ancient times. Development of agriculture and early urbanization was conditioned by increasing sophistication in irrigation techniques and water supply networks. The ancients in Armenia achieved incredible advancement in their waterworks, which were comparable with those in ancient Egypt and Mesopotamia. Having in mind the technological limitations of that period, hydraulic systems in ancient Armenia can be parallelized with some of grandiose modern technical achievements. In addition, having borne the test of time, a number of these technologies set the norm for subsequent centuries and have been used for thousands of years, with some of them, such as Menua Cannel, Shamiram Canal, and Rusa Dams, still in service in the third millennium AD.

There were some rules in the medieval Armenia that were correctly carried out by the population. From the time immemorial, separate rules and customs were created. These rules and regulations were so deeply rooted in the minds of the people that neither the arbitrariness of administrative changes nor government officials were not able to eradicate the ancient customs of the people who survived until the beginning of the twentieth century.

## REFERENCES

- Adams R. 1965. *Land Behind Baghdad*, Chicago, IL, University of Chicago Press.
- Arakelyan B. 1958. Cities and Crafts in Armenia IX–XIII cc., Vol. 1, Yerevan, Armenia, p. 441.
- Armenian Physical Geography. 1971. Yerevan, Armenia, p. 402
- Asatryan E. A. 1989. Water supply medieval systems of Talin. *Journal of Social Sciences*, 4, 83–88.
- Barkhudaryan S. 1964. *Remarks and New Material on the Irrigation System of Old Armenia* (Materials on Armenia's agricultural history and the peasantry), Vol. I, Yerevan, Armenia, pp. 267–268.
- Barkhudaryan V. 1973. *Divan of Lithography*, Issue IV, Yerevan, Armenia, p. 122.
- Belck W. 1899. Bewässerung der Ebene von Bergri und der Bendimahi-Tshai. *ZE*, 31, 244–248.
- Boramyanyan B. 1942. *Materials on the History of Armenian Architecture*, Yerevan, Armenia, p. 334.
- Burney C. 1956. Northern Anatolia before classical times. *AS*, VI, 179–203.
- Burney C. 2011. Urartian Irrigation Works. *Anatolian Studies*, Vol. 22, Special Number in Honour of the Seventieth Birthday of Professor Seton Lloyd (1972). British Institute at Ankara, London, UK, pp. 179–186.
- Burney C. A. 1970. Excavations at Haftavan Tepe 1968: First Preliminary Report. *Iran* VIII, pp. 157–171.
- Burney C. A. 1972. Excavations at Haftavn Tepe, 1969: Second Preliminary Report. *Iran* X, pp. 127–142, 169–170 (1971season), 137–42.
- Cifci A., Greaves M. A. 2013. Urartian irrigation systems: A critical review. *ANES*, 50, 191–214.
- Diakonov I. M. 1951. Reaping songs, *BAH*, 2, 336, (n. 51).
- Divan S. 1960. Yerevan, Armenia, p. 78.
- Durbin Gail E. S. 1971. Iron age pottery from the provinces of Tokat and Sivas, *AS*, XXI, 99–124.
- Dyson R. H. 1969a. Expedition 11, 2, 44.
- Dyson R. H. 1969b. Expedition 11, inscription no. 109.
- Garbrecht G. 1988. Water management for Irrigation in Antiquity (Urartu 850 to 600 B.C.). *Irrigation and Drainage Systems* 2, 185–198 (Kluwer Academic Publishers, Dordrecht, the Netherlands).
- Golenishev V. S. 1901. VIII, pub. N. 4, pp. 686–692. UCI; 281.
- Harutyunyan N. V. 1957. Dainala Tina (from the history of irrigation in Urartu)—“Izvestia.” *Academy of Sciences of the Armenian SSR (Public Science)*, 4, 97–106.
- Harutyunyan N. V. 1964. *Agriculture and Animal Husbandry of Urartu*, Yerevan, Armenia, p. 24–25.
- Harutyunyan N. V. 1966. New Urartian inscription Davti-Bloor—BAH C. 3, p. 104.
- Inscriptions nos. 1960. 29a–e, 30a–i.
- Inscription no. 33.
- Inscription no. 32.
- Inscriptions nos. 34, 35, 36, 38.
- Inscription no. 39.
- Inscription no. 40.

Inscriptions nos. 90, 91.

- Kalantar A. 1937. An ancient water distribution system in Soviet Armenia. Newsletter of Soviet History and Literature Institute, II book, Yerevan, Armenia, pp. 171–194.
- Kalantar A. 2003. *Materials on Armenian and Urartian History*, ed. Kalantaryan, A. National Academy of Sciences of Armenia, Institute of Archaeology and Ethnography, Scientific Heritage, Volume 2, Recherches et Publications, Neuchatel, Switzerland.
- Karapetyan L. 1979. Irrigation in Agriculture of Armenia in the late Bronze Age. *Historical Philological Journal*, 1, 59–74.
- Khachatryan M. M. 1971. The carved graph of Aragatsotn irrigation system in pre-Urartian period. *Historical Philological Journal*, 3, 127–137.
- Khachatryan T. S. 1963. *The Material Culture of the Ancient Artic*, Yerevan, Armenia.
- Khachatryan T. S. 1975. *The Ancient Culture of Shirak*, Yerevan, Armenia.
- Kleiss W. 1969a. Bericht uber zwe iErkundungs fahrten in Nordwest-Iran (Archaeologische Mitteilungen aus Iran, Band 2, pp. 20–26.
- Kleiss W. 1969b. Short reports on Bastam, Iran VII, p. 188; VIII, 1970, pp. 176–80.
- Konig F. W. 1955. Handbuch der chaldischen Inschriften (Archiv fiir Orientforschung, Beiheft 8).
- Konig F. W. 1976a. Handbuch, inscription no. 121.
- Konig F. W. 1976b. Handbuch, inscription no. 126.
- Kostanyants K. 1913a. *Lapidary Calendar*, St. Petersburg, p. 3.
- Kostanyants K. 1913b. *Lapidary Calendar*, St. Petersburg, p. 20.
- Kostanyants K. 1913c. *Lapidary Calendar*, St. Petersburg, p. 9.
- Lalayan E. 1906a. Vayots Dzor. *Folk Journal*, Book 13, Tbilisi, 9.
- Lalayan E. 1906b. New Bayazet province or Gegharkunik, *Ethnographic Magazine*, Book 13.
- Lloyd S. 1935. *Sennacherib's Aqueduct at Jerwan (OIP.24)*, University of Chicago Press, Chicago.
- Lynch H. F. B. 1901. Armenia: Vol. II—The Turkish Provinces (London, reprinted Beirut, 1965), pp. 76–115.
- Mallowan M. E. L. 1976. The Development of Cities from Al-'Ubaid to the End of Uruk 5, Part I (CAHI, fascicle 58, p. 8).
- Martirosyan A. A. 1960. Argishtikhinili, pp. 25–27.
- Martirosyan A. A. 1964. *Armenia in the Bronze Age and Early Iron Age*, Yerevan, Armenia, pp. 81–83.
- Martirosyan A. A. 1969. The burials settlement of the Late Bronze Age (Archaeological monuments in Armenia, pub. N. 2), Yerevan, Armenia.
- Melikishvili G. A. 1951. Urartian notes—BAH, N. 3.
- Melikishvili G. A. 1960. Urartian cuneiform inscription (UCI), Moscow, 59, pp. 1–7.
- Orhan A. et al. 2006. Urartian water constructions and hydraulics. *Journal of Applied Science Research* 2(6), 346–354. Available at <http://www.insipub.com/jasr/2006/346-354.pdf>.
- Piotrovsky B.B. 1949. Archaeology of Transcaucasus, L., pp. 51–59.
- Piotrovsky B. B. 1959. History and Culture of Urartu, pp. 132–133.
- Shirakatsi A. 1979. *Twentieth Problem*, Yerevan, Armenia, p. 58.
- Shirmazan D. 1960. Episodes from Armenian irrigation story, p. 148, 158.
- Shirmazan D. 1962. *Episodes from Armenian Irrigation Story*, Yerevan, Armenia, 50p.
- Thovma A. 1985. *Artsruni House History*, Yerevan, Armenia, page 77.
- Toramanyan T. 1984. *Material on the History of Armenian Architecture*, Yerevan, Armenia, p. 164
- Urartian cuneiform inscription (UCI). 1960. no. 136, table I; no. 137, table II; no. 285; no. 275; no. 276.
- Virabyan S. A. 1975. About the history of water system construction and water supply system in Medieval Armenia. *Historical Philological Journal* 1, 145–157.
- Yesayan S. A. 1976. *The Ancient Culture of the Tribes in the North-East of Armenia*, Yerevan, Armenia.





# Taylor & Francis

Taylor & Francis Group

<http://taylorandfrancis.com>

---

# 19 Evolution of the Qanāt (Kahriz) Systems in the Arid Countries of the Caucasus and Central Asia

*Alovsat Guliyev*

## CONTENTS

19.1	Introduction.....	323
19.2	Kahrizes in Central Asia.....	324
19.3	Kahrizes in Azerbaijan .....	324
19.4	Nakhchivan Kahrizes .....	328
19.4.1	Shikhali Khan Kahriz .....	330
19.4.2	Shai Kahriz.....	331
19.5	Conclusions .....	331
	References.....	332

## 19.1 INTRODUCTION

Some natural problems occur under arid climatic condition in the world. One of the most important problems is limitation of the water resources. Hence, some sources and methods are available to use water under this climatic condition. There is an urgent need for subsoil water resources utilization in these zones. The qanāt (kahriz) wells are used by consuming the subsoil waters in this direction.

As a hydrotechnical facility, kahriz extracts underground waters to the surface by gravity flow, regardless of the season, regularly provides pure water, and plays natural drainage role, positively affecting the environment. The scientists and governments care about the kahriz systems. Those ancient hydrotechnical settings were always for the mankind, and it is a significant meliorative system for the future. Being harmless for the nature, the kahrizes do not affect ecosystems negatively. They are considered the most reliable water sources in the dry zones. Study of the kahriz systems will be an important push for prevention of the water insufficiency.

There is a great scientific and practical importance of the definition of the historical use of the kahriz systems. For defining the kahriz age, it is advisable to use one of the following methods:

1. According to the ceramic products that are found in the kahriz deposit.
2. According to the installation, of which age and building techniques are known beforehand in the destructive part of the kahrizes.
3. According to the comparison of the residuum with the materials, of which age is known as a result of the archaeological research.
4. According to the drilling technology of the kahrizes.
5. According to the paleontological residuum that is found in the wells and the definition of the influence of the paleogeographical condition in the kahriz structure.

While investigating the kahriz systems, some of their features were determined, and they were classified on the basis of these characters. Kahriz systems are usually divided into the following categories according to the nutrition features (Guliyev 2008):

1. Kahrizes that feed on waters in the watery layers and fissures of the tectonic lines of the rainfalls that rain to the high mountainous-rocky zones.
2. Kahrizes that feed on underground flows formed in the foot zones.
3. Kahrizes that feed on underground waters (under channel) running from a riverbed.
4. Kahrizes that feed on underground streams collected from the narrow cross sections of the river valleys.
5. Kahrizes that feed on debris cones.
6. Kahrizes that feed on trias old layers scattered under foothill zones of the inclined plain.

As global warming and natural disasters call humanity to be vigilant, we must pay great attention to the protection and restoration of kahriz systems that provide clean and pure water continuously, require very low maintenance costs, and satisfy the needs of the population for drinking and irrigation water. The water insufficiency was constant in the arid regions, and methods of solution to this problem were investigated. One of the methods to solve this problem is creation of kahrizes. Those that are intended for irrigation and drinkable water source play a great role in the life of people (Azizov 2001).

## 19.2 KAHRIZES IN CENTRAL ASIA

Starting from 200 BC until 1600 AD, the geographical settlements throughout the Great Silk Way, running from the shore of the Eastern China sea to Europe and crossing through the north Turfan hollow, the Pamir mountain in Fargana valley, and Eastern Turkmenistan, played a great role in the development of the world civilization. Although the Great Silk Way begins with the territory of China, its main centers were Samarkand, Bukhara, Khorezm, Khiva, Derbent, Chamakh, Tabriz, Nakhchivan, and others. Ancient cities of Central Asia, including Sauran, Otrar, Mirtobe, and Karatobe in the lower rivers Amu-Darya and Sir-Darya, abound in the ruins of ancient cities and water systems. In such desert and arid regions, where the surface waterways (rivers, streams, and springs) are absent, the only springs of the water supplies were underground water pipes. The kahriz system of the water supply is one of the unique types of the cultural memorials. History of the kahriz water use systems in the arid countries of the Caucasus and Central Asia dates back to ancient times (Guliyev 2014).

The number of kahrizes in Central Asia is as follows: (a) South Kazakhstan, 200; (b) Turkmenistan, 235; and (c) Uzbekistan, more than 1000. Now, it is time to study the systems of kahriz and their history and development in Central Asia. We need to restore the kahriz systems at places where they are widespread. In Central Asia, a unique kahriz culture is investigated, which is extremely relevant for future research. In 2014, during the international kahriz expedition, together with the research group, I examined the kahriz established by the Great Alexander 2000 years ago in Nurata district of Navai region of Uzbekistan, which has been active thus far.

## 19.3 KAHRIZES IN AZERBAIJAN

There are rich water resources (more than 2.5 billion m<sup>3</sup>) in Azerbaijan areas with poorly developed river network. The Kur and Araz rivers, which pass through Azerbaijan to Georgia and Armenia, are significantly polluted with heavy metals and other factors. Furthermore, other rivers, lakes, and reservoirs are polluted by technogen and other factors. That is why, drinkable water problem becomes alarming here.

The kahrizes mainly extend on slopes of the Lesser Caucasus, Nakhchivan, Garabagh, around Ganja, and other regions in Azerbaijan. There are rich water resources (more than 2.5 billion m<sup>3</sup>) in the regions, with the weakly developed river systems in Azerbaijan. The number of kahrizes is up to 1500 in Azerbaijan. Substantial materials are provided in the ancient reference sources about kahriz water use in the arid zones of the world and Azerbaijan. “Geography” by Strabon, Khamadallah Karvin’s works, and studies by contemporary historians, archeologists, hydrometeorologists, soil scientists, and geographers are among those that highlight kahrizes in Azerbaijan and other neighboring countries.

According to Strabon, thanks to the irrigation ditches (aryks) and other waters, the Azerbaijan plains were irrigated better than the lands of Babylon and Egypt (Strabon 1879). Trever (1959) reported that by “other waters,” Strabon means a system of kahrizes, traces of which are found in different regions of Azerbaijan (Trever 1959). Hummel (1939) reported that the usage history of the Azerbaijan kahrizes belonged to the first century BC, but according to Trever, it belonged to the third century BC. In addition, Mahammad Mufid Mustofi Yardi notes in his work *Simple Mufid* from 1676 that there were 72 kahrizes with excellent-quality water (Naserli 1981).

At present, because of the stronger climate changes and increasing water need in the arid zones of the globe, anxiety about the exhaustion of water resources is growing. Several studies show the importance of kahriz systems and that there is a possibility in Azerbaijan and Central Asia not only to restore but also to realize the new projects on kahrizes (Guliyev 2014).

Azerbaijan is the country that has an old irrigated soils and is the country according to the same standards of the Middle East and Central Asia countries in this field. Hummel (1939) reported that out old kahriz residuum in 1938 when he carried out an archaeological excavation in the Shamkir river valley near Ganja. It was approved that these residuum belonged to the first century BC.

The kahriz water is the most reliable and strategically useful boon in a solution of the drinkable water problem in Azerbaijan. The population of the dwellings aside river canals compensates water provision of the arable areas and cattle by the kahrizes. Earlier, a river net and provision of the fertile soils with irrigative water in a great quantity were compensated at the expense of kahrizes (Hummel 1939).

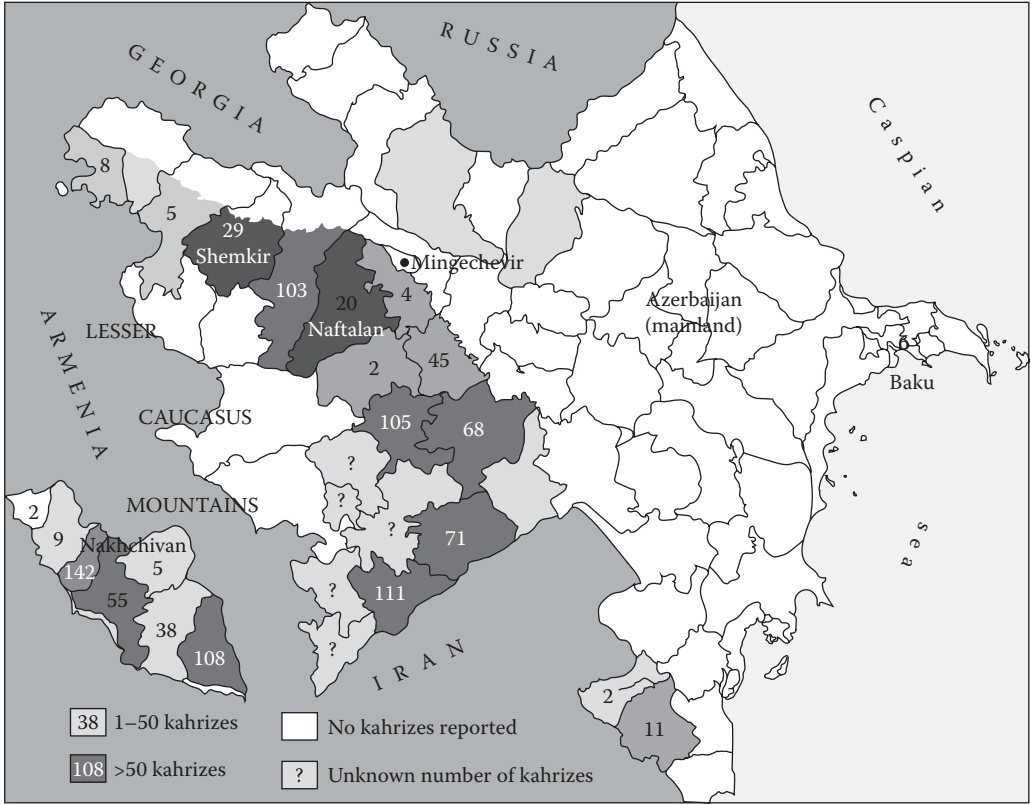
In ancient times, people considered some factors while choosing a place for the dwellings. The natural geographical condition and relief of the zone were taken into account. People cared about proximity of the water sources. Majority of the rivers and water sources dried. That is why the kahrizes were considered reliable water sources, and they were preferred over other water sources.

A role of the kahrizes was unexampled in water provision of Baku, Ganja, Aghdam, Barda, Nakhchivan, Ordubad, and in the nearly 200 villages. The kahrizes offered all necessary facilities for urbanization, and agglomeration development was a stimulus to build towns in former times (Guliyev 2000).

The research shows that well sinkers (*kankan*) of Iran drilled many kahrizes in Nakhchivan, Aghdam, Agjabedi, Ganja, and Garabagh. Movement of Iranian well sinkers to Nakhchivan after the collapse of the Soviet Union is an interesting fact (earlier, they worked in Nakhchivan for 70 years). Moreover, some of them settled in Azerbaijan as a result of the closure of the borderline in connection with the Second World War after 1939. Those well sinkers got married with Azerbaijanis and were busy with their profession till the end of their life in Azerbaijan (Rustamov 1964).

From the fourteenth century AD and until 1930s, the kahrizes played a great role in Azerbaijan agriculture. In this period, about 1500 kahrizes produced 25 m<sup>3</sup>/s water in Azerbaijan. More than 72.50 hectare arable areas were irrigated by the kahrizes every year.

As a result of the collapse of kahrizes over the past 50 years, unwanted processes took place, playing the natural drainage role. Those processes caused thousands of hectares of fertile land to become useless for the agricultural purposes. As a result of the disrupted ecological balance, the existing fauna and flora have been destroyed. New fauna and flora appeared in their place, adapted to the swampy terrain and saline lands. The distribution of kahriz in the regions of Azerbaijan is shown in Figure 19.1.



**FIGURE 19.1** The quantity of kahriz in the regions of Azerbaijan. (From Guliyev, A.G., *Tbilisi*, 10, 38–39, 2008. With Permission.)

In 1930s, 157 kahrizes, the output of which was 10.23 m<sup>3</sup>/s, were in Mil-Garabagh zone, but 140 kahrizes with the output of 5.79 m<sup>3</sup>/s were in the Araz valley. Eight kahriz systems with the output of 0.428 m<sup>3</sup>/s provided the city with water only in Ganja. Generally, 97 kahrizes existed in Ganja and 25 villages around it. Thirty of them were built in the city in different times. They are Masjid kahrizi (30 L/s), Cuma (25 L/s), Shahsevan (27 L/s), Ozan (27 L/s), Haji Mirgasim (30 L/s), Haji Gadimli (28 L/s), Javadkhan and Sharafkhanl (37 L/s), Haji Hilal and Sadilli (30 L/s), Zulular (15 L/s), Gaymaqli (32 L/s), Galalilar (27 L/s), Hajimammadli (26 L/s), Seyid (25 L/s), Arzumanli (18 L/s), Abuzarbayli (18 L/s), Orta (18 L/s), and others (Guliyev 2007).

There are abundant watery kahrizes in Azerbaijan such as Hamidakhanim I kahriz (160 L/s) in Garabagh, Chaykahriz (120 L/s) in Nakhichevan, and Aliabad kahriz (114 L/s). Although it was possible to extract underground water (1955) by the kahriz systems in Nakhichevan, AR, this quantity got reduced by 32.5 million m<sup>3</sup> (in 2008) at the end of the century; on an average, 53.1 million m<sup>3</sup> of underground water was not used, and thus, hundreds of hectare of the fertile soil areas were taken out of the circulation because of water insufficiency (Guliyev 2007).

According to the Semsar (2010) calculations, 885 kahrizes were in the official state registration in Azerbaijan in 1938 and their water expenditure was 13.35 m<sup>3</sup>/s (419.42 million m<sup>3</sup>/yr). At present, the quantity of the kahriz water formed 20%–25% of the capacity in 1938 (Semsar 2010).

Although the underground waters were used in ancient times, the research began in the middle of Carboniferous Period AD. The underground waters of the mountainous zones began from the carbon period; they belonged to the old deposits of the IV period and were connected with the tectonic destruction and weathering zones. The springs that go out of the valleys and slopes by circulation have their expenditure as 5–10 L/s; the springs with a great expenditure (60–100 L/s) are dispersed

in the karst limestone areas. The underground waters, which possess economical importance, consists of the river bed and under-deposit waters are collected in alluvial deposits in the mountainous zone. Maximum expenditure of the under-deposit waters is 40,000–60,000 m<sup>3</sup>/d.

Majority of underground drinkable water deposits is situated in the foothill plains, which are formed in the river debris cones. The highest water conductive coefficient of the underground watery horizons is 2000–5000 m<sup>3</sup>/d in the central part, but density gets reduced 250 m toward foothill zone and the edge of cone in the area of debris cones.

The hydrological condition of the Kur-Araz and Lenkoran lowlands that is formed from continental sea and sea lagoon by origin deposits of the fourth period belonging to the upper Pliocene is inconvenient in comparison with the foothill plains and the regimes that depend on complex natural and artificial (anthropogenic by origin) factors.

A level of the subsoil waters increased 3.26 m (2.45–5.71 m) on average and 0.82 m in a year under an influence of the irrigative systems during a long-term period. The highest increase is observed in the Nakhichevan and Garabagh plains of 6.4 m (5.36–11.76 m) and 4.07 m (2.14–6.21 m), respectively.

On average, Azerbaijan's kahriz waters contain 0.16 mg/L of ammoniac, 0.17 mg/L of nitrate nitrogen, and 0.55 mg/L of phosphorus. The potassium is comparatively poor (2.8 mg/L) in those kahrizes. Therefore, on average, 0.72 kg of ammoniac, 0.68 kg of nitrate nitrogen, 3.9 kg of phosphorus, and 13.7 kg of potassium are applied per 1 hectare of the irrigative field for a season of the kahriz waters in Azerbaijan.

Shown in Table 19.1 is the sum of 14068.44 thousand m<sup>3</sup>/d (5.13 km<sup>3</sup>/yr) drinkable and 34.1 thousand m<sup>3</sup>/d mineralized underground waters, part (0.2%) of which is originated from the mountainous zone in Azerbaijan. An exploitation of underground drinkable waters formed 1814 million m<sup>3</sup>/yr in 1976–2000, 23.8% of which is used for domestic and industrial uses and 76.2% is used for agriculture.

Table 19.1 shows Azerbaijan's underground water resources (Aliyev 2000). A total of 686.9 thousand m<sup>3</sup>/d (250.718 million m<sup>3</sup>/yr) of the existing kahriz water was used for water supply and 2463.9 thousand m<sup>3</sup>/d (899.36 million m<sup>3</sup>/yr) was used for irrigation and livestock.

The republic zone is rich in underground mineral waters. About 1000 mineral water outlets are noted. Their distribution over zones and heights is unequal. Mineral waters take part in feeding of some kahrizes.

Today, the amount of water used by kahrizes comprises 25%–30% of the water that was used in 1950s in Azerbaijan. As there was a water insufficiency in Garabagh, Ganja-Gazakh, and Nakhchivan, which have an arid climate, the kahriz systems had been built here since old times.

Azerbaijan kahrizes are distributed mainly on the slopes of the Lesser Caucasus Mountains, in Nakhchivan, Garabakh, Ganja, and other regions. Their consumption varies from 2–3 to 110–120 L/s. Their length varies from 30 m to 3–4 km.

**TABLE 19.1**  
**Azerbaijan Underground Water Resources**

Regions	Quantity (1000 m <sup>3</sup> /d)
In the mixed system of the Great Caucasus	251.72
In the canal of the East pre-Caucasus artesian	3,481.92
In the Kur's hollow	9,087.70
In the mixed system of the Little Caucasus	1,247.10
Over the Azerbaijan Republic	14,068.44

Source: Aliyev, F.S., *Underground Water Reserves of the Republic of Azerbaijan, Use, and Geo-Ecological Problems*, Chashioglu, Baku, Azerbaijan, 2000, p. 326.



## 19.4 NAKHCHIVAN KAHRIZES

The kahrizes of Nakhchivan, AR, were registered starting from the fourteenth century. Plan and profile of some kahrizes, chemical composition of their waters, calculation of their situation, and other works have been done accordingly. The geographical distribution of kahrizes in Nakhchivan is shown in Figure 19.2.

As a result of the anthropogenic effects, the kahriz spheres are exposed to pollution as a result of mixture of the surface waters with kahriz waters. Our water analyses confirmed pollution of the underground waters in Nakhchivan. Quality of these waters does not meet technical standards.

The kahrizes' office is attached to Melioration and Water Economy Agency in Nakhchivan. In accordance with the order of the Chairman of the Nakhchivan, AR, Supreme Assembly, more than 100 kahrizes were established in 2004 (Guliyev 2008).

An attention to irrigation work, like in many other areas, has been increased after Azerbaijan restored its independence. At present, the attention is paid to usage of the kahrizes traditional irrigation systems as well as to the establishment of the reservoirs and drilling of the subartesian wells. Furthermore, some measures have been fulfilled in order to meet population's drinkable and economical water needs.

At present, considerable work is being carried out in the direction of cleaning sewages of the kahriz wells and fastening work is being fulfilled in order to prevent kahrizes from destruction. Besides, important measures are being implemented in the spheres of the new kahriz systems.

The underground waters are exposed to pollution because of increase in the environmental waste volume in urban places, quickly growing cities, and development of the human society in Azerbaijan. Moreover, spreading of chemicals such as fertilizers and pesticides in the feeding zone of the kahrizes has also led to pollution.

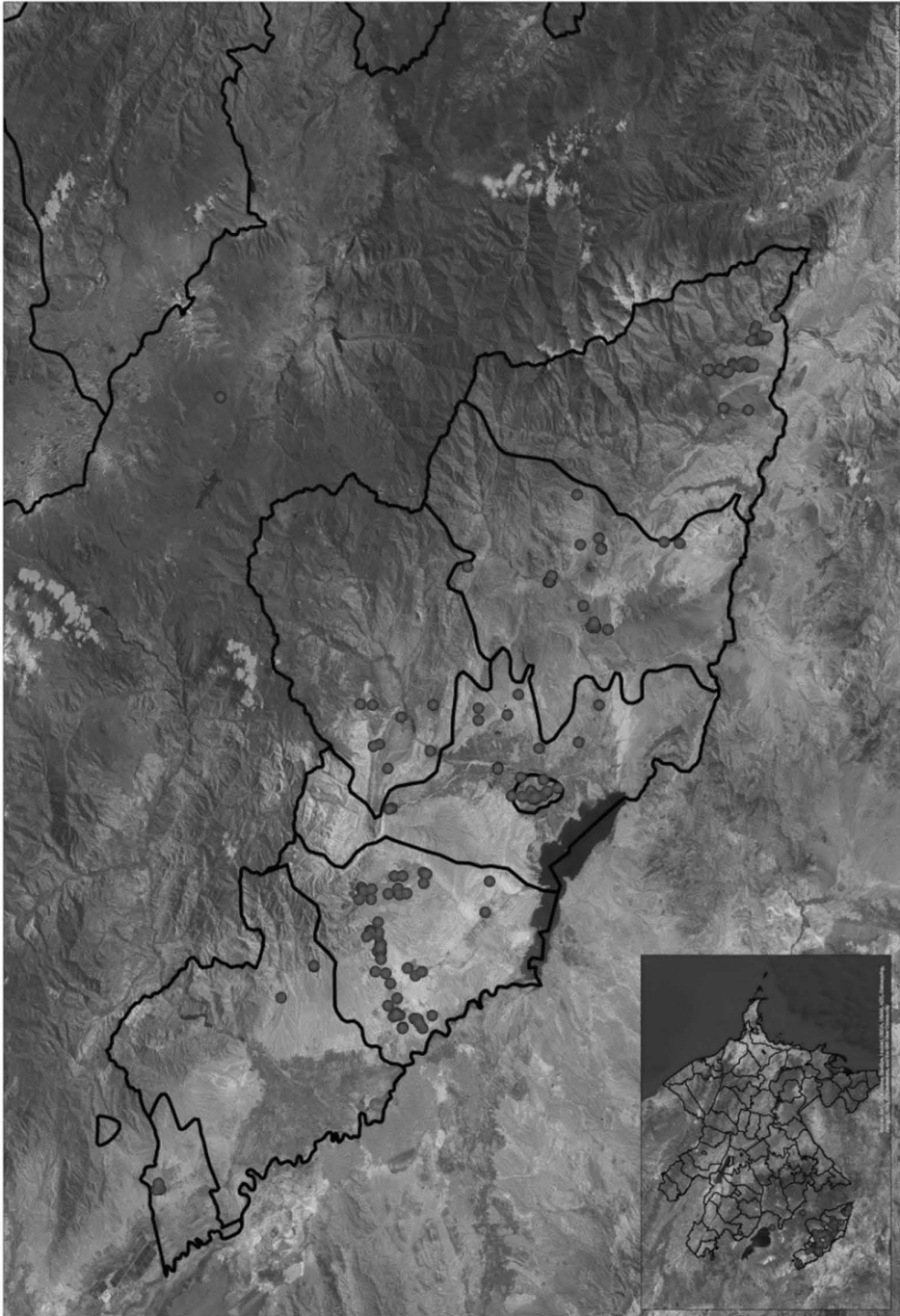
Kahrizes are established by the help of the communities, private businesses, and international organizations, in particular the International Organization for Migration (1999–2011). However, the work is fulfilled in self-acting principle, because there are no normative-legal and technical documents on the kahrizes. At the same time, not enough experiment is processed and there is a lack of quality control.

The biggest kahriz of the water consumption is *Chay kahrizi* kahriz in the village of Khyok of Kangarli district in the Nakhchivan Autonomous Republic. Its flow rate is 120 L/s. The biggest high-water spring is in the Garabaglar village of the same district. The "Asni Bulagi" spring (85–100 L/s) comes out to the surface 300 m at the top of the village. We conducted a detailed study of the kahriz facilities. Some of them can be shown with a description of their photos below.

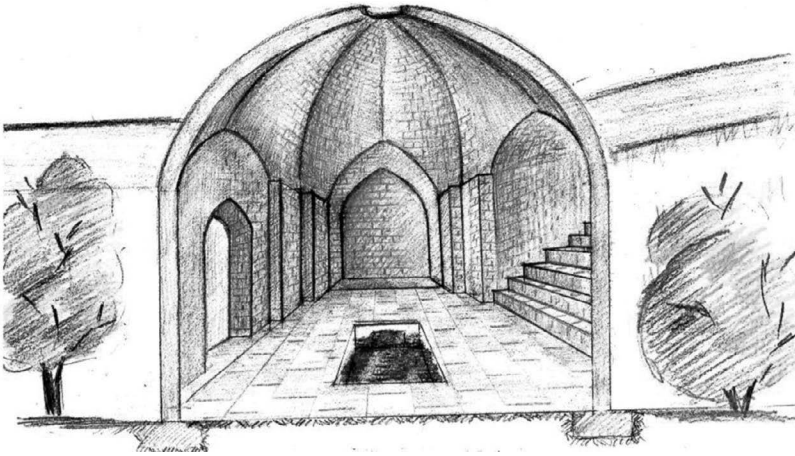
One of the ancient kahrizes in Nakhchivan is located in the villages of Yukhari and Ashagi Aylis in the Ordubad region of Nakhchivan, AR. Aylis is depicted as a large settlement in historical sources. There are many kahriz-architectural monuments and rich water systems in Aylis. Nonetheless, the city was completely destroyed and turned into ruins after the wars between Safavids and Ottomans in the sixteenth and seventeenth centuries (Salaeva 2002).

The construction of the kahrizes dates back to that period. The bridge and mosque related to the name of Shah Abbas show the construction and follow-up restoration works here.

The kahriz-architectural monuments in Yukhari Aylis village—"The Spring with Bird" (Qushlu cheshme), "Welcome" (Khoshkeshin), and "The Square" (Meydan)—are still there as result of special protection. Using local materials and together-baked bricks, water-architectural monuments that reflect the Eastern architecture traditions were founded (Rustamov 1964). The culture regarding water usage is high graded. In the wake of research, it is found that the water of Aylis River was used four to five times through kahriz systems for irrigation in Yukhari and Ashagi Aylis villages. An architectural building with the release of water from kahrizes, Yukhari Aylis, Ordubad, Azerbaijan, is shown in Figure 19.3.



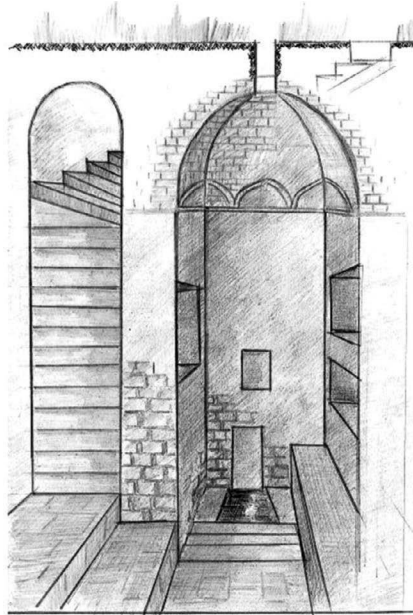
**FIGURE 19.2** The geographical distribution of kahrizes in Nakhchivan. (From Guliyev, A.G. and Hasanov, A.M., *International Conference on Traditional Knowledge for Water Resources Management*, Yazd, Iran, 2012.)



**FIGURE 19.3** The architectural building with the release of water from kahrizes, Yukhari Aylis, Ordubad, Azerbaijan. (From Guliyev, A.G. and Hasanov, A.M., *International Conference on Traditional Knowledge for Water Resources Management*, Yazd, Iran, 2012.)

#### 19.4.1 SHIKHALI KHAN KAHRIZ

The spring dates back to the seventeenth century. Author, builder, and customer are unknown. Architecture and construction of the spring are described as follows. Shikhali-khan merges in the sole volumetrically spatial solution. A new type of composition with well-developed forms and methods were worked out in this spring (Guliyev 2008). The scheme of section 40-stairs Shikhali Khan in the city Ordubad is shown in Figure 19.4.



**FIGURE 19.4** The scheme of section 40-stairs Shikhali Khan in the city Ordubad. (From Guliyev, A.G., *Tbilisi*, 10, 38–39, 2008. With Permission.)



**FIGURE 19.5** Architectural elements on the 40-stairs dome Shai, Ordubad. (From Guliyev, A.G. and Hasanov, A.M., *International Conference on Traditional Knowledge for Water Resources Management*, Yazd, Iran, 2012.)

#### 19.4.2 SHAI KAHRIZ

The memorial dates back to the seventeenth century. Author and builder are unknown. Customer is the local community. The spring “Shai” is an interesting example of the important element of the town equipment, and architectural structure is included into the town-building system of Ordubad (Guliyev 2008). Architectural elements of the 40-stairs dome Shai in Ordubad are shown in Figure 19.5.

### 19.5 CONCLUSIONS

Starting from the second century BC until the sixteenth century AD, the people settled down throughout the Great Silk Way, running from the shore of the Eastern China sea to Europe; this played a great role in the development of the world civilization. In such desert and arid regions, where the surface waterways (rivers, streams, and springs) are absent, the only springs of the water supplies were underground water pipes. The kahriz system of the water supply is one of the unique types of the cultural memorials. History of the kahriz water use systems in the arid countries of the Caucasus and Central Asia dates back to ancient times. In Azerbaijan, kahrizes mainly extend on the slopes of the Lesser Caucasus, Nakhchivan, Garabagh, Ganja, and other regions. There are rich water resources (more than 2.5 billion m<sup>3</sup>) in these regions, with the weakly developed river systems in Azerbaijan. There are nearly 1500 kahrizes in Azerbaijan. In terms of the kahriz systems, Azerbaijan is in the fifth place after Iran, Pakistan, Afghanistan, and Oman. At present, because of the stronger climate changes and increasing water needs in the arid zones of the globe, anxiety about the exhaustion of water resources is growing. There is a possibility in Azerbaijan and Central Asia not only to restore but also to realize the new projects on kahrizes.

Finally, the conclusions that could be drawn from this review are summarized as follows:

1. Although the kahrizes of the region served the Great Silkway for more than 4000 years, they are still of great importance for various purposes.
2. The chemical component and the volume of the kahriz waters are changing in the regions exposed to ecological challenges.



3. In the wake of anthropogenic activities (building of water reservoirs, loss in irrigation waters, etc.), underground waters is getting closer to the surface in foothill zones. Therefore, new kahrizes are required to be established in these areas.
4. Fortunately, over the last 15 years, many kahrizes have been restored in Azerbaijan, and there are fundamental positive results in this area. Similar works are currently implemented in Kazakhstan, Uzbekistan, and Turkmenistan.
5. In economic and ecological terms, kahriz systems are more rational installation than sub-artesian wells. Hence, the establishment of the ancient kahrizes and drilling of new kahrizes are the main solutions to the water insufficiency problem.

## REFERENCES

- Aliyev, F.S. 2000. *Underground Water Reserves of the Republic of Azerbaijan, Use, and Geo-Ecological Problems*. Chashioglu, Baku, Azerbaijan, p. 326.
- Azizov, Q. and Aliyev, H. 2001. *Irrigation History of Azerbaijan*. Izd, Elm, Baku, Azerbaijan, p. 102.
- Gazvini, G. 1983. *Nuzxat al kulub*. Izd. Elm, Baku, Azerbaijan (in Russian).
- Guliyev, A. 2000. Kahriz in Nakhchevan AR and their rational exploitation. In *The Materials of the International Symposium*, Nakhichevan, Azerbaijan, pp. 101–102.
- Guliyev, A.G. 2007. Kahrizes are pure water sources from ecological point of view. In *Proceeding of the International Congress on Ecology and Economy*, Baku, Azerbaijan, 7–9 June, pp. 376–379.
- Guliyev, A.G. 2008. Caucas kahrizes. The history of development of water use. *Caucasus Environment*. *Tbilisi* 10, 38–39.
- Guliyev, A.G. 2014. *Reports on Ecological Aspects*. Politex, Baku, Azerbaijan, p. 179.
- Guliyev, A.G. and Gambarova, G.G. 2012. Architectural elements of systems kahriz in Ordubad. In *International Conference on Traditional Knowledge for Water Resources Management* will be held on February 21–23, 2012, in Yazd, Iran. [http://confcd\\_tkwr01/files/TKWRM01\\_224.pdf](http://confcd_tkwr01/files/TKWRM01_224.pdf).
- Guliyev, A.G. and Hasanov, A.M. 2012. Azerbaijani kahrizes (qanats). In *International Conference on Traditional Knowledge for Water Resources Management* will be held on February 21–23 in Yazd, Iran. [http://confcd\\_tkwr01/files/TKWRM01\\_224.pdf](http://confcd_tkwr01/files/TKWRM01_224.pdf).
- Hummel, Y.H. 1939. Excavation report near by the Kirovabad in 1938. *Az. FAH USSR*, 3, 66 (in Russian).
- Naserli, M. 1981. About some sources water supply of settlements of the Azerbaijan Republic. *Ethnographic collections of Azerbaijan*, № 4, Baku, Azerbaijan, Elm (in Russian).
- Rustamov, Y.A. 1964. *Ethnographic Information of Kahriz Water Supply Systems in Azerbaijan XIX–XX Century*. Izd, Nauka, Moscow, Russia, p. 16 (in Russian).
- Salaeva, R. 2002. *Nakhchivan-heritage architecture*, Baku, Azerbaijan, p. 239.
- Semsar, A. Y. and Madjid, L.H. 2010. Veins of desert-a review on the technique of qanat/falaj/karez/, *Iran Water Resources Management Organization*, Tehran, Iran, pp. 194–195.
- Trever, V.K. 1959. *Essay of Caucasian Albany's Cultural and History*. Izd. M-L, Moscow, Russia, p. 71 (in Russian).

---

# 20 Ancient Water Mining in Tunnels and Wells in West Central Asia

*Renato Sala*

## CONTENTS

20.1	Underground Waterworks in West Central Asia: Definition and Historical Background .....	334
20.2	Karez of West Central Asia: Geographical Location by Type .....	336
20.2.1	Surface-Water Shaft-and-Gallery Aqueducts (SGA) (Karez Tunnels) .....	340
20.2.1.1	Kopet-Dag, Region (TM).....	340
20.2.1.2	Zeravshan, Upper Valley (TJ), and Plains (UZ).....	340
20.2.1.3	Usrushana, Eastern Part (TJ).....	340
20.2.1.4	Talas, Upper Valley (KG) .....	341
20.2.2	Aquifer SGA (Karez-Qanāt) .....	342
20.2.2.1	Kopet-Dag, Northern Piedmonts (TM) .....	343
20.2.2.2	Northern Bactria, Surkhandarya Valley (UZ).....	344
20.2.2.3	Nuratau Range, Central (UZ) .....	344
20.2.2.4	Fergana Valley, Northern Part (UZ).....	345
20.2.3	Groundwater Management System (GMS).....	345
20.2.3.1	Northern Bactria (UZ, TJ).....	346
20.2.3.2	Zeravshan, Upper Valley, and Plains (TJ) .....	346
20.2.3.3	Nuratau Range (UZ).....	346
20.2.3.4	Usrushana, Western Part (UZ).....	348
20.2.3.5	Ahangaran Valley (UZ).....	348
20.2.3.6	Karatau Range (KZ).....	348
20.3	Shafts or Wells? Qanāt or “Karez”? .....	350
20.4	Groundwater Management System (GMS).....	353
20.4.1	Clusters of Wells .....	354
20.4.2	Aligned Wells .....	355
20.4.3	The GMS of the Turkestan Oasis.....	356
20.5	Conclusions.....	357
	References.....	358

The article, on the basis of the reading of the rich soviet literature on the subject, provides the first complete list of the underground waterworks of West Central Asia (which in the region are all called “*karez*,” independently from their technical variants), inclusive of their location, technical features, and documentary references. This quite tedious list is intended to be a useful tool for both Russian- and English-speaking specialists (Sections 20.1 and 20.2).

A difficulty appears when analyzing the waterworks that have an aquifer as a source. In this case, the aquifer shaft-and-gallery model (qanāt) has been universally applied, disregarding the presence within the system of several elements that cannot be reduced to components of a qanāt but look like infiltration wells (Section 20.3).



Therefore, it has advanced the hypothesis of the development in medieval West Central Asia of an original type of Groundwater Management System (GMS), based on Karez-GM waterwork type intended for exploiting the water of multiple shallow aquifers, where the task of building a source is prioritized above the task of catching and transporting its water. The strategy is to manage the entire aquifer-to-aquifer circulation without tunnels but by alignments of infiltration wells, until a point where water is resurged, which, in some cases, will happen spontaneously (Section 20.4).

## 20.1 UNDERGROUND WATERWORKS IN WEST CENTRAL ASIA: DEFINITION AND HISTORICAL BACKGROUND

The most common types of underground waterworks are horizontal tunnels and vertical wells.

A *water tunnel* is a horizontal excavation below the ground, intended for transporting surface or underground water to a chosen locale (subterranean adduction channel). Water exchanges would happen along the way, so that the tunnel, if crossing a water-bearing layer, will get recharged by infiltration (and functions as a subterranean drainage channel or as a spring-flow tunnel).

A *water well* is a vertical excavation in the ground, putting in connection the land surface with an aquifer or with overlapping aquifers.\* In that way, it allows on one side the emergence of groundwater by artificial uplift or artesian pressure and, on the other side, the drainage and infiltration of surface water for replenishing the aquifer (drainage and infiltration well).

Among the underground waterworks of the archaeological record of West Central Asia, besides the huge number of single wells and a few semi-natural cisterns, several types of systems that provide the catchment and underground transport of water are documented. They can be classified into three basic types.

- Shafts-and-gallery aqueducts applied to a surface-water source (surface-water SGA, tunnel)
- Shafts-and-gallery aqueducts applied to an aquifer water source (aquifer SGA, qanāt)
- Clusters and alignments of wells for management of groundwater circulation (groundwater management karez, karez-GM)

Of course, to the list must be added the case of underground waterworks of mixed type, that is, GMS coupling karez-GM and SGA schemes.

In West Central Asia, all these systems are generically called “*karez*.” It is a Persian name that points to their common features: “*kar*” means “to draw a groove” and “*rez*” means “to flow,” and so, the term *karez* means “water flow along an artificial groove.” In the Sukhandarya and Nuratau regions, they are also called “*kanda*,” a Persian name meaning “hole.”†

Names, local accounts, and historical and scientific reports, all agree in affirming the Iranian origin of the Central Asian *karez*. The earliest historical record concerns a *karez-qanāt* made during the tenth century AD in the Kopet-Dag, but some authors suspect an earlier Achaemenid start of the building tradition (see Section 20.2.2.1). As a whole, there is accord in attributing the start of their construction to the Early Middle Ages and their blossoming period under Shaybanid rule in the late sixteenth AD. After that time, they have been continuously in use until the early twentieth century AD, and a few are active even today.

\* Overlapping aquifers are discontinuous lenses of aquifers at various elevations that are not physically interconnected.

† Actually, the term “*karez*” has a very wide range of possible meanings, all connected with water resurgence by aligned underground artificial structures. In Khorasan, N-Afghanistan, Bactria, and Central Asia, the term generically refers to any kind of underground waterwork characterized by vertical holes along the line, independent of the type of water source. In East Iran, it is strictly used for aquifer SGA systems, that is, as a synonym of *qanat*. In the Kopet-Dag, it can also mean the terminal underground or surface distributaries departing from the *qanat* main line, and all over West Central Asia, “*Karez*” is a common toponym for a village water-fed by *karez* structures.

Concerning the building masters, Russian geographers attribute the construction of karez in the Kopet-Dag and Fergana to Persian masters (Pendjiev 1978) and in the Nuratau to Tajik and Turkmen (Gulyamov 1979). In the Karatau, the construction of karez, is quoted by historical accounts as “dug by the work of 200 Indian slaves” and as a present from Mir-Arab, sheykh of the Sufi Naqshbandi sect of Bukhara, to his native land (Boldyrev 1976, p. 167–168) (Figure 20.1).

Besides the nationality of the karez builders, the historical records inform about their social status and tribal affiliation. It seems that the main protagonists involved in the “karez business” were the so-called “Chagatai” class and the “Khoja” tribe.

“Chagatai” is a generic name that refers to the social class of medieval Tajik or Uzbek bilingual land owners, who relied on brigades of karez builders organized as guilds.

The “Khoja” is a tribe that consists of skillful craftsmen and cunning religious entrepreneurs and is still now most widespread in whole Islamic world, particularly in Central Asia. Dissidents by nature and claiming direct descent from one of the first four caliphs or from some early saints, they have been very successful in converting Zoroastrian masters to Islam and have been the founders of three main Sufi sects (among which is the Naqshbandiya, the largest in the world). Starting from the eighth AD, they diffused to West and East Central Asia, where, after finding that the irrigation plains were already crowded, colonized the arid peripheries through the building of karez. In fact, in arid Central Asia, any tribe pretending independence must have been fit for desert colonization, which means they had a sound knowledge of water mining and, owing to the costs of the



**FIGURE 20.1** On the right, Persian workers in a chalk quarry near Ashgabad at the beginning of the twentieth century AD. (From Markov, E., *Rossiya v Srednei Azii: ocherki puteshchestviya po Zakavkazyu, Turkmenii, Bukhare, Samarkandskoi, Tashkentskoi i Ferganskoi oblastyam, Kaspiiskomu moryu i Volge* [Russia in Central Asia: Essays about travels in the Caucasus, Turkmenia, Bukhara, Samarkand, Tashkent and Fergana provinces, Caspian sea and Volga], St Petersburg, 1901, <http://rus-turk.livejournal.com/138202.html>.) On the left, photo of Turkmen karez master Durdy Khilliev of the Baharden oasis (From Suprunenko, V., *Molchivaya voda kyariza* [The silent water of the karez], *Vokrug Sveta* [Around the World], 60–61, April 4, 1984. With Permission.)

implementations, also good entrepreneurial capabilities. Eventually, the management of religious institutions and the building of karez became characteristic activities of the Khoja, and surely these were politically and economically gratifying activities, in that both were everywhere rewarded by property rights (waqf) and tax exemption.

Shortly, the Chagatai and the Khoja can quite correctly be considered the main developers and managers of the karez of the entire West Central Asia territory (Karmysheva 1976).

The karez of West Central Asia have never been studied systematically. Some books about ancient irrigation systems dedicate a generic paragraph to them (Bekturova et al. 2007, p. 67; Kolodin 1981). Articles specifically devoted to karez describe cases only at regional scale. In the Kopet-Dag (TM), karez are described by Nikshich, Ovezov, and Pendjiev; in the Surkhandarya (UZ) by Tursunov and Kabulov; in the Nuratau (UZ) by Gulyamov; in Usrushana (TJ) by Bilalov; and in the Karatau (KZ) by Dingelshtedt, Groshev, and Sala and Deom. The best accounts are by far the ones of Nikshich about the qanāts of the Kopet-Dag and of Dingelshtedt about the karez of the Karatau region. Apart from Sala and Deom, no author suspects the existence of karez without gallery.

The present documentation concerning karez is based on: historical accounts; geographical, ethnographical, and archaeological reports; toponymy of villages and locales (Karez, Kariz, Karizsai, Karizstau, Dolina Kariz, Korez, etc); and satellite images.

## 20.2 KAREZ OF WEST CENTRAL ASIA: GEOGRAPHICAL LOCATION BY TYPE

As a whole, in the West Central Asia expanses, the presence of karez of any type is documented in eight regions (Kopet-Dag, N-Bactria, Zeravshan, Nuratau, Usrushana, Ahangaran, Fergana, Karatau, and Talas), with the highest concentration occurring in the Kopet-Dag, Surkhandarya, Nuratau, and Karatau regions.

The three main types of karez spoken above differ by technology and geographical location.

- *Shafts-and-gallery aqueducts (SGA)* are underground waterworks intended for catchment and underground gallery transport of water from a water source. They have three main elements: the water catchment head, depending on the type of water source; a sloping tunnel connected to the land surface through a series of vertical holes (shafts, which can be absent in case of very short length), from which comes the system's name; and the final outlet (mouth). The water source can be of two types: surface water (a river, a spring [spring-flow tunnel], or a canal) and aquifer water; similarly, the SGA can be of two types: *surface-water SGA (tunnel)* or *aquifer SGA (qanāt)*. The geographical diffusion in West Central Asia of surface-water SGA and aquifer SGA is in both cases reported in four regions and is described in Sections 20.2.1 and 20.2.2.
- *Groundwater Management karez (karez-GM)* are underground waterworks intended for the management of groundwater circulation through the digging of clustered and aligned wells and the use of fossil riverbeds. Their geographical diffusion in West Central Asia is documented in six regions and is described in Section 20.2.3. Their technical aspects are quite original and will be discussed in Sections 20.3 and 20.4.

Quite understandable are the patterns of the geographical distribution of the different types of karez in the West Central Asia territory. Karez are present in different densities along the piedmonts of all mountain massifs, from the Kopet-Dag to the Pamirs and the Tianshan. Tunnels intended for the transport of surface water are found in the mountain zones where rivers are still active. Instead, groundwater structures (qanāt and karez-GM) are established on the piedmonts of the westernmost and most arid mountain ranges (Kopet-Dag, Surkhandarya, Nuratau, and Karatau), where the extreme water scarcity justifies higher labor investment in groundwater structures (see Table 20.1 and Figure 20.2).

**TABLE 20.1**  
**Karez of West Central Asia: Location, Type, Number, Technical Features, and Chronology**

Region	Type & N°	Geo Morphology		Water Source	Length	Vertical Holes		Start-End Centuries AD <sup>a</sup> (Builders)
		Asl (m)	Slope (%)			Distance Interval (m)	Depth (M)	
<b>Kopet-Dag</b>	Tunnel 10?		F	R	—	—	—	10–21 (Iranian, Turkmen)
	Qanāt 1100	400–150	M5 F60 P35	R25 S20 A55	1100/1	25	25–2	2–40
<b>Surkhandarya</b>	Qanāt 30	700	F60 P40	R30 S30 A30	40/0.7	15	—	8 10–20 (Turkmen, Chagatai)
	Karez 200?	900	F	A	60?/0.3	5–7	—	—
<b>Zeravshan upper karez</b>	Tunnel 36	1200–1000	M	C	7/0.25	20	—	15–19 (Tajik)
<b>Nuratau Central</b>	Qanāt 8?	530 450	F P	A	4.5/0.6	12	<25	— 10–20 (Tajik, Turkmen)
	Karez 360	800–350	M5 F10 P85	R20 S10 A70	200/0.8	15	15?	20
<b>Nuratau North</b>	Karez 3	970–430	F	R30 A70	3/1	15	<25	— 12–19 (Tajik, Uzbek)

(Continued)

**TABLE 20.1 (Continued)**  
**Karez of West Central Asia: Location, Type, Number, Technical Features, and Chronology**

Region	Type & N°	Geo Morphology		Water Source	Length	Vertical Holes		Water Outflow (L/s)	Start-End Centuries AD <sup>a</sup> (Builders)
		Asl (m)	Slope (%)			Distance Interval (m)	Depth (M)		
Usrushana W	Karez	1950–470	0.6	–	–	10–12	–	–	12–19 (Tajik)
	200?								
Usrushana E	Tunnel	470	0.01	R	12/0.5	5–8	20–7	–	
	25		F						
			P						
Fergana N	Qanat	750	0.4	A	0.04	15–20	6	10	18–20 (Persians)
Karatau South (Sauran)	Karez	320–200	0.4	A	123/0.47	15	4–3	–	10–19 (Uzbek, Indians)
	260		P40						
Karatau South (Turkestan oasis)	Karez	450–200	0.4	A	15/0.5	15	4–3	–	16–19 (Uzbek)
Talas upper	Tunnel	1300	0.8	R	0.4–0.2	15	–	–	7–10
	2								
	pipe	1700–1500	5	S	10–5	–	–	–	
2									

<sup>a</sup> The chronological attributions are based on historical accounts and on unverified correlation with the surrounding archaeological complex.

<sup>b</sup> Data not available.



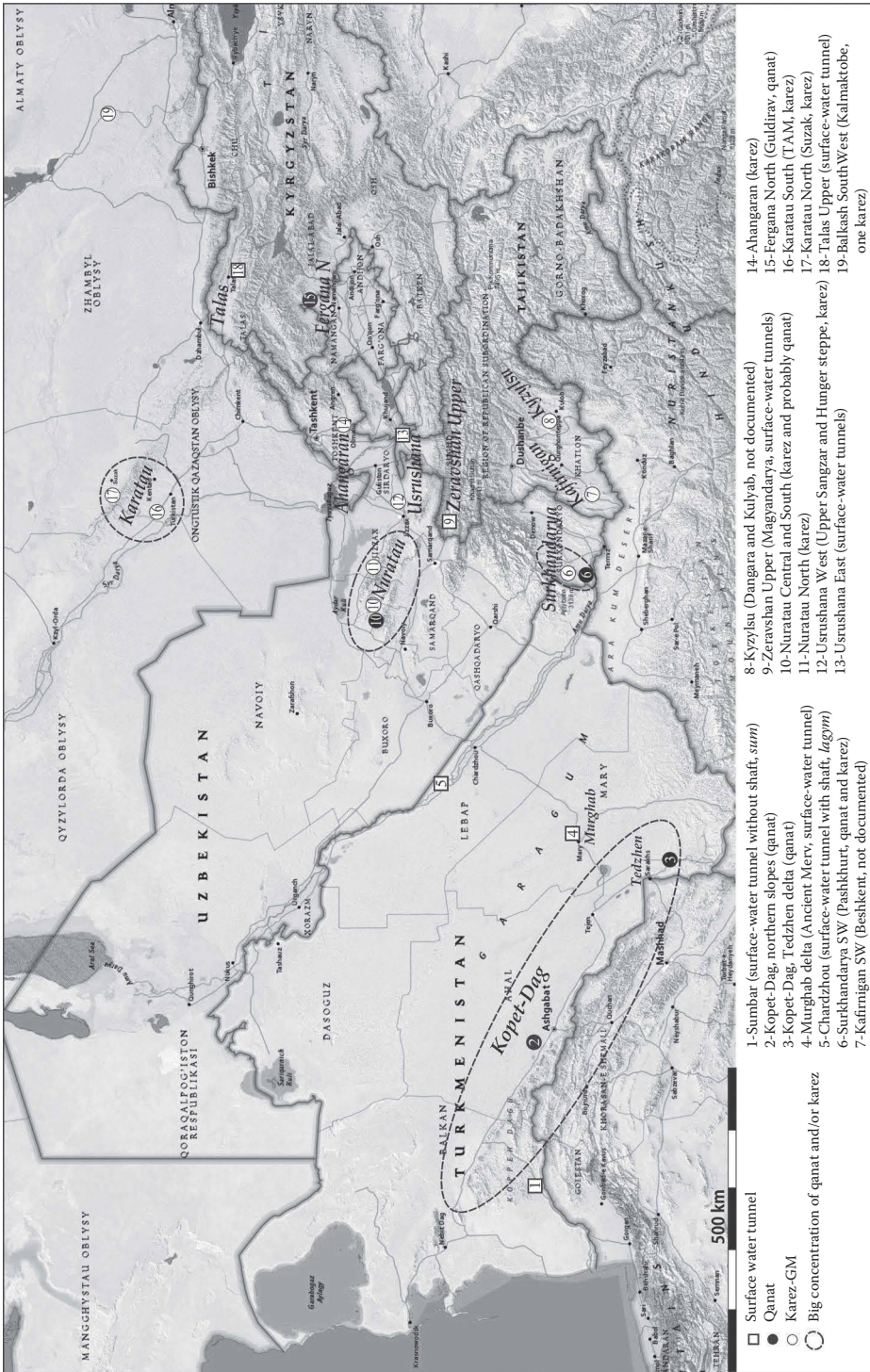


FIGURE 20.2 Map of the geographical location of underground waterworks by type. (tunnels, qanat, and karez-GM) in West Central Asia (Courtesy of JM Deom).



### 20.2.1 SURFACE-WATER SHAFTS-AND-GALLERY AQUEDUCTS (SGA) (KAREZ TUNNELS)

The simplest and the most diffused type of surface-water SGA is represented by the underground segment (a tunnel with or without shafts) of an open canal transporting water from a surface source (river or spring). In West Central Asia, tunnels of this kind are not very numerous, and just around 100 cases distributed in four regions are known to the author.

#### 20.2.1.1 Kopet-Dag, Region (TM)

Two sets of water tunnels are documented in the plains west of the Kopet-Dag range, along the *Sumbar* river, and in the *Chardzhou* region (Kodjakenepsi), near the left bank of the mid-Amudarya course, respectively. In both sites, these tunnels are segments of canals that transport river water to fields. On the Sumbar, a few short tunnels without shafts are excavated in the rocky cliffs of narrow passes: they are called “sum.” Around Chardzhou are found five tunnels with shafts; their type is of Iranian origin and is called “*lagym*” (which means “tunnel”) (Pendjiev 1978).

#### 20.2.1.2 Zeravshan, Upper Valley (TJ), and Plains (UZ)

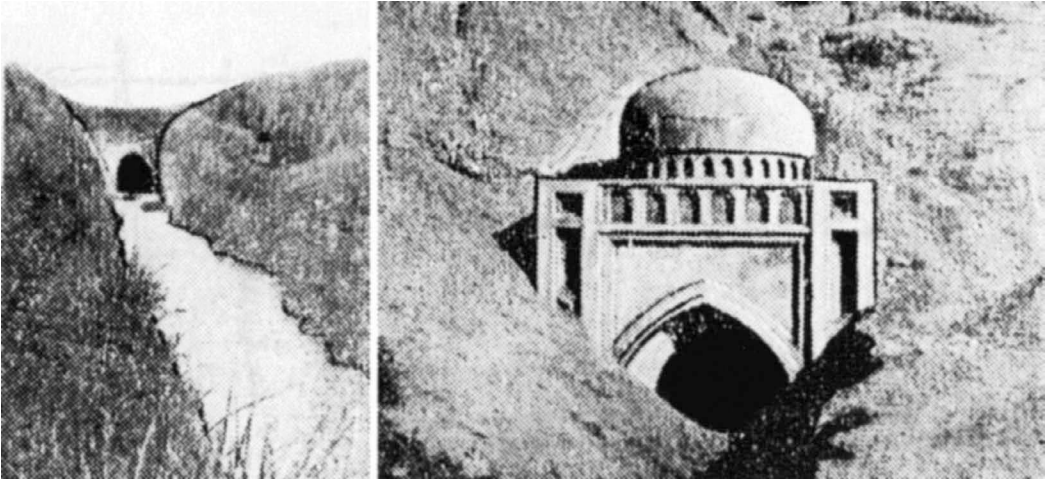
Here, the presence of surface-water SGA is documented in the mountain zone of the upper valley and in the plains.

- In four different areas of the upper valley (Penjikent, Aktam, Cherbak, and Kshtut), 36 tunnels are quoted as still active at the end of the nineteenth century. They are underground segments of canals from the Magyandarya river, a few hundred to 1000 m long, and are provided with vertical or horizontal shafts. Their construction is attributed to a leader of the Nakshbandi Sufi school during the fifteenth century AD (Arendarenko 1889, p. 162). In particular, one must quote a “karez” at Cherbak, which departs from a canal paralleling the river bed and develops for 3 km with 90 shafts, of which the construction is attributed to the Kharkanids (tenth to twelfth century AD), evident by a stone inscription located at the “mother well” (or, better, “at the first shaft”) (Fedchenko 1870).
- Concerning the Zeravshan plains, archaeological studies proved that in the Medieval time, the sardoba (water cistern) of the caravanserai of Rabat-i-Malik (near Navoi) was supplied by surface-water SGA from the Zeravshan river (Nemtseva 2009). Moreover, north of Navoi, on the southeastern slopes of the Aktau range, in the east of the Aksai river and of Aktepa village, the presence of a canal with several tunneled short segments (a type that all over Uzbekistan is called *qon-aryk*, buried canal) is documented; it is 6 km long, with a total of 600 shafts, and is dated to the sixteenth century AD (Hasanov 2014).

#### 20.2.1.3 Ushrushana, Eastern Part (TJ)

Here, around 25 tunnels, distributed in 3 parallel valleys are documented: 8 tunnels in the Basmanda valley, 7 in the Aksu, and 9 in the Hoja-Bakrygansai. All of them consist of the underground segment of a canal, with length from 50 to 1500 m and horizontal or vertical shafts, the last sometimes of relevant depth. Some tunnels have been built in the Middle Ages, and most of them were still active at the beginning of the nineteenth century AD (Bilalov 1980). Three tunnels (“karez”) at the end of the Aksu valley are relevant for their size and for the legends that surround them, all located 1–2 km far from each other, nearby the Tagoyak village.

- The Tagoyak karez, at the western limits of the Tagoyak village, is 1 km long, with vertical shafts 7–40 m deep, and, in the fields, their mouths are protected by a metallic enclosure. It was restored before the Soviet period, and its final outlet provided of a cement vault shaped as a mausoleum (Figure 20.3).



**FIGURE 20.3** Mouth of the Tagoyak karez, Aksu valley, Ustrushana (UZ). GPS coordinates: N40°07'16.43" E69°18'56.31". (From Bilalov, A.I., *Iz istorii irrigatsii Ustrushany (Materialnaya kultura Ustrushany, vyp. 4)* [From the history of the irrigation of Ustrushana (Material culture of Ustrushana, issue 4)], Doshin, Dushanbe, Tajikistan, 1980. With Permission.)

- The Shirin karez, which is 1.3 km north of the last, but not anymore detectable on the land surface, is described as pointing to the medieval town of Shirin-tepe, with unfinished shape and without visible head or end. It just consists of a 200 m long line made of only four vertical shafts having depth of 8–20 m, mouths of 4 m in diameter, and mounds 20 m large and 4 m high. A legend pretends to explain its mysterious shape.\*
- The Kallakhon karez, located on the opposite right bank of the Aksu river, is 1.5 km long, with very low declivity (0.12 m/km), carrying water of the canal “Shavkataryk” from Tashkuprik village to the medieval mound of Kallakhon. It was still active in 1970. According to a local legend, the Shavkataryk canal is very old, traced in the twelfth century AD by the younger brother of Ahmed Yasawi, Abdurakhman Bekhtar Bashi, whose mazar preserved during three centuries the big bronze cauldron that now stands at the entrance of the Yasawi mausoleum in Turkestan.

#### 20.2.1.4 Talas, Upper Valley (KG)

Two cases of underground water transport are found within the large medieval urban system of the *upper Talas* valley (Northern Tienshan), which grew in the quite arid landscape of the bottom valley (precipitation is less than 400–300 mm/y) but at the center of a very rich mining complex. The first case consists of two stream-side tunnels carrying the waters of a mountain stream to a metallurgic town surrounded by freshwater springs; the second case consists of two buried pipelines carrying fresh springwater to a metallurgic town reached by a channeled paleo-course of the Talas river.

\* The legend relates the story of Shirin, the daughter of a local dekhkan (landlord), whose beauty attracted two lovers, Chosrov and Farkhad, pretending her hand. Shirin challenged the pretenders to irrigate the lands of the Kurkat valley (5 km west of the Aksu valley) and promised to marry the first who would achieve this task. Farkhad decided to build a dam on the Syrdarya and bring water through canals. Chosrov chose for a karez from the Aksu river; however, after some time, seeing the amount of unfinished work and the proximity of the deadline, he settled for a ruse. On a full moon night, he put down a track of straw mat shining like a stream from the Aksu river to the tepe. At the view of the success of his rival, Farkhad in despair drowned himself in the Syrdarya, and the next morning, Shirin, seeing that she had been cheated, resolved to follow Farkhad, drowning herself in the same river. This legend might reflect the unfinished shape of this line but doesn't explain the fact that the mounds piled at the shafts' mouth are too high and could only be accumulated during some centuries of gallery cleaning.

- Two parallel tunnels around 200 m long and with horizontal shafts are dug at different elevations in the rocky cliff of the right shoulder of the mouth of the Urmamaral river valley, a left tributary of the Talas river, where it merges 16 km further north. The tunnels provide way for two open canals (of a system of four), catching and transporting the Urmamaral river waters at different heights and feeding the fields surrounding the medieval town of Aktobe-1 (Orlovskoe, 5.58 ha, seventh to fourteenth century AD). The Urmamaral valley, with 11 important mining points, represents one of the richest mining zones of the Talas valley, and Aktobe-1 is one of its five earliest and most enduring walled towns and metallurgic centers, surrounded by abundant freshwater springs but unconnected with the Talas river waters (Kozhemyako 1963; Sala and Deom 2016).
- On the slopes of the same left side of the Talas valley, 30 km upstream, where water resurgence becomes more scanty, the freshwater of a set of premountain springs of the Beshtash-Kolba interfluve is caught at 1700 m asl and conveyed 4 km down to 1500 m asl by two parallel clay water pipes buried underground. They end in the surroundings of the early metallurgic town of Kashkantobe (5.17 ha, seventh to twelfth century AD), which is facing a mountain zone hosting several mining points and is deprived of neighbor springs but reaches by a reworked distributary from the Talas river 4 km away (Sala and Deom 2016).

### 20.2.2 AQUIFER SGA (KAREZ-QANĀT)

The second and third types of karez listed above (Section 20.2) have groundwater as source; both represent soft sustainable ways of groundwater mining, but their techniques are quite different. Aquifer SGA (qanāt). In this case, the aquifer water is caught by a mother well (or by the tunnel itself) and transported by a gallery with shafts. In Central and West Iran, such structures are called “qanāt” (an Arabic name meaning “channel”), and in Central Asia, they are generically referred to as karez. Groundwater Management karez (karez-GM). In this case, the aquifer water is conveyed to emergence not from a mother well though a gallery but from aquifer to aquifer through a complex system of wells. This type of underground waterwork is the most diffused in W-CA.

From the land surface and satellite images, both types of aquifer karez appear quite similar as a line of vertical holes, which can be shafts or wells. In the first case, with mounds generally larger and more outdistanced, they correspond to the shafts of the gallery of an aquifer SGA; in the second case, they correspond to the wells of a karez-GM system.

The main advantage of these groundwater mining systems consists of providing, if not a constant, at least a continuous water outflow, which is the indispensable prerequisite for agriculture where summer rains are absent (at the price of a certain water waste during the winter season). Therefore, their technology diffused in arid regions deprived of summer precipitation, playing the major role in the colonization of dry interfluves and arid peripheries of fluvial irrigation valleys. Here, they are built on gently sloping piedmonts located below well-watered mountainous terrain, best on alluvial cones covered by a thickness of unconsolidated regolith deposits (soil, alluvium, etc) that are very conducive to infiltration and aquifer formation (Planhol 2011).

West Central Asia is an arid landlocked territory. Water resources are scanty and concentrated in the mountain and piedmont zones, consisting of ice deposits, springs, rivers, endorheic lakes, and ponds. In most of the arid plains, the only available water resource is groundwater.

This is particularly true in the case of Kazakhstan. Here, more than elsewhere, during the last 3000 years, the entire territory with all its landscapes, from mountain meadows to deserts, has been concerned and trodden by pastoralist activities; however, at the same time, the total renewable freshwater resources amounts to just  $23 \times 10^6 \text{m}^3$  per  $\text{km}^2$ , against the 230 of Turkmenistan, 110 of Kyrgyzstan, and 100 of Uzbekistan. Therefore, in the most arid zones of West Central Asia and

particularly of KZ, owing to the scarcity of surface water, among the different types of waterworks, by far, the most common are the ones applied to an aquifer source.

Aquifer SGA systems (qanāt) are described below (in Sections 20.2.2.1–20.2.2.4)\* and karez-GM systems in Section 20.2.3.

On the basis of the historical sources and archaeological reports, in West Central Asia, the identification of classic qanāts has been proved in four regions: more than 1100 samples have been documented in the northern piedmonts of the Kopet-Dag range, around 30 in the Surkhandarya, a few samples around Nurata town in the Central Nuratau region, and just 9 in the northern part of the Fergana valley.

A variant of aquifer SGA is represented by the case when the mother well is absent and groundwater is caught by infiltration in the tunnel itself (spring-flow tunnel). Generally, in this case, the tunnel is an underflow channel developing along a river bed and draining water from shallow aquifers formed by seepage from the water course; or, it crosses transversally parallel riverbeds or trains of alluvial fans; or, it is a side tunnel applied to the main qanāt line in fish-bone patterns. In the Kopet-Dag, half of the aquifer-SGA are provided of mother well and half catch groundwater as a spring-flow tunnel; in the other regions, most of the aquifer SGA seem to be of spring-flow tunnel type.

### 20.2.2.1 Kopet-Dag, Northern Piedmonts (TM)

All along the northern slopes of the range, more than 1100 classic qanāts, with or without mother-well and between 1500 and 5500 m long, are documented. Most of them are concentrated on the 10 largest alluvial fans of the piedmont band stretching for 130 km between the Bereket valley in the NW and the Ashgabat valley in the SE, with the highest density in the Baharden, Yaraja, Geoktepe, and Ashgabat valleys. East of Ashgabat, they are found in lesser number, until the Tedzhen and Murghab deltas. They are called karez by the local population as well as in scientific reports (Figure 20.4).

Many Russian geologists, hydrologists, and ethnographers provide the description of the Kopet-dag karez-qanāt. In their typology, all authors classify karez-qanāts by water source (river, spring, or aquifer), by shafts' depth (shallow [10 m], not deep [10–20 m], average [20–30 m], or deep [30–50 m]), and by outflow (very weak [ $<3$  L/s], weak [3–10 L/s], average [10–30 L/s], or abundant [up to 100 L/s]).

The best scientific account is given by the hydrogeologist I. Nikshich, who surveyed 110 qanāts, and of 78 of them provided information about location, water source,<sup>†</sup> length, shafts' number and depth, and outlet. In the entire region, in 1920, 200 qanāts were still active, with a total outlet of 2260 L/s; in 1965, 98 qanāts, with a total outlet of 1140 L/s; in 1970, around 54 qanāts were still in use, with a total outlet of 1000 L/s.<sup>‡</sup> In just the Ashgabat district, in the early 1890s, 17 short qanāts, with a total of 140 wells (30–40 m apart from each other), were still in use; and till 1940, four major qanāt systems were bringing water inside the city. One of the biggest qanāt lines near Ashgabat was the karez-Ishan,<sup>§</sup> with a length of 5200 m, a mother well of 52 m depth, and an abundant outlet of 40 L/s (Nikshich 1924, p. 99).

Ethnographic and historical information about them is provided by M. Pendjiev (1978) and M. Ovezov (1973). The last one supports their Achemenid origin, which is also proposed by the historian V. Barthold, notwithstanding the fact that the oldest historical record of a Kopet-Dag qanāt refers to a line of the Kyzyl-Arvat region, dated to the tenth century AD.

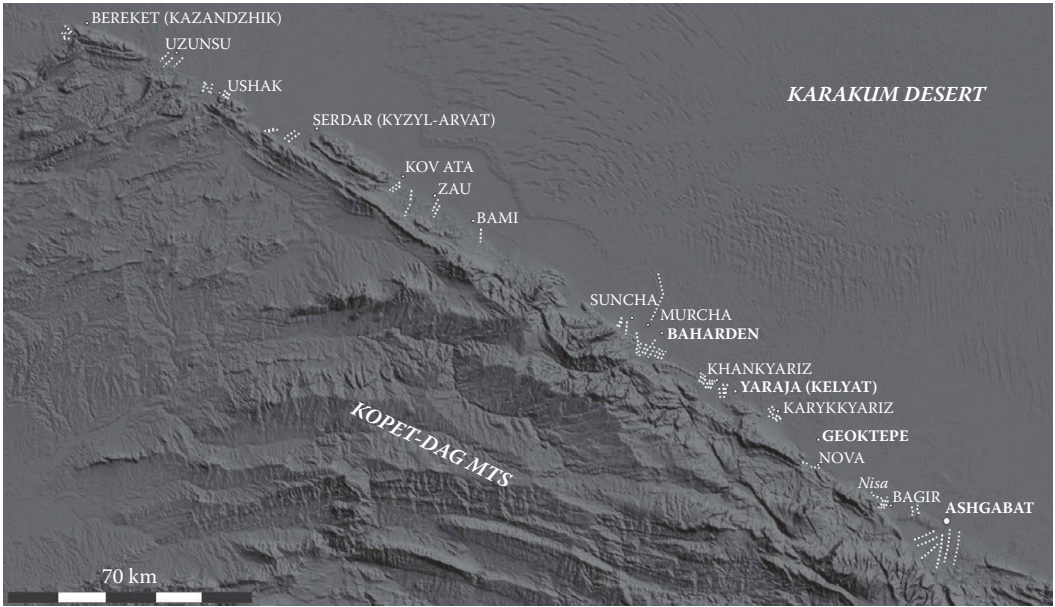
\* In the entire world, the total number of karez qanat, which in the last 50 years decreased by half, still provides a total outflow of 430 m<sup>3</sup>/s, which is enough for irrigating 1.5 million ha, that is, the 0.6% of the total irrigated areas. The 60% of them are located in Iran, the 25% in Afghanistan, and the 10% in Oman.

† Nikshich and Ovezov agree in pointing always to an aquifer as their water source: an aquifer near a spring, under a riverbed, or far from both.

‡ See "Ghidrogeologhia CCCP (Hydrogeology of SSSR)," 1972.

§ The important karez lines always deserve a proper name, and the last is always a Persian name.





**FIGURE 20.4** Map of the qanāts of the northern piedmonts of the Kopet-Dag (TM). White dashed line: qanāt. (on AsterGDEM image, GlobalMapper.)

### 20.2.2.2 Northern Bactria, Surkhandarya Valley (UZ)

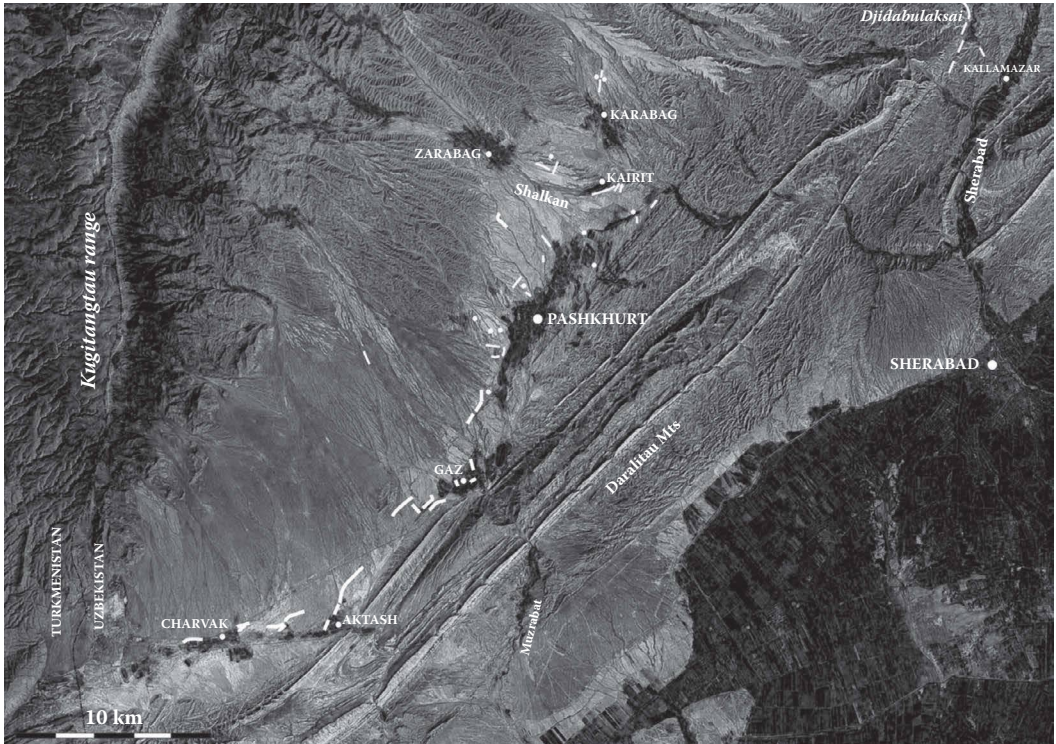
In the *Surkhandarya* valley, the best preserved lines of karez-qanāt are located in its SW part, on the eastern foothills of the Kugitangtau mountains, with the highest concentration on a piedmont band developing for 20 km between the villages of Pashkhurt and Charvak. Already documented in 1876 by the army journalist N. Maev (Kabulov 2015, p. 10), they consist of around 25 lines, most of them still clearly visible on satellite images. They have been interpreted as typical qanāts of foothill type, starting from an aquifer of the upper alluvial fan in a sloping environment of 5%, with average length of 700 m and max length of 3 km, shafts 15 m far from each other, and an average depth of 15 m. The outflow has been estimated from 4 to 50 L/s and reaches a peak of 80 L/s during springtime (Nazarov 2015, p. 123).

In the northern periphery of the complex, the presence of several karez-GM and of mixed-type karez systems is suspected (see below, Section 20.2.3.1) (Figure 20.5).

### 20.2.2.3 Nuratau Range, Central (UZ)

The Nuratau range is made of two parallel mountain groups: the Nuratau range on the North and the Karatau-Aktau ranges on the South. The Central Nuratau region is located between the two ranges spoken above and consists of two large parallel valleys developing East to West: the Selsai valley, 80 km long (the richest in karez lines, mainly of Karez-GM type; see below [Section 20.2.3.3]), and, on the south of it, the Arasai valley, 50 km long.

In the SE part of the Selsai valley, around the Dzhush village, the Russian geographer Radlov quotes in 1880 the presence of an ‘artificial river’ made of 8 lines of wells connected by deep underground galleries (Radlov 1880, p. 9). In the SW part of the Selsai valley, in the surroundings of Nurata town, the ethnographer N. Dingelshtedt recorded in 1889 the functioning of some karez lines with gallery (aquifer SGA, qanāts), each line averaging 30–250 shafts, 12 m far from each other. The longest among them was counting 300 shafts, reaching 25 m of max depth, and its yearly maintenance was provided by 4–6 working months of a brigade of 30 peoples (Dingelshtedt 1889, p. 281).



**FIGURE 20.5** Map of the qanāts of the Surkhandarya valley (Sherabad district, UZ). White thick line: qanāt; white thin line: karez-GM; white dots: cluster of wells. (on satellite image, SAS.Planet.)

Recent surveys by part of Uzbek geographers documented a qanāt line at the southern limits of Nurata town; it is named “karez-kalta” and is 600 m long, with 62 shafts going from 40 (doubtful data) to 5 m deep\* (Hasanov 2014).

#### 20.2.2.4 Fergana Valley, Northern Part (UZ)

In the *Namangan* region, along the Namangansai river, nine karez-qanāt lines have been found around the villages of Guldirav and studied by archaeologists in the 1986, but today, they are poorly visible on satellite images. They are reported as having average length of 40 m, shafts’ mounds of 4–10 m in diameter, and an underground tunnel transporting the groundwater of a shallow aquifer, with water table at the depth of 5–6 m. Each of these short lines had an average outflow of 10 L/s, irrigating 10 ha of land. According to the local inhabitants, these qanāts were built during the eighteenth to nineteenth century AD by Persian immigrants (Abdulkhamiddov et al. 1987).

### 20.2.3 GROUNDWATER MANAGEMENT SYSTEM (GMS)

Karez of karez-GM type, where the aligned vertical holes do not correspond to shafts of a gallery (that does not exist) but to wells for groundwater management, have been archaeologically studied only in one region (Karatau) and are suspected wherever the identification of qanāt SGA has not been successful. In that sense, they are the most diffused underground waterworks of West Central

\* South of Nurata, where the slope’s inclination is of 3.5%, a qanāt line 600 m long cannot have a mother well deeper than 10–15 m. If so, the referred qanāt could correspond to one of the eight lines visible in the area, possibly the one with GPS coordinates N 40°32’40.62” E 65°41’54.41”.



Asia, documented or suspected in six regions, and particularly numerous in the Surkhandarya, Nuratau, and Karatau, waiting for hydrogeological and archaeological investigation and confirmation. Isolated short lines have been also detected in peripheral areas.\*

### 20.2.3.1 Northern Bactria (UZ, TJ)

In this region, the presence of karez-GM systems has been documented or suspected in three parallel valleys at the south of the Hissar range: Surkhandarya, Kafirnigan, and Kyzylsu.

- In the SW part of the *Surkhandarya valley*, 15–30 km north of the area, where qanāts have been documented (Section 20.2.2.2), in some right-tributary valleys of the Sherabad river, recent investigations discovered hundreds of karez lines that, when compared with the ones of the local qanāts, appear shorter and with vertical holes smaller and two times nearer, which as a whole makes one suspect the presence of karez-GM type systems (Stančo 2009). These karez lines are most often located in elongated depressions and are surrounded by clustered wells and collector canals, as if intended more for replenishing than for redirecting functions (see Sections 20.4.1 and 20.4.2; Figures 20.5 and 20.9).
- In the *Kafirnigan valley* (TJ), in the SW part of the basin, on the southeastern foothills of the Babatag mountains (Bishkent valley), karez must have once been numerous, as testified by toponyms and archaeological reports (Mandelstam 1966), but today, they are no more detectable on the land surface.
- In the *Kyzylsu* basin (TJ), reference to the possible presence of karez is provided only by the toponymy of a few villages in the mid valley of its two tributary streams, Tairsu and Yaksu.

### 20.2.3.2 Zeravshan, Upper Valley, and Plains (TJ)

Along the low course of the *Magyandarya*, a left tributary of the Zeravshan river, beside the number of underground tunnels quoted above (Section 20.2.1.3), some short karez have also been realized in order to increase the water stock of the canals (Fedchenko 1870).

A few karez lines have also been recently documented in the southwestern periphery of Samarkand, in the piedmont plains of the western spurs of the Zeravshan range (Shishkina and Inevatkina 2012).

### 20.2.3.3 Nuratau Range (UZ)

As said above, the Nuratau range consists of the Nuratau and Karatau-Aktau ranges. Here, three regions must be distinguished: Nuratau Central, between the Nuratau and Karatau-Aktau ranges; Nuratau Southern, on the southern slopes of the Karatau-Aktau; and Nuratau Northern, on the northern slopes of the Nuratau. In all of them, the presence of karez has been documented.

- *Nuratau Central*. The region consists of two large parallel valleys, developing East to West: the Selsai valley, 80 km long, and, on the south of it, the Arasai valley, 50 km long. A total of 200 karez lines have been documented, averaging 1 km in length and stretching all together for total 200 km.  
The most crowded is the Selsai (Kalamadjar) valley, hosting 161 lines: 130 are paralleling and/or succeeding each other along and even inside the dry riverbed of the Kalamadjar

---

\* We describe below just two samples of peripheral karez:

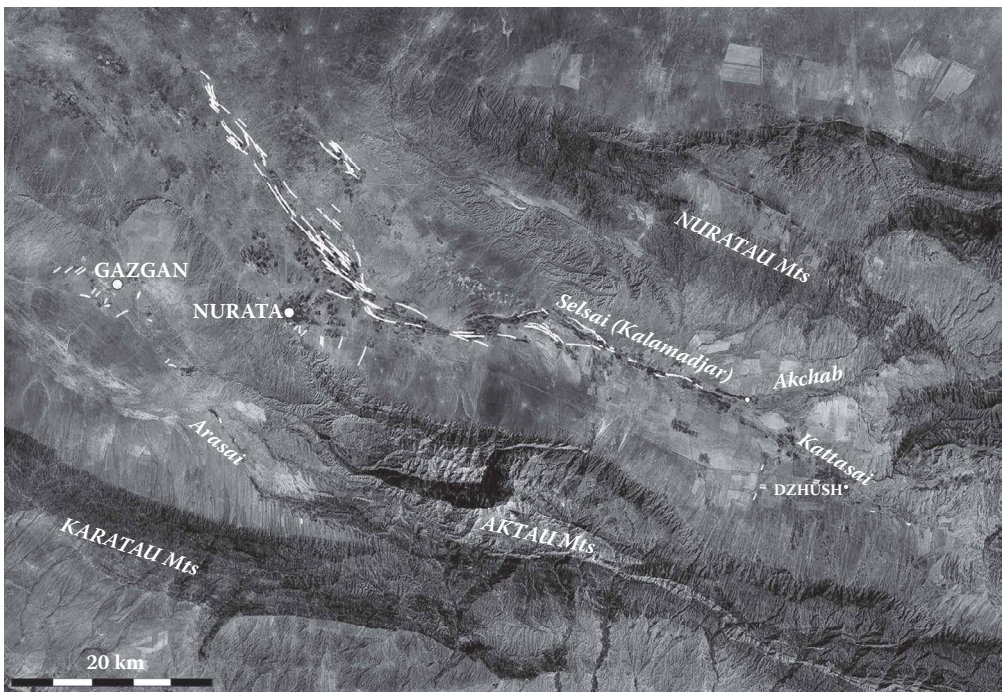
In the southern Kyzylkum desert, 165 km north of Nurata town, on the southern slopes of the Tokhtatau low-mountain range, a village called Karis is fed by two 300 m long karez lines dug into a fossil riverbed.

A single karez line 300 m long, representing the remotest karez-GM of West Central Asia, has been documented in the Anrakhai region of SW Balkhash. It is intended for filtering and purifying the water of a pond and channeling it to the late Medieval Kalmyk Fortress of Kalmaktobe 0.20 ha, seventeen to eighteen centuries AD. (see geographical location in Figure 20.2.1, number 19)

stream (see below, Figure 20.10); 20 are along its 2 upper tributaries; and 11 are located on the piedmont slopes at the south of the valley, of which 2 are at Chuya and 8 are south of the medieval town of Nurata (where N. Dingelstedt reports the presence of some qanāt lines; see Section 20.2.2.3). The Arasai valley hosts 39 lines around the Gazgan village, on the piedmont slopes of its northern side (Figure 20.6).

These karez have been recorded by historical sources,\* ethnographic documents,† and geographical and archaeological reports.‡ Moreover, their presence is witnessed by numerous villages' toponyms and local accounts, and they are detectable on satellite images, with impressive clarity.

- *Nuratau South.* On the southern slopes of the Aktau-Karatau range, in the Karangulsai valley, karez have not been surveyed, but their presence is suspected on the basis of villages' toponyms and by the detection of 10–20 short lines, with wells 5 m far from each other, on satellite images.
- *Nuratau North.* On the northern foothills of the Nuratau range, on the basis of archaeological reports, toponyms, and satellite images, the presence of karez is documented at three sites (Mukhamedzhanov 1969). The archaeologist S. Suyunov studied several karez lines in the easternmost site (Farish district). He does not mention the presence of any gallery but describes the vertical holes of one line that has source in the fossil bed of the Suloklisai (Sulaklisai) river; holes are at intervals of 15 m and have depth varying from 25–20 to



**FIGURE 20.6** Map of the karez of Central Nuratau (UZ). White line: karez-GM. (on satellite image, SAS. Planet.)

\* These karez are quoted in diplomas dated at the times of the Djuibars sheiks (sixteenth century AD) where their professional builders are called “karizgher”.

† The Uzbek specialist in irrigation archaeology YJ Gulyamov, in his article “Nur Bukhaurskii”, wrote: “According to the sayings of the local mirabs, in the past there were 360 karez in the Nurata steppes”... The names of some of them, like “Zulim” or “Zulfiqar,” reflect the date of their building: the firsts in 1563 AD, the seconds in 1696. Only few of these karez are still in use because the local population prefers using modern pumps for irrigation.” (Gulyamov 1979).

‡ See (Nizomov 2008) and (Nazarov et al. 2015).

4–2 m; the best preserved one has a mouth with diameter of 1.3 m and a mound 1.65 m high. He dated the karez on the basis of the surrounding medieval settlements to the eleventh to twelfth century AD (Suyunov 1999, pp. 11–12).

#### 20.2.3.4 Usrushana, Western Part (UZ)

Usrushana is the region located north of Samarkand, between the Turkestan range and the Syrdarya river. Here, besides the surface-water SGA of the Basmanda and Aksu valleys in the Usrushana's eastern part (quoted above, Section 20.2.1.3), the historical presence of groundwater karez is documented in two areas of its western part: on the northern piedmonts of the Turkestan range (Sanzar valley) and in the immediate following plain, which for its aridity is called “Hunger steppe” (Bilalov 1980). Today, only a few lines are visible.

- In the upper *Sanzar* valley, around the village of Nauka, in 2011, some technical works brought to light the segment of an unidentified underground structure consisting of a 15 m long gallery dug at a depth of 15 m, reinforced by a wooden frame and provided with one vertical shaft (Pardaev et al. 2012). In the lower Sanzar valley, around 23 km upstream from the town of Jizakh, the historical presence of several hundreds of karez lines is documented, each averaging 300 wells or more (Bekturova et al. 2007, p. 70), of which today only a few can be identified.\* Of this area, the Uzbek archaeologist Suyunov describes an archaeological complex made of 1 medieval town (Kurgan-tepe, second century BC to eighteenth century AD); 21 medieval villages; 2 karez lines 1.5 km long, dated to the sixteenth century AD; and around 5000 ha of irrigated land (Suyunov 1999, p. 14).
- The “Hunger steppe” is famous for its dryness and its huge medieval and soviet complex of irrigation networks that catch water from the Syrdarya river. In its southern part, out of reach of irrigation canals, the presence of karez is quoted by relatively old reports, and a few lines can be detected on satellite images today. According to NP Petrovski (1894), at the end of the nineteenth century, all area at the west of Dashtabad (Ulyanovo) was “full of remains of karez with their wells recognizable on the surface by their funnel-shaped depression”; and the karez on the alluvial fan of Akbulak had been freshly restored around 1880 by the Kyrgyz (Kazakh) Mulla Ismankul (Bilalov 1980, p. 33).

#### 20.2.3.5 Ahangaran Valley (UZ)

In the Chach region, south of Tashkent, on the left bank of the Ahangaran river (an historical mining district), the presence of karez is just suspected on the basis of the high number of toponyms.

#### 20.2.3.6 Karatau Range (KZ)

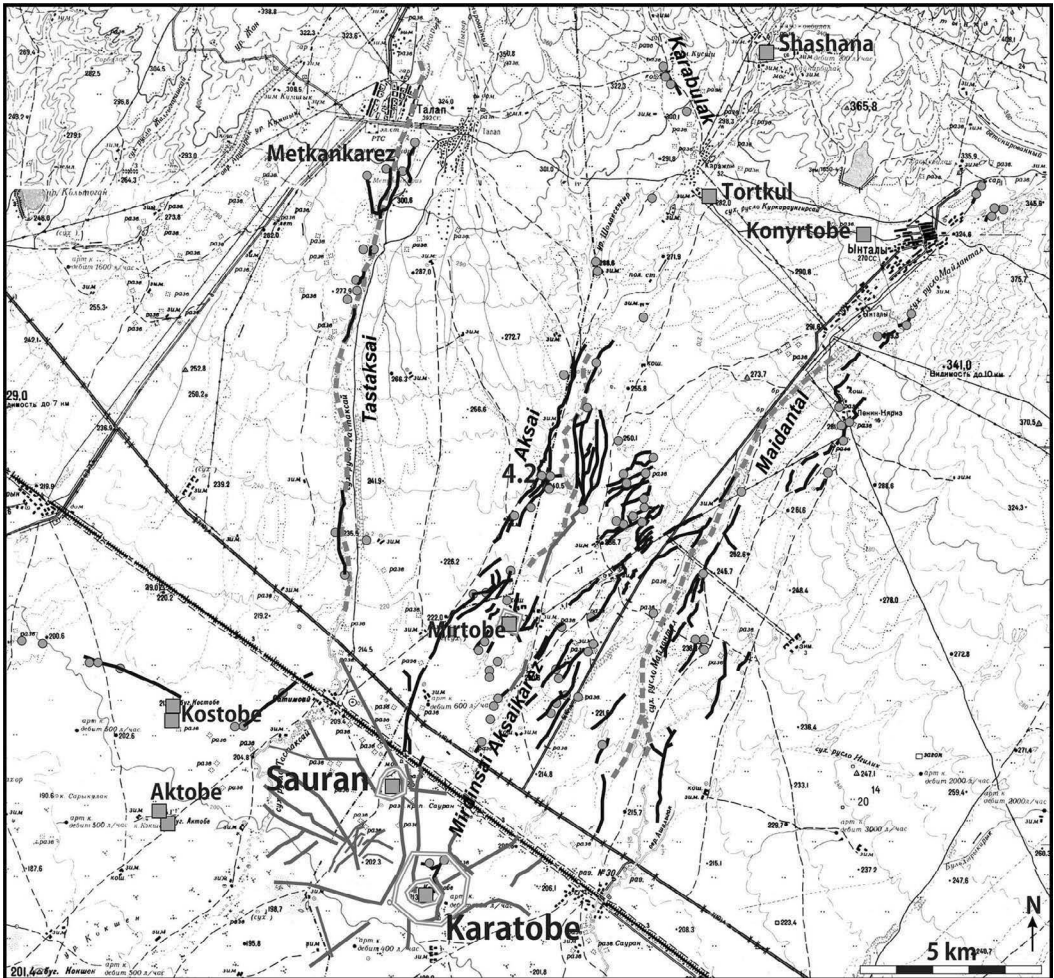
Karez are detected in the southern slopes of the Karatau range, in 5 of the 10 valleys of the Turkestan oasis, and, on the basis of the Dingelshtedt report (Dingelshtedt 1889, pp. 280–290), a few lines must be present on the northern foothills of the range, in the surroundings of the medieval town of Suzak.

- By far, their main concentration is found in the basin of the westernmost valley, the one of the Tastaksai, Aksai, and Maidantal rivers (TAM), where the medieval town of Sauran is located.† Here, 261 karez lines (interacting within 47 karez systems), with an average length

\* Today, here, like in many other places, most of the karez have been opened and transformed into aryk (canals) and can't be seen anymore on the land surface or in satellite images.

† Sauran is a Late Medieval (thirteenth to eighteenth century AD) walled town of 53 ha, surrounded by agricultural farms, within a radius of 2–3 km. It quickly developed after the decay of four previous towns of the area.





**FIGURE 20.7** Map of the karez of the southern slopes of Karatau range (TAM basin, KZ). Black line: karez-GM; gray line: drainage canal; gray dashed line: dry riverbed; gray dot: medieval village; gray square: medieval walled town; gray double line: town walls.

of 471 m, totaling all together 123 km of development, and around 10,000 aligned vertical holes (Figure 20.7) are counted. Most probably, this huge waterwork system evolved gradually in a few centuries, together with the knowledge of the hydrogeological conditions of the area. However, given such knowledge, the entire system could be materially realized in relatively short time and with small labor investment: a brigade of 100 men could dig manually 10,000 wells 3–5 m deep in less than 3 years (Sala 2010). A few campaigns of archaeological works have been dedicated to the study of TAM karez lines, trying to find traces of underground galleries, and have always ended up with negative results, so that the aligned vertical holes are today interpreted as wells of a karez-GM system.

Information about the TAM karez is given by historical sources (Makhmud Zainaddin Wasifi, sixteenth century AD), ethnographic accounts (Dingelshstedt 1889), and reports from three archaeological expeditions (Groshev 1996, pp. 180–189, 2004; Sala and Deom 2005; Sala et al. 2010; Akylbek 2011). Apart from Dingelshstedt, who had the chance to see somewhere a couple of karez with gallery, nobody mentioned or found galleries interconnecting wells.

### 20.3 SHAFTS OR WELLS? QANĀT OR “KAREZ”?

The features and functions of the aquifer SGA (qanāt) and of their constituting elements are quite complex and often misunderstood. Generally disregarded are the geomorphological-geological features of the terrain (mountain, foothill, plain, and depression) and of the itinerary of the system, in relation with the type of water source, groundwater circulation, regolith and soil, and so on. Concerning the elements and their functions, the tunnel's functions of water catchment and transport are emphasized, and the processes of water infiltration through the internal walls of tunnels and shafts,\* as well as the condensation of atmospheric moisture on them,† are underestimated (Laureano 2012).

Moreover, some of the vertical holes that from the land surface appear as morphologically similar to shafts can instead correspond to something having different structure and function. For example, in the context of aquifer SGA, besides aligned air shafts intended for maintenance and ventilation, sets of vertical holes dug above the start or on the sides of the main line, evidently intended for the artificial recharge of groundwater, are also present.‡ In other words, these holes are not shafts of a tunnel but are drainage and infiltration *wells*, which are intended for catching ephemeral surface water (from seasonal regimes or flash-flood abrupt events or meteoric run-off) and for percolating it underground in order to replenish the aquifer, the mother well, or the tunnel itself. Such wells appear in chaotic clusters (see Figure 20.8) or more or less aligned along the itinerary of a dry hydrographic network that has high infiltration capacity (see Figures 20.9 and 20.10). In this last case, the line of wells would sometimes end above the start of a qanāt, but very often, it stands as an isolated and independent scheme, unrelated to any kind of SGA system.

Such lines of wells without underground gallery, in the opinion of the author, constitute the most common case among the aligned vertical holes detected on the land surface of West Central Asia, and represent a most intriguing hydrogeological device that deserves study and interpretation.

First of all, within any artificial groundwater system, two main subsystems and managerial functions must be distinguished: the management of the groundwater source and the management of the water transport to resurgence. In the case of the classic qanāt of East Iran, where major groundwater basins are established, the source is a deep confined aquifer, of which the water flow is out of reach of managerial control: a mother well is dug as a water storehouse naturally replenished, and the main task is represented by the tunneled transport of its water for tens of kilometers. However, when such technology is applied to multiple local shallow unconfined aquifers of limited storage capacity, which is the common case in the alluvial fans of the piedmonts of West Central Asia, the aquifer water volumes can and must be previously enhanced through surface-water infiltration and interconnections. And such task, by importance, complexity, and labor investment, becomes equivalent and even superior to the task of transporting and bringing water to emergence at such point that in some regions (such as the Nuratau and Karatau mountains), it represents the characterizing feature of the karez system itself.

The expedients used for implementing the two tasks of aquifer infiltration and of water transport to resurgence are different. The management of the aquifers (replenishment and redirection of their waters) can be done by clusters or alignments of infiltration wells interacting with fossil riverbeds.

\* In the Ashrat region, near the modern Bagyr village, on the west of the Nisa fortress, a qanat line 1 km long and sloping from 369 to 343 m asl presents an anomalous itinerary across a train of four dry riverbeds, witnessing that its gallery plays functions of both infiltration and transport. GPS coordinates: N37°57'38.20" E58°11'30.78".

† Condensation of dew and fog, also called “occult” or “horizontal” precipitation, in arid regions represents an important contribution to moisture. It provides daily minuscule quantities but within the year can amount to more than half of vertical precipitation. The condensation on the internal walls of a qanat 1 km long could amount to 600 m<sup>3</sup> per year, that is, to a day of outflow from a weak qanat.

‡ “Sometimes, these supplies are associated with collateral works for the replenishment of water in the soil layers they pass through, such as weirs interred in the riverbed or roadbed torrents and other devices to direct flooding.” (Laureano 2012, p. 9)



**FIGURE 20.8** Clusters of wells at the start of the qanāt line “golan-kariz.” Baharden region, northern piedmonts of Kopet-Dag range. GPS coordinates: N38°23'13.04" E57°22'49.43". (satellite image, SAS.Planet.)

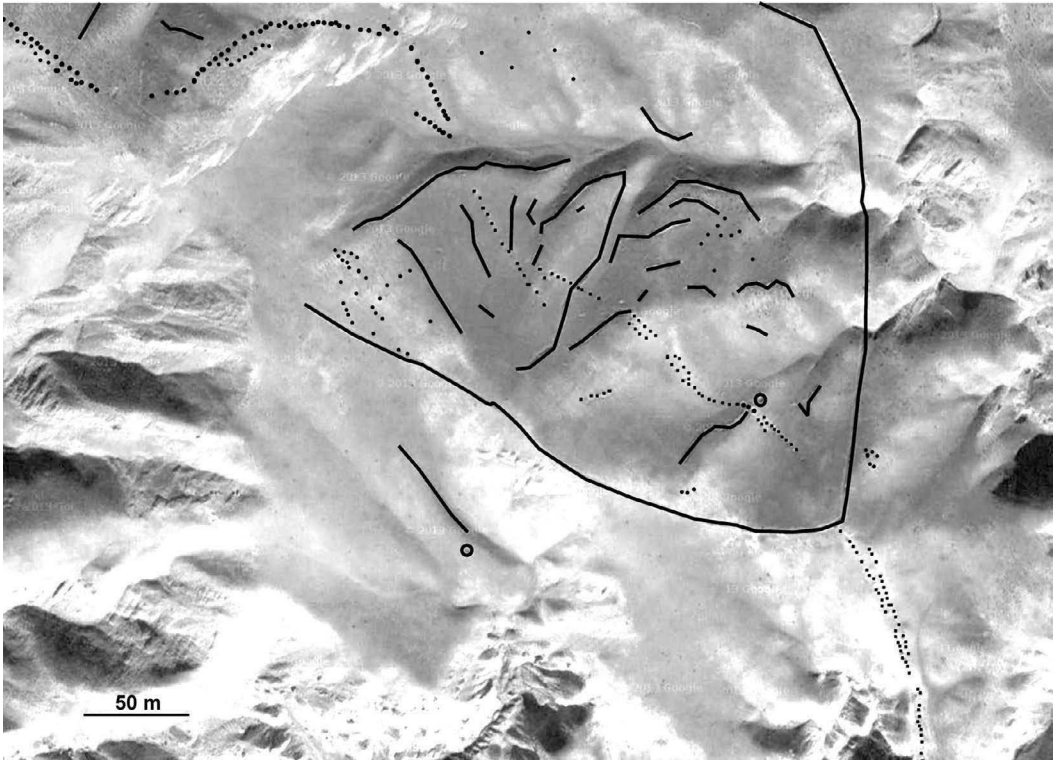
Water resurgence can be provided in several ways that do not exclude each other, not just by an SGA qanāt but also by a terminal simple tunnel without shafts, by a transversal drainage canal, or, in particular geomorphological and hydrogeological locations, even by spontaneous water resurgence out of gravity and/or micro-artesian pressure.

These karez-GM systems, when compared with classic Iranian qanāts, are more reduced in scale; they have shorter length, shallower reaches and lesser discharge, but their effectiveness, that is, their specific discharge (L/sec/km), is generally higher and their relative costs are much lower.

We can summarize by saying that in West Central Asia, as soon as we move North and far from the Iranian hydrogeological structure, the artificial management of shallow aquifers becomes more important and the groundwater works develop an unexpected wider and original character, inclusive of two different and equally important subsystems of tasks: for aquifer management (karez-GM) and for terminal water transport to resurgence. We call such systems as GMS, or, in the absence of major confusions and like the local inhabitants, we can keep calling them simply “karez,” Central Asia karez, or CA-karez.

Therefore, the question arises, why the presence of such subsystem of aligned infiltration wells in Central Asia does not have been pointed out yet, despite the several studies of aligned ground holes? A possible answer is that the qanāt scheme served as the best tentative model for approaching the study of lines of vertical holes and promoted the archaeological search for underground galleries; however, at the same time, it discouraged the perception of other possibilities. Underground galleries have been archaeologically studied in only three of the eight regions spoken above (mainly in the Kopet-dag, and only a few cases in Surkhandarya and Fergana), by the excavation of the final





**FIGURE 20.9** Karez-like systems in the Djidabulaksai valley at the west of the Kallamazar village (Surkhandarya region). Here, collector channels (black lines) are dug at the bottom of the slopes of the dendritic drainage, and clusters and lines of vertical holes (black dots) are dug in depressions, as if intended for replenishing local shallow unconfined aquifers. The double line of wells continues 0.7 km further south, ending by enhancing a fresh water spring in the surroundings of a farm. GPS coordinates: N37°49'36.04" E66°59'53.53". (satellite image, Google Earth 2013.)

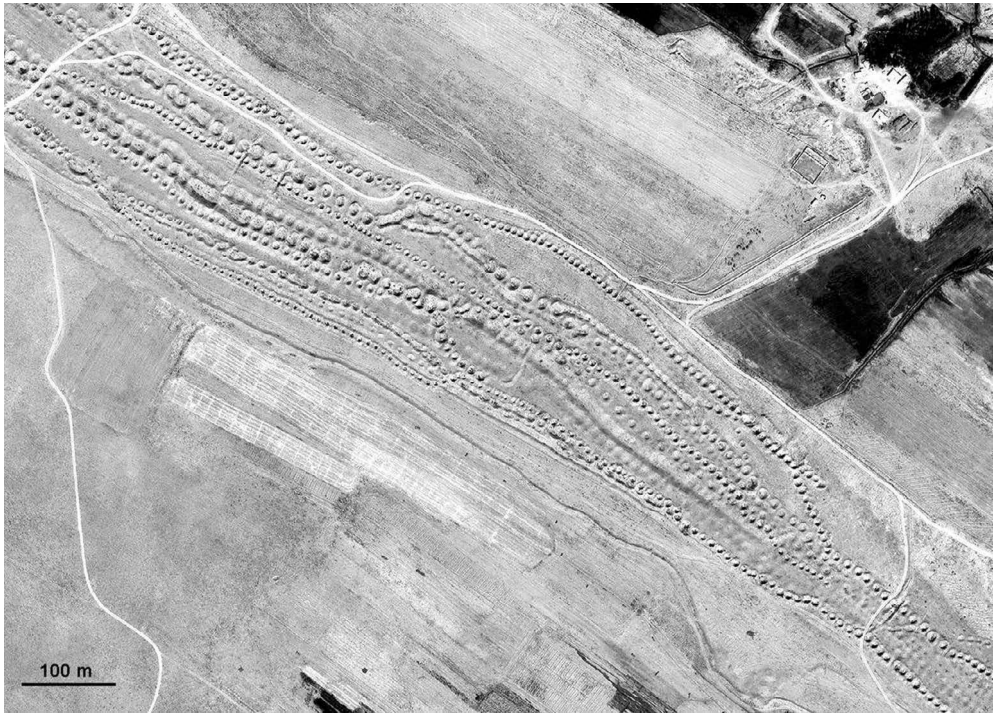
segments of the line,\* and are just suspected in Central Nuratau, but then, their presence has been extrapolated to all other components of the system, to all the lines of the region, and finally, also to the lines of the other regions.

An example of the persistence of the qanāt paradigm beyond its sustainability is provided by the historical accounts and the archaeological reports concerning the karez lines of the TAM region of the Turkestan oasis in Kazakhstan, which are well known to the author. The sixteenth century historian Wasifi quotes the presence of two karez lines but does not give information about their technical aspects (Boldyrev 1957, pp. 167–168). Dingelshstedt, at the end of the nineteenth century, attributes the introduction of the karez technology in the region to the sixteenth century, quotes the presence of 18 karez lines still active, and, after supervising nine of them, found two cases provided with gallery, one of which is in the TAM region (Dingelshstedt 1889, pp. 280–290).

In 1986–1988, the archaeologist Victor Groshev detected two karez lines north of the ruins of the medieval town of Sauran, which interpreted as the ones quoted by the medieval historian Wasifi (see Figure 20.12). According to his report of the 1996, he excavated two wells at the depth of 4 m,† without finding any trace of underground galleries (Groshev 1996, pp. 180–189), but a few years

\* The outlet gallery that is normally studied could be just a few hundred meters long tunnel applied as final element of a complex karez-GM system.

† In reality, 11 wells were excavated, 6 of which were dug by bulldozer.



**FIGURE 20.10** Band of 12 parallel karez lines dug into the dry bed of the Kalmadjar river, 4 km north of Nurata town (Central Nuratau region, UZ). GPS coordinates: E65°45'02.65" N40°35'32.65". (satellite image, SAS.Planet.)

later, in a popular article of the 2004, he quotes the excavation not of two but of three wells to a depth of 6 m and the finding of traces of underground galleries (!) (Groshev 2004).

In 2002, the Lab of Geoarchaeology of Almaty, besides extensive surface survey and documentation of the entire karez complex of the TAM basin, excavated one well 4 m deep of the same line near Sauran and also analyzed other TAM sites such as the profile of a few karez wells exposed by the erosive floods of the Maidantal river and some collapsed wells that have been enlarged by shepherds for water collection. In each case, no trace of a gallery connecting wells has been found. Moreover, verbal accounts gathered from local aged farmers reported that “there were no galleries, the water was flowing by itself from one well to the other.” Further archaeological excavations of two contiguous wells of the same line were implemented in 2011 by the archaeologist Serik Akylbek down to the water table, today at the depth of 12 m, with the same negative result.

## 20.4 GROUNDWATER MANAGEMENT SYSTEM (GMS)

Simple isolated wells dug into a saturated aquifer are not object of the present article but present few factors that must be underlined in order to understand the functioning of larger systems of clustered and aligned wells:

- The water volume of the well cavity, in the low-porosity silty clay soil of the alluvial fans of arid Central Asia, is 10 times higher than the yield of the water-bearing material of the aquifer.\*

\* The specific water yield (% of volume) of a saturated aquifer depends on the soil texture: clay holds the 0%–7%, silt and fine sand 10%–28%, sand 20%–35%, and gravel 25%–35%.

- Such kind of low-porosity soil has also low water conductivity,\* which would retard the natural recharge of the wellfield.
- Moreover, in the context of such low-porosity soil, a low-permeability layer (aquitard) above a shallow aquifer, supporting its semi-confined character, can be easily formed. In that case, the dig of the well down into the aquifer encounters a differential pressure, favoring a water rise inside the well above the water table (a hydraulic head higher than the water table), that is, a micro-artesian effect.

In the case of clustered wells (wellfield), the total volume of water yield and infiltration is just multiplied correspondently to their number. However, in case the wells are arranged along a sloping line, then three additional factors intervene:

- The differential gravity pressure induced by the sloping gradient will enhance the water infiltration and the micro-artesian effect between wells.
- The wells' alignment favors a privileged itinerary of groundwater circulation, particularly in the case when wells are deep enough to connect overlapping shallow aquifers.
- In case of lines of wells along a fossil riverbed, the groundwater circulation will be strongly enhanced by the presence of horizontal bands of alluvial pebbles. This is also valid for the riverbed itself, which can then represent a potential substitute of artificial wells' lines.

Altogether, the factors spoken above support the idea that systems of clustered or aligned wells could have been used as devices for managing the volume and circulation of groundwater resources, independent of the technique by which such groundwater is finally brought to emergence. Moreover, in the case of aligned wells, under optimal geomorphological and hydrological conditions, these factors also make possible a spontaneous water resurgence at some point along the line itself, which would make of such device an independent system for both groundwater management and water emergence.

### 20.4.1 CLUSTERS OF WELLS

Like single wells, sets of wells are relatively common and are located in areas with high water table of shallow unconfined aquifers, clustered on piedmont terraces below steep slopes, aligned along dry riverbeds or transversally between two delta distributaries, and so on. When in small number of 5–10, these wells are just intended for multiplying the water stock that can be uplifted; when numerous, these wells are infiltration wells for replenishing the aquifer.

The last ones deserve special attention. In fact, they are important elements for groundwater replenishment in the context of complex hydrogeological systems made of elements of different kind: clustered wells, lines of aligned wells, and fossil riverbeds for the purpose of groundwater management; and a final pond, an enhanced or spontaneous spring, a qanāt SGA, an open drainage canal, and so on for water resurgence.

A simple but impressive example of a system of groundwater replenishment, consisting of just infiltration wells and resurgence ponds, is found in the groundwater basin of the low Kotur-Gyaur river valley at the west of the Kopet-Dag range (TM). This is the most arid desert that from antiquity was crowded with fields and towns, until its total abandonment during Timurid times. Here, during the medieval period, clusters of wells were implemented in takyr depressions in order to subtract

---

\* Hydraulic conductivity depends on soil porosity, saturation, and slope. For vertical movements, clay has conductivity of  $10^{-9}$ – $10^{-6}$  cm/s, silt has  $10^{-6}$ – $10^{-4}$  cm/s, sand has  $10^{-4}$ – $10^{-1}$ , and gravel has  $10^{-2}$ – $1$  cm/s.

surface floods' water from evaporation, pour it underground, replenish a shallow aquifer, and rise its water table, until water emerges in the lowest relief point as a pond.\*

Infiltration wells interacting with a qanāt device for replenishing its mother well or its tunnel are found wherever qanāts are documented, that is, in most of the alluvial fans of the Kopet-Dag northern piedmonts. For example, on the Baharden alluvial fan, located at the center of the Kopet-dag piedmonts and holding the highest concentration of qanāts of the region, clusters of wells are surrounding the start of the qanāt lines (Figure 20.8).

More complex systems of groundwater management where clusters of infiltration wells interact with lines of wells and with fossilized remains of dry hydrographic networks are found in all the eight regions (as shown in the below sections).

#### 20.4.2 ALIGNED WELLS

Aligned wells are the most important elements of the karez-GM systems of West Central Asia, not just because they can perform replenishing function but also because they allow to direct the groundwater circulation across overlapping and adjacent aquifers by favoring specific corridors, by using fossil riverbeds, or even by breaking through occasional aquitard zones of low hydraulic conductivity.

Aligned wells are most often built on gently sloping (0.5%–1%) alluvial fans and plains and are parallel to dry riverbeds. Their starting segment is sometimes located in seeping areas or is surrounded by clusters of wells and drainage canals, but most often, it is applied to a dry riverbed (Figure 20.9). Their course is sometimes represented by a single line but most often by few parallel lines or even by bands of lines inside a dry riverbed (Figure 20.10). Their terminal segment is most often ending in the same dry riverbed or in a neighbor riverbed or is finally releasing water as an enhanced spring or into a short tunnel or in a drainage canal.

Complex systems of aligned wells are most widespread in the Surkhandarya, Nuratau, and Karatau regions, where the groundwater management of the aquifer has been developed at such point that the water transport, and, in some cases, even the water resurgence, can happen without the help of underground galleries. A deep knowledge of hydrogeological principles must be suspected by part of the building masters of such marvelous and sustainable implementations.

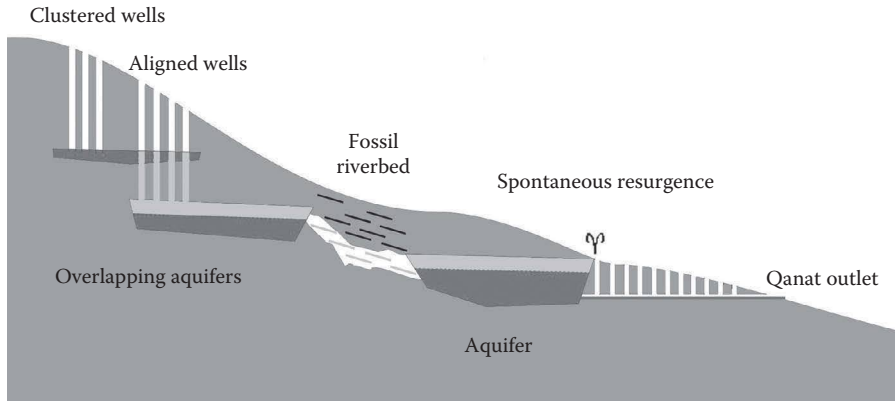
The principle underlying these schemes is that a number of shallow overlapping aquifers distributed at different elevation on the sloping alluvial plain must be recharged by clustered and aligned wells and must be wisely interlinked by wells' lines and fossil riverbeds. In that way, enhanced volumes of groundwater will circulate, from aquifer to aquifer, until enriching a final water-bearing soil, where resurgence waterworks are applied. Under favorable geomorphological, hydrological, and climatic conditions, a very high water table will be established somewhere along the way, favoring the spontaneous water resurgence, by gravity and micro-artesian pressure, from an enhanced spring or from the last wells of a line† (Figure 20.11).

Small canals are often paralleling the last segment of such lines, directed to small fields and villages located in proximity of these spontaneous water resurgence points; large agricultural areas and towns are built at the terminal water outlet of the system.

\* In subsequent soviet times, the entire Messerian plain has been covered by a regular lattice of lines 40–50 km long in the SN and WE directions, intersecting each other every 1–2 km, made of wells 100 m far from each other. They are clearly visible on satellite images, looking as a gigantic waterwork. Instead, they represent geological drills for hydrocarbons research.

† The articles of R. Sala on the subject of karez show successive steps of understanding. At the beginning (Sala 2003), the author is still showing some confidence in the existence of classic shaft-and-gallery systems. Then, in the following articles, after the absence of galleries was finally proved, the spontaneous water resurgence along the lines of wells is suspected and mainly attributed to a micro-artesian effect. Finally, in the present article, the geomorphological conditions of the terrain and the distribution of shallow aquifers are pointed out as precondition for the realization, by aligned wells and fossil riverbeds, of a complex Groundwater Management System (GMS), from which the water outflow can be provided in different (and complementary) ways: by an SGA, a drainage canal, or spontaneous resurgence out of gravity and micro-artesian pressure.





**FIGURE 20.11** General scheme of a Groundwater Management System (karez-GM, GMS). Clustered wells replenish the aquifer; aligned wells and fossil riverbeds interconnect aquifer lenses at different elevations. Water resurgence can happen spontaneously or by shafts-and-gallery transport (qanāt). (Courtesy of R. Sala.)

### 20.4.3 THE GMS OF THE TURKESTAN OASIS

The TAM region displays a majestic case of groundwater management, concerning an area of  $20 \times 20 \text{ km}^2$ . The seasonal streams of Tastaksai in the West and Maidantal in the East, as soon as they leave the mountain zone, start converging the respective groundwaters in a depression located between them, where the fossil riverbeds of the almost inexistent Aksai stream are detectable. This convergence point represents the upper start of the TAM GMS, the main objective of which is to provide water 20 km south, 60 m asl lower, to the medieval agricultural fields and town of Sauran (Sala and Deom 2005; Sala et al. 2010; Figure 20.7).

The provision of water to the Sauran plain does not happen by direct water flow but through the complex alternation of wells' lines (karez lines) and paleo riverbeds, which replenish and put in connection discontinuous shallow aquifers located at different elevations. Two main GMS karez systems of groundwater circulation are established on the right and left banks of the Aksai riverbed: the right way is fed by the Tastaksai groundwaters, while the left way is fed by the Maidantal's groundwaters. Only two lines of wells at the end of the right bank scheme (the lines that have been object of archaeological excavations) reach finally the northern borders of the Sauran town (Figure 20.12); the other wells' lines and the final groundwater stock as a whole are caught by two open-drainage canals (5–6 km long) converging to the town from the final delta distributaries of the Tastaksai river on the West and the Maidantal on the East.

Several points of probable spontaneous water resurgence are detected along the way, starting from wells along the course of particular karez lines. In fact, in 50% of the cases, the middle and lower segments of the karez lines are paralleled by a canal, and the corresponding wells have an inclined mouth's plane, as if intended for discharging groundwater into it.

In proximity of these points, traces of ancient fields and the ruins of more than 100 medieval farms are found. At the very center of the left bank system, 5.5 km north of Sauran, the ruins of a rectangular walled town of 19 ha, Mirtobe, are standing. They subsisted during four centuries (fourteenth to seventeenth century AD) in a desert landscape totally fed by resurgent karez waters.\*

\* GPS coordinates of Mirtobe: N43°33'28.69" E67°48'29.73".



**FIGURE 20.12** Aerial photo of karez line developing until the northern periphery of the medieval town of Sauran (thirteenth to eighteenth century AD). View to SE. GPS coordinates of the first well at the bottom left corner of the photo: N43°32′04.37″ E67°46′28.80″. (Courtesy of R. Sala.)

This corresponds to the “*charbag*” (quadrilateral garden)\* that Wasifi quotes as built on one of the Sauran karez lines, “similar to nothing that people traveling all around the world had ever seen neither on land neither on sea” (Boldyrev 1957, pp. 167–168).

## 20.5 CONCLUSIONS

Underground waterworks and, in particular, groundwater mining structures have been essential tools for the medieval colonization of the most arid expanses of West Central Asia. A few different types can be distinguished on the basis of the kind of water source and the technique of its transport to emergence: surface SGA (tunnels), aquifer SGA (qanāt), karez-GM.

Both the last two structures are applied to groundwater sources but differ by function and technology: qanāts are mainly planned for groundwater catchment and transport through galleries with shafts, whereas karez-GM are mainly devoted to management (replenishment and redirection) of groundwater circulation by lines of infiltration wells. The two types are potentially independent but not incompatible structures and can interact complementarily in the context of a complex system (GMS).

The SGA waterworks have clearly an Iranian origin, whereas karez-GM seem to be the result of an original West Central Asian development adapted to hydrogeological contexts made of multiple shallow overlapping aquifers.

The karez-GM are by far the most widespread type of waterworks in West Central Asia, which is explained by the fact that, given a preliminary sound knowledge of groundwater circulation, they represent an easy, quick, cheap, and most sustainable way of groundwater mining. Despite these highly profitable features, in the last 100 years, they have been substituted by the hydraulic schemes

\* “This highly structured geometrical scheme, called the ‘chahar bagh,’ became a powerful metaphor for the organization and domestication of the landscape, itself a symbol of political territory” (Fairchild Ruggles 2008). The Islamic “char-bag” are inheritors of the Old Persian tradition of paradise (in Persian meaning “walled”: pairi = around, diz = walls) gardens, always built in arid landscapes.



introduced by the Russian and Soviet colonizations (dams, canals, pipelines, electric pumps), and finally their technology has been totally forgotten.

The rediscovery of this obliterated technique represents a rare contribution by part of the archaeological discipline to the geological sciences, that is, to the hydrogeological and hydro-engineering disciplines; and its renewed implementation could have worldwide economic significance for modern water mining and land reclamation in arid zones.

## REFERENCES

- Abdulkhamiddov, A. and Isamiddinov M. 1987. O karyznom oroshenii Ferghany [The karez irrigation in Fergana]. *Obschestvennye Nauki v Uzbekistane [Social Sciences in Uzbekistan]*, 12:27–30.
- Abdullaev, K. and Stančo L. 2004. Archaologiskye rabotu na Dzhandvlyateppa [Archeological works in Dzhandvlyateppa]. In *Archeologicheski issledovaniya v Uzbekistane 2003 gadu [Archeological investigation in Uzbekistan of the year 2003]*, vol. 4. Tashkent, 25.
- Akylbek, S. 2011. Excavation report, Archaeological Expertise, Almaty. (archive material, in Russian language)
- Arendarenko, G.A. 1889. *Dosugi v Turkestan* [Leasures in Turkestan]. St. Petersburg, Russia.
- Bekturova, G.B. and Romanova O.A. ed. 2007. *Traditsionnye znaniya v oblasti zemlepolzovaniya v stranakh Tsentralnoi Azii: informatsionyi sbornik [Traditional knowledge in the land use in the Central Asian countries: digest of information]*. St. Petersburg, S-Print Russia.
- Bilalov, A.I. 1980. *Iz istorii irrigatsii Ustrushany (Materialnaya kultura Ustrushany, vyp. 4)* [From the history of the irrigation of Ustrushana (Material culture of Ustrushana, issue 4)]. Dushanbe, Tajikistan: Doshin.
- Boldyrev, L.N. 1957. *Zainaddin Vasifi. Tadjikskii pisatel XVI AC: opyt tvorcheskoi biographii* [The XVI century Tajik writer Zainaddin Wasifi: an example of creative biography]. Stalinabad, Tajikistan.
- Dingelstedt, N. 1889. *Opyt izucheniya irrigatsii Turkestan'skogo kraya* [Experience of study of the irrigation in the Turkestan region], *tome I-II*. St. Petersburg, Russia.
- Fairchild Ruggles D. (2008). *Islamic Gardens and Landscapes*. University of Pennsylvania Press, 39.
- Fedchenko, A.P. 1870. Puteshestvie v Turkestan [Travels in Turkestan]. *Turkestan vedomosti, 1870*, 15:91–92. (reprinted in 1950, Moscow).
- Groshev, V.A. 1996. *Drevnaya irrigatsia iouga Kazakhstana* [Ancient irrigation in south Kazakhstan]. Almaty, Kazakhstan.
- Groshev, V.A. 2004. Kyarizy Saurana [The karez of Sauran]. *Kumbez 2004*, 2:13.
- Gulyamov, Y.G. 1979. Nur bukharskii [Bukharian Nur]. In *Etnografiya i arkhologiya Srednei Azii* [Ethnography and archaeology of Central Asia], ed. A.V. Vinogradov, 133–138. Moscow.
- Hasanov, N. 2014. Yer osti suvlari “korizlar” va ulardan foydalanish tarixi (Nurota tumani misolida) [the Groundwater wells “karez” and their usage in history (the case of the Nurata district)]. MSc diss., Navoi. (archive material, in Uzbek language)
- Kabulov, E. 2015. Novye dannye o kyakiznoi sistemy orosheniya na yuge Uzbekistana [New data on irrigation by karez system in South Uzbekistan]. In *Sbornik publikatsii nauchnogo zhurnala “Globus” po materialam II mezhdunarodnoi nauchno-prakticheskoi konferentsii: «Dostozheniya i problemy sovremennoi nauki*. [Journal “Globus” 2015], pp. 9–13. St. Petersburg, Russia.
- Karmysheva, B. 1976. *Ocherki etnicheskoi istorii iujnykh rejonov Tajikistana i Uzbekistana (po etnograficheskim dannym)* [Essays on ethnographic history of the southern regions of Tajikistan and Uzbekistan (on the basis of ethnographic data)]. Moscow: Nauka.
- Kolodin, M. 1981. *Vada i pustini* [Water and desert]. Moscow: Mysl.
- Kozhemyako, P.N. 1963. Osedlye poseleniya Talasskoi doliny [Sedentary settlements in the Talas valley]. In *Arkhologicheskie pamiatniki Talasskoi doliny*, pp. 145–224. Frunze.
- Laureano, P. 2012. Water catchment tunnels: qanat, foggara, falaj. An ecosystem vision. *Water Science & Technology: Water Supply*, 10(3):337–349.
- Mandelstam, A.M. 1966. Kochevniki na puti v Indio [Riders on the way to India]. In *Works of ‘Tadj. Archeol. Exp. Inst. Arch. Acad. Sc. SSSR’ and ‘Inst History named after A. Dolisha Acad. Sc. Tadj SSR T V’*, MIA № 136, Introduction. Moscow-Leningrad.
- Markov, E. 1901. *Rossiya v Srednei Azii: ocherki puteshestviya po Zakavkazyu, Turkmenii, Bukhare, Samarkandskoi, Tashkentskoi i Ferganskoi oblastyam, Kaspiiskomu moryu i Volge* [Russia in Central Asia: essays about travels in the Caucasus, Turkmenia, Bukhara, Samarkand, Tashkent and Fergana provinces, Caspian sea and Volga]. St Petersburg. <http://rus-turk.livejournal.com/138202.html>.

- Mukhamedzhanov, A.P. 1969. Iz istorii drevnikh vodnykh sooruzhenii v Uzbekistane [From the history of ancient waterworks in Uzbekistan]. In *Zemli drevnego orosheniya i perspektivy ikh selskokhozyaistvennogo ispolzovaniya* [Ancient irrigated lands and the perspectives of their agricultural use]. Moscow.
- Nazarov, H.V. and Tugarina, M.A. 2015. Oput ispolzovaniya drevnix vodozabornix sooruzheniy dlia sovremennogo vodosnabzheniya [The experience of the use of ancient water catchment devices for modern water supply]. In *Sbornik docladov na Vsirossiiskoy studenskoj nauchno-practicheskoy XIV konferenzzii studencheskoj nauchno obshestva "Sovremennye issledovaniya b geologii" 10-12 apreliya 2015 goda* [Proceedings of the students from all Russia at the scientific-practical XIV conference "Current research in geology," April 10–12, 2015]. St. Petersburg.
- Nemtseva, N.B. 2009. Rabat-I Malik, XI-nachalo XVIII vv. (arkheologicheskie issledovaniya) [Rabat-I Malik, XI-beginning XVIII AD (archaeological investigations)]. Working paper of the IFEAC, № 33, Tashkent.
- Nikshich, I.I. 1924. *Kopet-Dag. Geologicheskie i gidrologicheskie glavnogo issledovaniya v Poltoratskom uезде Turkmenskoi oblasti v 1923* [Kopet-Dag. Geological and hydrogeological main investigation of the Poltorat (Ashgabat) district of the Turkmen province in 1923]. Tashkent, Uzbekistan.
- Nizomov, A. 2008. Uzbekistoning kadimni gidrotekhnika inshootlari geografisi [Geography of ancient hydro-technical constructions]. *Gidroingeo*, Tashkent, Uzbekistan (in Uzbek language).
- Ovezov, M. 1973. Kariznaya sistema vodosnabzheniya kopetdagskoi gruppy raionov Turkmenii v XIX - nachale XX v. [The kariz water supply system del Kopet-Dag group del Turkmen district during the XIX and early XX century]. In "*Ocherki po istorii khosiaistva narodov Sredney Asii i Kazakhstana* [Essays on the history of the farming peoples of Central Asia and Kazakhstan]". Trudy In-ta etnografii AN SSSR, vol. XCVIII. Moscow.
- Pardaev, M., Gofurov, Z., and Korabaev, S. 2012. Garbii Ustrushonaning er osti suv chikarish inshooti hakida [Water devices in Western Ustrushana]. In *Archaeological Researches in Uzbekistan season 2010–2011*, 8:214–217. Samarkand, Uzbekistan.
- Pendjiev, M. 1978. O kariznom oroshenie i oroshenie lagym b Turkmenskoy CCP [On the kariz irrigation and lagym irrigation in Turkmen SSR]. *CЭ [Soviet Ethnography]*, 1:98–102.
- Petrovski, N.P. 1894. Kratkom opisaniya polozheniya irrigatsii v Samarkandskoi oblasti [Short description of the situation of the irrigation in the Samarkand province]. Central State Archive of the Uzbek SSR for the year 1894. See: Bilalov, A.I. 1980, p. 33.
- Planhol de, X. 2011. Karez, I-V. *Encyclopedia Iranica*.
- Radlov, V.V. 1880. Srednyaya Zeravshanskaya dolina [The middle Zeravshan valley]. In *Zapiski Russkogo geograficheskogo obshchestva po otdeleniyu etnografii* [Memoires of the Russian geographical society, ethnographic section], tome 6:9. St. Petersburg, Russia.
- Sala, R. 2003. Underground water galleries in Middle East and Central Asia. <http://www.lgakz.org>.
- Sala, R. and Deom, J.M. 2005. The 232 karez of the Sauran region. In *Socranenie i ispolzovanie obiectov kulturnogo i smeshannogo nasledia sovremennoi Centralnoi Asii* [Conservation and use of cultural and mix properties in contemporary Central Asia], ed. A. Konusbaev et al. Almaty, Kazakhstan: NIPI PMK (in English language).
- Sala, R. and Deom, J.M. 2016. *Medieval monuments of the Talas valley*. In *Proceedings of "Orazbaevski chteniya."* Almaty, Kazakhstan: KazNU (in print, in English language).
- Sala, R., Deom, J.M., and Clarke, D. 2010. The karez of the Sauran region of Central Asia. *Water Science & Technology: Water Supply*, 10(4):656–663.
- Shishkina, G.V. and Inevatkina, O.N. 2012. Zapadnye zemli Samarkandskogo Sogda. Tipologiya arkheologicheskikh pamyatnikov [Western lands of the Samarkandian Sogdia. Typology of archaeological monuments]. *Problemy istorii, filologii, kultury* [Journal of Historical, Philological and Cultural Studies], 4:33–68. Moscow.
- Stančo, L. 2009. The activities in Uzbekistan in the 2008 season: Testing the Google Earth as a tool for archaeological prospecting. *Studia Hercynia*, XIII:15–122.
- Suprunenko, V. April 4, 1984. Molchivaya voda kyariza [The silent water of the karez]. *Vokrug Sveta* [Around the World], (2523):60–61.
- Suyunov, S.S. 1999. Istoriya orosheniya severo-zapadnoi Ustrushany (V-XVI vv. po arkheologicheskim materialam [History of the irrigation of N-E Ustrushana (V-XVI) from archaeological material]. MSc diss., Samarkand, Uzbekistan (archive material).
- Tursunov, S. and Tursunov, A. and Togaeva, M. 2014. *Sherdovod tarikidan lavkhalar* [Scenes from the history of Sherabad], pp. 110–116. Tashkent, Uzbekistan: Yangi nashrer (in Uzbek language).
- Wasifi, M.Z. XVI AD. *Amazing events*. See: Boldyrev, L.N. 1957.



# Taylor & Francis

Taylor & Francis Group

<http://taylorandfrancis.com>

# *Section VI*

---

*Asia*



# Taylor & Francis

Taylor & Francis Group

<http://taylorandfrancis.com>

---

# 21 Underground Aqueducts in Japan

*Chikaosa Tanimoto and Iwanai Shimada*

## CONTENTS

21.1	Introduction.....	364
21.2	Features of Japan and the Background of Aqueduct Projects .....	365
21.2.1	Geology and Topography.....	365
21.2.2	Life and Natural Disasters .....	366
21.2.3	Geological Structure .....	366
21.2.4	History of Japan .....	366
21.2.5	Population .....	366
21.3	Ako Aqueduct.....	367
21.3.1	General Features of the Ako Aqueduct .....	367
21.3.2	Kiryama Tunnel .....	367
21.3.3	Open Channel and Distribution Network .....	367
21.3.4	Additional Remarks .....	368
21.4	Tatsumi Aqueduct.....	369
21.4.1	General Features of the Tatsumi Aqueduct .....	369
21.4.2	Otateno River Terrace and Tatsumi Aqueduct.....	369
21.4.3	Adits and Segmented Tunneling Method.....	371
21.4.4	Additional Remarks .....	371
21.5	Fukara Aqueduct.....	372
21.5.1	General Features of the Fukara Aqueduct .....	372
21.5.2	Hakone Volcano and Tectonic Movement .....	373
21.5.3	Drought and Enterprise by the Common People .....	373
21.5.4	Survey Works and Geology .....	374
21.5.5	Excavation of Fukara Tunnel .....	374
21.5.6	Additional Remarks .....	376
21.6	Tsujun Aqueduct .....	376
21.6.1	History of Stone Bridges in Kyushu .....	376
21.6.2	Topographical Feature of the Shiraito Terrace and the Tsujun Aqueduct .....	376
21.6.3	Specific Features of the Tsujun Bridge .....	377
21.6.4	Remarks .....	378
21.7	Biwako Canal.....	379
21.7.1	Historical Background of the Biwako Canal Project.....	379
21.7.2	Environment of Kyoto and a Dream of a Canal.....	379
21.7.3	Biwako Canal Project and Keage Power Plant .....	379
21.7.4	Construction of the Shaft and the Nagarayama Tunnel.....	380
21.7.5	Inclined Ship Lift and Aqueduct Bridge.....	382
21.7.6	Remarks on the Biwako Aqueduct.....	383
21.8	Conclusions .....	383
	References.....	384



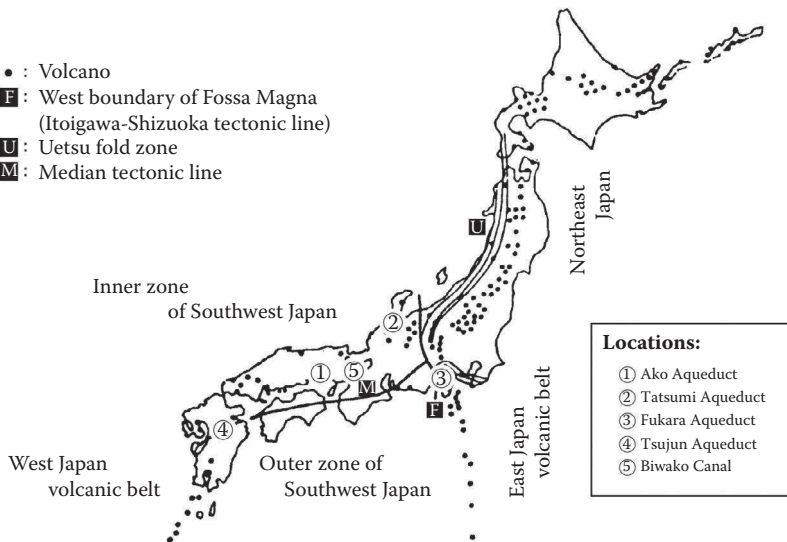
### 21.1 INTRODUCTION

The history of aqueducts in Japan is not so long as that of ancient Romans or the “Karez” in the Central Asia. Japanese Society for Civil Engineers (JSCE) and Japan Water Works Association (JWWA) have compiled and published several technical reports from the historical point of view (JWWA 1967; JSCE 1995). The former picked up 13 cases as the monuments and the latter quoted 40 cases as the historic projects. The most of the cases that were recorded in archives came after the late fifteenth century. The reasons for this are as follows: Japanese population of cities in the Ancient Period to Medieval Period was such smaller, that is, less than 100 thousands, with a few exceptions. The cities were built on the alluvial plains (i.e., river deltas), where residents could easily receive clean water from wells or streams nearby.

Japan was stabilized after the reunification of the country after the War Period in the fifteen and sixteenth centuries. Therefore, as to adopt the increasing population and to avoid water contamination, the public infrastructure began developing at the end of the War Period toward an urban society. The Tokugawa central government in Tokyo and its subordinate dominants, who acted as governors (principal lords) for the 250 domains over the entire Japan, wanted to boost and strengthen economy through trading by sea transport. Therefore, the local governments tried to locate their capital cities, that is, central business districts, in alluvial plains suitable for the easy access to seaports. The economy development, in conjunction with the population growth, resulted in the shortage of quality water supply, and consequently, in the necessity of constructing aqueducts in many cities, and, at the same time, in the reclamation of new rice fields.

The authors’ selection, from the reports by JSCE and JWWA, are the thirteen major historical aqueducts, namely (a) Ako, (b) Kenumadai, (c) Tatsumi, (d) Udogosen, (e) Cho-ondo, (f) Nobidome, (g) Tamagawa, (h) Fukara (Hakone), (i) Ao-no-dohmon, (j) Tsujun-kyo, (k) Asaka, (l) Biwako, and (m) Muro aqueducts.

In this chapter, the selected five projects are introduced for the following reasons. (Numbers in brackets after the project names indicate their locations in Figure 21.1.)



**FIGURE 21.1** Locations of selected five aqueducts on the geological structure map of Japan. (Locations are plotted onto the figure drawn by Okamoto, R. et al. Distribution and Engineering Properties of Weak Rocks in Japan, in *Proceedings of the International Symposium on Weak Rock*, vol. 5, Tokyo, Japan, pp. 89–101, 1981. With Permission.)

1. *Ako aqueduct* (1): It was started with the tunnel, which was constructed firstly in the history of Japanese aqueduct. In addition, the project aimed at availing the well-organized water distribution for the public. Water source is the Chikusa river.
2. *Tatsumi aqueduct* (2): A 15 km long tunnel was constructed in less than nine months by arranging 139 adits and connecting segmented excavations. Its concept is very similar to the karez available in the Central Asia. Water source is the Sai river.
3. *Fukara (Hakone) aqueduct* (3): The 1280 m long tunnel was excavated through the volcanic mountain with many geological difficulties in the manner that tunnel driving was done, so as to control geological conditions, by allowing workers' flexible choice. Water source is Lake Ashinoko.
4. *Tsujun-kyo aqueduct* (4): The masonry bridge, which was remarkably well designed, enabled the 30 km long aqueduct to be constructed in the deeply mountainous area. Moreover, the three-dimensional arch structures and the shock-absorbing devices against earthquake shaking were applied. Water source is Sasahara river.
5. *Biwako canal* (5): At the dawn of modern Japan in the nineteenth century, the 2436 m long tunnel was designed and successfully completed under the leadership of an outstanding young engineer. During construction, he brought in his new idea and materialized the hydroelectric power generation, which was the first enterprise in Japan and also in the world, as well as a commercial electric power supply. Water source is Lake Biwa.

Population is an index of water demand as well as of the amount of agricultural production. When we consider the sustainable quantity of water from the population viewpoint, the sustainable food production and its supporting agriculture must be discussed. According to the report *State of the World* published by WorldWatch Institute (WWI 1993), a ton of crop needs 1000 tons of water and a ton of meat needs 1000 tons of crops, that is, a 1 ton of meat needs 1 million tons of water. The growth of population in Japan was 12.3 million in 1600, 31 million in 1750, 30.7 million in 1804, 41.3 million in 1890, and 125.6 million in 1995 (Kito 2000).

## 21.2 FEATURES OF JAPAN AND THE BACKGROUND OF AQUEDUCT PROJECTS

### 21.2.1 GEOLOGY AND TOPOGRAPHY

The chief feature of the Japanese archipelago is its geological instability, including frequent volcanic activity and many earthquakes. Another distinctive characteristic would be the fact that the Japanese archipelago is made up almost entirely of steep mountainous areas and very few plains (Kodansha 1998).

*Volcanoes:* The large number and variety of volcanoes found throughout the Japanese archipelago constitute another remarkable feature. There have been 188 volcanoes active at some time or another since the Quaternary geological period, and more than 40 of these remain active today. Among these are volcanoes that have had numerous violent eruptions, such as Mts. Fuji, Asama, Bandai, Unzen, and Sakurajima. Further, a special characteristic of Japan's volcano zone is the development of large craters, or calderas, such as those at Akan, Daisetsu, Hakone, Aso, and Aira. The caldera at Aso is on a scale unrivaled anywhere in the world.

*Rivers:* A small number of large rivers, such as the Ishikari, Shinano, Tone, Kiso, Yodo, Yoshino, and Chikugo, have fair-sized delta plains at their mouths. Diluvial uplands and river and marine terraces have developed in many coastal areas of Japan, and are utilized, along with the plains, for both agriculture and habitation. Japanese rivers are characterized by the fact that their average gradient is 5–20 times steeper than major rivers in the world. Therefore, rivers run at a very fast pace in Japan.

*Precipitation:* Annual precipitation of Japan is 1600 mm (6600 m<sup>3</sup> per person), whereas it is 750 mm (40,800 m<sup>3</sup>) in the USA, 1170 mm (5500 m<sup>3</sup>) in the UK, and 1200 mm (9620 m<sup>3</sup>) in Switzerland.

### 21.2.2 LIFE AND NATURAL DISASTERS

The climate and the flora and fauna vary regionally, as the archipelago extends from the subarctic zone in the north to the subtropical zone in the south; there is also much seasonal change within a specific region. Japan's seasonal changes and geological structure bring many kinds of natural disasters. Heavy rains due to the squatting "baiu" front and the autumn typhoons bring about landslides, floods, and wind damage (Kodansha 1998). Heavy winter precipitation, especially on the coast of the Sea of Japan side, causes snow damage, as well as flooding and cold damage, to transport and buildings. In addition, major earthquakes strike somewhere in Japan every several decades. Typhoons and the earthquake-induced "tsunami" (tidal waves) also inflict damage on heavily populated, low-lying coastal areas. The horrible disaster of the East Japan Earthquake in March, 2011, represents how the big earthquake incurred the chains of disasters.

### 21.2.3 GEOLOGICAL STRUCTURE

The border of northeastern Japan and southwestern Japan is a great fault called the Itoigawa-Shizuoka Tectonic Line. The belt-like area east of this fault, running from the western part of Niigata Prefecture to the central part of Nagano Prefecture, Yamanashi Prefecture, and further to the eastern part of Shizuoka Prefecture, forms a single valley crossing Honshu that is called the Fossa Magna. The mountain ranges and the volcanic zones that form northeastern Japan turn south-southeast at the Fossa Magna and connect to the Izu Islands (Tanimoto 1982; Kodansha 1998).

Southwestern Japan is divided into an inner belt (the Sea of Japan side) and an outer belt (the Pacific Ocean side) by the great fault called the Median Tectonic Line, which runs lengthwise along the axis of southwestern Japan from the Ina mountains to Oita Prefecture. In southwestern Japan, there are fewer volcanoes than in northeastern Japan, and they are concentrated in the areas of the Sea of Japan side and Kyushu.

### 21.2.4 HISTORY OF JAPAN

The first inhabitants of the Japanese Islands were Paleolithic hunter-gatherers from the continent. They used sophisticated stone blades but had no ceramics or settled agriculture. This Paleolithic culture persisted until the close of the Pleistocene Epoch, about 13,000 years ago, when the Japanese climate ameliorated and sea levels began to rise. In these changing climatic circumstances, a new culture began to overlay the older Paleolithic culture. This new culture is known as Jomon from the magnificent pottery that characterized it. Although it has commonly been thought that the Jomon people were hunter-gatherers and did not practice cultivation, recent research revealed that they had begun to cultivate rice by about 1000 BC.

From about 300 BC, Jomon culture was overlaid by a distinctly different culture, the Yayoi, characterized by less flamboyant ceramics, knowledge of bronze and iron technologies, including fine weaponry, and the systematic development of wet-field rice agriculture. These developments laid the basis for the strong martial current found in Japan's early history and for the agricultural way of life that profoundly shaped Japanese society into the modern era (Kodansha 1998).

### 21.2.5 POPULATION

The population was distributed comparatively equally all over the country about a century ago, when Japan was still predominantly agricultural. However, with rapid industrialization, there was

a strong tendency toward regional concentration. As a result, more than 40% of Japanese live in the three major urban areas of Tokyo, Osaka, and Nagoya (Kito 2000).

## 21.3 AKO AQUEDUCT

### 21.3.1 GENERAL FEATURES OF THE AKO AQUEDUCT

The Ako aqueduct was a 7 km long water supply project. It is characterized by the following features: (a) it was begun with a tunnel, which appears in Japanese aqueduct history for the first time; (b) it is supposed to be one of the earliest public water supply system in Japan in which clear water was carefully separated from surface runoff and wastewater; (c) a water distribution network for all residences, including those for dominants and common people, was considered from its planning stage; and (d) an inverted siphon was employed in the distribution to the Ako Castle (Ako City 1983, 1995).

The development of Ako town started with salt production in the mid-fifteenth century. The town was located on the river delta of the Chikusa River. The Ako aqueduct was constructed by Lord Ikeda's subordinates in 1614–1616 in consideration of rebuilding a community after the destructive fire and of avoiding brine groundwater. It is notable that the purpose of the aqueduct was to supply water for all 4500 residents as an infrastructure, considering domestic, fire-preventive, irrigational, sanitary, and castle-defense uses (Hiroyama 1982; Ako Historical Museum 1997).

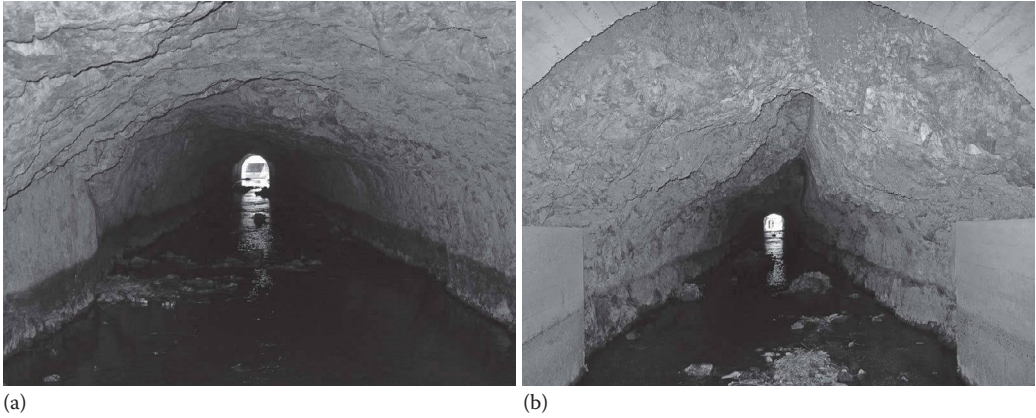
### 21.3.2 KIRIYAMA TUNNEL

The excavation of Kiriya Tunnel of 95 m in length was begun as an intake in the northern tip of Mt. Otakadai (270 m in height), located about 7 km north of the castle. The aqueduct consists of the Kiriya intake tunnel, the open channel along the east skirt of Mt. Otakadai, and the covered conduits from the distribution basins (Momoroyaura Basin) (Hyogo Prefecture 1995; Ako City 2015a).

The 95 m long tunnel was driven from both ends. Although there are few descriptions on surveying in old documents, it is supposed that tools such as a level, a plane table, an alidade, and candle-lights were employed. The tunnel was driven through highly fractured rhyolite, including small but smooth faults, whose strikes run nearly in parallel with the driving direction in the middle of the tunnel. In driving through hard rock, it was advantageous that rock was highly fractured, but fractures tightly and regularly contacted with each other, except the cave-in(s) in the middle, 15–20 m in length. The cave-in(s) were about 0.8–1.0 m high and wedge shaped. They took place where two small faults with clay intersected on the tunnel ceiling. The presence of faults deteriorates tunnel stability. The excavated surfaces of the tunnel and cave-in are shown in Figure 21.2a and b. The tunnel excavation was done successfully in 2 years. The deviations in the tunnel cross section at the breakthrough point were 20 cm and 1.2 m in vertical and horizontal directions, respectively. The Kiriya Tunnel in this project is supposed to be the oldest aqueduct tunnel in Japan as far as we know from 41 case histories of old aqueducts constructed during the fourteenth to nineteenth centuries.

### 21.3.3 OPEN CHANNEL AND DISTRIBUTION NETWORK

The aqueduct downstream of the Kiriya Tunnel was an open channel as far as the Momoroyaura Basin, where the distribution conduit networks started. The channel was located close along the skirt of Mt. Otakadai, and a wastewater ditch was situated, in parallel, beside the channel, so as to drain the household wastewater and surface runoff from mountains into the Chikusa River through the cross conduits. The open channel ends at the Momoroyaura Basin, as mentioned before, and 1 km upstream of this basin, a discharge gate was situated near Toshima Basin. Excess water was discharged to the Chikusa River. (Ako Historical Museum 1997)

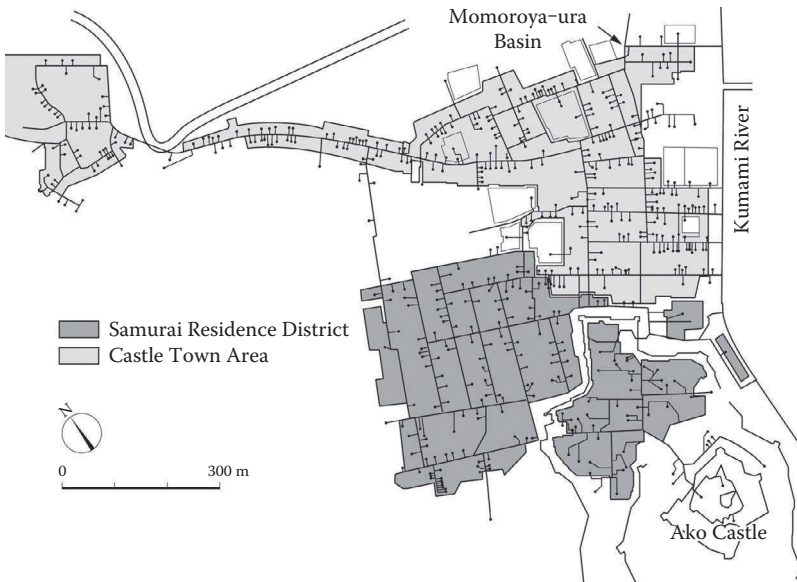


**FIGURE 21.2** Kiri-yama Tunnel in Ako aqueduct: (a) Normal surface of the enlarged tunnel and (b) Excavated surface of a cave-in section shows a parallel wedge and a thin clay-filled fault.

At the Momoroyaura Basin, the clean water was divided into three streams: a stream to the conduit network in the residential area, second to the castle area, and the last to western villages. The distribution network system in the town and the castle is shown in Figure 21.3 (Hiroyama 1982). The main stream to the castle was led through masonry conduits with a 0.45 m wide and 0.61 m high cross section, and domestic water to individual residences was supplied through the earthenware pipes, distributors (basins), and dip-up basins, which were buried underground at a depth of 0.5–0.6 m. Wooden basins and bamboo pipes were also employed conveniently.

**21.3.4 ADDITIONAL REMARKS**

Then, the main stream that runs 550 m from the Momoroyaura Basin to the main gate of the castle passed beneath the outer moat at the main gate by a siphon, and the water in the main stream was



**FIGURE 21.3** Distribution network in the town and castle. (From Hiroyama, T., *The Castle and Town of Banshu Ako*, August 10, 1982. With Permission.)

distributed in the same manner as the waterworks in the town area. The average gradient from the Toshima Basin through the castle was about 1/500. The excess water that reached the terminals of the main conduit was always discharged to adjacent rivers in order to keep it hygienically clean (Ako City 2015b).

According to the documents, the intake at the Kiriya Tunnel was relocated to 500 m and 2 km downstream twice in 1645 and 1702 in order to increase the quantity of water to be supplied. Currently, Ako city is planning to restore and sustain the main stream from the Momoroyaura basin to the Ako Castle as a historical monument.

## 21.4 TATSUMI AQUEDUCT

### 21.4.1 GENERAL FEATURES OF THE TATSUMI AQUEDUCT

The Tatsumi aqueduct, 12 km in length, was constructed in Kanazawa in 1632. After the nationwide reunification of Japan in the late sixteenth century, it was the time when the development of infrastructure had taken off, symbolizing the beginning of the early modern period of Japan. Kanazawa in Kaga Domain has been the largest city on the Sea of Japan side and also one of the top ten cities in Japan since the early seventeenth century. The sixteenth century was the era when the history of Japan drastically changed. Kanazawa developed as the economic and cultural center in Kaga and its neighboring domains (HP/Kanazawa City 2015a; HP/ Wikipedia 2015a; HP/Biglobe 2015).

The original concept of the Tatsumi aqueduct came from the experience with the big fire that burnt out the Kanazawa Castle and 6000 houses in Kanazawa in 1631. Lord Maeda III and his subordinates (forming the local government of Kaga Domain) tried to look for a new water source in consideration of fire-fighting use, drinking water for the castle, irrigation, reclamation, and moat water.

Geographically, Kanazawa is located at the north-side skirt of the Hakusan Mountain Range and also at the starting point of Kanazawa Delta. Owing to its geographical condition, it is subject to heavy snowfall in winter. Therefore, the Tatsumi Aqueduct Project had to take into account this climatic condition.

### 21.4.2 OTATENO RIVER TERRACE AND TATSUMI AQUEDUCT

The Kanazawa Castle was located on the Otateno river terrace (Pleistocene upland), which had been carved out by and between the Sai and Asano rivers, as shown in Figure 21.4 (HP/Google 2015a). As the castle stood on the terrace top 20 m higher than the surrounding alluvial delta plain, it was difficult to find an appropriate water source nearby. Itaya Heishiro, the commissioner who was in charge of finding new water sources, carried out topographical and geological surveys mostly along the Sai and Asano rivers. Then, he found a place feasible for an intake 12 km upstream of the castle along the Sai river, which gave a 46 m head difference required for the aqueduct (HP/Kanazawa City 2015b; HP/Ishikawa Prefecture 2015).

Considering the geological condition of the river terrace, which consisted of four formations of mudstone, sandstone, conglomerate, and alluvial deposits (from the bottom to the top), a feasibility study on the aqueduct was carried out intensively. Then, the final route of the aqueduct was determined along the south cliff of the terrace.

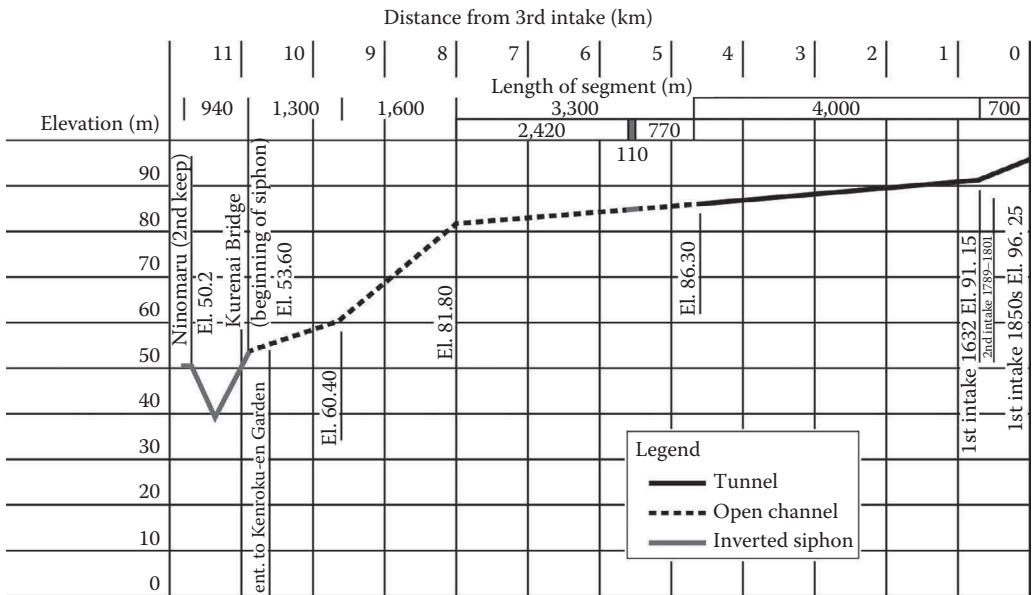
In addition, it had to be discussed in the final plan to minimize the possible risks that might be generated by heavy snowfall. In order to prevent the aqueduct from blockages by heavy snowfall and resultant debris, the construction of a 4.7 km-long tunnel was decided. On the other hand, it was well recognized by the people in charge of the project that the construction of such a long tunnel would take a tremendously long time and bring unexpected difficulties.

Consequently, the 4.7 km long tunnel and 110 m short one were decided to be built, followed by the 6.2 km long open channel and the 640 m long inverted siphon, as shown in Figures 21.5 and 21.6.

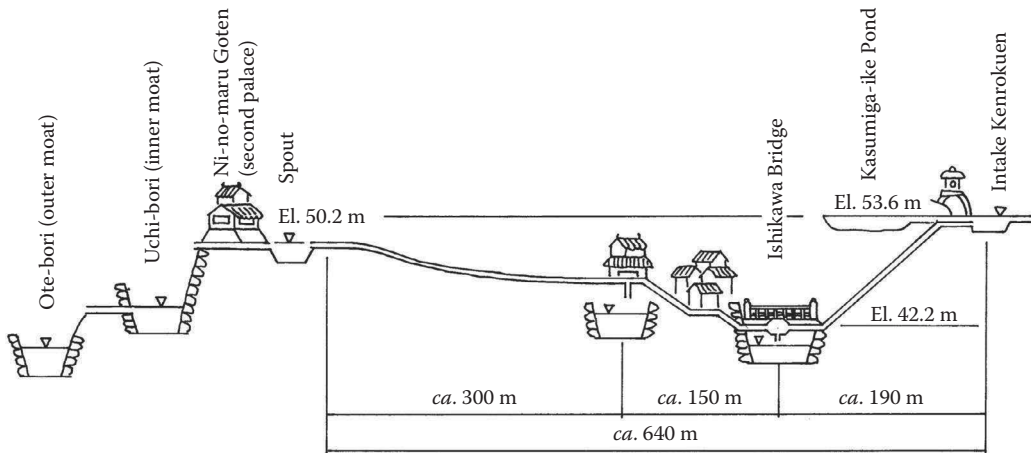




**FIGURE 21.4** Alignment of the tunnel on Google Earth shows close location to the scarp of the Otarui Terrace. (From HP/Google, Tatsumi Aqueduct, 2015a. With Permission.)



**FIGURE 21.5** Vertical alignment of the Tatsumi aqueduct (11,840 m). (From HP/Kanazawa City, Tatsumi Aqueduct, Cultural Assets Preservation Div, 2015a. With Permission.)



**FIGURE 21.6** Profile of the inverted siphon from the Kenrokuen Garden to the Kanazawa Castle. (From HP/Kanazawa City, Survey of Tatsumi Aqueduct, 11104/bunkazaimain, 2015b. With Permission.)

### 21.4.3 ADITS AND SEGMENTED TUNNELING METHOD

The dimensions of the aqueduct and the tunnels are summarized as follows: total length of the aqueduct: 11,840 m; total length of tunnels: 4810 m (4700 m + 110 m); elevations: *ca.* 103 m at the intake and *ca.* 53 m at the terminal in the castle (Kasumiga-ike Pond); average gradients: *ca.* 0.5% (50/10,600) from the intake to the terminal and *ca.* 0.2% (10/4,700) for the tunnel section; geology of the terrace: multiple formations with neogene mudstone and sandstone, diluvial conglomerate and alluvial deposits; tunnel access: 139 adits at 30 m spacing, excavated into the terrace cliff of 20 m in height; cross section of the tunnel: 2 m wide and 2 m high in inverted U shape; overburden thickness: 2.5–20 m; and construction period: *ca.* 9 months.

The construction method of tunneling employed in the Tatsumi aqueduct is unique in the history of tunneling in Japan. A total of 139 adits, accessing horizontally to the Otateno terrace wall (cliff face), were arranged at 30 m spacing in order to shorten the time in tunneling. The alignment that was made by individual adits remarkably helped achieve accurate survey works and excavations in the main tunnel, for the gradient of the tunnel was such a gentle one as 0.2% (10/4,700), and the tunnel excavation required intensive attention, so as to fit to the designated gradient.

From each adit, the excavation of the main tunnel started simultaneously in both directions, upstream and downstream. This means that the segmented driving of 15 m per face in two directions enabled to penetrate through a long tunnel by connecting each other. Actually, it is notable that it took only 9 months or so to excavate such 4.7 km long tunnel with primitive tools and by hand. The inside of the main tunnel is shown in Figure 21.7 (HP/Wikipedia 2015a). It is suggested to us that the surrounding ground (rocks and soils) owned a comparatively suitable stability for tunneling.

Such a segmented tunneling method, as employed in the Tatsumi aqueduct tunnel, reminds us of the karez system available in Iran, Central Asia, and western China (Lonely Planet 2000). The difference between the Tatsumi aqueduct and the karez system is only in directions of access, vertical (shaft) or horizontal (adit).

### 21.4.4 ADDITIONAL REMARKS

Some more facts concerning the tunneling in the Tatsumi Project are described as follows: The excavation began simultaneously from each adit by adopting different-in-size but similar cross-sections, that is, by making a downstream cross section a little larger than that of an upstream face



**FIGURE 21.7** Inside of the Tatsumi Tunnel (favorable ground) (From HP/Wikipedia, Tatsumi Aqueduct, 2015a. With Permission.)

in the main tunnel, so as to accommodate smooth water flow in the allowance of elevation within 10 cm or so.

Tunnel driving from numerous adits required tremendous amount of workforce such as more than 140,000 workers in total or more than 500 workers a day, that is, just less than four workers per face per day. It sounds very reasonable. Moreover, as might have been expected because of a poor geological survey at that time, a massive collapse occurred during the main tunnel driving under the Makuradani valley near the intake, and many fatalities were recorded in the accident.

Lastly, let us see another challenge in the Tatsumi Aqueduct Project. It is the construction of the 640 m long inverted siphon passing over the moat belts from the Kenrokuen Intake to the Ninomaru Outlet in the castle. It was extraordinarily on a big scale, as a siphon at that time had a difference between the intake and the outlet of only 2.4 m in elevation over the length of 640 m, namely with a gradient of 0.375%. As a whole, the Tatsumi aqueduct is outstanding achievement.

## 21.5 FUKARA AQUEDUCT

### 21.5.1 GENERAL FEATURES OF THE FUKARA AQUEDUCT

The Fukara aqueduct is a 7130 m long aqueduct, consisting of two structures of a 1280 m long tunnel and a 5850 m long open channel. The aqueduct was constructed for the purpose of supplying irrigation water on a large scale in 1666–1672. It is characterized by four features, as follows: (a) the project was developed entirely by the common people at that time, based on the contract between the local community as a client, represented by the local government, and the merchants in Tokyo as a contractor; (b) a 1280 m long tunnel was penetrated through the watershed mountain, whose geology is formed by volcanic rocks such as mostly tuff, breccia, and andesite; (c) water was distributed to wide area such as 530 ha, enabling to develop new rice fields in mountainous areas; and (d) the aqueduct started its water supply in 1679 and is still in service, in addition of commencing the hydroelectric power supply of 5700 kW in 1922 (HP/Susono City 2015a; HP/Wikipedia 2015b; HP/Google 2006).

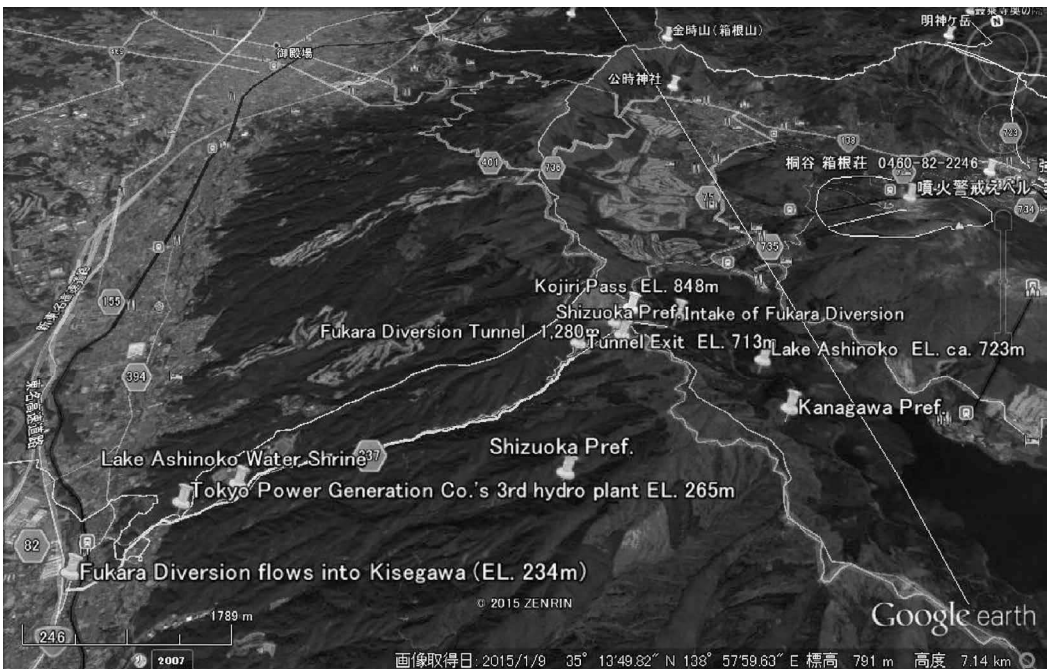
### 21.5.2 HAKONE VOLCANO AND TECTONIC MOVEMENT

The Fukara aqueduct is located on the west side of Mt. Hakone, one of the active volcanoes, which is located at the neck of the Izu Peninsula, stretching to south, as shown in Figure 21.8 (HP/Google 2015b). It is approximately 80 km west far from Tokyo and very close to Mt. Fuji, the highest in Japan (3776 m). Hakone volcano erupted about 500–250 thousand years ago, and formed the old Caldera about 250–180 thousand years ago. The last big eruption occurred about 66–45 thousand years ago and resulted in the formation of the present somma and caldera.

Mt. Hakone, Mt. Fuji, and the Izu Peninsula (the so-called Fuji-Izu-Hakone area) are situated in the tectonically complicated environment, which is subject to the most intensive tectonic movement in Japan (Okamoto et al. 1981). It is notable that three tectonic plates, namely Eurasian Plate (from west), Philippine Plate (from south), and North American Plate (from northeast), meet together under the Fuji-Izu-Hakone area. The formation of the Izu Peninsula is the result of the tectonic movement in the past. In addition, from a little farther east, the Pacific Plate intrudes under the north half of Japan at the rate of 10 cm per year, which is the highest magnitude among the four plates, as shown in Figure 21.9 (HP/Wikipedia 2015b). The difference in rates and directions aggressively generates earthquakes.

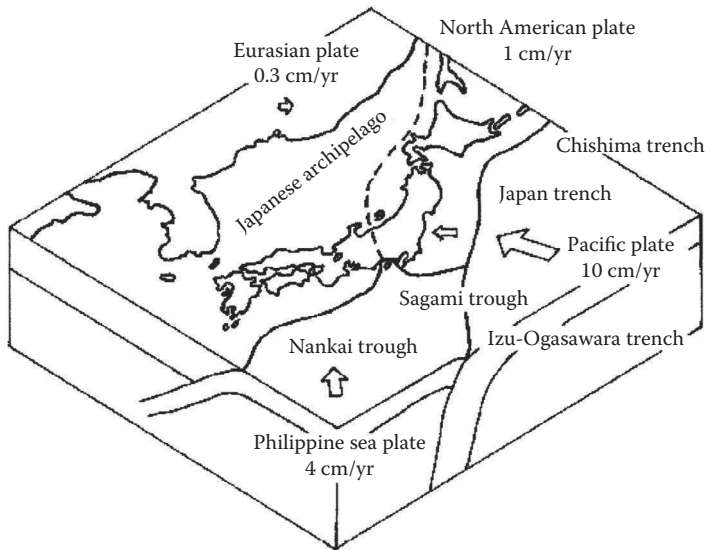
### 21.5.3 DROUGHT AND ENTERPRISE BY THE COMMON PEOPLE

Before the time of the Fukara Project, the people in Fukara village had been suffering from extreme drought and poor harvest owing to its severe natural environment. In the 1650s, Ohba Gen-nojo, chief of the village, after having experienced the fatal shortage of water, seriously envisaged to take advantage of using abundant water in Lake Ashinoko, which lies on the other side of the mountain (HP/Susono City 2015a). Under the growing social circumstances in the mid-seventeenth century, the developments of infrastructure and business market were eagerly expected by the common people, particularly by rich merchants in big cities. Tomono Yo-emon, one of the influential merchants



**FIGURE 21.8** Bird's eye view of Fukara aqueduct on Google Earth (From HP/Google, Hakone Aqueduct, 2015b. With Permission.)





**FIGURE 21.9** Tectonic movement under the Fukara aqueduct area (Fuji-Izu-Hakone area). (From HP/Wikipedia, Fukara Aqueduct, 2015b. With Permission.)

in Tokyo, who had invested in the increase of new rice fields, actively inspired Chief Ohba and was ready to invest in the Fukara Aqueduct Project. Finally, through his tough negotiation with the bureaucrats, Chief Ohba succeeded in obtaining the official approval for the new aqueduct project on the self-support basis, among the related people and enterprises in 1666.

#### 21.5.4 SURVEY WORKS AND GEOLOGY

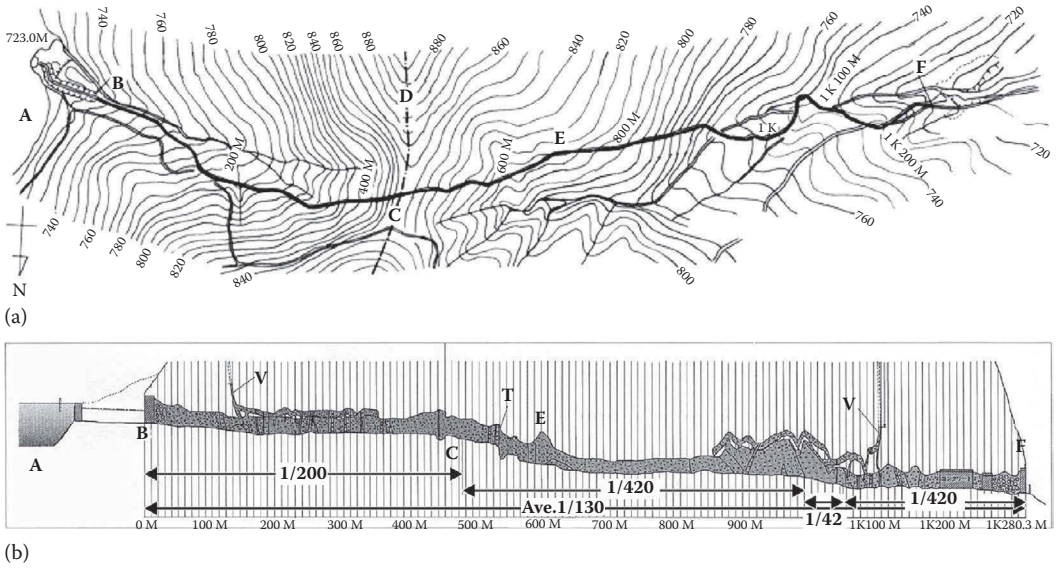
After the field survey of the Kojiri Pass (EL848m), Chief Ohba and his associates began the construction of the aqueduct with Fukara Tunnel. Tunnel excavation was started from both ends. The elevations of the east and west portals were set at 723 m and 713 m, respectively. The actual alignments of the tunnel are shown in Figure 21.10a and b (Fukara Local Historical Museum 2015). They were eventually determined at the convenience of excavation in easier ground control. As tunneling through volcanic rocks was very difficult to be driven as exact as designed, some extent of tolerance in driving direction had to be accepted, depending on daily encounter with unfavorable geology.

The survey work in the tunnel was done along the target lights, which were hung on the wall at 1–2 m spacing. The deviations of the tunnel alignments at the breakthrough point were *ca.* 1 m and 60 cm in vertical and horizontal directions, respectively, as shown in Figure 21.11 (HP/Wikipedia 2015b).

#### 21.5.5 EXCAVATION OF FUKARA TUNNEL

The dimensions of the tunnel are as follows: (a) geology: mostly volcanic tuff, breccia, and andesite; (b) tunnel length: 1280 m; (c) maximum overburden: *ca.* 130 m; (d) difference in elevation between the east and west portals: 9.8 m; (e) average longitudinal gradient: 1/130, or 0.77%; and (f) tunnel cross sections: inverted U-shape of 2 m width and 2 m height for the west section and rectangular shape of 2 m width and 2 m height for the east section.

Excavation was done with picks and chisels by hand. Sometimes, oil was spread and burned for making large and hard rocks to fracture easily by heating (HP/Susono City 2015b). As a whole, the tunnel excavation seems more difficult in the west section than in the east section, judging



**FIGURE 21.10** Fukara aqueduct tunnel: (a) As-built plane of Fukara Tunnel; (b) As-built profile of Fukara Tunnel. (From HP/Susono City, Aqueduct Tunnel, Hakone (Fukara) Aqueduct/daichi/part3, 2015b.) Note the acute change in cross sections and the longitudinal alignment, and horizontal alignment in (a), showing the geological difficulties in excavation. Two ventilation shafts are also seen in (b). Legend: A: Lake Ashinoko; B: Start of Fukara Tunnel (east portal); C: Umijiri Pass; D: Prefectural boundary between Kanagawa (left) and Shizuoka (right); E: Fukara Tunnel; F: End of Fukara Tunnel (west portal); T: Breakthrough point; and V: Ventilation shaft.



**FIGURE 21.11** Heritage study tour at the breakthrough point in Fukara Tunnel (From HP/Wikipedia, Fukara Aqueduct, 2015b. With Permission.)

from the horizontal alignment (on the plane), which meanders more in the west section, and the longitudinal one (on the profile), which shows more random and irregular crown positions caused by unstable rocks. The construction of the Fukara Tunnel was completed in 1670, having taken 3.5 years, with the manpower of 840,000 man\*days, which is equivalent to 660 workers per day.



### 21.5.6 ADDITIONAL REMARKS

The original length of the open channel was 4620 m from the west portal of the tunnel to the outlet in Fukara village. The difference between the two ends of the open channel is 458 m in elevation. Its average gradient is 9.9%. The maximum water flow drawn from Lake Ashinoko is 1.67 m<sup>3</sup>/s.

## 21.6 TSUJUN AQUEDUCT

### 21.6.1 HISTORY OF STONE BRIDGES IN KYUSHU

The 30 km long Tsujun aqueduct and 76 m long Tsujun Bridge are located on the outer skirt of the somma of Mt. Aso (Yamato Town 2015; HP/Kumamoto Prefecture 2015). Mt. Aso is an active volcano located at the center of Kyushu. The Meteorological Agency of Japan observes it with a keen attention.

It started erupting actively around 850,000 years ago, and the resultant gigantic pyroclastic flow, which was induced by the caldera eruption about 90,000 years ago, covered over not only Kyushu Island but also the entire Japan, with the volcanic products of 600 km<sup>3</sup> in volume.

Thus, the successive volcanic activities yielded the thick formation of welded tuff over a 1600 km<sup>2</sup> wide area around Mt. Aso. The welded tuff has a wide variety in its strength, depending on a magnitude of welding. It owns a strength of 50–70 MPa (under compression), which was suitable for masons to cut easily along weak planes and build stone bridges.

According to the history of stone bridges in Japan, amazingly, more than 95% of the stone bridges in Japan exist intensively in Kyushu, particularly around Mt. Aso (Mason Museum 2015). It is supposed that the theory of arch structure was conveyed in the 1630s through Nagasaki, in which the Dejima Isolation District had been located at the convenience of foreign trade. Thus, the combination of the use of the welded tuff and the technology of the stone-arch bridge had developed around Mt. Aso. The Tsujun Bridge was constructed in 1852–1854.

### 21.6.2 TOPOGRAPHICAL FEATURE OF THE SHIRAITO TERRACE AND THE TSUJUN AQUEDUCT

The pyroclastic terraces, which were formed by the successive eruptions of Mt. Aso over 0.85 Ma, have been subjected to erosion by surface water, resulting in deep cuts into the terrace top and slopes. Such terraces and valleys show extremely complicated shapes and irregular undulations. Sometimes, a sharp V-shaped cut reaches 30–150 m in depth.

As over two-thirds of Japan is occupied by mountain terrain, farmers must have struggled for keeping wet rice fields stable on steep lands. As a result, the step-wise rice fields have developed everywhere over Japan. The Shiraito Terrace of 3.0–3.5 ha in area is located in such situation. The villages on the Shiraito Terrace had suffered from the severe shortage of irrigation water for a long time. Owing to its location, the construction of a normal aqueduct was impossible without overcoming the difference of 30–40 m in elevation between Gorogataki river and the terrace top. Rice fields were placed on the steep terrace slope, where water had to be distributed uniformly from many places on several different elevations, but actually, the amount of water was not sufficient before the completion of the aqueduct. After the big drought in 1830–1844, Futa Yasunosuke, Administrator of Yabe District, decided to overcome the water problem by constructing an aqueduct bridge over Gorogataki river, as shown in Figure 21.12. This is the Tsujun Bridge.

The section of the aqueduct upstream of the bridge is 6 km long from the Kami-ide Intake along Sasahara River, and nine aqueduct tunnels were constructed en route. The section downstream of the bridge is divided into two channels, the upper and lower streams. The total length of the downstream section is approximately 24 km, including 39 tunnels en route. The Tsujun Bridge was vital in connecting downstream with upstream, and it was completed in 1854. It conveys 1.7 tons of water per second to a 150 ha area even now.



**FIGURE 21.12** Tsujun Bridge and arch structure.

### 21.6.3 SPECIFIC FEATURES OF THE TSUJUN BRIDGE

For planning an aqueduct and its vital bridge, Administrator Futa searched for feasible models through the stone bridges in the past. Approximately nineteen stone bridges had been built in vicinity of the Shiraito Terrace in 1800–1850. Among them, there are three bridges, whose length exceeded over 30 m: Hijiri (35 m, built in 1832); Reidai (90 m, in 1847); and Kanauchi Bridge (31 m, in 1850). Administrator Futa needed to build a bridge of 90 m length and 30 m height for the aqueduct use in order to solve the water problem about the Shiraito Terrain (Yamato Town 2015).

Only the Reidai Bridge of 90 m length was a realistic model per Futa's intension, but its height of 16 m did not satisfy his purpose. Initially, he expected to build a 30 m-high aqueduct bridge in order to supply water to the Shiraito District, but it was not possible at that time owing to technical difficulties. Finally, he decided to adopt an invert-arch siphon, which enabled the intended height to shorten from 30 m to 20 m. This siphon is 123.9 m long. However, still, a height such as 20 m was inexperienced with the aqueduct bridges in the past.

Then, Futa and his colleagues learned about a masonry work through the stone wall of Kumamoto Castle, one of the largest castles in Japan, with the high walls, whose stability was based on the principle of the invert-arch structure. Presumably, without understanding the mathematical theory of arch structure, the past masons must have empirically learned it. Thus, the Tsujun Bridge is characterized by the three-dimensional arch structure, which is formed with a single arch in longitudinal direction and four invert arches in lateral direction. It was the first case in Japan that the lateral invert arch was applied to the abutments of a bridge.

Futa and his colleagues launched their project in 1852. The actual dimensions of the bridge are as follows: (a) stone-masonry arch bridge of 76.3 m length, 6.3 m width, and 20.3 m height; (b) arch span: 26.5 m; (c) three stone conduit pipes run on the top of the bridge; and (d) inverted siphon structure with the difference of 1.1 m in elevation between the intake and outlet. Its length is 123.9 m.

In addition, it is notable on the stone conduits that the water tightness and the treatment against the blockage by debris were required for such a long aqueduct bridge. The three lines of the stone conduits were aligned in parallel on the 6.3 m wide top of the bridge, as shown in Figure 21.13a.

A stone block of welded tuff has three dimensions: 85 cm height; 85 cm width; and 55 cm length. In addition, individual blocks were produced in consideration of specific direction of schistose welded tuff, so as to fit its direction to the conduit axis, that is, horizontal direction. It is the same

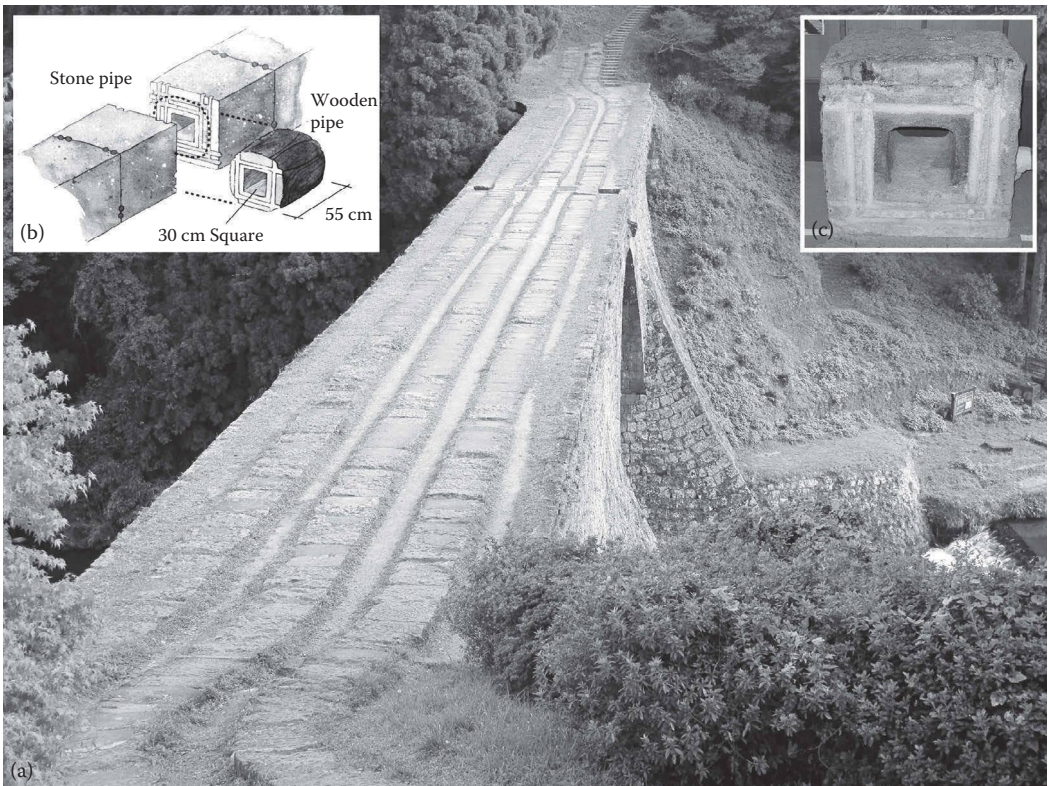
that the blocks for the arch structure were stacked in the manner that schistose planes were spread horizontally.

Considering the conveniences of the maintenance of the conduits, such as cleaning, removing plugged debris and fallen obstacles, and replacing damaged stone blocks with new ones, four wooden blocks of the same size as a stone block were inserted at four different positions along the respective conduit alignment, as shown in Figure 21.13b. The wooden blocks (12 pieces in total) were expected to play the role of a shock absorber at earthquake-shaking. It is a very practical idea, and the lateral invert arch was employed to the bridge for reinforcing its bearing capacity against earthquake-shaking.

Furthermore, each aperture between two conduit pipe blocks to be joined to each other was filled with sealing material (a sort of plaster) made from a mixture of clay, fine sand, slaked lime, salt, and resin (of pine) by careful mallet tamping into small space (holes) between two blocks. The accuracy of connecting individual blocks was very high, and its water tightness had lasted over 150 years. Figure 21.13c shows a block of the stone conduit (Yamato Town 2015).

#### 21.6.4 REMARKS

Having taken 1 year and 8 months, the Tsujun Aqueduct Project was successfully completed. The Tsujun Bridge charms many visitors with its beautiful views, against the stepwise rice fields, such as a simple arch structure of large size and spectacular water splashing for debris removal.



**FIGURE 21.13** Tsujun Bridge: (a) three conduit lines on the top; (b) stone and wood conduit pipes; and (c) stone block of conduit (From Yamato Town, Exhibition at Tsujun Museum, Kumamoto, 2015. With Permission.)

## 21.7 BIWAKO CANAL

The Biwako Canal, 19.3 km in total length, was constructed between Kyoto and Ohtsu: the first canal in 1885–1890, and the second, along the first, in 1906–1912. Particularly in this section, the authors focus on the two major challenges, tunneling and hydroelectric power generation, whose technical problems were solved by an outstanding young engineer and his colleagues.

### 21.7.1 HISTORICAL BACKGROUND OF THE BIWAKO CANAL PROJECT

After the relocation of Japan's capital to Tokyo in 1869, Kyoto city, which had served as the capital of Japan for more than a millennium, suffered a drastic decline, with its population dropping from 350,000 to 250,000. In order to revitalize the economy of the region, Governor Kitagaki Kunimichi of Kyoto Prefecture launched the “Biwako Canal Project” in 1881, which envisioned channeling water from Japan's largest lake, Lake Biwa, to Kyoto, with the aim of restoring Kyoto's prosperity (Kyoto City 1939, 1975).

To construct the Biwako Canal, a number of difficult issues had to be solved, regarding the tunnel construction and techniques, highly accurate survey required for tunnel driving, the utilization of domestic materials, and so on, for which a range of the most sophisticated measures could be arranged. Thus, the construction work on the Biwako Canal was started in June 1885, divided into the “main canal” (from the Mihogasaki Intake through the Keage Junction to the Reizei Outlet) and the “branch canal” (from the Keage Junction to the Ogawakashira Outlet), reaching 19.3 km in total length, and was completed in March 1890, resulting in the water intake of 8.3 m<sup>3</sup>/s from Lake Biwa.

The primary objective of this project was to use the water of Lake Biwa for waterway transportation, water turbines, drinking, irrigation, and fire-fighting, but amid the construction work, it was also decided to use the water for hydroelectric power generation, based on the investigation of the hydroelectric plant that had just started in Aspen, Colorado, USA. This visionary decision to revise the project to include hydroelectric power generation gave birth to the Keage Power Station, Japan's first commercial hydroelectric plant.

### 21.7.2 ENVIRONMENT OF KYOTO AND A DREAM OF A CANAL

Kyoto had been the capital city of Japan and the center of politics, economy, industry, and culture in association with the emperor system. Owing to its unfavorable topographical environment, as the inland city of Kyoto is located in a basin surrounded by mountains on its three sides except south, the capacity of transportation and material distribution was always a serious concern with the government. In particular, the 6 km long mountainous road between Kyoto and its eastern town, Ohtsu, was the severest bottleneck for the prime transportation along the Tokaido Route, connecting Kyoto with Edo (renamed “Tokyo” after Meiji Restoration) 500 km far to the east.

Moreover, Lake Biwa, Japan's largest lake of 500 km<sup>2</sup> area, lies 7 km east of Kyoto, separated by the Hiei mountain range in between, and Ohtsu, a harbor town located at the south end of Lake Biwa, had been playing an important role as the collecting base for food, materials, commodities, and tourists. Through a thousand-year-long period, some people had been experientially aware that Lake Biwa's water surface seemed fairly higher than Kyoto. Therefore, a considerable number of powerful rulers, dominants, and merchants in the past had wished to build a canal for mass transportation, but any plan did not come true before Meiji Restoration (Tamura 1982). Meiji Restoration was an incredibly drastic innovation of the country, changing all throughout.

### 21.7.3 BIWAKO CANAL PROJECT AND KEAGE POWER PLANT

Tanabe Sakuro, a student at “Kobu-Daigakko” (presently, Faculty of Engineering, the University of Tokyo), was sent to Kyoto for the land survey, starting in 1881, at Mihogasaki in Ohtsu, and resuming in 1882 at several locations between Ohtsu and Kyoto. Through the survey, he found that the



water table of Lake Biwa was 43 m higher than the altitude of Keage in Kyoto (Kyoto City 1939). Based on this survey work, Tanabe completed his graduation thesis entitled “A Construction Project of the Lake Biwa Canal” and presented it to Kobu-Daigakko, in May 1883. Just after graduation, he was invited to Kyoto as a prefectural officer in charge of designing and supervising the Biwako Canal Project.

Owing to the presence of mountains in the path of the Biwako Canal, three tunnels had to be built. Judging from the technical level at that time, tunnel excavation was a major challenge, since it involved such risks as cave-ins and dynamite accidents, plus problems such as scarcity of skilled labor. To overcome these difficulties, a variety of advanced machinery, such as pumps, steam engines, and air compressors, were improved. Moreover, to build the 2436 m long Nagarayama Tunnel, the longest in Japan at that time, two vertical shafts were excavated, so that lighting and ventilation could be provided from above as well as muck-haulage (mucking) from bottom; steam engines were adopted for hoisting; and compressed air was used for excavation in the main tunnel.

Accurate survey and excavation were also great challenges, which were overcome by utilizing the most advanced triangulation method available at that time. In addition, the materials for the construction work had to be domestically made to cultivate the material industry in Kyoto. A brick plant was established in Misasagi village on the route, mostly for the purpose of providing lining materials (bricks) for the tunnel.

In the midst of this construction work, two project engineers, Tanabe Sakuro and Takagi Bunpei, were sent to the USA in October 1888 to investigate the canal transportation systems used for the Potomac Canal (297 km from Washington, DC, to Cumberland, Maryland) and the Morris Canal (172 km from Philipsburg to Newark, New Jersey), as well as the hydraulic turbine facilities run for textile and paper production in Lowell and Holyoke, Massachusetts.

In fact, as soon as they arrived in Vancouver, Canada, in November 1888, they started for Washington to see the transportation system operated in the Potomac Canal and then moved on to Newark to investigate the inclined track facilities operated in the Morris Canal. Observing the actual facilities and operations, they found that the two railroads, Baltimore and Ohio Railroad and Morris and Essex Railroad, running along these canals, could transport within 10 h an amount that might take several days to transport via the canals.

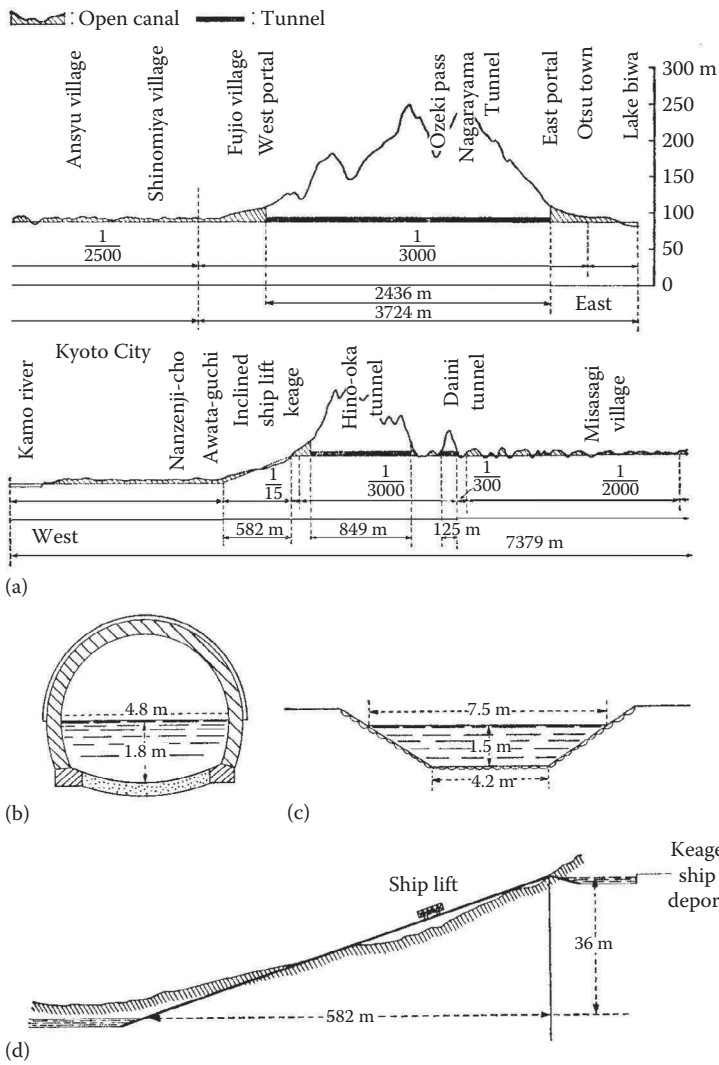
In December 1888, they visited Lowell and Holyoke and witnessed the revolutionary harnessing of hydraulic power for textile and paper production by means of giant water turbines. However, faced with the fact that stream turbines would potentially be much more practical than water turbines, they thought that it would be unwise to develop regional industries in Kyoto by adopting water turbines. Thus, they keenly felt that what they were attempting in Kyoto would be lagging far behind the trend in the USA.

At that time, Tanabe and Takagi luckily happened to hear about the hydroelectric plant that had just started at a silver mine in Aspen, Colorado. They immediately took a train from New York to Aspen, where they observed a 150 hp Pelton turbine and two generators, supplying electric power to the mine to lift ore by 333 m (1000 ft). They were so impressed with this breakthrough innovation that they dared to decide to incorporate power generation into the Biwako Canal Project. Thus, early in January 1889, on their way back to Japan, they visited the Pelton Water Wheel Company, which was just established in San Francisco, and ordered several Pelton turbines (Yanabu 2009; Kansai Electric Power Co. 2012).

As soon as they returned to Kyoto late in January 1889, they prepared a proposal to add the construction of the Keage Power Station to the original scope of the project. The construction work was started in January 1890 and completed in May 1897. The station was provided with two penstock runs and a total of 20 Pelton turbines for a hydraulic head of 32 m.

#### 21.7.4 CONSTRUCTION OF THE SHAFT AND THE NAGARAYAMA TUNNEL

On the route of the Biwako Canal, three tunnels were designed, as shown in Figure 21.14a. Figure 21.14 also shows (b) cross section of the main tunnel, (c) cross section of the open



**FIGURE 21.14** Biwako Canal: (a) profile, (b) cross section of the tunnel, (c) cross section of the open canal, and (d) the inclined ship lift. (From Kyoto City, *Construction of Biwako Canal and Electrification*, Bureau of Electric Supply, Ch. 5, pp. 177–349, 1939; Kyoto City, *Biwako Canal Project, History of Kyoto*, vol. 8, pp. 146–165, 1975. With Permission.)

channel, and (d) gradient of the inclined ship lift. The three tunnels are, in the order from east to west, the Nagarayama Tunnel (2436 m), the Dai-ni Tunnel (125 m), and the Hino-oka Tunnel (849 m). The construction of the canal was started with the shaft for the Nagarayama Tunnel (Kyoto City 1939). The Mihogasaki Intake was located at the east portal of this tunnel. As the Nagarayama Tunnel would be the longest in Japan at that time, Tanabe and his engineers, without any experience in tunneling before, searched for referable cases at home and abroad, such as Asaka (128 m, in Fukushima, 1878–1880), Mont Cenis (12.5 km, between France and Italy), and St. Gothard (15 km, in Switzerland, 1872–1882). They came up with the conclusion that it would be the best to provide with an access shaft before the main tunnel drive because of many technical advantages in construction period, mucking, material transportation, lighting, and ventilation.



Further, the main tunnel was going to be driven through the alternative layers of mostly slate, sandstone, and hornfels, and partly quartz porphyry. In general, such an alternative-layer formation, particularly slate, is unfavorable in tunneling. Tanabe and his engineers realized that such a situation might easily cause aggressive inflow as well as sudden cave-ins during construction. Shaft sinking was indispensable from the viewpoint of not only the technical advantages, as mentioned before, but also the drainage at an emergency. Thus, the 50 m long shaft was located at Kanabori Valley, 730 m far from the Fujio (West) Portal.

The dimensions of the shaft are (a) a circular cross section of 5.5 m diameter from the top to 5.5 m, (b) an elliptical cross section of 3.15 m in east-west and 2.7 m in north-south from 5.5 m to the bottom, and (c) 50 m in total length. When the excavation of the shaft reached the bottom of the main tunnel after frequent encounters with water inflow, the most aggressive inflow took place. It was overcome by reinforcing the drainage system with a specially designed pump and two Donkey pumps. The shaft sinking took 196 days.

Immediately following the shaft sinking, the excavation of the main tunnel was started from four driving faces, namely two faces from the shaft toward east (Ohtsu) and west (Kyoto) and two more from the west (Fujio) and east (Mihogasaki) portals. According to the original design drawings, it is considered that the excavation of the main tunnel was driven by the so-called Belgian and Austrian methods. Presumably, the Belgian method was adopted at many places, and the full-face timber support must have been difficult for the workers at that time, from the authors' viewpoint. Timber-support structure was replaced with brick lining. Sometimes, instead of bricks, granite blocks were placed onto the side wall in case of favorable ground conditions.

The dimensions of the tunnel are (a) cross section: horse-shoe shaped, half circle, with 2.5 m radius for the upper half, and 2.5 m height for the bottom half; (b) area of cross section: 26.55 m<sup>2</sup>; (c) lining: 40 cm and 50 cm in thickness, for favorable (normal) and unfavorable rocks, respectively, and 30 cm for the invert arch; (d) brick masonry: a stack of 4–5 brick layers in the cross section; and (e) construction period of the Nagarayama Tunnel: June 1885–February 1889 (4 years and 8 months) for a length of 2436 m.

Regarding the construction materials, cement products available at that time were not reliable owing to their unhomogeneous quality, in addition to immature skill in concrete work. Explosives such as dynamite were used, but their amount was considerably limited, because all explosives were imported from the UK at extraordinarily expensive cost. It means that excavation was done mostly by hand, with a little use of explosives.

Lastly, the survey works were concluded as follows: the reliability of survey works was the vital base for the successful canal project. The authors found some descriptions on the accuracy of survey at the breakthrough of the three tunnels in the archives. The deviations in the alignment of Nagarayama Tunnel were 1.20 m in longitudinal length, 1.2 cm in elevation, and 7.3 cm in horizontal direction at center. In the other two tunnels, there was no deviation, except 0.29 m in the longitudinal length of the second tunnel (123 m). These results are really amazing in consideration of the survey theory, instruments, calculation tools, and so on available at that time.

### 21.7.5 INCLINED SHIP LIFT AND AQUEDUCT BRIDGE

One of the original purposes of the Biwako Canal Project was to enable mass transportation, namely, ship transportation all through between Ohtsu and Kyoto, without any transfer. The difference in elevation between Mihogasaki Intake and Keage Junction is only 6 m over 6 km, or 1/1,000 in gradient. This was very suitable for the two-way canal transportation, but the difference between Keage Junction and the Nanzen-ji Ship Depot was 36 m in elevation and 582 m in length, or 1/15 in gradient, as shown in Figure 21.14d. Tanabe invented a sort of cable car, called "Inclined Ship Lift" (21.6 m wide), which carried ships simultaneously upstream and downstream by the principle of the cable-car operation. Thus, Tanabe could overcome the dilemma between transportation (requiring



**FIGURE 21.15** Brick-masonry arch bridge in Biwako Canal.

gentle gradient) and hydraulic power generation (requiring steep gradient). Hydraulic power was finally replaced with hydroelectric one (Kyoto City 1939, 1975).

In addition, on the route of the branch canal between Keage Junction and Nanzenji Intake, a 92 m long and 10 m high aqueduct bridge was built east of the Nanzenji Temple. It is a brick-masonry arch bridge with 14 spans, as shown in Figure 21.15.

### 21.7.6 REMARKS ON THE BIWAKO AQUEDUCT

Regarding the construction of the first canal in the Biwako Canal Project, the statistics are as follows: (a) total manpower: 4,000,000, (b) total number of bricks: 1,450,000 pieces, (c) total amount of explosives: 26.25 tons, and (d) total amount of cement: 25,000 barrels.

The second canal was constructed in parallel with the first canal in 1906–1912 in order to increase the amount of water three times more in total than that of the first canal. The Biwako Canal is still alive as an aqueduct, and the water is used for hydroelectric power generation, drinking, irrigation, and various industries. Its amount is approximately 200 million tons per year.

Japan had to learn a lot of things from developed countries at the dawn of the modern Japan, and the government of Japan invited more than 2500 engineers, scholars, technicians, experts, and so on from abroad, mostly from European countries such as the Netherlands, UK, Germany, France, and the USA. They worked particularly in the field of civil engineering (e.g., building, plants, harbors, river control, reclamation, channels, sewers, bridges, tunnels, and railways), so as to develop infrastructure as much as possible in a short period like a few decades. Not every scheme was always successful.

In such a situation, the Biwako Canal Project was the symbolic example, which was successfully contrived and implemented entirely by Japanese. The new challenge and wise decision, which were made by the inexperienced but contemplating young engineers, were realized in this project.

## 21.8 CONCLUSIONS

Five projects during the early seventeenth to late nineteenth centuries were described. Notable features are application of siphons, long tunnel driving with many adits, selection of geology, three-dimensional arch structure, earthquake-energy-releasing device, and outstanding decision making by a young engineer at the dawn of modern Japan. We realize that experience is the mother of wisdom.

## REFERENCES

- Ako City 1983. History of Ako City, vol.2, Mar.31.
- Ako City 1995. Visiting Historic Site of the Old Ako Aqueduct, No.4, Education Board.
- Ako City 2015a. Guide Board of Kiriyama Tunnel, Education Board.
- Ako City 2015b. Communication with Lifelong Learning Div., Education Commission.
- Ako Historical Museum 1997. The Castle Town and Its Water Supply, Nov.1.
- Fukara Local Historical Museum 2015. Fukara Aqueduct, Lake Ashinoko Irrigation & Drainage Assoc. of Shizuoka Pref.
- Hiroshima, T. 1982. The Castle and Town of Banshu Ako, Aug.10.
- HP/Biglobe 2015. Tatsumi Aqueduct.
- HP/Google 2006. On the Completion Day of the Hakone Aqueduct, 26 Feb. /blog.goo.ne.jp.
- HP/Google 2015a. Tatsumi Aqueduct.
- HP/Google 2015b. Hakone Aqueduct.
- HP/Ishikawa Prefecture 2015. Topography and Geology of Ishikawa Pref., Surveyors Association of Ishikawa Pref.
- HP/Kanazawa City 2015a. Tatsumi Aqueduct, Cultural Assets Preservation Div.
- HP/Kanazawa City 2015b. Survey of Tatsumi Aqueduct, 11104/bunkazaimain.
- HP/Kumamoto Prefecture 2015. Tsujun Aqueduct 7920.html.
- HP/Susono City 2015a. Fukara Aqueduct and Sightseeing/susono.shizuoka.
- HP/Susono City 2015b. Aqueduct Tunnel, Hakone (Fukara) Aqueduct/daichi/part3.
- HP/Wikipedia 2015a. Tatsumi Aqueduct.
- HP/Wikipedia 2015b. Fukara Aqueduct.
- Hyogo Prefecture 1995. Basic Geological Information, Human and Nature, no.5, pp. 37–43.
- JSCCE 1995. Japanese History of Construction, edited by Japanese Society for Civil Engineers, 80th Anniversary edition, Sankaido, pp. 353.
- JWWA 1967. The History of Aqueducts in Japan, Japan Water Works Assoc., pp. 1–186.
- Kansai Electric Power Co. 2012. Brochure, History of Keage Power Station.
- Kito, H. 2000. Japanese History through Population, Kodansha-Bunko.
- Kodansha 1998. The Kodansha Bilingual Encyclopedia of Japan, pp. 34–52; pp. 96–108.
- Kyoto City 1939. Construction of Biwako Canal and Electrification, Bureau of Electric Supply, Ch.5, pp. 177–349.
- Kyoto City 1975. Biwako Canal Project, History of Kyoto, vol. 8, pp. 146–165.
- Lonely Planet 2000. China, Lonely Planet Publications, pp. 938.
- Mason Museum 2015. Communication with Mason Museum, Toyoson Sekishoukan, Kumamoto, Japan.
- Okamoto, R., et al. 1981. Distribution and Engineering Properties of Weak Rocks in Japan, In *Proceedings of the International Symposium on Weak Rock*, vol. 5, Tokyo, Japan, pp. 89–101.
- Tamura, Y. 1982. Story on Kyoto Incline Ship Lift, Shinchosha, pp. 235.
- Tanimoto, C. 1982. Engineering Experience with Weak Rocks in Japan, 23rd U.S. Symposium on Rock Mechanics, Ch.99.
- WWI 1993. Report on State of the World, Ch.2, WorldWatch Institute.
- Yamato Town 2015. Exhibition at Tsujun Museum, Kumamoto, Japan.
- Yanabu, S. 2009. The History of the Electrification of Japan and the Keage Power Station, *IEEJ Transactions on Fundamentals and Materials*, 129(6):396–402.

---

# 22 Managing Drought through Qanāt and Water Conservation in Afghanistan

*Saifullah Khan and Saeid Eslamian*

## CONTENTS

22.1	Introduction .....	386
22.2	Drainage and Major Rivers.....	386
22.2.1	River Basin I: Kabul/Indus River Basin.....	387
22.2.2	River Basin II: Hilmand River Basin .....	387
22.2.3	River Basin III: Western Rivers Basin .....	387
22.2.4	River Basin IV: Northern Rivers Basin.....	387
22.2.5	River Basin V: Northeastern Rivers Basin.....	387
22.3	Climate .....	388
22.4	Ancient Empire and Early Dynasties .....	388
22.5	Water Resources .....	388
22.5.1	Surface Water Resources.....	389
22.5.2	Groundwater Resources.....	390
22.6	Irrigation in Afghanistan.....	391
22.6.1	Traditional Irrigation Systems .....	391
22.6.1.1	Small-Scale Informal Surface Water Systems .....	391
22.6.1.2	Large-Scale Informal Surface Water Systems.....	391
22.6.2	Shallow Wells (Arhad) System .....	392
22.6.3	Springs .....	392
22.6.4	Karez (Qanāt) Systems.....	393
22.6.4.1	Advantages.....	394
22.6.4.2	Disadvantages .....	394
22.6.4.3	Threats .....	395
22.6.5	Modern Irrigation Systems .....	395
22.6.5.1	Formal Surface Water Systems without Storage.....	395
22.6.5.2	Formal Surface Water Systems with Storage.....	396
22.6.5.3	Formal Ground Water Systems.....	396
22.6.6	Irrigation Methods and Efficiencies.....	397
22.7	Drought in Afghanistan .....	398
22.7.1	Effects of Current Drought on Livelihood .....	399
22.7.2	Precipitation during the Year 2001 .....	399
22.7.3	Food Production and Demand.....	400
22.7.4	Grazing (Pasture) and Livestock.....	400
22.8	Summary and Conclusions .....	400
	References.....	401

## 22.1 INTRODUCTION

Afghanistan is a landlocked country, bordered on the west by Iran; on the north by Turkmenistan, Tajikistan, and Uzbekistan; on the northeast by China; and on the east by Pakistan. Afghanistan, a country about the size of Texas, boasts elevations to more than 7315 m (24,000 f). Its rugged topography has both physical and cultural implications, critical to understanding why the country has never been totally conquered (Lineback 2001).

Afghanistan is a landlocked country of rugged mountains. The most prominent mountain range is the Hindu Kush, which extends about 966 km (600 miles) from the far northeast to the southwest, effectively bisecting the country. Mount Nushaq is the highest peak and reaches 7483 m (24,550 ft).

The Wakhan Corridor (the extreme northeasterly part of Afghanistan, which borders China, Tajikistan, and Pakistan) sits at the junction of the highest mountain systems in the world (including the Himalayas, Hindu Kush, Karakoram, and others), which together are sometimes called the “roof of the world.” North of the Hindu Kush, the Turkestan Plains run down to the Amu Darya (river) on the northern border. After broadening into the Hazarajat central plateau, the mountains disappear into western deserts such as the Registan. Northern Afghanistan is subject to major earthquake activity.

## 22.2 DRAINAGE AND MAJOR RIVERS

For water, Afghanistan relies on four major river systems: the Amu Darya, the Kabul, the Helmand, and the Hari Rud. Many villages in Afghanistan use a qanāt well system (a string of connected wells) to irrigate more arid parts of the country. Hydrologically, Afghanistan is divided into five following major river basins (Figure 22.1).



**FIGURE 22.1** Afghanistan, political and rivers basin. (By Alim, A.K. and Shobair, S.S., *Drought and Human Suffering in Afghanistan*, in *TAEAS2002 Proceedings, Agricultural and Forestry Research Center*, University of Tsukuba, Japan, p. 119–127, 2002. With Permission.)

### **22.2.1 RIVER BASIN I: KABUL/INDUS RIVER BASIN**

This basin is located in the eastern part of the country, including the southeastern river sub-basin. The outflow of River Basin 1 is in Pakistan. The total catchment area of this basin is 143,000 km<sup>2</sup>. The main direction of flow is from west to east. Run-off generated in this basin is discharged by Kabul river from Afghanistan and Indus rivers from Pakistan to the Indian Ocean.

### **22.2.2 RIVER BASIN II: HILMAND RIVER BASIN**

This basin is located in the southern part of Afghanistan, with a total catchment area of 166,000 km<sup>2</sup>. The discharging river mainly flows from the east to the west. The run-off of upper parts of this basin is collected in Kajaki reservoir. Owing to the current drought, the amount of water stored in this reservoir has been reduced significantly, and in at least 2 years, the water has not been spilled out from the spillways. The water released currently fulfills the needs of upper parts of the basin, while the demand for water in the lower parts remains unmet. Originally, the discharge of this basin was drained to Hamoon-e Helmand, partly situated in Iran. The root for the change is accounted to the rainfall reduction and improper management of irrigation water in the middle parts of the river. Some ephemeral rivers also exist in this basin; these rivers have outflow to Baluchistan/Pakistan.

### **22.2.3 RIVER BASIN III: WESTERN RIVERS BASIN**

This refers to the western watershed of the country. The watershed size of this basin is about 131,000 km<sup>2</sup>. Hari Rod, Farah Rod, and other smaller streams drain the run-off from the area. Hari Rod defines partially the boundary with Iran. The southwestern river of this basin drains into depressions situated along the Iranian border.

### **22.2.4 RIVER BASIN IV: NORTHERN RIVERS BASIN**

Several watersheds of the northern part of the country are classified as basin IV. The area of this drainage basin is 116,000 km<sup>2</sup>. The runoff is discharged by the Murghab, Kashan, Kushk, and Gulran rivers out from the basin to Turkmenistan by Amu (Oxus) river. However, the other rivers, such as the Samangan, Balkhab, Saripul, and Shirin Tagab, do not reach the Amu River.

### **22.2.5 RIVER BASIN V: NORTHEASTERN RIVERS BASIN**

Basin V is the northeastern river basin of Afghanistan. The size of this watershed is 86,000 km<sup>2</sup>. Run-off generated here is rooted to the Amu River by the Kunduz and Kokcha rivers. Amu River is finally drained to the Aral Sea.

Most of the rivers in Afghanistan are perennial; however, many of them fall dry at their lower reaches during late summer, owing to the diversion of water for irrigation purposes. Discharges rise continuously from March onward, originated by snowmelt ending in June/July before diminishing to a minimum in December/January. A large amount of the river flow (over 80%) occurs from April to September. Most disastrous floods occur after heavy rainfall in March/April, especially when snowmelt is already well advanced.

Over 80% of the country's water resources have their origin in the Hindu Kush mountain ranges at altitudes above 2000 masl, which function as a natural storage of water in form of snow. The gradual snowmelt supports perennial flow in all major rivers during summer.

The hydrological data of the rivers were collected regularly through 167 hydrologic stations before the war (Shobair 2001b). Presently, most of these recording stations are destroyed; their measurement equipment were looted and hence none is operational. The absence of hydrometrological stations has introduced a gap in the availability of hydrological data. Attempts are going on for rehabilitation of these stations.



With regard to groundwater situation in Afghanistan, although no reliable data on annual groundwater recharge exist, an estimation of 15 billion m<sup>3</sup> is made (Sheladia Associate 2001). In the same manner, the total amount of water extracted annually from groundwater is estimated to 3 bcm (Alim and Shubair 2002).

### 22.3 CLIMATE

The climate varies according to elevation and location. Generally, the capital city of Kabul (6000 ft or 1829 m) has cold winters and temperate summers; Jalalabad (1800 ft or 549 m) has a subtropical climate; and Kandahar (3500 ft or 1067 m) is mild all year round. Central and northeastern Afghanistan experiences heavy snowfall during winter.

Afghanistan receives irregular precipitation over the year, which varies from a low of 75 mm in Zaranj to 1170 mm in south Salang. Mainly, precipitation occurs in winter, particularly from December to April. The wet season is concentrated in winter and spring, when the vegetative cover and crop water requirements are low. In higher elevations, precipitation falls in the form of snow, which is highly critical for river flow and agricultural demand in summer. From June to October, Afghanistan hardly receives any precipitation. The southern part of Afghanistan receives less than 300 mm/yr, while the region south of Bust and Farah receives less than 100 mm/yr.

The Central Highland and Northern Afghanistan receive between 300 mm and 400 mm rainfall, and the highest mountains in these areas may receive some more rainfall. The annual evapotranspiration (ET) rates are relatively low in Hindu Kush mountain ranges (900–1200 mm) because of severe and long winters. The ET rates vary between 1200 mm and 1400 mm in the northern plains and can reach up to 1800 mm in the southern and southwestern plains. However, summer evapotranspiration rates are high all over the country, showing a daily peak of 5–8 mm in June, July, and August (Shobair 2001b). Owing to strong winds occurring particularly in Herat and in the southern-western plains, maximum daily ET rates are over 10 mm in this period (maximum 11 mm in July). The annual rainfall, ET, and the deficit to fulfill the potential ET is presented.

### 22.4 ANCIENT EMPIRE AND EARLY DYNASTIES

Located along the Silk Road (a trade route extending from China to Europe), Afghanistan has been the Crossroads of Asia since ancient times and thus has been subject to repeated invasion. Emperors and conquerors (Persians, Greeks, central Asians, and others) throughout history have attempted to control or pacify the region's inhabitants, always finding them fiercely independent and formidable military opponents aided by the country's defense—mountains. Islam was introduced in the seventh century and flourished in the Ghaznavid Empire (977–1186 AD). Great destruction occurred in the thirteenth century with the Mongol invasions of Genghis Khan. His Turko-Mongol descendant Tamerlane (also known as Timur) established the Timurid Dynasty (1370–1506 AD), famed for its arts and architecture. The Mughal Dynasty (1526–1707 AD) rose to control eastern Afghanistan and the Indian subcontinent, while the Persian Safavid Dynasty (1501–1732 AD) held western Afghanistan. Afghanistan's modern roots are in the Durrani Dynasty, founded in 1747 AD by Ahmed Shah Durrani.

### 22.5 WATER RESOURCES

Presently, the major water consumer in Afghanistan is the agriculture sector, with more than 21.9 bcm (98% of total). A total of 19.1 bcm (87%) of this amount is met by surface sources and 2.8 bcm (13%) from groundwater 1.74 bcm [8%] from qanāts, 0.98 bcm [4%] from springs, and

0.17 bcm [1%] from deep wells (Shobair 2001a). The available statistics show that, in 1995 (hydrologically a normal year), there were a number of 21.93 million sheep and 11.56 million qanāt systems (Alim and Shubair 2002).

**22.5.1 SURFACE WATER RESOURCES**

Although Afghanistan is located in half-deserted atmosphere, it is still rich in water resources, mainly due to the series of high mountains such as Wakhan, Hindu Kush, and Baba covered by snow. Over 80% of the country’s water resources have their origin in the Hindu Kush mountain ranges, at altitudes above 2000 m, which function as a natural storage of water in form of snow during winter and thus support perennial flow in all major rivers by snowmelt during summer.

Afghanistan is part of three large river basins: the Amu Darya basin in the north, separated by the Hindu Kush mountain range from the Desert basin in the south, and the Indus basin in the east. Because of practical reasons related to the quantification of available surface water volumes, the hydrological classification is based on principal watershed units. Based on the hydrological and morphological systems, the country can be divided into four main river basins. General characteristics of these four river basins are shown in Table 22.1.

Recent estimates indicate that the country has 75 bcm of potential water resources, of which 55 bcm is surface water and 20 bcm is groundwater. The annual volume of water used for irrigation is estimated to be 20 bcm, which is 99% of all water used. Total groundwater extraction amounts to some 3 bcm. Approximately 15% of the total water volume used annually originates from alluvial groundwater aquifers (9%) and springs (7%) and almost 85% from rivers and streams. Groundwater used from deep wells counts for less than 0.5%. The annual per capita water availability is approximately 2500 m<sup>3</sup>, which compares favorably with other countries of the region, for example, with Iran (1400 m<sup>3</sup> per capita per year) and Pakistan (1200 m<sup>3</sup> per capita per year). A qualitative assessment shows that Afghanistan’s water resources are still largely underused, which is supported by the data presented in Table 22.2.

**TABLE 22.1**  
**General Characteristics of Four River Basins of Afghanistan**

River Basin	Rivers Included in This Basin	Catchment Area (km <sup>2</sup> )	Storage Capacity (Billion m <sup>3</sup> )
Amu Darya basin	Wakhan, Kokcha, Kundz, Pamir/Panj, Marghab, Shrin Tagab, Sur pul, Bulkh, Kashan, Kushk, and Gulran	302,000	24
Helmand river basin	Helmand, Arghandab, Ghazni, Trank, Arghastan, and Musa Qala	218,600	6.5
Western rivers basin	Khash, Farharod, Aderskan, Harierod, and so on	85,300	2.5
Kabul/Indus basin	Kabul, Kunar, Alishing, Alinegar, Logar, Pangshir, Shutol, Ghorbund, Laghman, and Maidan	72,000	22
Total			55

**TABLE 22.2**  
**Estimated Surface and Groundwater Balance (BCM per Year)**

Water Resources	Potential	Present Use	Balance	Future Use	Balance
Surface water	57	17	40	30	27
Groundwater	18	3	15	5	13
Total	75	20	55	35	40

It is not clear, however, how much of this “potential” resource can be accessed without causing damage to people and ecosystem. For example, how much of the groundwater can be extracted without leading to an excessive decline in groundwater levels and reaching to a stage of “water mining.”

There are plenty of individual discharge data of many of Afghanistan’s rivers, particularly from the Kabul and the Helmand rivers, as well as from their tributaries. However, no reliable documentation is available about the systematic quantification of surface water resources at watershed level. An attempt is made to quantify the annual surface water resources at watershed level. The limited reliability of data collected did not allow presenting the surface water resources potential at regional level. Most of the rivers listed in the table are perennial, although many of them fall dry at their lower reaches during late summer, owing to the diversion of water for irrigation purposes. Discharges are rising continuously from March onward; these are caused by snowmelt culminating in June/July, before receding to a minimum in December/January. Most disastrous floods occur after heavy rainfall in March/April, especially when snowmelt is already well advanced.

Surface water quality is excellent in the upper basins of all rivers throughout the year and good in the lower basins despite large irrigated areas. As far as it is known, the presence of saline soils in irrigated areas is never caused by poor water quality but rather by over-irrigation (water logging) or lack of irrigation water (fallow fields and high groundwater table).

### 22.5.2 GROUNDWATER RESOURCES

Afghanistan possesses huge reserves of groundwater. According to FAO 1996, the annual potential of the groundwater in the country is about 20 billion m<sup>3</sup>. At present, only 3 billion m<sup>3</sup> is being used, and it is projected that in the next 10 years, it can increase to 8 billion m<sup>3</sup>, owing to increase in irrigation and domestic water supplies requirements.

More than 15% of Afghanistan’s irrigated land gets water from traditional underground systems such as karezes (qanāts), springs, and shallow wells (locally called Arhads). Karezes are underground systems, which tap groundwater by gravity from the aquifer to provide water for irrigating crops and domestic purposes. Ten top provinces of Afghanistan that have highest percentage of area irrigated with groundwater irrigation are given in Table 22.3.

**TABLE 22.3**  
**Ten Provinces with the Highest Percentage of Irrigated Area with Groundwater**

Name of the Province	Area Under GW Irrigation	Percentage of Total Area
	(ha)	(%)
Uruzgan	73,910	58.4
Ghazni	43,170	36.7
Farah	36,890	29.3
Helmand	27,280	16.8
Zabul	24,870	39.8
Kandahar	21,870	18.5
Kabul	18,270	32.5
Ghor	16,940	23.3
Nangarhar	13,820	32.6
Badghis	13,050	39.2

Source: FAO, Irrigation in Asia in figures. FAO Water Report No. 18. Rome, Italy, 2001.

According to an estimate, all traditional groundwater irrigation systems have reduced or dried up completely. About 60%–70% of the karezes are not in use, and 85% shallow wells are dried out. The population dependent on these systems has suffered badly, owing to failure or reduction in discharges of these systems. The main reason for the low discharges is low precipitation and consequently low recharge to the groundwater. In addition, boring of deep wells in the vicinity of karezes and shallow wells had adversely affected the production of these traditional irrigation systems. This has threatened the sustainability of these systems in the future too.

In most of the urban areas, shallow wells are used to get water for drinking and other household activities. As the water levels continue to fall, around 0.5–3 m each month, depending on the place, the poorer families are unable to dig their wells deeper and thus are forced to get water from communal wells. Many of these wells are already dried up, and people (often women and children) are forced to walk miles to meet their daily water demands (Ahmad et al. 2002).

## **22.6 IRRIGATION IN AFGHANISTAN**

The history of irrigated agriculture in Afghanistan goes back more than 4500 years ago (ancient settlement near Kandahar). Except for a few areas where rain-fed agriculture can be practiced, agricultural production in most of the country is not possible without irrigation, as the rainfall is either meager or unreliable. The allocation of water and land is closely related to customs and traditions of the sedentary population, and maintenance works of irrigation schemes have always been a well-defined activity in the farmers' seasonal calendar. Irrigation systems in Afghanistan can be divided into two categories: traditional irrigation systems and modern irrigation systems (Kawasaki et al. 2012).

### **22.6.1 TRADITIONAL IRRIGATION SYSTEMS**

#### **22.6.1.1 Small-Scale Informal Surface Water Systems**

These water systems are centuries-old systems. Water is supplied by stream flow diverted with the help of temporary brush weirs. They are often located in remote valleys along a stream or river and vary in size (up to 100 ha). These systems are constructed and maintained in a traditional informal manner on a communal village basis, and water rights are also determined and recognized in the similar manner.

#### **22.6.1.2 Large-Scale Informal Surface Water Systems**

These systems are mainly located in the plains and along the main river valleys. They can cover an area of up to 200,000 ha. Although they are called informal, their operation and maintenance were highly structured, involving different communities of different ethnic origins.

Many villages can share water from such a system. According to the water laws of 11981, the amount of water needed for irrigation is determined according to area under cultivation, the kind of crop, the irrigation regime, the water rights' document, the local practices, and the amount of water in its source. The regulations concerning the use of water in agriculture in Afghanistan (Ministry of Irrigation and Water Resources 2002), each village has at least one water master (mirab), who delegates his authority to subwater masters, who are in turn responsible for the allocation of water to different fields of the scheme. Lawyers (vakils) support the mirabs in disputes over water rights and provide the linkage to government authorities for the registration of land and water rights. Repair and maintenance works are executed by mobilizing large gangs of labor for a long period, and farmers in the command area have to contribute in labor, cash, or kind. Historically, large parts of these schemes have been abandoned because of the impact of wars, water logging, and salinization, particularly in the Harirud, Farah Rud, Balkhab, Murghab, and Helmand valleys (Table 22.4).

**TABLE 22.4**  
**Province-Wise Distribution of Different Irrigation Systems in Afghanistan**

No.	Province	Canals	Springs	Karez	Wells	Mills
1	Badakhshan	212	82		54	730
2	Badghis	120	50	30		500
3	Baghlan	109	63			565
4	Balkh	250	92	3	82	912
5	Bamyan	179	137		300	651
6	Farah	312	94	352	327	260
7	Faryab	157	79	960	867	1030
8	Ghazni	818	604	1516	636	994
9	Ghor	804	570	4	263	500
10	Helmand	227	135	276	60	516
11	Heart	302	153	228	450	1302
12	Jawzjan	382	87	2	443	475
13	Kabul	177	81	321	436	616
14	Kandahar	279	258	631	252	383
15	Kapisa	285	72	49	176	638
16	Kunarha	223	67		13	681
17	Kunduz	88			55	363
18	Laghman	45	3			561
19	Logar	154	169	124	91	433
20	Nangarhar	274	210	495	15	1001
21	Nimroz	193	2	18	140	133
22	Paktia	625	392	528	800	171
23	Parwan	120	93	34		756
24	Samangan	20	73	7	271	190
25	Takhar	316	288		509	653
26	Uruzgan	363	429	84	210	1266
27	Wardak	589	519	336		822
28	Zabul	199	756	743	148	373
		7822	5558	6741	6598	17475

### 22.6.2 SHALLOW WELLS (ARHAD) SYSTEM

Groundwater is lifted from shallow wells with the help of Persian wheel (arhad), which supplies irrigation water to the fields of an individual farmer. The size of the irrigated land does not exceed 3 ha. The total number of shallow wells in Afghanistan is 8595, which irrigate around 12,060 ha of land.

### 22.6.3 SPRINGS

When groundwater table reaches above the ground surface, it starts flowing on the surface and forms springs. There are about 5558 springs in the country, which irrigate about 188,000 ha of land. Springs are directly dependent on the groundwater level. When the groundwater level goes down, for example, during drought years, it results in a reduction of outflow from springs. That is why some of the worst drought-stricken areas of the country are located in regions where they depend heavily on spring water for irrigation. Spring irrigation is common in the east and south.

#### 22.6.4 KAREZ (QANĀT) SYSTEMS

Karezes are underground galleries that tap groundwater from the aquifers of alluvial fans. Underground tunnels with gentle slopes carry water from the source to the settled areas (Figure 22.2).

Karezes are usually small in dimensions but may be many kilometers in length. On average, their discharge varies between 10 L/s and 200 L/s but can, in some cases, reach up to 500 L/s. Karez water is used for irrigation purposes (irrigated area ranges from 10 to 200 ha), as well as for drinking water supply (UNICEF/WHO 1997).

The technique has been used for thousands of years in Afghanistan, Iran, the Middle East, and North Africa. It is one of the most economical methods of tapping groundwater for irrigation purposes. It is environmentally safe, and water is drawn by use of gravity. There are 6741 karezes in the country, which irrigate about 163,000 ha of land. Karez irrigation is common in the south and southwest of the country and less common in the north of the country. One of the disadvantages of the karezes is that there is no mechanism to stop water from flowing during winter or when there is no need for irrigation. In each karez, about 25% of total annual volume of water is wasted.

The qanāt system was invented by the people of the plateau of Iran. It is unique to Iran and is a typical feature of Iranian scenery. It is used all over the plateau, including Baluchistan and Afghanistan. In the eastern parts of Iran, where the qanāts are constructed, they are often called kahriz, which is a double word (Kah = straw and Riz = throw), because they used to throw through kah into the qanāts for the purpose of seeing how rapid the movement of water in the wells is and for repair works; the straw used would fill some of the gaps in the side of the subterranean channel. From this, the word qah-riz was derived. In the western parts of Iran, kahriz is called qanāt (Esfandiari 2007).

The qanāts are called karez (rhymes with “raze”) in Dari (Persian) and Pashto and have been in use since the pre-Islamic period. It is estimated that more than 20,000 karezes were in use in the twentieth century. The oldest functional kariz, which is more than 300 years old and 8 km long, is located in Wardak province and it still provides water to nearly 3000 people. The incessant war for the last 30 years has destroyed a number of these ancient structures. In the troubled times, maintenance was not always possible. To add to the troubles, as of 2008, the cost of labor has become very high and maintaining the karez structures is no longer possible. Lack of skilled artisans who have the traditional knowledge also poses difficulties. A large number of farmers are abandoning

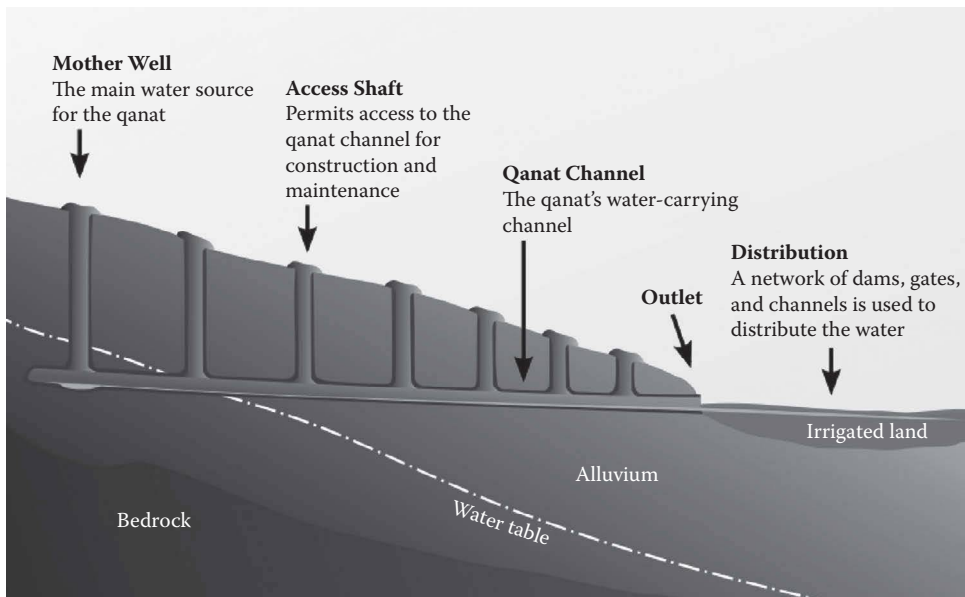


FIGURE 22.2 Karez system.



their kariz, which has been in their families sometimes for centuries, and moving to tube and dug wells backed by diesel pumps. However, the government of Afghanistan is aware of the importance of these structures, and all efforts are being made to repair, reconstruct, and maintain (through the community) the kariz. The Ministry of Rural Rehabilitation and Development, along with national and international non-governmental organizations, is making the effort.

There were still functional qanāt systems in 2009. American forces are reported to have unintentionally destroyed some of the channels during expansion of a military base, creating tensions between them and the local community. Some of these tunnels have been used to store supplies and to move men and equipment underground.

Karez (or qanāt) are a type of underground irrigation canals, running between an aquifer (underground water source) on the piedmont (mountain or higher elevation) and a garden on an arid plain. They are common in Afghanistan. The karez technology is used most extensively in areas where large rivers with year-round flows, which are sufficient to support irrigation, are absent. They are common when potentially fertile areas are close to precipitation-rich mountains or mountain ranges and when the climate is arid and has a high surface evaporation rate. They are also found where there is an aquifer in a potentially fertile area, which is too deep for convenient use of simple wells. In the middle of the twentieth century, it was estimated that approximately 20,000 karezes were in use in Afghanistan, each commissioned and maintained by local users. Although most are shorter than 5 km, the length of the karez can run up to 16 km, and it is said that the longest Afghanistani karez is 70 km long. One of the oldest known karez in Afghanistan is in Jalrez district of Wardak province, which, after 300 years, still provides drinking and agricultural water to nearly 3000 people. Its main well's depth is more than 60 m and length is 8 km.

The karez system has the advantage of being relatively immune to natural disasters (such as earthquakes and floods) and human destruction in war. Further, it is relatively insensitive to the levels of precipitation; a karez typically delivers a relatively constant flow, with only gradual variations from wet to dry years.

#### **22.6.4.1 Advantages**

As with any other water management system, the karez system has a number of advantages and disadvantages. One of the main advantages of the karez system is that it is cheap to operate. Karezes are gravity-based systems that exploit groundwater without any need for mechanical devices. Water is transported for substantial distances in subterranean conduits, with minimal loss of water through evaporation (Rout 2008). The karezes are a cost-effective alternative in the long run. Although expensive to build, they are the most affordable water management system to operate and maintain (Tamuri 2007). Properly maintained karezes have a significantly longer life span than modern pumps and wells. Pumps and wells have a life span of about 20 years, while karezes have been noted to function for centuries (Wegerich 2009). They are intrinsically sustainable, adjusting themselves to the level of available groundwater. If the level drops because of lower rainfall, then the amount of water flowing through the karez also drops. This makes it viable over the long term, as it allows groundwater levels to recharge (Mustafa and Qazi 2007). The Karez system can be identified as a historically unique global heritage and an intrinsic global benefit (Qureshi 2002). Karezes are also closely linked to the local community cooperation, thus creating solidarity and a sense of belonging at local levels.

#### **22.6.4.2 Disadvantages**

The karez system also has disadvantages, notably the challenge to make it an efficient and effective alternative in an increasingly modern society. The karez system requires continuous cleaning to prevent silting and collapsing. Its maintenance is thus a labor-intensive activity, which can be both difficult and dangerous (Hussain 2008). The labor-intensive nature of the karez maintenance means that if you have an increase in labor cost in the future, the relative cost-effectiveness will decrease. Moreover, karez systems are usually not able to provide enough water for large-scale agricultural and/or human consumption. This limits the capacity of the karez to be an alternative water supply

only for extensive agriculture. Similarly, the karez also has limited capacity to keep up and provide drinking water for the increasing population. It is also less flexible than other alternatives; the flow of water is more difficult to regulate, making it difficult to prevent the water from going to waste when it is not being used. Importantly, conflict over water is the second largest type of local conflict in Afghanistan (Dennys and Zaman 2009), and the karez system is no exception. According to local respondents, the karez is a key source of conflict within and between villages.

### 22.6.4.3 Threats

The karez system has been there in Afghanistan for centuries, but now, its existence is being challenged by modern alternatives, degradation of the groundwater, and changes in social perceptions. The shift toward pumps and wells has created a notable challenge for the karez system. The pumping of groundwater is a lucrative alternative in the short run, because it is more flexible and gives access to water when required by the user. However, this shift toward pumping groundwater has also caused a decrease in groundwater levels. The fall in groundwater levels means that the existing karezes cannot access the water and will thus dry up (Qureshi 2002). It is also becoming increasingly difficult to find the willingness among water users to contribute to the operation and maintenance of the karez (Hussain 2008) (Figure 22.3). The potential decrease in the perceived importance of the karez can have a notable negative effect on the ability of the karez system to be a source of positive social capital. Among the respondents in Sayyadabad, the perceived importance of the karez system was identified as the key factor, enabling the karez to bring people together and function as a source of social capital.

At the time of research, there had not been any decrease in the perceived importance of the karez system in the case study area. This might be due to the poor economic situation in various villages. According to the local respondents, very few people can afford to construct and/or operate wells and pumps. This makes the karez system a comparatively more reasonable and lucrative option, potentially explaining its continued perceived importance in Sayyadabad (GoA 2011).

## 22.6.5 MODERN IRRIGATION SYSTEMS

### 22.6.5.1 Formal Surface Water Systems without Storage

They have a permanent intake structure, which is operated and maintained by the Irrigation Department. The management of the irrigation scheme itself follows the rules of the large-scale



FIGURE 22.3 Karez canals require maintenance (Photo <http://www.afghanistan.gc.ca>).



**FIGURE 22.4** Typical irrigation facilities in Afghanistan: (a) intake gate in river, (b) earth canals, (c) shallow well, and (d) irrigation pond.

traditional surface water schemes described above (Figure 22.4). However, the significant difference is that the regulation of water flow to the system depends on the interaction between government authorities and the village communities (Table 22.4).

#### 22.6.5.2 Formal Surface Water Systems with Storage

Organized large-scale irrigation system development is a relatively recent innovation (1960–1978). However, by the late 1970s, five large-scale modern irrigation systems had been built and were in operation. Land tenure was different from traditional systems. Parts of the schemes were operated under private land-ownership agreements, while others were operated as state farms “owned” by the government. The government heavily subsidized these schemes, and farmers were given very limited choice of crop selection or farming practice.

#### 22.6.5.3 Formal Ground Water Systems

Very little is known about the irrigation schemes supplied by groundwater from deep and shallow wells. In Khost/Paktia province, surface water irrigation schemes were supplied by some 100 deep wells until the late 1980s. In the 1970s, about 100,000 ha are said to have been under sprinkler irrigation (private and government owned), and plans existed to introduce drip irrigation. In a few cases, particularly in the lower reaches of large traditional schemes, where water shortage is common, individual farmers undertook irrigation from shallow wells.

Cropping intensity varies widely from system to system, according to the scarcity of water versus land. It reaches 200% in the upper part of the irrigation schemes, while in the lower parts, up to two thirds of the command area is kept fallow each year on a rotational basis. Flood damages to

irrigated land are common, particularly in the large schemes supplied by rivers that change their course frequently owing to their high sediment load and unfavorable geo-morphological conditions.

### 22.6.6 IRRIGATION METHODS AND EFFICIENCIES

Irrigation practices today are characterized by the necessity to irrigate “by all means,” leaving little room for proper irrigation system management. Where village communities were able to organize themselves in a peaceful manner and received assistance in the rehabilitation of destroyed (intakes) or obsolete (conveyance canals) irrigation structures, irrigation is mostly practiced in the traditional way; operation and maintenance of the schemes as well as water distribution are managed on a communal basis under the supervision of mirabs, and disputes over water rights are resolved by vakils. In many other cases where communities share the same water resource for the irrigation of their individual fields but are ruled by different “authorities,” farmers are less fortunate and struggle to make their irrigation scheme somehow operational.

About 85% of all crops in Afghanistan are grown under irrigation. Canal irrigation is by far the most commonly used method of irrigation in Afghanistan. Canals in Afghanistan irrigate nearly 75% or 1.9 million ha of land. Generally, the proportion of canal-irrigated land is much greater than any other form of irrigation. Most of the canal-irrigated land is located in the north, west, and south-west of the country. These canals get water primarily from the snowmelt rivers in the region. At different locations along the river, small diversion structures are installed to divert water from river to the irrigation canals. These diversions are both open and gate fitted. Newly build Logar dam and a typical gate-fitted diversion point are shown in Figures 22.5 and 22.6. From these canals, water is diverted to small irrigation channels (water courses). According to the water laws of 1981, the amount of water given to each farmer is determined according to area under cultivation, the kind of crop, the irrigation regime, the water rights’ document, the local practice, and the amount of water present in the main source. However, these regulations are not strictly followed, and water distribution is mainly done on informal agreements among the farmers.

In traditional, as well as modern, irrigation schemes, the dominant irrigation method is basin/ border irrigation for cereals and furrow irrigation for vegetables and grapes. Farmers usually lack knowledge about crop water requirements, and over-irrigation of crops is a common practice. Overall efficiency is only about 25%–30% for both modern and traditional irrigation schemes, owing to the following reasons:



FIGURE 22.5 New dam on the Logar River.



**FIGURE 22.6** A typical gate fitted canal intake.

- High conveyance losses in traditional schemes with earth canals
- High operation losses in modern schemes with lined conveyance canals
- High on-farm distribution losses (over-irrigation and poorly leveled land) in both traditional and modern schemes

In addition, there is usually a waste of irrigation water in traditional schemes during the first half of the growing season, owing to unregulated flood water entering the conveyance canal, and a shortage of water during the second half, when river flow decreases to its annual minimum.

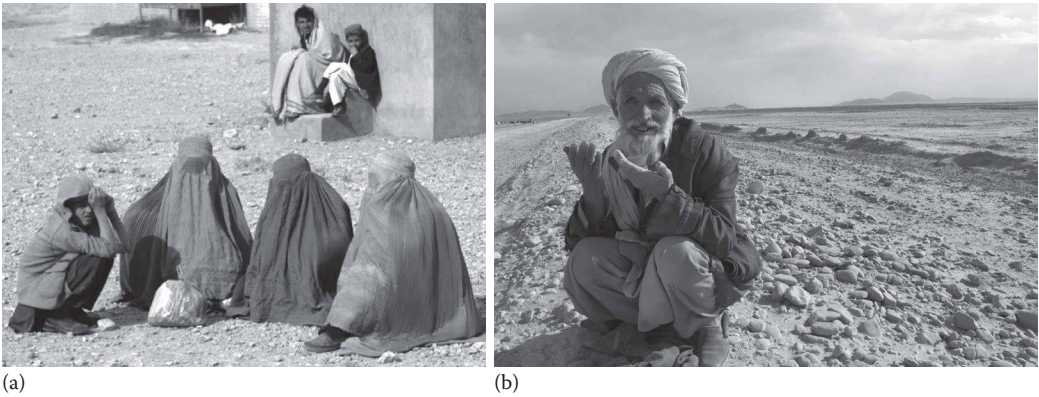
Owing to low water use efficiencies and lack of inputs, crop yields are very low. Present drought conditions have caused further reduction in crop yields, for example, average yield of wheat was about 1.1 t/ha in 1978 as compared with 0.8 t/ha of today. In Table 22.4, total area, production, and yields of different cereal crops for 1978 are presented. The total area (irrigated + rain-fed) under cereal crops was about 3.39 million ha. The total cereal production was 4.15 million t/ha, of which 2.65 million t/ha was only wheat.

## 22.7 DROUGHT IN AFGHANISTAN

Afghanistan is not regarded as drought-prone country (Figure 22.7). However, droughts have been recorded almost everywhere in different years. The most relevant one was recorded in 1970–1971 in almost all the country, but it particularly hit southwestern and northern regions. That drought resulted in displacement of population, loss of animals, and severe food shortage. Other droughts happened in 1948 and 1955 in southern part of the country, in 1961–1962 in central parts, in 1973 in central and northern regions, and in 1977 in northwestern regions.

Minor droughts have been recorded in 1981 and 1992 in Ghazni, Ghore, and Farah provinces. The recent drought is the only one that has caused unrecorded impacts. The recent drought compared with the previous droughts is multidimensional in its effect and severity. This worst drought has not been recorded in the last 50 years in Afghanistan. Drought occurred previously had affected only some parts of the country and had lasted for a maximum period of only 2 years. However, the current drought has so far continued for 3–4 years. This has affected rural and urban areas of Afghanistan, except for a few places located in the valley along the perennial rivers.





**FIGURE 22.7** Drought and water scarcity in Afghanistan. (From Shobair, S.S., Current Drought Situation in Afghanistan, Draft Report, FAO, Kabul, Afghanistan, 2001a. With Permission.)

The droughts recorded so far in the country can be categorized as: local drought in small parts of the country, occurring each 3–5 years; regional (zonal) drought, occurring each 9–11 years; and countrywide droughts, occurring each 20–30 years.

### 22.7.1 EFFECTS OF CURRENT DROUGHT ON LIVELIHOOD

Preliminary estimates suggest that the current drought has imposed negative effects on at least half of population. A total of 3–4 million people are affected severely, and 8–12 million are under threat of famine and starvation. An estimated 700,000 people abandoned their houses in search of food, water, and fodder (pasture); around 300,000 people have fled to neighboring countries, and more than 400,000 people (IDPs [internally displaced people]) have moved to the closest and safest places. Figure 22.6 shows population movement inside and outside of Afghanistan.

Lack of water, food, and shelter for IDPs has led to malnutrition, disease, and death. According to available reports, the acute malnutrition rate among children under 5 years of age is 24.6% and the mortality rate is recorded 2 people per 10,000 populations. Many of those who remained in their houses in drought-hit areas are those inhabitants who could not manage to move to other places owing to inability in covering transportation costs, lack of job opportunities, and mistreatment and abuse of refugees in the neighboring countries.

Per FAO/UNDP estimates in 1997, owing to continued war and instability in the country, out of 3.4 million ha of arable land in Afghanistan, only 30% is estimated to be cultivated. A total of 20% has poor on-farm water management, 10% is destroyed by war, and 40% is damaged due to the lack of maintenance or abandoned by farmers.

In 2001, most of families consumed the seeds kept for sowing their land for the next year. Consumption of wild food (wild sugar beet and wild grass) is widespread among the population of drought-hit areas. In some cases, the situation is aggravated by the fact that districts have no road link and can only be reached on horse's back or on foot.

### 22.7.2 PRECIPITATION DURING THE YEAR 2001

The winter of 2001 witnessed around 5%–20% more snowfall than the year before. However, owing to the lack of spring rainfall and increase in air temperature, the snow reserves exhausted faster. At the beginning of spring, the river discharges were higher than the year before but decreased drastically during spring.

The current drought has not much affected the discharge of main rivers, with main discharge forming basin above 4000 masl, but the discharge of tributaries with lower catchment area is



affected. In these types of rivers, water can flow (lower than the normal discharge) up to the end of their normal destination. In territory of Afghanistan, there is enough water for the land adjacent to these rivers, and no effect of drought has been seen in their valleys. However, the drought effects are seen in the adjacent valleys, where the main rivers do not provide irrigation water but the tributaries.

The rivers with main discharge-forming catchment basin between 3000 masl and 4000 masl have enough water in the upper and middle parts; however, in lower parts, shortage of water is observed noticeably. In all tributaries of these rivers, shortage of water is acute. In the rivers with main discharge-forming basins in an elevation lower than 3000 masl, an acute shortage of water is seen. In some cases, the groundwater table in the valleys of these rivers has declined. These types of rivers are mainly located in the northern, southwestern, and southern parts of the country.

All valleys and lowland plains with an altitude lower than 2000 masl, except for the valleys of main rivers crossing the area, which consist of most of the rain-fed lands, are seriously affected by the drought. According to reports from the field, all ephemeral rivers dried out in early spring and perennial rivers dried out in early or mid summer. Perennial rivers such as the Helmand river (mean discharge of 196.26 mVsec) in southwest, Farah Rud (mean discharge of 48.25 mVsec) in the west, Murghab river (mean discharge of 47 mVsec) in northwest, and Kunduz river (original mean discharge of 106 mVsec) in the north can now be crossed by foot.

During the recent drought, water level in the existing reservoirs of the country has reached to the critical level and even some of them are dried completely. These reservoirs are Dahla in Kandahar, Qargha (Kabul), Band-e-Ghazi (Kabul), Sorkhab and Kharwar (Logar), and Sultan and Sardeh (Ghazni).

The effect of drought on groundwater resources is also noticeable. Per an estimate, all traditional irrigation systems have reduced or dried up completely. A total of 60%–70% of qanāts are currently not in use, and 85% of shallow wells are dried out. The main reason for low discharge or failure is the low groundwater recharge. In addition to this, boring of deep wells close to qanāts and shallow wells imposed adverse effects on the discharge of these traditional irrigation systems.

### 22.7.3 FOOD PRODUCTION AND DEMAND

In year 2001, at the beginning of spring, the river discharges were higher than that in the year before, and hence, about 14% higher wheat was harvested in 2001 than that in year 2000. This amount is still 25% less than the production in 1999.

Owing to the lack of rainfall, production of rain-fed crops (wheat and barley) has reduced significantly, about 40% less than that in year 2000. In some parts of northern regions, the rain-fed crops dried out completely. Owing to 30% shortage of water flow in Kunduz river, a significant reduction in the cultivation of paddy has also occurred. It is worthy to mention that Kunduz valley in the north is one of the best and main rice producers in the country.

### 22.7.4 GRAZING (PASTURE) AND LIVESTOCK

Owing to drought and acute shortage of fodders, low growth or drying up of pasture, and lack of potable water in grazing area, nomads and farmers have sold or eaten an estimated 40% and in some case have exhausted their herd. Movement of nomads occurred earlier in 2001 than in the previous year. This is due to drying up of lowland pasture. The drought has also paralyzed nomad activities.

## 22.8 SUMMARY AND CONCLUSIONS

The karez system in Sayyadabad is part of the historical heritage of the people of Afghanistan. It has withstood the test of time and has served various people of the country throughout. The karez system is also an ingenious piece of engineering work. It is long lasting, relatively cheap to maintain, environmentally sustainable, and provides good-quality water. The karez system has the power to create social bonds between people, because it provides them with a vital resource—water—and

its management depends on cooperation. This creates a very strong incentive for people to work together in order to get access to the water supplied by the karez. This cooperation can grow into other parts of people's lives and create relationships that go further than just access to water. It can truly be a source of positive social capital.

The management surrounding the karez in the case study area is complicated, owing to the hybrid nature of the karez being both a common good and a private good. The private good aspect of the karez system prevents the build-up of social management systems required for the efficient management of common goods. This in turn creates room for conflict between various users and stakeholders. Such conflict has a negative effect on the potential of the karez to function as a social capital and can instead create divisions.

The future of the karez system depends on the establishment of efficient management systems. If not managed properly, the karez system can potentially falter even further and become a more intense source of conflict for the villages. This would greatly diminish the relative benefit received by having a karez. Beyond the need for improved management, the karez system must be fit into future development plans. The inability of the karez system to provide water on a large-scale basis prevents it from being a viable long-term option, owing to its inability to keep up with increasing demand. All future management of water systems in Afghanistan, including the karez, is dependent on the very core of its own functionality: cooperative management and planning.

## REFERENCES

- Ahmad, R., Musa, M.F., and Najibullah, M.S. (2002). Water and Health. WHO Report, Kabul, Afghanistan.
- Alim, A.K. and Shobair, S.S. (2002). Drought and Human Suffering in Afghanistan. In *TAEAS2002 Proceedings, Agricultural and Forestry Research Center, University of Tsukuba, Japan*, p. 119–127.
- Dennys, C. and Zaman, I. (2009). *Trends in Local Afghan Conflicts*, Cooperation for Peace and Unity, Kabul, Afghanistan.
- Esfandiari, O. (2007). Qanat; Iranian's Most Remarkable Ancient Irrigation System. In *International History Seminar on Irrigation and Drainage*, IRNCID-ICID, International History Seminar on Irrigation and Drainage Tehran-Iran May 2–5, 2007, Tehran, Iran, p. 7.
- FAO (2001). Irrigation in Asia in figures. FAO Water Report No. 18. Rome, Italy.
- GoA (2011). Social Realities of Karez System, A Case Study of Wardak, Afghanistan, Report of Cooperation for Peace and Unity, p. 18.
- Hussain, I., Abu-Rizaiza, O.S., Habib, M.A., and Ashfaq, M. (2008). Revitalizing a traditional dryland water supply system: the Karez in Afghanistan, Iran, Pakistan and the Kingdom of Saudi Arabia, *Water International*, 33(3):333–349.
- Kawasaki, S., Watanabe, F., Suzuki, S., Nishimaki, R., and Takahashi, S. (2012). Current situation and issues on agriculture of Afghanistan, *Journal of Arid Land Studies*, 22(1):345–348.
- Linebeck, G.N. (2001). *Afghanistan Topography*, Appalachian State University, Boone, NC, p. 1.
- Ministry of Irrigation and Water Resources (2002). Afghanistan Natural Resources and Agriculture Sector Comprehensive Needs Assessment, Draft Report, Multi Donor Phase II Mission, Kabul, Afghanistan.
- Mustafa, D. and Qazi, M.U. (2007). Transition from Karez to Tubewell irrigation: development, modernization, and social capital in Balochistan, Pakistan. *World Development*, 35(10):1796–1913.
- Qureshi, A. (2002). Water resources management in Afghanistan: The issues and options. Working paper 49, Pakistan Country Series No. 14, Pakistan.
- Rout, B. (2008). *Water Management, Livestock and the Opium Economy: How the Water Flows: A Typology of Irrigation Systems in Afghanistan*, AREU, Kabul, Afghanistan.
- Sheladia Associates (2001). Project Impact Monitoring and Evaluation (PIME) Studies, Chashma Right Bank Canal Project 2, 3 and 41–49, USA.
- Shobair, S.S. (2001a). Current Drought Situation in Afghanistan, Draft Report, FAO, Kabul, Afghanistan.
- Shobair, S.S. (2001b). Effects of Deep Wells on Groundwater Resources in Afghanistan. Draft Report, FAO, Kabul, Afghanistan.
- Tamuri, J. (2007). Karez: Afghanistan's Traditional Irrigation System. Retrieved January 5, 2010, from AKDN: <http://www.adkn.org/EN/agriculture/article.asp?a=67>.
- UNICEF/WHO (1997). Assisted Rural Water Supply Project, Kabul, p. 32.
- Wegerich, K. (2009). *Water Strategy Meets Local Reality*, AREU, Kabul, Afghanistan.



# Taylor & Francis

Taylor & Francis Group

<http://taylorandfrancis.com>

---

# 23 Utilization and Contribution of Underground Aqueducts in the Turpan Oasis of China

*Gofur Nuridin Tolmbok*

## CONTENTS

23.1	Overview .....	403
23.2	Features of Underground Aqueducts in the Turpan Oasis.....	404
23.2.1	Underground Engineering .....	405
23.2.2	Landmark Project.....	406
23.3	Lineament and Hydrogeology of the Turpan Oasis .....	407
23.4	Contributions Made by Water Yield of Underground Aqueducts to the Turpan Oasis .....	408
23.4.1	Contributions Made by the Underground Aqueduct System to Agricultural Production in the Turpan Oasis .....	408
23.4.2	Contributions Made by the Underground Aqueduct System to the Eco-Environment System in the Turpan Oasis .....	410
23.5	The Common Point and Difference between the Underground Aqueducts in the Turpan Oasis and the Underground Aqueduct Engineering in Various Countries.....	411
23.6	The Research Result and Expectations of the Underground Aqueduct System in the Turpan Oasis .....	411
23.7	Conclusions .....	412
	References.....	413

## 23.1 OVERVIEW

In the Turpan Oasis of China, there are 1237 underground channels of karez, which are underground aqueducts. They divert the underground water to the ground for agriculture irrigation, meeting the demands for living and maintaining ecological system via a long distance of delivery. It is of vital importance to extremely arid areas.

In addition to Turpan oasis in Xinjiang of China, where underground aqueducts are distributed concentratedly, there is Komul Prefecture, where there are a number of underground channels. In Guma County of Hotan Prefecture, Artux City of Kizilsu Kirgiz Autonomous Prefecture, Kashkar City of Kashkar Prefecture, Kuqa County of Aksu Prefecture, Qitai County and Mori Kazak Autonomous County of Changji Hui Autonomous Prefecture, and Urumqi City, there are a few underground aqueducts. At present, the academic circles identify that karez in these areas originate from Turpan.

Underground aqueducts of Turpan in quantity and water yield take absolute advantage, accounting for 73.8% of total underground channels in Xinjiang. In total, they are 3724 km long, for actual utilization and continuous water supply from 1957 to 1963. They consist of numerous underground channels, which are at an average length of 3 km. These underground aqueducts are as deep as about 100 m and as low as about 2 m, depending on topographic conditions. They are excavated and maintained with the help of 150,153 vertical shafts, which are 2421 km in

total depth and 16.1 m in average depth. Underground aqueducts of Tuygu karez in Zerip Karez Village, Tuyuk Township, Piqan County, have 533 vertical shafts, which are mostly throughout Xinjiang (Gofur 2003, 31).

### Contrast of Annual Water Supply of Different Projects in the Turpan Oasis Unit: $1 \times 10^8 \text{ m}^3$

Year	Total Water Consumption		Surface Water				Groundwater			
			Among	Reservoir supply			Among	Underground aqueducts		
2003	11.0	4.22	Among	Reservoir supply	1.38	6.77	Among	Underground aqueducts	2.31	
				Water diversion supply	2.84			Electric wells and springs	4.46	
2009	12.74	4.83	Among	Reservoir supply	1.02	6.91	Among	Underground aqueducts	1.427	
				Water diversion supply	4.81			Electric wells and springs	5.48	

Source: Gofur Nuridin Tolmbok, *Karez and Oasis Ecological Environment System*, Turfanological Research, Turpan, China, 2015a, pp. 84–92.

The history of Turpan karez is that of underground aqueducts of this prefecture. The definite birth of underground aqueducts of karez in Turpan is in the dispute until today. Some think that they only have 200 years of history (Huang Shengzhang 1993, 26–49), some think that they have 1200 years of history (Gofur 2015d, 81–140), and some think that they have more than 2000 years of history (Lin Kuicheng 1993, 80–86; Abdul 2006, 18). Their opinion on the birth of underground aqueducts is so different that it bothers us a lot. Direct evidence, such as the age of old trees,\* directional lamp of underground aqueducts,† and the test result of C14 in mulberry sluice gate of water pond,‡ proves that underground aqueducts have more than 400 years of history; However, indirect historical documents and circumstantial evidence demonstrate that they have over 1200 years of history§ (Gofur 2015d, 81–140), but they lack convincing archaeological results. Thus, the question whether they have several hundred years of history or over 1000 years of history has great space for research.

## 23.2 FEATURES OF UNDERGROUND AQUEDUCTS IN THE TURPAN OASIS

In order to build underground channels, the position of shallow groundwater has to be found first and then water conveyance segment is excavated according to this position and finally extended to ponding section. This project cannot be completed without the help of vertical shafts.

With unique structure, underground aqueducts are made up of vertical shafts, underground channels, water outlets, open channels, water ponds, and water channels for field irrigation (Gofur 2015e, 1–16). They are composed of underground engineering and surface engineering, based on their characteristics of water supply and utilization.

\* Age marked on the famous old-tree plate hung by forestry departments show that they have had 313 years of history by 2015.

† C-14 report made by Accelerator Mass Spectrometry (AMS) Laboratory of Peking University on February 27, 2002, shows that they have  $380 \pm 60$  years of history.

‡ C-14 report made by Accelerator Mass Spectrometry (AMS) Laboratory of Peking University on June 14, 2011, shows that they have  $170 \pm 30$  years of history.

§ A karez near Bexghar Thousand-Buddha Cave discovered in the Mountain of Flames of Turpan on March 29, 2006, by the author is collateral evidence that this karez has 1000–1200 years of history.

### 23.2.1 UNDERGROUND ENGINEERING

Underground channels in Turpan oasis take advantage of topographic conditions, collect underground water and field leakage water, and divert them to the ground, completely relying on water gravity, the relation between flow and topographic slope, and people's wisdom and hard work. They fit for environmental conditions of the oasis, so as to avoid water evaporation and sand filling.

The initial shape of underground channels excavated is arched, its two sides are vertical, and top is semicircular. This way of excavation is quite scientific from the angle of stress, since these channels are not easy to collapse. All the underground channels are this shape. However, as time passes, their sidewalls and top become irregular and tend to collapse, but some are still regular. As for building underground channels, vertical shafts have to be dug first. People dig vertical shafts according to local geographic conditions, spring water, streams, and aquifers. They have to find water source at first and then make preparations for digging and finally carry the earth to the ground. The ventilation and lighting conditions determine the direction of underground channels. Vertical shafts serve as access for karez artisans (called Karizqi in Uyghur); for maintenance, personnel go up and down underground channels. These shafts also serve to provide workers in the underground channels with production and life products and tools for going up and down and going to toilet. Underground channels mainly direct at water source, residence, and cultivated land.

First of all, the position of the first vertical shaft is determined by observation and experience on the basis of running underground channels around it and phreatic water situation. In order to determine the direction of underground channels, two vertical shafts, with space at about 30 m, have to be dug at the upper end and lower end, respectively (depending on terrain). These three wells are generally dug vertically, until they reach aquifers. The digging cannot be stopped until the water can be seen and water surface elevation conforms to the requirement of water yield of lower reaches. Then, water conveyance section is to be dug toward lower reaches. For the convenience of working, a vertical shaft has to be dug at a distance of 30–50 m. Local Uyghur farmers and karez artisans call ponding section "Tärlängä" (Gofur 2015f, 7), meaning "sweating section." Just as its name implies, in and around underground channels and even on the top of them, water seeps. Vertical shafts become shallow gradually, depending on the slope of running water of underground channels and topographic slope. Finally, the water comes out at intersection, since the topographic slope is greater than that of running water. After conveyance section of lower reaches is dug, landmark vertical shafts are dug upward to extend ponding section, until the water yield meets the demands. The process of underground channels excavation is digging the bottom first and then the top. Underground aqueducts are longer, while ponding sections are shorter. Vertical shafts are generally round, rectangular, or oval, and their direction was the same, with underground channels in length, so that they are easy to be excavated and their mouths are easy to be covered. Rectangular vertical shafts are generally 110–130 cm long and 50–60 cm wide. Underground channels are generally 60–70 cm wide and 150–160 cm high.

Folk "karez artisans" measure the length and depth of underground channels with arm (Ghulach in Uyghur), three fingers (Üqilik in Uyghur, equaling to about 2.6 in.), and so on. The gradient is calculated by 40 Ghulachs, reducing Üqilik to obtain the falling head of 1000/1 m. Sometimes, the position of vertical shafts is determined as follows: stretch your legs and sit down along the direction of underground channels; the distance from your hip to your heel is the length of vertical shafts, and the space in which your arms could move freely is the width.

The excavation and connection of underground aqueducts at the bottom of vertical shafts and diversion of water to the ground need prudence, experience, and technology. Without any modern measuring instruments, they can only be completed by experienced "karez artisans." For lower reaches of juncture of ponding section of underground aqueducts and conveyance section, no water construction is needed, because aquifers are not touched. "Karez artisans" preliminarily determine the "tray" at the bottom of underground aqueducts (Täpän in Uyghur, meaning sole) by deducting relevant depth from depth of each vertical shaft on the basis of the depth of each



vertical shaft and topographic slope in the course of underground aqueducts excavation and then to have these underground aqueducts connected. The determination of the tray's position is of vital importance. Water level of aquifers, topographic slope, and length of underground aqueducts for water delivery and gradient of the bottom are different, and "karez artisans" can make the determination by their experience and judgment. If the calculation of gradient of the bottom of underground aqueducts is precise, then the water of underground aqueducts will flow. This work can hardly be done successfully at a time. Sometimes, after ponding sections and conveyance sections are connected, the water in some section is so deep that it can submerge a person, while in some section, it is so shallow that it can only reach your ankles. These can be repaired by artisans for the second time. The method is: karez artisans take their knees (about 40 cm) as water level standard, bend down, and move toward upper streams in the water to level those nonstandard parts.

For the purpose of enhancing water yield, ponding sections can be increased by combining ponding sections, which are abandoned by conveyance sections but still have water, and extending a ponding section toward another direction.

### 23.2.2 LANDMARK PROJECT

Water outlets refer to the place where the water of underground aqueducts flows out. When topographic slope is greater than that of underground aqueducts, the two lines cross naturally toward the same direction, forming a water outlet. Local farmers reinforce it with cement, red bricks, or stones, if possible.

The ultimate target of underground aqueducts is to deliver the water to villages and farmland. In the course of construction, they can be extended according to needs. Lengthwise positions of water outlets are subject to adjustment of the bottom of underground aqueducts, geographic conditions, and topographic conditions, and thus, outlets are possibly at upper or lower place, further than expected site. On the one hand, farmers settle down on the basis of position of water outlets, forming villages, while, on the other hand, the length of open channels depends on their position as well. Farmers settle down near outlets, open channels, and water ponds of karez.

Open channels refer to the part from outlets of underground channels to water ponds. They deliver the water flowing out of the water outlets to the water ponds or farmland.

Varying in length, some open channels are very short, and the water just flows out of water outlets and then into water ponds, while some are several kilometers long. They are generally within the range of 100–500 m. Their length is related to topographic slope and cultivated land to be irrigated. The greater the slope and the further the farmland, the longer the open channels and vice versa. Open channels are called *Tilma* in Uyghur, meaning entrance. (*Erik* means channels in Uyghur language.)

Water ponds are called *Köl* in Uyghur, meaning lakes. They gather the water flowing out of underground channels to irrigate farmland after having the water warmed, and thus, they can enhance the water's use ratio. Around them, there are dense green trees, which attract different kinds of creatures, so they could improve ecological environment of villages and solve the problems of people's and livestock's demand for water.\*

The position of water ponds is on the basis of the direction of underground channels under excavation or already excavated, so that the water is easy to be diverted to the farmland and water for life is provided to villages. Ordinary water ponds are about 30 m long, 20 m wide, and 1.5–2 m deep.

---

\* Most of water flowing out of underground channels can be drunk directly; the water coming from upper reaches is particularly good, since it originates from underground with the standard for drinking water, after Water Environment Monitoring Center of Xinjiang Uyghur Autonomous Region made the water analytical test report (Shuihuan) Xue No. (S2006-16).

Heaping up the earth excavated at the edge of the ponds and tamp it and a simple pocket-shaped earth dam forms, and then facilities with overfall gap and outlet sluice are built on the lower reaches of the ponds. What is mentionable here is a “small island,” which almost all the water ponds have in the center and on which there are some trees and vegetation. In Uyghur, it is called Kündik, meaning navel. Local farmers show special preference to it. They are nearly superstitious to its existence.

Most underground channels have water ponds. In 2003, 404 underground channels have 295 water ponds (Gofur 2003, 31). Materials to build water ponds do not need to be transported from other places. As long as the location is suitable, local excavated earth is used to build a dam, after it is tamped, and local mulberry is used to make sluice materials.

A water pond consists of a water inlet, reservoir, dam body, mulberry sluice gate, and overfall gap, all of which have excellent performance on adaption to and coordination with underground aqueducts. In addition, a 200-year-old mulberry sluice gate is kept in Karez Museum of Turpan Karez Paradise of the Xinjiang Karez Study Society. The mulberry sluice gate is called Toma in Uyghur and overfall gap Taxurma.

### 23.3 LINEAMENT AND HYDROGEOLOGY OF THE TURPAN OASIS

Turpan oasis is a typical drought desert oasis without big river in its territory. Its north borders on Mount Bogda, the main peak of Tianshan Mountains. The highest peak of Tianshan Mountains is 5445 m above sea level, while the lowest point of the oasis, the middle of Aydingkol Lake, is -154 m, which is a typical basin. With a total area of 69,713 km<sup>2</sup>, Turpan Basin is in the inter-mountain deep of the Tianshan Mountains, and the famous Flaming Mountain is in it. The Flaming Mountain (tertiary system anticline structure) lies east-west in the middle of the basin, divides the basin into southern and northern basins, and forms northern basin oasis and southern basin oasis. Its main source of water comes from 14 creek formed by meltwater from the Tianshan Mountains and rainfall and groundwater resources infiltrated from these creeks.

Phreatic water and confined water are distributed under the northern basin. Phreatic water is mainly distributed in pebble gravel layer of alluvial fan flock under mountain front, and the buried depth of groundwater is decreasingly from over 200 to 50 m or less than 10 m from north to south, and the water inflow of single well is from over 1000 to 100 m<sup>3</sup>/d. Confined water is mainly distributed under the east area of the basin, which is mainly aquifer with multilayered structure with coarse and fine particle sediments; the burial depth of the roof of confined aquifer is deeper than 50 m; the water inflow of single well is hundreds cubic meter per day; the degree of mineralization of ground water is less than 1 g/L; and the hydrochemical type is HCO<sub>3</sub><sup>-</sup>Ca.

Phreatic water in the southern basin is distributed in circularity along the basin's edge; lithology of the aquifer is mainly dominated by sand and gravel-cobble; buried depth of groundwater is 5–50 m; and water inflow of single well is 500–1000 m<sup>3</sup>/d. Confined water is mainly distributed in the southern basin's alluvial fan, namely lacustrine plain, mostly an interstratified layer of medium-coarse sand, silty-fine sand, and cohesive soil; buried depth of confined water roof is less than 50 m; and water inflow of single well is 100–700 m<sup>3</sup>/d. The temperature of underground water (well water) is very stable, between 12° centigrade and 16° centigrade.

Turpan Basin has a typically continental dry desert climate in the warm temperate zone. The average rainfall for many years is 16.9 mm; the maximum rainfall was 48.4 mm (in 1958); the minimum rainfall was 2.9 mm (in 1968); and the average evaporation capacity for many years is 2845 mm (20 mm-caliber evaporation pan). Its climatic characteristics are desiccation, high temperature, windiness, less rainfall, four distinctive seasons, hot summer, frigid winter, rapid warming in spring, and rapid cooling in autumn. The extreme minimum temperature was -29.9°C; the extreme maximum air temperature was 49.6°C; the average air temperature for many years is 13.9°C; the maximum temperature in the direct sunlight on the ground was 76.6°C; the maximum

temperature actually measured on the surface of sand dune was 82.3°C; number of days with the air temperature higher than 0°C is up to 270 days; and the weather in Turpan Basin is mostly composed of wind and sand. High wind of force 7 or 8 above is up to 32 times per year; that in the wind gap is more than 100 times per year; the maximum wind velocity is up to 40 m/s; the average sunshine for many years is 122.7 days; and the maximum sunshine is 136 days (Gofur 2015c, 246).

### 23.4 CONTRIBUTIONS MADE BY WATER YIELD OF UNDERGROUND AQUEDUCTS TO THE TURPAN OASIS

The underground aqueduct system in Turpan oasis has played a decisive role in the oasis's formation and maintenance, and it has not completely lost its role so far. The utilization of the system's annual water supply meets the requirement of local seasons and climate. Its water supply is constant all the year round, and the utilization is restricted by season; therefore, its water yield can be separated into irrigation period and non-irrigation period. Water yield in irrigation period is mainly for agricultural production and that in non-irrigation period is for ecological system, while the water yield throughout the year continuously serves the drinking water for people and livestock, the maintenance of small surrounding environment of open channels, and reproduction of the biologic chain. It is relatively effective to work out water yield in irrigation period and non-irrigation period by a very simply approach as follows:

1. Water yield in irrigation period = irrigating days × aqueduct water yield.
2. Water yield in non-irrigation period = aqueduct water yield – water yield in irrigation period (Gofur 2009, 7–8).

#### 23.4.1 CONTRIBUTIONS MADE BY THE UNDERGROUND AQUEDUCT SYSTEM TO AGRICULTURAL PRODUCTION IN THE TURPAN OASIS

The underground aqueduct system has made a great contribution to the water supply in Turpan oasis, but it appears to be on the decrease year by year. The output of supplying water of the underground aqueducts has displayed a decreasing tendency in the 6 years, between 2003 and 2009. However, the water supply in other ways has been markedly increased.

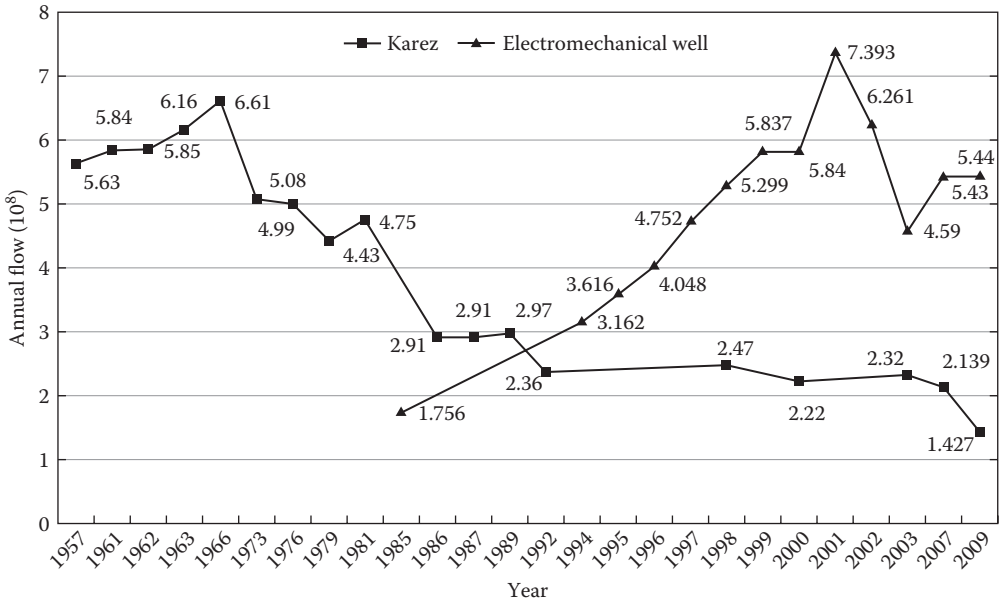
---

#### Statistical Table for General Survey in 2003 and Re-Examination in 2009 of Quantity, Water Yield, and Water Supply of Karez in the Turpan Prefecture

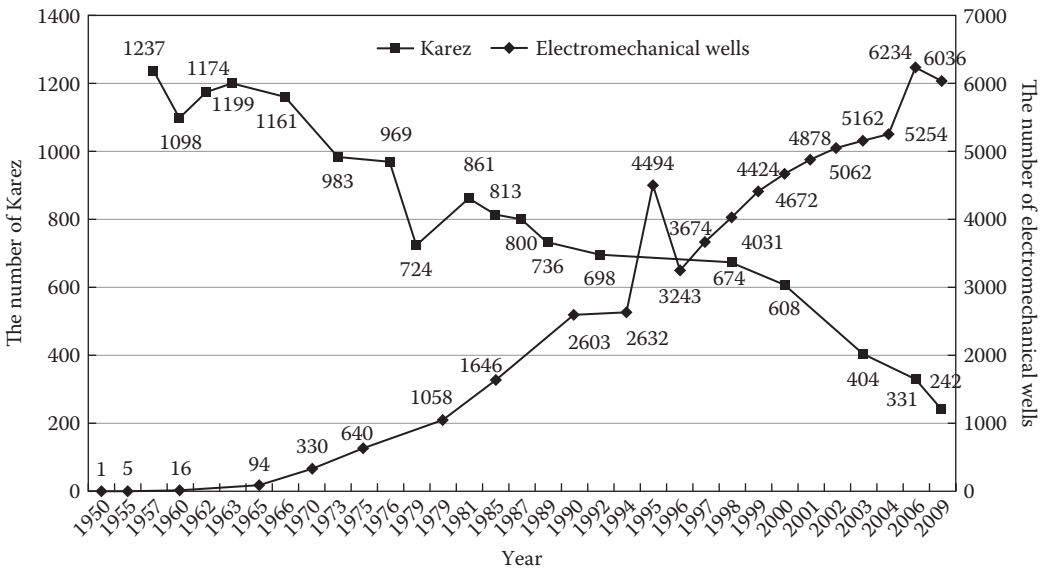
Year	General Survey in 2003		Re-Examination in 2009	
	1091	404 (Have Water)	404 + 6	237 + 5 (Have Water)
Quantity				
Water yield (10 <sup>8</sup> m <sup>3</sup> )		2.319		1.427
Total control irrigation area (ha)		132,300		6,581
Ecological vegetation area (ha)		97,400		2,932
Water yield in irrigation period (10 <sup>8</sup> m <sup>3</sup> )		1.619		0.9872
Ecological free water supply (10 <sup>8</sup> m <sup>3</sup> )		0.7000		0.4398
Quantity of reservoirs (set)		295		194
Capacity of reservoir dam (m <sup>3</sup> )		506,900		528,000

*Source:* Gofur Nuridin Tolmbok, *The Analytical Research Report on the Re-Investigation of Karez system in Xinjiang*, Xinjiang Karez Study Society, Hydrology and Water Resources Survey Bureau of Turpan Prefecture and Hami Hydrology and Water Resources Survey Bureau of Hami Prefecture, Urumqi, China, 2009, p. 15.

---



Comparison of annual flow trend between karez and electromechanical wells in the Turpan oasis. (From Gofur Nuridin Tolmbok, *Karez*, Xinjiang People’s General Publishing House and Xinjiang People’s Publishing House, Urumqi, China, 2015g, pp. 125–127. With Permission.)



Comparison of number of developments between karez and electromechanical wells in the Turpan oasis. (From Gofur Nuridin Tolmbok, *Karez*, Xinjiang People’s General Publishing House and Xinjiang People’s Publishing House, Urumqi, China, 2015g, pp. 125–127. With Permission.)

This trend also has been verified in the variation of water yield of underground aqueducts throughout Xinjiang.

### Water Supply Conditions of Karez throughout Xinjiang

Year	Number of Karez with Water	Annual Water Yield (10 <sup>8</sup> m <sup>3</sup> )	Water Consumption in Irrigation Period		Utilization (%)	Water Yield in Non-Irrigation Period (10 <sup>8</sup> m <sup>3</sup> )	Non-Irrigation Period (%)	Proportion of Water Yield (%)
			(10 <sup>8</sup> m <sup>3</sup> )	Area (mu)				
1957	1432	7.6	5.05	36.16	66.4	2.55	33.5	70
2003	614	3.01	2.108	17.25	70	0.9040	30	33
2009	422	1.92	1.302	13.63	67.8	0.6219	32.3	14

Source: Gofur Nuridin Tolmbok, *Karez and Oasis Ecological Environment System*, Turfanological Research, Turpan, China, 2015a, pp. 84–92.

Under the condition that water yield of the underground aqueduct system has decreased continuously over the years, the proportion of water supply therein for ecosystem never reduces.

In Turpan oasis, we could clearly see the outstanding contributions made by the underground aqueduct system to the agricultural production in the oasis from a peasant's production status or the collective production mode (Gofur 2015c, 246–263). Only an analysis on the quantified contributions made by the underground aqueducts to current situation of the oasis in a certain year can reveal the contributions made by the underground aqueduct system in Turpan oasis for centuries.

In 2003, total population of Turpan oasis was 571,700, including the agricultural population of 430,000, the agricultural acreage 83,140 ha, per capita cultivated land 0.193 ha. Among the agricultural acreage, cultivated area of grape accounted for 27.167 ha; cotton 10,780 ha; wheat 9,693 ha; vegetable, melon, and fruit 10,600 ha; other crop 6,713 ha; and pasture, forestry, and others 18,186 ha (The Planning 2005a, 37–41).

In 2003, annual water supply of the underground aqueducts in irrigation period was 162 million cubic meter (minus water supply in non-irrigation period) and the control irrigation area was 8,820 ha. The grape output value in the end of the year was 447.17 million Yuan (8820 ha × 50,700 Yuan/ha) and the net income was 278.62 million Yuan (8820 ha × 30,240 Yuan/ha). It demonstrates that in 2003, the underground aqueducts irrigated 132,300 mu of land, produced 447.17 million Yuan of output value, and provided pivotal water guarantee for 278.62 million Yuan of net income and 1393 Yuan of per capita income; this is only 1-year contribution. If the contributions made by the underground aqueducts in the aspect of ecosystem, drinking water for people and livestock, advantage of water price and tourism service function, and scientific research service function are calculated, the economic value of karez will increase by a large margin (Gofur 2015c, 261–263).

#### 23.4.2 CONTRIBUTIONS MADE BY THE UNDERGROUND AQUEDUCT SYSTEM TO THE ECO-ENVIRONMENT SYSTEM IN THE TURPAN OASIS

In 2003, the underground aqueducts provided the eco-system with 77 million cubic meter of water. If the aqueduct system's use ratio was calculated by 0.75, in winter non-irrigation period, 112 million cubic meter of water irrigated 6494 ha of vegetation eco-environment, including desert vegetation and forest belt; it maintained ecological balance and replenished the underground water (Gofur 2003, 31). The underground aqueducts' water flowed to lower vegetation zone, woods, and forest belt and played an important role in stabilization of sands, prevention of sand and dust, prevention of wind, and keeping sand off people among the oasis, wilderness, and desert. Based on this idea, the paper selects 1966, when the water yield of the underground aqueducts (661 million cubic meter) reached

maximum as status quo year; the rate of contribution of water supply to the ecological environment system in that year was up to 198 million cubic meter, and the area of ecological vegetation was up to 20,000 ha. If calculated accumulatively for many years, it would be very considerable. The water supply function of the underground aqueduct system to the eco-environment system in Turpan oasis can also be profoundly probed into from the perspectives of engineering contribution and feeding contribution (Gofur 2015b, 88–90).

### 23.5 THE COMMON POINT AND DIFFERENCE BETWEEN THE UNDERGROUND AQUEDUCTS IN THE TURPAN OASIS AND THE UNDERGROUND AQUEDUCT ENGINEERING IN VARIOUS COUNTRIES

From perspectives of basic engineering shape, ground landscape, water supply function, water yield, water source, and others, for comparison, the underground aqueduct engineering in Turpan oasis has no big and difference from those in other countries. However, they are different in some miscellaneous functions.

Qanāt underground aqueduct system in Iran has a kind of aqueduct water mill (Massoud 2015, 1–4) and Payab, which are nonexistent in the underground aqueducts in Turpan oasis. Only on the ground, 1–4 or 5 water mills built on an open channel based on length and fall of the open channel existed in history, but now, they do not exist anymore. Payab also does not exist in the underground aqueducts in Turpan oasis.

The underground aqueducts in the Sultanate of Oman, including Ayini, taking spring and other surface water as its source, and Ghayini, taking river water as its source, cannot be found in Turpan oasis (Semsar Yazdi and Majid Labbaf Khaneiki 2013, 178–182). In Yexilyurt, Nigde Province, Turkey, channels are dug on the ground and covered with flagstones in ancient Rome style; in Portugal, for the needs of cloistral garden and domestic water, channels are dug on the basis of terrain of the mountains and then covered with thick saddle plates and soil on the ground, which cannot be found in Turpan oasis too.

They are basically the same and exactly similar in the aspects of digging underground aqueducts to deliver water and using shaft to lift earthwork; raising the crew up and down; conveying digging tool and deliver meals; utilizing the water to maintain and develop life and production; maintaining the eco-environment system in drought region; and using the basic tools and other principal aspects.

### 23.6 THE RESEARCH RESULT AND EXPECTATIONS OF THE UNDERGROUND AQUEDUCT SYSTEM IN THE TURPAN OASIS

It has become an urgent affair to protect and inherit the work of the underground aqueducts in Turpan oasis for the past 20 years. In this respect, the Karez Study Society of Xinjiang Uyghur Autonomous Region has done a lot of fruitful work.

It has carried out all kinds of academic research activities concerning the underground aqueducts; done general surveys to find out the real situation; dynamically monitored the water volume and quality of the 27 typical underground aqueducts every year; and attempted and succeeded in the model project of applying modern science and technology, new materials, and new process to protect the underground aqueducts.\* It has proposed a protection planning for the underground

---

\* An academic conference or peasant karez artisan's seminar, is held every 2 years; in 2003, a general survey on karez (underground aqueducts) was carried out in Xinjiang, and the *General Survey and Pilot Research Report on Karez in Xinjiang* was written; in 2009, a re-check on Xinjiang karez was conducted, and the *Analysis Research Report on Re-check of Xinjiang Karez* was written; dynamic monitoring report is written annually; and model rescue is carried out on two or three underground aqueducts annually.



aqueducts,\* constructed permanent archives for the underground aqueducts,† made a distribution diagram for the underground aqueducts, and obtained relatively integrated achievements. It has done a lot of preliminary work for the introduction of regulation on protection of karez in Xinjiang Uyghur Autonomous Region.

In 1990, “International Colloquium on Karez Irrigation in Arid Region” was held, and the first “Collected Works for International Colloquium on Karez Irrigation in Arid Region” was published in 1993; in July 2012, “Xinjiang Karez Forum” was held in Turpan, and the “Collected papers on the study of Karez in Xinjiang” was published after the forum in 2015.

The central government and local relevant departments have made active efforts in respect of protecting the underground aqueducts in Turpan. In June 2005, based on “Xinjiang Karez Protection and Utilization Planning,” a national protection investment program was finalized, and conservation works had been put into effect year by year (Cultural Relics Bureau of Turpan Prefecture of Xinjiang, Turpan Research Institute 2013, 141–167). The engineering measures were mainly to reinforce, maintain, and dredge the underground aqueducts, water outlets, and shaft mouths.

Research results in recent years also have some valuable suggestion. In case it is suggested to construct crosswise underground aqueducts, there into, an expectation is proposed to transversely cut off and excavate an aqueduct to concentrate the water from several primitive underground aqueducts at an appropriate downstream point of a certain group of aqueducts (Deng Mingjiang 2015, 193–210). According to the conditions that the underground aqueduct system is distributed in three parts, namely the up, middle, and downstream in Turpan oasis under the conditions of life and production, an expectation is proposed to prolong the lifetime of the underground aqueducts by “Contour Line Sharding” (Zulati and Gofur 2015, 112–122). It is truly important to reinforce the underground aqueducts in engineering level by investing plenty of funds, but in case of problems that electromechanical wells and the underground aqueduct system fight for water resource and at the source location, namely when building controlled mountainous reservoirs at every brook’s exit without regard to the menace of underground water truncation, then the work will get half the result with twice the effort (Gofur 2015h, 170–171). A seepage experiment carried for the bottom of the aqueducts by geotechnical cloth, an effective reinforce and sealing experiment for the shaft mouth, and building grit chambers at the bottom of vertical shafts of underground aqueducts every 500m so as to prevent sediment from blocking the water and to reduce the trouble of choosing vertical shafts to draw out sludge (The Planning 2005b, 201–101), are all recommended methods.

## 23.7 CONCLUSIONS

The underground aqueducts in Turpan oasis have no big difference, with the engineering of the same kind around the world. They are basically similar in the aspects of historical function; the situation of coexistence with traditional karez as a community in image; contributions made to the production, ecology, and life in local oasis; current tendency; difficulties encountered; and approaches to resolve. In the researches of its emerging time period, historical development track, mutual adoption or release of experience, technology and tools among different areas, and so on, persuasive and reliable historical document is absent. Archaeological conclusion is also in void. On account of these, this chapter believes that, as a marginal subject of water conservancy discipline and a project coexisting with karez, meanwhile with rather high value in the aspects of humanity, history, heritage, archaeology, etc., the underground aqueduct system is provided with abundant content and comparative study value and space.

\* In 2005, funded by the Karez Study Society of Xinjiang Uyghur Autonomous Region, *Xinjiang Karez Protection and Utilization Planning* was co-made by the Xinjiang Institute of Water Resources and Hydropower Research and Hydraulic Research Institute of Turpan Prefecture.

† In 2006, *Xinjiang Karez* was published by People’s Publishing House of Xinjiang, edited by the Karez Study Society of Xinjiang Uyghur Autonomous Region, under the general editorship of Gofur Nuridin.

## REFERENCES

- Abdul Hemdul Niyaz, 2006, *Great Creation-Karez*, Xinjiang University Press, Urumqi, China, p. 18.
- Ali Askar Semsar Yazdi, Majid Labbaf Khaneiki, 2013, *Veins of Desert*, IWRM (Iran Water Resources Management Company), Iran, pp. 178–182.
- Cultural Relics Bureau of Turpan Prefecture of Xinjiang, Turpan Research Institute, 2013, *Watching over Karez, Documentary of Maintenance and Reinforcement of Turpan's Karez at First Stage*, Xinjiang People's General Publishing House and Xinjiang People's Publishing House, Urumqi, China, pp. 141–167.
- Deng Mingjiang, 2015, *Karez Wells in Arid Land and Mountain—Front Depressed Ground Reservoir, Collected Papers on the Study of Karez in Xinjiang*, Compiled by Xinjiang Karez Study Society of Xinjiang Uygur Autonomous Region, Editor in Chief, Gofur Nuridin Tolmbok, Urumqi, China, pp. 193–210.
- Gofur Nuridin Tolmbok, Chief Editor, 2003, *Xinjiang Karez General Survey and Pilot Study Report*, Xinjiang Karez Study Society, Water Conservancy Research Institute of Turpan Prefecture, Urumqi, China, p. 31.
- Gofur Nuridin Tolmbok, examiner, 2009, *The Analytical Research Report on the Re-Investigation of Karez system in Xinjiang*, Xinjiang Karez Study Society, Hydrology and Water Resources Survey Bureau of Turpan Prefecture and Hami Hydrology and Water Resources Survey Bureau of Hami Prefecture, Urumqi, China, pp. 7–8.
- Gofur Nuridin Tolmbok, 2015a, *Karez and Oasis Ecological Environment System*, Turfanological Research, Turpan, China, pp. 84–92.
- Gofur Nuridin Tolmbok, 2015b, *Karez and Oasis Ecological Environment System*, Turfanological Research, Turpan, China, pp. 88–90.
- Gofur Nuridin Tolmbok, 2015c, *Karez and Turpan Oasis Agriculture*, Arid Land Geography, Urumqi, China, pp. 246–263.
- Gofur Nuridin Tolmbok, 2015d, *Karez*, Xinjiang People's General Publishing House and Xinjiang People's Publishing House, Urumqi, China, pp. 81–140.
- Gofur Nuridin Tolmbok, 2015e, *Karez*, Xinjiang People's General Publishing House and Xinjiang People's Publishing House, Urumqi, China, pp. 1–16.
- Gofur Nuridin Tolmbok, 2015f, *Karez*, Xinjiang People's General Publishing House and Xinjiang People's Publishing House, Urumqi, China, p. 7.
- Gofur Nuridin Tolmbok, 2015g, *Karez*, Xinjiang People's General Publishing House and Xinjiang People's Publishing House, Urumqi, China, pp. 125–127.
- Gofur Nuridin Tolmbok, 2015h, *Karez*, Xinjiang People's General Publishing House and Xinjiang People's Publishing House, Urumqi, China, pp. 170–171.
- Huang Shengzhang, author, Zhong Xingqi, Chief Editor, 1993, *Origin and Development of Xinjiang's Karez*, Xinjiang University Press, Urumqi, China, pp. 26–49.
- Lin Kuicheng, 1993, *International Seminars about Karez Irrigation in Arid Areas, Karez Supposition*, Xinjiang People's Publishing House and Hong Kong Cultural Education Publishing House, Urumqi, China, pp. 80–86.
- Massoud Shamaezadeh, 2015, *Cumulus Mumbai 2015: In a Planet of Our Own—A Vision of Sustainability with Focus on Water* Being Green in Desert Sustainability analysis of Mohammadabad double-stone watermill, Central Iran, Safavid era (17–18th century), Cumulus Mumbai, <http://www.cumulumumbai2015.org>.
- The Planning, 2005a, *Xinjiang Karez Protection and Utilization Planning*, Xinjiang Academy of Water Conservancy and Hydropower and Water Conservancy Research Institute of Turpan Prefecture, Urumqi, China, pp. 37–41.
- The Planning, 2005b, *Xinjiang Karez Protection and Utilization Planning*, Xinjiang Academy of Water Conservancy and Hydropower, and Water Conservancy Research Institute of Turpan Prefecture, Urumqi, China, p. 101.
- Wupur Nurdin Tolunbuk, 2015, *Karez and Oasis Ekological Environment System*, Turfanological Research, Turpan, China, pp. 84–92.
- Zulati Litipu, Gofur Nuridin Tolmbok, 2012, *Evaluation of Comprehensive Economic Value of Karez in Turpan of Xinjiang*, Research Report of Humanities and Social Sciences Research Project of the Ministry of Education, pp. 112–122 (Approval No.: 08JA790113).



# Taylor & Francis

Taylor & Francis Group

<http://taylorandfrancis.com>

---

# 24 Traditional Methods of Groundwater Abstraction and Recharge along the Windward Side of the Foothills of the Western Ghats of India

*Darren Crook, Sudhir Tripathi, and Richard Jones*

## CONTENTS

24.1	Long-Term Patterns to the Onset and Length of the Southwest Monsoon .....	416
24.2	The Hydrogeology of the Windward Side of the Foothills of the Western Ghats.....	416
24.3	Traditional Water Harvesting Strategies Found on the Windward Side of the Foothills of the Western Ghats .....	417
24.4	<i>Suranga</i> Tunnel Well Gallery Filtration Systems .....	418
24.5	Conclusions .....	422
	Acknowledgment .....	422
	References.....	422

The windward side of the foothills of the Western Ghats of India contain a large number of traditional water harvesting techniques similar to those found in other parts of India, such as the Deccan Plateau and the Eastern Ghats, that are reliant on both surface and groundwaters. Many, but not all, of these techniques are ancient and long lived, and there is a close relationship between traditional surface water harvesting techniques and the recharge of groundwaters in the region dominated as it is by lateritic soils and geology that influence the hydrogeological regimes of the region. All of the traditional water harvesting systems described in this chapter are dependent on the timing and onset of the southwest monsoon for their water supplies in a region where groundwaters are becoming critically scarce because of over abstraction from tubewells and borewells that have expanded rapidly in use since the Green Revolution in India (Balakrishnan and Saritha 2007). This chapter will show that irrigation communities must be adaptable and employ mitigating strategies that reduce vulnerability in order to be resilient to changes in climate and weather patterns over time. It will show that in part environmental conditions provide the rationale for the creation of a relatively new and unique small-scale gallery filtration tunnel system known as *suranga* that draws on groundwater for both drinking water and irrigation. The chapter will describe the design principles and hydrogeological regimes that support *suranga* and conclude with a section on the modern pressures to the continued use of *suranga* and the potential opportunities for the transfer of the technology.

## 24.1 LONG-TERM PATTERNS TO THE ONSET AND LENGTH OF THE SOUTHWEST MONSOON

The foothills of the Western Ghats are subject to the annual southwest monsoon, a period when the region receives the majority of its total rainfall for the year. The timing of the monsoon rains in Asia are linked to July sea-level pressure (mbar) in the equatorial Indian Ocean, the Pacific (El Niño Southern Oscillation; ENSO), wind direction, and cooling of the Arabian Sea due to upwelling (Murari Lal et al. 2001; Gadgil et al. 2003; Gupta et al. 2003). It is an important component of the global climate, and has a significant role in the socioeconomic life of people of the Indian subcontinent. The southwest monsoon period is crucial for recharging man-made tanks and cisterns in the region and for the natural recharge of groundwaters. The key to farmers when planning for irrigation and drinking water needs is the date of onset of this monsoon and the variability in the pattern of the monsoon. Current understanding of the monsoon is that under current intergovernmental panel on climate change and providing regional climates for impact studies climate change scenarios it is likely to become less predictable and more variable (Figure 24.1). The providing regional climates for impact studies scenarios have the notable advantage of using an regional climate model that produces a more realistic representation of the spatial patterns of summer monsoon rainfall such as the maximum along the windward side of the Western Ghats (Rupa-Kumar et al. 2006). Model simulations under scenarios of increasing greenhouse gas concentrations and sulfate aerosols indicate marked increase in both rainfall and temperature toward the end of the twenty-first century in India. West central India shows maximum expected increase in rainfall with extremes in maximum and minimum temperatures expected to increase into the future, but the night temperatures are increasing faster than the day temperatures. Extreme precipitation shows substantial increases over a large area, particularly over the west coast of India and west central India (Rupa-Kumar et al. 2006). If these prove to be the case, it could mean that the farmers are faced with more rainfall at certain times of the year, but greater water stress at other times of the year. This view is borne out by the projection made by Lal et al. (2001) that during winter, India may experience between 5% and 25% decline in rainfall with the decline in winter-time rainfall over India likely to be significant and potentially leading to droughts during the dry summer months. To this respect, groundwaters will continue to be crucial if drinking water is to be made available to the populace, particularly in marginal areas like the foothills of the Western Ghats. Thus, it is crucial to better understand the use of underground aqueducts and other water harvesting techniques in this part of India.

## 24.2 THE HYDROGEOLOGY OF THE WINDWARD SIDE OF THE FOOTHILLS OF THE WESTERN GHATS

Within the foothills of the Western Ghats, groundwaters are found under phreatic conditions in weathered zones of gneiss, schist, and granite and under semi-confined and confined conditions in joints and fractures in the same rocks at deeper depths (Dhiman 2012). The pre-monsoon water

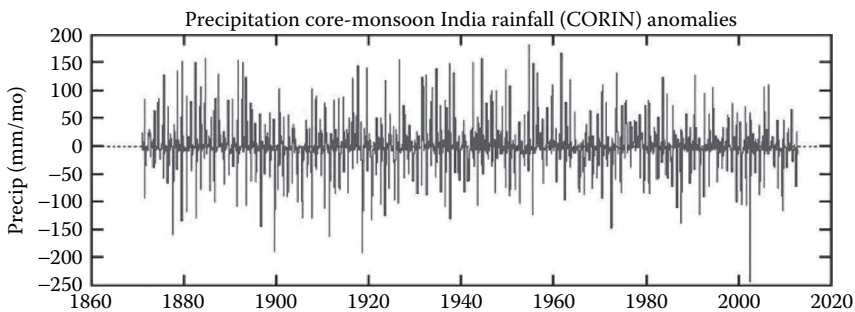


FIGURE 24.1 Precipitation core monsoon India rainfall (CORIN) anomalies.

table depths range from 4.12 to 15.2 mbgl and post-monsoon water table depths range from 0.75 to 8.65 mbgl in Dakshina Kannada (Dhiman 2012) with similar figures found in Kasaragod, Kerala. Laterite is a residual deposit that is a product of intense weathering in a tropical and humid climate like that found in the Western Ghats where the monsoon climate is mainly responsible for the type of laterites found. These laterites are characterized by textural diversity and may develop over an extensive range of bedrocks and sediments. Residual iron and aluminum compounds can form pebbles, nodules, and other structural heterogeneities in an earthy matrix, while porous structures of cellular or vermicular may also appear (Schellmann 1986). Other typical features of laterite are mottled zones of iron and aluminum oxides interwoven with silicate clay minerals. Laterite, when underlain by clay layers, may form aquifers that hold a perched shallow groundwater zone (Langsholt 1994) in which the hydraulic conductivity can be rapid because of the presence of pipes (Putty and Yadupathi 2006; Bonell et al. 2010). Flow simulations presented by Langsholt (1994) illustrate three aspects of the hydrology in a lateritic field that are crucial to our understanding of groundwaters in the foothills of the Western Ghats, these are rapid water table response, Hortonian surface runoff generation, and soil suction variability. Soils can be well-developed, thick, and stable in this region (Bourgeon 1989) that leads to continuous infiltration and dominant subsurface flows. Another typical feature is mottled zones of iron and aluminum oxides interwoven with silicate clay minerals. Overall, these soils are well suited to agriculture and they are fertile. As such traditional water harvesting strategies have been introduced to help exploit these soils.

### 24.3 TRADITIONAL WATER HARVESTING STRATEGIES FOUND ON THE WINDWARD SIDE OF THE FOOTHILLS OF THE WESTERN GHATS

This section briefly reviews complementing water harvesting techniques in the broad region of the foothills of the Western Ghats including *keni*, *madaka*, tanks, and *katta* explaining for each their relevance to groundwaters and groundwater recharge before providing more detail about the predominant traditional water harvesting system in the region known as *suranga* which is a gallery filtration tunnel system (Figure 24.2).



FIGURE 24.2 A *suranga* entrance.



*Kenis* are unique pond systems found in Wayanad district of Kerala with altitudes ranging from 700 to 2100 m from sea level that have a depth and diameter of 0.5–1.5 m. There are thought to be 2–300 *kenis* in this district constructed in clayey soils (Padre 2013). They are ground wells made of hollowed out tree trunks, usually made from toddy palm stem (*Caryota urens*), anjili (*Artocarpus hirsuta*), amla (*Phyllanthus emblica*), and another tree called *Kori Maram* in Malayalam, driven into the ground to support the sides of the well. In some *kenis* the sand lines at the outer rim of the wooden well is thought to act as a water purification system, as these waters are noted for their clarity. These wells appear to be exclusively used in paddy fields on upland plateau as opposed to normal dug and small-scale stepped wells that tend to be located close to farms and associated with drinking water supplies. There is lack of documentation to date about their provenance and origin, but some are thought to be 500–600 years old. Oral testimony suggests that the groundwater sources are very reliable and linked to water table levels. They are community operated and multiple families use these sources.

Another local adaptation to ponding water is the *madaka*. *Madaka* are semi-natural small- (1 × 1 m) to medium (100 × 440 m)-sized tanks that usually have just one side of a natural depression dammed to collect seasonally variable rainfall or the seasonal flows of lower order tributary streams. They can be found on steep slopes at high elevations, but also on extensive upland plateaus (Padre 2007). Their relevance to ground waters in the later locations is that they provide crucial recharge to perched shallow aquifer zones, by allowing infiltration into these aquifers. The *madaka*'s main role is to capture a large proportion of the run-off that flows from microcatchments at higher elevations during the rainy season. The *madaka* may only hold this rainwater for 6–7 months and thereafter dries up, but in the process it raises the water table of the aquifers below. Thus, building the *madaka* higher up ensures that there is water available in lower areas until the end of summer.

In contrast, research into the role of completely man-made tanks is extensive (Basak et al. 2005). These often large man-made features are often associated with religious establishments like Hindu temples and the rituals associated with them alongside everyday community uses like irrigation, but also trees, fishing, domestic water supply, livestock, and a number of minor uses, like washing. Their history is ancient and their use long lived, although there are increasing concerns about their abandonment and the perceived dying wisdom (Mosse 1999; Basak et al. 2005). In South India, both colonial and contemporary state policy initiatives have promoted local institutions for community management of decentralized resource systems in a highly politicized process (Mosse 1999). It has been recognized that there can be large annual variability in supply because they are rain fed, but they retain an important role in recharging groundwaters as water percolates through the ground (Palanisami and Meinzen-Dick 2001). Outside of temples, tanks tend to be managed communally by panchayat unions (PU) and public works departments (PWD). They can be found at the tail end and the head of subcatchments.

Another form of traditional groundwater recharge is the *Katta*. *Katta* are temporary dams traditionally made from earth that are used to block the flow of seasonal streams and medium-sized tributary rivers such as Shriya River in Manila village. The ponding of water allows waters for irrigation to be collected for longer periods of time, but also has the positive externality of encouraging groundwater recharge in these areas. Recently, Dr. Varanashi Krishna Moorthy of the Varanashi Foundation has been experimenting with alternative building materials for the dams like sand bags that can be reused each agricultural season to try and revitalize this practice.

#### 24.4 SURANGA TUNNEL WELL GALLERY FILTRATION SYSTEMS

As mentioned before the most ubiquitous water harvesting system found in this part of the windward side of the foothills of the Western Ghats are the *suranga* gallery filtration tunnel systems, horizontally excavated out from laterite. A survey of over 250 households in three states: Dakshin Kannada, Shimoga, Puttur, and Sullia (Karnataka); Kasaragod (Kerala); Ponda (Goa) identified 750 *suranga* in the foothills of the Western Ghats. When added to existing inventories from other

villages and districts (Kokkal 2002; Basak et al. 2005; Balooni et al. 2008, 2010), the real number is closer to 3000. The range of lengths of *suranga* from our study (Crook et al. 2015) is from 1 to 150 m with an average length of 33 m. The widths of these gallery filtration tunnel systems range from 0.45 to 0.7 m and heights range from 1 to 2 m which corresponds roughly to the height of the *suranga* digger who is either the owner of the land or a hired laborer and their reach with the swing of a pick axe (*pikaas*) and/or hammer used in conjunction with a metal piton. The laborer will dig away the often hardened laterite and some bedrock and remove this using either a head carrier (*chatti*) or a hollowed out piece of trunk that has rope attached to it. There appears to be no local name for this device that is used quite regularly by *suranga* builders (Figure 24.3). Bifurcation of tunnel systems is the norm at the distal end of the dug *suranga* tunnel. This division can be multiple hence the literal translation of fingers (*kai*) and indeed the *kai* may also have subdivisions (Figure 24.4). This is a strategy that is used to enhance water supply within *suranga* where water has been difficult to find in the first instance because of hitting bedrock. Tunnel planimetrics are not homogeneous. Sometimes the excavation of the main tunnel may be diverted at an angle to overcome rock barriers,



FIGURE 24.3 A *suranga* under construction.

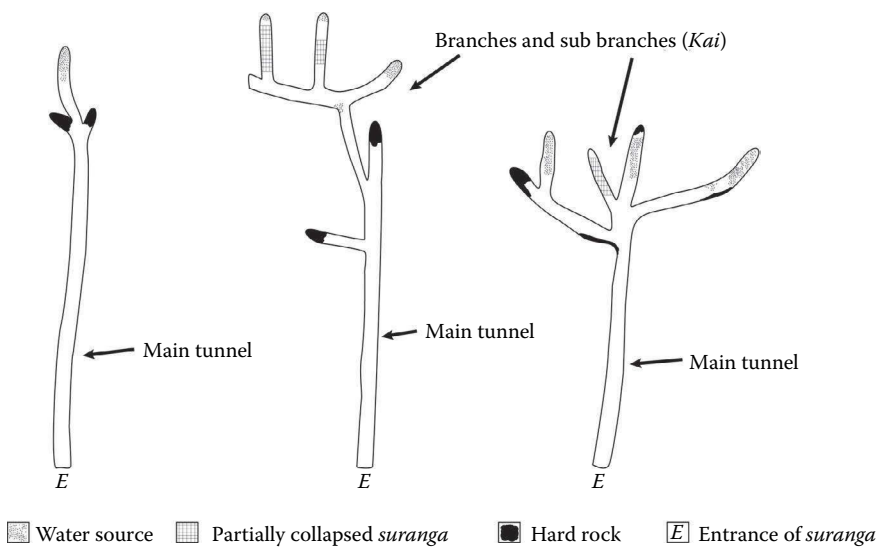


FIGURE 24.4 The plan view of *suranga* illustrating the use of *kai*.

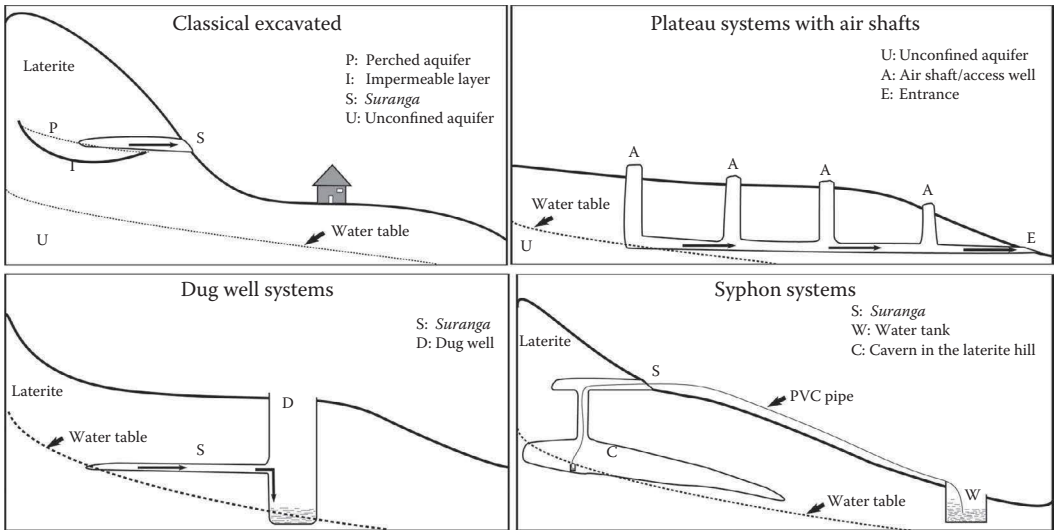


FIGURE 24.5 Four typical types of *suranga*.

this can happen multiple times to create zigzag patterns to some of these systems. There are four main types of *suranga* classical excavated, plateau systems with air shafts, dug well systems, and syphon systems (Figure 24.5). The latter is a relatively recent development used where initial digging of the *suranga* has revealed a natural dendritic cave system with groundwaters at lower levels. Syphoning techniques had to be learnt to draw water up from these deeper depths. Most of these systems are found on Posadigumpe hill in Bayar village, district of Kasaragod, in Kerala. To date we have only found three *suranga* with a small number of air shafts. These are found in upland plateau areas where there is a need for longer tunnels. Discharges from *suranga* vary according to the season, they range from  $0.005 \text{ m}^3\text{s}^{-1}$  in the dry season to  $0.1 \text{ m}^3\text{s}^{-1}$  soon after the monsoon. Farmers typically create a small earthen dam a few meters into the adit tunnel in order to create a small pool of water. They then run a small diameter pipe, usually of polyvinyl chloride (PVC), through the dam to collect a small constant flow of water. This practice has the benefit of reducing the chances of contamination from around the entrance to the *suranga* that receives the most disturbances from mammals and reptiles, and reduces water loss from infiltration.

The construction of *suranga* has over time been carried out by specialized *suranga* builders, coolies, and laborers and also by poorer owners from scheduled castes and tribes. Family finances and laborer availability drive this decision. There are one or two notable elderly *suranga* experts, who advise farmers as where to locate and dig a *suranga*. There are key ethnobotanical indicator species on hill slopes that are searched for to indicate water close to the surface, such as rows of termite mounds and tree species like dhoopada mara (*Vateria indica*), basari mara (*Ficus virens*), or uppallige mara (*Macranga indica*). Water divining with sticks is also sometimes used to locate water sources. A skilled *suranga* constructor, of which there are two or three notable ones, will follow signs (e.g., a mottled white color in the laterites that indicate a high water content) and vertical strata in the laterite for greater structural soundness. All *suranga* are privately owned and in the majority of cases individually used by small family units (<8 people as a norm) (see Suseelan 2009). There are just a few instances of communal water rights operating between families usually in a usury or usufructuary arrangement with water harvested in a rotation, that is, proportional to land ownership. Farmers typically adopt and integrate new irrigation and material technology where appropriate in particular to improve the distribution efficiency of water (Crook et al. 2015). This may include using drip irrigation, sprinkler systems, and hybrid microirrigation techniques like dripper, fogger, and sprinkler systems. These are used in conjunction with small farm ponds

(*kere*) and storage tanks that are found on most farms. Farmers can receive up to 90% government subsidies from agricultural banks for these distribution technologies to achieve greater water efficiencies.

Maintenance of *suranga* tends to be annual unless a blockage occurs during a season, whereby emergency maintenance may be needed. *Suranga* constructed from laterites on acidic rocks harden or indurate after drying (hence the use of brick stone) and are less likely to result in tunnel collapse whereas *suranga* dug from laterites on basalts are commonly soft and friable (Schellmann 1986) and tunnel collapse is more common. A further concern of farmers is crabs that inhabit a *suranga* because they can compromise the viability of the side walls through their burrowing activities. The number of times a farmer enters a *suranga* is limited because wildlife like wild boar, porcupine, turtles, and pythons may choose to live in the entrance and other more dangerous snakes like cobra and king cobra may drink from these sources. Typical problems encountered are partial or total tunnel collapse and/or seasonal water supplies. Abandonment of *suranga* is rare, but it does happen. Sometimes a *suranga* may function in a moribund status, with the threat of future collapse preventing re-entry and maintenance, but as long as water can still be retrieved a family will continue to use this. Thus, according to yields *suranga* can be divided up into three categories: perennial water supply, seasonal water supply, and dry *suranga*.

Not all *suranga* systems are designed to supply water year round with some systems functioning just for a rice crop, but not subsequent crop rotations, when dry crops are planted. Only those *suranga* that are dedicated to drinking water must guarantee an annual supply. There are numerous examples of partial and full abandonment of *suranga* caused by either collapse of tunnels and/or drying up of supplies and there are also examples of systematic failure by diggers to find water upon construction. There are individual success stories of great tenacity to discover water on land after numerous unsuccessful attempts and initial ridicule from peers. The use of multiple *suranga* systems on a farm to exploit different microcatchment dynamics is typical (Crook et al. 2015). Water supplies from traditional systems which include *suranga* as a key component often have a cascading system of hydrological connectivity linked to the multiple use of *kere* and dug or stepped wells. This may have implications for water supplies if this hydrological relationship is not fully appreciated and *suranga* are built in inappropriate places that will lead to the overexploitation of groundwaters. This issue requires more detailed assessment.

Overall groundwater supplies in Dakshin Kannada and Kasaragod are classified as semi-critical (Kokkal 2002), as a result of overexploitation. Many farmers in these areas where conditions allow are turning to supplementing their water supplies with water obtained from borewells. Borewell construction has spread rapidly over the past ~35 years in the districts where *suranga* are found partly as a result of government subsidies for their construction. This in part is said to be the cause for the semi-critical status of ground waters in these districts. At the same time there has been little to no subsidy provided by local or national government toward the construction and maintenance of *suranga*. Farmers, however, clearly favor *suranga* water for drinking, based upon clear distinctions between taste and quality. The waters obtained from both deep wells and borewells are said to taste metallic. One concern for farmers regarding water quality is ammonia pollution from guano resulting from resident bat populations that have set up communities in these tunnel systems. Bat species found in *suranga* include *Hipposideros ater* and *H. speoris* (Dr. Suthakar Isaac pers. comm.). As a result of this threat to water quality a few farmers tend to cover the entrance to *suranga* that are used for drinking, but they are happy for bats to reside in agricultural *suranga* not least because they are insectivores and will eat mosquitoes near home that spread diseases by acting as vectors. Their nitrogen-, phosphate-, and potassium-rich guano may also act as a fertilizer for crops.

Farmers on the whole favor this type of natural fertilization, because it is cost neutral and also because farmers in Kasaragod tend to prefer organic methods of farming as a result of their exposure to endosulfan, an organochlorine pesticide, mainly through water supplies. This was aeri-ally sprayed three times a year by the Plantation Corporation of Kerala (PCK) onto cashew crops in three plantations over an area of 4600 hectares between 1976 and 2000. Health issues started

arising in the human population soon after, that are connected to this spraying, many of which were critical (see Dewan 2002).

The sources of groundwater for *suranga* are different than those for borewells. Borewells draw water from older and deeper aquifer systems, while *suranga* generally draw on phreatic water tables where water has a shorter underground residency time as provenanced by  $^{14}\text{C}$  dating of these waters (Crook and Tripathi 2014). This in principle makes *suranga* more vulnerable to short-term changes in weather patterns than borewell sources. However, there is no regulation of the abstraction of borewell water whereas there is self-regulation of water supplies in *suranga*. This makes the awareness of water scarcity in *suranga* users more prevalent and compunction in use is a far more natural behavioral response.

## 24.5 CONCLUSIONS

Groundwater reservoirs or catchment areas along the windward side of the foothills of the Western Ghats are clearly under pressure and in some locations critical. Local panchayat officers must try and respond to these pressures. Clearly, there is a need to better understand the transmission of national and state water policy within local government and local farming networks to recognize issues that block or restrict their implementation or lead to different interpretations of these policies. Narain (1998) argues for a new institutional framework for the management of groundwater in India. He makes a case for separating (de facto) rights in groundwater from rights to land overlying it and conferring (de jure) rights in groundwater to local communities. Our research to some extent exposes the complexity and difficulty of implementing such change as *suranga* are privately owned and governed. Further to this there are examples of private enterprise that are learning the lessons from the past but incorporating new technologies such as the use of the “horizontal bore wells” (*Addaboru* in Kannada) that use galvanized pipes with a small diameter and work like a small *suranga* (Halemane 2007). Mosse’s (1999) assertion that the communal control of tanks is a colonial artifact that lends weight to the argument that more sensible solutions maybe sought through initiatives and education being targeted at the private sector. To this extent Narain’s (1998) arguments for a greater interface between policy and technical communities and coordination among the institutions engaged in managing groundwater do make sense.

## ACKNOWLEDGMENT

This research was funded by the Leverhulme Trust RPG-392.

## REFERENCES

- Balakrishnan, K. and Saritha, S. (2007) *Groundwater Information Booklet of Kasaragod District, Kerala State*, Central Ground Water Board, Ministry of Water Resources, Government of India, Trivandrum, India.
- Balooni, K., Kalro, A. H., and Kamalamma, A. G. (2008) Community initiatives in building and managing temporary check-dams across seasonal streams for water harvesting in South India, *Agricultural Water Management* 95, 1314–1322.
- Balooni, K., Kalro, A. H., and Kamalamma, A. G. (2010) Sustainability of tunnel wells in a changing agrarian context: A case study from South India, *Agricultural Water Management* 97(5), 659–665.
- Basak, P., Raghavendra Prasad, P. M., and Sreedharan, K. E. (2005) Western Ghats. In Agarwal, A. and Narain, S. (Eds.) *Dying Wisdom: Rise and Fall and Potential of India’s Traditional Water Harvesting Systems*, 4th edition. Centre for Science and Environment, New Delhi, India, pp. 220–223.
- Bonell, M., Purandara, B. K., Venkatesh, B., Krishnaswamy, J., Acharya, H. A. K., Singh, U. V., Jayakumar, R., and Chappell, N. (2010) The impact of forest use and reforestation on soil hydraulic conductivity in the Western Ghats of India: Implications for surface and sub-surface hydrology, *Journal of Hydrology* 391, 47–62.
- Bourgeon, G. (1989) Explanatory booklet on the reconnaissance soil map of forest area Western Karnataka and Goa, *Travaux de la Section Scientifique et Technique de l’Institut Français de Pondichery* 20, 203.



- Crook, D. S. and Tripathi, S. (2014) Competing uses of groundwater in Dakshin Kannada, South India: Implications for the resilience and sustainability of farming. *Presentation at the 9th Conference on Sustainable Development of Energy, Water and Environment Systems*, September 20–27, 2014, Venice-Istanbul. Number -0488.
- Crook, D. S., Tripathi, S. M., and Jones, R. T. (2015) An investigation into the age and origin of Suranga in the Western Ghats of India, *Water History* 7(3), 253–270.
- Dewan, A. (2002) *Environmental Epidemiological Study Related to Aerial Spray of Endosulfan on Cashewnut Plantations in Kasarogode District of North Kerala*, National Institute of Occupational Health, Ahmedabad, India.
- Dhiman, S. C. (2012) Groundwater information booklet Dakshina Kannada District, Karnataka, Government of India Ministry of water resources, Central Ground water Board, South Western Region Bangalore, Bangalore, India.
- Gadgil, S., Vinayachandran, P. N., and Francis, P. A. (2003) Droughts of the Indian summer monsoon: Role of clouds over the Indian Ocean, *Current Science* 85(12, 25), 1713–1719.
- Gupta, A. K., Anderson, D. M., and Overpeck, J. T. (2003) Abrupt changes in the Asian southwest monsoon during the Holocene and their links to the North Atlantic Ocean, *Nature* 421(6921), 354–357.
- Halemane, H. (2007) Suranga—A sustainable water resource, *National Seminar On Water & Culture- Hampi*, Bellary District, June 25–27, 2007, Karnataka, India.
- Kokkal, K. (2002) Studies on development of surangams as a non-conventional water resource in the khangad block panchayat, *Report on Project Conducted by Centre for Water Resources Development and Management*, Kasaragod District, Kerala, Ground Water Division, Kerala, Submitted to Centre for development Studies, Thiruvananthapuram, Kerala, India.
- Lal, M., Nozawa, T., Emori, S., Harasawa, H., Takahashi, K., Kimoto, M., Abe-Ouchi, A., Nakajima, T., Takemura, T., and Numaguti, A. (2001) Future climate change: Implications for Indian summer monsoon and its variability, *Current Science* 81(9), 1196–1207.
- Langsholt, E. (1994) Water balance modelling in lateritic terrain, *Hydrological Processes* 8, 83–99.
- Mosse, D. (1999) Colonial and contemporary ideologies of ‘community management’: The case of tank irrigation development in South India, *Modern Asian Studies* 33(2), 303–338.
- Murari Lal, T., Nozawa, S., Emori, H., Harasawa, K., Takahashi, M., Kimoto, A.-O., Nakajima, T., Takemura, T., and Numaguti, A. (2001) Future climate change: Implications for Indian summer monsoon and its variability, *Current Science* 81(9, 10), 1196–1207.
- Narain, V. (1998) Towards a new groundwater institution for India, *Water Policy* 1, 357–365.
- Padre, S. (2007) Water harvesting: Upper catchment, gains in the plains, *India Together*, September 23, 2007. <http://indiatogether.org/madaka-environment>
- Padre, S. (2013) Dying water bodies Kerala loses its precious Kenis, *India Together*, May 23, 2013. <http://indiatogether.org/keni-environment>
- Palanisami, K. and Meinzen-Dick, R. (2001) Tank performance and multiple uses in Tamil Nadu, South India, *Irrigation and Drainage Systems* 15, 173–195.
- Putty, M. and Yadupathi, R. (2006) Salient features of the hydrology of the Western Ghats in Karnataka. In Krishnaswamy, J., Lèlè, S., and Jayakumar, R. (Eds.) *Hydrology and Watershed Services in the Western Ghats of India: Effects of Land Use and Land Cover Change*. Tata McGraw-Hill Publishing Company, New Delhi, India.
- Rupa Kumar, K., Sahai, A. K., Krishna Kumar, K., Patwardhan, S. K., Mishra, P. K., Revadekar, J. V., Kamala, K., and Pant, G. B. (2006) High-resolution climate change scenarios for India for the 21st century, *Current Science* 90(3, 10), 334–345.
- Schellmann, W. (1986) A new definition of laterite: Geol, *Survey India Memoirs* 120, 1–7.
- Suseelan, A. (2009) Investigating the relation of a sustainable vernacular technique to settlement pattern. In Feyen, J., Shannon, K., Neville, M. (Eds.) *Water and Urban Development Paradigms: Towards an Integration of Engineering, Design and Management Approaches*. CRC Press, London, pp. 473–478.





# Taylor & Francis

Taylor & Francis Group

<http://taylorandfrancis.com>

---

# 25 Historical Development of Qanāts: Underground Aqueducts in Pakistan

*Saifullah Khan, Mahmood-Ul-Hasan,  
and Muhammad Ishaque Fani*

## CONTENTS

25.1	Introduction .....	426
25.2	Methodology .....	426
25.3	Results and Discussion .....	427
25.3.1	Indus Valley Civilization .....	428
25.3.1.1	The Great Bath .....	428
25.3.1.2	Water Treatment .....	429
25.3.1.3	Irrigation System .....	430
25.3.1.4	Rainwater Harvesting and Storage System .....	430
25.3.1.5	Dockyard at Lothal.....	432
25.3.2	Advancement in Karez System .....	434
25.3.2.1	Distribution of Karez in Pakistan.....	435
25.3.2.2	Contribution of Karez to Groundwater .....	435
25.3.3	Development of Karez System.....	436
25.3.3.1	Physical and Hydraulic System .....	436
25.3.3.2	Constriction of Karez System.....	437
25.3.3.3	Maintaining the Karez System.....	437
25.3.4	Modern Karaz System .....	438
25.3.4.1	Settlement Patterns.....	439
25.3.5	Impact on Functioning of Karez .....	439
25.3.5.1	Karez and Water Supply .....	439
25.3.5.2	Wells as Alternatives to Karez .....	439
25.3.5.3	Impacts of Tube Well Revolution .....	441
25.3.5.4	Dams as an Alternative to Karez .....	443
25.3.6	The Present Policies and Sustainability.....	443
25.3.6.1	Water from Indus River System .....	444
25.3.6.2	Floodwater.....	444
25.3.6.3	Wells/Tubewells .....	444
25.3.6.4	Minor Perennial Irrigation Schemes .....	444
25.3.6.5	Karez Systems.....	444
25.3.6.6	Storage and Delay-Action Dams .....	445
25.4	Issues and Challenges.....	445
25.5	Summary and Conclusion.....	446
	References.....	447

## 25.1 INTRODUCTION

A qanāt (an Arabic word) or karez (Persian) is a water management system used to provide a reliable supply of water for human settlements and irrigation in hot, arid, and semiarid climates in different parts of the world (Mohyuddin 2012). Qanāts are also called karez in Iran, Afghanistan, Pakistan, and Central Asia, derived from Persian kahan, khattara (Morocco), galeria (Spain), falaj (United Arab Emirates and Oman), kahn (Baloch), or foggara/fughara (North Africa).

In Pakistan, the people used different sources to get water for irrigation including *karezes*, wells, tube wells, streams, and so on. *Karezes* are still the most important source of irrigation in different parts of Pakistan particularly in Balochistan, Sindh, Lower Punjab, and parts of Khyber Pukhtunkhwa province. In lower latitudes of Pakistan, life is not possible without *karezes*. After *karezes*, there comes the number of wells and tube wells. Some of the land is also irrigated with rainwater or inland seasonal water reservoirs (Hanna Dam, Quetta, Balochistan). In the country, there are two types of underground water system that is traditional and modern. The traditional ways of underground water aqueducts includes *karezes* and *bowaries* (wells), whereas the modern ways are tube wells and streams which have been introduced in the rain-fed arid and semi-arid lands of Balochistan, Sindh, lower Punjab, and Khyber Pakhtoonkhwa province. The *karez* remained as the most important source of irrigation and domestic water use for centuries but now the modern technology of tube wells has reduced the importance of *karezes* down to certain level.

Pakistan is a densely settled land, having an area of approximately 88 million hectares and a population of about 132 million, growing at a rate of around 2.7% per annum (1998). Pakistan accounts for only 0.67% of the world's land and 2% of the world's population (Ghaffar 2012). The country comprises arid to semi-arid climate in the south (Balochistan, Sindh, lower Punjab) having precipitation less than 10 in. and humid to subhumid regions in the upper latitudes. The southeastern part of the country is covered by the Indus Basin plain, Balochistan plateau in the southwest, and the rigid Himalayas and Hindu Kush mountainous region in the north. Pakistan is located in southwest Asia with lofty Himalayas and Karakorum forming its northern region, while the southern part is bounded by the Arabian Sea. The Tropic of Cancer passes immediately south of the country. Pakistan extends northeast to southwest from latitude 37°N into 231/2°N and longitude 60°E to 75°East (Figure 25.1). The northeastern and northwestern part of the country consists of high mountain ranges like Himalayas, Hindu Kush, and Karakorum with highest peaks like, K-2 (8475 m), Nanga Parbat (7980 m), Rakkaposhi (7665 m), and Trichmir (7569 m).

It covers an area of 803,944 km<sup>2</sup>, out of which 60% in the northwest form mountain terrain and tableland and the remaining 40% is the Indus Plain (Kureshy 1988). The historical deserts of Kharan, Thar, Nara, and Cholistan are located at the southern part of the country.

A number of researchers have studied the underground aqueduct or irrigation system in Pakistan, in which the most outstanding are Ahmad (1996), Ahmad and Javaid (2008), Ambreen et al. (2008), Ann (2009), and GoP (2013).

## 25.2 METHODOLOGY

The chapter describes history of development of the traditional qanāts/karez (underground aqueducts) in the arid and semi-arid regions of Pakistan. The basic theme of the work is to find out the evolution of the underground aqueducts from Indus Valley civilization till the modern technologies era and to discuss how the technology was used in the pre-historic time in the Indian subcontinent. Qualitative anthropological methods which include participant observation, key informant interviews, in-depth interviews, and focus group discussions were used to collect empirical data regarding karez system in Pakistan. Most of the information are collected from the locals and literature cited. As the modern population is rare, knowledge regarding the karez or underground aqueduct, therefore special interviews were conducted with the aged people of Balochistan, Sindh, and lower

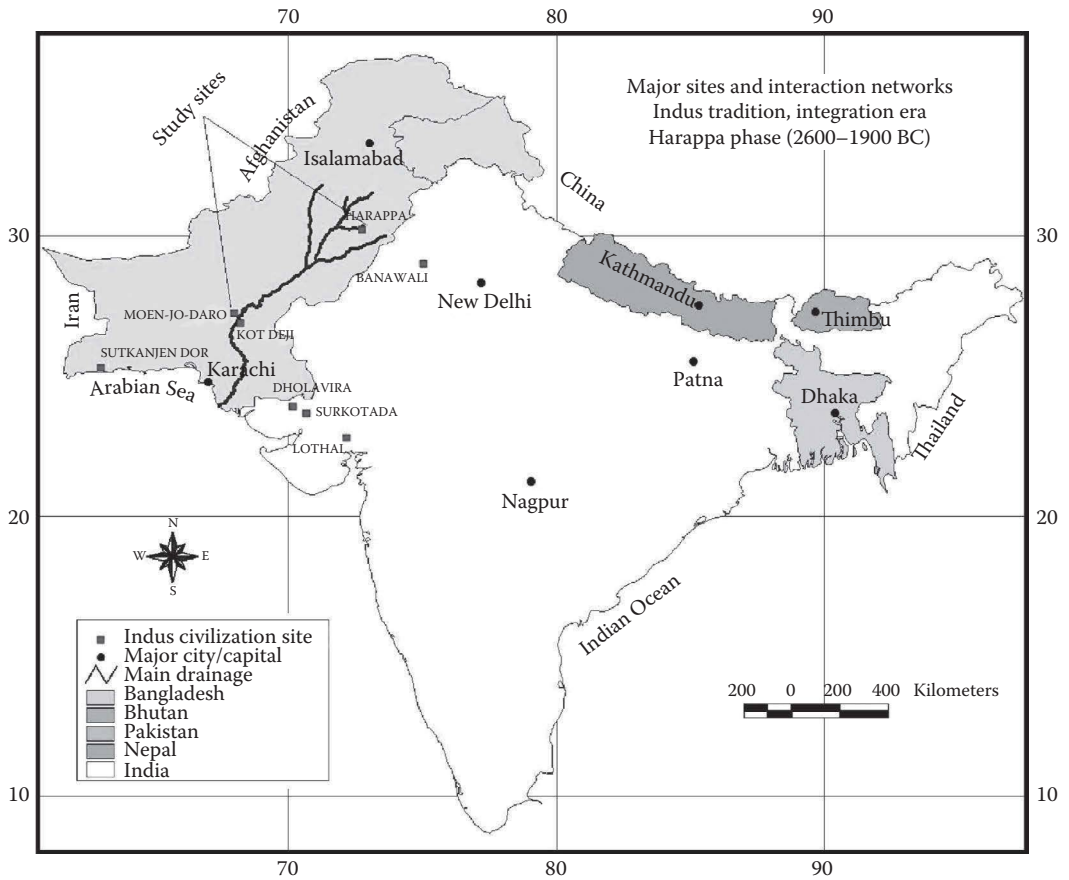


FIGURE 25.1 Pakistan location and historical sites of the Indus Valley civilization.

Punjab for the purpose to understand the process of construction of the karez system and its evolution. Field visits were made for the purpose to update the information about qanāts presented by the previous researchers. A detailed description on the evolution of the qanāts in Pakistan were compiled and presented in this chapter.

### 25.3 RESULTS AND DISCUSSION

The precise dating of qanāts is difficult, unless their construction was accompanied by documentation or, occasionally, by inscriptions. Most of the evidence we have for the age of qanāts is circumstantial; a result of their association with the ceramics or ruins of ancient sites whose chronologies have been established through archeological investigation, or the qanāt technology being introduced long ago by people whose temporal pattern of diffusion is known.

Written records leave little doubt that ancient Iran (Persia) was the birthplace of the *qanāt*. As early as the seventh century BC, the Assyrian king Sargon II reported that during a campaign in Persia he had found an underground system for tapping water. His son, King Sennacherib, applied the “secret” of using underground conduits in building an irrigation system around Nineveh.

During the period 550–331 BC, when Persian rule extended from the Indus to the Nile, *qanāt* technology spread throughout the empire. The Achaemenid rulers provided a major incentive for *qanāt* builders and their heirs by allowing them to retain profits from newly constructed *qanāts* for five generations. As a result, thousands of new settlements were established and others expanded.

To the west, *qanāts* were constructed from Mesopotamia to the shores of the Mediterranean, as well as southward into parts of Egypt. To the east of Persia, *qanāts* were constructed in Afghanistan, the Silk Route oases settlements of central Asia, and Chinese Turkistan (Turpan).

During Roman–Byzantine era (64 BC to 660 AD), many *qanāts* were constructed in Syria and Jordan. From here, the technology appears to have diffused into north and west Europe. There is evidence of Roman *qanāts* as far away as the Luxembourg area.

The expansion of Islam initiated another major diffusion of *qanāts* technology. The early Arab invasions spread *qanāts* westward across North Africa and into Cyprus, Sicily, Spain, and the Canary Islands. In Spain, the Arabs constructed one system at Crevillent, most likely for agricultural use, and others at Madrid and Cordoba for urban water supply. Evidence of New World *qanāts* can be found in western Mexico, in the Atacama regions of Peru, and Chile at Nazca and Pica. The *qanāt* systems of Mexico came into use after the Spanish conquest.

### 25.3.1 INDUS VALLEY CIVILIZATION

As the name denotes, the greater Indus region was home to the largest of the four Ancient urban civilizations of Egypt, Mesopotamia, South Asia, and China and was spread along river Indus and its tributaries that is Jhelum, Chenab, Ravi, Beas, and Sutlej. Geographically, the civilization covered an area of 1 million km<sup>2</sup> (Sharma 1992), bounded by the Great Himalayas in the North, Arabian Sea in the South, Rajasthan desert in the East, and rugged hills and plateaus of Balochistan in the West. The most outstanding sites are Mohenjo Daro, Harappa, Kot Diji, Dholavira, Rakhigarhi, and Lothal (Figure 25.1). The remains of the Harappan settlements are located in a vast desert region of Cholistan, Thar, Nara, and Kharan in the lower Indus basin.

History of harvesting groundwater is less known. For shallow water table and aquifer with soft water-bearing material, dug wells can be developed manually and that is a method as old as mankind. The techniques of digging wells definitely improved during the last millennia with the development of irrigated agriculture, the rise of large settlements and lining techniques of dug wells. These improvements made it possible to reach deep aquifers. Brick-lined dug wells are discovered in the Indus Valley civilization at Mohenjo Daro, Pakistan, in 2500 BC. These wells represent that the people of the Indus Valley civilization were aware about the use of the underground aqueducts construction and its use for agricultural and domestic purposes. Some of the evidences of underground aqueduct of the Indus Valley civilization are summarized as follows.

#### 25.3.1.1 The Great Bath

The “great bath” is without doubt the earliest public water tank in the ancient world located at the archeological site of Mohenjo Daro. The tank itself measures approximately 12 m north-south and 7 m wide, with a maximum depth of 2.4 m (Deonarine et al. 2001). Two wide staircases lead down into the tank from the north and south and small sockets at the edges of the stairs are thought to have held wooden planks or treads. At the foot of the stairs is a small ledge with a brick edging that extends the entire width of the pool. People coming down the stairs could move along this ledge without actually stepping into the pool itself (Figures 25.2).

The floor of the tank is water tight due to finely fitted bricks laid on edge with gypsum plaster and the sidewalls were constructed in a similar manner. To make the tank even more water tight, a thick layer of bitumen (natural tar) was laid along the sides of the tank and presumably also beneath the floor. Brick colonnades were discovered on the eastern, northern, and southern edges. The preserved columns have stepped edges that may have held wooden screens or window frames. Two large doors lead into the complex from the south and other access was from the north and east. A series of rooms are located along the eastern edge of the building and in one room is a well that may have supplied some of the water needed to fill the tank. Rainwater also may have been collected for this purpose, but no inlet drains have been found (Saffy 2011).



**FIGURE 25.2** The Great Bath, Indus Valley Civilization. (From Kenoyer, J.M., *Mohenjo-Daro, an ancient Indus Valley Metropolis*, University of Wisconsin, Madison, 1998, <http://www.harappa.com/indus3/kenoyer.html>. With Permission.)

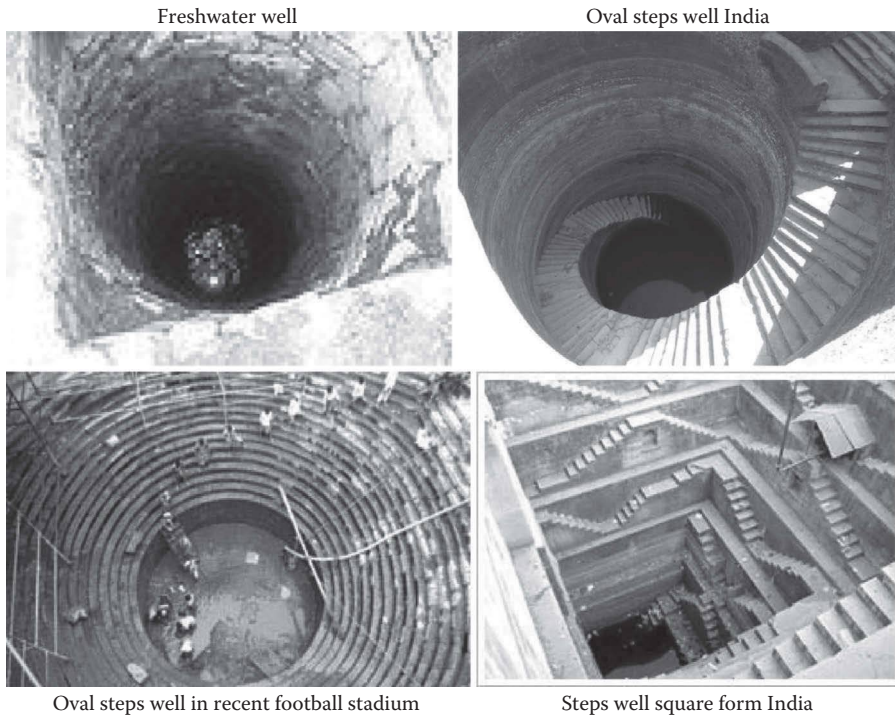
### 25.3.1.2 Water Treatment

The Indus Valley civilization was known for their water management. Most of the excavations have been found around the areas of the cities of Harappa, Mohenjo Daro, and Dholavira. They were known for their obsession with water (Jansen 1989). They prayed to the rivers every day and gave them a divine status. They had well-constructed wells, tanks, public baths, a wide drinking system, and a city sewage system. Each city had two regions—a higher ground, which contained the “Citadel,” was the main administrative area, and the lower city where the houses were situated. All the important areas were situated on the higher ground. The baths and wells were situated there, which suggests the importance they were given (Nambiar 2006).

The inhabitants of Mohenjo Daro were masters in constructing wells. It is estimated that about 700 wells have been built within their city, an average of one well for every third house. They were constructed with tapering bricks that were strong enough to last for centuries (Ann 2009). The cities too had strong walls to resist damages due to floods. One reason for this large number is that Mohenjo Daro received less winter rain and was situated further from the Indus River than the other prominent cities. Hence, it was necessary to collect and store water for various purposes (Figures 25.3 and 25.4).

In addition to wells, archaeologists have also found remains of giant reservoirs for water storage. Reservoirs were situated around the metropolis which was fortified with stonewalls. The Archaeological Survey of India has revealed that one-third of the area of the city of Dholavira in the Rann of Kutch, was devoted to collection and distribution of fresh water (Figure 25.3). The city was situated on a slope between two streams. At the point where one of the streams meets the city’s walls, people carved a large reservoir out of rock. This was connected to a network of small and big reservoirs that distributed water to the entire city all year round. All the reservoirs together could hold about 248,480 m<sup>3</sup> of water. Such was the importance they gave for water storage. According to Gray (1940), many of the houses in Indus civilization had their individual wells within buildings. These wells were usually circular in plan, though at times oval, and had copings of stones or bricks at the floor level, and brick lining for a moderate depth below the surface (Figure 25.4). In a few instances the streets drains ran rather too close to the wells, and it is





**FIGURE 25.3** Different types of wells, water tanks, and step wells in Indus valley civilization. (From Kenoyer, J.M., Mohenjo-Daro, an ancient Indus Valley Metropolis, University of Wisconsin, Madison, 1998, <http://www.harappa.com/indus3/kenoyer.html>. With Permission.)

possible that some contamination of the well occurred. But in most cases the wells were located at adequate distances from the drains.

### 25.3.1.3 Irrigation System

The Indus Valley civilization had an early canal irrigation system. Large-scale agriculture was practiced and an extensive network of canals was used for the purpose of irrigation. Sophisticated irrigation and storage systems were developed, including the reservoirs built at Girnar in *ca.* 3000 BC (Shirsath 2009). Besides, some of the toy pictures of the Indus Valley civilization indicate that they were a proper system of water supply into different houses and places with underground pipeline or aqueducts (Figure 25.5). Mostly, women had the responsibility to supply water into different places. Farmers made good use of water from the rivers. They sowed seeds after the rivers had flooded the fields, as floodwater made the soil rich. They planted different crops for winter (which was mild and wet) and summer (which was hot and dry). They were probably the first farmers to take water from underground wells. They may have used river water to irrigate their fields. Their main cultivation products, among others, were peas, sesame seed, and cotton. They also domesticated wild animals in order to use them for harvesting their farms (Lawler 2008).

### 25.3.1.4 Rainwater Harvesting and Storage System

“The kind of efficient system of Harappans of Dholavira, developed for conservation, harvesting and storage of water speaks eloquently about their advanced hydraulic engineering, given the state of technology” (Subramanian 2010). One of the unique features of Dholavira is the sophisticated water conservation system of channels and reservoirs, the earliest found anywhere in the world and completely built out of stone, of which three are exposed. Dholavira had massive reservoirs



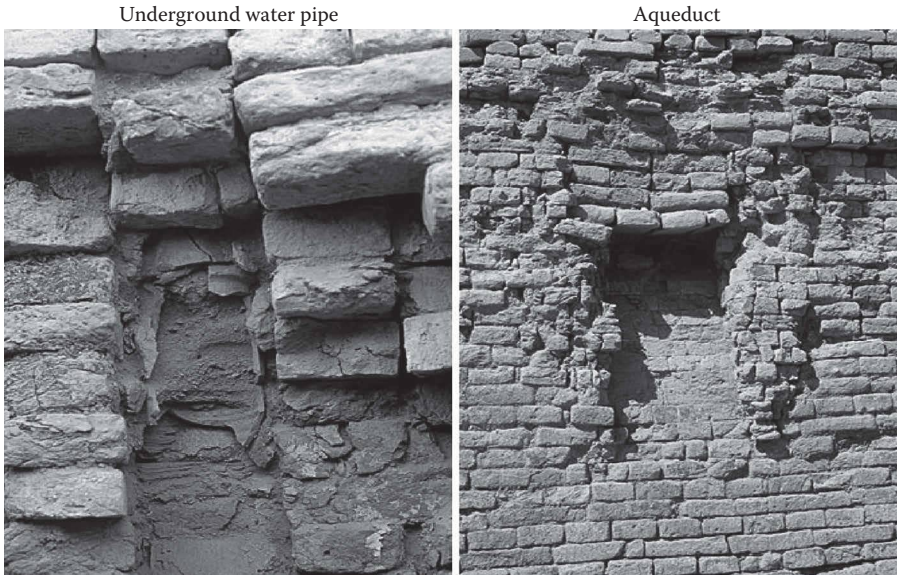
**FIGURE 25.4** Different types of wells, water tanks, and step wells in Indus valley civilization. (From Kenoyer, J.M., *Mohenjo-Daro, an ancient Indus Valley Metropolis*, University of Wisconsin, Madison, 1998, <http://www.harappa.com/indus3/kenoyer.html>. With Permission.)

(Figure 25.6) and were used for storing the freshwater brought by rains or to store the water diverted from two nearby rivulets. This clearly came in the wake of the desert climate and conditions of Kutch, where several years may pass without rainfall. A seasonal stream which runs in north-south direction of the site was dammed at several points to collect water (Violet 2007).

The inhabitants of Dholavira created 16 or more reservoirs of varying size. Some of these took advantage of the slope of the ground within the large settlement, a drop of 13 m from northeast to northwest. Other reservoirs were excavated, some into living rock. Recent work has revealed two large reservoirs, one to the east of the castle and one to its south, near the Annexe, shown in Figure 25.7 (Wales 2010).

Reservoirs are cut through stones vertically. They are about 7 m deep and 79 m long. Reservoirs skirted the city while citadel and bath are centrally located on raised ground. A large well with a stone-cut through to connect the drain meant for conducting water to a storage tank have also been found. Bathing tank had steps descending inward as in Figure 25.7.

A large number of tanks (Figure 25.7) were cut in the rocks to provide drinking water to tradesmen who used to travel along the trade route. Each fort in the area had its own water harvesting and storage system in the form of rock-cut cisterns, ponds, tanks, and wells that are still in use today (Wales 2010).



**FIGURE 25.5** Underground pipe/aqueduct at Mohenjo Daro. (From Kenoyer, J.M., Mohenjo-Daro, an ancient Indus Valley Metropolis, University of Wisconsin, Madison, 1998, <http://www.harappa.com/indus3/kenoyer.html>. With Permission.)



**FIGURE 25.6** Hydraulic engineering Indus civilization at Dholavira, Rann at Gujarat. (From Wales, J., Dholavira, Wikipedia, the free encyclopedia, 2010, [http://en.wikipedia.org/wiki/Dholavira#cite\\_note-frontline-1#cite\\_note-frontline-1](http://en.wikipedia.org/wiki/Dholavira#cite_note-frontline-1#cite_note-frontline-1). With Permission.)

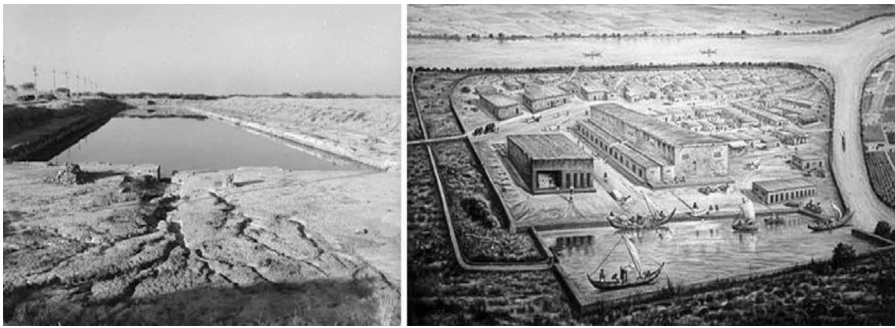
#### 25.3.1.5 Dockyard at Lothal

The dominant sight at Lothal is the massive dockyard which has helped make this place so important to international archaeology. Spanning an area 37 m from east to west and nearly 22 m from north to south, the dock is said to be the greatest work of maritime architecture before the birth of Christ





**FIGURE 25.7** Storm water storage in rock tank and dry well at Dholavira and Lothal. (From Wales, J., Dholavira, Wikipedia, the free encyclopedia, 2010, [http://en.wikipedia.org/wiki/Dholavira#cite\\_note-frontline-1#cite\\_note-frontline-1](http://en.wikipedia.org/wiki/Dholavira#cite_note-frontline-1#cite_note-frontline-1). With Permission.)



**FIGURE 25.8** Dockyards at Lothal. (Courtesy of Professor Kenoyer, 1998.)

(Mulchandani and Shukla 2010). To be sure, not all archaeologists are convinced that the structure was used as a dockyard and some prefer to refer to it as a large tank that may have been a reservoir (Figure 25.8).

It was excavated besides the river Sabarmati, which has since changed course. The structure's design shows a thorough study of tides, hydraulics, and the effect of sea water on bricks. Ships could have entered into the northern end of the dock through an inlet channel connected to an estuary of the Sabarmati during high tide. The lock gates could then have been closed so the water level would rise sufficiently for them to float (Figure 25.8).

An inlet channel 1.7 m above the bottom level of the 4.26 m deep tank allowed excess water to escape. Other inlets prevented siltation of the tanks and erosion of the banks. After a ship would have unloaded its cargo, the gates would have opened and allowed it to return to the Arabian Sea waters in the Gulf of Combay (Mulchandani and Shukla 2010).

Archaeological finds from the excavations testify to trade with ancient Egypt and Mesopotamia. The hydraulic knowledge of the ancient Harappans can be judged by the fact that boats could dock at Lothal in the 1850s. In 1942 timber was brought from Baruch to nearby Sagarwala. It is said that then the dockyard could hold 30 ships of 60 tons each or 60 ships of 30 tons each. This would be comparable to the modern docks at Vishakapatnam (Mulchandani and Shukla 2010).

A long wharf connected the dockyard to the main warehouse, which was located on a plinth some 3.5 m above the ground. The first concern of the Harappan engineers might have been to ensure against floods and tides (which may have been their undoing at Mohenjo Daro and Harappa).

### 25.3.2 ADVANCEMENT IN KAREZ SYSTEM

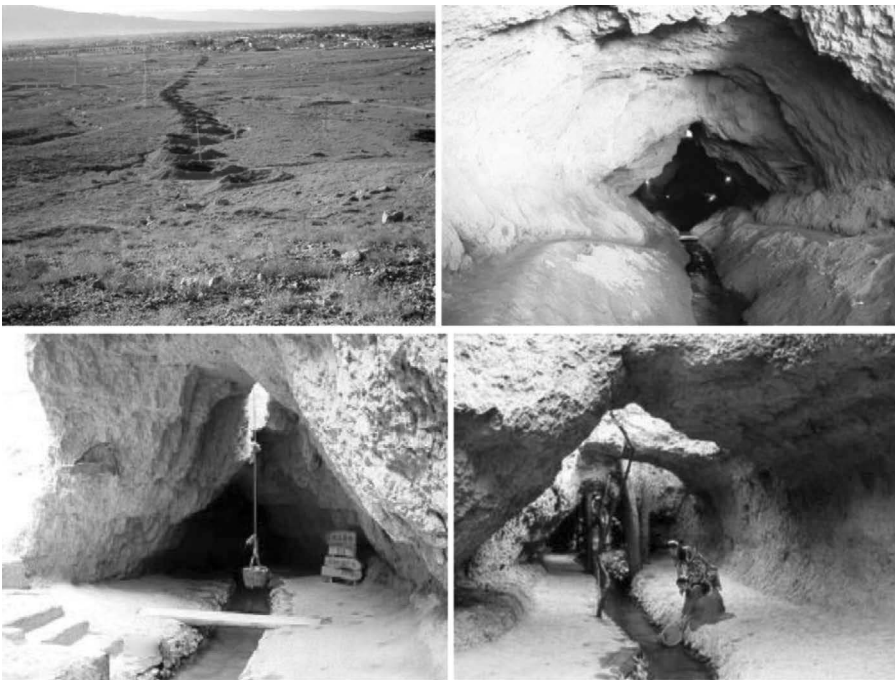
Karez system becomes the more advanced technological innovation when it becomes a system that gave birth to a new spring—man-made spring. Such systems can be of different kinds, but the well documented is conveying aquifer waters to the daylight point by the underground galleries. The most evident pictures are found in the archeological site at Udigram Swat, which is still waiting for execution (Figure 25.9). The first historical appearance of karez is believed to have happened in the mining works during the Urartu kingdom (North Iran, eighth century BC) for drainage of ground-water because water collected in mining ditches poses serious problem of drainage.

In Pakistan, karez is the most outstanding source of irrigation system in the arid Balochistan plateau, while very little evidences are found in the eastern Sindh and Punjab provinces. During 1904 there were 496 karez systems and 1803 springs in Balochistan and were important source of wealth and irrigation as two-third of the cropped area in Quetta and Pishin Districts were irrigated by karez and springs (*Gazetteer of Balochistan* 1906). In reality, the number of karez systems must be much more if the unadministered area is included.

Before discussing further details it may be interesting to quote a statement from the *Gazetteer of Makran District* “the importance attached to irrigation from karez systems may be gauged from the Baloch saying: ‘A mosque should be demolished if it obstructs the course of karez.’” (GoI 1906)

It is believed that in Balochistan, until 1970, around 3000 karez systems were in use, providing water supply to towns and for irrigated agriculture. Afterward, with the availability of electric power and tube wells technology, the karez systems started declining and over one-third are still functioning, constituting as one of the major water source in Balochistan province.

The internationally sponsored irrigation surveys in the 1970 viewed the karez as traditional and outdated system not amenable to updating. The transition to dug wells and tube wells was encouraged, lowering the water table, and decreasing the flow of water in the karez.



**FIGURE 25.9** Ancient karez at Pishin District, Quatta, Balochistan. (From Tanver, A., *Traditional Karez Water Management in Pakistan*, SCOPE, Pakistan, 2007, p. 16. With Permission.)

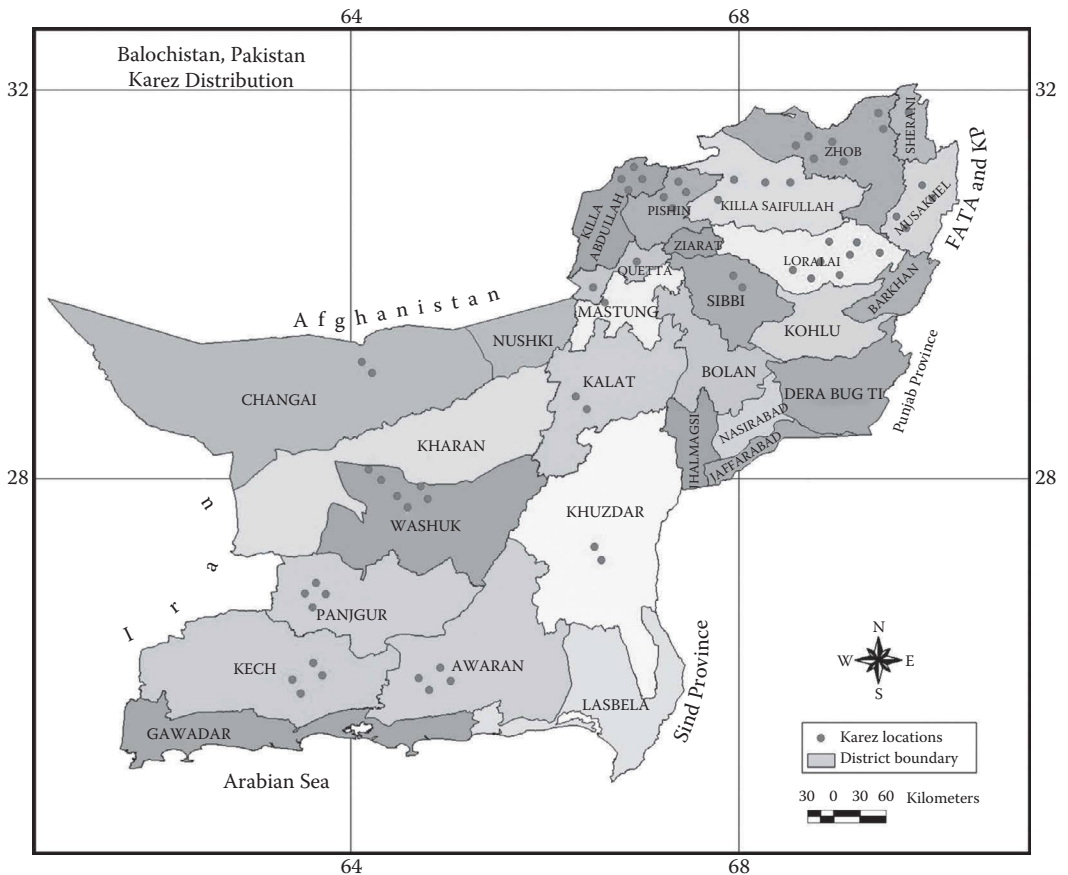
**25.3.2.1 Distribution of Karez in Pakistan**

In Pakistan, the karez system is distributed in the entire area of Balochistan, where it is used as a traditional system for irrigation and water resources. But some of the modern karezes are also located at the area of Dera Ismail Khan division in Khyber Pakhtunkhwa, eastern part of Sindh, and lower Punjab. It is the need of time that Balochistan and the desert area of eastern Sindh and lower eastern Punjab should be considered karez as cultural heritage in natural and agricultural sectors.

During the drought period (1998–2006), the survey conducted by the Irrigation and Power Department (IPD 2013) revealed a different set of karez distribution in the province. The highest concentration of karez systems is found in Qilla Abdulla (243) followed by Panjgoor (188), Turbat (138), Pishin (123), Qilla Saifulla (122), Zoab (70), Ziarat (67), Chagai (56), and Loralie (50). Rest of the districts each is having less than 50 karez systems. The sample survey includes documentation of 1146 karez systems in Balochistan (Figure 25.10).

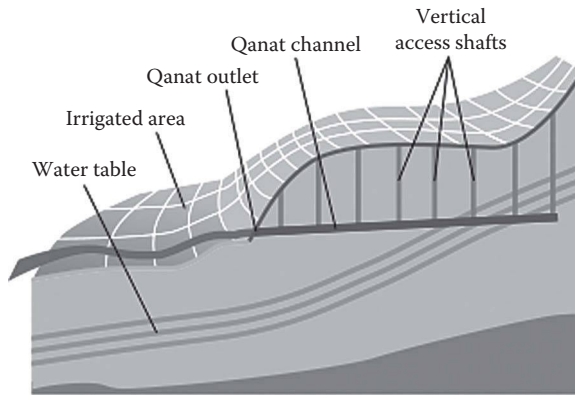
**25.3.2.2 Contribution of Karez to Groundwater**

Almost equal area is irrigated by canals and groundwater in Balochistan. A total of 0.595 million hectares are irrigated through three main sources: karez/springs (140,001 ha), dug wells (80,976 ha), and tube wells (373,774 ha) corresponding to 24%, 14%, and 62% irrigated area, respectively. Thus, roughly one-fourth of the area irrigated by groundwater is contributed by karez and springs (*Economical Year Book* 2013).



**FIGURE 25.10** Location map of Qanāt in Balochistan. (Modified from Ahmad, S., *Water Balochistan Policy Brief*, 3, 13, 2007. With Permission.)





**FIGURE 25.11** Cross Section of Qanāt. (From Ahmad, S., *Water Balochistan Policy Brief*, 3, 13, 2007. With Permission.)

There are four main kinds of abstractions: electric-operated deep tube wells, diesel-operated tube wells/dug wells (shallow to medium depths), and bucket-operated or small motors fitted shallow dug wells, perennial irrigation schemes (Figure 25.11). The groundwater abstractions from electric-operated tube wells are 2.025 billion m<sup>3</sup>, the diesel-operated tube wells/wells abstract 0.712 billion m<sup>3</sup>, and dug wells abstraction is 0.427 billion m<sup>3</sup>/yr. About 294 perennial schemes (karez and springs) provide 0.862 billion m<sup>3</sup> of groundwater annually (GoP 2008).

### 25.3.3 DEVELOPMENT OF KAREZ SYSTEM

There are different types of karez system development in Pakistan. But the most traditional and historical karez system used in Balochistan is discussed as follows.

#### 25.3.3.1 Physical and Hydraulic System

In the beginning of the first millennium BC, under the Persian influence, the Balochistan farmers started constructing karez systems for harvesting groundwater in the river basins of Balochistan. Karez underground galleries were manually dug, just large enough to fit the person while digging.

Along the length of a karez, which can be several kilometers, vertical wells were dug at intervals of 20–30 m to remove excavated material and to provide ventilation and access for maintenance (Ambreen et al. 2008).

The karez underground gallery sloped gently down from pre-mountainous alluvial fans to an outlet at the command area. These structures allowed farmers to have sustainable farming even during droughts when surface water is not available. The components of karez/qanāts are (Figure 25.11)

- Water table
- Infiltration part of the tunnel
- Water conveyance part of the tunnel
- Vertical wells or access shafts
- Qanāt outlet (daylight point)
- Open channel
- Storage pond
- Irrigated command area

The advantages of karez system are: major part of the channel is underground and it reduces seepage and evaporation losses, gravity-fed system, and it does not require any energy for pumping, abstracts groundwater as a renewable resource by posing maximum limits.

The rate of flow of water in a karez is controlled by the water table. Thus, a karez cannot cause significant drawdown in an aquifer because its flow varies directly with the subsurface water supply. When properly maintained, a karez is a sustainable system that provides water indefinitely. The self-limiting feature of a karez is its biggest drawback when compared to the range of technologies available today. Water flows continuously in a karez, and it is largely needed during spring and summer seasons.

Farmers also prefer to irrigate during daytimes. Although the continuous flow in a karez is frequently viewed as wasteful, it can be managed. During periods of low water use (fall and winter), water-tight gates can seal off the karez opening damming up and conserving groundwater for periods of high demand. In spring and summer, night flow may be stored in small reservoirs at the mouth of the karez for daytime use.

### 25.3.3.2 Constriction of Karez System

In Pakistan, Balochistan province experiences the ancient karez systems. It is in the Qilla Abdullah and Panjgoor districts having the biggest concentration of karez systems and the most skilful diggers. Their building methods are very traditional using ancient technologies. For the building of a karez three phases can be distinguished that is investigation and planning, construction, and maintenance.

Generally, in order to increase the water flow to a required volume, not one but several mother wells are built, together with relative galleries bifurcating from the main one. Karez systems built parallel to seasonal streams bring groundwater to the surface during a dry period; and provide filtered clean water out of the muddy flow during the wet periods.

The karez stops functioning as soon as the water table falls below the drainage level of the mother well; and it restarts as soon the water level rises back. So it constitutes a sustainable way of exploitation of water resources, with the geological and technical features of the mother well fixing and regulating the rates of drainage.

### 25.3.3.3 Maintaining the Karez System

There are many methods for the renovation and maintenance of qanāts in different seasons. But the most important steps defined by the ICARDA (2013) are discussed as follows.

#### 25.3.3.3.1 A Stable Groundwater Level

Pumping is a major threat to qanāts. If there is a fast decrease of groundwater level, it is impossible to re-use qanāts for agriculture unless the pumping stops within a range of 3.5 km from the qanāt tunnel.

#### 25.3.3.3.2 Consistent Underground Tunnel Construction

Many of the ancient qanāt workers died because of the danger of job and potential of collapsing of tunnels. If there is any doubt about the consistency of the underground construction, care should be taken and renovation reconsidered out of safety reasons.

#### 25.3.3.3.3 Strong Social Cohesion in Community

This is a condition for management of any qanāt as a common water resource system. It should be noted that social cohesion differs and that it therefore should be studied on a case-to-case basis. In the Balochistan rural areas, a strong village or family leader is usually a condition for good social cohesion.

#### 25.3.3.3.4 Clear Ownership of Qanāt

This is a condition, not to have any problems or conflicts about claiming ownership when there is more water coming from the qanāt.

1. Existing system of rights and regulations on water to be used when water increases.
2. Willingness of users, who are the ultimate beneficiaries and if they are not willing to clean, the work is not likely to be sustainable (ICARDA 2013).

#### 25.3.3.3.5 *Social and Cultural Aspects*

The cost, time, and skills necessary for building and maintaining a karez are very high. But in arid zones, when in function, the karez represents a kind of miraculous pure spring, capable of determining the survival of a whole village and so carrying economic, social, and cultural impacts.

Around 90% karez are having discharge exceeding the deep tube wells and as large as or equal to 5–20 tube wells. In fact, the successful construction and utilization of a karez system does not just depend upon its technical and structural arrangements but also upon several social factors. On one side, it has high costs, on the other it provides economical profits because of low operational cost of water compared to the pumped water. It also promotes social integration.

The pre-conditions of the functioning of a karez are the existence of a very cheap class of workers supporting its material construction and maintenance; the commitment of tribal leaders, landlords, rich families, and kinship groups promoting the construction; a class of skilful specialists that guarantee the technological aspects; and a perfect social cohesion. Any disharmony and conflict between or inside each of these protagonists will undermine the functioning of some parts of the system.

The government of Balochistan could not provide the required support to train the labor for the construction of karez systems; and today labor costs are sufficiently high and such labor is hard to find for functioning the old karez systems or for building new ones.

In the past, the tribal leaders used to give incentives for the construction of karez systems by allowing the diggers and their heirs to retain profits for an agreed period. In fact to build and manage a karez does not only give local privileges in the use of valuable water but represents also a profitable business. The ownership can be individual, or by kinship clan, or collective.

The karez gives an oasis to the people; to the owners it gives privileges and profits. Most probably a cast of water wizards existed from ancient times, which, cooperating first with the miners and then with the tribal leaders. The builders of karez are semi-nomadic kinship groups with secret hereditary transmission of knowledge. Their difficult and hazardous work encounters many problems and frequent death by accidents: from very young age the karez diggers risk their life, with the father helping and directing the operations from outside, so that only few of them reach an old age. The job requires skill, courage, and a specific spiritual taint that attires honor and devotion. They are well paid and highly respected; they work only during favorable days and prayers are said over them by the villagers every time they descend in the wells.

### 25.3.4 MODERN KARAZ SYSTEM

In Pakistan, the qanāts technology is used most extensively in areas with the following characteristics:

- Absence of perennial rivers to support surface irrigation.
- Proximity of potentially fertile areas to precipitation-rich mountains or mountain ranges.
- Arid climate with high evaporation rates so that shallow surface reservoirs and smaller canals would result in higher losses.
- Aquifer at the potentially fertile area which is too deep for shallow dug wells.

The investment and organization required by the construction and the maintenance of a karez is typically provided by local landowners in small groups. At the end of 1960s, it is estimated that over 3000 karez systems were in use in Balochistan, each commissioned and maintained by local users. The karez system has the advantage of being relatively immune to natural disasters (earthquakes, floods) and human destruction.

Further, it is relatively insensitive to the levels of precipitation; a karez typically delivers a relatively constant flow with only gradual variations from wet to dry years.

#### **25.3.4.1 Settlement Patterns**

A typical town or city in Balochistan and elsewhere where the karez is used, the command area is located both over the karez, a short distance before they emerge from the ground, and after the outlet. Water from the karez defines both the social regions in the city and the layout of the city. The water is fresh, clean, and cool in the upper reaches and more prosperous people live at the outlet or immediately upstream of the outlet. Downstream of the outlet, the water runs through surface canal with laterals to carry water to the command area. The water grows progressively more polluted as it passes downstream. In dry years the lower reaches are the most likely to see reductions in flow.

### **25.3.5 IMPACT ON FUNCTIONING OF KAREZ**

#### **25.3.5.1 Karez and Water Supply**

Since the past 40 years, the role of karez systems in securing water in Balochistan has been diminishing. The same has been adversely affected due to the drought (1998–06 and 2000) and inadequate support from the public sector. The labor required for maintaining or constructing the karez system is also diminishing.

The civil society and the public sector both have assumed that the age of karez is over. Due to inadequate policies in Balochistan, lack of awareness about the indigenous technologies, and poor understanding of the interactions between karez systems and the local community and productivity patterns. The original and critical role of karez has been somewhat neglected due to the availability of electric power through the national grid system and subsidy on electric tariff, which resulted in installation of deep tube wells and abstracting groundwater beyond the sustainable levels (Figures 25.12 and 25.13).

The real question is that why the society could not learn from the karez system and due to short-sightedness, the groundwater aquifer was overmined in a very short period of 40 years, resulting in creating intergenerational issues, because we might deprive our coming generations the right to have groundwater.

#### **25.3.5.2 Wells as Alternatives to Karez**

Since 1970s, wells/tube wells have succeeded in replacing or affecting the karez systems. These electric or diesel-operated tube wells/wells have been excavated without considering the original location of karez. However, in comparison to karez, tube wells/wells have a shorter life span (currently that is between 10 and 15 years), whereas karez system holds good for centuries.

Installation of deep tube wells in the past 40 years has further led to the drying up of shallow dug wells and karez systems. There is no doubt that in Balochistan tube wells/wells are absolutely necessary. But these must be considered as a complementary feature to karez; however, these have been excavated in exactly the same areas where karez are used to provide water for centuries.

There is a feeling that karez systems are being abandoned because it is not cost-effective to sustain these systems without conducting any study. Similar is the case with Sailaba agriculture, which is not outdated compared to karez and constitute around two-third of total water resource available in the province but a similar treatment has been given. One should not forget that energy is a critical issue in Pakistan's economy and how long the federal and provincial governments would continue to provide huge subsidy to over 15,206 electric-operated tube wells in Balochistan. The un-planned investments on tube wells in terms of subsidy also resulted in increasing the cost of production and now tube well agriculture is not profitable for field crops (Figure 25.12).



**FIGURE 25.12** Different types of well development in Pakistan. (From GoP, The irrigation and power department, Balochistan, 2013, [http://www.balochistan.gov.pk/index.php?option=com\\_content&view=category&id=1093&Itemid=65](http://www.balochistan.gov.pk/index.php?option=com_content&view=category&id=1093&Itemid=65). With Permission.)

#### 25.3.5.2.1 Advantages of a Karez Over a Well

- Even though the cost of excavating a karez proves to be higher than installing the deep tube well including the pumping system. But if karez systems are regularly dredged and repaired they have prolonged and unlimited life. Whereas, life span of a well/tube well is about 10–15 years. The cost-effectivity of karez seems much higher than tube well.
- Water output of a karez within a definite period of time is determined, large and much more reliable. Thus, karez proves to be a safer source of water supply.
- Karez has no reliance on electric power, whereas oil products have to be imported requiring foreign exchange.
- Low expenditure of karez in comparison to high maintenance charges of wells/tube wells and pumping system is a definite advantage. Karez systems do not impair the quality or quantity of groundwater. This is due to the fact that they are utilized gradually and assist in keeping the balance of groundwater in various layers of ground intact. In fact, even during periods of severe drought, karez systems are not detrimental to groundwater reservoirs.
- Karez reflects collective and cooperative work, and in areas where karez are constructed labor or work opportunities are provided to the local community. The skills for maintaining karez systems are part of the indigenous knowledge of the province and have heritage value.
- Karez has the ability to collect wastewater that penetrates into the soil and it is for this reason that the excavation of karez in arid zones tends to save more water. Freshwater from





**FIGURE 25.13** Different types of tube wells in Pakistan. (From Ahmad, S., *Water Balochistan Policy Brief*, 3, 13, 2007. With Permission.)

the mountain plateau is transferred to the low lying plains. Thereby, soil salinity is kept under control which also helps in combating desertification in Balochistan, Sindh, and Punjab provinces.

- Watermills can be installed on the vertical wells of the karez system, which can provide water for domestic and stock water purposes and also will be used for the commercial purpose as source of energy for watermills.

### 25.3.5.3 Impacts of Tube Well Revolution

According to Barker, Shah, and Molle (2003), several lessons can be drawn. The study revealed that tube wells in Balochistan helped to tap deep or shallow aquifers to expand irrigated agriculture. These developments are in most cases the result of unchecked individual initiatives and are very hard to control. Aquifer mining, declining water table and water quality, and rising pumping costs are the most common threats. Management problems are those related to open-access resources and/or associated with lack of regulation and enforcement capacity. Poor farmers also cannot generally afford costs. The impacts as outlined by the study and relevant to Balochistan are summarized as under Figures 25.13 and 25.14.

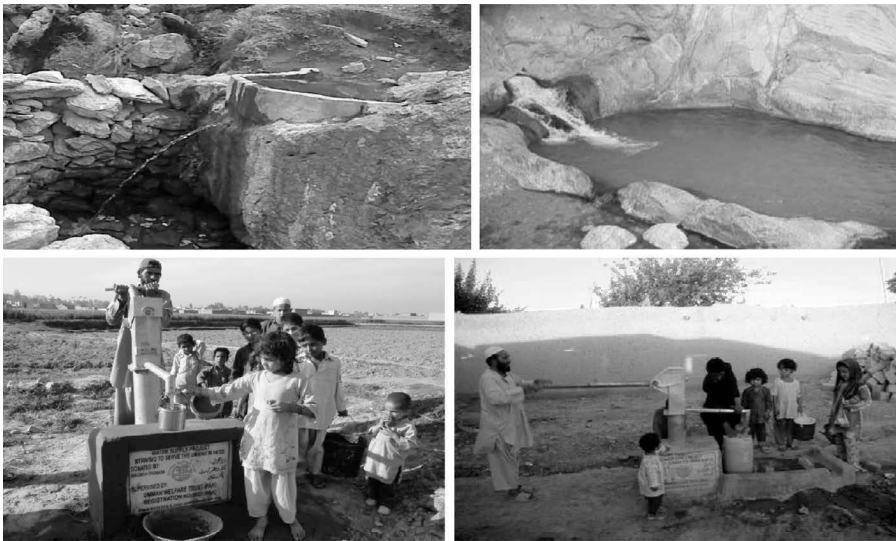
#### 25.3.5.3.1 Hydrological Impacts

Pumps in large numbers may alter the hydrological regime. They may not only deplete aquifers but by doing so also dries up springs and karez, and reduce the base flow to rivers. These modifications of flow regimes also impact the quality of water and, through irrigation, the evolution of soil salinity. Overall, the actual degree of overdraft of groundwater in Balochistan is a very critical question with implications on the sustainability of irrigated agriculture (Figure 25.15).





**FIGURE 25.14** Modern structure of tube wells in Balochistan. (From GoP, The irrigation and power department, Balochistan, 2013, [http://www.balochistan.gov.pk/index.php?option=com\\_content&view=category&id=1093&Itemid=65](http://www.balochistan.gov.pk/index.php?option=com_content&view=category&id=1093&Itemid=65). With Permission.)



**FIGURE 25.15** Lion Mouth Spring at Bolan Pass and water pumps. (From GoP, The irrigation and power department, Balochistan, 2013, [http://www.balochistan.gov.pk/index.php?option=com\\_content&view=category&id=1093&Itemid=65](http://www.balochistan.gov.pk/index.php?option=com_content&view=category&id=1093&Itemid=65). With Permission.)

#### 25.3.5.3.2 Social Impacts

In a majority of cases, pumps tend to be owned individually. They may be used for the owner's benefit and also to sell water to other users. Since they require access to capital, they also tend to exclude poorer users. The hydrological disruptions also impact on preexisting uses. Whenever collective dependency upon vital water resources defines a tight-knitted relationship between the social structure and arrangements around water management, the disruption of supply, as for example caused by the expansion of area served by private pumps, necessarily has social implications.

#### 25.3.5.3.3 Management Impacts

Because pumps easily multiply in large numbers and they are not easily taken into consideration in basin-level water management. By altering the balance and the flows between surface and

groundwater, they make integrated water resources management more complex. On the one hand, pumps are managed locally and by users, obviating the need for large-scale infrastructure and bureaucracies, and they pose challenges both at the scheme level (when they complement surface irrigation water supply) and at the basin level. Their control, when becoming necessary, calls for the provision of laws and regulations. These, however, are typically marred with enforcement problems.

#### 25.3.5.3.4 Economic Aspects

The first economic impact of pumps is that their action on the hydrological cycle is often tantamount to a redistribution or spatial re-appropriation of water. Third-party impacts are very common, especially in closed basins, although they are often made “invisible” by the complexity of surface or groundwater interactions. A second economic impact is that pumps often tap a resource that could otherwise be diverted by gravity somewhere further downstream, thus adding energy costs to the reallocation. Finally, because their main attractiveness resides in the flexibility and security of the supply of water they allow, there is a tendency toward overcapacity (Ahmad et al. 1996).

This brief review of the “pump revolution” in diverse contexts has shown the variety and complexity of the implications of the spread of pumping devices. It claims that this revolution has often been “silent” and that its importance and significance are generally overlooked. Pumps are the main instrument of tapping groundwater: as such, they are central to the most crucial aspects of the closing of river basins and to the much-heralded need for water resources management.

#### 25.3.5.4 Dams as an Alternative to Karez

In Pakistan, the Balochistan government is responsible for the construction of dams, whereas wells/tube wells have been mostly constructed by the farmers. If dams were considered as complementary to the karez system for the purpose of improving agricultural development (with parallel investments in both areas) we would have had a better surface cover in the province and extensive agriculture as well as reduced drought and flood events.

Although the number of dams in Balochistan till the year 2010 was somewhat limited, ever since dam construction has become a dominant priority of the government policy to fulfill demand for recharge, water supply, and energy. In the year 2007, the amount of water that has been secured from dams in the province has been reported as 0.20 billion m<sup>3</sup>. Most of the water stored in the dams has been used for agriculture and domestic purposes (Figure 25.16).

### 25.3.6 THE PRESENT POLICIES AND SUSTAINABILITY

Currently, in Balochistan, the IWRM (Integrated Water Resources Management) Policy emphasizes the need for IWRM covering all subsectors of water use and all sources of water including

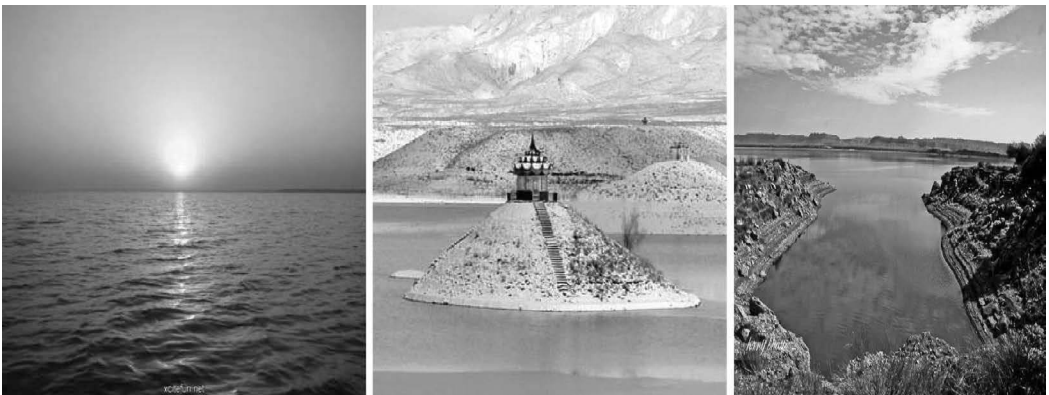


FIGURE 25.16 Heliji Lake Thatta, Hanna Lake Quetta, and Hub lake Lasbella, Balochistan.

karez systems, but still the emphasis of water development and management is for canal and tube well irrigated areas and minor perennial irrigation schemes (MPIS). The MPIS include karez and spring irrigation systems but the major emphasis is on surface waters (Ahmad and Javaid 2008).

There is hardly any support available for either development of new karez systems or improvising the existing karez systems. The emphasis is only on rehabilitation due to deferred maintenance. The communities managing the karez systems have adapted to present conditions despite being weakened to a great extent. However, there are some strength of the karez systems especially in areas like Qilla Abdulla, Panjgur, Turbat, and Qilla Saifulla having major concentration of the karez systems; the communities are still managing the systems because of strong social action by all stakeholders (Ahmad et al. 2008). As far as, the recent drought of 1998–06, which ended up with flood in the province, the impacts on various methods of water use are elaborated in the following sections.

### 25.3.6.1 Water from Indus River System

The Indus river flows during 2001–2002 were lowest in the history since 1937 (112.5 billion m<sup>3</sup>), which were even less than the average canal diversions (130 billion m<sup>3</sup>). The canal diversions during 2001–2002 were 30% less than the average diversions (90.3 billion m<sup>3</sup>). This reduction in canal diversions also adversely affected the canals irrigation in the arid region.

### 25.3.6.2 Floodwater

According to Asian Development Bank (ADB 2013) 25.2, 10.8, and 3.3 billion m<sup>3</sup> of water were available under 25%, 50%, and 75% probability of exceedance. This shows that during drought the floodwater may reduce to 1/3 to 1/4 from that of an average year. Most of the river basins of Balochistan are having only seasonal flows. This is the reason why in persistent droughts, rivers and surface irrigation streams dry up rather quickly.

### 25.3.6.3 Wells/Tubewells

In the droughts of 1998–06 and 2000, the shallow dug wells were worst affected, as the transmissibility of shallow aquifer is much less and lowering of water table had direct impact on drying of shallow dug wells. The deep tube wells were relatively less affected as with the lowering of water table farmers started deepening their wells. Therefore, the deep tube well farmers adapt to the situation by lowering the tube wells having additional cost and more devastating impacts on the sustainability of groundwater during the drought. It had extremely adverse impacts on karez irrigation systems. The drought did not have that detrimental impact on the karez system rather than deepening the tube wells.

### 25.3.6.4 Minor Perennial Irrigation Schemes

The minor perennial irrigation schemes include surface perennial waters, springs, and karez systems. Both the surface perennial and springs were adversely affected by drought, where initially these schemes observed reduction in water supply and then some of these dried up. Karez systems were less affected by drought per se rather impacts were largely due to lowering of deep tube wells which are installed in the catchment and command of the karez systems.

### 25.3.6.5 Karez Systems

For understanding the sustainability of karez system it is essential to view it in a much longer perspective. The karez systems were sustainable for millenniums and fulfilling the needs of human, livestock, and nature. The life of tube wells in Balochistan is less than half a century. In the past 40 years, the deep tube wells have contributed in lowering of water table from less than 30 m to over 150 m in major parts of the province. Further signs of negative impacts of mining of groundwater are now visible. Therefore, the role of karez system can be understood only in longer-term basis. Period of 40 years is nothing in the life of nations. Signs are clear that deep tube wells are going to

evacuate aquifers quite rapidly. So if the life span of a tube well does not come to an end in case of a drought, they shall dry up very quickly. Thus, wells/tube wells are generally useful for short-term usage and alter their surrounding environment very swiftly (Clark and Ghaffar 1968).

### 25.3.6.6 Storage and Delay-Action Dams

The dams, although are more resistant to droughts, but certain conditions are necessary for their long-term sustainability including location, technical engineering details and know-how, and regular maintenance. This is essential in Balochistan, because of the arid environments and lack of vegetative cover, which results in serious problems of watershed degradation. The primary “generation” of small dams that have been constructed in the province or in the country during 1960–1990 have lost major part of their live storage capacity. Even dams that have been designed and constructed using adequate engineering feasibilities have suffered adversely by drought.

It is under these severe climatic changes and environmental degradation, the value of karez systems can be assessed. In periods of drought, karez are more resilient and do not dry up rapidly, as they have the capability of abstracting the aquifers slowly. In addition, karez systems are constructed in harmony with human settlement patterns and water requirements for domestic and agriculture uses. In a drought situation, when the need for water is critical and every drop of groundwater needs to be accounted for, water from karez is returned to the aquifer, in addition, the evaporation losses are minimal in comparison to the dams where extremely large quantities of water evaporate especially in shallow depths. Therefore, karez systems prove stable in times of drought especially for securing water supply.

Finally, the most vital point related to karez is to recognize and understand that karez systems are closely linked to the local communities and their abilities in planning and management of their own water resources. The management system is such that the water is distributed more equitably. As a result, water security and equity in water access and distribution are supporting the foundations of the local community and agriculture at large.

In brief, karez system is not only an engineering and hydrological wonder, but also a social phenomenon that survived in the last millenniums despite climatic change, socioeconomic development, and environmental conditions, even though it has kept a low profile.

## 25.4 ISSUES AND CHALLENGES

The issues and challenges of karez systems in the arid region of Baluchistan, Sindh, lower Punjab, and lower Khyber Pakhtoonkhwa are as follows:

- Karez systems provide ecosystem goods and services (water, staple food, fruits, and vegetables); and promote social cohesion through participation of water users and cultural rituals. The system has survived in millenniums until recently in the past 40 years indiscriminate development of deep tube wells and subsidy on electric tariff resulted in assigning low priority to these stable systems in the arid region. In the process of modernizing harvesting of groundwater the traditional systems were neglected.
- Karez irrigated farming is threatened by a number of factors especially lowering of water table, mining of groundwater. Reduction in flow due to siltation of canals, moving sand dunes, migration of youth to nearby towns, decline of skilled technicians for managing, and lack of support from the public and private sectors.
- There is hardly any program supported by the public sector to improvize the traditional karez systems, as there is hardly any research and development activity. In contrast, in Iran, where karez systems are much more sustainable than Pakistan, the government of Iran has established “International Qanāt Research Centre in Yazd” in collaboration with UNESCO. The government of Pakistan is required to establish a center for promoting the karez system in the drought-prone areas and to save the lives of the locals.

- The current policy of investment in water sector development still emphasize for the development of tube wells, minor perennial irrigation schemes, and canal development like the Kachhi canal. Hardly any study has been undertaken considering technical, institutional, and economic dimensions of karez systems and farming in arid zones of Pakistan.
- Karez system is a relic form of harvesting groundwater for irrigated farming in the arid zones and has been introduced in many other parts of the world. Most of the countries have given importance to sustaining the karez systems but in the arid region of Pakistan, these systems are facing relatively more abandonment due to lack of right focus in maintaining balance between expansion of tube wells and sustaining the karez systems. The experiences from other parts of the world are hardly brought back to the arid region of Pakistan where the lives at risks and facing a drought condition is a commonality since 1980.

## 25.5 SUMMARY AND CONCLUSION

A karez system has a profound influence on the lives of the water users in the arid region of Pakistan. It allows those living in arid zones adjacent to a mountain watershed to create a large oasis in an otherwise stark environment. The government of Pakistan and donor agencies are encouraging the revitalization of traditional water harvesting and supply technologies in arid areas because experts are now of the opinion that karez system is vital for sustainable water use in fragile environments. The options appropriate for Balochistan and the drought-prone areas of Thar and Cholistan deserts of Pakistan and India are as follows:

- As some of the countries like Iran has declared the karez system as “National Heritage” and started giving higher priority for sustaining this system of harvesting groundwater on longer term basis. Similarly, the governments of Pakistan should declare karez system as “National Heritage” and initiate mass awareness campaigns and develop curriculum for schools and universities in Balochistan, Thar, and Cholistan deserts. A special corner in the National and Provincial Museums for “Water” should also include some of the information on karez systems.
- The UNESCO and United Nations University, Tokyo, Japan, are promoting studies on karez systems through International Hydrological Programme that cover member states and the Traditional Technology in Dryland Programme that supports systematic studies. Similarly, Iran has established the International Qanāt Research Centre at Yazd. Therefore, governments of Pakistan should initiate a modest programme for initiating R&D for the karez systems in the arid region. The focus should be to conduct research in real-life situation initially to understand these systems and issues and constraints and then build technologies and processes for improving these systems.
- Initiate a similar research and development programme for improving karez-irrigated farming with an objective to improve water productivity by introducing water-efficient high value crops, fruits, and vegetables in the arid region of Sind, Lower Punjab, Lower Khyber Pakhtoonkhwa, and Balochistan plateau.
- Develop and enforce a programme of organizing the karez communities and skilled technicians in the rural areas leading toward capacity building. Initially, a Polytechnic Trade Institute may be established with satellites in the districts having major concentration of karez systems (Panjgur, Turbat, Qilla Abdulla, Qilla Saifulla, Zoab, Tharparker, Umarkot, Nawabshah, Bahwalpur, Bahwalnagar, Dera Ismail Khan). The purpose of this institution should be to upgrade the skills of technicians in the use of relatively modern tools for assessment of water resources, sitting the mother well, aligning the underground galleries, lining the sensitive reaches of underground galleries using pre-cast concrete or plastic tiles,



digging of vertical wells and covering these to minimize the maintenance, and operation and maintenance of karez system.

- Creating awareness for the civil society at large in conveying the message that karez systems are more sustainable and electric power-based deep tubewells are going to be a disaster both in terms of groundwater and energy use in the province. Furthermore, the karez system is going to support the challenge of poverty reduction as poor and rich are treated in more or less a similar manner.
- Initiate a study to collect all the written material available on karez systems of the arid region especially at the time of Indus Valley civilization, as there is hardly any useful information available in the Internet about karez systems in the area.
- Prepare the new generation to be able to understand that karez systems are more sustainable as they were sustained for millenniums in the past and going to be much more sustainable in future compared to deep tubewells, which in less than half a century started giving signs of nonsustainability. The new generation must understand, use, conserve, and further build the karez systems in the arid region. This would require including the curriculum of water in schools and universities for the awareness of local in the arid region. The schoolchildren may be exposed to the karez and Sailaba systems in their relatively early age so they are not overwhelmed from the modern technology without considering the environmental consequences.

## REFERENCES

- ADB, (2013), TA Grant Project, <http://www.adb.org/site/business-opportunities/operational-procurement/consulting/shortlist>.
- Ahmad K et al., (1996), Economics of Karez Irrigation in Balochistan, *Pakistan Journal of Agricultural Sciences* 33, 64–65.
- Ahmad S, (2007), Karez—A Cultural Heritage of Natural and Agricultural Sectors an Interminable System of Harvesting Groundwater in Balochistan, *Water for Balochistan Policy Briefings* 3(14), 13.
- Ahmad S and Javid I, (2008), Conjunctive Water Use and Management for Minor Perennial Irrigation Schemes in Balochistan—Key Issues and Revised Strategy for Investment, *Water for Balochistan Policy Briefings* 4(6), 10.
- Ambreen M, Chaudhary H, and Mahyuddin A, (2008), Social Organization of Karez in Balochistan, *International Journal of Arts and Commerce* 1(2), 131–148.
- Ann C, (2009), History of Water Pumps, eHow Contributor, [http://www.ehow.com/facts\\_5031932\\_history-water-pumps.html](http://www.ehow.com/facts_5031932_history-water-pumps.html).
- Barker R, Shah T, and Molle F, (2003), The Groundswell of Pumps: Multilevel Impacts of a Silent Revolution, <http://citeseerx.ist.psu.edu/showciting?cid=5934295>.
- Clark W and Ghaffar M, (1968), Statistical Series on Private Tubewells Development in West Pakistan, Research Report No. 7, Installation of Private tubewells in West Pakistan, 1964–1967, Pakistan Institute of Development Economics, Karachi, Pakistan, p. 16.
- Ghaffar R, (2012), Pakistan Environmental Profile, <http://envirocivil.com/environment/pakistan-environmental-profile/>.
- GoI, (1906), Baluchistan District Gazetteer Series. (Bombay, India: Times Press, 1906–1913), <http://onlinebooks.library.upenn.edu/webbin/book/browse?type=lcsb&key=Balochistan%20%28Pakistan%29%20--%20Gazetteers&c=x>.
- GoP, (2008), Crops Area and Production, (by Districts), Government of Pakistan Ministry of Food and Agriculture (Economic Wing) Islamabad, Pakistan.
- GoP, (2013), The Irrigation and Power Department, Balochistan, [http://www.balochistan.gov.pk/index.php?option=com\\_content&view=category&id=1093&Itemid=65](http://www.balochistan.gov.pk/index.php?option=com_content&view=category&id=1093&Itemid=65).
- Gray HF, (1940), Sewerage in Ancient and Mediaeval Times, *Sewage Works Journal* 12(5), 939–949.
- ICARDA, (2013), International Centre for Agricultural Research in Dry Areas, <http://en.wikipedia.org/wiki/ICARDA>.
- Jansen M, (1989), Water Supply and Sewage Disposal at Mohenjo-Daro, *World Archaeol* 21(2), 177–192.
- Kenoyer JM, (1998), Mohenjo-Daro, An Ancient Indus Valley Metropolis, University of Wisconsin, Madison, <http://www.harappa.com/indus3/kenoyer.html>.



- Kureshy KU, (1968–1988), *Geography of Pakistan*. National Book Service, Lahore, Pakistan, pp. 13–62.
- Lawler A, (2008), Boring No More, a Trade-Savvy Indus Emerges. *Science* 320, 1276–1281. <http://www.academicroom.com/article/boring-no-more-trade-savvy-indus-emerges>.
- Mohyuddin A, (2012), Social Organization of a Karez in Balochistan, *International Journal of Arts and Commerce* 1(2), 131–148.
- Mulchandani A and Shukla D, (2010), A walk through Lothal, <http://www.harappa.com/lothal/index.html>.
- Nambiar A, (2006), Indus Valley—How They Managed Their Water Resources, *Water Management in the Ancient Indus Valley*, <http://voices.yahoo.com/indus-valley-they-managed-their-water-resources-82580.html>.
- Saffy H, (2011), The Great Bath at Moenjodaro, Wikipedia online, [en.wikipedia.org/wiki/Great\\_Bath,\\_Mohenjo-daro](http://en.wikipedia.org/wiki/Great_Bath,_Mohenjo-daro).
- Sharma LP, (1992), Ancient India History, Indus Valley Civilization, <http://www.culturalindia.net/indian-history/ancient-india/indus-valley.html>.
- Shirsath PB, (2009), Irrigation Development in India: History & Impact, Water Technology Centre, WTC, IARI, New Delhi, [http://indiairrigation.blogspot.com/2009/01/history-of-irrigation-development-in\\_01.html](http://indiairrigation.blogspot.com/2009/01/history-of-irrigation-development-in_01.html).
- Subramanian TS, (2010), The rise and fall of a Harappan city, 27, Issue 12, June 05–18, 2010, India's National Magazine from the Publishers of The Hindu, <http://www.frontlineonnet.com/fl2712/stories/20100618271206200.htm>.
- Tanver A, (2007), *Traditional Karez Water Management in Pakistan*, SCOPE, Pakistan, p. 16.
- Violett PL, (2007), Water Engineering in Ancient Civilizations: 5,000 Years of History, (Translation into English by Forrest M. Holly), International Association of Hydraulic Engineering and Research (IAHR), Madrid. <http://www.amazon.com/Water-Engineering-Ancient-Civilizations-Monographs/dp/9078046058>.
- Wales J, (2010), Dholavira, Wikipedia, the free encyclopedia, [http://en.wikipedia.org/wiki/Dholavira#cite\\_note-frontline-1#cite\\_note-frontline-1](http://en.wikipedia.org/wiki/Dholavira#cite_note-frontline-1#cite_note-frontline-1).

---

# 26 Underground Aqueduct and Water Tunneling Development in Thailand

*Vilas Nitivattananon, Dollachet Klahan,  
Visnu Charoen, and Yin Mon Naing*

## CONTENTS

26.1	Introduction .....	449
26.1.1	Overview of Underground Aqueducts in Thailand.....	450
26.1.2	Scope of This Chapter .....	450
26.2	Water Supply.....	450
26.2.1	Overview and Description of the Bangkok System.....	450
26.2.2	Works of MWA .....	451
26.2.3	Development and Construction of Water Tunnels and Main Distributions .....	453
26.2.3.1	Tunnels in the Early Days .....	453
26.2.3.2	Tunnels Today .....	453
26.2.4	Barriers .....	455
26.3	Flood and Sewer Drainage .....	455
26.3.1	Overview and Description of the Bangkok System.....	455
26.3.2	BMA Measures of Flood Prevention and Sewerage Management .....	455
26.3.3	Development and Construction of Drainage Tunnels and Maintenance .....	455
26.3.4	Barriers .....	457
26.4	Other Applications of Underground Aqueducts .....	457
26.4.1	Water Diversion .....	457
26.4.2	Irrigation .....	458
26.5	Conclusions and Recommendations .....	459
26.5.1	Conclusions .....	459
26.5.2	Recommendations.....	460
	List of Abbreviations.....	460
	References.....	460

## 26.1 INTRODUCTION

In Thailand, underground infrastructure construction was started in eighteenth century; however, there were not many underground structures during those periods because of higher construction cost and misconception of the risk and safety of underground space construction. In late nineteenth century, the country had started to realize that underground space development is a better option in long run as they have fewer problems with land expropriation and environmental impacts which encouraged choosing underground space in infrastructure development. The tunnels are constructed as a part of the country's development plan to address the results of economic boom, which is the rapid need of basic services and infrastructures for growing population with more residential, commercial, and industrial developments, leaving less space for other infrastructures development.

Underground infrastructures in Thailand can be found as rail tunnels, water supply tunnels, flood drain and sewer tunnels, water diversion tunnels in dams and reservoirs, road tunnels and underpasses, power line tunnels, and subway tunnels. Many challenges have been encountered during construction not only due to geological conditions but also other externalities such as existing infrastructures and technical and financial difficulties. From difficulties, related professionals and engineers have found out the solutions and nowadays, they have an important role in the country's infrastructure development and have a great potential to expand in the future.

### **26.1.1 OVERVIEW OF UNDERGROUND AQUEDUCTS IN THAILAND**

Tunneling technology in Thailand started with a railway construction project which was done almost 100 years ago. Large-scale tunneling construction was started in late 1970s when Metropolitan Waterworks Authority (MWA) planned to expand the service to suburban areas for the growing city and Bangkok Metropolitan Administration (BMA) addressed the flood in Bangkok and surrounding areas.

Water supply tunnels and conduits had been constructed using shield tunneling (ST) methods in earlier days, later switched to earth pressure balance (EPB) methods and they can be found as ST pipes or combination of PC-ST pipes.

Many new flood drain tunnels were developed since 2001 due to the rapid residential, commercial, and industrial developments, interfering water drainage system causing flood. Most of the tunnels were constructed using pipe jacking techniques, EPB shields. Tunnels in later periods used reinforced concrete (RC) segments which are in trapezoidal shapes (Kongsomboon 2012).

In addition, underground aqueducts can also be found in dams as diversion tunnels to divert surplus water to other areas. Excavation for diversion tunnels were mostly rock excavation and the technologies ranged from drilling and blasting method to the New Austrian Tunneling Method (NATM) concept, along with shielded Tunnel boring machines (TBM). Most of the tunnels for irrigation purpose were built up using drilling and blasting method while later period tunnels adopted slurry microtunneling method for excavation. Table 26.1 presents a summary of water supply tunnels, drainage tunnels, and irrigation in Thailand.

### **26.1.2 SCOPE OF THIS CHAPTER**

This chapter focuses on underground aqueduct systems in Thailand, which are used as water supply tunnels, flood drain and sewer tunnels, water diversion tunnels in dams, and water conveyance tunnels in irrigation projects. The specific sections cover on the development of those tunneling systems from the technical aspects in construction and design with background information and management system and barriers. For water supply and drainage tunnels, it is focused on those found in Bangkok Metropolitan areas. Water diversion tunnels and water conveyance tunnels include the projects that have been implemented in Thailand; however, only those significant excavation technologies are provided in this chapter.

## **26.2 WATER SUPPLY**

### **26.2.1 OVERVIEW AND DESCRIPTION OF THE BANGKOK SYSTEM**

Bangkok water production system includes transferring untreated raw water from rivers to water treatment plants, passing through raw water pumping station and east and west canals/ tunnels. As of 2009, MWA has four treatment plants (Bangkhen, Mahasawat, Thonburi, and Samsen), with a total production capacity of 5.52 mcm/day (ADB and NUS 2012). Treated water is supplied to the distributed system through a network of 16 pumping stations in different branch offices. Water is treated by chemical feeding before distributed to the consumers. There are four main additives: lime, chlorine, alum, and polyelectrolyte (Metropolitan Waterworks Authority 2014).

**TABLE 26.1**  
**Summary of Water Supply Tunnels, Drainage Tunnels, and Irrigation in Thailand**

Tunnels and Conduit	Water Supply Tunnels and Conduits			
	Pipe Length (km) (2014)			
Diameter size (mm)	ST	PC-ST	PC	Total
3400–1500	142.95	33.91	13.87	190.73
Unit (million cubic meters year)	2004	2007	2011	2014
Total water consumption	177.65	211.20	261.51	–
Water distribution capacity	343.00	473.00	473.00	–

Description	Flood Drain Tunnels			
	Diameter (mm)	Length (km)	Drainage Capacity (m <sup>3</sup> /s)	Year of Completion
Total (7) flood drain tunnels	1000–4600	19.54	155.5	1983–2007

National economic and social development plan	Irrigation			
	First Plan (1961–1966)	Fifth Plan (1982–1986)	Ninth Plan (2002–2006)	Tenth Plan (2007–2011)
Irrigation area (million hectare)	1.56	0.48	4.56	2.32
% Irrigation area over total area	18.71	5.83	8.88	28.70
Capacity (million m <sup>3</sup> )	30.71	9.58	36.60	39.25

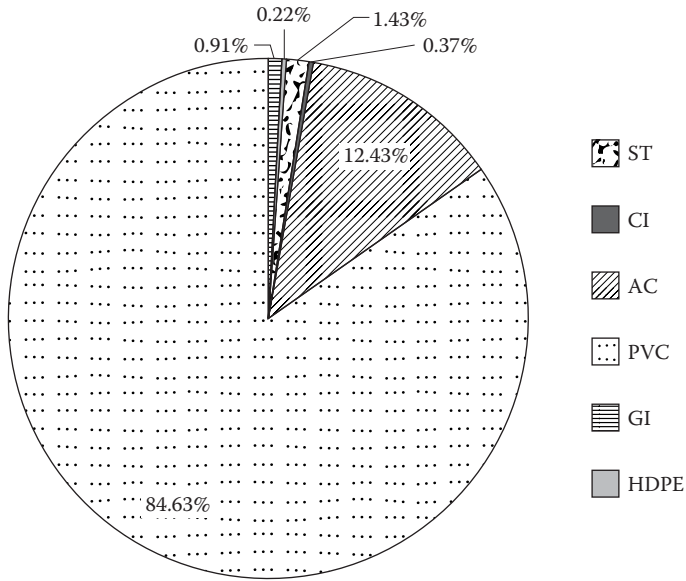
Sources: Asian Development Bank et al. *Comparative Infrastructure Development Assessment of the Kingdom of Thailand and the Republic of Korea*, Philippines, ADB, 2012; East Water, Annual report 2011. Retrieved February 1, 2016, from <http://eastw.listedcompany.com/misc/AR/20120308-EASTW-AR2011-EN.pdf>, 2012; Metropolitan Waterworks Authority (MWA), Annual report 2014. Retrieved January 21, 2016, from [http://www.mwa.co.th/download/pln0201/annual\\_web2014\\_e/mobile/index.html#p=1](http://www.mwa.co.th/download/pln0201/annual_web2014_e/mobile/index.html#p=1), 2014; Kongsomboon, T., *Tunneling and Underground Spaces in Thailand*, Thailand Underground and Tunneling Group (TUTG), under The Engineering Institute of Thailand under His Majesty the King's Patronage, Bangkok, Thailand, 2012.

The transmission system is comprised of transmission tunnels and conduits with the total length of about 200 km, while the distribution system is comprised of trunk mains, with approximately 1,700 km in length, and distribution pipes, with the total length of approximately 30,000 km, which is accounted for 93% of total piping asset of MWA. Majority of trunk mains are mild steel, while distribution pipes are made of a vast variety of materials. The proportion of material types is as shown in Figure 26.1.

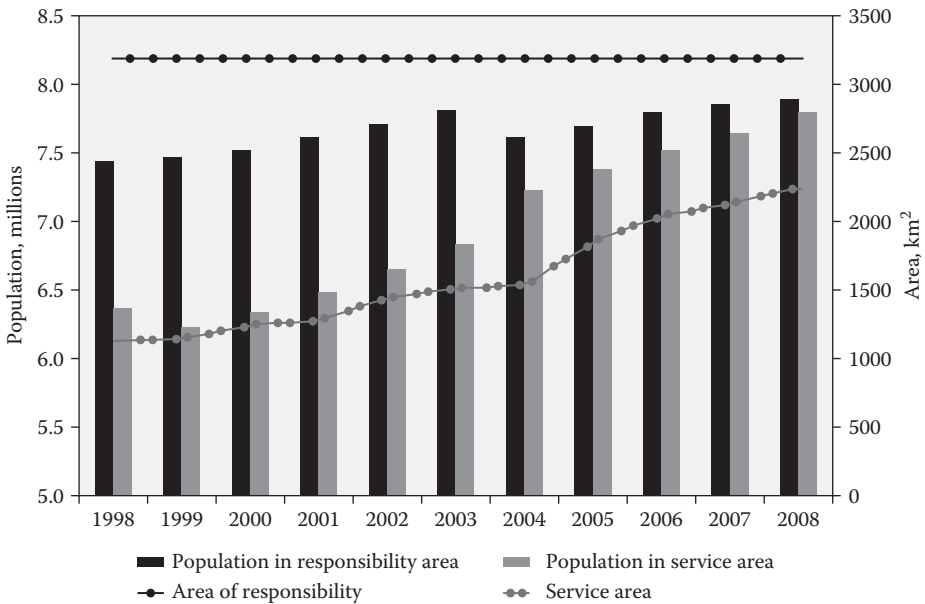
## 26.2.2 WORKS OF MWA

MWA was established in 1967 and within a decade, MWA's service area doubled from 35% (1129 km<sup>2</sup>) in 1998 to 70% (2251 km<sup>2</sup>) in 2008 (Figure 26.2). In Bangkok alone, its service area increased from 726.3 km<sup>2</sup> to 1182.8 km<sup>2</sup> (ADB and NUS 2012). Apart from extension of transmission system, MWA is also responsible for development and construction of distribution piping networks in two aspects including new construction and rehabilitation of existing facilities. A wide alternative of construction techniques is employed ranging from cut and cover, pipe jacking, micro-tunneling, and even horizontal directional drill (HDD).

To ensure acceptable levels of service, apart from expansion of the piping networks, MWA is also committed to maintain existing pipes to be in acceptably good condition. MWA adopts two main schemes for rehabilitation of distribution pipes which are pipe replacement and pipe repair. Pipe replacement is consisted of various methods including slip lining, pipe insertion,



**FIGURE 26.1** Proportion of the pipes used in MWA's distribution system based on materials. ST, steel; AC, asbestos cement; GI, galvanized steel; CI, cast iron; PVC, polyvinylchloride; HDPE, high-density polyethylene. (Data from MWA, 2015.)



**FIGURE 26.2** Service coverage of the metropolitan waterworks authority. *Note:* The decrease in population between 2003 and 2004 is due to the updating of persons per house certificate. (Data from Annual reports 1998 and 2008 of the Metropolitan Waterworks Authority [MWA 1999, 2000, 2001a, 2002–2009]; Department of Provincial Administration. This was first published as Figure 1 in Babel et al. 2010, p. 199. Reprinted with permission of publisher; ADB and NUS, 2012.)

swage lining, pipe bursting, and fold and form. Pipe repair can be done by cured-in-place pipe (CIPP), spray lining, and spirally wound technique. Aside from construction and rehabilitation of piping networks, MWA also integrates technology that enables analysis of true characteristic of customers' demand possible. The so-called pressure trends control (PTC) had been developed and implemented since 2008. As a result, MWA can effectively manipulate the distribution to meet customers' real demand, meanwhile get significant reduction of pipe bursting, leading to lower NRW losses (reducing from 29.17% in 2008 to 27.9% at the end of year 2009 and to 26.4% in the end of 2010).

### **26.2.3 DEVELOPMENT AND CONSTRUCTION OF WATER TUNNELS AND MAIN DISTRIBUTIONS**

According to Kongsomboon (2012), water supply tunnels construction in Thailand can be divided into two phases: Phase I (between 1975 and 1991) and Phase II (from late 1990s).

#### **26.2.3.1 Tunnels in the Early Days**

From 1975 to 1991, tunnels of total 34.7 km in length (from Bang Khen water treatment plant to Tha Phra and Khlong Toei distribution pumping stations) were constructed with diameters of between 2.0 and 3.4 m, and excavated mostly in stiff clay layers at depths of 17–20 m. During the period, the shields used for excavation had three main types depending on the types of soil deposits in each water transmission routes.

From Bang Khen water treatment plant to Pradipat-Rama 6 intersection, excavation was done by using mechanical shields (blind type with cutting disk) as the ground was mostly stiff clay. In this case, stabilizer and braking plates were required to control the alignment as the closed face made it difficult to maneuver the shield. When tunnel went out from Bang Khen water treatment plant, the shield was changed into slurry type as the soil became sand layer.

Another shield type, semi-mechanical shield was mostly used for construction of water transmission tunnels of those days. Tunnels of this shield type were made 18 km in length, where the ground was medium to stiff clay. The shield face was fully open for the excavation by a backhoe inside and had a higher excavation rate than the others and could cope with the curve with a radius as short as 20 m.

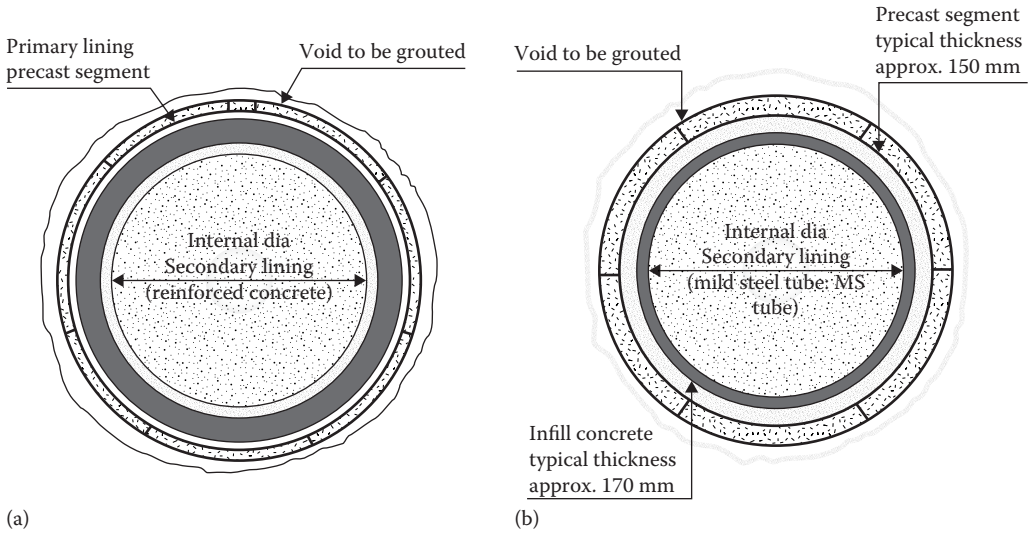
Pneumatic excavation system (compressed air chamber) was required in order to prevent the soil from collapsing at tunnel face, even excavation was done in stiff soil to cover some uncertainty such as sand pockets or soft lenses. Tunnels in those early periods were constructed of reinforced concrete as secondary layer which later had some cracks due to differential subsidence of ground. Thus, tunnels in later stage were made of reinforced concrete as primary lining and inside were mild steel pipe as secondary lining (which are shown in Figure 26.3).

#### **26.2.3.2 Tunnels Today**

One of notable works was the 7th Bangkok Water Supply Improvement Project, which covered approximately 50.8 km in length and had five contracts, as shown in Table 26.2. Excavation had to be done in long distance, passing different types of soil layers with different geological properties and needed to accommodate with many sharp curves.

TBM, EPB type, were used in all contracts under this 7th Bangkok Water Supply Improvement Project. The EPB close-type shielded machines used in the first contract had the size of 4.2 m in outer diameter and was equipped with articulation system capable of adjusting turn at 3.5° angle to cope with curvature radius as small as 50 m. Route of second and third contracts included from Sukapiban 1 Road to Minburi Pumping Station, with total length of 14 km. and from Thap Chang to Bang Phli, with total length of 17.5 km, respectively. Taking into account the length of the contracts, TBMs used for these tunnels had to be modified and reused. TBMs for the fourth and fifth contracts had 4 m in outer diameter and was equipped with 12 hydraulic jacks enabling up to





**FIGURE 26.3** (a) Tunnels with secondary reinforced concrete lining (stage 1 phase I). (b) Tunnels with secondary steel lining which is used nowadays. (Data from Kongsomboon, T. (2012). *Tunneling and Underground Spaces in Thailand*. Bangkok, Thailand: Thailand Underground and Tunneling Group (TUTG), under The Engineering Institute of Thailand under His Majesty the King’s Patronage. With Permission.)

**TABLE 26.2**  
**Summary of the Water Transmission Tunnels under the MWA’s 7th Bangkok Water Supply Improvement Project**

Route Name	Number of SM	Shield O.D (m)	Size of Tunnel Diameter		Length (km)
			Primary	Secondary	
Bang Khen-Vibhavadi	2	4.20	3.77	3.40	6.7
Rangsit—Ngamwongwan					
Sukapiban 1—Min Buri	4	3.14	2.67	2.3	14.0
Thap Chang—Bang Phli	5	3.64	3.50	2.8	17.5
Sukapiban 1—Eastern Outer Ring Road	1	4.01	3.58	3.2	3.0
Eastern Outer Ring Road—Thap Chang	2	4.01	3.58	3.2	9.6

Source: Kongsomboon, T., *Tunneling and Underground Spaces in Thailand*, Thailand Underground and Tunneling Group (TUTG), under The Engineering Institute of Thailand under His Majesty the King’s Patronage, Bangkok, Thailand, 2012.

1200 tons of shoving thrust force. They could achieve noteworthy performance with shoving rate up to 24 m per day compared to the average rate of 12 m per day.

The construction comprised of two parts: RC segment as primary lining and MS-steel pipe tube as secondary lining. The size of RC segment ranged from 1.1 to 1.2 m in width, with the thickness of 15 cm. Typically, 6 RC segments made up a ring, with inner diameter ranging from 2.7 to 3.8 m. After completing excavation and erection of RC segments, mild steel tube (11 to 18 mm in thickness) were inserted to be able to provide higher capability to withstand pumping pressure, higher durability, and higher potential to prevent water leakage.

### 26.2.4 BARRIERS

During earlier days, as tunneling had to be done in soft ground, there were relatively few specialized engineers and skilled workers and was run mainly by foreign experts. Three large ground subsidence happened due to the variations of geological conditions along the tunnel route, even though pneumatic system was used for the construction. It is counteracted by changing the type of shield and stabilizing the ground with chemical jet grouting technique. Maneuvering the shield was one of the difficulties in those days, particularly when entering curves or passing through soft soil and sand layers; various accessories such as brakes, stabilizer, overcutter, and pulley were required to keep tunnels in alignment. In addition, special equipments for vertical grouting were required when sand or soft clay pockets were encountered. Another barrier is the need for excavation of extremely small tunnel curve radius and the risks for ground deformation above tunnel alignment, which required the proper selection of type of machine with backup system and accessories that suited with the requirements as well as appropriate technology.

## 26.3 FLOOD AND SEWER DRAINAGE

### 26.3.1 OVERVIEW AND DESCRIPTION OF THE BANGKOK SYSTEM

Bangkok has adopted a combined sewer network for surface runoff and wastewater where wastewater pipes are connected to the existing public sewer, through an interceptor chamber, to carry domestic wastewater to the treatment plant.

Current drainage system is able to drain all rainwater at an intensity of no more than 60 mm/h. The drainage system consists of moats and drainage canals, drainage pipes, pumping stations, water regulators, sump pits, and drainage tunnels. Bangkok has 1,682 canals which made of about 2,600 km in length where drainage pipes have a combined length of 6,400 km along main roads (1,640 km), small lanes or sois (4,760 km). As of 2009, it had a total of 2,625 km of canals and drainage tunnels with 5,900 km of sewer line. Drainage runoff is accelerated using pumps with the capacity of 1,057 m<sup>3</sup>/s on the eastern side and 474 m<sup>3</sup>/s on the western side (ADB 2012). The runoff water is carried to the Monkey Cheeks in 21 locations through drainage tunnels (24 km), with a total storage capacity of 12.75 million m<sup>3</sup> (Babel and Rivas 2012).

### 26.3.2 BMA MEASURES OF FLOOD PREVENTION AND SEWERAGE MANAGEMENT

In response to the flood, under the royal initiative, the BMA has developed its flood-prevention system, which covers four areas: (a) polder system, (b) operations to prevent water-related problems, (c) water management by flood-control center, and (d) integration of public support.

To control flood, BMA divides flood protection into two systems: (a) flood protection system using polder systems to protect discharge from upstream and high tide and (b) drainage system by improving drainage capacity to protect inundated causing from rain.

It included constructing floodwalls, moats, canals, drainage tunnels, pumps, sandbag walls and elevated roads, and flood control center. In addition to those flood prevention system, DDS under BMA developed measures to address sewerage and drainage problems. Short-term measures include treatment of wastewater to ensure DO level is water to be not less than 1.3 mg/L. Long-term measures are to construct wastewater treatment plants where five have been constructed with total capacity to treat 1,765,000 m<sup>3</sup> of wastewater per day, together with other seven plants.

### 26.3.3 DEVELOPMENT AND CONSTRUCTION OF DRAINAGE TUNNELS AND MAINTENANCE

According to Kongsomboon (2012), drainage tunnels in Thailand are mostly flood drain tunnels, constructed in order to enhance the efficiency of drainage wells in flood-prone areas. As the city is located in low-lying area, drainage systems such as pipes, ditches, and canals had limited capacities

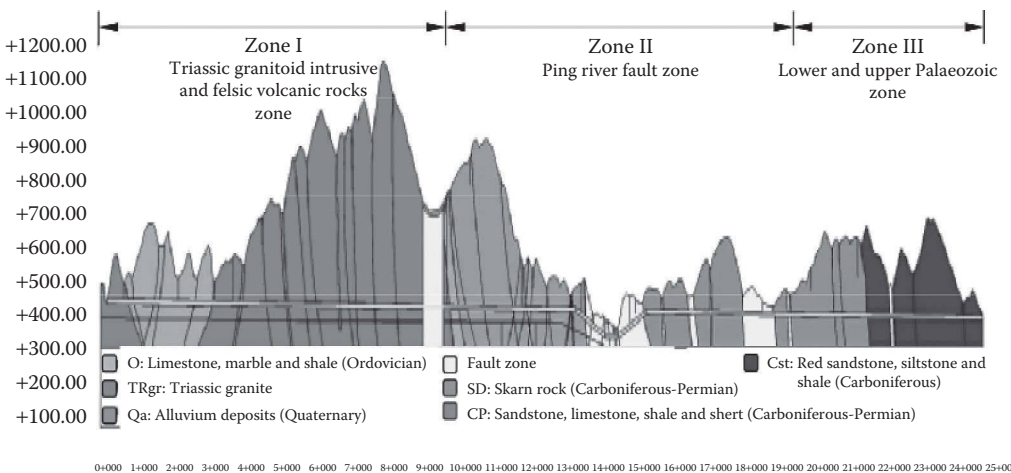
**TABLE 26.3**  
**Seven Drainage Tunnel Projects in Bangkok (1983–2007)**

Description	Water-Drainage Capacity (m <sup>3</sup> /s)	Diameter (m)	Length (km)
Drainage tunnel, Soi Sukhumvit 26	4.00	1.00	1.10
Water diversion system for Premprachakorn canal	30.00	3.40	1.88
Water drainage system for Phaya Thai district	4.50	1.50	1.90
		2.40	0.68
Drainage tunnel, Soi Sukhumvit 36	6.00	1.50	0.03
		1.80	1.32
Drainage tunnel, Soi Sukhumvit 42	6.00	1.50	0.03
		1.80	1.10
Drainage tunnel from Makkasan Pond to Chao Phraya River	45.00	4.60	5.98
Drainage tunnel from Saen Saeb Canal and Lad Phrao Canal to Chao Phraya River	60.00	5.00	5.11
Total	155.5		19.13

Source: Kongsomboon, T., *Tunneling and Underground Spaces in Thailand*, Thailand Underground and Tunneling Group (TUTG), under the Engineering Institute of Thailand under His Majesty the King’s Patronage, Bangkok, Thailand, 2012.

to control all flood water, resulting in bypassing of the main drainage system with tunnels. Table 26.3 and Figure 26.4 show the seven completed drainage tunnels in Bangkok which were constructed between 1983 and 2007.

Thailand’s first flood drain tunnel was constructed in 1970, which was constructed in soft soil layer at 5–8 m below ground surface. The excavation was first done by using a compressed air shield, however, due to stability problem, it was changed to a closed shield. Second tunnel was constructed in 1983, which was one of the early tunnels which adopted microtunneling method in Thailand. In 1990, BMA developed comprehensive flood and sewerage tunnel network with other



**FIGURE 26.4** Geology of Mae Tang-Mae Ngad diversion project. (Data from Kaewkongkaew, K., Phienwej, N., Harnpattahapanich, T., and Sutiwanich, C. (2013). Geological model of Mae Tang-Mae Ngad diversion tunnel project, Northern Thailand. *Open Journal of Geology*, 03(05), 340–351. With Permission.)

agencies. The construction was carried out by jacking concrete piles in soft clay layer with drill heads ranging from blind, EPB, and slurry types. The jacking distance ranged between 200 and 600 m. The system was constructed altogether with a length of 100 m with a diameter of 3 m and if it was combined with other drainage system, the length was increased to more than 200 m.

The most significant is the Dindaeng-Makkasan Water Transmission Tunnel Project, 10 km long, has three tunnel sizes: 3.2, 2.5, and 1.7 m, excavated in soft clay, medium clay, and stiff to very stiff clay along roads and canals. The tunnel lining consisted of precast concrete segments as primary lining and reinforced concrete as secondary lining; thickness ranged from 18 to 28 cm depending on the induced stresses around the tunnel when it passed through different soil layers and depths. These drainage tunnels aimed to drain water from inner Bangkok at a rate of 180 m<sup>3</sup>/s. As a result, total of more than 300 m<sup>3</sup> of storm water per second can be discharged.

Since most of tunnels were constructed in sand layer and next to existing structures, consistent monitoring on the movement of ground and nearby buildings has been done to prevent any damages. The measurements done along the tunnel route showed that the volume loss ratio was 1.5%–1.9% which was lower than acceptable standard of 2.0%, showing it is safe.

### 26.3.4 BARRIERS

Several problems had been encountered since the excavation had to be done in various layers from sand layer to very stiff clay layer. During construction, a problem was encountered during the launch of shield from the shaft due to poor quality of jet grouting in sand layer. The problem was counteracted by using cement columns together with grouting around the shaft, resulting in satisfactory waterproofing while with slower excavation rate. Another problem was the potential of occurrence of cracks in tunnels in the long run due to differential settlement in the transition of soil layer from soft to stiff clay when trying to avoid crashing with water tunnel, leading to relocation of tunnel. In addition to those problems, since a certain degree of slope is required, the tunnels were excavated to deeper depth with various ground layer changes.

## 26.4 OTHER APPLICATIONS OF UNDERGROUND AQUEDUCTS

In Thailand, in addition to water supply tunnels and flood and sewer drainage tunnels, underground aqueducts can be found as water diversion tunnels in dams and water transmission tunnels in irrigation projects. Table 26.4 presents the methods of excavation done in some of water diversion tunnels and water transmission tunnels in Thailand.

### 26.4.1 WATER DIVERSION

Thailand's first major underground excavation project, Lam Ta Khong Pumped Storage Project, features excavation of a very large underground cavern (25 m wide, 48 m high, and 175 m long) and associated tunnels and shafts for a combined length of 10 km at 350 m depth in medium-strength siltstone and sandstone. It adopted the NATM concept in the excavation of the tunnels and shafts where shotcrete and rock bolts were used as the primary support and convergence measurement was closely made. Prestressed rock anchors in combination with rock bolts and steel-filter reinforced shotcrete have been adopted as primary support for this large cavern in excavation for powerhouse (Phienwej 1998).

Khlong Tha Dan Dam was constructed in early 2000s in order to provide water supply, which consisted of two main RCC dam bodies, located in a volcanic rock belt of Permo-Triassic age near the rim of the Khorat Plateau. Five small size tunnels were built as a part of the rock foundation treatment scheme. Tunnels were excavated in the abutments and central spur with a maximum cover of 65 m. Rocks encountered in the tunnels are mostly rhyolite and tuff in some places. Majority of discontinuities were oriented obliquely with or normal to the tunnel axes dipping steeply with 60°–90° (Kaewkongkaew et al. 2014).

**TABLE 26.4**  
**Methods of Excavation of Water Diversion Tunnels and Water Transmission Tunnels in Thailand**

Project Name	Soil Type	Construction Methods
Lam Ta Khong Pumped Storage project (25 m wide, 48 m high, and 175 m long)	Medium-strength siltstone and sandstone	New Austrian tunneling method (NATM) Shot Crete and rock bolts as primary support
Khlong Tha Dan Dam	Mostly rhyolite and tuff in some places	Excavated in the abutments and central spur with max. cover of 65 m
Kok-Ing-Nan project and Salawin-Moei Bhumiphol project	Mostly gneissic or granitic rocks	Expanded/horseshoe shaped tunnel
Water conveyance tunnels in irrigation projects	Rock excavation Underground excavation	Control drilling and blasting method D-shaped and grouting tunnels in horseshoe shape Concrete lining with steel ribs support
Water transmission pipelines from East side of Chao Praya river to Bang-Pra reservoir	Stiff and very stiff clay with sand lenses, very soft clay in deeper section of river	Slurry microtunneling, pipe jacking

Sources: Kaewkongkaew, K. et al. *KSCE J. Civil Eng.*, 19(1), 81–90, 2014;; Phienwej, N., *Tunn. Undergr. Sp. Tech.*, 13(3), 317–330, 1998; Thai Triumph, 2015.

Most of the rocks found at Thailand water diversion tunnel sites are mainly igneous and metamorphic rocks such as granite and marble which are highly fractured and having local faults. The influence of granitoid intrusion and tectonic faulting and folding on the rock mass structure highly affects the variable dip orientation and angle of bedding planes which was encountered in Mae Tang-Mae Ngad diversion project (Kaewkongkaew et al. 2013). Figure 26.4 shows the location of Mae Tang-Mae Ngad Project area and their geological conditions.

Kok-Ing-Nan project which was constructed to divert surplus water from the Mae Khong, Kok and Ing River basins in the northern area of the country to the Sirikit dam reservoir. Water diversion tunnel was constructed as widen horseshoe tunnel with 70 km in length and up to 7 m in width through rugged mountainous areas with depth to 1500 m close to the Lao border (The Consulting Engineers Association of Thailand n.d. A; n.d. B).

## 26.4.2 IRRIGATION

Irrigation in Thailand is an age-old practice and comprised of diversion-type works, small in size. During 1930s, the Department of Irrigation initiated the construction of a network of navigation and drainage canals to cover more than 500,000 hectares in the Southern Chao Phraya Plain. Expansion of irrigation area leads to the difficulty in building new water storage in support of increasing water demand. However, in order to support agricultural activities, Thailand continued to construct diversion dams and river improvement projects (Budhaka et al. n.d.).

In irrigation projects, water is mostly conveyed from the source to the target by barrages, canals, and/or pumped from groundwater (Micheal 2008). Water conveyance tunnels in irrigation projects were done by control drilling and blasting method for open excavation work of rock excavation. In underground excavation works, drainage tunnels are mostly in D shape and the grouting tunnels in horseshoe shape. The cross section of tunnels is of concrete lining with steel rib support.



**FIGURE 26.5** Slurry microtunneling at 14 m depth (water transmission pipelines from east side of Chao Praya river to the Bang-Pra reservoir). (Courtesy of Thai Triumph, 2015.)

One of the remarkable projects is water transmission pipelines from East side of Chao Praya River to the Bang-Pra Reservoir. The excavation was done by using slurry microtunneling machines. The pipejacking machine was launched from a 24 deep caisson shaft, as in Figure 26.5. The launching eye was protected by a jet grout block of 8 m length and 5 m width. The technical challenges were encountered in pipejacking works under the Bang Pa-Kong River which is 365 m wide and has irregular bedding and unpredictable and variable depths. Eleven boreholes were drilled to get the geological conditions over the drive and also the depths of the river bed. Excavation was done mostly in stiff and very stiff clay with sand lenses, however, very soft clay is found in the deeper section of the river, required to be treated by several grouting phases (Thai Triumph 2015).

## 26.5 CONCLUSIONS AND RECOMMENDATIONS

### 26.5.1 CONCLUSIONS

Water transmission tunnels in the early days adopted manual, semi-mechanical, mechanical, and slurry shields for excavation. At present, construction of water transmission tunnel has adopted newly developed technology such as TBM, EPB shielded machine, which is able to make excavation in all types of soil profile in Bangkok as well as GYRO system. Tunnels in earlier days used RC as secondary lining but later changed into RC as primary lining and mild steel pipe as secondary lining.

Drainage tunnels in Thailand are mostly flood drain tunnels and first flood drain tunnel excavation was done by using compressed air shield and closed shield. The excavation was later carried out using microtunneling method, jacking concrete piles with drill heads ranging from blind, and EPB and slurry types. Tunnels were constructed into precast concrete segments as primary lining and RC as secondary layer. In later days, it is found that tunnels used newly developed RC segment (generally in six segments) formed in trapezoidal shape which helps facilitate tunneling through all radius of curvature.

Water diversion tunnels in Thailand are mostly constructed as widened horseshoe tunnel and drilling and blasting method was commonly used. The significant excavation was the use of the



NATM concept in Lam Ta Khong Pumped Storage Project. Drilling and blasting method is also adopted in water transmission tunnels in irrigation projects while slurry microtunneling system is used in later days.

Many challenges had been encountered as tunneling had to be done in soft ground, sand layers, and highly fractured rocks and local faults. Flood drainage and water supply tunnels were placed in deep soft clay layer to avoid problems with existing infrastructures which has higher risk for ground subsidence than excavation in stiff layer. In addition, excavation for water diversion tunnels in dams had to pay attention to selection of machine types, as these areas are contain highly fractured rocks and local faults.

Nevertheless, with urbanization and growing population, tunnel plays an important role in infrastructure development throughout the country as there is the need for more space for residential, commercial, and industrial development and more infrastructures to support these developments. In this context, making use of underground space is tremendously useful in terms of environment, safety, scenic sight, and usage space, resulting in increased potential usage for underground aqueducts.

## 26.5.2 RECOMMENDATIONS

The information included in this chapter is based on some selected underground aqueduct systems and projects in Thailand. The areas that may need further development are as follows: more insight into water diversion tunnels and water transmission tunnels in irrigation projects, focusing on evolution of excavation methods and barriers throughout the years, and practices of operation and maintenance system of those underground aqueduct systems, with a focus on sustainability and cost-effectiveness.

## LIST OF ABBREVIATIONS

BMA	Bangkok Metropolitan Administration
EPB	Earth Pressure Balance
MWA	Metropolitan Waterworks Authority
NATM	New Austrian Tunneling Method
RC	Reinforced Concrete
RID	Royal Irrigation Department
TBM	Tunnel Boring Machine

## REFERENCES

- Asian Development Bank (ADB) and National University of Singapore (NUS). (2012). *Good Practices in Urban Water Management: Decoding Good Practices for a Successful Future* (A. Chiplunkar, K. Seetharam, and C. K. Tan, Eds.). Manila, Philippines: ADB.
- Asian Development Bank et al. (2012). *Comparative Infrastructure Development Assessment of the Kingdom of Thailand and the Republic of Korea*. Philippines: ADB.
- Babel, M., Rivas, A., and Seetharam, K. (2010). Municipal Water Supply Management in Bangkok: Achievements and Lessons. *International Journal of Water Resources Development*, 26(2), 193–217.
- Babel, M. S., and Rivas, A. A. (2012). *Good Practices in Urban Water Management: Decoding Good Practices for a Successful Future* (A. Chiplunkar, K. Seetharam, and C.K. Tan, Eds.). Philippines: ADB.
- Budhaka, B., Srikajorn, M., and Boonkird, V. (n.d.). Thailand country report on investment in water. Retrieved January 28, 2016, from <http://www.fao.org/docrep/005/ac623e/ac623e0m.htm>.
- East Water. (2012). Annual report 2011. Retrieved February 1, 2016, from <http://eastw.listedcompany.com/misc/AR/20120308-EASTW-AR2011-EN.pdf>.
- Kaewkongkaew, K., Phienwej, N., Harnpattahapanich, T., and Sutiwanich, C. (2013). Geological model of Mae Tang-Mae Ngad diversion tunnel project, Northern Thailand. *Open Journal of Geology*, 03(05), 340–351.

- Kaewkongkaew, K., Phienwej, N., and Khamai, D. (2014). Prediction of rock mass along tunnels by geostatistics. *KSCE Journal of Civil Engineering*, 19(1), 81–90.
- Kongsomboon, T. (2012). *Tunneling and Underground Spaces in Thailand*. Bangkok, Thailand: Thailand Underground and Tunneling Group (TUTG), under The Engineering Institute of Thailand under His Majesty the King's Patronage.
- Metropolitan Waterworks Authority (MWA). (1997). Annual Report 1996. Bangkok.
- Metropolitan Waterworks Authority (MWA). (1998). Annual Report 1997. Bangkok.
- Metropolitan Waterworks Authority (MWA). (1999). Annual Report 1998. Bangkok.
- Metropolitan Waterworks Authority (MWA). (2000). Annual Report 1999. Bangkok.
- Metropolitan Waterworks Authority (MWA). (2001a). Annual Report 2000. Bangkok.
- Metropolitan Waterworks Authority (MWA). (2001b). An Introduction to MWA's Unaccounted-for-Water and Plan. Bangkok.
- Metropolitan Waterworks Authority (MWA). (2002). Annual Report 2001. Bangkok.
- Metropolitan Waterworks Authority (MWA). (2003). Annual Report 2002. Bangkok.
- Metropolitan Waterworks Authority (MWA). (2004). Annual Report 2003. Bangkok.
- Metropolitan Waterworks Authority (MWA). (2005). Annual Report 2004. Bangkok.
- Metropolitan Waterworks Authority (MWA). (2006). Annual Report 2005. Bangkok.
- Metropolitan Waterworks Authority (MWA). (2007). Annual Report 2006. Bangkok.
- Metropolitan Waterworks Authority (MWA). (2008). Annual Report 2007. Bangkok.
- Metropolitan Waterworks Authority (MWA). (2009). Annual Report 2008. Bangkok.
- Metropolitan Waterworks Authority (MWA). (2014). Annual report 2014. Retrieved January 21, 2016, from [http://www.mwa.co.th/download/pln0201/annual\\_web2014\\_e/mobile/index.html#p=1](http://www.mwa.co.th/download/pln0201/annual_web2014_e/mobile/index.html#p=1).
- Metropolitan Waterworks Authority (MWA). (2015). Annual Report 2014. Bangkok
- Micheal, A. M. (2008). *Irrigation: Theory and Practice* (2nd ed.). New Delhi, India: Vikas Publishing House.
- Phienwej, N. (1998). Tunneling for infrastructure development in Thailand. *Tunneling and Underground Space Technology*, 13(3), 317–330.
- Thai Triumph. (February 14, 2015). Underground utilities. Retrieved January 28, 2016, from <http://www.uu-magazine.com/features/thai-triumph-080615-4595306/>.
- The Consulting Engineers Association of Thailand. (n.d., A). Water diversion from Salawin to Chao Phraya River basins project. Retrieved January 20, 2016, from <http://www.ceat.or.th/2010/index.php/water-resources-and-rural-development/325-water-diversion-from-salawin-to-chao-phraya-river-basins-project-.html>.
- The Consulting Engineers Association of Thailand. (n.d., B). Feasibility and environmental impact study on Kok-Ing-Nan development project. Retrieved January 20, 2016, from <http://www.ceat.or.th/2010/index.php/environmental-water-supply-sanitation/384-feasibility-and-environmental-impact-study-on-kok-ing-nan-development-project-.html>.



# Taylor & Francis

Taylor & Francis Group

<http://taylorandfrancis.com>

# *Section VII*

---

*Americas*



# Taylor & Francis

Taylor & Francis Group

<http://taylorandfrancis.com>

---

# 27 Puquios and Aqueducts in the Central Andes of South America

*Kevin Lane*

## CONTENTS

27.1	Dating the Puquios.....	465
27.2	Function and Construction.....	468
27.3	Concluding Remarks .....	471
	Acknowledgments.....	472
	References.....	472

Complex hydraulic systems are a mainstay of South America, and especially the Andean region (Denevan 2001). In fact, the Central Andes were considered a key area in the development of “hydraulic society” theory (*sensu* Wittfogel 1957; see Steward 1955; see also, Mitchell 1973; Stanish 1994; Lane 2009 for reappraisals of this theory’s applicability to the Andes). As such ancient hydraulic technology in the Andes was varied, geographically diverse, and extensive. That said, the use of underground aqueducts otherwise known as filtration galleries or *puquios* (the local indigenous name for these structures) was only present in a few select places across the Andes.

Little studied subterranean irrigation canals linked to cultivation fields have been documented from the site of Northwest Argentina (Tarragó 1977; Páez and Giovannetti 2014). Nevertheless, filtration galleries of the type most reminiscent of the Old World *qanāts* (Denevan 2001:161) occur along some valleys of Central and the South-central Andes of Peru and Northern Chile, which we have divided into three groups—Central Andean, Nasca, and South Andean (see Figure 27.1). Apart from these large areas, there is documentary or physical evidence to support their existence in four other discreet places, namely, the Santa Valley, Huancavelica, Paucartambo, and in Potosí (Barnes and Fleming 1991:51). Like the *qanāts* the South American *puquios* tap into the underlying aquifer mother source either through the means of an open trench, or a lateral tunneled gallery that connected directly with the aquifer (see Figure 27.2).

In this chapter, in assessing the function, historicity, and use of *puquios* in the Andes we first consider their antiquity and cultural ascription, before describing the systems themselves. Finally, we reflect on their present use and their possible future.

## 27.1 DATING THE PUQUIOS

Although the existence of the *puquios* has been known for a long time (Barnes and Fleming 1991:54), it has been notoriously difficult to date them precisely. These difficulties are further compounded for pre-industrial and pre-literate societies, given that records of their original construction are nonexistent. In the case of the subterranean aqueducts of the Andes, it is possible that we are dealing with at least two distinct sets of these type of technologies. These two sets share commonalities in design and function but seem to have been constructed at different





FIGURE 27.1 Map of Central Andes showing areas with *puquios*.

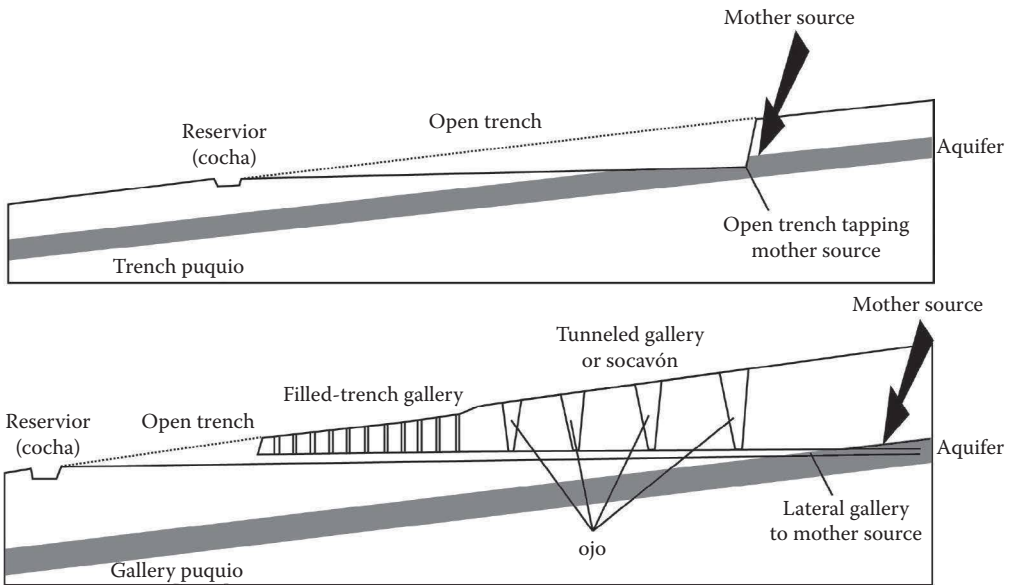


FIGURE 27.2 Schematic of trench and gallery *puquios*. (Modified from Schreiber, K. and Lancho Rojas, J., *Latin Am. Antiquity*, 6, 229–254, 1995. With Permission.)

moments in time. As mentioned previously, the *puquios* of the Andes separate themselves into three main groups—Central Andean, Nasca, and South Andean—with four isolated outliers. Of these all, excepting the Nasca group would seem to have been built by the Spanish (Barnes and Fleming 1991:51–55, 56), to supply water to various settlements and for agriculture—Santa Valley, Paucartambo, Central Andean group, and South Andean group (part)—or for use in the mining industry—South Andean group (part), Huancavelica, and Potosí. The only exception to this group are the Nasca group *puquios*, which probably included the one recorded by Uhle (1914:5) in the adjacent Ica Valley.

Since being recorded in Spanish chronicles and traveler journals from the sixteenth through to the nineteenth century (Barnes and Fleming 1991), the Nasca group of *puquios* have also been studied and researched by archaeologists and geographers (e.g., Mejía Xesspe 1939; Regal Matienzo 1943, 1964; Rossel Castro 1942). While a considerable amount of information is known of the functions, construction, and uses of these, precise dating for the *puquios* has been harder to ascertain leading to a certain degree of controversy.

Perhaps the first serious attempt to define a date for their construction was in the 1930s (González García 1978 [1934]). González García's article attributes their creation to the Incas (AD 1480–1532), specifically the sixth *sapa inca*—Inca Roca—who reigned during the mid-fourteenth century. Given that the Incas had not yet started their expansion into this region, it would seem that the author was in fact stating that these constructions dated to the Late Intermediate Period (AD 1000–1480) and were therefore pre-Inca. Nevertheless, at the time González García and others labored under the limitations of relative chronologies making their estimates at best, informed guesses.

Nevertheless, while later studies were not limited by imprecise chronologies they were still constrained by the inability to directly date the features themselves, a problem common to the dating of most types of hydraulic technology worldwide. Attempts to circumvent these limitations by dating rock varnish (Dorn, et al. 1992; Clarkson and Dorn 1995) were later proven to be flawed (Schreiber and Lancho Rojas 2006:281).

While direct radiocarbon dating of the wooden lintels used within the Nasca region filtration galleries have revealed that these were placed there during the nineteenth century, this would seem to agree with what the local informers were saying (Schreiber and Lancho Rojas 2006:67, 280–281). Nevertheless, this is not to say that the “new roofs” of the nineteenth century were not the last in a long sequence of repairs and replacements stretching back in time. Even so, what remains is that even with radiometric dating we would seem to be at an impasse for dating the initial construction of these features.

Monica Barnes and David Fleming (Barnes and Fleming 1991; Barnes 1992; Fleming 1993) have made a very strong case for a Spanish-period construction for the Nasca group of *puquios*, while Katherina Schreiber and Josué Lancho Rojas make an equally strong one for a Nasca period (AD 1–750) construction of these features. Schreiber and Lancho Rojas (1995, 2003, 2006) make a particular bid for a Nasca 6 Phase (AD 400–500) of construction citing adverse arid conditions during the fifth and sixth centuries as the primer for *puquio* construction.

Barnes and Fleming (1991) posit that the lack of historical records to support a pre-Hispanic origin for all South American *puquios* proves that they were built by the Spanish. Meanwhile, Schreiber and Lancho Rojas (1995, 2003, 2006) defend a pre-Hispanic origin for the Nasca *puquios* using three different strands of evidence. First, they cast doubt on the veracity of the sixteenth and seventeenth century sources noting that a significant number of the historical writers cited by Barnes and Fleming (1991) in their arguments never actually visited the region. Second, they interpret Nasca 5–6 iconography as showing wells and anthrozoological representations of orca whales as representing water flow and *puquios* (Schreiber and Lancho Rojas 2006:278–280). In lieu of historical documents, water representations in Nasca iconography allude directly to the important role water held in pre-Hispanic rituals and belief systems (Carrión Cachot 1955; Proulx 2006).

Finally, they date the *puquios* through settlement site association. Given that direct dating of these features is currently not possible, the next best method is dating of features through settlement

site association. The principle behind this is that these sites would have benefited from the close location of the *puquios*. It is on this basis that they suggest a Middle Nasca date for their construction. This form of dating has been used in the past with some success.

Currently then, the general consensus—echoed by Schreiber and Lancho Rojas (2006:284–286)—is that of a pre-Hispanic, Middle Nasca, origin for the *puquios* with subsequent Spanish and Republican modifications (see also Proulx 1999; Denevan 2001:162; Ortloff 2010:201–202). Yet, the truth remains that even given the relative robustness of the case as set out by Schreiber and Lancho Rojas (2006), the fact that doubts persist should alert us to the need for further research in this topic.

## 27.2 FUNCTION AND CONSTRUCTION

Although interest in the Nasca *puquios* has a long pedigree it was only with González García (1978 [1934]) that the first detailed measurements and plans of these structures was undertaken. This seminal study was only superseded by the detailed and literally groundbreaking research undertaken by Schreiber and Lancho Rojas's team (1995, 2003, 2006) in the 1980s and 1990s. These comprehensive studies have completed our understanding of these structures to date.

In essence, the Nasca *puquios* are a tool to regulate water supply in the arid Nasca Basin and adjacent regions. The South-central Andean region, where Nasca is located, is one of the driest areas in Peru and South America, precipitation averages 4 mm a year, the water that accumulates there come from the adjacent highlands down onto seasonal rivers and streams (Silverman and Proulx 2002). It should be noted though that present aridity is not necessarily a true reflection of past environmental conditions (see Beresford-Jones et al. 2009; Beresford-Jones 2011 on research supporting a more wooded and productive pre-Hispanic landscape).

Nevertheless, above ground water availability is constant only during the months of January through April when rains originating in the area above 2000 m—sweep downhill from the highlands feeding the lowlands, thereby replenishing seasonal rivers, streams, and aquifers. This water is then siphoned off by more traditional above ground irrigation canals. Water supply becomes an increasing problem between April and December as its easy accessibility decreases through use, transpiration, and the lack of replenishing highland rains during the dry season (May to August). Humid sea fog, known as *garua*, forms between late May and mid-October along the coast and a few kilometers inland. Yet, while this moisture provides the wherewithal to make the usually dry *lomas*—lowland hill fog-meadows bloom—it is patently insufficient to compensate for the loss of riverine irrigation water.

As agriculture became a mainstay of coastal Peruvian society, hydraulic technology was increasingly harnessed to alleviate the naturally existent water paucity occurring during these dry months. Given that natural subsurface aquifers exist in all Southern valleys, local hydraulic technology developed to exploit these underground water horizons through a combination of wells and filtration galleries (*puquios*). The depth at which these aquifers exist vary considerably within a given valley, for instance, in the Ica Valley the depth of these aquifers varies from 120 m in the middle valley to as little as 2 m in the lower valley (Beresford-Jones 2011).

While wells tap into the deeper sections of the aquifers it is filtration galleries or *puquios* that provide the best means by which to provide water across long stretches of the existing river courses. *Puquios* come in two types—open or closed—and are essentially shafts that dig sideways into the underground aquifer allowing it to flow onto purpose-built reservoirs (*cochas*) or directly into connecting irrigation canals (see Figure 27.2). They are a critical resource for successful agriculture in these dry valleys, for instance, in the Nasca Valley, they provide all the water in the area located between 450 and 675 m above sea level (Schreiber and Lancho Rojas 1995:233). The closer a *puquio* is to the riverbed the longer it is, and the greater the amount of water it captures and distributes.



FIGURE 27.3 Cantalloq *puquio*—trench *puquio*. (Courtesy of D. Proulx.)

Two types of *puquios* have been identified—trench and gallery (Schreiber and Lancho Rojas 1995, 2003, 2006), although these are not mutually exclusive. In the open trench-type *puquios*, an open slot (*zanja*) is dug across the whole of the *puquios* (Figure 27.3). While the base channel itself is rarely wider than a meter, the open nature of this feature means that it can be over 10 m wide at the top. The walls of the trench are stone-lined and stepped back creating short step terraces. The water thus harnessed is then siphoned directly to irrigation canals or into small reservoirs (*cochas*) before subsequently feeding onto irrigation canals. When found on their own trench *puquios* tend to be shorter, they do however combine with the more elaborate gallery *puquios*.

Gallery *puquios* are the hydraulic-type technology most analogous to the Old World *qanāts* or filtration galleries. They can comprise up to four separate elements. Depending on the subsoil hardness these galleries are either tunneled directly into the earth creating a “tunneled gallery” or *socavón*, or they are created as open trenches that then have a roof built into them with compacted earth layered above the trench, thereby creating a tunneled gallery section known as a “filled-trench gallery” (Figure 27.4), this last section has the added advantage of maximizing total cultivation area. In many cases, this cut and cover type of construction had a wooden roof over which the earth was then piled upon. With the deterioration of these wooden roofs either the wood is replaced or the





**FIGURE 27.4** Cantalloq *puquio*—filled-trench gallery. (Courtesy of D. Proulx.)

“filled-trench gallery” is converted into a trench-type *puquio*. Given the scarcity of good wood in the area this is increasingly what is occurring with filtration galleries that need their roof replaced (Schreiber and Lancho Rojas 2006:67). Schreiber and Lancho Rojas (2006:284–286) tentatively suggest that the “filled-trench gallery” might have been a Spanish innovation. From here, the water would normally flow onto a stretch of open, trench *puquio*, before either ending at an irrigation canal or reservoir (*cocha*).

An important feature of gallery *puquios* are the *ojo*, these are vertical shafts that allow light and access into the gallery itself for periodic cleaning and maintenance (Figure 27.5). Given the depth at which some of these galleries run, the entrance to the *ojo* can be up to 15 m in diameter providing a conical funnel-like, terraced entrance to the gallery *puquio*. The width of the *ojo* is determined by the underlying geology, the *ojo* that is dug into hard sediments or strata tend to be narrow while those in softer geology are wider and have to be shored-up, hence the terraced funnel-like openings. In the “filled-trench gallery” section of gallery *puquios* the *ojo* tend to be narrower and vertical. Likewise, galleries in laterally tunneled sections are rarely above a meter in height, while they can be up to 2 m in height along “filled-trench gallery” sections. Cement was introduced into some of the *puquios* sometime in the twentieth century. In this manner, certain segments of tunnel and some of the vertical *ojo* slots have cement piping or are re-rendered with cement (Schreiber and Lancho Rojas 1995:235). In general though, *puquio* construction has remained remarkably conservative.



FIGURE 27.5 Cantalalloq *puquio*—*ojo* opening. (Courtesy of D. Proulx.)

### 27.3 CONCLUDING REMARKS

Not every *puquio* has been preserved; in fact only 43 *puquios* were still in use in the wider Nasca Valley at the beginning of the new millennium (Schreiber and Lancho Rojas 2006:84–85). Within the existing ones, there is great variety in length, varying between 300 and 1500 m, and depth, at between 4 and 10 m. Furthermore, the existing number of *puquios* in the Río Grande de Nasca Basin is a paltry reflection of the total that must have been active in the past. It is probable that their use extended to the adjacent valleys located immediately to the North—Ica—and South—Acarí—of the Nasca Basin (Schreiber and Lancho Rojas 2003:16).

Decline in use of this technology seems to have become a social fact. Indeed the long-term survival of this artisan mode of water collection and distribution is under increasing threat from industrial agro-production on coastal Peru. The rapid development of monocultivar, agro-industries such as asparagus, most of it destined for First World markets (Lawrence 2010), coupled with a concomitant increase in coastal populations is placing scarce water resources under extreme pressure. Indeed, deep-ground, well digging to tap subterranean water sources is reaping a significant toll on an already fragile environment and water regime, rendering it increasingly unsustainable (Whaley et al. 2010:623).



Nor is this situation likely to be easily reversed. In their hunger for cheap labor this same agro-industry provides work for the smallholder, traditional farmer and their families. It is exactly this group of people that would have used the artisan *puquios*. This job migration therefore directly removes from the land the people with the expertise and need to maintain these systems. This process is not confined to the coast either, highland to coast migration is leading directly to the wholesale abandonment of cultivation fields and terrace systems across the Andean region, thereby creating anew, ghost towns and widowed landscapes (*sensu* Jennings 1975), 525 years after the first Europeans set sight on the Americas.

In end effect, in the face of rampant modernity there seems to be little interest or desire to maintain, or even less propagate, what are seen as antique methods of water management. We should therefore be thankful that what has remained has at the very least been recorded for posterity.

## ACKNOWLEDGMENTS

Thanks go to Eustathios D. Chiotis for his invitation to contribute to this volume, I am grateful also for his patience and insightful comments on earlier versions of the same. I thank Donald Proulx for kindly offering his photos of the Cantalloq *puquio*, Tierras Blancas, and Nasca. As always, all errors and omissions remain the author's.

## REFERENCES

- Barnes, Monica. 1992. Dating of Nazca aqueducts. *Nature* 359:111.
- Barnes, Monica and David Fleming. 1991. Filtration-Gallery Irrigation in the Spanish new World. *Latin American Antiquity* 2(1):48–68.
- Beresford-Jones, David. 2011. *The Lost Woodlands of Ancient Nasca: A Case Study in Ecological and Cultural Collapse*. The British Academy/Oxford University Press, Oxford.
- Beresford-Jones, David, Susana Arce, Oliver Q. Whaley, and Alex J. Chepstow-Lusty. 2009. The Role of *Prosopis* in Ecological and Landscape Change in the Samaca Basin, Lower Ica Valley, South Coast Peru from the Early Horizon to the Late Intermediate Period. *Latin American Antiquity* 20(2):303–332.
- Carrión Cachot, Rebeca. 1955. El Culto al Agua en el Antiguo Peru: La Paccha, Elemento Cultural Pan-Andino. *Separata de la Revista del Museo Nacional de Antropología y Arqueología* 11(1):1–100.
- Clarkson, Persis B. and Ronald I. Dorn. 1995. New Chronometric Dates for the Puquios of Nazca, Peru. *Latin American Antiquity* 6(1):56–69.
- Denevan, William M. 2001. *Cultivated Landscapes of Native Amazonia and the Andes*. Oxford Geographical and Environmental Studies Series. Oxford University Press, Oxford.
- Dorn, Ronald I., Persis B. Clarkson, M. Nobbs, L. Loendorf, and D. Whitley. 1992. New Approaches to the Radiocarbon Dating of Rock Varnish, with Examples from Drylands. *Annals of the American Association of Geographers* 82(1):136–151.
- Fleming, David. 1993. The “Puquios” of Nazca in Peru: A Prehispanic Invention or Colonial Artifact? *South American Explorer* (34):25–28.
- González García, Francisco M. 1978 (1934). Los Acueductos Incaicos de Nazca. In *Tecnología Andina*, edited by R. Ravines, pp. 129–156. vol. Fuentes e Investigaciones para la Historia del Perú, 4 IEP/ITINTEC, Lima.
- Jennings, Francis. 1975. *The Invasion of America: Indians, Colonialism, and the Cant of Conquest*. University of North Carolina Press, Chapel Hill, NC.
- Lane, Kevin. 2009. Engineered highlands: The social organisation of water in the Ancient North-central Andes (AD 1000–1480). *World Archaeology* 41(1):169–190.
- Lawrence, Felicity. 2010. How Peru's wells are being sucked dry by British love of asparagus. *The Guardian* 15 September. <http://www.guardian.co.uk/environment/2010/sep/15/peru-asparagus-british-wells>.
- Mejía Xesspe, Toribio. 1939. Acueductos y Caminos Antiguos de la Hoya del Río Grande de Nazca. *Actas y Trabajos Científicos del 27 Congreso Internacional de Americanistas* 1:559–569.
- Mitchell, William P. 1973. The Hydraulic Hypothesis: A Reappraisal. *Current Anthropology* 14(5):532–534.
- Ortloff, Charles R. 2010. *Water Engineering in the Ancient World: Archaeological and Climate Perspectives on Societies of Ancient South America, the Middle East, and South-East Asia*. Oxford University Press, Oxford.

- Páez, María Cecilia and Marco Antonio Giovannetti. 2014. Canales aéreos y subterráneos de Las Pailas (Cachi - Salta). Aproximaciones al estudio de la red hidráulica. *Revista Estudios Antropología Historia, del Museo Arqueológico "Pío Pablo Díaz"* 2:20–35.
- Proulx, Donald A. 1999. Puquios—das Bewässerungssystem zur Zeit der Nasca—Kultur. In *Nasca: Geheimnisvolle Zeichen im Alten Peru*, edited by J. Rickenbach, pp. 89–96. Museum Rietberg Zürich, Zürich, Switzerland.
- Proulx, Donald A. 2006. *A Sourcebook of Nasca Ceramic Iconography: Reading a culture through its art*. University of Iowa Press, Iowa City, Iowa.
- Regal Matienzo, A. 1943. Los Acueductos Precolombinos de Nasca. *Revista de la Universidad Católica del Perú* 11(4–5):210–213.
- Regal Matienzo, A. 1964. Los acueductos pre-hispanicos de Nasca. *Boletín Informativo de la Universidad Nacional de Ingeniería, Lima* IV(30):15–18.
- Rossel Castro, P. A. 1942. Sistema de Irrigación Antigua de Rio Grande de Nasca. *Revista del Museo Nacional* 11(2):196–202.
- Schreiber, Katharina and Josué Lancho Rojas. 1995. The Puquios of Nasca. *Latin American Antiquity* 6(3):229–254.
- Schreiber, Katharina and Josué Lancho Rojas. 2003. *Irrigation and Society in the Peruvian Desert: The Puquios of Nasca*. Lexington Books, New York.
- Schreiber, Katharina and Josué Lancho Rojas. 2006. *Agua en el desierto: los puquios de Nasca*. Fondo Editorial de la PUCP, Lima, Peru.
- Silverman, Helaine and Donald A. Proulx. 2002. *The Nasca*. Blackwell Publishing, Malden, MA.
- Stanish, Charles. 1994. The Hydraulic Hypothesis Revisited: Lake Titicaca Basin Raised Fields in Theoretical Perspective. *Latin American Antiquity* 5(4):312–332.
- Steward, Julian H. (editor) 1955. *Irrigation Civilizations: A Comparative Study*. Pan American Union, Washington, DC.
- Tarragó, Myriam N. 1977. La localidad arqueológica de Las Pailas, provincia de Salta, Argentina. *Proceedings of the Actas del VII Congreso Nacional de Arqueología Chilena* 2:499–517.
- Uhle, Max. 1914. The Nazca Pottery of Ancient Peru. *Proceedings of the Davenport Academy of Sciences* 13:1–16.
- Whaley, Oliver Q., David G. Beresford-Jones, William Milliken, Alfonso Orellana, Anna Smyk, and Joaquín Leguía. 2010. An Ecosystem Approach to Restoration and Sustainable Management of Dry Forest in Southern Peru. *Kew Bulletin* 65:613–641.
- Wittfogel, Karl A. 1957. *Oriental Despotism: A Comparative Study of Total Power*. Yale University Press, New Haven, CT.



**Taylor & Francis**

Taylor & Francis Group

<http://taylorandfrancis.com>

---

# 28 The Ancient Hydraulic Catchment Systems of the Tepeaca-Acatzingo Archaeological Zone, Puebla, Mexico

*Miguel Medina Jaen, Norma G. Peñaflores Ramírez, and Jay E. Silverstein*

## CONTENTS

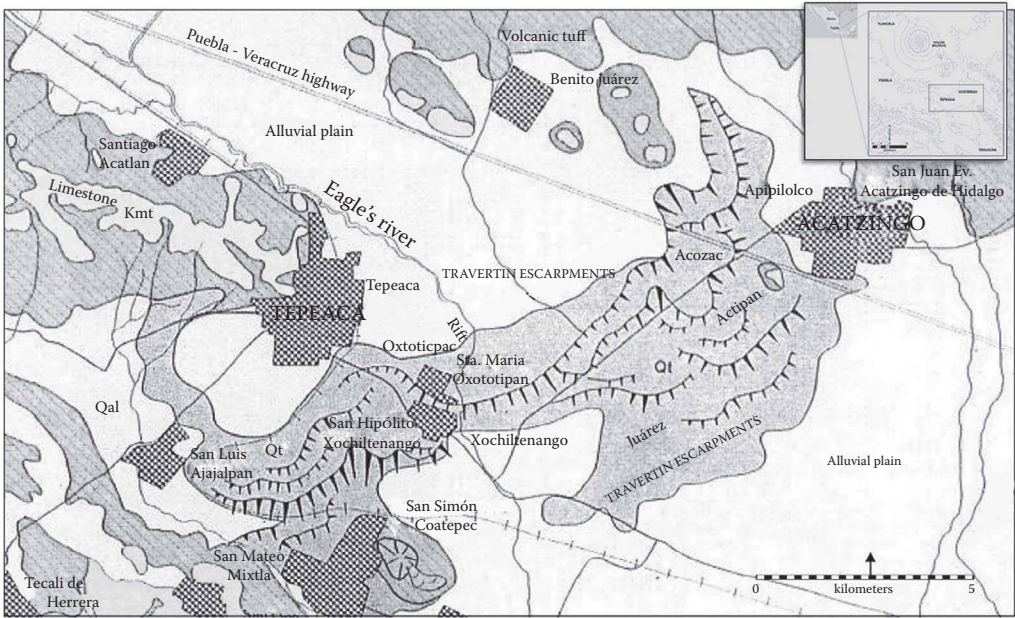
28.1	Introduction.....	475
28.2	Background.....	476
28.3	The Area of Study.....	477
28.4	The Pre-Hispanic Hydraulic Capture Techniques.....	477
28.5	Development of the <i>Galerías Filtrantes</i> during the Sixteenth through Twentieth Centuries.....	482
28.6	Conclusions.....	484
	References.....	485

## 28.1 INTRODUCTION

The area between the modern cities of Tepeaca and Acatzingo contains numerous filtration galleries (*galerías filtrantes*) that are generally believed to have been constructed between the Spanish conquest of Mexico in the sixteenth century and the first half of the twentieth century. However, important pre-Hispanic population centers in the same area also developed systems for the collection of water by exploiting the hydrographic properties of the sedimentary geology of the region. The continuity and periodization of elaboration of water collection systems in this area, which had their origin in prehistoric times and which climaxed with the post-conquest construction of extensive networks of *galerías filtrantes*, is poorly understood. Within a historic and hydrographic context, we examine the details of the use of pre-Hispanic hydraulic system and their relation to the later *galerías filtrantes* in the Tepeaca-Acatzingo region\* (Figure 28.1).

---

\* In the study area the *galerías filtrantes* are tunnels and trenches dug in the ground for the extraction of infiltration groundwater from both rain and fluvial origin as well as those waters accessible from certain springs or aquifers. Through these tunnels, groundwater is captured and taken to the surface, where it is stored or taken to the fields through canals. Their main purpose is to provide water for irrigation and to a lesser extent for domestic consumption of the populations in this humid environment where the bodies of surface water are scarce limiting its direct exploitation due to rapid infiltration into the subsoil. For more details, see Seele (1969, 1973, 1979), Cleek (1973), Monterrosa (1976), Palerm-Viqueira (2002, 2004), Hernández-Garciadiego and Herreras Guerra (2004), Martínez-Saldaña et al. (2005), and Enciso (2007), Montes-Hernández et al. (2011).



**FIGURE 28.1** Geological map of the Tepeaca-Acatzingo Region indicating the area of travertine escarpments. (Adapted from von Erffa et al. 1976.)

## 28.2 BACKGROUND

In 1969, the German investigator Enno Seele presented the first report of nearly 150 *galerías filtrantes* in the Tepeaca-Acatzingo area. He proposed that the origin of the filtration galleries could be placed between the pre-Hispanic era and the sixteenth century, after the Spanish conquest.\* However, his dating lacked supporting archaeological or historical data. Because of this, Seele's analysis has been subject to criticism by Jacinto Palerm and others† who argued that “there is no evidence of an introduction of the technologies of *galería filtrante* or *qanāts* in the Early Colonial Period nor of their Prehispanic existence.” Furthermore, as discussed below, the available information can only affirm the introduction of the technology to Mexico between the nineteenth and twentieth centuries.

Theories regarding the introduction of *galerías filtrantes* in Mexico and South America are controversial. On one side various authors have approached the topic from a perspective of diffusion, which traces the origin of the filtration galleries to the Middle East or North Africa where the technologies known as *qanāts* or *fuggaras* would have followed the spread of Islam to Spain and then to the Americans in the wake of European colonization.‡ Other authors with a focus on cultural evolution accept that some hydraulic catchment systems similar to the filtration galleries were autochthonous developments by the pre-Hispanic populations of Mesoamerica and Peru.§ Others criticize the overgeneralization of the classic definition of *qanāt*, noting that there could be considerable variation in time and geography and in the construction techniques and functions of this hydraulic catchment systems.¶

\* Seele (1969, 1972).

† Palerm et al. (2001), Palerm (2004:143).

‡ For examples, see Blázquez (1957), Seele (1969), Cleek (1973), (Wilken, 1990: 277, 281), Palerm-Viqueira (2004), Martínez-Saldaña et al. (2005), and Montes-Hernández et al. (2011).

§ For examples, see Seele (1969, 1973), Schreiber and Lancho (1995), Enciso (2007), Rodríguez-Zubiarte (s/f), and Medina and Peñaflores (2013).

¶ Boucharlat (2001).

To evaluate the postulates of Palerm and Seele (op.cit.) as to whether *galerías filtrantes* were used in the pre-Hispanic Period or the Early Colonial Period, we examine the scale of use and the hydraulic technology of *galerías filtrantes* at pre-Hispanic and Colonial sites in the Tepeaca-Actazingo area. While the dating of *galerías filtrantes* remains problematic, as discussed below, understanding these hydraulic constructions provides a foundation for understanding the scope of engineering and technological innovation that allowed populations to flourish in the Tepeaca-Acatzingo region.

### 28.3 THE AREA OF STUDY

The Tepeaca-Acatzingo area is located 30 km east of the city of Puebla, at an average altitude of 2220 m above sea level. The region is at the north end of an alluvial valley that extends between ridges of limestone produced by Cretaceous tectonics and subsequent eruptions of the volcano La Malinche (4460 m). The regional volcanic activity accelerated erosion of the limestone massifs, causing heavy siltation and filling basins during the Pleistocene period, thus forming a plateau whose surface is very porous due to its calcareous nature. This geology favors a rapid infiltration of rainwater. Thus, drainage hydrography is primarily through underground features. Currently, the only semi-permanent surface water is in the Barranca del Aguila, a narrow river channel flowing between Tepeaca and Acatzingo which is part of the catchment system of water flowing from the La Malinche volcano and surrounding hillsides toward the Atoyac River Basin (see Figure 28.1).

Between Tepeaca and Acatzingo the valley floor is interrupted by an abrupt drop of 100 m, where the terrain becomes steep and descends in the form of several natural steps caused by the progressive accumulation of limestone and volcanic sediments, formed from mixed ashes, volcanic tuffs, and fossilized plant matter carbonates, creating a porous and permeable substrate. The uneven terrain and natural stepped topography generates underground current fed by infiltration in the upper parts of the valley that, when mixed with the volcanic flows, resulted in the formation of numerous cavities that permeate the escarpments. This geological zone covers an area of approximately 10 km from side to side (the distance between Tepeaca and Acatzingo), with a stepped edge with a width of 2 km and is designated as a “stepped plateau with travertine escarpments.”\*

Given these geological and hydrographic conditions, the ancient people of the area had to devise techniques for capturing the water available in the subsoil required for both domestic consumption and for agricultural development, especially in the dry season when the shortage of surface water was critical. Archaeological evidence shows that this area has been occupied by various people with agriculture-based subsistence for at least 3000 years. Throughout their long history the people of the Tepeaca-Actazingo region managed to adapt to the natural conditions, taking advantage of pluvial, fluvial, and subsurface water to achieve an enduring legacy of irrigated agriculture that persists today.

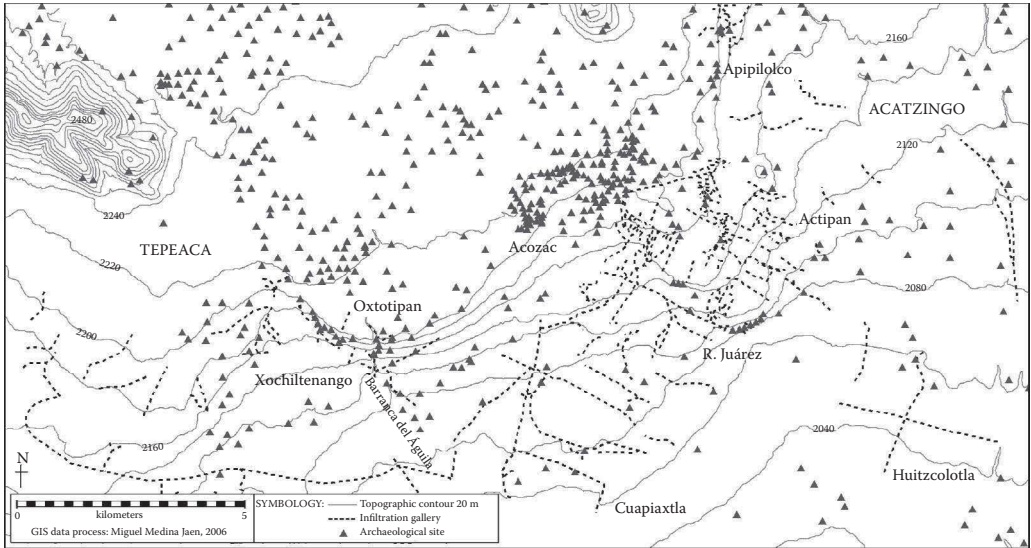
### 28.4 THE PRE-HISPANIC HYDRAULIC CAPTURE TECHNIQUES

Archaeological survey in the zone between the municipalities of Tepeaca and Acatzingo have registered approximately 500 pre-Hispanic sites with a time span stretching from *ca.* 2000 BC to 1520 AD, the year of the Spanish conquest of Tepeaca.† At least half of these sites are located in the area where the 111 filtration galleries were registered by Seele in 1969 (Figure 28.2). By *ca.* 1600 BC, at the base of the travertine escarpment, farming settlements were established that made use of simple systems of irrigation canals by exploiting springs in the Barranca del Aguila along with runoff and infiltration captured in caves in the escarpment. In the area of escarpments 83 archaeological cave sites were

\* Seele (1969–1973); Werner (1978).

† Sheehy (1994, 1997), Medina (2000), Castanzo (2002), Peñaflores (2004), Aguilar et al. (2005).





**FIGURE 28.2** Topographic map of the zone showing the *galerías filtrantes* and archaeological sites. The dotted lines indicate the path of the *galerías* that were constructed during the period of New Spain and in the twentieth century. The triangles indicate registered pre-Hispanic sites ranging in dates from 1600 BC to 1520 AD. (Adapted from Seele, E., *Galerías filtrantes en el área de Acatzingo-Tepeaca, Estado de Puebla*, in *Boletín del INAH*, No. 35, March 1969, INAH, México; Medina Jaen, M., *Las cuevas de Acatzingo-Tepeaca: Estudio Arqueológico, Etnohistórico y Etnográfico*, Licenciatura Thesis in Arqueología, Escuela Nacional de Antropología e Historia, INAH, México, 2000, pp. 109–137. With Permission.)

documented with abundant evidence of occupation by pre-Hispanic people.\* As a whole, the caves demonstrate various uses including habitation, funerary, and religious, as well as serving as sources of water produced by filtration. Many of the caves were modified and expanded by their former occupants to suit their subsistence needs as well as religious beliefs consistent with indigenous symbolic association of underground spaces as points of communication with the gods of fertility, water, birth, and death.† After the Spanish conquest, the religious uses of these caves were largely but not completely abandoned but the exploitation of infiltrated water continued until just a few decades ago.

Even today the ideological association of caves with life giving water is preserved in syncretic Catholic masses held inside a cave known as The Cave of the Cross, located in the town of Oxtotipan (word from the Nahuatl language meaning “above the Caverns”), very near Tepeaca. Masses are held on May 3 and June 11 to make requests of rain and enough water for agriculture.‡ The foundation of the current village dates to the seventeenth century. Near this cave is an abandoned filtration gallery that was probably built between the eighteenth and nineteenth centuries. It appears to be an elaboration of a spring that in ancient times naturally filled the caves. It is also significant that the current inhabitants preserve myths of characters known as “water dwarfs” (“los enanos del agua”) that, in pre-Hispanic times, lived inside the caves, and who were responsible for taking care of water, referencing the ancient cult of the indigenous god of water, Tlaloc. The myth of the dwarfs refers to worship paid by indigenous peoples to the ancient water god, Tlaloc. The caves connected the rather arid surface world to the water-rich phreatic zone below.§

\* Medina (2000).

† Medina-Jaen, *loc. cit.*; also see, Aguilar et al. (2005).

‡ Medina, *loc. cit.*

§ Medina, *loc. cit.*: 283–288.

Another example of the exploitation of water infiltrated inside a cave is in the “Cave of the Three Fathers” (Cueva de Los Tres Padres), located in the town of Los Reyes de Juárez, where the cave was modified by pre-Hispanic people to make it wider and by digging a hole allowing the water from the cave to be conducted through a small channel carved in the rock leading to lower parts of the land where there were numerous farming terraces and evidence of significant pre-Hispanic occupation.\* This cave has dried completely, but some ancient canals that were dug at the foot of other caves are still used to carry well water to the fields. In the same area is another larger cave in which there is a hole in the floor constructed for a *galería filtrante* that was, perhaps, excavated more recently.

Other important caves are located in the cliff faces of the Barranca del Aguila, located 3 km southeast of Tepeaca, where rainwater and fluvial flow from the La Malinche volcano eroded the limestone substrate to form a vertical cut of almost 100 m deep. The walls of the barranca abound in natural caves, many of which were expanded and modified in the pre-Hispanic era to use as rooms, religious spaces, and for burials. Modifications include the excavation of graves in the rock floor for human interment, the carving of niches, and construction of holes in the ceilings to illuminate the interior of the underground spaces, demonstrating a significant capability for working within the bedrock centuries before the time of New Spain.†

At the deepest point of this same barranca there are springs that form waterfalls and pools of a particular color of blue. These springs held a particular significance to prehistoric peoples who settled in the place. In a pictographic document from the sixteenth century, el *Mapa de Cuauhtinchan Número 2*, this barranca is represented with its particular flow of blue water which rises to mark the place where, during the thirteenth century AD, the town of Oxtotipan was founded.

At the foot of the highest waterfall, in the deepest part of the barranca, three tunnels were discovered by Norma Peñaflores where the water flows into a pool with walls that have been artificially cut.‡ The longest tunnel reaches 4 m in height with a width slightly greater than 2 m (Figure 28.5). Apparently, the canals were dug to increase the flow of groundwater as indicated by the fact that the water follows a channel carved approximately 100 m where it feeds into a dammed reservoir which in turn supports an irrigation canal that leads to agricultural fields.§

While there is insufficient data to firmly date hydraulic work, both margins of the barranca contain important pre-Hispanic sites suggesting pre-conquest usage. In addition, this place is represented in a mid-sixteenth century document (cited above), supporting the idea that the tunnels were constructed in the pre-Hispanic or Early Colonial period. However, in the seventeenth century the waters of this barranca were owned by the municipality of San Miguel de la Pila,¶ located 2.5 km southeast of this place, and there is always the possibility that these tunnels were built or expanded during that time. On one of the walls of this barranca near the tunnels, there was a carved inscription with the date September 3, 1885.

The oldest evidence for ancient water exploitation is found on the eastern side of the Barranca del Aguila, set at the base of limestone cliffs is the archaeological site Xochilteneño. Among the various structures that can be found there is a pyramid almost 15 m high. The site dates to the Formative Period (*ca.* 950 BC–200 AD) with its fluorescence between *ca.* 200 BC and 200 AD. Xochilteneño was a first order site in the regional political hierarchy,\*\* with a core settlement area of 2 km<sup>2</sup>. Fundamental to the development of the city was the permanent water supply provided by the Barranca del Águila and other natural runoff that could be accessed through the

\* Medina (*loc. cit.*: 283).

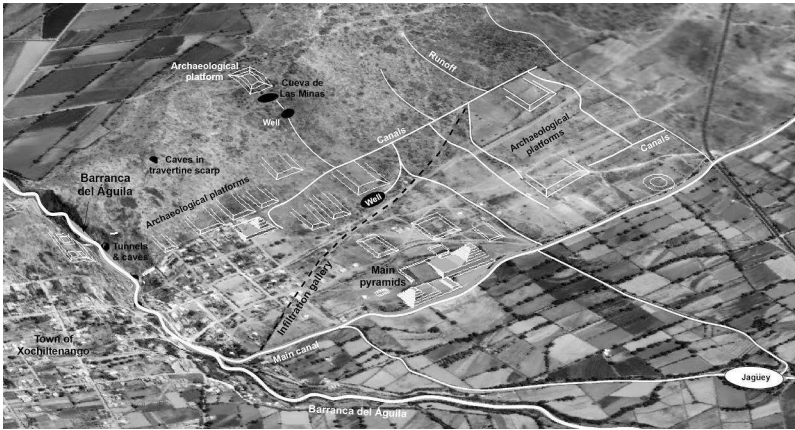
† Medina, *op. cit.*: 198–199.

‡ Peñaflores (2004: 76–80).

§ Palerm et al. (2001) tells us that the springs that emerge “out of caves” may correspond to a hydraulic technology called “spring tunnels” which may be different from *galerías filtrantes*.

¶ Rosario (2013: 217–230).

\*\* Castanzo (2002: 217–237, 315–323).

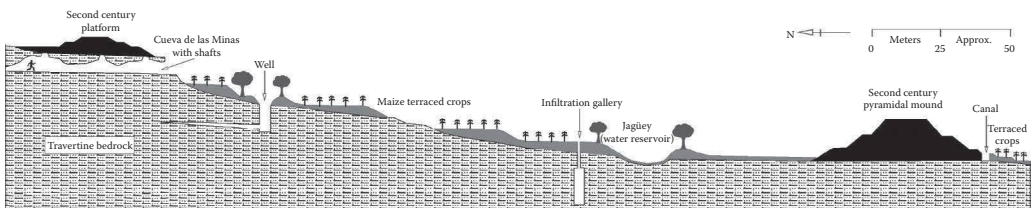


**FIGURE 28.3** Overhead perspective of the Xochiltlenango archaeological site located on the eastern side of the Barranca del Águila. The white lines are preserved runoff channels and canals that were constructed to irrigate agricultural fields.

caves located in the sedimentary steps. The dependable water sources were channeled into the cultivation fields\* (see Figure 28.3).

One of the largest caves of this site, known as “Cueva de Las Minas,” was formed by subterranean water currents. It shows clear evidence of having been modified and expanded by the inhabitants of the site to shape burial chambers and places of worship coincident with the remains of a temple built just above the cave.† The porosity of the cave is a consequence of abundant seepage and infiltration. The roofs of the inner chambers have perforations or portals, which could have served for both the illumination of the underground space and to enhance the collection of rainwater inside the cave; water was channeled into an artificial well outside the cave and then to cultivated terraces.

We believe that this type of naturally occurring cave modified by the ancient peoples to increase water uptake may represent the evolutionary antecedents of the *galerías filtrantes*, a model in which people modify and increase the productivity of natural hydrological phenomena to intensify agriculture‡ (Figure 28.4). Following this idea, the first tier pyramid site is coincident with one of the largest *galerías filtrantes* in the area. The *galería filtrante* is 17 m deep and almost 2 km long with access and portals distributed at intervals of 30–60 m along its entire length (Figures 28.4 and 28.5).

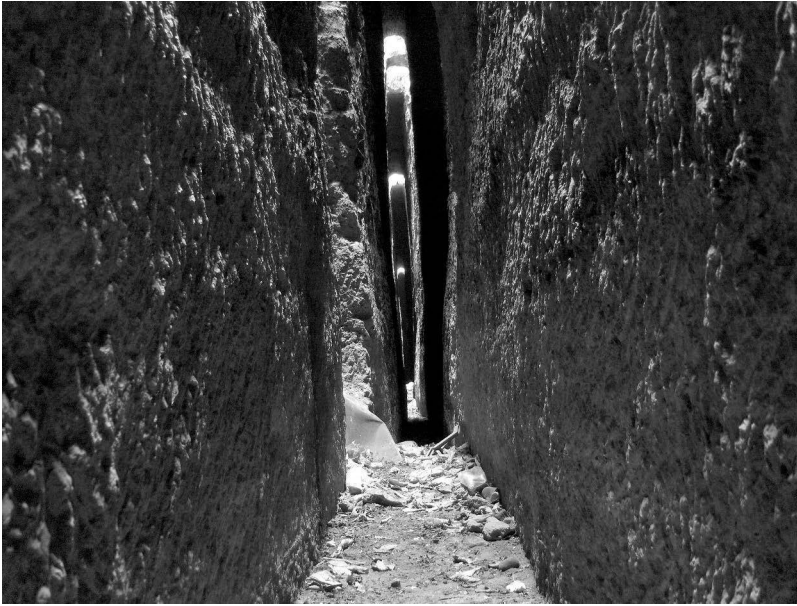


**FIGURE 28.4** Schematic profile view of the central part of the Xochiltlenango site showing elements and relationships with the underground capture of water. (Adapted from Medina Jaen, M., *Las cuevas de Acatzingo-Tepeaca: Estudio Arqueológico, Etnohistórico y Etnográfico*, Licenciatura Thesis in Arqueología, Escuela Nacional de Antropología e Historia, INAH, México, 2000, p. 285. With Permission.)

\* Medina (2000: 244), Peñaflores (2004: 106–111).

† In Mesoamerica, one of the best examples of the association of caves and temples for religious purposes is in the artificial cave constructed under the Pyramid of the Sun in Teotihuacan. Here also the remains of a man-made canal carved in stone captured infiltrating water to the interior of the cave. For more details see the works of Doris Heyden (1991) and Linda Manzanilla (1994).

‡ Medina (*loc. cit.*: 266–275).



**FIGURE 28.5** An interior view of the *galería filtrante* at the archaeological site of Xochiltlenango. It has a maximum height of 17 m and width of 80 cm. (Courtesy of Norma Peñafleres, 2004.)

A portion of the water that generated in this galería fed the Barranca del Águila. Another part was channeled to a reservoir from which the waters were distributed to fields. Again, the dating of this *galería filtrante* is ambiguous and the present inhabitants do not remember the time of its construction, but its monumental dimensions and marks from iron tools that were used for digging the tunnel suggest two possibilities: (a) the feature visible today is the product of an enlargement made to a number of wells, tunnels, or channels that were present from ancient times and (b) the features are wholly Colonial Period constructions, dating from between the seventeenth and nineteenth centuries to meet the increasing demand for water in both la Barranca del Águila and in the fields for the benefit of San Miguel de La Pila in the seventeenth century.

In the years prior to the Spanish conquest, the lords of Tepeaca and Acatzingo ruled the region of the *galerías filtrantes*. In the Early Colonial Period this power and importance manifested in the construction of Franciscan monastery in each of the cities.\* To supply water for these populations, which together are estimated at over 100,000 persons† in a zone with few rivers or perennial sources of surface water,‡ it was imperative to exploit all methods for hydraulic capture. A clear example of the methods used to control water sources in this epoch was also recorded in the *Mapa de Cuauhtinchan Número 2*. The map was made in the middle of the sixteenth century in Cuauhtinchan, a town located 10 km west of Tepeaca. In this document the authors illustrated two streams that had their headwaters in the hillside of Sierra de Tepeaca. These streams were channeled to supply water to the town of Cuauhtinchan where they could be stored in a pond or reservoir.§ However, few other settlements in the region had access to surface water.

Given the continuous human occupation of the area and the absence of permanent surface water, pre-Hispanic people had to develop techniques for water catchment by building dams, canals, wells, and *jagüeyes* (large tanks for water storage) and to exploit springs and infiltrated and runoff water

\* For more details on pre-Hispanic cities, see Reyes (1988) and Martínez (1984, 1994).

† Calvo (1973: 77).

‡ *Relación de Tepeaca y su Partido*, año 1580: 19.

§ This interpretation is based on the investigations of Zaragoza-Ocaña (1977: 53, foto 30) and Yoneda (2005: 208–221).



that collected in the many caves that exist in the sedimentary escarpments.\* It is noteworthy that most of the pre-Hispanic settlements are geographically coincident in an area of nearly 100 km<sup>2</sup> to more than 100 filtration galleries reported by Seele (1969), Medina (2000), and Peñaflores (2004) (see Figure 28.2).

The spatial correlation of the archaeological sites suggests that, at the time of the Spanish conquest, knowledge and techniques for hydraulic engineering had been well-developed by the prehistoric people and, as was the case with many other aspects of *La Conquista*, the Colonial administration simply built on pre-existing systems, quite likely including the construction or expansion of the large *galerías filtrantes* to increase the capture and management of infiltration, as we shall see below.

## 28.5 DEVELOPMENT OF THE *GALERÍAS FILTRANTES* DURING THE SIXTEENTH THROUGH TWENTIETH CENTURIES

According to the data reported by Seele (1969–1973) as well as Medina (2000) and Peñaflores (2004), the maximum use of the largest *galerías filtrantes* took place between the sixteenth and twentieth centuries, with the system growing to perhaps more than 150 culverts in an area of approximately 100 km<sup>2</sup> (see Figure 28.3). The expansion of the network of *galerías* ranged from the creation of modest systems covering only a few dozen meters to systems that stretched over 2 km with depths ranging between 1 and 28 m. Inside the *galerías*, the height from floor to ceiling, representing the facing surface area for the seepage of infiltrating water, varies between 1 and 12 m, and the width of the collection channel ranges from 1 to 2 m. Throughout their history, the galleries had portals or gallery shafts, like wells, used for construction, maintenance, light, and access, distributed at different intervals (see Figures 28.4). The monumental dimensions of some galleries show the investment of a huge labor force for construction, which could only have been achieved with abundant peasant labor and iron tools, as indicated by the fact that the walls of many *galerías* still retain traces of such tool marks (see Figure 28.5).

As can be seen in the map in Figure 28.2, the distribution of *galerías filtrantes* is confined to the area of travertine escarpments where it is obvious that this system is an adaptation to the specific geological and hydrographic character of these sedimentary steps of the upper valley. The correlation with pre-Hispanic settlements as well as Early Colonial towns, monasteries, haciendas, and ranches, all of which exploited the subterranean water sources that could be extracted through hydraulic engineering from this natural formation is noteworthy.

Toponyms often provide clues to the antiquity and significance of geographic features relevant to a culture. As with towns and other human-made or natural features of a cultural landscape, the *galerías filtrantes* carry different names that, taken as a whole, carry connotations of relative antiquity. The following names may represent a historical progression of *galerías filtrantes* construction and use:

1. *Galerías* with names in the Náhuatl language, for example, “Huehue” (honored elder), “Tenexatl” (ash water), “Acozac” (yellow water), “Amellali” (spring), “Alcuat” (serpent water), and so on. Seele (1969:4) suggested that *galerías* with Náhuatl names indicated those that were most ancient and with construction dates initiated in pre-Hispanic times or very soon after the Spanish conquest. These *galerías* are the smallest and are found in the areas of higher elevation where the phreatic zone was closer to the surface. Later *galerías* were located in lower lands and built in greater numbers, of greater length, and of much greater size to optimize the collection capacity lower terrain.
2. The *galerías* carry the name of the hacienda or the landowners that controlled the *galerías*: “Hacienda Apipilolco,” “Hacienda Alhuelica,” “Rancho Avarro,” and “Agua del Borqués.”

\* Medina-Jaen (2000: 243–319).

3. The *galerías* with names referencing nationalistic personalities and terms of the nineteenth century such as “Hidalgo,” “La Libertad,” “Zaragoza,” and “5 de Mayo.”
4. The *galerías* with names that denote the communal ideology of the twentieth century such as “Porvenir,” “Democracia,” and “Progreso.”

This historical progression in the construction of the *galerías* is consistent with Palerm’s (2004:143) assertion that, in Mexico, the technology was introduced in various ways at various times. Cleek (1973:901–906) proposed two episodes of technological diffusion in the system of *galerías* in the Tehuacán Valley: the first introduction with the Spanish administration between the sixteenth and seventeenth centuries (without any clear evidence), and a second period of innovation and implementation by government engineers in the twentieth century.

When considering the relative antiquity of this network of galleries, we must take into account that pre-Hispanic populations had a well-developed agricultural economy in place many centuries before the Spanish army of Hernan Cortes arrived in Tepeaca in 1520; after this the peasant villages were stripped of their land and placed under the colonial administrative government established in the cities of Tepeaca and Acatzingo,\* disrupting traditional village management of water catchment systems.

A precise dating for the construction of filtration galleries on the scale visible in the archaeological record is not known. There are, however, reports from the Early Colonial Period (1520–1700) noting the lack of water faced by the population of Tepeaca, and how they worked to augment their supply. For example, in the *Relación de Tepeaca y su Partido en el año de 1580*, it says:

... [Tepeaca] is a land built on limestone...There are no rivers that pass through the land and no springs of any significance, and so in the time that they were infidels and after the Christians arrived they harvested their water from the rain which they collected in earthen basins they called jagüeyes... with this method they augmented their springs like they do in Almagro in Spain, where the springs have an origin half a league from where they emerge from the scree.† (translated and annotated by the authors)

The sources of water mentioned in this *Relación* correspond to the springs that exist in the Barranca del Águila (discussed above) or in the subject towns of Tepeaca like Oxtotipan and Xochiltlenango, places where ancient *galerías filtrantes* are known to have existed.

By the mid-sixteenth century, this lack of water led the first Franciscan friars established in Tepeaca to order the construction of the aqueduct of Tepeaca, a monumental feat of engineering that was done to supply the city with water from the volcano La Malinche located 20 km away.‡ Considering that the water shortage predated the construction of the aqueduct, it is logical to think that pre-Hispanic populations in this area faced the same lack of surface water and had the same need to develop techniques to exploit aquifers. In this context, with the arrival of technologies and tools brought by the Spanish, they were able to intensify the indigenous catchment systems or begin the construction of the first *galerías filtrantes*. However, in historical documents of the Early Colonial Period no direct references to these galleries have been found; perhaps because they were never registered or because the technique had different names at that time.§ For example, one of the few references to what could already be the first galleries used by the village of Actipan (Nahuatl

\* Martínez (1984, 1994), Medina (2000: 150–155).

† *Relación de Tepeaca y su Partido*, año 1580: 15 (also see Calvo, 1973: 10).

‡ *Relación de Tepeaca y su Partido*, año 1580: 18. Seele (1969: 3) that refers to the work, “La Cañería de Tepeaca, el sistema de mayor longitud que se conoce en la región.” However, this was not a *galería filtrante* according to Monterrosa (1976: 57), but an aqueduct that had an underground pipe and an open canal.

§ Currently the people of the region know the *galerías filtrantes* as wells, pipes, trenches, pits, and so on.



“over or above the water”),\* was found in *Memorias de Acatzingo*, for the years 1777 and 1791, where it is mentioned that:

[These towns] abound with water distillers [*galerías filtrantes?*] that water their vegetable gardens that support much of the populations.... and for the benefit of these vegetables they make gashes [cut or dig] in the hill where the village is located [travertine escarpment] and to two or three *varas* [rods] they gather short streams of water into pools [*jagüeyes*] and with these they water their plants and provide a great part to the Bishopric. (Calvo, 1973: pp. 11–12, 92–95; translated and annotated by the authors)

This account seems to indicate the construction of galleries after the Spanish conquest through the late seventeenth century. One possible reason for a gap in the importance of *galerías filtrantes* in the Early Colonial Period could be the sharp decline in indigenous population that resulted from dispossession of their lands, migrations and relocations, and devastating epidemics that followed the conquest.† The availability of Indian labor to construct filtration galleries and the need to develop agricultural land to meet the demands of colonial exploitation led to the development of a system that could meet the production needs of the haciendas.‡ The first haciendas arrived in the Tepeaca area between 1559 and 1702,§ and then grew considerably until the middle of the eighteenth century when the Mayor of Tepeaca counted 203 haciendas and 162 farms.¶ These farms were characterized by high production of cereals and vegetables which were then sold in regional markets in Tepeaca and Puebla.\*\*

One of the many examples of the direct association between haciendas and *galerías filtrantes* can be seen at the Hacienda Apipilolco (which means in Náhuatl “where waters fall fast”), located to the west of Acatzingo. At this hacienda, the major building is built on top of a group of *galerías filtrantes* located between 3 and 5 m below the floor. The network of tunnels exceeds 500 m in length. Access to one of the shafts or luminaries of the largest gallery is located right in the courtyard of the building and was used as a water well. This is a clear example of a gallery built specifically for the benefit of a hacienda that was built between the eighteenth and nineteenth centuries, unlike those that could have been used for family and community benefit, such as those located within the towns of Acatzingo, Acozac, Actipan, Los Reyes de Juárez, and Oxtotipan.

## 28.6 CONCLUSIONS

We have demonstrated the relationship between the magnitude of the *galerías filtrantes* that existed in the Tepeaca-Acatzingo area with pre-Hispanic and Colonial settlements built upon the same sedimentary deposits. From this relationship, we have tried to discern a historical process for the development of means and requirement for the management of water, rather than the desire to see if the infiltration galleries were also invented by the prehistoric people of this region. Without a doubt, many centuries before the Spanish conquest, the pre-Hispanic towns developed methods for the capture of subsurface water in the caves and springs of the region. Cultures across Mesoamerica provide numerous examples of advanced hydraulic engineering (e.g., Scarborough 2003) to include management of infiltrating water (Silverstein et al. 2009); however, in the case of the *galerías filtrantes* there simply is insufficient archaeological data to firmly include *galerías filtrantes* among the known pre-Hispanic hydraulic engineering accomplishments. We believe that the natural caves that were modified by the pre-Hispanic inhabitants to increase the uptake of filtered water could represent a “natural model” genesis of the technology that led to the development of

\* Following the *Indonimia Geográfica del Estado de Puebla* by Felipe Franco (1976).

† Calvo (1973: 77–78).

‡ For more detail about haciendas of Puebla, see Nickel (1996).

§ Méndez-Martínez, s/f.

¶ Nickel (1996: 205–211).

\*\* Martínez (1984–1994), Grosso (1989–1996).

*galerías filtrantes*. Although many of the registered galleries are within pre-Hispanic archaeological sites, traces of metal tool marks that were used in construction indicate that the large culverts were dug or expanded in later times.

Palerm et al. (2001) said that “the existing galleries are not necessarily survivals of traditional technology of antiquity; but there is a significant reevaluation and implementation of the technology in the nineteenth and twentieth centuries.” We agree, however, that the archaeological and historical data indicating the places and techniques of hydraulic capture had been developed by prehistoric people and that this likely contributed to the technical, production tools, and interests expressed by the Spaniards. Thus, conditions favorable to the development and expansion of *galería filtrante* technology pre-existed in the same geographical space and with the same hydrographic challenges that, in the Colonial Period, were expressed as a massive expansion and refinement of the technology. If the indigenous technology had some continuity into the Colonial Period, the first methods of water capture used in the sixteenth and seventeenth centuries would have been on a small scale and consisted of adits, fissures, trenches, and small tunnels and caves that were excavated at the foot of the sedimentary escarpments and that could have been expanded and modified incrementally to create more extensive systems of *galerías*.

The documentary evidence indicates that it was not until the eighteenth and nineteenth centuries, coinciding with rise of the hacienda-based system of exploitation, that there is a significant increase in the construction of *galerías filtrantes* on a grand scale. This situation continued until the Mexican Revolution between 1910 and 1920, when the hegemony of the haciendas was overthrown. Cleek (1973:904–906) notes that construction of galleries boomed again shortly after the Revolution when the technology was consciously promoted by engineers from the Mexican government, as part of the agrarian reform, who recognized the potential source of water *galerías filtrantes* could provide.

Unfortunately, the use and construction of *galerías filtrantes* began to decline in the second half of the twentieth century with the proliferation of deep wells throughout the zone, wells whose construction was enabled by the motorization and eventual electrification of the countryside. The continued exploitation of agricultural lands through the newer deep well technology allowed the government to meet needs for increased agricultural production to supply domestic and international markets. With the contemporary proliferation of wells, the water table has dropped below 100 m, leaving the once abundant galleries in an advanced state of dryness, neglect, and pollution (see Figure 28.5).

## REFERENCES

- Aguilar, Manuel, Miguel Medina-Jaen, Tim M. Tucker, and James Brady 2005 The significance of a Chicomoztoc Complex at Acatzingo Viejo. In *In the Maw of the Earth Monster. Mesoamerican Ritual Cave Use*, James E. Brady and Keith M. Prufer (eds), University of Texas Press, Austin, TX.
- Blázquez, Luis 1957 Hidrogeología de una parte del Valle de Tehuacán, Estado de Puebla. In *Anales del Instituto de Geología*, t. XII, Universidad Nacional Autónoma de México, México, pp. 9–55.
- Boucharlat, R. 2001 Les galeries de captage dans la péninsule d’oman au premier millénaire avant J.-C: Questions sur leurs relations avec les galeries du plateau iranien. In *Irrigation et Drainage Dans l’Antiquité, qanâts et Canalizations Souterraines en Iran, en Egypte et en Grece*, Pierre Briant (ed), Thotm éditions, Avec le concours du College de France, Paris, France, pp 157–184.
- Calvo, Thomas 1973 *Acatzingo: Demografía de una Parroquia Mexicana*, INAH, Colección Científica, Serie Historia, núm. 6, México.
- Castanzo, Ronald A. 2002 *The Development of Socioeconomic Complexity in the Formative Period Central Puebla—Tlaxcala Basin Mexico*. Doctoral Thesis in Anthropology, Department of Anthropology, The Pennsylvania State University, State College, PA.
- Cleek, Richard K. 1973 The infiltration gallery in Mexico: Two diffusions. In *Anthropos*, number 68, pp. 897–909.
- Enciso Gutiérrez, Antonio 2007 *Puesta en Valor de Riegos Ancestrales: Galerías Filtrantes, Andenes, Amunas y Waru Waru—Peru*. Universidad Nacional Agraria La Molina, Lima, Perú. [http://ceer.isa.utl.pt/cyted/2007/bolivia2007/Tema%202/2.5\\_AEnciso\\_LaPaz\\_Set07.pdf](http://ceer.isa.utl.pt/cyted/2007/bolivia2007/Tema%202/2.5_AEnciso_LaPaz_Set07.pdf).

- Grosso, Juan Carlos 1989 *El tianguis de Tepeaca a finales del siglo XVIII*. Gobierno del Estado de Puebla, Secretaría de Cultura, Serie Lecturas Históricas de Puebla, Puebla, México.
- Grosso, Juan Carlos 1996 Campesinos, poblados de hacienda y producción indígena en el entorno agrario de Tepeaca en la segunda mitad del siglo XVIII. In *Anuario del Instituto de Estudios Histórico-Sociales*, núm. 11, Facultad de Ciencias Humanas, Universidad Nacional del Centro, Tandil, Argentina.
- Hernández Garcadiago, Raúl and Gisela Herrerías Guerra 2004 Evolución de la tecnología hidro-agro-ecológica mesoamericana desde su origen prehistórico. El valle de Tehuacán, Pue. México. In *Alternativas y procesos de Participación Social A.C.*, Tehuacán Pue., México, Junio de 2004, <http://www.alternativas.org.mx/Evolucion%20de%20la%20tecnologia.pdf>.
- Heyden, Doris 1991 La matriz de la tierra. In *Arqueoastronomía y etnoastronomía en Mesoamérica*; edited by Johanna Broda, Stanislaw Iwaniszewski y Lucrecia Maupomé, UNAM, México.
- Manzanilla, Linda 1994 Las cuevas en el mundo mesoamericano. In *Ciencias*, Revista de difusión de la Facultad de Ciencias, UNAM, No. 36, octubre-diciembre, México.
- Martínez, Hildeberto 1984 *Tepeaca en el Siglo XVI, Tenencia de la tierra y organización de un señorío*. CIESAS, México.
- Martínez, Hildeberto 1994 *Codiciaban la tierra: el despojo agrario de los señoríos de Tecamachalco y Quecholac (Puebla, 1520–1650)*. CIESAS, México.
- Martínez Saldaña, Tomás, Cristina Martínez, and Herbert Ealing McKintosh 2005 Las Galerías Filtrantes, una historia de éxito en Santa María de Las Parras. In *Boletín del Archivo Histórico del Agua*, año 10, núm. 31, septiembre-diciembre de 2005, México.
- Medina Jaen, Miguel 2000 *Las cuevas de Acatzingo-Tepeaca: Estudio Arqueológico, Etnohistórico y Etnográfico*. Licenciatura Thesis in Arqueología, Escuela Nacional de Antropología e Historia, INAH, México.
- Medina Jaen, Miguel and Norma G. Peñaflores Ramírez 2013 El sistema de galerías filtrantes en la zona de Tepeaca-Acatzingo (valle oriental de Puebla). In *El Agua en las regiones. Miradas históricas y perspectivas contemporáneas*, coordinado por María Teresa Ventura Rodríguez, Sergio Francisco Rosas Salas y Sandra Rosario Jiménez, Benemérita Universidad Autónoma de Puebla, Instituto de Ciencias Sociales y Humanidades, Puebla, México.
- Méndez Martínez, Enrique *S/f Índice del Ramo de Tierras del Estado de Puebla*, INAH, Colección Científica Fuentes (Etnohistoria) No. 70, México.
- Monterrosa-Prado, Mariano 1976 Las galerías filtrantes. In *Cuadernos de Culhuacán*, año II, I (2), SEP-INAH, México, pp. 57–61.
- Montes Hernández, Roberto, Antonio Romero, Carlos Solís, Gladys Rivera, and Sergio Zamorano 2011 Las galerías filtrantes del Alto Lerma: usos y manejos sociales. In *Economía, Sociedad y Territorio* [en línea] 2011, vol. XI (citado October 21, 2011), disponible en: <http://redalyc.uaemex.mx/src/inicio/ArtPdfRed.jsp?iCve=11118171007>.
- Nickel, Herbet 1996 *Morfología social de la hacienda mexicana*, Fondo de Cultura Económica, México.
- Palerm Viqueira, Jacinta 2004 Las Galerías Filtrantes o Qanats en México: Introducción y Tipología de Técnicas. In *Agricultura, Sociedad y Desarrollo*, Volumen 1, Número 2, Julio-Diciembre 2004, México.
- Palerm Viqueira, Jacinta, José Luis Pimentel Equihua, Martín Sánchez Rodríguez et al. 2001 Técnicas hidráulicas en México, paralelismos con el Viejo Mundo: II. Galerías Filtrantes (*qanats*). In *II Encuentro sobre Historia y Medio Ambiente* 24 al 26 de octubre 2001, (Sesión preparatoria del XIII Economic History Congress), Huesca, España. <http://jacintapalerm.hostei.com/GALERIAS.html#seisa>.
- Palerm Viqueira, Jacinta and Martín Sánchez Rodríguez 2002 Técnicas hidráulicas en México, paralelismos con el Viejo Mundo: II. Galerías Filtrantes. Ponencia a la *Sesión 17* “Technological exchange, modes of production and water utilisation in Europe and Latin America (from Ancient times to XXth century)” del *Economic History Congress*, Buenos Aires (22 al 26 de julio 2002). [http://web.archive.org/web/20050428125240/http://geocities.com/jacinta\\_palerm/buenos\\_aires.pdf](http://web.archive.org/web/20050428125240/http://geocities.com/jacinta_palerm/buenos_aires.pdf).
- Peñaflores Ramírez and Norma Guadalupe 2004 *Entre la Tierra y el Agua: Arqueología subacuática y de tierra en la Barranca del Águila, Puebla*. Master’s Thesis in Anthropology with focus on Archaeology, UNAM, Facultad de Filosofía y Letras, Instituto de Investigaciones Antropológicas, México.
- Relación de Tepeaca y su Partido, año de 1580* 1905 Papeles de la Nueva España, segunda serie, Geografía y Estadística, vol. V: 12–45, Francisco del Paso y Troncoso (editor), Madrid, España.
- Reyes-García, Luis 1988 *Cauachtinchan del siglo XII al XVI, Formación y desarrollo histórico de un señorío prehispánico*, Coedición CIESAS-FCE-Gobierno del Edo. de Puebla, México.
- Rodríguez-Zubiarte, Edgar “Las Galerías Filtrantes de Nazca, Perú.” In *Revista Técnica N° 30 del Capítulo de Ingeniería Civil—CIP*, Perú, [www.lnh-uni.org/articulos/articulo01.pdf](http://www.lnh-uni.org/articulos/articulo01.pdf).

- Rosario Jiménez, Sandra 2013 Administración del riego en el campo poblano: La Junta de Aguas de la Barranca del Águila, 1925–1947. In *El Agua en las regiones. Miradas históricas y perspectivas contemporáneas*, coordinado por María Teresa Ventura Rodríguez, Sergio Francisco Rosas Salas y Sandra Rosario Jiménez, Benemérita Universidad Autónoma de Puebla, Instituto de Ciencias Sociales y Humanidades, Puebla, México.
- Scarborough, Vernon L. 2003 *The Flow of Power: Ancient Water Systems and Landscapes*, SAR Press, Santa Fe, NM.
- Schreiber, Katharina J. and Lancho Rojas Josué Sep. 1995 The Puquios of Nasca. *Latin American Antiquity*, 6(3), 229–254, published by: Society for American Archaeology, stable URL: <http://www.jstor.org/stable/971674>.
- Seele, Enno 1969 Galerías filtrantes en el área de Acatzingo-Tepeaca, Estado de Puebla. In *Boletín del INAH*, No. 35, March 1969, INAH, México.
- Seele, Enno 1973 Galerías filtrantes en el Estado de Puebla. In *Comunicaciones*, núm. 7, Proyecto Puebla-Tlaxcala, Puebla, México.
- Seele, Enno 1979 Algunos aspectos de la intensificación de la agricultura de la región de Puebla-Tlaxcala. In *Comunicaciones*, núm. 16, Proyecto Puebla-Tlaxcala, Puebla, México.
- Sheehy, James 1994–1997 *Proyecto Acatzingo-Tepeaca*, informes técnicos de las temporadas 1994, 1995, 1996–1997, Archivo Técnico de Arqueología, INAH, México.
- Silverstein, Jay, David Webster, Horacio Martínez, and Alvaro Soto 2009 Rethinking the great Earthwork of Tikal: A hydraulic hypothesis for the classic Maya polity. *Ancient Mesoamerica*, 20(1), 45–58.
- Von Erffa, A. and W. Hilger 1976 Mapa geológico de la región Puebla-Tlaxcala. In *Comunicaciones*, Proyecto Puebla-Tlaxcala, Fundación Alemana para la Investigación Científica, Puebla, México.
- Werner G. 1978 La influencia del material de origen sobre el desarrollo del suelo en el Área Puebla-Tlaxcala. In *Los suelos de la Cuenca Alta de Puebla-Tlaxcala y sus alrededores*. Suplemento *Comunicaciones*, núm. VI Proyecto Puebla-Tlaxcala, FAIC, Puebla, México.
- Wilken, G. C. 1990 Las galerías filtrantes de México. In: Modesto Suarez/Universidad Iberoamericana (ed) *Historia, Antropología y Política, homenaje a Ángel Palerm*, Vol. I Alianza Editorial Mexicana, pp: 275–305.
- Yoneda, Keiko 2005 *Mapa de Cuauhtinchan Número 2*, coedición Miguel Ángel Porrúa-CIESAS, México.
- Zaragoza, Ocaña, Diana 1977 *Procesos de desarrollo en el área de Cuauhtinchan-Tepeaca: constatación arqueológica de algunos rasgos del Mapa de la Ruta Chicomoztoc-Cuauhtinchan*, Tesis de licenciatura, Escuela Nacional de Antropología e Historia, México.



# Taylor & Francis

Taylor & Francis Group

<http://taylorandfrancis.com>

# *Section VIII*

---

*Past, Present, and Future Trends*





# Taylor & Francis

Taylor & Francis Group

<http://taylorandfrancis.com>

---

# 29 Underground Aqueducts: Past, Present, and Future Trends

*Joseph I. Wessels, Sotirios Vardakos, Herbert Weingartner,  
Saeid Eslamian, and Andreas N. Angelakis*

## CONTENTS

29.1	Prolegomena .....	491
29.2	The Past .....	492
29.3	Present Times .....	496
29.3.1	Qanāts .....	496
29.3.2	Athens Aqueducts .....	498
29.3.3	Acheloos River Diversion Tunnels in Greece .....	499
29.3.4	Modern Use of Ancient Hydraulic Systems in Syria.....	500
29.4	Tunneling Technology and Future Trends.....	500
29.4.1	Modern Tunneling Technology for Underground Water Conveyance.....	500
29.4.2	Major Water Conveyance Tunnel Examples from the West .....	502
29.4.3	Future Trends .....	504
29.5	Epilogue.....	505
	Acknowledgments.....	506
	References.....	506

## 29.1 PROLEGOMENA

Study the past, if you would define the future.

**Confucius (551–479 BC)**

Since antiquity, management of drinking water supply has always been fundamental for humankind. In order to have the available water resources in their cities, ancient populations were obliged to make tremendous efforts concerning planning, construction, and the maintenance of long and complex aqueducts, many of them built in underground construction for most of their route. Underground aqueducts (e.g., qanāts, tunnels, various types of inclined galleries with and without shafts or with inverted siphons) bring groundwater and/or surface water from an often mountainous area to the lowlands, sometimes several kilometers away, from where the water is used domestically and for irrigation.

Tunnels and other underground hydraulic works are known since prehistoric times (De Feo et al. 2013). Tunnels are used for underground passages such as foot or vehicular road, railways, electrical power or telecommunication cables, and water for irrigation or water supply in urban

areas, in hydroelectric stations or are sewers and/or drains. Much of the early of tunneling technology evolved from mining and military engineering. A variety of modern tunneling techniques are known, including earth pressure balance tunnel boring machines (TBM), hard rock TBMs, conventional drill blast tunneling, sequential excavation methods (SEM), and remote-controlled tunneling systems.

In the ancient times, no large-scale lifting techniques were available, and water was transferred from the source (usually a spring) in aqueducts by gravity. For the arid and semi-arid regions inhabited by the prehistoric people, it was natural for every city to have its own water supply system as a basic feature of civilized life and development. Yet, due to the continuous war between ancient cities, aqueducts used to be hidden and subterranean, rather than with visible conduits on bridges. The aqueduct system based on underground transport had been widely used by Minoans, Greeks, Samaritans, Indus valley civilizations, Egyptians, Persians, and Romans. This was reported since the Roman period, during Frontinus's time (97 AD), who was the commissioner of Rome's aqueduct at the time. It had the advantage of protecting water from external impacts and pollution and at the same time could be better maintained and preserved. An aqueduct of this type was composed of tubes or channels, made of stone slabs or terracotta (Malacrino 2010).

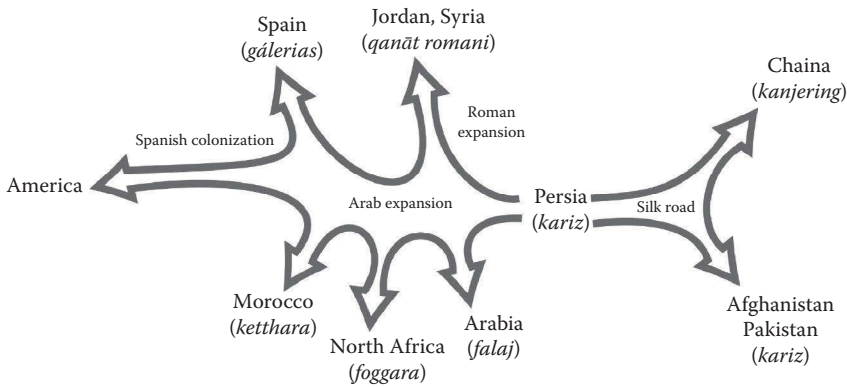
Qanāt is a very well-known underground hydraulic work based on tunneling. A qanāt is a collection and conveyance system for groundwater that was developed originally in ancient Persia. A qanāt consists of an underground gallery which uses gravity to convey water from the water table (or springs) at higher elevations to the surface of lower lands. Qanāts also have a series of vertical shafts that were used for excavation of the tunnel and provided air circulation and lighting. The oldest qanāts have been found in the northern part of Iran and date back to around 3000 years ago when the Aryans settled in present day Iran (Javan et al. 2006). The longest (71 km with 2115 vertical shafts) and oldest (over 3000 years) is in the ancient city of Zarch. Qanāt comes from the Semitic word meaning “to dig.” Presently, there are about 34,000 operational qanāts in Iran (Javan et al. 2006; Eslamian et al. 2015).

Having proven their longevity, qanāts are the most sustainable systems to bring water to the desert, yet their use and upkeep has been in severe decline over the past century. The aim of this chapter is to give a brief assessment of the past, present, and future of water tunneling technology, specifically the building of qanāts. What was their role in the past, how can we preserve them in the present, so that they will remain meaningful in the future?

## 29.2 THE PAST

Our antecedents have developed sophisticated groundwater collection systems, very well known since early times. This technology was probably developed later on well-known as “qanāt” technology in Persia (Samsar Yazdi and Khaneiki 2013). Qanāt is a system of water supply consisting of an underground tunnel connected to the surface by a series of shafts which uses gravity to bring water from the water table of the higher elevation lands to the surface of the lower elevation lands. Written records leave little doubt that ancient Iran (Persia) was the birthplace of the qanāt. As early as the *ca.* seventh century BC, the Assyrian king Sargon II reported that during a campaign in Persia he had found an underground system for tapping water (Goblot 1979). His son, King Sennacherib, applied the “secret” of using underground conduits in building an irrigation system around Nineveh (Samsar Yazdi and Khaneiki 2013). However, archaeological evidences from the territory of today's United Arab Emirates indicates that the first significant underground hydraulic works, in fact qanāts appeared worldwide in the first millennium BC (Al Tikriti 2002, 2011).

The word qanāt comes from a Semitic word meaning “to dig” and, over the centuries, the technology was transferred to other civilizations and become known with different names such as *hydragogeion*, that is, aqueduct (from the words *hydro* = water and *agogos* = conduit, Greece), *karez* (Afghanistan and Pakistan), *kanerjing* (China), “*falaj*” (United Arab Emirates), *aflaj* (Oman), *foggarafughara* (Algeria and other North Africa countries), *ifli* (Magreb Sahara territories), *kahriz*



**FIGURE 29.1** Qanāt expansion from Persia to the world. (From Goblot, H., *Les Qanāts: Une technique d'acquisition de l'eau*. Editions de l'École des Hautes Etudes en Sciences Sociales, Paris, France, 1979. With Permission.)

(Countries of the Caucasus and Central Asia), and *khettharas* (Morocco). According to UNESCO recommendations, some of those projects are protected as monuments of world heritage (Mays et al. 2007). The first qanāt was probably developed as a by-product of mining where, when groundwater was struck, this water was removed from the mining site by digging a channel or tunnel to drain it away (Schacht 2003).

The widespread distribution of qanāts, known in different places by local names, has confounded the question of its origin. No one can claim where and when exactly in Iran that the first qanāt was constructed, but there is no question that qanāt is an Iranian technology and ancient Iran (Persia) was its birthplace. According to Goblot (1979), the idea behind qanāts was devised by miners to extract water from coal mines via canals in north-western Iran around 800 BC, and subsequently, was gradually extended to other regions to supply water for irrigation (see Figure 29.1).

In several areas of the Arabian Peninsula, beginning in the middle of the First Millennium, and for several centuries after, hydraulic works were mounted to convey water from mountain aquifers, via subsurface aqueducts, onto drier valleys and plains (Lightfoot 2000). Such subterranean gravity-driven galleries were developed first by Persians, and later by others (e.g., Algerians, Omanis, Libyans, Moroccans, Tunisians, Syrians, and Egyptians) who borrowed their technology. This technology and its application has been in use a very long period of time, for example, Iran and Algeria, where a significant percentage of water used in these countries for irrigation and domestic consumption was provided by such systems (Wulff 1968). However, qanāt technologies were known in Central Europe since the Classical period (Garbrecht 1995; Margat and van der Gun 2013). In addition, Romans developed similar technologies in Luxembourg, Croatia, Spain, Germany (Trier), Italy (South), and Hellas (Weingartner 2007, 2012; De Feo et al. 2010; Martínez-Santos and Martínez-Alfaro 2014). The most famous northern qanāt is the Raschpëtzer qanāt in Walferdange, Luxembourg, with a main gallery of 600 m and 35 different airshafts (Kohl and Waringo 2003). This qanāt has been renovated and researched by a dedicated group of volunteers since the 1970s and is now a main tourist attraction in the local area.

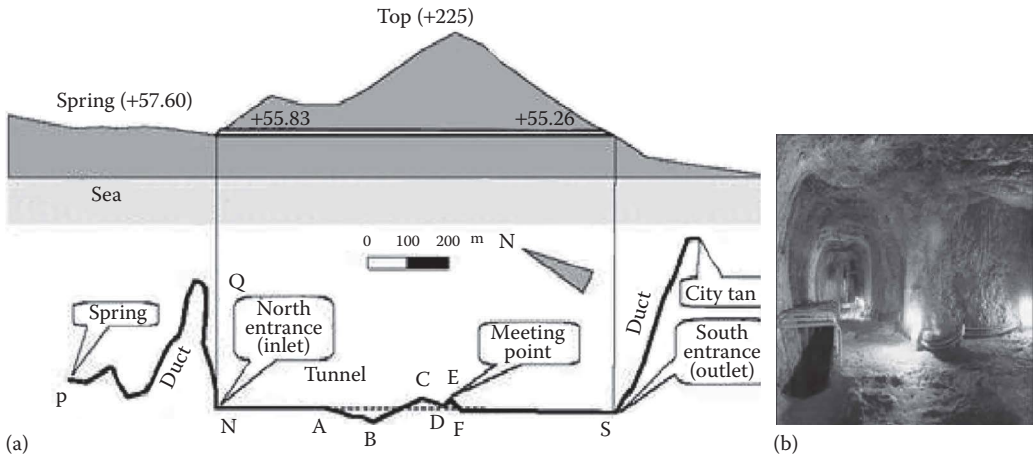
Like all traditional resource management systems, qanāt technology in active use is embedded in a complex sociocultural context. In fact, qanāt can be seen as so-called human ecosystems. In fact, a qanāt is a remarkable social phenomenon and cannot be viewed just as an engineering wonder only (Balali 2009). Wessels (2008a) developed an elaborate tool of analysis to assess collective action and social energy flows using a holistic approach to qanāts as human ecosystems whereby humans are integral part of the biophysical ecosystem. Honari (1989) describes a qanāt as an excellent example of an ecosystem that interacts between biotic and nonbiotic environments within the context of human society and qanāts seen as an example of human cultural

achievement requires a holistic approach. Honari (1989) justifies the ecosystem approach for qanāts based on the following:

1. Culture is the heritage of human beings; it is both dynamic and multidimensional. Different groups of people have contributed to the enrichment of this heritage in different periods of history. The qanāt as an example of human cultural achievement should be described using a holistic approach.
2. All the physical, social, economic, political, cultural, and behavioral aspects of the environment in the qanāt system represent all the factors interacting within the surrounding culture.
3. The qanāt is a good example of an ecosystem which interacts between biotic and nonbiotic environments within the context of human society. One of the themes in the ecological approach is adaptation and resilience. The qanāt is a way of adaptation. The qanāt has enabled humans to adapt to the extreme environment of arid zones.
4. The holistic approach of human ecology takes account of appropriate technology. Learning from past experiences is applied to the future. Most of these experiences are well adapted to the environment and meet social needs. The qanāt represents the concepts and application of appropriate technology.
5. The worldwide geographical distribution of qanāts calls for an international cooperation to protect them and relevant settlements in the arid parts of the world. It is the system of water supply which ensures the flow of water with natural energy.

Therefore, the qanāt system is closely linked to the local community's ability to plan and manage its own water resources, especially for agriculture. For example, the number of officials involved in managing qanāts in Ancient Persia was considerable (Wessels 2008a). During the Achaemenid Empire, carefully planned and managed systems of administration, land and water distribution, tax collection, communication, and post backed the Iranian expansion of their empire and established a wide network of qanāt settlements (Honari 1989). Government offices were in charge of construction, digging, and maintenance of qanāts (Honari 1989). Some scholars have described Boneh as a cooperative lifestyle more than just a management system (Farshad and Zinck 1997) and also *a social hierarchy which defines roles and responsibilities*. In fact, Boneh was developed as a system of collective ownership and management of qanāt water along with some participatory practices. These two technical and social phenomena, qanāt and Boneh, along with relevant value systems, were the main characteristics of the land and water management in pre-modern Iranian rural society (Balali 2009). Qanāts needed social cohesion for water allocation, water distribution, water use and system maintenance, the constant need for tunnel repairs, and communal methods of water rotation (English 1998; Wessels 2008a, 2005b, 2012). These factors are the driving forces behind the emergence and formation of the Boneh or the multifamily collective production (Eslamian et al. 2015).

Construction of qanāts expanded from Persia to the East along the silk route to China and subsequently spread to India, Saudi Arabia, North Africa, Cyprus, the Canary Islands, and Spain. The distribution of qanāts to Northern Africa and Spain is strongly connected to the expansion of Islam (Garbrecht 1995, 58), although the systems had existed there before already (English 1966, 190; Wilson 2003). Around 550 BC, the design concepts of qanāts were taken by the Iranian army to Egypt, and then subsequently to Oman and Saudi Arabia about 525 BC. Spaniards extended qanāts to Mexico in 1520 AD, and from there they came into use in Los Angeles. Pika, in Chile, utilized Qanāts in 1540 AD. Qanāts can be traced in China to 120 BC, but there is no evidence currently available indicating their presence in ancient society in Turkistan, and particularly in Tourfan, where well diggers have all been from the Khorasan Province of Iran. Qanāt technology was introduced into Eastern Asia around 280 AD. Japanese qanāts, which are generally located across Narva, the former capital of Japan and are termed Manboo (Munbu), appear to have been derived from the Persian word (Manbae), which means “reservoir” (Goblot 1979).



**FIGURE 29.2** Tunnel of Eupalinos: (a) longitudinal section up and horizontal plan (down) and (b) view of tunnel and sloped channel. (From Koutsoyiannis, D. et al. *ASCE J. Water Res. Plan. Manag.*, 134, 45–54, 2008. With Permission.)

The first known underground aqueduct in the Hellenic world is that in Megara in West Attica, which consists of several stretches of an underground canal with tubing, dated to archaic period, have been found (Malacrino 2010). It is considered to have been constructed in the sixth century BC by Eupalinos of Megara. Aqueducts, engineered under surface canals, are used to collect groundwater, not necessarily reaching the groundwater table, are known in several places of the country in early Classical times. One of the oldest well-known aqueduct based on tunneling in Hellas is that of Eupalinos in Samos from the sixth century BC and already described by Herodotus (Figure 29.2). The goal was to transfer water into the town from a spring that existed at a village, Agiades, north-west from the city. The tunnel, 1036 m long, that was built for this purpose was dug through limestone by two separate teams advancing in a straight line from both sides of the mountain (Voudouris et al. 2013; Angelakis et al. 2016).

Another underground aqueduct is that Hymettos in Athens which was constructed later (late fifth or early fourth century BC) and it consists of tunnels and wells up to 14 m deep (De Feo et al. 2013). Also in Magna Graecia, a system of tunnels for collecting and transporting water (section 2 m × 1 m) to feed about 20 fountains in the whole city was constructed by the engineer Phaeax at Hellenistic times. The total length of these tunnels beneath the ancient city surpasses 15 km (Tassios 2004). At the same period two underground aqueducts were constructed in Polyrrhenia lies in the mountainous hinterland of the Kissamos district in the western Crete (Voudouris et al. 2013). The water supply of antique cities like Korinthos during the Classical Period had also been secured by galleries, constructed with qanāt technique (Crouch 1993, 86f, 113). Within the sixth century BC the combination of subsurface water conduits and vertical aeration shafts is typical for many Greek water supply systems (Crouch 1993, 117).

During the Roman period several aqueducts consisting of tunnels were constructed such as the Hortiatis in Thessaloniki, Greece, with a 20 km tunnel, the Hadrianic aqueduct in Athens with 20 km tunnels, the Hadrian's aqueduct in ancient Korinthos, and the aqueduct in island of Rhodes. More on this are presented by Voudouris et al. (2015).

The Ottoman period is characterized by the construction of aqueducts-like qanāts and the exploitation of springs in several regions. In Phyllida (Serres, North Greece) more than 18 aqueducts-like qanāts of a length ranged from 35 to 4000 m each are described by Vavliakis (1989). The qanāts in northern Greece are qanāts *sensu strictu*. They are not only constructed by using qanāt technique but also have the same features as the systems in the area of their origin. Unlike to the qanāt systems



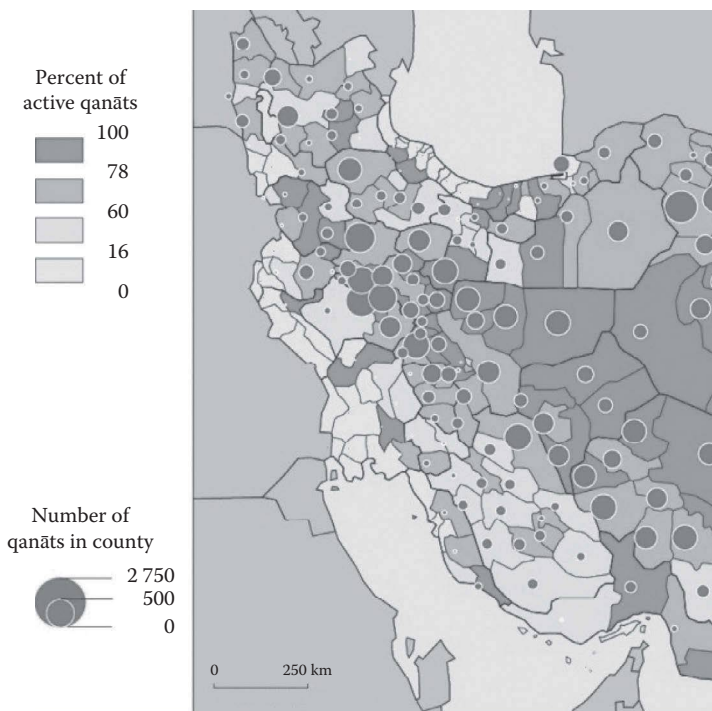
of the Classical Period, the systems in Northern Greece have probably been built after the occupation of Greece by the Turks (Vavliakis and Sotiriadis 1993, 194). The most recent qanāt system between Menikion and Pangeon Mts. has been built around 1895 and supplied the steamers at the local train station until 1935.

### 29.3 PRESENT TIMES

After the end of the World War I urbanization was starting in several regions of the world and urban centers were under high pressure to supply water. Construction of aqueducts, including underground structures were a common practice for water supply of highly populated cities. Relevant paradigms are as follows.

#### 29.3.1 QANĀTS

Since the introduction of pumped wells, many of the qanāts have been phased out. But in some countries such as Iran, Oman, Afghanistan, Pakistan, China, Azerbaijan, Syria, and Tajikistan some qanāts were still operational and supply a considerable amount of water to the agricultural sector. According to existing reports (2010), some countries, for example, Iran, Afghanistan, Pakistan, Oman, Morocco, Algeria, Syria, and China enjoy active qanāts. Most of the qanāts in the world are found in Iran, around the extensive plateau that forms central Iran. In Iran the system of qanāts has played a vital role. Iranian Ministry of Energy (WRMO 2005) estimated that there were 34,355 qanāts with an annual discharge of 8212 million m<sup>3</sup> in the country (see Figure 29.3). This amount is 11% of the total amount of groundwater that was being discharged by means of deep pumped wells, semi-deep wells, qanāts, and springs.

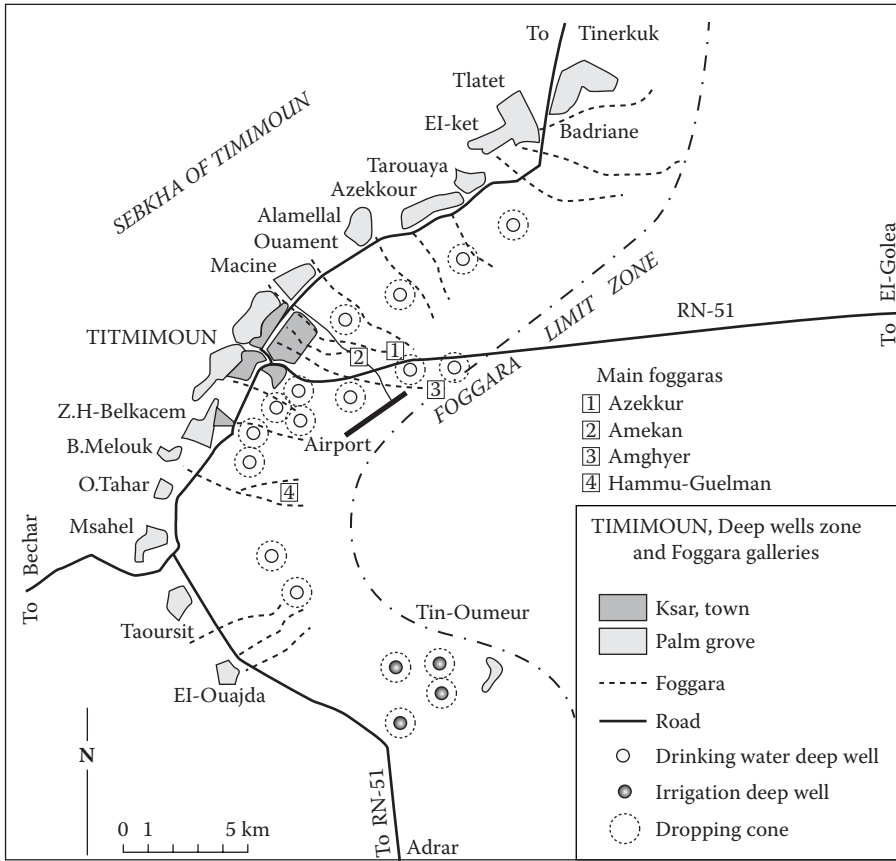


**FIGURE 29.3** Distribution of qanāts in Iran. (From Salih, A., Qanāts a unique groundwater management tool in Arid Regions: The case of bam region in Iran, in *International Symposium on Ground Water Sustainability*, Alicante, Spain, 2006, pp. 79–87; Hamidian, A. et al. *Agric. Agric. Sci. Proc.*, 4, 119–125, 2015. With Permission.)

Also in Oman *aflaj* are very important water acquisition systems, they provide people with fresh water for drinking and irrigation in rural communities (Al Amri et al. 2014; Megdiche-Kharrat and Moussa 2014). According to the results of the national *aflaj* inventory project conducted by the Ministry of Regional Municipalities, Environment and Water in the period from 1997 to 1999, there are 4112 *aflaj* distributed throughout the regions of Oman (MRMWR 2008, 2009). Nowadays, only 3017 are still operational (MRMWR website 2012). They currently provide 680 million m<sup>3</sup>/yr and irrigate around 26,500 ha of farmlands (Al Amri et al. 2014, 127). *Aflaj* are commonly defined as tunnels which bring water from wadi, springs, or aquifers. Thus, they are classified into three different types (*ghaili*, *dawoodi*, and *aini*) according to their different methods of water extraction: “channeling surface flow, tapping springs, and draining water-soaked” (Costa, 1983, 275). The first type, commonly called *ghaili*, reroutes flow from wadi or river through a man-made channel to the nearby plantations (Al-Marshudi, 2007, 34). The second type, named *aini*, conveys water from one or more natural springs to places of use. In most cases, the *aini falaj* is entirely above the ground; it may also be partly subterranean (Costa 1983, 276). The third type, known as *dawoodi*, brings water from underground aquifers. The *dawoodi falaj* originates from one or more mother well (*Umm Al Falaj*) and conveys water by gravity through an underground tunnel till it reaches the surface and then is distributed to the community of users. In July 2006, the World Heritage Committee, under UNESCO, adopted the inscription of five Omani *aflaj* in the World Heritage List: *falaj Daris* and *falaj Al-Khatmeen* in Willayat Nizwa, *falaj Al-Malaki* in Willayat Izki, *falaj Al-Mayssar* in Willayat Al-Rustaq, and *falaj Al-Jeela* in Willayat Sur. This inscription is not only restricted to the *falaj* channel, but also includes its location and surrounding environment (MRMWR 2012). *Falaj Daris* and *falaj Al-Khatmeen* are among the most important *dawoodi aflaj* (qanāts) in Oman. Their water flow can exceed 2000 L/s. The qanāt length of *falaj Daris* is 1.7 km; the total demand area is 238.2642 ha and the irrigation area is equal to 171.5502 ha (MRMWR 2012). The qanāt length of *falaj Al-Khatmeen* is 2.45 km; it irrigates an area of 100.4345 ha of which 72.3124 ha is agricultural land (Al Amri et al. 2014, 127).

In Algeria, according to an inventory of 1829, 707 *foggaras* remain perennial (Ansari 2014). However, due to the most redoubtable threat coming from the neighboring deep wells, the general trend is a continuous dropping down of the *foggara* flow rate. To keep the *foggara* alive, it has to be supported by continuous maintenance, otherwise it has to be revitalized by the public program as it is unthinkable to charge the *foggara* owners. Two *foggaras* could figure out the situation, both of them remain in use for centuries until the present days. At the north of Timimoun, the *foggara Azekkur* [1] is representative of the revitalization program; it used to have the second largest flow rate after *amghyer* [3] (Figure 29.4); since the revitalization project (2009–2010) it recovers part of its previous flow rate (10.53 L/s, reported from ANRH/SW, 2011, pers. comm.); its course draws presently the north urban limit of the town. By the 1970s a well has been dug and equipped with a pump to reinforce its flow rate, the shareholders were not able to pay the pumping charge and the well has been closed within a built room along the road taking to the local airport. At the south side, the *foggara Hammu-Guelman* [4] is representative of the *foggaras* which remain in use due to an autonomous effort of maintenance. It is one of the rare *foggaras* having a gallery in branches upward. Even with a medium flow rate (7.5 L/s, reported from ANRH/SW, 2011, pers. comm.), as it is witnessed by the local practitioners, *Hammu-Guelman* could be a perennial *foggara* representative case in Timimoun due to the maintenance support. Due to its good maintenance and additional work its flow rate has increased (15.6 L/s). Finally the *Amekan* [3] *foggara* was in use until recently, when its gallery was damaged by the expansion of the urban area.

A recent survey of *foggaras* in the Wadi al-Ajal (Fezzan region) identified 550 main channels, which indicates the probably densest area of qanāts in the whole Sahara (Wilson 2003, 227). Already English (1968) and some other authors mentioned about the importance and density of *foggaras* in Fezzan. The economic importance of the region is clearly mirrored by the density of *foggaras*. It is argued that the *foggaras* may have spread from Fezzan to southern Tunisia and the southern Aurès Mts. (Algeria) during the Roman period (Wilson 2003).



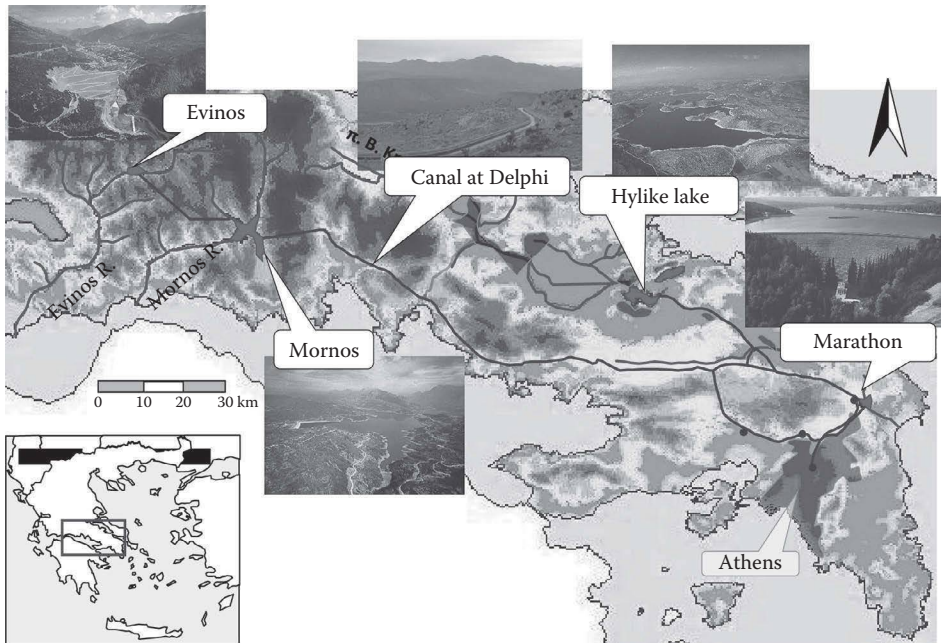
**FIGURE 29.4** The threat of the deep wells dug within the foggara gallery area. The wells reinforce the dropping down water table process. (Courtesy of K. Dahmen. With permission.)

According to Poupart (1949), only within the plain of El Haouz (where Marrakech is situated) more than 600 galleries existed. In 1974 Braun described the water supply of Marrakech by qanāts. Meanwhile, the collapsing of the khettara system is significantly affecting the water supply of Marrakech (El Faiz & Ruf 2010, 151), a destiny shared by most qanāts in Northern Africa.

**29.3.2 ATHENS AQUEDUCTS**

In Athens the first major project was the construction of the Marathon dam (1926–1929). Over 900 people were involved in the construction of the dam, with a total height of 54 m and a length of 285 m (Tsatsanifos and Michalis 2014). It is a gravity dam considered unique because it is entirely paneled externally with the unique Pentelikon white marble. The dam is founded on crystalline limestones close to the contact with watertight schists. Minimal impermeabilization grouting was performed. The capacity of its reservoir is 40.8 million m<sup>3</sup>. Today it is used as a daily to monthly regulating reservoir, the daily consumption in Athens being more than one million m<sup>3</sup>. The Boyati Tunnel (13.4 km long, 2.6 m wide, and 2.1 m high) was constructed to transport water from the Marathon reservoir to a new water treatment plant in Athens (Figure 29.5).

The continuously increasing need of the expanding capital demanded more water and, in 1956, the water from the Yliki Lake was added to the system until 1981 when the operation of the Mornos dam and aqueduct officially began. The Yliki, aqueduct, 66.7 km long conveys water to Athens by



**FIGURE 29.5** Schematic representation of the Athens water supply system in modern times. (From Xenos, D. et al. Water demand management and the Athens water supply. In: *Proceedings of the 7th BNAWQ Scientific and Practical Conference “Water Quality Technologies and Management in Bulgaria,”* Bulgarian National Association on Water Quality, Sofia, Bulgaria, pp. 44–45, 2002. With Permission.)

pumping. Now the Yliki lake and aqueduct is used only in contingency management and in case of emergency. This was the case with the drought of 1989–1991 when the Mornos reservoir reached the lowest operation level. This drought accelerated the construction of the Evinos aqueduct, diverting water from the regulative new Evinos reservoir to the Mornos (Tsatsanifos and Michalis 2014).

The Mornos dam is a 126 m high earth fill dam with central clay core. It is efficiently founded on flysch. The majority of its reservoir is again on the watertight flysch, except in the area of the Pynros ridge where karstic limestones outcrop, conveying their infiltration to the Corinthian Gulf. A very important isolation has been made, one of the few in the world, along a length of 2.6 km, where a bituminous concrete was applied on the limestone ground surface. The capacity of the Mornos reservoir, of 640 million m<sup>3</sup>, is much higher than the potential of the Mornos dam catchment area. The Mornos aqueduct, which transports water from the Mornos reservoir to Athens, is the second longest aqueduct in Europe (Tsatsanifos and Michalis 2014). It has a total length of 188 km, made up of 15 tunnels (71 km) of 3.2 m diameter, 12 siphons crossing valleys (7 km), and 15 canals (110 km). It was the first time of a TBM was used in Hellas for the excavation of the first tunnel of the aqueduct, the Giona tunnel (14.75 km) and the Kirfi tunnel (9.3 km).

### 29.3.3 ACHELOOS RIVER DIVERSION TUNNELS IN GREECE

Another ongoing project with major hydraulic tunnels is the one associated with the partial diversion of the Acheloos River to the Thessaly plain for water supply, irrigation, and power generation purposes. The project consists of the Sykia Dam (150 m) and the diversion tunnel, of 17.4 km length and 4.9 ÷ 6 m internal diameter (6 m for 10.4 km and 4.9 m for 7 km), planned to transport water from the Sykia dam to the Pefkofyto hydroelectric station and to the diversion projects—Messochora dam (150 m) and the Messochora–Glystra tunnel (7.5 km) in the Acheloos basin as well as the Pyli dam and the Pyli–Mouzaki tunnel in the Thessaly plain (Tsatsanifos and Michalis 2014).

### 29.3.4 MODERN USE OF ANCIENT HYDRAULIC SYSTEMS IN SYRIA

Syria's most famous river is the Euphrates and contemporary use of irrigation systems with river water is mainly found in the elaborate Euphrates irrigation scheme which waters most of the wheat and barley fields in Syria but also is used to cultivate vast areas of cotton, chickpea, and vegetables. However, Syria enjoys a very long history of hydraulic systems in use in order to survive in this arid environment.

The city of Hama in Syria is famous for its so-called Noria or Byzantine waterwheels, still in use and providing water for irrigation and domestic purposes. Ancient dams and elaborate hydraulic structures in Syria have been described by Calvet and Geyer et al. (Geyer 1990; Calvet and Geyer 1992). The most famous are the norias of Hama built on the rivers Orontes and Khabour. The norias date from the *ca.* fifth century AD as Calvet and Geyer reported that a famous mosaic from that period in the city of Apamea at the Orontes depicts a similar waterwheel (Calvet and Geyer 1992). The norias were until recently still in active use and formed a major tourist attraction in the city of Hama. Also the dams of the lake of Homs and the many dams to be found in the Syrian desert of which notable are the dams connected to the forts of the Strata Diocletana, of late Roman origin such as the ones Qasr al Heir al Gharbi (Geyer 1990; Calvet and Geyer 1992). The dams are part of an elaborate system to capture rainwater and store it for the summer, replenishing the aquifers underneath the dam lake. One of the earliest dam systems is the water infrastructure in Ras Shamra, which dates from the time of Ugarit and places these hydraulic structure in the twelfth century BC. Both Calvet & Geyer claim that it is most likely that dams and water capture systems existed in Syria as early as the Bronze age (*ca.* thirteenth century BC).

In combination with dams, other hydraulic systems can be found in Syria. At various locations in Syria, contemporary communities still make use of qanāts for irrigation purposes, drinking water, and domestic use, for example, in the desert settlements of Arak and Dumayr and the towns of Qara in the southwest of Syria as well has a high concentration of qanāts in use in the northwest hilly areas with higher rainfall (Kobori 1990, 1982; Wessels 2003, 2008a, 2012).

Wessels (2005b) developed crucial criteria for renovation and using ancient qanāts, whereby both from the traditional as well as the modern realm regulations are considered. The criteria are divided into six major conditions for successful and effective qanāt renovation: (a) a stable groundwater level, (b) consistent tunnel construction, (c) social cohesion of the users community, and (d) agreed system of water rights, and (vi) willingness of users community to continue maintenance and upkeep. The renovation and rehabilitation of qanāts should be aimed at improving those elements to ensure a sustainable qanāt use for the future.

## 29.4 TUNNELING TECHNOLOGY AND FUTURE TRENDS

### 29.4.1 MODERN TUNNELING TECHNOLOGY FOR UNDERGROUND WATER CONVEYANCE

Today tunneling methods have progressed to such a degree, that allow safe and efficient excavation and lining or pipe installation under a wide range of subsurface conditions, proximity to the ground surface or other nearby utilities and for a wide range of tunnel sizes. Today the grand majority of new underground water conveyance projects that have circular shaped cross section takes place in a semi- or fully mechanized fashion using various types of TBMs tailored for the size, type of expected subsurface conditions, expected hardness of rock, and other factors. Today the industry trend is that conventional excavation methods, such as the drill-and-blast method, are typically reserved for noncircular openings, which serve as ancillary facilities, adit tunnels, de-aeration chambers, and major underground power stations and caverns while TBMs show great utilization potential for uniform diameter water tunnels. However, major water tunnel projects have also been performed in the past using conventional drill-and-blast methods.

Most water conveyance projects are also associated with hydraulic drop shaft, riser shaft, or pumping station structures which are not discussed here. In certain occasions tunnels conveying



water from existing lake water bodies require a “lake tap” connection, a difficult construction task which has been practiced from the late 1800s in examples such as Chicago’s water intake tunnels and crib structures, to Juneau Alaska’s Annex Lake intake, and various Norwegian projects reaching water depths of 100 m.

The horizontal and vertical alignment, curvatures, pipeline slope, size, and length of water conveyance tunnels are the product of an optimization study that needs to consider various factors including not only the hydraulic aspects and requirements of the project but also geotechnical, right-of-way, mining equipment limitations, environmental, social (socioeconomic impact to the affected communities), and risk factors, all in the light of the regional available contractor practice and mining technology. The type of intended use, that is, forced water main, pressurized water tunnels, or gravity driven also influence sizes and pipe/lining design.

Within the large family of mechanized tunneling, a distinction can be made between trenchless technologies, such as microtunneling and pipejacking from larger full-scale TBM designed to bore through soft ground or rock. Pipejacking is the most often used method in underground water and sewer line installation, where an open cut excavation is impossible due to surface restrictions, or depth. The method typically involves first the construction of a shaft from which a small diameter shield is advanced into the ground via a jacking system of continuously fed prefabricated pipes. Startup of operations from the slope of an existing embankment is also possible. Typical sizes permit the operation of the shield by one person and the mining technology may vary from fully equipped shields with a cutterhead (1.2–2.4 m) to simple open face shields equipped with a backhoe or roadheader excavator (2.4–4.3 m). It is noted that such dimensions are only provided as general guide and variations between the size limits between different methods may change depending on equipment manufacturers and so on. However, for manned small diameter tunneling 1.8 m is often the minimum practical dimension in the industry (U.S. National Committee on Tunneling Technology 1989).

In both cases, excavated spoils are conveyed via conveyor belt or rail haulage system back to the launch shaft. Although many features remain similar, the term microtunneling in general refers to a set of methods and equipment tailored for small diameter projects. In its most encountered form, microtunneling is a type of pipe jacking and involves an unmanned type of automated excavation whereby a small diameter TBM (shield) typically less than 2.5 m is remotely guided while a jacking system advances the pipeline and shield at the front. The main benefit of this system is that the tunnel lining also constitutes the conveyance system. The small form factor is highly advantageous in urban settings and the impact to overlying utilities and existing infrastructure can be limited only to the construction and temporary operation of the launch and retrieval shafts. Slurry face support micromachines, however, typically require additional real estate at the surface for slurry production and de-sanding/recycling. Typical pipes are manufactured from high strength reinforced concrete and are designed to resist the temporary high jacking forces. Depending on the chemical behavior of the surrounding ground or in the case of sewer lines the chemistry of the conveyed fluids. Today prefabricated pipe types are in existence made of centrifugally laid fiberglass such as the HOBAS system ([www.hobas.com](http://www.hobas.com)) or concrete–polymer mixes which are designed to withstand highly corrosive constituents either inside or outside the pipeline.

Larger diameter conventional manned TBMs for soil or rock are also widely used for water conveyance projects across the world. Technology for larger diameter soft ground tunneling involves the use of closed face shields that offer some form of face pressure either by using the excavated soft ground itself as it happens in the case of earth pressure balance (EPB) machines or by applying to the face a circulating support medium such as bentonite slurry in the case of slurry TBMs. Precast segmental lining is used as a first pass, in order to serve as temporary support system, while a secondary cast-in-place system is typically performed once the whole tunnel has been mined, in order to provide long-term support against internal or external loads and a smooth hydraulic conveyance surface. The face pressure that is applied during operation of these systems is closely monitored real-time and compared continuously against other factors such as the weight of the extracted



material, the advance rate, settlement at the ground surface, and annulus grouting, and varied if required depending on the feedback of such measurements. Excavation is cyclic and propulsion is provided by longitudinal jacking cylinders inside the shield that push against the last installed prefabricated liner ring.

Water tunnels in rock can be excavated at various diameters using rock TBMs. These are more simple in principle from the soft ground types and are often called as “main-beam” TBMs since a longitudinal center beam serves as chassis for the TBM, carrying all its components, including the drive and bearing, gripper pads, rock support installation means, and any front shield protecting the cutterhead and workers. Rock TBMs can be designed to bore through highly competent, strong, or abrasive rock and can accommodate rock support features such as rock bolting, steel ribs, shotcrete, and can even be tailored for probe drilling or subhorizontal grouting ahead of the face if the conditions dictate. In rock TBM-mined water tunnels, the tunnel typically receives a final cast-in-place concrete liner, designed to accommodate the hydraulic conditions and long-term rock loads.

#### 29.4.2 MAJOR WATER CONVEYANCE TUNNEL EXAMPLES FROM THE WEST

Major hydraulic conveyance tunnels have been built around the world since the late 1800s and cover a wide scope of function, from raw or treated water conveyance, headrace tunnels at dams to various applications of sewer, combined sewer overflow, flood control, diversion, storage, or hydroelectric. Especially the last few decades, the increased capacity needs in water and sewer conveyance, and the elevated environmental protection requirements, have led various cities and authorities to investment in new tunnel infrastructure or rehabilitation of existing assets. Some notable examples of raw water conveyance projects from the United States are provided below.

Some of the earliest examples of raw water conveyance projects in North America are the water intake tunnels in the city of Chicago ([https://en.wikipedia.org/wiki/Water\\_cribs\\_in\\_Chicago](https://en.wikipedia.org/wiki/Water_cribs_in_Chicago)), which were built to supply water from Lake Michigan. The first intake structure on the lake was the Two-Mile Crib and its brick-lined tunnel, built in 1866 to carry uncontaminated freshwater to the city. Other tunnels and cribs followed to keep up the demands and the pollution levels the lake experienced due to the untreated water and sewage entering uncontrollably the Chicago River at the time from various domestic and industrial sources. A total of seven cribs and even more intake tunnels were eventually built with the tunnels varying in finished diameter from 1.50 to 6.10 m. The last crib and tunnel was built in 1935 and by that time the whole supply system had nearly 104.60 km of water tunnels and at the time supplied the water to the city with approximately 3.78 M m<sup>3</sup>/d (*Chicago Daily Tribune* 1935). Today the city still receives its water from four of these intake structures. The tunnels transport water to Chicago’s purification plants and one of them, the Jardine Water Purification Plant, being the largest capacity water treatment plant in the world.

Another early example of a water tunnel involving an open piercing lake tap is the Annex Creek lake intake near Juneau Alaska, which was performed in 1915. According to Westfall (1996), this was the first water intake tunnel in North America where the open-piercing method was followed to construct the connection between the tunnel and the lake bottom. This method which only applies to water tunnels in rock, involves the excavation of the water tunnel first and raising the tunnel end as close to the lake intake point as possible. Typically, a 4–5 m rock plug is left in place. A special trap is also excavated at the invert of the tunnel just before the rock plug to serve as trap for the spoils during final blasting. A controlled air cushion is also maintained inside the plug at the time of blasting to limit the shock to the existing tunnel. Similar methods have been pioneered in various water intake tunnels in Norway and the method is often called as “Norwegian lake tap.” Palstrøm (2009) provides an overview of the method and various examples of subwater tunnels and lake-tap projects from Norway.

Another example of monumental water conveyance tunnels comes from New York. The city receives water, which is produced by three major watershed regions: the Catskill, Delaware, and Croton. A series of aqueducts, reservoirs, lakes, and tunnels comprise a complex water supply

system which was initialized into development more than 150 years ago, with the development of the Croton System around 1842. A historic review of the water tunnel history in New York can be found in Del Vescovo and Rosteck (1997).

The city Tunnel 1 which was constructed as part of the Catskill System in the period 1905–1928 is a 29 km water tunnel with 4.6 m finished diameter, excavated by drill and blast methods in rock. The city Tunnel No. 2 followed closely after, in the period 1928–1936 as a response to the increasing demands. It was a 32 km tunnel excavated also in rock with same means. The Delaware System was also planned to augment the total supply to the New York City area and consists of 129 km of tunnels and 145 km of aqueducts with construction starting in the 1930s. In the mid-1950s, requirements and forecasting demands pointed the direction toward the construction of a new supply tunnel, the city Tunnel 3 in various stages and contracts. The first stage was a 21 km long tunnel, excavated in hard rock by drill and blast methods, with a 7.3 m finished diameter. Construction was finished in 1984 while in 1993 construction started for the second stage of the city Tunnel 3. Plans called for two main sections of the tunnel: one, the Brooklyn–Queens section and one in Manhattan, 18 and 11 km long, respectively. Plans called for a 4.9 m (Brooklyn side) to 6.1 m (Queens side) finished diameter and 3.0 m for the Manhattan segment. This was the first TBM-mined water tunnel in New York City. The three tunnels were excavated successfully through hard and abrasive rock, thanks to advanced geotechnical investigations that took place from the planning phases and optimal selection and configuration of the TBM cutters as described by Kwiatkowski et al. (2007). The city Tunnel 3 was considered as one of the largest and costly construction projects in New York City. In all three constructions, Robbins TBM units were used for the mining of the tunnels. The water supply system includes also older conveyance structures which are still kept today after having received extensive rehabilitation work. A notable example from New York's system is the New Croton Aqueduct, which is a 50 km long, 3.7–4.3 m diameter brick-lined tunnel of cross section varying between circular and horseshoe at locations, constructed between 1885 and 1891. Due to the importance of this structure to the whole supply system, and condition inspection studies showing the potential of lining problems, the city decided its rehabilitation which was completed in 2006 (Sokol et al. 2007). The existing tunnel layout supplies New York City with an estimated 5.678 M m<sup>3</sup>/d (Del Vescovo and Rosteck 2007).

North of New York City, another major hydropower water tunnel was recently constructed successfully. The Niagara Tunnel Project consists of a new flow diversion tunnel that allows excess water flow from the Niagara River to be harnessed for shared energy. The plans called for a new 10.4 km long, 12.5 m finished diameter tunnel which is aligned under the city of Niagara Falls, conducting water from an intake at the Upper Niagara River to the Sir Adam Beck Power Station (Harding 2007). The project involved the world's largest diameter rock TBM made by Robbins TBM and a two-pass lining system was used consisting of an interface grouting system, multilayer waterproofing, and prestressed unreinforced cast-in-place lining as described by Delmar et al. (2008). The design/build contract was awarded in 2005 and final delivery was in 2013.

Further to the west, another major water work was recently accomplished in Nevada. The Lake Mead Intake 3 Water Tunnel in Las Vegas operated by the Southern Nevada Water Authority was the result of the extended drought that caused a reduction of the lake's level and ultimate inability of the two existing intake tunnels to supply water. Planning called for a new intake deeper tunnel intake at elevation 262 m. that will provide service and cover the future demands (Feroz et al. 2007). The design/build contract was awarded in 2008 for a section including a deep-water lake tap, a pumping station, and a 6.1 m diameter tunnel between the intake and pumping station, and will serve the existing Alfred Merritt Smith Water Treatment Facility. It is interesting to note, that the Intake 1 at elevation 320 m was constructed in the early 1970s while the Intake 2 at elevation 305 m, and positioned close to the Intake 1, was delivered to service in 2002 (Hurt et al. 2009). Drill and blast methods were used to perform the Intake 2 while a rock TBM was selected to perform the tunneling for Intake 3.

### 29.4.3 FUTURE TRENDS

The future water conveyance and management will be governed by the following macrodrivers: (a) faster population growth, (b) higher urbanization, (c) climatic variability, and (d) aging infrastructure assets. These will present both a challenge and an opportunity on how to re-configure the water treatment processes as well as financing of water infrastructure to meet the future challenges. The development of proper decentralized water management technology including tunneling and underground water conveyance will be increased especially in the developing world.

Several major renovation projects for rehabilitating qanāts have been developed in countries like Oman, Iran, Morocco, Algeria, North Iraq (Kurdistan), Kazakhstan, and Syria (Wessels 2008a, b).<sup>\*</sup> The majority of the renovation activities focus on the cleaning of the tunnels, lowering of the bottom, and elongation of the tunnel in order to reach more water underneath the lowering groundwater table. All of these contemporary initiatives have had positive effect on the water supply and sustainability and efficiency of local water use (Wessels 2005). The UNESCO World Heritage list has now listed several Iranian qanāts and it is hoped that UNESCO will continue to protect the cultural and hydrological heritage (Figure 29.6). However, qanāts are not heritage and should not belong in the past as if situated in a museum. Qanāts and other hydraulic systems are still important in the world today. Even more so now the global water crisis becomes increasingly apparent.

The successful operation of qanāts is proved by innumerable examples worldwide (e.g., in this book). Using the best known example of a central European qanāt (Walferdingen, Luxembourg), the persistence of these systems is visible, as the subterranean 600 m long conduit from the second century AD still supplies 180 m<sup>3</sup> potable water daily (Kayser and Waringo 2003).



**FIGURE 29.6** Iranian/Dutch team of qanāt experts rehabilitating a qanāt in Kurdistan, 2010/2011 for a UNESCO qanāt renovation project.

<sup>\*</sup> For an audiovisual compilation on modern Qanāt renovation efforts in Kurdistan, Morocco, and Syria, UNESCO published and distributed the film *Water from the Dawn of Civilization* by J.I. Wessels which is available on-line at the Earth Sciences website: [http://www.unesco.org/archives/multimedia/?s=films\\_details&pg=33&id=1557](http://www.unesco.org/archives/multimedia/?s=films_details&pg=33&id=1557).

The recently investigated qanāt of Nea Zichni (Macedonia, Northern Greece) with a length of less than 1 km has a water discharge of  $>250,000 \text{ m}^3$ . Counting an average daily water consumption of 140 L/inhabitant about 5000 people can be supplied with drinking water (Weingartner 2008). Thus, a local and regional meaning of qanāt systems is testified.

The future trend for qanāt rehabilitation lies in the merger between modern drilling and lining technology, tunnel construction, and traditional knowledge about what the best locations are for qanāts, how they should be build. The UNESCO-ICQHS in Yazd, Iran, organized the first international conference on qanāts and hydraulic systems back in the year 2000. At that time, many traditional qanāt diggers, also called muqanni, were invited as guests of honor. The majority of these men were above 65 years old and they possessed a wealth of traditional knowledge on qanāt digging and construction. The muqannis do not construct or dig qanāts anymore due to safety and health risks. Digging a qanāt is one of the most dangerous activities and many diggers died in the process of building and digging these hydraulic structures. Many scholarly participants in this first conference on qanāts were fortunate to be able to gain knowledge about qanāt from these qanāt experts by asking many questions and the UNESCO-ICQHS has been active in documenting their extensive knowledge. However as more years pass, the less muqannis will be alive to tell us the important story of qanāts. It would be a great loss if we did not capture and document all of their knowledge, also for the future as we depend on the in-depth knowledge that these men gained over the years of digging and constructions that they have done.

## 29.5 EPILOGUE

Ancient hydraulic systems worldwide have been and will be important for a sustainable future where water shortages will be increasingly part of a global water crisis. It is adamant that human kind will need to conserve and preserve knowledge and expertise on sustainable systems to extract water. It is wrong to consider water ancient knowledge as useless compared to the great economic and technological processes under way. Even from a quantitative point of view, their use still supports most of humankind that is distributed throughout the less industrialized countries. Paradoxically, in these places where traditional techniques and especially underground hydraulic works are still used in a massive way, the modernist considers these as a phenomenon of backwardness, whereas in advanced countries, they create an image of desirability and provide added value (Laureano 2016).

Historical and archaeological evidences show that our ancestors had developed underground aqueducts since the prehistoric times. However, innovative methods of underground aqueducts were developed in Greece, Iran, Algeria, Oman, and other regions of the world mainly during the Classical, Hellenistic, and Roman periods. Since the first qanāts in Iran and the well-known tunnel at the island of Samos, Greece, were constructed several underground tunnels (with and without well-like vertical shafts) were implemented worldwide. After late Roman times a gap of about seventeen hundred years in construction of such hydraulic works is noticed. However, a remarkable development of tunneling appeared mainly in developed world during the past 100 years by constructing of infrastructure projects using modern technology. As a consequence, significant design and construction experiences were gained. Overall, it seems that underground aqueducts of modern societies are not very different in principles from those during antiquity.

With increasing threats to the existence of ancient underground hydraulic systems, in the form of major droughts, overexploitation but also civil strife and destructive violent warfare, the major priority worldwide should lie in physically save those hydraulic systems that are still intact, flowing, and giving some water. We should protect them and enlist them on the UNESCO World Heritage list both as tangible and intangible heritage in order to preserve the technology and the traditional knowledge on which the technology is based. The underground hydraulic systems are relics from the past that are still barely alive in the present. But it does not have to be this way. It is only hoped

that in the future, humankind starts to appreciate these major feats of engineering that can still be of great importance to ensure a sustainable future for everyone. Qanāts and other ancient hydraulic systems should be part and parcel of our sustainable future. Brief descriptions and examples of modern methods and projects were provided that showcase some of the strengths of modern tunneling methods and the scale and sophistication of water conveyance projects performed today. As the population and environmental demands increase, so will be investments in such projects. Although many water conveyance principles remain the same since the historic examples mentioned throughout, modern tunneling and water conveyance technology is available to perform any project at almost any conditions. We have to look back from time to time, not only for learning, but for the sheer pleasure of discovering our professional ancestors.

## ACKNOWLEDGMENTS

Many thanks are due to Dr. Feirouz Megdiche and to Dr. Krime Dahmen for the information provided.

## REFERENCES

- Al Amri S, Al Ghafri A, and Abd Rahman N. 2014. Water Management of Falaj Al Khatmain in Sultanate of Oman. *Journal of Earth Science and Engineering* 4:127–133.
- Al-Marshudi A. S. 2007. Institutional Arrangement and Water Rights in Aflaj System in the Sultanate of Oman. In *Proceedings of the International History Seminar on Irrigation and Drainage*, May 2–5, 2007, Tehran, Iran, pp. 31–42.
- Al Tikriti, W. Y. 2002. The South-East Arabian Origin of the Falaj System. *Proceedings of the Seminar for Arabian Studies* 32:117–138.
- Al Tikriti, W. Y. 2011. *Archaeology of the Falaj: A Field Study of the Ancient Irrigation Systems of the United Arab Emirates*. Department of Historic Environment/Abu Dhabi Authority for Culture and Heritage, Abu Dhabi, United Arab Emirates.
- Angelakis, A. N., Voudouris, K., and Mariolakos, I. 2016. Groundwater Utilization through the Centuries with Emphasis on Hellenic Civilizations. *Hydrogeology Journal* (in press).
- Ansari T. 2014. The preservation of foggaras in Algeria's Adrar Province. In: *Water Scarcity, Security and Democracy: A Mediterranean Mosaic. Global Water Partnership Mediterranean* (F. Chatel, G. Warhaft, and T Steenhuis, Eds.). GWP Publications, Stockholm, Sweden, pp. 108–113.
- Balali, Mohammad Reza. 2009. *Towards Reflexive Land and Water Management in Iran: Linking Technology, Governance and Culture*. Wageningen Universiteit (Wageningen University), Wageningen, The Netherlands.
- Calvet Y. and Geyer, B. 1992. Barrages antiques de Syrie, Collection de la Maison de l'Orient méditerranéen n° 21, série archéologique 12, Lyon.
- Chicago Daily Tribune. 1935. Volume XCIV-No.48, February 25, 1935. The Tribune Company Publishers, Chicago, IL.
- Costa, P. M. 1983. Notes on Traditional Hydraulics and Agriculture in Oman. *World Archeology* 14/3:273–295.
- Crouch, D. A. 1993. *Water Management in Ancient Greek Cities*. Oxford University Press, New York.
- De Feo, G., Laureano, P., Drusiani, R., and Angelakis, A. N., 2010. Water and Wastewater Management Technologies through the Centuries. *Water Science and Technology: Water Supply* 10(3):337–349.
- De Feo, G., Angelakis, A. N., Antoniou, G. P., El-Gohary, F., Haut, B., Passchier, C. W., and Zheng, X. Y. 2013. Historical and Technical Notes on Aqueducts from Prehistoric to Medieval Times. *Water* 5(4):1996–2025.
- Delmar, R., Hughes, M., Besaw, D., and Kapeller, E. 2008. Design and Construction of the Bored, Two-Pass Niagara Water Diversion Tunnel. In: *Proceedings: North American Tunneling Conference* (M. F. Roach, M. R. Kritzer, D. Ofiara, and B. F. Townsend, Eds.). SME, San Francisco, CA.
- Del Vescovo, A. and Rosteck, J. W. 1997. Construction of City Tunnel No.3, Stage 2 from Brooklyn to Queens. In: *Proceedings Rapid Excavation and Tunneling Conference* (J. E. Carlson and T. H. Budd, Eds.). SME, Las Vegas, NV.



- El Faiz, M. and Ruf, T. 2010. An Introduction to the Khettara in Morocco: Two Contrasting Cases. In: *Water and Sustainability in Arid Regions. Bridging the Gap between Physical and Social Sciences* (G. Schneier-Madanés and M.-F. Courel Eds.). Springer Sciences and Business Media, Berlin and Heidelberg, Germany, pp. 151–163.
- English, P.W. 1966. *City and Village in Iran.*, University of Wisconsin Press, Madison, WI.
- English, P.W. 1968. The Origin and Spread of Qanats in the Old World. *Proceedings of the American Philosophical Society* 112:170–181.
- English, P. W. 1998. Qanats and Lifeworlds in Iranian Plateau Villages. *Transformation of Middle Eastern Natural Environment, Bulletin Series* 103:187–205.
- Eslamian, S., Davari, A., and Reyhani, M. N. 2015. Qanat, the Symbol of Sustainability. In: *Proceedings of 2nd IWA International Workshop on Evolution of Qanats and Relevant Hydraulic Technologies* (A. A. Semsar Yazdi and A. R. Bahri, Eds.), November 08–10, 2015, Yazd, Iran, pp. 128–140.
- Farshad, A. and Zinck, J. A. 1997. Indigenous Knowledge and Agricultural Sustainability: case study in semi - arid regions of Iran. Printed from: *CD-ROM Proceedings of the international conference on geo-information for sustainable land management* (K.J. Beek, C.A. deBie, and P. Driessen, Eds.). Enschede, ITC, 17–21 August 1997.
- Feroz, M., Jensen, M., and Lindell, J. E. 2007. The Lake Mead Intake 3 Water Tunnel and Pumping Station, Las Vegas, Nevada, USA. In: *Proceedings: Rapid Excavation and Tunneling Conference* (M. T. Traylor and J. W. Townsend, Eds.). SME, Toronto, Canada.
- Garbrecht, G. 1995 *Meisterwerke Antiker Hydrotechnik*. Teubner, München, Germany.
- Geyer B. (Ed.) 1990. Techniques et pratiques hydro-agricoles traditionnelles en domaine irrigué: Approche pluridisciplinaire des modes de culture avant la motorisation en Syrie, Actes du Colloque de l'IFAPO, Damas 1987, Bibliothèque Archéologique et Historique 136, 2 vol., P. Geuthner, Paris, France.
- Goblot, H. 1979. Les Qanats: Une technique d 'acquisition de l ' eau. Editions de l ' Ecole des Hautes Etudes en Sciences Sociates. Paris, France.
- Hamidian, A., Ghorbani, M., Abdolshahnejad, M., and Abdolshahnejad, A. 2015. Qanat, Traditional Eco-Technology for Irrigation and Water Management. *Agriculture and Agricultural Science Procedia* 4:119–125.
- Harding, D. 2007. Niagara Tunnel Project. In: *Proceedings Rapid Excavation and Tunneling Conference* (M. T. Traylor and J. W. Townsend, Eds.). SME, Toronto, Canada.
- Honari, M. 1989. Qanats and Human Ecosystems in Iran. In *Qanat, Kariz and Khattara. Traditional water systems in the Middle East and North Africa* (P. Beaumont, M. Bonine, and K. Mc Lachlan, Eds.). Middle East and North African Studies Press, London, pp. 61–87.
- Hurt, J., McDonald, J., Sherry, G., McGinn A. J. 2009. Design and Construction of Lake Mead Intake No. 3 Shafts and Tunnel. In: *Proceedings Rapid Excavation and Tunneling Conference* (G. Almeraris and B. Mariucci, Eds.). SME, Las Vegas, NV.
- Javan, M., Hassanli, A. M., and Shahrokhnia, M. A. 2006. The Ancient Qanats of Iran. In: *Proceedings 1st IWA International Symposium Water and Wastewater Technologies in Ancient Civilizations, National Agricultural Research Foundation, Iraklio, Greece, Held*, pp. 28–30.
- Kayser, P. and Waringo G. 2003. die unterirdische Wasserleitung der Raschpetzer, ein Monument antiker Ingenieurbaukunst aus Luxemburg. In: *Internationales Frontinus-Symposium "Was-serversorgung aus Qanaten—Qanate als Vorbilder im Tunnelbau"*, 2.-5.Okt. 2003, Wal-ferdange, Luxemburg (=Schriftenreihe der Frontinus-Gesellschaft, H. 26), pp. 277–292.
- Kobori, I. 1982. *Case Studies of Foggara Oases in the Algerian Sahara and Syria*. Department of Geography, University of Tokyo, Tokyo, Japan.
- Kobori, I. 1990. Les qanat en Syrie. In: *Techniques et pratiques hydro-agricoles traditionnelles en domaine irrigue*, vol. 2 (B. Geyer, Ed.). Librairie Orientaliste Paul Geuthner, Paris, France, pp. 321–328.
- Kohl, N. and Waringo, G. 2003. *Einzigartig, auch im vergleich; der Raschpëtzer-qanat das Walferdinger forschungsmodell*. Syndicat d'Initiative et de Tourisme de la Commune de Walferdange, Luxemburg.
- Koutsoyiannis, D., Zarkadoulas, N., Angelakis, A.N., Tchobanoglous, G. 2008. Urban Water management in Ancient Hellas: Legacies and lessons. *ASCE, Journal of Water Resources Planning & Management* 134(1):45–54.
- Kwiatkowski T. P., Bhore, J. S., Velez, J., and Orlandi, C. D. 2007. Successful Tunneling for Water Tunnel No.3 New York City, New York. In: *Proceedings Rapid Excavation and Tunneling Conference* (M. T. Traylor and J. W. Townsend, Eds.). SME, Toronto, Canada.
- Laureano, P. 2016. Water Reuse Traditional Systems. In: *Urban Water Reuse Handbook* (S. Eslamian, Ed.). CRC Press, Taylor & Francis Group, Boca Raton, FL, Chapter 30, pp. 357–370.



- Lightfoot D. R. 2000. The Origin and Diffusion of Qanats in Arabia: New Evidence from the Northern and Southern Peninsula. *The Geographical Journal* 166(3):215–226.
- Malacrino, C.G. 2010. *Constructing the Ancient World: Architectural Techniques of the Greeks and Romans*. Getty Publications, Los Angeles, CA.
- Margat, J. and Van der Gun, J. 2013. *Groundwater Around the World: A Geographic Synopsis*. CRC Press, Taylor & Francis Group, Boca Raton, FL, pp. 343.
- Martínez-Santos, P. and Martínez-Alfaro, P. E. 2014. A Priori Mapping of Historical Water-Supply Galleries based on Archive Records and Sparse Material Remains. An Application to the Amanuel Qanat (Madrid, Spain). *Cultural Heritage* DOI: 10.1016/j.culher.2013.12.003.
- Mays, L. W., D Koutsoyiannis, D., and Angelakis, A. N. 2007. A Brief History of Water in Antiquity. *Water Science and Technology: Water Supply* 7(1):1–12.
- Megdiche-Kharrat, F. and Moussa M. 2014. The Qanat as a Crucial Antique Water Acquisition System Common to Arid Zones' Communities: Two case Studies, Foggaras in Tunisia and Aflaj in Oman. *The International Journal Research Publications, Singapore (TIJRP)—Research Journal of Social Science & Management—RJSSM* 3(12) Issued on April 1st, 2014.
- MRMWR (Ministry of Regional Municipalities and Water Resources). 2008. *Aflaj Oman in the World Heritage List*. MRMWR, Muscat, Oman.
- MRMWR (Ministry of Regional Municipalities and Water Resources). 2009. *Experimental Project for Archiving Ownerships and Norms and Sunan and Data Related to Aflaj*. MRMWR, Muscat, Oman.
- MRMWR (Ministry of Regional Municipalities and Water Resources). 2012. Website Which Provides a Wide Range of Information on Water Resources in Oman and Delivers Annual Reports Implemented with Statistics. <http://www.mrmwr.gov.om/en/>.
- Palstrøm, A. 2009. *Sub-Sea Tunnels and Lake Taps in Norway—A Short Overview*. In: *Subsea Tunnels*, Publication No. 18, Norwegian Tunneling Society, Oslo Norway.
- Poupart, J-M. 1949. Les problèmes de l'eau a Marrakech. *Les Cahiers d'Outre-Mer* 2:38–53.
- Salih, Abdin. 2006. Qanats a Unique Groundwater Management Tool in Arid Regions: The Case of Bam Region in Iran. In: *International Symposium on Ground Water Sustainability (ISGWAS), Alicante, Spain*, pp. 79–87.
- Schacht, I. 2003. A Preliminary Survey of the Ancient Qanat Systems of the Northern Kharga Oasis. In: *Mitteilungen des Deutschen Archaologischen Instituts*. The American University, Kairo, Egypt, pp. 279–306.
- Semsar Yazdi, A. A. and Khaneiki, M. L. 2013. *Veins of Desert: A Review of the Technologies of Qanat/Falaj/Karez*. Iran Water Resources management Company, Teheran, Iran.
- Sokol, N., Kim, T., Pannuti, C., and Herrick, W. 2007. Rehabilitation of a Brick-lined Aqueduct. In: *Proceedings Rapid Excavation and Tunneling Conference* (M. T. Traylor and J. W. Townsend, Eds.). SME, Toronto, Canada.
- Tassios, Th. 2004. The Tunnels of Ancient Greeks, *TO VIMA* (Athens Newspaper), December 12, 2004 (in Hellenic).
- Tsatsanifos, C. and Michalis, I. 2014. Tunnelling in Hellas: Past, Present, Future. In: *Proceedings of 2nd Eastern European Tunnelling Conference “Tunnelling in a Challenging Environment” Making Tunnelling Business in Difficult Times*, Athens, Hellas, September 28–October 01, 2014.
- U.S. National Committee on Tunneling Technology. 1989. Micro- and Small-Diameter Tunneling: The U.S Perspective. *A Report of Tunneling and Underground Space Technology* 4(2):193–199.
- Vavliakis, E. 1989. *The Qanat systems in Hellas: A Study of Qanat Systems in Phyllida of Serres From Morphological, Hydrographic and Socio-Economical View*. Department of Geology, Aristotle University of Thessaloniki, Thessaloniki, Hellas, p. 93 (in Hellenic).
- Vavliakis, E. and Sotiriadis, L. 1993. Die aktiven Qanatsysteme in Griechenland. Untersuchung der aktiven Qanatsysteme in der Provinz Phyllis (Nomos Serres) aus morphologischer und hydrographischer Sicht. W.Kern, E. Stocker, H. Weingartner (Hrsg), Festschrift Helmut Riedl (= Salzburger Geographische Arbeiten, 25), pp. 193–205.
- Voudouris, K., Christodoulakos, Y., Stiakakis, M., and Angelakis, A. N. 2013. Hydrogeological Characteristics of Hellenic Aqueducts-like Qanats. *Water* 5:1326–1345.
- Voudouris, K., Tsatsanifos, C., Yannopoulos, S., and Angelakis, A. N. 2015. Evolution of Underground Aqueducts in Hellas through the Centuries. In: *Proceedings of 2nd IWA International Workshop on Evolution of Qanats and Relevant Hydraulic Technologies* (A. A. Semsar Yazdi and A. R. Bahri, Eds.). November 08–10, 2015, Yazd, Iran, pp. 89–110.

- Weingartner H. 2007. Water Supply by Qanats: A Contribution to Water Shortage in Mediterranean Areas. In: *Proceedings of the 10th International Conference on Environmental Science and Technology*, Kos Island, Hellas, September 5–7, 2007, pp. 1555–1561.
- Weingartner, H. 2008. Wasserknappheit im Mittelmeerraum. Können Qanate zu einer nachhaltigen Wasserversorgung beitragen? In: *Ein Beispiel aus Ostmazedonien (Griechenland)*. (O. Blumenstein, W. Krüger, and H. Schachtzabel Hrsg.). Arbeiten der AG Landschaft und Nachhaltige Entwicklung der Universität Salzburg (= Stoffdynamik in Geosystemen, Bd. 14), Selbstverlag der Arbeitsgruppe Stoffdynamik in Geosystemen, Potsdam, Germany, pp. 49–66.
- Weingartner, H. 2012. Qanats—A Circum Mediterranean Perspective. In: *Water—Contributions to Sustainable Supply and Use* (=Landscape and Sustainable Development/Landschaft und Nachhaltige Entwicklung, Bd. IV), (H. Weingartner, O. Blumenstein und M. Vavelidis, Hrsg.). Arbeitsgruppe Landschaft und Nachhaltige Entwicklung, Salzburg, Austriapp. 1–14.
- Wessels J. 2003. Qanats in Syria Ease the Water Shortage. *Waterlines* 22(2):8–10.
- Wessels, J. I. 2005a. What Is the Future for Ancient Water Tunnels in the Middle East? *Arid Lands Newsletter*, No. 57, May/June 2005, University of Arizona, Tucson, AZ.
- Wessels, J. I. 2005b. Criteria for Renovating and Using Ancient Qanats in Syria-Case Studies. In: *Proceedings of the International Frontinus Symposium* October 2–5, 2003, Walferdange, Luxemburg, pp. 249–262.
- Wessels, J. I. 2008a. To Cooperate or Not to Cooperate? Collective Action for Rehabilitation of Traditional Water Tunnel Systems (Qanats) in Syria. PhD Thesis. Vossius Press, Amsterdam, the Netherlands.
- Wessels, J. I. 2008b. Assessment of Three Collective Renovations of Traditional Qanat Systems in Syria. In: *What Makes Traditional Technologies Tick? A Review of Traditional Approaches for Water Management in Drylands* (Z. Adeel, B. Schuster, and H. Bigas, Eds.). United Nations University International Network on Water, Environment and Health (UNU-INWEH), Toronto, Canada, pp. 11–20.
- Wessels, J. I. 2012. Groundwater and Qanats in Syria; Leadership, Ownership and Abandonment. In: *Water, Cultural Diversity, and Global Environmental Change: Emerging Trends, Sustainable Futures?* (B. R. Johnston et al., Ed.). United Nations Educational and Scientific Organisation-International Hydrological Programme. Springer, New York, pp. 149–163.
- Westfall, D. E. 1996. Water Conveyance Tunnels. In: *Tunnel Engineering Handbook* (J. O. Bickel, T. R. Kuesel, and E. H. King, Eds.). Chapman & Hall, New York.
- Wilson, A. 2003. Foggara Irrigation and Early State Formation in the Libyan Sahara. In: *Internatio-Nales Frontinus-Symposium “Wasserversorgung aus Qanaten—Qanate als Vorbilder im Tunnelbau”*, 2.-5. Okt. 2003, Walferdange, Luxemburg (=Schriftenreihe der Frontinus-Gesellschaft, H. 26), pp. 223–234.
- Wulff H. E. 1968. The Qanats of Iran. *Scientific American*, April 1968, pp. 94–105. <http://users.bart.nl/~leenders/txt/qanats.html> (accessed on October 10, 2011).
- Xenos, D., Passios, I., Georgiades, S., Parliss, E., and Koutsoyiannis, D. 2002. Water demand management and the Athens water supply. In: *Proceedings of the 7th BNAWQ Scientific and Practical Conference “Water Quality Technologies and Management in Bulgaria”*, Bulgarian National Association on Water Quality, Sofia, Bulgaria, pp. 44–45.



# Taylor & Francis

Taylor & Francis Group

<http://taylorandfrancis.com>